

<b>Pictorial index</b>	Search by illustration	
<b>For safety and security</b>	Make sure to read through them (Main topics: Child seat, theft deterrent system)	1
<b>Vehicle status information and indicators</b>	Reading driving-related information (Main topics: Meters, multi-information display)	2
<b>Before driving</b>	Opening and closing the doors and windows, adjustment before driving (Main topics: Keys, doors, seats)	3
<b>Driving</b>	Operations and advice which are necessary for driving (Main topics: Starting engine system, refueling)	4
<b>Interior features</b>	Usage of the interior features (Main topics: Air conditioner, storage features)	5
<b>Maintenance and care</b>	Caring for your vehicle and maintenance procedures (Main topics: Interior and exterior, light bulbs)	6
<b>When trouble arises</b>	What to do in case of malfunction and emergency (Main topics: Battery discharge, flat tire)	7
<b>Vehicle specifications</b>	Vehicle specifications, customizable features (Main topics: Fuel, oil, tire inflation pressure)	8
<b>For owners</b>	Reporting safety defects for U.S. owners, seat belt, SRS airbag and headlight aim instructions for Canadian owners	9
<b>Index</b>	Search by symptom	
	Search alphabetically	

For your information .....	6
Reading this manual.....	13
How to search.....	14
Pictorial index .....	15

## 1 For safety and security

<b>1-1. For safe use</b>	
Before driving.....	28
For safe driving .....	29
Seat belts .....	31
SRS airbags .....	37
Front passenger occupant clas- sification system.....	44
Exhaust gas precautions.....	49
<b>1-2. Child safety</b>	
Riding with children.....	50
Child restraint systems.....	51
<b>1-3. Emergency assistance</b>	
Safety Connect .....	68
<b>1-4. Theft deterrent system</b>	
Engine immobilizer system ...	72
Alarm.....	73

## 2 Vehicle status information and indicators

<b>2-1. Instrument cluster</b>	
Warning lights and indicators .....	76
Gauges and meters (7-inch dis- play) .....	81
Gauges and meters (12.3-inch display).....	84
Multi-information display (7-inch display).....	89
Multi-information display (12.3-inch display).....	95
Head-up display .....	102
Fuel consumption information .....	106

## 3 Before driving

<b>3-1. Key information</b>	
Keys .....	110
Digital Key.....	113
<b>3-2. Opening, closing and locking the doors</b>	
Side doors.....	115
Power back door .....	119
Smart key system .....	136
<b>3-3. Adjusting the seats</b>	
Front seats .....	141
Rear seats.....	142
Head restraints.....	147
<b>3-4. Adjusting the steering wheel and mirrors</b>	
Steering wheel .....	150
Inside rear view mirror .....	151
Digital Rear-view Mirror .....	152
Outside rear view mirrors...	161
<b>3-5. Opening, closing the win- dows and moon roof</b>	
Power windows .....	164
Panoramic moon roof.....	167
<b>3-6. Favorite settings</b>	
Driving position memory ....	171
My Settings .....	175

## 4 Driving

<b>4-1. Before driving</b>	
Driving the vehicle.....	179
Cargo and luggage .....	186
Vehicle load limits .....	189
Trailer towing (vehicles without towing package).....	190
Trailer towing (vehicles with tow- ing package) .....	191
Dinghy towing .....	201

**4-2. Driving procedures**  
 Engine (ignition) switch ..... 203  
 Automatic transmission ..... 207  
 Turn signal lever..... 211  
 Parking brake ..... 212  
 Brake Hold ..... 216

**4-3. Operating the lights and wipers**  
 Headlight switch ..... 218  
 AHB (Automatic High Beam) ..... 220  
 Fog light switch ..... 223  
 Windshield wipers and washer ..... 224  
 Rear window wiper and washer ..... 229

**4-4. Refueling**  
 Opening the fuel tank cap .. 231

**4-5. Using the driving support systems**  
 Toyota Safety Sense 3.0 software update ..... 233  
 Toyota Safety Sense 3.0 .... 235  
 Driver monitor..... 243  
 PCS (Pre-Collision System) ..... 245  
 LTA (Lane Tracing Assist)... 257  
 LCA (Lane Change Assist) ..... 262  
 LDA (Lane Departure Alert) ..... 265  
 PDA (Proactive driving assist) ..... 271  
 FCTA (Front Cross Traffic Alert) ..... 277  
 RSA (Road Sign Assist) .... 280  
 Dynamic radar cruise control ..... 282  
 Cruise control..... 294  
 Emergency Driving Stop System ..... 298  
 Traffic Jam Assist ..... 301

Stop & Start system ..... 307  
 BSM (Blind Spot Monitor) .. 313  
 Safe Exit Assist ..... 318  
 Intuitive parking assist..... 322  
 RCTA (Rear Cross Traffic Alert) function ..... 328  
 RCD (Rear Camera Detection) ..... 334  
 PKSB (Parking Support Brake) ..... 338  
 Parking Support Brake function (static objects front and rear of the vehicle) ..... 342  
 Parking Support Brake function (moving vehicles rear of the vehicle) ..... 345  
 Parking Support Brake function (pedestrians rear of the vehicle) ..... 346  
 Driving mode select switch ..... 348  
 Multi-terrain Select ..... 349  
 Snow mode switch ..... 352  
 Downhill assist control system ..... 352  
 Driving assist systems ..... 354

**4-6. Driving tips**  
 Winter driving tips ..... 360  
 Utility vehicle precautions .. 363

**5 Interior features**

**5-1. Using the air conditioning system and defogger**  
 Front automatic air conditioning system ..... 368  
 Rear automatic air conditioning system ..... 377  
 Heated steering wheel/seat heaters/seat ventilators.... 381

**5-2. Using the interior lights**  
 Interior lights list ..... 384

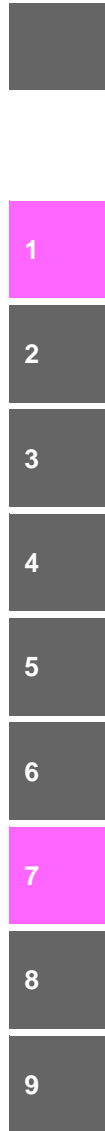

- 5-3. Using the storage features**
  - List of storage features ..... 387
  - Luggage compartment features  
..... 393
- 5-4. Using the other interior features**
  - Other interior features ..... 397
  - Garage door opener..... 411

## 6 Maintenance and care

- 6-1. Maintenance and care**
  - Cleaning and protecting the vehicle exterior..... 420
  - Cleaning and protecting the vehicle interior..... 423
- 6-2. Maintenance**
  - Maintenance requirements  
..... 426
  - General maintenance..... 427
  - Emission inspection and maintenance (I/M) programs..... 430
- 6-3. Do-it-yourself maintenance**
  - Do-it-yourself service precautions ..... 431
  - Hood ..... 433
  - Positioning a floor jack ..... 434
  - Engine compartment..... 435
  - Tires ..... 443
  - Tire inflation pressure..... 455
  - Wheels ..... 457
  - Air conditioning filter..... 459
  - Electronic key battery..... 460
  - Checking and replacing fuses  
..... 462
  - Headlight aim ..... 465
  - Light bulbs..... 466

## 7 When trouble arises

- 7-1. Essential information**
  - Emergency flashers ..... 470
  - If your vehicle has to be stopped in an emergency ..... 470
  - If the vehicle is submerged or water on the road is rising  
..... 471
- 7-2. Steps to take in an emergency**
  - If your vehicle needs to be towed  
..... 473
  - If you think something is wrong  
..... 475
  - Fuel pump shut off system  
..... 476
  - If a warning light turns on or a warning buzzer sounds .... 477
  - If a warning message is displayed ..... 488
  - If you have a flat tire..... 495
  - If the engine will not start ... 503
  - If you lose your keys ..... 505
  - If the fuel filler door cannot be opened..... 505
  - If the electronic key does not operate properly..... 506
  - If the vehicle battery is discharged..... 508
  - If your vehicle overheats .... 512
  - If the vehicle becomes stuck  
..... 514

## 8 Vehicle specifications

- 8-1. Specifications**
  - Maintenance data (fuel, oil level, etc.)..... 518
  - Fuel information ..... 526
  - Tire information ..... 528

<b>8-2. Customization</b>	
Customizable features ..... 538	
<b>8-3. Initialization</b>	
Items to initialize..... 552	
<b>9 For owners</b>	
<b>9-1. For owners</b>	1
Reporting safety defects for U.S. owners ..... 554	2
Reporting safety defects for Canadian owners ..... 554	3
Seat belt instructions for Canadian owners (in French) ... 555	4
SRS airbag instructions for Canadian owners (in French) ..... 556	5
Headlight aim instructions for Canadian owners (in French) ..... 562	6
<b>Index</b>	
What to do if... (Troubleshooting) ..... 564	7
Alphabetical Index..... 567	8
	9

## For your information

### Main Owner's Manual

Please note that this manual applies to all models and explains all equipment, including options. Therefore, you may find explanations for equipment not installed on your vehicle and the illustrations used may differ from your vehicle.

All specifications provided in this manual are current at the time of printing. Over time, your vehicle may receive updates that modify the vehicle and make material in this manual incomplete and/or inaccurate. Because of Toyota's interest in continual product improvement, Toyota reserves the right to make changes to this manual at any time without notice.

If Toyota chooses to update the manual, updated versions can be viewed by selecting your vehicle by model and year at the following URL or on your mobile device if you have access to the Toyota app.

[www.toyota.com/owners](http://www.toyota.com/owners)

### Noise from under vehicle after turning off the engine

Approximately five hours after the engine is turned off, you may hear sound coming from

under the vehicle for several minutes. This is the sound of a fuel evaporation leakage check and, it does not indicate a malfunction.

### Accessories, spare parts and modification of your Toyota

A wide variety of non-genuine spare parts and accessories for Toyota vehicles are currently available in the market. You should know that Toyota does not warrant these products and is not responsible for their performance, repair, or replacement, or for any damage they may cause to, or adverse effect they may have on, your Toyota vehicle.

This vehicle should not be modified with non-genuine Toyota products. Modification with non-genuine Toyota products could affect its performance, safety or durability, and may even violate governmental regulations. In addition, damage or performance problems resulting from the modification may not be covered under warranty.

Also, remodeling like this will have an effect on advanced safety equipment such as Toyota Safety Sense 3.0 and there is a danger that it will not work properly or the danger that it

may work in situations where it should not be working.

### Cyber Attack Risk

Installing electronic devices and radios increases the risk of cyber attacks through the installed parts, which may lead to unexpected accidents and leakage of personal information.

Toyota does not make any guarantees for problems caused by installing non-genuine Toyota products.

### Installation of a mobile two-way radio system

The installation of a mobile two-way radio system in your vehicle could affect electronic systems such as:

- Multiport fuel injection system/sequential multiport fuel injection system
- Toyota Safety Sense 3.0
- Anti-lock brake system
- SRS airbag system
- Seat belt pretensioner system

Be sure to check with your Toyota dealer for precautionary measures or special instructions regarding installation of a mobile two-way radio system.

### Vehicle data recording

This vehicle is equipped with sophisticated computers that record certain data regarding vehicle controls and operations.

#### ■ Data recorded by the computers\*1

\*1: The recorded data varies according to the vehicle grade level and options with which it is equipped.

Certain data, such as the following, is recorded depending on the operation timing and status of each function.

- Basic vehicle behavior related data (engine speed, accelerator/brake pedal operation, vehicle speed, etc.)
- Operating state of the driving support systems (recorded during system operation, includes basic vehicle behavior related data)
- Driving support system sensor data
- Image data (images from the front, rear, vehicle periphery, and driver monitor cameras)\*2

\*2: The vehicle has multiple cameras. For details on from which cameras images are recorded, contact your Toyota dealer.

#### ● Location information

These computers do not record conversations, sounds, or images of the inside of the vehicle.

Also, personal information which may be used to identify the owner of the vehicle (name, gender, age, etc.) is not recorded.

■ **Usage of recorded data and personal information by the Toyota Safety Sense 3.0**

The operating state of each system, data from each sensor, image data (images from the front/rear cameras), and position information is recorded by the Toyota Safety Sense 3.0 in the following situations. Toyota obtains this information when the vehicle is brought to the dealership or when sent to the Toyota servers.

- In certain collisions or collision-like situations
- When driving on roads with certain traffic situations, such as congestion, poor road surfaces, poor weather, etc.
- When driving on certain roads, such as roads which were recently opened or extended
- After the engine is started, for a certain amount of time

To learn more about the vehicle data collected, used and shared by Toyota, please visit [www.toyota.com/privacyvts/](http://www.toyota.com/privacyvts/).

■ **Data provision and use purpose by third parties**

Data recorded by the computers may be used for collision analy-

sis, malfunction diagnosis, automated driving, advanced safety and map related technologies (technology, product development, product improvement, etc.) and products and services which use data (maps used for automated driving and advanced safety technologies, driving condition analysis, analysis of the driving environment, such as road infrastructure, traffic condition communication, etc. Herein referred to as “individual services”.) Also, this data may be used for customer support related to a collision, collision analysis or resolution.

In situations such as the following, Toyota may disclose the recorded data to a third party:

- When the consent of the vehicle owner (or the lessee if the vehicle is leased) has been given
- When officially requested by the police, a court of law or a government agency
- When it is to be used by Toyota in a lawsuit
- When data is to be used research purposes after processing so that the data is not tied to a specific vehicle or vehicle owner

In addition to the above, Toyota may disclose the data recorded by the Toyota Safety Sense 3.0 to a third party in the following situations:



- When separate consent of the vehicle owner (or the lessee if the vehicle is leased) has been given. This includes situations when the user subscribes to an individual service which is provided by a second party and uses vehicle recorded data, where the provider has obtained the user's consent for providing data to a third-party
- When providing data to a company involved in autonomous driving software, etc. for the purpose of research and development (technology, product development, product improvement, etc.) of automated driving, advanced safety and map related technologies
- When providing image data and position information to a company involved in map creation, etc. for the purpose of research and development map related technologies
- When providing image data and position information to a local government for the purpose of road maintenance, etc.
- When providing processed image data and position information to traffic condition communication individual services
- When providing image data

from near a fire, or other area that emergency services are dispatched, to the fire department of a local government which has entered a separate contract with Toyota

Image information recorded by the vehicle can be erased by your Toyota dealer.

The image recording function can be disabled. However, if the function is disabled, data from when systems operate will not be available.

If you wish to stop the collection of Toyota Safety Sense 3.0 data by the Toyota servers for the purpose of research and development and provision to individual services, contact your Toyota dealer.

#### **Statement on Warranty Coverage for Aftermarket and Recycled Parts (For U.S. Owners)**

The Magnuson-Moss Warranty Act, 15 U.S.C. s.2301 et seq., makes it illegal for motor vehicle manufacturers to void a motor vehicle warranty or deny warranty coverage solely because an aftermarket or recycled part has been used to repair the vehicle or someone other than the authorized service provider performed service on the vehicle. This provision does not apply to a new motor vehicle purchased solely for commercial or industrial use.

Under federal law, a manufac-

turer may deny warranty coverage and charge for repairs to a vehicle if it is discovered that an aftermarket or recycled part installed on the vehicle is defective or was installed incorrectly and caused damage to another part of the vehicle otherwise covered under warranty. The Federal Trade Commission requires that a manufacturer demonstrate that an aftermarket or recycled part or service performed by a person other than an authorized service provider caused damage to another part of the vehicle otherwise covered under warranty before denying warranty coverage. Additionally, federal law allows a manufacturer to void a motor vehicle warranty or deny warranty coverage if the manufacturer provides the article or service to consumers free of charge under the warranty or the manufacturer has secured a waiver from the Federal Trade Commission.

### **Event data recorder**

This vehicle is equipped with an event data recorder (EDR). The main purpose of an EDR is to record, in certain crash or near crash-like situations, such as an air bag deployment or hitting a road obstacle, data that will assist in understanding how a

vehicle's systems performed. The EDR is designed to record data related to vehicle dynamics and safety systems for a short period of time, typically 30 seconds or less.

The EDR in this vehicle is designed to record such data as:

- How various systems in your vehicle were operating;
- Whether or not the driver and passenger safety belts were buckled/fastened;
- How far (if at all) the driver was depressing the accelerator and/or brake pedal; and,
- How fast the vehicle was traveling.

These data can help provide a better understanding of the circumstances in which crashes and injuries occur.

NOTE: EDR data are recorded by your vehicle only if a non-trivial crash situation occurs; no data are recorded by the EDR under normal driving conditions and no personal data (e.g., name, gender, age, and crash location) are recorded. However, other parties, such as law enforcement, could combine the EDR data with the type of personally identifying data routinely acquired during a crash investigation.

To read data recorded by an EDR, special equipment is

required, and access to the vehicle or the EDR is needed. In addition to the vehicle manufacturer, other parties, such as law enforcement, that have the special equipment, can read the information if they have access to the vehicle or the EDR.

- **Disclosure of the EDR data**

Toyota will not disclose the data recorded in an EDR to a third party except when:

- An agreement from the vehicle's owner (or the lessee for a leased vehicle) is obtained
- In response to an official request by the police, a court of law or a government agency
- For use by Toyota in a lawsuit

However, if necessary, Toyota may:

- Use the data for research on vehicle safety performance
- Disclose the data to a third party for research purposes without disclosing information about the specific vehicle or vehicle owner

### **Scrapping of your Toyota**

The SRS airbag and seat belt pretensioner devices in your Toyota contain explosive chemicals. If the vehicle is scrapped with the airbags and seat belt pretensioners left as they are, this may cause an accident such as fire. Be sure to have the systems of the SRS airbag and seat belt pretensioner removed and disposed of by a qualified ser-

vice shop or by your Toyota dealer before you scrap your vehicle.

### **Perchlorate Material**

Special handling may apply, See [www.dtsc.ca.gov/hazardouswaste/perchlorate](http://www.dtsc.ca.gov/hazardouswaste/perchlorate).

Your vehicle has components that may contain perchlorate. These components may include the airbags, seat belt pretensioners, wireless remote control batteries, and the batteries in the tire pressure warning valve and transmitters.

### **“QR Code”**

The word “QR Code” is registered trademark of DENSO WAVE INCORPORATED in Japan and other countries.

**WARNING****■ General precautions while driving**

Driving under the influence: Never drive your vehicle when under the influence of alcohol or drugs that have impaired your ability to operate your vehicle. Alcohol and certain drugs delay reaction time, impair judgment and reduce coordination, which could lead to an accident that could result in death or serious injury.

Defensive driving: Always drive defensively. Anticipate mistakes that other drivers or pedestrians might make and be ready to avoid accidents.

Driver distraction: Always give your full attention to driving. Anything that distracts the driver, such as adjusting controls, talking on a cellular phone or reading can result in a collision with resulting death or serious injury to you, your occupants or others.

**■ General precaution regarding children's safety**



Never leave children unattended in the vehicle, and never allow children to have or use the key.



Children may be able to start the vehicle or shift the vehicle into neutral. There is also a danger that children may injure themselves by playing with the windows, the moon roof or panoramic moon roof, or other features of the vehicle. In addition, heat build-up or extremely cold temperatures inside the vehicle can be fatal to children.

**Reading this manual**



**Explains symbols used in this manual.**

**Symbols in this manual**

Symbols	Meanings
	<b>WARNING:</b> Explains something that, if not obeyed, could cause death or serious injury to people.
	<b>NOTICE:</b> Explains something that, if not obeyed, could cause damage to or a malfunction in the vehicle or its equipment.
1 2 3...	Indicates operating or working procedures. Follow the steps in numerical order.

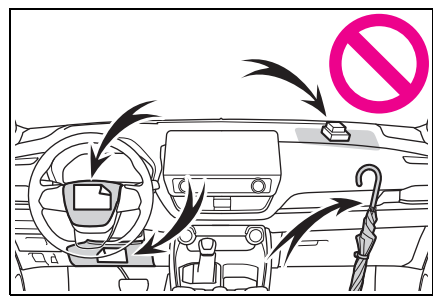
Symbols	Meanings
	Indicates the action (pushing, turning, etc.) used to operate switches and other devices.
	Indicates the outcome of an operation (e.g. a lid opens).



Symbols	Meanings
	Indicates the component or position being explained.
	Means <b>Do not, Do not do this, or Do not let this happen.</b>

**Symbols in illustrations**

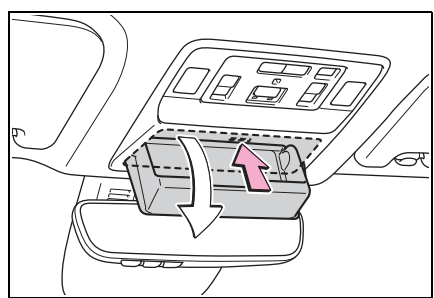

## How to search

### ■ Searching by name

- Alphabetical index: →P.567

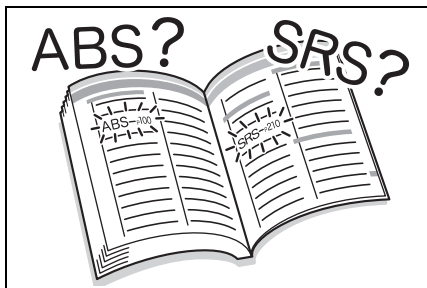

### ■ Searching by installation position

- Pictorial index: →P.15

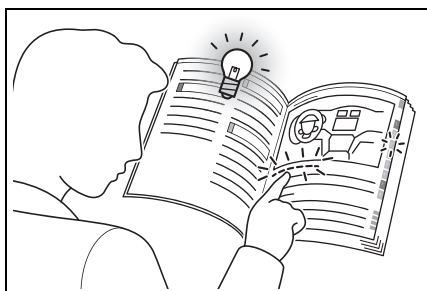

### ■ Searching by symptom or sound

- What to do if... (Troubleshooting): →P.564

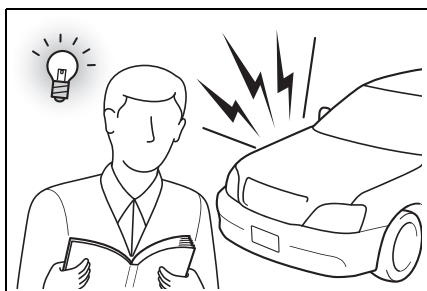

### ■ Searching by title

- Table of contents: →P.2

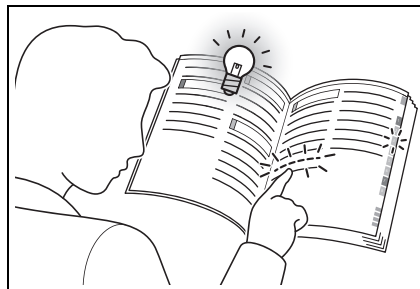

Pictorial index

■ Exterior

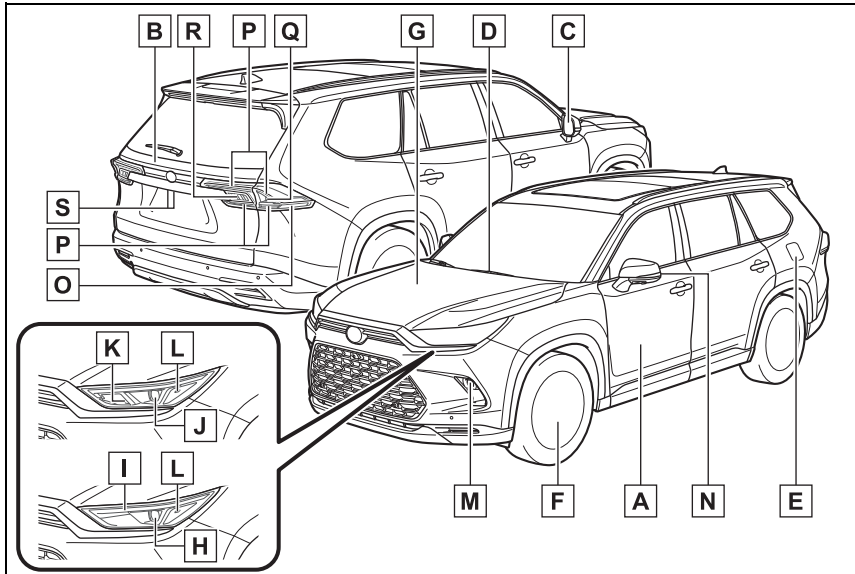

The shape of the lights may differ depending on the grade, etc.

<b>A</b>	<b>Side doors</b> .....	<b>P.115</b>
	Locking/unlocking .....	P.115
	Opening/closing the side windows.....	P.164
	Locking/unlocking by using the mechanical key .....	P.506
	Warning messages .....	P.488
<b>B</b>	<b>Back door</b> .....	<b>P.119</b>
	Opening from inside the cabin .....	P.122
	Opening from outside.....	P.122
	Warning messages .....	P.488
<b>C</b>	<b>Outside rear view mirrors</b> .....	<b>P.161</b>
	Adjusting the mirror angle .....	P.161
	Folding the mirrors .....	P.162
	Driving position memory* .....	P.171
	Defogging the mirrors .....	P.370
<b>D</b>	<b>Windshield wipers</b> .....	<b>P.224</b>

Precautions for winter season..... P.360  
 To prevent freezing (windshield wiper de-icer)..... P.370  
 Precautions for car wash \* ..... P.421

**E Fuel filler door ..... P.231**  
 Refueling method ..... P.231  
 Fuel type/fuel tank capacity ..... P.519

**F Tires..... P.443**  
 Tire size/inflation pressure ..... P.443, 524  
 Winter tires/tire chains ..... P.360  
 Checking/rotation/tire pressure warning system ..... P.443  
 Coping with flat tires..... P.495

**G Hood..... P.433**  
 Opening ..... P.433  
 Engine oil ..... P.520  
 Coping with overheating ..... P.512  
 Warning messages ..... P.488

**Light bulbs of the exterior lights for driving**

(Replacing method: P.466, Watts: P.525)

**H Headlights..... P.218**

**I Parking lights/daytime running lights/front turn signal lights  
 P.211, 218**

**J Headlights/daytime running lights ..... P.218**

**K Parking lights/front turn signal lights ..... P.211, 218**

**L Front side marker lights ..... P.218**

**M Front fog lights\* ..... P.223**

**N Side turn signal lights ..... P.211**

**O Rear side marker lights ..... P.218**

**P Tail lights..... P.218**

**Q Stop lights/rear turn signal lights..... P.211, 218**

**R Back-up lights**



Shifting the shift position to R ..... P.208

**S** License plate lights..... P.218

\* : If equipped

■ Instrument panel

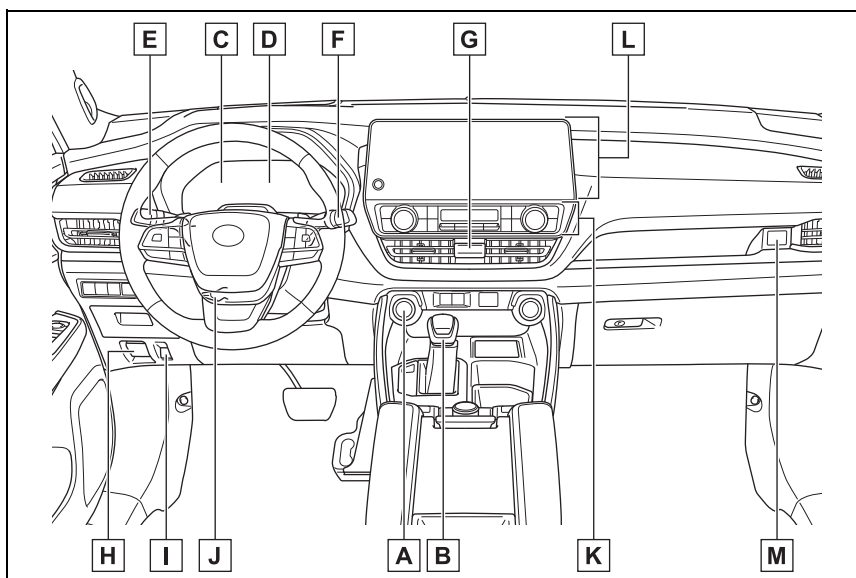

- A Engine switch ..... P.203**
  - Starting the engine/changing the modes ..... P.203
  - Emergency stop of the engine ..... P.470
  - When the engine will not start ..... P.503
  - Warning messages ..... P.488
- B Shift lever ..... P.207**
  - Shifting the shift position ..... P.208
  - Precautions for towing ..... P.473
  - When the shift lever does not move ..... P.209
- C Meters ..... P.81, 84**
  - Reading the meters/adjusting the instrument panel light . P.81, 84
  - Warning lights/indicator lights ..... P.76
  - When a warning light turns on ..... P.477
- D Multi-information display ..... P.89, 95**
  - Display ..... P.89, 84
  - When the warning messages are displayed ..... P.488

<b>E</b>	<b>Turn signal lever</b> .....	<b>P.211</b>
	<b>Headlight switch</b> .....	<b>P.218</b>
	Headlights/parking lights/tail lights/side marker lights/license plate lights/daytime running lights.....	P.218
	Front fog lights <sup>*1</sup> .....	P.223
<b>F</b>	<b>Windshield wiper and washer switch</b> .....	<b>P.224, 229</b>
	Usage.....	P.224, 229
	Adding washer fluid.....	P.442
	Warning messages .....	P.488
<b>G</b>	<b>Emergency flasher switch</b> .....	<b>P.470</b>
<b>H</b>	<b>Hood lock release lever</b> .....	<b>P.433</b>
<b>I</b>	<b>Fuel filler door opener switch</b> .....	<b>P.231</b>
<b>J</b>	<b>Tilt and telescopic steering lock release lever</b> .....	<b>P.150</b>
	Adjustment .....	P.150
<b>K</b>	<b>Air conditioning system</b> .....	<b>P.368</b>
	Usage.....	P.368
	Rear window defogger .....	P.370
	Windshield wiper de-icer .....	P.370
<b>L</b>	<b>Audio system</b> <sup>*2</sup>	
<b>M</b>	<b>USB charging ports</b> .....	<b>P.397</b>

<sup>\*1</sup>: If equipped

<sup>\*2</sup>: Refer to the "MULTIMEDIA OWNER'S MANUAL".

■ Switches

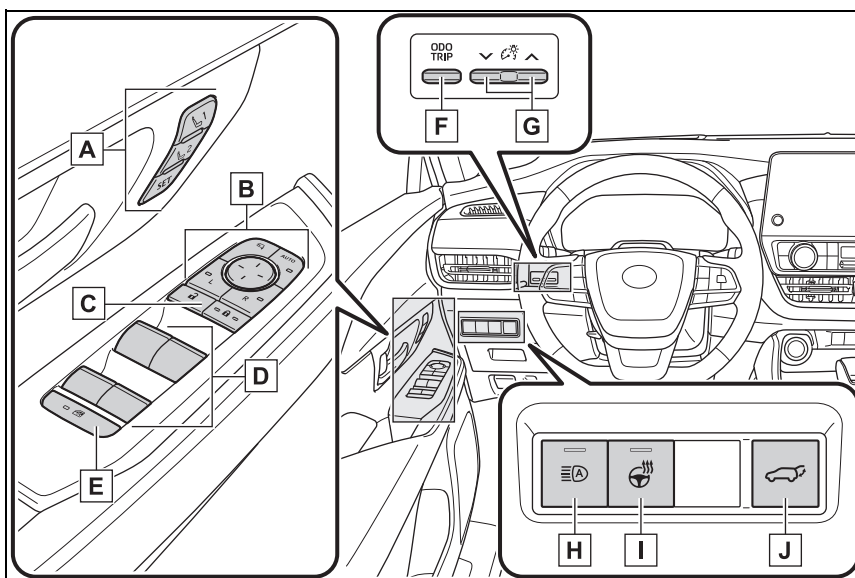

- A** Driving position memory switches \* ..... P.171
- B** Outside rear view mirror switches ..... P.161
- C** Door lock switches ..... P.118
- D** Power window switches ..... P.164
- E** Window lock switch ..... P.166
- F** “ODO TRIP” switch ..... P.82, 87
- G** Instrument panel light control switches ..... P.83, 88
- H** Automatic High Beam switch ..... P.220
- I** Heated steering wheel switch \* ..... P.381
- J** Power back door switch ..... P.122

\*: If equipped

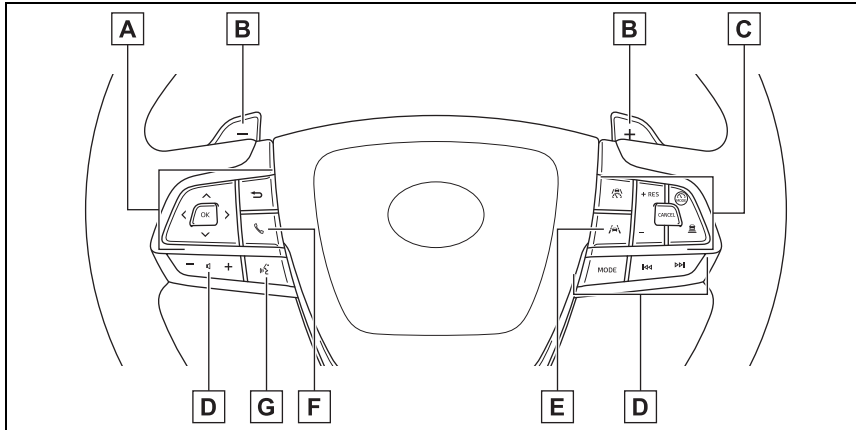

- A** Meter control switches ..... P.90, 95
- B** Paddle shift switches <sup>\*1</sup> ..... P.209
- C** Cruise control switch
  - Dynamic radar cruise control ..... P.282
  - Cruise control ..... P.294
- D** Audio remote control switches <sup>\*2</sup>
- E** LTA (Lane Tracing Assist) switch ..... P.257
- F** Telephone switch <sup>\*2</sup>
- G** Talk switch <sup>\*2</sup>

<sup>\*1</sup>: If equipped

<sup>\*2</sup>: Refer to the "MULTIMEDIA OWNER'S MANUAL".

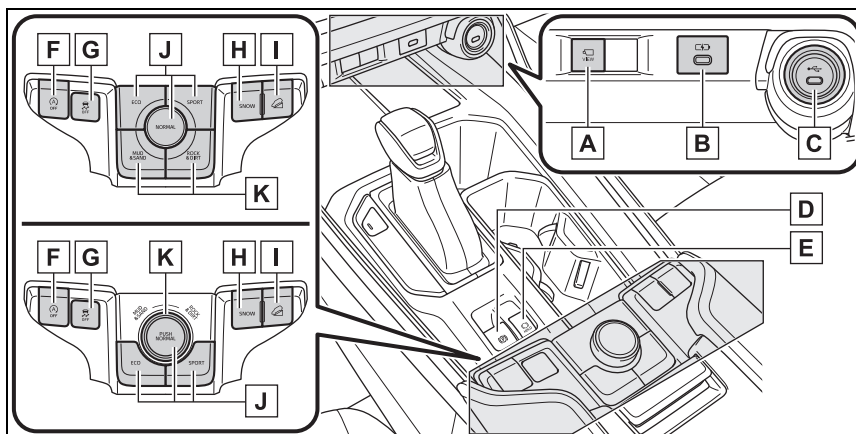

- A** Camera switch<sup>\*1</sup>
- B** USB charging ports ..... P.397
- C** USB port<sup>\*1</sup>
- D** Parking brake switch ..... P.212
  - Applying/releasing..... P.212
  - Precautions for winter season..... P.361
  - Warning buzzer/messages..... P.488
- E** Brake hold switch ..... P.216
- F** Stop & Start cancel switch ..... P.308
- G** VSC OFF switch ..... P.355
- H** Snow mode switch..... P.352
- I** Downhill assist control switch<sup>\*2</sup>..... P.352
- J** Driving mode select switch..... P.348
- K** Multi-terrain Select switch<sup>\*2</sup> ..... P.349

<sup>\*1</sup>: Refer to the "MULTIMEDIA OWNER'S MANUAL".

<sup>\*2</sup>: If equipped

■ Interior

► 7-passenger models

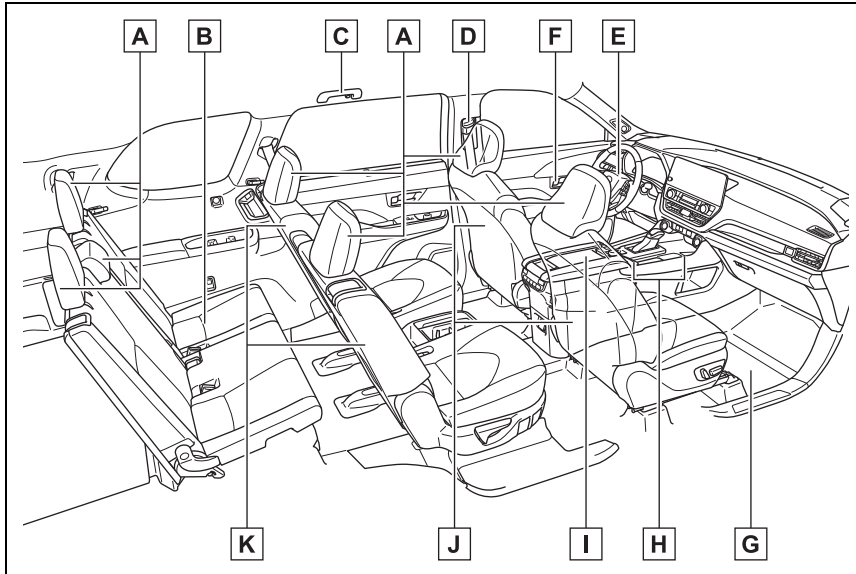

<b>A</b>	<b>Head restraints</b> .....	<b>P.147</b>
<b>B</b>	<b>Third seats</b> .....	<b>P.143</b>
<b>C</b>	<b>Assist grips</b> .....	<b>P.406</b>
<b>D</b>	<b>Seat belts</b> .....	<b>P.31</b>
<b>E</b>	<b>SRS airbags</b> .....	<b>P.37</b>
<b>F</b>	<b>Inside lock buttons</b> .....	<b>P.118</b>
<b>G</b>	<b>Floor mats</b> .....	<b>P.28</b>
<b>H</b>	<b>Cup holders</b> .....	<b>P.389</b>
<b>I</b>	<b>Console box</b> .....	<b>P.388</b>
<b>J</b>	<b>Front seats</b> .....	<b>P.141</b>
<b>K</b>	<b>Second seats</b> .....	<b>P.143</b>

► 8-passenger models

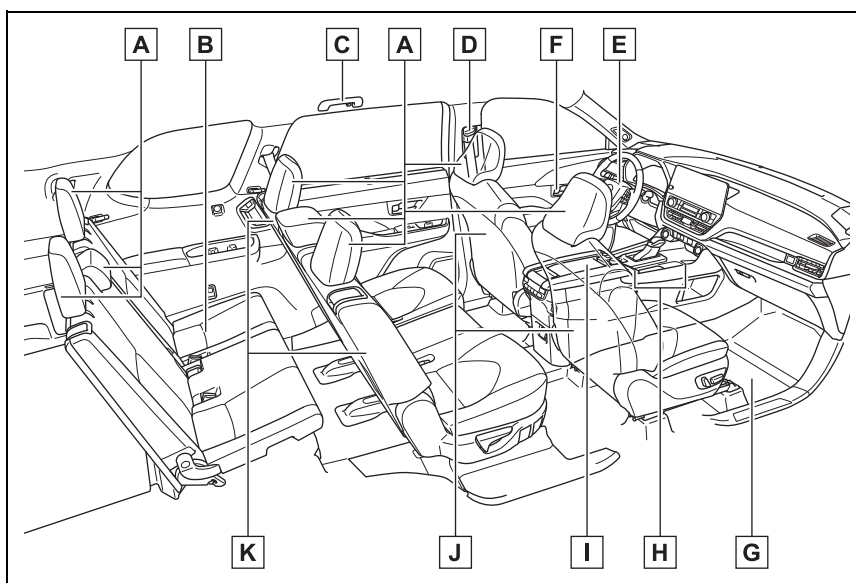

<b>A</b>	<b>Head restraints</b> .....	<b>P.147</b>
<b>B</b>	<b>Third seats</b> .....	<b>P.143</b>
<b>C</b>	<b>Assist grips</b> .....	<b>P.406</b>
<b>D</b>	<b>Seat belts</b> .....	<b>P.31</b>
<b>E</b>	<b>SRS airbags</b> .....	<b>P.37</b>
<b>F</b>	<b>Inside lock buttons</b> .....	<b>P.118</b>
<b>G</b>	<b>Floor mats</b> .....	<b>P.28</b>
<b>H</b>	<b>Cup holders</b> .....	<b>P.389</b>
<b>I</b>	<b>Console box</b> .....	<b>P.388</b>
<b>J</b>	<b>Front seats</b> .....	<b>P.141</b>
<b>K</b>	<b>Second seats</b> .....	<b>P.143</b>



## ■ Ceiling

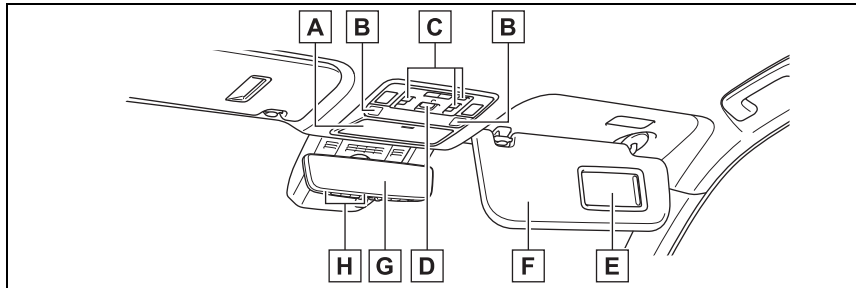

<b>A</b>	<b>Auxiliary box</b> .....	<b>P.390</b>
<b>B</b>	<b>Interior light</b> .....	<b>P.384</b>
	<b>Personal lights</b> <sup>*1</sup> .....	<b>P.385</b>
<b>C</b>	<b>Panoramic moon roof switches</b> <sup>*2</sup> .....	<b>P.167</b>
<b>D</b>	<b>“SOS” button</b> .....	<b>P.68</b>
<b>E</b>	<b>Vanity mirrors</b> .....	<b>P.409</b>
<b>F</b>	<b>Sun visors</b> .....	<b>P.409</b>
<b>G</b>	<b>Inside rear view mirror</b> <sup>*2</sup> .....	<b>P.151</b>
	<b>Digital Rearview Mirror</b> <sup>*2</sup> .....	<b>P.152</b>
<b>H</b>	<b>Garage door opener switches</b> .....	<b>P.411</b>

<sup>\*1</sup>: The illustration shows the front, but they are also equipped in the rear.

<sup>\*2</sup>: If equipped



**For safety and security**

1

**1-1. For safe use**

- Before driving ..... 28
- For safe driving ..... 29
- Seat belts ..... 31
- SRS airbags ..... 37
- Front passenger occupant classification system .... 44
- Exhaust gas precautions ..... 49

**1-2. Child safety**

- Riding with children ..... 50
- Child restraint systems... 51

**1-3. Emergency assistance**

- Safety Connect ..... 68

**1-4. Theft deterrent system**

- Engine immobilizer system ..... 72
- Alarm ..... 73

1

For safety and security

### Before driving

Observe the following before starting off in the vehicle to ensure safety of driving.

### Installing floor mats

Use only floor mats designed specifically for vehicles of the same model and model year as your vehicle. Fix them securely in place onto the carpet.

- 1 Insert the retaining hooks (clips) into the floor mat eyelets.

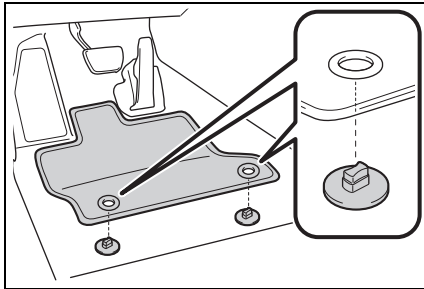

- 2 Turn the upper knob of each retaining hook (clip) to secure the floor mats in place.

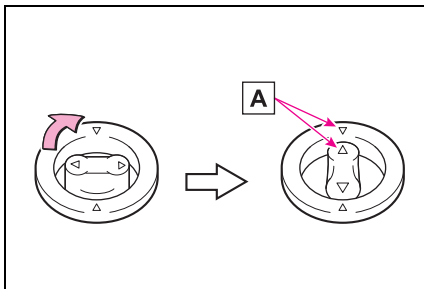

Always align the  $\triangle$  marks **A**.

The shape of the retaining hooks (clips) may differ from that shown in the illustration.

### WARNING

Observe the following precautions. Failure to do so may cause the driver's floor mat to slip, possibly interfering with the pedals while driving. An unexpectedly high speed may result or it may become difficult to stop the vehicle. This could lead to an accident, resulting in death or serious injury.

#### When installing the driver's floor mat

- Do not use floor mats designed for other models or different model year vehicles, even if they are Toyota Genuine floor mats.
- Only use floor mats designed for the driver's seat.
- Always install the floor mat securely using the retaining hooks (clips) provided.
- Do not use two or more floor mats on top of each other.
- Do not place the floor mat bottom-side up or upside-down.

**⚠ WARNING****■ Before driving**

- Check that the floor mat is securely fixed in the correct place with all the provided retaining hooks (clips). Be especially careful to perform this check after cleaning the floor.

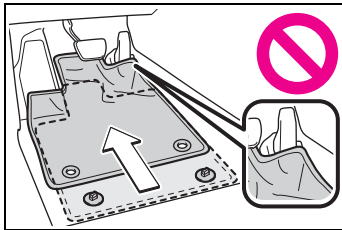

- With the engine stopped and the shift position in P, fully depress each pedal to the floor to make sure it does not interfere with the floor mat.

**For safe driving**

**For safe driving, adjust the seat and mirror to an appropriate position before driving.**

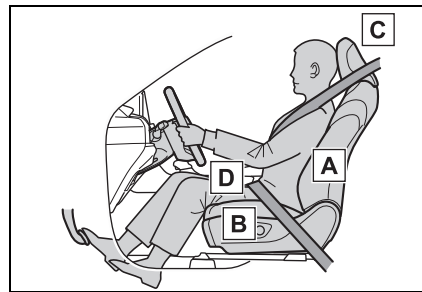
**Correct driving posture**

- A** Adjust the angle of the seat-back so that you are sitting straight up and so that you do not have to lean forward to steer. (→P.141)
- B** Adjust the seat so that you can depress the pedals fully and so that your arms bend slightly at the elbow when gripping the steering wheel. (→P.141)
- C** Lock the head restraint in place with the center of the head restraint closest to the top of your ears. (→P.147)
- D** Wear the seat belt correctly. (→P.31)

**⚠ WARNING****■ For safe driving**

Observe the following precautions.

Failure to do so may result in death or serious injury.

- Do not adjust the position of the driver's seat while driving. Doing so could cause the driver to lose control of the vehicle.
- Do not place a cushion between the driver or passenger and the seatback. A cushion may prevent correct posture from being achieved, and reduce the effectiveness of the seat belt and head restraint.
- Do not place anything under the front seats. Objects placed under the front seats may become jammed in the seat tracks and stop the seat from locking in place. This may lead to an accident and the adjustment mechanism may also be damaged.
- Always observe the legal speed limit when driving on public roads.
- When driving over long distances, take regular breaks before you start to feel tired. Also, if you feel tired or sleepy while driving, do not force yourself to continue driving and take a break immediately.

**Correct use of the seat belts**

Make sure that all occupants are wearing their seat belts before driving the vehicle. (→P.31)

Use a child restraint system appropriate for the child until the

child becomes large enough to properly wear the vehicle's seat belt. (→P.51)

**Adjusting the mirrors**

Make sure that you can see backward clearly by adjusting the inside and outside rear view mirrors properly. (→P.151, 152, 161)

## Seat belts

**Make sure that all occupants are wearing their seat belts before driving the vehicle.**

### WARNING

Observe the following precautions to reduce the risk of injury in the event of sudden braking, sudden swerving or an accident. Failure to do so may cause death or serious injury.

#### ■ Wearing a seat belt

- Ensure that all passengers wear a seat belt.
- Always wear a seat belt properly.
- Each seat belt should be used by one person only. Do not use a seat belt for more than one person at once, including children.
- Toyota recommends that children be seated in the rear seat and always use a seat belt and/or an appropriate child restraint system.
- To achieve a proper seating position, do not recline the seat more than necessary. The seat belt is most effective when the occupants are sitting up straight and well back in the seats.
- Do not wear the shoulder belt under your arm.
- Always wear your seat belt low and snug across your hips.

#### ■ Pregnant women

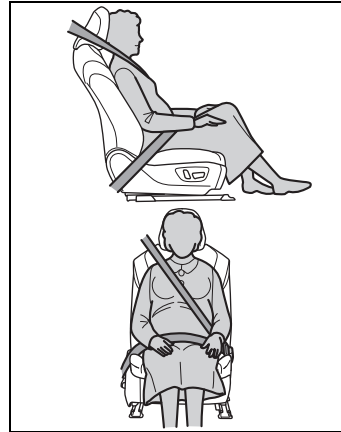

Obtain medical advice and wear the seat belt in the proper way. (→P.32)

Women who are pregnant should position the lap belt as low as possible over the hips in the same manner as other occupants, extending the shoulder belt completely over the shoulder and avoiding belt contact with the rounding of the abdominal area.

If the seat belt is not worn properly, not only the pregnant woman, but also the fetus could suffer death or serious injury as a result of sudden braking or a collision.

#### ■ People suffering illness

Obtain medical advice and wear the seat belt in the proper way. (→P.32)

#### ■ When children are in the vehicle

→P.61

#### ■ Seat belt damage and wear

- Do not damage the seat belts by allowing the belt, plate, or buckle to be jammed in the door.

**⚠ WARNING**

- Inspect the seat belt system periodically. Check for cuts, fraying, and loose parts. Do not use a damaged seat belt until it is replaced. Damaged seat belts cannot protect an occupant from death or serious injury.
- Ensure that the belt and plate are locked and the belt is not twisted. If the seat belt does not function correctly, immediately contact your Toyota dealer.
- Replace the seat assembly, including the belts, if your vehicle has been involved in a serious accident, even if there is no obvious damage.
- Do not attempt to install, remove, modify, disassemble or dispose of the seat belts. Have any necessary repairs carried out by your Toyota dealer. Inappropriate handling may lead to incorrect operation.

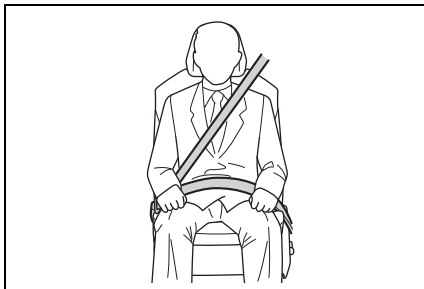
**Correct use of the seat belts**

- Extend the shoulder belt so that it comes fully over the shoulder, but does not come into contact with the neck or slide off the shoulder.
- Position the lap belt as low as

possible over the hips.

- Adjust the position of the seatback. Sit up straight and well back in the seat.
- Do not twist the seat belt.

**■ Emergency locking retractor (ELR)**

The retractor will lock the belt during a sudden stop or on impact. It may also lock if you lean forward too quickly. A slow, easy motion will allow the belt to extend so that you can move around fully.

**■ Automatic locking retractor (ALR)**

When a passenger's shoulder belt is completely extended and then retracted even slightly, the belt is locked in that position and cannot be extended. This feature is used to hold the child restraint system (CRS) firmly. To free the belt again, fully retract the belt and then pull the belt out once more. (→P.51)

**■ Child seat belt usage**

The seat belts of your vehicle were principally designed for persons of adult size.

- Use a child restraint system appropriate for the child, until the child becomes large enough to properly wear the vehicle's seat belt. (→P.51)
- When the child becomes large enough to properly wear the vehicle's seat belt, follow the instructions regarding seat belt usage. (→P.31)

**■ Seat belt extender**

If your seat belts cannot be fastened securely because they are not long enough, a personalized seat belt extender is available from your Toyota dealer free of charge.



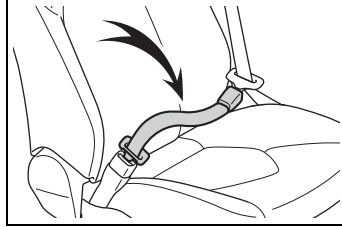

### ⚠ WARNING

#### ■ Using a seat belt extender

Observe the following precautions to reduce the risk of injury in the event of sudden braking, sudden swerving or an accident. Failure to do so may cause death or serious injury.

- Do not wear the seat belt extender if you can fasten the seat belt without the extender.
- Do not use the seat belt extender when installing a child restraint system because the belt will not securely hold the child restraint system, increasing the risk of death or serious injury in the event of an accident.
- The personalized extender may not be safe on another vehicle, when used by another person, or at a different seating position other than the one originally intended.

### ⚠ NOTICE

#### ■ When using a seat belt extender

When releasing the seat belt, press on the buckle release button on the extender, not on the seat belt. This helps prevent damage to the vehicle interior and the extender itself.

### Fastening and releasing the seat belt (except for the third center seat)

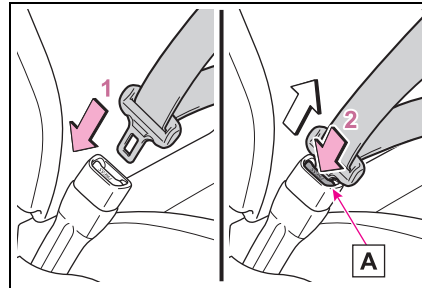

- 1 To fasten the seat belt, push the plate into the buckle until a click sound is heard.
- 2 To release the seat belt, press the release button **A**.

### ■ When not using the rear seat belts

Pass the outer seat belts through the seat belt hangers and secure the seat belt plates to prevent the shoulder belts from being damaged.

#### ▶ Second seat belts

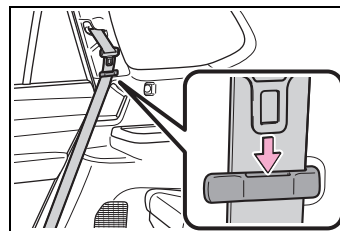

#### ▶ Third seat belts

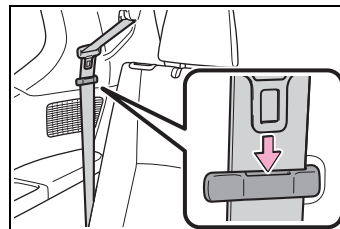

### Fastening the seat belt (for the third center seat)

- 1 Take the plate out of the holder, and then pull down the seat belt.

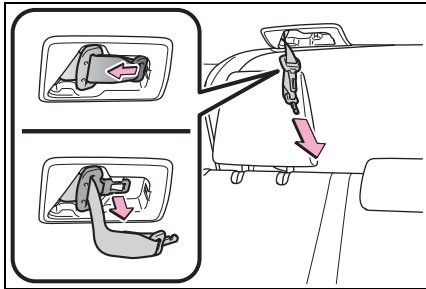

- 2 Push plate **A** into buckle **B** until a click sound is heard.

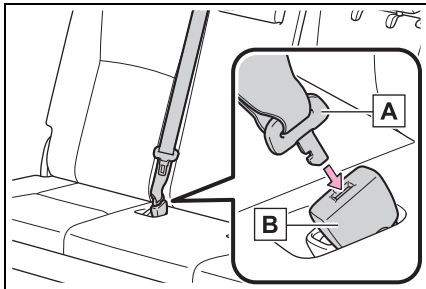

- 3 Push plate **C** into buckle **D** until a click sound is heard.

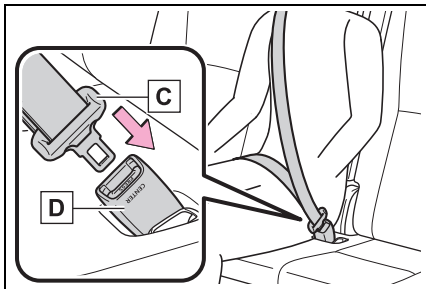

### ⚠ WARNING

- When using the third center seat belt

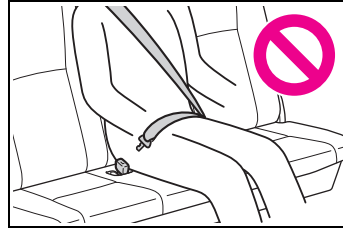

Do not use the third center seat belt with either buckle released. Fastening only one of the buckles may result in death or serious injury in case of sudden braking, sudden swerving or a collision.

### Releasing and stowing the seat belt (for the third center seat)

- 1 To release plate **C**, press the release button **E** on buckle **D**.

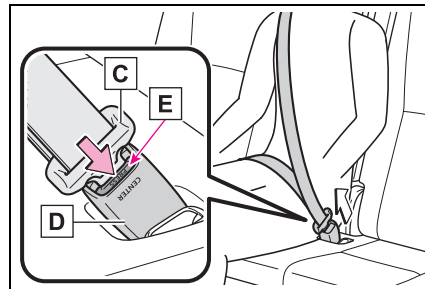

- 2 To release plate **A**, insert the mechanical key (→P.110) or plate **C** into the hole on buckle **B**.

Retract the belt slowly when releas-

ing and stowing the seat belt.

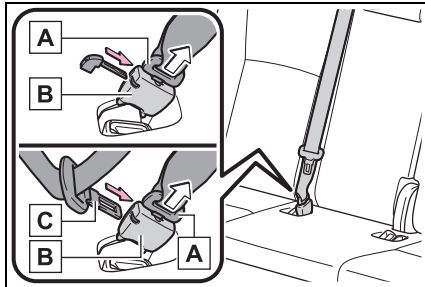

**3** Stow the plate **C** and **A** in the holder on the roof.

In order to securely stow them, firmly insert them as far as possible.

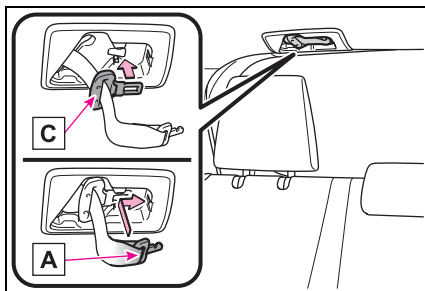

**Adjusting the seat belt shoulder anchor height (front seats)**

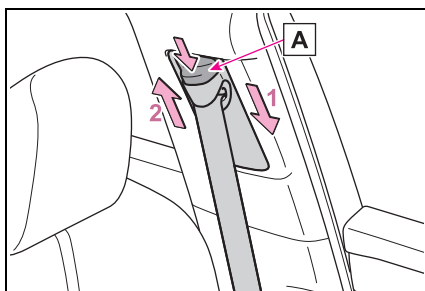

- 1** Push the seat belt shoulder anchor down while pressing the release button **A**.
- 2** Push the seat belt shoulder

anchor up while pressing the release button **A**.

Move the height adjuster up and down as needed until you hear a click.

**WARNING**

**Adjustable shoulder anchor**

Always make sure the shoulder belt is positioned across the center of your shoulder. The belt should be kept away from your neck, but not falling off your shoulder. Failure to do so could reduce the amount of protection in an accident and cause death or serious injuries in the event of a sudden stop, sudden swerve or accident.

**Seat belt pretensioners (front and outboard second seats)**

When the vehicle is subjected to a severe frontal or side impact or rollover, the pretensioners retract the seat belts of the front seats and rear outer seats to securely restrain the occupants.

The pretensioners will not operate in minor frontal or side impacts, or rear impacts.

**Replacing the belt after the pretensioner has been activated**

If the vehicle is involved in multiple collisions, the pretensioner will activate for the first collision, but will not activate for the second or subsequent collisions.

**PCS-linked control**

If the PCS (Pre-Collision System) determines that the possibility of a

collision with a vehicle is high, the seat belt pretensioners will be prepared to operate.

**WARNING****■ Seat belt pretensioners**

Observe the following precautions to reduce the risk of injury in the event of sudden braking or an accident.

Failure to do so may result in death or serious injury.

- Do not place anything, such as a cushion, on the front passenger's seat. Doing so will disperse the passenger's weight, which prevents the sensor from detecting the passenger's weight properly. As a result, the seat belt pretensioner for the front passenger's seat may not operate in the event of a collision.
- If a pretensioner has operated, the SRS warning light will illuminate. In this situation, the seat belt cannot be used and must be replaced by your Toyota dealer.

## SRS airbags

The SRS airbags deploy when the vehicle is subjected to certain types of severe impact that may cause significant injury to the occupants. The airbags work together with the seat belts to help reduce the risk of death or serious injury.

### SRS airbag system

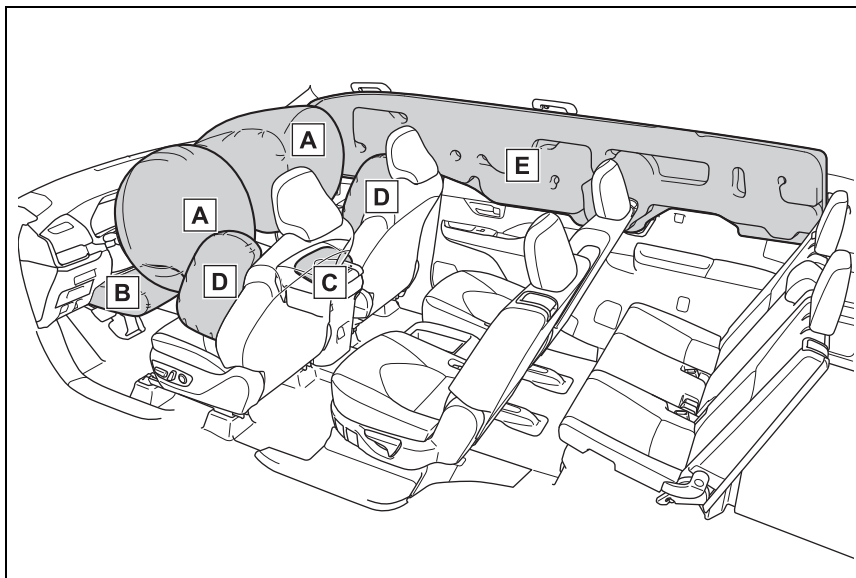

**A** SRS driver airbag/front passenger airbag

Help reduce impact to the head and chest of the driver and front passenger

**B** SRS knee airbag

Help reduce impact to the driver

**C** SRS seat cushion airbag

Helps reduce impact to the front passenger

**D** SRS side airbags

Help reduce impact to the chest of the occupants of the front seats

**E** SRS curtain shield airbags

- Help reduce impact to the heads of the occupants of the front and rear outer seats
- Can help prevent the occupants from being thrown from the vehicle in the event of a vehicle rollover

Your vehicle is equipped with ADVANCED AIRBAGS designed based on US motor vehicle safety standards (FMVSS208). The airbag sensor assembly (ECU) controls airbag deployment based on information obtained from the sensors, etc., shown in the system components diagram above. This information includes crash severity and occupant information. As the airbags deploy, a chemical reaction in the inflators quickly fills the airbags with non-toxic gas to help restrain the motion of the occupants.

#### ■ If the SRS airbags deploy (inflate)

- Slight abrasions, burns, bruising, etc., may be sustained from SRS airbags, due to the extremely high speed of deployment (inflation) by hot gases.
- A loud noise and white powder will be emitted.
- Parts of the airbag module (steering wheel hub, airbag cover and inflator) as well as the parts around the airbags may be hot for several minutes. The airbag itself may also be hot.
- The windshield may crack.
- All of the doors will be unlocked. (→P.116)
- The brakes and stop lights will be controlled automatically. (→P.355)
- The interior lights will turn on automatically. (→P.385)
- The emergency flashers will turn on automatically. (→P.470)
- Fuel supply to the engine will be stopped. (→P.476)
- For Safety Connect subscribers, if any of the following situations occur, the system is designed to send an emergency call to the response center, notifying them of the vehicle's location (without needing to push the "SOS" button) and an agent will attempt to speak with the occupants to ascertain the level of emergency and assistance required. If the occupants are unable to communicate, the

agent automatically treats the call as an emergency and helps to dispatch the necessary emergency services. (→P.68)

- When an SRS airbag has been deployed
- When a seat belt pretensioner has operated
- When the vehicle has been involved in a severe rear-end collision

#### ■ The SRS airbags deploy in a frontal impact when

- The following SRS airbags will deploy in the event of an impact that exceeds a threshold level (level of force corresponding to an approximately 12 - 18 mph [20 - 30 km/h] frontal collision with a fixed wall that does not move or deform):
  - SRS front airbags
  - SRS seat cushion airbag
  - SRS knee airbag
- The threshold level at which the SRS airbags will deploy will be higher than normal in the in the following situations:
  - When the vehicle collides with an object, such as a parked vehicle or sign pole, which moves or deforms on impact
  - If the vehicle is involved in an underride collision, such as a collision in which the front of the vehicle "underrides", or goes under, the bed of a truck
- Depending on the type of collision, only the following may deploy:
  - Seat belt pretensioners
- The SRS airbags for the front pas-

senger's seat will not deploy if there is no passenger in the front passenger seat. However, the SRS airbags for the front passenger's seat may deploy, even if the seat is unoccupied, if luggage is put on the seat.

- The SRS seat cushion airbag for the front passenger's seat will not deploy if the seat belt of the front passenger's seat is unfastened.
- In the event of an especially severe frontal collision, the left and right SRS curtain shield airbags may also deploy.

#### ■ The SRS airbags deploy in a side impact when

- The following SRS airbags will deploy in the event of an impact that exceeds the set threshold level (level of force corresponding to the impact force produced by an approximately 3300 lb. [1500 kg] vehicle colliding with the passenger compartment at a perpendicular angle at an approximate speed of 12 - 18 mph [20 - 30 km/h]):
  - SRS side airbags
  - SRS curtain shield airbags
- If the vehicle is involved in a rollover, the following SRS airbags will deploy:
  - Both left and right SRS curtain shield airbags

#### ■ The SRS airbags deploy in an underside impact when

- The following airbags may deploy if the underside of the vehicle collides with a hard object:
  - SRS front airbags
  - SRS knee airbag
  - SRS seat cushion airbag
  - SRS side airbags
  - SRS curtain shield airbags

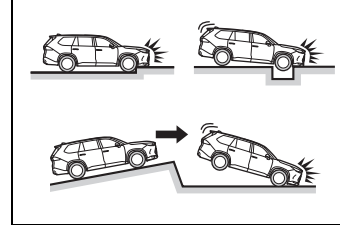

- The following airbags may deploy if the vehicle becomes significantly tilted or is strongly impacted by skidding into a curb, etc.:
  - SRS curtain shield airbags

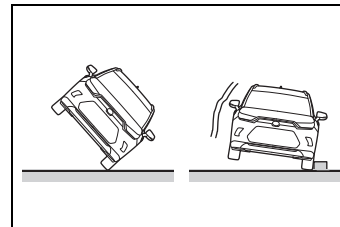

#### ■ The SRS side airbags will not deploy when

- The following SRS airbags will not normally deploy in side or rear collisions, vehicle rollovers, or low speed frontal collisions. However, if such a collision causes sufficient sudden deceleration, the SRS airbags may deploy.
  - SRS front airbags
  - SRS knee airbag
  - SRS seat cushion airbag

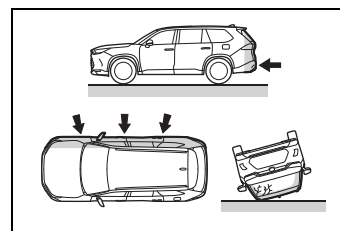

- The following SRS airbags may not deploy if the vehicle is collided with at a certain angle or in a side collision where an area of the vehicle other than the passenger compartment is collided with:
  - SRS side airbags
  - SRS curtain shield airbags

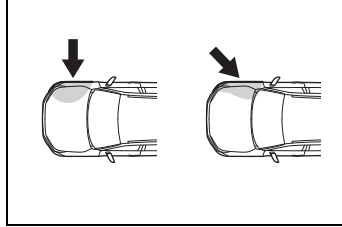

- The following SRS airbags will not normally deploy in front or rear collisions, vehicle rollovers, or low speed side collisions:
- SRS side airbags

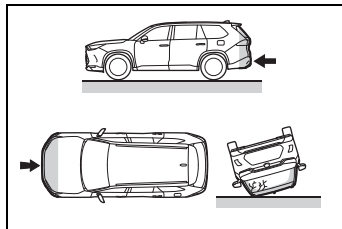

- The following SRS airbags will not normally deploy in rear collisions, end over end vehicle rollovers, or low speed front or side collisions:
- SRS curtain shield airbags

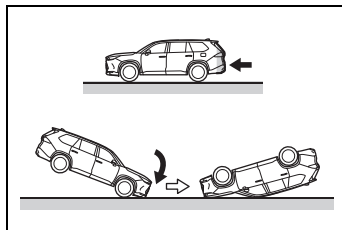

#### ■ When to contact your Toyota dealer

In the following situations, the vehicle will require inspection and/or repair. Contact your Toyota dealer as soon as possible.

- When any of the SRS airbags have been deployed
- When the front of the vehicle is damaged or deformed, or was involved in a collision that was not severe enough to cause any of the following SRS airbags to deploy:

- SRS front airbags
- SRS knee airbag
- SRS seat cushion airbag

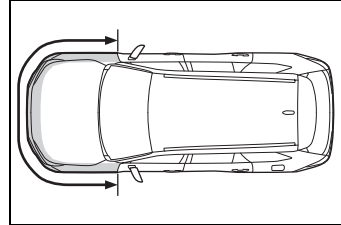

- When a door or its surrounding area is damaged, deformed or has had a hole made in it, or was involved in a collision that was not severe enough to cause any of the following SRS airbags to deploy:
- SRS side airbags
- SRS curtain shield airbags

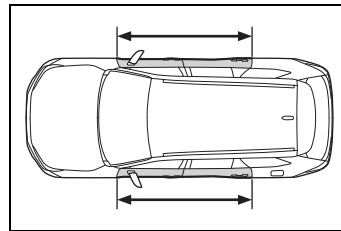

- When the pad section of the steering wheel, the dashboard near the front passenger SRS airbag or the lower side of the instrument panel is scratched, cracked, or otherwise damaged.
- When the seat cushion surface is scratched, cracked, or otherwise damaged.
- When the surface of a seat with an SRS side airbag is scratched, cracked, or otherwise damaged.
- When the part of a front pillar, rear pillar or roof side rail garnish (padding) which covers a SRS curtain shield airbag is scratched, cracked, or otherwise damaged.



 **WARNING**

■ **SRS airbag precautions**

Observe the following precautions.

Failure to do so may result in death or serious injury.

- The driver and all passengers must wear their seat belts correctly. The SRS airbags are supplemental devices to be used with the seat belts.
- The SRS driver airbag deploys with considerable force, and can cause death or serious injury, especially if the driver is very close to the airbag. The National Highway Traffic Safety Administration (NHTSA) advises:

Since the risk zone for the driver's airbag is the first 2 - 3 in. (50 - 75 mm) of inflation, placing yourself 10 in. (250 mm) from your driver airbag provides you with a clear margin of safety. This distance is measured from the center of the steering wheel to your breastbone. If your current driving position places you less than 10 in. (250 mm) away from the driver airbag, you can change your driving position in several ways:

- Move your seat to the rear as far as possible while still being able to reach the pedals comfortably.

- Slightly recline the seatback. Although vehicle designs vary, many drivers can achieve the 10 in. (251 mm) distance, even with the driver seat all the way forward, simply by reclining the seatback somewhat. If reclining the seatback makes it hard to see the road, raise yourself by using a firm, non-slippery cushion, or raise the seat if your vehicle has that feature.
- If your steering wheel is adjustable, tilt it downward. This points the airbag toward your chest instead of your head and neck. The seat should be adjusted as recommended by the NHTSA, while still being able to control the vehicle with the pedals and steering wheel, and maintaining your view of the instrument panel controls.
- If a seat belt extender has been connected to the front passenger seat belt buckle but the latch plate of the front passenger seat belt has not been fastened to the seat belt extender, the SRS airbag system will judge that the front passenger is wearing the seat belt even though the seat belt has not been fastened. In this case, the SRS front airbags for the front passenger may not deploy correctly in a collision, resulting in death or serious injury. Be sure to wear the seat belt correctly when using a seat belt extender.

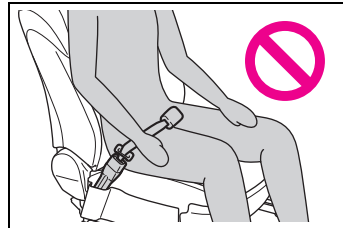

**⚠ WARNING**

- The SRS front passenger airbag deploys with considerable force, and can cause death or serious injury, especially if the front passenger is very close to the airbag. The front passenger seat should be positioned as far possible from the airbag with the seatback adjusted so that the passenger is sat upright.
- Improperly seated and/or restrained infants and children can be killed or seriously injured by a deploying airbag. An infant or child who is too small to use a seat belt should be properly secured using a child restraint system. Toyota strongly recommends that all infants and children be placed in the rear seats of the vehicle and properly restrained. The rear seats are safer for infants and children than the front passenger seat. (→P.51)
- Do not sit on the edge of the seat or lean against the dashboard.

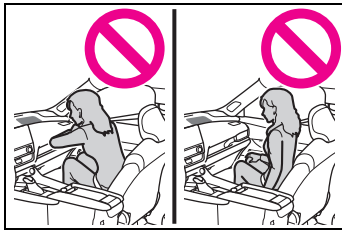

- Do not allow a child to stand in front of the SRS front passenger airbag or sit on the lap of a front passenger.

- Front seat occupants should never hold items on their lap.

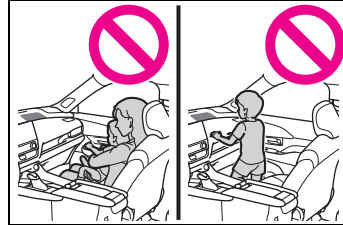

- Do not lean against the door, roof side rail, or front, side, or rear pillar.



- Do not allow anyone to kneel on a seat toward the door or put their head or hands outside the vehicle.

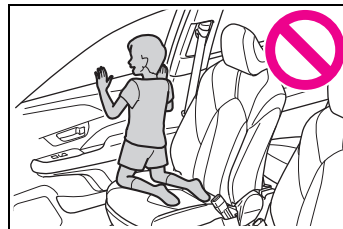

- Do not attach anything to or lean anything against areas such as the dashboard, steering wheel pad and lower portion of the instrument panel.

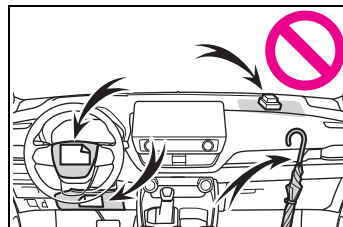

**⚠ WARNING**

- Do not attach anything to areas such as the doors, windshield, side windows, front or rear pillars, roof side rails and assist grips.

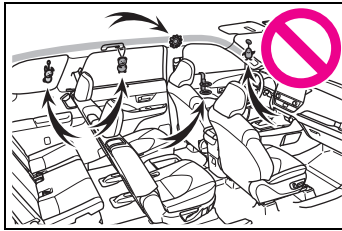

- Do not hang coat hangers or other hard objects on the coat hooks. These items could become projectiles if the SRS curtain shield airbags deploy, possibly leading to death or serious injury.
- If a vinyl cover is attached to the area where the SRS knee airbag deploys, be sure to remove it.
- Do not use seat accessories which cover the parts from which the SRS airbags deploy, as they may interfere with inflation of the SRS airbags. Such accessories may prevent the SRS airbags from deploying correctly, may disable the system or cause the SRS airbags to inflate unintentionally, possibly resulting in death or serious injury.
- Do not strike or apply significant force to the SRS airbag system components, front doors or their surrounding area. Doing so may cause the SRS airbags to malfunction.

- Do not touch any components of the SRS airbags immediately after the SRS airbags have deployed (inflated) as they may be hot.
- If breathing becomes difficult after the SRS airbags have deployed, open a door or window to allow fresh air in, or leave the vehicle if it is safe to do so. Wash off any residue as soon as possible to prevent skin irritation.
- If a part where an SRS airbag is stored is damaged or cracked, have it replaced by your Toyota dealer.
- Do not place anything, such as a cushion, on the front passenger's seat. Doing so will disperse the passenger's weight, which prevents the sensor from detecting the passenger's weight properly. As a result, the SRS front airbags for the front passenger's seat may not deploy in the event of a collision.

**■ Modification and disposal of SRS airbag system components**

Do not dispose of your vehicle or perform any of the following modifications without consulting your Toyota dealer. The SRS airbags may malfunction or deploy unintentionally, possibly leading to death or serious injury.

- Removal, installation, disassembly or repair of the SRS airbags
- Repair, removal or modification of the following parts or their surrounding
  - Steering wheel
  - Instrument panel

**WARNING**

- Dashboard
- Seats
- Seat upholstery
- Front pillars
- Side pillars
- Rear pillars
- Roof side rails
- Front door panels
- Front door trim
- Front door speakers
- Modifications to the front door panels (such as making holes in them)
- Repair or modification of the following parts or their surrounding
  - Front fender
  - Front bumper
  - Sides of the vehicle interior
- Installation of the following parts or accessories
  - Bull bars or kangaroo bars
  - Snow plows
  - Winches
  - Roof luggage carriers
- Modifications to the vehicle's suspension
- Installation of electronic devices such as mobile two-way radios (RF-transmitter) and CD players
- Modifications to your vehicle for a persons with a physical disability

**Front passenger occupant classification system**

**Your vehicle is equipped with a front passenger occupant classification system.**

**This system detects the conditions of the front passenger seat and activates or deactivates the following SRS airbags.**

- SRS front passenger airbag
- Front passenger's seat SRS seat cushion airbag

### System components

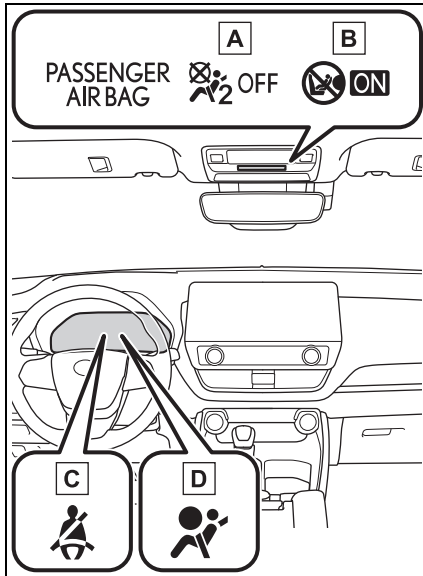

- A** "AIR BAG OFF" indicator light
- B** "AIR BAG ON" indicator light
- C** Front passenger's seat belt reminder light
- D** SRS warning light

#### **⚠ WARNING**

##### **■ Front passenger occupant classification system precautions**

Observe the following precautions regarding the front passenger occupant classification system. Failure to do so may cause death or serious injury.

- Wear the seat belt properly.
- Make sure the front passenger's seat belt plate has not been left inserted into the buckle before someone sits in the front passenger seat.

- Make sure the "AIR BAG OFF" indicator light is not illuminated when using the seat belt extender for the front passenger seat. If the "AIR BAG OFF" indicator light is illuminated, disconnect the extender tongue from the seat belt buckle, and reconnect the seat belt. Reconnect the seat belt extender after making sure the "AIR BAG ON" indicator light is illuminated. If you use the seat belt extender while the "AIR BAG OFF" indicator light is illuminated, the SRS airbags for the front passenger will not activate, which could cause death or serious injury in the event of a collision.

- Do not apply a heavy load to the front passenger seat or equipment (e.g. seatback pocket).

- Do not put weight on the front passenger seat by putting your hands or feet on the front passenger seat seatback from the rear passenger seat.

- Do not let a rear passenger lift the front passenger seat with their feet or press on the seatback with their legs.

- Do not put objects under the front passenger seat.

**WARNING**

- Do not recline the front passenger seatback so far that it touches a rear seat. This may cause the “AIR BAG OFF” indicator light to be illuminated, which indicates that the SRS airbags for the front passenger will not activate in the event of a severe accident. If the seatback touches the rear seat, return the seatback to a position where it does not touch the rear seat. Keep the front passenger seatback as upright as possible when the vehicle is moving. Reclining the seatback excessively may lessen the effectiveness of the seat belt system.
  - If an adult sits in the front passenger seat, the “AIR BAG ON” indicator light is illuminated. If the “AIR BAG OFF” indicator is illuminated, ask the passenger to sit up straight, well back in the seat, feet on the floor, and with the seat belt worn correctly. If the “AIR BAG OFF” indicator still remains illuminated, either ask the passenger to move to the rear seat, or if that is not possible, move the front passenger seat fully rearward.
  - When it is unavoidable to install a forward-facing child restraint system on the front passenger seat, install the child restraint system on the front passenger seat in the proper order. (→P.53)
  - Do not modify or remove the front seats.
- Do not kick the front passenger seat or subject it to severe impact. Otherwise, the SRS warning light may come on to indicate a malfunction of the front passenger occupant classification system. In this case, contact your Toyota dealer immediately.
  - Child restraint systems installed on the rear seat should not contact the front seatbacks.
  - Do not use a seat accessory, such as a cushion and seat cover, that covers the seat cushion surface.
  - Do not modify or replace the upholstery of the front seat.

### Front passenger occupant classification system conditions and operation

#### ■ Adult<sup>\*1</sup>

Indicator/warning light	"AIR BAG ON" and "AIR BAG OFF" indicator lights	"AIR BAG ON"
	SRS warning light	Off
	Front passenger's seat belt reminder light	Off <sup>*2</sup> or flashing <sup>*3</sup>
Devices	Front passenger airbag	Activated
	Seat cushion airbag in the front passenger side	Activated <sup>*2</sup> or deactivated <sup>*3</sup>

#### ■ Child<sup>\*4</sup>

Indicator/warning light	"AIR BAG ON" and "AIR BAG OFF" indicator lights	"AIR BAG OFF" or "AIR BAG ON" <sup>*4</sup>
	SRS warning light	Off
	Front passenger's seat belt reminder light	Off <sup>*2</sup> or flashing <sup>*3</sup>
Devices	Front passenger airbag	Deactivated or activated <sup>*4</sup>
	Seat cushion airbag in the front passenger side	Deactivated or activated <sup>*4, 2</sup>

#### ■ Child restraint system with infant<sup>\*5</sup>

Indicator/warning light	"AIR BAG ON" and "AIR BAG OFF" indicator lights	"AIR BAG OFF" <sup>*6</sup>
	SRS warning light	Off
	Front passenger's seat belt reminder light	Off <sup>*2</sup> or flashing <sup>*3</sup>
Devices	Front passenger airbag	Deactivated
	Seat cushion airbag in the front passenger side	

■ **Unoccupied**

Indicator/warning light	"AIR BAG ON" and "AIR BAG OFF" indicator lights	"AIR BAG OFF"
	SRS warning light	Off
	Front passenger's seat belt reminder light	
Devices	Front passenger airbag	Deactivated
	Seat cushion airbag in the front passenger side	

■ **System malfunction**

Indicator/warning light	"AIR BAG ON" and "AIR BAG OFF" indicator lights	"AIR BAG OFF"
	SRS warning light	On
	Front passenger's seat belt reminder light	
Devices	Front passenger airbag	Deactivated
	Seat cushion airbag in the front passenger side	

\*1: The system judges a person of adult size as an adult. When a smaller adult sits in the front passenger seat, the system may not recognize them as an adult depending on their physique and posture.

\*2: In the event the front passenger is wearing a seat belt.

\*3: In the event the front passenger does not wear a seat belt.

\*4: For some children, child in seat, child in booster seat or child in convertible seat, the system may not recognize them as a child. Factors which may affect this can be the physique or posture.

\*5: Never install a rear-facing child restraint system on the front passenger seat. A forward-facing child restraint system should only be installed on the front passenger seat when it is unavoidable. (→P.51)

\*6: In case the indicator light is not illuminated, consult this manual on how to install the child restraint system properly. (→P.53)



## Exhaust gas precautions

**Harmful substance to the human body is included in exhaust gases if inhaled.**

### **WARNING**

Exhaust gases include harmful carbon monoxide (CO), which is colorless and odorless. Observe the following precautions. Failure to do so may cause exhaust gases enter the vehicle and may lead to an accident caused by light-headedness, or may lead to death or a serious health hazard.

#### ■ **Important points while driving**

- Keep the back door closed.
- If you smell exhaust gases in the vehicle even when the back door is closed, open the windows and have the vehicle inspected at your Toyota dealer as soon as possible.

#### ■ **When parking**

- If the vehicle is in a poorly ventilated area or a closed area, such as a garage, stop the engine.
- Do not leave the vehicle with the engine running for a long time.  
If such a situation cannot be avoided, park the vehicle in an open space and ensure that exhaust fumes do not enter the vehicle interior.

- Do not leave the engine running in an area with snow build-up, or where it is snowing. If snowbanks build up around the vehicle while the engine is running, exhaust gases may collect and enter the vehicle.

#### ■ **Exhaust pipe**

The exhaust system needs to be checked periodically. If there is a hole or crack caused by corrosion, damage to a joint or abnormal exhaust noise, be sure to have the vehicle inspected and repaired by your Toyota dealer.

**Riding with children**

**Observe the following precautions when children are in the vehicle.**

**Use a child restraint system appropriate for the child, until the child becomes large enough to properly wear the vehicle's seat belt.**

- It is recommended that children sit in the rear seats to avoid accidental contact with the shift lever, wiper switch, etc.
- Use the rear door child-protector lock or the window lock switch to avoid children opening the door while driving or operating the power window accidentally.  
(→P.118, 166)
- Do not let small children operate equipment which may catch or pinch body parts, such as the power window, hood, back door, seats etc.

 **WARNING****■ When children are in the vehicle**

Never leave children unattended in the vehicle, and never allow children to have or use the key.

Children may be able to start the vehicle or shift the vehicle into neutral. There is also a danger that children may injure themselves by playing with the windows, the panoramic moon roof, or other features of the vehicle. In addition, heat build-up or extremely cold temperatures inside the vehicle can be fatal to children.

## Child restraint systems

**Before installing a child restraint system in the vehicle, there are precautions that need to be observed, different types of child restraint systems, as well as installation methods, etc., written in this manual.**

Use a child restraint system when riding with a small child that cannot properly use a seat belt. For the child's safety, install the child restraint system to a rear seat. Be sure to follow the installation method that is in the operation manual enclosed with the restraint system.

## Table of contents

- Points to remember: P.51
- Child restraint system: P.53
- When using a child restraint system: P.55
- Child restraint system installation method
  - Fixed with a seat belt: P.57
  - Fixed with a child restraint LATCH anchor: P.62
  - Using an anchor bracket (for top tether strap): P.65

## Points to remember

The laws of all 50 states of the U.S.A. as well as Canada now require the use of child restraint systems.

- Prioritize and observe the warnings, as well as the laws and regulations for child restraint systems.
- Use a child restraint system until the child becomes large enough to properly wear the vehicle's seat belt.
- Choose a child restraint system that suits your vehicle and is appropriate to the age and size of the child.

## WARNING

### ■ When a child is riding

Observe the following precautions.

Failure to do so may result in death or serious injury.

- For effective protection in automobile accidents and sudden stops, a child must be properly restrained, using a seat belt or child restraint system which is correctly installed. For installation details, refer to the operation manual enclosed with the child restraint system. General installation instruction is provided in this manual.

**WARNING**

- Toyota strongly urges the use of a proper child restraint system that conforms to the weight and size of the child, installed on the rear seat. According to accident statistics, the child is safer when properly restrained in the rear seat than in the front seat.
- Holding a child in your or someone else's arms is not a substitute for a child restraint system. In an accident, the child can be crushed against the windshield or between the holder and the interior of the vehicle.

**■ Handling the child restraint system**

If the child restraint system is not properly fixed in place, the child or other passengers may be seriously injured or even killed in the event of sudden braking, sudden swerving, or an accident.



- If the vehicle were to receive a strong impact from an accident, etc., it is possible that the child restraint system has damage that is not readily visible. In such cases, do not reuse the restraint system.
- Make sure you have complied with all installation instructions provided with the child restraint system manufacturer and that the system is properly secured.
- Keep the child restraint system properly secured on the seat even if it is not in use. Do not store the child restraint system unsecured in the passenger compartment.
- If it is necessary to detach the child restraint system, remove it from the vehicle or store it securely in the luggage compartment.

## Child restraint system

### ■ Types of child restraint system installation methods

Confirm with the operation manual enclosed with the child restraint system about the installation of the child restraint system.

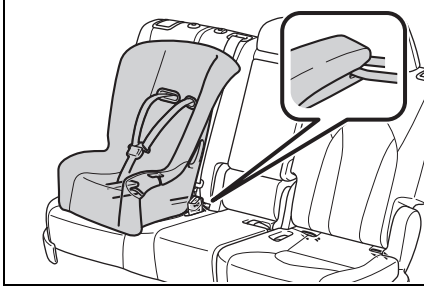
	Installation method	Page
Seat belt attachment		P.57

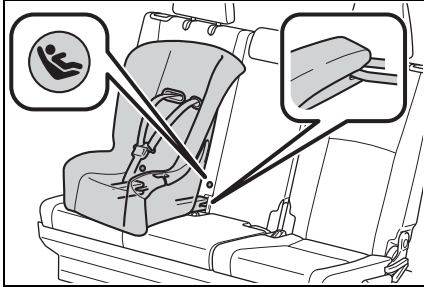
	Installation method	Page
<p>Child restraint LATCH anchors attachment</p>	<p>Second outboard seats (8-passenger models):</p> 	<p>P.62</p>
	<p>Second seats (7-passenger models):</p> 	
	<p>Third right seat:</p> 	

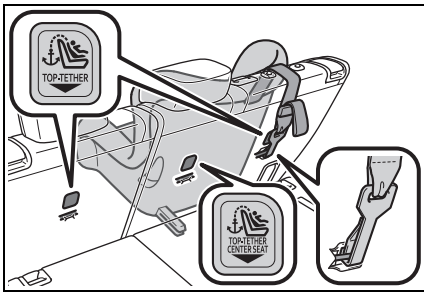
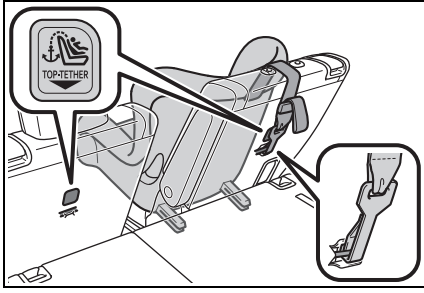
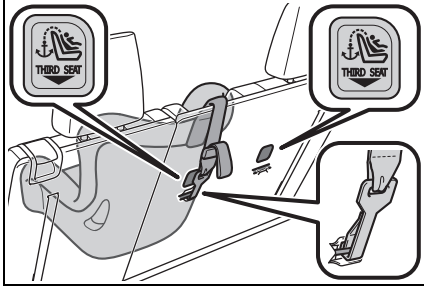
Installation method	Page
<p>Anchor brackets (for top tether strap) attachment</p>	<p>Second seats (8-passenger models):</p>  <p>Second seats (7-passenger models):</p>  <p>Third center and right seats:</p> 

P.65

**When using a child restraint system**

■ **When installing a child restraint system to a front passenger seat**

For the safety of a child, install child restraint systems to a rear

seats. When installing child restraint system to a front passenger seat is unavoidable, adjust the seat as follows and install the child restraint system.

- Move the seat fully rearward.
- Move the seat height to the

upper most position.

- Adjust the seatback angle to the most upright position.

If there is a gap between the child seat and the seatback, adjust the seatback angle until good contact is achieved.

- If the head restraint interferes with your child restraint system, and the head restraint can be removed, remove the head restraint.

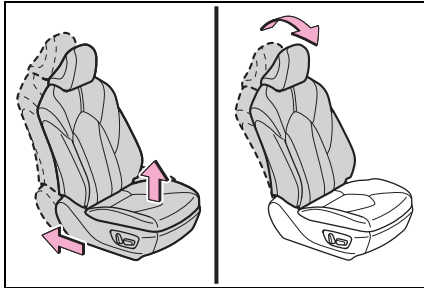

**⚠ WARNING**

■ **When using a child restraint system**

Observe the following precautions. Failure to do so may result in death or serious injury.

- Never install a rear-facing child restraint system on the front passenger seat even if the "AIR BAG OFF" indicator light is illuminated. In the event of an accident, the force of the rapid inflation of the front passenger airbag can cause death or serious injury to the child if the rear-facing child restraint system is installed on the front passenger seat.

- A forward-facing child restraint system may be installed on the front passenger seat only when it is unavoidable. A child restraint system that requires a top tether strap should not be used in the front passenger seat since there is no top tether strap anchor for the front passenger seat.

- A forward-facing child restraint system may be installed on the front passenger seat only when it is unavoidable. When installing a forward-facing child restraint system on the front passenger seat, raise the seatback as much as possible, move the seat to the rearmost position, and raise the seat to the highest position, even if the "AIR BAG OFF" indicator light is illuminated.

If the head restraint interferes with the installation of the child restraint system, and the head restraint can be removed, remove the head restraint.





**⚠ WARNING**

- Do not allow the child to lean his/her head or any part of his/her body against the door or the area of the seat, front or rear pillars, or roof side rails from which the SRS side airbags or SRS curtain shield airbags deploy even if the child is seated in the child restraint system. It is dangerous if the SRS side airbags and curtain shield airbags inflate, and the impact could cause death or serious injury to the child.



- When a booster seat is installed, always ensure that the shoulder belt is positioned across the center of the child's shoulder. The belt should be kept away from the child's neck, but not so that it could fall off the child's shoulder.
- Use child restraint system suitable to the age and size of the child and install it to the rear seat.

- If the driver's seat interferes with the child restraint system and prevents it from being attached correctly, attach the child restraint system to the right-hand rear seat.

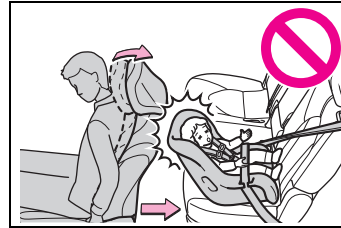

- Adjust the front passenger seat so that it does not interfere with the child restraint system.

**Child restraint system fixed with a seat belt**

A child restraint system for a small child or baby must itself be properly restrained on the seat with the lap portion of the lap/shoulder belt.

**■ Installing child restraint system using a seat belt (child restraint lock function belt)**

Install the child restraint system in accordance to the operation manual enclosed with the child restraint system.

**■ Rear-facing — Infant seat/convertible seat****1 Adjust the rear seat.**

If there is a gap between the child seat and the seatback, adjust the seatback angle until good contact is achieved.

- 2 Place the child restraint system on the rear seat facing the rear of the vehicle.

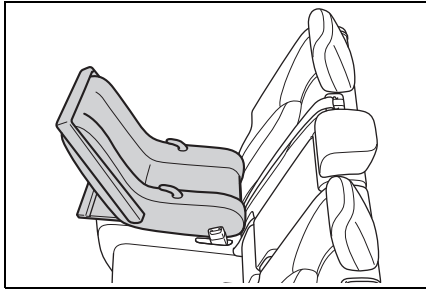

- 3 Run the seat belt through the child restraint system and insert the plate into the buckle. Make sure that the belt is not twisted.

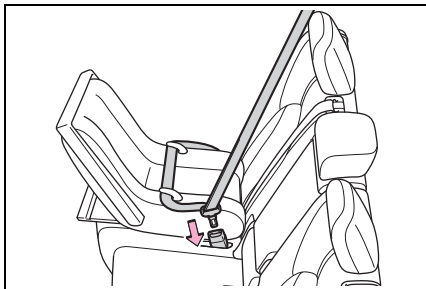

- 4 Fully extend the shoulder belt and allow it to retract to put it in lock mode. In lock mode, the belt cannot be extended.

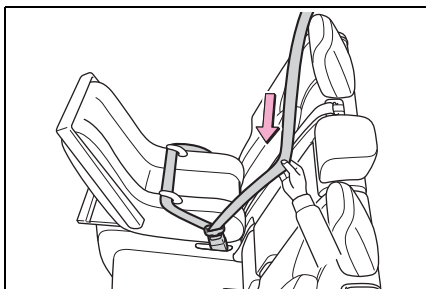

- 5 While pushing the child restraint system down into

the rear seat, allow the shoulder belt to retract until the child restraint system is securely in place.

After the shoulder belt has retracted to a point where there is no slack in the belt, pull the belt to check that it cannot be extended.

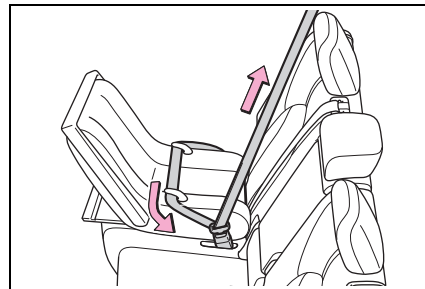

- 6 After installing the child restraint system, rock it back and forth to ensure that it is installed securely. (→P.61)

#### ■ Forward-facing — Convertible seat

- 1 Adjust the seat.
- ▶ When using the front passenger seat

If installing the child restraint system to the front passenger seat is unavoidable, refer to P.55 for the front passenger seat adjustment.

- ▶ When using the rear seat

If there is a gap between the child seat and the seatback, adjust the seatback angle until good contact is achieved.

- 2 Remove the head restraint if it interferes with your child restraint system. (→P.147)

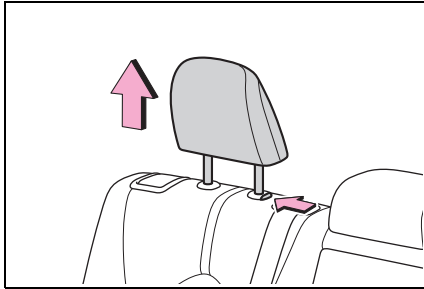

- 3 Place the child restraint system on the seat facing the front of the vehicle.

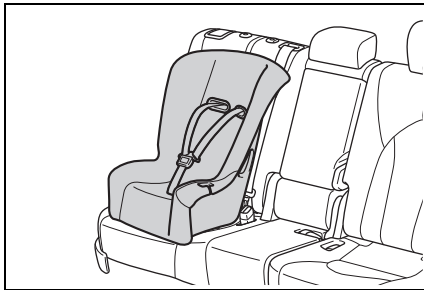

- 4 Run the seat belt through the child restraint system and insert the plate into the buckle. Make sure that the belt is not twisted.



- 5 Fully extend the shoulder belt and allow it to retract to put it

in lock mode. In lock mode, the belt cannot be extended.

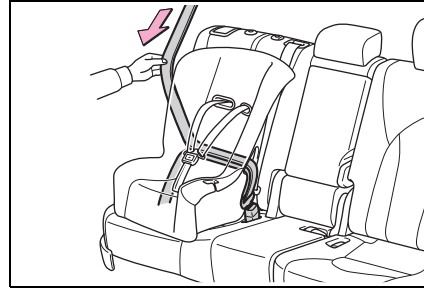

- 6 While pushing the child restraint system into the rear seat, allow the shoulder belt to retract until the child restraint system is securely in place.

After the shoulder belt has retracted to a point where there is no slack in the belt, pull the belt to check that it cannot be extended.

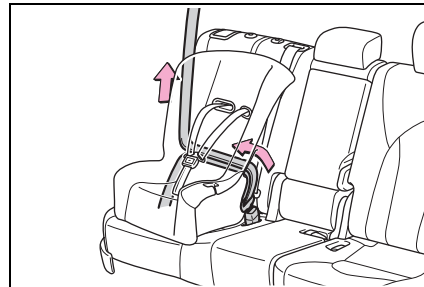

- 7 If the child restraint has a top tether strap, follow the child restraint manufacturer's operation manual regarding the installation, using the top tether strap to latch onto the top tether strap anchor. (→P.65)

- 8 After installing the child restraint system, rock it back

and forth to ensure that it is installed securely. (→P.61)

■ **Booster seat**

- 1 If installing the child restraint system to the front passenger seat is unavoidable, refer to P.55 for the front passenger seat adjustment.
- 2 High back type: Remove the head restraint if it interferes with your child restraint system. (→P.147)

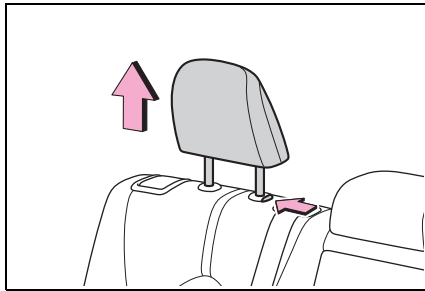

- 3 Place the child restraint system on the seat facing the front of the vehicle.

► **Booster type**

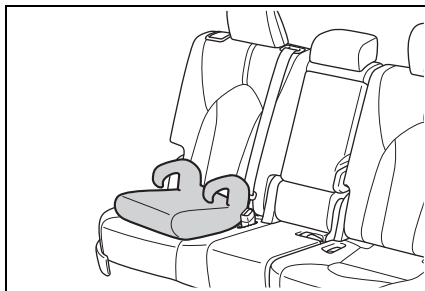

► **High back type**



- 4 Sit the child in the child restraint system. Fit the seat belt to the child restraint system according to the manufacturer's instructions and insert the plate into the buckle. Make sure that the belt is not twisted.

Check that the shoulder belt is correctly positioned over the child's shoulder and that the lap belt is as low as possible. (→P.31)



■ **Removing a child restraint system installed with a seat belt**

Press the buckle release button and fully retract the seat belt.

When releasing the buckle, the child restraint system may spring up due to the rebound of the seat cushion. Release the buckle while holding down the child restraint

system.

Since the seat belt automatically reels itself, slowly return it to the stowing position.

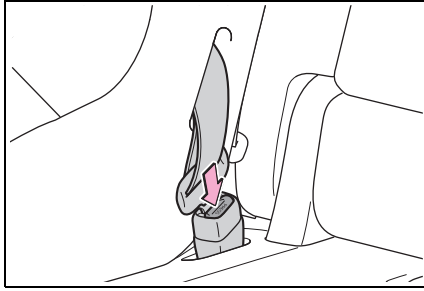

### **⚠ WARNING**

#### ■ **When installing a child restraint system**

Observe the following precautions.

Failure to do so may result in death or serious injury.

- Do not allow children to play with the seat belt. If the seat belt becomes twisted around a child's neck, it may lead to choking or other serious injuries that could result in death. If this occurs and the buckle cannot be unfastened, scissors should be used to cut the belt.
- Ensure that the belt and plate are securely locked and the seat belt is not twisted.
- Shake the child restraint system left and right, and forward and backward to ensure that it has been securely installed.
- After securing a child restraint system, never adjust the seat.

- When a booster seat is installed, always ensure that the shoulder belt is positioned across the center of the child's shoulder. The belt should be kept away from the child's neck, but not so that it could fall off the child's shoulder.

- Follow all installation instructions provided by the child restraint system manufacturer.

- When securing some types of child restraint systems in rear seats, it may not be possible to properly use the seat belts in positions next to the child restraint without interfering with it or affecting seat belt effectiveness. Be sure your seat belt fits snugly across your shoulder and low on your hips. If it does not, or if it interferes with the child restraint, move to a different position. Failure to do so may result in death or serious injury.

- If the seat is adjusted, reconfirm the security of the child restraint system.

#### ■ **When installing a booster seat**

To prevent the belt from going into ALR lock mode, do not fully extend the shoulder belt. ALR mode causes the belt to tighten only. This could cause injury or discomfort to the child. (→P.32)

#### ■ **Do not use a seat belt extender**

If a seat belt extender is used when installing a child restraint system, the seat belt will not securely hold the child restraint system, which could cause death or serious injury to the child or other passengers in the event of sudden braking, sudden swerving or an accident.

### Child restraint system fixed with a child restraint LATCH anchor

#### ■ Child restraint LATCH anchors

LATCH anchors are provided for the following seats.

- ▶ Second outboard seats (8-passenger models)

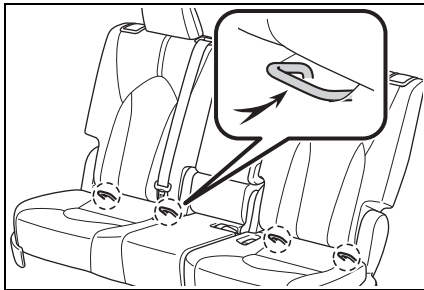

- ▶ Second seats (7-passenger models)

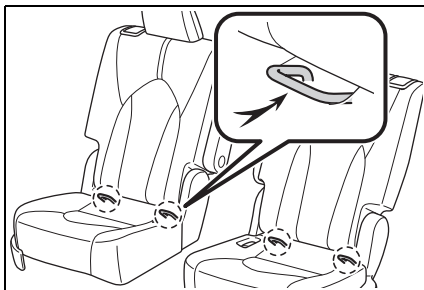

- ▶ Third right seat

Buttons displaying the location of the anchors are attached to the seat.

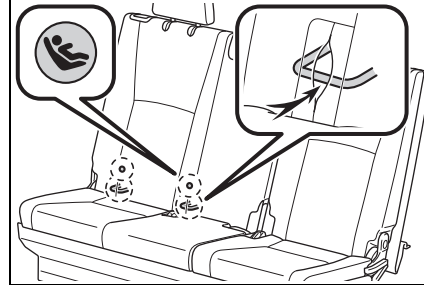

- **When installing in the second outboard seats (8-passenger models) or second seats (7-passenger models)**

Install the child restraint system in accordance to the operation manual enclosed with the child restraint system.

- 1 Adjust the seat.

If there is a gap between the child seat and the seatback, adjust the seatback angle until good contact is achieved.

- 2 Remove the head restraint if it interferes with your child restraint system. (→P.147)

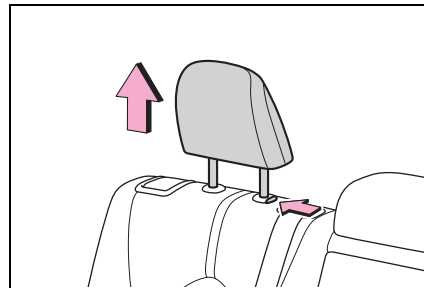

- ▶ With flexible lower attachments

- 3 Latch the hooks of the lower attachments onto the LATCH anchors.

For owners in Canada:  
The symbol on a child

restraint system indicates **A** the presence of a lower connector system.

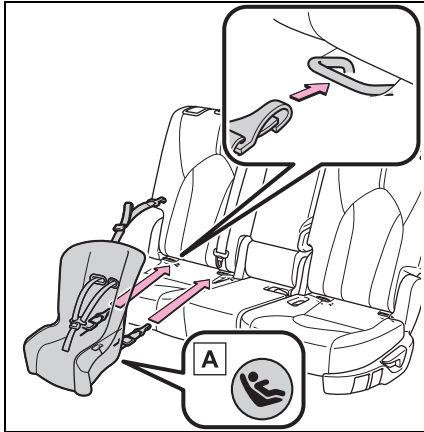

**A** Canada only

► With rigid lower attachments

3 Latch the buckles onto the LATCH anchors.

For owners in Canada:

The symbol on a child restraint system indicates **A** the presence of a lower connector system.

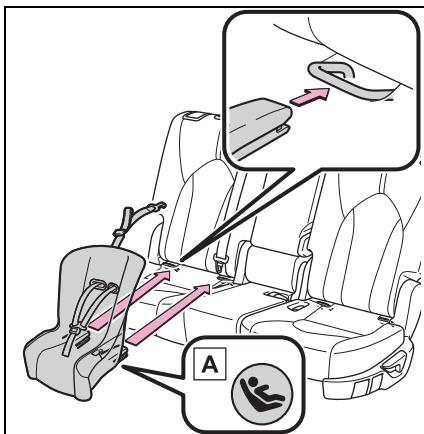

**A** Canada only

4 If the child restraint has a top tether strap, follow the child restraint manufacturer's operation manual regarding the installation, using the top tether strap to latch onto the top tether strap anchor. (→P.65)

5 After installing the child restraint system, rock it back and forth to ensure that it is installed securely. (→P.61)

■ **When installing in the second center seat (8-passenger models)**

There are no LATCH anchors behind the second center seat. However, the inboard LATCH anchors of the outboard seats, which are 18.6 in. (472.9 mm) apart, can be used if the child restraint system manufacturer's instructions permit use of those anchors with the anchor spacing stated.

Child restraint systems with rigid lower attachments cannot be installed in the center seat. This type of child restraint system can only be installed in the outboard seat.

■ **When installing in the third right seat**

Install the child restraint system in accordance to the operation manual enclosed with the child restraint system.

1 Adjust the seat.

If there is a gap between the child seat and the seatback, adjust the seatback angle until good contact is achieved.

2 Widen the slit in the seatback slightly.

► With flexible lower attachments

3 Latch the hooks of the lower attachments onto the LATCH anchors.

For owners in Canada:  
The symbol on a child restraint system indicates **A** the presence of a lower connector system.

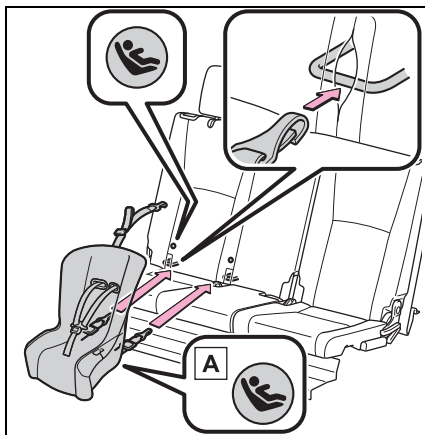

**A** Canada only

► With rigid lower attachments

3 Latch the buckles onto the LATCH anchors.

For owners in Canada:  
The symbol on a child restraint system indicates **A**

the presence of a lower connector system.

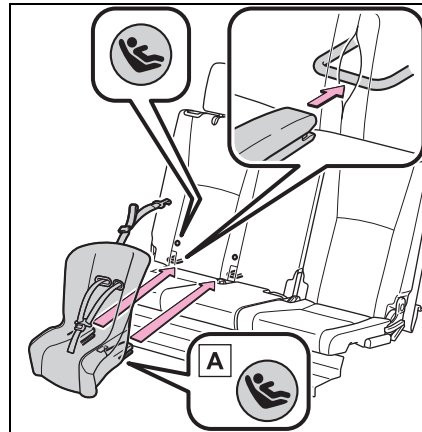

**A** Canada only

4 If the child restraint has a top tether strap, follow the child restraint manufacturer's operation manual regarding the installation, using the top tether strap to latch onto the top tether strap anchor. (→P.65)

5 After installing the child restraint system, rock it back and forth to ensure that it is installed securely. (→P.61)

■ **Laws and regulations pertaining to anchors**

The LATCH system conforms to FMVSS225 or CMVSS210.2. Child restraint systems conforming to FMVSS213 or CMVSS213 specifications can be used. This vehicle is designed to conform to SAE J1819.



**⚠ WARNING****■ When installing a child restraint system**

Observe the following precautions.

Failure to do so may result in death or serious injury.

- When using the LATCH anchors, be sure that there are no foreign objects around the anchors and that the seat belt is not caught behind the child restraint system.
- Follow all installation instructions provided by the child restraint system manufacturer.
- Never attach two child restraint system attachments to the same anchor. In a collision, one anchor may not be strong enough to hold two child restraint system attachments and may break. If the LATCH anchors are already in use, use the seat belt to install a child restraint system in the second center seat (8-passenger models).
- When securing some types of child restraint systems in rear seats, it may not be possible to properly use the seat belts in positions next to the child restraint without interfering with it or affecting seat belt effectiveness. Be sure your seat belt fits snugly across your shoulder and low on your hips. If it does not, or if it interferes with the child restraint, move to a different position. Failure to do so may result in death or serious injury.
- If the seat is adjusted, reconfirm the security of the child restraint system.

**Using an anchor bracket (for top tether strap)****■ Anchor brackets (for top tether strap)**

Anchor brackets are provided for the following seats:

Use anchor brackets when fixing the top tether strap.

- ▶ Second seats (8-passenger models)

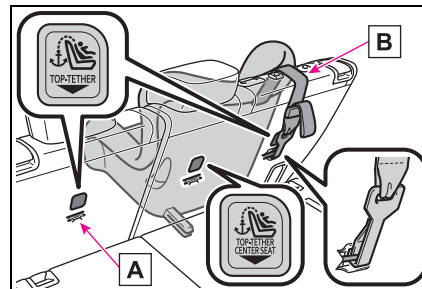

**A** Anchor brackets

**B** Top tether strap

- ▶ Second seats (7-passenger models)

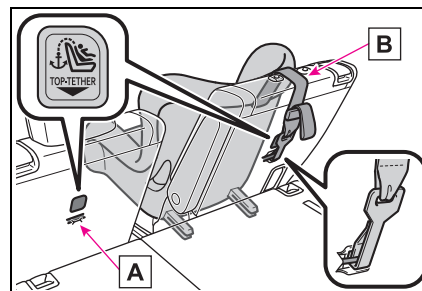

**A** Anchor brackets

**B** Top tether strap

▶ Third center and right seats

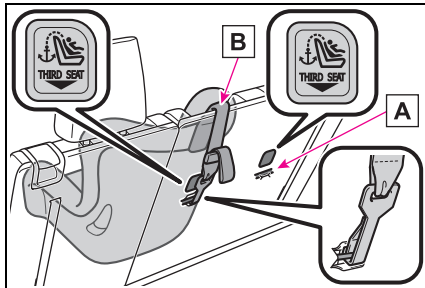

**A** Anchor brackets

**B** Top tether strap

■ **Fixing the top tether strap to the anchor bracket**

Install the child restraint system in accordance to the operation manual enclosed with the child restraint system.

- 1 Remove the head restraint if it interferes with your child restraint system. (→P.147)

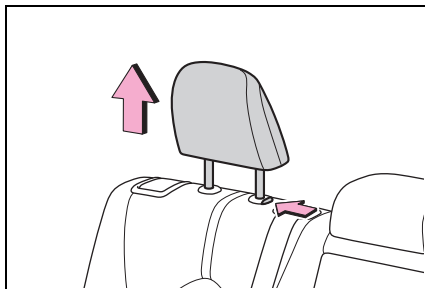

- 2 Latch the hook onto the anchor bracket and tighten the top tether strap.

Make sure the top tether strap is securely latched. (→P.61)  
When installing the child restraint system with the head restraint being raised, be sure to have the top tether strap pass underneath the head restraint.

▶ Second seats (8-passenger models)

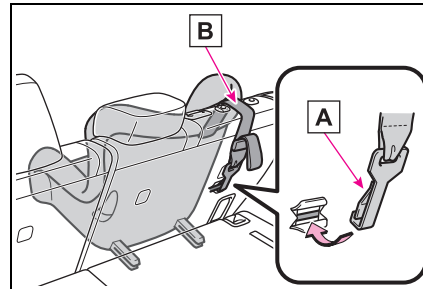

**A** Hook

**B** Top tether strap

▶ Second seats (7-passenger models)

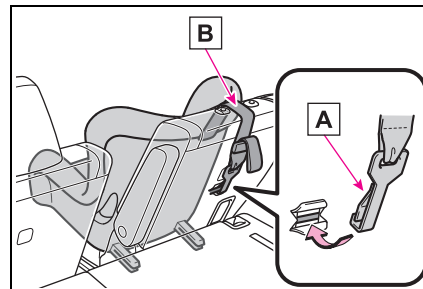

**A** Hook

**B** Top tether strap

▶ Third center and right seats

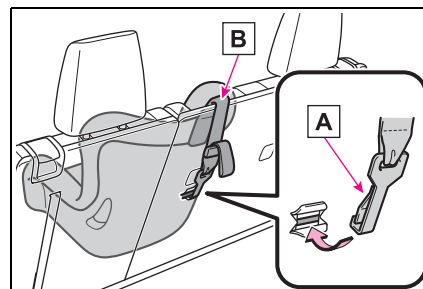

**A** Hook

**B** Top tether strap

**■ Laws and regulations pertaining to anchors**

The LATCH system conforms to FMVSS225 or CMVSS210.2. Child restraint systems conforming to FMVSS213 or CMVSS213 specifications can be used. This vehicle is designed to conform to SAE J1819.

- If the seat is adjusted, reconfirm the security of the child restraint system.

**⚠ WARNING****■ When installing a child restraint system**

Observe the following precautions.

Failure to do so may result in death or serious injury.

- Firmly attach the top tether strap and make sure that the belt is not twisted.
- Do not attach the top strap to anything other than the anchor bracket.
- Follow all installation instructions provided by the child restraint system manufacturer.
- When installing the child restraint system with the head restraint being raised, after the head restraint has been raised and then the anchor bracket has been fixed, do not lower the head restraint.
- When installing a child restraint system in the rear center seat, adjust both seat cushions to the same position and align both seatbacks at the same angle. The seatbacks must be adjusted to the same angle. Otherwise, the child restraint system cannot be securely restrained and this may cause death or serious injuries in the event of sudden braking, sudden swerving or an accident.

## Safety Connect

Safety Connect is a subscription-based telematics service that uses Global Positioning System (GPS) data and embedded cellular technology to provide safety and security features to subscribers. Safety Connect is supported by Toyota's designated response center, which operates 24 hours per day, 7 days per week.

Safety Connect service is available by subscription on select, telematics hardware-equipped vehicles.

By using the Safety Connect service, you are agreeing to be bound by the Telematics Subscription Service Agreement and its Terms and Conditions, as in effect and amended from time to time, a current copy of which is available at [Toyota.com](http://Toyota.com) in the United States, [Toyotapr.com](http://Toyotapr.com) in Puerto Rico and [Toyota.ca](http://Toyota.ca) in Canada. All use of the Safety Connect service is subject to such then-applicable Terms and Conditions.

## System components

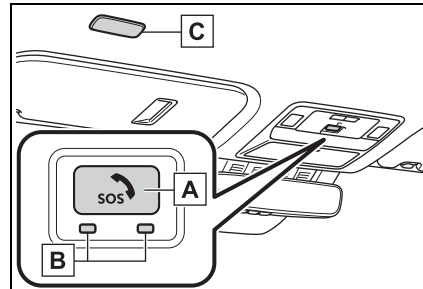

- A "SOS" button
- B LED light indicators
- C Microphone

## Services

Subscribers have the following Safety Connect services available:

- Automatic Collision Notification\*

Helps drivers receive necessary response from emergency service providers. (→P.70)

\*: U.S. Patent No. 7,508,298 B2

- Stolen Vehicle Location

Helps drivers in the event of vehicle theft. (→P.70)

- Emergency Assistance Button ("SOS")

Connects drivers to response-center support. (→P.70)

- Enhanced Roadside Assistance

Provides drivers various on-road assistance. (→P.71)

## Subscription

After you have signed the Telematics Subscription Service Agreement and are enrolled, you can begin receiving services.

A variety of subscription terms are available for purchase. Contact your Toyota dealer, call the following appropriate Customer Experience Center or push the “SOS” button in your vehicle for further subscription details.

- The United States

1-800-331-4331

- Canada

1-888-869-6828

- Puerto Rico

1-877-855-8377

### ■ Safety Connect Services Information

- Phone calls using the vehicle’s Bluetooth® technology will not be possible when Safety Connect is active and in use.
- Safety Connect is available beginning Fall 2009 on select Toyota models (in the contiguous United States only). Contact with the Safety Connect response center is dependent upon the telematics device being in operative condition, cellular connection availability, and GPS satellite signal reception, which can limit the ability to reach the response center or receive emergency service support. Enrollment and Telematics Subscription Service Agreement are required. A variety of subscription terms are available; charges

vary by subscription term selected and location.

- Automatic Collision Notification, Emergency Assistance and Stolen Vehicle Location are available in the United States, including Hawaii and Alaska, Puerto Rico and Canada, and Enhanced Roadside Assistance are available in the United States, Puerto Rico and Canada.
- Automatic Collision Notification, Emergency Assistance, Stolen Vehicle and Enhanced Road Assistance are not available in the U.S. Virgin Islands. For vehicles first sold in the U.S. Virgin Islands, no Safety Connect services will function in or outside the U.S. Virgin Islands.
- Safety Connect services are not subject to section 255 of the Telecommunications Act and the device is not TTY compatible.

### ■ Languages

The Safety Connect response center will offer support in multiple languages. The Safety Connect system will offer voice prompts in English, Spanish, and French. Please indicate your language of choice when enrolling.

### ■ When contacting the response center

You may be unable to contact the response center if the network is busy.

## Safety Connect LED light Indicators

When the engine switch is turned to ON, the red indicator light comes on for 2 seconds then turns off. Afterward, the green indicator light comes on, indicating that the service is

active.

The following indicator light patterns indicate specific system usage conditions:

- Green indicator light on = Active service
- Green indicator light flashing = Safety Connect call in process
- Red indicator light (except at vehicle start-up) = System malfunction (contact your Toyota dealer)
- No indicator light (off) = Safety Connect service not active

### **Safety Connect services**

#### **■ Automatic Collision Notification**

In case of either airbag deployment or severe rear-end collision, the system is designed to automatically call the response center. The responding agent receives the vehicle's location and attempts to speak with the vehicle occupants to assess the level of emergency. If the occupants are unable to communicate, the agent automatically treats the call as an emergency, contacts the nearest emergency services provider to describe the situation, and requests that assistance be sent to the location.

#### **■ Stolen Vehicle Location**

If your vehicle is stolen, Safety Connect can work with local authorities to assist them in locating and recovering the vehicle. After filing a police report, call the Customer Experience Center at 1-800-331-4331 in the United States, 1-877-855-8377 in Puerto Rico or 1-888-869-6828 in Canada, and follow the prompts for Safety Connect to initiate this service.

In addition to assisting law enforcement with recovery of a stolen vehicle, Safety-Connect-equipped vehicle location data may, under certain circumstances, be shared with third parties to locate your vehicle. Further information is available at [Toyota.com](http://Toyota.com) in the United States, [Toyotapr.com](http://Toyotapr.com) in Puerto Rico and [Toyota.ca](http://Toyota.ca) in Canada.

#### **■ Emergency Assistance Button (“SOS”)**

In the event of an emergency on the road, push the “SOS” button to reach the Safety Connect response center. The answering agent will determine your vehicle's location, assess the emergency, and dispatch the necessary assistance required.

If you accidentally press the “SOS” button, tell the response-center agent that you are not experiencing an emergency.

### ■ Enhanced Roadside Assistance

Enhanced Roadside Assistance adds GPS data to the already included warranty-based Toyota roadside service.

Subscribers can press the “SOS” button to reach a Safety Connect response-center agent, who can help with a wide range of needs, such as: towing, flat tire, fuel delivery, etc. For a description of the Enhanced Roadside Assistance services and their limitations, please see the Safety Connect Terms and Conditions, which are available at [Toyota.com](http://Toyota.com) in the United States, [Toyotapr.com](http://Toyotapr.com) in Puerto Rico and [Toyota.ca](http://Toyota.ca) in Canada.

### Safety information for Safety Connect

Important! Read this information before using Safety Connect.

#### ■ Exposure to radio frequency signals

The Safety Connect system installed in your vehicle is a low-power radio transmitter and receiver. It receives and also sends out radio frequency (RF) signals.

In August 1996, the Federal Communications Commission (FCC) adopted RF exposure guidelines with safety levels for

mobile wireless phones. Those guidelines are consistent with the safety standards previously set by the following U.S. and international standards bodies.

- ANSI (American National Standards Institute) C95.1 [1992]
- NCRP (National Council on Radiation Protection and Measurement) Report 86 [1986]
- ICNIRP (International Commission on Non-Ionizing Radiation Protection) [1996]

Those standards were based on comprehensive and periodic evaluations of the relevant scientific literature. Over 120 scientists, engineers, and physicians from universities, and government health agencies and industries reviewed the available body of research to develop the ANSI Standard (C95.1).

The design of Safety Connect complies with the FCC guidelines in addition to those standards.

#### ■ Free/Open Source Software Information

This product contains Free/Open Source Software (FOSS).

The license information and/or the source code of such FOSS can be found at the following URL.

<https://opensource.lge.com/osSch/list?types=ALL&search=TL21BNU>

### Engine immobilizer system

The vehicle's keys have built-in transponder chips that prevent the engine from starting if a key has not been previously registered in the vehicle's on-board computer.

Never leave the keys inside the vehicle when you leave the vehicle.

This system is designed to help prevent vehicle theft but does not guarantee absolute security against all vehicle thefts.

### Operating the system

The indicator light flashes after the engine switch has been turned off to indicate that the system is operating.

The indicator light stops flashing after the engine switch has been turned to ACC or ON to indicate that the system has been canceled.

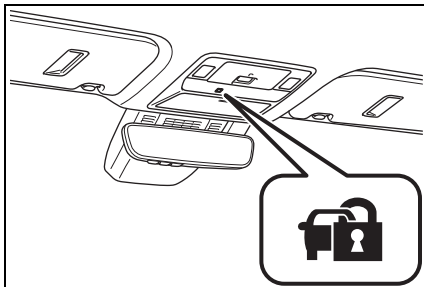

### System maintenance

The vehicle has a maintenance-free type engine immobilizer system.

### Conditions that may cause the system to malfunction

- If the grip portion of the key is in contact with a metallic object
- If the key is in close proximity to or touching a key registered to the security system (key with a built-in transponder chip) of another vehicle



### NOTICE

#### To ensure the system operates correctly

Do not modify or remove the system. If modified or removed, the proper operation of the system cannot be guaranteed.



## Alarm

**The alarm uses light and sound to give an alert when an intrusion is detected. The alarm is triggered in the following situations when the alarm is set:**

- A locked door or back door is unlocked or opened in any way other than using the entry function, wireless remote control or mechanical key. (The doors will lock again automatically.)
- The hood is opened.

### Setting/deactivating/stopping the alarm system

#### ■ Items to check before locking the vehicle

To prevent unexpected triggering of the alarm and vehicle theft, make sure of the following:

- Nobody is in the vehicle.
- The windows and panoramic moon roof (if equipped) are closed before the alarm is set.
- No valuables or other personal items are left in the vehicle.

#### ■ Setting

Close the doors, back door and hood, and lock all the doors. The system will be set automatically after 30 seconds.

The indicator light changes from being on to flashing when the system is set.

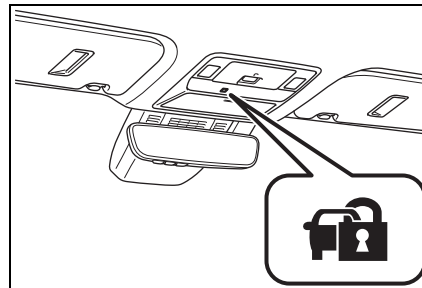

#### ■ Deactivating or stopping

Do one of the following to deactivate or stop the alarms:

- Unlock the doors.
- Turn the engine switch to ACC or ON, or start the engine. (The alarm will be deactivated or stopped after a few seconds.)

#### ■ Setting the alarm

The alarm can be set if all the doors are closed even with the hood open.

#### ■ System maintenance

The vehicle has a maintenance-free type alarm system.

#### ■ Triggering of the alarm

The alarm may be triggered in the following situations: (Stopping the alarm deactivates the alarm system.)

- A person inside the vehicle opens a door, the back door or hood, or unlocks the vehicle.

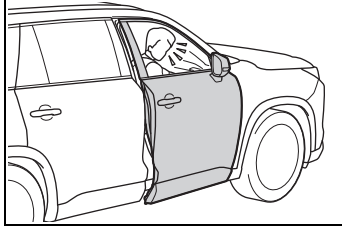

- The battery is recharged or replaced when the vehicle is locked. (→P.508)

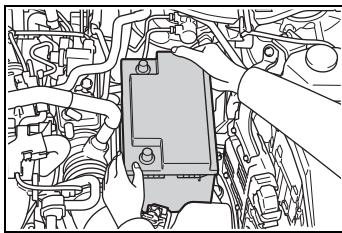

■ Alarm-operated door lock

In the following cases, depending on the situation, the door may automatically lock to prevent improper entry into the vehicle:

- When a person remaining in the vehicle unlocks the door and the alarm is activated.
- While the alarm is activated, a person remaining in the vehicle unlocks the door.
- When recharging or replacing the battery

 NOTICE

■ To ensure the system operates correctly

Do not modify or remove the system. If modified or removed, the proper operation of the system cannot be guaranteed.

**Pre-alarm**

If a door is unlocked with the mechanical key while the alarm is being set, the pre-alarm will

sound for 10 seconds.

If either the door is locked again or the pre-alarm is stopped within those 10 seconds, an alarm will sound.

Do any of the following in order to deactivate or stop the pre-alarm:

- Close the doors, and lock all doors by smart key system or wireless remote control.
- Turn the engine switch to ACC or ON, or start the engine. (The alarm will be deactivated or stopped after a few seconds.)

## Vehicle status information and indicators

2

75

### 2-1. Instrument cluster

- Warning lights and indicators ..... 76
- Gauges and meters (7-inch display)..... 81
- Gauges and meters (12.3-inch display)..... 84
- Multi-information display (7-inch display)..... 89
- Multi-information display (12.3-inch display)..... 95
- Head-up display ..... 102
- Fuel consumption information ..... 106













2















Vehicle status information and indicators





**Warning lights**

Warning lights inform the driver of malfunctions in the indicated vehicle's systems.

-  Brake system warning light\*<sup>1</sup> (→P.477)
-  Brake system warning light\*<sup>1</sup> (→P.477)  
(Canada)
-  Brake system warning light\*<sup>1</sup> (→P.477)  
(yellow)
-  High coolant temperature warning light\*<sup>2</sup> (→P.477)
-  Charging system warning light\*<sup>2</sup> (→P.478)
-  Low engine oil pressure warning light\*<sup>2</sup> (→P.478)
-  Malfunction indicator lamp\*<sup>1</sup> (→P.478)  
(U.S.A.)
-  Malfunction indicator lamp\*<sup>1</sup> (→P.478)  
(Canada)
-  SRS warning light\*<sup>1</sup> (→P.478)
-  ABS warning light\*<sup>1</sup> (→P.479)  
(U.S.A.)
-  ABS warning light\*<sup>1</sup> (→P.479)  
(Canada)
-  Inappropriate pedal operation warning light\*<sup>2</sup> (→P.479)
-  Electric power steering system warning light\*<sup>1</sup> (red/yellow)

-  Low fuel level warning light(→P.479)
-  Driver's and front passenger's seat belt reminder light (→P.480)
-  Rear passengers' seat belt reminder light (→P.480)
-  Tire pressure warning light\*<sup>1</sup> (→P.481)
-  Stop & Start cancel indicator\*<sup>1</sup> (→P.481)  
(flashes)
-  PCS warning light\*<sup>1</sup> (→P.481)
-  LTA indicator (→P.481)  
(yellow)
-  LDA indicator (→P.482)  
(yellow)
-  PDA indicator (→P.482)  
(yellow)
-  Dynamic radar cruise control indicator (→P.482)  
(yellow)
-  Cruise control indicator (→P.482)  
(yellow)
-  Driving assist information indicator\*<sup>1</sup> (→P.483)
-  Intuitive parking assist OFF indicator\*<sup>1</sup> (if equipped) (→P.483)
-  Slip indicator\*<sup>1</sup> (→P.484)

 Parking brake indicator\*<sup>1</sup>  
(flashes) (→P.484)  
(U.S.A.)

 Parking brake indicator\*<sup>1</sup>  
(flashes) (→P.484)  
(Canada)

 Brake hold operated indicator\*<sup>1</sup> (→P.484)  
(flashes)

\*<sup>1</sup>: These lights turn on when the engine switch is turned to ON to indicate that a system check is being performed. They will turn off after the engine is started, or after a few seconds. There may be a malfunction in a system if a light does not come on, or turn off. Have the vehicle inspected by your Toyota dealer.

\*<sup>2</sup>: This light illuminates on the multi-information display.

 **WARNING**

**■ If a safety system warning light does not come on**

Should a safety system light such as the ABS and SRS warning lights not come on when you start the engine, this could mean that these systems are not available to help protect you in an accident, which could result in death or serious injury. Have the vehicle inspected by your Toyota dealer immediately if this occurs.

**Indicators**

The indicators inform the driver of the operating state of the vehicle's various systems.

 Turn signal indicator  
(→P.211)

 Headlight indicator  
(→P.218)  
(U.S.A.)

 Tail light indicator  
(→P.218)  
(Canada)

 Headlight high beam indicator (→P.220)

 AHB indicator (→P.220)

 Front fog light indicator (if equipped) (→P.223)

 Stop & Start indicator\*<sup>1</sup>  
(→P.307)

 Stop & Start cancel indicator\*<sup>1, 2</sup> (→P.308)

 PCS warning light\*<sup>1, 2</sup>  
(→P.256)

 LTA indicator (→P.260)  
(green/white)

















 REC indicator (if equipped) (→P.305)





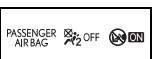

 LDA indicator (→P.269)  
(green/white)

 LDA OFF indicator (if equipped) (→P.269)

 PDA indicator (→P.275)  
(green/white)

 Dynamic radar cruise control indicator (→P.285)  
(green/white)

-  Cruise control indicator (green/white) (→P.294)
-  Driving assist information indicator \*1, 2 (→P.313, 318, 329, 335, 338)
-  Intuitive parking assist OFF indicator \*1, 2 (if equipped) (→P.323)
-  Intuitive parking assist detection indicator \*3 (if equipped) (→P.322)
-  Slip indicator \*1 (→P.355) (flashes)
-  VSC OFF indicator \*1, 2 (→P.356)
-  Parking brake indicator (U.S.A.) (→P.212)
-  Parking brake indicator (Canada) (→P.212)
-  Brake hold standby indicator \*1 (→P.216)
-  Brake hold operated indicator \*1 (→P.216)
-  Eco Driving Indicator Light (→P.91, 99)
-  Low outside temperature indicator \*4 (→P.81, 84)
-  Stop light indicator \*5
-  Outside rear view mirror indicators \*1, 6 (→P.313, 318, 329)
-  "AIR BAG ON/OFF" indicator \*7 (→P.45)
-  Security indicator \*7 (→P.73)

-  Snow mode indicator (→P.352)
-  Downhill assist control system indicator (AWD models) (→P.352)
-  Eco drive mode indicator (→P.348)
-  Sport mode indicator (→P.348)
-  Mud & sand mode indicator (AWD models) (→P.349)
-  Rock & dirt mode indicator (AWD models) (→P.349)

\*1: These lights turn on when the engine switch is turned to ON to indicate that a system check is being performed. They will turn off after the engine is started, or after a few seconds. There may be a malfunction in a system if a light does not come on, or turn off. Have the vehicle inspected by your Toyota dealer.

\*2: This light comes on when the system is turned off.

\*3: Vehicles without Multimedia Display or rear camera

\*4: When the outside temperature is approximately 37°F (3°C) or lower, this indicator will flash for approximately 10 seconds, then stay on.

\*5: This light comes on when the stop lights are illuminated by the operation of the brake pedal or the driving assist system.

\*6: This light illuminates on the outside rear view mirrors.

\*7: This light illuminates on the front interior/personal lights.

**■ Intuitive parking assist OFF indicator**

Vehicles without Multimedia Display: The indicators turn off when the shift position is changed to R regardless of whether the intuitive parking assist function is turned on or off.



## Gauges and meters (7-inch display)

## Meter display

## ■ Locations of gauges and meters

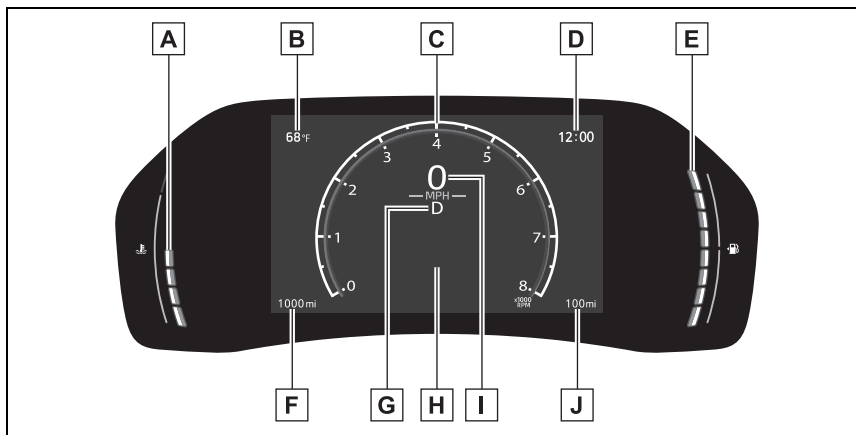

The units used on the meters may differ depending on the target region.

**A** Engine coolant temperature gauge

Displays the engine coolant temperature

**B** Outside temperature

Displays the outside temperature within the range of -40°F (-40°C) to 141°F (60°C)

**C** Speedometer/Tachometer

Tachometer: Displays the engine speed in revolutions per minute

This setting can be changed on the setting screen. (→P.93)

**D** Clock (→P.83)

**E** Fuel gauge

Displays the quantity of fuel remaining in the tank

**F** Odometer and trip meter display (→P.82)

**G** Shift position and gear position indicator (→P.207)

**H** Multi-information display

Presents the driver with a variety of vehicle data (→P.89)

Displays warning messages if a malfunction occurs (→P.488)

**I** Speedometer

**J** Driving range

Displays driving range with remaining fuel. (→P.82)

■ **Outside temperature display**

- In the following situations, the correct outside temperature may not be displayed, or the display may take longer than normal to change:
  - When stopped, or driving at low speeds (less than 12 mph [20 km/h])
  - When the outside temperature has changed suddenly (at the entrance/exit of a garage, tunnel, etc.)
- When "--" or "E" is displayed, the system may be malfunctioning. Take your vehicle to your Toyota dealer.

■ **Driving range**

- Use the displayed values as a reference only.
- This distance is computed based on your average fuel consumption. As a result, the actual distance that can be driven may differ from that displayed.
- When only a small amount of fuel is added to the tank, the display may not be updated. When refueling, turn the engine switch off. If the vehicle is refueled without turning the engine switch off, the display may not be updated.

■ **Liquid crystal display**

→P.89

■ **Free/Open Source Software Information**

This product contains Free/Open Source Software (FOSS). The license information and/or the source code of such FOSS can be found at the following URL.

<https://www.denso.com/global/en/opensource/meter/toyota/>

■ **Customization**

The meters can be customized on

 of the multi-information display. (→P.93)

 **WARNING**

■ **The information display at low temperatures**

Allow the interior of the vehicle to warm up before using the liquid crystal information display. At extremely low temperatures, the information display monitor may respond slowly, and display changes may be delayed.

For example, there is a lag between the driver's shifting and the new gear number appearing on the display. This lag could cause the driver to downshift again, causing rapid and excessive engine braking and possibly an accident resulting in death or injury.

 **NOTICE**

■ **To prevent damage to the engine and its components**

- Do not let the indicator needle of the tachometer enter the red zone, which indicates the maximum engine speed.
- The engine may be overheating if the engine coolant temperature gauge is in the red zone (H). In this case, immediately stop the vehicle in a safe place, and check the engine after it has cooled completely. (→P.512)

**Odometer and trip meter display**

■ **Display items**

- Odometer

Displays the total distance the vehicle has been driven.

- Trip meter A/trip meter B

Displays the distance the vehicle has been driven since the meter was last reset. Trip meters A and B can be used to record and display different distances independently.

- Distance until next engine oil change

Displays the distance the vehicle can be driven until an oil change is necessary.

- **Changing the display**

Each time the “ODO TRIP” switch is pressed, the displayed item will be changed. When the trip meter is displayed, pressing and holding the switch will reset the trip meter.

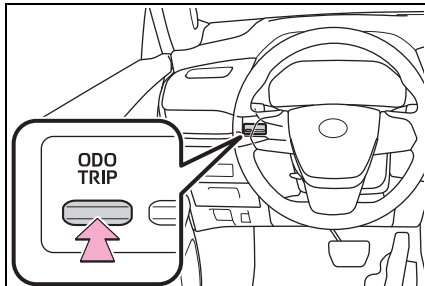

### Changing the instrument panel light brightness

The brightness of the instrument panel lights can be adjusted.

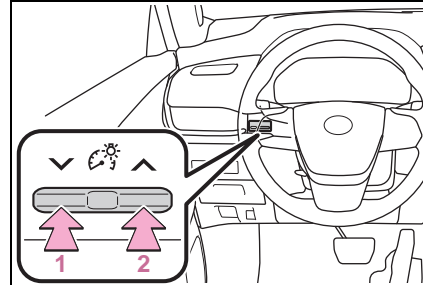

- 1 Darker
- 2 Brighter

- **Brightness of the meters (day mode and night mode)**

The brightness of the meters is changed between day mode and night mode.

- Day mode: When the tail lights are off
- Night mode: When the tail lights are on and the surrounding area is dark

When the tail lights are on but the surrounding area is bright, any adjustments made to the meter brightness levels will be applied to both modes at once.

### Adjusting the clock

The clocks can be adjusted on the multimedia display.

Refer to the “MULTIMEDIA OWNER’S MANUAL”.

## Gauges and meters (12.3-inch display)

## Meter display

## ■ Locations of gauges and meters

## ▶ 2-dial type

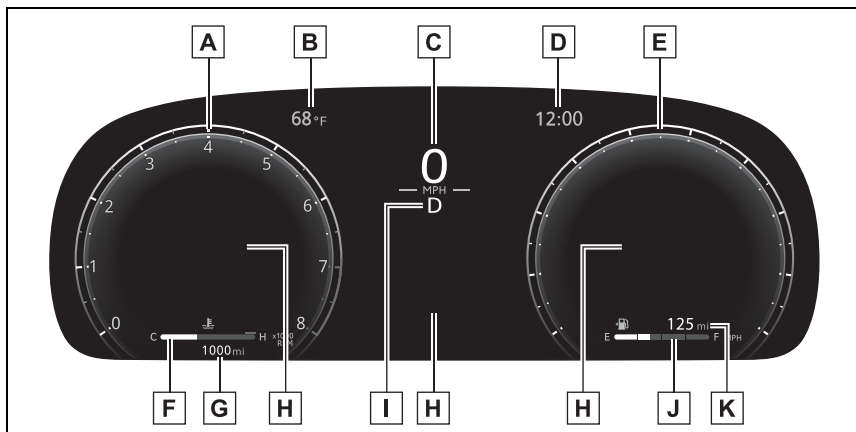

The units used on the meters may differ depending on the target region.

**A** Tachometer

Displays the engine speed in revolutions per minute

**B** Outside temperature

Displays the outside temperature within the range of -40°F (-40°C) to 141°F (60°C)

**C** Speedometer

**D** Clock (→P.88)

**E** Speedometer

**F** Engine coolant temperature gauge

Displays the engine coolant temperature

**G** Odometer and trip meter display (→P.87)

**H** Multi-information display

Presents the driver with a variety of vehicle data (→P.95)

Displays warning messages if a malfunction occurs (→P.488)

**I** Shift position and gear position indicator (→P.207)

**J** Fuel gauge

Displays the quantity of fuel remaining in the tank

**K** Driving range

Displays driving range with remaining fuel.

## ► 1-dial display

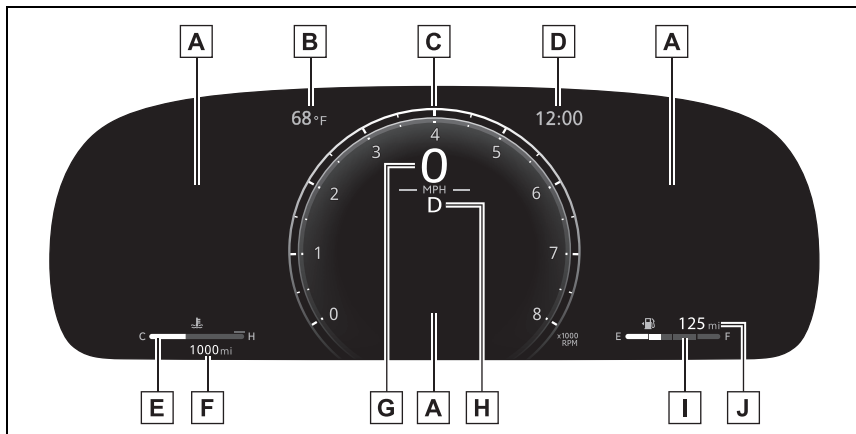

The units used on the meters may differ depending on the target region.

**A** Multi-information display

Presents the driver with a variety of vehicle data (→P.95)  
Displays warning messages if a malfunction occurs (→P.488)

**B** Outside temperature

Displays the outside temperature within the range of -40°F (-40°C) to 141°F (60°C)

**C** Speedometer/Tachometer

Tachometer: Displays the engine speed in revolutions per minute  
This setting can be changed on the setting screen. (→P.97)

**D** Clock (→P.88)**E** Engine coolant temperature gauge

Displays the engine coolant temperature

**F** Odometer and trip meter display (→P.87)**G** Speedometer**H** Shift position and gear position indicator (→P.207)**I** Fuel gauge

Displays the quantity of fuel remaining in the tank

**J** Driving range

Displays driving range with remaining fuel.

► Non-dial display

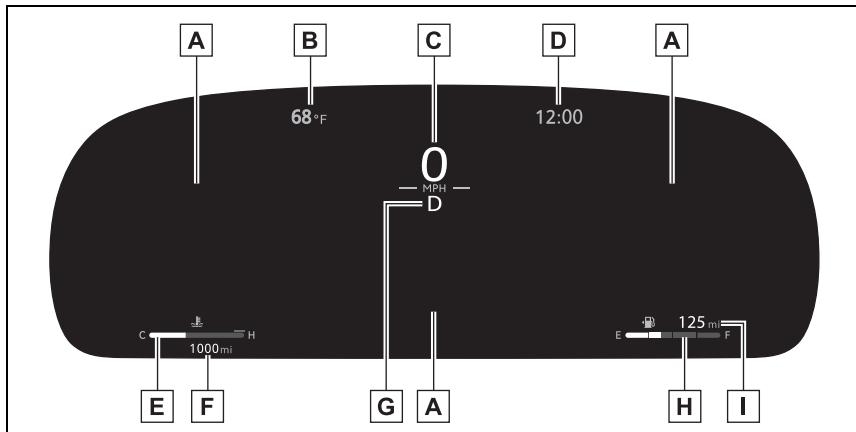

The units used on the meters may differ depending on the target region.

**A** Multi-information display

Presents the driver with a variety of vehicle data (→P.95)  
 Displays warning messages if a malfunction occurs (→P.488)

**B** Outside temperature

Displays the outside temperature within the range of -40°F (-40°C) to 141°F (60°C)

**C** Speedometer

**D** Clock (→P.88)

**E** Engine coolant temperature gauge

Displays the engine coolant temperature

**F** Odometer and trip meter display (→P.87)

**G** Shift position indicator and gear position indicator (→P.207)

**H** Fuel gauge

Displays the quantity of fuel remaining in the tank

**I** Driving range

Displays driving range with remaining fuel.

■ **Outside temperature display**

- In the following situations, the correct outside temperature may not be displayed, or the display may take longer than normal to change:
  - When stopped, or driving at low

- speeds (less than 12 mph [20 km/h])
- When the outside temperature has changed suddenly (at the entrance/exit of a garage, tunnel, etc.)
- When "--" or "E" is displayed, the system may be malfunctioning.

Take your vehicle to your Toyota dealer.

#### ■ Driving range

- Use the displayed values as a reference only.
- This distance is computed based on your average fuel consumption. As a result, the actual distance that can be driven may differ from that displayed.
- When only a small amount of fuel is added to the tank, the display may not be updated. When refueling, turn the engine switch off. If the vehicle is refueled without turning the engine switch off, the display may not be updated.

#### ■ Liquid crystal display

→P.95

#### ■ Free/Open Source Software Information

This product contains Free/Open Source Software (FOSS). The license information and/or the source code of such FOSS can be found at the following URL.

<https://www.denso.com/global/en/opensource/meter/toyota/>

#### ■ Customization

The gauges and meters can be customized in  of the multi-information display. (→P.97)



#### WARNING

##### ■ The information display at low temperatures

Allow the interior of the vehicle to warm up before using the liquid crystal information display. At extremely low temperatures, the information display monitor may respond slowly, and display changes may be delayed.

For example, there is a lag between the driver's shifting and the new gear number appearing on the display. This lag could cause the driver to downshift again, causing rapid and excessive engine braking and possibly an accident resulting in death or injury.



#### NOTICE

##### ■ To prevent damage to the engine and its components

- Do not let the indicator needle of the tachometer enter the red zone, which indicates the maximum engine speed.
- The engine may be overheating if the engine coolant temperature gauge is in the red zone (H). In this case, immediately stop the vehicle in a safe place, and check the engine after it has cooled completely. (→P.512)

### Odometer and trip meter display

#### ■ Display items

- Odometer

Displays the total distance the vehicle has been driven.

- Trip meter A/Trip meter B

Displays the distance the vehicle has been driven since the meter was last reset. Trip meters A and B can be used to record and display different distances independently.

- Distance until next engine oil change

Displays the distance the vehicle can be driven until an oil change is

necessary.

### ■ Changing the display

Each time the “ODO TRIP” switch is pressed, the displayed item will be changed. When the trip meter is displayed, pressing and holding the switch will reset the trip meter.

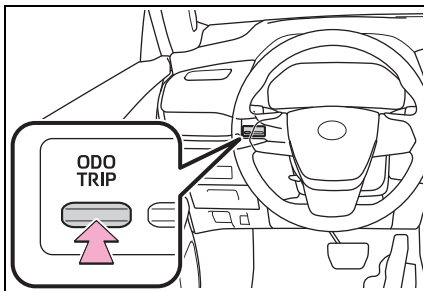

### ■ Changing the instrument panel light brightness

The brightness of the instrument panel lights can be adjusted.

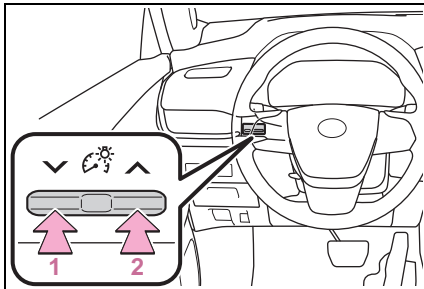

1 Darker

2 Brighter

### ■ Brightness of the meters (day mode and night mode)

The brightness of the meters is changed between day mode and night mode.

● Day mode: When the tail lights are

off

● Night mode: When the tail lights are on and the surrounding area is dark

When the tail lights are on but the surrounding area is bright, any adjustments made to the meter brightness levels will be applied to both modes at once.

### ■ Adjusting the clock

■ The clocks can be adjusted on the multimedia display.

Refer to the “MULTIMEDIA OWNER’S MANUAL”.



## Multi-information display (7-inch display)

### Display and menu icons

#### ■ Display

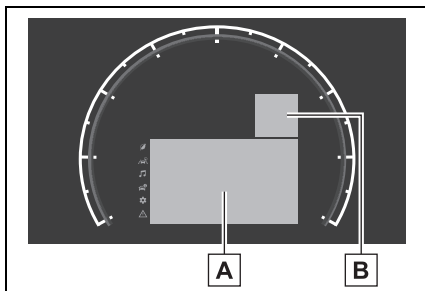

#### A Content display area

By selecting menu icons on the multi-information display, a variety of driving-related information can be displayed. The multi-information display can also be used to change display settings and other vehicle settings.

Warning or advice pop-up displays are also displayed in certain situations.



#### B Driving support system status display area







Displays an image when the following systems are operating and a menu icon other than  is selected:

- PCS (Pre-Collision System) (→P.245)
- LTA (Lane Tracing Assist) (→P.257)
- LDA (Lane Departure Alert) (→P.265)
- LCA (Lane Change Assist) (if equipped) (→P.262)

- Dynamic radar cruise control (→P.282)
- Cruise control (→P.294)
- PDA (Proactive driving assist) (→P.271)

#### ■ Menu icons

The menu icons will be displayed by pressing the  or  meter control switch.

- |   |  |
|---|--|
|    | Driving information display (→P.90)                |
|    | Driving support system information display (→P.91) |
|    | Audio system-linked display (→P.92)                |
|  | Vehicle information display (→P.92)                |
|  | Settings display (→P.93)                           |
|  | Warning message display (→P.488)                   |

#### ■ Liquid crystal display

Small spots or light spots may appear on the display. This phenomenon is characteristic of liquid crystal displays, and there is no problem continuing to use the display.

#### WARNING

##### ■ Caution for use while driving

- When operating the multi-information display while driving, pay extra attention to the safety of the area around the vehicle.
- Do not look continuously at the multi-information display while driving as you may fail to see pedestrians, objects on the road, etc. ahead of the vehicle.

**⚠ WARNING**

■ The information display at low temperatures

→P.82

**Changing the meter display**

The multi-information display is operated using the meter control switches.

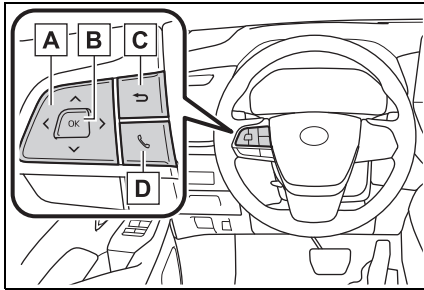

- A** ▲/▼ : Select menu icons, scroll the screen and move the cursor  
     ◀ / ▶ : Change displayed content, scroll the screen and move the cursor
- B** Press: Enter/Set  
     Press and hold: Reset/Display customizable items
- C** Return to the previous screen
- D** Call sending/receiving and history display

Linked with the hands-free system, sending or receiving call is displayed. For details regarding the hands-free system, refer to the "MULTIMEDIA OWNER'S MANUAL".

**Content of driving information****■ Display items**

- Fuel economy
- Eco Driving Indicator

**■ Fuel economy**

Use the displayed values as a reference only.

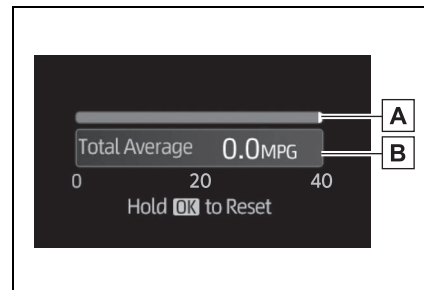

- A** Current fuel consumption  
     Displays instantaneous current fuel consumption.
- B** Average fuel economy  
     The average fuel economy display can be changed in ⚙️. (→P.93)
  - Average fuel economy (after reset)  
     Displays average fuel consumption since display was reset.  
     To reset the average fuel economy display, press and hold the OK meter control switch.
  - Average fuel economy (after start)  
     Displays the average fuel consumption since engine start.
  - Average fuel economy (after refuel)

Displays the average fuel consumption since the vehicle was refueled.

### ■ Eco Driving Indicator

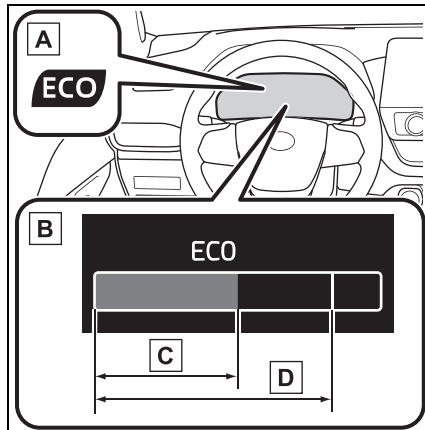

**A** Eco Driving Indicator Light  
During Eco-friendly acceleration (Eco driving), the Eco Driving Indicator Light will turn on. When the acceleration exceeds the Zone of Eco driving, or when the vehicle is stopped, the light turns off.

**B** Eco Driving Indicator Zone Display

Suggests the Zone of Eco driving with current Eco driving ratio based on acceleration.

**C** Eco driving ratio based on acceleration

If the acceleration exceeds the Zone of Eco driving, the right side of the Eco Driving Indicator Zone Display will illuminate.

At this time, the Eco Driving Indicator Light will turn off.

**D** Zone of Eco driving

### ■ Eco Driving Indicator

Eco Driving Indicator will not operate under the following conditions:

- The shift position is in a position other than D.
- The driving mode is set to Sport mode.
- The vehicle speed is approximately 80 mph (130 km/h) or higher.

### Driving support system information display

#### ■ Driving support system information

Select to display the operational status of the following systems:

- PCS (Pre-Collision System) (→P.245)
- LTA (Lane Tracing Assist) (→P.257)
- LDA (Lane Departure Alert) (→P.265)
- LCA (Lane Change Assist) (if equipped) (→P.262)
- Dynamic radar cruise control (→P.282)
- Cruise control (→P.294)
- PDA (Proactive driving assist) (→P.271)

#### ■ Navigation system-linked display

Select to display the following navigation system-linked information:

- Route guidance to destination

- Compass display

### Audio system-linked display

Select to enable selection of an audio source or track on the meter using the meter control switches.

This menu icon can be set to be displayed/not displayed in .

### Vehicle information display

#### ■ Display items

- Drive information
- Tire Pressure (→P.445)
- AWD operation status display (AWD models)

#### ■ Drive information

Displays drive information such as the following:

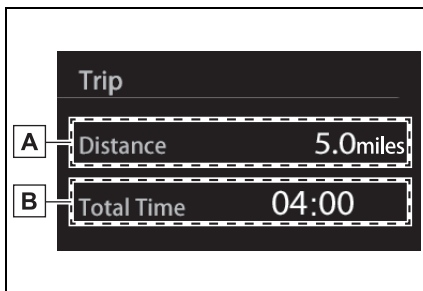

**A** Drive information 1

**B** Drive information 2

Displays the following depending on which drive information type and drive information items were selected in . (→P.93)

#### ● After start

- Distance: Displays the distance driven since engine start
- Elapsed time: Displays the elapsed time since engine start
- Average vehicle speed: Displays the average vehicle speed since engine start

#### ● After reset

- Distance: Displays the distance driven since the display was reset\*
- Elapsed time: Displays the elapsed time since the display was reset\*
- Average vehicle speed: Displays the average vehicle speed since the display was reset\*

\*: To reset, display the desired item and press and hold the OK meter control switch.

#### ■ AWD operation status display (AWD models)

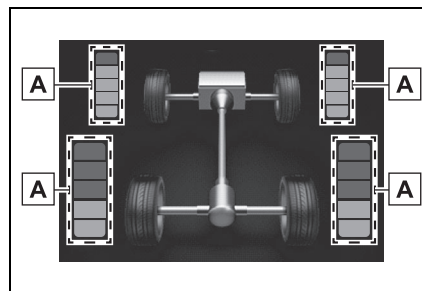

The illustration used is intended as an example, and may differ from the image that is actually displayed on the multi-information display.

**A** Torque distribution display

Displays the drive status of each

wheel in 6 steps from 0 to 5.

### Settings display

#### ■ Meter display settings that can be changed

- Stop light indicator

Select to enable/disable the stop light indicator.

- Language

Select to change the language displayed.

- Units

Select to change the units of measure displayed.

- Meter Type

Select to change the meter type.

- Dial Type

Select to change the display of the speedometer or tachometer.

- Eco Driving Indicator Light

Select to enable/disable the Eco Driving Indicator Light.

- 

Fuel economy display

Select to change the average fuel consumption display to any of the following: trip average/total average/tank average. (→P.90)

- 

Select to display/not display the audio system linked display.

- 

Select to change the displayed content of the following:

- Display contents

Select to display/not display AWD operation status display.

- Drive information type

Select to change the drive information type display between trip information/total information.

- Drive information items

Select to set the first and second items of the drive information display to any of the following: average vehicle speed/distance/elapsed time.

- Pop-up display

Select to enable/disable pop-up displays for each relevant system.

- Multi-information display off

Select to turn the multi-information display off.

To turn the multi-information display on again, press any of the following meter control switches

^ / v / < / > / OK / ↵.

- Default setting

Select to reset the meter display settings to the default setting.

#### ■ Vehicle functions and settings that can be changed

→P.538

#### ■ Suspension of the settings display

- Some settings cannot be changed while driving. When changing settings, park the vehicle in a safe place.

- If a warning message is displayed, operation of the settings display will be suspended.

 **WARNING**

■ **Cautions during setting up the display**

If the engine is running when changing the display settings, ensure that the vehicle is parked in a place with adequate ventilation. In a closed area such as a garage, exhaust gases including harmful carbon monoxide (CO) may collect and enter the vehicle. This may lead to death or a serious health hazard.

 **NOTICE**

■ **During setting up the display**

To prevent battery discharge, ensure that the engine is running while setting up the display features.

**Suggestion function**

Displays suggestions to the driver in the following situations. To select a response to a displayed suggestion, use the meter control switches.

■ **Suggestion to enable the power back door**

If the power back door system is disabled (setting on the multi-information display set to off) and the power back door switch on the instrument panel is operated, a suggestion message will be displayed asking if you wish to enable the power back door system.

To enable the power back door system, select "Yes".

After enabling the power back door system, press the power back door switch again to open or close the power back door.

## Multi-information display (12.3-inch display)

### Display

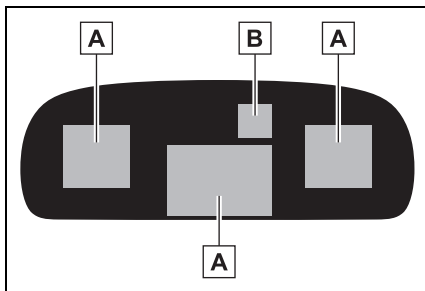

#### A Content display area

A variety of driving-related information can be displayed. The multi-information display can also be used to change display settings and other vehicle settings.

Warning or advice pop-up displays are also displayed in certain situations.

#### B Driving support system status display area

Displays a contracted display of the driving support system status when not selected for the multi-information display, while any of the following systems are operating:

- PCS (Pre-Collision System) (→P.245)
- LTA (Lane Tracing Assist) (→P.257)
- LDA (Lane Departure Alert) (→P.265)
- LCA (Lane Change Assist) (if equipped) (→P.262)
- Dynamic radar cruise control (→P.282)
- Cruise control (→P.294)

- PDA (Proactive Driving Assist) (→P.271)

#### Liquid crystal display

Small spots or light spots may appear on the display. This phenomenon is characteristic of liquid crystal displays, and there is no problem continuing to use the display.

### WARNING

#### Caution for use while driving

- When operating the multi-information display while driving, pay extra attention to the safety of the area around the vehicle.

- Do not look continuously at the multi-information display while driving as you may fail to see pedestrians, objects on the road, etc. ahead of the vehicle.

#### The information display at low temperatures

→P.87

### Changing the meter display

#### Meter control switch

The multi-information display is operated using the meter control switches.

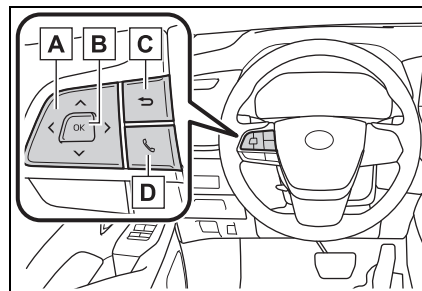

A < / > : Select multi-informa-

tion display

▲/▼: Change displayed content, scroll up/down the screen and move the cursor up/down

**B** Press: Enter/Set

Press and hold: Reset/Display customizable items

**C** Return to the previous screen

**D** Call sending/receiving and history display

Linked with the hands-free system, sending or receiving call is displayed. For details regarding the hands-free system, refer to the "MULTIMEDIA OWNER'S MANUAL".

#### ■ Changing meter pages

Press the < or > meter control switch to change the meter page.

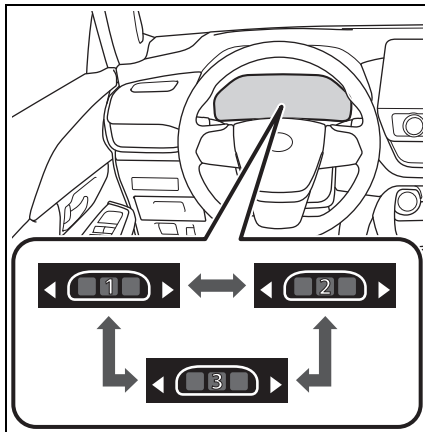

### Content of multi-information display (Center)

#### ■ Display contents

- Driving support system information display
- Navigation system-linked display
- Settings
- Warning message (→P.488)
- Blank

#### ■ Changing contents in a page

Select the desired content on the page's setting mode display.

- 1 Press the < or > meter control switch to select a page.
- 2 To enable page edit, press and hold the OK meter control switch.
- 3 Press the < or > meter control switch to select a display to be changed.
- 4 Press ▲ or ▼ meter control switch to select a content.
- 5 When the setting is complete, press ↵.

#### ■ Driving support system information display

Select to display the operational status of the following systems:

- PCS (Pre-Collision System) (→P.245)



- LTA (Lane Tracing Assist) (→P.257)
- LDA (Lane Departure Alert) (→P.265)
- LCA (Lane Change Assist) (if equipped) (→P.262)
- Dynamic radar cruise control (→P.282)
- Cruise control (→P.294)
- PDA (Proactive Driving Assist) (→P.271)

#### ■ Navigation system-linked display

Select to display the following navigation system-linked information:

- Route guidance to destination
- Street name

#### ■ Settings

- The meter display settings can be changed in .

- Stop light indicator

Select to enable/disable the stop light indicator.

- Language

Select to change the language displayed.

- Units

Select to change the units of measure displayed.

- Meter Type

Select to change the meter type.

- Meter Style

Select to change the meter style.

- Dial Type

1 dial: Select to change the display of the speedometer or tachometer.

- Eco Driving Indicator Light

Select to enable/disable the Eco Driving Indicator Light.

- Fuel Economy

Select to set the display of the fuel economy.

- Drive Info Items

Select to change the display of the drive information.

- TRIP A/B Items

Select to change the display of the drive information of TRIP A/B.

- Pop-up display

Select to enable/disable pop-up displays for each relevant system.

- Default settings

Select to reset the meter display settings to the default setting.

- Vehicle functions and settings that can be changed in



→P.538

#### ■ Street name display

Only street names which are included in the map data will be displayed.

#### ■ Suspension of the settings display

- Some settings cannot be changed while driving. When changing settings, park the vehicle in a safe place.

- If a warning message is displayed, operation of the settings display will be suspended.

**⚠ WARNING****■ Cautions during setting up the display**

If the engine is running when changing the display settings, ensure that the vehicle is parked in a place with adequate ventilation. In a closed area such as a garage, exhaust gases including harmful carbon monoxide (CO) may collect and enter the vehicle. This may lead to death or a serious health hazard.

**⚠ NOTICE****■ During setting up the display**

To prevent battery discharge, ensure that the engine is running while setting up the display features.



**Content of multi-information display (Side)****■ Display contents (Side)**

- Blank
- Fuel economy
- Eco Driving Indicator
- Driving support system information display (→P.96)
- Navigation system-linked display
- Audio system-linked display
- Drive information
- Drive information of Trip A/B
- Tire Pressure (→P.445)
- AWD operation status display (AWD models)

**■ Changing contents in a page**

→P.96

**■ Changing contents to be displayed on the side multi-information displays**

- 1 Press the < or > meter control switch to select a page.
- 2 To enable page edit, press and hold the OK meter control switch.
- 3 Press the < or > meter control switch to select the desired side multi-information display to be changed.
- 4 Press the < or > meter control switch for the side that  is displayed to move to a content list screen that enables to select display/not display each items.
- 5 Press  or  meter control switch to select a content and select OK to set for display/not display the item.

**■ Fuel economy**

Use the displayed values as a reference only.

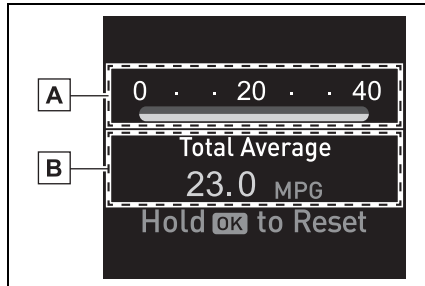

**A** Current fuel consumption  
Displays instantaneous current fuel consumption.

**B** Average fuel economy  
The average fuel economy display can be changed in .  
(→P.97)

- Average fuel economy (after start)

Displays the average fuel consumption since engine start.

- Average fuel economy (after reset)

Displays average fuel consumption since display was reset.

To reset the average fuel economy display, press and hold the OK meter control switch.

## ■ Eco Driving Indicator

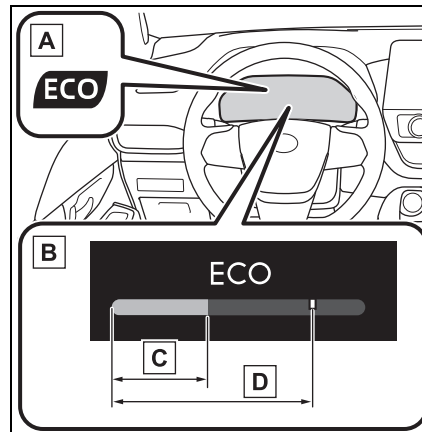

**A** Eco Driving Indicator Light  
During Eco-friendly acceleration (Eco driving), the Eco Driving Indicator Light will turn on. When the acceleration exceeds the Zone of Eco driving, or when the vehicle is stopped, the light turns off.

**B** Eco Driving Indicator Zone Display  
Suggests the Zone of Eco driving with current Eco driving ratio based on acceleration.

**C** Eco driving ratio based on acceleration

If the acceleration exceeds the Zone of Eco driving, the right side of the Eco Driving Indicator Zone Display will illuminate.

At this time, the Eco Driving Indicator Light will turn off.

**D** Zone of Eco driving

## ■ Navigation system-linked display

Select to display the following navigation system-linked information:

- Route guidance to destination
- Compass display

■ **Audio system-linked display**

Displays the audio source or track.

■ **Drive information**

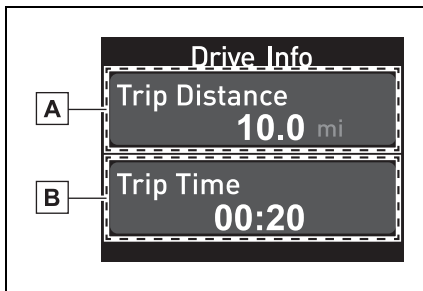

**A** Drive information 1

**B** Drive information 2

Displays the following depending on which drive information type and drive information items were selected in . (→P.97)

- Average speed: Displays the average vehicle speed since engine start
- Trip distance: Displays the distance driven since engine start
- Trip time: Displays the elapsed time since engine start

■ **Drive information of TRIP A/B**

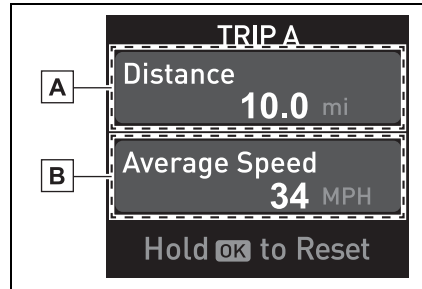

**A** Drive information of trip A/B 1

**B** Drive information of trip A/B 2

Displays the following depending on which drive information type and drive information items were selected in . (→P.97)

- Average speed: Displays the average vehicle speed of trip A/B
- Trip distance: Displays the distance driven of trip A/B
- Trip time: Displays the elapsed time of trip A/B

■ **AWD operation status display (AWD models)**

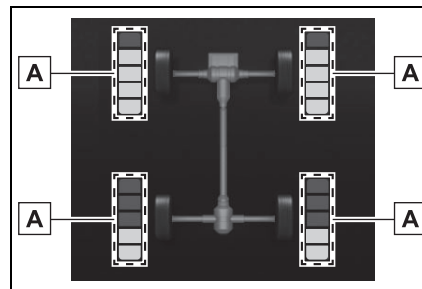

The illustration used is intended as an example, and may differ from the image that is actually displayed on the multi-information display.

**A** Torque distribution display

Displays the drive status of each wheel in 6 steps from 0 to 5.

**Eco Driving Indicator**

Eco Driving Indicator will not operate under the following conditions:

- The shift lever is in any position other than D.
- The driving mode is set to sport mode.
- The vehicle speed is approximately 80 mph (130 km/h) or higher.

**Suggestion function**

Displays suggestions to the driver in the following situations.

To select a response to a displayed suggestion, use the meter control switches.

**Suggestion to enable the power back door**

If the power back door system is disabled (setting on the multi-information display set to off) and the power back door switch on the instrument panel is operated, a suggestion message will be displayed asking if you wish to enable the power back door system.

To enable the power back door system, select "Yes".

After enabling the power back door system, press the power back door switch again to open or close the power back door.

**Customization**

Some functions can be customized. (→P.538)

**Head-up display\***

\*: If equipped

**The head-up display projects a variety of driving-related information and the operating state of the driving support systems on the windshield.**

**System components**

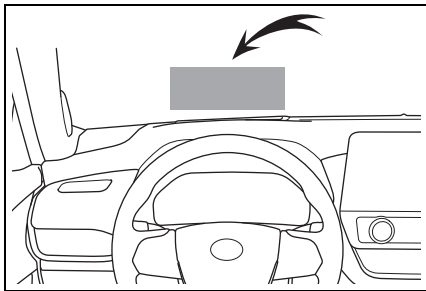

Can be changed the head-up display type.

The content displayed will differ according to the driving conditions and display mode of the head-up display. Depending on the situation, pop-up displays will also be displayed.

- Full

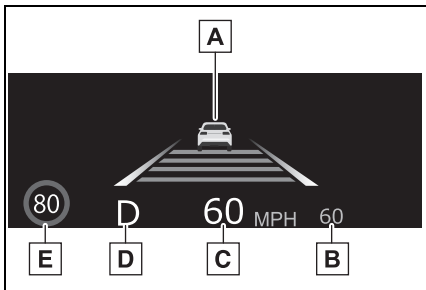

These images are examples only,

and may vary slightly from actual conditions.

**A** Content display area

- Driving support system information display (→P.105)
- Tachometer

Displays the engine speed in revolutions per minute

- Eco Driving Indicator (→P.105)

**B** Driving support system information display (→P.105)

**C** Speedometer

**D** Shift position and gear position indicator (→P.207)

**E** Speed limit/RSA (Road Sign Assist) display area (if equipped)

Displays the following items:

- Speed limit of the current road (linked to the navigation system) (U.S.A. only)
- RSA (Road Sign Assist) display (→P.280)

- Standard

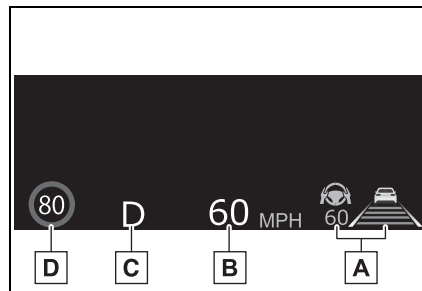

These images are examples only, and may vary slightly from actual conditions.

**A** Driving support system information display (→P.105)

**B** Speedometer

**C** Shift position and gear position indicator (→P.207)

**D** Speed limit/RSA (Road Sign Assist) display area (if equipped)

Displays the following items:

- Speed limit of the current road (linked to the navigation system) (U.S.A. only)
- RSA (Road Sign Assist) display (→P.280)

● Minimum

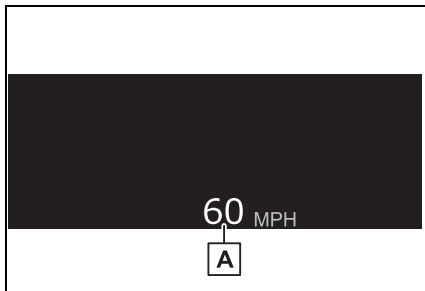

These images are examples only, and may vary slightly from actual conditions.

**A** Speedometer

**■ Head-up display will operate when**

The engine switch is in ON.

**■ When using the head-up display**

The head-up display may seem dark or hard to see when viewed through sunglasses, especially polarized sunglasses. Adjust the brightness of the head-up display or remove your sunglasses.

**⚠ WARNING**

**■ Before using the head-up display**

- Check that the position and brightness of the head-up display image does not interfere with safe driving. Incorrect adjustment of the image's position or brightness may obstruct the driver's view and lead to an accident, resulting in death or serious injury.
- Do not continuously look at the head-up display while driving as you may fail to see pedestrians, objects on the road, etc. ahead of the vehicle.

**⚠ NOTICE**

**■ To prevent damage to components**

- Do not place any drinks near the head-up display projector. If the projector gets wet, electrical malfunctions may result.

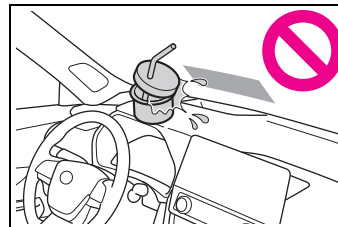

- Do not place anything on or put stickers onto the head-up display projector. Doing so could interrupt head-up display indications.
- Do not touch the inside of the head-up display projector or thrust sharp edges or the like into the projector. Doing so could cause mechanical malfunctions.

**Using the head-up display**

■ **Changing settings of the head-up display**

Select  on the multi-information display (→P.97) and then “HUD Main”.

■ **Enabling/disabling the head-up display**

Press the OK meter control switch to enable/disable the head-up display.

■ **Changing the head-up display settings**

Press and hold OK meter control switch to change the following settings:

- Brightness and vertical position of the head-up display

Select to adjust the brightness and vertical position of the head-up display.

- Display type

Select to change the display type of the head-up display (→P.102)

- Display angle

Select to adjust the angle of the head-up display.

■ **Enabling/disabling of the head-up display**

If the head-up display is disabled, it will remain disabled when the engine switch is turned off then back to ON.

■ **Display brightness**

The brightness of the head-up display

can be adjusted on  of the multi-information display. Also, it is automatically adjusted according to the ambient brightness.

■ **Automatic adjustment of the head-up display position (vehicles with driving position memory)**

A desired head-up display position can be entered to memory and recalled automatically by the driving position memory system. (→P.171)

■ **When the battery is disconnected**

The customize settings of the head-up display will be reset.

■ **Customization**

Some functions can be customized. (→P.538)

 **WARNING**

■ **Caution for changing settings of the head-up display**

As the engine needs to be running while changing the settings of the head-up display, ensure that the vehicle is parked in a place with adequate ventilation. In a closed area such as a garage, exhaust gases including harmful carbon monoxide (CO) may collect and enter the vehicle. This may lead to death or a serious health hazard.

 **NOTICE**

■ **When changing the settings of the head-up display**

To prevent battery discharge, ensure that the engine is running while the changing the settings of the head-up display.



**Driving support system information display**

Displays the operational status of the following systems:

- PCS (Pre-Collision System) (→P.245)
- LTA (Lane Tracing Assist) (→P.257)
- LDA (Lane Departure Alert) (→P.265)
- LCA (Lane Change Assist) (if equipped) (→P.262)
- PDA (Proactive driving assist) (→P.271)
- Dynamic radar cruise control (→P.282)
- Cruise control (→P.294)

Details of content displayed on the head-up display may differ from that displayed on the multi-information display. For details, refer to the explanation of each system.

**Pop-up display**

Pop-up displays for the following systems will be displayed when necessary:

■ **Driving support systems**

Displays a warning/suggestion/advice message or the operating state of a relevant system.

■ **Navigation system-linked display area**

Displays the following items

which are linked to the navigation system:

- Street name
- Route guidance to destination

■ **Warning message**

Some warning messages are displayed when necessary, according to certain conditions.

Details of content displayed on the head-up display may differ from that displayed on the multi-information display.

■ **When a pop-up display is displayed**

When a pop-up display is displayed, a current display may no longer be displayed. In this case, the display will return after the pop-up display disappears.

■ **Street name display**

Only street names which are included in the map data will be displayed.

**Eco Driving Indicator/Tachometer**

■ **Eco Driving Indicator**

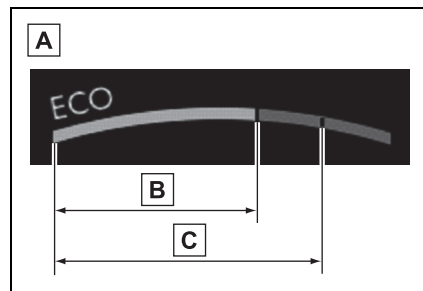

A Eco Driving Indicator Zone Display

B Eco driving ratio based on

2  
Vehicle status information and indicators

acceleration

**C** Zone of Eco driving

Displayed content is the same as that displayed on the multi-information display (Eco Driving Indicator). For details, refer to P.99.

■ **Tachometer**

Displays the engine speed in revolutions per minute.

■ **Eco Driving Indicator or tachometer is displayed when**

- Eco Driving Indicator is displayed when all of the following conditions are met:
  - Driving support system information (→P.105) is not displayed.
  - When other than Sport mode is selected.
  - Full mode (→P.102) is selected as head-up display type.
- Tachometer is displayed when all of the following conditions are met:
  - Driving support system information (→P.105) is not displayed.
  - When Sport mode is selected.
  - Full mode (→P.102) is selected as head-up display type.

Fuel consumption information

**Fuel consumption information can be displayed on the Multimedia Display.**

System components

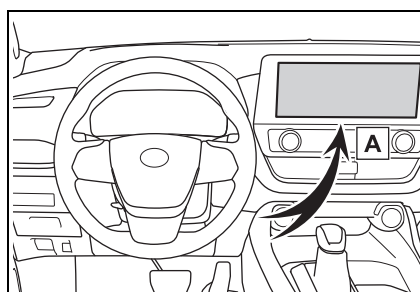

**A** Multimedia Display

Consumption

■ **Trip information**

- 1 Select on the main menu.
- 2 Select "Trip information".

If a screen other than "Current" is displayed, select "Current".

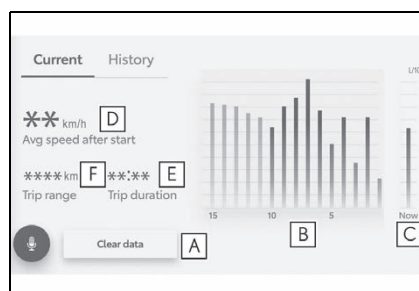

**A** Resetting the consumption data

**B** Fuel consumption in the past

15 minutes

- C** Current fuel consumption
- D** Average vehicle speed since the engine was started.
- E** Elapsed time since the engine was started.
- F** Cruising range

Use the displayed average fuel consumption as a reference.

The image is an example only, and may vary slightly from actual conditions.

**History**

- 1 Select  on the main menu.
- 2 Select "Trip information".

If a screen other than "History" is displayed, select "History".

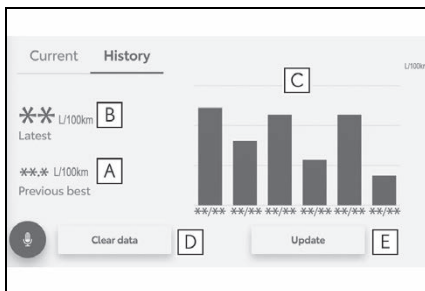

- A** Best recorded fuel consumption
- B** Latest fuel consumption
- C** Previous fuel consumption record
- D** Resetting the history data
- E** Updating the latest fuel consumption data

Use the displayed average fuel consumption as a reference.

The image is an example only, and may vary slightly from actual conditions.

**Updating the history data**

Update the latest fuel consumption by selecting "Update" to measure the current fuel consumption again.

**Resetting the data**

The fuel consumption data can be deleted by selecting "Clear data".

**Cruising range**

Displays the estimated maximum distance that can be driven with the quantity of fuel remaining.

This distance is computed based on your average fuel consumption. As a result, the actual distance that can be driven may differ from that displayed.



- 3-1. Key information**
- Keys ..... 110
  - Digital Key ..... 113
- 3-2. Opening, closing and locking the doors**
- Side doors ..... 115
  - Power back door ..... 119
  - Smart key system ..... 136
- 3-3. Adjusting the seats**
- Front seats ..... 141
  - Rear seats ..... 142
  - Head restraints ..... 147
- 3-4. Adjusting the steering wheel and mirrors**
- Steering wheel ..... 150
  - Inside rear view mirror ..... 151
  - Digital Rear-view Mirror ..... 152
  - Outside rear view mirrors ..... 161
- 3-5. Opening, closing the windows and moon roof**
- Power windows ..... 164
  - Panoramic moon roof.. 167
- 3-6. Favorite settings**
- Driving position memory ..... 171
  - My Settings ..... 175

## Keys

### The keys

The following keys are provided with the vehicle.

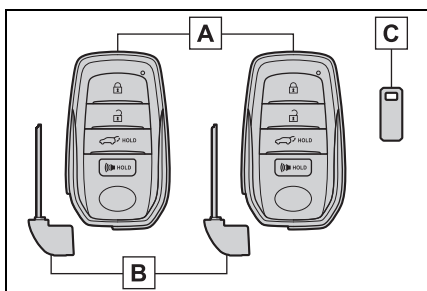

#### A Electronic keys

- Operating the smart key system (→P.136)
- Operating the wireless remote control function (→P.111)

#### B Mechanical keys

#### C Key number plate

#### ■ When riding in an aircraft

When bringing an electronic key onto an aircraft, make sure you do not press any buttons on the electronic key while inside the aircraft cabin. If you are carrying an electronic key in your bag, etc., ensure that the buttons are not likely to be pressed accidentally. Pressing a button may cause the electronic key to emit radio waves that could interfere with the operation of the aircraft.

#### ■ Electronic key battery depletion

- The standard battery life is 1 to 2 years.
- If the battery becomes low, an alarm will sound in the cabin when the engine is stopped.
- To reduce key battery depletion

when the electronic key is to not be used for long periods of time, set the electronic key to the battery-saving mode. (→P.137)

- As the electronic key always receives radio waves, the battery will become depleted even if the electronic key is not used. The following symptoms indicate that the electronic key battery may be depleted. Replace the battery when necessary.
- The smart key system or the wireless remote control does not operate.
- The detection area becomes smaller.
- The LED indicator on the key surface does not turn on.
- You can replace the battery by yourself (→P.460). However, as there is a danger that the electronic key may be damaged, it is recommended that replacement is carried out by your Toyota dealer.
- To avoid serious deterioration, do not leave the electronic key within 3 ft. (1 m) of the following electrical appliances that produce a magnetic field:
  - TVs
  - Personal computers
  - Cellular phones, cordless phones and battery chargers
  - Recharging cellular phones or cordless phones
  - Table lamps
  - Induction cookers
- If the electronic key is near the vehicle for longer than necessary, even if the smart key system is not used, the key battery may become depleted faster than normal. When not using the smart key system, it is recommended not to stay with the electronic key near the vehicle longer than necessary.

#### ■ Replacing the battery

→P.460

■ **The electronic key function is suspended when**

The electronic key function may be suspended when the electronic key is kept unmoved in a same location for a certain period, such as it is left on a same place. This is to reduce battery consumption. The function will be restored automatically when the electronic key is moved, such as it is picked up.

■ **Confirmation of the registered key number**

The number of keys already registered to the vehicle can be confirmed. Ask your Toyota dealer for details.

■ **If “A New Key has been Registered Contact Your Dealer for Details” is shown on the multi-information display**

This message will be displayed each time the driver’s door is opened when the doors are unlocked from the outside for approximately one week after a new electronic key has been registered. If this message is displayed but you have not had a new electronic key registered, ask your Toyota dealer to check if an unknown electronic key (other than those in your possession) has been registered.

	<p><b>NOTICE</b></p>
<p>■ <b>To prevent key damage</b></p> <ul style="list-style-type: none"> <li>● Do not drop the keys, subject them to strong shocks or bend them.</li> <li>● Do not expose the keys to high temperatures for long periods of time.</li> <li>● Do not get the keys wet or wash them in an ultrasonic washer, etc.</li> </ul>	

- Do not attach metallic or magnetic materials to the keys or place the keys close to such materials.

- Do not disassemble the keys.

- Do not attach a sticker or anything else to the surface of the electronic key.

- Do not place the keys near objects that produce magnetic fields, such as TVs, audio systems and induction cookers.

- Do not place the keys near medical electrical equipment such as low-frequency therapy equipment or microwave therapy equipment, and do not receive medical attention with the keys on your person.

■ **Carrying the electronic key on your person**

Carry the electronic key 3.9 in. (10 cm) or more away from electric appliances that are turned on. Radio waves emitted from electric appliances within 3.9 in. (10 cm) of the electronic key may interfere with the key, causing the key to not function properly.

■ **In case of a smart key system malfunction or other key-related problems**

→P.505

■ **When an electronic key is lost**

→P.505

**Wireless remote control**

The electronic keys are equipped with the following wireless remote control:

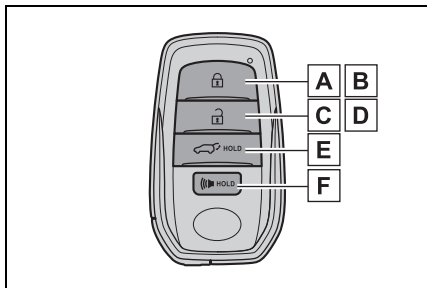

- A** Locks all the doors (→P.115)
- B** Closes the windows and the panoramic moon roof\*<sup>1, 2</sup> (→P.115)
- C** Unlocks all the doors (→P.115)
- D** Opens the windows\*<sup>1</sup> and the panoramic moon roof\*<sup>1, 2</sup> (→P.115)
- E** Opens and closes the power back door (→P.121)
- F** Sounds the alarm

\*<sup>1</sup>: These settings must be customized at your Toyota dealer.

\*<sup>2</sup>: If equipped

■ **Theft deterrent panic mode**

When  is pressed for longer than about one second, an alarm will sound intermittently and the vehicle lights will flash to deter any person from trying to break into or damage your vehicle.

To stop the alarm, press any button on the electronic key.



**Using the mechanical key**

To take out the mechanical key, push the release button and take the key out.

The mechanical key can only be inserted in one direction, as the key only has grooves on one side. If the key cannot be inserted in a lock cylinder, turn it over and re-attempt to insert it.

After using the mechanical key, store it in the electronic key. Carry the mechanical key together with the electronic key. If the electronic key battery is depleted or the entry function does not operate properly, you will need the mechanical key. (→P.506)

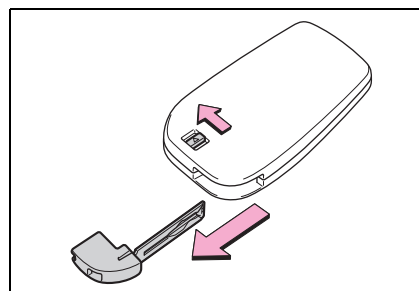

■ **When required to leave the vehicle's key with a parking attendant**

Lock the glove box as circumstances demand. (→P.388)  
Remove the mechanical key for your own use and provide the atten-



dant with the electronic key only.

■ **If you lose your mechanical keys**

→P.505

■ **If a wrong key is used**

The key cylinder rotates freely, isolated from the internal mechanism.

### Digital Key\*

\*: If equipped

**A smartphone can be used instead of the electronic key of the vehicle by installing the dedicated Digital Key App on a smartphone. Also, Digital Key can be shared with your family or friends using the Digital Key App.**

### ■ Free/open source software information

This product contains Free/open source software (FOSS). License information and/or the source code of this FOSS can be obtained at the following URL:

<https://www.denso.com/global/en/opensource/dkey/toyota/>

### Digital key usage conditions

In order to use the Digital Key, you need to install the Toyota App. Register the Vehicle to the customer's Toyota App profile, and subscribe to Remote Services, and enroll in Digital Key.

### Digital key precautions

- A Digital Key can be used when the smartphone and server can communicate. The Digital Key may become unusable if the smartphone is not connected to the Internet. Be sure to carry the electronic

key of the vehicle if traveling to a location with unreliable communications.

- If the smartphone battery is depleted, the smartphone cannot be used as Digital Key. If the battery level is low, be sure to charge the smartphone prior to going out.
- The Digital Key system is related to the smart key system. If the smart key system has been deactivated in the vehicle customization setting, the Digital Key will also be disabled.
- The Digital Key cannot be used to lock or unlock the doors by touching or gripping a door handle. (Doors can be locked or unlocked using the Digital Key App.)
- Depending on the radio wave environment, the Digital Key may not be able to be used. (→P.137)
- When transferring vehicle ownership, make sure to delete the Digital Keys.
- If the vehicle is not operated for 14 days or more, the Digital Key will not connect automatically. Therefore, it may take some time before the system operates after a door handle is touched.
- A part of the services may be stopped for a certain period of

time due to server maintenance. However, registered Digital Keys can be used during the maintenance.

- A smartphone with the Digital Key App enabled will be able to lock and unlock the doors, start the engine and perform any other operations as same as the electronic key of the vehicle. Be especially careful not to lose the smartphone or allow it to be stolen.

If the smartphone is lost or stolen, contact your Toyota dealer immediately.

- When taking your vehicle to a Toyota dealer for an inspection or repairs, make sure to bring an electronic key.
- With the digital key alone, no vehicle lights will illuminate when approached to the vehicle. Also, with the digital key alone, some functions, such as the power back door's close & lock (walk-away) function, etc., cannot be used

Side doors

The vehicle can be locked and unlocked using the entry function, wireless remote control or door lock switches.

Unlocking and locking the doors from the outside

Smart key system

Carry the electronic key to enable this function.

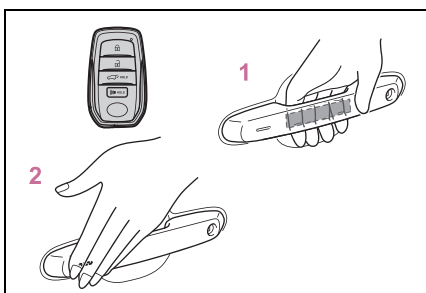

- 1 Grip the driver's door handle to unlock the door. Holding the driver's door handle for approximately 2 seconds unlocks all the doors. Grip any passenger door handle to unlock all the doors.\*

Make sure to touch the sensor on the back of the handle.

The doors cannot be unlocked for 3 seconds after the doors are locked.

\*: The door unlock settings can be changed.

- 2 Touch the lock sensor (indentation on the surface of the door handle) to lock all the

doors.

Check that the door is securely locked.

Wireless remote control

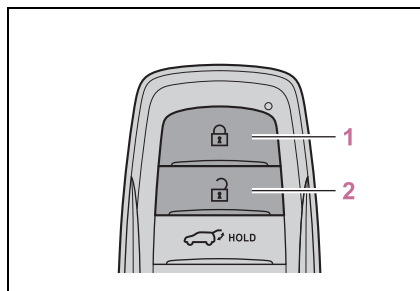

- 1 Locks all the doors

Check that the door is securely locked.

- 2 Unlocks all the doors

Pressing the button unlocks the driver's door. Pressing the button again within 5 seconds unlocks the other doors.

Press and hold to open the windows\*1 and panoramic moon roof\*1, 2

\*1: This setting must be customized at your Toyota dealer.

\*2: If equipped

Switching the door unlock function

It is possible to set which doors the entry function unlocks using the wireless remote control.



- 1 Turn the engine switch off.
- 2 When the indicator light on the key surface is not on, press and hold , or for approximately 5 seconds while pressing and holding .

The setting changes each time an operation is performed, as shown below. (When changing the setting

3

Before driving

continuously, release the buttons, wait for at least 5 seconds, and repeat step 2.)

Multi-information display/Beep	Unlocking function
 <p>Exterior: Beeps 3 times</p>	<p>Holding the driver's door handle unlocks only the driver's door.</p>
 <p>Exterior: Beeps twice</p>	<p>Holding any of the passenger door handles unlocks all the doors.</p>
	<p>Holding a door handle unlocks all the doors.</p>

To prevent unintended triggering of the alarm, unlock the doors using the wireless remote control and open and close a door once after the settings have been changed. (If a door is not opened within 60 seconds after  is pressed, the doors will be locked again and the alarm will automatically be set.)

In case that the alarm is triggered, immediately stop the alarm. (→P.73)

**■ Impact detection door lock release system**

In the event that the vehicle is subject to a strong impact, all the doors are unlocked. Depending on the force of the impact or the type of accident, however, the system may not operate.

**■ Operation signals**

A buzzer sounds and the emergency flashers flash to indicate that the doors have been

locked/unlocked. (Locked: Once; Unlocked: Twice)

A buzzer sounds to indicate that the windows and the panoramic moon roof\* are operating.

\*: If equipped

**■ Security feature**

If a door is not opened within approximately 60 seconds after the vehicle is unlocked, the security feature automatically locks the vehicle again.

**■ When the doors cannot be locked by the lock sensor on the surface of the door handle**

When the door cannot be locked even if the lock sensor on the surface of the door handle is touched by a finger, touch the lock sensor with the palm.

When gloves are being worn, remove the gloves.

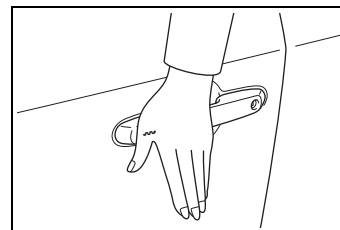

**■ Door lock buzzer**

If an attempt to lock the doors using the smart key system is made when a door is not fully closed, a buzzer will sound continuously for 5 seconds. Fully close the door to stop the buzzer, and lock the doors again.

**■ Setting the alarm**

Locking the doors will set the alarm system. (→P.73)

**■ Conditions affecting the operation of the smart key system or wireless remote control**

→P.137

■ **If the smart key system or the wireless remote control does not operate properly**

Use the mechanical key to lock and unlock the doors. (→P.506)

Replace the key battery with a new one if it is depleted. (→P.460)

■ **If the battery is discharged**

The doors cannot be locked and unlocked using the smart key system or wireless remote control. Lock or unlock the doors using the mechanical key. (→P.506)

■ **Rear seat reminder function**

As the first reminder so as not to forget luggage, etc. in the rear seat, when the engine switch is turned off after any of the following conditions are met, a buzzer will sound and a message will be displayed on the multi-information display for approximately 6 seconds.

Also, as the second reminder, when the doors are locked, a buzzer will sound and the emergency flashers will flash for a few seconds, and a message will be displayed on the multi-information display

- The engine is started within approximately 10 minutes after opening and closing a rear door.
- A rear door has been opened and closed after the engine was started.

The second reminder will not be activated if a rear door was opened before the doors are locked.

However, if a rear door is opened and then closed within approximately 2 seconds, the rear seat reminder function may not operate.

The rear seat reminder function determines that luggage, etc. has been placed in a rear seat based on opening and closing of a rear door. Therefore, depending on the situation, the rear seat reminder function may not operate and you may still forget luggage, etc. in the rear seat,

or it may operate unnecessarily.

The rear seat reminder function can be enabled/disabled. (→P.538)

■ **Customization**

Some functions can be customized. (→P.538)

 **WARNING**

■ **To prevent an accident**

Observe the following precautions while driving the vehicle. Failure to do so may result in a door opening and an occupant falling out, resulting in death or serious injury.

- Ensure that all doors are properly closed and locked.

- Do not pull the inside handle of the doors while driving.

Be especially careful for the front doors, as the doors may be opened even if the inside lock buttons are in locked position.

- Set the rear door child-protector locks when children are seated in the rear seats.

■ **When opening or closing a door**

Check the surroundings of the vehicle such as whether the vehicle is on an incline, whether there is enough space for a door to open and whether a strong wind is blowing. When opening or closing the door, hold the door handle tightly to prepare for any unpredictable movement.

### Unlocking and locking the doors from the inside

#### ■ Door lock switches

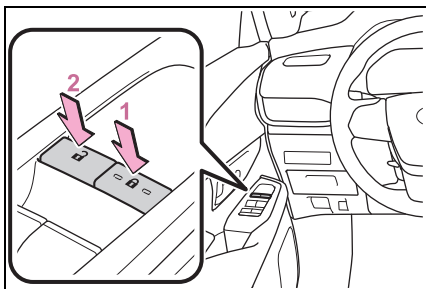

- 1 Locks all the doors
- 2 Unlocks all the doors

#### ■ Inside lock buttons

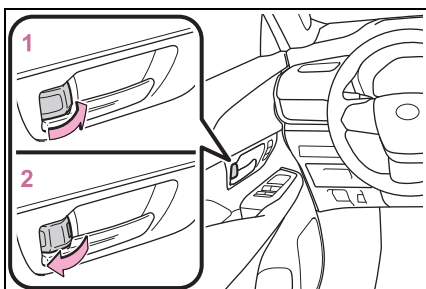

- 1 Locks the door
- 2 Unlocks the door

The front doors can be opened by pulling the inside handle even if the lock buttons are in the lock position.

#### ■ Locking the front doors from the outside without a key

- 1 Move the inside lock button to the lock position.
- 2 Close the door.

The door cannot be locked if the engine switch is in ACC or ON, or the electronic key is left inside the vehicle.

The key may not be detected correctly and the door may be locked.

#### ■ Open door warning buzzer

If a door or the hood is not fully closed, a buzzer will sound when the vehicle speed reaches 3 mph (5 km/h).

The open door(s) or hood is displayed on the multi-information display.

### Rear door child-protector lock

The door cannot be opened from inside the vehicle when the lock is set.

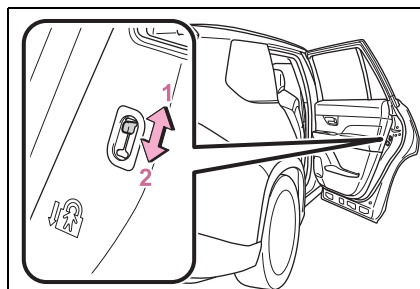

- 1 Unlock
- 2 Lock

These locks can be set to prevent children from opening the rear doors. Push down on each rear door switch to lock both rear doors.

### Automatic door locking and unlocking systems

The following functions can be set or canceled:

For instructions on customizing, refer to P.538.

Function	Operation
Speed linked door locking function	All doors are automatically locked when vehicle speed is approximately 12 mph (20 km/h) or higher.
Shift position linked door locking function	All doors are automatically locked when changing the shift position out of P.
Shift position linked door unlocking function	All doors are automatically unlocked when changing the shift position to P.
Driver's door linked door unlocking function	All doors are automatically unlocked when driver's door is opened.

### Power back door

**The power back door can be opened using the power back door opener switch, smart key system or wireless remote control.**

#### **WARNING**

Observe the following precautions. Failure to do so may result in death or serious injury.

#### ■ **Before driving the vehicle**

Before driving the vehicle, make sure that the power back door is fully closed. If the power back door is not fully closed, it may open unexpectedly while driving, causing an accident.

#### ■ **Caution while driving**

- Keep the power back door closed while driving.

If the power back door is left open, it may hit nearby objects while driving or luggage may be unexpectedly thrown out, causing an accident.

In addition, exhaust gases may enter the vehicle, causing death or a serious health hazard. Make sure to close the power back door before driving.

- Never let anyone sit in the luggage compartment. In the event of sudden braking, sudden swerving or a collision, they are susceptible to death or serious injury.

**⚠ WARNING**

**■ When children are in the vehicle**

Observe the following precautions.

Failure to do so may result in death or serious injury.

- Do not allow children to play in the luggage compartment.

If a child is accidentally locked in the luggage compartment, they could have heat exhaustion or other injuries.

- Do not allow a child to open or close the power back door.

Doing so may cause the power back door to move unexpectedly, or cause the child's hands, arms, head, or neck to be caught by the closing power back door.

**■ Operating the power back door**

Observe the following precautions.

Failure to do so may cause parts of the body to be caught, resulting in death or serious injury.

- Remove any heavy loads, such as snow and ice, from the power back door before opening it. Failure to do so may cause the power back door to suddenly shut again after it is opened.
- When opening or closing the power back door, thoroughly check to make sure the surrounding area is safe.
- If anyone is in the vicinity, make sure they are safe and let them know that the power back door is about to open or close.

- Use caution when opening or closing the power back door in windy weather as it may move abruptly in strong wind.

- The power back door may suddenly shut if it is not opened fully. It is more difficult to open or close the back door on an incline than on a level surface, so beware of the back door unexpectedly opening or closing by itself. Make sure that the back door is fully open and secure before using the luggage compartment.

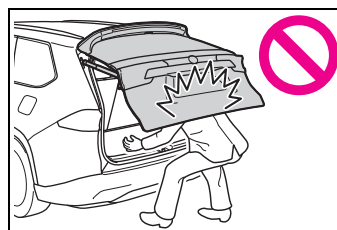

- When closing the power back door, take extra care to prevent your fingers, etc., from being caught.

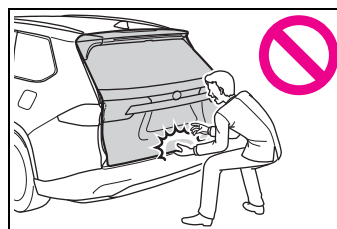

- When closing the power back door, make sure to press it lightly on its outer surface. If the back door handle is used to fully close the power back door, it may result in hands or arms being caught.



**⚠ WARNING**

- Do not pull on the back door spindle (→P.133) to close the power back door, and do not hang on the back door spindle. Doing so may cause hands to be caught or the back door spindle to break, causing an accident.
- If a bicycle carrier or similar heavy object is attached to the power back door, it may suddenly shut again after being opened, causing someone's hands, arms, head or neck to be caught and injured. When installing an accessory part to the power back door, using a genuine Toyota part is recommended.

**Unlocking and locking the power back door from the outside**

■ **Smart key system**

Carry the electronic key to enable this function.

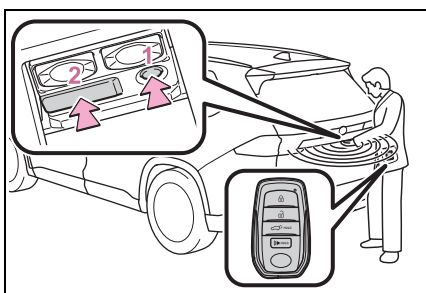

- 1** Locks all the doors  
Check that the door is securely locked.
- 2** Unlocks all the doors  
The doors cannot be unlocked for 3 seconds after the doors are locked.

■ **Wireless remote control**

→P.111

**Unlocking and locking the power back door from the inside**

■ **Door lock switch**

→P.118

**Opening/closing the power back door**

■ **Opening/closing the power back door using the wireless remote control**

Press and hold the switch for approximately 1 second.

The power back door can be operated whether it is locked\* or unlocked.

Pressing the switch while the power back door is opening/closing will stop the operation.

Pressing and holding the switch again for approximately 1 second will operate the power back door in the opposite direction.

\*: Opening of the power back door when it is locked can be disabled by a customized setting.

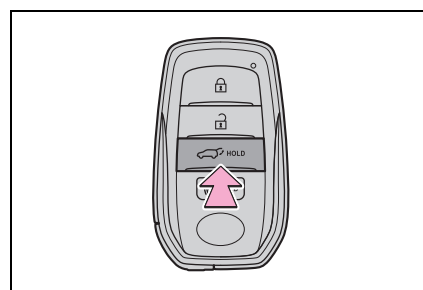

■ **Opening/closing the power back door from the inside**

Press and hold the switch for approximately 1 second.

A buzzer will sound and the power back door will automatically open or close. However, if the power back door is locked, it will not open.

Pressing the switch while the power back door is opening/closing will stop the operation.

Pressing and holding the switch again for approximately 1 second will operate the power back door in the opposite direction.

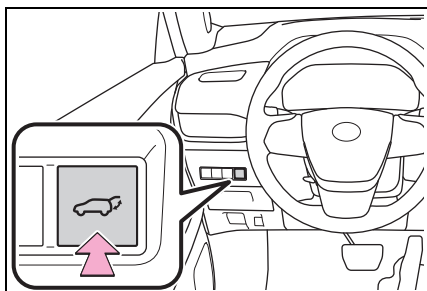

■ **Back door opener switch**

● **Open**

When the power back door is unlocked: Press the back door opener switch.

When the power back door is locked: While carrying an electronic key, press and hold the back door opener switch.

A buzzer will sound and the power back door will automatically open.

Pressing the switch while the power back door is opening/closing will stop the operation.

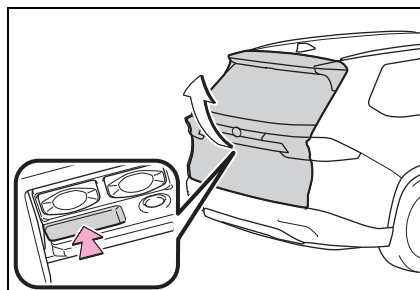

● **Close**

Press the  switch.

A buzzer will sound and the power back door will automatically close.

Pressing the  switch while the power back door is closing will stop the operation. Pressing the switch again will open the power back door automatically.

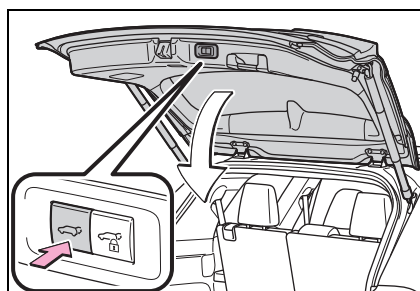

● **Close the back door and lock all doors after moving away from the back door (close & lock [Walk-Away] function)\***

\*: This setting can be customized by your Toyota dealer.

- 1 Close all of the doors except the back door, carrying an electronic key and press the  switch on the lower part of the back door.

A different buzzer than the normal

one will sound and the close & lock (Walk-Away) function will go into standby.

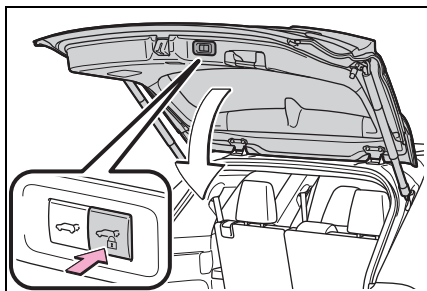

- 2 While the buzzer is sounding, move away from the back door.

When the sensor detects that you are away from the back door, the emergency flashers will flash, and the buzzer will sound. Depending on the direction of moving away from the back door, the location and how to hold the electronic key or circumstances, it may not be detected properly.

All the doors other than the back door will be locked, and after the back door is closed, the back door will also be locked. When all the doors have been closed and locked, the buzzer will sound and the emergency flashers will flash.

The standby state is canceled if you do not move away from the back door for 30 seconds. To operate the function again, perform the procedure again from the beginning.

If you approach the back door carrying the electronic key, the back door operation will stop, all the doors will be unlocked, and the buzzer will sound and the emergency flashers will flash.

If the  switch is pressed after the back door operation has stopped, the close & lock (Walk-Away) function will go into standby again.

- Close the back door and lock

all doors (close & lock function)\*

\*: This setting can be customized by your Toyota dealer.

Press the  switch.

The power back door will close and all of the doors will be locked at the same time.

A different buzzer than the normal one will sound and the power back door will begin closing automatically. When the power back door is closed, all of the doors will lock simultaneously and operation signals will indicate that all of the doors have been locked.

If the  switch is pressed while the power back door is closing, the operation will stop.

Pressing the switch again will open the power back door automatically.

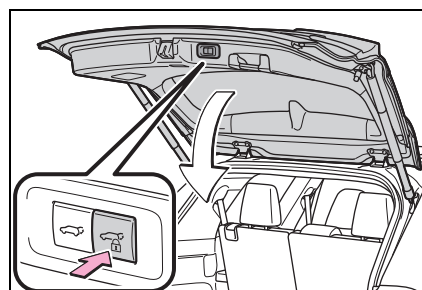

■ **Closing the power back door using the back door handle**

Lower the power back door using the back door handle, then a buzzer will sound and the power back door will automatically close.

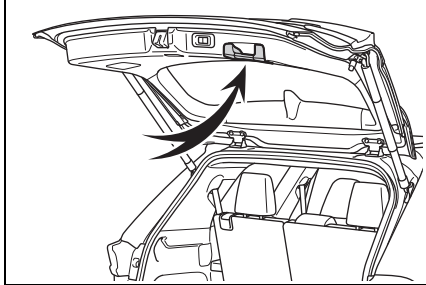

### ■ Hands Free Power Back Door (if equipped)

- 1 While carrying an electronic key, stand within the smart key system operation range, approximately 19.7 to 23.6 in. (50 to 60 cm) from the rear bumper.

#### ► Vehicles without tow hitch

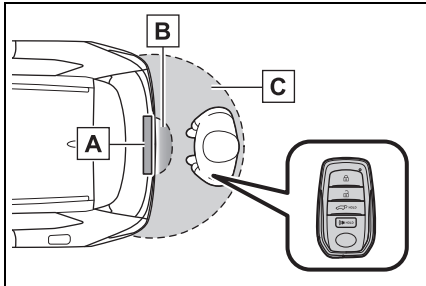

- A** Kick sensor
- B** Hands Free Power Back Door operation detection area
- C** Smart key system operation detection area (→P.136)

#### ► Vehicles with tow hitch

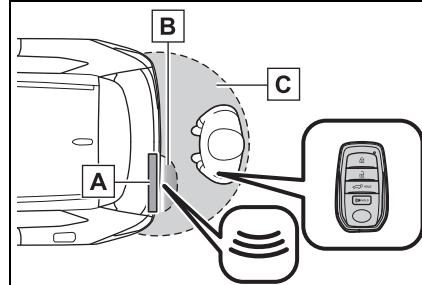

- A** Kick sensor
  - B** Hands Free Power Back Door operation detection area
  - C** Smart key system operation detection area (→P.136)
- 2 Perform a kick operation by moving your foot to within approximately 3.9 in. (10 cm) of the rear bumper and then pulling your foot back after the buzzer sounds.
    - Perform the entire kick operation within 1 second.
    - The Hands Free Power Back Door will not start operating while a foot is detected under the rear bumper.
    - Operate the Hands Free Power Back Door without contacting the rear bumper with your foot.
    - If another electronic key is in the cabin or luggage compartment, it may take slightly longer than normal for the operation to occur.
    - If the buzzer sounds twice,

perform a kick operation again.

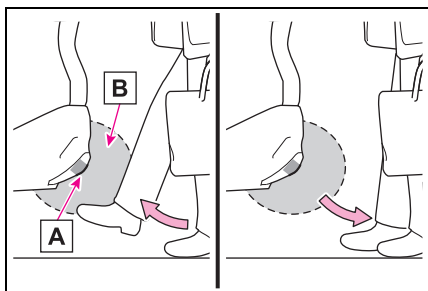

- A** Kick sensor
- B** Hands Free Power Back Door operation detection area

- 3 When the kick sensor detects that your foot is pulled back, a buzzer will sound and the power back door will automatically fully open/close.

If kick operation is performed again in the middle of back door operating, the operation will stop.

■ **Closing and locking the back door after moving away from the back door using the kick sensor (Hands Free close & lock [Walk-Away] function) \*1, 2**

\*1: If equipped

\*2: This setting can be customized by your Toyota dealer.

- 1 While carrying an electronic key, stand within the smart key system operation range, approximately 19.7 to 23.6 in. (50 to 60 cm) from the rear bumper.

▶ Vehicles without tow hitch

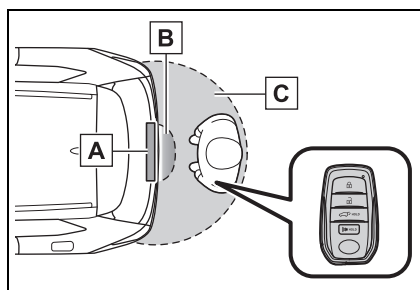

- A** Kick sensor
- B** Hands Free Power Back Door operation detection area
- C** Smart key system operation detection area (→P.136)

▶ Vehicles with tow hitch

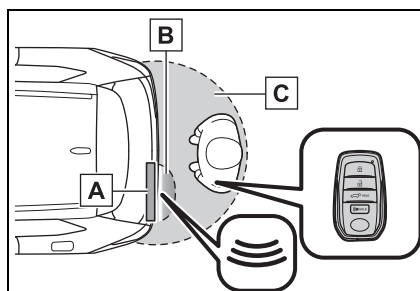

- A** Kick sensor
- B** Hands Free Power Back Door operation detection area
- C** Smart key system operation detection area (→P.136)

- 2 Perform a kick operation by moving your foot to within approximately 3.9 in. (10 cm) of the rear bumper and then pulling your foot back after the buzzer sounds.

- Perform the entire kick operation within 1 second.
- The Hands Free Power Back Door will not start operating while a foot is detected under the rear bumper.
- Operate the Hands Free Power Back Door without contacting the rear bumper with your foot.
- If another electronic key is in the cabin or luggage compartment, it may take slightly longer than normal for the operation to occur.
- If the buzzer sounds twice, perform a kick operation again.

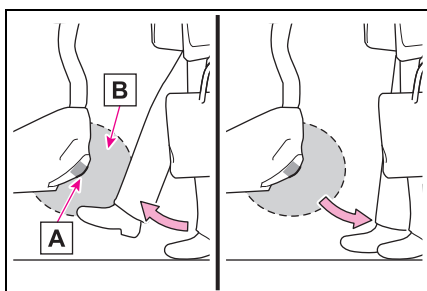

- A** Kick sensor
  - B** Hands Free Power Back Door operation detection area
- 3 When the kick sensor detects that your foot is pulled back, a different buzzer than the normal one will sound and the Hands Free close & lock (Walk-Away) function will go into standby.

- 4 While the buzzer is sounding, move away from the back door.

When the sensor detects that you are away from the back door, the emergency flashers will flash, and the buzzer will sound. Depending on the direction of moving away from the back door, the location and how to hold the electronic key or circumstances, it may not be detected properly.

All the doors other than the back door will be locked, and after the back door is closed, the back door will also be locked. When all the doors have been closed and locked, the buzzer will sound and the emergency flashers will flash.

The standby state is canceled if you do not move away from the back door for 30 seconds. To operate the function again, perform the procedure again from the beginning.

If you approach the back door carrying the electronic key, the back door operation will stop, all the doors will be unlocked, and the buzzer will sound and the emergency flashers will flash.

If the power back door is operated after the back door operation has stopped, the Hands Free close & lock (Walk-Away) function will go into standby again.

#### ■ Luggage compartment lights

- The luggage compartment lights turn on when the back door is opened.
- When the engine switch is turned off, the lights will go off automatically after 20 minutes.

#### ■ Back door closer

In the event that the power back door is left slightly open, the back door closer will automatically close it to the fully closed position.

- The back door closer can function when the engine switch is in any mode.
- The power back door can be opened using the back door opener switch even if the back door closer is operating.

#### ■ Power back door operating conditions

If the following conditions are met with the power back door operation enabled, the power back door can be opened and closed automatically.

- When an electronic key is being carried and the back door opener switch is pressed\*
- When the wireless remote control is used\*
- When the engine switch is in ON, the vehicle speed must be lower than 2 mph (3 km/h) and one of the following conditions must be met in addition to the above conditions:
  - The parking brake is engaged.
  - The brake pedal is depressed.
  - The shift position is in P.

\*: When the operation of the power back door when it is locked has been disabled by a customized setting, operate the power back door after it has been unlocked.

#### ■ Operation of the power back door

- When the power back door begins to operate, the emergency flashers will flash and a buzzer will sound.
- When the power back door is disabled, the power back door will not operate but can be opened and closed manually.
- The power back door turns to manual operation when the back door opener switch is pressed while the power back door is in an automatic opening/closing operation.

tion.

- If anything obstructs the power back door while opening, a buzzer will sound and the power back door will stop immediately. If anything obstructs the power back door while closing, a buzzer will sound and the power back door will automatically move slightly in the opposite direction and then stop.

#### ■ Jam protection function

Sensors are installed in the right and left sides of the power back door. When the door is automatically closing and the sensors are pushed due to an object being caught, etc., the jam protection function will operate.

From that position the door will automatically move a little in the opposite direction and then the function will stop.

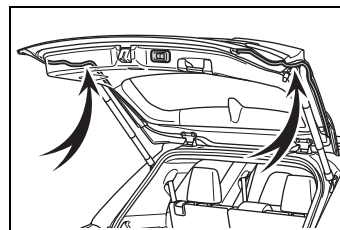

#### ■ Fall-down protection function

While the power back door is opening automatically, applying excessive force to it will stop the opening operation to prevent the power back door from suddenly shutting.

#### ■ Back door closing assist

If the back door is lowered manually when the back door is stopped at an open position, the back door will fully close automatically.

#### ■ Back door reserve lock function

This function reserves the locking of the power back door when the power back door is open. If the following operations are performed, all of the doors except the power back

door will lock and then the power back door will lock when it is completely closed.

- 1 Close all of the doors, except the power back door.
- 2 Perform an automatic closing operation of the power back door and lock the doors using the wireless remote control (→P.111) or smart key system (→P.115) while the power back door is closing.

Operation signals will indicate that all the doors have been closed and locked. (→P.116)

- If the electronic key is placed inside the vehicle after starting a close operation via the door reserve lock function, the electronic key may become locked inside the vehicle.
- If the back door does not fully close due to the operation of the jam protection function, etc., while the back door is automatically closing after a reserve lock operation is performed, the reserve lock function is canceled and all the doors will unlock.
- Before leaving the vehicle, make sure that all the doors are closed and locked.

#### ■ Close & lock (Walk-Away) function operating conditions

This function can be operated when all of the following conditions are met:

- Close & lock (Walk-Away) function is enabled\*.
- An electronic key is not detected within the vehicle.
- All of the doors other than the power back door are closed.
- The brake pedal is not depressed.
- The engine switch is off.
- The electronic key is within the effective range (detection areas).

\*: This setting can be customized by

your Toyota dealer.

#### ■ Situations in which the close & lock (Walk-Away) function\* may not operate properly

In the following situations, the function may not operate properly:

- When the smart key system does not operate properly.
- When the close & lock function does not operate properly.
- When moving away from the back door while the close & lock (Walk-Away) function is in the standby state.

\*: This setting can be customized by your Toyota dealer.

#### ■ Close & lock function\* operating conditions



This function can be operated when all of the following conditions are met:

- An electronic key is not detected within the vehicle.
- All of the doors other than the power back door are closed.
- The engine switch is off.

\*: This setting can be customized by your Toyota dealer.

#### ■ Situations in which the close & lock function\* may not operate properly

In the following situations, the close & lock function may not operate properly:

- If the  switch on the lower part of the power back door (→P.122) is pressed by a hand which is holding an electronic key
- If the  switch on the lower part of the power back door (→P.122) is pressed when the electronic key is in a bag, etc. that is placed on the ground
- If the  switch on the lower part



of the power back door (→P.122) is pressed with the electronic key not near the vehicle.

\* : This setting can be customized by your Toyota dealer.

**■ Hands Free Power Back Door operating conditions (if equipped)**

- The Hands Free Power Back Door (kick sensor) setting is on.
- When an electronic key is carried within the operation range.

**■ Situations in which the Hands Free Power Back Door may not operate properly (if equipped)**

In the following situations, the Hands Free Power Back Door may not operate properly:

- When a foot remains under the rear bumper
- If the rear bumper is strongly hit with a foot or is touched for a while.  
If the rear bumper has been touched for a while, wait for a short time before attempting to operate the Hands Free Power Back Door again.
- When standing excessively close to the rear bumper
- When an external radio wave source interferes with the communication between the electronic key and the vehicle (→P.137)
- When the vehicle is parked near metal, or an external radio wave or electrical noise source which affects the sensitivity of the Hands Free Power Back Door, such as a pay parking spot, gas station, electrically heated road, fluorescent light, or metal plate
- When the vehicle is near a TV tower, electric power plant, radio station, large display, airport or other facility that generates strong radio waves or electrical noise
- When a large amount of water is

applied to the rear bumper, such as when the vehicle is being washed or in heavy rain

- When mud, snow, ice, etc. is attached to the rear bumper
- When the vehicle has been parked for a while near objects that may move and contact the rear bumper, such as plants
- When an accessory is installed to the rear bumper

If an accessory has been installed, turn the Hands Free Power Back Door (kick sensor) operation setting off.

**■ Preventing unintentional operation of the Hands Free Power Back Door (if equipped)**

When an electronic key is in the operation detection area, the Hands Free Power Back Door may operate unintentionally, so be careful in the following situations:

- When a large amount of water is applied to the rear bumper, such as when the vehicle is being washed or in heavy rain
- When dirt is wiped off the rear bumper
- When a small animal or small object, such as a ball, moves under the rear bumper
- When an object is moved from under the rear bumper
- If someone is swinging their legs while sitting on the rear bumper
- If the legs or another part of someone's body contacts the rear bumper while passing by the vehicle
- When the vehicle is parked near an electrical noise source which affects the sensitivity of the Hands Free Power Back Door, such as a pay parking spot, gas station, electrically heated road, or fluorescent light
- When the vehicle is near a TV

tower, electric power plant, radio station, large display, airport or other facility that generates strong radio waves or electrical noise

- When the vehicle is parked in a place where objects such as plants are near the rear bumper
- If luggage, etc. is set near the rear bumper
- If accessories or a vehicle cover is installed/removed near the rear bumper
- When the vehicle is being towed

To prevent unintentional operation, turn the Hands Free Power Back Door (kick sensor) operation setting off.

■ **Hands Free close & lock (Walk-Away) function<sup>\*1</sup> operating conditions**

This function can be operated when all of the following conditions are met:

- Hands Free close & lock (Walk-Away) function is enabled<sup>\*2</sup>.
- Hands Free Power Back Door<sup>\*1</sup> is enabled.
- An electronic key is not detected within the vehicle.
- All of the doors other than the back door are closed.
- The brake pedal is not depressed.
- The engine switch is off.
- The electronic key is within the effective range (detection areas).

<sup>\*1</sup>: If equipped

<sup>\*2</sup>: This setting can be customized by your Toyota dealer.

■ **Situations in which the Hands Free close & lock (Walk-Away) function<sup>\*1, 2</sup> may not operate properly**

In the following situations, the function may not operate properly:

- When the smart key system does not operate properly.
- When the close & lock function does not operate properly.
- When moving away from the back door while the Hands Free close & lock (Walk-Away) function is in the standby state.
- When the Hands Free Power Back Door does not operate properly.<sup>\*1</sup>

<sup>\*1</sup>: If equipped

<sup>\*2</sup>: This setting can be customized by your Toyota dealer.

■ **If the power back door stops the automatic operation**

When the automatic operation of the power back door is enabled and the power back door is left open for a long time, it may stop the automatic operation.

To re-enable the automatic operation, fully close the power back door manually.

■ **When reconnecting the battery**

To operate the power back door properly, close the back door completely by hand then operate for unlocking.

■ **If the power back door opener is inoperative**

The power back door can be unlocked from the inside

- 1 Remove the cover.

To prevent damage, cover the tip of the screwdriver with a rag.

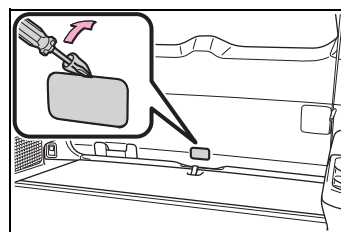

2 Loosen the screw.

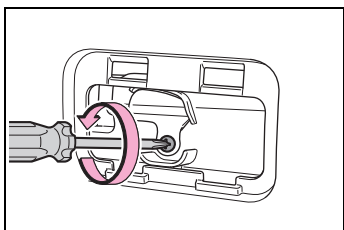

3 Turn the cover.

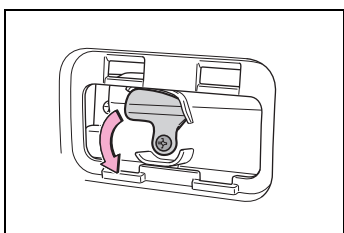

4 Move the lever.

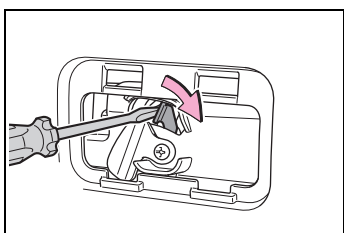

5 When installing, reverse the steps listed.

■ **Customization**

Some functions can be customized. (→P.538)

**! WARNING**

■ **Back door closer**

● In the event that the power back door is left slightly open, the back door closer will automatically close it to the fully closed position. It takes several seconds before the back door closer begins to operate. Be careful not to get fingers caught or anything else in the power back door, as this may cause bone fractures or other serious injuries.

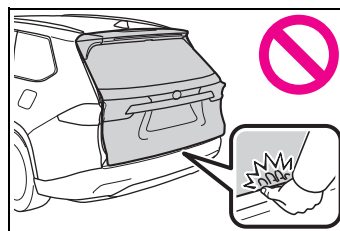

● Use caution when using the back door closer as it still operates when the power back door system is disabled.

■ **Power back door**

Observe the following precautions when operating the power back door.

Failure to do so may cause death or serious injury.

- Check the safety of the surrounding area to make sure there are no obstacles or anything that could cause any of your belongings to get caught.
- If anyone is in the vicinity, make sure they are safe and let them know that the power back door is about to open or close.



**WARNING**

- If the power back door system is disabled while the power back door is operating, the power back door will stop operating. The power back door must then be operated manually. Take extra care in this situation, as the power back door may open or close suddenly.
- If the operating conditions of the power back door (→P.127) are no longer met, a buzzer may sound and the power back door may stop opening or closing. The power back door must then be operated manually. Take extra care on an incline in this situation, as the power back door may move suddenly.
- On an incline, the power back door may suddenly shut after it opens. Make sure the power back door is fully open and secure.
- In the following situations, the power back door may detect an abnormality and automatic operation may be stopped. In this case, the power back door must then be operated manually. Take extra care in this situation, as the stopped power back door may suddenly open or close, causing an accident.
  - When the power back door contacts an obstacle
  - When the battery voltage suddenly drops, such as when the engine switch is turned to ON or the engine is started during automatic operation

- If a bicycle carrier or similar heavy object is attached to the power back door, the power back door may not operate, causing a malfunction, or the power back door may suddenly shut again after being opened, causing someone's hands, arms, head or neck to be caught and injured. When installing an accessory part to the power back door, using a genuine Toyota part is recommended.

**Jam protection function**

Observe the following precautions.

Failure to do so may cause death or serious injury.

- Never use any part of your body to intentionally activate the jam protection function.
- The jam protection function may not work if something gets caught just before the power back door fully closes. Be careful not to get fingers caught or anything else.
- The jam protection function may not work depending on the shape of the object that is caught. Be careful not to catch fingers or anything else.

**Hands Free Power Back Door (if equipped)**

Observe the following precautions.

Failure to do so may cause death or serious injury.

- Check the safety of the surrounding area to make sure there are no obstacles or anything that could cause any of your belongings to get caught.

**⚠ WARNING**

- Exhaust gasses cause the exhaust pipes to become quite hot. When operating the Hands Free Power Back Door, be careful not to touch the exhaust pipe.
- Do not operate the Hands Free Power Back Door if there is little space under the rear bumper.

■ **Close & lock (Walk-Away) function\*<sup>1</sup> and Hands Free close & lock (Walk-Away) function\*<sup>1, 2</sup>**

\*<sup>1</sup>: This setting can be customized by your Toyota dealer.

\*<sup>2</sup>: If equipped

The back door starts to close automatically when leaving the back door. Check the safety of the surrounding area to make sure there are no obstacles or anything that could cause any of your belongings to get caught.

**⚠ NOTICE**

■ **Back door spindles**

The power back door is equipped with spindles **A** that hold the power back door in place.

Observe the following precautions.

Failure to do so may cause damage to the back door spindle **A**, resulting in malfunction.

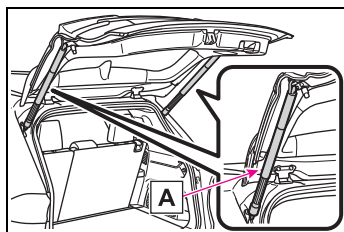

● Do not attach any foreign objects, such as stickers, plastic sheets, or adhesives to the spindle rod.

● Do not attach any accessories other than genuine Toyota parts to the power back door.

● Do not place your hand on the spindle or apply lateral forces to it.

■ **To prevent back door closer malfunction**

● Do not apply excessive force to the power back door while the back door closer is operating. Applying excessive force may cause the back door closer to malfunction.

● If the power back door is opened and closed repeatedly in a short amount of time, the back door closer may stop operating. In this case, manually open the power back door once and wait for a while before attempting to close it again.

■ **To prevent malfunction of the power back door**

● Make sure that there is no ice between the power back door and frame that would prevent movement of the power back door. Operating the power back door when excessive load is present on the power back door may cause a malfunction.

● Do not apply excessive force to the power back door while the power back door is operating.

● Take care not to damage the sensors installed on the right and left edges of the power back door (→P.127) with a knife or other sharp object. If a sensor is disconnected, the power back door will not close automatically.



**NOTICE**

■ **Close & lock function\***

\*: This setting can be customized by your Toyota dealer.

When closing the power back door using the close & lock function, a different buzzer than the normal one will sound before the operation begins.

To check that the operation has started correctly, check that a different buzzer than the normal one has sounded.

Additionally, when the power back door is fully closed and locked, operation signals will indicate that all of the doors have been locked.

Before leaving the vehicle, make sure that the operational signals have operated and that all of the doors are locked.

■ **Hands Free Power Back Door precautions (if equipped)**

The kick sensor is located behind lower center part of the rear bumper. Observe the following to ensure that the Hands Free Power Back Door function operates properly:

- Keep the lower center part of the rear bumper clean at all times.

If the lower center part of the rear bumper is dirty or covered with snow, the Hands Free Power Back Door may not operate. In this situation, clean off the dirt or snow, move the vehicle from the current position and then check if the Hands Free Power Back Door operates. If it does not operate, have the vehicle inspected by your Toyota dealer.

- Do not apply coatings that have a rain clearing (hydrophilic) effect, or other coatings, to the lower center part of the rear bumper.

- Do not park the vehicle near objects that may move and contact the lower center part of the rear bumper, such as grass or trees.

If the vehicle has been parked for a while near objects that may move and contact the lower center part of the rear bumper, such as grass or trees, the Hands Free Power Back Door may not operate. In this situation, move the vehicle from the current position and then check if the Hands Free Power Back Door operates. If it does not operate, have the vehicle inspected by your Toyota dealer.

- Do not subject the rear bumper or its surrounding area to a strong impact.

If the rear bumper or its surrounding area has been subjected to a strong impact, the Hands Free Power Back Door may not operate properly.

If the Hands Free Power Back Door does not operate in the following situations, have the vehicle inspected by your Toyota dealer.

- The kick sensor or its surrounding area has been subjected to a strong impact.
- The lower center part of the rear bumper is scratched or damaged.

- Do not disassemble the rear bumper.

- Do not attach stickers to the rear bumper.

- Do not paint the rear bumper.

 **NOTICE**  
 ● If a bicycle carrier or similar heavy object is attached to the power back door, disable the Hands Free Power Back Door (kick sensor).

**Changing settings of the power back door system**

The settings of the power back door system can be changed by displaying the “Vehicle Settings” - “PBD” screen from the  screen of the multi-information display. →(P.538)

The changed power back door settings are not reset by turning the engine switch to OFF. In order to restore the original settings, they need to be changed back on the  screen of the multi-information display.

**Adjusting the open position of the power back door**

The open position of the power back door can be adjusted.

- 1 Stop the power back door at the desired position. (→P.122)
  - 2 Press and hold the  switch on the lower part of the power back door for 2 seconds.
- When setting is complete, a

buzzer will sound 4 times.

- The next time the power back door is opened, it will stop at that position.

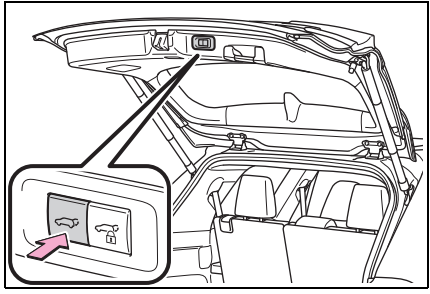

■ **Returning the power back door opening position to the default setting**

Press and hold the  switch on the lower part of the power back door for 7 seconds.

After the buzzer sounds 4 times, it sounds twice more. When the power back door does the opening operation the next time, the door will open to the initial settings position.

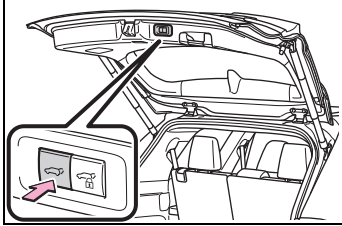

■ **Customization**

The opening position can be set with the multi-information display.

Priority for the stop position is given to the last position set by either the  switch or multi-information display.

(Customizable features:→P.538)

**3**  
Before driving

**Smart key system**

The following operations can be performed simply by carrying the electronic key on your person, for example in your pocket. The driver should always carry the electronic key.

- Locks and unlocks the doors (→P.115)
- Locks and unlocks the back door (→P.121)
- Starts and stops the engine (→P.203)

**Antenna location**

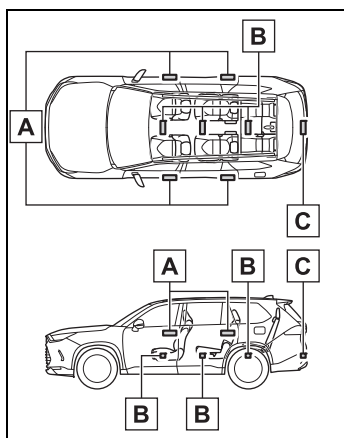

- A** Antennas outside the cabin
- B** Antennas inside the cabin
- C** Antenna outside the luggage compartment

**Effective range (areas within which the electronic key is detected)**

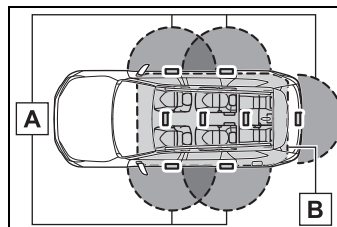

- A** When locking or unlocking the doors

The system can be operated when the electronic key is within about 2.3 ft. (0.7 m) of an outside door handle. (Only the doors detecting the key can be operated.)

- B** When starting the engine or changing engine switch modes

The system can be operated when the electronic key is inside the vehicle.

**Alarms and warning messages**

An alarm sounds and warning messages are displayed on the multi-information display to protect against unexpected accidents or theft of the vehicle resulting from erroneous operation. When a warning message is displayed, take appropriate measures based on the displayed message. (→P.488)

When only an alarm sounds, circumstances and correction procedures are as follows.

- When an exterior alarm sounds once for 5 seconds

Situation	Correction procedure
An attempt was made to lock the vehicle while a door was open.	Close all of the doors and lock the doors again.



- When an interior alarm sounds continuously

Situation	Correction procedure
The engine switch was turned to ACC while the driver's door was open (The driver's door was opened when the engine switch was in ACC).	Turn the engine switch off and close the driver's door.

■ **If “Key Detected in Vehicle” is shown on the multi-information display**

An attempt was made to lock the doors using the smart key system while the electronic key was still inside the vehicle. Retrieve the electronic key from the vehicle and lock the doors again.



■ **Battery-saving function**

The battery-saving function will be activated in order to prevent the electronic key battery and the battery from being discharged while the vehicle is not in operation for a long time.

- In the following situations, the smart key system may take some time to unlock the doors. Also the illuminated entry system may not operate properly.
- The electronic key has been left in an area of approximately 11 ft. (3.5 m) of the outside of the vehicle for 40 seconds or longer.
- The smart key system has not been used for 5 days or longer.
- If the smart key system has not been used for 14 days or longer, the doors cannot be unlocked at any doors except the driver's door. In this case, take hold of the driver's door handle, or use the wireless remote control or the mechanical key, to unlock the doors.

■ **Turning an electronic key to battery-saving mode**

When battery-saving mode is set, battery depletion is minimized by stopping the electronic key from receiving radio waves.

Press  twice while pressing and holding . Confirm that the electronic key indicator flashes 4 times.

While the battery-saving mode is set, the smart key system cannot be used. To cancel the function, press any of the electronic key buttons.

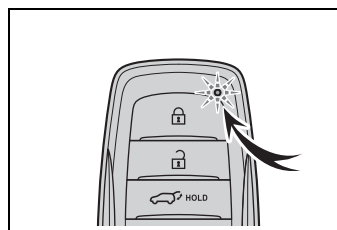

■ **When electronic key function stops**

If the position of the electronic key has not changed for a certain amount of time such as when the electronic key is left somewhere, the function of the electronic key stops to reduce depletion of the battery.

■ **Conditions affecting operation**

The smart key system, wireless remote control and engine immobilizer system use weak radio waves. In the following situations, the communication between the electronic key and the vehicle may be affected, preventing the smart key system, wireless remote control and engine immobilizer system from operating properly. (Ways of coping:→P.506)

- When the electronic key battery is depleted
- Near a TV tower, electric power plant, gas station, radio station, large display, airport or other facility that generates strong radio

waves or electrical noise

- When the electronic key is in contact with, or is covered by the following metallic objects
  - Cards to which aluminum foil is attached
  - Cigarette boxes that have aluminum foil inside
  - Metallic wallets or bags
  - Coins
  - Hand warmers made of metal
  - Media such as CDs and DVDs
- When other wireless keys (that emit radio waves) are being used nearby
- When carrying the electronic key together with the following devices that emit radio waves
  - Portable radio, cellular phone, cordless phone or other wireless communication devices
  - Another vehicle's electronic key, another electronic key of your vehicle, or a wireless key that emits radio waves
  - Personal computers or personal digital assistants (PDAs)
  - Digital audio players
  - Portable game systems
- If window tint with a metallic content or metallic objects are attached to the rear window
- When the electronic key is placed near a battery charger or electronic devices
- When the vehicle is parked in a pay parking spot where radio waves are emitted

If the doors cannot be locked/unlocked using the smart key system, lock/unlock the doors by performing any of the following:

- Bring the electronic key close to either front door handle and operate the entry function.
- Operate the wireless remote control.

If the doors cannot be locked/unlocked using the above methods, use the mechanical key.

(→P.506)

If the engine cannot be started using the smart key system, refer to →P.507

#### ■ Note for the entry function

- Even when the electronic key is within the effective range (detection areas), the system may not operate properly in the following cases:
  - The electronic key is too close to the window or outside door handle, near the ground, or in a high place when the doors are locked or unlocked.
  - The electronic key is on the instrument panel, luggage compartment, floor, or in the door pockets or glove box when the engine is started or engine switch modes are changed.
- Do not leave the electronic key on top of the instrument panel or near the door pockets when exiting the vehicle. Depending on the radio wave reception conditions, it may be detected by the antenna outside the cabin and the door will become lockable from the outside, possibly trapping the electronic key inside the vehicle.
- As long as the electronic key is within the effective range, the doors may be locked or unlocked by anyone. However, only the doors detecting the electronic key can be used to unlock the vehicle.
- Even if the electronic key is not inside the vehicle, it may be possible to start the engine if the electronic key is near the window.
- The doors may unlock if a large amount of water splashes on the door handle, such as in the rain or in a car wash when the electronic key is within the effective range. (The door will automatically be locked after approximately 60 seconds if the doors are not opened and closed.)
- If the wireless remote control is

used to lock the doors when the electronic key is near the vehicle, there is a possibility that the door may not be unlocked by the entry function. (Use the wireless remote control to unlock the doors.)

- Touching the door lock sensor while wearing gloves may delay or prevent lock operation. Remove the gloves and touch the lock sensor again.
- When the lock operation is performed using the lock sensor, recognition signals will be shown up to two consecutive times. After this, no recognition signals will be given.
- If the door handle becomes wet while the electronic key is within the effective range, the door may lock and unlock repeatedly. In that case, follow the following correction procedures to wash the vehicle:
  - Place the electronic key in a location 6 ft. (2 m) or more away from the vehicle. (Take care to ensure that the key is not stolen.)
  - Set the electronic key to battery-saving mode to disable the smart key system. (→P.137)
- If the electronic key is inside the vehicle and a door handle becomes wet during a car wash, a message may be shown on the multi-information display and a buzzer will sound outside the vehicle. To turn off the alarm, lock all the doors.
- The lock sensor may not work properly if it comes into contact with ice, snow, mud, etc. Clean the lock sensor and attempt to operate it again.
- A sudden approach to the effective range or door handle may prevent the doors from being unlocked. In this case, return the door handle to the original position and check that the doors unlock before pulling the door handle again.

- If there is another electronic key in the detection area, it may take slightly longer to unlock the doors after the door handle is gripped.

#### ■ When the vehicle is not driven for extended periods

- To prevent theft of the vehicle, do not leave the electronic key within 6 ft. (2 m) of the vehicle.
- The smart key system can be deactivated in advance.
- Setting the electronic key to battery-saving mode helps to reduce key battery depletion. (→P.137)

#### ■ To operate the system properly

Make sure to carry the electronic key when operating the system. Do not get the electronic key too close to the vehicle when operating the system from the outside of the vehicle.

Depending on the position and holding condition of the electronic key, the key may not be detected correctly and the system may not operate properly. (The alarm may go off accidentally, or the door lock prevention may not operate.)

#### ■ If the smart key system does not operate properly

- If the doors cannot be locked or unlocked and the back door cannot be opened, perform the following.
  - Bring the electronic key close to the door handle and perform a lock or unlock operation.
  - Bring the electronic key close to the button on the back door (→P.121) and press the button.
  - Use the wireless remote control.

If the doors cannot be locked or unlocked by perform the above, use the mechanical key. (→P.506)

However, if the mechanical key is used while the alarm system is set, the warning will sound. (→P.73)

- If the engine cannot be started,

refer to →P.507

■ **Customization**

Some functions can be customized.  
(→P.538)

■ **If the smart key system has been deactivated in a customized setting**

- Locking and unlocking the doors:  
Use the wireless remote control or mechanical key. (→P.115, 121, 506)
- Starting the engine and changing engine switch modes: →P.507
- Stopping the engine: →P.203

Ask your Toyota dealer for details on disabling the entry function.

 **WARNING**

■ **Caution regarding interference with electronic devices**

- People with implantable cardiac pacemakers, cardiac resynchronization therapy-pacemakers or implantable cardioverter defibrillators should keep away from the smart key system antennas. (→P.136)  
The radio waves may affect the operation of such devices. If necessary, the entry function can be disabled. Ask your Toyota dealer for details, such as the frequency of radio waves and timing of the emitted radio waves. Then, consult your doctor to see if you should disable the entry function.
- Users of any electrical medical device other than implantable cardiac pacemakers, cardiac resynchronization therapy-pacemakers or implantable cardioverter defibrillators should consult the manufacturer of the device for information about its operation under the influence of radio waves.  
Radio waves could have unexpected effects on the operation of such medical devices.

## Front seats

### WARNING

#### ■ When adjusting the seat position

- Take care when adjusting the seat position to ensure that other passengers are not injured by the moving seat.
- Do not put your hands under the seat or near the moving parts to avoid injury. Fingers or hands may become jammed in the seat mechanism.
- Make sure to leave enough space around the feet so they do not get stuck.

#### ■ Seat adjustment

To reduce the risk of sliding under the lap belt during a collision, do not recline the seat more than necessary.

If the seat is too reclined, the lap belt may slide past the hips and apply restraint forces directly to the abdomen, or your neck may contact the shoulder belt, increasing the risk of death or serious injury in the event of an accident. Adjustments should not be made while driving as the seat may unexpectedly move and cause the driver to lose control of the vehicle.

## Adjustment procedure

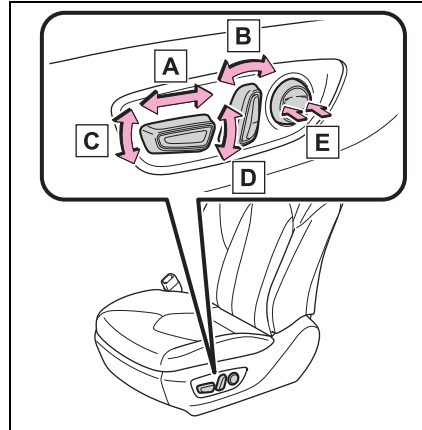

- A** Seat position adjustment switch
- B** Seatback angle adjustment switch
- C** Seat cushion (front) angle adjustment switch
- D** Vertical height adjustment switch
- E** Lumbar support adjustment switch

#### ■ When adjusting the seat

- Make sure that any surrounding passengers or objects are not contact the seat.
- Make sure that the head restraint does not touch the ceiling or sun visor.

#### ■ Jam protection function

While the driving position is recalled, if an object is stuck behind the front seat, the front seat will stop and then slightly move forward.

When the jam protection function operates, the seat stops at a position other than the set seat position. Check the seat position.

## Rear seats

The seat position and seat-back angle can be adjusted, and the seatback can be folded by operating a seat-back angle adjustment lever.

### WARNING

#### ■ Seat adjustment

- To reduce the risk of sliding under the lap belt during a collision, do not recline the seat more than necessary.

If the seat is too reclined, the lap belt may slide past the hips and apply restraint forces directly to the abdomen, or your neck may contact the shoulder belt, increasing the risk of death or serious injury in the event of an accident.

Adjustments should not be made while driving as the seat may unexpectedly move and cause the driver to lose control of the vehicle.

- Be careful that the seat does not hit passengers or luggage.
- Be careful not to get your hands or feet caught in the seat.

#### ■ After adjusting or returning the seats

Observe the following precautions. Failure to do so may result in death or serious injury.

- Make sure that the seat and seatback are securely locked in position by lightly rocking them back and forth.
- Check that the seat belts are not twisted or caught in the seatback.

#### ■ When folding the rear seat-backs down

Observe the following precautions. Failure to do so may result in death or serious injury.

- Do not fold the seatbacks down while driving.
- Stop the vehicle on level ground, set the parking brake and change the shift position to P.
- Do not allow anyone to sit on a folded seatback or in the luggage compartment while driving.
- Do not allow children to enter the luggage compartment.
- Do not fold down a rear seatback when there are passengers sitting in the rear seats or when there is luggage placed on the rear seats.
- Be careful not to catch your hand when folding the rear seatbacks.

**Adjustment procedure**

■ **Second seats**

▶ **8-passenger models**

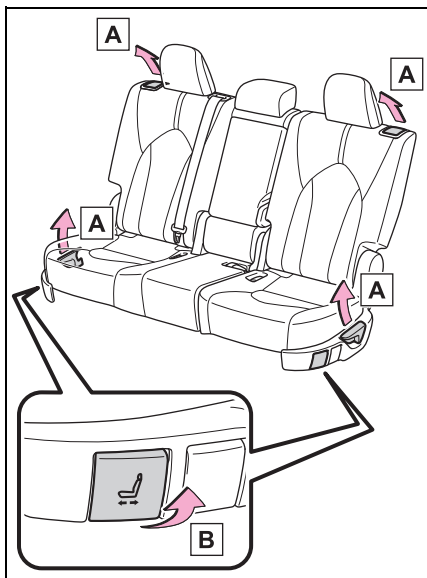

- A** Seatback angle adjustment lever
- B** Seat position adjustment lever

▶ **7-passenger models**

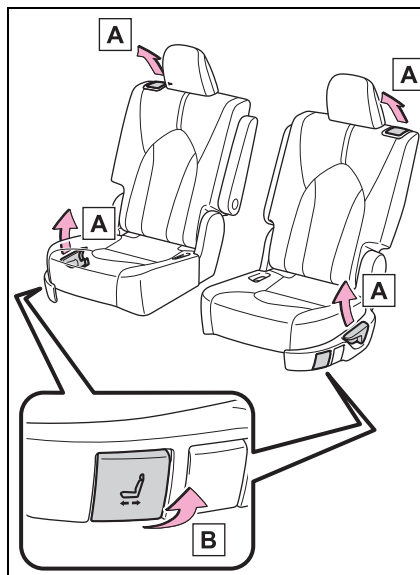

- A** Seatback angle adjustment lever
- B** Seat position adjustment lever

■ **Third seats**

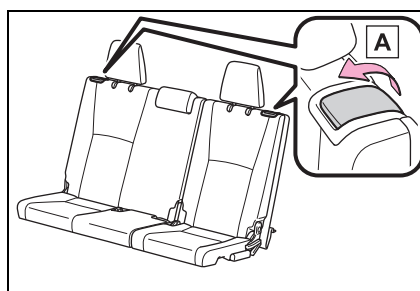

- A** Seatback angle adjustment lever

3

Before driving

**Moving a second seat for third seat access**

■ **When entering/exiting the vehicle**

Pull the seatback angle adjustment lever **A** or **B** to tilt the seatback forward and then slide the seat forward.

Make sure that the second seat is free of passengers and obstructions before operating the lever.

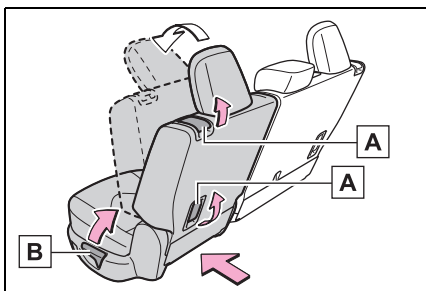

■ **After passengers have entered/exited the vehicle**

Lift up the seatback and slide the seat backward until it locks.

**Folding down the second seats**

■ **Before folding down the second seats**

- 1 Stow the armrest. (→P.406)

- 2 Stow the second seat belt buckles.

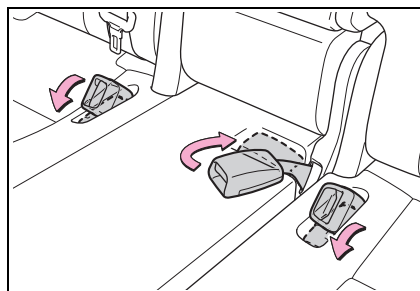

- 3 Pass the outer seat belts through the seat belt hangers and secure the seat belt plates.

This prevents the shoulder belts from being damaged.

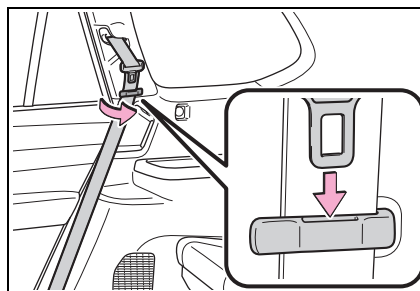

- 4 Lower the head restraints to the lowest position. (→P.147)

■ **Folding down the second seats**

- 1 Pull the seatback angle adjustment lever **A** or **B** to tilt the seatback forward.

Each seatback may be folded sep-



arately.

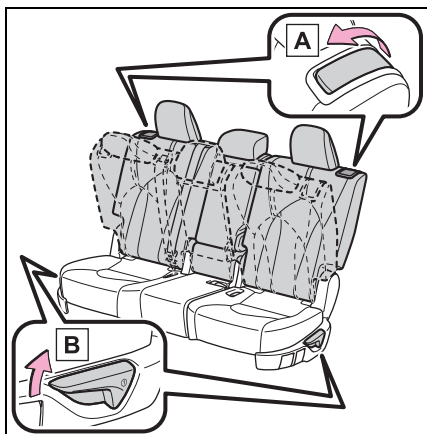

- 2 Pull the seatback folding lever to unlock the seatback. The seatback will be folded down.

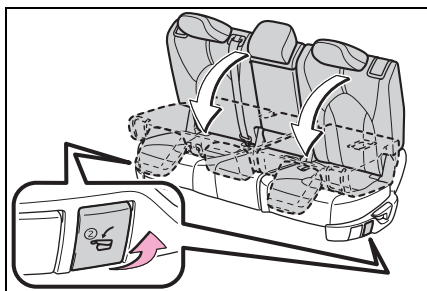

■ **Returning the second seats**

Lift up the seatbacks until they lock.

Remove the secured seat belts from the seat belt hangers before using them.

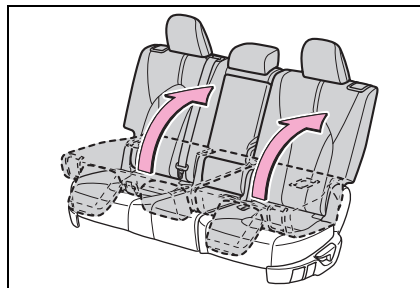

**Folding down the third seats**

■ **Before folding down the third seats**

- 1 Stow the third seat belt buckles.

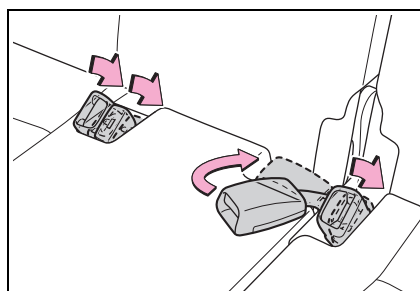

- 2 Pass the outer seat belts through the seat belt hangers and secure the seat belt plates.

This prevents the shoulder belts from being damaged.

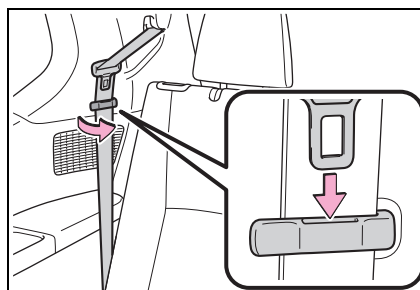

3

Before driving

- 3 Lower the center head restraint to the lowest position. (→P.147)

■ **Folding down the third seats**

While pulling the seatback angle adjustment lever, fold down the seatbacks.

The outer head restraints will fold forward.

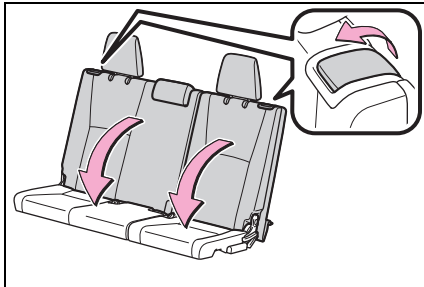

■ **Returning the third seats**

- 1 Returning the seatbacks

► From inside

Lift up the seatbacks until they lock.

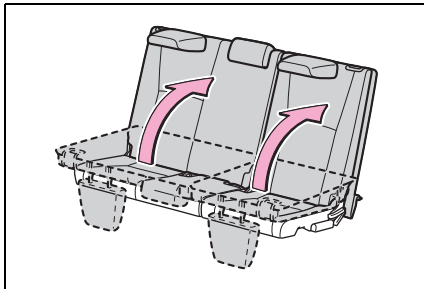

► From outside

Pull the straps and raise the seatbacks until they lock.

After using either strap, use the velcro on the strap to attach it to the seatback.

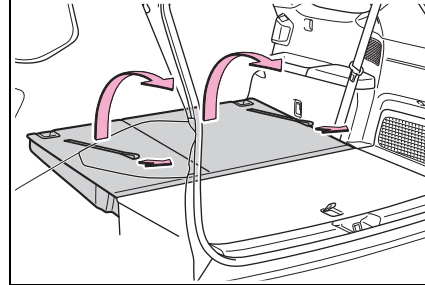

- 2 Returning the outer head restraints.

Remove the secured seat belts from the seat belt hangers before using them.

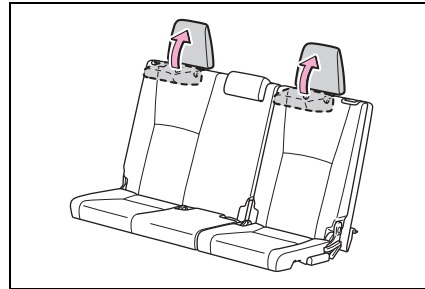

## Head restraints

**Head restraints are provided for all seats.**

### **WARNING**

#### ■ **Head restraint precautions**

Observe the following precautions regarding the head restraints. Failure to do so may result in death or serious injury.

- Use the head restraints designed for each respective seat.
- Adjust the head restraints to the correct position at all times.
- After adjusting the head restraints, push down on them and make sure they are locked in position.
- Do not drive with the head restraints removed.
- When sitting on the third seat, make sure that the head restraint is not folded.

## Adjusting a head restraint vertically

### ■ **Front seats**

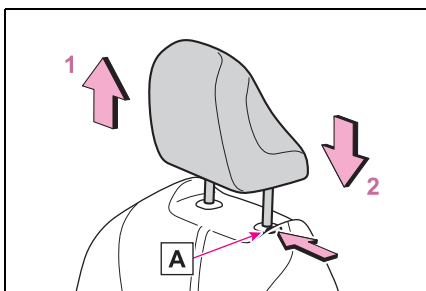

- 1 Up**  
Pull the head restraints up.

- 2 Down**  
Push the head restraint down while pressing the lock release button **A**.

### ■ **Second seats**

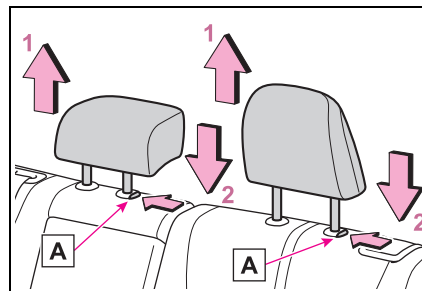

- 1 Up**  
Pull the head restraints up.
- 2 Down**  
Push the head restraint down while pressing the lock release button **A**.

### ■ **Third center seat**

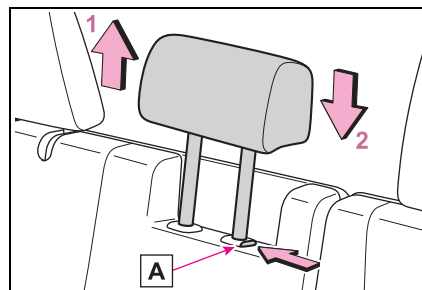

- 1 Up**  
Pull the head restraints up.
- 2 Down**  
Push the head restraint down while pressing the lock release button **A**.

**3**

Before driving

■ Adjusting the height of the head restraints

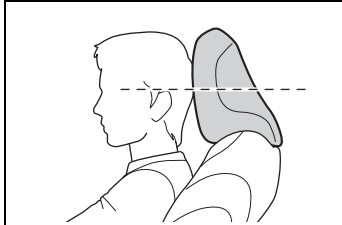

Make sure that the head restraints are adjusted so that the center of the head restraint is closest to the top of your ears.

■ Adjusting the rear center seat head restraints

Always raise the head restraint one level from the stowed position when using.

**Removing the head restraints**

Pull the head restraint up while pressing the lock release button



If the head restraint touches the ceiling, making the removal difficult, change the seat height or angle. (→P.141, 142)

► Front seats

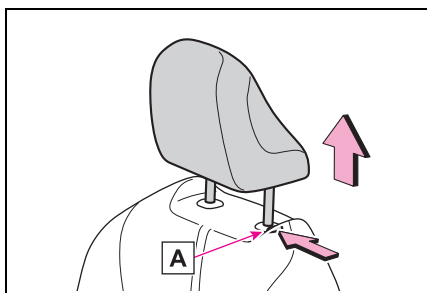

► Second seats

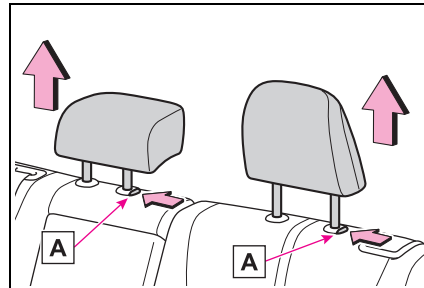

► Third center seat

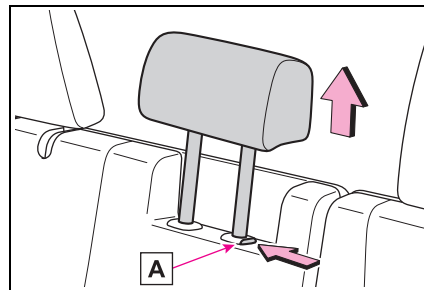

**Installing the head restraints**

Align the head restraint with the installation holes and push it down to the lock position.

Press and hold the lock release button **A** when lowering the head restraint.

► Front seats

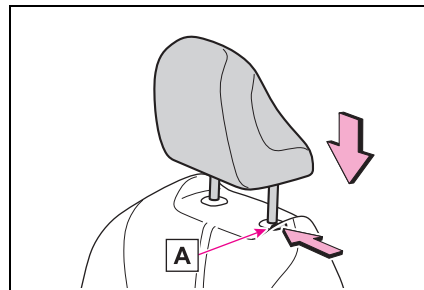

▶ Second seats

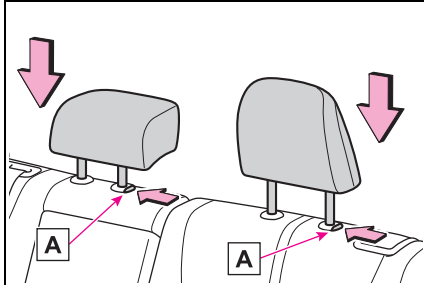

▶ Third center seat

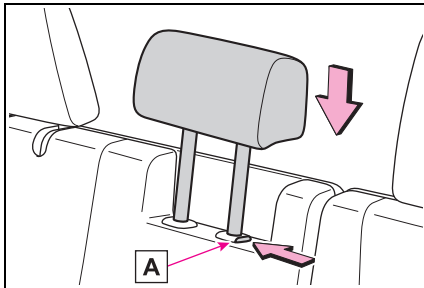

### Steering wheel

#### Adjustment procedure

- 1 Hold the steering wheel and push the lever down.

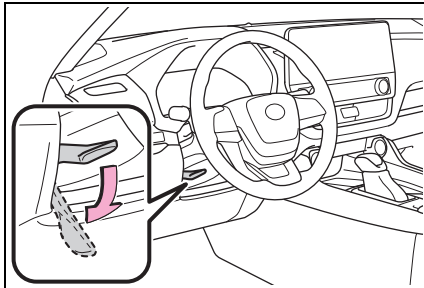

- 2 Adjust to the ideal position by moving the steering wheel horizontally and vertically.

After adjustment, pull the lever up to secure the steering wheel.

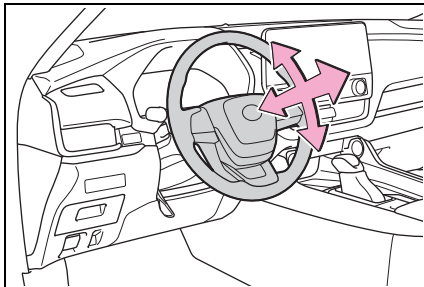

#### WARNING

##### ■ Caution while driving

Do not adjust the steering wheel while driving. Doing so may cause the driver to mishandle the vehicle and cause an accident, resulting in death or serious injury.

##### ■ After adjusting the steering wheel

Make sure that the steering wheel is securely locked. Otherwise, the steering wheel may move suddenly, possibly causing an accident, and resulting in death or serious injury. Also, the horn may not sound if the steering wheel is not securely locked.

### Sounding the horn

Press on or close to the  mark.

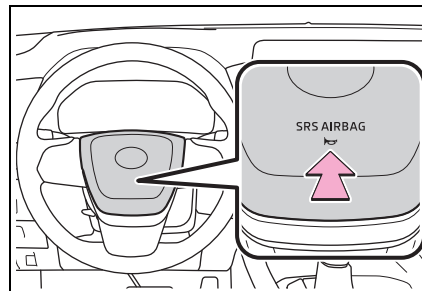

**Inside rear view mirror\***

\*: If equipped

**The rear view mirror's position can be adjusted to enable sufficient confirmation of the rear view.**

**Adjusting the height of rear view mirror**

The height of the rear view mirror can be adjusted to suit your driving posture.

Adjust the height of the rear view mirror by moving it up and down.

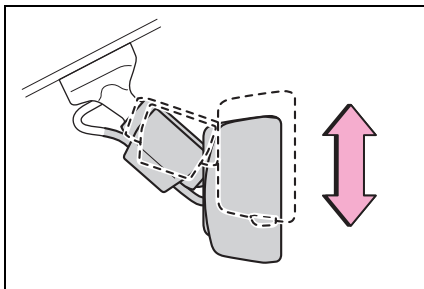

**⚠ WARNING**

**■ Caution while driving**

Do not adjust the position of the mirror while driving. Doing so may lead to mishandling of the vehicle and cause an accident, resulting in death or serious injury.

**Anti-glare function**

Responding to the level of brightness of the headlights of

vehicles behind, the reflected light is automatically reduced.

**■ To prevent sensor error**

To ensure that the sensors operate properly, do not touch or cover them.

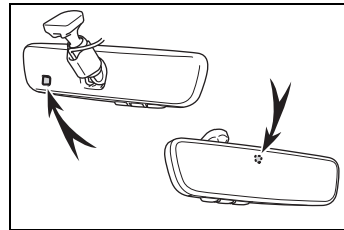

**3**

Before driving

### Digital Rear-view Mirror\*

\*: If equipped

The Digital Rear-view Mirror is a system that uses the camera on the rear of the vehicle and displays its image on the display of the Digital Rear-view Mirror.

The Digital Rear-view Mirror can be changed between optical mirror mode and digital mirror mode by operating the lever.

The Digital Rear-view Mirror allows the driver to see the rear view despite obstructions, such as the head restraints or luggage, ensuring rear visibility. Also, the rear seats are not displayed and privacy of the passengers is enhanced.

#### WARNING

Observe the following precautions. Failure to do so may result in death or serious injury.

#### ■ Before using the Digital Rear-view Mirror

- Make sure to adjust the mirror before driving. (→P.154)
- Change to optical mirror mode and adjust the position of the Digital Rear-view Mirror so that the area behind your vehicle can be viewed properly.

- Change to digital mirror mode and adjust the display settings.

- As the range of the image displayed by the Digital Rear-view Mirror is different from that of the optical mirror, make sure to check this difference before driving.

### System components

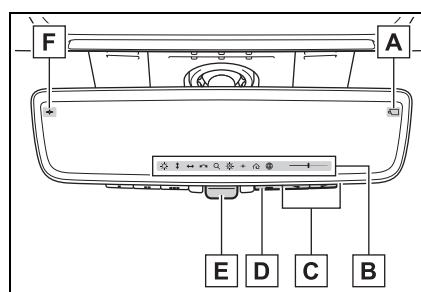

#### A Camera indicator

Indicates that the camera is operating normally.

#### B Icon display area

Displays icons, adjusting gauge, etc. (→P.154)

#### C Select/adjust button

Press to change the setting of the item you want to adjust.

#### D Menu button

Press to display the icon display area and select the item you want to adjust.

#### E Lever

Operate to change between digital mirror mode and optical mirror mode.

#### F Digital anti-glare mode indicator

In digital mirror mode, this indicates that the anti-glare function is on.



(→P.154)

### Changing modes

Operate the lever to change between digital mirror mode and optical mirror mode.

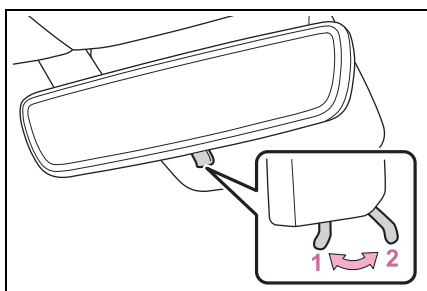

#### 1 Digital mirror mode

Displays an image of the area behind the vehicle.

 will illuminate in this mode.

#### 2 Optical mirror mode

Turns off the display of the Digital Rearview Mirror allows it to be used as an optical mirror.

#### ■ Digital mirror mode operating condition

The engine switch is turned to ON. When the engine switch is changed from ON to OFF or ACC, the image will disappear after several seconds.

#### ■ When using the Digital Rear-view Mirror in digital mirror mode

- If it is difficult to see the displayed image due to light reflected off the Digital Rear-view Mirror, the camera being dirty or covered with water droplets, dust, etc., or if lights of a vehicle behind your vehicle or the displayed image are bothering you, change to optical mirror mode.

- When it is raining, if the image is unclear due to water on the rear window, operate the rear wiper.
- When the back door is open, the Digital Rear-view Mirror image may not display properly. Before driving, make sure the back door is closed.
- If the display is difficult to see due to reflected light, close the electronic sunshade for the panoramic moon roof (if equipped).
- Any of the following conditions may occur when driving in the dark, such as at night. None of them indicates that a malfunction has occurred.
- Colors of objects in the displayed image may differ from their actual color.
- Depending on the height of the lights of the vehicle behind, the area around the vehicle may appear white and blurry.
- Automatic image adjustment for brighter surrounding image may cause flickering.

If it is difficult to see the displayed image or flickering bothers you, change to optical mirror mode.

- The Digital Rear-view Mirror may become hot while it is in digital mirror mode. This is not a malfunction.
- Depending on your physical condition or age, it may take longer than usual to focus on the displayed image. In this case, change to optical mirror mode.
- Do not let passengers stare at the displayed image when the vehicle is being driven, as doing so may cause motion sickness.

#### ■ When the system malfunctions

If the symbol shown in the illustration is displayed when using the Digital Rear-view Mirror in digital mirror mode, the system may be malfunctioning. The symbol will disappear in a few seconds. Operate

the lever, change to optical mirror mode and have the vehicle inspected by your Toyota dealer.

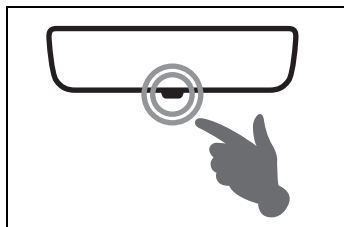

### Adjusting the mirror

#### ■ Adjusting the mirror height

The height of the rear view mirror can be adjusted to suit your driving posture.

Change to optical mirror mode, adjusting the height of the rear view mirror by moving it up and down.

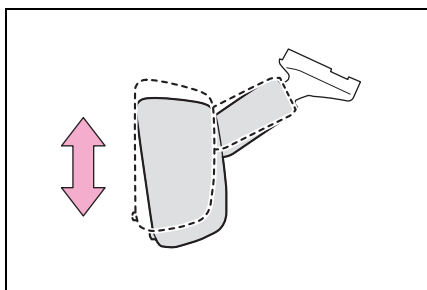

#### ■ Display settings (digital mirror mode)

Settings of the display in the digital mirror mode, on/off operation of the automatic anti-glare function, etc. can be changed.

- 1 Press the menu button.



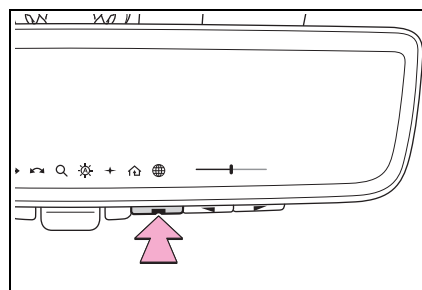

The icons will be displayed.



- 2 Press the menu button repeatedly and select the item you want to adjust.
- 3 Press or to change the setting.

The icons will disappear if a button is not operated for approximately 5 seconds or more.

Icons	Settings
	Select to adjust the brightness of the display.
	Select to adjust the area displayed up/down.
	Select to adjust the area displayed to the left/right.
	Select to adjust the angle of the displayed image.
	Select to zoom in/out the displayed image.

Icons	Settings
	<p>Select to enable/disable the automatic anti-glare function.*</p> <p>Responding to the brightness of the headlights of vehicles behind, the reflected light is automatically adjusted.</p> <p>The automatic anti-glare function is enabled each time the engine switch is changed to ON.</p>
	<p>The digital anti-glare mode can be turned on and off. When enabled, the brightness of the display is reduced at night to reduce headlight glare from vehicles to the rear.</p>
	<p>Select to display HomeLink® Training Tutorial to assist customers to train their garage door opener system. (→P.411)</p>
	<p>Select to change the language of the Homelink® Training Tutorial.</p>

\*: This is a function for the optical mirror mode, however, the setting can also be changed while using the digital mirror mode.

**■ Enabling/disabling the automatic anti-glare function (optical mirror mode)**

The automatic anti-glare function in the optical mirror mode can be enabled/disabled. The setting can be changed in both the digital mirror mode and the optical mirror mode.

- ▶ When using the digital mirror mode



→P.154

- ▶ When using the optical mirror mode

1 Press the menu button.

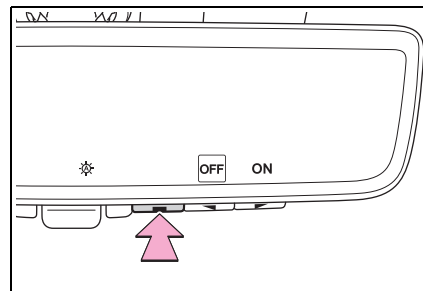
The icons will be displayed.



2 Press  or  to enable (“ON”)/disable (“OFF”) the automatic anti-glare function.

The icons will disappear if a button is not operated for approximately 5 seconds or more.

**■ Adjusting the display (digital mirror mode)**

- The icons will disappear if a button is not operated for approximately 5 seconds or more.
- If the displayed image is adjusted, it may appear distorted. This is not

a malfunction.

- If the brightness of the Digital Rearview Mirror is set too high, it may cause eye strain. Adjust the Digital Rear-view Mirror to an appropriate brightness. If your eyes become tired, change to optical mirror mode.
- The brightness of the Digital Rear-view Mirror will change automatically according to the brightness of the area in front of your vehicle.
- The digital anti-glare mode operates only in locations where the surroundings are dark. Depending on the surrounding illumination environment, the image may not darken and it may not be possible to reduce headlight glare from vehicles to the rear.

■ **To prevent the light sensors from malfunctioning**

To prevent the light sensors from malfunctioning, do not touch or cover them.

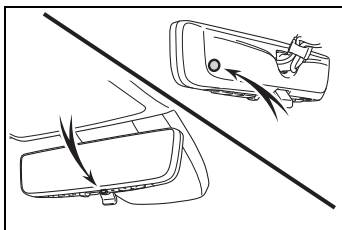

**⚠ WARNING**

Observe the following precautions. Failure to do so may result in death or serious injury.

■ **While driving**

- Do not adjust the position of the Digital Rear-view Mirror or adjust the display settings while driving. Stop the vehicle and operate the Digital Rear-view Mirror control switches. Failure to do so may cause a steering wheel operation error, resulting in an unexpected accident.
- Always pay attention to the vehicle's surroundings.

The size of the vehicles and other objects may look different when in digital mirror mode and optical mirror mode. When backing up, make sure to directly check the safety of the area around your vehicle, especially behind the vehicle. Additionally, if a vehicle approaches from the rear in the dark, such as at night, the surrounding area may appear dim.

■ **To prevent causes of fire**

If the driver continues using the Digital Rear-view Mirror while smoke or odor comes from the mirror, it may result in fire. Stop using the system immediately and contact your Toyota dealer.

**Cleaning the Digital Rear-view Mirror**

■ **Cleaning the mirror surface**

If the mirror surface is dirty, the image on the display may be difficult to see. Clean the mirror surface gently using a soft dry cloth.

■ **The camera**

The camera for the Digital

Rear-view Mirror is located as shown.

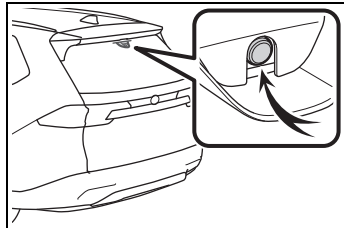

 NOTICE

- **To prevent the camera from malfunctioning**
- Observe the following precautions, otherwise the Digital Rear-view Mirror may not operate properly.
- Do not strike or hit the camera or subject it to a strong impact, as the camera installation position and angle may be changed.



- Do not remove, disassemble or modify the camera.
- Do not allow an organic solvent, car wax, window cleaner or glass coating to adhere to the camera. If this happens, wipe it off as soon as possible.
- When applying colored film (including transparent film) to the rear window glass, do not apply it to the area in front of the camera. If film is applied to the area in front of the camera, the image from the camera may not display properly.
- Do not subject the camera to a strong impact as this could cause a malfunction. If this happens, have the vehicle inspected by your Toyota dealer as soon as possible.



**If you notice any symptoms**

If you notice any of the following symptoms, refer to the following table for the likely cause and the solution.

If the symptom is not resolved by the solution, have the vehicle inspected by your Toyota dealer.

Symptom	Likely cause	Solution
The image is difficult to see.	The mirror surface is dirty.	Clean the mirror surface gently, using a soft dry cloth.
	Sunlight or headlights are shining directly into the Digital Rear-view Mirror.	Change to optical mirror mode. (If the light is coming through the panoramic moon roof [if equipped], close the electronic sunshade.)
	<ul style="list-style-type: none"> <li>• The vehicle is in a dark area.</li> <li>• The vehicle is near a TV tower, broadcasting station, electric power plant, or other location where strong radio waves or electrical noise may be present.</li> <li>• The temperature around the camera is extremely high/low.</li> <li>• The ambient temperature is extremely low.</li> <li>• It is raining or humid.</li> <li>• Sunlight or headlights are shining directly into the camera lens.</li> <li>• The vehicle is under fluorescent lights, sodium lights, mercury lights, etc.</li> <li>• Exhaust gas is obstructing the camera.</li> </ul>	Change to optical mirror mode. (Change back to digital mirror mode when the conditions have improved.)

Symptom	Likely cause	Solution
The image is difficult to see.	Foreign matters such as water droplets or dust is on the camera lens.	Have the vehicle inspected by your Toyota dealer.
	The luggage in the luggage compartment is reflected off the rear window glass and obstructing the camera.	<ul style="list-style-type: none"> <li>• Change to optical mirror mode.</li> <li>• Move the luggage to a position where it does not obstruct the camera or cover it with a black cloth to reduce the amount it is reflected off the rear window glass.</li> </ul>
	The rear window glass is fogged up.	Change to optical mirror mode. After defogging the rear window using the rear window defogger (→P.368), use the digital mirror mode again.
	The outside of the rear window glass is dirty.	Use the rear window wiper to remove dirt.
	The inside of the rear window glass is dirty.	Have the vehicle inspected by your Toyota dealer.
The image is out of alignment.	The back door is not fully closed.	Fully close the back door.
	The camera or its surrounding area has received a strong impact.	Change to optical mirror mode and have the vehicle inspected by your Toyota dealer.
The display is dim and  is displayed.	The system may be malfunctioning.	Change to optical mirror mode and have the vehicle inspected by your Toyota dealer.
 goes off.		

Symptom	Likely cause	Solution
 is displayed.	<p>The Digital Rear-view Mirror is extremely hot.</p> <p>(The display will gradually become more dim. If the temperature continues to increase, the Digital Rear-view Mirror will turn off.)</p>	<p>Reducing the cabin temperature is recommended to reduce the temperature of the mirror.</p> <p>( will disappear when the mirror becomes cool.)</p> <p>If  does not disappear even though the mirror is cool, have the vehicle inspected by your Toyota dealer.</p>
The lever cannot be operated properly.	The lever may be malfunctioning.	<p>Change to optical mirror mode and have the vehicle inspected by your Toyota dealer.</p> <p>(To change to optical mirror mode, press and hold the menu button for approximately 10 seconds.)</p>



**Outside rear view mirrors**

The rear view mirror's position can be adjusted to enable sufficient confirmation of the rear view.

**When using the outside rear view mirrors in a cold weather**

When it is cold and the outside rear view mirrors are frozen, it may not be possible to fold/extend them or adjust the mirror surface. Remove the ice, snow, etc. covering the outside rear view mirrors.

**⚠ WARNING**

**Important points while driving**

Observe the following precautions while driving. Failing to do so may result in loss of control of the vehicle and cause an accident, resulting in death or serious injury.

- Do not adjust the mirrors while driving.
- Do not drive with the mirrors folded.
- Both the driver and passenger side mirrors must be extended and properly adjusted before driving.

**Adjustment procedure**

- 1 To select a mirror to adjust, press the switch.

- ▶ Vehicles with outer mirror electric storage switch

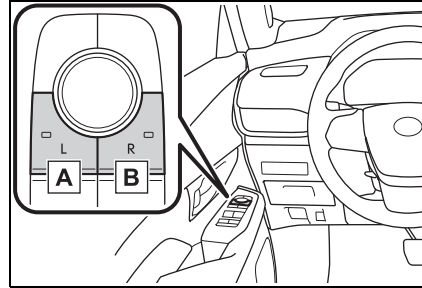

**A** Left

**B** Right

- ▶ Vehicles without outer mirror electric storage switch

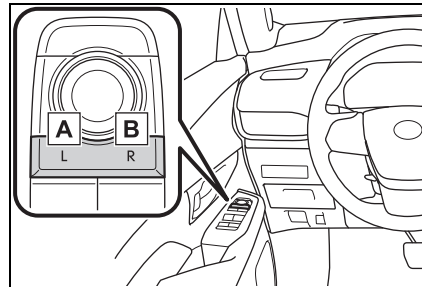

**A** Left

**B** Right

Pressing the same switch again will put the switch in neutral.

- 2 To adjust the mirror, press the switch.

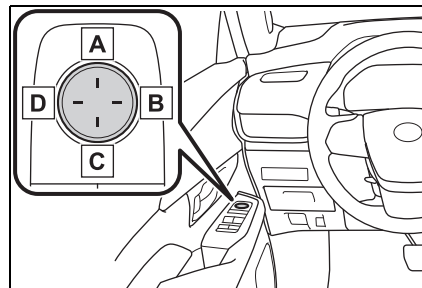

- A Up
- B Right
- C Down
- D Left

■ **Mirror angle can be adjusted when**

The engine switch is in ACC or ON.

■ **Defogging the mirrors**

The outside rear view mirrors can be cleared using the mirror defoggers. Turn on the rear window defogger to turn on the outside rear view mirror defoggers. (→P.370)

■ **Automatic adjustment of the mirror angle (if equipped)**

A desired mirror face angle can be entered to memory and recalled automatically by the driving position memory. (→P.171)

■ **Linked mirror function when reversing (if equipped)**

When either “L” or “R” of the mirror select switch is selected, the outside rear view mirrors will automatically angle downwards when the vehicle is reversing in order to give a better view of the ground.

To disable this function, select neither “L” nor “R”.

To set the mirror angle used when the vehicle is reversing, adjust the mirror angle at a desired position with the shift position in R.

The adjusted angle will be memorized and the mirror will automatically tilt to the memorized angle whenever the shift position is shifted to R from next time.

The memorized downward tilt position of the mirror is linked to the normal position (angle adjusted with the shift position in other than R). Therefore, if the normal position is changed after adjustment, the tilt position will also change.

When the normal position is changed, readjust the angle in reversing.

■ **Auto anti-glare function (if equipped)**

When the anti-glare inside rear view mirror is set to automatic mode, the outside rear view mirrors will activate in conjunction with the anti-glare inside rear view mirror to reduce reflected light. (→P.151, 154)

**! WARNING**

■ **When the mirror defoggers are operating**

Do not touch the rear view mirror surfaces, as they can become very hot and burn you.

**Folding the mirrors (manual type)**

Push the mirror back in the direction of the vehicle’s rear.

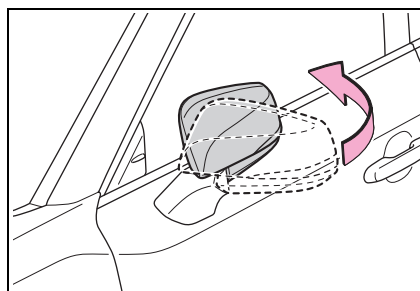

**Folding and extending the mirrors (power type)**

■ **Using the switch**

Press the switch to fold the mirrors.

Press it again to extend them to the original position.

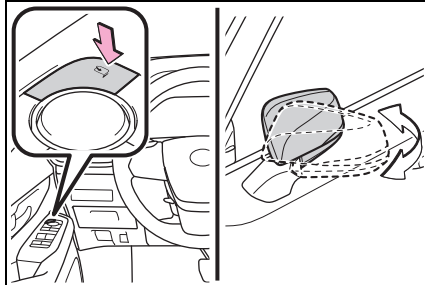

**! WARNING**

**■ When a mirror is moving**  
 To avoid personal injury and mirror malfunction, be careful not to get your hand caught by the moving mirror.

**■ Setting automatic mode**

Automatic mode allows the folding or extending of the mirrors to be linked to locking/unlocking of the doors.

Press the “AUTO” switch to set automatic mode.

The indicator **A** will come on.

Pressing the switch once more will return to manual mode.

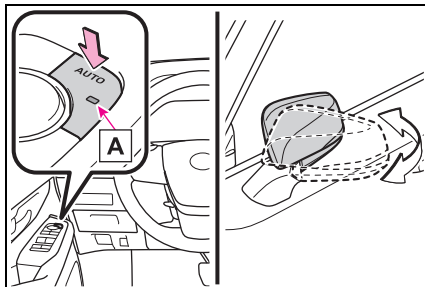

**■ When disconnecting and reconnecting battery terminals**

The automatic folding/extending mirror function will return to off as default. To turn the function on, press the switch again to select on.

**■ Customization**

Some functions can be customized. (→P.538)

## Power windows

### Opening and closing the power windows

The power windows can be opened and closed using the switches.

Operating the switch moves the windows as follows:

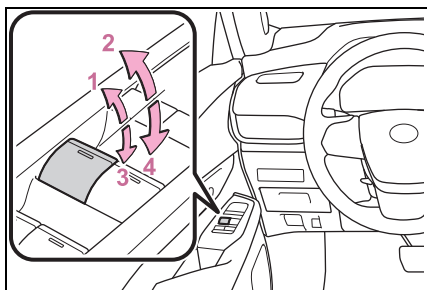

- 1 Closing
- 2 One-touch closing\*
- 3 Opening
- 4 One-touch opening\*

\*: To stop the window partway, operate the switch in the opposite direction.

#### ■ The power windows can be operated when

The engine switch is in ON.

#### ■ Operating the power windows after turning the engine off

The power windows can be operated for approximately 45 seconds even after the engine switch is turned to ACC or turned off. They cannot, however, be operated once either front door is opened.

#### ■ Jam protection function

If an object becomes jammed between the window and the win-

dow frame while the window is closing, window movement is stopped and the window is opened slightly.

#### ■ Catch protection function

If an object becomes caught between the door and window while the window is opening, window movement is stopped.

#### ■ When the window cannot be opened or closed

When the jam protection function or catch protection function operates unusually and the door window cannot be opened or closed, perform the following operations with the power window switch of that door.

- Stop the vehicle. With the engine switch in ON, within 4 seconds of the jam protection function or catch protection function activating, continuously operate the power window switch in the one-touch closing direction or one-touch opening direction so that the door window can be opened and closed.
- If the door window cannot be opened and closed even when performing the above operations, perform the following procedure for function initialization.
  - 1 Turn the engine switch to ON.
  - 2 Pull and hold the power window switch in the one-touch closing direction and completely close the door window.
  - 3 Release the power window switch for a moment, resume pulling the switch in the one-touch closing direction, and hold it there for approximately 6 seconds or more.
  - 4 Press and hold the power window switch in the one-touch opening direction. After the door window is completely opened, continue holding the switch for an additional 1 second or more.
  - 5 Release the power window switch for a moment, resume

pushing the switch in the one-touch opening direction, and hold it there for approximately 4 seconds or more.

- 6 Pull and hold the power window switch in the one-touch closing direction again. After the door window is completely closed, continue holding the switch for a further 1 second or more.

If you release the switch while the window is moving, start again from the beginning.

If the window reverses and cannot be fully closed or opened, have the vehicle inspected by your Toyota dealer.

**■ Door lock linked window operation**

- The power windows can be opened and closed using the mechanical key.\* (→P.506)
- The power windows can be opened using the wireless remote control.\* (→P.115)

\*: These settings must be customized at your Toyota dealer.

**■ Alarm**

The alarm may be triggered if the alarm is set and a power window is closed using the door lock linked power window operation function. (→P.73)

**■ Power windows open warning buzzer**

A buzzer sounds and a message is shown on the multi-information display in the instrument cluster when the engine switch is turned off and the driver's door is opened with the power windows open.

**■ Customization**

Some functions can be customized. (→P.538)

**⚠ WARNING**

Observe the following precautions. Failing to do so may result in death or serious injury.

**■ Closing the windows**

- The driver is responsible for all the power window operations, including the operation for the passengers. In order to prevent accidental operation, especially by a child, do not let a child operate the power windows. It is possible for children and other passengers to have body parts caught in the power window. Also, when riding with a child, it is recommended to use the window lock switch. (→P.166)
- Check to make sure that all passengers do not have any part of their body in a position where it could be caught when a window is being operated.

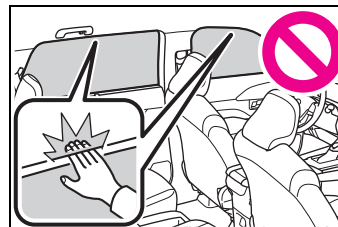

- When using the wireless remote control or mechanical key and operating the power windows, operate the power window after checking to make sure that there is no possibility of any passenger having any of their body parts caught in the window. Also do not let a child operate window by the wireless remote control or mechanical key. It is possible for children and other passengers to get caught in the power window.

**⚠ WARNING**

- When exiting the vehicle, turn the engine switch off, carry the key and exit the vehicle along with the child. There may be accidental operation, due to mischief, etc., that may possibly lead to an accident.

■ **Jam protection function**

- Never use any part of your body to intentionally activate the jam protection function.

- The jam protection function may not work if something gets jammed just before the window is fully closed. Be careful not to get any part of your body jammed in the window.

■ **Catch protection function**

- Never use any part of your body or clothing to intentionally activate the catch protection function.

- The catch protection function may not work if something gets caught just before the window is fully opened. Be careful not to get any part of your body or clothing caught in the window.

opened and closed using the driver's switch even if the lock switch is on.

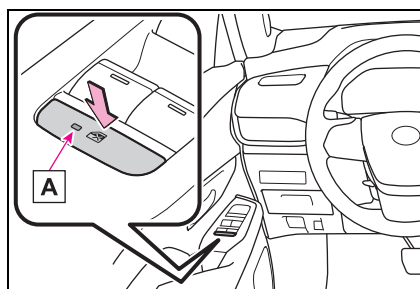

■ **The power windows can be operated when**

The engine switch is in ON.

■ **When the battery is disconnected**

The window lock switch is disabled. If necessary, press the window lock switch after reconnecting the battery.

**Preventing accidental operation (window lock switch)**

This function can be used to prevent children from accidentally opening or closing a passenger window.

Press the switch.

The indicator **A** will come on and the passenger windows will be locked.

The passenger windows can still be

**Panoramic moon roof\***

\*: If equipped

**Use the overhead switches to operate the panoramic moon roof and electronic sunshade.**

**Operating the panoramic moon roof**

■ **Opening and closing the electronic sunshade**

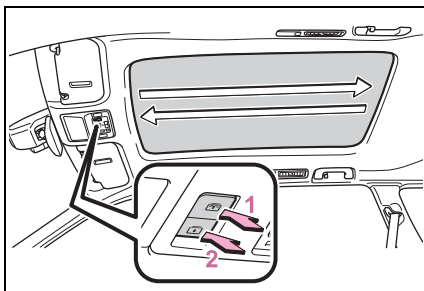

- 1 Opens the electronic sunshade\*<sup>1</sup>
- 2 Closes the electronic sunshade\*<sup>2</sup>

\*<sup>1</sup>: Lightly press either end of the  switch to stop the electronic sunshade while it is operating.

\*<sup>2</sup>: Lightly press either end of the  switch to stop the electronic sunshade while it is operating.

■ **Tilting the panoramic moon roof up and down**

Tilts the panoramic moon roof up (press)\*

When the panoramic moon roof is

tilted up, the electronic sunshade will open to the half-open position of the roof.

\*: Lightly press the  switch again to stop the panoramic moon roof partway.

Tilts the panoramic moon roof down (press and hold)

The panoramic moon roof can be tilted down only when it is in the tilt-up position.

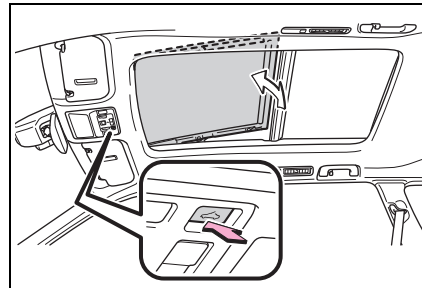

■ **Opening and closing the panoramic moon roof**

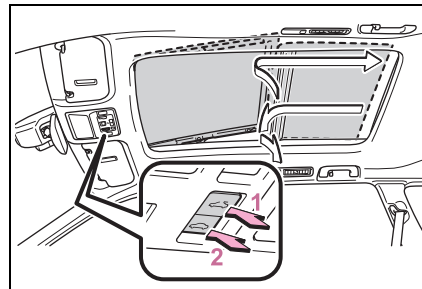

- 1 Opens the panoramic moon roof\*<sup>1</sup>

The panoramic moon roof and electronic sunshade will open.

The panoramic moon roof can be opened from the tilt-up position.

- 2 Closes the panoramic moon roof\*<sup>2</sup>

The panoramic moon roof stops at

3

Before driving

the tilt-up position.

Press and hold the  switch again to fully close the panoramic moon roof.

\*1: Lightly press either end of the  switch to stop the electronic sunshade while it is operating.

\*2: Lightly press either end of the  switch to stop the electronic sunshade while it is operating.

#### ■ The panoramic moon roof can be operated when

The engine switch is in ON.

#### ■ Operating the panoramic moon roof after turning the engine off

The panoramic moon roof and electronic sunshade can be operated for approximately 45 seconds after the engine switch is turned to ACC or turned off. They cannot, however, be operated once the driver's door is opened.

#### ■ Jam protection function

If an object is detected between the panoramic moon roof and the frame in the following situations, travel is stopped and the panoramic moon roof opens slightly:

- The panoramic moon roof is closing or tilting down.
- The electronic sunshade is closing.

#### ■ Door lock linked panoramic moon roof operation

- The panoramic moon roof can be opened and closed using the mechanical key.\* (→P.506)
- The panoramic moon roof can be opened using the wireless remote control.\* (→P.115)
- The alarm may be triggered if the alarm is set and the panoramic

moon roof is closed using the door lock linked moon roof operation function. (→P.73)

\*: These settings must be customized at your Toyota dealer.



#### ■ Closing both the panoramic moon roof and electronic sunshade

Press the  switch.

The electronic sunshade will close to the half-open position and pause. The panoramic moon roof will then fully close. Then the electronic sunshade will fully close.

#### ■ When the panoramic moon roof or electronic sunshade does not close normally

Perform the following procedure:

- 1 Stop the vehicle.
- 2 Turn the engine switch to ON.
- 3 Press and hold the  switch or  switch. Continue pressing the switch for approximately 10 seconds after the panoramic moon roof or electronic sunshade closes and reopens. The panoramic moon roof and electronic sunshade will start to close.\*
- 4 Check that the panoramic moon roof and electronic sunshade are fully closed and release the switch.

\*: If the switch is released at the incorrect time, the procedure will have to be performed again from the beginning.

If the panoramic moon roof or electronic sunshade does not fully close even after performing the above procedure correctly, have the vehicle inspected by your Toyota dealer.

#### ■ Panoramic moon roof open warning buzzer

A buzzer sounds and a message is shown on the multi-information dis-



play in the instrument cluster when the engine switch is turned off and the driver's door is opened with the panoramic moon roof open.

**■ Customization**

Some functions can be customized. (→P.538)

**⚠ WARNING**

Observe the following precautions. Failing to do so may cause death or serious injury.

**■ Opening and closing the electronic sunshade**

- Check to make sure that all passengers do not have any part of their body in a position where it could be caught when the electronic sunshade is being operated.

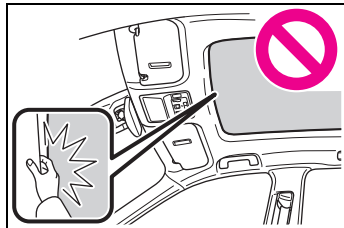

- Do not let a child operate the electronic sunshade. Closing the electronic sunshade on someone can cause death or serious injury.

**■ Opening the panoramic moon roof**

- Do not allow any passengers to put their hands or heads outside the vehicle while it is moving.
- Do not sit on top of the panoramic moon roof.

**■ Opening and closing the panoramic moon roof**

- The driver is responsible for panoramic moon roof opening and closing operations. In order to prevent accidental operation, especially by a child, do not let a child operate the panoramic moon roof. It is possible for children and other passengers to have body parts caught in the panoramic moon roof.
- Check to make sure that all passengers do not have any part of their body in a position where it could be caught when the panoramic moon roof is being operated.

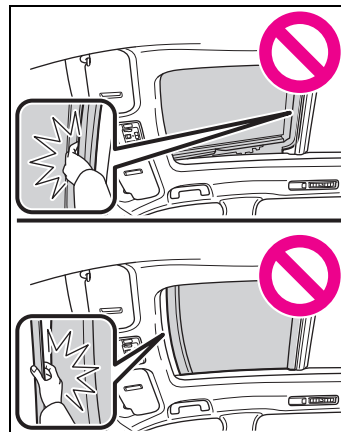

- When using the wireless remote control or mechanical key and operating the panoramic moon roof, operate the panoramic moon roof after checking to make sure that there is no possibility of any passenger having any of their body parts caught in the panoramic moon roof. Also, do not let a child operate panoramic moon roof by the wireless remote control or mechanical key. It is possible for children and other passengers to get caught in the panoramic moon roof.

 **WARNING**

- When exiting the vehicle, turn the engine switch off, carry the key and exit the vehicle along with the child. There may be accidental operation, due to mischief, etc., that may possibly lead to an accident.



■ **Jam protection function**

- Never use any part of your body to intentionally activate the jam protection function.

- The jam protection function may not work if something gets caught just before the panoramic moon roof or electronic sunshade is fully closed. Also, the jam protection function is not designed to operate while the switch is being pressed. Take care so that your fingers, etc. do not get caught.

■ **To prevent burns or injuries**

Do not touch the area between the underside of the panoramic moon roof and the electronic sunshade. Your hand may get caught and you could injure yourself. Also, if the vehicle is left in direct sunlight for a long time, the underside of the panoramic moon roof could become very hot and could cause burns.

- Do not continuously press the  switch or  switch after the panoramic moon roof has been fully opened or closed.

■ **After the vehicle has been washed or rained on**

Before opening the panoramic moon roof, wipe any water off the panoramic moon roof. Otherwise, water may enter the cabin when the panoramic moon roof is opened.

 **NOTICE**

■ **To prevent damage to the panoramic moon roof**

- Before opening the panoramic moon roof, make sure that there are no foreign objects, such as stones or ice, around the opening.

- Do not hit the surface or edge of the panoramic moon roof with hard objects.

**Driving position memory\***

\*: If equipped

**This feature automatically adjusts the driver's seat, outside rear view mirrors and head-up display (if equipped) to make entering and exiting the vehicle easier or to suit your preferences.**

**Up to 2 different driving positions can be recorded.**

**Each electronic key can be registered to recall your preferred driving position.**

**Recording a driving position into memory**

- 1** Check that the shift position is in P.
- 2** Turn the engine switch to ON.
- 3** Adjust the driver's seat, outside rear view mirrors and head-up display (if equipped) to the desired positions.
- 4** While pressing the "SET" button, or within 3 seconds after the "SET" button is pressed, press button "1" or "2" until the buzzer sounds.

If the selected button has already been preset, the previously recorded position will be overwritten.

ten.

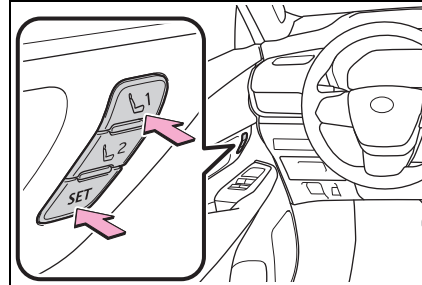

**■ Seat positions that can be memorized (→P.141)**

The adjusted positions other than the position adjusted by lumbar support switch can be recorded.

**■ In order to correctly use the driving position memory function**

If a seat position is already in the furthest possible position and the seat is operated in the same direction, the recorded position may be slightly different when it is recalled.

**⚠ WARNING**

**■ Seat adjustment caution**

Take care during seat adjustment so that the seat does not strike the rear passenger or squeeze your body against the steering wheel.

**Recalling a driving position**

- 1** Check that the shift position is in P.
- 2** Turn the engine switch to ON.
- 3** Press one of the buttons for the driving position you want

**3**

Before driving

to recall until the buzzer sounds.

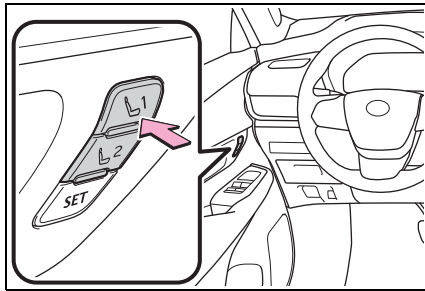

■ **To stop the position recall operation part-way through**

Perform any of the following operations:

- Press the “SET” button.
- Press button “1” or “2”.
- Operate any of the seat adjustment switches (only cancels seat position recall).

■ **Jam protection function**

While the driving position is recalled, if an object is stuck behind the front seat, the front seat will stop and then slightly move forward. When the jam protection function operates, the seat stops at a position other than the set seat position. Check the seat position.

■ **Operating the driving position memory after turning the engine switch off**

Recorded seat positions can be activated up to 180 seconds after the driver’s door is opened and another 60 seconds after it is closed again.

■ **When the recorded seat position cannot be recalled**

The seat position may not be recalled in some situations when the seat position is recorded in a certain range. For details, contact your Toyota dealer.

■ **Using the voice control system\***

\*: If equipped

The following operations can be performed using the voice control system:

- Driving position registration
- Driving position recall (only when the shift position is in P)

For details, refer to the “MULTIMEDIA OWNER’S MANUAL”

**Registering/canceling/recall a driving position to an electronic key (memory recall function)**

■ **Identifying a driver with the electronic key assigned and registered in My Settings**

The driving positions can be automatically recalled for each registered driver by registering electronic key assignments in My Settings.

- Driving position registration procedure

When the shift position is shifted to P after driving the vehicle, the current driving position will be recorded.

- Driving position recall procedure

- 1 Carry only the key that has been assigned and registered in My Settings, and then unlock and open the driver’s door using the smart key system or wireless remote control.

The driving position other than the

head-up display (if equipped) will move to the recorded position.

If the driving position is in a position that has already been recorded, the driving position will not move.

- 2 Turn the engine switch to ON.

The head-up display (if equipped) will move to the recorded position.

- Memory recall function cancellation procedure

Initialize the driver registered settings in My Settings.

For information on initializing driver registered settings, refer to the "MULTIMEDIA OWNER'S MANUAL".

#### ■ Identifying a driver with face information assigned and registered in My Settings

The driving positions can be automatically recalled for each registered driver by registering face information in the face authentication system and registering the face information assignment in My Settings.

- Driving position registration procedure

When the shift position is shifted to P after driving the vehicle, the current driving position will be recorded.

- Driving position recall procedure

Turn the engine switch to ACC or ON.

After face authentication is per-

formed successfully, the seat, outside rear view mirrors and head-up display (if equipped) (only when the engine switch is turned on) will move to the registered driving position. They will not move if already in the registered driving position.

- Memory recall function cancellation procedure

Delete face information from the face authentication system.

For information on deleting fingerprint information, refer to the "MULTIMEDIA OWNER'S MANUAL".

#### ■ Vehicles without a My Settings function

Each electronic key can be registered to automatically recall your preferred driving position.

- Driving position registration procedure

Record your driving position to button "1" or "2" before performing the following:

Carry only the key you want to register, and then close the driver's door.

If 2 or more keys are in the vehicle, the driving position cannot be recorded properly.

- 1 Check that the shift position is in P.
- 2 Turn the engine switch to ON.
- 3 Recall the driving position that you want to record.
- 4 While pressing the recalled button, press and hold the

door lock switch (either lock or unlock) until the buzzer sounds.

If the button could not be registered, the buzzer sounds continuously for approximately 3 seconds.

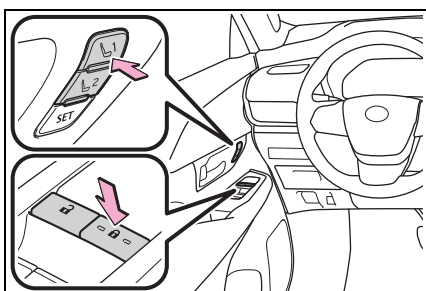

- Driving position recall procedure

- 1 Make sure that the doors are locked before recalling the driving position. Carry the electronic key that has been registered to the driving position, and then unlock and open the driver's door using the smart key system or wireless remote control.

The driving position will move to the recorded position (not including the head-up display [if equipped]).

If the driving position is in a position that has already been recorded, the seat and outside rear view mirrors will not move.

- 2 Turn the engine switch to ON.

The head-up display (if equipped) will move to the recorded position.

- Memory recall function cancellation procedure

Carry only the key you want to cancel and then close the

driver's door.

If 2 or more keys are in the vehicle, the driving position cannot be canceled properly.

- 1 Check that the shift position is in P.
- 2 Turn the engine switch to ON.
- 3 While pressing the "SET" button, press and hold the door lock switch (either lock or unlock) until the buzzer sounds twice.

If it button could not be canceled, the buzzer sounds continuously for approximately 3 seconds.

- Recalling the driving position using the memory recall function (vehicles with the My setting)

Different driving positions can be registered for each electronic key. Therefore, the driving position that is recalled may be different depending on the key being carried.

- Recalling the driving position using the memory recall function (vehicles without the My setting)

- Different driving positions can be registered for each electronic key. Therefore, the driving position that is recalled may be different depending on the key being carried.
- If a door other than the driver's door is unlocked with the smart key system, the driving position cannot be recalled. In this case, press the driving position button which has been set.

- Jam protection function

While the driving position is recalled, if an object is stuck behind

the front seat, the front seat will stop and then slightly move forward. When the jam protection function operates, the seat stops at a position other than the set seat position. Check the seat position.

#### ■ Customization

Some functions can be customized. (→P.538)

### My Settings\*

\*: If equipped

**By identifying an individual through a device, such as an electronic key, the driving position and vehicle settings recorded for that driver can be recalled when the vehicle is entered.**

**By assigning an authentication device to a driver in advance, the driver can enter the vehicle with their preferred settings.**

**Settings for up to 3 drivers can be recorded by My Settings.**

**For details on how to assign/delete electronic keys, set driver names, perform initialization, change drivers manually, or delete a driver, refer to the “MULTI-MEDIA OWNER’S MANUAL”.**

### Types of assigned authentication devices

An individual can be identified using the following authentication devices:

- Electronic key/Digital key\*

An individual is identified when the smart key system detects their electronic key/digital key. (→P.113, 136)

- **Face authentication system\***

An individual is identified at the opening/closing of the door when face information registered using the driver monitor camera is identified. (→P.243)

Individual identification by face authentication is prioritized than by electronic key/digital key\*, if the latter has identified with another registered driver.

- **Bluetooth® devices**

An individual can be identified if the same Bluetooth® device that was used as a hands-free phone the last time the vehicle was entered is connected to the audio system.

If an individual is identified by detecting an electronic key, identification by Bluetooth® device will not be performed.

\*: If equipped

### Recalled functions

When an individual is identified from an authentication device, settings for the following functions are recalled.

- **Driving position (memory recall function)**

After an individual is identified, the driving position that was set when driving was last completed (with shift position set to P) is recalled when the following operation is performed.

However, when a Bluetooth® device is used to identify an individ-

ual, the driving position is not recalled.

- When an individual is identified from an electronic key: Unlocking the doors using the smart key system or wireless remote control
- When an individual is identified from a digital key\*<sup>1</sup>: Unlocking the doors using the smart key system
- When an individual is identified from the face authentication system\*<sup>1</sup>: After the driver monitor identifies face information, turning the engine switch to ACC or ON.

- **Meter displays\*<sup>2</sup>, head-up display\*<sup>1,2</sup>, and Multimedia Display\*<sup>2</sup>**

When an individual is identified, the vehicle settings used when the engine switch was last turned off are recalled.

- **Safe driving support function\*<sup>2</sup>**

When an individual is identified, the vehicle settings used when the engine switch was last turned off are recalled.

- **Vehicle settings available on the Multimedia Display\*<sup>2</sup>**

When an individual is identified, the vehicle settings used when the engine switch was last turned off are recalled.

\*<sup>1</sup>: If equipped

\*<sup>2</sup>: Some settings are excluded



- |  |   |
|--|---|
| <p><b>4-1. Before driving</b></p> <ul style="list-style-type: none"> <li>Driving the vehicle..... 179</li> <li>Cargo and luggage ..... 186</li> <li>Vehicle load limits ..... 189</li> <li>Trailer towing (vehicles without towing package) .. 190</li> <li>Trailer towing (vehicles with towing package)..... 191</li> <li>Dinghy towing ..... 201</li> </ul> <p><b>4-2. Driving procedures</b></p> <ul style="list-style-type: none"> <li>Engine (ignition) switch ..... 203</li> <li>Automatic transmission ..... 207</li> <li>Turn signal lever..... 211</li> <li>Parking brake ..... 212</li> <li>Brake Hold ..... 216</li> </ul> <p><b>4-3. Operating the lights and wipers</b></p> <ul style="list-style-type: none"> <li>Headlight switch..... 218</li> <li>AHB (Automatic High Beam)..... 220</li> <li>Fog light switch ..... 223</li> <li>Windshield wipers and washer..... 224</li> <li>Rear window wiper and washer..... 229</li> </ul> <p><b>4-4. Refueling</b></p> <ul style="list-style-type: none"> <li>Opening the fuel tank cap ..... 231</li> </ul> | <p><b>4-5. Using the driving support systems</b></p> <ul style="list-style-type: none"> <li>Toyota Safety Sense 3.0 software update..... 233</li> <li>Toyota Safety Sense 3.0 ..... 235</li> <li>Driver monitor..... 243</li> <li>PCS (Pre-Collision System) ..... 245</li> <li>LTA (Lane Tracing Assist) ..... 257</li> <li>LCA (Lane Change Assist) ..... 262</li> <li>LDA (Lane Departure Alert) ..... 265</li> <li>PDA (Proactive driving assist) ..... 271</li> <li>FCTA (Front Cross Traffic Alert)..... 277</li> <li>RSA (Road Sign Assist) ..... 280</li> <li>Dynamic radar cruise control ..... 282</li> <li>Cruise control ..... 294</li> <li>Emergency Driving Stop System ..... 298</li> <li>Traffic Jam Assist ..... 301</li> <li>Stop &amp; Start system .... 307</li> <li>BSM (Blind Spot Monitor) ..... 313</li> <li>Safe Exit Assist ..... 318</li> <li>Intuitive parking assist. 322</li> </ul> |
|--|---|

---

RCTA (Rear Cross Traffic Alert) function .....	328
RCD (Rear Camera Detection) .....	334
PKSB (Parking Support Brake).....	338
Parking Support Brake function (static objects front and rear of the vehicle) ....	342
Parking Support Brake function (moving vehicles rear of the vehicle).....	345
Parking Support Brake function (pedestrians rear of the vehicle).....	346
Driving mode select switch .....	348
Multi-terrain Select .....	349
Snow mode switch .....	352
Downhill assist control system .....	352
Driving assist systems .....	354
<b>4-6. Driving tips</b>	
Winter driving tips .....	360
Utility vehicle precautions .....	363

## Driving the vehicle

The following procedures should be observed to ensure safe driving:

### Driving procedure

#### ■ Starting the engine

→P.203

#### ■ Driving

- 1 With the brake pedal depressed, change the shift position to D. (→P.207)

Check that the shift position indicator shows D.

- 2 If the parking brake is set, release the parking brake. (→P.212)

If the parking brake is in automatic mode, the parking brake will be released automatically. (→P.213)

- 3 Gradually release the brake pedal and gently depress the accelerator pedal to accelerate the vehicle.

#### ■ Stopping

- 1 Depress the brake pedal.
- 2 If necessary, set the parking brake. (→P.212)

If the vehicle is to be stopped for an extended period of time, change the shift position to P. (→P.207)

#### ■ Parking the vehicle

- 1 Depress the brake pedal to stop the vehicle completely.

- 2 If the parking brake is released, set the parking brake. (→P.212)
- 3 Change the shift position to P. (→P.207)

Check that the shift position indicator shows P and the parking brake indicator is illuminated.

- 4 Press the engine switch to stop the engine.
- 5 Slowly release the brake pedal.
- 6 Lock the door, making sure that you have the electronic key on your person.

If parking on a hill, block the wheels as needed.

#### ■ Starting off on a steep uphill

- 1 Firmly depress the brake pedal and change the shift position to D. (→P.207)

The hill-start assist control will be activated.

- 2 Set the parking brake. (→P.212)
- 3 Release the brake pedal and gently depress the accelerator pedal to accelerate the vehicle.
- 4 Release the parking brake. (→P.212)

#### ■ Driving in the rain

- Drive carefully when it is raining, because visibility will be reduced, the windows may become fogged-up, and the road will be slippery.

- Drive carefully when it starts to rain, because the road surface will be especially slippery.
- Refrain from high speeds when driving on an expressway in the rain, because there may be a layer of water between the tires and the road surface, preventing the steering and brakes from operating properly.

■ **Engine speed while driving**

In the following conditions, the engine speed may become high while driving. This is due to automatic up-shifting control or down-shifting implementation to meet driving conditions. It does not indicate sudden acceleration.

- The vehicle is judged to be driving uphill or downhill
- When the accelerator pedal is released
- When the brake pedal is depressed

■ **Restraining the engine output (Brake Override System)**

- When the accelerator and brake pedals are depressed at the same time, the engine output may be restrained.
- A warning message is displayed on the multi-information display while the system is operating.

■ **Breaking in your new Toyota**

To extend the life of the vehicle, observing the following precautions is recommended:

- For the first 200 miles (300 km):  
Avoid sudden stops.
- For the first 500 miles (800 km):  
Do not tow a trailer. (vehicles with towing package)
- For the first 1000 miles (1600 km):
  - Do not drive at extremely high speeds.
  - Avoid sudden acceleration.
  - Do not drive continuously in low

- gears.
- Do not drive at a constant speed for extended periods.

■ **Operating your vehicle in a foreign country**

Comply with the relevant vehicle registration laws and confirm the availability of the correct fuel. (→P.519)

■ **Idling time before engine stop**

To prevent damage to the turbo-charger, allow the engine to idle immediately after high-load driving.

Driving condition	Idling time
Normal city driving or high-speed driving (at the highway speed limit or recommended speed)	Not necessary
Steep hill driving, continuous driving (race track driving etc.), or towing a trailer or another vehicle (vehicles with towing package)	Approximately 1 minute

■ **Eco-friendly driving**

→P.91, 99

**⚠ WARNING**

Observe the following precautions. Failure to do so may result in death or serious injury.

■ **When starting the vehicle**

Always keep your foot on the brake pedal while stopped with the engine running. This prevents the vehicle from creeping.

**WARNING****■ When driving the vehicle**

- Do not drive if you are unfamiliar with the location of the brake and accelerator pedals to avoid depressing the wrong pedal.
- Accidentally depressing the accelerator pedal instead of the brake pedal will result in sudden acceleration that may lead to an accident.
- When backing up, you may twist your body around, leading to a difficulty in operating the pedals. Make sure to operate the pedals properly.
- Make sure to keep a correct driving posture even when moving the vehicle only slightly. This allows you to depress the brake and accelerator pedals properly.
- Depress the brake pedal using your right foot. Depressing the brake pedal using your left foot may delay response in an emergency, resulting in an accident.
- Do not drive the vehicle over or stop the vehicle near flammable materials.  
The exhaust system and exhaust gases can be extremely hot. These hot parts may cause a fire if there is any flammable material nearby.
- During normal driving, do not turn off the engine. Turning the engine off while driving will not cause loss of steering or braking control, but the power assist to these systems will be lost. This will make it more difficult to steer and brake, so you should pull over and stop the vehicle as soon as it is safe to do so. However, in the event of an emergency, such as if it becomes impossible to stop the vehicle in the normal way:  
→P.470
- Use engine braking (downshift) to maintain a safe speed when driving down a steep hill. Using the brakes continuously may cause the brakes to overheat and lose effectiveness.  
(→P.207)
- Do not adjust the positions of the steering wheel, the seat, or the inside or outside rear view mirrors while driving. Doing so may result in a loss of vehicle control.
- Always check that all passengers' arms, heads or other parts of their body are not outside the vehicle.
- AWD models: This vehicle is not designed for extreme off-roading.
- When driving in sand or mud is unavoidable, drive carefully and avoid continuous driving on sand or mud.
- Do not drive on extremely rocky roads or extremely uneven roads.

 **WARNING**

- Do not drive across a river or through other bodies of water. This may cause electric/electronic components to short circuit, damage the engine or cause other serious damage to the vehicle.
- Do not drive in excess of the speed limit. Even if the legal speed limit permits it, do not drive over 85 mph (140 km/h) unless your vehicle has high-speed capability tires. Driving over 85 mph (140 km/h) may result in tire failure, loss of control and possible injury. Be sure to consult a tire dealer to determine whether the tires on your vehicle are high-speed capability tires or not before driving at such speeds.

■ **When driving on slippery road surfaces**

- Sudden braking, acceleration and steering may cause tire slippage and reduce your ability to control the vehicle.
- Sudden acceleration, engine braking due to shifting, or changes in engine speed could cause the vehicle to skid.
- After driving through a puddle, lightly depress the brake pedal to make sure that the brakes are functioning properly. Wet brake pads may prevent the brakes from functioning properly. If the brakes on only one side are wet and not functioning properly, steering control may be affected.

■ **When changing the shift position**

- Do not let the vehicle roll backward while a forward driving position is selected, or roll forward while the shift position is in R. Doing so may cause the engine to stall or lead to poor brake and steering performance, resulting in an accident or damage to the vehicle.
- Do not change the shift position to P while the vehicle is moving. Doing so can damage the transmission and may result in a loss of vehicle control.
- Do not change the shift position to R while the vehicle is moving forward. Doing so can damage the transmission and may result in a loss of vehicle control.
- Do not change the shift position to a driving position while the vehicle is moving backward. Doing so can damage the transmission and may result in a loss of vehicle control.
- Changing the shift position to N while the vehicle is moving will disengage the engine from the transmission. Engine braking is not available when N is selected.
- Be careful not to change the shift position with the accelerator pedal depressed. Changing the shift position to any positions other than P or N may lead to unexpected rapid acceleration of the vehicle that may cause an accident and result in death or serious injury. After changing the shift position, make sure to confirm the current shift position displayed on the shift position indicator inside the meter.

**WARNING****■ If you hear a squealing or scraping noise (brake pad wear limit indicators)**

Have the brake pads checked and replaced by your Toyota dealer as soon as possible.

Rotor damage may result if the pads are not replaced when needed.

It is dangerous to drive the vehicle when the wear limits of the brake pads and/or those of the brake discs are exceeded.

**■ When the vehicle is stopped**

- Do not race the engine.  
If the vehicle is in any gear other than P or N, the vehicle may accelerate suddenly and unexpectedly, causing an accident.
- In order to prevent accidents due to the vehicle rolling away, always keep depressing the brake pedal while the engine is running, and apply the parking brake as necessary.
- If the vehicle is stopped on an incline, in order to prevent accidents caused by the vehicle rolling forward or backward, always depress the brake pedal and securely apply the parking brake as needed.
- Avoid revving or racing the engine.  
Running the engine at high speed while the vehicle is stopped may cause the exhaust system to overheat, which could result in a fire if combustible material is nearby.

**■ When the vehicle is parked**

- Do not leave glasses, cigarette lighters, spray cans, or soft drink cans in the vehicle when it is in the sun.  
Doing so may result in the following:
  - Gas may leak from a cigarette lighter or spray can, and may lead to a fire.
  - The temperature inside the vehicle may cause the plastic lenses and plastic material of glasses to deform or crack.
  - Soft drink cans may fracture, causing the contents to spray over the interior of the vehicle, and may also cause a short circuit in the vehicle's electrical components.
- Do not leave cigarette lighters in the vehicle. If a cigarette lighter is in a place such as the glove box or on the floor, it may be lit accidentally when luggage is loaded or the seat is adjusted, causing a fire.
- Do not attach adhesive discs to the windshield or windows. Do not place containers such as air fresheners on the instrument panel or dashboard. Adhesive discs or containers may act as lenses, causing a fire in the vehicle.
- Do not leave a door or window open if the curved glass is coated with a metallized film such as a silver-colored one. Reflected sunlight may cause the glass to act as a lens, causing a fire.

 **WARNING**

- Always apply the parking brake, change the shift position to P, stop the engine and lock the vehicle.

Do not leave the vehicle unattended while the engine is running.

If the vehicle is parked with the shift position in P but the parking brake is not set, the vehicle may start to move, possibly leading to an accident.

- Do not touch the exhaust pipes while the engine is running or immediately after turning the engine off. Doing so may cause burns.

■ **When taking a nap in the vehicle**

Always turn the engine off. Otherwise, if you accidentally move the shift lever or depress the accelerator pedal, this could cause an accident or fire due to engine overheating. Additionally, if the vehicle is parked in a poorly ventilated area, exhaust gases may collect and enter the vehicle, leading to death or a serious health hazard.

■ **When braking**

- When the brakes are wet, drive more cautiously. Braking distance increases when the brakes are wet, and this may cause one side of the vehicle to brake differently than the other side. Also, the parking brake may not securely hold the vehicle.

- If the brake booster device does not operate, do not follow other vehicles closely and avoid hills or sharp turns that require braking.

In this case, braking is still possible, but the brake pedal should be depressed more firmly than usual. Also, the braking distance will increase. Have your brakes fixed immediately.

- Do not pump the brake pedal if the engine stalls.

Each push on the brake pedal uses up the reserve for the power-assisted brakes.

- The brake system consists of 2 individual hydraulic systems; if one of the systems fails, the other will still operate. In this case, the brake pedal should be depressed more firmly than usual and the braking distance will increase. Have your brakes fixed immediately.

■ **If the vehicle becomes stuck (AWD models)**

Do not spin the wheels excessively when any of the tires is up in the air, or the vehicle is stuck in sand, mud, etc. This may damage the driveline components or propel the vehicle forward or backward, causing an accident.

 **NOTICE**

■ **When driving the vehicle**

- Do not depress the accelerator and brake pedals at the same time during driving, as this may restrain the engine output.

- Do not use the accelerator pedal or depress the accelerator and brake pedals at the same time to hold the vehicle on a hill.



 **NOTICE**

**■ Avoiding damage to vehicle parts**

- Do not turn the steering wheel fully in either direction and hold it there for an extended period of time.  
Doing so may damage the power steering motor.
- When driving over bumps on the road, drive as slowly as possible to avoid damaging the wheels, underside of the vehicle, etc.
- Make sure to idle the engine immediately after high-load driving. Stop the engine only after the turbocharger has cooled down.  
Failure to do so may cause damage to the turbocharger.

**■ If you get a flat tire while driving**

A flat or damaged tire may cause the following situations. Hold the steering wheel firmly and gradually depress the brake pedal to slow down the vehicle.

- It may be difficult to control your vehicle.
- The vehicle will make abnormal sounds or vibrations.
- The vehicle will lean abnormally.

Information on what to do in case of a flat tire (→P.495)

**■ When encountering flooded roads**

Do not drive on a road that has flooded after heavy rain etc. Doing so may cause the following serious damage to the vehicle:

- Engine stalling

- Short in electrical components
- Engine damage caused by water immersion

In the event that you drive on a flooded road and the vehicle is flooded, be sure to have your Toyota dealer check the following:

- Brake function
- Changes in quantity and quality of oil and fluid used for the engine, transmission, transfer (AWD models), rear differential (AWD models), etc.
- Lubricant condition for the propeller shaft (AWD models), bearings and suspension joints (where possible), and the function of all joints, bearings, etc.

**■ When parking the vehicle**

Always set the parking brake and change the shift position to P. Failure to do so may cause the vehicle to move or the vehicle may accelerate suddenly if the accelerator pedal is accidentally depressed.

**Sudden start restraint control (Drive-Start Control [DSC])**

When the following unusual operation is performed with the accelerator pedal depressed, the engine output may be restrained.

- When the shift position is shifted to R\*.
- When the shift position is shifted from P or R to forward drive shift position such as D\*.

When the system operates, a message appears on the multi-information display. Read the message and follow the instruction.

\*: Depending on the situation, the shift position may not be changed.

#### ■ Drive-Start Control (DSC)

When the TRAC is turned off (→P.356), sudden start restraint control also does not operate. If your vehicle have trouble escaping from the mud or fresh snow due to sudden start restraint control operation, deactivate TRAC (→P.356) so that the vehicle may become able to escape from the mud or fresh snow.

Also, sudden start restraint control will not operate in the following conditions:

- When Multi-terrain Select is selected (AWD vehicles)

## Cargo and luggage

**Take notice of the following information about storage precautions, cargo capacity and load.**

## Capacity and distribution

Cargo capacity depends on the total weight of the occupants.

(Cargo capacity) = (Total load capacity) — (Total weight of occupants)

Steps for Determining Correct Load Limit —

(1) Locate the statement “The combined weight of occupants and cargo should never exceed XXX kg or XXX lbs.” on your vehicle’s placard.

(2) Determine the combined weight of the driver and passengers that will be riding in your vehicle.

(3) Subtract the combined weight of the driver and passengers from XXX kg or XXX lbs.

(4) The resulting figure equals the available amount of cargo and luggage load capacity.

For example, if the “XXX” amount equals 1400 lbs. and there will be five 150 lb passengers in your vehicle, the amount of available cargo and luggage load capacity is 650 lbs. (1400 –

750 (5 × 150) = 650 lbs.)

(5) Determine the combined weight of luggage and cargo being loaded on the vehicle. That weight may not safely exceed the available cargo and luggage load capacity calculated in Step 4.

(6) If your vehicle will be towing a trailer, load from your trailer will be transferred to your vehicle. Consult this manual to determine how this reduces the available cargo and luggage load capacity of your vehicle. (→P.189)

Vehicles without towing package: Toyota does not recommend towing a trailer with your vehicle. Your vehicle is not designed for trailer towing.

**Calculation formula for your vehicle**

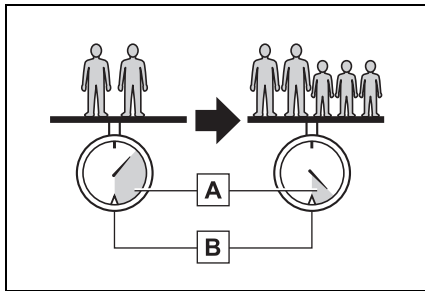

- A** Cargo capacity
- B** Total load capacity (vehicle capacity weight) (→P.518)

When 2 people with the combined weight of A lb. (kg) are rid-

ing in your vehicle, which has a total load capacity (vehicle capacity weight) of B lb. (kg), the available amount of cargo and luggage load capacity will be C lb. (kg) as follows:

$$B^{*2} \text{ lb. (kg)} - A^{*1} \text{ lb. (kg)} = C^{*3} \text{ lb. (kg)}$$

\*1: A =Weight of people

\*2: B =Total load capacity

\*3: C =Available cargo and luggage load

In this condition, if 3 more passengers with the combined weight of D lb. (kg) get on, the available cargo and luggage load will be reduced E lb. (kg) as follows:

$$C \text{ lb. (kg)} - D^{*4} \text{ lb. (kg)} = E^{*5} \text{ lb. (kg)}$$

\*4: D =Additional weight of people

\*5: E =Available cargo and luggage load

As shown in the example above, if the number of occupants increases, the cargo and luggage load will be reduced by an amount that equals the increased weight due to the additional occupants. In other words, if an increase in the number of occupants causes an excess of the total load capacity (combined weight of occupants plus cargo and luggage load), you must reduce the cargo and luggage on your vehicle.



**WARNING**

■ **Things that must not be carried in the luggage compartment**

The following things may cause a fire if loaded in the luggage compartment:

- Receptacles containing gasoline
- Aerosol cans

■ **Storage precautions**

Observe the following precautions.

Failure to do so may prevent the pedals from being depressed properly, may block the driver's vision, or may result in items hitting the driver or passengers, possibly causing an accident.

- Stow cargo and luggage in the luggage compartment whenever possible.
- Do not stack cargo and luggage in the luggage compartment higher than the seatbacks.
- When you fold down the rear seats, long items should not be placed directly behind the front seats.
- Never allow anyone to ride in the luggage compartment. It is not designed for passengers. They should ride in their seats with their seat belts properly fastened.
- Do not place cargo or luggage in or on the following locations.
  - At the feet of the driver
  - On the front passenger or rear seats (when stacking items)
  - On the luggage cover
  - On the instrument panel

- On the dashboard

- Secure all items in the occupant compartment.

■ **Capacity and distribution**

- Do not exceed the maximum axle weight rating or the total vehicle weight rating.
- Even if the total load of occupant's weight and the cargo load is less than the total load capacity, do not apply the load unevenly. Improper loading may cause deterioration of steering or braking control which may cause death or serious injury.

■ **When using a roof luggage carrier**

Observe the following precautions:

- Place the cargo so that its weight is distributed evenly between the front and rear axles.
- If loading long or wide cargo, never exceed the vehicle overall length or width. (→P.518)
- Before driving, make sure the cargo is securely fastened on the roof luggage carrier.
- Loading cargo on the roof luggage carrier will make the center of gravity of the vehicle higher. Avoid high speeds, sudden starts, sharp turns, sudden braking or abrupt maneuvers, otherwise it may result in loss of control or vehicle rollover due to failure to operate this vehicle correctly and result in death or serious injury.
- If driving for a long distance, on rough roads, or at high speeds, stop the vehicle now and then during the trip to make sure the cargo remains in its place.

 **WARNING**

- Do not exceed 154 lb. (70 kg) cargo weight on the roof luggage carrier.

 **NOTICE**

- **When loading cargo (vehicles with a panoramic moon roof)**  
Be careful not to scratch the surface of the panoramic moon roof.

**Vehicle load limits**

**Vehicle load limits include total load capacity, seating capacity, trailer weight rating and cargo capacity.**

- **Total load capacity (vehicle capacity weight):** →P.518  
Total load capacity means the combined weight of occupants, cargo and luggage.
- **Seating capacity:**→P.518  
Seating capacity means the maximum number of occupants whose estimated average weight is 150 lb. (68 kg) per person.
- **TWR (Trailer Weight Rating) (vehicles with towing package):** →P.196, 518  
TWR means the maximum gross trailer weight (trailer weight plus its cargo weight) that your vehicle is able to tow.
- **TWR (Trailer Weight Rating) (vehicles without towing package)**  
Toyota does not recommend towing a trailer with your vehicle.
- **Cargo capacity**  
Cargo capacity may increase or decrease depending on the weight and the number of occupants.

■ **Total load capacity and seating capacity**

These details are also described on the tire and loading information

label. (→P.455)



**WARNING**

■ **Overloading the vehicle**

Do not overload the vehicle. It may not only cause damage to the tires, but also degrade steering and braking ability, resulting in an accident.

**Trailer towing (vehicles without towing package)**

**Toyota does not recommend towing a trailer with your vehicle. Toyota also does not recommend the installation of a tow hitch or the use of a tow hitch carrier for a wheelchair, scooter, bicycle, etc. Your vehicle is not designed for trailer towing or for the use of tow hitch mounted carriers.**



**Trailer towing (vehicles with towing package)**

Your vehicle is designed primarily as a passenger-and-load-carrying vehicle. Towing a trailer can have an adverse impact on handling, performance, braking, durability, and fuel consumption. For your safety and the safety of others, you must not overload your vehicle or trailer. You must also ensure that you are using appropriate towing equipment, that the towing equipment has been installed correctly and used properly, and that you employ the requisite driving habits.

Vehicle-trailer stability and braking performance are affected by trailer stability, brake performance and setting, trailer brakes, the hitch and hitch systems (if equipped).

To tow a trailer safely, use extreme care and drive the vehicle in accordance with your trailer's characteristics and operating conditions.

**Toyota warranties do not apply to damage or malfunction caused by towing a trailer for commercial purposes.**

**Contact your Toyota dealer for further information about additional requirements such as a towing kit, etc.**

**Matching trailer ball height to trailer coupler height**

No matter which class of tow hitch applies, for a more safe trailer hookup, the trailer ball setup must be the proper height for the coupler on the trailer.

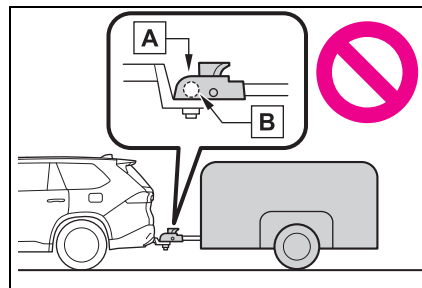
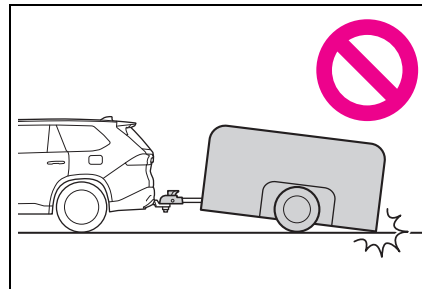

- A** Coupler
- B** Trailer ball

**Before towing**

Check that the following conditions are met:

- Ensure that your vehicle's tires are properly inflated. (→P.524)
- Trailer tires are inflated according to the trailer manufacturer's recommendation.
- All trailer lights work as required by law.
- All lights work each time you connect them.
- The trailer ball is set at the proper height for the coupler on the trailer.
- The trailer is level when it is hitched.  
Do not drive if the trailer is not level, and check for improper tongue weight, overloading, worn suspension, or other possible causes.
- The trailer cargo is securely loaded.
- The rear view mirrors conform to all applicable federal, state/provincial or local regulations. If they do not, install rear view mirrors appropriate for towing purposes.

#### ■ When towing a trailer

Disable the following systems, as the systems may not operate properly.

- LTA (Lane Tracing Assist) (→P.257)
- LDA (Lane Departure Alert) (→P.265)
- Dynamic radar cruise control (→P.282)
- Cruise control (→P.294)
- PKSB (Parking Support Brake) (if equipped) (→P.338)
- BSM (Blind Spot Monitor) (→P.313)
- Intuitive parking assist (if equipped) (→P.322)
- RCTA (Rear Cross Traffic Alert) function (→P.328)
- RCD (Rear Camera Detection) function (if equipped)(→P.334)

#### ■ Break-in schedule

If your vehicle is new or equipped with any new power train components (such as an engine, transaxle, transfer [AWD models], rear differential [AWD models] or wheel bearing), Toyota recommends that you do not tow a trailer until the vehicle has been driven for over 500 miles (800 km).

After the vehicle has been driven for over 500 miles (800 km), you can start towing. However, for the next 500 miles (800 km), drive the vehicle at a speed of less than 50 mph (80 km/h) when towing a trailer, and avoid full throttle acceleration.

#### ■ Maintenance

- If you tow a trailer, your vehicle will require more frequent maintenance due to the additional load. (See "Scheduled Maintenance Guide" or "Owner's Manual Supplement".)
- Retighten the fixing bolts of the towing ball and bracket after approximately 600 miles (1000 km) of trailer towing.

#### ■ If trailer sway occurs

One or more factors (crosswinds, passing vehicles, rough roads, etc.) can adversely affect handling of your vehicle and trailer, causing instability.

- If trailer swaying occurs:
  - Firmly grip the steering wheel. Steer straight ahead. Do not try to control trailer swaying by turning the steering wheel.
  - Begin releasing the accelerator pedal immediately but very gradually to reduce speed. Do not increase speed. Do not apply vehicle brakes.

If you make no extreme correction with the steering or brakes, your vehicle and trailer should stabilize. (if enabled, Trailer Sway Control can also help to stabilize the vehicle and trailer.)



- After the trailer swaying has stopped:
  - Stop in a safe place. Get all occupants out of the vehicle.
  - Check the tires of the vehicle and the trailer.
  - Check the load in the trailer. Make sure the load has not shifted. Make sure the tongue weight is appropriate, if possible.
  - Check the load in the vehicle. Make sure the vehicle is not overloaded after occupants get in.

If you cannot find any problems, the speed at which trailer swaying occurred is beyond the limit of your particular vehicle-trailer combination. Drive at a lower speed to prevent instability. Remember that swaying of the towing vehicle-trailer increases as speed increases.

#### **WARNING**

##### ■ **Trailer towing precautions**

To tow a trailer safely, use extreme care and drive the vehicle in accordance with the trailer's characteristics and operating conditions. Failure to do so could cause an accident resulting in death or serious injury. Vehicle stability and braking performance are affected by trailer stability, brake setting and performance, and the hitch. Your vehicle will handle differently when towing a trailer.

##### ■ **To avoid accident or injury**

- Do not exceed the TWR, unbraked TWR, GCWR, GVWR or GAWR.
- If the gross trailer weight is over 2000 lb. (907 kg), a sway control device with sufficient capacity is required.

- Adjust the tongue weight within the appropriate range. Place heavier loads as close to the trailer axle as possible.
- Do not exceed 65 mph (104 km/h), the posted towing speed limit or the speed limit for your trailer as set forth in your trailer owner's manual, whichever is lowest. Slow down sufficiently before making a turn, in cross winds, on wet or slippery surface, etc. to help avoid an accident. If you experience a vehicle-trailer instability from reducing a certain speed, slow down and make sure you keep your vehicle speed under the speed of which you experience the instability.
- Do not make jerky, abrupt or sharp turns.
- Do not apply the brakes suddenly as you may skid, resulting in jackknifing and loss of vehicle control. This is especially true on wet or slippery surfaces.
- Do not exceed the trailer hitch assembly weight, gross vehicle weight, gross axle weight and trailer tongue weight capacities.
- Slow down and downshift before descending steep or long downhill grades. Do not make sudden downshifts while descending steep or long downhill grades.

**⚠ WARNING**

- Vehicle-trailer instability is more likely on steep long downhills. Before descending steep or long downhill grades, slow down and downshift. Do not make sudden downshifts when descending steep or long downhill grades. Avoid holding the brake pedal down too long or applying the brakes too frequently. This could cause the brakes to overheat and result in reduced braking efficiency.
- Do not tow a trailer when the compact spare tire is installed on your vehicle.

**■ When towing a trailer**

Toyota recommends trailers with brakes that conform to any applicable federal and state/provincial regulations.

- If the gross trailer weight exceeds unbraked TWR, trailer brakes are required. Toyota recommends trailers with brakes that conform to all applicable federal and state/provincial regulations.
- Never tap into your vehicle's hydraulic system, as this will lower the vehicle's braking effectiveness.
- Never tow a trailer without using a safety chain securely attached to both the trailer and the vehicle. If damage occurs to the coupling unit or hitch ball, there is danger of the trailer wandering into another lane.

**Towing related terms**

**■ GCWR (Gross Combination Weight Rating)**

The maximum allowable gross

combination weight. The gross combination weight is the sum of the total vehicle weight (including the occupants, cargo and any optional equipment installed on the vehicle) and the weight of the trailer being towed (including the cargo in the trailer).

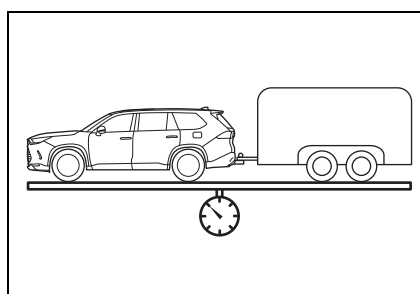

**■ GVWR (Gross Vehicle Weight Rating)**

The maximum allowable gross vehicle weight. The gross vehicle weight is the total weight of the vehicle. When towing a trailer, it is the sum of the vehicle weight (including the occupants, cargo and any optional equipment installed on the vehicle) and the tongue weight.

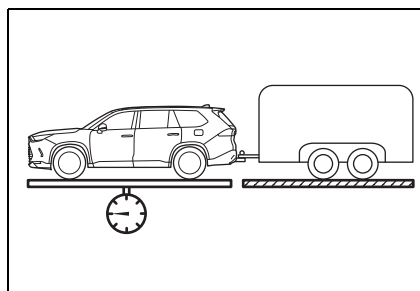

■ **GAWR (Gross Axle Weight Rating)**

The maximum allowable gross axle weight. The gross axle weight is the load placed on each axle (front and rear).

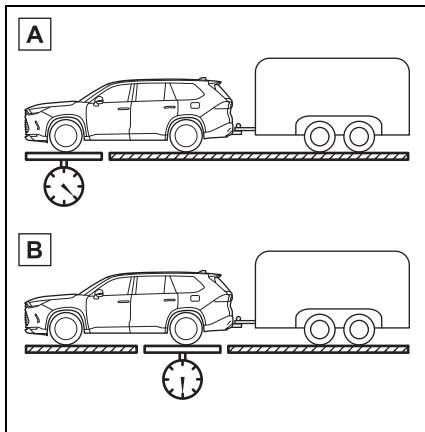

A Front GAWR

B Rear GAWR

■ **TWR (Trailer Weight Rating)**

The maximum allowable gross trailer weight. The gross trailer weight is the sum of the trailer weight and the weight of the cargo in the trailer.

TWR is calculated assuming base vehicle with one driver, one front passenger, towing package (if available), hitch and hitch systems (if required).

Additional optional equipment, passengers and cargo in the vehicle will reduce the trailer weight rating so as not to exceed GCWR, GVWR and GAWR.

If the gross trailer weight exceeds 3000 lb. (1360 kg), it is recom-

mended to use a trailer with 2 or more axles.

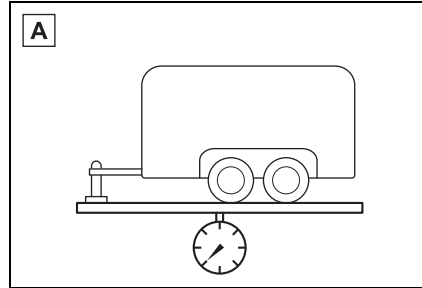

A With brakes

■ **Unbraked TWR (Unbraked Trailer Weight Rating)**

The trailer weight rating for towing a trailer without a trailer service brake system.

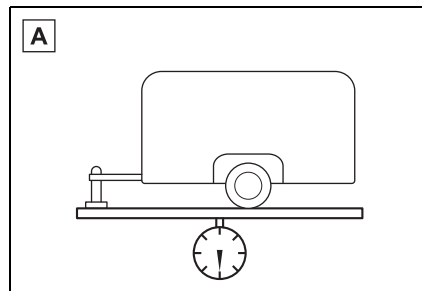

A Without brakes

■ **Tongue Weight**

The load placed on the trailer hitch ball. (→P.196)

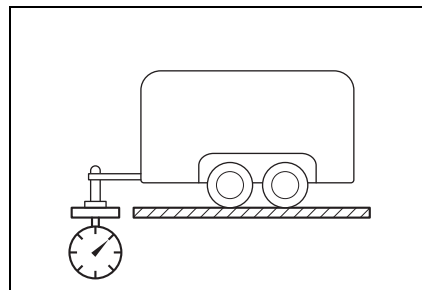

### Weight limits

- The gross trailer weight must never exceed 5000 lb. (2265 kg).
- The gross combination weight must never exceed 10600 lb. (4800 kg).
- The gross vehicle weight must never exceed the GVWR indicated on the Certification Label. (→P.518)
- The gross axle weight on each axle must never exceed the GAWR indicated on the Certification Label. (→P.518)
- If the gross trailer weight is over the unbraked TWR, trailer service brakes are required.
- If the gross trailer weight is over 2000 lb. (907 kg), a sway control device with sufficient capacity is required.

### GCWR, TWR and Unbraked TWR

Confirm that the gross trailer weight, gross combination weight, gross vehicle weight, gross axle weight and tongue weight are all within the limits.

#### ■ GCWR\*

10600 lb. (4800 kg)

#### ■ TWR\*

5000 lb. (2265 kg)

#### ■ Unbraked TWR\*

1000 lb. (453 kg)

\*: This models meet the tow-vehicle trailering requirement of SAE International per SAE J2807.

### Trailer Tongue Weight

- A recommended tongue weight varies in accordance with the types of trailers or towing as described below.
- To ensure the recommended values shown below, the trailer must be loaded by referring to the following instructions.

#### • Tongue Weight

The gross trailer weight should be distributed so that the tongue weight is 9% to 11%.

(Tongue weight/Gross trailer weight x 100 = 9% to 11%)

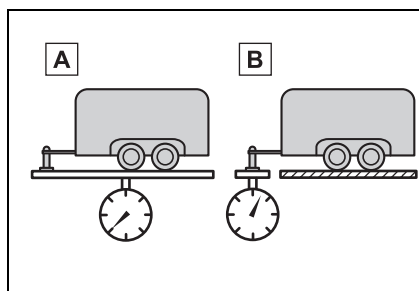

**A** Gross trailer weight

**B** Tongue weight

If using a weight distributing hitch when towing, return the front axle to the same weight as before the trailer connection.

If front axle weight cannot be mea-

sured directly, measure the front fender height above the front axle before connection. Adjust weight distributing hitch torque until front fender is returned to the same height as before connection.

The gross trailer weight, gross axle weight and tongue weight can be measured with platform scales found at a highway weighing station, building supply company, trucking company, junk yard, etc.

### Hitch

Trailer hitch assemblies have different weight capacities. Toyota recommends the use of Toyota hitch/bracket for your vehicle. For details, contact your Toyota dealer.

- If you wish to install a trailer hitch, contact your Toyota dealer.
- Use only a hitch that conforms to the gross trailer weight requirement of your vehicle.
- Follow the directions supplied by the hitch manufacturer.
- Lubricate the hitch ball with a light coating of grease.
- Remove the hitch ball whenever you are not towing a trailer. Remove the trailer hitch if you do not need it. After removing the hitch, seal any mounting hole in the vehicle body to prevent entry of any substances into the vehi-

cle.

#### **WARNING**

##### **Hitches**

Trailer hitch assemblies have different weight capacities established by the hitch manufacturer. Even though the vehicle may be physically capable of towing a higher weight, the operator must determine the maximum weight rating of the particular hitch assembly and never exceed the maximum weight rating specified for the trailer-hitch. Exceeding the maximum weight rating set by the trailer-hitch manufacturer can cause an accident resulting in death or serious personal injuries.

#### **NOTICE**

##### **When installing a trailer hitch**

Use only the position recommended by your Toyota dealer. Do not install the trailer hitch on the bumper; this may cause body damage.

### Selecting trailer ball

Use the correct trailer ball for your application.

Trailer class	Typical trailer ball size
IV	2 5/16 in.
II and III	2 in.
I	1 7/8 in.

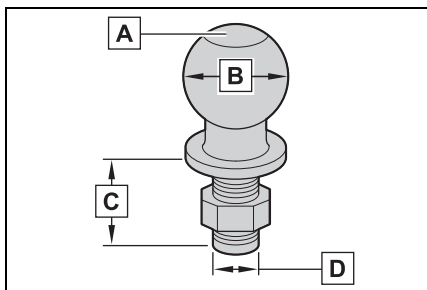

- A** Trailer ball load rating  
Matches or exceeds the gross trailer weight rating of the trailer.
- B** Ball diameter  
Matches the size of the trailer coupler. Most couplers are stamped with the required trailer ball size.
- C** Shank length  
Protrudes beyond the bottom of the lock washer and nut by at least 2 threads.
- D** Shank diameter  
Matches the ball mount hole diameter size.

### Positions for towing hitch receiver and hitch ball

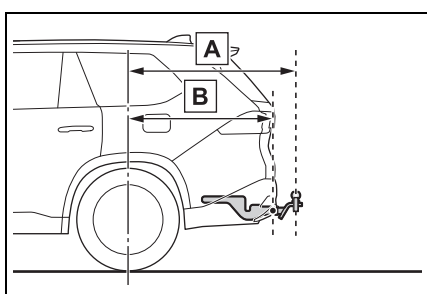

- A** Weight carrying ball position: 50.63 in. (1286 mm)
- B** Hitch receiver pin hole position: 44.25 in. (1124 mm)

### Connecting trailer lights (if equipped)

Use the wire harness stored in the rear end under body.

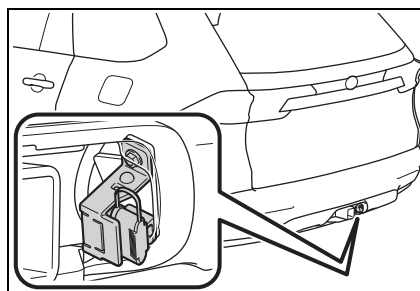

#### Auto current cut-off function

In case of over current, the auto cut-off function stops the power flowing to the trailer lights to prevent damage to the vehicle's electrical system.

This function is activated when the rated current of any of the following trailer light circuit components is exceeded:

- Tail lights: maximum 8.0 A
- Stop/turn signal light (right): maximum 5.0 A
- Stop/turn signal light (left): maximum 5.0 A

#### When the auto current cut function is activated

If a trailer light does not come on due to the activation of the auto current cut function, the light system will need to be reset.

Follow the reset procedure shown below.

- If a tail light does not come on, turn off the headlight switch.
- If the right-side stop/turn signal light does not come on, put the turn signal in the off position or remove foot from the brake pedal.
- If the left-side stop/turn signal light

does not come on, put the turn signal in the off position or remove foot from the brake pedal.

If the emergency flashers do not operate, press the emergency flasher switch to turn them off.

After the light system is reset, operate the light switches again to see if the lights operate normally.

If the lights do not operate normally, have the vehicle inspected by your Toyota dealer.

**NOTICE**

**Do not directly splice trailer lights**

Do not directly splice trailer lights. Directly splicing trailer lights may damage your vehicle's electrical system and cause a malfunction.

### Trailer towing tips

Your vehicle will handle differently when towing a trailer. Help to avoid an accident, death or serious injury, keep the following in mind when towing:

- Speed limits for towing a trailer vary by state or province. Do not exceed the posted towing speed limit.
- Toyota recommends that the vehicle-trailer speed limit is 65 mph (104 km/h) on a flat, straight, dry road. Do not exceed this limit, the posted towing speed limit or the speed limit for your trailer as set forth in your trailer owner's manual, whichever is lowest. Instability of the towing vehi-

cle-trailer combination (trailer sway) increases as speed increases. Exceeding speed limits may cause loss of control.

- Before starting out, check the trailer lights, tires and the vehicle-trailer connections. Recheck after driving a short distance.
- Practice turning, stopping and reversing with the trailer attached in an area away from traffic until you become accustomed to the feel of the vehicle-trailer combination.
- Reversing with a trailer attached is difficult and requires practice. Grip the bottom of the steering wheel and move your hand to the left to move the trailer to the left. Move your hand to the right to move the trailer to right. (This is generally opposite to reversing without a trailer attached.) Avoid sharp or prolonged turning. Have someone guide you when reversing to reduce the risk of an accident.
- As stopping distance is increased when towing a trailer, vehicle-to-vehicle distance should be increased. For each 10 mph (16 km/h) of speed, allow at least one vehicle and trailer length.
- Avoid sudden braking as you

may skid, resulting in the trailer jackknifing and a loss of vehicle control. This is especially true on wet or slippery surfaces.

- Avoid jerky starts or sudden acceleration.
- Avoid jerky steering and sharp turns, and slow down before making turn.
- Note that when making a turn, the trailer wheels will be closer than the vehicle wheels to the inside of the turn. Compensate by making a wider than normal turning radius.
- Slow down before making a turn, in cross winds, on wet or slippery surfaces, etc. Increasing vehicle speed can destabilize the trailer.
- Take care when passing other vehicles. Passing requires considerable distance. After passing a vehicle, do not forget the length of your trailer, and be sure you have plenty of room before changing lanes.
- To maintain engine braking efficiency and charging system performance when using engine braking, do not put the transmission in D.

If in the M mode, the transmission shift range position must be in 6 or lower. (→P.207)

- Instability happens more fre-

quently when descending steep or long downhill grades. Before descending, slow down and downshift. Do not make sudden downshifts while descending steep or long downhill grades.

- Avoid holding the brake pedal down too long or applying the brakes too frequently. This could cause the brakes to overheat and result in reduced braking efficiency.
- Due to the added load of the trailer, your vehicle's engine may overheat on hot days (at temperatures over 85°F [30°C]) when driving up a long or steep grade. If the engine coolant temperature gauge indicates overheating, immediately turn off the air conditioning (if in use), pull your vehicle off the road and stop in a safe spot. (→P.512)
- Always place wheel blocks under both the vehicle's and the trailer's wheels when parking. Put the transmission in P and apply the parking brake. Avoid parking on a slope, but if unavoidable, do so only after performing the following:
  - 1 Apply the brakes and keep them applied.
  - 2 Have someone place wheel blocks under both the vehicle's and trailer's wheels.



- 3 When the wheel blocks are in place, release the brakes slowly until the blocks absorb the load.
  - 4 Shift into P and apply the parking brake.
  - 5 Turn off the engine.
- When restarting after parking on a slope:
    - 1 With the transmission in P, start the engine. Be sure to keep the brake pedal depressed.
    - 2 Shift into a forward gear. If reversing, shift into R.
    - 3 If the parking brake is in manual mode, release the parking brake. (→P.212)
    - 4 Release the brake pedal, and slowly pull or back away from the wheel blocks. Stop and apply the brakes.
    - 5 Have someone retrieve the blocks.

### Dinghy towing

**Your vehicle is not designed to be dinghy towed (with 4 wheels on the ground) behind a motor home.**

 NOTICE

■ **To avoid serious damage to your vehicle**

Do not tow your vehicle with the 4 wheels on the ground.

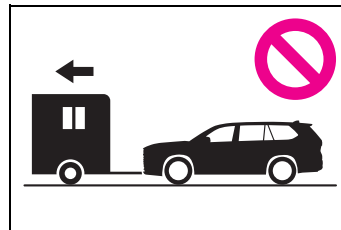

■ **To prevent causing serious damage to the transmission and AWD system**

2WD models: Never tow this vehicle from the rear with the front wheels on the ground.

This may cause serious damage to the transmission.

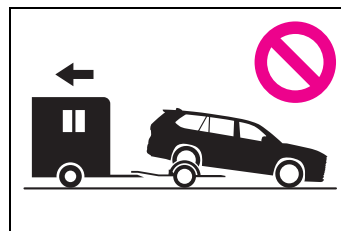



**NOTICE**

AWD models: Never dinghy tow your vehicle to prevent causing serious damage to the Dynamic Torque Control AWD system and transmission.

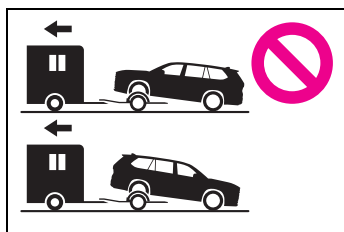

## Engine (ignition) switch

Performing the following operations when carrying the electronic key on your person starts the engine or changes engine switch modes.

### Starting the engine

- 1 Check that the parking brake is set.
- 2 Check that the shift lever is in P.
- 3 Firmly depress the brake pedal.

 and a message will be displayed on the multi-information display. If it is not displayed, the engine cannot be started.

- 4 Press the engine switch shortly and firmly.

When operating the engine switch, one short, firm press is enough. It is not necessary to press and hold the switch.

The engine will crank until it starts or for up to 30 seconds, whichever is less.

Continue depressing the brake pedal until the engine is completely started.

The engine can be started from any

engine switch mode.

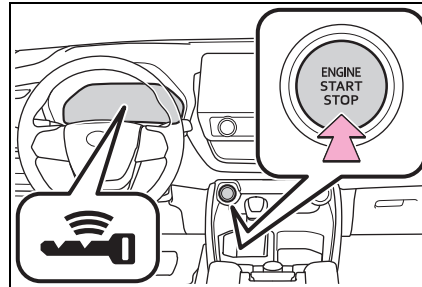

### ■ Engine switch illumination

According to the situation, the engine switch illumination operates as follows.

- When a door is opened, or the engine switch is changed from ACC or ON to off, the engine switch illumination illuminates.
- When depressing the brake pedal with carrying the electronic key on your person, the engine switch illumination blinks.
- When the engine switch is in ACC or ON, the engine switch illumination illuminates.

### ■ If the engine does not start

- The engine immobilizer system may not have been deactivated. (→P.72)  
Contact your Toyota dealer.
- If a message related to start-up is shown on the multi-information display, read the message and follow the instructions.
- If the door is unlocked with the mechanical key, the engine cannot be started using the smart key system. Refer to P.507 to start the engine. However, if the electronic key is carried inside the vehicle and the doors are locked (→P.118), the engine can be started.

### ■ Electronic key battery depletion

→P.110

■ **Conditions affecting operation**

→P.137

■ **Note for the entry function**

→P.138

■ **When “Smart Key System malfunction See owner’s manual” is displayed on the multi-information display**

The system may be malfunctioning. Have the vehicle inspected by your Toyota dealer immediately.

■ **Electronic key battery**

→P.460

■ **Operation of the engine switch**

- If the switch is not pressed shortly and firmly, the engine switch mode may not change or the engine may not start.
- If attempting to restart the engine immediately after turning the engine switch off, the engine may not start in some cases. After turning the engine switch off, please wait a few seconds before restarting the engine.

■ **Customization**

If the smart key system has been deactivated in a customized setting, refer to P.506.

 **WARNING**

■ **When starting the engine**

Always start the engine while sitting in the driver’s seat. Do not depress the accelerator pedal while starting the engine under any circumstances. Doing so may cause an accident resulting in death or serious injury.

 **NOTICE**

■ **When starting the engine**

- Do not race a cold engine.

- If the engine becomes difficult to start or stalls frequently, have your vehicle checked by your Toyota dealer immediately.

■ **Symptoms indicating a malfunction with the engine switch**

If the engine switch seems to be operating somewhat differently than usual, such as the switch sticking slightly, there may be a malfunction. Contact your Toyota dealer immediately.

**Stopping the engine**

- 1 Stop the vehicle completely.
- 2 Set the parking brake (→P.212), and shift the shift lever to P.

Check the parking brake indicator is illuminated.

Do not press the shift release button after shifting the shift position to P.

- 3 Press the engine switch.

The engine will stop, and the meter display will be extinguished.

- 4 Release the brake pedal and check that ACC or ON is not shown on the meter.

■ **Automatic engine shut off feature**

- The vehicle is equipped with a feature that automatically shuts off the engine when the shift position is in P with the engine running for an extended period.
- The engine will automatically shut off after approximately 1 hour if it has been left running while the shift position is in P.
- The timer for the automatic engine

shut off feature will reset if the brake pedal is depressed, or if the shift position is in a position other than P.

- After the vehicle is parked, if the door is locked with the door lock switch (→P.118) from the inside or the mechanical key (→P.506) from the outside, the automatic engine shut off feature will be disabled. The timer for the automatic engine shut off feature will be re-enabled if the driver's door is opened.

#### ■ When the engine is stopped

Even if the engine switch is turned off, the cooling fan may continue to operate for a short time.

#### WARNING

##### ■ Stopping the engine in an emergency

- If you want to stop the engine in an emergency while driving the vehicle, press and hold the engine switch for more than 2 seconds, or press it briefly 3 times or more in succession. (→P.470)  
However, do not touch the engine switch while driving except in an emergency. Turning the engine off while driving will not cause loss of steering or braking control, but the power assist to these systems will be lost. This will make it more difficult to steer and brake, so you should pull over and stop the vehicle as soon as it is safe to do so.
- If the engine switch is operated while the vehicle is running, a warning message will be shown on the multi-information display and a buzzer sounds.

- To restart the engine after performing an emergency shut-down, shift the shift lever to N and then press the engine switch.

##### ■ When parking

Exhaust gases include harmful carbon monoxide (CO), which is colorless and odorless. Observe the following precautions.

Failure to do so may cause exhaust gases to enter the vehicle and may lead to an accident caused by light-headedness, or may lead to death or a serious health hazard.

- If the vehicle is in a poorly ventilated area or a closed area, such as a garage, stop the engine.
- Do not leave the vehicle with the engine running for a long time. If such a situation cannot be avoided, park the vehicle in an open space and ensure that exhaust fumes do not enter the vehicle interior.
- Do not leave the engine running in an area with snow build-up, or where it is snowing. If snowbanks build up around the vehicle while the engine is running, exhaust gases may collect and enter the vehicle.

#### Changing engine switch modes

Modes can be changed by pressing the engine switch with brake pedal released. (The mode changes each time the switch is pressed.)

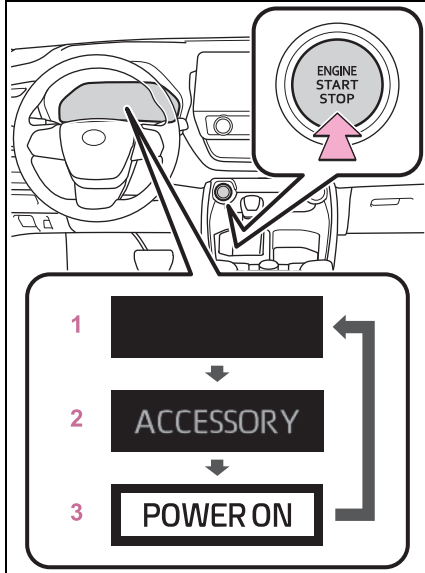

**1 Off<sup>\*1</sup>**

The emergency flashers can be used.

**2 ACC<sup>\*2</sup>**

Some electrical components such as the audio system can be used.

**3 ON**

All electrical components can be used.

<sup>\*1</sup>: If the shift lever is in a position other than P or the shift release button is pressed when turning off the engine, the engine switch will be turned to ACC, not to OFF.

<sup>\*2</sup>: ACC mode can be enabled/disabled on the customize menu. (→P.538)

**■ Auto power off function**

If the vehicle is left in ACC or ON (the engine is not running) for more than 20 minutes with the shift lever is in P or the shift release button is

not pressed, the engine switch will automatically turn to OFF. However, this function cannot entirely prevent battery discharge. Do not leave the vehicle with the engine switch in ACC or ON for long periods of time when the engine is not running.

**■ When ACC customization is in off**

- With the engine switch is turned off, the Multimedia Display can still be used for a certain time until the battery saving function starts operating.
- When the safe exit assist is operating, a buzzer will sound and a voice guidance will be given. (→P.319)

**⚠ NOTICE**

**■ To prevent battery discharge**

- Do not leave the engine switch in ACC or ON for long periods of time without the engine running.
- If “ACCESSORY” or “POWER ON” is displayed on the meters while the engine is not running, the engine switch is not off. Exit the vehicle after turning the engine switch off.

**When stopping the engine with the shift position in a position other than P**

If the engine is stopped when the shift lever is in a position other than P or the shift release button is pressed, the engine switch will not be turned off but instead be turned to ACC. Perform the following procedure to turn the switch off:

- 1** Check that the parking brake is set.

- 2** Shift the shift lever to P.  
Do not press the shift release button after shifting the shift position to P.
- 3** Check that “POWER ON” is displayed on the multi-information display and press the engine switch shortly and firmly.
- 4** Check that “ACCESSORY” or “POWER ON” on the multi-information display are off.

 **NOTICE**

**■ To prevent battery discharge**  
Do not stop the engine with the shift lever in a position other than P or the shift release button pressed. If the engine is stopped with the shift lever in a position other than P or the shift release button pressed, the engine switch will not be turned off and remained to ON. If the vehicle is left in ON, battery discharge may occur.

## Automatic transmission

**Select the shift position depending on your purpose and situation.**

### Shift position purpose

Shift position	Objective or function
P	Parking the vehicle/starting the engine
R	Reversing
N	Neutral
D	Normal driving*1
M	M mode driving*2 (→P.210)

\*1: Shifting to the D position allows the system to select a gear suitable for the driving conditions. Setting the shift lever to the D position is recommended for normal driving.

\*2: Selecting gears using M mode fixes the gear step, controls engine braking force, and prevents unnecessary upshifting.

### ■ To protect the automatic transmission

If the automatic transmission fluid temperature is high, “Transmission Oil Temp High Stop in a Safe Place and See Owner’s Manual” will be displayed on the multi-information display and the vehicle will go into transmission protection mode automatically. Have the vehicle inspected by your Toyota dealer.

■ **When driving with dynamic radar cruise control activated**

Even when performing the following actions with the intent of enabling engine braking, engine braking will not be activated because dynamic radar cruise control will not be canceled.

- Vehicles with paddle shift switches: While driving in the D position, downshifting to D5 or D4. (→P.209)
- When switching the driving mode to sport mode while driving in the D position (→P.348)

■ **Sudden start restraint control (Drive-Start Control [DSC])**

→P.185

■ **AI-SHIFT**

The AI-SHIFT automatically selects the suitable gear according to driver performance and driving conditions. The AI-SHIFT automatically operates when the shift lever is in D. (Shifting the shift lever to the M position cancels the function.)

**⚠ WARNING**

■ **When driving on slippery road surfaces**

Be careful of downshifting and sudden acceleration, as this could result in the vehicle skidding to the side or spinning.

**Shifting the shift lever**

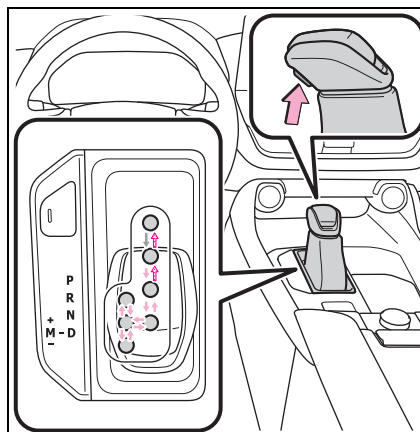

←: While the engine switch is in ON and the brake pedal depressed\*, shift the shift lever while pushing the shift release button on the shift knob.

←: Shift the shift lever while pushing the shift release button on the shift knob.

←: Shift the shift lever normally.

When shifting the shift lever between P and D, make sure that the vehicle is completely stopped.

\*: For the vehicle to be able to be shifted from P, the brake pedal must be depressed before the shift release button is pushed. If the shift release button is pushed first, the shift lock will not be released.

■ **Shift lock system**

The shift lock system is a system to prevent accidental operation of the shift lever in starting.

The shift lever can be shifted from P only when the engine switch is in



ON and the brake pedal is being depressed.

**■ If the shift lever cannot be shifted from P**

First, check whether the brake pedal is being depressed.

If the shift lever cannot be shifted with your foot on the brake pedal, there may be a problem with the shift lock system. Have the vehicle inspected by your Toyota dealer immediately.

The following steps may be used as an emergency measure to ensure that the shift lever can be shifted.

Releasing the shift lock:

- 1 Turn the engine switch to ON and check that the parking brake is set. (→P.205, 212)
- 2 Turn the engine switch to off.
- 3 Depress the brake pedal.
- 4 Pry the cover up with a flathead screwdriver or equivalent tool.

To prevent damage to the cover, cover the tip of the screwdriver with a rag.

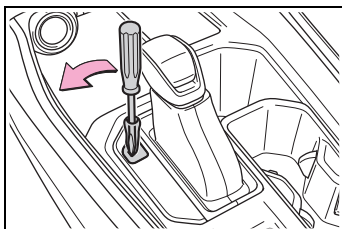

- 5 Press and hold the shift lock override button.

The shift lever can be shifted while both buttons are pressed.

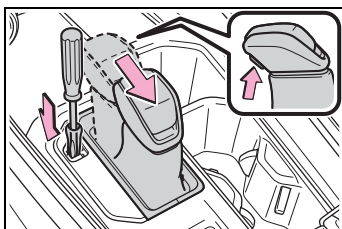

**⚠ WARNING**

**■ To prevent an accident when releasing the shift lock**

Before pressing the shift lock override button, make sure to set the parking brake and depress the brake pedal.

If the accelerator pedal is accidentally depressed instead of the brake pedal when the shift lock override button is pressed and the shift lever is shifted out of P, the vehicle may suddenly start, possibly leading to an accident resulting in death or serious injury.

**Selecting the driving mode and snow mode**

→P.348, 352

**Selecting shift ranges in the D position (vehicles with paddle shift switches)**

To drive using temporary shift range selection, operate the “-” or “+” paddle shift switch.

When the “-” paddle shift switch is operated, the shift range switches to a range that enables engine braking force that is suitable to driving conditions. When the “+” paddle shift switch is operated, the shift range switches to a range that is one range higher than the current range.

Changing the shift range allows restriction of the highest gear, preventing unnecessary upshift-

ing and enabling the level of engine braking force to be selected.

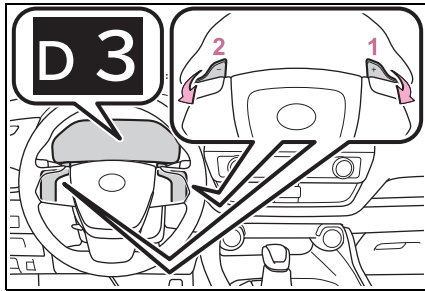

- 1 Upshifting
- 2 Downshifting

The selected shift range, from D1 to D8, will be displayed on the meter. To return to normal D position driving, the “+” paddle shift switch must be held down for a period of time.

■ **Shift ranges and their functions**

Meter display	Function
D2 - D8	A gear in the range between 1 and the selected gear is automatically chosen depending on vehicle speed and driving conditions
D1	1st gear is set

A lower shift range will provide greater engine braking forces than a higher shift range.

■ **Automatic deactivation of shift range selection in the D position**

Shift range selection in the D position will be deactivated in the follow-

ing situations:

- When the vehicle comes to a stop
- If the accelerator pedal is depressed for more than a certain period of time
- When the shift position is shifted to a position other than D.

■ **Downshifting restriction warning buzzer**

To help ensure safety and driving performance, downshifting operation may sometimes be restricted. In some circumstances, downshifting may not be possible even when the paddle shift switch is operated. (A buzzer will sound twice.)

**Selecting gears in the M position**

To enter M mode, shift the shift lever to M. Gears can then be selected by operating the shift lever or paddle shift switches\*, allowing you to drive in the gear of your choosing.

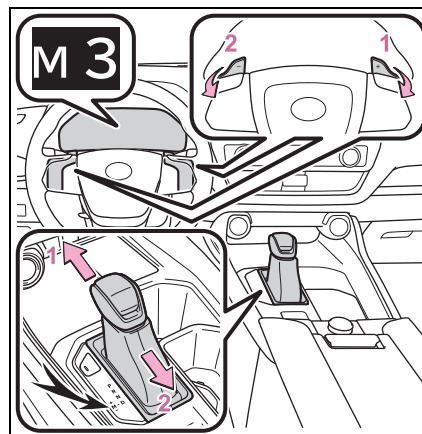

- 1 Upshifting
- 2 Downshifting

The gear changes once every time the shift lever or a paddle shift

switch is operated.

The selected gear, from M1 to M8, will be fixed and displayed on the meters.

When in the M position, the gear will not change unless the shift lever or a paddle shift switch is operated.

However, even when in the M position, the gears will be automatically changed in the following situation:

- When vehicle speed drops (downshift only).
- When it is necessary to protect the transmission when the transmission fluid temperature is high or low, or other reasons.
- When the needle of the tachometer is in the red zone (the range which exceeds the allowable revs of the engine).

In the following situation, the gear will not shift even if the shift lever is operated.

- The vehicle speed is low (upshift only).

#### ■ Downshifting restriction warning buzzer

To help ensure safety and driving performance, downshifting operation may sometimes be restricted. (A buzzer will sound twice.)

## Turn signal lever

### Operating instructions

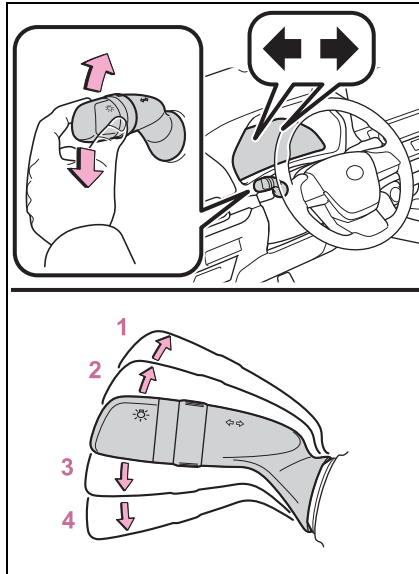

- 1 Right turn
- 2 Lane change to the right (move the lever partway and release it)

The right hand signals will flash 3 times.

- 3 Lane change to the left (move the lever partway and release it)
- 4 Left turn

The left hand signals will flash 3 times.

- 4 Left turn

#### ■ Turn signals can be operated when

The engine switch is in ON.

#### ■ If the indicator flashes faster than usual

Vehicles with Front turn signal lights/parking lights (bulb type):

Check that a light bulb has not burned out.

Otherwise, have the vehicle inspected by your Toyota dealer.

- **If the turn signals stop flashing before a lane change has been performed**

Operate the lever again.

## Parking brake

**The parking brake can be set or released automatically or manually.**

**In automatic mode, the parking brake can be set or released automatically according to shift position operation.**

**Also, even in automatic mode, the parking brake can be set or released manually.**

## Operating instructions

- **Using the manual mode**

The parking brake can be set and released manually.

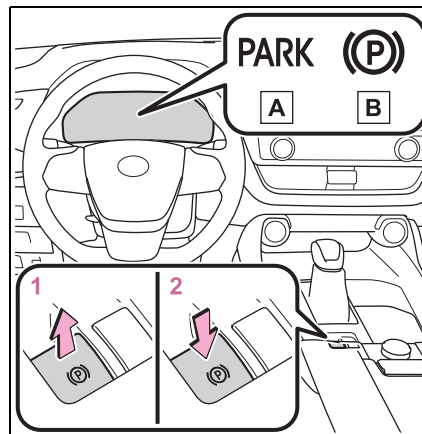

**A** Parking brake indicator (U.S.A.)

**B** Parking brake indicator (Canada)

- 1** Pull the switch to set the parking brake.

The parking brake indicator will turn on.

Pull and hold the parking brake switch if an emergency occurs and it is necessary to operate the parking brake while driving.

## 2 Press the switch to release the parking brake.

- Operate the parking brake switch while depressing the brake pedal.
- Using the parking brake automatic release function, the parking brake can be released by depressing the accelerator pedal. When using this function, slowly depress the accelerator pedal. (→P.213)

Make sure that the parking brake indicator turn off.

If the parking brake indicator flash, operate the switch again. (→P.484)

### ■ Turning the automatic mode on

While the vehicle is stopped, pull and hold the parking brake switch until a buzzer sounds and a message is shown on the multi-information display.

When the automatic mode is turned on, the parking brake operates as follows.

- When the shift position is shifted from P, the parking brake will be released, and the parking brake indicator will turn off.
- When the shift position is shifted to P, the parking brake will be set, and the parking brake indicator will turn on.

Operate the shift position with the vehicle stopped and the brake pedal depressed.

The auto function may not operate if the shift lever is moved extremely quickly or the brake pedal is not firmly depressed. In this situation, apply the parking brake manually. (→P.212)

### ■ Turning the automatic mode off

While the vehicle is stopped and depressing the brake pedal, press and hold the parking brake switch until a buzzer sounds and a message is shown on the multi-information display.

### ■ Parking brake operation

- When the engine switch is not in ON, the parking brake cannot be released using the parking brake switch.
- When the engine switch is not in ON, automatic mode (automatic brake setting and releasing) is not available.

### ■ Parking brake automatic release function

When all of the following conditions are met, the parking brake can be released by depressing the accelerator pedal.

- The driver's door is closed
- The driver is wearing the seat belt
- The shift position is in a forward driving position or reverse driving position
- The malfunction indicator lamp or brake system warning light is not illuminated.

When depressing the accelerator

pedal, depress it slowly.

If the parking brake is not released when the accelerator pedal is depressed, release the parking brake manually.

When the shift position is shifted from P, the parking brake will be released automatically.

■ **Parking brake automatic lock function**

The parking brake will be set automatically under the following conditions:

- The brake pedal is not depressed
- The driver's door is open
- The driver's seat belt is not fastened
- The shift position is in a position other than P or N
- The malfunction indicator lamp and brake system warning light are not illuminated

■ **If “Parking Brake Temporarily Unavailable” is displayed on the multi-information display**

If the parking brake is operated repeatedly over a short period of time, the system may restrict operation to prevent overheating. If this happens, refrain from operating the parking brake. Normal operation will return after about 1 minute.

■ **If “EPB Activation Stopped Incompletely” or “Parking Brake Unavailable” is displayed on the multi-information display**

Operate the parking brake switch. If the message does not disappear after operating the switch several times, the system may be malfunctioning. Have the vehicle inspected by your Toyota dealer.

■ **Parking brake operation sound**

When the parking brake operates, a motor sound (whirring sound) may be heard. This does not indicate a malfunction.

■ **Parking brake indicator**

- Depending on the engine switch mode, the parking brake indicator will turn on and stay on as described below:  
ON: Comes on until the parking brake is released.  
Not in ON: Stays on for approximately 15 seconds.
- When the engine switch is turned off with the parking brake set, the parking brake indicator will stay on for about 15 seconds. This does not indicate a malfunction.

■ **When the parking brake switch malfunctions**

Automatic mode (automatic brake setting and releasing) will be turned on automatically.

■ **Parking the vehicle**

→P.179

■ **Parking brake engaged warning buzzer**

A buzzer will sound if the vehicle is driven with the parking brake engaged. “Parking Brake ON” is displayed on the multi-information display (with the vehicle reaching a speed of 3 mph [5 km/h]).

■ **If the brake system warning light comes on**

→P.477

■ **Usage in winter time**

→P.361

<p> <b>WARNING</b></p>
<p>■ <b>When parking the vehicle</b></p> <p>Do not leave a child in the vehicle alone. The parking brake may be released unintentionally by a child and there is the danger of the vehicle moving that may lead to an accident resulting in death or serious injury.</p>

 **WARNING****■ Parking brake switch**

Do not set any objects near the parking brake switch. Objects may interfere with the switch and may lead the parking brake to unexpectedly operate.

**■ Parking brake automatic lock function**

Never use the automatic parking brake engagement function in place of normal parking brake operation. This function is designed to reduce the risk of a collision due to the driver forgetting to engage the parking brake. Over-reliance on this function to park the vehicle safely may lead to an accident resulting in death or serious injury.

**■ When the parking brake cannot be released due to a malfunction**

Driving the vehicle with the parking brake set will lead to brake components overheating, which may affect braking performance and increase brake wear. Have the vehicle inspected by your Toyota dealer immediately if this occurs.

 **NOTICE****■ When parking the vehicle**

Before you leave the vehicle, change the shift position to P, set the parking brake and make sure that the vehicle does not move.

**■ When the system malfunctions**

Stop the vehicle in a safe place and check the warning messages.

**■ When the vehicle battery is discharged**

The parking brake system cannot be activated. (→P.508)

## Brake Hold

**The brake hold system keeps the brake applied when the shift position is in D, M or N with the system on and the brake pedal has been depressed to stop the vehicle. The system releases the brake when the accelerator pedal is depressed with the shift position in D or M to allow smooth start off.**

### Enabling the system

Turns the brake hold system on

The brake hold standby indicator (green) **A** comes on. While the system is holding the brake, the brake hold operated indicator (yellow) **B** comes on.

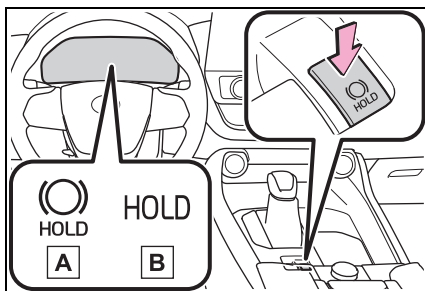

### Brake hold system operating conditions

The brake hold system cannot be turned on in the following conditions:

- The driver's door is not closed.
- The driver is not wearing the seat belt.

- "EPB Activation Stopped Incompletely" or "Parking Brake Malfunction Visit Your Dealer" is displayed on the multi-information display.

If any of the conditions above are detected when the brake hold system is enabled, the system will turn off and the brake hold standby indicator light will go off. In addition, if any of the conditions are detected while the system is holding the brake, a warning buzzer will sound and a message will be shown on the multi-information display. The parking brake will then be set automatically.

### Brake hold function

- If the brake pedal is left released for a period of about 3 minutes after the system has started holding the brake, the parking brake will be set automatically. In this case, a warning buzzer sounds and a message is shown on the multi-information display.
- The brake hold function may not hold the vehicle when the vehicle is on a steep incline. In this situation, it may be necessary for the driver to apply the brakes. A warning buzzer will sound and the multi-information display will inform the driver of this situation. If a warning message is shown on the multi-information display, read the message and follow the instructions.
- To turn the system off while the system is holding the brake, firmly depress the brake pedal and press the button again.

### When the parking brake is set automatically while the system is holding the brakes

Perform any of the following operations to release the parking brake:

- Depress the accelerator pedal. (The parking brake will not be released automatically if the seat belt is not fastened.)



- Operate the parking brake switch with the brake pedal depressed.

Make sure that the parking brake indicator goes off. (→P.212)

#### ■ When an inspection at your Toyota dealer is necessary

When the brake hold standby indicator (green) does not illuminate even when the brake hold switch is pressed with the brake hold system operating conditions met, the system may be malfunctioning. Have the vehicle inspected at your Toyota dealer.

#### ■ If “Brake Hold Malfunction Press Brake to Deactivate Visit Your Dealer” or “Brake Hold Malfunction Visit Your Dealer” is displayed on the multi-information display

The system may be malfunctioning. Have the vehicle inspected by your Toyota dealer.

#### ■ Warning messages and buzzers

Warning messages and buzzers are used to indicate a system malfunction or to inform the driver of the need for caution. If a warning message is shown on the multi-information display, read the message and follow the instructions.

#### ■ When another control activates with the brake hold system (AWD vehicles)

A message is displayed on the multi-information display in any of the following cases.

- “Brake Hold Unavailable See the Owner’s Manual”
- When the brake hold switch is pressed while the downhill assist control system is activated.
- “Brake Hold Unavailable Press Brake to Deactivate”
- When the DAC switch is operated while the brake hold system is activated.

The brake hold system and downhill assist control system cannot be acti-

vated at the same time. Please press the brake hold switch with the brake pedal depressed to turn off the brake hold system.

#### ■ If the brake hold operated indicator flashes

→P.484

#### WARNING

##### ■ When the vehicle is on a steep incline

Take care when using the brake hold system on a steep incline, exercise caution. The brake hold function may not hold brakes in such situations.

Also, the system may not activate depending on the angle of the slope.

##### ■ When stopped on a slippery road

The system cannot stop the vehicle when the gripping ability of the tires has been exceeded. Do not use the system when stopped on a slippery road.

#### NOTICE

##### ■ When parking the vehicle

The brake hold system is not designed for use when parking the vehicle for a long period of time. Turning the engine switch off while the system is holding the brake may release the brake, which would cause the vehicle to move. When operating the engine switch, depress the brake pedal, change the shift position to P and set the parking brake.

### Headlight switch

The headlights can be operated manually or automatically.

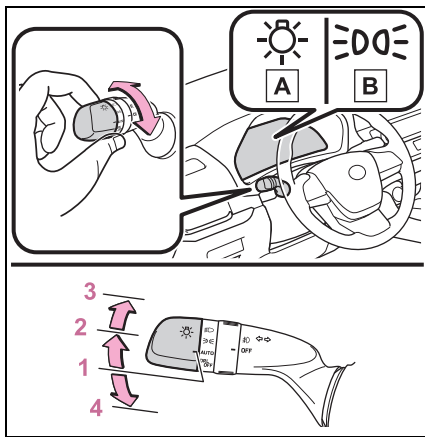

### Operating instructions

Operating the  switch turns on the lights as follows:



**A** U.S.A.

**B** Canada

- 1  The headlights, daytime running lights (→P.218) and all the lights listed below turn on and off automatically. (When the engine switch is in ON.)
- 2  The side marker, parking, tail, license plate, instrument panel lights, and daytime running lights (→P.218) turn on.
- 3  The headlights and all

lights listed above (except daytime running lights) turn on.

4  (U.S.A.) Off

#### ■ AUTO mode can be used when

The engine switch is in ON.

#### ■ Daytime running light system

- Vehicles without front fog lights: The daytime running lights illuminate using the same lights as the low beam headlights and illuminate dimmer than the low beam headlights.
- Vehicles with front fog lights: The daytime running lights illuminate using the same lights as the parking lights and illuminate brighter than the parking lights.
- To make your vehicle more visible to other drivers during daytime driving, the daytime running lights turn on automatically when all of the following conditions are met. (The daytime running lights are not designed for use at night.)
  - The engine is running
  - The parking brake is released
  - The headlight switch is in the  or **AUTO** \* position

\*: When the surroundings are bright

The daytime running lights remain on after they illuminate, even if the parking brake is set again.

- For the U.S.A.: Daytime running lights can be turned off by operating the switch.
- Compared to turning on the headlights, the daytime running light system offers greater durability and consumes less electricity, so it can help improve fuel economy.

#### ■ Headlight control sensor



The sensor may not function properly if an object is placed on the sen-

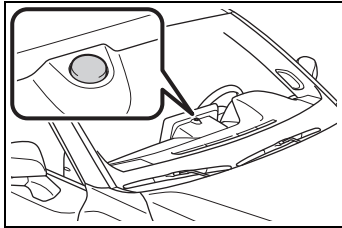

sor, or anything that blocks the sensor is affixed to the windshield. Doing so interferes with the sensor detecting the level of ambient light and may cause the automatic headlight system to malfunction.



■ **Automatic light off system**

- When the headlights come on: The headlights and tail lights turn off 30 seconds after a door is opened and closed if the engine switch is turned off. (The lights turn off immediately if  on the key is pressed after all the doors are locked.)
- When only the tail lights are on: The tail lights turn off automatically if the engine switch is turned off and the driver's door is opened.

For U.S.A.: To turn the lights on again, turn the engine switch to ON, or turn the light switch off once and then back to  or .

For Canada: To turn the lights on again, turn the engine switch to ON, or turn the light switch to AUTO once and then back to  or .

■ **Light reminder buzzer**

A buzzer sounds when the engine switch is turned to ACC or OFF and the driver's door is opened while the lights are turned on.

■ **Windshield wiper linked headlight illumination**

When driving during daytime with the headlight switch turned to AUTO, if

the windshield wipers are used, the headlights will turn on automatically after several seconds to help enhance the visibility of your vehicle.

■ **Battery-saving function**

In order to prevent the battery of the vehicle from discharging, if the headlights and/or tail lights are on when the engine switch is turned off the battery saving function will operate and automatically turn off all the lights after approximately 20 minutes. When the engine switch is turned to ON, the battery-saving function will be disabled.

When any of the following are performed, the battery-saving function is canceled once and then reactivated. All the lights will turn off automatically 20 minutes after the battery-saving function has been reactivated:

- When the headlight switch is operated
- When a door is opened or closed

■ **When unlocking the doors (welcome lamp)**

The parking lights automatically turn on when the surroundings are dark and the doors are unlocked using the entry function or wireless remote control if the light switch is in the

AUTO position.

■ **Customization**

Some functions can be customized. (→P.538)

 NOTICE

■ **To prevent battery discharge**

Do not leave the lights on longer than necessary when the engine is off.

### Turning on the high beam headlights

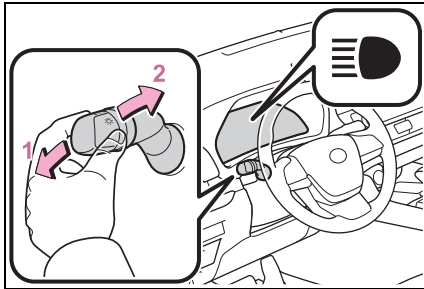

**1** With the headlights on, push the lever away from you to turn on the high beams.

Pull the lever toward you to the center position to turn the high beams off.

**2** Pull the lever toward you and release it to flash the high beams once.

You can flash the high beams with the headlights on or off.

### AHB (Automatic High Beam)

The Automatic High Beam uses a front camera located on the upper portion of the windshield to detect the brightness of the lights of vehicles ahead, streetlights, etc., and automatically changes the head lights between the high beams and low beams.

#### **WARNING**

##### ■ For safe use

Do not overly rely on the Automatic High Beam. Always drive safely, taking care to observe your surroundings and turning the high beams on or off manually if necessary.

##### ■ To prevent unintentional operation of the Automatic High Beam System

When it is necessary to disable the system: →P.235

### Using the Automatic High Beam system

**1** Press the Automatic High Beam switch.

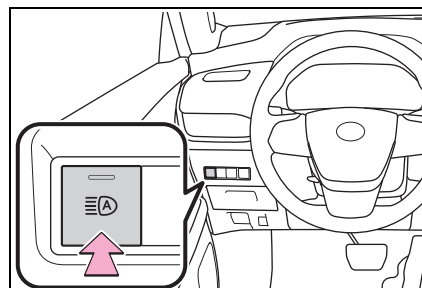

- 2 Turn the headlight switch to the AUTO or  position.

When the headlight switch lever is in the low beam position, the AHB system will be enabled and the AHB indicator will illuminate.

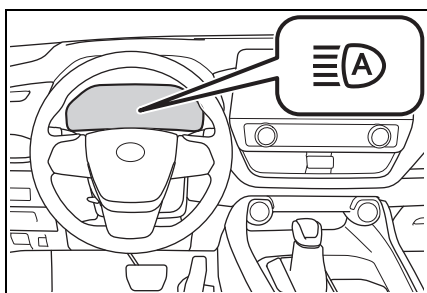

#### ■ Automatic operating conditions of the high beams

- When all of the following conditions are met, the high beams will illuminate automatically:
  - The vehicle speed is approximately 21 mph (34 km/h) or more.
  - The area ahead of the vehicle is dark.
  - There are no vehicles ahead with lights on.
  - There are few streetlights or other lights on the road ahead.
- If any of the following conditions are met, the headlights will change to the low beams:
  - Vehicle speed drops below approximately 17 mph (27 km/h).
  - The area ahead of the vehicle is not dark.
  - There is a vehicle ahead with lights on.
  - There are many streetlights or other lights on the road ahead.

#### ■ Front camera detection

- In the following situations, the high beams may not be automatically changed to the low beams:
  - When a vehicle cuts in front of your vehicle
  - When another vehicle crosses in front of the vehicle

- When vehicles ahead are repeatedly detected and then hidden due to repeated curves, road dividers or roadside trees
- When a vehicle ahead approaches from a far lane
- When a vehicle ahead is far away
- When a vehicle ahead has no lights
- When the lights of a vehicle ahead are dim
- When a vehicle ahead is reflecting strong light, such as own headlights
- Situations in which the sensors may not operate properly: →P.240
- The headlights may change to the low beams if a vehicle ahead that is using fog lights without its headlights turned on is detected.
- House lights, street lights, traffic signals, and illuminated billboards or signs may cause the high beams to change to the low beams, or the low beams to remain on.
- The following may change the timing at which the headlights change to the low beams:
  - The brightness of lights of vehicles ahead
  - The movement and direction of vehicles ahead
  - The distance between the vehicle and a vehicle ahead
  - When a vehicle ahead only has lights illuminated on one side
  - When a vehicle ahead is a two-wheeled vehicle
  - The condition of the road (gradient, curve, condition of the road surface, etc.)
  - The number of passengers and amount of luggage
- The headlights may change between the high beams and low beams unexpectedly.
- Bicycles and other small vehicles may not be detected.
- In the following situations, the system may not be able to correctly detect the brightness of the sur-

roundings. This may cause the low beams to remain on or the high beams to flash or dazzle pedestrians or vehicles ahead. In such a case, it is necessary to manually change between the high beams and low beams.

- When there are lights similar to headlights or tail lights in the surrounding area
- When headlights or tail lights of vehicles ahead are turned off, dirty, changing color, or not aimed properly
- When the headlights are repeatedly changing between the high beams and low beams.
- When use of the high beams is inappropriate or when the high beams may be flashing or dazzling pedestrians or other drivers.
- When the vehicle is used in an area in which vehicles travel on the opposite side of the road of the country for which the vehicle was designed, for example using a vehicle designed for right-hand traffic in a left-hand traffic area, or vice versa
- When it is necessary to disable the system: →P.235
- Situations in which the sensors may not operate properly: →P.240

#### ■ Temporarily reducing front camera sensitivity

The sensitivity of the front camera can be temporarily reduced.

- 1 Turn the engine switch off with the following conditions met.
  - The headlight switch is in the  or AUTO position.
  - The headlight switch lever is in the low beam position.
  - The Automatic High Beam switch is on.
- 2 Turn the engine switch to ON.
- 3 Within 60 seconds after performing step 2, push the headlight switch lever to the high beam position then pull it to the original

position quickly 10 times, then leave the lever in its original position.

- 4 If the sensitivity is changed, the Automatic High Beam indicator will blink 3 times.

#### Turning the high beams on/off manually

##### ■ Changing to the high beams

- 1 Push the lever forward.

The AHB indicator will turn off and the high beam indicator will turn on.

Pull the lever to its original position to enable the Automatic High Beam system again.

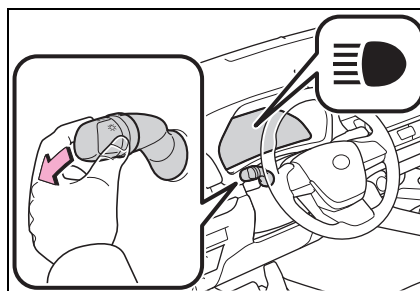

##### ■ Changing to the low beams

- 1 Press the Automatic High Beam switch.

The AHB indicator will turn off.

Press the switch to enable the Automatic High Beam system again.

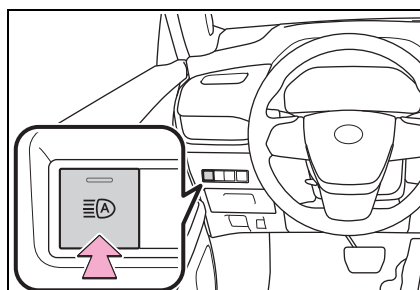

**Temporarily changing to the low beams**

It is recommended to switch to the low beams when use of the high beams is inappropriate or when the high beams may cause problems or distress to other drivers or pedestrians nearby.

- 1 Pull the lever rearward and then return it to its original position.

The high beams will illuminate while the lever is pulled, however, after the lever is returned to its original position, the low beams will remain on for a certain amount of time. After this, the Automatic High Beam system will operate.

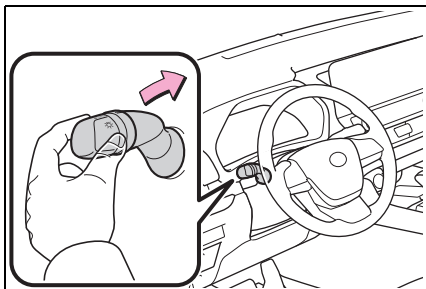

**Fog light switch\***

\*: If equipped

**The fog lights secure excellent visibility in difficult driving conditions, such as in rain and fog.**

**Operating instructions**

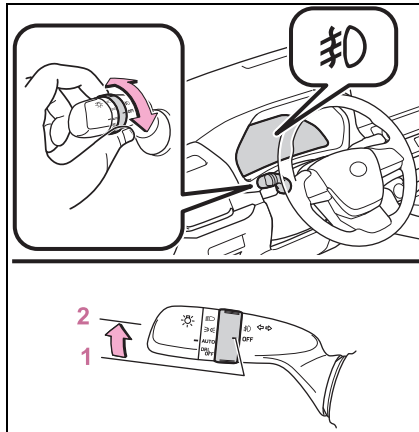

- 1 OFF (U.S.A.) or ● (Canada)  
Turns the fog lights off
- 2 ☁ Turns the fog lights on

■ **Fog lights can be used when**  
The headlights are on in low beam.

**Windshield wipers and washer**

Operating the lever can switch between automatic operation and manual operation, or can use the washer.



**NOTICE**  
 ■ **When the windshield is dry**  
 Do not use the wipers, as they may damage the windshield.

**Operating the wiper lever**

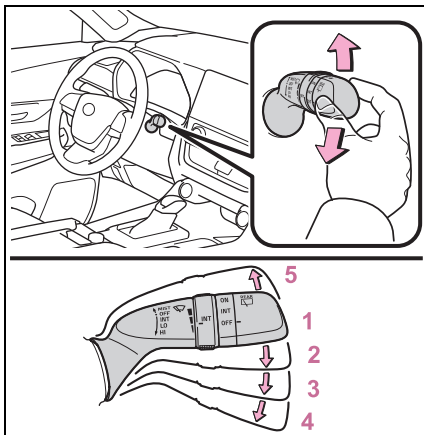

Operating the  lever operates the wipers or washer as follows:

- ▶ Intermittent windshield wipers with interval adjuster



- 1** OFF (U.S.A.) or  (Canada)  
Off
- 2** INT (U.S.A.) or  (Canada)  
Intermittent windshield wiper

operation

- 3** LO (U.S.A.) or  (Canada)  
Low speed operation
- 4** HI (U.S.A.) or  (Canada)  
High speed operation
- 5** MIST (U.S.A.) or  (Canada)  
Temporary operation

Wiper intervals can be adjusted when intermittent operation is selected.

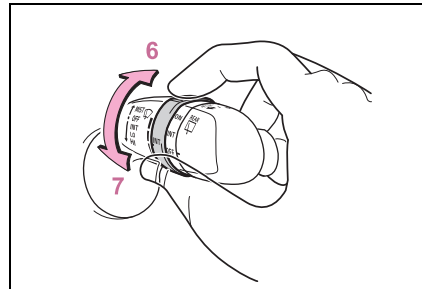

- 6** Increases the intermittent windshield wiper frequency
- 7** Decreases the intermittent windshield wiper frequency

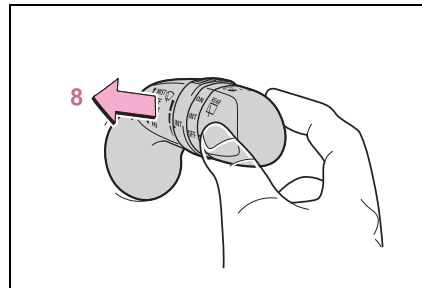

- 8**  Washer/wiper dual operation

Pulling the lever operates the wipers and washer.  
 (After operating several times, the wipers operate once more time



after a short delay to prevent dripping. However, the dripping prevention does not operate while the vehicle is moving.)

► Rain-sensing windshield wipers

When “AUTO” is selected, the wipers will operate automatically when the sensor detects falling rain. The system automatically adjusts wiper timing in accordance with rain volume and vehicle speed.

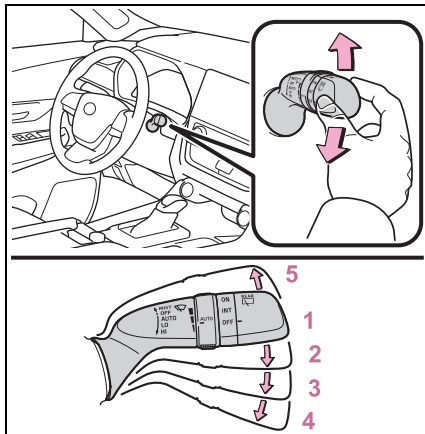

- 1 OFF (U.S.A.) or ● (Canada) Off
- 2 AUTO Rain-sensing wiper operation
- 3 LO (U.S.A.) or ▼ (Canada) Low speed operation
- 4 HI (U.S.A.) or ▼▼ (Canada) High speed operation
- 5 MIST (U.S.A.) or ▲ (Canada) Temporary operation

When AUTO mode is selected,

the sensor sensitivity can be adjusted by turning the switch ring.

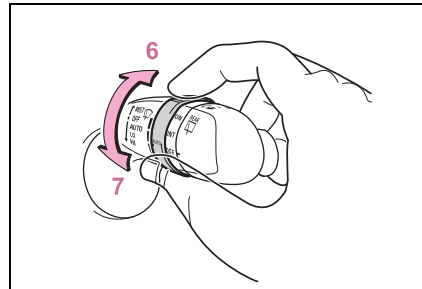

- 6 Increases the sensitivity
- 7 Decreases the sensitivity

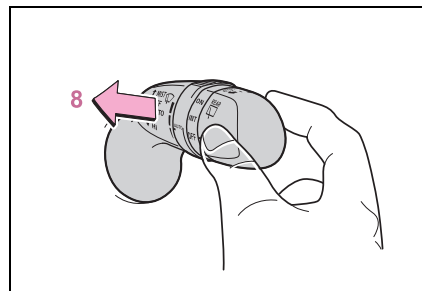

- 8 Washer/wiper dual operation

Pulling the lever operates the wipers and washer. (After operating several times, the wipers operate once more time after a short delay to prevent dripping. However, the dripping prevention does not operate while the vehicle is moving.)

■ The windshield wipers and washer can be operated when

The engine switch is in ON.

■ Operating the windshield wipers and washer using the voice control system\*

\*: If equipped

The following operation can be performed using the voice control system.

- Operating the windshield wipers only once
- Operating the windshield washer (it can be performed only when the vehicle is stopped)

For details regarding the voice control system, refer to the "MULTIMEDIA OWNER'S MANUAL".

■ **Effects of vehicle speed on wiper operation (vehicles with rain-sensing windshield wipers)**

With low speed windshield wiper operation selected, wiper operation will be switched from low speed to intermittent wiper operation when the vehicle is stationary. (However, when the sensor sensitivity is adjusted to the highest level, the mode will not switch.)

■ **Raindrop sensor (vehicles with rain-sensing windshield wipers)**

- The raindrop sensor judges the amount of raindrops. An optical sensor is adopted. It may not operate properly when sunlight from the rising or setting of the sun intermittently strikes the windshield, or if bugs, etc. are present on the windshield.

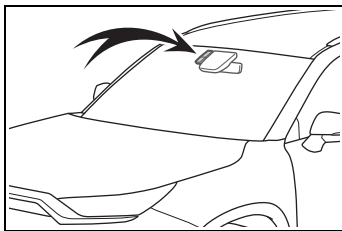

- If the wiper switch is turned to the AUTO position while the engine switch is in ON, the wipers will operate once to show that AUTO mode is activated.
- When the sensor sensitivity ring is turned toward high while in AUTO

position, the wipers will operate once to indicate that the sensor sensitivity is enhanced.

- If the temperature of the raindrop sensor is 185°F (85°C) or higher, or 5°F (-15°C) or lower, automatic operation may not occur. In this case, operate the wipers in any mode other than AUTO mode.

■ **If no windshield washer fluid sprays**

Check that the washer nozzles are not blocked, if there is washer fluid in the washer fluid tank.

■ **Front door opening linked windshield wiper stop function (vehicles with rain-sensing windshield wipers)**

When AUTO is selected and the windshield wipers are operating, if a front door is opened, the operation of the windshield wipers will be stopped to prevent anyone near the vehicle from being sprayed by water from the wipers, provided the vehicle is stopped with the parking brake applied or the shift position in P. When the front door is closed, wiper operation will resume.

**⚠ WARNING**

■ **Caution regarding the use of windshield wipers in AUTO mode (vehicles with rain-sensing windshield wipers)**

The windshield wipers may operate unexpectedly if the sensor is touched or the windshield is subject to vibration in AUTO mode. Take care that your fingers, etc. do not become caught in the windshield wipers.

**⚠ WARNING**

■ **Caution regarding the use of washer fluid**

When it is cold, do not use the washer fluid until the windshield becomes warm. The fluid may freeze on the windshield and cause low visibility. This may lead to an accident, resulting in death or serious injury.

**⚠ NOTICE**

■ **When the washer fluid tank is empty**

Do not operate the switch continually as the washer fluid pump may overheat.

■ **When a nozzle becomes blocked**

In this case, contact your Toyota dealer.  
Do not try to clear it with a pin or other object. The nozzle will be damaged.

■ **To prevent battery discharge**

Do not leave the wipers on longer than necessary when the engine is off.

**Changing the windshield wiper rest position/Lifting the windshield wipers**

When the windshield wipers are not being used, they retract to below the hood. To enable the windshield wipers to be lifted when parking in cold conditions or when replacing a windshield wiper insert, change the rest position of the windshield wipers to the service position using the

wiper lever.

■ **Raising the wipers to the service position**

Within approximately 45 seconds of turning the engine switch off, move the wiper lever to the MIST (U.S.A.) or Δ (Canada) position and hold it for approximately 2 seconds or more.

The wipers will move to the service position.

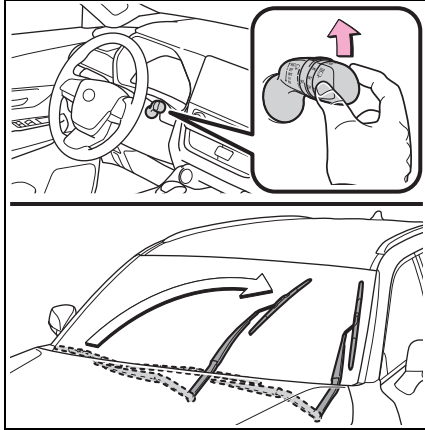

■ **Lifting the windshield wipers**

While holding the hook portion of the wiper arm, lift the windshield wiper from the windshield.

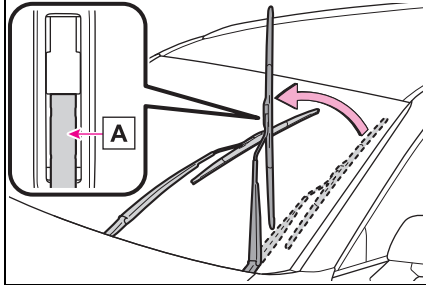

A Hook portion

**■ Lowering the windshield wipers to the retracted position**

With the windshield wipers placed on the windshield, turn the engine switch to ON and then move the wiper lever to an operating position. When the wiper switch is turned off, the windshield wipers will stop at the retracted position.

**■ Operating the windshield wipers and washer using the voice control system\***

\*: If equipped

► For the U.S.A.

The windshield wipers can be moved to the service position using the voice control system. (Operation is possible only when the vehicle is stopped with the wiper switch in OFF .)

► For Canada

The windshield wipers can be moved to the service position using the voice control system. (Operation is possible only when the vehicle is stopped with the wiper switch in

○ .)

For details regarding the voice control system, refer to the “MULTIMEDIA OWNER’S MANUAL”.

 NOTICE

**■ When lifting the windshield wipers**

- Do not lift the windshield wipers when they are in the retracted position below the hood. Otherwise, they may contact the hood, possibly resulting in damage to a windshield wiper and/or the hood.
- Do not lift a windshield wiper by the wiper blade. Otherwise, the wiper blade may be deformed.

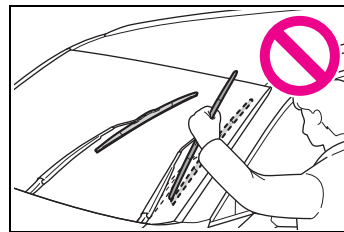

- Do not operate the wiper lever when the windshield wipers are lifted. Otherwise, the windshield wipers may contact the hood, possibly resulting in damage to the windshield wipers and/or hood.

**Rear window wiper and washer**

 NOTICE



**When the rear window is dry**

Do not use the wiper, as it may damage the rear window.

**Operating the wiper lever**

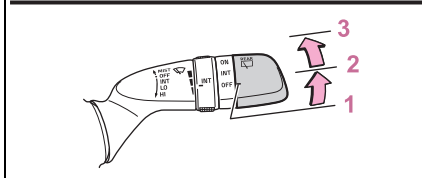
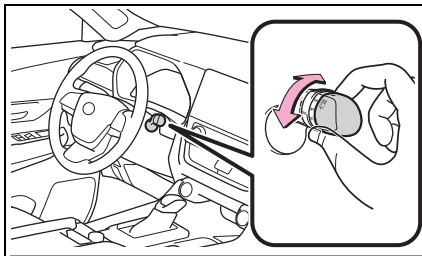
Operating the  switch operates the rear wiper as follows:



- 1** OFF (U.S.A.) or  (Canada)  
Off
- 2** INT (U.S.A.) or  (Canada)  
Intermittent operation
- 3** ON (U.S.A.) or  (Canada)  
Normal operation

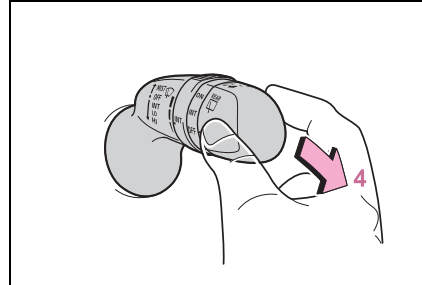

**4**  Washer/wiper dual operation

Pushing the lever operates the wiper and washer.

The wiper will automatically operate a couple of times after the washer squirts.

The washer will automatically operate and clean the camera for the Digital Rear-view Mirror\*<sup>1</sup> (→P.156) and rear camera\*<sup>2</sup>.

\*<sup>1</sup>: If equipped

\*<sup>2</sup>: Refer to the “MULTIMEDIA OWNER’S MANUAL”.

**The rear window wiper and washer can be operated when**

The engine switch is in ON.

**Operating the rear window wiper and washer using the voice control system\***

\*: If equipped

The following operation can be performed using the voice control system.

- Operating the rear window wiper only once
- Operating the rear window washer (it can be performed only when the vehicle is stopped)

For details regarding the voice control system, refer to the “MULTIMEDIA OWNER’S MANUAL”.

■ **If no washer fluid sprays**

Check that the washer nozzle is not blocked if there is washer fluid in the washer fluid tank.

■ **Reverse-linked rear window wiper function**

When the shift position is shifted to R when the front wipers are operating, the rear window wiper will operate once.

■ **Back door opening linked rear window wiper stop function**

When the rear window wiper is operating, if the back door is opened while the vehicle is stopped, operation of the rear window wiper will be stopped to prevent anyone near the vehicle from being sprayed by water from the wiper. When the back door is closed, wiper operation will resume.



**NOTICE**

■ **When the washer fluid tank is empty**

Do not operate the switch continually as the washer fluid pump may overheat.

■ **When a nozzle becomes blocked**

In this case, contact your Toyota dealer.  
Do not try to clear it with a pin or other object. The nozzle will be damaged.

■ **To prevent battery discharge**

Do not leave the wiper on longer than necessary when the engine is off.

## Opening the fuel tank cap

Perform the following steps to open the fuel tank cap:

### Before refueling the vehicle

- Close all the doors and windows, and turn the engine switch off.
- Confirm the type of fuel.

#### ■ Fuel types

→P.526

#### ■ Fuel tank opening for unleaded gasoline

To help prevent incorrect fueling, your vehicle has a fuel tank opening that only accommodates the special nozzle on unleaded fuel pumps.

#### ■ If the malfunction indicator lamp illuminates

The malfunction indicator lamp may illuminate erroneously if refueling is performed repeatedly when the fuel tank is nearly full.

### WARNING

#### ■ When refueling the vehicle

Observe the following precautions while refueling the vehicle. Failure to do so may result in death or serious injury.

- After exiting the vehicle and before opening the fuel door, touch an unpainted metal surface to discharge any static electricity. It is important to discharge static electricity before refueling because sparks resulting from static electricity can cause fuel vapors to ignite while refueling.

- Always hold the grips on the fuel tank cap and turn it slowly to remove it. A whooshing sound may be heard when the fuel tank cap is loosened. Wait until the sound cannot be heard before fully removing the cap. In hot weather, pressurized fuel may spray out of the filler neck and cause injury.

- Do not allow anyone that has not discharged static electricity from their body to come close to an open fuel tank.

- Do not inhale vaporized fuel. Fuel contains substances that are harmful if inhaled.

- Do not smoke while refueling the vehicle. Doing so may cause the fuel to ignite and cause a fire.

- Do not return to the vehicle or touch any person or object that is statically charged. This may cause static electricity to build up, resulting in a possible ignition hazard.

#### ■ When refueling

Observe the following precautions to prevent fuel overflowing from the fuel tank:

- Securely insert the fuel nozzle into the fuel filler neck.

- Stop filling the tank after the fuel nozzle automatically clicks off.

**⚠ WARNING**

- Do not top off the fuel tank.

**⚠ NOTICE**

■ **Refueling**

Do not spill fuel during refueling. Doing so may damage the vehicle, such as causing the emission control system to operate abnormally or damaging fuel system components or the vehicle's painted surface.

**Opening the fuel tank cap**

- 1 Press the switch to open the fuel filler door.

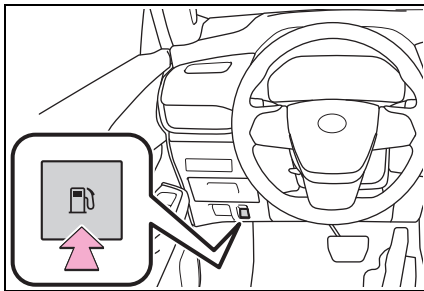

- 2 Turn the fuel tank cap slowly and remove it, then put it into the holder on the fuel filler door.

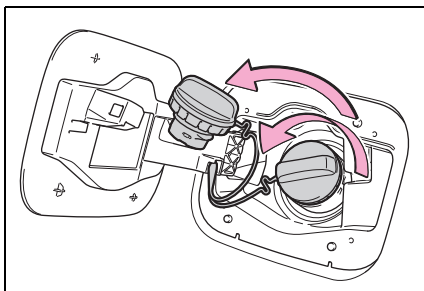

■ **If the fuel filler door cannot be opened**

→P.505

**Closing the fuel tank cap**

After refueling, turn the fuel tank cap until you hear a click. Once the cap is released, it will turn slightly in the opposite direction.

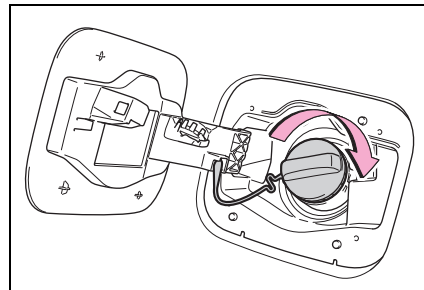

■ **When “Check Fuel Cap” is displayed on the multi-information display**

The fuel tank cap may be unfastened or loose. Turn the engine switch off, check the cap and tighten it securely. If the message remains, wait a few seconds and then turn the engine switch off once again.

**⚠ WARNING**

■ **When replacing the fuel tank cap**

Do not use anything but a genuine Toyota fuel tank cap designed for your vehicle. Doing so may cause a fire or other incident which may result in death or serious injury.



**Toyota Safety Sense 3.0 software update**

**It is necessary to enter a connected services contract, provided by Toyota, to use these functions. For details, contact your Toyota dealer.**

**⚠ WARNING**

**■ For safe use**

When the Toyota Safety Sense 3.0 software is updated, the operating methods of functions may change. Using this system without knowing the correct operating methods may lead to an accident resulting in death or serious injury.

- Make sure to read the Digital Owner's Manual which corresponds to the software version of the system, available at the Owner's Manual website, before using this system.

**Content of the Toyota Safety Sense 3.0 Owner's Manual**

This Owner's Manual contains information for Ver. 2. For the latest information about the controls, use, warnings/precautions, etc. of each function of Toyota Safety Sense 3.0, refer to the Digital Owner's Manual at the Owner's Manual website.

If the software of this system has been updated after initial purchase of the vehicle, before using this system, be sure to

read the Owner's Manual which corresponds to the software version of the system.

**■ Precautions for use**

- Be aware that some functions may temporarily be disabled if a legal or safety related issue occurs.
- If a connected services contract has not been entered or has expired, software updates will not be able to be performed wirelessly.

**Checking your vehicle's Toyota Safety Sense 3.0 version**

If the software of this system has been updated after initial purchase of the vehicle, to access the appropriate Owner's Manual, it is necessary to check the software version of the system and then visit the Owner's Manual website.

**Checking the version using OneApp**

The software version of the system can be checked using OneApp.

**Selecting your vehicle's Toyota Safety Sense 3.0 version**

- 1 Access the following URL using a computer or smartphone:

► For U.S.A. owners

<https://www.toyota.com/owners/resources/warranty-owners-manuals/manual?om=om0e126u.grandhighlander.2024.2306.cv.vh>



► For Canadian owners

<https://www.toyota.ca/toyota/owners/manual?om=om0e126u.grandhighlander.2024.2306.cv.vh>



- 2 Select the file which includes the previously checked system version.

### Updating the software

If a software update is available, a notification will be displayed by OneApp. Follow the instructions displayed on the screen.

### ■ Software update precautions

- After a software update has been performed, it will not be possible to revert to a previous version.
- Depending on the communication environment and the content of an update, a software update may take several hours. Although an update will be suspended when the engine switch is turned off, it will resume when the engine switch is changed back to ON.
- Toyota Safety Sense 3.0 can still be used while a software update is being performed.

### ■ What can be checked using the OneApp

The following items can be checked or performed.

- Software version, update details, precautions, use methods, etc.
- Software update

**Toyota Safety Sense 3.0**

**The Toyota Safety Sense 3.0 consists of the driving assist systems and contributes to a safe and comfortable driving experience:**

**⚠ WARNING****■ Toyota Safety Sense 3.0**

The Toyota Safety Sense 3.0 operates under the assumption that the driver will drive safely, and is designed to help reduce the impact to the occupants in a collision and assist the driver under normal driving conditions.

As there is a limit to the degree of recognition accuracy and control performance that this system can provide, do not overly rely on this system. The driver is solely responsible for paying attention to the vehicle's surroundings and driving safely.

**■ For safe use**

- Do not overly rely on this system. The driver is solely responsible for paying attention to the vehicle's surroundings and driving safely. This system may not operate in all situations and provided assistance is limited. Over-reliance on this system to drive the vehicle safely may lead to an accident resulting in death or serious injury.
  - Do not attempt to test the operation of the system, as it may not operate properly, possibly leading to an accident.
- If attention is necessary while performing driving operations or a system malfunction occurs, a warning message or warning buzzer will be operated. If a warning message is displayed on the display, follow the instructions displayed.
  - Depending on external noise, the volume of the audio system, etc. it may be difficult to hear the warning buzzer. Also, depending on the road conditions, it may be difficult to recognize the operation of the system.

**■ When it is necessary to disable the system**

In the following situations, make sure to disable the system.

Failure to do so may lead to the system not operating properly, possibly leading to an accident resulting in death or serious injury.

- When the vehicle is tilted due to being overloaded or having a flat tire
- When driving at extremely high speeds
- When towing another vehicle
- When the vehicle is being transported by a truck, ship, train, etc.
- When the vehicle is raised on a lift and the tires are allowed to rotate freely
- When inspecting the vehicle using a drum tester such as a chassis dynamometer or speedometer tester, or when using an on vehicle wheel balancer
- When the vehicle is driven in a sporty manner or off-road
- When using an automatic car wash

**⚠ WARNING**

- When a sensor is misaligned or deformed due to a strong impact being applied to the sensor or the area around the sensor
- When accessories which obstruct a sensor or light are temporarily installed to the vehicle
- When a compact spare tire or tire chains are installed to the vehicle or an emergency tire puncture repair kit has been used
- When the tires are excessively worn or the inflation pressure of the tires is low
- When tires other than the manufacturer specified size are installed
- When the vehicle cannot be driven stably, due to a collision, malfunction, etc.

**Driving assist systems**

- **AHB (Automatic High Beam)**  
→P.220
- **PCS (Pre-Collision System)**  
→P.245
- **LTA (Lane Tracing Assist)**  
→P.257
- **LDA (Lane Departure Alert)**  
→P.265
- **LCA (Lane Change Assist)\***  
→P.262  
\*: If equipped

■ **FCTA (Front Cross Traffic Alert)\***

→P.277

\*: If equipped

■ **PDA (Proactive Driving Assist)**

→P.271

■ **RSA (Road Sign Assist)\***

→P.280

\*: If equipped

■ **Dynamic radar cruise control**

→P.282

■ **Cruise control**

→P.294

■ **Emergency Driving Stop System\***

→P.298

\*: If equipped

■ **Traffic Jam Assist\***

→P.301

\*: If equipped

■ **Driver monitor\***

→P.243

\*: If equipped

**Sensors used by Toyota Safety Sense 3.0**

Various sensors are used to obtain the necessary information for system operation.

■ **Sensors which detect the surrounding conditions**

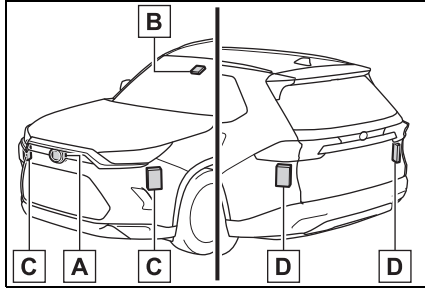

- A** Front radar sensor
- B** Front camera
- C** Front side radar sensors \*
- D** Rear side radar sensors

\*: If equipped

■ **Sensors which detect the driver condition**

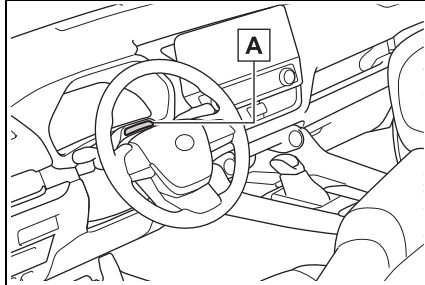

- A** Driver monitor camera \*

\*: If equipped

**⚠ WARNING**

■ **To prevent malfunction of the radar sensors**

Observe the following precautions.

Failure to do so may lead to a radar sensor not operating properly, possibly leading to an accident resulting in death or serious injury.

- Keep the radar sensors and radar sensor covers clean at all times.

Clean the front of a radar sensor or the front or back of a radar sensor cover if it is dirty or covered with water droplets, snow, etc.

When cleaning the radar sensor and radar sensor cover, use a soft cloth to remove dirt so as to not damage them.

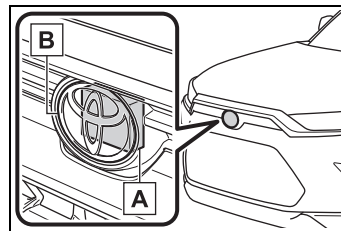

- A** Radar sensor
- B** Radar sensor cover

- Vehicles with front side radar sensors: Keep the surrounding area of the front side radar sensors on the front bumper clean at all times.

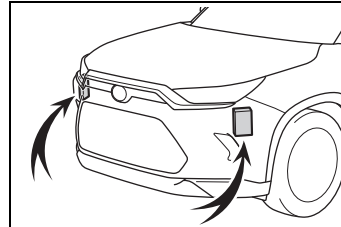

- Do not attach accessories, stickers (including transparent stickers), aluminum tape, etc. to a radar sensor or radar sensor cover and their surrounding area.

**⚠ WARNING**

- Do not subject a radar sensor or its surrounding area to impact. If a radar sensor, the front grille, or front bumper has been subjected to a impact, have the vehicle inspected by your Toyota dealer.
- Do not disassemble the radar sensors.
- Do not modify or paint the radar sensors or radar sensor cover, or replace them with anything other than Toyota genuine parts.
- In the following situations, recalibration of the radar sensors will be necessary. For details, contact your Toyota dealer.
  - When a radar sensor is removed and installed, or replaced
  - When the front bumper or the front grille has been replaced

**■ To prevent malfunction of the front camera**

Observe the following precautions.

Failure to do so may lead to the front camera not operating properly, possibly leading to an accident resulting in death or serious injury.

- Always keep the windshield clean.
  - If the windshield is dirty or covered with an oily film, water droplets, snow, etc., clean the windshield.
  - Even if a glass coating agent is applied to the windshield, it will still be necessary to use the windshield wipers to remove water droplets, etc. from the area of the windshield in front of the front camera.

- If the inner side of the windshield where the front camera is installed is dirty, contact your Toyota dealer.
- Do not attach stickers (including transparent stickers) or other items to the area of the windshield in front of the front camera (shaded area in the illustration).

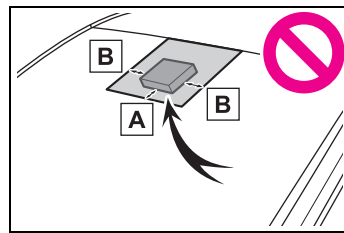

**A** Approximately 1.6 in. (4 cm)

**B** Approximately 1.6 in. (4 cm)

- If the part of the windshield in front of the front camera is fogged up or covered with condensation or ice, use the windshield defogger to remove the fog, condensation, or ice.
- If water droplets cannot be properly removed from the area of the windshield in front of the front camera by the windshield wipers, replace the wiper insert or wiper blade.
- Do not attach window tint to the windshield.
- Replace the windshield if it is damaged or cracked. If the windshield has been replaced, recalibration of the front camera will be necessary. For details, contact your Toyota dealer.
- Do not allow liquids to contact the front camera.
- Do not allow bright lights to shine into the front camera.



**WARNING**

- Do not damage the lens of the front camera or allow it to become dirty.  
When cleaning the inside of the windshield, do not allow glass cleaner to contact the lens of the front camera. Do not touch the lens of the front camera. If the lens of the front camera is dirty or damaged, contact your Toyota dealer.
- Do not subject the front camera to a strong impact.
- Do not change the position or orientation of the front camera or remove it.
- Do not disassemble the front camera.
- Do not modify any parts around the front camera, such as the inside rear view mirror or ceiling.
- Do not attach accessories which may obstruct the front camera to the hood, front grille, or front bumper. For details, contact your Toyota dealer.
- If a surfboard or other long object is to be mounted on the roof, make sure that it will not obstruct the front camera.
- Do not modify or change the headlights and other lights.

**■ Front camera installation area on the windshield**

If the system determines that the windshield may be fogged up, it will automatically operate the heater to defog the part of the windshield around the front camera. When cleaning, etc., be careful not to touch the area around the front camera until the windshield has cooled sufficiently, as touching it may cause burns.

**■ Precautions for the driver monitor camera (if equipped)**

Observe the following precautions.

Failure to do so may lead to malfunction of the driver monitor camera and the systems not operating properly, possibly leading to an accident resulting in death or serious injury.

- Do not subject the driver monitor camera or its surrounding area to strong impact.  
If subjected to a strong impact, the driver monitor camera may move out of alignment and the driver may no longer be detected correctly. In this case, have the vehicle inspected by your Toyota dealer.
- Do not disassemble or modify the driver monitor camera.
- Do not attach accessories, stickers (including transparent stickers), etc. to the driver monitor camera or its surrounding area.
- Do not allow the driver monitor camera or its surrounding area to get wet.
- Do not cover the driver monitor camera or place anything in front of it.
- Keep the lens of the driver monitor camera free from damage.
- Do not touch the lens of the driver monitor camera or allow it to become dirty.  
When there is dirt or fingerprints on the camera lens, clean it with a dry, soft cloth so as to not mark or damage it.
- When cleaning the lens, do not use detergents or organic solvents that may damage plastic.

■ **Situations in which the sensors may not operate properly**

- When the height or inclination of the vehicle has been changed due to modifications
- When the windshield is dirty, fogged up, cracked or damaged
- When the ambient temperature is high or low
- When mud, water, snow, dead insects, foreign matter, etc., is attached to the front of the sensor
- When in inclement weather such as heavy rain, fog, snow, or a sandstorm
- When water, snow, dust, etc. is thrown up in front of the vehicle, or when driving through mist or smoke
- When the headlights are not illuminated while driving in the dark, such as at night or when in a tunnel
- When the lens of a headlight is dirty and illumination is weak
- When the headlights are misaligned
- When a headlight is malfunctioning
- When the headlights of another vehicle, sunlight, or reflected light shines directly into the front camera
- When the brightness of the surrounding area changes suddenly
- When driving near a TV tower, broadcasting station, electric power plant, radar equipped vehicles, etc., or other location where strong radio waves or electrical noise may be present
- When a wiper blade is blocking the front camera
- When in a location or near objects which strongly reflect radio waves, such as the following:
  - Tunnels

- Truss bridges
- Gravel roads
- Rutted, snow-covered roads
- Walls
- Large trucks
- Manhole covers
- Guardrail
- Metal plates
- When near a step or protrusion
- When a detectable vehicle is narrow, such as a small mobility vehicle
- When a detectable vehicle has a small front or rear end, such as an unloaded truck
- When a detectable vehicle has a low front or rear end, such as a low bed trailer

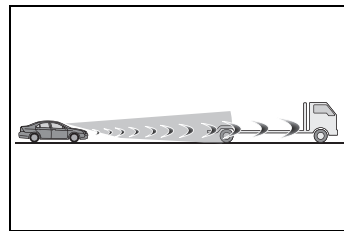

- When a detectable vehicle has extremely high ground clearance

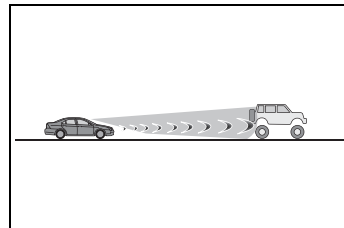

- When a detectable vehicle is carrying a load which protrudes from its cargo area
- When a detectable vehicle has little exposed metal, such as a vehicle which is partially covered with cloth, etc.
- When a detectable vehicle is irregularly shaped, such as a tractor, sidecar, etc.
- When the distance between the vehicle and a detectable vehicle



has become extremely short

- When a detectable vehicle is at an angle
- When snow, mud, etc. is attached to a detectable vehicle
- When driving on the following kinds of roads:
  - Roads with sharp curves or winding roads
  - Roads with changes in grade, such as sudden inclines or declines
  - Roads which is sloped to the left or right
  - Roads with deep ruts
  - Roads which are rough and unmaintained
  - Roads which frequently undulate or are bumpy
- When the steering wheel is being operated frequently or suddenly
- When the vehicle is not in a constant position within a lane
- When parts related to this system, the brakes, etc. are cold or extremely hot, wet, etc.
- When the wheels are misaligned
- When driving on slick road surfaces, such as when it is covered with ice, snow, gravel, etc.
- When the course of the vehicle differs from the shape of a curve
- When the vehicle speed is excessively high when entering a curve
- When entering/exiting a parking lot, garage, car elevator, etc.
- When driving in a parking lot
- When driving through an area where there are obstructions which may contact your vehicle, such as tall grass, tree branches, a curtain, etc.
- When driving in strong wind

■ **Situations in which the lane may not be detected**

- When the lane is extremely wide or narrow

- Immediately after changing lanes or passing through an intersection
- When driving in a temporary lane or lane regulated by construction
- When there are structures, patterns, shadows which are similar to lane lines in the surrounding
- When there are multiple white lines for a lane line
- When the lane lines are not clear or driving on a wet road surface
- When a lane line is on a curb
- When driving on a bright, reflective road surface, such as concrete

■ **Situations in which some or all of the functions of the system cannot operate**

- When a malfunction is detected in this system or a related system, such as the brakes, steering, etc.
- When the VSC, TRAC, or other safety related system is operating
- When the VSC, TRAC, or other safety related system is off

■ **Changes in brake operation sound and pedal response**

- When the brakes have been operated, brake operation sounds may be heard and the brake pedal response may change, but this does not indicate a malfunction.
- When the system is operating, the brake pedal may feel stiffer than expected or sink. In either situation the brake pedal can be depressed further. Further depress the brake pedal as necessary.

■ **Situations in which the driver monitor may not operate properly (if equipped)**

In situations such as the following, the driver monitor camera may not be able to detect the driver's face, and the function may not operate properly.

- When the inside of the vehicle is hot, such as after the vehicle has been parked in the sun
- When a very bright light, such as the sun or the headlights of following vehicle, shines onto the driver monitor camera
- When the brightness inside the vehicle changes frequently due to the shadows of surrounding structures, etc.
- When a very bright light, such as the sun or the headlights of an oncoming vehicle, is shining onto the driver's face
- When light, either inside or outside of the vehicle, is being reflected from the lenses of eyeglasses or sunglasses
- When there are multiple faces in the detection range of the driver monitor camera, such as when a front or rear passenger is leaning toward the driver's seat
- When the driver's face is outside of the detection range of the driver monitor camera, such as when leaned forward or when their head is outside of the window
- When the driver monitor camera is being blocked by the steering wheel, a hand holding the steering wheel, an arm, etc.
- When the driver is wearing a hat
- When the driver is wearing an eyepatch
- When the driver is wearing eyeglasses or sunglasses that do not easily transmit infrared rays
- When the driver is wearing contact lenses
- When the driver is wearing a face mask
- When the driver is laughing or their eyes are only slightly open
- When the driver's eyes, nose, mouth, or shape of their face is blocked
- When the driver is wearing makeup which makes it difficult to detect their eyes, nose, mouth, or shape of their face
- When the driver's eyes are blocked by the frame of eyeglasses, sunglasses, hair, etc.
- When there is a device inside the vehicle that radiates near infrared rays, such as a non-genuine driver monitoring system.

**Driver monitor\***

\*: If equipped

**Basic functions**

During controlled driving, the driver monitor camera detects the position and direction the driver is facing, and whether their eyes are opened or closed. Through this, the system determines if the driver is checking their surroundings and if the driver can perform driving operations.

In order to operate properly, the driver monitor camera requires an unobstructed view of the driver's face. If the steering column or seat position is either too high or too low, or if any other condition is present that obstructs the driver monitor camera's view of the driver's face, some driving support systems may not operate properly, or a warning message may be displayed.

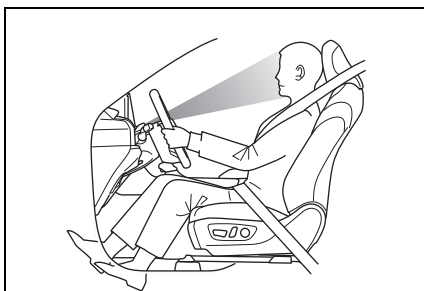

■ **Warning function**

In situations such as the follow-

ing, a buzzer will sound and a message will be displayed to warn the driver.

- When the system determines that the driver is not paying attention to the road or their eyes are closed
- When the driver's face cannot be detected or the system determines that the driver has poor driving posture

When the seated position of the driver is such that the upper or lower part of the meter is not visible, the driver's entire face may not be recognized by the driver monitor camera. To mitigate the appearance of this warning, adjust the steering wheel and seat position so the driver can see the entire meter.

■ **Face identification**

The driver monitor is used as a device to identify faces in order to identify an individual.

For information about how to use the face identification function, priorities among other devices of individual identification, and linked vehicle settings, see "My Settings". (→P.175)

**WARNING**

■ **For safe use**

- The driver monitor is not designed to prevent the driver from driving carelessly or having a poor driving posture. Pay careful attention to the surrounding conditions in order to ensure safe driving.

- The driver monitor cannot reduce drowsiness. If you feel unable to concentrate or drowsy, take a break and sleep as necessary in order to ensure safe driving.

#### ■ Warning function

These functions may not operate when the vehicle speed is low.

#### ■ Face identification

Face identification starts when the door is opened then closed.

In face identification, facial traits are digitized and stored in a built-in computer, to be used for identification in My Settings.

- Face image or video are not stored. Voice is not stored either.
- Digitized face information is not used for any purpose other than identification in My Settings. Additionally, face information cannot be decoded and will not be disclosed or provided to a third party.
- Face information can be deleted by yourself.
- For the handling of face information, please consent to the following before using it:
  - Face identification does not guarantee a complete identity authentication, collation, or identification.
  - When face information registration fails frequently or face identification fails frequently, the driver cameras should be cleaned or face information should be registered again.
  - Face information stored in the vehicle computer cannot be decoded or moved to another media. Therefore, it is necessary to register face information again once it is deleted or relevant parts are replaced.
  - Once deleted, face information cannot be restored. It is necessary to register face information again.

#### ■ Situations where face identification may not be performed correctly

This system is designed for use to identify facial traits. In the following situations, face information may not be able to be registered or identified correctly:

- When a part of the driver's face (eyebrows, eyes, nose, or mouth) is not visible
- When the driver is wearing glasses/sun glasses, a face mask, muffler, etc.
- When the driver is not facing front
- When part of driver's face is covered with hair, beard, a hand, clothes, jewelry, etc.
- When the driver is closing eyes
- When a non-registered driver is a twin, etc. with a registered driver, whose face looks quite alike with each other

#### ■ Situations in which the driver monitor may not operate properly

→P.241

### Changing Driver monitor settings

The settings of Driver monitor can be changed through customize settings. (→P.538)

**PCS (Pre-Collision System)**

The pre-collision system uses sensors to detect objects (→P.245) in the path of the vehicle. When the system determines that the possibility of a frontal collision with a detectable object is high, a warning operates to urge the driver to take evasive action and the potential brake pressure is increased to help the driver avoid the collision. If the system determines that the possibility of a collision is extremely high, the brakes are automatically applied to help avoid the collision or help reduce the impact of the collision.

The pre-collision system can be disabled/enabled and the warning timing can be changed. (→P.256)

**⚠ WARNING****■ For safe use**

- Driving safely is solely the responsibility of the driver. Pay careful attention to the surrounding conditions in order to ensure safe driving.

Never use the pre-collision system in place of normal braking operations. This system cannot help avoid or reduce the impact of a collision in every situation.

Over-reliance on this system to drive the vehicle safely may lead to an accident resulting in death or serious injury.

- Although the pre-collision system is designed to help avoid or help reduce the impact of a collision, its effectiveness may change according to various conditions. Therefore, it may not always be able to achieve the same level of performance. Read the following items carefully. Do not overly rely on this system and always drive carefully.

- For safe use: →P.235

**■ When to disable the pre-collision system**

- When it is necessary to disable the system: →P.235

**Detectable objects**

The system can detect the following as detectable objects. (Detectable objects differ depending on the function.)

- Vehicles
- Bicycles\*
- Pedestrians

- Motorcycles \*
- Walls

\* : Detected as a detectable object only when being ridden.

### System functions

#### ■ Pre-collision warning

When the system determines that the possibility of a collision is high, a buzzer will sound and an icon and warning message will be displayed on the multi-information display to urge the driver to take evasive action. If the detectable object is a vehicle, moderate braking will be performed with the warning.

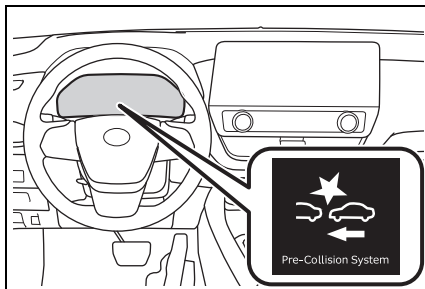

If the system determines that the accelerator pedal is strongly depressed, the following icon and message will be displayed on the multi-information display.

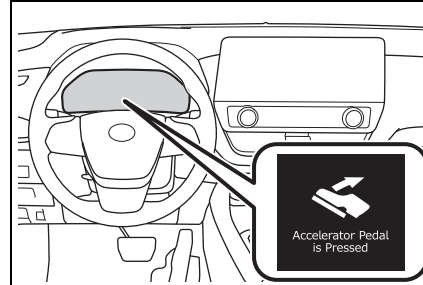

#### ■ Pre-collision brake assist

If the system determines that the possibility of a collision is high and the brake operation by the driver is insufficient, the braking power will be increased.

#### ■ Pre-collision brake control

If the system determines that the possibility of a collision is extremely high, the brakes are automatically applied to help avoid the collision or reduce the impact of the collision.

#### ■ Emergency steering assist

If the system determines that the following conditions are met, assistance will be provided to help enhance vehicle stability and prevent lane departure. During assistance, in addition to the pre-collision warning, the following icon will be displayed on the multi-information display.

- The possibility of a collision is high
- There is sufficient space within the lane to perform evasive steering maneuvers
- The driver is operating the

steering wheel

Vehicles with active steering function: The brakes and steering are controlled to help avoid a collision or reduce the impact of a collision, regardless of the evasive steering maneuvers performed by the driver.

During assistance, the pre-collision warning will operate and a message will be displayed to warn the driver.

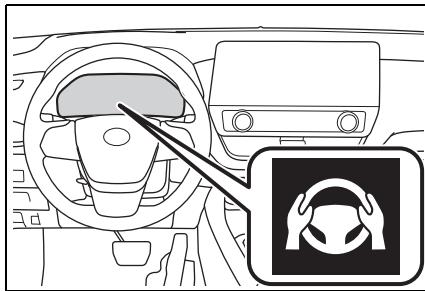

■ **Intersection collision avoidance support (left/right turn)**

In situations such as the following, if the system determines that the possibility of a collision is high, the pre-collision warning and pre-collision braking will operate.

Depending on the intersection, assistance may not operate correctly.

- When turning left/right at an intersection and crossing the path of an oncoming vehicle

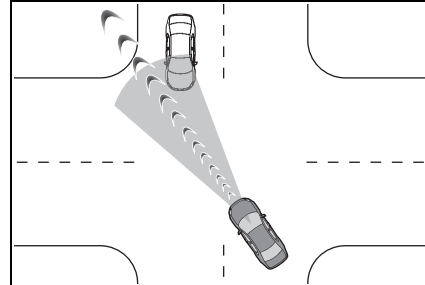

- When turning left/right and a pedestrian or bicycle is detected

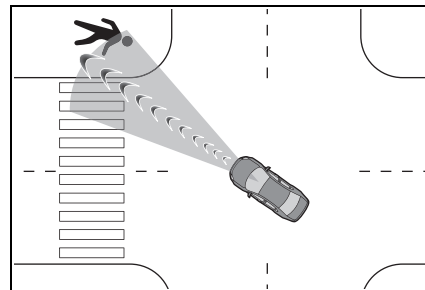

■ **Intersection collision avoidance support (crossing vehicles)**

At an intersection, etc., if the system determines that the possibility of a collision with an approaching vehicle or motorcycle is high, the pre-collision warning and pre-collision braking will operate.

Depending on the intersection, assistance may not operate correctly.

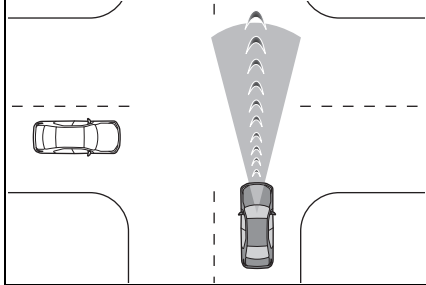

■ **Acceleration Suppression at Low Speed**

When driving at a low speed, if the accelerator pedal is strongly depressed and the system determines that there is a possibility of a collision, engine output will be restrained or the brakes will be applied weakly to restrict acceleration. During operation, a buzzer will sound and a warning indicator and message will be displayed on the multi-information display.

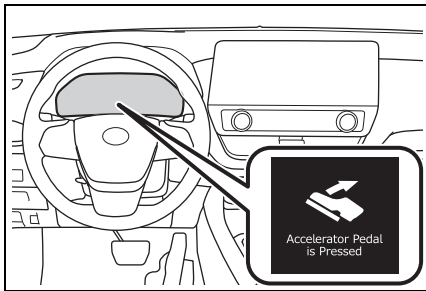

▲ **WARNING**

■ **Pre-collision braking**

- When the pre-collision braking function is operating, a large amount of braking force will be applied.

- The pre-collision braking function is not designed to hold the vehicle stopped. If the vehicle is stopped by pre-collision brake control, the driver should operate the brakes immediately as necessary.

- The pre-collision braking function may not operate if certain operations are performed by the driver. If the accelerator pedal is being depressed strongly or the steering wheel is being turned, the system may determine that the driver is taking evasive action and possibly prevent the pre-collision braking function from operating.

- If the brake pedal is being depressed, the system may determine that the driver is taking evasive action and possibly delay the operation timing of the pre-collision brake control.

■ **Acceleration Suppression at Low Speed**

If the steering wheel is being turned, the system may determine that the driver is taking evasive action and possibly prevent the Acceleration Suppression at Low Speed function from operating or possibly causing its operation to be canceled.

■ **Emergency steering assist**

- The emergency steering assist will be canceled when the system determines that lane departure prevention control has completed.



**WARNING**

- Depending on operations performed by the driver, emergency steering assist may not operate or operation may be canceled.
- If the accelerator pedal is depressed strongly, the steering wheel is turned heavily, the brake pedal is depressed, or the turn signal lever is operated, the system may determine that the driver is taking evasive action and the emergency steering assist may not operate.
- While the emergency steering assist is operating, if the accelerator pedal is depressed strongly, the steering wheel is turned heavily, or the brake pedal is depressed, the system may determine that the driver is taking evasive action and emergency steering assist operation may be canceled.
- While the emergency steering assist is operating, if the steering wheel is held or turned in the opposite direction of system operation, emergency steering assist operation will be canceled.

**■ Operating conditions of each function of the pre-collision system**

The pre-collision system is enabled and the system determines that the possibility of a frontal collision with a detected object is high.

However, the system will not operate in the following situations:

- When the vehicle has not been driven a certain amount after a terminal of the battery has been disconnected and reconnected
- When the shift position is in R
- When the VSC OFF indicator is illuminated (only the pre-collision warning function will be operational)

The following are the operational speeds and cancelation conditions of each function:

- Pre-collision warning

Detectable objects	Vehicle speed	Relative speed between your vehicle and object
Preceding vehicles, stopped vehicles	Approximately 3 to 110 mph (5 to 180 km/h)	Approximately 3 to 110 mph (5 to 180 km/h)
Oncoming vehicles	Approximately 20 to 110 mph (30 to 180 km/h)	Approximately 50 to 130 mph (80 to 220 km/h)
Bicycles	Approximately 3 to 50 mph (5 to 80 km/h)	Approximately 3 to 50 mph (5 to 80 km/h)
Pedestrians	Approximately 3 to 50 mph (5 to 80 km/h)	Approximately 3 to 50 mph (5 to 80 km/h)
Preceding motorcycles, stopped motorcycles	Approximately 3 to 110 mph (5 to 180 km/h)	Approximately 3 to 50 mph (5 to 80 km/h)
Oncoming motorcycles	Approximately 20 to 110 mph (30 to 180 km/h)	Approximately 20 to 110 mph (30 to 180 km/h)

While the pre-collision warning is operating, if the steering wheel is operated heavily or suddenly, the pre-collision warning may be cancelled.

● Pre-collision brake assist

Detectable objects	Vehicle speed	Relative speed between your vehicle and object
Preceding vehicles, stopped vehicles	Approximately 20 to 110 mph (30 to 180 km/h)	Approximately 7 to 110 mph (10 to 180 km/h)
Bicycles	Approximately 20 to 50 mph (30 to 80 km/h)	Approximately 20 to 50 mph (30 to 80 km/h)
Pedestrians	Approximately 20 to 50 mph (30 to 80 km/h)	Approximately 20 to 50 mph (30 to 80 km/h)
Preceding motorcycles, stopped motorcycles	Approximately 20 to 110 mph (30 to 180 km/h)	Approximately 7 to 50 mph (10 to 80 km/h)

● Pre-collision braking

Detectable objects	Vehicle speed	Relative speed between your vehicle and object
Preceding vehicles, stopped vehicles	Approximately 3 to 110 mph (5 to 180 km/h)	Approximately 3 to 110 mph (5 to 180 km/h)
Oncoming vehicles	Approximately 20 to 110 mph (30 to 180 km/h)	Approximately 50 to 130 mph (80 to 220 km/h)

Detectable objects	Vehicle speed	Relative speed between your vehicle and object
Bicycles	Approximately 3 to 50 mph (5 to 80 km/h)	Approximately 3 to 50 mph (5 to 80 km/h)
Pedestrians	Approximately 3 to 50 mph (5 to 80 km/h)	Approximately 3 to 50 mph (5 to 80 km/h)
Preceding motorcycles, stopped motorcycles	Approximately 3 to 110 mph (5 to 180 km/h)	Approximately 3 to 50 mph (5 to 80 km/h)
Oncoming motorcycles	Approximately 20 to 110 mph (30 to 180 km/h)	Approximately 20 to 110 mph (30 to 180 km/h)

If either of the following occur while the pre-collision braking function is operating, it will be canceled:

- The accelerator pedal is strongly depressed
- The steering wheel is operated heavily or suddenly
- Emergency steering assist

The emergency steering assist will not operate when the turn signal lights are flashing.

Detectable objects	Vehicle speed	Relative speed between your vehicle and object
Preceding vehicles, stopped vehicles, bicycles, pedestrians, motorcycles	Approximately 25 to 50 mph (40 to 80 km/h)	Approximately 25 to 50 mph (40 to 80 km/h)
	Active steering function: * to 50 mph (* to 80 km/h)	Active steering function: * to 50 mph (* to 80 km/h)

\*: Minimum vehicle speed: Vehicle speed at which evasion using pre-collision brake control is difficult

While the emergency steering assist is operating, if any of the following are performed, emergency steering assist operation may be cancelled:

- The accelerator pedal is strongly depressed
- The steering wheel is operated heavily or suddenly
- The brake pedal is depressed
- Intersection collision avoidance support (left/right turn)

The intersection collision avoidance support (for left/right turning vehicles) will not operate when the turn signal lights are not flashing.

Detectable objects	Vehicle speed	Oncoming vehicle speed	Relative speed between your vehicle and object
Oncoming vehicles	Approximately 3 to 25 mph (5 to 40 km/h)	Approximately 3 to 45 mph (5 to 75 km/h)	Approximately 7 to 70 mph (10 to 115 km/h)
Pedestrians	Approximately 3 to 20 mph (5 to 30 km/h)	—	Approximately 3 to 25 mph (5 to 40 km/h)
Bicycles	Approximately 3 to 20 mph (5 to 30 km/h)	—	Approximately 3 to 30 mph (5 to 50 km/h)
Oncoming motorcycles	Approximately 3 to 25 mph (5 to 40 km/h)	Approximately 3 to 45 mph (5 to 75 km/h)	Approximately 7 to 70 mph (10 to 115 km/h)

- Intersection collision avoidance support (crossing vehicles)
- ▶ Vehicles without front side radars

Detectable objects	Vehicle speed	Crossing vehicle speed	Relative speed between your vehicle and object
Vehicles, Motorcycles (side)	Approximately 3 to 38 mph (5 to 60 km/h)	<ul style="list-style-type: none"> <li>● Your vehicle speed or less</li> <li>● Approximately 25 mph or less (40 km/h or less)</li> </ul>	Approximately 3 to 38 mph (5 to 60 km/h)

- ▶ Vehicles with front side radars

Detectable objects	Vehicle speed	Crossing vehicle speed	Relative speed between your vehicle and object
Vehicles, Motorcycles (side)	Approximately 3 to 38 mph (5 to 60 km/h)	Approximately 31mph or less (50 km/h or less)	Approximately 3 to 38 mph (5 to 60 km/h)

When driving at approximately 29 mph (40 km/h) or more, this system will only operate when the speed of the other vehicle is approximately 29 mph (40 km/h) or less.

The system operates only when the crossing vehicle speed is same as or less than the vehicle speed.

- Acceleration Suppression at Low Speed

The Acceleration Suppression at Low Speed function will not operate when the turn signal lights are flashing.

Detectable objects	Vehicle speed	Relative speed between your vehicle and object
Preceding vehicles, stopped vehicles, Pedestrians, Bicycles, Wall	Approximately 0 to 9 mph (0 to 15 km/h)	Approximately 0 to 9 mph (0 to 15 km/h)

While the Acceleration Suppression at Low Speed function is operating, if any of the following are performed, the low speed sudden acceleration suppression function operation will be cancelled:

- The accelerator pedal is released.
- The steering wheel is operated heavily or suddenly

**■ Detection of detectable objects**

Objects are detected based on their size, shape, and movement.

Depending on the ambient brightness, movement, posture and direction of a detectable object, it may not be detected and the system may not operate properly.

The system detects shapes, such as the following, as detectable objects.

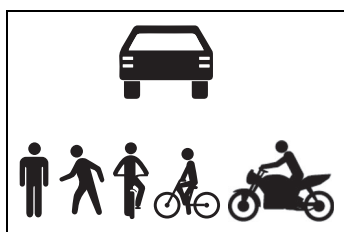

**■ Situations in which the system may operate even though the possibility of a collision is not high**

- In certain situations, such as the following, the system may determine that the possibility of a collision is high and operate:
  - When passing a detectable object
  - When changing lanes while overtaking a detectable object
  - When suddenly approaching a detectable object
  - When approaching a detectable object or other object on the road-

side, such as guardrails, utility poles, trees, walls, etc.

- When there is a detectable object or other object by the roadside at the entrance of a curve

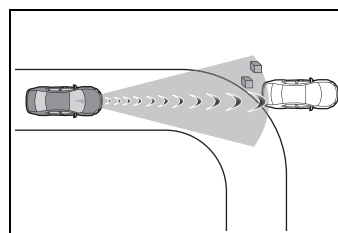

- When there are patterns or a painting ahead of the vehicle that may be mistaken for a detectable object
- When passing a detectable object that is changing lanes or turning left/right

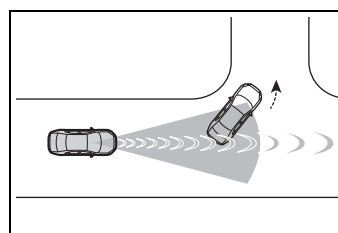

- When passing a detectable object which is stopped to make a left/right turn

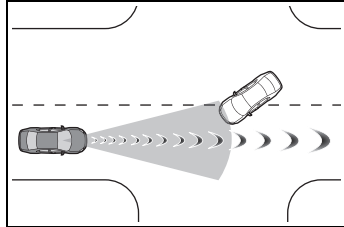

- When a detectable object stops immediately before entering the path of the vehicle
- When passing through a location with a structure above the road (traffic sign, billboard, etc.)

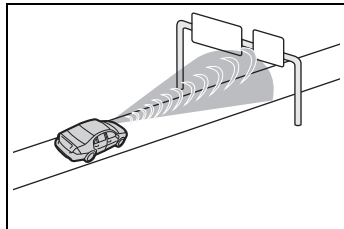

- When approaching an electric toll gate barrier, parking lot barrier, or other barrier that opens and closes
- When turning left/right and an oncoming vehicle, oncoming motorcycle, pedestrian or bicycle crosses in front of the vehicle
- When attempting to turn left/right in front of an oncoming vehicle, oncoming motorcycle, pedestrian or bicycle
- When turning left/right and an oncoming vehicle, oncoming motorcycle, pedestrian or bicycle stops or changes course immediately before entering the path of the vehicle
- When turning left/right and an oncoming vehicle turns left/right in front of the vehicle

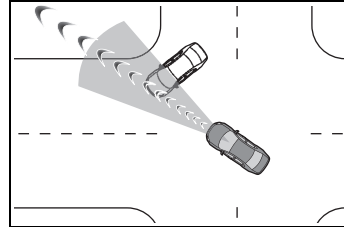

- When the steering wheel is operated toward the path of an oncoming vehicle
- When there is an object moving above or under the road

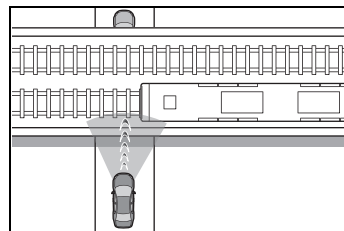

■ **Situations in which the system may not operate properly**

- In certain situations, such as the following, a detectable object may not be detected by the front sensors, and the system may not operate properly:
  - When a detectable object is approaching your vehicle
  - When your vehicle or a detectable object is wandering
  - When a detectable object makes an abrupt maneuver (such as sudden swerving, acceleration or deceleration)
  - When suddenly approaching a detectable object
  - When the detectable object is near a wall, fence, guardrail, manhole cover, steel plate on the road surface, or another vehicle
  - When there is a structure above a detectable object
  - When part of a detectable object is hidden by another object (large luggage, umbrella, guardrail, etc.)
  - When multiple detectable objects are overlapping
  - When a bright light, such as the sun, is reflecting off of a detect-

able object

- When a detectable object is white and looks extremely bright
- When the color or brightness of a detectable object causes it to blend in with its surroundings
- When a detectable object cuts in front of or suddenly emerges in front of your vehicle
- When approaching a vehicle which is diagonal
- If a bicycle is a child sized bicycle, is carrying a large load, is carrying an extra passenger, is carrying a forward leaning rider, or has an unusual shape (bicycles equipped with a child seat, tandem bicycles, etc.)
- If a pedestrian or bicycle is shorter than approximately 3.2 ft. (1 m) or taller than approximately 6.5 ft. (2 m).
- When the silhouette of a pedestrian or bicycle is unclear (such as when they are wearing a raincoat, long skirt, etc.)
- When a pedestrian is bending forward or squatting
- When a pedestrian or bicycle is moving at high speed
- When a pedestrian is pushing a stroller, wheelchair, bicycle or other vehicle
- When a detectable object blends in with the surrounding area, such as when it is dim (at dawn or dusk) or dark (at night or in a tunnel)
- When the vehicle has not been driven for a certain amount of time after the engine was started
- While turning left/right or a few seconds after turning left/right
- While driving around a curve and a few seconds after driving around a curve
- When turning left/right and an oncoming vehicle is driving in a lane 3 or more lanes from the vehicle
- When turning left/right and the direction of the vehicle differs greatly from the direction traffic flows in the oncoming lane

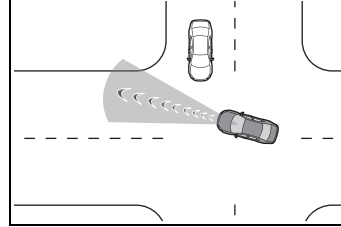

- When turning left/right, a pedestrian or bicycle behind the vehicle comes in front of it as if it overtakes the vehicle

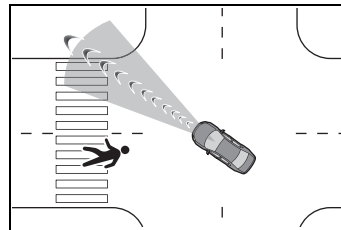





- When at an intersection, the approaching crossing vehicle is long in overall length, such as a large truck, towing trailer, etc.
- In addition to the preceding, in certain situations, such as the following, the emergency steering assist may not operate properly:
  - When a detectable object is too close to the vehicle
  - When there is insufficient space to perform evasive steering maneuvers or an obstruction exists in the evasion direction
  - When there is an oncoming vehicle
- In addition to the preceding, in certain situations, such as the following, walls may not be detected as a target object and the Acceleration Suppression at Low Speed function may not operate properly:
  - When scenery behind the wall is visible, such as a glass door, grid fence, etc.
  - When the wall is slanted or low
  - When the wall is narrow, such as a pole, etc.
  - When the wall is made of plants, such as a hedge, etc.

- When the road, etc. is reflected on the wall
- When the vehicle is approaching the wall at an angle

### Changing the pre-collision setting

- The pre-collision system can be enabled/disabled through a customize setting. (→P.538)

The system is enabled each time the engine switch is turned to ON.

- When the system is disabled, the PCS warning light will illuminate and a message will be displayed on the multi-information display.
- The pre-collision setting can be changed on the customize settings. (→P.538)
- Vehicles without active steering function: When the pre-collision warning timing is changed, the emergency steering assist timing will also be changed. When  is selected, the emergency steering assist (excluding the active steering function) will not operate in most cases.
- Vehicles with active steering function: When the pre-collision warning timing is changed, the emergency steering assist (excluding the active steering function) timing will also be changed. When  is selected, the emergency steering assist (excluding the active steering function) will not operate in most cases.
- Vehicles with a driver monitor camera: When the system determines that the driver is not facing forward, the pre-collision warning and emergency steering assist will operate at the  timing, regardless of the user setting.
- When the dynamic radar cruise control is operating, the pre-collision warning will operate at the  timing, regardless of the user setting.
- Vehicles with Traffic Jam Assist: When the Traffic Jam Assist is operating, the pre-collision warning will operate at the  timing, regardless of the user setting.



## LTA (Lane Tracing Assist)

### LTA functions

- When driving on a road with clear lane lines with the dynamic radar cruise control operating, lane lines and preceding and surrounding vehicles are detected using the front camera and radar sensor, and the steering wheel is operated to maintain the vehicle's lane position.

Use the this function only on highways and expressways.

If the dynamic radar cruise control is not operating, the function will not operate.

In situations where the lane lines are difficult to see or are not visible, such as when in a traffic jam, support will be provided using the path of preceding and surrounding vehicles.

If the system determines that the steering wheel has not been operated for a certain amount of time or the steering wheel is not being firmly gripped, the driver will be alerted and this function will be temporarily canceled.

If the steering wheel is firmly gripped, the function will begin operating again.

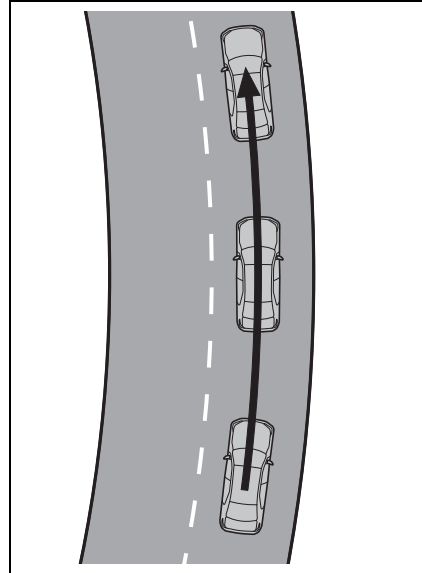

- When the function is operating, if the vehicle is likely to depart from its lane, the driver will be alerted via a display and buzzer.

When the buzzer sounds, check the area around the vehicle and carefully operate the steering wheel to move the vehicle back to the center of the lane.

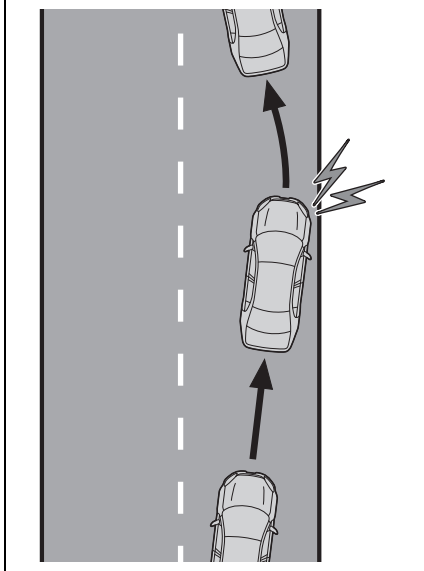

**⚠ WARNING**

■ **Before using the LTA system**

- Do not overly rely on the LTA system. The LTA system is not a system which provides automated assistance in driving and it is not a system which reduces the amount of attention necessary for safe driving. The driver is solely responsible for paying attention to their surroundings and operating the steering wheel as necessary to ensure safety. Also, the driver is responsible for taking adequate breaks when fatigued, such as when driving for a long time.
- Failure to perform appropriate driving operations and pay careful attention may lead to an accident.
- When not using the LTA system, turn it off using the LTA switch.

■ **Operating conditions of function**

This function is operable when all of

the following conditions are met:

- The LTA system detects lane lines or the path of preceding or surrounding vehicles.
- The dynamic radar cruise control is operating.
- The lane width is approximately 10 to 13 ft. (3 to 4 m).
- The turn signal lever is not being operated.
- The vehicle is not being driven around a sharp curve.
- The vehicle is not accelerating or decelerating more than a certain amount.
- The steering wheel is not being turned with a large force.
- The hands off steering wheel warning (→P.259) is not operating.
- The vehicle is being driven in the center of a lane.

■ **Temporary cancelation of functions**

- When the operating conditions are no longer met, a function may be temporarily canceled. However, when the operation conditions are met again, operation of the function will automatically be restored. (→P.258)
- If the operating conditions of a function are no longer met while the function is operating, a buzzer may sound to indicate that the function has been temporarily canceled.
- The steering assist operation of the function can be overridden by the steering wheel operation of the driver.

■ **Lane departure warning function when the LTA is operating**

- Even if the LDA warning method is changed to vibration of the steering wheel, if the vehicle deviates from the lane while the LTA is operating, the warning buzzer will

sound to alert the driver.

- If steering wheel operation equivalent to that necessary for a lane change is detected, the system will determine the vehicle is not deviating from the lane and the warning will not operate.

■ **Hands off steering wheel warning operation**

- When the system determines the driver is not holding the steering wheel, a message urging the driver to grip the steering wheel and the icon shown in the illustration will be displayed on the multi-information display to warn the driver. If the system detects that the steering wheel is held, the warning will be canceled. When using the system, make sure to grip the steering wheel firmly, regardless of whether the warning is operating or not.

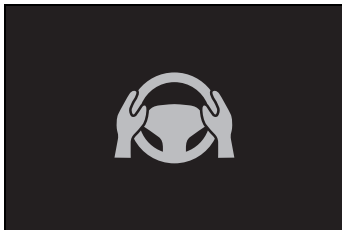

- If no operations are detected for a certain amount of time, the warning will operate and the function will be temporarily canceled. This warning may also operate if the driver only operates steering wheel a small amount continuously.

■ **Situations in which the hands off steering wheel warning may not operate properly**

- Depending on the condition of the vehicle, handle control condition and road surface, the warning function may not operate.
- Vehicles with LCA: In the following situations, the system may not be able to detect when the driver's hands are off the steering wheel.

- When a steering wheel cover is installed
- When the driver is wearing gloves
- When foreign matter is attached to the steering wheel
- When the driver is gripping the wood trim, seam of the leather, spokes, or other part of the steering wheel that does not have sensors
- Vehicles with LCA: In the following situations, the hands off steering wheel warning may not operate and the LTA function may continue operating even though the driver's hands are off the steering wheel:
  - When something other than a hand is contacting the steering wheel
  - When a wide object or arms are held across the steering wheel

**Enabling/disabling the system**

The LTA will change between ON/OFF each time the LTA switch is pressed.

When the LTA is ON, the LTA indicator will illuminate.

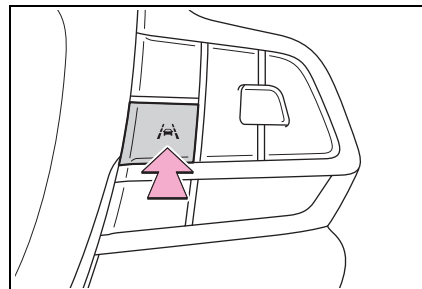

**⚠ WARNING**

**■ Situations in which the functions may not operate properly**

In the following situations, the functions may not operate properly and the vehicle may depart from its lane. Do not overly rely on these functions. The driver is solely responsible for paying attention to their surroundings and operating the steering wheel as necessary to ensure safety.

- When a preceding or surrounding vehicle changes lanes (Your vehicle may follow the preceding or surrounding vehicle and also change lanes)

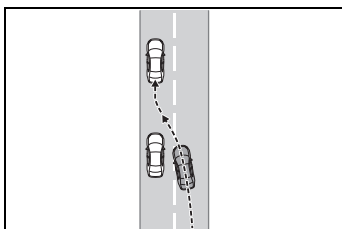









- When a preceding or surrounding vehicle is swaying (Your vehicle may sway accordingly and depart from the lane)
- When a preceding or surrounding vehicle departs from a lane (Your vehicle may follow the preceding or surrounding vehicle and also depart from the lane)
- When a preceding or surrounding vehicle is being driven extremely close to the left/right lane line (Your vehicle may follow the preceding or surrounding vehicle accordingly and depart from the lane)

- When there are moving objects or structures in the surrounding area (Depending on the position of the moving object or structure relative to your vehicle, your vehicle may sway)
- When the vehicle is struck by a crosswind or the turbulence of other nearby vehicles
- Situations in which the sensors may not operate properly: →P.240
- Situations in which the lane may not be detected: →P.241
- When it is necessary to disable the system: →P.235

**Operation display of steering wheel operation support**

The operating state of the LTA system is indicated.

Indicator	Lane display	Steering icon	Situation
 White	 Grey/White	 Grey	LTA is on standby
 Green	 Green	 Green	LTA is operating
 Yellow Flashing	 Yellow Flashing	 Green	The vehicle is departing the lane toward the side which the lane display is flashing

## LCA (Lane Change Assist)\*

\*: If equipped

### LCA functions

This function is linked to the LTA and provides assistance in performing lane changes through steering wheel operations.

Use the this function only on highways and expressways.

The steering assist operation can be overridden by the steering wheel operation of the driver.

The lane change assist function is not designed to operate when changing lanes at a junction.

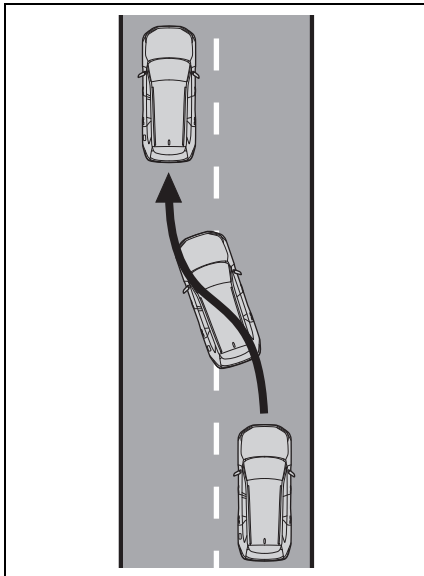

### ⚠ WARNING

#### ■ Before using the LCA system

- Do not overly rely on the LCA system.

The LCA system is not a system which provides automated assistance in driving and it is not a system which reduces the need for checking an adjacent lane for other vehicles, approaching vehicles, etc. when changing lanes. The driver is solely responsible for paying attention to their surroundings and operating the steering wheel as necessary to ensure safety.

Also, do not use the LCA to change lanes into which a lane change should not be performed (oncoming lanes, road shoulders, etc.).

- Failure to perform appropriate driving operations and pay careful attention may lead to an accident.

#### ■ Operating conditions of function

This function is operable when all of the following conditions are met:

- The LTA is operating.
- The lane change assist function is enabled by a customize setting.
- The vehicle speed is between approximately 55 and 85 mph (90 and 140 km/h).
- The system detects a broken white line on the side which the lane change is to be performed.
- A vehicle is not detected in the lane toward which the turn signal is operated.
- The steering wheel is not being turned with a large force.
- The hands off steering wheel warning (→P.259) is not operat-

ing.

#### ■ Cancellation of functions

In the following situations, operation of the LCA may be canceled with the display and buzzer:

- When the operating conditions (→P.262) are no longer met
- When the system can no longer detect lane lines
- When the turn signal lever is operated to the second position (→P.263)
- When the turn signal lever is operated in the opposite direction of the lane change
- When the system detects operation of the steering wheel, brake pedal or accelerator pedal by the driver.

If the system detects that a vehicle is quickly approaching in the lane toward which the turn signal is operated a buzzer will sound and a message will be displayed to alert the driver. At the same time the steering wheel may be slightly operated to help keep the vehicle away from the approaching vehicle.

#### ■ Hands off steering wheel warning operation

When the system determines the driver is not holding the steering wheel, a message urging the driver to grip the steering wheel and the icon shown in the illustration will be displayed on the multi-information display to warn the driver. If the system detects that the steering wheel is held, the warning will be canceled. When using the system, make sure to grip the steering wheel firmly, regardless of whether the warning is operating or not.



#### ■ Situations in which the hands off steering wheel warning may not operate properly

- Depending on the condition of the vehicle, handle control condition and road surface, the warning function may not operate.
- In the following situations, the system may not be able to detect when the driver's hands are off the steering wheel.
  - When a steering wheel cover is installed
  - When the driver is wearing gloves
  - When foreign matter is attached to the steering wheel
  - When the driver is gripping the wood trim, seam of the leather, spokes, or other part of the steering wheel that does not have sensors
- In the following situations, the hands off steering wheel warning may not operate and the LCA function may continue operating even though the driver's hands are off the steering wheel:
  - When something other than a hand is contacting the steering wheel
  - When a wide object or arms are held across the steering wheel

#### Operating the LCA

If the turn signal lever is held in the first position, the lane change direction will be displayed and the function will operate.

## 264 4-5. Using the driving support systems

To change lanes by holding the turn signal lever in the first position without using the LCA, turn the customize setting of the LCA off.

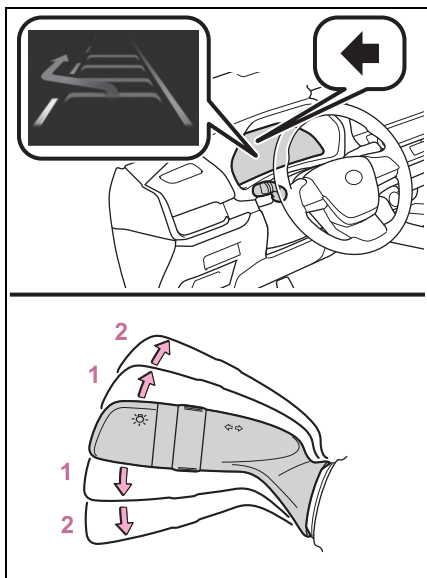

- 1 First position: LCA is operational
- 2 Second position: LCA is not operational

### **! WARNING**

#### ■ Situations in which the LCA should not be used





- When driving on a one lane road
- When there is no broken white line between the current lane and the lane to be changed to

### Enabling/disabling the system

LCA can be enabled/disabled through a customize setting. (→P.538)

## Displays and system operation

The operating state of the LCA system is indicated.

LCA display	Steering icon	Condition
 Blue arrow and white line	 Green	LCA is operating
	 Grey	Approaching vehicle detected while LCA is operating
Not displayed	 Grey	Lane line no longer detected while LCA is operating



## LDA (Lane Departure Alert)

### Basic functions

The LDA system warns the driver if the vehicle may deviate from the current lane or course\*, and also can slightly operate the steering wheel to help avoid deviation from the lane or course\*.

The front camera is used to detect lane lines or a course\*.

\*: Boundary between the asphalt and grass, soil, etc., or structures, such as a curb, guardrail, etc.

#### ■ Lane departure alert function

When the system determines that the vehicle might depart from its lane or course\*, a warning is displayed on a display, and either a warning buzzer will sound or the steering wheel will vibrate to alert the driver.

Check the area around your vehicle and carefully operate the steering wheel to move the vehicle back to the center of the lane or course\*.

If the system determines that the vehicle may collide with a vehicle in an adjacent lane, the lane departure alert will operate even if the turn signals are operating.

\*: Boundary between the asphalt and grass, soil, etc., or structures, such as a curb, guardrail, etc.

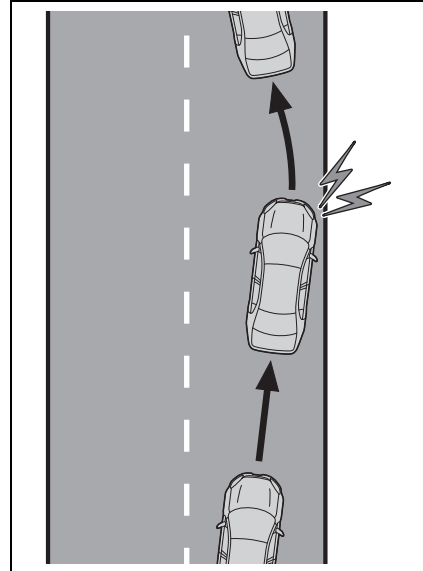

#### ■ Lane departure prevention function

If the system determines that the vehicle is likely to depart from its lane or course\*, it provides assistance through steering wheel operations to help avoid deviation from the lane or course\*.

If the system determines that the steering wheel has not been operated for a certain amount of time or the steering wheel is not being firmly gripped, a warning message may be displayed and a warning buzzer may sound to alert the driver.

If the system determines that the vehicle may collide with a vehicle in an adjacent lane, the lane departure prevention function will operate even if the turn signals are operating.

\*: Boundary between the asphalt

and grass, soil, etc., or structures, such as a curb, guardrail, etc.

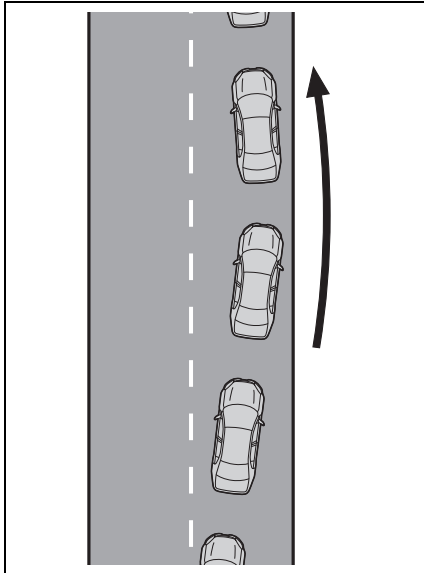

■ Break suggestion function

If the vehicle is swaying, a message will be displayed and a buzzer will sound to urge the driver to take a break.

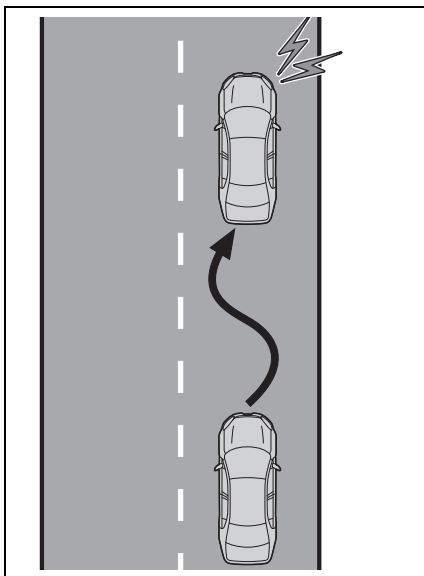

**⚠ WARNING**

■ Before using the LDA system

● Do not overly rely on the LDA system. The LDA system is not a system which provides automated assistance in driving. However, as it is not a system which reduces the amount of attention necessary for safe driving. The driver is solely responsible for paying attention to their surroundings and operating the steering wheel as necessary to ensure safety. Also, the driver is responsible for taking adequate breaks when fatigued, such as when driving for a long time.

● Failure to perform appropriate driving operations and pay careful attention may lead to an accident.

■ Operating conditions of each function

- Lane departure alert/prevention function

This function is operable when all of the following conditions are met:

- The vehicle speed is approximately 30 mph (50 km/h) or more.

Operation may be possible when the vehicle speed is approximately 25 mph (40 km/h) or more if vehicles, motorcycles, bicycles, or pedestrians are detected near the lane.

- The system recognizes a lane or course\*. (When recognized on only one side, the system will operate only for the recognized side.)
- The lane width is approximately 9.8 ft. (3 m) or more.
- The turn signal lever is not being operated.

(Except when a vehicle is detected

in the direction that the turn signal lever is operated.)

- The vehicle is not being driven around a sharp curve.
- The vehicle is not accelerating or decelerating more than a certain amount.
- The steering wheel is not being turned sufficiently to perform a lane change.
- When the VSC or TRAC system is not turned off.

\*: Boundary between the asphalt and grass, soil, etc., or structures, such as a curb, guardrail, etc.

■ **Temporary cancellation of functions**

When the operating conditions are no longer met, a function may be temporarily canceled. However, when the operation conditions are met again, operation of the function will automatically be restored. (→P.266)

■ **Operation of the lane departure alert function/lane departure prevention function**

- Depending on the vehicle speed, road conditions, lane departure angle, etc., operation of the lane departure prevention function may not be felt or the function may not operate.
- Depending on the conditions, the warning buzzer may operate even if vibration is selected through a customize setting.
- If a course\* is not clear or straight, the lane departure alert function or lane departure prevention function may not operate.
- The lane departure alert function or lane departure prevention function may not operate if the system judges that the vehicle is intentionally being steered to avoid a pedestrian or parked vehicle.
- It may not be possible for the system to judge if there is danger of a

collision with a vehicle in an adjacent lane.

- Vehicles with a driver monitor camera: Depending on the driver condition, the lane departure alert function or lane departure prevention function changes the timing of operation.
- The steering assist operation of the lane departure prevention function can be overridden by the steering wheel operation of the driver.

\*: Boundary between the asphalt and grass, soil, etc., or structures, such as a curb, guardrail, etc.

■ **Hands off steering wheel warning operation**

In the following situations, a message urging the driver to operate the steering wheel and an icon will be displayed and a buzzer will sound to warn the driver. When using the system, make sure to grip the steering wheel firmly, regardless of whether the warning is operating or not.

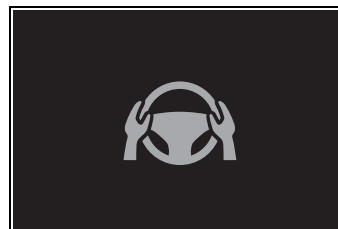

- When the system determines that the driver is not securely holding the steering wheel, or the steering wheel is not being operated when the steering assist operation of the lane departure prevention function is operating

Except for Puerto Rico: The length of time that the warning buzzer operates will become longer as the frequency of the steering assist operating increases. If the system judges that the steering wheel has been operated, the warning buzzer

will stop.

For Puerto Rico: The length of time that the warning buzzer operates will become longer as the frequency of the steering assist operating increases. Even if the system judges that the steering wheel has been operated, the warning buzzer will sound for a certain amount of time.

**■ Break suggestion function**

This function is operable when all of the following conditions are met:

- The vehicle speed is approximately 40 mph (65 km/h) or more.<sup>\*1</sup>
- The vehicle speed is approximately 32 mph (50 km/h) or more.<sup>\*2</sup>
- The lane width is approximately 9.8 ft. (3 m) or more.

Depending on the condition of the vehicle and road surface, the break suggestion function may not operate.

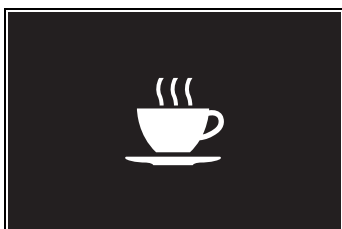

Press the  meter control switch to turn off the message.<sup>\*1</sup>

Unless  is pressed, the message of the break suggestion function will remain displayed.<sup>\*1</sup>

<sup>\*1</sup>: For Puerto Rico <sup>\*3</sup>

<sup>\*2</sup>: Except for Puerto Rico <sup>\*3</sup>

<sup>\*3</sup>: The countries and areas for each region listed in the table are cur-

rent as of June 2023. However, depending on when the vehicle was sold, the countries and areas of each region may be different. Contact your Toyota dealer for details.

**Changing LDA settings**

- The LDA system can be enabled/disabled through a customize setting. (→P.538)
- The settings of the LDA can be changed on the customize settings. (→P.538)

**⚠ WARNING**

**■ Situations in which the system may not operate properly**

In the following situations, the system may not operate properly and the vehicle may depart from its lane. Do not overly rely on these functions. The driver is solely responsible for paying attention to their surroundings and operating the steering wheel as necessary to ensure safety.













- When the boundary between the asphalt and grass, soil, etc., or structures, such as a curb, guardrail, etc. is not clear or straight
- When the vehicle is struck by a crosswind or the turbulence of other nearby vehicles
- Situations in which the lane may not be detected: →P.241
- Situations in which the sensors may not operate properly: →P.240
- Situations in which some or all of the functions of the system cannot operate: →P.241

**⚠ WARNING**  
 ● When it is necessary to disable the system: →P.235











**Displays and system operation**

The operating state of the lane departure alert function and steering assist operation of the lane departure prevention function are indicated.

► Except for Puerto Rico

Indicator	Lane display	Steering icon	Situation
Not illuminated	Not illuminated	Not illuminated	System disabled
 White	 Grey	Not illuminated	Lane lines are not detected by the system
 White	 White	Not illuminated	Lane lines are detected by the system
 Yellow Flashing	 Yellow Flashing	Not illuminated	Lane departure alert function is operating for the side which the lane display is flashing
 Green	 Green	 Green	Lane departure prevention function is operating for the side which the lane display is illuminated
 Yellow Flashing	 Yellow Flashing	 Green	Lane departure alert function/lane departure prevention function is operating for the side which the lane display is flashing

► For Puerto Rico

Indicator	Lane display	Steering icon	Situation
 Yellow Illuminated	Not illuminated	Not illuminated	System disabled
Not illuminated	 Grey	Not illuminated	Lane lines are not detected by the system
Not illuminated	 White	Not illuminated	Lane lines are detected by the system
 Yellow Flashing	 Yellow Flashing	Not illuminated	Lane departure alert function is operating for the side which the lane display is flashing
 Green	 Green	 Green	Lane departure prevention function is operating for the side which the lane display is illuminated
 Yellow Flashing	 Yellow Flashing	 Green	Lane departure alert function/lane departure prevention function is operating for the side which the lane display is flashing

**PDA (Proactive driving assist)**

**When a detectable object (→P.272) is detected, the proactive driving assist operates the brakes and steering wheel to help prevent the vehicle from approaching too close to the object.**

 **WARNING**

■ **For safe use**

Driving safely is solely the responsibility of the driver.

- The proactive driving assist is designed to provide some assistance for regular braking and steering operations, as well as helping to prevent the vehicle from approaching too close to a detectable object. However, the scope of this assistance is limited.

The driver should perform brake and steering operations as necessary. Read the following items carefully. Do not overly rely on the proactive driving assist and always drive carefully. (→P.274)

- The proactive driving assist is not a system which reduces the amount of attention necessary for safe driving. Even if the system is operating correctly, the surrounding conditions as recognized by the driver and detected by the system may differ. It is necessary for the driver to pay attention, assess risks, and ensure safety. Over-reliance on this system to drive the vehicle safely may lead to an accident resulting in death or serious injury.

- Proactive driving assist is not a system which allows for inattentive driving and is not a system which assists in poor visibility conditions. The driver is solely responsible for paying attention to their surroundings and driving safely.

■ **When turning proactive driving assist off**

- Situations in which the sensors may not operate properly: →P.240
- When it is necessary to disable the system: →P.235

### System operating conditions and detectable objects

According to the driving conditions, the operation and detectable objects of the proactive driving assist will change as follows.

Function	Conditions	Operation	Detectable objects
Obstacle Anticipation Assist (OAA)	A detectable object is detected crossing the road	Assistance with some brake operations is provided in order to reduce the possibility of a collision.	<ul style="list-style-type: none"> <li>• Pedestrians</li> <li>• Bicyclists</li> </ul>
	A detectable object is detected on the side of the road	<p>Assistance with some brake and steering wheel operations are provided according to the surrounding conditions to help prevent the vehicle from approaching too close to a detected object.</p> <p>Assistance with steering wheel operations is provided within a range that the vehicle will not deviate from its current lane.</p>	<ul style="list-style-type: none"> <li>• Pedestrians</li> <li>• Bicyclists</li> <li>• Parked vehicles</li> </ul>



Function	Conditions	Operation	Detectable objects
Deceleration Assist (DA)	A preceding vehicle or an adjacent vehicle cutting in front of the vehicle is detected	The vehicle is gently decelerated so that the vehicle-to-vehicle distance will not be excessively short.	<ul style="list-style-type: none"> <li>• Preceding vehicles</li> <li>• Motorcycles</li> </ul>
	A curve is detected ahead of the vehicle	The vehicle is gently decelerated if the vehicle speed is determined to be too high for the curve ahead.	None
Steering Assist (SA)	Lane is detected	The system anticipates the driver's operation and supports the operation of the steering wheel.	None

■ **Vehicle speeds at which the system can operate**

- Detectable object crossing the road assistance  
Approximately 20 to 35 mph (30 to 60 km/h)
- Detectable object on the side of the road assistance  
Approximately 20 to 35 mph (30 to 60 km/h)
- Preceding vehicle deceleration assistance  
Approximately 15 mph (20 km/h) or more
- Curve deceleration assistance  
Approximately 15 mph (20 km/h) or more
- Steering assist within a lane  
Approximately 5 to 80 mph (10 to 140 km/h)

■ **System operation will be canceled when**

- In the following situations, system operation will be canceled:
  - When the dynamic radar cruise control or cruise control is operating
  - When the PCS is off
  - Situations in which some or all of the functions of the system cannot operate: →P.241
  - When the P, R or N shift position is selected
- In the following situations, the brake operation assist will be canceled:
  - Approximately 9 mph (15 km/h) or less
  - When a certain vehicle speed has been reached, as judged by the system, according to the surrounding conditions
- In the following situations, system operation may be canceled:
  - When the brake control or output restriction control of a driving support system operates

(For example: PCS, drive-start control)

- When the system determines that a detected object has moved away from the vehicle
- When lane lines can no longer be detected
- When the brake pedal has been depressed
- When the accelerator pedal has been depressed
- When the steering wheel has been operated with more than a certain amount of force
- When the turn signal lever is operated to the left/right turn position



**WARNING**

■ **Situations in which the system may not operate properly**

- Situations in which the lane may not be detected: →P.241
- When a detectable object stops immediately before entering the path of the vehicle
- When passing extremely close to a detectable object behind a guardrail, fence, etc.
- When changing lanes while overtaking a detectable object
- When passing a detectable object that is changing lanes or turning left/right
- When there are objects (guardrails, power poles, trees, walls, fences, poles, traffic cones, mailboxes, etc.) in the surrounding area
- When there are patterns or a painting ahead of the vehicle that may be mistaken for a detectable object
- When passing through a place with a low structure above the road (tunnel with a low ceiling, traffic sign, signboard, etc.)

- When driving on snowy, icy, or rutted roads
- When a detectable object is approaching your vehicle
- When your vehicle or a detectable object is wandering
- When the movement of a detectable object changes (change in direction, sudden acceleration or deceleration, etc.)
- When suddenly approaching a detectable object
- When a preceding vehicle or motorcycle is not directly in front of your vehicle
- When there is a structure above a detectable object
- When part of a detectable object is hidden by another object (large luggage, umbrella, guardrail, etc.)
- When multiple detectable objects are overlapping
- When a bright light, such as the sun or headlights of another vehicle, is reflecting off of the detectable object
- When the detectable object is white and looks extremely bright
- When the color or brightness of the detectable object causes it to blend in with its surroundings
- When a detectable object cuts in front of or emerges from beside a vehicle
- When approaching a vehicle ahead which is perpendicular or at an angle to the vehicle, or is facing the vehicle
- If a parked vehicle is perpendicular or at an angle to the vehicle

**⚠ WARNING**

- When a bicycle is a child sized bicycle, is carrying a large load, is carrying an extra passenger, or has an unusual shape (bicycles equipped with a child seat, tandem bicycles, etc.)
- When a pedestrian or bicyclist is shorter than approximately 3.2 ft. (1 m) or taller than approximately 6.5 ft. (2 m)
- When the silhouette of a pedestrian or bicyclist is unclear (such as when they are wearing a raincoat, long skirt, etc.)
- When a pedestrian or bicyclist is bending forward or squatting
- When a pedestrian or bicyclist is moving at high speed
- When a pedestrian is pushing a stroller, wheelchair, bicycle or other vehicle
- When a detectable object blends in with the surrounding area, such as when it is dim (at dawn or dusk) or dark (at night, in a tunnel, etc.)
- When the lane width is 13.1 ft. (4 m) or more
- When the lane width is 8.2 ft. (2.5 m) or less

- When the vehicle has not been driven for a certain amount of time after the engine was started
- While turning left or right or a few seconds after turning left or right
- While changing lanes or a few seconds after changing lanes
- When entering a curve, driving around a curve and a few seconds after driving around a curve







**Changing proactive driving assist settings**

- The proactive driving assist can be enabled/disabled through a customize setting. (→P.538)
- The following settings of the proactive driving assist can be changed through customize settings. (→P.538)

**System operation display**

Depending on the situation, the following indicators or icons will be displayed.

Some icons cannot be displayed unless the display is changed to the driving safety support function information screen.

Icon	Meaning
	<ul style="list-style-type: none"> <li>• White: Monitoring for detectable objects</li> <li>• Green: Detectable object crossing the road or detectable object on the side of the road assistance operating</li> </ul>
	<p>A pedestrian has been detected as crossing the road or on the side of the road and brake or steering assistance is operating</p>
	<p>A vehicle has been detected on the side of the road and brake or steering operation assistance is being performed</p>
	<ul style="list-style-type: none"> <li>• Steering operation assistance is being performed to prevent the vehicle from approaching too close to a detectable object on the side of the road</li> <li>• When the steering assist is operating</li> </ul>
	<p>Preceding vehicle deceleration assistance is being performed</p>
	<p>Warning to maintain appropriate vehicle-to-vehicle distance</p>
	<p>Curve deceleration assistance is being performed</p>

■ **Hands off steering wheel warning operation**

In the following situations, a message urging the driver to grip the steering wheel and the icon shown in the illustration will be displayed on the display to warn the driver. If the system detects that the steering wheel is held, the warning will be canceled. When using the system, make sure to grip the steering wheel firmly, regardless of whether the warning is operating or not.

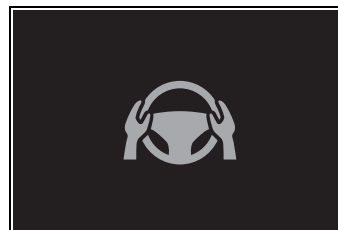

- When assistance to a detectable object crossing the road or assistance to a detectable object on the side of the road is performed and the system determines the driver is not holding the steering wheel

If no operations are detected for a certain amount of time, a buzzer will sound, the warning will operate.

This warning may also operate if the driver only operates steering wheel a small amount continuously.

**■ Warning operation after preceding vehicle deceleration assistance has ended**

After preceding vehicle deceleration assistance has ended, if the driver does not operate the brake pedal or accelerator pedal and the vehicle approaches the preceding vehicle, the display will flash and a buzzer will sound to urge the driver to decelerate. If the system determines that the driver is operating the brake pedal or accelerator pedal, the warning will be canceled.



**FCTA (Front Cross Traffic Alert)\***

\*: If equipped

**When approaching an intersection, etc., at a low speed, vehicles approaching from the left and right of the front of the vehicle can be detected and the driver informed of these vehicles.**

**FCTA system control**

- When the system detects a vehicle approaching from the left or right in front of your vehicle when approaching an intersection, a notification will be displayed.
- Head-up display

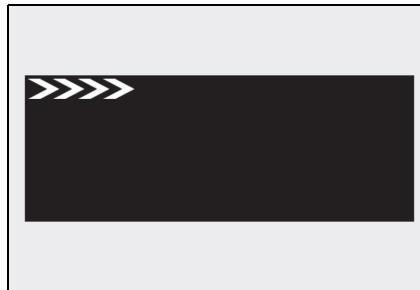

- When the system determines that your vehicle may be about to enter an intersection even though a vehicle is approaching from the left or right in front of your vehicle, a buzzer will sound and a message will be displayed to urge you to depress the brake pedal.

- Multi-information display



**⚠ WARNING**

**■ For safe use**

Driving safely is solely the responsibility of the driver. Pay careful attention to the surrounding conditions in order to ensure safe driving.

The FCTA system is a supplementary system that informs the driver of vehicles approaching from the left and right of the front of the vehicle.

Over-reliance on this system may lead to an accident resulting in death or serious injury.

The details of the warning display may differ from the actual traffic conditions.

Although the warning display will stop being displayed after a certain amount of time, this does not necessarily indicate that there are no longer any vehicles or pedestrians around your vehicle.

**■ FCTA system operating conditions**

The system will operate when all of the following conditions are met:

- A shift position other than P or R is selected
- The vehicle speed is approximately 10 mph (15 km/h) or less
- A vehicle is approaching from the left or right in front of your vehicle

at a speed between approximately 7 to 37 mph (10 to 60 km/h)

- There are no vehicles in front of your vehicle
- The accelerator pedal is not being strongly depressed
- The brake pedal is not being strongly depressed

**■ Situations in which the system may operate even though no vehicles are approaching**

In certain situations, such as the following, the system may operate even though no vehicles are approaching:

- When approaching objects on the roadside, such as guardrails, traffic signs, utility poles, street lights, trees, tall grass, walls, etc.
- When passing an object on the side of the road, such as a parked vehicle
- When a vehicle or pedestrian is approaching from the left or right in front of your vehicle in the distance
- When a vehicle or pedestrian is moving within a parking spot, etc., next to the lane your vehicle is in
- When a pedestrian or bicyclist is approaching on a sidewalk
- When a vehicle or pedestrian is moving away from your vehicle
- When an approaching vehicle is decelerating or stops
- When an approaching vehicle makes a left/right turn immediately in front of your vehicle
- When a pedestrian is approaching your vehicle
- When an oncoming vehicle makes a right/left turn
- When your vehicle enters an intersection before a vehicle approaching from the left or right in front of your vehicle
- When stopped at traffic light and a

- vehicle approaches from the left or right in front of your vehicle
- When making a left/right turn in front of an approaching vehicle

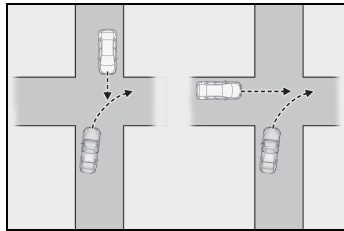

- When an oncoming vehicle approaches and passes
- When being overtaken by another vehicle
- When driving next to another vehicle or a pedestrian
- When a vehicle or pedestrian approaches the side of your vehicle

■ **Situations in which the system may not operate properly**

In situations such as the following, a vehicle may not be detected by a front side radar sensor and the system may not operate properly:

- If an approaching vehicle moves suddenly (sudden steering, acceleration, deceleration, etc.)

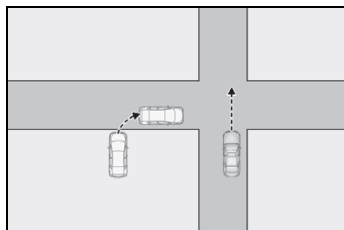

- If a vehicle is approaching from the left or right of the front of your vehicle diagonally
- When a vehicle is approaching from the left or right in front of your vehicle in the distance
- When there is an object between your vehicle and an approaching vehicle

- When several vehicles are approaching with little space between them
- Situations in which the sensors may not operate properly: →P.240
- Situations in which some or all of the functions of the system cannot operate: →P.241

**Changing FCTA settings**

- The FCTA can be enabled/disabled through a customize setting. (→P.538)
- The following settings of the FCTA can be changed through customize settings. (→P.538)

## RSA (Road Sign Assist)\*

\*: If equipped

**The RSA system detects specific road signs using the front camera and/or navigation system (when speed limit information is available) and warns the driver via displays and buzzers.**

### WARNING

#### ■ For safe use

- Driving safely is solely the responsibility of the driver. Pay careful attention to the surrounding conditions in order to ensure safe driving.
- Do not rely solely upon the RSA. The RSA assists the driver by providing road sign information, but it is not a replacement for the driver's own vision and awareness. Driving safely is solely the responsibility of the driver. Pay careful attention to the surrounding conditions in order to ensure safe driving.

#### ■ Situations in which the RSA should not be used

- When it is necessary to disable the system: →P.235

#### ■ Situations in which the system may not operate properly

- Situations in which the sensors may not operate properly: →P.240

## Display Function

- When the front camera

detects a sign or information of a sign is available from the navigation system, the sign will be displayed on the display.

- Multiple signs can be displayed.

Depending on the specifications of the vehicle, the number of displayed signs may be limited.

### ■ Operating conditions of sign display

Signs will be displayed when the following conditions are met:

- The system has detected a sign

In the following situations, a displayed sign may stop being displayed:

- When a new sign has not been detected for a certain distance
- When the system determines that the road being driven on has changed, such as after a left or right turn

### ■ Situations in which the display function may not operate properly

In the following situations, the RSA system may not operate properly and may not detect signs or may display the incorrect sign. However, this does not indicate a malfunction.

- When a sign is dirty, faded, tilted or bent
- When the contrast of an electronic sign is low
- When all or part of a sign is hidden by a tree, utility pole, etc.
- When a sign is detected by the front camera for a short amount of time
- When the driving state (turning, changing lanes, etc.) is judged incorrectly



- When a sign is immediately after a freeway junction or in an adjacent lane just before merging
- When stickers are attached to the rear of a preceding vehicle
- When a sign similar to a system compatible sign is detected as a system compatible sign
- When a speed limit sign for a frontage road is within detection range of the front camera
- When driving around a round-about
- When a sign intended for trucks, etc. is detected
- When the navigation system map data is out of date
- When the navigation system cannot be used

In this case, the speed limit signs displayed on the multi-information display and navigation system display may differ.

### Notification function

In the following situations, the RSA system will output a warning to notify the driver.

- If the vehicle speed exceeds the speed warning threshold of the speed limit sign displayed on the display, the sign display will be emphasized and a buzzer will sound.
- When the RSA system detects a do not enter sign and determines that the vehicle has entered a no-entry area, the do not enter sign displayed on the display will flash and a buzzer will sound.

### Operating conditions of the notification functions

- Excess speed notification function

This function will operate when the following condition is met:

- A speed limit road sign is recognized by the system.

- No entry notification function





This function will operate when all of the following conditions are met:



- More than one no entry road signs are recognized by the system simultaneously.
- The vehicle is passing between no entry road signs recognized by the system.

### Types of road signs supported

- The following types of road signs can be displayed.

However, non-standard or recently introduced traffic signs may not be displayed.

	Speed limit
	
	Do Not Enter
	No U-turn
	No Turn On Red

	Stop
	Yield
	Warning

- Depending on the specifications of the vehicle, signs may be displayed overlapping.

### Changing RSA settings

The following settings of the RSA can be changed through customize settings. (→P.538)

### Dynamic radar cruise control

This dynamic radar cruise control detects the presence of vehicles ahead, determines the current vehicle-to-vehicle distance, and operates to maintain a suitable distance from the vehicle ahead. The desired vehicle-to-vehicle distance can be set by operating the vehicle-to-vehicle distance switch.

Use the dynamic radar cruise control only on highways and expressways.

#### WARNING

##### ■ For safe use

- Driving safely is solely the responsibility of the driver. Do not overly rely on this system, and pay careful attention to the surrounding conditions in order to ensure safe driving.
- The dynamic radar cruise control provides driving assistance to reduce the driver's burden. However, there are limitations to the assistance provided.

Read the following items carefully. Do not overly rely on this system and always drive carefully.

- Conditions under which the system may not operate correctly:  
→P.288

**⚠ WARNING**

- Set the speed appropriately according to the speed limit, traffic flow, road conditions, weather conditions, etc. The driver is responsible for confirming the set speed.

- Even if the system is operating correctly, the condition of a preceding vehicle as recognized by the driver and detected by the system may differ. Therefore, it is necessary for the driver to pay attention, assess risks, and ensure safety. Over-reliance on this system to drive the vehicle safely may lead to an accident resulting in death or serious injury.

**■ Precautions for the driving assist systems**

Observe the following precautions, as there are limitations to the assistance provided by the system. Over-reliance on this system may lead to an accident resulting in death or serious injury.

- Details of support provided for the driver's vision

The dynamic radar cruise control is only intended to help the driver in determining the distance between the driver's own vehicle and a designated preceding vehicle. It is not a system which allows for careless or inattentive driving, and is not a system which assists in poor visibility conditions.

The driver must pay attention to their surroundings, even when the vehicle stops.

- Details of support provided for the driver's judgement

The dynamic radar cruise control determines whether the distance between the driver's own vehicle and a designated preceding vehicle is within a set range. It is not capable of making any other type of judgement. Therefore, it is absolutely necessary for the driver to remain vigilant and to determine whether or not there is a possibility of danger.

- Details of support provided for the driver's operation

The dynamic radar cruise control does not include functions which will prevent or avoid collisions with vehicles ahead of your vehicle. Therefore, if there is ever any possibility of danger, the driver must take immediate and direct control of the vehicle and act appropriately in order to ensure safety.

**■ Situations in which the dynamic radar cruise control should not be used**

Do not use the dynamic radar cruise control in the following situations. As the system will not be able to provide appropriate control, using it may lead to an accident resulting in death or serious injury.

- Roads where there are pedestrians, cyclists, etc.

- When driving on a highway or expressway entrance or exit

- When the approach warning sounds frequently

- Situations in which the sensors may not operate properly:  
→P.240

- Situations in which the lane may not be detected: →P.241

### Basic functions

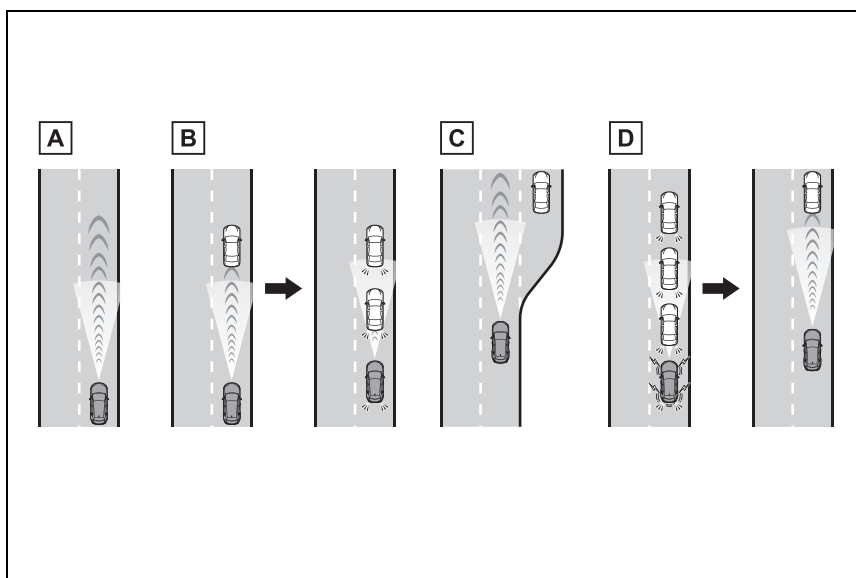

#### **A** Constant speed cruising:

When there are no vehicles ahead

The vehicle drives at the speed set by the driver.

If the set vehicle speed is exceeded while driving down a hill, the set vehicle speed display will blink and a buzzer will sound.

#### **B** Deceleration and follow-up cruising:

When a preceding vehicle driving slower than the set vehicle speed is detected

When a vehicle is detected driving ahead of your vehicle, the vehicle automatically decelerates and if a greater reduction in vehicle speed is necessary, the brakes are applied (the stop lights will come on at this time). The vehicle is controlled to maintain the vehicle-to-vehicle distance set by the driver, in accordance with changes in the speed of the preceding vehicle. If vehicle deceleration is not sufficient and the vehicle approaches the vehicle ahead, the approach warning will sound.

#### **C** Acceleration:

When there are no longer any preceding vehicles driving slower than the set vehicle speed

The vehicle accelerates until the set vehicle speed is reached and then resumes constant speed cruising.

#### **D** Starting off:

If a preceding vehicle stops, the vehicle will also stop (controlled stop). After the preceding vehicle starts off, pressing the “RES” switch or depressing the accelerator pedal will resume follow-up cruising (start off operation). If a start off operation is not performed, the controlled stop will continue.

Vehicles with Traffic Jam Assist: While driving on a highway or expressway, if a preceding vehicle stops, your vehicle will stop accordingly. On some highways and expressways, if the system determines that the preceding vehicle starts off within approximately 3 minutes of stopping, a buzzer will sound and a message will be displayed on the multi-information display to notify the driver, and your vehicle will start off accordingly following the preceding vehicle. (Extended resume time)

**System components**

■ Meter display

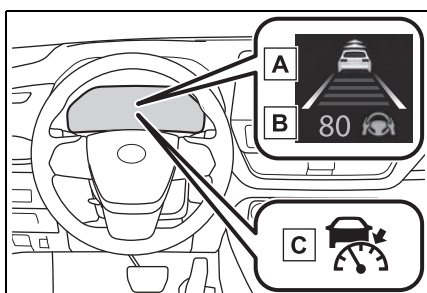

- A Multi-information display
- B Set vehicle speed
- C Indicators

■ Switches

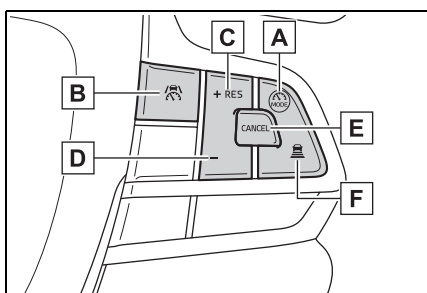

- A Driving assist mode select switch
- B Driving assist switch

- C “+” switch/“RES” switch
- D “-” switch
- E Cancel switch
- F Vehicle-to-vehicle distance switch

**Using the dynamic radar cruise control**

**Setting the vehicle speed**

- 1 Press the driving assist mode select switch to select dynamic radar cruise control.

The dynamic radar cruise control indicator will illuminate.

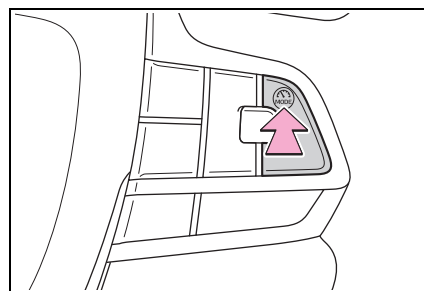

- 2 Using the accelerator pedal, accelerate or decelerate to the desired vehicle speed

(approximately 20 mph [30 km/h] or more), and press the driving assist switch to set the set vehicle speed.

The set vehicle speed will be displayed on the multi-information display.

The vehicle speed at the moment the switch is released will be the set vehicle speed.

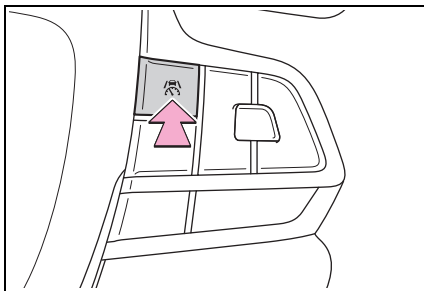

**Adjusting the set vehicle speed**

- Adjusting the set vehicle speed using the switches

To change the set vehicle speed, press the “+” switch or “-” switch until the desired speed is displayed.

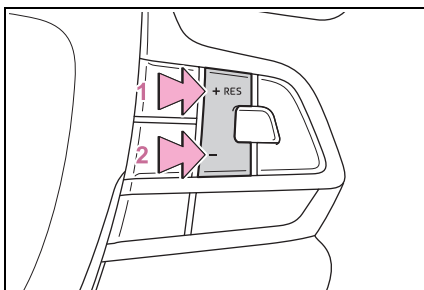

- 1 Increase set vehicle speed
- 2 Decrease set vehicle speed

Short press adjustment: Press the switch

Long press adjustment: Press and hold the switch until the desired set vehicle speed is reached.

The set vehicle speed will increase or decrease as follows:

Short press adjustment: Increases or decreases by 1 mph (1.6 km/h) each time the switch is pressed

Long press adjustment: Increases or decreases in 1 mph (1.6 km/h) increments continuously while the switch is pressed and held

- Increasing the set vehicle speed using the accelerator pedal
- 1 Depress the accelerator pedal to accelerate the vehicle to the desired vehicle speed.
  - 2 Press the “+” switch.

**Canceling/resuming control**

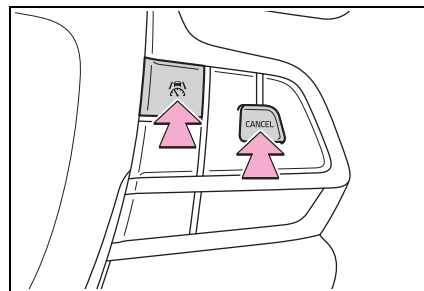

- 1 Press the cancel switch or driving assist switch to cancel control.

Control will also be canceled if the brake pedal is depressed.

(If the vehicle has been stopped by system control, depressing the brake pedal will not cancel control.)

- 2 Press the “RES” switch to resume control.

**Changing the vehicle-to-vehicle distance**

Each time the switch is pressed, the vehicle-to-vehicle distance setting will change as follows:

If a preceding vehicle is detected, the preceding vehicle mark will be displayed.

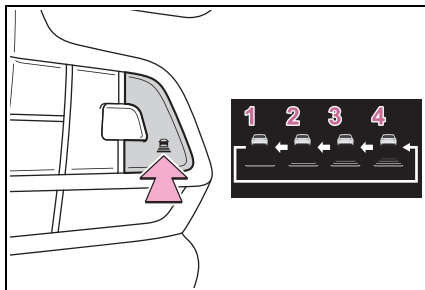

Illustration Number	Vehicle-to-vehicle distance	Approximate Distance (Vehicle Speed: 60 mph [100 km/h])
1	Short	Approximately 85 ft. (25 m)
2	Medium	Approximately 100 ft. (30 m)
3	Long	Approximately 145 ft. (45 m)
4	Extra long	Approximately 200 ft. (60 m)

The actual vehicle-to-vehicle distance varies in accordance with the vehicle speed. Also, when the vehicle is stopped by system control, it will be stopped at a certain distance from the preceding vehicle,

depending on the situation, regardless of the setting.

**Operating conditions**

- The desired set speed can be set when the vehicle speed is approximately 20 mph (30 km/h) or more.
- If the vehicle speed is set while driving at below approximately 20 mph (30 km/h), the set vehicle speed will be approximately 20 mph (30 km/h).
- If the vehicle speed is set while driving at a speed that exceeds the system’s upper limit, the set vehicle speed will be the system’s upper limit.

**Accelerating after setting the vehicle speed**

As with normal driving, acceleration can be performed by depressing the accelerator pedal. After accelerating, the vehicle will return to the set vehicle speed. However, while in vehicle-to-vehicle distance control mode, the vehicle speed may decrease to below the set vehicle speed in order to maintain the distance from the preceding vehicle.

**When the vehicle is stopped by system control during follow-up cruising**

- When the “RES” switch is pressed while the vehicle is stopped by system control, if the preceding vehicle starts off within approximately 3 seconds, follow-up cruising will resume.
- If the preceding vehicle starts off within approximately 3 seconds of the vehicle being stopped by system control, follow-up cruising will resume.

**Automatic cancellation of vehicle-to-vehicle distance control mode**

In the following situations, vehicle-to-vehicle distance control mode will be canceled automatically:

- When the brake control or output restriction control of a driving support system operates (For example: Pre-Collision System, drive-start control)
- When the parking brake has been operated
- When the vehicle is stopped by system control on a steep incline
- When any of the following are detected while the vehicle is stopped by system control:
  - The driver's seat belt is unfastened
  - The driver's door is opened
  - Approximately 3 minutes have elapsed since the vehicle was stopped

The parking brake may be activated automatically.

- Situations in which some or all of the functions of the system cannot operate: →P.241

#### ■ Dynamic radar cruise control system warning messages and buzzers

For safe use: →P.235

#### ■ Preceding vehicles that the sensor may not detect correctly

In the following situations, depending on the conditions, if the system cannot provide sufficient deceleration or acceleration is necessary, operate the brake pedal or accelerator pedal.

As the sensor may not be able to correctly detect these types of vehicles, the approach warning (→P.288) may not operate.

- When a vehicle cuts in front of your vehicle or changes lanes away from your vehicle extremely slowly or quickly
- When changing lanes
- When a preceding vehicle is driving at a low speed
- When a vehicle is stopped in the same lane as the vehicle

- When a motorcycle is traveling in the same lane as the vehicle

#### ■ Conditions under which the system may not operate correctly

In the following situations, operate the brake pedal (or accelerator pedal, depending on the situation) as necessary.

As the sensor may not be able to correctly detect a vehicle, the system may not operate properly.

- When a preceding vehicle brakes suddenly
- When changing lanes at low speeds, such as in a traffic jam

#### ■ Conditions for extended resume time (vehicles with Traffic Jam Assist)

Extended resume time is activated when all of the following conditions are satisfied:

- The vehicle is driving on a vehicle-only road, such as an expressway.
- There is a preceding vehicle and the system is able to detect it.
- No vehicle interruptions occur.
- The preceding vehicle has not been replaced.
- Clearance sonar and FCTA are not detecting the object in front of you.
- The driver monitor judges that the driver is looking forward.
- The steering wheel has not been operated.
- The brake pedal has not been operated.

### Approach warning

In situations where the vehicle approaches a preceding vehicle and the system cannot provide sufficient deceleration, such as



if a vehicle cuts in front of the vehicle, a warning display will flash and a buzzer will sound to alert the driver. Depress the brake pedal to ensure appropriate vehicle-to-vehicle distance.

#### ■ Warnings may not occur when

In the following situations, the warning may not operate even though the vehicle-to-vehicle distance is short.

- When the preceding vehicle is traveling at the same speed or faster than your vehicle
- When the preceding vehicle is traveling at an extremely low speed
- Immediately after the vehicle speed has been set
- When the accelerator pedal is depressed

#### Curve speed reduction function

When a curve is detected, the vehicle speed will begin being reduced. When the curve ends, the vehicle speed reduction will end.

Depending on the situation, the vehicle speed will then return to the set vehicle speed.

In situations where vehicle-to-vehicle distance control needs to operate, such as when a preceding vehicle cuts in front of your vehicle, the curve speed reduction function

will be canceled.



#### ■ Situations in which the curve speed reduction function may not operate

In situations such as the following, the curve speed reduction function may not operate:

- When the vehicle is being driven around a gentle curve
- When the accelerator pedal is being depressed
- When the vehicle is being driven around an extremely short curve

#### Driver Monitor support function (if equipped)

While a warning of the driver monitor is being displayed, the vehicle acceleration will be restrained.

When the warning of the driver monitor disappears, the restrained acceleration control will end.

#### Support for lane change

If your vehicle is being driven at approximately 50 mph (80 km/h) or more and a lane change to the passing lane is performed,

when the turn signal lever is operated and the lane is changed, the vehicle will accelerate up to the set speed to assist in overtaking.

The system's recognition of which lane is the passing lane may be based solely on the location of the steering wheel in the vehicle (left-hand drive/right-hand drive). If the vehicle is driven in a location where the passing lane is on the opposite side of that where the vehicle was originally sold, the vehicle may accelerate when the turn signal lever is operated away from the passing lane. (e.g. The vehicle was manufactured for a right-hand traffic location, but is being driven in a left-hand traffic location. The vehicle may accelerate when the turn signal lever is operated to the right.)





If your vehicle is being driven at approximately 50 mph (80 km/h) or more and the lane is changed to that with a vehicle traveling slower than your vehicle, when the turn signal lever is operated the vehicle will gradually decelerate to assist in changing lanes.



#### **Changing Dynamic radar cruise control settings**

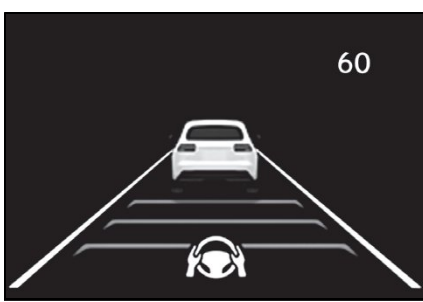

- The settings of Dynamic radar cruise control can be changed through customize settings. (→P.538)

**Display and system operation state**

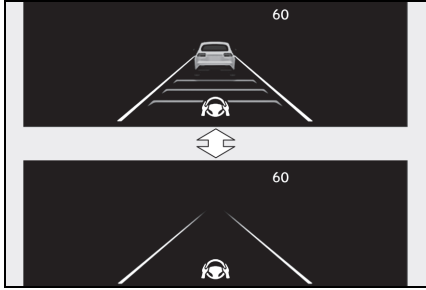
The operating state of Dynamic radar cruise control is indicated.

Indicator	Multi-information display		Situation
 White		Vehi- cle-to-vehi- cle distance setting: Grey	Dynamic radar cruise control being OFF
 Green		Vehi- cle-to-vehi- cle distance setting: Blue  Set vehicle speed: Green	Constant speed cruis- ing
 Green		Vehi- cle-to-vehi- cle distance setting: Blue  Set vehicle speed: Green  Preceding vehicle: White	Follow-up cruising

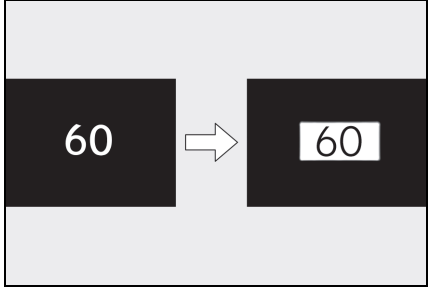
Indicator	Multi-information display		Situation
 Green		Vehicle-to-vehicle distance setting: Orange flashing Set vehicle speed: Green Preceding vehicle: Yellow flashing	Approach warning
 Green		Vehicle-to-vehicle distance setting: Grey Set vehicle speed: White Preceding vehicle: Grey	Accelerating with the accelerator pedal

Indicator	Multi-information display		Situation
 <p>Green</p>			<p>Set vehicle speed: Green in reverse display</p> <p>Set vehicle speed being exceeded</p>
 <p>Green</p>			<p>Vehicle-to-vehicle distance setting: Grey</p> <p>Set vehicle speed: White</p> <p>Preceding vehicle: Grey</p> <p>Vehicle in controlled stop</p>

### Cruise control

The vehicle can be driven at a set speed even if the accelerator pedal is not depressed.

Use the cruise control only on highways and expressways.

#### WARNING

##### ■ For safe use

- Driving safely is solely the responsibility of the driver. Therefore, do not overly rely on this system. The driver is solely responsible for paying attention to the vehicle's surroundings and driving safely.
- Set the speed appropriately according to the speed limit, traffic flow, road conditions, weather conditions, etc. The driver is responsible for confirming the set speed.

##### ■ Situations in which cruise control should not be used

Do not use the cruise control in the following situations. As the system will not be able to provide appropriate control, using it may lead to an accident resulting in death or serious injury.

- On roads with sharp bends
- On winding roads
- On slippery roads, such as those covered with rain, ice or snow

- On steep downhill, or where there are sudden changes between sharp up and down gradients

Vehicle speed may exceed the set speed when driving down a steep hill.

- When it is necessary to disable the system: →P.235

### System Components

#### ■ Meter display

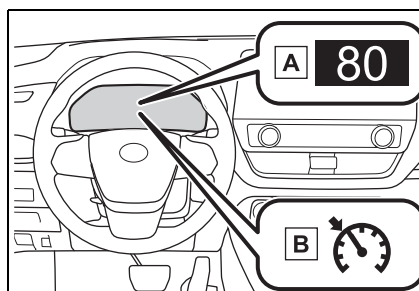

- A** Set vehicle speed
- B** Cruise control indicator

#### ■ Switches

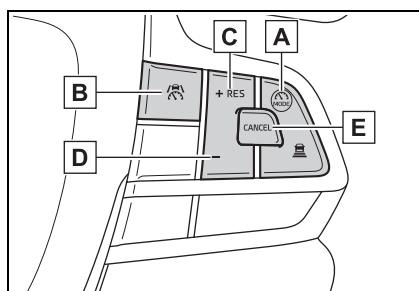

- A** Driving assist mode select switch
- B** Driving assist switch
- C** "+" switch/"RES" switch
- D** "-" switch

**E** Cancel switch

**Using the cruise control**

**Setting the vehicle speed**

- 1 Press the driving assist mode select switch to select cruise control.

The cruise control indicator will illuminate.

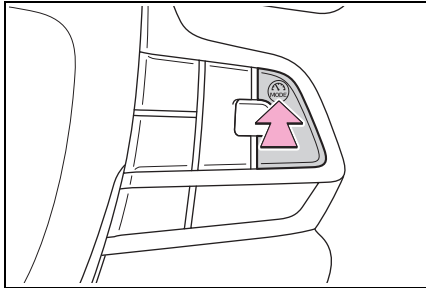

- 2 Using the accelerator pedal, accelerate to the desired vehicle speed (approximately 20 mph [30 km/h] or more), and press the driving assist switch to set the set vehicle speed.

The vehicle speed at the moment the switch is released will be the set vehicle speed.

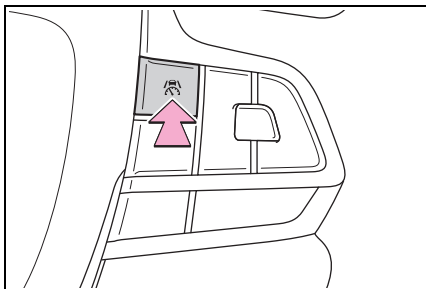

**Adjusting the set vehicle speed**

- Adjusting the set vehicle speed using the switches

To change the set vehicle speed, press the “+” switch or “-” switch until the desired speed is displayed.

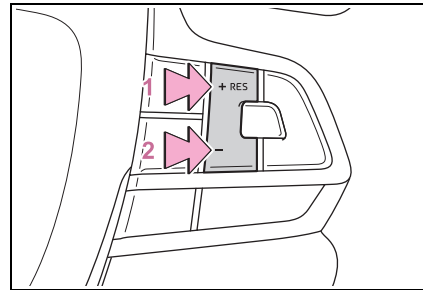

- 1 Increase set vehicle speed
- 2 Decrease set vehicle speed

The set vehicle speed will increase or decrease as follows:

Fine adjustment: By 1 km/h (0.6 mph) or 1 mph (1.6 km/h) each time the switch is pressed

Large adjustment: Increases continuously while the switch is pressed and held

- Increasing the set vehicle speed using the accelerator pedal

- 1 Depress the accelerator pedal to accelerate the vehicle to the desired vehicle speed.
- 2 Press the “+” switch.

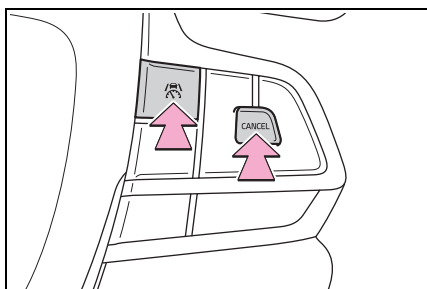
**Canceling/resuming control**

- 1 Press the cancel switch or driving assist switch to cancel control.

Control will also be canceled if the brake pedal is depressed.

- 2 Press the "RES" switch to resume control.

**Automatic cancellation of the cruise control**

In the following situations, the cruise control will be canceled automatically:

- When the vehicle speed drops approximately 10 mph (16 km/h) or more below the set vehicle speed
- When the vehicle speed drops below approximately 20 mph (30 km/h)
- When the brake control or output restriction control of a driving support system operates





(For example: PCS, drive-start control)

- When the parking brake has been operated
- Situations in which some or all of the functions of the system cannot operate: →P.241



**Display and system operation state**

The operating state of cruise control is indicated.

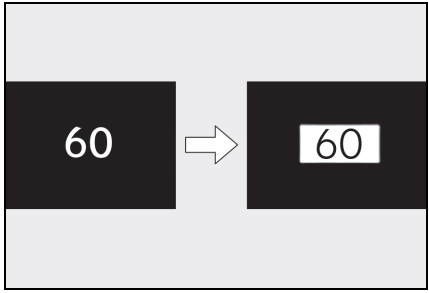
Indicator	Multi-information display		Situation
 White			Blank Cruise control being OFF
 Green			Set vehicle speed: Green Constant speed cruising
 Green			Set vehicle speed: Green in reverse display Set vehicle speed being exceeded

### Emergency Driving Stop System\*

\*: If equipped

**The emergency driving stop system is a system which automatically decelerates and stops the vehicle within its lane if the driver becomes unable to continue driving the vehicle, such as if they have suffered a medical emergency, etc.**

**During LTA (Lane Tracing Assist) control, if the system does not detect driving operations, such as if the driver is not holding the steering wheel, and determines the driver is not responsive, the vehicle will be decelerated and stopped within its current lane to help avoid a collision or reduce the impact of a collision.**

**The vehicle will also decelerate/stop during the Traffic Jam Assist (if equipped) controls, when no driver's response to the vehicle's warning to hold the steering wheel is detected.**

### WARNING

#### ■ For safe use

- Driving safely is solely the responsibility of the driver. Pay careful attention to the surrounding conditions in order to ensure safe driving. The emergency driving stop system is designed to provide support in an emergency where it is difficult for the driver to continue driving, such as if they have had a medical emergency. It is not designed to support driving while drowsy or in poor physical health, or inattentive driving.
- Although the emergency driving stop system is designed to decelerate the vehicle within its lane to help avoid or help reduce the impact of a collision if the system determines that it is difficult for the driver to continue driving, its effectiveness may change according to various conditions. Therefore, it may not always be able to achieve the same level of performance. Also, if the operating conditions are not met, this function will not operate.
- After the emergency driving stop system operates, if driving becomes possible again, immediately begin driving again or, if necessary, park the vehicle on the shoulder of the road and set a warning reflector and flare to warn other drivers of your stopped vehicle.
- After this system operates, passengers should attend to the driver as necessary and take appropriate hazard prevention measures, such as moving to a place where safety can be ensured, such as the shoulder of the road or behind a guardrail.

**⚠ WARNING**

- This system detects the condition of the driver through the operation of the steering wheel. This system may operate if the driver is aware but intentionally and continuously does not operate the vehicle. Also, the system may not operate if it cannot determine that the driver is not responsive, such as if they are leaning on the steering wheel.
- Situations in which the driver monitor may not operate properly (vehicles with a driver monitor): →P.241

**Summary of the system**

Operation of this system is separated into 4 control states. Through control state “Warning phase 1” and “Warning phase 2”, the system determines if the driver is aware and responsive while outputting a warning and controlling the vehicle speed. If the system determines the driver is not responsive, it will operate in control state “Deceleration stop phase” and “Stop hold phase” and decelerate and stop the vehicle. It will then operate continuously in “Stop hold phase”.

**■ Operating conditions**

This system operates when all of the following conditions are met:

- When the LTA is on
- Or during the Traffic Jam Assist controls (if equipped)
- When the vehicle speed is

approximately 30 mph (50 km/h) or more

During the Traffic Jam Assist (if equipped) controls, the system may operate at below 30 mph (50 km/h).

**■ Operation cancelation conditions**

In the following situations, system operation will be canceled:

- When LTA control has been canceled (the LTA switch has been pressed, etc.)
- When the dynamic radar cruise control has been canceled
- When driver operations are detected (the steering wheel is held, the brake pedal, accelerator pedal, parking brake, hazard light switch, or turn signal lever is operated)
- When the driving assist switch is pressed while in the stop and hold phase
- When the engine switch has been turned from ON to off
- Situations in which some or all of the functions of the system cannot operate: →P.241

**■ LTA control when operation is canceled**

When emergency driving stop system operation is canceled, LTA control may also be canceled.

**Warning phase 1**

If driving operations are not detected after the hands off steering wheel warning operates, a buzzer will sound intermittently and a message will be displayed to warn the driver, and the system will judge if the driver is responsive or not. If driving operations, such as holding the

steering wheel, are not performed within a certain amount of time, the system will enter warning phase 2.

Vehicles with a driver monitor camera: Depending on the type of detection of the driver's unresponsiveness, the system may skip warning phase 1 and start the control of warning phase 2.

### Warning phase 2

After entering warning phase 2, a buzzer will sound in short intervals and a message will be displayed to warn the driver, and the vehicle will slowly decelerate. If driving operations, such as holding the steering wheel, are not performed within a certain amount of time, the system will determine that the driver is not responsive and enter the deceleration stop phase.

The audio system will be muted until the driver becomes responsive.

When the vehicle is decelerating, the brake lights may illuminate, depending on the road conditions, etc.

### Deceleration stop phase

After entering the deceleration stop phase, a buzzer will sound continuously and a message will be displayed to warn the driver, and the vehicle will slowly decel-

erate and stop. After the vehicle stops, the system will enter the stop and hold phase.

### Stop hold phase

After the vehicle is stopped, the parking brake will be applied automatically. After entering the stop and hold phase, the buzzer will continue sounding continuously and the emergency flashers (hazard lights) will flash to warn other drivers of the emergency.

### Restricted functions after the operation is canceled

After shifting to the deceleration stop phase, the following functions will not be available until the engine is re-started even though the emergency driving stop system is canceled:

- LTA
- LCA (if equipped)
- Traffic Jam Assist (if equipped)

### Traffic Jam Assist\*

\*: If equipped

#### Function Outline

Traffic Jam Assist is a system which, through confirmation of the conditions by the driver, provides lane keeping, accelerating/decelerating, stopping, and starting off support on some highways and expressways. Also, in an emergency, the system can decelerate and stop, to help avoid a collision or help reduce the impact of a collision.

#### Sensors that support the Traffic Jam Assist

- Sensors which detect the surrounding conditions (→P.237)
- Sensors which detect the driver condition (→P.237)

#### Situations in which some or all of the functions of the system cannot operate

→P.241

#### Changes in brake operation sound and pedal response

→P.241

#### Situations in which the driver monitor may not operate properly

→P.241

### Emergency Driving Stop System

→P.298

### Extended resume time of Dynamic radar cruise control

→P.282

### Traffic Jam Assist Function

The Traffic Jam Assist function, through confirmation of the conditions by the driver, provides lane keeping, accelerating/decelerating and stopping support on some highways and expressways.

This function is operable when all of the operation conditions are met.

When this function is operating, it is possible to take your hands off of the steering wheel. (→P.304)

Before using the Traffic Jam Assist function, familiarize yourself with the content of the dynamic radar cruise control and the LTA (Lane Tracing Assist).

Make sure that the driver steers the vehicle when entering a service area/parking area or toll gate, or when changing lanes.

### Driver monitor camera recording

When the operation of Traffic Jam Assist is started, the following message will be displayed:

- “Allow Driver Monitor Camera Recording?”

When recording is approved, the system records images of the area around the driver in certain crash or near crash-like situations, such as an SRS airbag being deployed or the vehicle hitting an object on the road. (→P.10)

#### WARNING

##### ■ For safe use

- Driving safely is solely the responsibility of the driver. Do not overly rely on this system, and pay careful attention to the surrounding conditions in order to ensure safe driving.
- The Traffic Jam Assist function is not an automated driving system. This function provides the driver with information and driving assistance according to the road shape and conditions, traffic conditions, and the condition of the driver themselves. Always pay careful attention to the surrounding conditions as use of the system is the responsibility of the driver.
- Depending on the condition of the surrounding area, the road, or the driver, the Traffic Jam Assist function may not operate or operation may be suspended. Also, it may not always be able to achieve the same level of performance. Read the operating conditions of the function carefully. Do not overly rely on this function and always drive carefully.
- As the recognition performance and control performance of the Traffic Jam Assist function are limited, driver operation is necessary to ensure safety while the system is operating. Also, the steering assist of this system is designed to operate only for slow steering operations during a traffic jam. While this function is operating, the lane deviation control function of the LDA will not operate. If, for some reason, the vehicle is about to deviate the lane, it is the driver's responsibility to drive properly.
- Even if Traffic Jam Assist is operating properly, the surrounding conditions as recognized by the driver and detected by the system may differ. Therefore, it is necessary for the driver to pay attention, assess risks, and ensure safety. Over-reliance on this system to drive the vehicle safely may lead to an accident resulting in death or serious injury.
- While the Traffic Jam Assist function is operating, as driver operation may become necessary, the driver must ensure they have clear visibility of their surroundings.

**⚠ WARNING**

● In certain situations, a message urging the driver to hold the steering wheel may be displayed by the Traffic Jam Assist function. In this case, hold the steering wheel and drive the vehicle manually to ensure safety.

● The Traffic Jam Assist function cannot detect the following objects. Operate the steering wheel, accelerator pedal, or brake pedal as necessary to avoid a collision. As the function will not be able to provide appropriate control, using it may lead to an accident resulting in death or serious injury.

- Objects on the road surface
- Vehicles outside of a lane (such as on the shoulder of the road)
- Potholes, cracks, ruts, or other road damage
- Road construction zones
- Vehicles running in parallel with your vehicle or nearby walls
- Animals

■ **Situations in which Traffic Jam Assist Function should not be used**

Do not use Traffic Jam Assist Function in situations such as the following. As the system will not be able to provide appropriate control, using it may lead to an accident resulting in death or serious injury.

● When it is necessary to disable the system  
→P.235

● Situations in which the sensors may not operate properly  
→P.240

● Situations in which the lane may not be detected  
→P.241

■ **Situations in which the function may not operate properly**

In situations such as the following, the Traffic Jam Assist function may not operate properly. Manually operate the vehicle as necessary.

- When a sensor is splashed by water
- When the ambient temperature is high or low
- When a vehicle cuts in front of your vehicle
- When another lane merges into the lane in the same traveling direction as your vehicle
- When driving in low visibility condition
- When the vehicle posture is changing
- When the traction on the road surface differs greatly between the left and right side tires
- When driving on an expressway with no median strips or when driving on an expressway equipped with temporary median markers, such as poles.
- When there is a significant difference in speed between your vehicle and the other vehicle
- The map data has not been updated properly.

**⚠ WARNING**

- **To prevent malfunction of the radar sensors**  
→P.237
- **To prevent malfunction of the front camera**  
→P.238
- **Front camera installation area on the windshield**  
→P.239

■ **Operating conditions of the function**

This function is operable when all of the following conditions are met:

- The system detects lane lines and the path of preceding or surrounding vehicles.
- The dynamic radar cruise control and the lane tracing assist are operating.
- The turn signal lever is not being operated.
- The vehicle is not being driven around a sharp curve.
- The vehicle is being driven in the center of a lane.
- The driver monitor camera is detecting that the driver is facing front of the vehicle.
- The vehicle is driving in traffic jam on a highway or expressway at approximately 25 mph (40 km/h) or less. (In some situations, such as when a traffic jam starts, this function may be operational at approximately 20 mph [30 km/h] or less.)
- Safety Connect is being subscribed to.
- The driver's door is closed.
- The driver's seat belt is fastened.
- Customized setting of the Traffic Jam Assist is not set to off.

- Functions and components composing the system are in proper condition.
  - Customized setting of the PCS (Pre-Collision System) is not set to off.
  - Customized setting of the dynamic radar cruise control (re-start time extension) is not set to off.
- **Temporary cancelation of the function**
- When the operating conditions are no longer met, a function may be temporarily canceled. However, when the operation conditions are met again, operation of the function will automatically be restored.
  - If the operating conditions of a function are no longer met while the function is operating, a buzzer may sound with a display to indicate that the function has been temporarily canceled. If no driver's responses to the indication are detected, the driver emergency stop assist function may operate. For types of display and action to be taken, see the page mentioned below. (→P.305)

■ **Driving operations during controlled driving**

● **Accelerator pedal**

As with normal driving, acceleration can be performed by depressing the accelerator pedal. In some situations, such as when driving at approximately 6 mph (10 km/h) or more and the accelerator pedal is depressed, this function will be canceled.

● **Brake pedal**

As with normal driving, deceleration can be performed by depressing the brake pedal. However, controlled driving will be cancelled.

● **Steering wheel**

As with normal driving, the steering



wheel can be operated. If the steering wheel is operated more than a certain amount, controlled driving will be cancelled.

**■ When a warning message is displayed**

- “TrafficJamAsst System Malfunction Visit Your Dealer”

The Traffic Jam Assist function may not be operating properly.

- “TrafficJamAsst Unavailable Stop Assist Activated”

The system temporarily cannot be used as the driver emergency stop





assist function has operated.



**Changing Traffic Jam Assist settings**

- The setting of Traffic Jam Assist can be enabled/disabled through a customize setting. (→P.538)
- The setting of driver monitor camera recording can be enabled/disabled through a customize setting. (→P.538)

**Displays and system operation**

The following displays indicate the operating status of the Traffic Jam Assist function:

Display	Status	Action to be taken
	Traffic Jam Assist function is operating	—
	Traffic Jam Assist function is about to end	Hold the steering wheel.
	Traffic Jam Assist function has ended	Hold the steering wheel.
	Operation of either or both of dynamic radar cruise control /LTA (Lane Tracing Assist) ended	Manually operate the steering wheel immediately.

Display	Status	Action to be taken
 (Yellow)	Indicates that driving actions are necessary to cope with cut-in or other behavior of surrounding vehicles	The driver must operate the steering wheel, accelerator pedal and brake pedal in accordance with the surrounding environment.
	Indicates that the recording function of the driver monitor camera is operational (Blinking of this icon indicates that recording is undergoing, and constant illumination indicates ready for recording.)	—

**Stop & Start system**

**The Stop & Start system stops and starts the engine according to brake pedal or shift lever operation when the vehicle is stopped, such as at a stoplight, intersection, etc., in order to improve fuel economy and reduce noise pollution caused by the engine idling.**

**Stop & Start system operation**

■ **Stopping the engine**

While driving with the D shift position selected, depress the brake pedal and stop the vehicle. The engine will stop automatically.

When the engine stops, the Stop & Start indicator will illuminate.

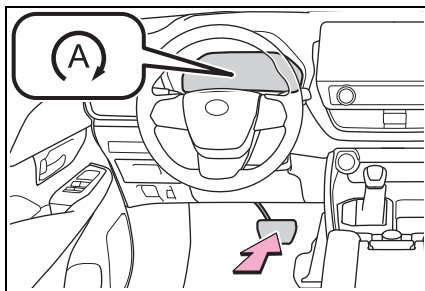

■ **Restarting the engine**

Release the brake pedal. The engine will start automatically.

When the engine starts, the Stop & Start indicator will turn off.

■ **When the brake hold system is operating**

- When the engine is stopped by the Stop & Start system, if the brake pedal is released the engine will remain stopped.
- If the accelerator pedal is depressed while the engine is stopped by the Stop & Start system, the engine will restart.
- While the engine is stopped by the Stop & Start system, if the engine is restarted, the brake hold system will continue to apply the brakes, unless the operation conditions of the brake hold system are no longer met. (→P.216)

■ **When the dynamic radar cruise control is operating**

- When the vehicle is stopped by the dynamic radar cruise control, the engine will stop automatically even though the brake pedal is not depressed.
- When the preceding vehicle starts off, the engine will restart automatically.
- If the engine is restarted by the Stop & Start system while the vehicle is stopped by the dynamic radar cruise control, the vehicle will remain stopped.

### Disabling the Stop & Start system

Press the Stop & Start cancel switch to disable the Stop & Start system.

The Stop & Start cancel indicator will illuminate.

Pressing the switch again will enable the Stop & Start system and the Stop & Start cancel indicator will turn off.

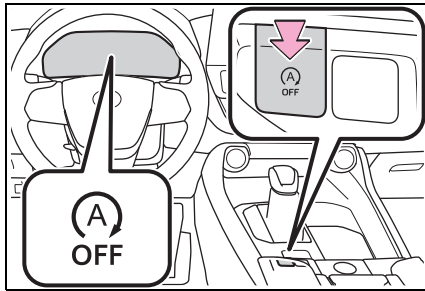

### Automatic enabling of the Stop & Start system

If the Stop & Start system is disabled using the Stop & Start cancel switch, it will be automatically re-enabled once the engine switch is turned off and then the engine is started.

### Hill-start assist control

When the engine is stopped by the Stop & Start system when the vehicle is on an incline, when the brake pedal is released, brake force is temporarily maintained to prevent the vehicle from rolling backwards before the engine is restarted and drive force is generated.

When drive force is generated, the maintained brake force is automatically canceled.

- This function operates on flat surfaces as well as steep inclines.
- Sound may be generated from the brake system, but this does not indicate a malfunction.
- Brake pedal response may change and vibration may occur, but this does not indicate a malfunction.

### Points for use

- If the engine switch is pressed when the engine is stopped by the Stop & Start system, the engine will not be able to be restarted by the automatic engine start function. In this case, restart the engine using the normal engine starting procedure. (→P.203)
  - When the engine is being restarted by the Stop & Start system, the power outlets may be temporarily unusable, but this does not indicate a malfunction.
  - Installation and removal of electrical components and wireless devices may affect the Stop & Start system. Contact your Toyota dealer for details.
  - When stopping the vehicle for a longer period of time, turn the engine switch off to stop the engine completely.
  - When the engine is restarted by the Stop & Start system, the steering wheel may temporarily feel heavy.
- ### Operating conditions
- The Stop & Start system is operational when all of the following

- conditions are met:
- The vehicle has been driven a certain amount of time.
  - The brake pedal is being depressed firmly. (Except when the vehicle is stopped by the dynamic radar cruise control when in vehicle-to-vehicle distance control mode)
  - The D shift position is selected.
  - The driver's seat belt is fastened.
  - The driver's door is closed.
  - The selected driving mode is not SNOW mode.
  - The windshield defogger is off.
  - The accelerator pedal is not being depressed.
  - The engine is adequately warmed up.
  - The hood is closed. (→P.309)
- In the following situations the engine may not be stopped by the Stop & Start system. This is not a malfunction of the Stop & Start system.
    - When the air conditioning system is being used.
    - When the battery is undergoing a periodic recharge.
    - When the battery is not sufficiently charged, such as if the vehicle has been parked for a long time and the battery charge has decreased, the electric load is large, the battery fluid temperature is excessively low or the battery has deteriorated.
    - When the brake booster vacuum is low.
    - When the elapsed time since the engine was restarted is short.
    - When the vehicle is stopped frequently, such as when in a traffic jam.
    - When the engine coolant temperature or transmission fluid temperature is extremely low or high.
    - When the vehicle is stopped on a steep incline.
    - When the vehicle is being driven in a high altitude area.
    - When the battery fluid temperature is extremely low or high.
    - For a while after the battery have been replaced
  - When the engine is stopped by the Stop & Start system, the engine will be restarted automatically if any of the following conditions are met: (To enable the engine to be stopped by the Stop & Start system again, drive the vehicle.)
    - The air conditioning system is being used.
    - The windshield defogger is turned on.
    - The shift lever is shifted from D or P.
    - The shift lever is shifted from P. (When the engine is stopped by the Stop & Start system when the shift lever is in P.)
    - The driver's seat belt is unfastened.
    - The driver's door is opened.
    - The driving mode is changed to SNOW mode.
    - The Stop & Start cancel switch is pressed.
    - The accelerator pedal is depressed.
    - The vehicle starts to roll on an incline.
  - When the engine is stopped by the Stop & Start system, the engine may restart automatically in the following situations: (To enable the engine to be stopped by the Stop & Start system again, drive the vehicle.)
    - When the brake pedal is pumped or strongly depressed.
    - When the air conditioning system is being used.
    - When a switch of the air conditioning system is operated (windshield defogger switch, etc.).
    - If the battery charge becomes low.
- **When the hood is opened**
- If the hood is opened while the engine is stopped by the Stop & Start system, the engine will stall and will not be able to be restarted by the automatic engine start function. In this case, restart the

engine using the normal engine starting procedure. (→P.203)

- If the hood is closed after the engine is started with the hood open, the Stop & Start system will not operate. Close the hood, turn the engine switch off, wait 30 seconds or more, and then start the engine.

#### ■ Air conditioning system operation while the engine is stopped by the Stop & Start system

When the air conditioning is in automatic mode and the engine is stopped by the Stop & Start system, the fan may operate at a low speed in order to prevent the temperature in the cabin from increasing or decreasing or may be stopped.

To prioritize air conditioning system performance when the vehicle is stopped, disable the Stop & Start system by pressing the Stop & Start cancel switch.

- If the windshield is fogged up  
Turn the windshield defogger on.  
(→P.370)

If the windshield fogs up frequently, press the Stop & Start cancel switch to disable the Stop & Start system.

- If an odor is emitted from the air conditioning system  
Press the Stop & Start cancel switch to deactivate the Stop & Start system.

#### ■ Changing the idling stop time with the air conditioning system on

The length of time the Stop & Start system will operate when the air conditioning system is on can be changed in  of the multi-information display (→P.548), 97. (The length of time the Stop & Start system will operate when the air conditioning system is off cannot be changed.)

#### ■ Displaying the Stop & Start system status

→P.93, 97

#### ■ Multi-information display messages

If the following situations,  and a message may be displayed on the multi-information display.

- When the engine cannot be stopped by the Stop & Start system

 “Press Brake More to Activate”

- The brake pedal is not sufficiently depressed.

→ If the brake pedal is depressed further, the system will operate.

 “Non-Dedicated Battery”

- A battery not designed for use with a Stop & Start system may have been installed.

→ Have the vehicle inspected by your Toyota dealer.

 “Battery Charging”

- The battery charge may be low.  
→ Stopping of the engine is temporarily prohibited to prioritize charging of the battery. After the engine runs for a certain amount of time, the system will be enabled.

- A refresh charge may be being performed, such as during a periodic recharge, after the battery terminals have been disconnected and reconnected, after the battery has been replaced, etc.

→ After a refresh charge for up to an hour completes, the system can be operated.

- If displayed continuously for a long time (more than an hour)  
→ The battery may be deteriorated.  
Contact your Toyota dealer for

details.

 "Stop & Start System Unavailable"

- The Stop & Start system is temporarily disabled.

→ Allow the engine to run for some time.

- The engine may have been started with the hood open.

→ Close the hood, turn the engine switch off, wait for 30 seconds or more, and then start the engine.

 "In Preparation"

- The vehicle is being driven in a high altitude area.
  - The brake booster vacuum is low.
- When the brake booster vacuum reaches a predetermined level, the system will be enabled.

 "For Climate Control"

- The air conditioning system is being used when the ambient temperature is high or low.

→ If the difference between the set temperature and cabin temperature becomes small, the system will be enabled.

- The windshield defogger is on.

- When the engine automatically restarts while stopped by the Stop & Start system

 "In Preparation"

- The brake pedal has been depressed further or pumped.

→ The system will be enabled after the engine runs and the brake booster vacuum reaches a predetermined level.

 "For Climate Control"

- The air conditioning system is

being used.

- The windshield defogger has been turned on.

 "Battery Charging"

- The battery charge may be low.

→ The system will be enabled after the engine runs to sufficiently charge the battery.

■ **When the buzzer sounds**

If the driver's door is opened when the engine is stopped by the Stop & Start system and the shift lever is in D, a buzzer will sound and the Stop & Start system indicator will flash. To stop the buzzer, close the driver's door.

■ **The Stop & Start system protection function**

- When the volume of the audio system is excessively high, sound output from the audio system may suddenly be cut off in order to reduce battery consumption. To prevent the audio system from being cut off, keep the volume of audio system at a moderate level. If the audio system has been cut off, turn the engine switch off, wait for 3 seconds or more and then turn it to ACC or ON to re-enable the audio system.
- The audio system may not be activated if the battery terminals are disconnected and then reconnected. If this occurs, turn the engine switch off and then repeat the following operation twice to activate the audio system normally.
- Turn the engine switch to ON and then to off.

■ **Replacing the battery**

→P.510

■ **If the Stop & Start cancel indicator flashes continuously**

The system may be malfunctioning. Have the vehicle inspected by your

Toyota dealer.

■ **If “Stop & Start System Malfunction Visit Your Dealer” is displayed on the multi-information display**

The system may be malfunctioning. Have the vehicle inspected by your Toyota dealer.

 **WARNING**

■ **When the Stop & Start system is operating**

Make sure to disable the Stop & Start system while the vehicle is in a poorly ventilated area. If not disabled, the engine may be automatically restarted unexpectedly, causing exhaust gases to collect and enter the vehicle, possibly resulting in death or a serious health hazard.

- Do not leave the vehicle while the engine is stopped by the Stop & Start system (while the Stop & Start indicator is on). An accident may occur due to the automatic engine start function.
- Depress the brake pedal and apply the parking brake when necessary while the engine is stopped by the Stop & Start system (while the Stop & Start indicator is on).

- Even though the driver's seat belt is not fastened, the driver's and front passenger's seat belt reminder light does not illuminate.
- Even though the driver's door is closed, the open door warning light is illuminated or the interior light is illuminated when the interior light switch is in the door position.
- Even though the driver's door is open, the open door warning light does not illuminate or the interior light does not illuminate when the interior light switch is in the door position.

 **NOTICE**

■ **To ensure the system operates correctly**

If any of the following situations occur, the Stop & Start system may not operate correctly. Have your vehicle inspected by your Toyota dealer.

- While the driver's seat belt is fastened, the driver's and front passenger's seat belt reminder light flashes.



**BSM (Blind Spot Monitor)**

The Blind Spot Monitor is a system that uses rear side radar sensors installed on the inner side of the rear bumper on the left and right side to assist the driver in confirming safety when changing lanes.

**⚠ WARNING**

■ **Cautions regarding the use of the system**

- The driver is solely responsible for safe driving. Always drive safely, taking care to observe your surroundings.
- The Blind Spot Monitor is a supplementary function which alerts the driver that a vehicle is in a blind spot of the outside rear view mirrors or is approaching rapidly from behind into a blind spot. Do not overly rely on the Blind Spot Monitor. As the function cannot judge if it is safe to change lanes, over reliance could lead to an accident resulting in death or serious injury. As the system may not function correctly under certain conditions, the driver's own visual confirmation of safety is necessary.

**System components**

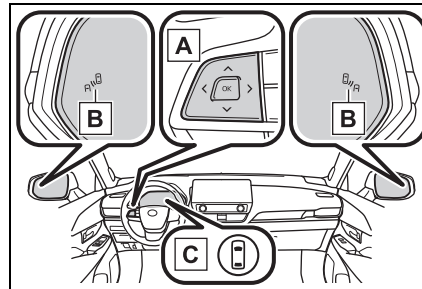

**A** Meter control switches

Turning the Blind Spot Monitor on/off.

**B** Outside rear view mirror indicators

When a vehicle is detected in a blind spot of the outside rear view mirrors or approaching rapidly from behind into a blind spot, the outside rear view mirror indicator (→P.78) on the detected side will illuminate. If the turn signal lever is operated toward the detected side, the outside rear view mirror indicator will flash and a buzzer will sound.

**C** Driving assist information indicator

Illuminates when the Blind Spot Monitor is turned off. At this time, a message will be displayed on the multi-information display.

■ **Outside rear view mirror indicator visibility**

In strong sunlight, the outside rear view mirror indicator may be difficult to see.

■ **Buzzer**

If the volume setting of the audio system is high or the surrounding area is loud, it may be difficult to hear the buzzer.

■ Customization

Some functions can be customized. (→P.538)

**⚠ WARNING**

■ To ensure the system can operate properly

Blind Spot Monitor sensors are installed behind the left and right sides of the rear bumper respectively. Observe the following to ensure the Blind Spot Monitor can operate correctly.

- Keep the sensors and the surrounding areas on the rear bumper clean at all times.

If a sensor or its surrounding area on the rear bumper is dirty or covered with snow, the Blind Spot Monitor may not operate and a warning message will be displayed. In this situation, clear off the dirt or snow and drive the vehicle with the operation conditions of the BSM function (→P.316) satisfied for approximately 10 minutes. If the warning message does not disappear, have the vehicle inspected by your Toyota dealer.

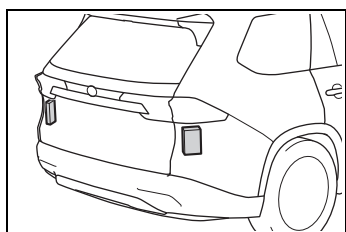

- Do not attach accessories, stickers (including transparent stickers), aluminum tape, etc. to a sensor or its surrounding area on the rear bumper.

- Do not paint the surrounding area of a sensor on the rear bumper.
- Do not subject a sensor or its surrounding area on the rear bumper to a strong impact. If a sensor is moved even slightly off position, the system may malfunction and vehicles may not be detected correctly. In the following situations, have your vehicle inspected by your Toyota dealer.
  - A sensor or its surrounding area is subject to a strong impact.
  - If the surrounding area of a sensor is scratched or dented, or part of them has become disconnected.
- Do not disassemble the sensor.
- Do not modify the sensor or surrounding area on the rear bumper.
- If a sensor or the rear bumper needs to be removed/installed or replaced, contact your Toyota dealer.
- The sensors are likely to be affected by paint on the rear bumper. If the rear bumper is not repaired correctly, the Blind Spot Monitor may not operate with a warning message displayed. If any paint repair is needed, contact your Toyota dealer.

**Turning the Blind Spot Monitor on/off**

The Blind Spot Monitor can be enabled/disabled through a customize setting. (→P.538)

When the Blind Spot Monitor is off, the driving assist information

indicator (→P.78) will illuminate and a message will be displayed on the multi-information display.

Each time the engine switch is turned to ON, the Blind Spot Monitor is enabled.

### Blind Spot Monitor operation

#### ■ Objects that can be detected while driving

The Blind Spot Monitor uses rear side radar sensors to detect the following vehicles traveling in adjacent lanes and advises the driver of the presence of such vehicles via the indicators on the outside rear view mirrors.

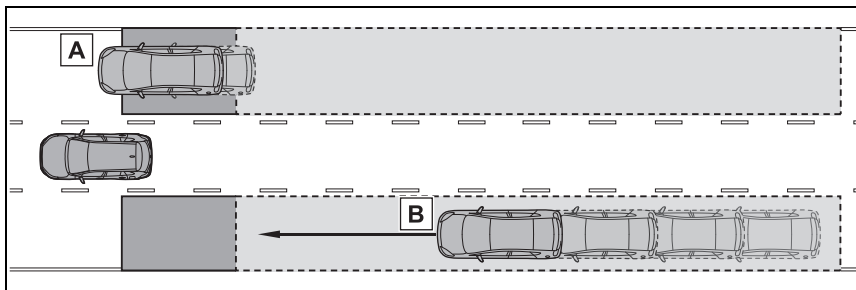

- A** Vehicles that are traveling in areas that are not visible using the outside rear view mirrors (the blind spots)
- B** Vehicles that are approaching rapidly from behind in areas that are not visible using the outside rear view mirrors (the blind spots)

#### ■ Detection range while driving

The areas that vehicles can be detected in are outlined below.

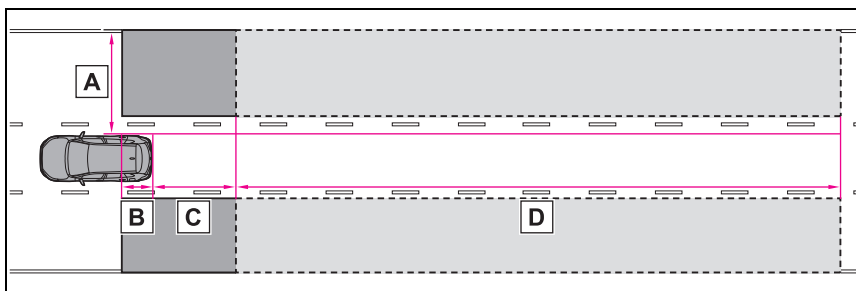

The range of each detection area is:

- A** Approximately 1.6 ft. (0.5 m) to 11.5 ft. (3.5 m) from either side of the vehicle\*<sup>1</sup>

- B Approximately 3.3 ft. (1 m) forward of the rear bumper<sup>\*2</sup>
- C Approximately 9.8 ft. (3 m) from the rear bumper
- D Approximately 9.8 ft. (3 m) to 230 ft. (70 m) from the rear bumper<sup>\*3</sup>

<sup>\*1</sup>: The area between the side of the vehicle and 1.6 ft. (0.5 m) from the side of the vehicle cannot be detected.

<sup>\*2</sup>: While the vehicle is to being overtaken, up to approximately 9.8 ft. (3 m) forward of the rear bumper will be detected.

<sup>\*3</sup>: The greater the difference in speed between your vehicle and the detected vehicle is, the farther away the vehicle will be detected, causing the outside rear view mirror indicator to illuminate or flash.

#### ■ The Blind Spot Monitor linked function

The LDA (Lane Departure Alert) has a function that uses information of detected vehicles driving in an adjacent lane. For details about the function and its operating conditions, P.265.

#### ■ The Blind Spot Monitor is operational when

The Blind Spot Monitor is operational when all of the following conditions are met:

- The engine switch is in ON.
- The Blind Spot Monitor is on.
- The shift position is in a position other than R.
- The vehicle speed is greater than approximately 7 mph (10 km/h).

#### ■ The Blind Spot Monitor will detect a vehicle when

The Blind Spot Monitor will detect a vehicle present in the detection area in the following situations:

- A vehicle in an adjacent lane overtakes your vehicle.
- You overtake a vehicle in an adjacent lane slowly.

- Another vehicle enters the detection area when it changes lanes.

#### ■ Situations in which the Blind Spot Monitor cannot detect vehicles.

The Blind Spot Monitor cannot detect the following vehicles and other objects:

- Small motorcycles, bicycles, pedestrians, etc.\*
- Vehicles traveling in the opposite direction
- Guardrails, walls, signs, parked vehicles and similar stationary objects\*
- Following vehicles that are in the same lane\*
- Vehicles traveling 2 lanes away from your vehicle\*
- Vehicles which are being overtaken rapidly by your vehicle\*

\*: Depending on the conditions, detection of a vehicle and/or object may occur.

#### ■ Conditions in which a buzzer may not sound

In situations such as the following, while the turn signal lever is being operated, the indicator will flash but a buzzer may not sound.

- When a second vehicle is detected while the turn signal lever is being held
- When overtaking a vehicle in the adjacent lane at a much higher speed than it\*

\*: Depending on the situations, a buzzer may sound.

■ **Conditions under which the system may not function correctly**

- The Blind Spot Monitor may not detect vehicles correctly in the following situations:
  - When the sensor is misaligned due to a strong impact to the sensor or its surrounding area
  - When mud, snow, ice, a sticker, etc. is covering the sensor or surrounding area on the rear bumper
  - When driving on a road surface that is wet with standing water during bad weather, such as heavy rain, snow, or fog
  - When multiple vehicles are approaching with only a small gap between each vehicle
  - When the distance between your vehicle and a following vehicle is short
  - When there is a significant difference in speed between your vehicle and the vehicle that enters the detection area
  - When the difference in speed between your vehicle and another vehicle is changing
  - When a vehicle enters a detection area traveling at about the same speed as your vehicle
  - As your vehicle starts from a stop, a vehicle remains in the detection area
  - When driving up and down consecutive steep inclines, such as hills, dips in the road, etc.
  - When driving on roads with sharp bends, consecutive curves, or uneven surfaces
  - When vehicle lanes are wide, or when driving on the edge of a lane, and the vehicle in an adja-

- cent lane is far away from your vehicle
- When an accessory (such as a bicycle carrier) is installed to the rear of the vehicle
- When there is a significant difference in height between your vehicle and the vehicle that enters the detection area
- Immediately after the Blind Spot Monitor is turned on
- When towing with the vehicle
- Instances of the Blind Spot Monitor unnecessarily detecting a vehicle and/or object may increase in the following situations:
  - When the sensor is misaligned due to a strong impact to the sensor or its surrounding area
  - When the distance between your vehicle and a guardrail, wall, etc. that enters the detection area is short
  - When driving up and down consecutive steep inclines, such as hills, dips in the road, etc.
  - When vehicle lanes are narrow, or when driving on the edge of a lane, and a vehicle traveling in a lane other than the adjacent lanes enters the detection area
  - When driving on roads with sharp bends, consecutive curves, or uneven surfaces
  - When the tires are slipping or spinning
  - When the distance between your vehicle and a following vehicle is short
  - When an accessory (such as a bicycle carrier) is installed to the rear of the vehicle
  - When towing with the vehicle

### Safe Exit Assist

The safe exit assist is a system that uses rear side radar sensors installed on the inner side of the rear bumper to help occupants judge if an approaching vehicle or bicycle may collide with a door when exiting, to help reduce the possibility of a collision.

#### WARNING

##### ■ Cautions regarding the use of the system

- The driver is solely responsible for safe driving. Always drive safely, taking care to observe your surroundings.
- The safe exit assist is a supplementary system that, when the vehicle is stopped, informs occupants of the existence of approaching vehicles and bicycles. As this system alone cannot be used to judge safety, over-reliance on this system may lead to an accident resulting in death or serious injury.

In certain situations, this system may not function to its fullest extent. Therefore it is necessary for the occupants to visually check for safety directly and using the mirrors.

### System components

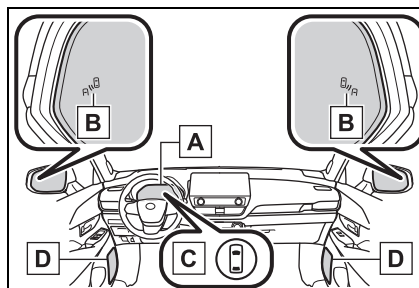

#### **A** Multi-information display

Turning the safe exit assist on/off.

If collision with a door is likely and the door is opened, the door will be displayed on the multi-information display. Also, if a door is opened when an outside rear view mirror indicator is illuminated, a buzzer will sound as a warning.

#### **B** Outside rear view mirror indicators

When a vehicle or bicycle which may collide with a door (other than the back door) when opened is detected, the outside rear view mirror indicator (→P.78) on the detected side will illuminate. If the door on the detected side is opened, the outside rear view mirror indicator will blink.

#### **C** Driving assist information indicator

Illuminates when the safe exit assist is turned off. At this time, a message will be displayed on the multi-information display.

#### **D** Speakers

When the outside rear view mirror indicator blinks, the driver is informed through voice guidance

that the system has operated. After the notification through voice guidance is made, no more voice guidance notifications will be made again until the door is fully closed.

■ **Outside rear view mirror indicator visibility**

In strong sunlight, the outside rear view mirror indicator may be difficult to see.

■ **Buzzer**

If the volume setting of the audio system is high or the surrounding area is loud, it may be difficult to hear the buzzer.

■ **Voice notifications**

In the following situations, voice notifications will not be output:

- When it is estimated that no occupants are on board\*
- After opening a door and entering the vehicle, until the engine is started
- When 3 minutes or more have elapsed since the engine was stopped
- When the language setting of the Multimedia Display has been set to a language that does not support voice notifications
- When all of the doors have been locked from outside the vehicle
- When a door remains open for 1 minute or more after the engine is stopped
- When the ACC mode (→P.538) has been enabled through a cus-

tomize setting on the Multimedia Display and the engine has been stopped

- When the parking assist volume setting on the Multimedia Display has been set to off

\*: For each seating position, judgment is made based on the opening and closing of a door, before driving for ingress and after driving for egress.

■ **Customization**

Some functions can be customized. (→P.538)

 **WARNING**

■ **To ensure the system can operate properly**

→P.314

**Turning the safe exit assist system ON/OFF**

The safe exit assist system can be enabled/disabled through a customize setting. (→P.538)

When the safe exit assist is off, the driving assist information indicator will illuminate and a message will be displayed on the multi-information display. Each time the engine switch is turned to ON, the safe exit assist is enabled.

**Safe exit assist operation**

■ **Objects that can be detected by the safe exit assist**

When the safe exit assist detects the following vehicles or bicycles behind your vehicle using a rear side radar sensor, the occupants of the vehicle are informed through an outside rear view mirror indica-

tor, buzzer, multi-information display, and voice notification.

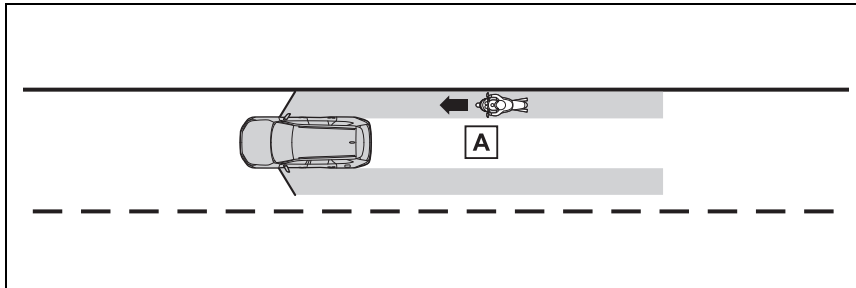

**A** Vehicle or bicycle which has a high possibility of colliding with a door (other than the back door) when opened

■ **The safe exit assist detection areas**

The areas that vehicles can be detected in are outlined below.

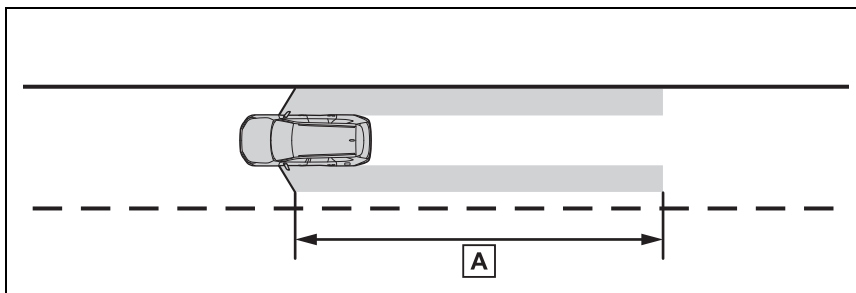

**A** Approximately 145 ft. (45 m) rearward from the front door\*

\*: The faster a vehicle or bicycle is approaching, the distance at which an outside rear view mirror indicator will illuminate or blink will become further.

■ **The safe exit assist is operational when**

The safe exit assist is operational when all of the following conditions are met:

- When the engine switch is ON, less than 3 minutes have elapsed since the engine was off, or less than 3 minutes have elapsed since a door was opened and someone has entered the vehicle (the time which operation is possible may be extended if a door is opened and closed)

- Safe exit assist is on
- The vehicle is stopped.
- The shift position is in a position other than R.

■ **The safe exit assist will detect a vehicle when**

The safe exit assist will detect a vehicle present in the detection area in the following situations:

- When the vehicle is stopped and a vehicle or bicycle, which is traveling parallel to the vehicle, is approaching within the area that a door opens (other than the back



door)

■ **Conditions under which the system will not detect a vehicle**

- Safe exit assist does not detect the following objects, vehicles, and bicycles:
  - Vehicles or bicycles which are approaching slowly\*
  - Vehicles or bicycles which are determined to have a low possibility of colliding with a door (other than the back door) when opened\*
  - Vehicles or bicycles which are approaching from directly behind\*
  - Vehicles or bicycles which are approaching from the front\*
  - Guardrails, walls, signs, parked vehicles, and other stationary objects\*
  - Pedestrians, animals, etc.\*
- In situations such as the following, safe exit assist will not operate:
  - When 3 minutes or more have elapsed since the engine off (the time which operation is possible may be extended if a door is opened and closed)
  - When your vehicle is not completely stopped

\*: Depending on the conditions, detection of a vehicle and/or object may occur.

■ **Conditions under which the system may not function correctly**

- The safe exit assist may not detect vehicles correctly in the following situations:
  - When the sensor is misaligned due to a strong impact to the sensor or its surrounding area
  - When mud, snow, ice, a sticker, etc. is covering the sensor or surrounding area on the rear bumper
  - When driving on a road surface that is wet with standing water during bad weather, such as heavy rain, snow, or fog
  - When a vehicle or bicycle

approaches from behind a nearby parked vehicle

- When an approaching vehicle or bicycle suddenly changes direction
- Immediately after a vehicle or bicycle starts moving
- When the back door is open
- When a bicycle carrier, ramp, or other accessory is installed to the back of the vehicle
- When a parked vehicle, wall, sign, person or other stationary object is behind the vehicle
- When the vehicle is stopped at an angle to the road
- When a vehicle is traveling near an approaching vehicle or bicycle
- When an approaching vehicle or bicycle is traveling along a stationary object, such a wall or sign
- When a vehicle or bicycle is approaching at high speed
- When towing with the vehicle
- When stopped on a steep slope
- When stopped on a curve or at the exit of a curve
- Instances of the safe exit assist unnecessarily detecting a vehicle and/or object may increase in the following situations:
  - When the sensor is misaligned due to a strong impact to the sensor or its surrounding area
  - When a vehicle or bicycle approaches your vehicle from directly behind in an offset position
  - When the vehicle is stopped at an angle to the road
  - When a vehicle or bicycle approaches from behind a parked vehicle at an angle
  - When a parked vehicle, wall, sign, person or other stationary object is behind the vehicle
  - When an approaching vehicle or bicycle suddenly changes direction
  - When an approaching vehicle or bicycle is traveling along a stationary object, such a wall or sign
  - When the back door is open
  - When a bicycle carrier, ramp, or

other accessory is installed to the back of the vehicle

- When a vehicle or bicycle is approaching at high speed
- When towing with the vehicle
- When stopped on a steep slope
- When stopped on a curve or at the exit of a curve
- When a vehicle or bicycle approaches from behind a vehicle stopped in an adjacent lane

### Intuitive parking assist\*

\*: If equipped

**The intuitive parking assist function detects the approximate distance from the vehicle and an object such as a wall using ultrasonic sensors and informs the driver with the Multimedia Display distance display and buzzer.**

### System components

#### ■ Type of sensors

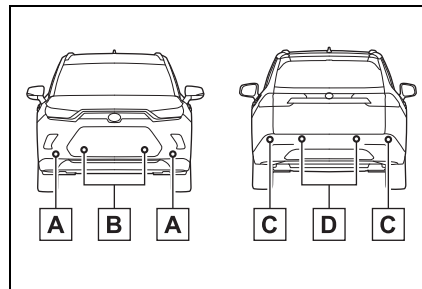

**A** Front corner sensors

**B** Front center sensors

**C** Rear corner sensors

**D** Rear center sensors

#### ■ Display

When the sensors detect an object, such as a wall, a graphic is shown on the Multimedia Display depending on the position and distance to the object.

Vehicles without Multimedia Display or rear camera: When

detecting a stationary object, the intuitive parking assist detection indicator illuminates. (→P.78)

Multimedia Display:

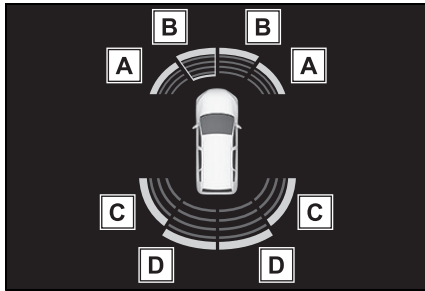

- A** Front corner sensor detection
- B** Front center sensor detection
- C** Rear corner sensor detection
- D** Rear center sensor detection

**Turning the intuitive parking assist function ON/OFF**

The intuitive parking assist function can be enabled/disabled through a customize setting. (→P.538)

When the intuitive parking assist function is disabled, the intuitive parking assist OFF indicator (→P.78) illuminates on the multi-information display.

If the system switches to OFF (disabled) and the intuitive parking assist is stopped, the intuitive parking assist will not be re-enabled until ON (enabled) is selected again from the customize setting (→P.538). (It remains off even if the engine switch is

turned to ON again after the engine switch has been turned off.)

Vehicles without the Multimedia Display or rear camera: However, the system will automatically turn on (enabled) and the intuitive parking assist OFF indicator will turn off if the shift position is changed to R.

When the shift position is R, the intuitive parking assist cannot be turned on or off.

The setting of intuitive parking assist itself will not change.

**⚠ WARNING**

**■ Cautions regarding the use of the system**

There is a limit to the degree of recognition accuracy and control performance that this system can provide, do not overly rely on this system. The driver is always responsible for paying attention to the vehicle's surroundings and driving safely.

**■ To ensure the system can operate properly**

Make sure to observe the following precautions. The system may not operate properly and may lead to an unexpected accident. When these precautions cannot be observed, turn the system off.

- Do not damage the sensors, and always keep them clean.
- Do not attach a sticker or install an electronic component, such as a backlit license plate (especially fluorescent type), fog lights, fender pole or wireless antenna near a radar sensor.



**WARNING**

- Do not subject the surrounding area of the sensor to a strong impact. If subjected to an impact, have the vehicle inspected by your Toyota dealer. If the front or rear bumper needs to be removed/installed or replaced, contact your Toyota dealer.
- Do not modify, disassemble or paint the sensors.
- Do not attach a license plate cover.
- Keep your tires properly inflated.
- Do not install a suspension other than a genuine suspension.
- **Notes when washing the vehicle**
  - When using a high pressure washer to wash the vehicle, do not spray the sensors directly, as doing so may cause a sensor to malfunction.
  - When using steam to clean the vehicle, do not direct steam too close to the sensors, as doing so may cause a sensor to malfunction.

■ **The system can be operated when**

- The engine switch is in ON.
- The intuitive parking assist is on.
- The vehicle speed is less than about 6 mph (10 km/h).
- A shift position other than P is selected.
- Vehicles without the Multimedia Display or rear camera: The system will automatically turn on (enabled) and the intuitive park-

ing assist OFF indicator will turn off if the shift position is changed to R.

The setting of intuitive parking assist itself will not change.

■ **Sensor detection information**

- The sensor's detection areas are limited to the areas around the vehicle's front and rear bumpers.
- Certain vehicle conditions and the surrounding environment may affect the ability of a sensor to correctly detect an object.
- Objects may not be detected if they are too close to the sensor.
- There will be a short delay between object detection and display. Even at low speeds, there is a possibility that the object will come within the sensor's detection areas before the display is shown and the warning beep sounds.
- It might be difficult to hear the buzzer due to the volume of the audio system or air flow noise of the air conditioning system.
- It may be difficult to hear the sound of this system due to the buzzers of other systems.
- If the meter malfunctions, the buzzer may not sound.

■ **Objects which the system may not be properly detected**

The shape of the object may prevent the sensor from detecting it. Pay particular attention to the following objects:

- Wires, fences, ropes, etc.
- Cotton, snow and other materials that absorb sound waves
- Sharply-angled objects
- Low objects
- Tall objects with upper sections projecting outwards in the direction of your vehicle

People may not be detected if they

are wearing certain types of clothing.

#### ■ Situations in which the system may not operate properly

Certain vehicle conditions and the surrounding environment may affect the ability of a sensor to correctly detect objects. Particular instances where this may occur are listed below.

- There is dirt, snow, water drops or ice on a sensor. (Cleaning the sensors will resolve this problem.)
- A sensor is frozen. (Thawing the area will resolve this problem.) In especially cold weather, if a sensor is frozen the sensor display may be displayed abnormally, or objects, such as a wall, may not be detected.
- When a sensor or the area around a sensor is extremely hot or cold.

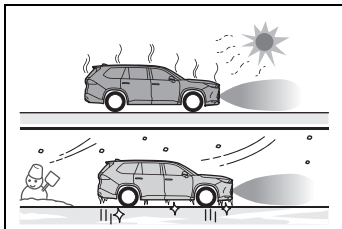

- On an extremely bumpy road, on an incline, on gravel, or on grass.
- When vehicle horns, vehicle detectors, motorcycle engines, air brakes of large vehicles, the clearance sonar of other vehicles or other devices which produce ultrasonic waves are near the vehicle
- A sensor is coated with a sheet of spray or heavy rain
- If objects draw too close to the sensor.
- When a pedestrian is wearing clothing that does not reflect ultrasonic waves (ex. skirts with gathers or frills).
- When objects that are not perpendicular to the ground, not perpen-

dicular to the vehicle traveling direction, uneven, or waving are in the detection range.

- When strong winds are blowing
  - When driving in inclement weather such as fog, snow or a sandstorm
  - When an object that cannot be detected is between the vehicle and a detected object
  - If an object such as a vehicle, motorcycle, bicycle or pedestrian cuts in front of the vehicle or runs out from the side of the vehicle
  - If the orientation of a sensor has been changed due to a collision or other impact
  - When equipment such as a towing eyelet, transport hook, bumper protector, bumper trim, bicycle carrier or snow-removal device (snow plow) is installed near the sensor
  - If the front of the vehicle is raised or lowered due to the carried load
  - If the vehicle cannot be driven in a stable manner, such as when the vehicle has been in an accident or is malfunctioning
  - When tire chains, compact spare tire or an emergency tire puncture repair kit are used
  - When towing with the vehicle
- #### ■ Situations in which the system may operate even if there is no possibility of a collision
- In some situations, such as the following, the system may operate even though there is no possibility of a collision.
- When driving on a narrow road

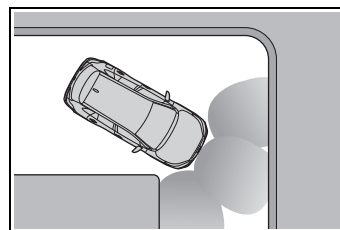

- When driving toward a banner, flag, low-hanging branch or boom barrier (such as those used at railroad crossings, toll gates and parking lots)
- When there is a rut or hole in the surface of the road
- When driving on a metal cover (grating), such as those used for drainage ditches
- When driving up or down a steep slope
- If a sensor is hit by a large amount of water, such as when driving on a flooded road
- There is dirt, snow, water drops or ice on a sensor. (Cleaning the sensors will resolve this problem.)
- A sensor is coated with a sheet of spray or heavy rain
- When driving in inclement weather such as fog, snow or a sandstorm
- When strong winds are blowing

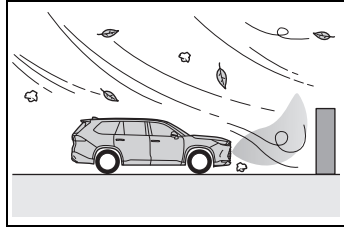

- When vehicle horns, vehicle detectors, motorcycle engines, air brakes of large vehicles, the clearance sonar of other vehicles or other devices which produce ultrasonic waves are near the vehicle
- If the front of the vehicle is raised or lowered due to the carried load
- If the orientation of a sensor has been changed due to a collision or other impact
- The vehicle is approaching a tall or curved curb
- Driving close to columns (H-shaped steel beams, etc.) in multi-story parking garages, construction sites, etc.

- If the vehicle cannot be driven in a stable manner, such as when the vehicle has been in an accident or is malfunctioning
- On an extremely bumpy road, on an incline, on gravel, or on grass

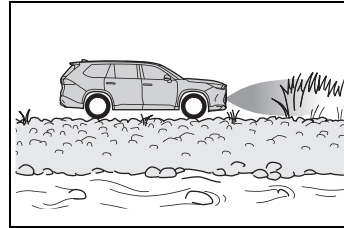

- When tire chains, compact spare tire or an emergency tire puncture repair kit are used
- When towing with the vehicle

### Sensor detection display, object distance

#### ■ Detection range of the sensors

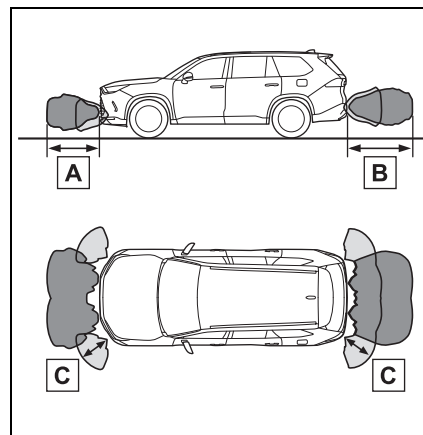

- A** Approximately 3.3 ft. (100 cm)
- B** Approximately 4.9 ft. (150 cm)
- C** Approximately 2.0 ft. (60 cm)

The diagram shows the detection range of the sensors.  
Note that the sensors cannot detect objects that are extremely close to

the vehicle.  
The range of the sensors may change depending on the shape of the object, etc.

■ **The distance and buzzer**

Approximate distance to obstacle	Buzzer
Front center sensor: Approximately 3.3 ft. (100 cm) to 2.0 ft. (60 cm)* Rear center sensor: Approximately 4.9 ft. (150 cm) to 2.0 ft. (60 cm)*	Slow
Approximately 2.0 ft. (60 cm) to 1.5 ft. (45 cm)*	Medium
Approximately 1.5 ft. (45 cm) to 1.0 ft. (30 cm)*	Fast
Approximately less than 1.0 ft. (30 cm)	Continuous

\*: Automatic buzzer mute function is enabled. (→P.327)

■ **Intuitive parking assist buzzer**

A buzzer sounds when the sensors are operating.

- The buzzer beeps faster as the vehicle approaches a static object. When the vehicle comes within the approximately 1.0 ft. (30 cm) of the object, the buzzer will sound continuously.
- When 2 or more sensors simultaneously detect a static object, the buzzer sounds for the nearest object.
- After a buzzer begins sounding, if the distance between

the vehicle and the detected a static object does not become shorter, the buzzer will be muted automatically. (automatic buzzer mute function)

■ **Adjusting the buzzer volume**

The buzzer volume of the intuitive parking assist, RCTA, and RCD (if equipped) can all be changed at once from the customize settings. (→P.538)

■ **Muting a buzzer**

When the temporary mute switch is displayed on the Multimedia Display, this switch can be pressed to temporarily mute the buzzer.

Select the switch to mute a buzzer of the intuitive parking assist, RCTA, and RCD (if equipped) all together.

- Mute will be automatically canceled in the following situations:
  - When the shift position is changed.
  - When the vehicle speed exceeds a certain speed.
  - When there is a malfunction in a sensor or the system is temporarily unavailable.
  - When the operating function is disabled manually.
  - When the engine switch is turned off.

### **RCTA (Rear Cross Traffic Alert) function**

**The RCTA function uses the BSM rear side radar sensors installed behind the rear bumper. This function is intended to assist the driver in checking areas that are not easily visible when backing up.**

#### **WARNING**

##### **■ Cautions regarding the use of the system**

The driver is solely responsible for safe driving. Always drive safely, taking care to observe your surroundings. The RCTA function is only a supplementary function which alerts the driver that a vehicle is approaching from the right or left at the rear of the vehicle. As the RCTA function may not function correctly under certain conditions, the driver's own visual confirmation of safety is necessary. Over reliance on this function may lead to an accident resulting death or serious injury.

##### **■ To ensure the system can operate properly**

→P.314



**System components**

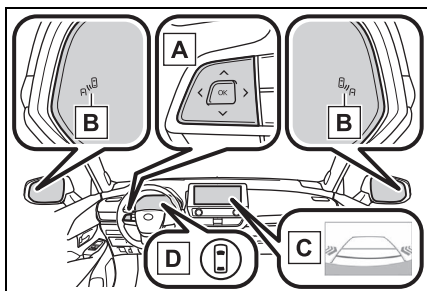

**A** Meter control switches  
Operate the meter control switches to enable/disable the RCTA function on the multi-information display.

**B** Outside rear view mirror indicators  
If a vehicle is detected as approaching from the left or right behind the vehicle, both outside rear view mirror indicators (→P.78) will blink and a buzzer will sound.

**C** Multimedia Display  
If a vehicle approaching from the right or left at the rear of the vehicle is detected, the RCTA icon (→P.330) for the detected side will be displayed on the Multimedia Display. This illustration\* shows an example of a vehicle approaching from both sides of the vehicle.

\*: Depending on the vehicle grade and equipped options, the actual screen may be different from this

illustration.

**D** Driving assist information indicator

Illuminates when the RCTA is turned off. At this time, a message will be displayed on the multi-information display.

**Turning the RCTA function on/off**

The RCTA can be enabled/disabled through a customize setting. (→P.538)

When the RCTA function is off, the driving assist information indicator (→P.78) will illuminate and a message will be displayed on the multi-information display. Each time the engine switch is turned to ON, the RCTA function is enabled.

■ **Outside rear view mirror indicator visibility**

In strong sunlight, the outside rear view mirror indicator may be difficult to see.

■ **Hearing the RCTA buzzer**

The RCTA buzzer may be difficult to hear over loud noises, such as if the audio system volume is high.

■ **Rear side radar sensors**

→P.314

**RCTA function**

■ **Operation of the RCTA function**

The RCTA function uses rear side radar sensors to detect vehicles approaching from the right or left at the rear of the vehicle and alerts

the driver of the presence of such vehicles by flashing the outside rear view mirror indicators and sounding a buzzer.

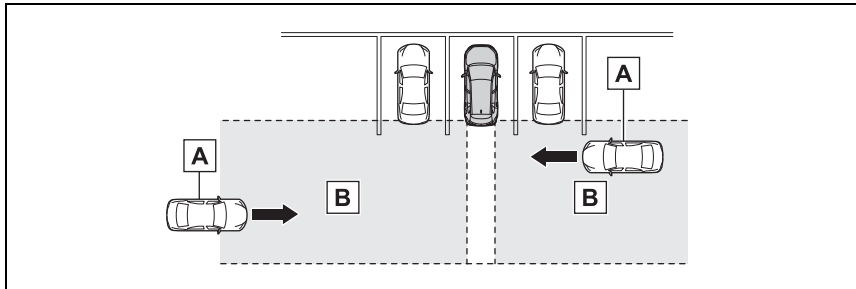

**A** Approaching vehicles

**B** Detection areas of approaching vehicles

■ **RCTA icon display**

of the vehicle

When a vehicle approaching from the right or left at the rear of the vehicle is detected, the following will be displayed on the Multimedia Display.

- Example (Toyota parking assist monitor): Vehicles are approaching from both sides

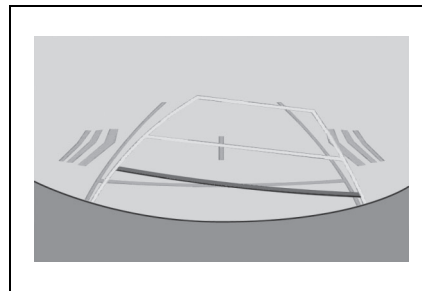

■ **RCTA function detection areas**

The areas that vehicles can be detected in are outlined below.

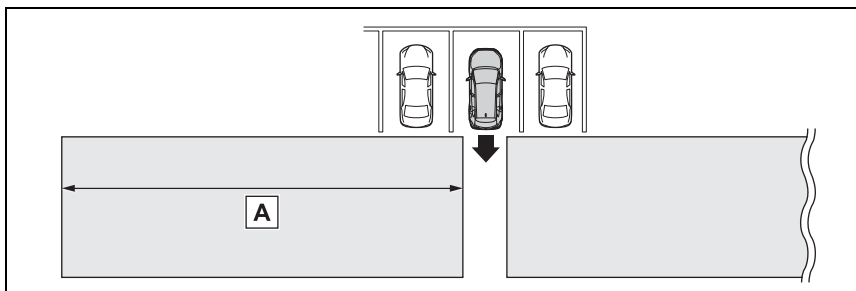

The buzzer can alert the driver of faster vehicles approaching from farther away.

Example:

Approaching vehicle speed	A Approximate alert distance
34 mph (56 km/h) (fast)	98 ft. (30 m)
5 mph (8 km/h) (slow)	13 ft. (4 m)

**■ The RCTA function is operational when**

The RCTA function operates when all of the following conditions are met:

- The engine switch is ON.
- The RCTA function is on.
- The shift position is in R.
- The vehicle speed is less than approximately 9 mph (15 km/h).
- The approaching vehicle speed is between approximately 5 mph (8 km/h) and 34 mph (56 km/h).

**■ Setting the buzzer volume**

The volume of the RCTA buzzer can be adjusted through a customize setting. (→P.538)

The buzzer volume of the RCTA, intuitive parking assist (if equipped) and RCD (if equipped) can be adjusted all together through a customize setting. (→P.538)

**■ Muting a buzzer temporarily**

When an object is detected, the temporary mute switch is displayed on the Multimedia Display. Select the switch to mute the buzzer of the intuitive parking assist (if equipped), RCTA, and RCD (if equipped) all together.

Mute will be canceled automatically in the following situations:

- When the shift position is changed.
- When the vehicle speed exceeds a certain speed.
- When there is a malfunction in a

sensor or the system is temporarily unavailable.

- When the operating function is disabled manually.
- When the engine switch is turned off.

**■ Conditions under which the system will not detect a vehicle**

The RCTA function is not designed to detect the following types of vehicles and/or objects:

- Vehicles approaching from directly behind
- Vehicles backing up in a parking space next to your vehicle
- Vehicles that the sensors cannot detect due to obstructions

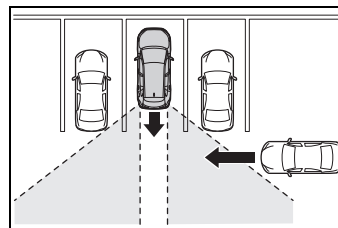

- Guardrails, walls, signs, parked vehicles and similar stationary objects\*
- Small motorcycles, bicycles, pedestrians, etc.\*
- Vehicles moving away from your vehicle
- Vehicles approaching from the parking spaces next to your vehicle\*
- The distance between the sensor and approaching vehicle gets too close

\*: Depending on the conditions, detection of a vehicle and/or object may occur.

**■ Situations in which the system may not operate properly**

The RCTA function may not detect vehicles correctly in the following

situations:

- When the sensor is misaligned due to a strong impact to the sensor or its surrounding area
- When mud, snow, ice, a sticker, etc., is covering the sensor or surrounding area on the position above the rear bumper
- When driving on a road surface that is wet with standing water during bad weather, such as heavy rain, snow, or fog
- When multiple vehicles are approaching with only a small gap between each vehicle
- When a vehicle is approaching at high speed
- When equipment that may obstruct a sensor is installed, such as a towing eyelet, bumper protector (an additional trim strip, etc.), bicycle carrier, or snow plow
- When backing up on a slope with a sharp change in grade

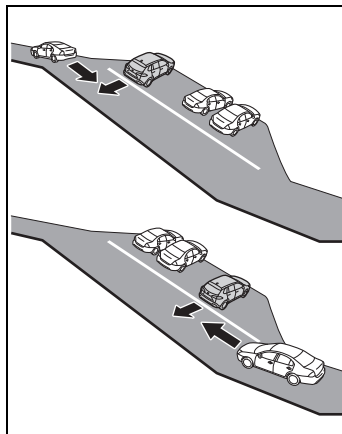

- When backing out of a sharp angle parking spot

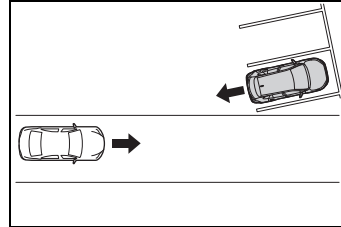

- Immediately after the RCTA function is turned on
- Immediately after the engine is started with the RCTA function on
- When the sensors cannot detect a vehicle due to obstructions
- When towing with the vehicle
- When there is a significant difference in height between your vehicle and the vehicle that enters the detection area
- When a sensor or the area around a sensor is extremely hot or cold
- If the suspension has been modified or tires of a size other than specified are installed
- If the front of the vehicle is raised or lowered due to the carried load
- When turning while backing up

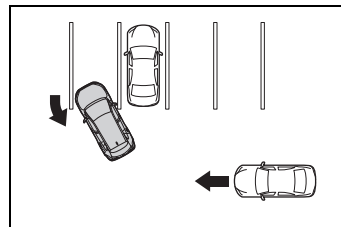

- When a vehicle turns into the detection area

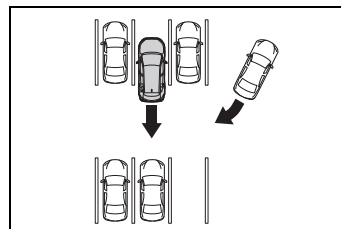

■ **Situations in which the system may operate even if there is no possibility of a collision**

Instances of the RCTA function unnecessarily detecting a vehicle and/or object may increase in the following situations:

- When the parking space faces a street and vehicles are being driven on the street

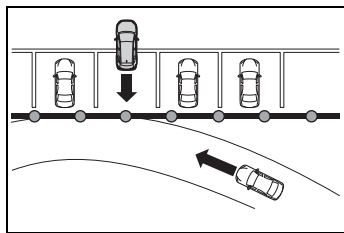

- When the distance between your vehicle and metal objects, such as a guardrail, wall, sign, or parked vehicle, which may reflect electrical waves toward the rear of the vehicle, is short

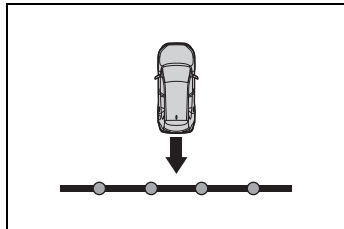

- When equipment that may obstruct a sensor is installed, such as a towing eyelet, bumper protector (an additional trim strip, etc.), bicycle carrier, or snow plow
- When a vehicle passes by the side of your vehicle

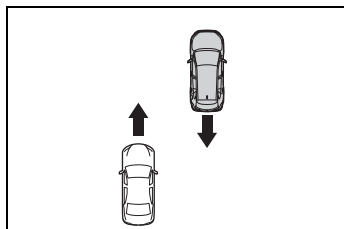

- When a detected vehicle turns

while approaching the vehicle

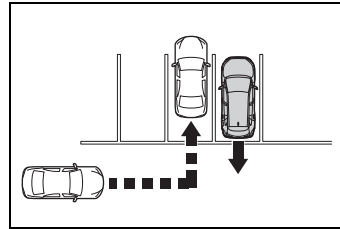

- When there are spinning objects near your vehicle such as the fan of an air conditioning unit
- When water is splashed or sprayed toward the rear bumper, such as from a sprinkler
- Moving objects (flags, exhaust fumes, large rain droplets or snowflakes, rain water on the road surface, etc.)
- When the distance between your vehicle and a guardrail, wall, etc., that enters the detection area is short
- Gratings and gutters
- When a sensor or the area around a sensor is extremely hot or cold
- If the suspension has been modified or tires of a size other than specified are installed
- If the front of the vehicle is raised or lowered due to the carried load
- When towing with the vehicle.

### RCD (Rear Camera Detection)\*

\*: If equipped

**When the vehicle is backing up, the rear camera detection function can detect pedestrians in the detection area behind the vehicle. If a pedestrian is detected, a buzzer will sound and an icon will be displayed on the Multimedia Display to inform the driver of the pedestrian.**

#### WARNING

##### ■ Cautions regarding the use of the system

The recognition and control capabilities for this system are limited.

The driver should always drive safely by always being responsible without over relying on the system and have a understanding of the surrounding situations.

##### ■ To ensure the system can operate properly

Observe the following, otherwise there is the danger that could lead to an accident.

- Always clean the camera without damaging it.
- Do not install market electronic parts (such as illuminated license plate, fog lamps, etc.) in the camera vicinity.

- Do not subject the camera vicinity to strong impacts. If the vicinity is subjected to a strong impact, have the vehicle inspected by your Toyota dealer.
- Do not disassemble, remodel or paint the camera.
- Do not attach accessories or stickers to the camera.
- Do not install market protection parts (bumper trim, etc.) to the rear bumper.
- Maintain suitable tire air pressure.
- Make sure the back door is completely closed.

##### ■ RCD function is turned off

In the following situations the system turns off. The RCD function may not operate properly and thus there is the danger that an accident may occur.

- The contents mentioned above are not observed.
- Suspensions other than the genuine parts are installed.

### System component

Location of the rear camera

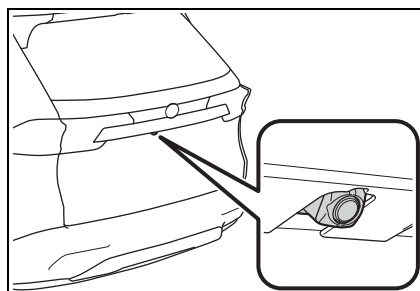

**RCD display**

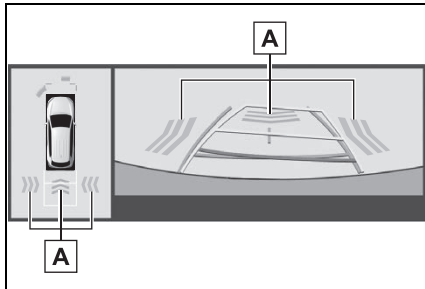

**A** Pedestrian detection icon  
Displayed automatically when a pedestrian is detected behind the vehicle.

**Turning the RCD function on/off**

The RCD function can be enabled/disabled through a customize setting. (→P.538)

When the RCD function is disabled, the driving assist information indicator (→P.78) illuminates, and a message is displayed on the multi-information display.

Each time the engine switch is turned off then changed to ON, the RCD function will be enabled automatically.

**When a pedestrian is detected**

If a pedestrian is in the area behind the vehicle or if the rear camera detected that a pedestrian is approaching the vehicle

from behind, the system urges caution from the driver by sounding the buzzer and displaying the detection of a pedestrian on the Multimedia Display as follows:

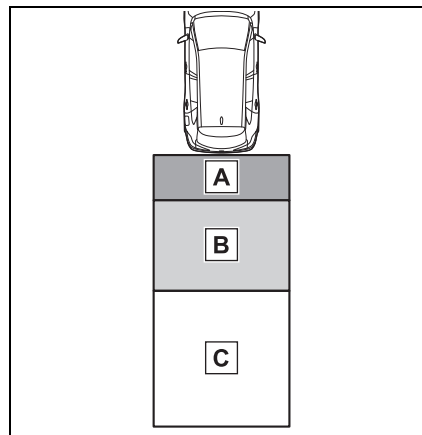

**A** If a pedestrian is detected in area **A**  
Buzzer: Sounds repeatedly  
Pedestrian detection icon: Blinks

**B** If a pedestrian is detected in area **B**  
Buzzer (When the vehicle is stationary): Sounds 3 times  
Buzzer (When the vehicle is backing up, when a pedestrian approaches the rear of the vehicle): Sounds repeatedly  
Pedestrian detection icon: Blinks

**C** If the system determines that your vehicle may collide with a pedestrian in area **C**  
Buzzer: Sounds repeatedly

Pedestrian detection icon:  
Blinks

■ **The rear camera detection function is operational when**

- The engine switch is in ON.
- RCD function is on.
- The shift position is in R.

■ **Setting the buzzer volume**

The buzzer volume of the intuitive parking assist, RCTA, and RCD can all be changed at once from the customize settings. (→P.538)

■ **Muting a buzzer temporarily**

When an object is detected, the temporary mute switch is displayed on the Multimedia Display. Select the switch to mute a buzzer of the intuitive parking assist, RCTA, and RCD all together.

Mute will be automatically canceled in the following situations:

- When the shift position is changed.
- When the vehicle speed exceeds a certain speed.
- When there is a malfunction in a sensor or the system is temporarily unavailable.
- When the operating function is disabled manually.
- When the engine switch is turned off.

■ **Situations in which the system may not operate properly**

- Some pedestrians, such as the following, may not be detected by the rear camera detection function, preventing the function from operating properly:
  - Pedestrians who are bending forward or squatting
  - Pedestrians who are lying down
  - Pedestrians who are running
  - Pedestrians who suddenly appear from the shadow of the vehicle or a building

- Pedestrians who are riding moving objects such as a bicycle or skateboard
- Pedestrians wearing oversized clothing such as a rain coat, long skirt, etc., making their silhouette obscure
- Pedestrians whose body is partially hidden by an object, such as a cart or umbrella
- Pedestrians which are obscured by darkness, such as at night
- In some situations, such as the following, pedestrians may not be detected by the rear camera detection function, preventing the function from operating properly:
  - When backing up in inclement weather (rain, snow, fog, etc.)
  - The lens is dirty (by dirt or snow-melting agent, etc.) or scratched
  - When a very bright light, such as the sun, or the headlights of another vehicle, shines directly into the rear camera
  - When backing up in a place where the surrounding brightness changes suddenly, such as at the entrance or exit of a garage or underground parking lot
  - When backing up in a dim environment such as during dusk or in an underground parking lot
  - When the camera position and direction are deviated
  - When a towing hook is attached
  - When water droplets are flowing on the camera lens
  - When the vehicle height is extremely changed (nose up, nose down, etc.)
  - When tire chains or an emergency tire puncture repair kit are used
  - When the suspension has been lowered or tires that have a different size than the genuine tires are installed
  - When an aftermarket electronic part (backlit license plate, fog light, etc.) is installed near the rear camera
  - If a bumper protector, such as an additional trim strip, is installed to



- the rear bumper
- When towing with the vehicle
- **Situations in which the system may operate unexpectedly**
- Even though there are no pedestrians in the detection area, some objects, such as the following, may be detected, possibly causing the rear camera detection function to operate.
  - Three dimensional objects, such as a pole, traffic cone, fence, or parked vehicle
  - Moving objects, such as a car or motorcycle
  - Objects moving toward your vehicle when backing up, such as flags or puddles (or airborne matter, such as smoke, steam, rain, or snow)
  - Cobblestone or gravel roads, tram rails, road repairs, white lines, pedestrian crossings or fallen leaves on the road
  - Metal covers (gratings), such as those used for drainage ditches
  - Objects reflected in a puddle or on a wet road surface
  - Shadows on the road
- In some situations, such as the following, the rear camera detection function may operate even though there are no pedestrians in the detection area.
  - When backing up toward the road-side or a bump on the road
  - When backing up toward an incline/decline
  - When the vehicle height is extremely changed (nose up, nose down, etc.)
  - When an aftermarket electronic part (backlit license plate, fog light, etc.) is installed near the rear camera
  - If a bumper protector, such as an additional trim strip, is installed to the rear bumper
  - If the orientation of the rear camera has been changed due to a collision or other impact, or removal and installation
  - If a towing eyelet is installed to the rear of the vehicle
- When water is flowing over the rear camera lens
- The lens is dirty (by dirt or snow-melting agent, etc.)
- If there is a flashing light in the detection area, such as the emergency flashers of another vehicle
- When tire chains or an emergency tire puncture repair kit are used
- When towing with the vehicle
- Situations in which the rear camera detection function may be difficult to notice
  - The buzzer may be difficult to hear if the surrounding area is noisy or the audio system volume is high.
  - If the temperature in the cabin is extremely high or low, the Multimedia Display may not operate correctly.

### PKSB (Parking Support Brake)\*

\*: If equipped

**The PKSB (Parking Support Brake) is a system that issues warnings and automatically performs braking to help reduce collision damage with operation targets that were detected when traveling at a low speed such as when parking.**

### PKSB (Parking Support Brake) system

The system has detected the following as operation targets. (The operation targets vary depending on the function.)

- Parking Support Brake function (static objects front and rear of the vehicle): →P.342
- Parking Support Brake function (moving vehicles rear of the vehicle): →P.345
- Parking Support Brake function (pedestrians rear of the vehicle): →P.346

### WARNING

#### ■ Cautions regarding the use of the system

Do not overly rely on the system, as doing so may lead to an accident. Always drive while checking the safety of the surroundings of the vehicle.

Depending on the vehicle and road conditions, weather, etc., the system may not operate.

The detection capabilities of sensors and radars are limited.

Always drive while checking the safety of the surroundings of the vehicle.

- The driver is solely responsible for safe driving. Always drive carefully, taking care to observe your surroundings. The Parking Support Brake system is designed to provide support to lessen the severity of collisions. However, it may not operate in some situations.

- The Parking Support Brake system is not designed to stop the vehicle completely. Additionally, even if the system has stopped the vehicle, it is necessary to depress the brake pedal immediately as brake control will be canceled after approximately 2 seconds.

- It is extremely dangerous to check the system operations by intentionally driving the vehicle into the direction of a wall, etc. Never attempt such actions.

#### ■ When to disable the Parking Support Brake

In the following situations, disable the Parking Support Brake as the system may operate even though there is no possibility of a collision.

**⚠ WARNING**

- When inspecting the vehicle using a chassis roller, chassis dynamo or free roller
- When loading the vehicle onto a boat, truck or other transport vessel
- If the suspension has been modified or tires of a size other than specified are installed
- If the front of the vehicle is raised or lowered due to the carried load
- When equipment such as a towing hook, transport hook, bumper protector, bumper trim, bicycle carrier or snow-removal device (snow plow) is installed near the sensor
- When using automatic car washing devices
- If the vehicle cannot be driven in a stable manner, such as when the vehicle has been in an accident or is malfunctioning
- When the vehicle is driven in a sporty manner or off-road
- When the tires are not properly inflated
- When the tires are very worn
- When tire chains, a compact spare tire or an emergency tire puncture repair kit are used.
- When towing with the vehicle

**■ Precautions for the suspension**

Do not modify the suspension of the vehicle. If the height or tilt of the vehicle is changed, the sensors may not be able to detect detectable objects and the system may not operate correctly, possibly leading to an accident.

**Enabling/Disabling the Parking Support Brake**

The Parking Support Brake function can be enabled/disabled through a customize setting. (→P.538)

When the PKSB (Parking Support Brake) is disabled, the driving assist information indicator (→P.78) illuminates, and a message is displayed on the multi-information display. If the system switches to OFF (disabled) and the PKSB (Parking Support Brake) is stopped, the PKSB (Parking Support Brake) will not be re-enabled until ON (enabled) is selected again from the customize setting (→P.538). (It remains off even if the engine switch is turned to ON again after the engine switch has been turned off.)

**Display and buzzer for engine output restriction control and brake control**

If the engine output restriction control or brake control operates, a

buzzer will sound and a message will be displayed on the Multimedia Display and multi-information display, to alert the driver.

Depending on the situation, output restriction control operates to either limit acceleration or restrict output as much as possible.

- Engine output restriction control is operating (acceleration restriction)

Acceleration greater than a certain amount is restricted by the system.

Multimedia Display: No warning displayed

Multi-information display: "Object Detected Acceleration Reduced"

Driving assist information indicator: Not illuminated

Buzzer: Does not sound

- Engine output restriction control is operating (output restricted as much as possible)

The system has determined that stronger-than-normal brake operation is necessary.

Multimedia Display (vehicles with a panoramic view monitor or Toyota parking assist monitor with RCD [Rear Camera Detection]): A display urging to operate the brakes

Multi-information display: A display urging to operate the brakes

Driving assist information indicator: Not illuminated

Buzzer: Short beep

- Brake control is operating

The system determined that emer-

gency braking is necessary.

Multimedia Display (vehicles with a panoramic view monitor or Toyota parking assist monitor with RCD [Rear Camera Detection]): A display urging to operate the brakes

Multi-information display: A display urging to operate the brakes

Driving assist information indicator: Not illuminated

Buzzer: Short beep

- Vehicle stopped by system operation

The vehicle has been stopped by brake control operation.

Multimedia Display (vehicles with a panoramic view monitor or Toyota parking assist monitor with RCD [Rear Camera Detection]): "Switch to Brake"

Multi-information display: "Accelerator Pedal is Pressed Press Brake Pedal"

If the accelerator pedal is not depressed, "Press Brake Pedal" will be displayed.

Driving assist information indicator: Illuminated

Buzzer: Sounds repeatedly

### System overview

If the Parking Support Brake determines that a collision with a detected object or pedestrian is possible, the engine output will be restricted to restrain any increase in the vehicle speed. (Engine output restriction control: See figure 2 below.)

Additionally, if the accelerator pedal continues to be depressed, the brakes will be applied automatically to reduce the vehicle speed. (Brake control: See figure 3.)

- Figure 1: When the PKSB (Parking Support Brake) is not operating

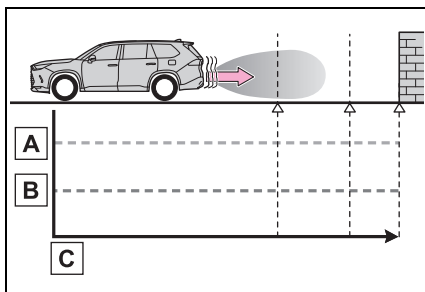

- A Engine output
- B Braking force
- C Time

- Figure 2: When engine output restriction control operates

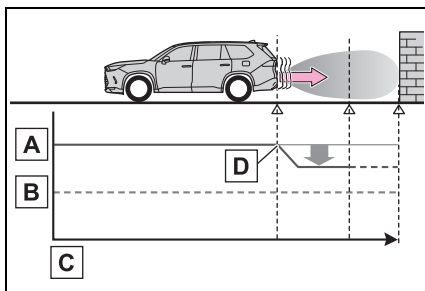

- A Engine output
- B Braking force
- C Time
- D Engine output restriction control begins operating (System

determines that possibility of collision with detected object is high)

- Figure 3: When engine output restriction control and brake control operates

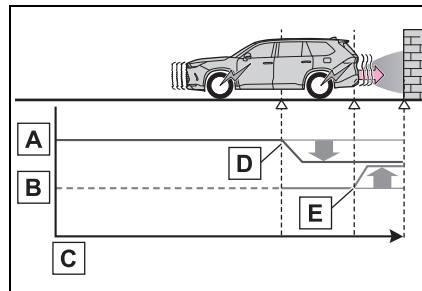

- A Engine output
- B Braking force
- C Time
- D Engine output restriction control begins operating (System determines that possibility of collision with detected object is high)
- E Brake control begins operating (System determines that possibility of collision with detected object is extremely high)

■ If the Parking Support Brake has operated

If the vehicle is stopped due to operation of the Parking Support Brake, the Parking Support Brake will be disabled and the driving assist information indicator will illuminate.

In addition, even when the PKSB (Parking Support Brake) operates, the brake control is canceled after approximately 2 seconds to start off.

Furthermore, the brake control also

can be canceled by depressing the brake pedal. Depressing the accelerator pedal again after that allows the vehicle to start off.

#### ■ Re-enabling the Parking Support Brake

To re-enable the Parking Support Brake when it is disabled due to operation of the PKSB (Parking Support Brake), either enable the system again, or turn the engine switch off and then back to ON.

Additionally, if any of the following conditions are met, the system will be re-enabled automatically and the driving assist information indicator will turn off (→P.78) :

- The P shift position is selected
- Drive with no operation targets in the traveling direction of the vehicle
- Change the traveling direction of the vehicle

#### ■ Buzzer

Regardless of whether the intuitive parking assist sensor is enabled or not (→P.323), if the PKSB (Parking Support Brake) system is enabled (→P.339), the buzzer will sound to notify the driver of the approximate distance to the object when the brake control and the engine output restriction control are operated.

Parking Support Brake function (static objects front and rear of the vehicle)\*

\*: If equipped

**If the sensors detect a static object, such as a wall, in the traveling direction of the vehicle and the system determines that a collision may occur due to the vehicle suddenly moving forward due to an accidental accelerator pedal operation, the vehicle moving the unintended direction due to the wrong shift position being selected, or while parking or traveling at low speeds, the system will operate to lessen the impact with the detected static object and reduce the resulting damage.**

**Examples of function operation (static objects front and rear of the vehicle)**

This function will operate in situations such as the following if an object is detected in the traveling direction of the vehicle.

- When traveling at a low speed and the brake pedal is not depressed, or is depressed late

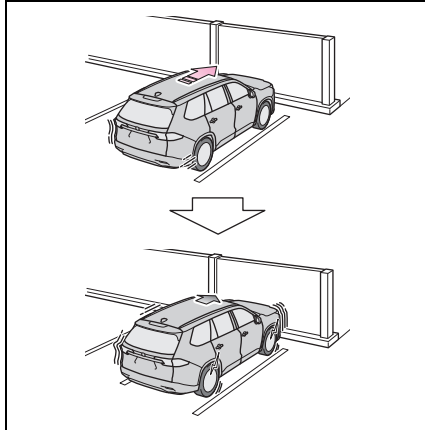

- When the accelerator pedal is depressed excessively

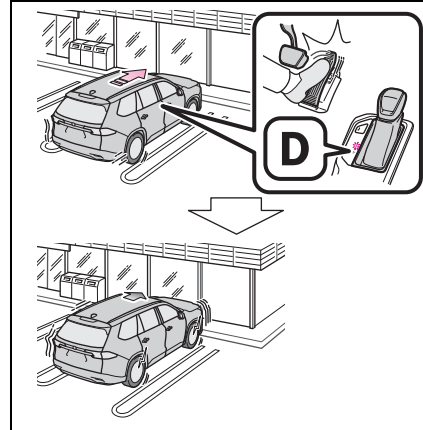

### Types of sensors

→P.322

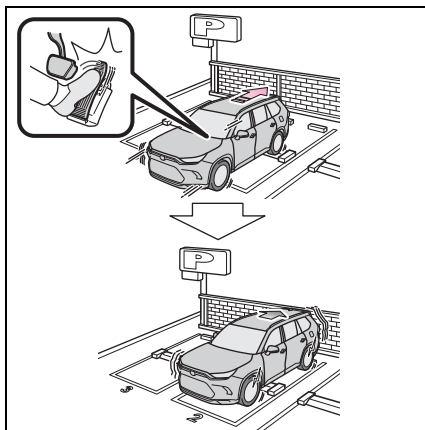

- When the vehicle moves forward due to the incorrect shift position being selected

### ! WARNING

■ To ensure the system can operate properly

→P.323

■ If the Parking Support Brake function operates unnecessarily, such as at a railroad crossing

→P.340

■ Notes when washing the vehicle

→P.323

### ■ The Parking Support Brake function (static objects front and rear of the vehicle) will operate when

The function will operate when the driving assist information indicator is not illuminated (→P.77, 78) and all of the following conditions are met:

- Engine output restriction control
- The Parking Support Brake is enabled.
- The vehicle speed is approximately 9 mph (15 km/h) or less.

- There is a static object in the traveling direction of the vehicle and approximately 6 to 13 ft. (2 to 4 m) away.
- The Parking Support Brake determines that a stronger-than-normal brake operation is necessary to avoid a collision.
- Brake control
- Engine output restriction control is operating.
- The Parking Support Brake determines that an immediate brake operation is necessary to avoid a collision.

■ **The Parking Support Brake function (static objects front and rear of the vehicle) will stop operating when**

The function will stop operating if any of the following conditions are met:

- Engine output restriction control
- The Parking Support Brake is disabled.
- The system determines that the collision has become avoidable with normal brake operation.
- The static object is no longer approximately 6 to 13 ft. (2 to 4 m) away from the vehicle or in the traveling direction of the vehicle.
- Brake control
- The Parking Support Brake is disabled.
- Approximately 2 seconds have elapsed since the vehicle was stopped by brake control.
- The brake pedal is depressed after the vehicle is stopped by brake control.
- The static object is no longer approximately 6 to 13 ft. (2 to 4 m) away from the vehicle or in the traveling direction of the vehicle.

■ **Detection range of the Parking Support Brake function (static objects front and rear of the vehicle)**

The detection range of the Parking Support Brake function (static

objects front and rear of the vehicle) differs from the detection range of the intuitive parking assist (→P.326). Therefore, even if the intuitive parking assist detects an object and provides a warning, the Parking Support Brake function (static objects front and rear of the vehicle) may not start operating.

■ **Situations in which the system may not operate properly**

→P.325

■ **Situations in which the system may operate even if there is no possibility of a collision**

→P.325



**Parking Support Brake function (moving vehicles rear of the vehicle)\***

\*: If equipped

**If a rear radar sensor detects a vehicle approaching from the right or left at the rear of the vehicle and the system determines that the possibility of a collision is high, this function will perform brake control to reduce the likelihood of an impact with the approaching vehicle.**

**Examples of the function operation**

This function will operate in situations such as the following if a vehicle is detected in the traveling direction of the vehicle.

- When reversing, a vehicle is approaching and the brake pedal is not depressed, or is depressed late

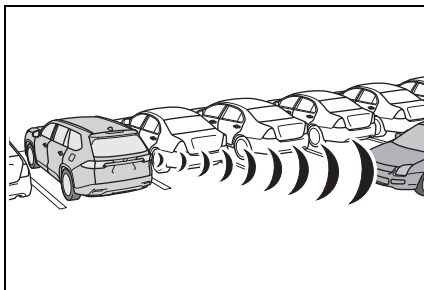

**Types of sensors**

→P.314

**WARNING**

**To ensure the system can operate properly**

→P.314

**The Parking Support Brake function (moving vehicles rear of the vehicle) will operate when**

The function will operate when the driving assist information indicator is not illuminated (→P.77, P.78) and all of the following conditions are met:

- Engine output restriction control
- The Parking Support Brake is enabled.
- The vehicle speed is approximately 9 mph (15 km/h) or less.
- Vehicles are approaching from the right or left at the rear of the vehicle at a traveling speed of approximately 5 mph (8 km/h) or more.
- The shift position is in R.
- The Parking Support Brake determines that a stronger than normal brake operation is necessary to avoid a collision with an approaching vehicle.
- Brake control
- Engine output restriction control is operating.
- The Parking Support Brake determines that an emergency brake operation was necessary to avoid a collision with a vehicle approaching from the rear.

**The Parking Support Brake function (moving vehicles rear of the vehicle) will stop operating when**

The function will stop operating if any of the following conditions are met:

- Engine output restriction control

- The Parking Support Brake is disabled.
- The collision becomes avoidable with normal brake operation.
- A vehicle is no longer approaching from the right or left at the rear of the vehicle.

- Brake control
- The Parking Support Brake is disabled.
- Approximately 2 seconds have elapsed since the vehicle was stopped by brake control.
- The brake pedal is depressed after the vehicle is stopped by brake control.

■ **Situations in which the system may not operate properly**

→P.331

■ **Situations in which the system may operate even if there is no possibility of a collision**

→P.333

**Parking Support Brake function (pedestrians rear of the vehicle)\***

\*: If equipped

**If the rear camera sensor detects a pedestrian behind the vehicle while backing up and the system determines that the possibility of colliding with the detected pedestrian is high, a buzzer will sound. If the system determines that the possibility of colliding with the detected pedestrian is extremely high, the brakes will be applied automatically to help reduce the impact of the collision.**

**Examples of system operation**

The system operates when an approaching pedestrian is detected behind the vehicle while backing up, and when the brake pedal is not depressed or is depressed late.

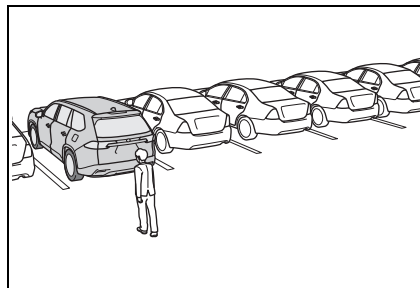

**Screen display of pedestrians rear of the vehicle**

Displays a message to urge the driver to take evasive action when a pedestrian is detected in the detection area behind the vehicle.

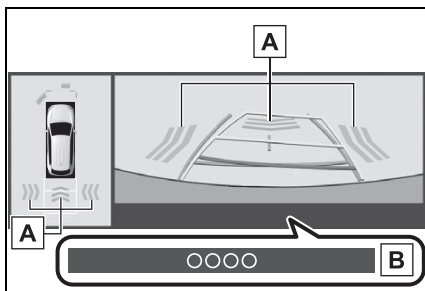

- A** Pedestrian detection icon
- B** Brake reminder

**⚠ WARNING**

■ **If the Parking Support Brake function (pedestrians rear of the vehicle) operates unnecessarily**

Depress the brake pedal immediately after the Parking Support Brake function (pedestrians rear of the vehicle) operates. (Operation of the function is canceled by depressing the brake pedal.)

■ **Correct use of the Parking Support Brake function (pedestrians rear of the vehicle)**

→P.334

■ **The Parking Support Brake function (pedestrians rear of the vehicle) will operate when**

The function will operate when the driving assist information indicator is not illuminated (→P.76, 477) and all

of the following conditions are met:

- Engine output restriction control
- The Parking Support Brake is enabled.
- The vehicle speed is 9 mph (15 km/h) or less.
- The shift position is in R.
- When a pedestrian is to the rear of the vehicle
- The PKSB (Parking Support Brake) determines that a stronger than-normal-brake operation is necessary to avoid a collision.
- Brake control
- Engine output restriction control is operating.
- The Parking Support Brake determines that an emergency brake operation is necessary to avoid a collision with a pedestrian.

■ **The Parking Support Brake function (pedestrians rear of the vehicle) will stop operating when**

The function will stop operating if any of the following conditions are met:

- Engine output restriction control
- The Parking Support Brake is disabled.
- The collision becomes avoidable with normal brake operation.
- The pedestrian is no longer detected behind your vehicle.
- Brake control
- The Parking Support Brake is disabled.
- Approximately 2 seconds have elapsed since the vehicle was stopped by brake control.
- The brake pedal is depressed after the vehicle is stopped by brake control.

■ **Re-enabling the Parking Support Brake function (pedestrians rear of the vehicle)**

→P.342

■ **Detection area of the Parking Support Brake function (pedestrians rear of the vehicle)**

The detection area of the Parking Support Brake function (pedestrians rear of the vehicle) differs from the detection area of the RCD function (→P.335). Therefore, even if the RCD function detects a pedestrian and provides an alert, the Parking Support Brake function (pedestrians rear of the vehicle) may not start operating.

■ **Situations in which the system may not operate properly**

→P.336

■ **Situations in which the system may operate unexpectedly**

→P.337

Driving mode select switch

The driving modes can be selected to suit the driving and usage conditions.

Selecting a driving mode

► Type A

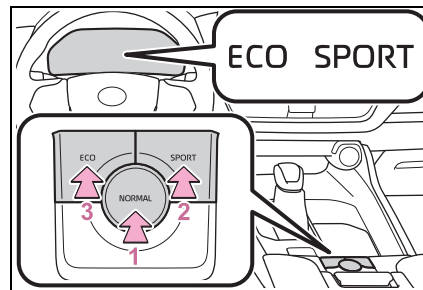

► Type B

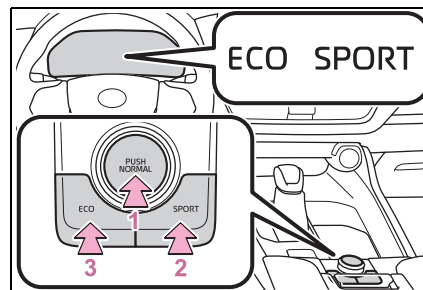

1 Normal mode

Provides an optimal balance of fuel economy, quietness, and dynamic performance. Suitable for normal driving.

2 Sport mode

Controls the transmission and engine to provide quick, powerful acceleration. This mode also changes the steering feel, making it suitable for when agile driving

response is desired, such as when driving on roads with many curves. When Sport mode is selected, Sport mode indicator comes on.

**3 Eco drive mode**

Helps the driver accelerate in an eco-friendly manner and improve fuel economy through moderate throttle characteristics and by controlling the operation of the air conditioning system (heating/cooling). When Eco drive mode is selected, Eco drive mode indicator comes on.

**■ When changing to a driving mode other than normal mode (AWD vehicles)**

The AWD control switches to that suitable for the selected driving mode.

**■ Air conditioning system operation in Eco drive mode**

In Eco drive mode, heating/cooling operations and the fan speed is controlled to improve fuel efficiency. Perform the following procedures to increase the air conditioning performance.

- Turn eco air conditioning mode off (→P.374)
- Adjust the fan speed (→P.369, 377)
- Cancel Eco drive mode

**■ Canceling a driving mode**

- Sport mode is automatically canceled and the driving mode returns to normal mode when the engine switch is turned off.
- Normal mode and Eco drive mode are not canceled until another driving mode is selected. (Even if the engine switch is turned off, normal mode and Eco drive mode will not be automatically canceled.)

**Multi-terrain Select (AWD models)**

**Multi-terrain Select is designed to control AWD, brake and driving force systems in accordance with the road condition.**

**Use the system when driving over muddy, sandy or rough road surfaces.**

**Control in each mode**

Select a mode that is appropriate for the road condition.

**■ Mud & Sand mode**

Suitable for driving on roads with increased driving resistance in which tires could become stuck, such as sandy roads, muddy roads, etc.

**■ Rock & Dirt mode**

Suitable for driving on bumpy roads, such as on unpaved forest roads.

**■ Normal mode**

Suitable for normal driving. Use Normal mode when not driving off-road.

**Changing the mode**

▶ Push type

Pressing the switch switches the mode as follows:

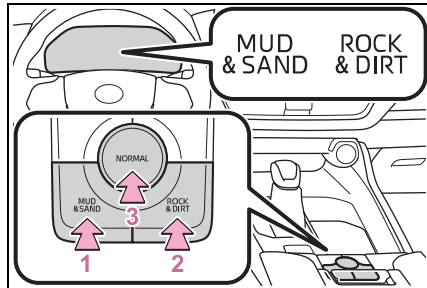

- 1 Switches to Mud & Sand mode
- 2 Switches to Rock & Dirt mode
- 3 Switches to Normal mode

► Dial type

Operating the dial switch switches the mode as follows:

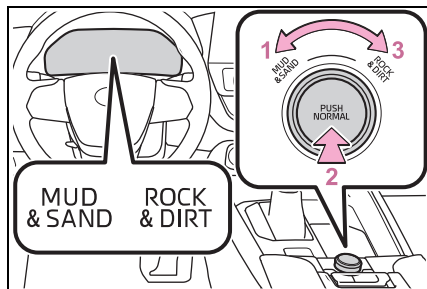

- 1 Switches to Mud & Sand mode
- 2 Switches to Normal mode
- 3 Switches to Rock & Dirt mode

When the mode is switched, the state of the indicator/warning light will change as follows:

- Mud & Sand mode

Mud & Sand mode indicator, VSC OFF indicator and PCS warning light illuminate.

- Rock & Dirt mode

Rock & Dirt mode indicator illuminates.

- Normal mode

The indicators and/or warning lights above turn off.

■ Multi-terrain Select

- Multi-terrain Select is intended for use when driving on rough roads. Drive in Normal mode during normal driving.
- The Mud & Sand and Rock & Dirt modes control the vehicle so that it can maximize the drive force and improve the drive force on rough roads. As a result, fuel efficiency may diminish when compared to driving in Normal mode.

■ When Multi-terrain Select brake control is operating

- The slip indicator flashes when Multi-terrain Select brake control is operating.

■ AWD control for Mud & Sand and Rock & Dirt modes

If the vehicle speed exceeds the speeds listed below, the same level of AWD control for Normal mode is performed, even if Mud & Sand or Rock & Dirt mode is selected.

- Mud & Sand mode: Vehicle speed is approximately 25mph (40 km/h) or more
- Rock & Dirt mode: Vehicle speed is approximately 16mph (25 km/h) or more

If the vehicle speed drops below the above speeds, the system automatically returns to the AWD control for each mode.

■ When “Traction Control Turned OFF” is displayed on the multi-information display

Multi-terrain Select brake control is temporarily stopped due to overheat of the brakes.

Stop the vehicle in a safe location as

soon as possible and wait until the message disappears from the multi-information display.

■ **When the system switches to Normal mode automatically**

In the following situations, the system switches to Normal mode automatically:

- When the driving mode is changed (→P.348)
- When the engine switch is turned off

■ **Sounds and vibrations when driving in Mud & Sand or Rock & Dirt mode**

Any of the following conditions may occur when Multi-terrain Select is operating. None of these indicates that a malfunction has occurred:

- Vibrations may be felt throughout the vehicle or steering wheel
- Sounds may be heard from the engine compartment

■ **When the slip indicator illuminates**

The system may be malfunctioning. Have the vehicle inspected by your Toyota dealer immediately.

■ **When the indicator for each mode does not illuminate**

The system may be malfunctioning if the indicator does not illuminate when selecting the mode other than Normal mode. Have the vehicle inspected by your Toyota dealer immediately.

- Check that the Mud & Sand and Rock & Dirt indicators are illuminated before driving.
- Multi-terrain Select is not intended to expand the limit performance of the vehicle. Thoroughly check the road conditions and driving route before driving, and drive with caution.

 NOTICE

■ **In order to ensure that Multi-terrain Select operates properly**

Do not continuously use Multi-terrain Select for a long period of time. Depending on the driving conditions, the load on related parts increases and the system may not operate properly.

 **WARNING**

■ **Before using Multi-terrain Select**

Make sure to observe the following precautions. Failure to observe these precautions may result in an unexpected accident.

**Snow mode switch**

**Snow mode can be selected to suit the conditions when driving on slippery road surfaces, such as on snow.**

**System operation**

Press the snow mode switch. When the switch is pressed, the system switches to snow mode and the snow mode indicator illuminates on the multi-information display. When the switch is pressed again, the snow mode indicator turns off.

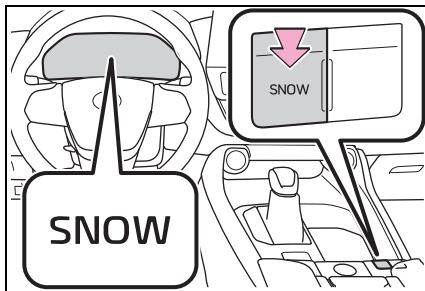

**■ Canceling the snow mode**

Snow mode is automatically canceled when the engine switch is turned OFF or Mud & Sand or Rock & Dirt mode is selected for Multi-terrain Select (AWD models).

**Downhill assist control system (AWD vehicles)**

**The downhill assist control system helps to prevent excessive speed on steep downhill slopes. The system will operate when the vehicle is traveling under 18 mph (30 km/h) with the accelerator and brake pedals released.**

**System operation**

Press the downhill assist control switch. The downhill assist control system indicator will come on and the system will operate. When the system is in operation, the slip indicator will flash, and the stop lights/high mounted stop lights will be lit. A sound may also occur during the operation. This does not indicate a malfunction.

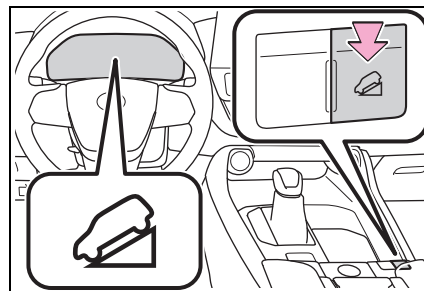

**Turning off the system**

Press the downhill assist control switch while the system is in



operation.

The downhill assist control system indicator will flash as the system gradually ceases operation, and will turn off when the system is fully off. Press the downhill assist control switch while the downhill assist control system indicator is flashing to start the system again.

■ **Operating tips**

The system will operate when the shift position is in a 1 range of M mode or R.

■ **If the downhill assist control system indicator flashes**

- In the following situations, the indicator flashes and the system will not operate:
  - The shift position is in a position other 1 range of M mode or R.
  - The accelerator or brake pedal is depressed.
  - The vehicle speed exceeds approximately 15 mph (25 km/h).
  - The brake system overheats.
- In the following situation, the indicator flashes to alert the driver, but the system will operate:
  - The downhill assist control switch is turned off while the system is operating.

The system will gradually ceases operation. The indicator will flash during operation, and then go off when the system is fully off.

■ **When the downhill assist control system is operated continuously**

This may cause the brake actuator to overheat. In this case, the downhill assist control system will stop operating, a buzzer will sound and the downhill assist control system indicator will start flashing, and the “Traction Control Turned OFF” will be shown on the multi-information

display. Refrain from using the system until the downhill assist control system indicator stays on and the “Traction Control Turned OFF” goes off. (The vehicle can be driven normally during this time.)

■ **Sounds and vibrations caused by the downhill assist control system**

- A sound may be heard from the engine compartment when the engine is started or just after the vehicle begins to move. This sound does not indicate that a malfunction has occurred in downhill assist control system.
- Either of the following conditions may occur when the downhill assist control system is operating. None of these are indicators that a malfunction has occurred.
  - Vibrations may be felt through the vehicle body and steering.
  - A motor sound may be heard after the vehicle comes to a stop.

■ **System malfunction**

In the following cases, have your vehicle checked by your Toyota dealer.

- The downhill assist control system indicator does not come on when the engine switch is turned to ON.
- The downhill assist control system indicator does not come on when the downhill assist control switch is pressed.
- The slip indicator comes on.

 **WARNING**

■ **When using downhill assist control system**

Do not rely overmuch on the downhill assist control system. This function does not extend the vehicle’s performance limitations. Always thoroughly check the road conditions, and drive safely.

 **WARNING**

■ **Situations in which the system may not operate properly**

The system may not operate on the following surfaces, which may lead to an accident causing death or serious injury.

- Slippery surfaces such as wet or muddy roads
- Icy surface
- Unpaved roads

**Driving assist systems**

**To keep driving safety and performance, the following systems operate automatically in response to various driving situations. Be aware, however, that these systems are supplementary and should not be relied upon too heavily when operating the vehicle.**

**Summary of the driving assist systems**

■ **ABS (Anti-lock Brake System)**

Helps to prevent wheel lock when the brakes are applied suddenly, or if the brakes are applied while driving on a slippery road surface

■ **Brake assist**

Generates an increased level of braking force after the brake pedal is depressed when the system detects a panic stop situation

■ **VSC (Vehicle Stability Control)**

Helps the driver to control skidding when swerving suddenly or turning on slippery road surfaces.

#### ■ **Enhanced VSC (Enhanced Vehicle Stability Control)**

Provides cooperative control of the ABS, TRAC, VSC and EPS. Helps to maintain directional stability when swerving on slippery road surfaces by controlling steering performance.

#### ■ **Trailer Sway Control**

Helps the driver to control trailer sway by selectively applying brake pressure for individual wheels and reducing driving torque when trailer sway is detected.

#### ■ **TRAC (Traction Control)**

Helps to maintain drive power and prevent the drive wheels from spinning when starting the vehicle or accelerating on slippery roads

#### ■ **Active Cornering Assist (ACA)**

Helps to prevent the vehicle from drifting to the outer side by performing inner wheel brake control when attempting to accelerate while turning

#### ■ **Hill-start assist control**

Helps to reduce the backward movement of the vehicle when starting on an uphill

#### ■ **EPS (Electric Power Steering)**

Employs an electric motor to reduce the amount of effort needed to turn the steering

wheel

#### ■ **Dynamic Torque Control AWD system (AWD models)**

Automatically controls the drive system such as to front-wheel drive or AWD (all wheel drive) according to various running conditions including normal driving, during cornering, on a uphill, when starting off, during acceleration, on a slippery roads due to snow or rain, thus contributing to stable operability and driving stability.

#### ■ **The Secondary Collision Brake**

When the SRS airbag sensor detects a collision and the system operates, the brakes and brake lights are automatically controlled to reduce the vehicle speed and help reduce the possibility of further damage due to a secondary collision.

#### ■ **When the TRAC/VSC/Trailer Sway Control systems are operating**

The slip indicator light will flash while the TRAC/VSC/Trailer Sway Control systems are operating.

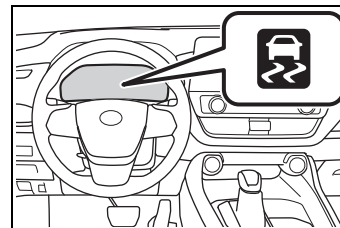

#### ■ **Disabling the TRAC system**

If the vehicle gets stuck in mud, dirt

or snow, the TRAC system may reduce power from the engine to the wheels. Pressing the  switch to turn the system off may make it easier for you to rock the vehicle in order to free it.

To turn the TRAC system off, quickly press and release the  switch.

The “Traction Control Turned OFF” will be shown on the multi-information display.

Press the  switch again to turn the system back on.

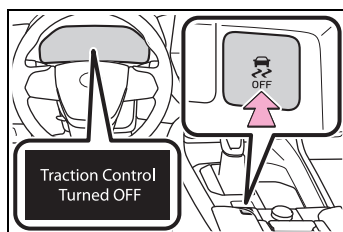

#### ■ Turning off both TRAC, VSC and Trailer Sway Control systems

To turn the TRAC, VSC and Trailer Sway Control systems off, press and hold the  switch for more than 3 seconds while the vehicle is stopped.

The VSC OFF indicator light will come on and the “Traction Control Turned OFF” will be shown on the multi-information display.\*

Press the  switch again to turn the system back on.

\*: On vehicles with PCS (Pre-Collision System), PCS will also be disabled (only Pre-Collision warning is available). The PCS warning light will come on and a message will be displayed on the multi-information display.

(→P.246)

#### ■ When the message is displayed on the multi-information display showing that TRAC has been disabled even if the switch has not been pressed

TRAC is temporary deactivated. If the information continues to show, contact your Toyota dealer.

#### ■ Operating conditions of hill-start assist control

When the following four conditions are met, the hill-start assist control will operate:

- The shift position is in a position other than P or N (when starting off forward/backward on an upward incline)
- The vehicle is stopped
- The accelerator pedal is not depressed
- The parking brake is not engaged
- Engine switch is turned to ON

#### ■ Automatic system cancellation of hill-start assist control

The hill-start assist control will turn off in any of the following situations:

- The shift position is shifted to P or N
- The accelerator pedal is depressed
- The brake pedal is depressed and the parking brake is engaged
- A maximum of 2 seconds have elapsed after the brake pedal is released
- Engine switch is turned to OFF

#### ■ Sounds and vibrations caused by the ABS, brake assist, VSC, Trailer Sway Control, TRAC and hill-start assist control systems

- A sound may be heard from the engine compartment when the brake pedal is depressed repeatedly, when the engine is started or

just after the vehicle begins to move. This sound does not indicate that a malfunction has occurred in any of these systems.

- Any of the following conditions may occur when the above systems are operating. None of these indicates that a malfunction has occurred.
- Vibrations may be felt through the vehicle body and steering.
- A motor sound may be heard also after the vehicle comes to a stop.
- The brake pedal may pulsate slightly after the ABS is activated.
- The brake pedal may move down slightly after the ABS is activated.

#### ■ Active Cornering Assist operation sounds and vibrations

When the Active Cornering Assist is operated, operation sounds and vibrations may be generated from the brake system, but this is not a malfunction.

#### ■ Reduced effectiveness of the EPS system

The effectiveness of the EPS system is reduced to prevent the system from overheating when there is frequent steering input over an extended period of time. The steering wheel may feel heavy as a result. Should this occur, refrain from excessive steering input or stop the vehicle and turn the engine off. The EPS system should return to normal within 10 minutes.

#### ■ Automatic reactivation of TRAC, Trailer Sway Control and VSC systems

After turning the TRAC, Trailer Sway Control and VSC systems off, the systems will be automatically re-enabled in the following situations:

- When the engine switch is turned off
- If only the TRAC system is turned off, the TRAC will turn on when vehicle speed increases

If both the TRAC and VSC systems are turned off, automatic re-enabling will not occur when vehicle speed increases.

#### ■ Operating conditions of Active Cornering Assist

The system operates when the following occurs.

- TRAC/VSC can operate
- The driver is attempting to accelerate while turning
- The system detects that the vehicle is drifting to the outer side
- The brake pedal is released

#### ■ Secondary Collision Brake operating conditions

The system operates when the SRS airbag sensor detects a collision while the vehicle is in motion. However, the system does not operate when the components are damaged.

#### ■ Secondary Collision Brake automatic cancellation

The system is automatically canceled in any of the following situations.

- The vehicle speed drops below approximately 0 mph (0 km/h)
- A certain amount of time elapses during operation
- The accelerator pedal is depressed a large amount

#### ■ If a message about AWD is shown on the multi-information display (AWD models)

Perform the following actions.

- "AWD System Overheated Switching to 2WD Mode"

AWD system is overheated. Stop the vehicle in a safe place with the engine running.\*

If the message disappears after a while, there is no problem. If the message remains, have the vehicle inspected by your Toyota dealer

immediately.

- “AWD System Overheated 2WD Mode Engaged”

AWD system has been temporarily released and switched to front-wheel drive due to overheating. Stop the vehicle in a safe place with the engine running.\*

If the message disappears after a while, AWD system will automatically recover. If the message remains, have the vehicle inspected by your Toyota dealer immediately.

- “AWD System Malfunction 2WD Mode Engaged Visit Your Dealer”

A malfunction occurs in the AWD system. Have the vehicle inspected by your Toyota dealer immediately.

\*: When stopping the vehicle, do not stop the engine until the display message has turned off.



**WARNING**

■ **The ABS does not operate effectively when**

- The limits of tire gripping performance have been exceeded (such as excessively worn tires on a snow covered road).
- The vehicle hydroplanes while driving at high speed on wet or slick roads.

■ **Stopping distance when the ABS is operating may exceed that of normal conditions**

The ABS is not designed to shorten the vehicle's stopping distance. Always maintain a safe distance from the vehicle in front of you, especially in the following situations:

- When driving on dirt, gravel or snow-covered roads
- When driving with tire chains

- When driving over bumps in the road

- When driving over roads with potholes or uneven surfaces

■ **TRAC/VSC may not operate effectively when**

Directional control and power may not be achievable while driving on slippery road surfaces, even if the TRAC/VSC system is operating. Drive the vehicle carefully in conditions where stability and power may be lost.

■ **Active Cornering Assist does not operate effectively when**

- Do not overly rely on Active Cornering Assist. Active Cornering Assist may not operate effectively when accelerating down slopes or driving on slippery road surfaces.

- When Active Cornering Assist frequently operates, Active Cornering Assist may temporarily stop operating to ensure proper operation of the brakes, TRAC and VSC.

■ **Hill-start assist control does not operate effectively when**

- Do not overly rely on hill-start assist control. Hill-start assist control may not operate effectively on steep inclines and roads covered with ice.
- Unlike the parking brake, hill-start assist control is not intended to hold the vehicle stationary for an extended period of time. Do not attempt to use hill-start assist control to hold the vehicle on an incline, as doing so may lead to an accident.

 **WARNING**

■ **When the TRAC/VSC/Trailer Sway Control is activated**

The slip indicator light flashes. Always drive carefully. Reckless driving may cause an accident. Exercise particular care when the indicator light flashes.

■ **When the TRAC/VSC/Trailer Sway Control systems are turned off**

- Be especially careful and drive at a speed appropriate to the road conditions. As these are the systems to help ensure vehicle stability and driving force, do not turn the TRAC/VSC/Trailer Sway Control systems off unless necessary.
- Trailer Sway Control is part of the VSC system and will not operate if VSC is turned off or experiences a malfunction.

■ **Replacing tires**

Make sure that all tires are of the specified size, brand, tread pattern and total load capacity. In addition, make sure that the tires are inflated to the recommended tire inflation pressure level.

The ABS, TRAC, Trailer Sway Control and VSC systems will not function correctly if different tires are installed on the vehicle. Contact your Toyota dealer for further information when replacing tires or wheels.

■ **Handling of tires and the suspension**

Using tires with any kind of problem or modifying the suspension will affect the driving assist systems, and may cause a system to malfunction.

■ **Trailer Sway Control precaution**

The Trailer Sway Control system is not able to reduce trailer sway in all situations. Depending on many factors such as the conditions of the vehicle, trailer, road surface and driving environment, the Trailer Sway Control system may not be effective. Refer to your trailer owner's manual for information on how to tow your trailer properly.

■ **If trailer sway occurs**

Observe the following precautions. Failing to do so may cause death or serious injury.

- Firmly grip the steering wheel. Steer straight ahead. Do not try to control trailer sway by turning the steering wheel.
- Begin releasing the accelerator pedal immediately but very gradually to reduce speed. Do not increase speed. Do not apply vehicle brakes.

If you make no extreme correction with the steering or brakes, your vehicle and trailer should stabilize. (→P.192)

■ **Secondary Collision Brake**

Do not rely solely upon the Secondary Collision Brake. This system is designed to help reduce the possibility of further damage due to a secondary collision, however, that effect changes according to various conditions. Overly relying on the system may result in death or serious injury.

### Winter driving tips

**Carry out the necessary preparations and inspections before driving the vehicle in winter. Always drive the vehicle in a manner appropriate to the prevailing weather conditions.**

#### Preparation for winter

- Use fluids that are appropriate to the prevailing outside temperatures.
- Engine oil
- Engine coolant
- Washer fluid
- Have a service technician inspect the condition of the battery.
- Have the vehicle fitted with four snow tires or purchase a set of tire chains for the front tires\*.

Ensure that all tires are the specified size and brand, and that chains match the size of the tires.

\*: Tire chains cannot be mounted on vehicles with 20-inch tires

#### WARNING

##### ■ Driving with snow tires

Observe the following precautions to reduce the risk of accidents. Failure to do so may result in a loss of vehicle control and cause death or serious injury.

- Use tires of the specified size.

- Maintain the recommended level of air pressure.
- Do not drive in excess of 75 mph (120 km/h), regardless of the type of snow tires being used.
- Use snow tires on all, not just some wheels.

##### ■ Driving with tire chains (vehicles with 18-inch tires)

Observe the following precautions to reduce the risk of accidents. Failure to do so may result in the vehicle being unable to be driven safely, and may cause death or serious injury.

- Do not drive in excess of the speed limit specified for the tire chains being used, or 30 mph (50 km/h), whichever is lower.
- Avoid driving on bumpy road surfaces or over potholes.
- Avoid sudden acceleration, abrupt steering, sudden braking and shifting operations that cause sudden engine braking.
- Slow down sufficiently before entering a curve to ensure that vehicle control is maintained.
- Do not use the LTA (Lane Tracing Assist) system.

#### NOTICE

##### ■ Repairing or replacing snow tires

Request repairs or replacement of snow tires from Toyota dealers or legitimate tire retailers. This is because the removal and attachment of snow tires affects the operation of the tire pressure warning valves and transmitters.



**Before driving the vehicle**

Perform the following according to the driving conditions:

- Do not try to forcibly open a window or move a wiper that is frozen. Pour warm water over the frozen area to melt the ice. Wipe away the water immediately to prevent it from freezing.
- To ensure proper operation of the climate control system fan, remove any snow that has accumulated on the air inlet vents in front of the windshield.
- Check for and remove any excess ice or snow that may have accumulated on the exterior lights, outside rear view mirrors, windows, vehicle's roof, chassis, around the tires or on the brakes.
- Remove any snow or mud from the bottom of your shoes before getting in the vehicle.

**When driving the vehicle**

Accelerate the vehicle slowly, keep a safe distance between you and the vehicle ahead, and drive at a reduced speed suitable to road conditions.

**When parking the vehicle**

- Turn automatic mode of the

parking brake off. Otherwise, the parking brake may freeze and not be able to be released automatically.

Also, avoid using the following as the parking brake may operate automatically, even if automatic mode is off.

- Brake hold system
- Park the vehicle and change the shift position to P without setting the parking brake. The parking brake may freeze up, preventing it from being released. If the vehicle is parked without setting the parking brake, make sure to block the wheels.

Failure to do so may be dangerous because it may cause the vehicle to move unexpectedly, possibly leading to an accident.

- When the parking brake is in automatic mode, release the parking brake after changing the shift position to P. (→P.213)

Turn off the engine switch while pressing the parking brake switch.

- If the vehicle is parked without setting the parking brake, confirm that the shift position cannot be moved out of P.
- If the vehicle is left parked with the brakes damp in cold temperatures, there is a possibility of the brakes freezing.

### Selecting tire chains (vehicles with 18-inch tires)

Use the correct tire chain size when mounting the tire chains. Chain size is regulated for each tire size.

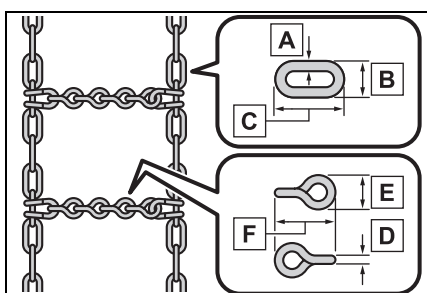

- A** Side chain (0.12 in. [3 mm] in diameter)
- B** Side chain (0.39 in. [10 mm] in width)
- C** Side chain (1.18 in. [30 mm] in length)
- D** Cross chain (0.16 in. [4 mm] in diameter)
- E** Cross chain (0.55 in. [14 mm] in width)
- F** Cross chain (0.98 in. [25 mm] in length)

### Regulations on the use of tire chains (vehicles with 18-inch tires)

Regulations regarding the use of tire chains vary depending on location and type of road. Always check local regulations

before installing chains.

### Tire chain installation (vehicles with 18-inch tires)

Observe the following precautions when installing and removing chains:

- Install and remove tire chains in a safe location.
- Install tire chains on the front tires only. Do not install tire chains on the rear tires.
- Install tire chains on the front tires as tightly as possible. Retighten chains after driving 1/4—1/2 mile (0.5—1.0 km).
- Install tire chains following the instructions provided with the tire chains.

#### NOTICE

#### Fitting tire chains

The tire pressure warning valves and transmitters may not function correctly when tire chains are fitted.

### Windshield wipers

To enable the windshield wipers to be lifted when heavy snow or icy conditions are expected, change the rest position of the windshield wipers from the retracted position below the hood to the service position using the wiper lever. (→P.227)

### Utility vehicle precautions

**This vehicle belongs to the utility vehicle class, which has higher ground clearance and narrower tread in relation to the height of its center of gravity.**

### Utility vehicle feature

- Specific design characteristics give it a higher center of gravity than ordinary passenger cars. This vehicle design feature causes this type of vehicle to be more likely to rollover. And, utility vehicles have a significantly higher rollover rate than other types of vehicles.
- An advantage of the higher ground clearance is a better view of the road allowing you to anticipate problems.
- It is not designed for cornering at the same speeds as ordinary passenger cars any more than low-slung sports cars are designed to perform satisfactorily under off-road conditions. Therefore, sharp turns at excessive speeds may cause the vehicle to roll over.

### WARNING

#### ■ Utility vehicle precautions

Always observe the following precautions to minimize the risk of death, serious injury or damage to your vehicle:

- In a rollover crash, an unbelted person is significantly more likely to die than a person wearing a seat belt. Therefore, the driver and all passengers should always fasten their seat belts.
- Avoid sharp turns or abrupt maneuvers, if at all possible. Failure to operate this vehicle correctly may result in loss of control or vehicle rollover causing death or serious injury.
- Loading cargo on the roof luggage carrier will make the center of the vehicle gravity higher. Avoid high speeds, sudden starts, sharp turns, sudden braking or abrupt maneuvers, otherwise it may result in loss of control or vehicle rollover due to failure to operate this vehicle correctly.
- Always slow down in gusty crosswinds. Because of its profile and higher center of gravity, your vehicle is more sensitive to side winds than an ordinary passenger car. Slowing down will allow you to have better control.
- Do not drive horizontally across steep slopes. Driving straight up or straight down is preferred. Your vehicle (or any similar off-road vehicle) can tip over sideways much more easily than forward or backward.

### Off-road driving

FF models: Your vehicle is not designed to be driven off-road. However, in the event that off-road driving cannot be avoided, please observe the following precautions to help avoid the areas prohibited to vehicles.

AWD models: When driving your vehicle off-road, please observe the following precautions to ensure your driving enjoyment and to help prevent the closure of areas to off-road vehicles:

- Drive your vehicle only in areas where off-road vehicles are permitted to travel.
- Respect private property. Get owner's permission before entering private property.
- Do not enter areas that are closed. Honor gates, barriers and signs that restrict travel.
- Stay on established roads. When conditions are wet, driving techniques should be changed or travel delayed to prevent damage to roads.

#### Additional information for off-road driving

- ▶ For owners in U.S. mainland, Hawaii and Puerto Rico:

To obtain additional information pertaining to driving your vehicle off-road, consult the following organizations.

- State and Local Parks and Recreation Departments

- State Motor Vehicle Bureau
- Recreational Vehicle Clubs
- U.S. Forest Service and Bureau of Land Management

#### WARNING

##### Off-road driving precautions

Always observe the following precautions to minimize the risk of death, serious injury or damage to your vehicle:

- Drive carefully when off the road. Do not take unnecessary risks by driving in dangerous places.
- Do not grip the steering wheel spokes when driving off-road. A bad bump could jerk the wheel and injure your hands. Keep both hands and especially your thumbs on the outside of the rim.
- Always check your brakes for effectiveness immediately after driving in sand, mud, water or snow.
- After driving through tall grass, mud, rock, sand, rivers, etc., check that there is no grass, bush, paper, rags, stone, sand, etc. adhering or trapped on the underbody. Clear off any such matter from the underbody. If the vehicle is used with these materials trapped or adhering to the underbody, a breakdown or fire could occur.
- When driving off-road or in rugged terrain, do not drive at excessive speeds, jump, make sharp turns, strike objects, etc. This may cause loss of control or vehicle rollover causing death or serious injury. You are also risking expensive damage to your vehicle's suspension and chassis.

**NOTICE****■ To prevent water damage**

Take all necessary safety measures to ensure that water damage to the engine or other components does not occur.

- Water entering the engine air intake will cause severe engine damage.
- Water entering the automatic transmission will cause deterioration in shift quality, locking up of your transmission accompanied by vibration, and ultimately damage.
- Water can wash the grease from wheel bearings, causing rusting and premature failure, and may also enter the differential, transmission and transfer (AWD models only) case, reducing the gear oil's lubricating qualities.

**■ When you drive through water**

If driving through water, such as when crossing shallow streams, first check the depth of the water and the bottom of the riverbed for firmness. Drive slowly and avoid deep water.

**■ Inspection after off-road driving**

- Sand and mud that has accumulated around brake discs may affect braking efficiency and may damage brake system components.

- Always perform a maintenance inspection after each day of off-road driving that has taken you through rough terrain, sand, mud, or water. For scheduled maintenance information, refer to the "Scheduled Maintenance Guide" or "Owner's Manual Supplement".



**Interior features****5****5-1. Using the air conditioning system and defogger**

Front automatic air conditioning system ..... 368

Rear automatic air conditioning system ..... 377

Heated steering wheel/seat heaters/seat ventilators ..... 381

**5-2. Using the interior lights**

Interior lights list ..... 384

**5-3. Using the storage features**

List of storage features ..... 387

Luggage compartment features ..... 393

**5-4. Using the other interior features**

Other interior features. 397

Garage door opener.... 411

## Front automatic air conditioning system

Air outlets and fan speed are automatically adjusted according to the temperature setting.

The air conditioning system can be displayed and operated on the Multimedia Display.

## Air conditioning controls

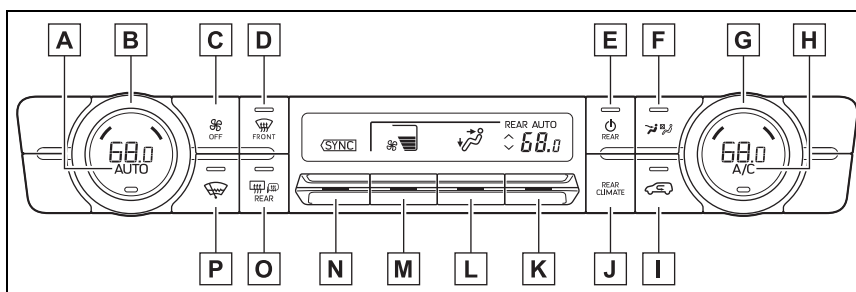

- A** Automatic mode switch (→P.374)
- B** Left-hand side temperature control switch
- C** “OFF” switch
- D** Windshield defogger switch
- E** Rear air conditioning system on/off switch (→P.378)
- F** S-FLOW mode switch (→P.374)
- G** Right-hand side temperature control switch
- H** “A/C” switch
- I** Outside/recirculated air mode switch
- J** “REAR CLIMATE” switch (→P.378)
- K** Rear seat temperature control knob (→P.378)
- L** Airflow mode control knob
- M** Fan speed control knob
- N** “SYNC” control knob
- O** Rear window defogger and outside rear view mirror defoggers switch
- P** Windshield wiper de-icer switch



### ■ Adjusting the temperature setting

Turn driver's side temperature control switch clockwise to increase the temperature and turn the switch counterclockwise to decrease the temperature.

If "A/C" switch is not pressed, the system will blow ambient temperature air or heated air.

The temperature for the driver, front passenger and rear seats can be adjusted separately when:

- "SYNC" control knob is moved upward or downward. (The "PASS" and "REAR" displays disappear)
- The passenger's side temperature control switch is turned. (The "PASS" display disappears)
- The rear seat temperature control knob is moved upward or downward. (The "REAR" display disappears)

To switch the air conditioning system between individual and simultaneous modes, move "SYNC" control knob upward or downward.

### ■ Setting the fan speed

To set the fan speed, move the fan speed control knob upward or downward.

Upward: Increases the fan speed

Downward: Decreases the fan speed

Pressing the "OFF" switch turns off

the fan.

### ■ Change the airflow mode

To change the airflow mode, move the airflow mode control knob upward or downward.

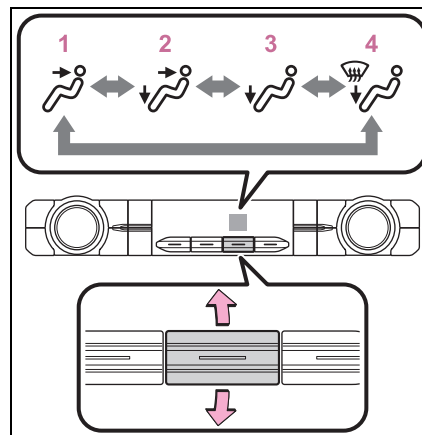

- 1 Upper body
- 2 Upper body and feet
- 3 Feet
- 4 Feet and the windshield defogger operates

### ■ Switching between outside air and recirculated air modes

Press the outside/recirculated air mode switch.

The mode switches between outside air mode and recirculated air mode each time the switch is operated.

When recirculated air mode is selected, the indicator illuminates on the outside/recirculated air mode switch.

### ■ Set cooling and dehumidification function

Press the "A/C" switch.

When the function is on, the indicator illuminates on the "A/C" switch.

### ■ Defogging the windshield

Defoggers are used to defog the windshield and front side windows.

Press the windshield defogger switch.

Set the outside/recirculated air mode switch to outside air mode if the recirculated air mode is used. (It may switch automatically.)

To defog the windshield and the side windows quickly, turn the air flow and temperature up.

To return to the previous mode, press the windshield defogger switch again when the windshield is defogged.

When the windshield defogger switch is on, the indicator illuminates on the windshield defogger switch.

### ■ Defogging the rear window and outside rear view mirrors

Defoggers are used to defog the rear window and to remove raindrops, dew and frost from the outside rear view mirrors.

Press the rear window defogger and outside rear view mirror defoggers switch.

When the rear window defogger and outside rear view mirror defog-

gers switch is on, the indicator illuminates on the rear window defogger and outside rear view mirror defoggers switch.

The defoggers will automatically turn off after a while.

### ■ Windshield wiper de-icer

This feature is used to prevent ice from building up on the windshield and wiper blades.

Press the windshield wiper de-icer switch.

When the windshield wiper de-icer switch is on, the indicator illuminates on the windshield wiper de-icer switch.

The windshield wiper de-icer will automatically turn off after a period of time.

### ■ When the outside temperature exceeds 75°F (24°C) and the air conditioning system is on

- In order to reduce the air conditioning power consumption, the air conditioning system may switch to recirculated air mode automatically. This may also reduce fuel consumption.
- Recirculated air mode is selected as a default mode when the engine switch is turned to ON.
- It is possible to switch to outside air mode at any time by pressing the outside air mode switch.

### ■ Fogging up of the windows

- The windows will easily fog up when the humidity in the vehicle is high. Turning "A/C" on will dehumidify the air from the outlets and defog the windshield effectively.
- If you turn "A/C" off, the windows may fog up more easily.
- The windows may fog up if the

recirculated air mode is used.

#### ■ When driving on dusty roads

Close all windows. If dust thrown up by the vehicle is still drawn into the vehicle after closing the windows, it is recommended that the air intake mode be set to outside air mode and the fan speed to any setting except off.

#### ■ Outside/recirculated air mode

- Setting to the recirculated air mode temporarily is recommended in preventing dirty air from entering the vehicle interior and helping to cool the vehicle when the outside air temperature is high.
- Outside/recirculated air mode may automatically switch depending on the temperature setting or the inside temperature.

#### ■ Operation of the air conditioning system in Eco drive mode

- In Eco drive mode, the air conditioning system is controlled as follows to prioritize fuel efficiency:
  - Engine speed and compressor operation controlled to restrict heating/cooling capacity
  - Fan speed restricted when automatic mode is selected
- To improve air conditioning performance, perform the following operations:
  - Adjust the fan speed
  - Turn off Eco drive mode (→P.348)

#### ■ When the outside temperature is low

The dehumidification function may not operate even when the "A/C" switch is pressed.

#### ■ Ventilation and air conditioning odors

- To let fresh air in, set the air conditioning system to the outside air mode.
- During use, various odors from inside and outside the vehicle may

enter into and accumulate in the air conditioning system. This may then cause odor to be emitted from the vents.

- To reduce potential odors from occurring:
  - It is recommended that the air conditioning system be set to outside air mode prior to turning the vehicle off.
  - The start timing of the blower may be delayed for a short period of time immediately after the air conditioning system is started in automatic mode.
- When parking, the system automatically switches to outside air mode to encourage better air circulation throughout the vehicle, helping to reduce odors that occur when starting the vehicle.

#### ■ Air conditioning system operations when the engine is stopped due to the Stop & Start system

When the engine is stopped due to Stop & Start system operations, the automatic air conditioning cooling, heating and dehumidification functions turn off and the fan speed is decreased according to the outside temperature etc. or air blowing stops. To stop the air conditioning system from turning off, press the Stop & Start cancel switch and refrain from using the Stop & Start system.

#### ■ When the windshield is fogged up and the engine is stopped due to the Stop & Start system

Press the windshield defogger switch to restart the engine and defog the windshield.

If the windshield continuously fogs up, press the Stop & Start cancel switch and refrain from using the Stop & Start system.

■ **When an odor comes from the air conditioning system while the engine is stopped due to the Stop & Start system**

Press the Stop & Start cancel switch to restart the engine.

■ **Air conditioning filter**

→P.459

■ **Air conditioning system refrigerant**

- A label regarding the refrigerant of the air conditioning system is attached to the location shown in the following illustration.

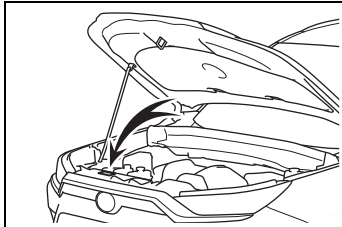

- The meaning of each symbol on the label are as follows:

	Caution
	Air conditioning system
	Air conditioning system lubricant type
	Requires registered technician to service air conditioning system
	Flammable refrigerant

■ **Customization**

Some functions can be customized. (→P.538)

**WARNING**

■ **To prevent the windshield from fogging up**

Do not use the windshield defogger switch during cool air operation in extremely humid weather. The difference between the temperature of the outside air and that of the windshield can cause the outer surface of the windshield to fog up, blocking your vision.

■ **When the outside rear view mirror defoggers are operating**

Do not touch the rear view mirror surfaces when the outside rear view mirror defoggers are on.

■ **When the windshield wiper de-icer is operating**

Do not touch the glass at lower part of the windshield or to the side of the front pillars when the windshield wiper de-icer is on.

**NOTICE**

■ **To prevent battery discharge**

Do not leave the air conditioning system on longer than necessary when the engine is off.

■ **When repairing/replacing parts of the air conditioning system**

Have repair/replacement performed by your Toyota dealer. When a part of the air conditioning system, such as the evaporator, is to be replaced, it must be replaced with a new one.



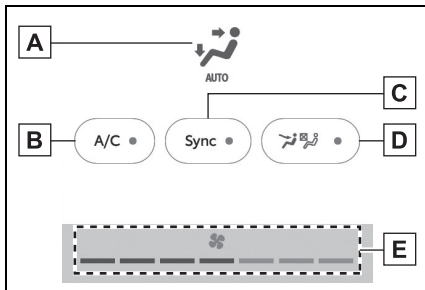

**Front air conditioning control screen (Multimedia Display)**

■ **Main screen**

- 1 Touch  on the main menu.
- 2 Select "Climate".
- 3 Select "Front".



**A** Select the air flow mode

-  : Air flows to the upper body
-  : Air flows to the upper body and feet
-  : Air flows to the feet
-  : Air flows to the feet and the windshield defogger operates

**B** Set cooling and dehumidification function

If "A/C" switch is not pressed, the system will blow ambient temperature air or heated air.

**C** "Sync" switch

If the indicator on the "Sync" switch is off, the temperature for the driver, passenger and rear seats can be adjusted separately.

**D** Select front seat concentrated airflow mode (S-FLOW) (→P.374)

**E** Adjust the fan speed setting

■ **Option screen**

- 1 Touch  on the main menu.
- 2 Select "Climate".
- 3 Select "Options".

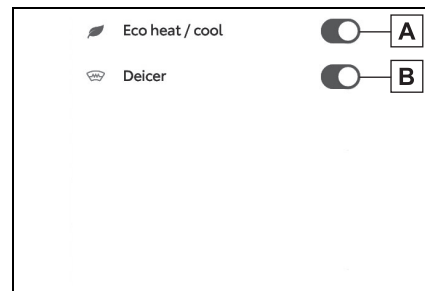

**A** Set eco air conditioning mode on/off. (→P.348)

The air conditioning is controlled with low fuel consumption prioritized such as reducing fan speed, etc.

**B** Set windshield wiper de-icer on/off. (→P.370)

■ **When the outside temperature exceeds 75°F (24°C) and the air conditioning system is on**

In order to reduce the air conditioning power consumption, the air conditioning system may switch to recirculated air mode automatically. This may also reduce fuel consumption.

■ **Fogging up of the windows**

- The windows will easily fog up when the humidity in the vehicle is high. Turning "A/C" on will dehumidify the air from the outlets and defog the windshield effectively.
- If you turn "A/C" off, the windows may fog up more easily.

**■ Eco air conditioning mode**

When Eco drive mode is selected using the driving mode select switch, eco air conditioning mode turns on.

When a drive mode other than Eco drive mode is selected, eco air conditioning mode may turn off.

**■ Operation of the air conditioning system in Eco drive mode**

- In Eco drive mode, the air conditioning system is controlled as follows to prioritize fuel efficiency:
  - Engine speed and compressor operation controlled to restrict heating/cooling capacity
  - Fan speed restricted when automatic mode is selected
- To improve air conditioning performance, perform the following operations:
  - Adjust the fan speed
  - Turn off Eco drive mode (→P.348)
  - Turn off Eco air conditioning mode
- When the driving mode is set to Eco driving mode, the air conditioning eco mode will be turned on automatically. Even in this case, the air conditioning eco mode can be turned off by pressing the Eco air conditioning mode switch.

**■ When the outside temperature is low**

The dehumidification function may not operate even when "A/C" is pressed.

**Using automatic mode**

- 1 Press the automatic mode switch.

The dehumidification function begins to operate. Air outlets and fan speed are automatically adjusted according to the temperature setting and humidity.

- 2 Adjust the temperature setting.

- 3 To stop the operation, press the "OFF" switch.

If the fan speed setting or air flow modes are operated, the automatic mode indicator goes off. However, automatic mode for functions other than that operated is maintained.

**■ Using automatic mode**

Fan speed is adjusted automatically according to the temperature setting and the ambient conditions.

Therefore, the fan may stop for a while until warm or cool air is ready to flow immediately after the automatic mode switch is pressed.

**Front seat concentrated airflow mode (S-FLOW)**

This function automatically controls the air conditioning airflow so that priority is given to the front seats. Unnecessary air conditioning is suppressed, contributing to increased fuel efficiency.

Front seat concentrated airflow mode operates in the following situations.

- No passengers are detected in the rear seats
- The windshield defogger is not operating

While operating, the indicator illuminates on the S-FLOW mode switch. (→P.368)

### ■ Manually turning front seat concentrated airflow mode on/off

In front seat concentrated airflow mode, directing airflow to the front seats only and to all seats can be switched via switch operation. When the mode has been switched manually, automatic airflow control stops operating.

Select  on the main control screen or press the S-FLOW mode switch on the air conditioning operation panel and switch the airflow.

- Indicator illuminated: Airflow to the front seats only
- Indicator off: Airflow to all the seats

### ■ Operation of automatic airflow control

- In order to maintain a comfortable interior, airflow may be directed to seats without passengers immediately after the engine is started and at other times depending on the outside temperature.
- After the engine is started, if passengers move around inside or enter/exit the vehicle, the system cannot accurately detect the presence of passengers and automatic airflow control will not operate.

### ■ Operation of manual airflow control

Even if the function is manually switched to directing airflow to only the front seats, when a rear seat is occupied, it may automatically direct airflow to all seats.

### ■ To return to automatic airflow control

- 1 With the indicator off, turn the engine switch off.
- 2 After 60 minutes or more elapse, turn the engine switch to ON.

## Air outlet layout and operations

### ■ Location of air outlets

The air outlets and air volume change according to the selected air flow mode.

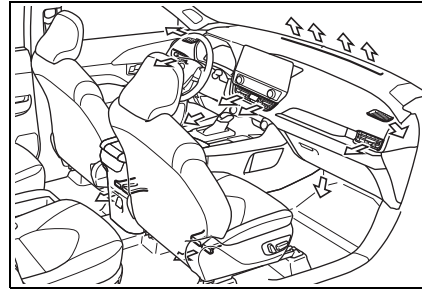

### ■ Adjusting the air flow direction and opening/closing the air outlets

#### ▶ Front center outlets

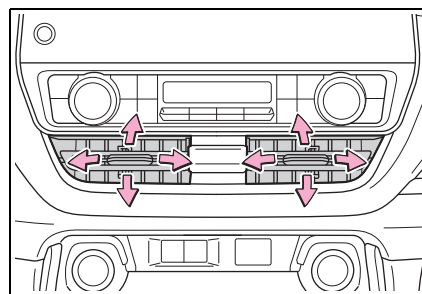

Direct air flow to the left or right, up or down

► Front side outlets

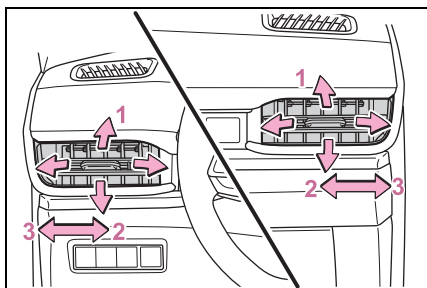

- 1** Direct air flow to the left or right, up or down
- 2** Open the vent
- 3** Close the vent

**⚠ WARNING**

■ **To not interrupt the windshield defogger from operating**

Do not place anything on the instrument panel which may cover the air outlets. Otherwise, air flow may be obstructed, preventing the windshield defoggers from defogging.

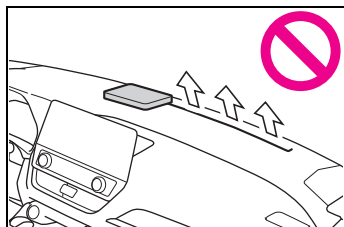



## Rear automatic air conditioning system

The air outlets and fan speed are automatically adjusted according to the temperature setting.

The rear air conditioning system can be operated using the front air conditioning control panel and rear air conditioning control panel. Press the “REAR CLIMATE” switch on the front air conditioning control panel to change the rear air conditioning control mode.



The rear air conditioning system can also be operated on the Multimedia Display.

## Rear air conditioning control operation

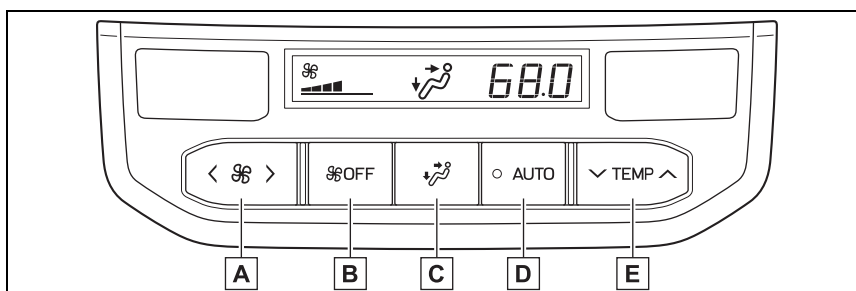
### ■ Rear air conditioning control panel



#### **A** Adjust the rear seats fan speed setting

Press  to increase the fan speed and  to decrease the fan speed.

#### **B** “OFF” switch



Pressing the “OFF” switch turns off the fan.

#### **C** Air flow mode control switch

#### **D** Automatic mode switch

When the function is on, the indicator illuminates on the control screen.

#### **E** Adjust the rear seats temperature setting

Press  to increase the temperature and  to decrease the temperature.

■ Front air conditioning control panel

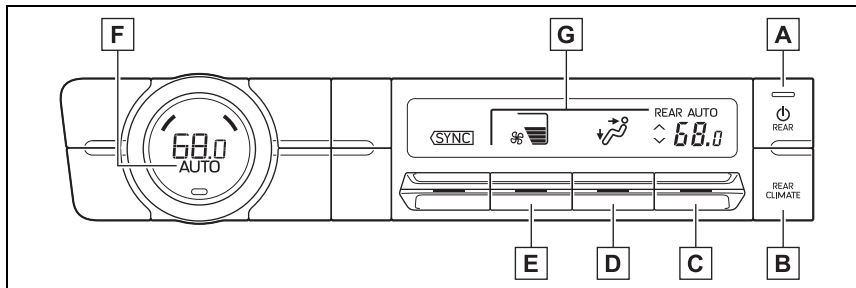

**A** Rear air conditioning system on/off switch

**B** “REAR CLIMATE” switch

The mode switches between the rear air conditioning control mode and front air conditioning control mode each time the “REAR CLIMATE” switch is pressed.

**C** Rear seat temperature control knob

To set temperature, move the rear seat temperature control knob upward or downward.

Upward: Increases the temperature

Downward: Decreases the temperature

**D** Airflow mode control knob

The airflow mode control knob can be operated while the rear air conditioning control indicator is appeared.

**E** Adjust the rear seats fan speed setting

Rear seats fan speed setting can be adjusted while the rear air conditioning control indicator is appeared.

To set the fan speed, move the fan speed control knob upward or downward.

Upward: Increases the fan speed

Downward: Decreases the fan speed

**F** Automatic mode switch (→P.380)

The automatic mode switch can be operated when the rear air conditioning control indicator is displayed.

**G** Rear air conditioning control indicator

When the “REAR CLIMATE” switch is pressed, the rear air conditioning control indicator is displayed for several seconds.

■ Rear air conditioning control screen (Multimedia Display)

- 1 Touch  on the main menu.

- 2 Select "Climate".
- 3 Select "Rear".

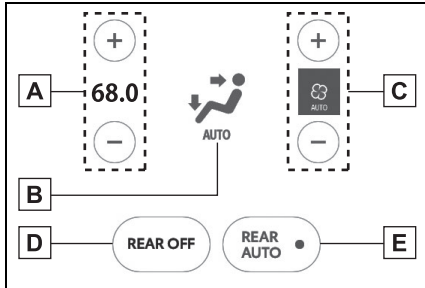

- A** Adjust the rear seats temperature setting
- B** Air flow mode control switch
- C** Adjust the rear seats fan speed setting
- D** "REAR OFF" switch  
Selecting the "REAR OFF" switch turns off the fan.
- E** Automatic mode switch

**Change the airflow mode**

■ **Rear air conditioning control panel**

To change the airflow mode, press the airflow mode control switch.

The air outlets used are switched each time the switch is pressed.

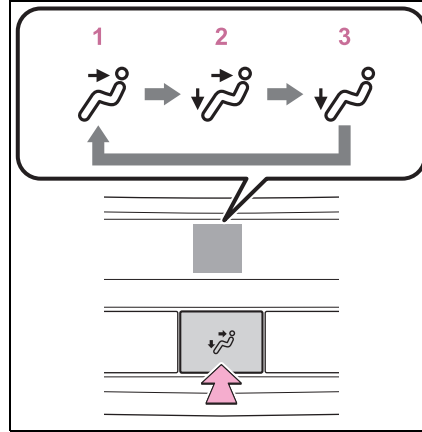

- 1 Upper body
- 2 Upper body and feet
- 3 Feet

■ **Front air conditioning control panel**

To change the airflow mode, move the airflow mode control knob upward or downward.

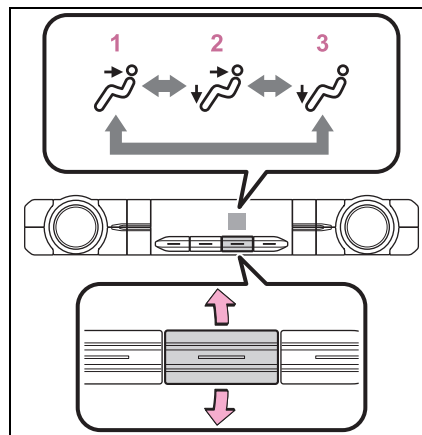



- 1 Upper body
- 2 Upper body and feet
- 3 Feet

■ **Rear air conditioning control screen**

To change the airflow mode, select the airflow mode control switch.

The air outlets used are switched each time the switch is selected.

 : Air flows to the upper body

 : Air flows to the upper body and feet

 : Air flows to the feet

**Using automatic mode**

- 1 Press the automatic mode switch.
- 2 Adjust the temperature setting.
- 3 To stop the operation, press the "OFF" switch.

If the fan speed setting or air flow modes are operated, the automatic mode indicator goes off. However, automatic mode for functions other than that operated is maintained.

■ **Using automatic mode**

Fan speed is adjusted automatically according to the temperature setting and the ambient conditions.

Therefore, the fan may stop for a while until warm or cool air is ready to flow immediately after the automatic mode switch is pressed.

**Air outlets**

■ **Location of air outlets**

The air outlets and air volume changes according to the selected air flow mode.

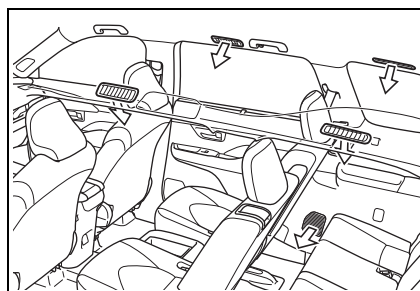

■ **Adjusting the position of and opening and closing the air outlets**

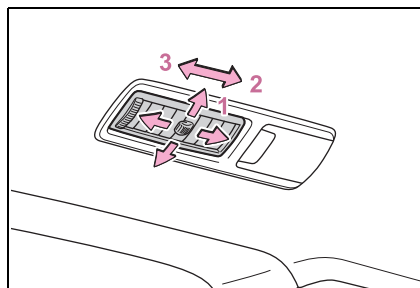

- 1 Direct air flow to the left or right, up or down
- 2 Open the vent
- 3 Close the vent

 **NOTICE**

■ **To prevent battery discharge**

Do not leave the air conditioning system on longer than necessary when the engine is off.

**Heated steering wheel\*/seat heaters/seat ventilators\***

\*: If equipped

- Heated steering wheel  
Warms up the grip of the steering wheel
- Seat heaters  
Warm up the seat upholstery
- Seat ventilators  
Maintain good ventilation using a fan built into the seat

**⚠ WARNING**

■ **To prevent minor burn injuries**

Care should be taken if anyone in the following categories comes in contact with the steering wheel or seats when the heater is on:

- Babies, small children, the elderly, the sick and the physically challenged
- Persons with sensitive skin
- Persons who are fatigued
- Persons who have taken alcohol or drugs that induce sleep (sleeping drugs, cold remedies, etc.)

**⚠ NOTICE**

■ **To prevent damage to the seat heaters**

Do not put heavy objects that have an uneven surface on the seat and do not stick sharp objects (needles, nails, etc.) into the seat.

■ **To prevent battery discharge**

Do not use the functions when the engine is off.

**Heated steering wheel**

Turns the heated steering wheel on/off

The indicator light comes on when the heated steering wheel is operating.

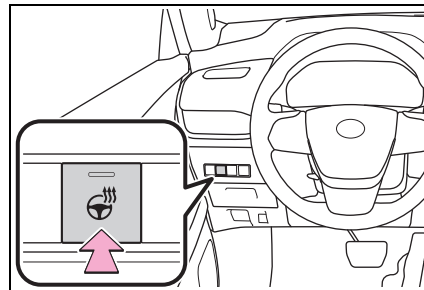

■ **Operation condition**

The engine switch is in ON.

■ **Timer function**

The heated steering wheel will automatically turn off after a period of time.

**Seat heaters**

■ **Front seats**

Each time the switch is pressed, the operation condition changes as follows.

Hi (3 segments lit)→Mid (2 segments lit)→Lo (1 segment lit)→Off

The level indicator (amber) **A** lights up during operation.

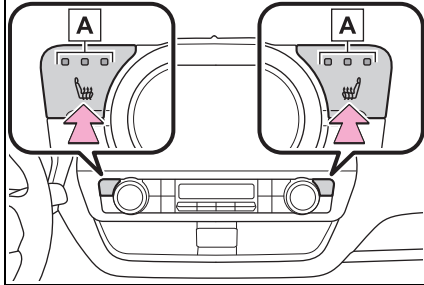

■ **Second seats (If equipped)**

Each time the switch is pressed, the operation condition changes as follows.

Hi (3 segments lit)→Mid (2 segments lit)→Lo (1 segment lit)→Off

The level indicator (amber) **A** lights up during operation.

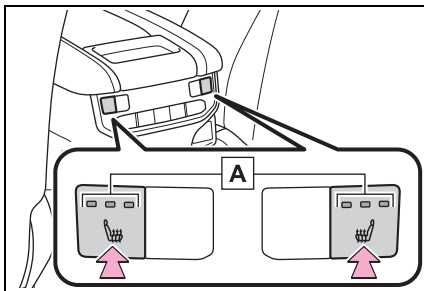

■ **Operation condition**

The engine switch is in ON.

**⚠ WARNING**

■ **To prevent overheating and minor burn injuries**

Observe the following precautions when using the seat heaters.

- Do not cover the seat with a blanket or cushion when using the seat heater.

- Do not use seat heater more than necessary.

**Seat ventilators**

■ **Front seats (If equipped)**

Each time the switch is pressed, the operation condition changes as follows.

Hi (3 segments lit)→Mid (2 segments lit)→Lo (1 segment lit)→Off

The level indicator (green) **A** lights up during operation.

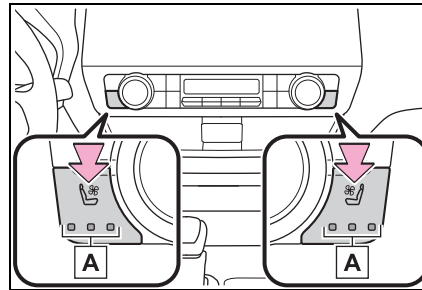

■ **Second seats (If equipped)**

Each time the switch is pressed, the operation condition changes as follows.

Hi (3 segments lit)→Mid (2 segments lit)→Lo (1 segment lit)→Off

The level indicator (green) **A** lights up during operation.

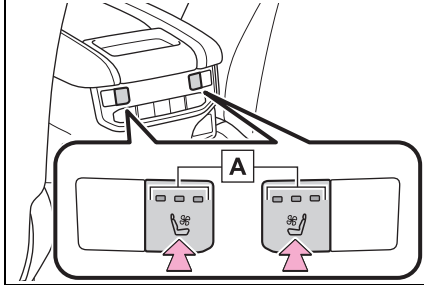

■ **Operation condition**  
The engine switch is in ON.

## Interior lights list

### Location of the interior lights

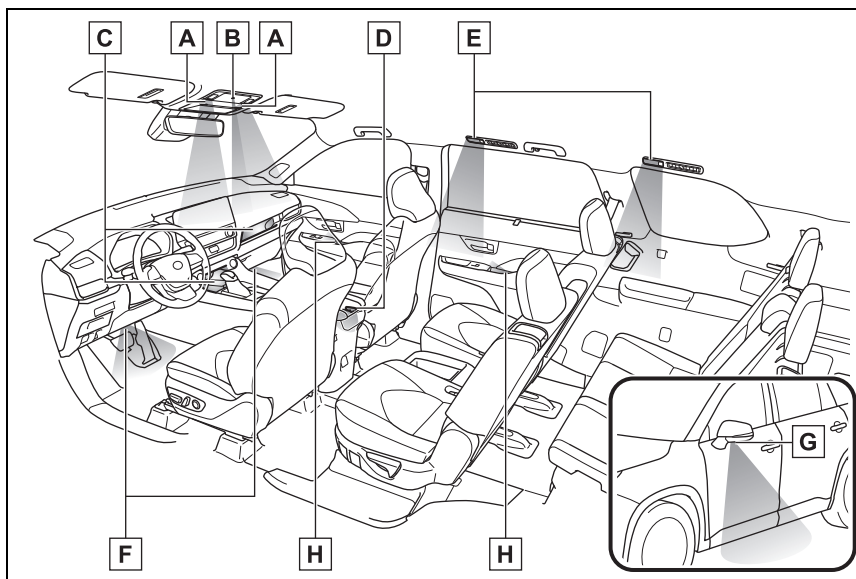

- A** Front personal lights (→P.385)  
Front interior lights (→P.384)
- B** Center console light
- C** Open tray lights (if equipped)
- D** Door courtesy lights
- E** Rear personal lights (→P.385)
- F** Footwell lights
- G** Outer foot lights (if equipped)
- H** Ambient lights (if equipped)

### Operating the interior lights

- **Turning the interior lights on/off**

Press the interior light switch



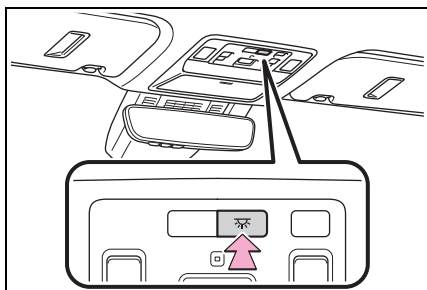

■ **Turning the door position on**

Press the door-linked interior light switch

The lights are turned on and off according to whether the doors are opened/closed.

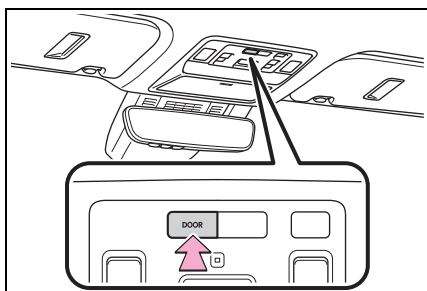

**Operating the personal lights**

■ **Front personal lights**

Turns the lights on/off

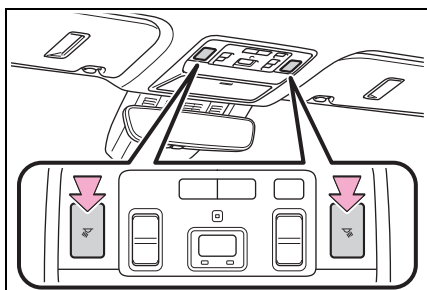

■ **Rear personal lights**

Turns the lights on/off

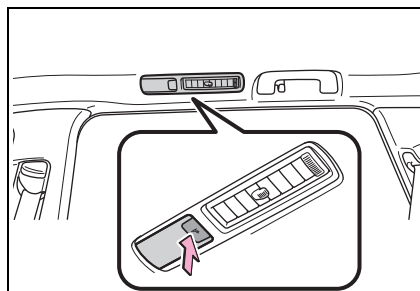

■ **Illuminated entry system**

The lights automatically turn on/off according to the engine switch mode, the presence of the electronic key, whether the doors are locked/unlocked, and whether the doors are opened/closed.

■ **To prevent the battery from being discharged**

If the interior lights remain on when the engine switch is turned off, the lights will go off automatically after 20 minutes.

■ **Automatic illumination of the interior lights**

If any of the SRS airbags deploy (inflate) or in the event of a strong rear impact, the interior lights will turn on automatically.

The interior lights will turn off automatically after approximately 20 minutes.

The interior lights can be turned off manually. However, in order to help prevent further collisions, it is recommended that they be left on until safety can be ensured.

(The interior lights may not turn on automatically depending on the force of the impact and conditions of the collision.)

■ **Customization**

Some functions can be customized. (→P.538)



NOTICE

■ **To prevent battery discharge**

Do not leave the lights on longer than necessary when the engine is not running.

**List of storage features**

**Location of the storage features**

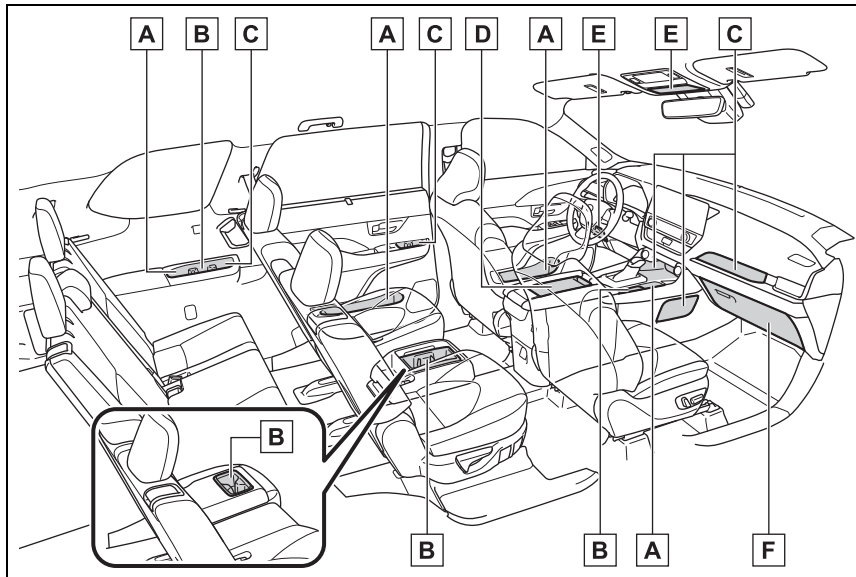

- A** Bottle holders (→P.390)
- B** Cup holders (→P.389)
- C** Open tray (→P.391)
- D** Console box (→P.388)
- E** Auxiliary boxes (→P.390)
- F** Glove box (→P.388)

**⚠ WARNING**

**■ Items that should not be left in the storage spaces**

Do not leave glasses, lighters or spray cans in the storage spaces, as this may cause the following when cabin temperature becomes high:

- Glasses may be deformed by heat or cracked if they come into contact with other stored items.

- Lighters or spray cans may explode. If they come into contact with other stored items, the lighter may catch fire or the spray can may release gas, causing a fire hazard.

**⚠ WARNING**

**■ When storage compartments are not in use**

When driving or when the storage compartments are not in use, keep the lids closed.

In the event of sudden braking or sudden swerving, an accident may occur due to an occupant being struck by an open lid or the items stored inside.

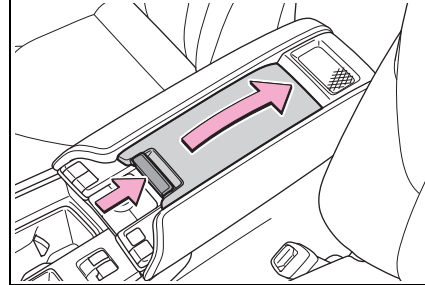

**■ Tray inside console box**

The tray can be slid forward/backward.

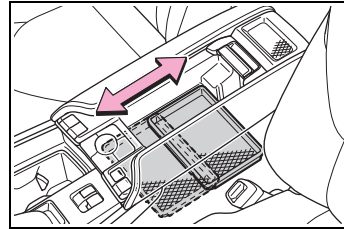

**■ When the tray inside console box is not in use**

When not in use, the tray can be stowed in the console box as shown.

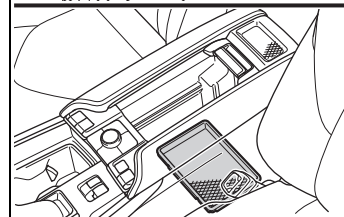
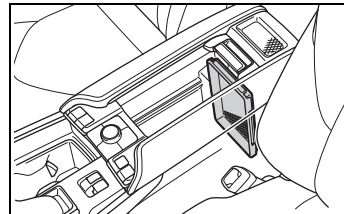

**Glove box**

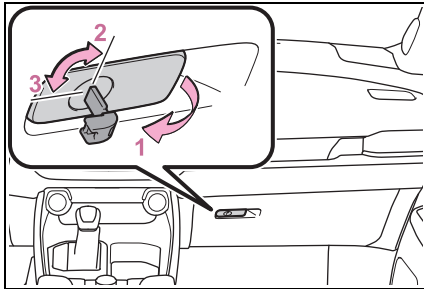

- 1** Open (pull the lever)
- 2** Lock with the mechanical key
- 3** Unlock with the mechanical key

**■ Glove box light**

The glove box light turns on when the tail lights are on.

**Console box**

Push the tab and slide the console box lid.

**Cup holders**

▶ Front seats

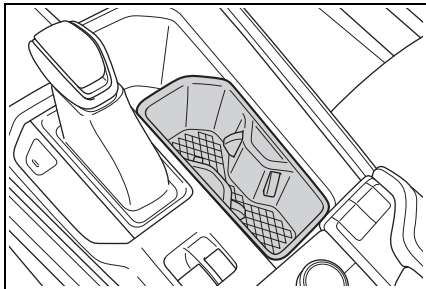

▶ Second seats (8-seat models)

Pull the armrest down.

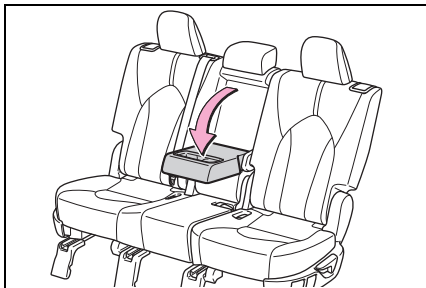

▶ Second seats (7-seat models)

• Type A

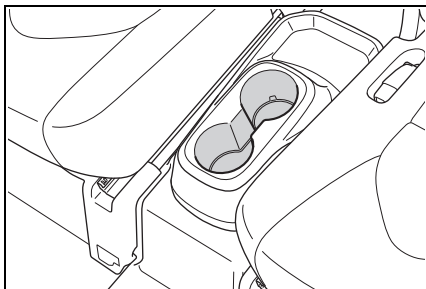

• Type B

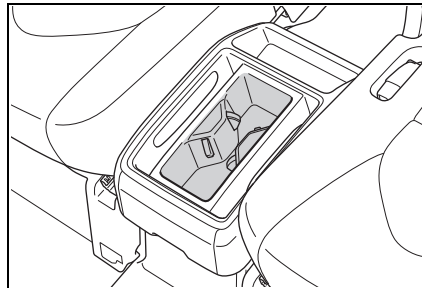

▶ Third seats

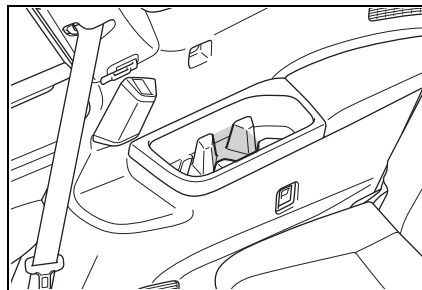

■ When the cup holders are not in use

Type B cup holder unit of the second seats (7-seat models) can be removed.

While lifting the tab, push up the front edge of the cup holder unit then pull it forward.

After removing the cup holder unit, store it in the exclusive bag attached.

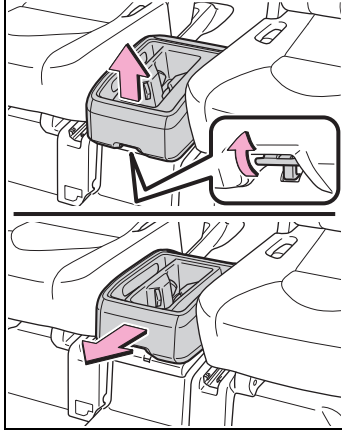

**⚠ WARNING**

**■ Items unsuitable for the cup holder**

Do not place anything other than cups, aluminum cans, or water bottles in the cup holders. Other items may be thrown out of the holders in the event of an accident or sudden braking, possibly causing injury. If possible, cover hot drinks to prevent burns.

**Bottle holders**

► Front seats

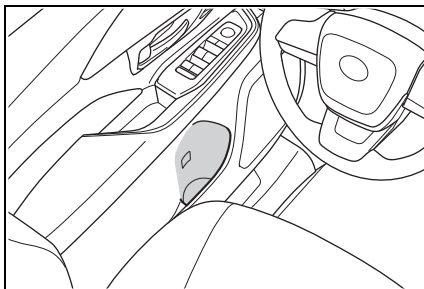

► Second seats

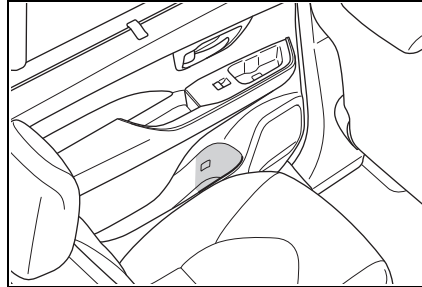

► Third seats

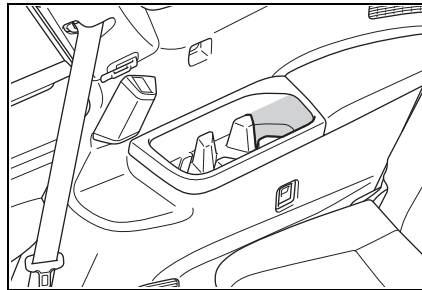

**■ Bottle holders**

- When storing a bottle, close the cap.
- The bottle may not be stored depending on its size or shape.

**⚠ NOTICE**

**■ Items unsuitable for the bottle holders**

Do not place open bottle, glass or paper cups containing liquid in the bottle holders. Otherwise, contained liquid may be spilled. Glass cups may break if used in the bottle holders.

**Auxiliary boxes**

► Overhead

Push the lid.

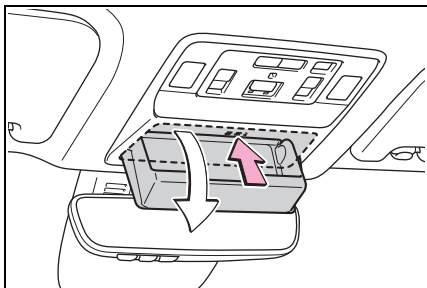

► Driver's side instrument panel  
Push the tab to open.

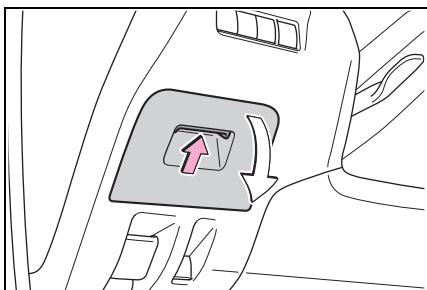

**Open tray**

► Instrument panel

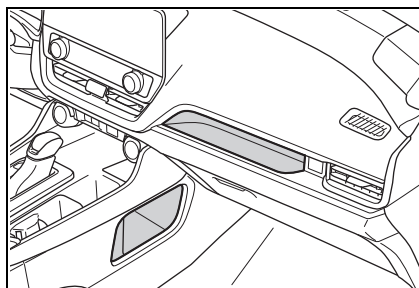

► Front of console

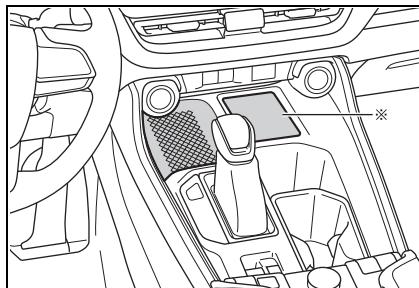

► Second seats

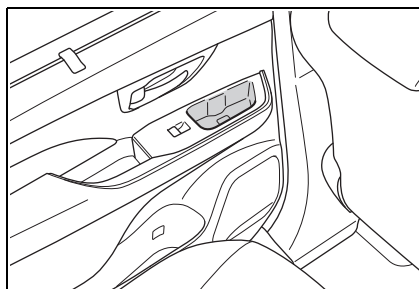

**⚠ WARNING**

■ **Items unsuitable for storing (Overhead)**

Do not store items heavier than 0.44 lb. (200 g). Doing so may cause the auxiliary box to open and the items inside may fall out, resulting in an accident.

■ **Caution while driving (Driver's side instrument panel)**

Keep the auxiliary box closed while driving. Injuries may result in the event of an accident or sudden braking.

▶ Third seats

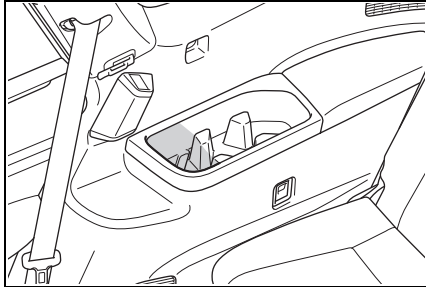

\*: Wireless charger

■ Tablet holders

Tablets can be stored in the following places:

Depending on the situations, such as the size or shape of a smart-phone, it may not be stored.

- Second seat (if equipped)

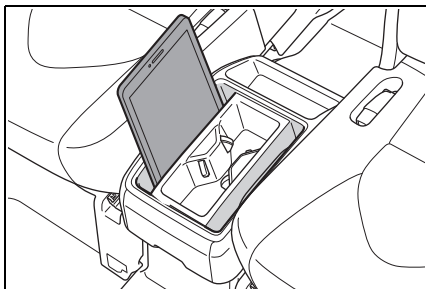

- Third seats

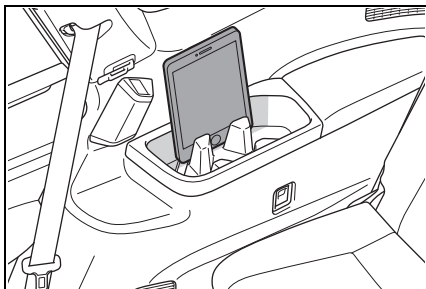

**⚠ WARNING**

■ Items unsuitable for the open tray

Observe the following precautions when putting items in the open tray. Failure to do so may cause items to be thrown out of the tray in the event of sudden braking or steering. In these cases, the items may interfere with pedal operation or cause driver distraction, resulting in an accident.

- Do not store items in the tray that can easily shift or roll out.
- Do not stack items in the tray higher than the tray's edge.
- Do not put items in the tray that may protrude over the tray's edge.



**Luggage compartment features**

**Cargo hooks**

Pull down the hook to use.

The cargo hooks are provided for securing loose items.

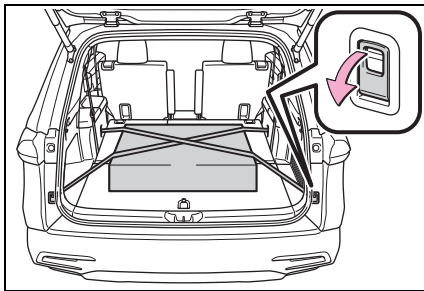

**⚠ WARNING**

■ **When cargo hooks are not in use**

To avoid injury, always return the hooks to their stowed positions when not in use.

**Cargo net hooks**

To hang the cargo net, use the cargo net hooks and cargo hooks.

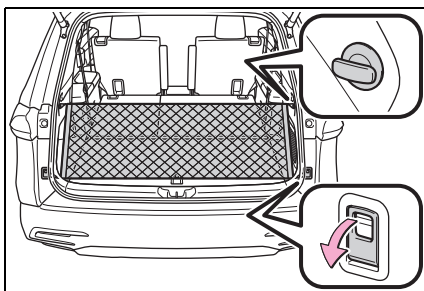

**⚠ WARNING**

■ **When the cargo net is not in use**

To avoid injury, always return the hooks to their stowed positions when not in use.

**Grocery bag hooks**

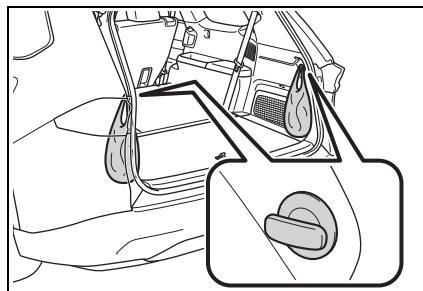

**⚠ NOTICE**

■ **To prevent damage to the grocery bag hooks**

Do not hang any object heavier than 6.6 lb. (3 kg) on the grocery bag hooks.

**Luggage cover (if equipped)**

■ **Removing the luggage cover unit**

- 1 Fold down the third seats. (→P.145)

- 2 Remove the center deck board (→P.396) and take out the luggage cover unit.

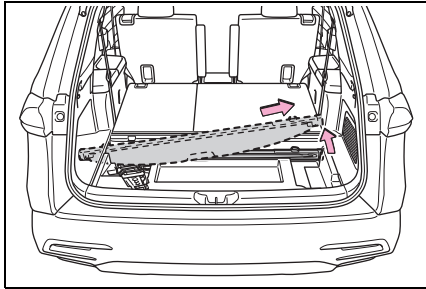

■ **Installing the luggage cover**

- 1 Fold down the third seats. (→P.145)
- 2 Press the lock release buttons to extend the ends of the luggage cover unit.

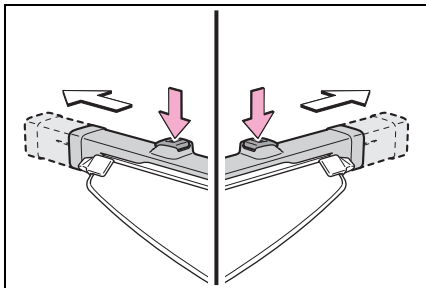

- 3 To install the luggage cover unit, with the lock release buttons facing upward, insert one end into the recess, then

compress the other end and insert it into the other recess.

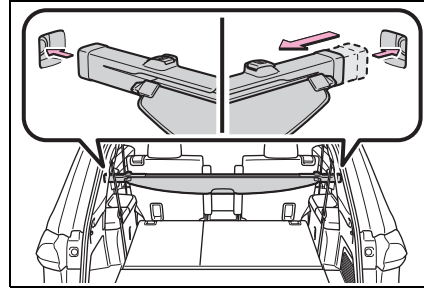

- 4 Pull out the luggage cover and hook it onto the anchors.

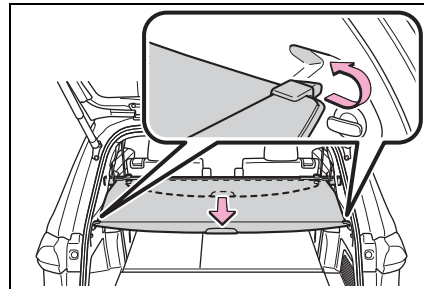

■ **Removing the luggage cover**

- 1 Release the cover from the left and right anchors and allow it to retract.

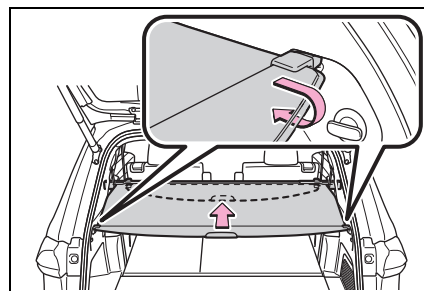

- 2 Compress the end of the luggage cover and lift the luggage cover up.

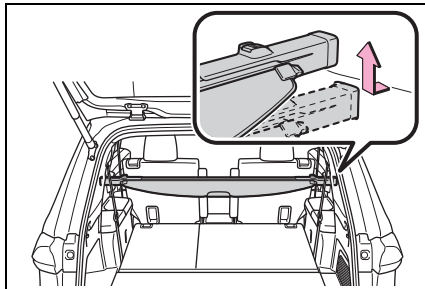

■ **Stowing the luggage cover**

- 1 Remove the center deck board. (→P.396)
- 2 To store the luggage cover unit, compress both ends until they lock.

Store the unit with the lock release buttons facing up and the cover portion facing the rear of the vehicle.

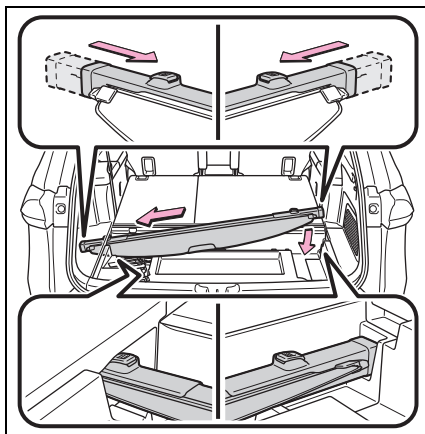

**! WARNING**

■ **Luggage cover**

- When installing/stowing the luggage cover, make sure that the luggage cover is securely installed/stowed. Failure to do so may result in serious injury in the event of sudden braking or a collision.
- Do not place anything on the luggage cover. In the event of sudden braking or turning, the item may go flying and strike an occupant. This could lead to an unexpected accident, resulting in death or serious injury.
- Do not allow children to climb on the luggage cover. Climbing on the luggage cover could result in damage to the luggage cover, possibly causing death or serious injury to the child.
- Do not point the luggage cover unit at your face or body, as doing so may cause injuries if the cover ends extend suddenly.

**! NOTICE**

■ **When using the luggage cover**

- Do not put heavy items on the luggage cover.
- Install the cover unit in the correct direction so that the lock release button faces upward.

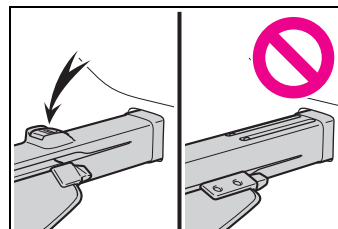

### Deck board

#### ■ Opening the deck board

- 1 Pull the strap upwards to open the center deck board.

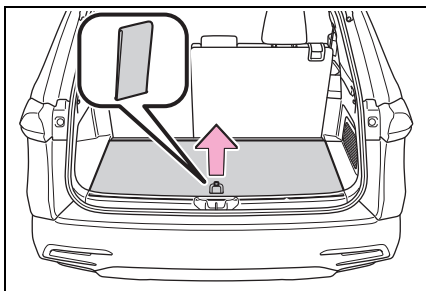

- 2 To fix the center deck board at the upright position, using the straps of the back side of the third-row seats, fasten the velcro tapes to the underside of the center deck board.

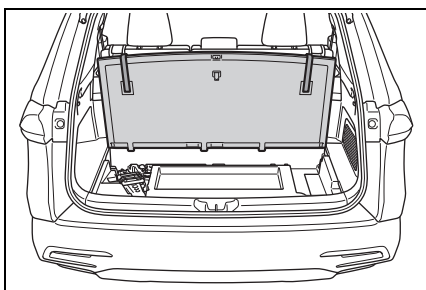

#### **WARNING**

##### ■ **Caution while driving**

Keep the deck board closed. In the event of sudden braking, an accident may occur due to an occupant being struck by the deck board or the items stored under the deck board.

### Deck under tray

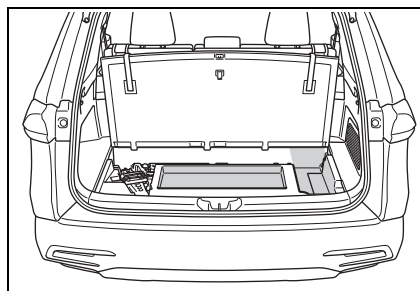

Other interior features

**USB charging ports**

The USB charging ports are used to supply 3 A of electricity at 5 V to external devices. The USB charging ports are for charging only. They are not designed for data transfer or other purposes.

Depending on the external device, it may not charge properly. Refer to the manual included with the device before using a USB charging port.

■ **Using the USB charging ports**

- ▶ On the instrument panel (center)

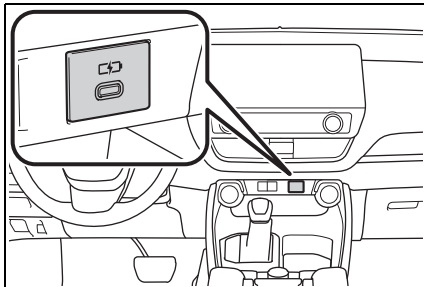

- ▶ On the instrument panel (passenger side)

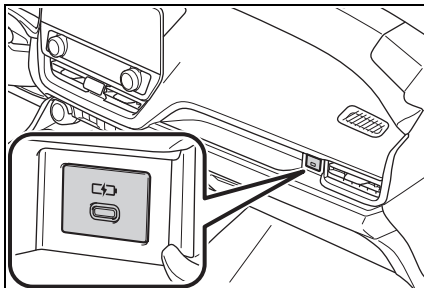

- ▶ Rear of console box

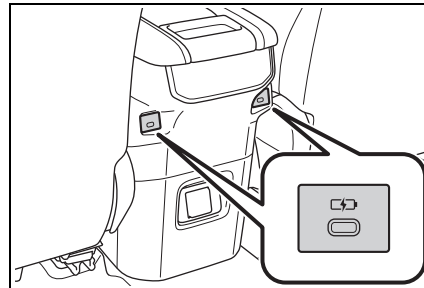

- ▶ Third seats

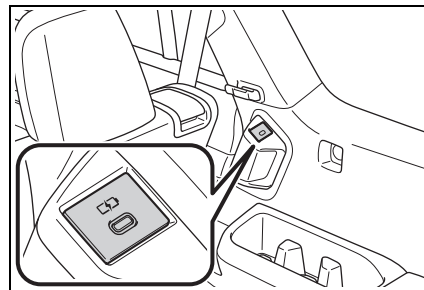

■ **The USB charging ports can be used when**

The engine switch is in ACC or ON.

■ **Situations in which the USB charging ports may not operate correctly**

- If a device which consumes more than 3 A at 5 V is connected
- If a device designed to communicate with a personal computer, such as a USB memory device, is connected
- If the connected external device is turned off (depending on device)
- If the temperature inside the vehicle is high, such as after the vehicle has been parked in the sun

■ **About connected external devices**

Depending on the connected external device, charging may occasionally be suspended and then start again. This is not a malfunction.

 NOTICE

■ **To prevent damage to the USB charging ports**

- Do not insert foreign objects into the ports.
- Do not spill water or other liquids into the ports.
- Do not apply excessive force to or impact the USB charging ports.
- Do not disassemble or modify the USB charging ports.

■ **To prevent damage to external devices**

- Do not leave external devices in the vehicle. The temperature inside the vehicle may become high, resulting in damage to an external device.
- Do not push down on or apply unnecessary force to an external device or the cable of an external device while it is connected.

■ **To prevent battery discharge**

Do not use the USB charging ports for a long period of time with the engine stopped.

**Wireless charger**

A portable device, such as a smartphone or mobile battery, can be charged by just placing it on the charging area, provided the device is compatible with the Qi wireless charging standard created by the Wireless Power Consortium.

The wireless charger cannot be used with a portable device that is larger than the charging tray.

Additionally, depending on the portable device, the wireless charger may not operate properly. Refer to the operation manual of the portable device.

■ **The “Qi” symbol**

The “Qi” symbol is a trademark of the Wireless Power Consortium.



■ **Name for all parts**

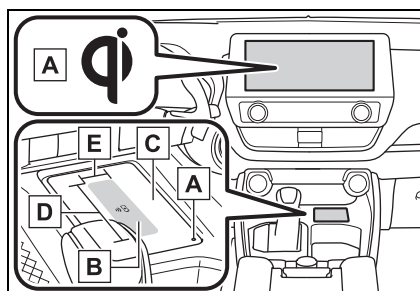

- A** Operation indicator light
- B** Charge area\*
- C** Charging tray
- D** Approximately 3.9 in. (10 cm)
- E** Approximately 1.0 in. (2.5 cm)

\*: The charging coil in the wireless charger can be moved within the charge area up to the position of the charging coil inside a portable device. Charging is possible if the

center of the coil of the portable device is placed within the charge area.

Additionally, if 2 or more portable devices are placed on the charging tray at the same time, each charging coil may not be detected correctly and charging may not be possible.

■ **Using the wireless charger**

Place the portable device on the wireless charger.

Place the charging side of the portable device down with the center of the device in the center of the charge area.

When charging, the operation indicator light (orange) on the wireless charger comes on.

Refer to “Situations in which the function may not operate normally” (→P.404) when charging is not performed.

When charging is complete, the operation indicator light (green) on the wireless charger comes on.

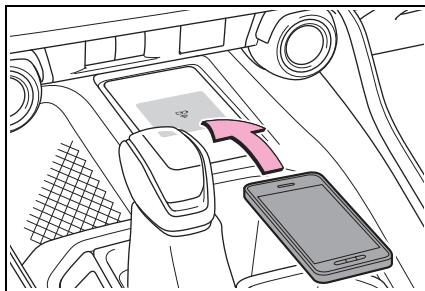

■ **Recharging function**

- If a certain amount of time has elapsed since charging completed and the portable device has not been moved, the

wireless charger will restart charging.

- If a portable device is moved significantly within the charging area, the charging coil may disconnect and charging may temporarily be stopped. However, if a charging coil is detected within the charging area, the charging coil inside the wireless charger will move near the other coil and charging will resume.

■ **Rapid charging function**

- The following portable devices support rapid charging.
  - Portable devices compliant with WPC Ver1.3.2 and compatible with rapid charging
  - iPhone's with an iOS version that supports 7.5 W charging (iPhone 8 and later models)
  - Portable devices compatible with Galaxy original rapid charging standard.
- When a portable device that supports rapid charging is charged, charging automatically switches to the rapid charging function.

### ■ Operation indicator light status

Operation indicator light		Conditions
Charging tray	Multimedia Display	
Turning off	Disappear	When the Multimedia power supply is off or ACC OFF
Green (comes on)	Gray	On Standby (charging possible state) <sup>*1</sup>
		When charging is complete <sup>*2</sup>
Orange (comes on)	Blue	Charging

\*1: Charging power will not be output during standby. A metallic object will not be heated, if it is placed on the wireless charger in this state.

\*2: Depending on the portable device, there are cases where the operation indicator light will continue being lit up orange even after the charging is complete.

### ■ The wireless charger is not working properly.

The followings are situations in which the wireless charger does not work properly and how to deal with the possible causes.

Operation indicator light		Suspected causes/Handling method
Charging tray	Multimedia Display	
Green (Flashing repeatedly once every second)	Disappear	Wireless charger and multimedia system communication failure → <b>If the engine is running, stop and then restart the engine.</b> If the engine switch is in ACC, start the engine. (→P.203)
Orange (Flashing repeatedly once every second)	Gray	Vehicle to wireless charger communication failure → <b>If the engine is running, stop and then restart the engine.</b> If the engine switch is in ACC, start the engine. (→P.203)



Operation indicator light		Suspected causes/Handling method
Charging tray	Multimedia Display	
Green (comes on)	Blue	AM radio stations are being automatically selected → <b>Wait until the system has completed the automatic selection of AM radio stations. In the case that automatic selection cannot be completed, stop automatic selection.</b>
		The smart key system is detecting the key. → <b>Wait until electronic key detection has completed.</b>

Operation indicator light		Suspected causes/Handling method
Charging tray	Multimedia Display	
Green (comes on)	Gray	<p>Foreign substance detection: A metallic foreign substance is in the charge area, and so the abnormal heating prevention function of the metallic foreign object operated → <b>Remove the foreign substance from the charge area.</b></p>
		<p>Portable device misaligned / distanced from charging surface: The charging coil in the portable device moved outside of the charging area, or lens convex is large, or case is thick so the abnormal heating prevention function operated → <b>Remove the portable device from the wireless charger, after 5 seconds, then place the portable device so that it is near the center of the wireless charger. Also, if a case or cover is installed to the portable device, remove it.</b></p>
		<p>Battery protection function of portable device: Before full charging, battery protection function of portable device operated → <b>Confirm the setting of portable device.</b></p>
		<p>Continued detection of an electronic key: When a Multimedia function is used through vehicle customization, the electronic key is continually detected without being confirmed. → <b>In this case, turn the engine switch ACC or ON to confirm the key.</b></p>

Operation indicator light		Suspected causes/Handling method
Charging tray	Multimedia Display	
Orange (Repeatedly flashes 4 times continuously)	Gray	Safety shutdown resulting when the temperature within the wireless charger exceeded the set value → <b>Stop charging, remove the portable device from the wireless charger, wait for the temperature to drop, and then start charging again.</b>

■ **The wireless charger can be operated when**

The engine switch is in ACC or ON.

■ **Portable devices that can be charged**

- Portable devices compatible with the Qi wireless charging standard can be charged by the wireless charger. However, compatibility with portable devices that comply with Qi Ver. 1.0, 1.3.2 and later versions is not guaranteed.
- The wireless charger is designed to supply low power electricity (5 W or less) to a cellular phone, smartphone, or other portable device.

However, portable devices, such as the following, can be charged with more than 5 W.

- 7.5 W charging compatible iPhones can be charged at 7.5 W or less.
- Devices that comply with independent Galaxy charging standards support rapid charging. Check the specifications of each portable device for the charging electricity.
- Portable devices compliant with EPP output as defined by WPC standard Ver1.3.2. can be charged at 15 W or less.

■ **Using the smart key system**

During charging, when the smart key system searches for an elec-

tronic key, charging may be temporarily suspended.

■ **If a cover or accessory is attached to the portable device**

Do not charge a portable device if a cover or accessory which is not Qi compatible is attached. Depending on the type of cover (including the certain genuine manufacture parts) and/or accessory attached, it may not be possible to charge the portable device. If the portable device is placed on the charging area and does not charge, remove the cover and/or accessories.

■ **AM radio cooperation function during charging**

- During charging, if noise occurs when listening to the AM radio, the charging frequency is automatically changed to reduce the noise.
- When automatically seeking AM radio stations, charging will be suspended to prevent charging noise from being detected as a radio station. Charging will resume automatically when seek tuning is stopped.

■ **Charging precautions**

While charging, the wireless charger and the portable device will become warm. This is not a malfunction. If a portable device becomes warm while charging and charging stops due to the protection function of the

portable device, wait until the portable device cools down and charge it again.

Also, to decrease the temperature inside the wireless charger, a fan may operate. This does not indicate a malfunction.

#### ■ Sound generated during operation

Operation sounds may be heard when the engine switch is pressed to change to ACC or ON, or when a portable device is being detected. This does not indicate a malfunction.

#### ■ Cleaning the wireless charger

→P.424

#### ■ Situations in which the wireless charger may not operate correctly

In the following situations, the wireless charger may not operate correctly:

- When a portable device is fully charged
- When a portable device is being charged by a wired connection
- When there is a foreign object between the charging area and portable device
- When the temperature of a portable device becomes high while charging
- When the temperature near the charging tray is 95°F (35°C) or more due to being in direct sunlight, etc.
- When a portable device is placed with its charging surface facing up
- The small portable device such as foldable type is placed in an area misaligned from the charge area
- When a portable device is larger than the charging tray
- When the vehicle is near a TV tower, electric power plant, fuel station, radio station, large display, airport, or other facility that generates strong radio waves or electrical noise
- The electronic key is not inside the vehicle
- When the any of the following objects are between the charging surface of a portable device and the charging are:
  - Thick cases or covers
  - A case or cover attached with an uneven or tilted surface, so that the charging side is not flat
  - Thick decorations
  - Accessories, such as finger rings, straps, etc.
- When there is a gap between the charging side of the portable device and the charge area due to a protrusion such as a camera on the charging side of the portable device.
- When the portable device is in contact with, or is covered by any of the following metallic objects:
  - Cards covered with metal, such as aluminum foil
  - Cigarette boxes that have aluminum foil inside
  - Metallic wallets or bags
  - Coins
  - Heat packs
  - Recorded media such as CDs and DVDs
  - Metallic decorations
  - Metallic cases or covers
  - Casing which has magnet in it on the charging side of the portable device
- When wireless keys (that emit radio waves) other than those of your vehicle are being used nearby
- When 2 or more portable devices are placed on the charging tray at the same time
- If a portable device built in S-pen (Galaxy "Note" series etc.) used, a portable device that inserted S-pen is placed on the tray

In situations other than above, if the

wireless charger does not operate properly or the operation indicator light blinks continuously, the wireless charger may be malfunctioning.

Contact your Toyota dealer.

■ **If the smartphone OS has been updated**

If the smartphone OS has been updated to a newer version, its charging specifications may have changed significantly. For details, check the information on the manufacturer's website.

■ **Trademark information**

iPhone is a trademark of Apple Inc., registered in the U.S. and other countries.

 **WARNING**

■ **Caution while driving**

When charging a portable device while driving, for safety reasons, the driver should not operate the portable device.

■ **Precautions for when driving**

Do not charge small, lightweight portable devices, such as wireless earbuds, while driving. Lightweight devices may fly off of the charging tray, possibly leading to an accident.

■ **Caution regarding interference with electronic devices**

People with implantable cardiac pacemakers, cardiac resynchronization therapy pacemakers or implantable cardioverter defibrillators, as well as any other electrical medical device, should consult their physician about the usage of the wireless charger.

Operations of the wireless charger may have an affect on medical devices.

■ **To prevent damage or burns**

Observe the following precautions.

Failure to do so may result in the possibility of fire, equipment failure or damage, or burns due to heat.

- Do not put any metallic objects between the charging area and the portable device while charging.
- Do not attach metallic objects, such as aluminum stickers, to the charging area.
- Do not charge portable devices with aluminum stickers or other metallic objects attached to the side which touches the charging area.
- Do not store items on the wireless charger instead of in an auxiliary box.
- Do not apply force or impact to the wireless charger.
- Do not disassemble, modify or remove the wireless charger.
- Do not attempt to charge portable devices which are not compatible with the Qi wireless charging standard.
- Do not allow magnetic objects to come near the wireless charger.
- Do not perform charging if the charging area is dirty.
- When not using the wireless charger, to prevent foreign matter or liquids from contacting it, make sure to close the lid.
- Keep the lid open while charging is taking place.

**⚠ WARNING**

- Do not cover the wireless charger with a cloth or other object while charging.

**⚠ NOTICE**

■ **To prevent failure or damage to data**

- Do not place magnetic cards, such as a credit card, or magnetic recording media, close to the wireless charger while charging. Otherwise, data may be erased due to the influence of magnetism. Additionally, do not bring precision instruments such as wrist watches, close to the wireless charger, as such objects may malfunction.
- Do not perform charging with a contactless smart card, such as a transportation system IC card, between the charging surface of a portable device and the charging area. The IC chip in the card may become extremely hot, possibly damaging the portable device or smart card. Be extra careful to not charge a portable device with a case or cover which a contactless smart card can be inserted.
- Do not leave portable devices in the cabin. The temperature inside the cabin may become high when parked in the sun, and cause damage to the device.

■ **To prevent battery discharge**

Do not use the wireless charger for a long period of time with the engine stopped.

**Armrest**

- ▶ **Second seats (8-seat models)**

Pull the armrest down for use.

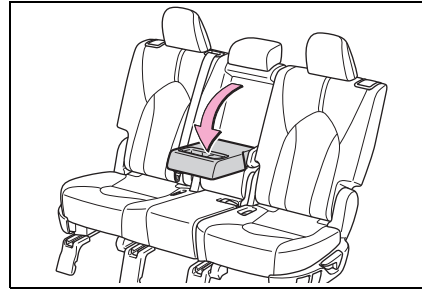

- ▶ **Second seats (7-seat models)**

Pull the armrest down for use.

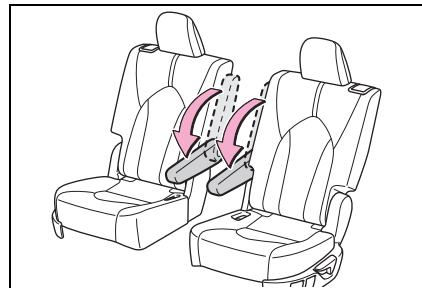

**⚠ NOTICE**

■ **To prevent damage to the armrest**

Do not apply too much load on the armrest.

**Assist grips**

An assist grip installed on the ceiling can be used to support your body while sitting on the seat.

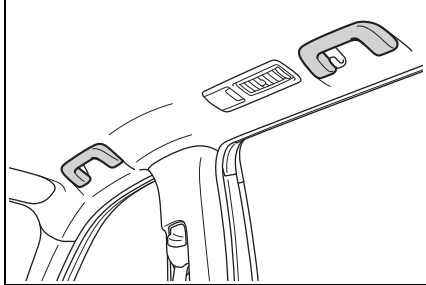

**⚠ WARNING**  
**■ Assist grip**  
 Do not use the assist grip when getting in or out of the vehicle or rising from your seat.

**⚠ NOTICE**  
**■ To prevent damage to the assist grip**  
 Do not hang any heavy object or put a heavy load on the assist grip.

**Coat hooks**

The coat hooks are provided with the rear assist grips.

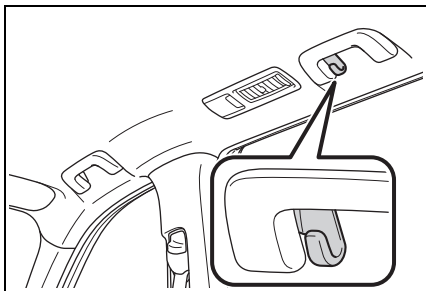

**⚠ WARNING**  
**■ Items that must not be hung on the hook**  
 Do not hang coat hangers or other hard or sharp objects on the hook. If the SRS curtain shield airbags deploy, these items may become projectiles, causing death or serious injury.

**Power outlets (12 VDC)**

Please use as a power supply for electronic goods that use less than 12 VDC/10 A (power consumption of 120 W).

When using electronic goods, make sure that the power consumption of all the connected power outlets is less than 120 W.

- ▶ Inside the console box  
 Open the lid.

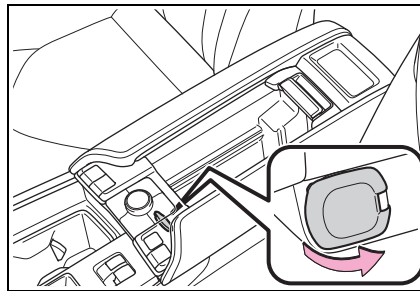

- ▶ Rear of console box (if equipped)  
 Open the lid.

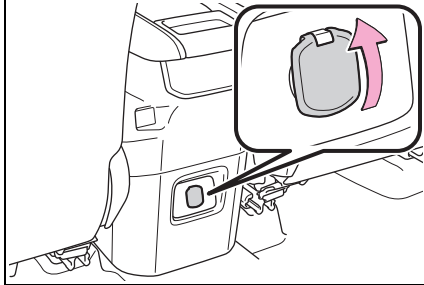

■ **The power outlet can be used when**

The engine switch is in ACC or ON.

■ **Using the power outlet**

When the engine restarts after having been stopped by the Stop & Start system, the power outlets may be temporarily unusable, but this is not a malfunction.

■ **When turning the engine switch off**

Disconnect electrical devices with charging functions, such as mobile battery packs. If such devices are left connected, the engine switch may not be turned off normally.

 NOTICE

■ **To avoid damaging the power outlet**

Close the power outlet lid when the power outlet is not in use. Foreign objects or liquids that enter the power outlet may cause a short circuit.

■ **To prevent the battery from being discharged**

Do not use the power outlet longer than necessary when the engine is not running.

**Power outlets (120 VAC) (if equipped)**

Accessories that use less than 100 W.

Open the lid.

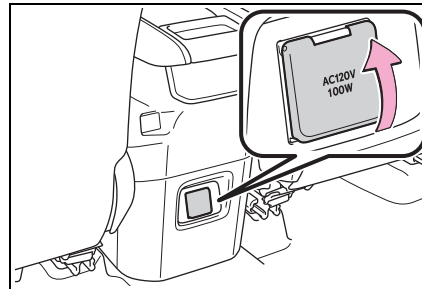

■ **The power outlet can be used when**

The engine switch is in ON.

■ **Using the power outlet**

When the engine restarts after having been stopped by the Stop & Start system, the power outlets may be temporarily unusable, but this is not a malfunction.

■ **When turning the engine switch off**

Disconnect electrical devices with charging functions, such as mobile battery packs. If such devices are left connected, the engine switch may not be turned off normally.

 NOTICE

■ **To prevent the fuse from being blown**

Do not use a 120 VAC appliance that requires more than 100 W. If a 120 VAC appliance that consumes more than 100 W is used, the protection circuit will cut the power supply.



 **NOTICE**

■ **To avoid damaging the power outlet**

Close the power outlet lid when the power outlet is not in use. Foreign objects or liquids that enter the power outlet may cause a short circuit.

■ **To prevent the battery from being discharged**

Do not use the power outlet longer than necessary when the engine is not running.

■ **Appliances that may not operate properly**

The following 120 VAC appliances may not operate properly even if their power consumption is under 100 W.

- Appliances with high initial peak wattage
- Measuring devices that process precise data
- Other appliances that require an extremely stable power supply

**Sun visors**

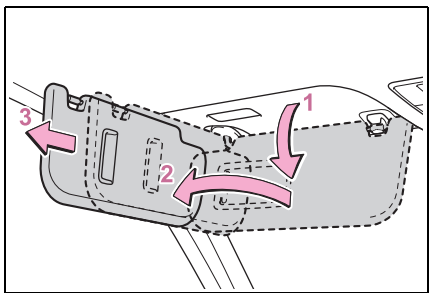

- 1** To set the visor in the forward position, flip it down.
- 2** To set the visor in the side position, flip down, unhook, and swing it to the side.
- 3** To use the side extender, place the visor in the side position, then slide it backward.

**Vanity mirrors**

Slide the cover to open.  
The light turns on when the cover is opened.

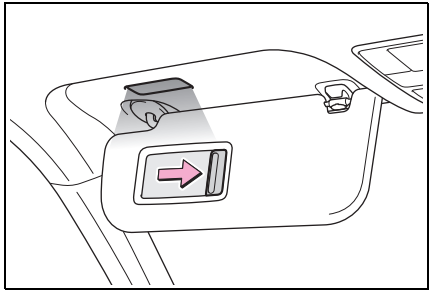

■ **To prevent battery discharge**

If the vanity lights remain on when the engine switch is turned off, the lights will go off automatically after 20 minutes.

 **NOTICE**

■ **To prevent the battery from being discharged**

Do not leave the vanity lights on for extended periods while the engine is off.

### Rear door sunshades

- 1 Pull the tab up.

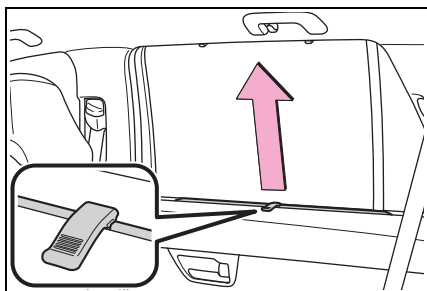

- 2 Hook the sunshade on to the anchors.

To lower the sunshade, pull the tab up slightly to unhook the shade from the anchors, and lower it slowly.

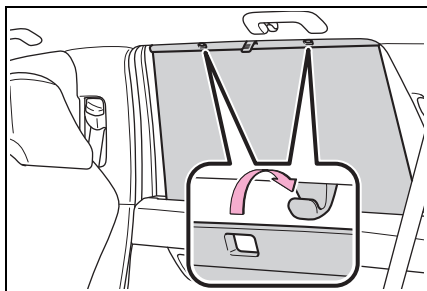

### WARNING

#### ■ Closing the rear door sunshade

When a rear door sunshade is in use, do not put fingers, etc. on the anchors or in the groove of the rear door sunshade. Otherwise, a finger, etc. may get caught, possibly causing an injury.

### NOTICE

#### ■ To ensure normal operation of the sunshades

- Do not put anything in an area where it may interfere with the operation of a rear door sunshade.
- To prevent damage to the rear door sunshades, do not apply excessive load or attach items to the rear door sunshades.

**Garage door opener**

The garage door opener can be programmed using the HomeLink® to operate garage doors, gates, entry doors, door locks, home lighting systems, security systems, and other devices.

**HomeLink® programming procedure**

The programming procedures can also be found at the following URL.

Website: [www.homelink.com/toyota](http://www.homelink.com/toyota)



For support, contact customer support at the following.

Help Line: 1-800-355-3515

**System components**

The HomeLink® wireless control system in your vehicle has 3 buttons which can be programmed to operate 3 different devices. Refer to the programming methods on the following pages to determine the method which is appropriate for the device.

- ▶ Vehicles with auto anti-glare inside rear view mirror

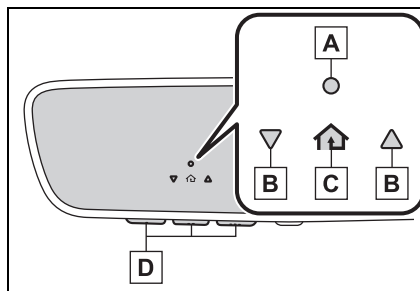

- A** HomeLink® indicator light
- B** Garage door operation indicators
- C** HomeLink® icon

Illuminates while HomeLink® is operating.

- D** Buttons

- ▶ Vehicles with Digital Rearview Mirror

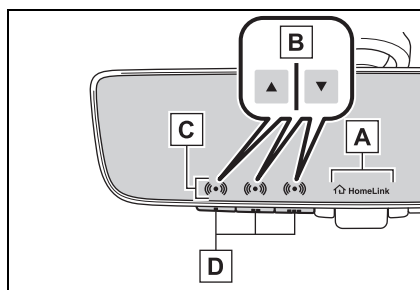

- A** HomeLink® logo  
Appears while HomeLink® is operating. When the menu button (→P.152) is pressed, the logo disappears even while the HomeLink® is operating.
- B** Garage door operation indicators
- C** HomeLink® indicator light

Illuminates above each button selected.

**D** Buttons

■ **Codes stored in the HomeLink® memory**

- The registered codes are not erased even if the battery cable is disconnected.
- If learning failed when registering a different code to a HomeLink® button that already has a code registered to it, the already registered code will not be erased.

**⚠ WARNING**

■ **When programming a garage door or other remote control device**

The garage door or other device may operate, so ensure people and objects are out of danger to prevent potential harm.

■ **Conforming to federal safety standards**

Do not use the HomeLink® compatible transceiver with any garage door opener or device that lacks safety stop and reverse features as required by federal safety standards.

This includes any garage door that cannot detect an interfering object. A door or device without these features increases the risk of death or serious injury.

■ **When operating or programming HomeLink®**

Never allow a child to operate or play with the HomeLink® buttons.

**Programming the HomeLink®**

■ **Before programming HomeLink®**

- During programming, it is possible that garage doors, gates, or other devices may operate. For this reason, make sure that people and objects are clear of the garage door or other devices to prevent injury or other potential harm.
- It is recommended that a new battery be placed in the remote control transmitter for more accurate programming.
- Garage door opener motors manufactured after 1995 may be equipped with rolling code protection. If this is the case, you may need a stepladder or other sturdy, safe device to reach the “Learn” or “Smart” button on the garage door opener motor.

■ **Programming HomeLink®**

Steps **1** through **3** must be performed within 60 seconds, otherwise the HomeLink® indicator light will stop flashing and programming will not be successfully completed.

- 1** Press and release the HomeLink® button you want to program and check that the

HomeLink® indicator light flashes (orange).

- 2 Point the remote control transmitter for the device at the rear view mirror, 1 to 3 in. (25 to 75 mm) from the HomeLink® buttons.

Keep the HomeLink® indicator light in view while programming.

- ▶ Vehicles with auto anti-glare inside rear view mirror

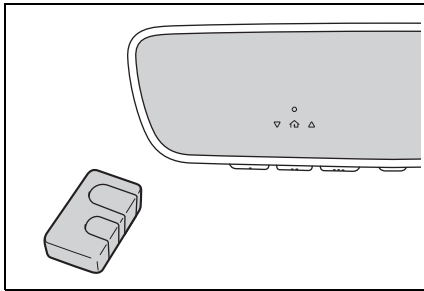

- ▶ Vehicles with Digital Rearview Mirror

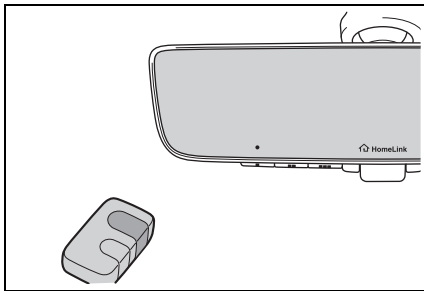

- 3 Program a device.

- ▶ Vehicles with auto anti-glare inside rear view mirror

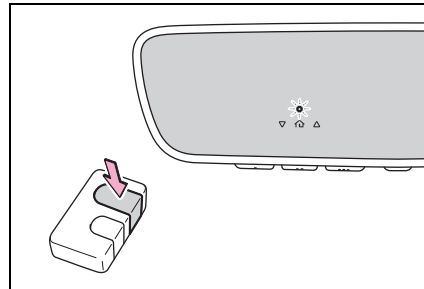

- ▶ Vehicles with Digital Rearview Mirror

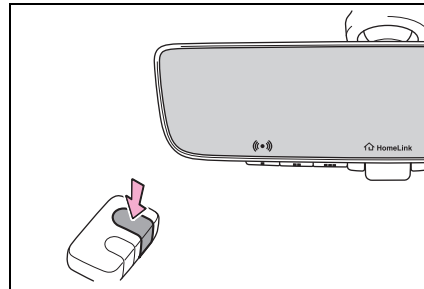

- ▶ Programming a device other than an entry gate (for U.S.A. owners)

Press and hold the remote control transmitter button until the HomeLink® indicator light changes from slowly flashing orange to rapidly flashing green (rolling code) or continuously lit green (fixed code), then release the button.

- ▶ Programming an entry gate (for U.S.A. owners)/Programming a device in the Canadian market

Press and release the remote control transmitter button at 2

second intervals, repeatedly, until the HomeLink<sup>®</sup> indicator light changes from slowly flashing (orange) to rapidly flashing (green) (rolling code) or continuously lit (green) (fixed code).

4 Test the HomeLink<sup>®</sup> operation by pressing the newly programmed button and observing the indicator light:

- HomeLink<sup>®</sup> indicator light illuminates: Programming of a fixed code device has completed. The garage door or other device should operate when a HomeLink<sup>®</sup> button is pressed and released.

- HomeLink<sup>®</sup> indicator light flashes rapidly: The garage door opener motor or other device is equipped with a rolling code. To complete programming, firmly press and hold the HomeLink<sup>®</sup> button for 2 seconds then release it.

- If the garage door or other device does not operate, proceed to “Programming a rolling code system”.

5 Repeat the steps above to program another device for any of the remaining HomeLink<sup>®</sup> buttons.

#### ■ Programming a rolling code system

Two or more people may be necessary to complete rolling

code programming.

1 Locate the “Learn” or “Smart” button on the garage door opener motor in the garage.

This button can usually be found where the hanging antenna wire is attached to the unit. The name and color of the button may vary by manufacturer. Refer to the owner’s manual supplied with the garage door opener motor for details.

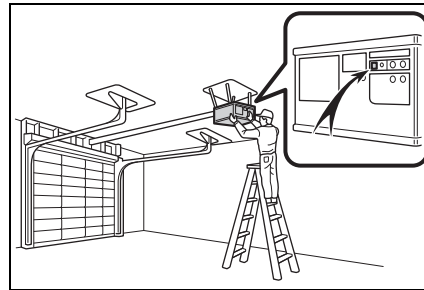

2 Press and release the “Learn” or “Smart” button.

Perform 3 within 30 seconds after performing 2.

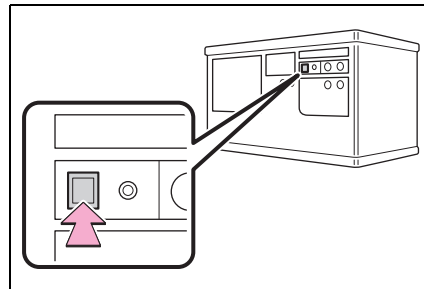

3 Press and hold the desired HomeLink<sup>®</sup> button (inside the vehicle) for 2 seconds and release it. Repeat this sequence (press/hold/release) up to 3 times to complete programming.

If the garage door opener

motor operates when the HomeLink® button is pressed, the garage door opener motor recognizes the HomeLink® signal.

- ▶ Vehicles with auto anti-glare inside rear view mirror

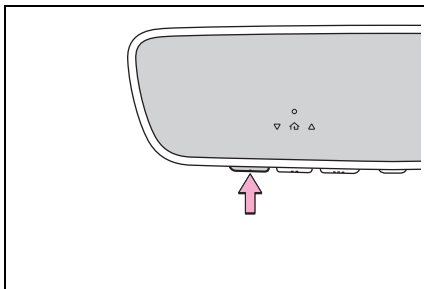

- ▶ Vehicles with Digital Rearview Mirror

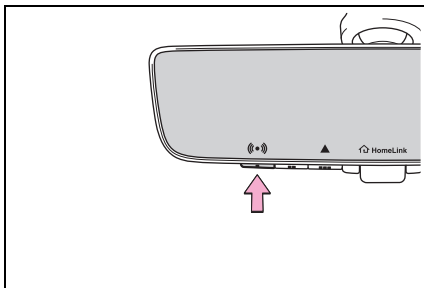

■ **Enabling 2-way communication with a garage door (only available for compatible devices)**

When enabled, 2-way communication allows you to check the status of the opening and closing of a garage door through indicators in your vehicle.

2-way communication is only available if the garage door opener motor used is a compati-

ble device. (To check device compatibility, refer to [www.homelink.com](http://www.homelink.com).)

- 1 Within 5 seconds after programming the garage door opener has been completed, if the garage door opener motor is trained to HomeLink®, both garage door operation indicators will flash rapidly (green) and the light on the garage door opener motor will blink twice, indicating that 2-way communication is enabled.

If the indicators do not flash, perform 2 and 3 within the first 10 presses of the HomeLink® button after programming has been completed.

- 2 Press a programmed HomeLink® button to operate a garage door.
- 3 Within 1 minute of pressing the HomeLink® button, after the garage door operation has stopped, press the “Learn” or “Smart” button on the garage door opener motor. Within 5 seconds of the establishment of 2-way communication with the garage door opener, both garage door operation indicators in the vehicle will flash rapidly (green) and the light on the garage door opener motor will blink twice, indicat-

ing that 2-way communication is enabled.

■ **Reprogramming a single HomeLink® button**

When the following procedure is performed, buttons which already have devices registered to them can be overwritten:

- 1 Press and hold the desired HomeLink® button.
- 2 When the HomeLink® indicator starts flashing orange, release the HomeLink® button and perform “Programming HomeLink®” 1 (it takes 20 seconds for the HomeLink® indicator to start flashing).

■ **Before programming**

- Install a new battery in the transmitter.
- The battery side of the transmitter must be pointed away from the HomeLink® buttons.

**Operating HomeLink®**

Press the appropriate HomeLink® button. The HomeLink® indicator light should turn on.

The status of the opening and closing of a garage door is shown by the garage door opener indicators.

- ▶ Vehicles with auto anti-glare inside rear view mirror

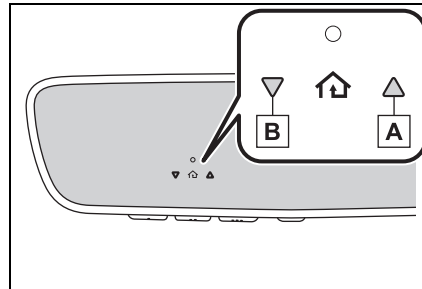

- A** Opening
- B** Closing

- ▶ Vehicles with Digital Rearview Mirror

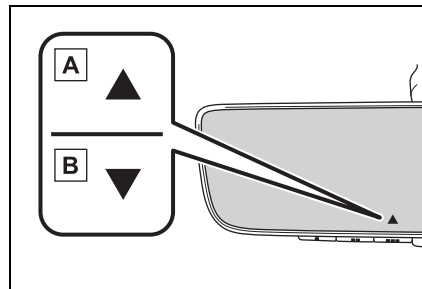

- A** Opening
- B** Closing









This function is only available if the garage door opener motor used is a compatible device. (To check device compatibility, refer to [www.homelink.com](http://www.homelink.com).)

Color	Status
Orange (flashing)	Currently opening/closing



Color	Status
Green	Opening/closing has completed
Red (flashing)	Feedback signals cannot be received

The indicators can operate within approximately 820 ft. (250 m) of the garage door. However, if there are obstructions between the garage door and the vehicle, such as houses and trees, feedback signals from the garage door may not be received.

To recall the previous door operation status, press and release either HomeLink® buttons  and  or  and  (vehicles with auto anti-glare inside rear view mirror),  and  or  and  (vehicles with Digital Rearview Mirror), simultaneously. The last recorded status will be displayed for 3 seconds.

**Erasing the entire HomeLink® memory (all three codes)**

Press and hold the 2 outside buttons for 10 seconds until the HomeLink® indicator light changes from continuously lit (orange) to rapidly flashing (green).

If you sell your vehicle, be sure to erase the programs stored in the HomeLink® memory.

- ▶ Vehicles with auto anti-glare inside rear view mirror

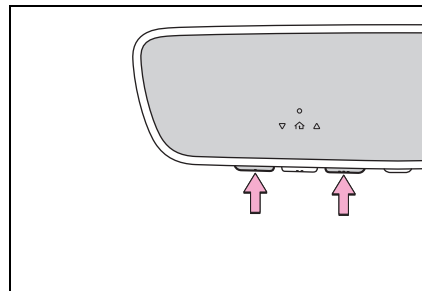

- ▶ Vehicles with Digital Rearview Mirror

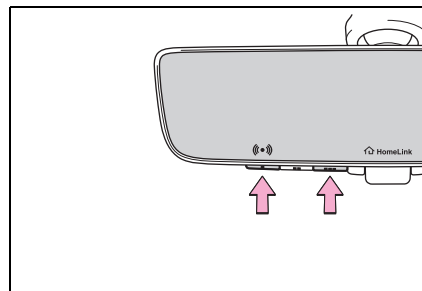



**Maintenance and care****6****6-1. Maintenance and care**

Cleaning and protecting the  
vehicle exterior..... 420

Cleaning and protecting the  
vehicle interior..... 423

**6-2. Maintenance**

Maintenance requirements  
..... 426

General maintenance.. 427

Emission inspection and  
maintenance (I/M) pro-  
grams ..... 430

**6-3. Do-it-yourself mainte-  
nance**

Do-it-yourself service pre-  
cautions..... 431

Hood ..... 433

Positioning a floor jack  
..... 434

Engine compartment... 435

Tires ..... 443

Tire inflation pressure.. 455

Wheels ..... 457

Air conditioning filter.... 459

Electronic key battery.. 460

Checking and replacing  
fuses..... 462

Headlight aim ..... 465

Light bulbs..... 466

## Cleaning and protecting the vehicle exterior

**Perform cleaning in a manner appropriate to each component and its material.**

### Cleaning instructions

- Working from top to bottom, liberally apply water to the vehicle body, wheel wells and underside of the vehicle to remove any dirt and dust.
- Wash the vehicle body using a sponge or soft cloth, such as a chamois.
- For hard-to-remove marks, use car wash soap and rinse thoroughly with water.
- Wipe away any water.
- Wax the vehicle when the waterproof coating deteriorates.

If water does not bead on a clean surface, apply wax when the vehicle body is cool.

#### ■ Automatic car washes

- Before washing the vehicle:
  - Fold the mirrors
  - Turn off the power back door

Start washing from the front of the vehicle. Extend the mirrors before driving.

- Brushes used in automatic car washes may scratch the vehicle surface, parts (wheel, etc.) and harm your vehicle's paint.

- Rear spoiler may not be washable in some automatic car washes. There may also be an increased risk of damage to vehicle.

#### ■ High pressure car washes

As water may enter the cabin, do not bring the nozzle tip near the gaps around the doors or perimeter of the windows, or spray these areas continuously.

#### ■ When using a car wash

If the door handle becomes wet while the electronic key is within the effective range, the door may lock and unlock repeatedly. In that case, follow the following correction procedures to wash the vehicle:

- Place the key in a position 6 ft. (2 m) or more separate from the vehicle while the vehicle is being washed. (Take care to ensure that the key is not stolen.)
- Set the electronic key to battery-saving mode to disable the smart key system. (→P.137)

#### ■ Wheels and wheel ornaments

- Remove any dirt immediately by using a neutral detergent.
- Wash detergent off with water immediately after use.
- To protect the paint from damage, make sure to observe the following precautions.
  - Do not use acidic, alkaline or abrasive detergent
  - Do not use hard brushes
  - Do not use detergent on the wheels when they are hot, such as after driving or parking in hot weather

#### ■ Brake pads and calipers

Rust may form if the vehicle is parked with wet brake pads or disc rotors, causing them to stick. Before parking the vehicle after it is washed, drive slowly and apply the brakes several times to dry the parts.

■ **Bumpers**

Do not scrub with abrasive cleaners.

■ **Plated portions**

If dirt cannot be removed, clean the parts as follows:

- Use a soft cloth dampened with an approximately 5% solution of neutral detergent and water to clean the dirt off.
- Wipe the surface with a dry, soft cloth to remove any remaining moisture.
- To remove oily deposits, use alcohol wet wipes or a similar product.

**⚠ WARNING**

■ **When washing the vehicle**

Do not apply water to the inside of the engine compartment. Doing so may cause the electrical components, etc. to catch fire.

■ **When cleaning the windshield (vehicles with rain-sensing windshield wipers)**

Set the wiper switch to off. If the switch is in "AUTO", the wipers may operate unexpectedly in the following situations, and may result in hands being caught or other serious injuries and cause damage to the wiper blades.

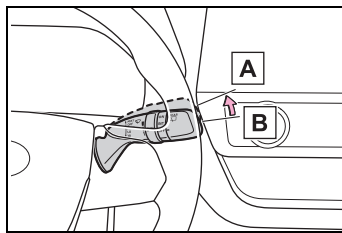

- A** Off
- B** AUTO

- When the upper part of the windshield where the raindrop sensor is located is touched by hand

- When a wet rag or similar is held close to the raindrop sensor

- If something bumps against the windshield

- If you directly touch the raindrop sensor body or if something bumps into the raindrop sensor

■ **Precautions regarding the exhaust pipe**

Exhaust gasses cause the exhaust pipe to become quite hot. When washing the vehicle, be careful not to touch the pipe until it has cooled sufficiently, as touching a hot exhaust pipe can cause burns.

■ **Precaution regarding the front and rear bumpers**

If the paint of the front or rear bumper is chipped or scratched, the following systems may not function correctly. If this occurs, consult your Toyota dealer.

- Toyota Safety Sense 3.0
- BSM
- RCTA
- SEA
- PKSB (if equipped)
- Intuitive parking assist (if equipped)

**⚠ NOTICE**

■ **To prevent paint deterioration and corrosion on the body and components (aluminum wheels, etc.)**

- Wash the vehicle immediately in the following cases:
  - After driving near the sea coast
  - After driving on salted roads



**NOTICE**

- If coal tar or tree sap is present on the paint surface
- If dead insects, insect droppings or bird droppings are present on the paint surface
- After driving in an area contaminated with soot, oily smoke, mine dust, iron powder or chemical substances
- If the vehicle becomes heavily soiled with dust or mud
- If liquids such as benzene and gasoline are spilled on the paint surface
- If the paint is chipped or scratched, have it repaired immediately.
- To prevent the wheels from corroding, remove any dirt and store in a place with low humidity when storing the wheels.

■ **Cleaning the exterior lights**

- Wash carefully. Do not use organic substances or scrub with a hard brush. This may damage the surfaces of the lights.
- Do not apply wax to the surfaces of the lights. Wax may cause damage to the lenses.

■ **When using an automatic car wash (vehicles with rain-sensing windshield wipers)**

Set the wiper switch to the off position. If the wiper switch is in "AUTO", the wipers may operate and the wiper blades may be damaged.

■ **When using a high pressure car wash**

- When washing the vehicle, do not spray the camera or its surrounding area directly with a high pressure washer. Shock applied from high pressure water may cause the device to not operate normally.
- Do not spray water directly on the radar which is equipped behind the emblem. Otherwise it may cause the device to be damaged.
- Do not bring the nozzle tip close to boots (rubber or resin manufactured cover), connectors or the following parts. The parts may be damaged if they come into contact with high-pressure water.
  - Traction related parts
  - Steering parts
  - Suspension parts
  - Brake parts
- Keep the cleaning nozzle at least 11.9 in. (30 cm) away from the vehicle body. Otherwise resin section, such as moldings and bumpers, may be deformed and damaged.

Also, do not continuously hold the nozzle in the same place.

- Do not spray the lower part of the windshield continuously. If water enters the air conditioning system intake located near the lower part of the windshield, the air conditioning system may not operate correctly.
- Do not wash the underside of the vehicle using a high pressure car washer.

 NOTICE**■ Handling of the decorative plastic parts (some 20-inch wheels )**

Do not hold a wheel by the decorative plastic parts to lift up or carry the wheel.

Failure to do so may result in damage to the wheel.

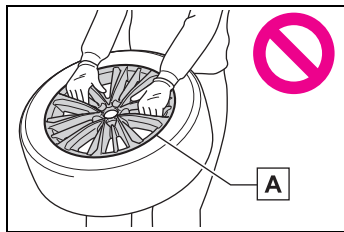

**A** Plastic parts

**Cleaning and protecting the vehicle interior**

**Perform cleaning in a manner appropriate to each component and its material.**

**Protecting the vehicle interior**

- Remove dirt and dust using a vacuum cleaner. Wipe dirty surfaces with a cloth dampened with lukewarm water.
- If dirt cannot be removed, wipe it off with a soft cloth dampened with neutral detergent diluted to approximately 1%.

Wring out any excess water from the cloth and thoroughly wipe off remaining traces of detergent and water.

**■ Shampooing the carpets**

There are several commercial foaming-type cleaners available. Use a sponge or brush to apply the foam. Rub in overlapping circles. Do not use water. Wipe dirty surfaces and let them dry. Excellent results are obtained by keeping the carpet as dry as possible.

**■ Handling the seat belts**

Clean with mild soap and lukewarm water using a cloth or sponge. Also check the belts periodically for excessive wear, fraying or cuts.

 **WARNING**

■ **Water in the vehicle**

- Do not splash or spill liquid in the vehicle.  
Doing so may cause electrical components, etc. to malfunction or catch fire.
- Do not get any of the SRS components or wiring in the vehicle interior wet.  
(→P.37)  
An electrical malfunction may cause the airbags to deploy or not function properly, resulting in death or serious injury.
- Do not let the wireless charger (→P.398) get wet. Failure to do so may cause the charger to become hot and cause burns or could cause electric shock resulting in death or serious injury.

■ **Cleaning the interior (especially instrument panel)**

Do not use polish wax or polish cleaner. The instrument panel may reflect off the windshield, obstructing the driver's view and leading to an accident, resulting in death or serious injury.

 **NOTICE**

■ **Cleaning detergents**

- Do not use the following liquids, as they may discolor the vehicle interior or cause streaks or damage to painted surfaces:
  - Areas other than the seats and steering wheel: Organic substances such as benzene or gasoline, alkaline or acidic solutions, dye, and bleach
  - Seats: Alkaline or acidic solutions, such as thinner, benzene, and alcohol

- Steering wheel: Organic substances, such as thinner, and cleaner that contains alcohol

- Do not use polish wax or polish cleaner. The instrument panel's or other interior part's painted surface may be damaged.

■ **Preventing damage to leather surfaces**

Observe the following precautions to avoid damage to and deterioration of leather surfaces:

- Remove any dust or dirt from leather surfaces immediately.
- Do not expose the vehicle to direct sunlight for extended periods of time. Park the vehicle in the shade, especially during summer.
- Do not place items made of vinyl, plastic, or containing wax on the upholstery, as they may stick to the leather surface if the vehicle interior heats up significantly.

■ **Water on the floor**

Do not wash the vehicle floor with water.

Vehicle systems such as the audio system may be damaged if water comes into contact with electrical components such as the audio system above or under the floor of the vehicle. Water may also cause the body to rust.

■ **When cleaning the inside of the windshield**

Do not allow glass cleaner to contact the lens. Also, do not touch the lens. (→P.236)



**NOTICE****■ Cleaning the inside of the rear window**

- Do not use glass cleaner to clean the rear window, as this may cause damage to the rear window defogger heater wires or antenna. Use a cloth dampened with lukewarm water to gently wipe the window clean. Wipe the window in strokes running parallel to the heater wires or antenna.
- Be careful not to scratch or damage the heater wires or antenna.

**■ Cleaning the leather areas**

- Remove dirt and dust using a vacuum cleaner.
- Wipe off any excess dirt and dust with a soft cloth dampened with diluted detergent.

Use a diluted water solution of approximately 5% neutral wool detergent.

- Wring out any excess water from the cloth and thoroughly wipe off all remaining traces of detergent.
- Wipe the surface with a dry, soft cloth to remove any remaining moisture. Allow the leather to dry in a shaded and ventilated area.

**■ Caring for leather areas**

Toyota recommends cleaning the interior of the vehicle at least twice a year to maintain the quality of the vehicle's interior.

**■ Cleaning the synthetic leather areas**

- Remove dirt and dust using a vacuum cleaner.
- Wipe it off with a soft cloth dampened with neutral detergent diluted to approximately 1%.
- Wring out any excess water from the cloth and thoroughly wipe off remaining traces of detergent and water.

### Maintenance requirements

**To ensure safe and economical driving, day-to-day care and regular maintenance are essential. It is the owner's responsibility to perform regular checks. Toyota recommends the following maintenance:**

#### ■ Repair and replacement

It is recommended that genuine Toyota parts be used for repairs to ensure performance of each system. If non-Toyota parts are used in replacement or if a repair shop other than a Toyota dealer performs repairs, confirm the warranty coverage.

#### ■ Allow inspection and repairs to be performed by a Toyota dealer

- Toyota technicians are well-trained specialists and are kept up to date with the latest service information. They are well informed about the operation of all systems on your vehicle.
- Keep a copy of the repair order. It proves that the maintenance that has been performed is under warranty coverage. If any problem should arise while your vehicle is under warranty, your Toyota dealer will promptly take care of it.

#### WARNING

#### ■ If your vehicle is not properly maintained

Improper maintenance could result in serious damage to the vehicle and possible death or serious injury.

#### ■ Handling of the battery

- Engine exhaust, some of its constituents, and a wide variety of automobile components contain or emit chemicals known to the State of California to cause cancer and birth defects and other reproductive harm. Work in a well ventilated area.
- Oils, fuels and fluids contained in vehicles as well as waste produced by component wear contain or emit chemicals known to the State of California to cause cancer and birth defects or other reproductive harm. Avoid exposure and wash any affected area immediately.
- Battery posts, terminals and related accessories contain lead and lead compounds which are known to cause brain damage. Wash your hands after handling. (→P.440)

### General maintenance

General maintenance should be performed on a daily basis. This can be done by yourself or by a Toyota dealer.

### Scheduled maintenance

Scheduled maintenance should be performed at specified intervals according to the maintenance schedule.

For details about maintenance items and schedules, refer to the "Scheduled Maintenance Guide" or "Owner's Manual Supplement".

**■ Resetting the message indicating maintenance is required**

After the required maintenance is performed according to the maintenance schedule, please reset the message.

To reset the message, follow the procedure described below:

- 1 Select  of the multi-information display using the meter control switches and then press OK .
- 2 Select “Vehicle Settings” and then press and hold OK .
- 3 Select “Scheduled Maintenance” and then press OK .
- 4 Select “Yes” and then press OK .

“Reset Complete” will be displayed on the multi-information display when the reset procedure has been completed.

**Do-it-yourself maintenance**

You can perform some maintenance procedures by yourself. Please be aware that do-it-yourself maintenance may affect warranty coverage.

The use of Toyota repair manuals is recommended.

For details about warranty coverage, refer to the separate “Owner’s Guide”, “Warranty and Service Guide”, “Owner’s Manual Supplement” or “Warranty Booklet”.

**General maintenance**

Listed below are the general maintenance items that should be performed at the intervals specified in the “Owner’s Warranty Information Booklet” or “Owner’s Manual Supplement/Scheduled Maintenance Guide”. It is recommended that any problem you notice should be brought to the attention of your Toyota dealer or qualified service shop for advice.

 **WARNING**

**■ If the engine is running**

Turn the engine off and ensure that there is adequate ventilation before performing maintenance checks.

**Engine compartment**

Items	Check points
Battery	Check the connections. (→P.440)
Brake fluid	Is the brake fluid at the correct level? (→P.439)
Engine/inter-cooler coolant	Is the engine/inter-cooler coolant at the correct level? (→P.438)
Engine oil	Is the engine oil at the correct level? (→P.435)

Items	Check points
Exhaust system	There should not be any fumes or strange sounds.
Radiator, condenser and intercooler radiator	The radiator, condenser and intercooler radiator should be free from foreign objects. (→P.439)
Washer fluid	Is there sufficient washer fluid? (→P.442)

### Vehicle interior

Items	Check points
Accelerator pedal	<ul style="list-style-type: none"> <li>The accelerator pedal should move smoothly (without uneven pedal effort or catching).</li> </ul>
Automatic transmission "Park" mechanism	<ul style="list-style-type: none"> <li>When parked on a slope and the shift position is in P, is the vehicle securely stopped?</li> </ul>

Items	Check points
Brake pedal	<ul style="list-style-type: none"> <li>Does the brake pedal move smoothly?</li> <li>Does the brake pedal have appropriate clearance from the floor? (→P.523)</li> <li>Does the brake pedal have the correct amount of free play? (→P.523)</li> </ul>
Brakes	<ul style="list-style-type: none"> <li>The vehicle should not pull to one side when the brakes are applied.</li> <li>The brakes should work effectively.</li> <li>The brake pedal should not feel spongy.</li> <li>The brake pedal should not get too close to the floor when the brakes are applied.</li> </ul>
Head restraints	<ul style="list-style-type: none"> <li>Do the head restraints move smoothly and lock securely?</li> </ul>
Indicators/buzzers	<ul style="list-style-type: none"> <li>Do the indicators and buzzers function properly?</li> </ul>

Items	Check points
Lights	<ul style="list-style-type: none"> <li>• Do all the lights come on?</li> <li>• Are the headlights aimed correctly? (→P.465)</li> </ul>
Parking brake	<ul style="list-style-type: none"> <li>• Does the parking brake switch operate normally?</li> <li>• When parked on a slope and the parking brake is on, is the vehicle securely stopped?</li> </ul>
Seat belts	<ul style="list-style-type: none"> <li>• Do the seat belts operate smoothly?</li> <li>• The seat belts should not be damaged.</li> </ul>
Seats	<ul style="list-style-type: none"> <li>• Do the seat controls operate properly?</li> </ul>
Steering wheel	<ul style="list-style-type: none"> <li>• Does the steering wheel rotate smoothly?</li> <li>• Does the steering wheel have the correct amount of free play?</li> <li>• There should not be any strange sounds coming from the steering wheel.</li> </ul>

**Vehicle exterior**

Items	Check points
Doors	<ul style="list-style-type: none"> <li>• Do the doors operate smoothly?</li> </ul>
Engine hood	<ul style="list-style-type: none"> <li>• Does the engine hood lock system work properly?</li> </ul>
Fluid leaks	<ul style="list-style-type: none"> <li>• There should not be any signs of fluid leakage after the vehicle has been parked.</li> </ul>
Tires	<ul style="list-style-type: none"> <li>• Is the tire inflation pressure correct?</li> <li>• The tires should not be damaged or excessively worn.</li> <li>• Have the tires been rotated according to the maintenance schedule?</li> <li>• The wheel nuts should not be loose.</li> </ul>
Windshield wipers/rear window wiper	<ul style="list-style-type: none"> <li>• The wiper blades should not show any signs of cracking, splitting, wear, contamination or deformation.</li> <li>• The wiper blades should clear the windshield/rear window without streaking or skipping.</li> </ul>

### Emission inspection and maintenance (I/M) programs

**Some states have vehicle emission inspection programs which include OBD (On Board Diagnostics) checks. The OBD system monitors the operation of the emission control system.**

### If the malfunction indicator lamp comes on

The OBD system determines that a problem exists somewhere in the emission control system. Your vehicle may not pass the I/M test and may need to be repaired. Contact your Toyota dealer to service the vehicle.

### Your vehicle may not pass the I/M test in the following situations:

- When the battery is disconnected or discharged

Readiness codes that are set during ordinary driving are erased. Also, depending on your driving habits, the readiness codes may not be completely set.

- When the fuel tank cap is loose

The malfunction indicator lamp comes on indicating a temporary malfunction and your vehicle may not pass the I/M test.

### When the malfunction indicator lamp still remains on after several driving trips

The error code in the OBD system will not be cleared unless the vehicle is driven 40 or more times.

### If your vehicle does not pass the I/M test

Contact your Toyota dealer to prepare the vehicle for re-testing.

**Do-it-yourself service precautions**

**If you perform maintenance by yourself, be sure to follow the correct procedure as given in these sections.**

**Maintenance**

Items	Parts and tools
Battery condition (→P.440)	<ul style="list-style-type: none"> <li>• Warm water</li> <li>• Baking soda</li> <li>• Grease</li> <li>• Conventional wrench (for terminal clamp bolts)</li> <li>• Distilled water</li> </ul>
Brake fluid level (→P.439)	<ul style="list-style-type: none"> <li>• FMVSS No.116 DOT 3 or SAE J1703 brake fluid</li> <li>• FMVSS No.116 DOT 4 or SAE J1704 brake fluid</li> <li>• Rag or paper towel</li> <li>• Funnel (used only for adding brake fluid)</li> </ul>

Items	Parts and tools
Engine/inter-cooler coolant level (→P.438)	<ul style="list-style-type: none"> <li>• “Toyota Super Long Life Coolant” or a similar high quality ethylene glycol-based non-silicate, non-amine, non-nitrite and non-borate coolant with long-life hybrid organic acid technology For the U.S.A.: “Toyota Super Long Life Coolant” is pre-mixed with 50% coolant and 50% deionized water. For Canada: “Toyota Super Long Life Coolant” is pre-mixed with 55% coolant and 45% deionized water.</li> <li>• Funnel (used only for adding coolant)</li> </ul>
Engine oil level (→P.435)	<ul style="list-style-type: none"> <li>• “Toyota Genuine Motor Oil” or equivalent</li> <li>• Rag or paper towel</li> <li>• Funnel (used only for adding engine oil)</li> </ul>
Fuses (→P.462)	<ul style="list-style-type: none"> <li>• Fuse with same amperage rating as original</li> </ul>

Items	Parts and tools
Headlight aim (→P.465)	• Phillips-head screwdriver
Light bulbs (→P.466)	• Bulb with same number and wattage rating as original
Radiator, condenser and intercooler radiator (→P.439)	—
Tire inflation pressure (→P.455)	• Tire pressure gauge • Compressed air source
Washer fluid (→P.442)	• Water or washer fluid containing antifreeze (for winter use) • Funnel (used only for adding water or washer fluid)

 **WARNING**

The engine compartment contains many mechanisms and fluids that may move suddenly, become hot, or become electrically energized. To avoid death or serious injury, observe the following precautions.

■ **When working on the engine compartment**

- Keep hands, clothing and tools away from the moving fan and engine drive belt.
- Be careful not to touch the engine, radiator, exhaust manifold, etc. right after driving as they may be hot. Oil and other fluids may also be hot.

- Do not leave anything that may burn easily, such as paper and rags, in the engine compartment.

- Do not smoke, cause sparks or expose an open flame to fuel or the battery. Fuel and battery fumes are flammable.

- Be extremely cautious when working on the battery. It contains poisonous and corrosive sulfuric acid.

■ **When working near the electric cooling fan or radiator grille**

Be sure the engine switch is off. With the engine switch in ON, the electric cooling fan may automatically start to run if the air conditioning is on and/or the coolant temperature is high. (→P.439)

■ **Safety glasses**

Wear safety glasses to prevent flying or falling material, fluid spray, etc. from getting in your eyes.

 **NOTICE**

■ **If you remove the air cleaner filter**

Driving with the air cleaner filter removed may cause excessive engine wear due to dirt in the air.



**Hood**

**Opening the hood**

- 1 Pull the hood lock release lever.

The hood will pop up slightly.

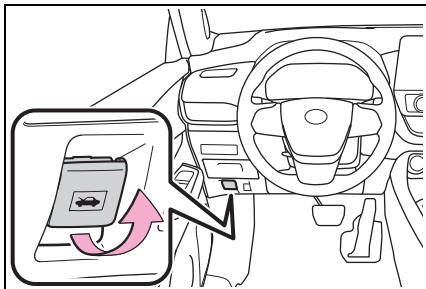

- 2 Pull up the auxiliary catch lever and lift the hood.

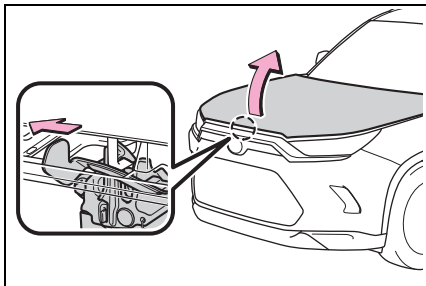

- 3 Hold the hood open by inserting the support rod into the slot.

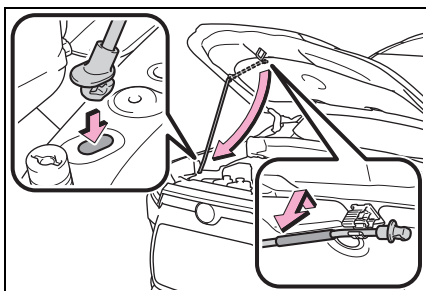

**! WARNING**

**When the hood is open**

Even if the engine switch is turned off, the cooling fan may continue to operate for a short time. When the cooling fan is rotating, do not touch or approach the inside of the engine compartment.

**Pre-driving check**

Check that the hood is fully closed and locked. If the hood is not locked properly, it may open while the vehicle is in motion and cause an accident, which may result in death or serious injury.

**To prevent a injuries**

The support rod may be hot after driving the vehicle. Touching the hot support rod may lead to burns or other serious injuries.

**After installing the support rod into the slot**

Make sure the rod supports the hood securely preventing it from falling down onto your head or body.

**! NOTICE**

**When closing the hood**

Be sure to return the support rod to its clip before closing the hood. Closing the hood with the support rod not clipped could cause the hood to bend.

### Positioning a floor jack

When using a floor jack, follow the instructions in the manual provided with the jack and perform the operation safely.

When raising your vehicle with a floor jack, position the jack correctly. Improper placement may damage your vehicle or cause injury.

### Location of the jack point

#### ■ Front

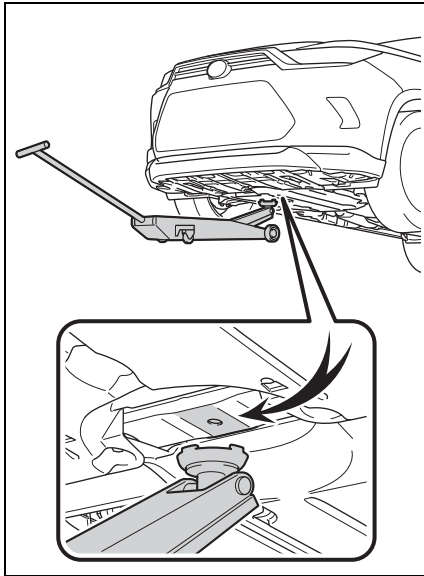

#### ■ Rear

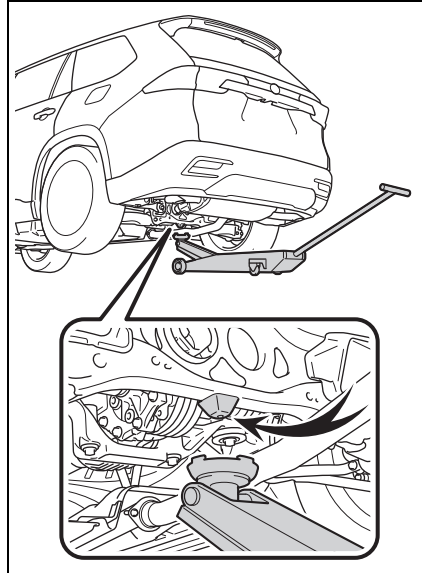

## Engine compartment

## Components

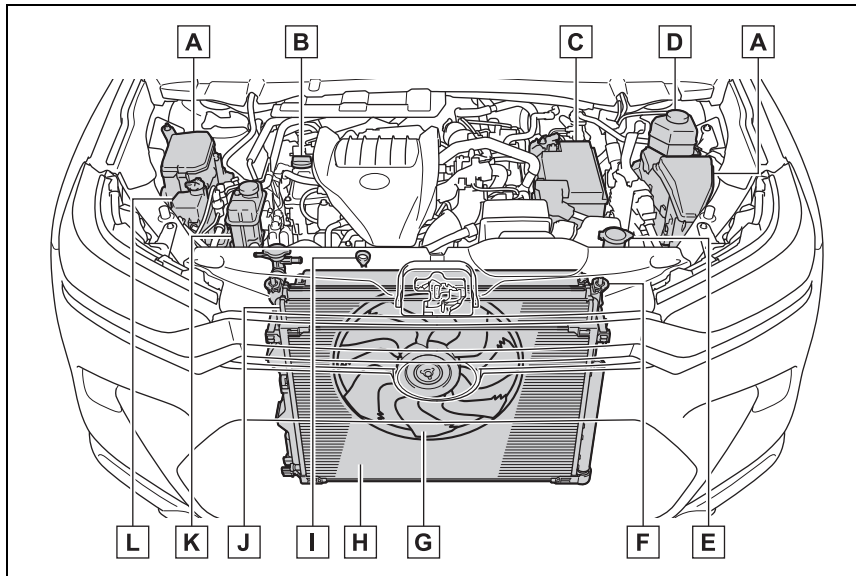

- A** Fuse boxes (→P.462)
- B** Engine oil filler cap (→P.437)
- C** Battery (→P.440)
- D** Brake fluid reservoir (→P.439)
- E** Washer fluid tank (→P.442)
- F** Radiator (→P.439)
- G** Electric cooling fan
- H** Condenser (→P.439)
- I** Engine oil level dipstick (→P.435)
- J** Intercooler radiator (→P.439)
- K** Intercooler coolant reservoir (→P.438)
- L** Engine coolant reservoir (→P.438)

**Checking the engine oil**

With the engine at operating

temperature and turned off, check the oil level on the dipstick.

- 1 Park the vehicle on level ground. After warming up the engine and turning off the engine, wait about 5 minutes for the oil to drain back into the bottom of the engine.
- 2 Holding a rag under the end, pull the dipstick out.

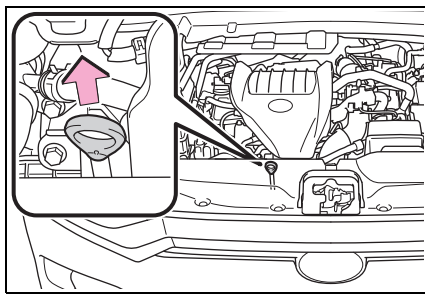

- 3 Wipe the dipstick clean.
- 4 Reinsert the dipstick fully.
- 5 Holding a rag under the end, pull the dipstick out and check whether the oil level is above low level mark.

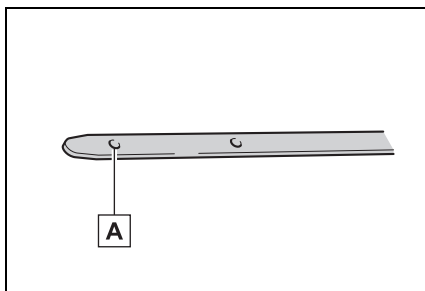

**A** Low level mark

The shape of the dipstick may differ depending on the type of vehicle or engine.

- 6 Wipe the dipstick and reinsert it fully.

 NOTICE

**To prevent serious engine damage**

Check the oil level on a regular basis.

**Engine oil consumption**

A certain amount of engine oil will be consumed while driving. In the following situations, oil consumption may increase, and engine oil may need to be refilled in between oil maintenance intervals.

- When the engine is new, for example directly after purchasing the vehicle or after replacing the engine
- If low quality oil or oil of an inappropriate viscosity is used
- When driving at high engine speeds or with a heavy load, when towing\*, or when driving while accelerating or decelerating frequently
- When leaving the engine idling for a long time, or when driving frequently through heavy traffic

\*: Vehicles with towing package

**Engine oil level rise**

If the vehicle is repeatedly driven without the engine warmed up, moisture caused by dew condensation inside the engine or fuel which did not burn mixes into the engine oil, resulting in a rise in engine oil level. However, this is not a malfunction.

For example, the engine become difficult to be warmed up in the following situations.

- When driving a short distance
- When driving at a low speed
- When the outside temperature is low

When checking the engine oil, make

sure that the engine is warmed up. If the engine oil level exceeds the refill upper limit mark, contact your Toyota dealer.

### Adding engine oil

#### ■ Checking the oil type and preparing the item needed

Make sure to check the oil type and prepare the items needed before adding oil.

- Engine oil selection  
→P.520
- Oil quantity (Low level mark  
→ Refill upper limit mark)  
1.6 qt. (1.5 L, 1.3 Imp. qt.)
- Item  
Clean funnel

#### ■ Adding engine oil

If the oil level is below or near the low level mark, add engine oil of the same type as that already in the engine.

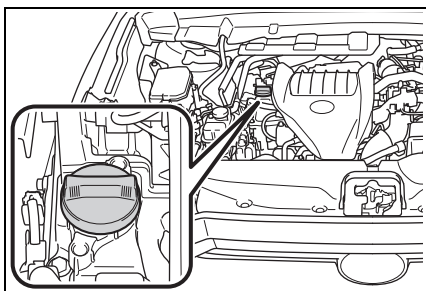

- 1 Remove the oil filler cap by turning it counterclockwise.
- 2 Add engine oil slowly, checking the dipstick.

Make sure that the oil level does not exceed the refill upper limit mark and is between the low level

mark and refill upper limit mark.

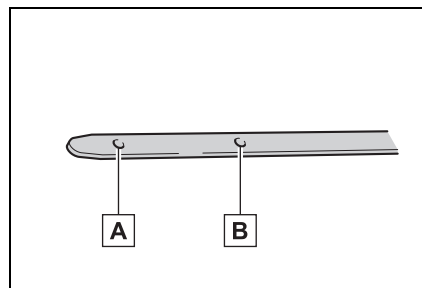

**A** Low level mark

**B** Refill upper limit mark

The shape of the dipstick may differ depending on the type of vehicle or engine.

- 3 Install the oil filler cap by turning it clockwise.

#### ■ After changing the engine oil

After the engine oil has been replaced, the engine oil maintenance data should be reset. Perform the following procedures:

- 1 Park the vehicle in a safe place and then start the engine.
- The oil maintenance cannot be reset while the vehicle is moving.
- 2 Select  of the multi-information display using the meter control switches and then press OK .
- 3 Select "Vehicle Settings" and then press and hold OK .
- 4 Select "Oil Maintenance" and then press OK .
- 5 Select "Yes" and then press OK .

"Reset Complete" will be displayed on the multi-information display when the reset procedure has been completed.

**⚠ WARNING**

■ **Used engine oil**

- Used engine oil contains potentially harmful contaminants which may cause skin disorders such as inflammation and skin cancer, so care should be taken to avoid prolonged and repeated contact. To remove used engine oil from your skin, wash thoroughly with soap and water.
- Dispose of used oil and filters only in a safe and acceptable manner. Do not dispose of used oil and filters in household trash, in sewers or onto the ground. Call your Toyota dealer, service station or auto parts store for information concerning recycling or disposal.
- Do not leave used engine oil within the reach of children.

**⚠ NOTICE**

■ **When replacing the engine oil**

- Be careful not to spill engine oil on the vehicle components.
- Avoid overfilling, or the engine could be damaged.
- Check the oil level on the dipstick every time you refill the vehicle.
- Be sure the engine oil filler cap is properly tightened.

■ **If oil is spilled on the engine cover**

To prevent the engine cover from being damaged, remove any engine oil from the engine cover as soon as possible using a neutral detergent. Do not use an organic solvent such as brake cleaner.

**Checking the coolant**

■ **Engine coolant reservoir**

The coolant level is satisfactory if it is between the “MAX” and “MIN” lines on the reservoir when the engine is cold.

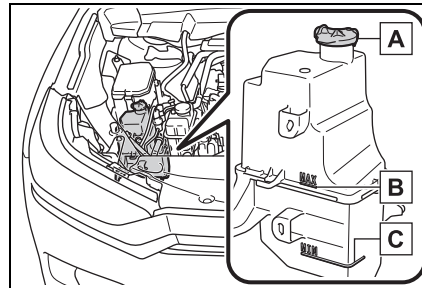

- A Reservoir cap
- B “MAX” line
- C “MIN” line

■ **Intercooler coolant reservoir**

The coolant level is satisfactory if it is between the “FULL” and “LOW” lines on the reservoir when the engine is cold.

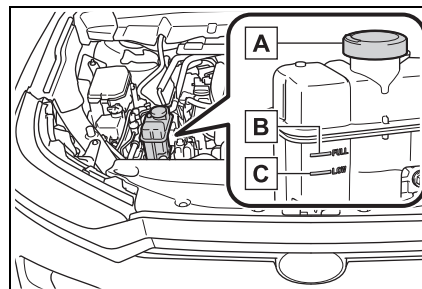

- A Reservoir cap
- B “FULL” line
- C “LOW” line

If the level is on or below the “LOW”

line, add coolant up to the “FULL” line. (→P.512)

**■ Coolant selection**

Only use “Toyota Super Long Life Coolant” or a similar high quality ethylene glycol based non-silicate, non-amine, non-nitrite, and non-borate coolant with long-life hybrid organic acid technology.

U.S.A.:

“Toyota Super Long Life Coolant” is a mixture of 50% coolant and 50% deionized water. (Minimum temperature: -31°F [-35°C])

Canada:

“Toyota Super Long Life Coolant” is a mixture of 55% coolant and 45% deionized water. (Minimum temperature: -44°F [-42°C])

For more details about coolant, contact your Toyota dealer.

**■ If the coolant level drops within a short time of replenishing**

Visually check the radiator, hoses, engine coolant reservoir caps, drain cock and water pump.

If you cannot find a leak, have your Toyota dealer test the cap and check for leaks in the cooling system.

 **WARNING**

**■ When the engine is hot**

Do not remove the engine coolant reservoir cap, intercooler coolant reservoir cap and radiator cap.

The cooling system may be under pressure and may spray hot coolant if the cap is removed, causing serious injuries, such as burns.

 **NOTICE**

**■ When adding coolant**

Coolant is neither plain water nor straight antifreeze. The correct mixture of water and antifreeze must be used to provide proper lubrication, corrosion protection and cooling. Be sure to read the antifreeze or coolant label.

**■ If you spill coolant**

Be sure to wash it off with water to prevent it from damaging parts or paint.

**Checking the radiator, condenser and inter-cooler radiator**

Check the radiator, condenser and intercooler radiator and clear away any foreign objects. If any of the above parts are extremely dirty or you are not sure of their condition, have your vehicle inspected by your Toyota dealer.

 **WARNING**

**■ When the engine is hot**

Do not touch the radiator, condenser or intercooler radiator as they may be hot and cause serious injuries, such as burns.

**Checking and adding the brake fluid**

**■ Checking fluid level**

The brake fluid level should be between the “MAX” and “MIN” lines on the tank.

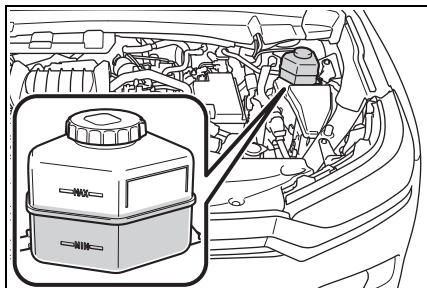

■ **Adding fluid**

Make sure to check the fluid type and prepare the necessary item.

● Fluid type

FMVSS No.116 DOT 3 or SAE J1703 brake fluid

FMVSS No.116 DOT 4 or SAE J1704 brake fluid

● Item

Clean funnel

■ **Brake fluid can absorb moisture from the air**

Excess moisture in the brake fluid can cause a dangerous loss of braking efficiency. Use only newly opened brake fluid.

**! WARNING**

■ **When filling the reservoir**

Take care as brake fluid can harm your hands and eyes and damage painted surfaces. If fluid gets on your hands or in your eyes, flush the affected area with clean water immediately. If you still experience discomfort, see a doctor.

**! NOTICE**

■ **If the fluid level is low or high**

It is normal for the brake fluid level to go down slightly as the brake pads wear out or when the fluid level in the accumulator is high. If the reservoir needs frequent refilling, there may be a serious problem.

**Battery**

Check the battery as follows.

■ **Battery exterior**

Make sure that the battery terminals are not corroded and that there are no loose connections, cracks, or loose clamps.

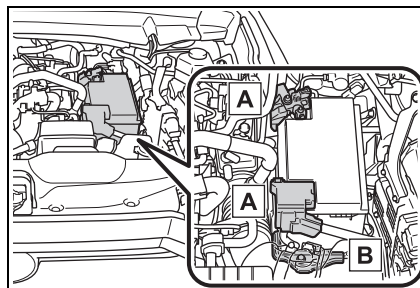

A Terminals

B Hold-down clamp

■ **Before recharging**

When recharging, the battery produces hydrogen gas which is flammable and explosive. Therefore, observe the following precautions before recharging:

- If recharging with the battery installed on the vehicle, be sure to disconnect the ground cable.
- Make sure the power switch on the charger is off when connecting and disconnecting the charger cables to the battery.



### ■ After recharging/reconnecting the battery

- Unlocking the doors using the smart key system may not be possible immediately after reconnecting the battery. If this happens, use the wireless remote control or the mechanical key to lock/unlock the doors.
- Start the engine with the engine switch in ACC. The engine may not start with the engine switch turned off. However, the engine will operate normally from the second attempt.
- The engine switch mode is recorded by the vehicle. If the battery is disconnected and reconnected, the vehicle will return the engine switch mode to the status it was in before the battery was disconnected. Make sure to turn off the engine switch before disconnecting the battery. Take extra care when connecting the battery if the engine switch mode prior to the battery being disconnected is unknown.

If the system will not start even after multiple attempts at all the methods above, contact your Toyota dealer.



### WARNING

#### ■ Chemicals in the battery

Batteries contain poisonous and corrosive sulfuric acid and may produce hydrogen gas which is flammable and explosive. To reduce the risk of death or serious injury, take the following precautions while working on or near the battery:

- Do not cause sparks by touching the battery terminals with tools.
- Do not smoke or light a match near the battery.

- Avoid contact with eyes, skin and clothes.
- Never inhale or swallow electrolyte.
- Wear protective safety glasses when working near the battery.
- Keep children away from the battery.

#### ■ Where to safely charge the battery

Always charge the battery in an open area. Do not charge the battery in a garage or closed room where there is insufficient ventilation.

#### ■ Emergency measures regarding electrolyte

- If electrolyte gets in your eyes  
Flush your eyes with clean water for at least 15 minutes and get immediate medical attention. If possible, continue to apply water with a sponge or cloth while traveling to the nearest medical facility.
- If electrolyte gets on your skin  
Wash the affected area thoroughly. If you feel pain or burning, get medical attention immediately.
- If electrolyte gets on your clothes  
It can soak through clothing on to your skin. Immediately take off the clothing and follow the procedure above if necessary.
- If you accidentally swallow electrolyte  
Drink a large quantity of water or milk. Get emergency medical attention immediately.

**⚠ WARNING**

■ **When there is insufficient battery fluid**

Do not use if there is insufficient fluid in the battery. There is a possible danger that the battery may explode.

**⚠ NOTICE**

■ **When recharging the battery**

Never recharge the battery while the engine is running. Also, be sure all accessories are turned off.

**Washer fluid**

If any washer does not work or the warning message appears on the multi-information display, the washer tank may be empty. Add washer fluid.

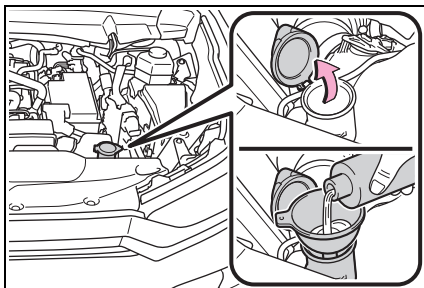

**⚠ WARNING**

■ **When adding washer fluid**

Do not add washer fluid when the engine is hot or running as washer fluid contains alcohol and may catch fire if spilled on the engine, etc.

**⚠ NOTICE**

■ **Do not use any fluid other than washer fluid**

Do not use soapy water or engine antifreeze instead of washer fluid.

Doing so may cause streaking on the vehicle's painted surfaces, as well as damaging the pump leading to problems of the washer fluid not spraying.

■ **Diluting washer fluid**

Dilute washer fluid with water as necessary.

Refer to the freezing temperatures listed on the label of the washer fluid bottle.

**Tires**

**Replace or rotate tires in accordance with maintenance schedules and treadwear.**

**Checking tires**

Check if the treadwear indicators are showing on the tires. Also check the tires for uneven wear, such as excessive wear on one side of the tread.

Check the spare tire condition and pressure if not rotated.

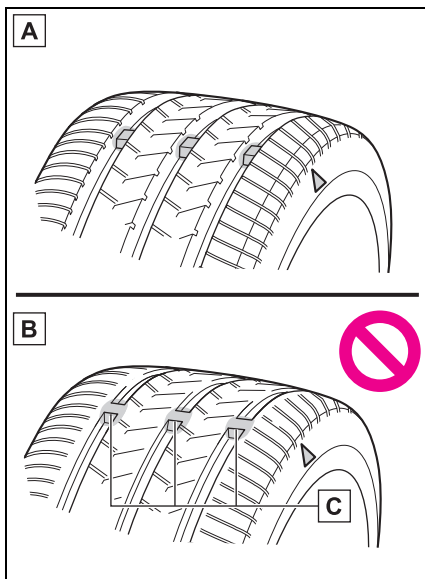

- A** New tread
- B** Worn tread
- C** Treadwear indicator

The location of treadwear indicators is shown by a “TWI” or “△” mark,

etc., molded into the sidewall of each tire.

Replace the tires if the treadwear indicators are showing on a tire.

**When to replace your vehicle's tires**

Tires should be replaced if:

- The treadwear indicators are showing on a tire.
- You have tire damage such as cuts, splits, cracks deep enough to expose the fabric, and bulges indicating internal damage.
- A tire goes flat repeatedly or cannot be properly repaired due to the size or location of a cut or other damage.

If you are not sure, consult with your Toyota dealer.

**Tire life**

Any tire over 6 years old must be checked by a qualified technician even if it has seldom or never been used or damage is not obvious.

**Maximum load of tire**

Check that the number given by dividing the maximum load by 1.10 of the replacement tire is greater than 1/2 of the Gross Axle Weight Ratings (GAWR) of either the front axle or the rear axle, whichever is greater.

For the GAWR, see the Certification Label.

For the maximum load of the tire, see the load limit at maximum cold tire inflation pressure mentioned on the sidewall of the tire. (→P.528)

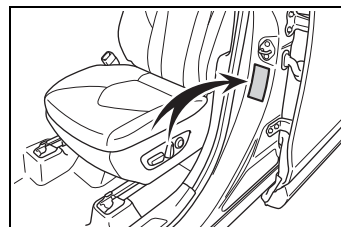

■ **Tire types**

● **Summer tires**

Summer tires are high-speed performance tires best suited to highway driving under dry conditions. Since summer tires do not have the same traction performance as snow tires, summer tires are inadequate for driving on snow-covered or icy roads. For driving on snow-covered roads or icy roads, the use of snow tires is recommended. When installing snow tires, be sure to replace all four tires.

● **All season tires**

All season tires are designed to provide better traction in snow and to be adequate for driving in most winter conditions as well as for use year-round. All season tires, however, do not have adequate traction performance compared with snow tires in heavy or loose snow. Also, all season tires fall short in acceleration and handling performance compared with summer tires in highway driving.

● **Snow tires**

For driving on snow-covered roads or icy roads, we recommend using snow tires. If you need snow tires, select tires of the same size, construction and load capacity as the originally installed tires. Since your vehicle has radial tires as original equipment, make sure your snow tires also have radial construction. Do not install studded tires without first checking local regulations for possible restrictions. Snow tires should be installed on all wheels. (→P.360)

■ **If the tread on snow tires wears down below 0.16 in. (4 mm)**

The effectiveness of the tires as snow tires is lost.

■ **Checking the tire valves**

When replacing the tires, check the tire valves for deformation, cracks, and other damage.

 **WARNING**

■ **When inspecting or replacing tires**

Observe the following precautions to prevent accidents. Failure to do so may cause damage to parts of the drive train as well as dangerous handling characteristics, which may lead to an accident resulting in death or serious injury.

- Do not mix tires of different makes, models or tread patterns. Also, do not mix tires of remarkably different treadwear.
- Do not use tire sizes other than those recommended by Toyota.
- Do not mix differently constructed tires (radial, bias-belted or bias-ply tires).
- Do not mix summer, all season and snow tires.
- Do not use tires that have been used on another vehicle. Do not use tires if you do not know how they were used previously.
- Do not tow if your vehicle has a spare tire installed.

 NOTICE**■ Driving on rough roads**

Take particular care when driving on roads with loose surfaces or potholes.

These conditions may cause losses in tire inflation pressure, reducing the cushioning ability of the tires. In addition, driving on rough roads may cause damage to the tires themselves, as well as the vehicle's wheels and body.

**■ If tire inflation pressure of each tire becomes low while driving**

Do not continue driving, or your tires and/or wheels may be ruined.

**Tire rotation**

Rotate the tires in the order shown.

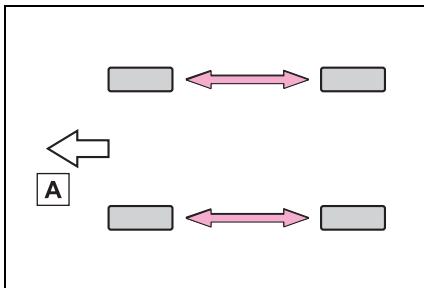
**A** Front

To equalize tire wear and extend tire life, Toyota recommends that tire rotation is carried out at the same interval as tire inspection.

Make sure to perform wheel position registration procedure after rotating the tires. (→P.448)

**Tire pressure warning system**

Your vehicle is equipped with a tire pressure warning system that uses tire pressure warning valves and transmitters to detect low tire inflation pressure before serious problems arise.

The tire pressure warning system of this vehicle adopts a 2-type warning system. (→P.481)

- When “Adjust Pressure” is displayed on the multi-information display (Normal Warning)

A warning with the tire pressure warning light and warning buzzer when there is an unknown level of low tire pressure with the appearance of the tire due to natural air leakage as well as the pressure lowering due to changes in the pressure according to the outside temperature.

- When “Immediately Check tire when Safe” is displayed on the multi-information display (Emergency Warning)

A warning with the tire pressure warning light and warning buzzer when there is a known level of low tire pressure with the appearance of the tire due to pressure suddenly lowering. (Ways of coping: →P.481, 495)

However, the system may not be able to detect sudden tire ruptures (bursting, etc.).

- The tire pressure detected by the tire pressure warning system can be displayed on the multi-information display.

▶ 7-inch display

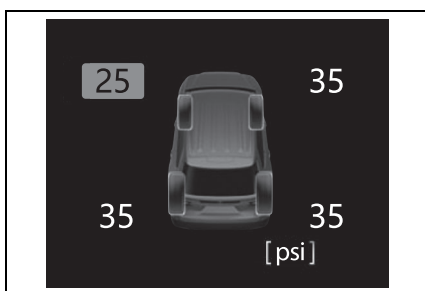

▶ 12.3-inch display

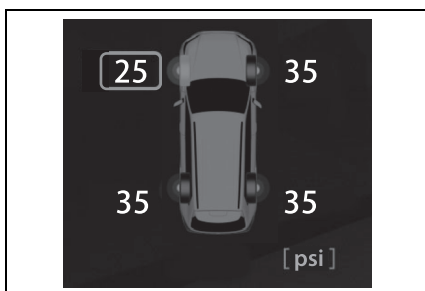

■ How to change the unit

- 1 Park the vehicle in a safe place and turn the engine switch off.

Changing the unit cannot be performed while the vehicle is moving.

- 2 Turn the engine switch to ON.
- 3 Select  of the multi-information display using the meter control switches and then press OK .
- 4 Select "Vehicle Settings" and then press and hold OK .

- 5 Select "TPWS setting" and then press OK .
- 6 Select "Pressure unit setting".
- 7 Select the desired unit and then press OK .

■ Routine tire inflation pressure checks

The tire pressure warning system does not replace routine tire inflation pressure checks. Make sure to check tire inflation pressure as part of your routine of daily vehicle checks.

■ Tire inflation pressure

- It may take a few minutes to display the tire inflation pressure after the engine switch is turned to ON. It may also take a few minutes to display the tire inflation pressure after inflation pressure has been adjusted.
- Tire inflation pressure changes with temperature. The displayed values may also be different from the values measured using a tire pressure gauge.

■ Situations in which the tire pressure warning system may not operate properly

- In the following cases, the tire pressure warning system may not operate properly.
  - If non-genuine Toyota wheels are used.
  - A tire has been replaced with a tire that is not an OE (Original Equipment) tire.
  - A tire has been replaced with a tire that is not of the specified size.
  - Tire chains, etc. are equipped.
  - If a window tint that affects the radio wave signals is installed.
  - If there is a lot of snow or ice on the vehicle, particularly around the wheels or wheel housings.

- If the tire inflation pressure is extremely higher than the specified level.
- If tires not equipped with tire pressure warning valves and transmitters are used.
- If the ID code on the tire pressure warning valves and transmitters is not registered in the tire pressure warning computer.
- Performance may be affected in the following situations.
  - Near a TV tower, electric power plant, gas station, radio station, large display, airport or other facility that generates strong radio waves or electrical noise
  - When carrying a portable radio, cellular phone, cordless phone or other wireless communication device
- If tire position information is not correctly displayed due to the radio wave conditions, the display may be corrected by changing the location of the vehicle as the radio wave conditions may change.
- When the vehicle is parked, the time taken for the warning to start or go off could be extended.
- When tire inflation pressure declines rapidly for example when a tire has burst, the warning may not operate.

### Installing tire pressure warning valves and transmitters

When replacing tires or wheels, tire pressure warning valves and transmitters must also be installed.

When new tire pressure warning valves and transmitters are installed, new ID codes must be registered in the tire pressure

warning computer. (→P.451)

### Replacing tires and wheels

If the ID code of the tire pressure warning valve and transmitter is not registered, the tire pressure warning system will not work properly. In this case, after driving for about 20 minutes, the tire pressure warning light blinks for 1 minute and stays on to indicate a system malfunction.

#### NOTICE

#### Repairing or replacing tires, wheels, tire pressure warning valves, transmitters and tire valve caps

- When removing or fitting the wheels, tires or the tire pressure warning valves and transmitters, contact your Toyota dealer as the tire pressure warning valves and transmitters may be damaged if not handled correctly.
- Make sure to install the tire valve caps. If the tire valve caps are not installed, water could enter the tire pressure warning valves, corrode the valve, and cause sticking and air leaks.
- When replacing tire valve caps, do not use tire valve caps other than those specified. The cap may become stuck.

#### To avoid damage to the tire pressure warning valves and transmitters

When a tire is repaired with liquid sealants, the tire pressure warning valve and transmitter may not operate properly. If a liquid sealant is used, contact your Toyota dealer or other qualified service shop as soon as possible. Make sure to replace the tire pressure warning valve and transmitter when replacing the tire. (→P.447)

### Registering the position of each wheel

#### ■ When to register the position of each wheel

It is necessary to register the position of each wheel after performing a tire rotation.

Wheel position registration can be performed by oneself. Wheel position registration is performed by driving forward with moderate left and right turns. However, depending on the driving conditions and driving environment, registration may take some time to complete.

#### ■ Registering the position of each wheel

- 1 Park the vehicle in a safe place, turn the engine switch off and wait 15 minutes or more.
- 2 Start the engine.

The wheel position registration procedure cannot be performed while the vehicle is moving.

- 3 Select  of the multi-information display using the meter control switches and then press OK .
- 4 Select "Vehicle Settings" and then press and hold OK .
- 5 Select "TPWS setting" and then press OK .

- 6 Select "Tire Rotation" and then press OK .
- 7 Select "Yes" and then press OK .

A message indicating that wheel position registration is being performed will be displayed on the multi-information display. "---" will be displayed for the tire inflation pressure of each tire and wheel position registration will begin.

- 8 Drive straight (with occasional left and right turns) at approximately 25 mph (40 km/h) or more for approximately 10 to 30 minutes.

When wheel position registration is complete, a message indicating that registration has been completed and the inflation pressure of each tire will be displayed on the multi-information display.

Even if it is not possible to drive continuously at approximately 25 mph (40 km/h) or more, registration can be completed by driving for a long time. However, if registration does not complete after driving for 1 hour or more, park the vehicle in a safe place and leave it with the engine switch in ON for approximately 15 minutes or more, and then perform the driving procedure again.

#### ■ When performing wheel position registration

- Normally, wheel position registration can be completed within approximately 30 minutes.
- Wheel position registration is performed while driving at a vehicle speed of approximately 25 mph (40 km/h) or more.



#### ■ Wheel position registration procedure

- If the engine switch is turned off while registering the wheel position, the next time the engine switch is turned to ON, the wheel position registration will resume and it will not be necessary to restart the procedure.
- While the position of each wheel is being determined and the inflation pressures are not being displayed, if the inflation pressure of a tire drops, the tire pressure warning light will come on.

#### ■ If the wheel position cannot be registered easily

- In the following situations, wheel position registration may take longer than usual to be completed or may not be possible.
  - Vehicle is not driven at approximately 25 mph (40 km/h) or more
  - Vehicle is driven on unpaved roads
- If wheel position registration does not complete after driving for 1 hour or more, park the vehicle in a safe place for approximately 15 minutes and then drive the vehicle again.
- If the vehicle is reversed during wheel position registration, all data collected until then will be cleared. Perform driving again.

### Setting the tire pressure

#### ■ When you need to setting the tire pressure

In the following situations, it will be necessary to perform the tire inflation pressure setting procedure of the tire pressure warning system.

- When the specified tire inflation pressure has changed,

such as due to carried load, etc.

- When the tire inflation pressure is changed such as when the tire size is changed.

If the tire inflation pressure has been adjusted to the specified level, perform the tire inflation setting procedure by selecting specified inflation pressure on the multi-information display. (→P.449)

When the tire inflation pressure is to be other than specified, such as when tires other than the specified size are used, etc., set the tire inflation pressure using the current pressure. Make sure to adjust the tire inflation pressure of each tire to the appropriate level before performing tire pressure setting. The tire pressure warning system operates based on this tire inflation pressure. (→P.450)

#### ■ Setting by selecting a specified tire inflation pressure

- 1 Park the vehicle in a safe place and then start the engine.

The tire inflation pressure cannot be set while the vehicle is moving.

- 2 Select  of the multi-information display using the meter control switches and then press OK .

- 3 Select "Vehicle Settings" and then press and hold OK .
- 4 Select "TPWS setting" and then press OK .
- 5 Select "Tire Pressure Setting" and then press OK .
- 6 Select "Setting by Specified Pressure" and then press OK .
- 7 Select the desired tire pressures, then press OK .  
(→P.455)

The tire pressure warning light will slowly blink 3 times.

After setting the tire inflation pressure, a message indicating that setting has been completed will be displayed on the multi-information display.

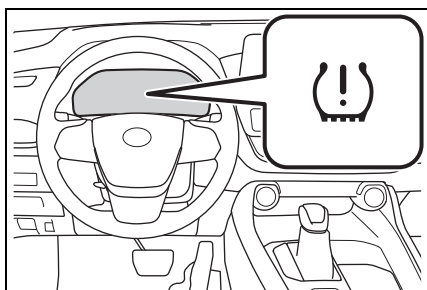

■ **Setting using the current tire inflation pressure**

- 1 Adjust the tire inflation pressure of each tire to the appropriate level.

Make sure to adjust the tire inflation pressure with the tires cold.

- 2 Start the engine.

The tire inflation pressure cannot

be set while the vehicle is moving.

- 3 Select  of the multi-information display using the meter control switches and then press OK .
- 4 Select "Vehicle Settings" and then press and hold OK .
- 5 Select "TPWS setting" and then press OK .
- 6 Select "Tire Pressure Setting" and then press OK .
- 7 Select "Setting by Current Pressure" and then press OK .

The tire pressure warning light will slowly blink 3 times and a message indicating that tire inflation pressure is being set will be displayed on the multi-information display.

After setting the tire inflation pressure, a message indicating that setting has been completed will be displayed on the multi-information display.

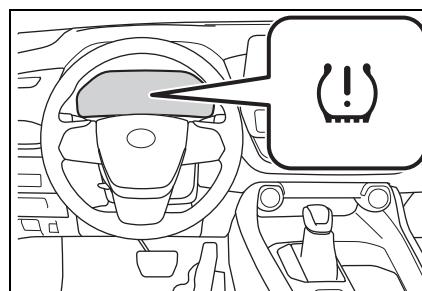

■ **Warning performance of the tire pressure warning system (Setting using the current tire inflation pressure)**

- When performing the tire pressure setting using the current tire infla-

tion pressure, the warning timing of the tire pressure warning system will vary according to the conditions under which tire pressure setting was performed. Therefore, a warning may be output even if the tire inflation pressure drops slightly or if the tire inflation pressure increases above that when the tire inflation pressure was set.

- Make sure to perform the tire pressure setting procedure after adjusting the tire inflation pressure. Also, make sure the tires are cold before performing the tire pressure setting procedure or adjusting the tire inflation pressure.
- **Tire inflation pressure setting procedure (Setting using the current tire inflation pressure)**
  - If the engine switch is turned off while setting the tire inflation pressure, the next time the engine switch is turned to ON, the setting procedure will resume and it will not be necessary to restart the procedure.
  - If the tire inflation pressure setting procedure is started unnecessarily, adjust the tire inflation pressure to the specified level with the tires cold and then perform setting by selecting a specified tire inflation pressure, or perform the tire inflation pressure setting procedure with the current tire inflation pressure.
  - **If the tire inflation pressure cannot be set easily**
    - Normally, it takes approximately 3 minutes to complete the setting procedure to the current tire inflation pressure.
    - If the tire pressure warning light does not blink 3 times when starting the tire inflation pressure setting procedure, the procedure may not have started. Perform the procedure again from the beginning.
- If tire inflation pressure setting procedure cannot be completed after performing the above procedure, contact your Toyota dealer.

#### **WARNING**

##### ■ **When setting using the current tire inflation pressure**

Make sure to adjust the tire inflation pressure of each tire to the appropriate level before performing tire pressure setting. Otherwise, the tire pressure warning light may not illuminate even if the tire inflation pressure drops or may illuminate even though the tire inflation pressure is normal.

#### **Registering ID codes**

##### ■ **When to register ID codes**

The tire pressure warning valve and transmitter is equipped with a unique ID code. When new tire pressure warning valves and transmitters are installed, new ID codes must be registered in the tire pressure warning computer.

##### ■ **How to registration ID code**

Before performing ID code registration, make sure that no wheels with tire pressure warning valve and transmitters installed are near the vehicle.

- 1 Park the vehicle in a safe place, turn the engine switch off and wait 15 minutes or more.
- 2 Start the engine.

The ID code registration procedure cannot be performed while the

vehicle is moving.

- 3 Select  of the multi-information display using the meter control switches and then press OK .
- 4 Select "Vehicle Settings" and then press and hold OK .
- 5 Select "TPWS setting" and then press OK .
- 6 Select "Tire Set Switching" and then press OK .
- 7 Select "Register New Valve / ID" and then press OK .
- 8 Select "Tire Set 1" or "Tire Set 2". Then press OK .

ID codes will be registered to the displayed wheel set.

To change the wheel set to be registered, select the displayed set, and then select the wheel set you wish to register.

If ID codes have already been registered for that wheel set, the tire pressure warning light will slowly blink 3 times, and a message indicating that change is occurring will be displayed on the multi-information display.

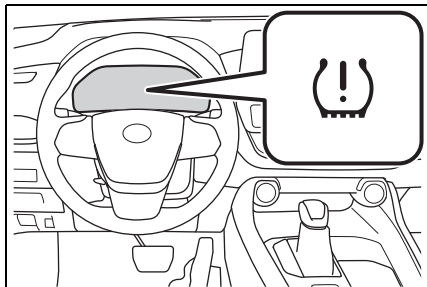

- 9 Select "Yes" and then press OK .

The tire pressure warning light will slowly blink 3 times and a message indicating that ID code registration is being performed will be displayed on the multi-information display. Wheel set changing will be canceled and registration will begin.

When registration is being performed, the tire pressure warning light will blink for approximately 1 minute then illuminate and "---" will be displayed for the inflation pressure of each tire on the multi-information display.

- 10 Drive straight (with occasional left and right turns) at approximately 25 mph (40 km/h) or more for approximately 10 to 30 minutes.

When registration is complete, the tire pressure warning light will turn off and a message indicating that registration has been completed will be displayed on the multi-information display.

Registration may take longer than normal to complete if the vehicle speed cannot be maintained at approximately 25 mph (40 km/h) or more. If registration cannot be completed after driving for 1 hour or more, perform the registration procedure again from the beginning.

- 11 If the tire inflation pressure of the wheel set installed differs from that of the previous set, it will be necessary to perform the tire inflation pressure setting procedure of the tire pressure warning system. (→P.449)

If the specified tire inflation pressure is the same, it will not be nec-

essary to perform the tire inflation pressure setting procedure.

#### ■ When registering ID codes

- Normally, wheel position registration can be completed within approximately 30 minutes.
- ID code registration is performed while driving at a vehicle speed of approximately 25 mph (40 km/h) or more.
- ID codes can be registered by yourself, but depending on the driving conditions and driving environment, registration may take some time to complete.
- When using a wheel set which all of the ID codes have already been registered, the wheel set can be changed in a short amount of time. (→P.453)

#### ■ If ID codes are not registered easily

- In the following situations, ID code registration may take longer than usual to be completed or may not be possible.
  - When the vehicle has not been parked for approximately 15 minutes or more before being driven
  - Vehicle is not driven at approximately 25 mph (40 km/h) or more
  - Vehicle is driven on unpaved roads
  - Vehicle is driven near other vehicles and system cannot recognize tire pressure warning valve and transmitters of your vehicle over those of other vehicles
  - Wheel with tire pressure warning valve and transmitter installed is inside or near the vehicle
- If the vehicle is reversed during registration, all data collected until then will be cleared. Perform driving again.
- If registration does not complete after driving for 1 hour or more, perform the ID code registration procedure again from the begin-

ning.

- If the tire pressure warning light does not blink 3 times when starting ID code registration procedure, the procedure may not have started. Perform the procedure again from the beginning.
- If the ID codes cannot be registered even when performing the above procedure, contact your Toyota dealer.

#### ■ Canceling ID code registration

To cancel ID code registration after it has been started, select "Register New Valve / ID" again on the multi-information display.

If ID code registration has been canceled, the tire pressure warning light will turn off.

If the warning light does not turn off, ID code registration may not have been cancelled correctly. To cancel registration, select "Register New Valve / ID" on the multi-information display.

### Selecting wheel set

Your vehicle is equipped with a tire pressure warning system with a function to register two sets of ID codes. This allows for registration of a second wheel set, for example a winter set.

- The wheel set can be changed only if a second wheel set has been registered to the system. If a second wheel set has not been registered, "Switching Incomplete See Owner's Manual" will be displayed and it will not be possible to change to the selected wheel set.

ID codes can be registered by yourself. (→P.451)

- Only a change between both registered wheel set is possible, mixing between these wheel sets is not supported.
- While registering ID codes, it may not be possible to change between wheel sets normally. Cancel registration before changing between wheel sets.

#### ■ Changing ID codes between different wheel sets

- 1 Install the desired wheel set.
- 2 Select  of the multi-information display using the meter control switches and then press OK .
- 3 Select "Vehicle Settings" and then press OK .
- 4 Select "TPWS setting" and then press OK .
- 5 Select "Tire Set Switching" and then press OK .
- 6 Select "Register Valve / ID" and then press OK .
- 7 Select "Tire Set 1" or "Tire Set 2". Then press OK .
- 8 Select "Yes" and then press OK .

The tire pressure warning light will slowly blink 3 times, a message

indicating that change is occurring will be displayed, and the wheel set change will begin.

Wheel set change will begin and the tire pressure warning light will blink for 1 minute and then illuminate. Also, while the change is being performed, "---" will be displayed for the tire inflation pressure of each tire on the multi-information display.

After approximately 2 minutes, the wheel set change will complete, the tire pressure warning light will turn off, and a completion message will be displayed on the multi-information display.

If changing does not complete after approximately 4 minutes, a message indicating that the change could not be completed will be displayed.

Check which wheel set is installed and perform the change procedure again from the beginning.

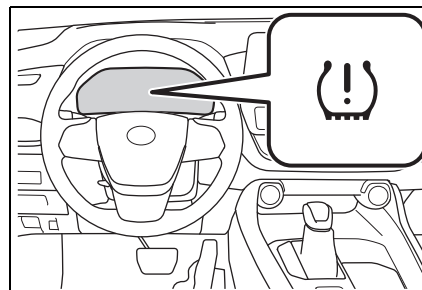

- 9 If the specified tire inflation pressure of the wheel set installed differs from that of the previous set, it will be necessary to perform the tire inflation pressure setting procedure of the tire pressure warning system. (→P.449)

If the specified tire inflation pressure is the same, it will not be necessary to perform the tire inflation pressure setting procedure.

10 Register the position of each wheel. (→P.448)

■ If “Tire Set Switching Incomplete Try Tire Set Registration Again See Owner's Manual” is displayed

The wheel set change could not be completed.

Check which wheel set is installed and perform the change procedure again from the beginning.

## Tire inflation pressure

### Checking the specified tire inflation pressure

The recommended cold tire inflation pressure and tire size are displayed on the tire and loading information label. (→P.524)

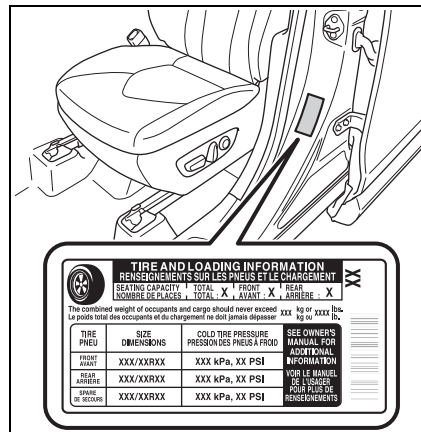

### Inspection and adjustment procedure

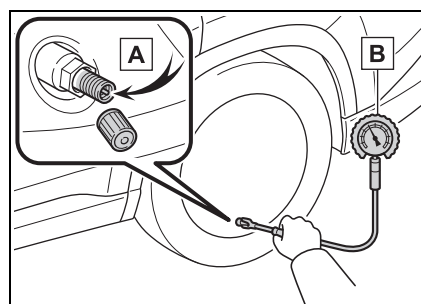

**A** Tire valve

**B** Tire pressure gauge

1 Remove the tire valve cap.

- 2** Press the tip of the tire pressure gauge onto the tire valve.
- 3** Read the pressure using the gauge gradations.
- 4** If the tire inflation pressure is not at the recommended level, adjust the pressure. If you add too much air, press the center of the valve to deflate.
- 5** After completing the tire inflation pressure measurement and adjustment, apply soapy water to the valve and check for leakage.
- 6** Put the tire valve cap back on.

**■ Tire inflation pressure check interval**

You should check tire inflation pressure every two weeks, or at least once a month. Do not forget to check the spare.

**■ Effects of incorrect tire inflation pressure**

Driving with incorrect tire inflation pressure may result in the following:

- Reduced fuel economy
- Reduced driving comfort and poor handling
- Reduced tire life due to wear
- Reduced safety
- Damage to the drive train

If a tire needs frequent inflating, have it checked by your Toyota dealer.

**■ Instructions for checking tire inflation pressure**

When checking tire inflation pres-

sure, observe the following:

- Check only when the tires are cold.  
If your vehicle has been parked for at least 3 hours or has not been driven for more than 1 mile or 1.5 km, you will get an accurate cold tire inflation pressure reading.
- Always use a tire pressure gauge. It is difficult to judge if a tire is properly inflated based only on its appearance.
- It is normal for the tire inflation pressure to be higher after driving as heat is generated in the tire. Do not reduce tire inflation pressure after driving.
- Never exceed the vehicle capacity weight. Passengers and luggage weight should be placed so that the vehicle is balanced.

 **WARNING**

**■ Proper inflation is critical to save tire performance**

Keep your tires properly inflated. If the tires are not properly inflated, the following conditions may occur which could lead to an accident resulting in death or serious injury:

- Excessive wear
- Uneven wear
- Poor handling
- Possibility of blowouts resulting from overheated tires
- Air leaking from between tire and wheel
- Wheel deformation and/or tire damage
- Greater possibility of tire damage while driving (due to road hazards, expansion joints, sharp edges in the road, etc.)



**NOTICE****■ When inspecting and adjusting tire inflation pressure**

Be sure to put the tire valve caps back on.

If a valve cap is not installed, dirt or moisture may get into the valve and cause an air leak, resulting in decreased tire inflation pressure.

**Wheels**

**If a wheel is bent, cracked or heavily corroded, it should be replaced. Otherwise, the tire may separate from the wheel or cause a loss of handling control.**

**Wheel selection**

When replacing wheels, care should be taken to ensure that they are equivalent to those removed in load capacity, diameter, rim width and inset\*.

Replacement wheels are available at your Toyota dealer.

\*: Conventionally referred to as offset.

Toyota does not recommend using the following:

- Wheels of different sizes or types
- Used wheels
- Bent wheels that have been straightened

**■ When replacing wheels**

The wheels of your vehicle are equipped with tire pressure warning valves and transmitters that allow the tire pressure warning system to provide advance warning in the event of a loss in tire inflation pressure. Whenever wheels are replaced, tire pressure warning valves and transmitters must be installed. (→P.447)

**⚠ WARNING****■ When replacing wheels**

- Do not use wheels that are a different size from those recommended in the Owner's Manual, as this may result in a loss of handling control.
- Never use an inner tube in a leaking wheel which is designed for a tubeless tire. Doing so may result in an accident, causing death or serious injury.

**■ When installing the wheel nuts**

Never use oil or grease on the wheel bolts or wheel nuts. Oil and grease may cause the wheel nuts to be excessively tightened, leading to bolt or disc wheel damage. In addition, the oil or grease can cause the wheel nuts to loosen and the wheel may fall off, causing an accident and resulting in death or serious injury. Remove any oil or grease from the wheel bolts or wheel nuts.

**■ Use of defective wheels prohibited**

Do not use cracked or deformed wheels. Doing so could cause the tire to leak air during driving, possibly causing an accident.

- Ensure that only genuine Toyota wheels are used on your vehicle. Tire pressure warning valves and transmitters may not work properly with non-genuine wheels.

**Aluminum wheel precautions**

- Use only Toyota wheel nuts and wrenches designed for use with your aluminum wheels.
- When rotating, repairing or changing your tires, check that the wheel nuts are still tight after driving 621 miles (1000 km).
- Be careful not to damage the aluminum wheels when using tire chains.
- Use only Toyota genuine balance weights or equivalent and a plastic or rubber hammer when balancing your wheels.

**⚠ NOTICE****■ Replacing tire pressure warning valves and transmitters**

- Because tire repair or replacement may affect the tire pressure warning valves and transmitters, make sure to have tires serviced by your Toyota dealer or other qualified service shop. In addition, make sure to purchase your tire pressure warning valves and transmitters at your Toyota dealer.

**Air conditioning filter**

**The air conditioning filter must be changed regularly to maintain air conditioning efficiency.**

**Removing the air conditioning filter**

- 1 Turn the engine switch off.
- 2 Open the glove box. Slide off the damper.

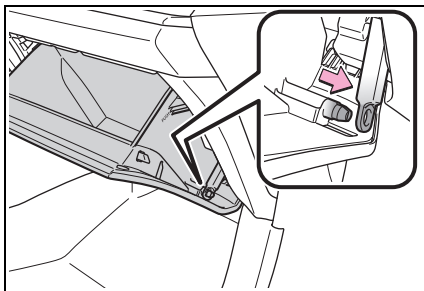

- 3 Push in each side of the glove box to disconnect the claws. Then pull out the glove box and disconnect the lower claws.

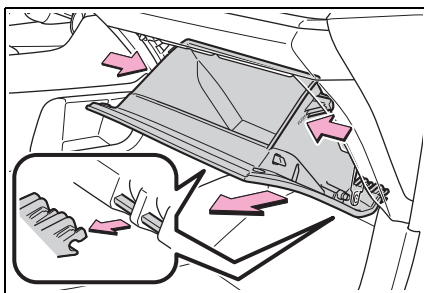

- 4 Unlock the filter cover (A), pull the filter cover out of the

claws (B), and remove the filter cover.

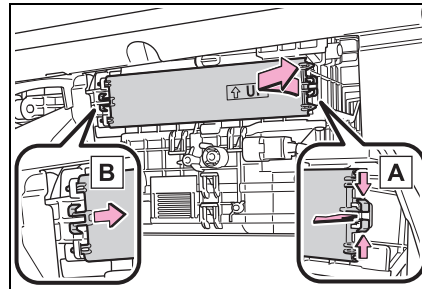

- 5 Remove the filter case.

There may be foreign objects on top of the air conditioning filter.

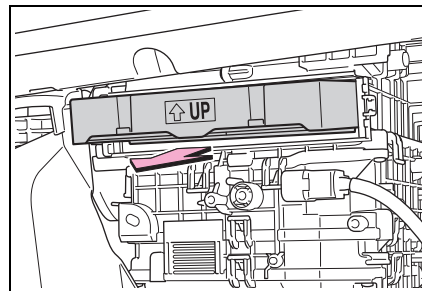

- 6 Remove the air conditioning filter from the filter case and replace it with a new one.

The "↑ UP" marks shown on the filter and the filter case should be pointing up.

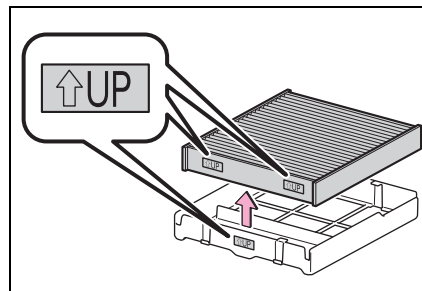

**■ Checking interval**

Inspect and replace the air condi-

tioning filter according to the maintenance schedule. In dusty areas or areas with heavy traffic flow, early replacement may be required. (For scheduled maintenance information, please refer to the “Owner’s Manual Supplement” or “Scheduled Maintenance Guide”.)

■ **If air flow from the vents decreases dramatically**

The filter may be clogged. Check the filter and replace if necessary.

 NOTICE

■ **When using the air conditioning system**

Make sure that a filter is always installed. Using the air conditioning system without a filter may cause damage to the system.

■ **To prevent damage to the filter cover**

When moving the filter cover in the direction of arrow to release the fitting, pay attention not to apply excessive force to the claws. Otherwise, the claws may be damaged.

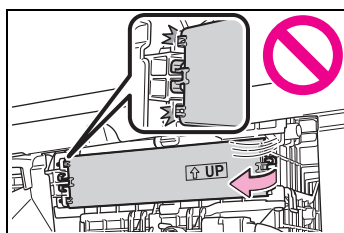

**Electronic key battery**

**Replace the battery with a new one if it is depleted. As the key may be damaged if the following procedure is not performed properly, it is recommended that key battery replacement be performed by your Toyota dealer.**

■ **If the electronic key battery is depleted**

The following symptoms may occur:

- The smart key system and wireless remote control will not function properly.
- The operational range will be reduced.

**You will need the following items:**

- Flathead screwdriver
- Small flathead screwdriver
- Lithium battery CR2450

■ **Use a CR2450 lithium battery**

- Batteries can be purchased at your Toyota dealer, local electrical appliance shops or camera stores.
- Replace only with the same or equivalent type recommended by the manufacturer.
- Dispose of used batteries according to local laws.

**Replacing the battery**

- 1 Release the lock and remove the mechanical key.

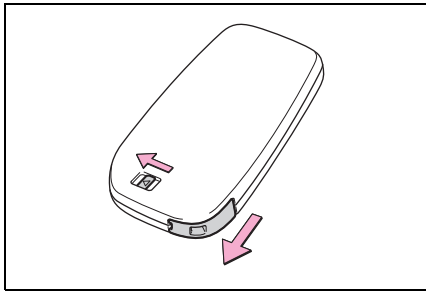

- 2 Remove the key cover.

To prevent damage to the key, cover the tip of the flathead screwdriver with a rag.

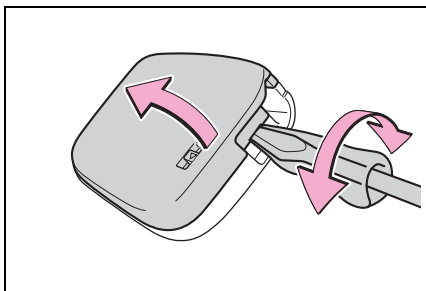



- 3 Remove the depleted battery using a small flathead screwdriver.

When removing the cover, the electronic key module may stick to the cover and the battery may not be visible. In this case, remove the electronic key module in order to remove the battery.

Insert a new battery with the “+” terminal facing up.

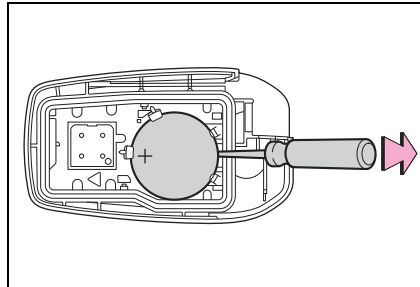
terminal facing up.



- 4 When installing the key cover and mechanical key, install by conducting step 2 and step 1 with the directions reversed.
- 5 Operate the  or  switch and check that the doors can be locked/unlocked.

**⚠ WARNING**

**■ Battery precautions**

Observe the following precautions. Failure to do so may result in death or serious injury.

- Do not swallow the battery. Doing so may cause chemical burns.
- A coin battery or button battery is used in the electronic key. If a battery is swallowed, it may cause severe chemical burns in as little as 2 hours and may result in death or serious injury.
- Keep away new and removed batteries from children.
- If the cover cannot be firmly closed, stop using the electronic key and stow the key in the place where children cannot reach, and then contact your Toyota dealer.

**⚠ WARNING**

- If you accidentally swallow a battery or put a battery into a part of your body, get emergency medical attention immediately.
- **To prevent battery explosion or leakage of flammable liquid or gas**
- Replace the battery with a new battery of the same type. If a wrong type of battery is used, it may explode.
- Do not expose batteries to extremely low pressure due to high altitude or extremely high temperatures.
- Do not burn, break or cut a battery.

**⚠ NOTICE**

- **When replacing the battery**  
Use a flathead screwdriver of appropriate size. Applying excessive force may deform or damage the cover.
- **For normal operation after replacing the battery**  
Observe the following precautions to prevent accidents:
- Always work with dry hands. Moisture may cause the battery to rust.
- Do not touch or move any other component inside the remote control.
- Do not bend either of the battery terminals.

**Checking and replacing fuses**

**If any of the electrical components do not operate, a fuse may have blown. If this happens, check and replace the fuses as necessary.**

**Checking and replacing fuses**

- 1 Turn the engine switch off.
  - 2 Open the fuse box cover.
    - ▶ Engine compartment
- Push in the claw and remove the lid.
- Type A

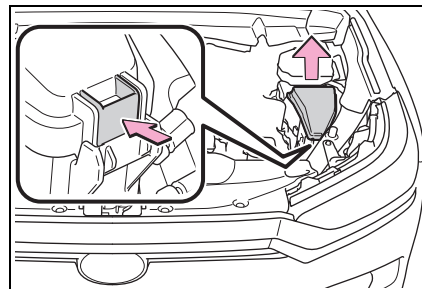

- Type B

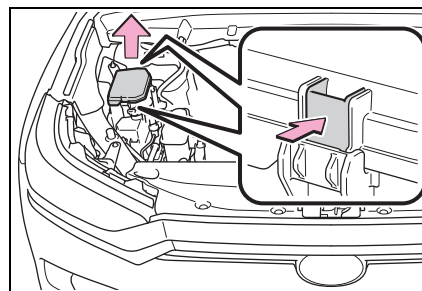

- ▶ Driver's side instrument panel
- Remove the lid.

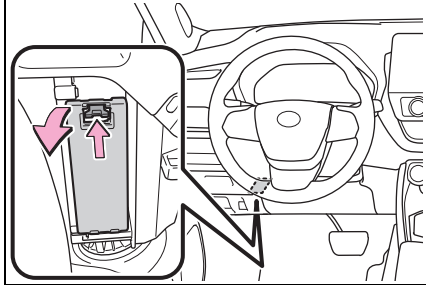

3 Remove the fuse with the pullout tool. Only some fuses can be removed using the pullout tool.

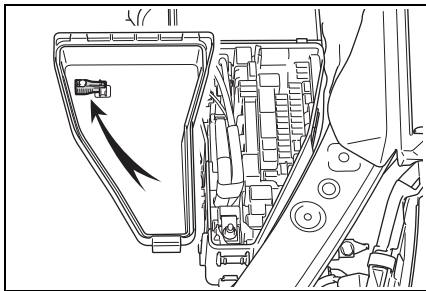

4 Check if the fuse is blown. Replace the blown fuse with a new fuse of an appropriate amperage rating. The amperage rating can be found on the fuse box lid. Many types of fuse are used on this vehicle. This illustration shows a common type of fuse used on this vehicle.

► Type A

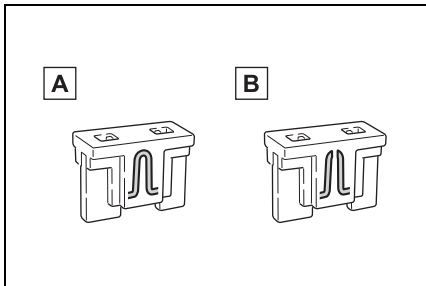

A Normal fuse

B Blown fuse

► Type B

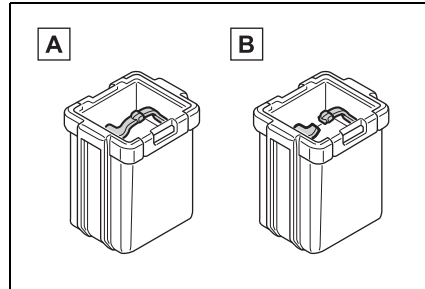

A Normal fuse

B Blown fuse

► Type C

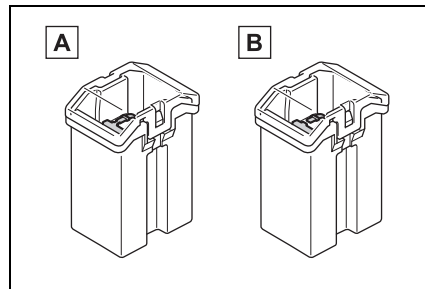

A Normal fuse

B Blown fuse

► Type D

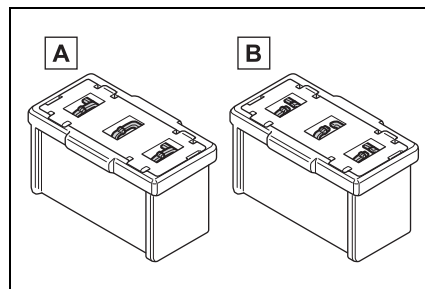

A Normal fuse

B Blown fuse

■ **After a fuse is replaced**

- When installing the lid, make sure that the tab is installed securely.
- If the lights do not turn on even after the fuse has been replaced, a bulb may need replacement. (→P.466)
- If the replaced fuse blows again, have the vehicle inspected by your Toyota dealer.

■ **If there is an overload in a circuit**

The fuses are designed to blow, protecting the wiring harness from damage.

■ **When replacing light bulbs**

Toyota recommends that you use genuine Toyota products designed for this vehicle. Because certain bulbs are connected to circuits designed to prevent overload, non-genuine parts or parts not designed for this vehicle may be unusable.

 **NOTICE**

■ **Before replacing fuses**

Have the cause of electrical overload determined and repaired by your Toyota dealer as soon as possible.

 **WARNING**

■ **To prevent system breakdowns and vehicle fire**

Observe the following precautions. Failure to do so may cause damage to the vehicle, and possibly a fire or injury.

- Never use a fuse of a higher amperage rating than that indicated, or use any other object in place of a fuse.
- Always use a genuine Toyota fuse or equivalent. Never replace a fuse with a wire, even as a temporary fix.
- Do not modify the fuses or fuse boxes.



## Headlight aim

### Vertical movement adjusting bolts

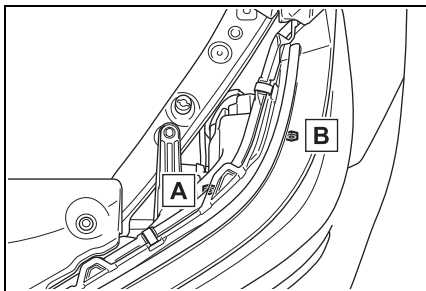

**A** Adjustment bolt A

**B** Adjustment bolt B

### Before checking the headlight aim

- 1 Make sure the vehicle has a full tank of gasoline and the area around the headlight is not deformed.
- 2 Park the vehicle on level ground.
- 3 Make sure the tire inflation pressure is at the specified level.
- 4 Have someone sit in the driver's seat.
- 5 Bounce the vehicle several times.

### Adjusting the headlight aim

- 1 Using a Phillips-head screwdriver, turn bolt A in either direction.

Remember the turning direction and the number of turns.

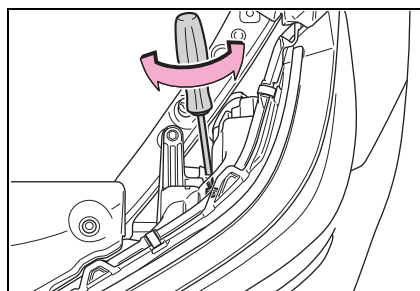

- 2 Turn bolt B the same number of turns and in the same direction as step 1.

If the headlight cannot be adjusted using this procedure, take the vehicle to your Toyota dealer to adjust the headlight aim.

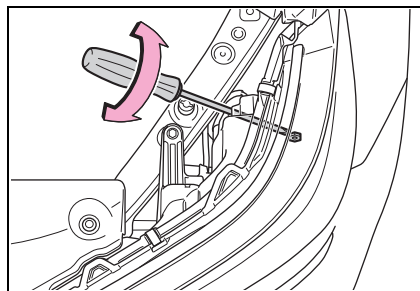

## Light bulbs

**You may replace the following bulbs by yourself. The difficulty level of replacement varies depending on the bulb. If necessary bulb replacement seems difficult to perform, contact your Toyota dealer.**

**For more information about replacing other light bulbs, contact your Toyota dealer.**

## Preparing for light bulb replacement

Check the wattage of the light bulb to be replaced. (→P.525)

## Bulb locations

### ■ Front

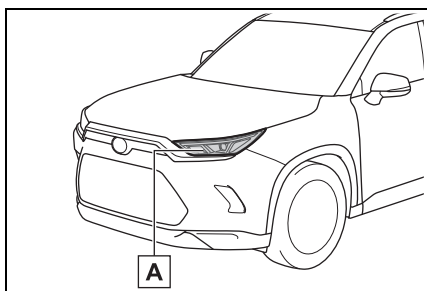

**A** Front turn signal lights/parking lights (bulb type)

### ■ Replacing the following lights

If any of the lights listed below has burnt out, have it replaced by your Toyota dealer.

- Headlights
- Daytime running lights
- Front turn signal lights/parking lights (LED type)
- Front side marker lights
- Front fog lights (if equipped)
- Side turn signal lights
- Stop lights/rear turn signal lights
- Tail lights
- Back-up lights
- Rear side marker lights
- High mounted stoplight
- License plate lights
- Outer foot lights (if equipped)

### ■ LED Lights

The lights other than the front turn signal lights/parking lights (bulb type) each consist of a number of LEDs. If any of the LEDs burn out, take your vehicle to your Toyota dealer to have the light replaced.

### ■ Condensation build-up on the inside of the lens

Temporary condensation build-up on the inside of the lens of any lights does not indicate a malfunction. Contact your Toyota dealer for more information in the following situations:

- Large drops of water have built up on the inside of the lens of any light.
- Water has built up inside of any lights.

### ■ When replacing light bulbs

→P.464

**Replacing light bulbs**

■ **Front turn signal lights/parking lights (bulb type)**

- 1 Turn the bulb base counter-clockwise and remove it.

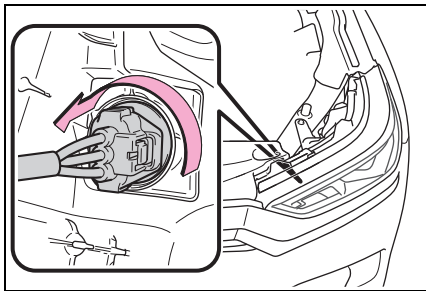

- 2 Remove the light bulb.

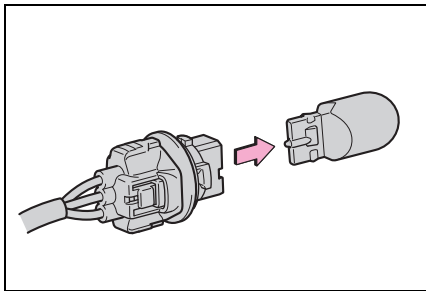

- 3 Install a new light bulb and then install the bulb base to the light unit by inserting it and turning it clockwise.

After installing the bulb base, wiggle it lightly to make sure it is securely installed and turn the lights on to visually check that there is no light leaking from between the bulb

base and light unit.

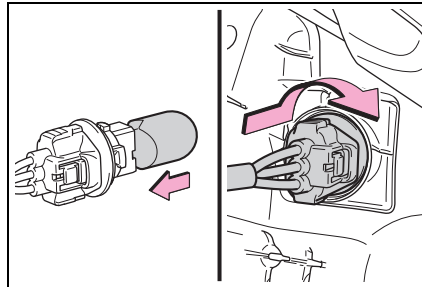

**⚠ WARNING**

■ **To prevent injury**

Before performing any light bulb replacement procedure, be sure to turn the engine switch off. Failure to do so may result in burns from hot components or a part of your body may get caught on an operating component, possibly causing serious injury.

■ **Replacing light bulbs**

- Turn off the lights. Do not attempt to replace the bulb immediately after turning off the lights. The bulbs become very hot and may cause burns.
- Do not touch the glass portion of the light bulb with bare hands. When it is unavoidable to hold the glass portion, use and hold with a clean dry cloth to avoid getting moisture and oils on the bulb. Also, if the bulb is scratched or dropped, it may blow out or crack.
- Fully install light bulbs and any parts used to secure them. Failure to do so may result in heat damage, fire, or water entering the headlight unit. This may damage the headlights or cause condensation to build up on the lens.



**WARNING**

- Do not attempt to repair or disassemble the light bulbs, connectors, electric circuits or component parts. Doing so may result in death or serious injury due to electric shock.
- **To prevent damage or fire**
- Make sure bulbs are fully seated and locked.
- Check the wattage of the bulb before installing to prevent heat damage.

**When trouble arises****7****7-1. Essential information**

Emergency flashers .... 470

If your vehicle has to be  
stopped in an emergency  
..... 470If the vehicle is submerged  
or water on the road is ris-  
ing ..... 471**7-2. Steps to take in an emer-  
gency**If your vehicle needs to be  
towed..... 473If you think something is  
wrong ..... 475Fuel pump shut off system  
..... 476If a warning light turns on or  
a warning buzzer sounds  
..... 477If a warning message is dis-  
played..... 488

If you have a flat tire.... 495

If the engine will not start  
..... 503

If you lose your keys ... 505

If the fuel filler door cannot  
be opened ..... 505If the electronic key does  
not operate properly.. 506If the vehicle battery is dis-  
charged ..... 508If your vehicle overheats  
..... 512If the vehicle becomes stuck  
..... 514

## Emergency flashers

The emergency flashers are used to warn other drivers when the vehicle has to be stopped on the road due to a breakdown, etc.

### Operating instructions

Press the switch.

All the turn signal lights will flash. To turn them off, press the switch once again.

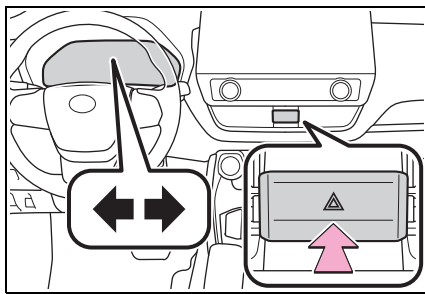

### Emergency flashers

- If the emergency flashers are used for a long time while the engine is not operating, the battery may discharge.
- If any of the SRS airbags deploy (inflate) or in the event of a strong rear impact, the emergency flashers will turn on automatically. The emergency flashers will turn off automatically after operating for approximately 20 minutes. To manually turn the emergency flashers off, press the switch twice. (The emergency flashers may not turn on automatically depending on the force of the impact and conditions of the collision.)

If your vehicle has to be stopped in an emergency

Only in an emergency, such as if it becomes impossible to stop the vehicle in the normal way, stop the vehicle using the following procedure:

### Stopping the vehicle

- 1 Steadily step on the brake pedal with both feet and firmly depress it.

Do not pump the brake pedal repeatedly as this will increase the effort required to slow the vehicle.

- 2 Change the shift position to N.
  - ▶ If the shift position is shifted to N
- 3 After slowing down, stop the vehicle in a safe place by the road.
- 4 Stop the engine.
  - ▶ If the shift position cannot be shifted to N
- 3 Keep depressing the brake pedal with both feet to reduce vehicle speed as much as possible.
- 4 To stop the engine, press and hold the engine switch for 2 consecutive seconds or

more, or press it briefly 3 times or more in succession.

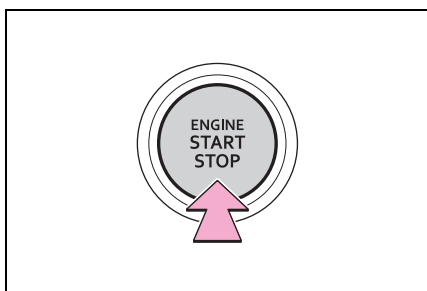

- 5 Stop the vehicle in a safe place by the road.

**⚠ WARNING**

■ **If the engine has to be turned off while driving**

Power assist for the brakes and steering wheel will be lost, making the brake pedal harder to depress and the steering wheel heavier to turn. Decelerate as much as possible before turning off the engine.

**If the vehicle is submerged or water on the road is rising**

**This vehicle is not designed to be able to drive on roads that are deeply flooded with water. Do not drive on roads where the roads may be submerged or the water may be rising. It is dangerous to remain in the vehicle, if it is anticipated that the vehicle will be flooded or set adrift. Remain calm and follow the following.**

- If the door can be opened, open the door and exit the vehicle.
- If the door cannot be opened, open the window using the power window switch and ensure an escape route.
- If the window can be opened, exit the vehicle through the window.
- If the door and window cannot be opened due to the rising water, remain calm, wait until the water level inside the vehicle rises to the point that the water pressure inside of the vehicle equals the water pressure outside of the vehicle and then open the door after waiting for the rising water to enter the vehicle, and exit the vehicle. When the

outside water level exceeds half the height of the door, the door cannot be opened from the inside due to water pressure.

■ **Water level exceeds the floor**

When the water level exceeds the floor and time has passed, the electrical equipment will get damaged, the power windows will not operate, the engine stop, and the vehicle may not be able to get moving.

■ **Using an emergency escape hammer<sup>\*1</sup>**

Laminated glass<sup>\*2</sup> is used in the windshield and the windows on this vehicle.

Laminated glass cannot be shattered with an emergency hammer<sup>\*1</sup>.

<sup>\*1</sup>: Contact your Toyota dealer or aftermarket accessory manufacturer for further information about an emergency hammer.

<sup>\*2</sup>: If equipped

■ **How to distinguish laminated glass**

When looking from the cross-sectional view point, laminated glass is two sheets of glass pasted together.

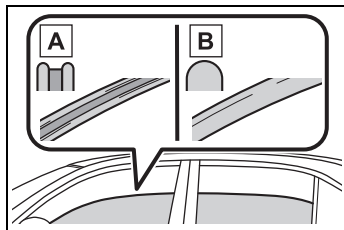

**A** Laminated glass

**B** Tempered glass

**! WARNING**

■ **Caution while driving**

Do not drive on roads where the roads may be submerged or the water may be rising. Otherwise the vehicle may be damaged and cannot move, as well as become flooded and set adrift, which may lead to death.



**If your vehicle needs to be towed**

If towing is necessary, we recommend having your vehicle towed by your Toyota dealer or commercial towing service, using a wheel-lift type truck or flat-bed truck.

Use a safety chain system for all towing, and abide by all state/provincial and local laws.

**Towing with a wheel-lift type truck**

- ▶ From the front (2WD models)

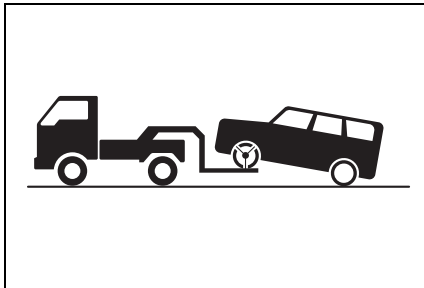

Release the parking brake.  
Turn automatic mode off.  
(→P.213)

- ▶ From the front (AWD models)

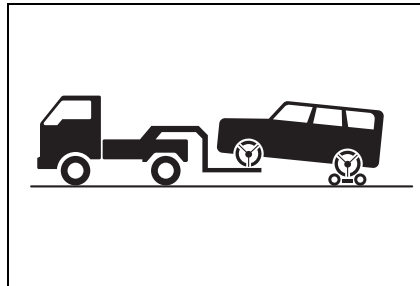

Use a towing dolly under the rear wheels.

- ▶ From the rear

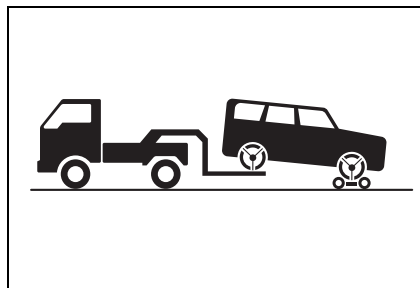

Use a towing dolly under the front wheels.

**! WARNING**

Observe the following precautions. Failure to do so may result in death or serious injury.

**⚠ WARNING**

■ **When towing the vehicle**

▶ 2WD models

Be sure to transport the vehicle with the front wheels raised or with all four wheels raised off the ground. If the vehicle is towed with the front wheels contacting the ground, the drivetrain and related parts may be damaged.

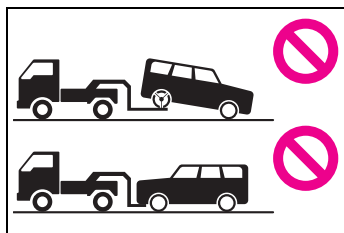

▶ AWD models

Be sure to transport the vehicle with all four wheels raised off the ground. If the vehicle is towed with the tires contacting the ground, the drivetrain or related parts may be damaged, the vehicle may fly off the truck.

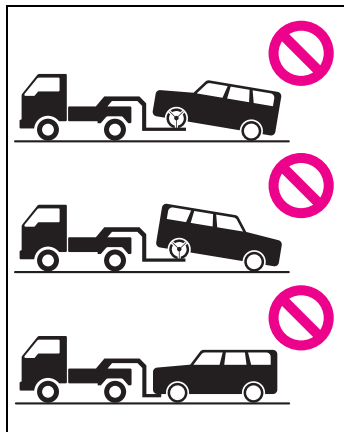

**⚠ NOTICE**

■ **To prevent damage to the vehicle when towing using a wheel-lift type truck**

- Do not tow the vehicle from the rear when the engine switch is off. The steering lock mechanism is not strong enough to hold the front wheels straight.
- When raising the vehicle, ensure adequate ground clearance for towing at the opposite end of the raised vehicle. Without adequate clearance, the vehicle could be damaged while being towed.

■ **Towing with a sling-type truck**

Do not tow with a sling-type truck to prevent body damage.

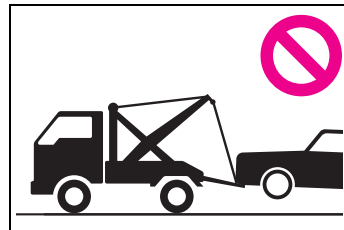

**Using a flatbed truck**

When using a flat-bed truck to transport the vehicle, use tire strapping belts. Refer to the owner's manual of the flat-bed truck for the tire strapping method.

In order to suppress vehicle movement during transportation, set the parking brake and turn the engine switch off.

**NOTICE****■ To prevent damage to the vehicle during emergency towing**

Do not secure cables or chains to the suspension components.

**If you think something is wrong**

**If you notice any of the following symptoms, your vehicle probably needs adjustment or repair. Contact your Toyota dealer as soon as possible.**

**Visible symptoms**

- Fluid leaks under the vehicle (Water dripping from the air conditioning after use is normal.)
- Flat-looking tires or uneven tire wear
- Engine coolant temperature gauge continually points higher than normal

**Audible symptoms**

- Changes in exhaust sound
- Excessive tire squeal when cornering
- Strange noises related to the suspension system
- Pinging or other noises related to the engine

**Operational symptoms**

- Engine missing, stumbling or running roughly
- Appreciable loss of power
- Vehicle pulls heavily to one

## 476 7-2. Steps to take in an emergency

---

side when braking

- Vehicle pulls heavily to one side when driving on a level road
- Loss of brake effectiveness, spongy feeling, pedal almost touches the floor

### Fuel pump shut off system

To minimize the risk of fuel leakage when the engine stalls or when an airbag inflates upon collision, the fuel pump shut off system stops the supply of fuel to the engine.

### Restarting the engine

Follow the procedure below to restart the engine after the system is activated.

- 1 Turn the engine switch to ACC or OFF.
- 2 Restart the engine.



#### NOTICE

##### ■ Before starting the engine

Inspect the ground under the vehicle.

If you find that fuel has leaked onto the ground, the fuel system has been damaged and is in need of repair. Do not restart the engine.

If a warning light turns on or a warning buzzer sounds

Calmly perform the following actions if any of the warning lights comes on or flashes. If a light comes on or flashes, but then goes off, this does not necessarily indicate a malfunction in the system. However, if this continues to occur, have the vehicle inspected by your Toyota dealer.

Actions to the warning lights or warning buzzers

■ Brake system warning light (warning buzzer)

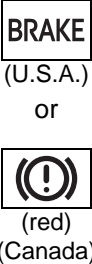
Warning light	Details/Actions
 <p><b>BRAKE</b> (U.S.A.) or (red) (Canada)</p>	<p>Indicates that:</p> <ul style="list-style-type: none"> <li>● The brake fluid level is low; or</li> <li>● The brake system is malfunctioning</li> </ul> <p>→ <b>Immediately stop the vehicle in a safe place and contact your Toyota dealer. Continuing to drive the vehicle may be dangerous.</b></p>

■ Brake system warning light (warning buzzer)

Warning light	Details/Actions
 <p>(red) (Canada)</p>	<p>Indicates a malfunction in the parking brake system</p> <p>→ <b>Have the vehicle inspected by your Toyota dealer immediately.</b></p>

■ High coolant temperature warning light\* (warning buzzer)

Warning light	Details/Actions
	<p>Indicates that the engine coolant temperature is too high</p> <p>→ <b>Immediately stop the vehicle in a safe place. Handling method (→P.512)</b></p>

\*: This light illuminates on the multi-information display.

### ■ Charging system warning light\*

Warning light	Details/Actions
	Indicates a malfunction in the vehicle's charging system → <b>Immediately stop the vehicle in a safe place and contact your Toyota dealer.</b>



\*: This light illuminates on the multi-information display.

### ■ Low engine oil pressure warning light\* (warning buzzer)

Warning light	Details/Actions
	Indicates that the engine oil pressure is too low → <b>Immediately stop the vehicle in a safe place and contact your Toyota dealer.</b>

\*: This light illuminates on the multi-information display.



### ■ Malfunction indicator lamp

Warning light	Details/Actions
 (U.S.A.) or  (Canada)	Indicates a malfunction in: <ul style="list-style-type: none"> <li>● The electronic engine control system;</li> <li>● The electronic throttle control system; or</li> <li>● The electronic automatic transmission control system</li> </ul> → <b>Immediately stop the vehicle in a safe place and contact your Toyota dealer.</b>

### ■ SRS warning light

Warning light	Details/Actions
	Indicates a malfunction in: <ul style="list-style-type: none"> <li>● The SRS airbag system;</li> <li>● The front passenger occupant classification system; or</li> <li>● The seat belt pretensioner system</li> </ul> → <b>Have the vehicle inspected by your Toyota dealer immediately.</b>

### ■ ABS warning light

Warning light	Details/Actions
 (U.S.A.) or  (Canada)	Indicates a malfunction in: <ul style="list-style-type: none"> <li>● The ABS; or</li> <li>● The brake assist system</li> </ul> → <b>Have the vehicle inspected by your Toyota dealer immediately.</b>

### ■ Inappropriate pedal operation warning light\* (warning buzzer)

Warning light	Details/Actions
	When a buzzer sounds: <ul style="list-style-type: none"> <li>● Brake Override System is malfunctioning;</li> <li>● Drive-Start Control is operating;</li> <li>● Drive-Start Control is malfunctioning; or</li> </ul> → <b>Follow the instructions displayed on the multi-information display.</b>  When a buzzer does not sound: Brake Override System is operating → <b>Release the accelerator pedal and depress the brake pedal.</b>

\*: This light illuminates on the multi-information display.

### ■ Electric power steering system warning light (warning buzzer)

Warning light	Details/Actions
 (red/yellow)	Indicates a malfunction in the EPS (Electric Power Steering) system → <b>Have the vehicle inspected by your Toyota dealer immediately.</b>

### ■ Low fuel level warning light

Warning light	Details/Actions
	Indicates that remaining fuel is approximately 2.6 gal. (10.1 L, 2.2 Imp. gal.) or less → <b>Refuel the vehicle.</b>

### ■ Driver's and front passenger's seat belt reminder light (warning buzzer)\*

Warning light	Details/Actions
	<p>Warns the driver and/or front passenger to fasten their seat belts</p> <p>→ <b>Fasten the seat belt.</b>  <b>If the front passenger's seat is occupied, the front passenger's seat belt also needs to be fastened to make the warning light (warning buzzer) turn off.</b></p>

\*: Driver's seat belt warning buzzer:

The driver's seat belt warning buzzer sounds to alert the driver that his or her seat belt is not fastened. Once the engine switch is turned to ON, the buzzer sounds. If the seat belt is still unfastened, the buzzer sounds intermittently for a certain period of time after the vehicle reaches a certain speed.

Front passenger's seat belt warning buzzer:

The front passenger's seat belt warning buzzer sounds to alert the front passenger that his or her seat belt is not fastened. If the seat belt is unfastened, the buzzer sounds intermittently for a certain period of time after the vehicle reaches a certain speed.

### ■ Rear passengers' seat belt reminder light (warning buzzer)\*

Warning light	Details/Actions
	<p>Warns the second and/or third seat passengers to fasten their seat belts. An indicator corresponding to an unfastened second or third seat seat belt will illuminate.</p> <p>→ <b>Fasten the seat belt.</b></p>

\*: Rear passengers' seat belt warning buzzer:

The rear passengers' seat belt warning buzzer sounds to alert the rear passenger that his or her seat belt is not fastened. If the seat belt is unfastened, the buzzer sounds intermittently for a certain period of time, after the seat belt is fastened and unfastened and the vehicle reaches a certain speed.



### ■ Tire pressure warning light (warning buzzer)

Warning light	Details/Actions
	<p>When the light comes on (a buzzer sounds):</p> <ul style="list-style-type: none"> <li>● Low tire inflation pressure from natural causes → <b>After the temperature of the tires has lowered sufficiently, check the inflation pressure of each tire and adjust them to the specified level.</b></li> <li>● Low tire inflation pressure from flat tire → <b>Immediately stop the vehicle in a safe place and perform the necessary actions. (→P.485)</b></li> </ul> <p>When the light comes on after blinking for approximately 1 minute (a buzzer does not sound):</p> <p>Malfunction in the tire pressure warning system → <b>Have the system checked by your Toyota dealer.</b></p>

### ■ Stop & Start cancel indicator

Warning light	Details/Actions
	<p>Indicates a malfunction in the Stop &amp; Start system → <b>Have the vehicle inspected by your Toyota dealer immediately.</b></p>

### ■ PCS warning light (warning buzzer)

Warning light	Details/Actions
	<p>Indicates a malfunction in the PCS (Pre-Collision System). → <b>Follow the instructions displayed on the multi-information display.</b></p> <p>If the PCS (Pre-Collision System) or VSC (Vehicle Stability Control) system is disabled, the PCS warning light will illuminate.</p>

### ■ LTA indicator (warning buzzer)

Warning light	Details/Actions
	<p>Indicates a malfunction in the LTA (Lane Tracing Assist) → <b>Follow the instructions displayed on the multi-information display.</b></p>

■ **LDA indicator (warning buzzer)**

Warning light	Details/Actions
 <p>(yellow)</p>	Indicates a malfunction in the LDA (Lane Departure Alert). → <b>Follow the instructions displayed on the multi-information display.</b>

■ **PDA indicator (warning buzzer)**

Warning light	Details/Actions
 <p>(yellow)</p>	Indicates a malfunction in the PDA (Proactive Driving Assist). → <b>Follow the instructions displayed on the multi-information display.</b>

■ **Dynamic radar cruise control indicator (warning buzzer)**

Warning light	Details/Actions
 <p>(yellow)</p>	Indicates a malfunction in the dynamic radar cruise control. → <b>Follow the instructions displayed on the multi-information display.</b>

■ **Cruise control indicator (warning buzzer)**

Warning light	Details/Actions
 <p>(yellow)</p>	Indicates a malfunction in the cruise control. → <b>Follow the instructions displayed on the multi-information display.</b>

■ Driving assist information indicator

Warning light	Details/Actions
	<p>Indicates either of the following systems may be malfunctioning.</p> <ul style="list-style-type: none"> <li>● PCS (Pre-Collision System)</li> <li>● LDA (Lane Departure Alert)</li> </ul> <p>→ <b>Follow the instructions displayed on the multi-information display.</b></p> <p>Indicates one of the following systems is malfunctioning or disabled.</p> <ul style="list-style-type: none"> <li>● PKSB (Parking Support Brake)*</li> <li>● RCD (Rear Camera Detection)*</li> <li>● BSM (Blind Spot Monitor)</li> <li>● RCTA (Rear cross traffic alert)</li> <li>● Safe Exit Assist</li> </ul> <p>→ <b>Follow the instructions displayed on the multi-information display.</b></p>

\*: If equipped

■ Intuitive parking assist OFF indicator (warning buzzer)

Warning light	Details/Actions
 <p>(if equipped)</p>	<p>When a buzzer sounds:</p> <p>Indicates a malfunction in the intuitive parking assist function</p> <p>→ <b>Have the vehicle inspected by your Toyota dealer immediately.</b></p> <p>When a buzzer sounds:</p> <p>Indicates that the system is temporarily unavailable, possibly due to a sensor being dirty or covered with ice, etc.</p> <p>→ <b>Follow the instructions displayed on the multi-information display. (→P.493)</b></p>

■ Slip indicator

Warning light	Details/Actions
	<p>When the warning light is illuminated:</p> <p>Indicates a malfunction in:</p> <ul style="list-style-type: none"> <li>● The VSC system;</li> <li>● The TRAC system;</li> <li>● The Multi-terrain Select system* ;</li> <li>● The Trailer Sway Control* ; or</li> <li>● The hill-start assist control system</li> </ul> <p>→ <b>Have the vehicle inspected by your Toyota dealer immediately.</b></p> <p>When the warning light flashes:</p> <p>Indicates that the ABS, VSC, TRAC or Trailer Sway Control system is operating</p>

\*: If equipped

■ Parking brake indicator

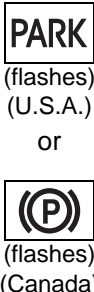
Warning light	Details/Actions
<p></p>	<p>It is possible that the parking brake is not fully engaged or released</p> <p>→ <b>Operate the parking brake switch once again.</b></p> <p>This light comes on when the parking brake is not released. If the light turns off after the parking brake is fully released, the system is operating normally.</p>

■ Brake hold operated indicator

Warning light	Details/Actions
<p></p>	<p>Indicates a malfunction in the brake hold system</p> <p>→ <b>Have the vehicle inspected by your Toyota dealer immediately.</b></p>

■ Warning buzzer

In some cases, the buzzer may not be heard due to being in a noisy location or audio sound.

■ Front passenger detection sensor, seat belt reminder and warning buzzer

- If luggage is placed on the front passenger seat, the front passenger detection sensor may cause

the warning light to flash and the warning buzzer to sound even if a passenger is not sitting in the seat.

- If a cushion is placed on the seat, the sensor may not detect a passenger, and the warning light may not operate properly.

#### ■ SRS warning light

This warning light indicates problems with the following:

- Airbag sensor assembly
- Front impact sensors
- Side impact sensors (front door)
- Side impact sensors (front)
- Side impact sensors (rear door)
- Front passenger occupant classification sensors
- Driver's seat position sensor
- Front passenger's seat belt buckle switch
- "AIR BAG ON" indicator light
- "AIR BAG OFF" indicator light
- Seat belt pretensioners
- SRS airbags
- SRS system related wiring harnesses and power sources

#### ■ If the malfunction indicator lamp comes on while driving

First check the following:

- Is the fuel tank empty?  
If it is, fill the fuel tank immediately.
- Is the fuel tank cap loose?  
If it is, tighten it securely.

The light will go off after several driving trips.

If the light does not go off even after several trips, contact your Toyota dealer as soon as possible.

#### ■ Electric power steering system warning light (warning buzzer)

When the battery charge becomes insufficient or the voltage temporarily drops, the electric power steering

system warning light may come on and the warning buzzer may sound.

#### ■ When the tire pressure warning light comes on

Inspect the tires to check if a tire is punctured.

If a tire is punctured: →P.495

If none of the tires are punctured: Turn the engine switch off then turn it to ON. Check if the tire pressure warning light comes on or blinks.

- ▶ If the tire pressure warning light blinks for 1 minute then stays on

There may be a malfunction in the tire pressure warning system. Have the vehicle inspected by your Toyota dealer immediately.

- ▶ If the tire pressure warning light comes on
  - 1 After the temperature of the tires has lowered sufficiently, check the inflation pressure of each tire and adjust them to the specified level.
  - 2 If the warning light does not turn off even after several minutes have elapsed, check that the inflation pressure of each tire is at the specified level and perform the tire inflation pressure setting procedure.. (→P.449)

If the warning light does not turn off even after several minutes have elapsed since performing the tire inflation pressure setting procedure, have the vehicle inspected by your Toyota dealer immediately.

#### ■ The tire pressure warning light may come on due to natural causes

The tire pressure warning light may come on due to natural causes such as natural air leaks and tire inflation pressure changes caused by temperature. In this case, adjusting the tire inflation pressure will turn off the warning light (after a few minutes).

■ **When a tire is replaced with a spare tire**

The compact spare tire is not equipped with a tire pressure warning valve and transmitter. If a tire goes flat, the tire pressure warning light will not turn off even though the flat tire has been replaced with the spare tire. Replace the spare tire with the repaired tire and adjust the tire inflation pressure. The tire pressure warning light will go off after a few minutes.

■ **Conditions that the tire pressure warning system may not function properly**

→P.446

 **WARNING**

■ **If both the ABS and the brake system warning lights remain on**

Stop your vehicle in a safe place immediately and contact your Toyota dealer.

The vehicle will become extremely unstable during braking, and the ABS system may fail, which could cause an accident resulting in death or serious injury.

■ **When the electric power steering system warning light comes on**

When the light comes on yellow, the assist to the power steering is restricted. When the light comes on red, the assist to the power steering is lost and handling operations of the steering wheel become extremely heavy.

When steering wheel operations are heavier than usual, grip the steering wheel firmly and operate it using more force than usual.

■ **If the tire pressure warning light comes on**

Be sure to observe the following precautions.

Failure to do so could cause a loss of vehicle control and result in death or serious injury.

● Stop your vehicle in a safe place as soon as possible. Adjust the tire inflation pressure immediately.

● If the tire pressure warning light comes on even after tire inflation pressure adjustment, it is probable that you have a flat tire. Check the tires. If a tire is flat, change it with the spare tire and have the flat tire repaired by the nearest Toyota dealer.

● Avoid abrupt maneuvering and braking. If the vehicle tires deteriorate, you could lose control of the steering wheel or the brakes.

■ **If a blowout or sudden air leakage should occur**

The tire pressure warning system may not activate immediately.

■ **Maintenance of the tires**

Each tire, including the spare (if provided), should be checked monthly when cold and inflated to the inflation pressure recommended by the vehicle manufacturer on the vehicle placard or tire inflation pressure label (tire and load information label). (If your vehicle has tires of a different size than the size indicated on the vehicle placard or tire inflation pressure label [tire and load information label], you should determine the proper tire inflation pressure for those tires.)

**⚠ WARNING**

As an added safety feature, your vehicle has been equipped with a tire pressure monitoring system (TPMS-tire pressure warning system) that illuminates a low tire pressure telltale (tire pressure warning light) when one or more of your tires is significantly under-inflated. Accordingly, when the low tire pressure telltale (tire pressure warning light) illuminates, you should stop and check your tires as soon as possible, and inflate them to the proper pressure. Driving on a significantly under-inflated tire causes the tire to overheat and can lead to tire failure. Under-inflation also reduces fuel efficiency and tire tread life, and may affect the vehicle's handling and stopping ability.

Please note that the TPMS (tire pressure warning system) is not a substitute for proper tire maintenance, and it is the driver's responsibility to maintain correct tire pressure, even if under-inflation has not reached the level to trigger illumination of the TPMS low tire pressure telltale (tire pressure warning light).

Your vehicle has also been equipped with a TPMS (tire pressure warning system) malfunction indicator to indicate when the system is not operating properly. The TPMS (tire pressure warning system) malfunction indicator is combined with the low tire pressure telltale (tire pressure warning light). When the system detects a malfunction, the telltale will flash for approximately one minute and then remain continuously illuminated. This sequence will continue upon subsequent vehicle start-ups as long as the malfunction exists. When the malfunction indicator is illuminated, the system may not be able to detect or signal low tire pressure as intended.

TPMS (tire pressure warning system) malfunctions may occur for a variety of reasons, including the installation of replacement or alternate tires or wheels on the vehicle that prevent the TPMS (tire pressure warning system) from functioning properly. Always check the TPMS (tire pressure warning system) malfunction telltale after replacing one or more tires or wheels on your vehicle to ensure that the replacement or alternate tires and wheels allow the TPMS (tire pressure warning system) to continue to function properly.

**⚠ NOTICE****■ To ensure the tire pressure warning system operates properly**

Do not install tires with different specifications or makers, as the tire pressure warning system may not operate properly.

**If a warning message is displayed**

**The multi-information display shows warnings for system malfunctions and incorrectly performed operations, and messages that indicate a need for maintenance. When a message is displayed, perform the appropriate corrective action for the message.**

**Additionally, if a warning light comes on or flashes at the same time that a warning message is displayed, take the appropriate corrective action for the warning light. (→P.477)**

**If a warning message is displayed again after the appropriate actions have been performed, contact your Toyota dealer.**



## Messages and warnings

The warning lights and warning buzzers operate as follows depending on the content of the message. If a message indicates the need for inspection by a dealer, have the vehicle inspected by your Toyota dealer immediately.

Warning light	Warning buzzer*	Warning
-	Sounds	<ul style="list-style-type: none"> <li>Indicates an important situation, such as when a system related to driving is malfunctioning or that danger may result if the correction procedure is not performed</li> <li>Indicates a situation, such as when damage to the vehicle or danger may result</li> </ul>
Comes on or flashes	Sounds	Indicates an important situation, such as when the systems shown on the multi-information display may be malfunctioning
-	Does not sound	<ul style="list-style-type: none"> <li>Indicates a condition, such as malfunction of electrical components, their condition, or indicates the need for maintenance</li> <li>Indicates a situation, such as when an operation has been performed incorrectly, or indicates how to perform an operation correctly</li> </ul>

\*: A buzzer sounds the first time a message is shown on the multi-information display.

### ■ Warning messages

The warning messages explained below may differ from the actual messages according to operation conditions and vehicle specifications.

### ■ Warning buzzer

In some cases, the buzzer may not be heard due to being in a noisy location or audio sound.

### ■ If “Engine Oil Level Low Add or Replace” is displayed

The engine oil level is low. Check the level of the engine oil, and add if necessary. (→P.437)

This message may appear if the vehicle is stopped on a slope. Move the vehicle to a level surface and check to see if the message disappears.

■ **If “Engine Stopped Steering Power Low” is displayed**

This message is displayed if the engine is stopped while driving.

When steering wheel operations are heavier than usual, grip the steering wheel firmly and operate it using more force than usual.

■ **If “Power Reduced to Lower Engine Temp” is displayed**

This message may be displayed when the engine coolant temperature is high.

At that time, the engine power output is reduced until the temperature decreases to the specified level. It is still possible to continue driving normally, meanwhile the acceleration performance or vehicle speed may be lowered. After driving for a while and the engine coolant temperature is dropped, this message will disappear and engine power output will resume once the engine coolant temperature has decreased to normal.

If after driving for a while the message does not disappear or it comes on and off frequently, contact your Toyota dealer.

■ **If “Auto Power OFF to Conserve Battery” is displayed**

Power was cut off due to the automatic power off function. Next time when starting the engine, increase the engine speed slightly and maintain that level for approximately 5 minutes to recharge the battery.









■ **If “Headlight System Malfunction Visit Your Dealer” is displayed**

The following systems may be malfunctioning. Have the vehicle inspected by your Toyota dealer immediately.

- The LED headlight system
- AHB (Automatic High Beam)

■ **If “System Malfunction Visit Your Dealer” is displayed**



Indicates one of the following systems is disabled.







- PCS (Pre-Collision System)
- LDA (Lane Departure Alert)
- LTA (Lane Tracing Assist)
-  LCA (Lane Change Assist) (if equipped)
- AHB (Automatic High Beam)
- Dynamic radar cruise control
-  RSA (Road Sign Assist) (if equipped)
- PDA (Proactive Driving Assist)
-  BSM (Blind Spot Monitor)
-  RCTA (Rear Cross Traffic Alert)
-  Safe Exit Assist
-  Intuitive Parking Assist (if equipped)
-  PKSB (Parking Support Brake) (if equipped)
-  RCD (Rear camera detection) (if equipped)

Have the vehicle inspected by your Toyota dealer immediately.

■ **If “System Stopped See Owner’s Manual” is displayed**

Indicates one of the following systems is disabled.

- PCS (Pre-Collision System)
- LDA (Lane Departure Alert)
- LTA (Lane Tracing Assist)
-  LCA (Lane Change Assist) (if equipped)
- AHB (Automatic High Beam)
- Dynamic radar cruise control
-  RSA (Road Sign Assist) (if equipped)

- PDA (Proactive Driving Assist)
-  BSM (Blind Spot Monitor)
-  RCTA (Rear Cross Traffic Alert)
-  Safe Exit Assist
-  Intuitive Parking Assist (if equipped)
-  PKSB (Parking Support Brake) (if equipped)
-  RCD (Rear camera detection) (if equipped)

Follow the following correction methods.

- Check the voltage of the battery
- Check the sensors that the Toyota Safety Sense 3.0 uses for foreign matter covering them. Remove them if any. (→P.237)
- Check if the back door is open.

Indicates the sensors may not be operating properly.

- Intuitive Parking Assist (if equipped) (→P.325)
- PKSB (static objects front and rear of the vehicle) (if equipped) (→P.344)
- PKSB (moving vehicles rear of the vehicle) (if equipped) (→P.346)
- PKSB (pedestrians rear of the vehicle) (if equipped) (→P.348)
- RCD (if equipped) (→P.336)
- BSM (Blind Spot Monitor) (→P.317)
- RCTA (Rear Cross Traffic Alert) (→P.331)
- Safe Exit Assist (→P.321)

Check the rear bumper around the sensors (→P.314) used by the BSM, RCTA, Safe Exit Assist for foreign matter covering them. Remove them if any.



Check the sensors including camera sensors used by the Intuitive Park-

ing Assist, and PKSB, for foreign matter covering them. Remove them if any.

When problems are solved and the sensors are operational, this indication may disappear by itself.

■ **If “System Stopped Front Camera Low Visibility See Owner's Manual” is displayed**

Indicates one of the following systems is disabled.

- PCS (Pre-Collision System)
- LDA (Lane Departure Alert)
- LTA (Lane Tracing Assist)
-  LCA (Lane Change Assist) (if equipped)
- AHB (Automatic High Beam)
- Dynamic radar cruise control
-  RSA (Road Sign Assist) (if equipped)
- PDA (Proactive Driving Assist)

Follow the following correction methods.

- Using the windshield wipers, remove the dirt or foreign matter from the windshield.
- Using the air conditioning system, defog the windshield.
- Close the hood, remove any stickers, etc. to clear the obstruction in front of the front camera.

■ **If “System Stopped Front Camera Out of Temperature Range Wait until Normal Temperature” is displayed**

Indicates one of the following systems is disabled.

- PCS (Pre-Collision System)
- LDA (Lane Departure Alert)
- LTA (Lane Tracing Assist)
-  LCA (Lane Change Assist) (if equipped)
- AHB (Automatic High Beam)

- Dynamic radar cruise control
-  RSA (Road Sign Assist) (if equipped)
- PDA (Proactive Driving Assist)

Follow the following correction methods.

- If the front camera is hot, such as after the vehicle is parked in the sun, use the air conditioning system to decrease the temperature around the front camera
- If a sunshade was used when the vehicle was parked, depending on its type, the sunlight reflected from the surface of the sunshade may cause the temperature of the front camera to become excessively high
- If the front camera is cold, such as after the vehicle is parked in an extremely cold environment, use the air conditioning system to increase the temperature around the front camera

■ **If “System Stopped Front Radar Sensor Blocked Clean Radar Sensor” is displayed**

Indicates one of the following systems is disabled.

- PCS (Pre-Collision System)
- LDA (Lane Departure Alert)
- LTA (Lane Tracing Assist)
-  LCA (Lane Change Assist) (if equipped)
- AHB (Automatic High Beam)
- Dynamic radar cruise control
- PDA (Proactive Driving Assist)

Follow the following correction methods.

- Check if there is any foreign matter attached to the radar sensor or radar sensor cover and clean them if necessary (→P.237)
- This message may be displayed when driving in an open area with few nearby vehicles or structures,

such as a desert, grasslands, suburbs, etc. The message may be cleared by driving the vehicle in an area with structures, vehicles, etc. nearby.

■ **If “System Stopped Front Radar Sensor Out of Temperature Range Wait until Normal Temperature” is displayed**

Indicates one of the following systems is disabled.

- PCS (Pre-Collision System)
- LDA (Lane Departure Alert)
- LTA (Lane Tracing Assist)
-  LCA (Lane Change Assist) (if equipped)
- AHB (Automatic High Beam)
- Dynamic radar cruise control
- PDA (Proactive Driving Assist)

The temperature of the radar sensor is outside of the operating range. Wait for the temperature to become appropriate.

■ **If “System Stopped Front Radar In Self Calibration See Owner's Manual” is displayed**

Indicates one of the following systems is disabled.

- PCS (Pre-Collision System)
- LDA (Lane Departure Alert)
- LTA (Lane Tracing Assist)
-  LCA (Lane Change Assist) (if equipped)
- AHB (Automatic High Beam)
- Dynamic radar cruise control
- PDA (Proactive Driving Assist)

Follow the following correction methods.

- Check if there is any foreign matter attached to the radar sensor or radar sensor cover and clean them if necessary (→P.237)
- The radar sensor may be misaligned and will be adjusted auto-

matically while driving. Continue driving for a while.

■ **If “Unavailable Activation Condition not Satisfied See Owner's Manual” is displayed**

 The LCA function cannot be used as the operating conditions have not been met.

Operate the turn signal lever again after all of the operating conditions are met.

■ **If “Cruise Control Unavailable See Owner's Manual” is displayed**

Indicates one of the following systems is disabled.

- Dynamic radar cruise control
- Cruise control

A message is displayed when the driving assist switch is pushed repeatedly.

Press the driving assist switch quickly and firmly.

■ **If “Driver Monitor Out of Temperature Range Wait until Normal Temperature” is displayed**

Indicates one of the following systems is disabled.

- Driver monitor (if equipped)
- Traffic Jam Assist (if equipped)

The temperature of the driver monitor camera is outside of the operating range. Wait for the temperature to become appropriate.

■ **If “Driver Monitor Unavailable See Owner's Manual” is displayed**

The lens of the driver monitor camera may be dirty.

When there is dirt on the camera lens, clean it with a dry, soft cloth so as to not damage it.

■ **If “Parking Assist Unavailable Sensor Blocked” is displayed**

A sensor may be covered with water

drops, ice, snow, dirt, etc. Remove the water drops, ice, snow, dirt, etc., from the sensor to return the system to normal.



Also, due to ice forming on a sensor at low temperatures, a warning message may be displayed or the sensor may not be able to detect an object. Once the ice melts, the system will return to normal.

If a sensor is dirty, the position of the dirty sensor will be shown on the display.

If an abnormality is displayed even though there are no water drops, ice, snow or dirt, the sensor may be operating abnormally. Have the vehicle inspected by your Toyota dealer.

■ **If “Parking Assist Unavailable Low Visibility See Owner's Manual” is displayed**

Indicates one of the following systems is disabled.

-  RCD (Rear camera detection) (if equipped)
-  PKSB (Parking Support Brake) (if equipped)

Remove any dirt or foreign matter from the rear camera.

■ **If “Check Fuel Cap” is displayed**

The fuel tank cap is not properly installed. Correctly install the fuel tank cap.

■ **If “Maintenance Required Soon” is displayed**

Indicates that all maintenance according to the driven distance on the maintenance schedule\* should be performed soon.

Comes on approximately 4500 miles (7200 km) after the message has been reset. If necessary, perform maintenance. Please reset the message after the maintenance is performed. (→P.427)

\*: Refer to the separate “Scheduled Maintenance Guide” or “Owner’s Manual Supplement” for the maintenance interval applicable to your vehicle.

■ **If “Maintenance Required” is displayed**

Indicates that all maintenance is required to correspond to the driven distance on the maintenance schedule\*.

Comes on approximately 5000 miles (8000 km) after the message has been reset. (The indicator will not work properly unless the message has been reset.) Perform the necessary maintenance. Please reset the message after the maintenance is performed. (→P.427)

\*: Refer to the separate “Scheduled Maintenance Guide” or “Owner’s Manual Supplement” for the maintenance interval applicable to your vehicle.

■ **If “Oil Maintenance Required Soon” is displayed**

Indicates that the engine oil should be scheduled to be changed.

Check the engine oil and change it if necessary. After changing the engine oil, make sure to reset the message. (→P.437)

■ **If “Oil Maintenance Required Visit Your Dealer” is displayed**

Indicates that the engine oil should be changed.

Check and change the engine oil, and oil filter by your Toyota dealer. After changing the engine oil, make sure to reset the message. (→P.437)

■ **If a message that indicates the need for visiting your Toyota dealer is displayed**

The system or part shown on the multi-information display is malfunctioning. Have the vehicle inspected by your Toyota dealer immediately.

tioning. Have the vehicle inspected by your Toyota dealer immediately.

■ **If a message that indicates the need for referring to Owner’s Manual is displayed**

● If any of the following messages are shown on the multi-information display, it may indicate a malfunction. Immediately stop the vehicle and contact your Toyota dealer.

- “Braking Power Low”
- “12-Volt Battery Charging System Malfunction”
- “Oil pressure low”

● If “Smart Key System malfunction See owner’s manual” is shown on the multi-information display, it may indicate a malfunction. Have the vehicle inspected by your Toyota dealer immediately.

● If any of the following messages are shown on the multi-information display, follow the instructions.

- “Engine Coolant Temp High” (→P.512)
- “High Transmission Fluid Temp” (→P.207)

**If you have a flat tire**

Your vehicle is equipped with a compact spare tire. The flat tire can be replaced with the compact spare tire.

For details about tires:  
→P.443

 **WARNING****■ If you have a flat tire**

Do not continue driving with a flat tire. Driving even a short distance with a flat tire can damage the tire and the wheel beyond repair, which could result in an accident.

**Before jacking up the vehicle**

- Stop the vehicle in a safe place on a hard, flat surface.
- Set the parking brake.
- Change the shift position to P.
- Stop the engine.
- Turn on the emergency flashers. (→P.470)
- Turn off the power back door system. (→P.538)

### Location of the spare tire, jack and tools

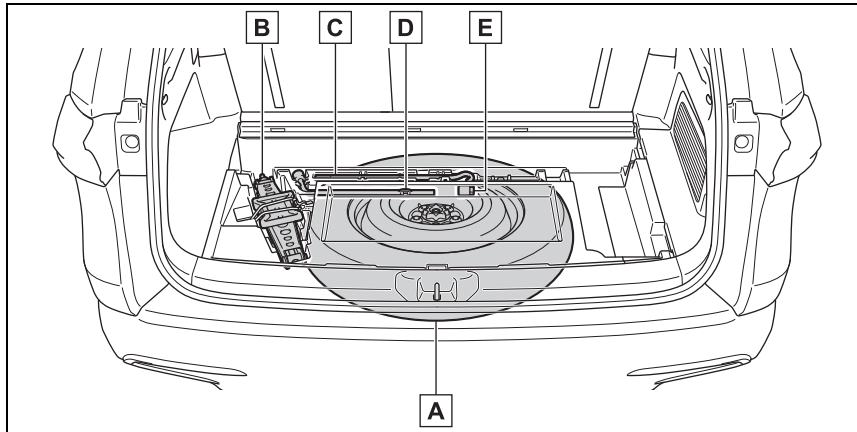

- A** Compact spare tire
- B** Jack
- C** Jack handle
- D** Wheel nut wrench
- E** Wheel lock key (if equipped)

#### **WARNING**

##### ■ Using the tire jack

Observe the following precautions. Improper use of the tire jack may cause the vehicle to suddenly fall off the jack, leading to death or serious injury.

- Do not use the tire jack for any purpose other than replacing tires or installing and removing tire chains.
- Only use the tire jack that comes with this vehicle for replacing a flat tire. Do not use it on other vehicles, and do not use other tire jacks for replacing tires on this vehicle.

- Put the jack properly in its jack point.

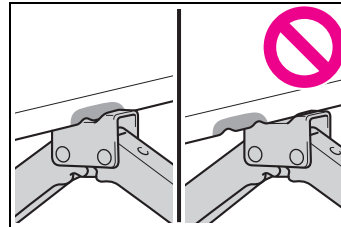

- Do not put any part of your body under the vehicle while it is supported by the jack.
- Do not start the engine or drive the vehicle while the vehicle is supported by the jack.
- Do not raise the vehicle while someone is inside.



**⚠ WARNING**

- When raising the vehicle, do not put an object on or under the jack.
- Do not raise the vehicle to a height greater than that required to replace the tire.
- Use a jack stand if it is necessary to get under the vehicle.
- When lowering the vehicle, make sure that there is no-one near the vehicle. If there are people nearby, warn them vocally before lowering.

**■ Replacing a flat tire for vehicles with power back door**

In cases such as when replacing tires, make sure to cancel the power back door system (→P.135). Failure to do so may cause the back door to operate unintentionally if the power back door switch is accidentally touched, resulting in hands and fingers being caught and injured.

**Wheel lock nut (if equipped)**

When replacing tires on a vehicle with wheel lock nuts, use the following procedures to remove and install the wheel lock nuts. The wheel lock key is stored in the tray inside the luggage compartment. Always return the wheel lock key to its original position after use, so that it does not get lost. (→P.496)

**■ Removal**

For ease of removal, the wheel lock nut should always be the

first one loosened.

- 1 Place the wheel lock key on top of the wheel lock nut, turning until the wheel lock key and wheel lock nut patterns engage.
- 2 Place the wheel nut wrench on the wheel lock key, and while applying pressure on the wheel lock key, loosen the wheel lock nut.

**■ Installation**

For ease of installation, the wheel lock nut should always be the last one tightened.

- 1 By hand, install a wheel lock nut on each wheel.
- 2 Place the wheel lock key on top of the wheel lock nut, turning until the wheel lock key and wheel lock nut patterns engage.
- 3 Place the wheel nut wrench on the wheel lock key, and while applying pressure on the wheel lock key, tighten the wheel lock nut to the recommended torque.

**⚠ NOTICE****■ When using a wheel lock key (if equipped)**

Do not use an impact wrench. Using an impact wrench may cause permanent damage to wheel lock nut and wheel lock key. If in doubt about wheel lock application, contact your Toyota dealer.

**Taking out the jack**

- 1 Remove the center deck board. (→P.396)
- 2 Take out the jack.  
Disengage the tightening strap.

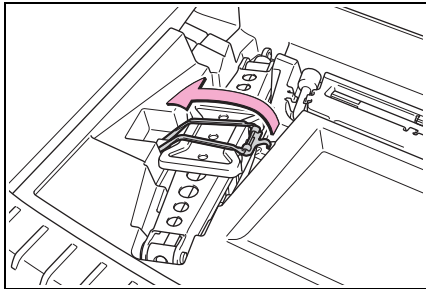

**Taking out the spare tire**

- 1 Remove the center deck board. (→P.396)
- 2 Removing the cover  
Disengage the 7 claws and pull the side deck board to remove it.

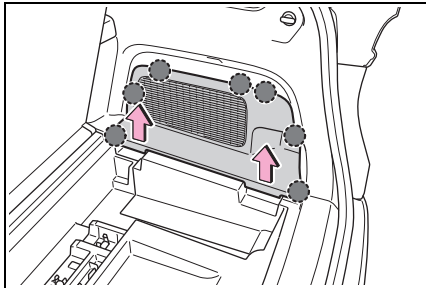

- 3 Disengage the 5 claws and pull the cover to remove it.

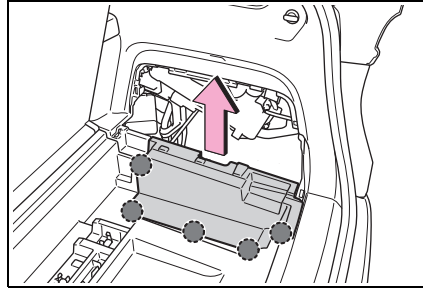

- 4 Remove the center deck under tray.

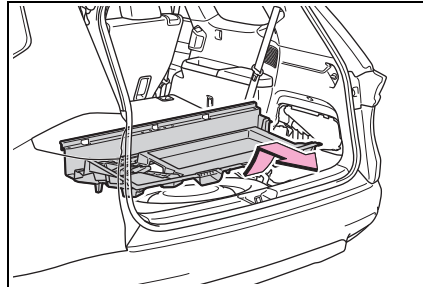

- 5 Loosen the center fastener that secures the compact spare tire.

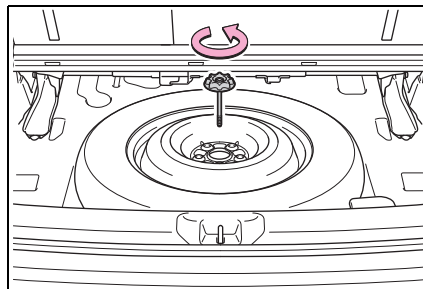

**⚠ WARNING**

**■ When storing the compact spare tire**

Be careful not to catch fingers or other body parts between the spare tire and the body of the vehicle.

**Replacing a flat tire**

1 Check the tires.

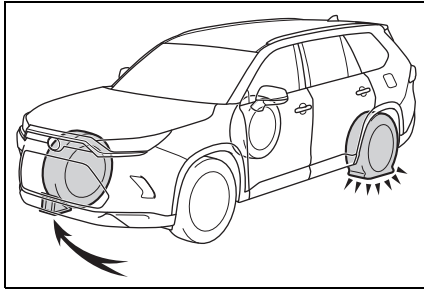

Flat tire	Wheel chock positions
Front left-hand side	Behind the rear right-hand side tire
Front right-hand side	Behind the rear left-hand side tire
Rear left-hand side	In front of the front right-hand side tire
Rear right-hand side	In front of the front left-hand side tire

2 Using a wheel nut wrench, slightly loosen the wheel nuts (approximately one turn).

Vehicles with wheel locks: Use the wheel lock key to loosen the wheel

lock.

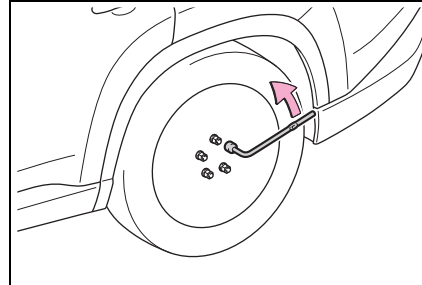

3 Turn the tire jack portion **A** by hand until the notch of the jack is in contact with the jack point.

The jack point guides are located under the rocker panel. They indicate the jack point positions.

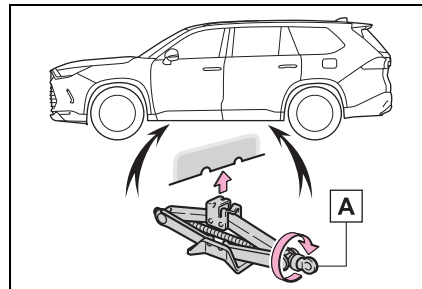

4 Install the wheel nut wrench to the jack handle.

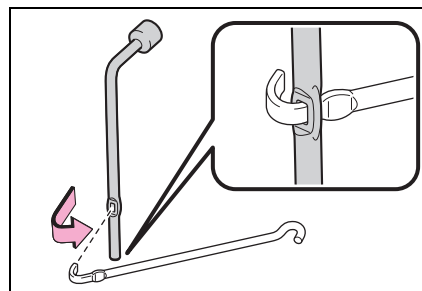

7  
When trouble arises

## 500 7-2. Steps to take in an emergency

- 5** Raise the vehicle until the tire is slightly raised off the ground.

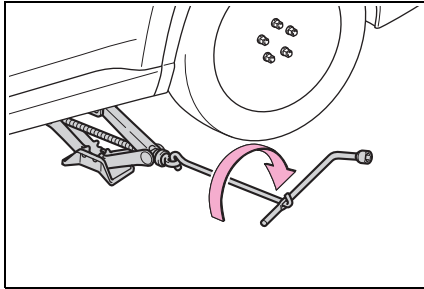

- 6** Remove all the wheel nuts and the tire.

When resting the tire on the ground, place the tire so that the wheel design faces up to avoid scratching the wheel surface.

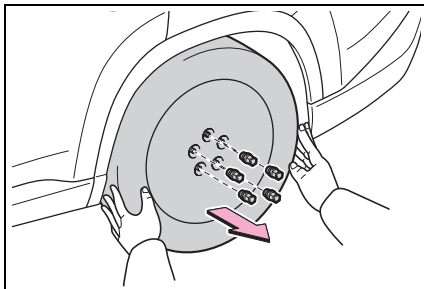

### **WARNING**

#### **Replacing a flat tire**

- Do not touch the disc wheels or the area around the brakes immediately after the vehicle has been driven. After the vehicle has been driven the disc wheels and the area around the brakes will be extremely hot. Touching these areas with hands, feet or other body parts while changing a tire, etc. may result in burns.

- Failure to follow these precautions could cause the wheel nuts to loosen and the tire to fall off, resulting in death or serious injury.

- Never use oil or grease on the wheel bolts or wheel nuts. Oil and grease may cause the wheel nuts to be excessively tightened, leading to bolt or disc wheel damage. Remove any oil or grease that has adhered when installing the wheel nuts.

- After replacing a tire, check the tightening torque as soon as possible.  
Wheel nut torque: 103 ft•lbf (140 N•m, 14.3 kgf•m)

- When installing a tire, only use wheel nuts that have been specifically designed for that wheel.

- If there are any cracks or deformations in the bolt screws, nut threads or bolt holes of the wheel, have the vehicle inspected by your Toyota dealer.

- Do not attach a heavily damaged wheel ornament, as it may fly off the wheel while the vehicle is moving.

- Do not try to remove the wheel ornament by hand. Take due care in handling the ornament to avoid unexpected personal injury.

### **Installing the spare tire**

- 1** Remove any dirt or foreign matter from the wheel contact surfaces and wheel nuts.

If foreign matter is on the wheel contact surface, the wheel nuts may loosen while the vehicle is in

motion, causing the tire to come off.

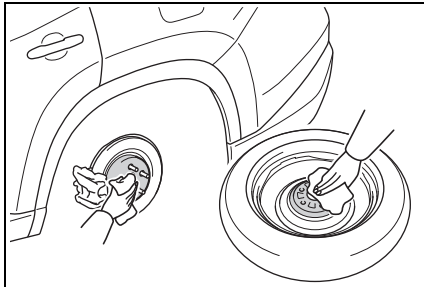

- 2 Install the spare tire and loosely tighten each wheel nut by hand by approximately the same amount.

When replacing an aluminum wheel with a steel wheel, tighten the wheel nuts until the tapered portion **A** comes into loose contact with the disc wheel seat **B**.

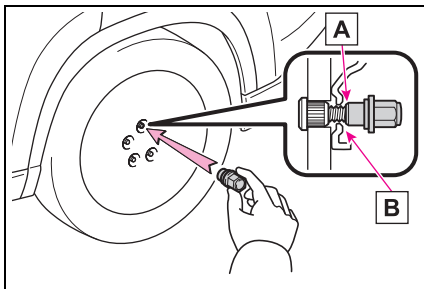

- 3 Lower the vehicle.

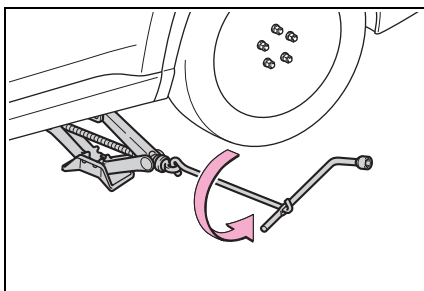

- 4 Securely tighten the wheel nuts two or three times in the order shown in the illustration using a wheel nut wrench.

Vehicles with wheel locks: Tighten the wheel lock using the wheel lock key after tightening the other wheel nuts.

Tightening torque:  
103 ft•lb (140 N•m, 14.3 kgf•m)

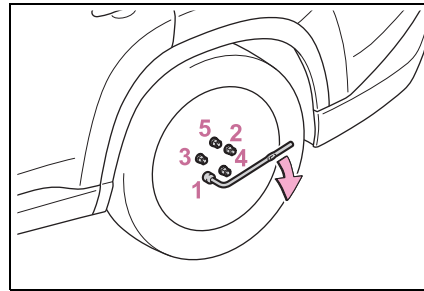

- 5 Stow the flat tire, tire jack and all tools.

■ **The compact spare tire**

- The compact spare tire is identified by the label "TEMPORARY USE ONLY" on the tire sidewall.
- Use the compact spare tire temporarily, and only in an emergency.
- Make sure to check the tire inflation pressure of the compact spare tire. (→P.524)

■ **When using the compact spare tire**

As the compact spare tire is not equipped with a tire pressure warning valve and transmitter, low inflation pressure of the compact spare tire will not be indicated by the tire pressure warning system. Also, if you replace the compact spare tire after the tire pressure warning light comes on, the light remains on.

■ **When the compact spare tire is equipped**

The vehicle becomes lower when driving with the compact spare tire compared to when driving with standard tires.

## 502 7-2. Steps to take in an emergency

### ■ If you have a flat front tire on a road covered with snow or ice (vehicles with 18-inch tires)

Install the compact spare tire on one of the rear wheels of the vehicle. Perform the following steps and fit tire chains to the front tires:

- 1 Replace a rear tire with the compact spare tire.
- 2 Replace the flat front tire with the tire removed from the rear of the vehicle.
- 3 Fit tire chains to the front tires.

### WARNING

#### ■ When using the compact spare tire

- Remember that the compact spare tire provided is specifically designed for use with your vehicle. Do not use your compact spare tire on another vehicle.
- Do not use more than one spare tire simultaneously.
- Replace the compact spare tire with a standard tire as soon as possible.
- Avoid sudden acceleration, abrupt steering, sudden braking and shifting operations that cause sudden engine braking.

#### ■ When the compact spare tire is attached

The vehicle speed may not be correctly detected, and the following systems may not operate correctly:

- ABS & Brake assist
- VSC
- TRAC
- Trailer Sway Control
- EPS

- Dynamic radar cruise control
- PCS (Pre-Collision System)
- LTA (Lane Tracing Assist)
- LDA (Lane Departure Alert)
- RSA (Road Sign Assist) (if equipped)
- AHB (Automatic High Beam)
- Tire pressure warning system
- Intuitive parking assist (if equipped)
- PKSB (Parking Support Brake) (if equipped)
- Toyota parking assist monitor (if equipped)
- Panoramic view monitor (if equipped)
- BSM (Blind Spot Monitor)
- RCTA (Rear cross traffic alert)
- Safe Exit Assist (with door opening control)
- Navigation system

Also, not only can the following system not be utilized fully, but it may even negatively affect the drive-train components:

- AWD system (AWD models)

#### ■ Speed limit when using the compact spare tire

Do not drive at speeds in excess of 50 mph (80 km/h) when a compact spare tire is installed on the vehicle.

The compact spare tire is not designed for driving at high speeds. Failure to observe this precaution may lead to an accident causing death or serious injury.

**⚠ WARNING****■ After using the tools and jack**

Before driving, make sure all the tools and jack are securely in place in their storage location to reduce the possibility of personal injury during a collision or sudden braking.

**⚠ NOTICE****■ Be careful when driving over bumps with the compact spare tire installed on the vehicle**

The vehicle becomes lower when driving with the compact spare tire compared to when driving with standard tires. Be careful when driving over uneven road surfaces.

**■ Driving with tire chains and the compact spare tire**

Do not fit tire chains to the compact spare tire.  
Tire chains may damage the vehicle body and adversely affect driving performance.

**■ When replacing the tires**

When removing or fitting the wheels, tires or the tire pressure warning valve and transmitter, contact your Toyota dealer as the tire pressure warning valve and transmitter may be damaged if not handled correctly.

**If the engine will not start**

**If the engine will not start even though correct starting procedures are being followed (→P.203), consider each of the following points:**

**The engine will not start even though the starter motor operates normally.**

One of the following may be the cause of the problem:

- There may not be sufficient fuel in the vehicle's tank. Refuel the vehicle.
- The engine may be flooded. Try to restart the engine again following correct starting procedures. (→P.203)
- There may be a malfunction in the engine immobilizer system. (→P.72)

**The starter motor turns over slowly, the interior lights and headlights are dim, or the horn does not sound or sounds at a low volume.**

One of the following may be the cause of the problem:

- The battery may be discharged. (→P.508)

- The battery terminal connections may be loose or corroded. (→P.440)

### **The starter motor does not turn over**

The engine starting system may be malfunctioning due to an electrical problem such as electronic key battery depletion or a blown fuse. However, an interim measure is available to start the engine. (→P.504)

### **The starter motor does not turn over, the interior lights and headlights do not turn on, or the horn does not sound.**

One of the following may be the cause of the problem:

- One or both of the battery terminals may be disconnected. (→P.440)
- The battery may be discharged. (→P.508)

Contact your Toyota dealer if the problem cannot be repaired, or if repair procedures are unknown.

### **Starting the engine in an emergency**

When the engine does not start, the following steps can be used as an interim measure to start the engine if the engine switch is

functioning normally.

Do not use this starting procedure except in cases of emergency.

- 1 Pull the parking brake switch to check that the parking brake is set. (→P.212)

Parking brake indicator will come on.

- 2 Turn the engine switch to ACC.<sup>\*1, 2</sup>
- 3 Press and hold the engine switch for about 15 seconds while depressing the brake pedal firmly.

Even if the engine can be started using the above steps, the system may be malfunctioning. Have the vehicle inspected by your Toyota dealer.

<sup>\*1</sup>: ACC mode can be enabled/disabled on the customize menu. (→P.538)

<sup>\*2</sup>: When ACC is disabled, turn the engine switch to ON then OFF, and start the engine as described in P.507 within 5 seconds.



**If you lose your keys**

New genuine mechanical keys can be made by your Toyota dealer using another mechanical key and the key number stamped on your key number plate.

Keep the plate in a safe place such as your wallet, not in the vehicle.

 NOTICE

■ **When an electronic key is lost**

If the electronic key remains lost, the risk of vehicle theft increases significantly. Visit your Toyota dealer immediately with all remaining electronic keys that were provided with your vehicle.

**If the fuel filler door cannot be opened**

If the fuel filler door opener switch cannot be operated, contact your Toyota dealer to service the vehicle. In case where refueling is urgently necessary, the following procedure can be used to open the fuel filler door.

**Opening the fuel filler door**

- If the fuel filler door opener switch cannot be operated, remove the cover inside the luggage compartment and pull the lever to open the fuel filler door.

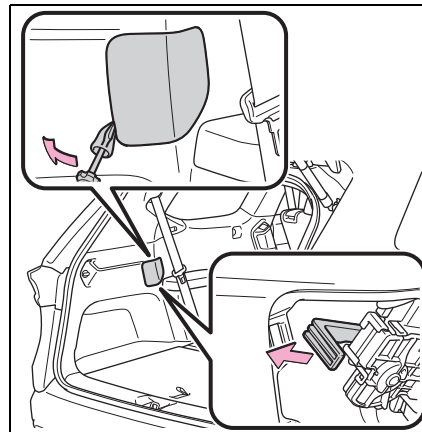

**If the electronic key does not operate properly**

If communication between the electronic key and vehicle is interrupted (→P.137) or the electronic key cannot be used because the battery is depleted, the smart key system and wireless remote control cannot be used. In such cases, the doors can be opened and the engine can be started by following the procedure below.

**■ When the electronic key does not work properly**

- Make sure that the smart key system has not been deactivated in the customization setting. If it is off, turn the function on. (Customizable features: →P.538)
- Check if battery-saving mode is set. If it is set, cancel the function. (→P.137)
- The electronic key function may be suspended. (→P.110)

 NOTICE

**■ In case of a smart key system malfunction or other key-related problems**

Take your vehicle with all the electronic keys provided with your vehicle to your Toyota dealer.

**Locking and unlocking the doors**

Use the mechanical key

(→P.112) in order to perform the following operations:

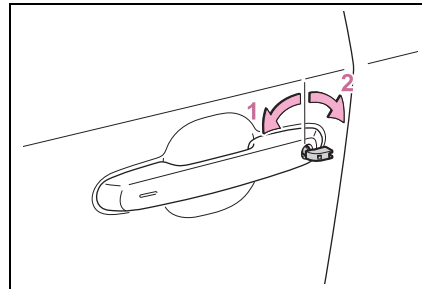

- 1 Locks all the doors
- 2 Unlocks all the doors

Turning the key unlocks the driver's door. Turning the key again unlocks the other doors.

**■ Key linked functions**

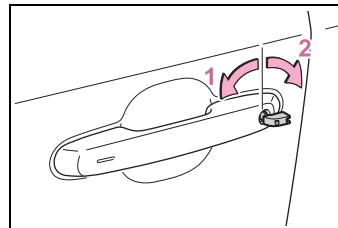

- 1 Closes the windows and the panoramic moon roof\* (turn and hold)
- 2 Opens the windows and the panoramic moon roof\* (turn and hold)

These settings must be customized at your Toyota dealer.

\*: If equipped

**⚠ WARNING****■ When using the mechanical key and operating the power windows or the panoramic moon roof\***

\* : If equipped

Operate the power window or the panoramic moon roof after checking to make sure that there is no possibility of any passenger having any of their body parts caught in the window or the panoramic moon roof.

Also, do not allow children to operate the mechanical key. It is possible for children and other passengers to get caught in the power window or the panoramic moon roof.

**Starting the engine**

- 1** Ensure that the shift position is in P and depress the brake pedal.
- 2** Touch the electronic key to the engine switch.

When the electronic key is detected, a buzzer sounds and the engine switch will turn to ON.

When the smart key system is deactivated in customization setting, the engine switch will turn to ACC.

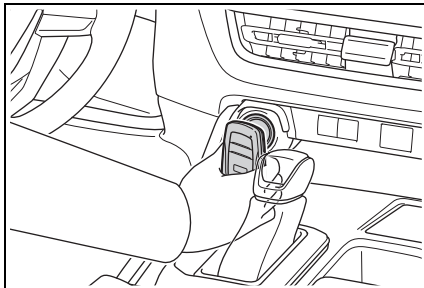

- 3** Firmly depress the brake pedal and check that  is shown on the multi-information display.
- 4** Press the engine switch shortly and firmly.

In the event that the engine still cannot be started, contact your Toyota dealer.

**■ Stopping the engine**

Change the shift position to P, set the parking brake, and press the engine switch as you normally do when stopping the engine.

**■ Replacing the key battery**

As the above procedure is a temporary measure, it is recommended that the electronic key battery be replaced immediately when the battery is depleted. (→P.460)

If a door is unlocked using the mechanical key when the alarm system is set, the alarm may be triggered. (→P.73)

**■ Changing engine switch modes**

Release the brake pedal and press the engine switch in step **3** above. The engine does not start and modes will be changed each time the switch is pressed. (→P.205)

If the vehicle battery is discharged

The following procedures may be used to start the engine if the vehicle's battery is discharged. You can also call your Toyota dealer or a qualified repair shop.

Restarting the engine

If you have a set of jumper (or booster) cables and a second vehicle with a 12-volt battery, you can jump start your vehicle by following the steps below.

- 1 Confirm that the electronic key is being carried.

When connecting the jumper (or booster) cables, depending on the situation, the alarm may activate and doors locked. (→P.74)

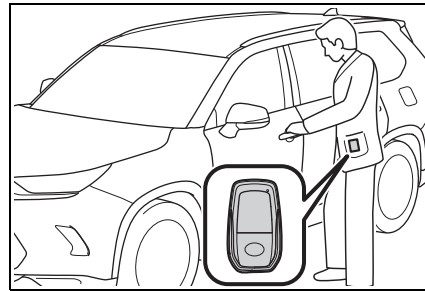

- 2 Open the hood. (→P.433)
- 3 Open the positive (+) battery terminal cover.

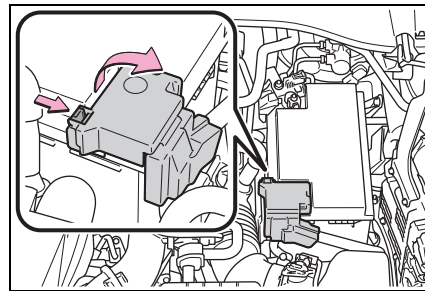

- 4 Connect a positive jumper cable clamp to **A** on your vehicle and connect the clamp on the other end of the positive cable to **B** on the second vehicle. Then, connect a negative cable clamp to **C** on the second vehicle and connect the clamp at the other end of the negative cable to **D**.

Use jumper cables that can reach the specified terminals and connecting

point.

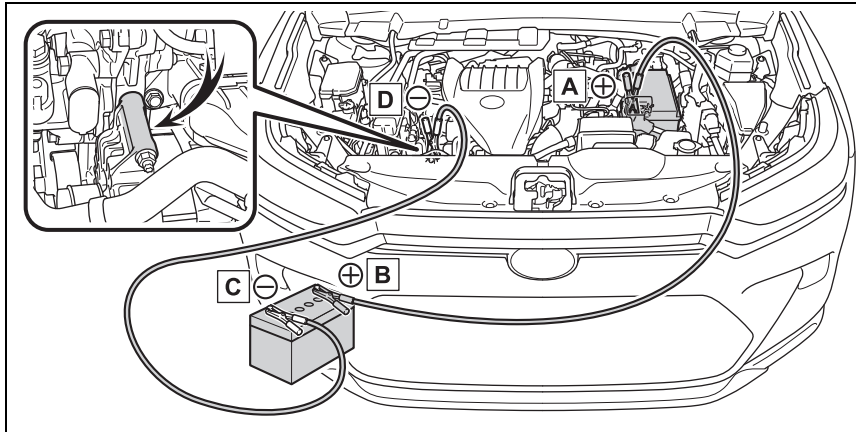

- A** Positive (+) battery terminal (your vehicle)
- B** Positive (+) battery terminal (second vehicle)
- C** Negative (-) battery terminal (second vehicle)
- D** Metallic point shown in the illustration

- 5 Start the engine of the second vehicle. Increase the engine speed slightly and maintain at that level for approximately 5 minutes to recharge the battery of your vehicle.
- 6 Open and close any of the doors of your vehicle with the engine switch off.
- 7 Maintain the engine speed of the second vehicle and start the engine of your vehicle by turning the engine switch to ON.
- 8 Once the vehicle's engine has started, remove the jumper cables in the exact reverse order from which they were connected.

Once the engine starts, have the vehicle inspected at your Toyota dealer as soon as possible.

#### ■ Starting the engine when the battery is discharged

The engine cannot be started by push-starting.

#### ■ To prevent battery discharge

- Turn off the headlights and the audio system while the engine is stopped. (Except when the engine is stopped by the Stop & Start system.)
- Turn off any unnecessary electrical components when the vehicle is running at a low speed for an extended period, such as in heavy traffic.

#### ■ When the battery is removed or discharged

- Information stored in the ECU is cleared. When the battery is depleted, have the vehicle

## 510 7-2. Steps to take in an emergency

inspected at your Toyota dealer.

- Some systems may require initialization. (→P.552)

### ■ When removing the battery terminals

When the battery terminals are removed, the information stored in the ECU is cleared. Before removing the battery terminals, contact your Toyota dealer.

### ■ Charging the battery

The electricity stored in the battery will discharge gradually even when the vehicle is not in use, due to natural discharge and the draining effects of certain electrical appliances. If the vehicle is left for a long time, the battery may discharge, and the engine may be unable to start. (The battery recharges automatically during driving.)

### ■ After jump starting the vehicle

Be sure to disable the Stop & Start system so that the battery can be charged. (→P.308)

### ■ When recharging or replacing the battery

- In some cases, it may not be possible to unlock the doors using the smart key system when the battery is discharged. Use the wireless remote control or the mechanical key to lock or unlock the doors.
- The engine may not start on the first attempt after the battery has recharged but will start normally after the second attempt. This is not a malfunction.
- The engine switch mode is memorized by the vehicle. When the battery is reconnected, the system will return to the mode it was in before the battery was discharged. Before disconnecting the battery, turn the engine switch off. If you are unsure what mode the engine switch was in before the battery discharged, be especially

careful when reconnecting the battery.

- Some systems may require initialization. (→P.552)
- The Stop & Start system may not automatically stop the engine for up to an hour.

### ■ When replacing the battery

- Use a genuine battery specifically designed for use with the Stop & Start system or a battery with equivalent specifications to a genuine battery. If an unsupported battery is used, Stop & Start system functions may be restricted to protect the battery. Also, battery performance may decrease and the engine may not be able to restart. Contact your Toyota dealer for details.
- Use a battery that the case size is same as the previous one (LN3), 20 hour rate capacity (20HR) is equivalent (65Ah) or greater, and performance rating (CCA) is equivalent (603A) or greater.
  - If the sizes differ, the battery cannot be properly secured.
  - If the 20 hour rate capacity is low, even if the time period where the vehicle is not used is a short time, the battery may discharge and the engine may not be able to start.

For details, consult your Toyota dealer.

### WARNING

#### ■ When removing the battery terminals

Always remove the negative (-) terminal first. If the positive (+) terminal contacts any metal in the surrounding area when the positive (+) terminal is removed, a spark may occur, leading to a fire in addition to electrical shocks and death or serious injury.

**⚠ WARNING****■ Avoiding battery fires or explosions**

Observe the following precautions to prevent accidentally igniting the flammable gas that may be emitted from the battery:

- Make sure each jumper cable is connected to the correct terminal and that it is not unintentionally in contact with any other than the intended terminal.
- Do not allow the other end of the jumper cable connected to the “+” terminal to come into contact with any other parts or metal surfaces in the area, such as brackets or unpainted metal.
- Do not allow the + and - clamps of the jumper cables to come into contact with each other.
- Do not smoke, use matches, cigarette lighters or allow open flame near the battery.

**■ Battery precautions**

The battery contains poisonous and corrosive acidic electrolyte, while related parts contain lead and lead compounds. Observe the following precautions when handling the battery:

- When working with the battery, always wear safety glasses and take care not to allow any battery fluids (acid) to come into contact with skin, clothing or the vehicle body.
- Do not lean over the battery.

- In the event that battery fluid comes into contact with the skin or eyes, immediately wash the affected area with water and seek medical attention. Place a wet sponge or cloth over the affected area until medical attention can be received.

- Always wash your hands after handling the battery support, terminals, and other battery-related parts.

- Do not allow children near the battery.

**■ When replacing the battery**

- When the vent plug and indicator are close to the hold down clamp, the battery fluid (sulfuric acid) may leak.

- For information regarding battery replacement, contact your Toyota dealer.

**■ When disconnecting the battery**

Do not disconnect the negative (-) terminal on the body side. The disconnected negative (-) terminal may touch the positive (+) terminal, which may cause a short and result in death or serious injury.

**⚠ NOTICE****■ When handling jumper cables**

When connecting the jumper cables, ensure that they do not become entangled in the cooling fan or engine drive belt.

**■ When connecting jumper cables**

Make sure to connect jumper cables to the specified terminals and connecting point. Failure to do so may adversely affect the electronic devices or damage to them.

**If your vehicle overheats**

**The following may indicate that your vehicle is overheating.**

- The engine coolant temperature gauge (→P.81, 84) is in the red zone or a loss of engine power is experienced. (For example, the vehicle speed does not increase.)
- “Engine Coolant Temp High Stop in a Safe Place See Owner’s Manual” is shown on the multi-information display.
- Steam comes out from under the hood.

**Correction procedures**

- 1 Stop the vehicle in a safe place and turn off the air conditioning system, and then stop the engine.
- 2 If you see steam: Carefully lift the hood after the steam subsides.  
If you do not see steam: Carefully lift the hood.
- 3 After the engine has cooled down sufficiently, inspect the

hoses and radiator core (radiator) for any leaks.

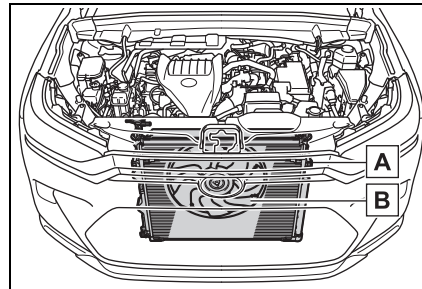

**A** Radiator

**B** Cooling fan

If a large amount of coolant leaks, immediately contact your Toyota dealer.

- 4 The coolant level is satisfactory if it is between the “MAX”/“FULL” and “MIN”/“LOW” lines on the reservoir.

► Engine

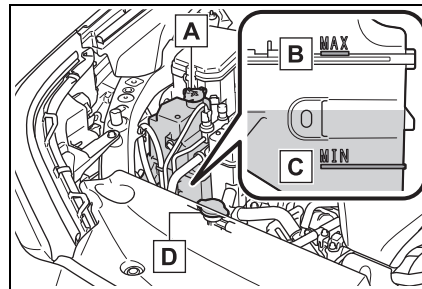

**A** Reservoir

**B** “MAX” line

**C** “MIN” line

**D** Radiator cap



► Intercooler

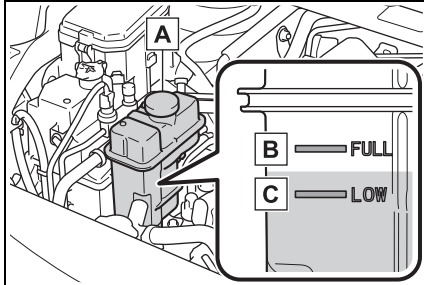

- A** Reservoir
- B** "FULL" line
- C** "LOW" line

**5** Add coolant if necessary.

Water can be used in an emergency if coolant is unavailable.

► Engine

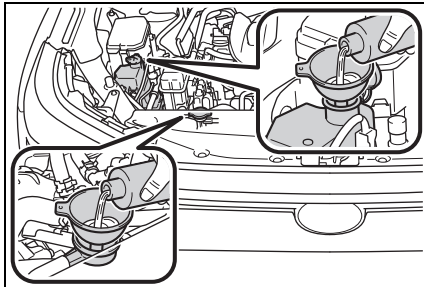

► Intercooler

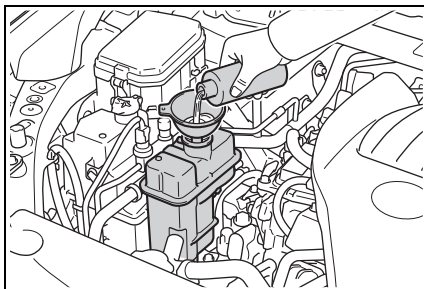

**6** Start the engine and turn the air conditioning system on to check that the radiator cooling fan operate and to check

for coolant leaks from the radiator or hoses.

The fan operate when the air conditioning system is turned on immediately after a cold start. Confirm that the fan is operating by checking the fan sound and air flow. If it is difficult to check these, turn the air conditioning system on and off repeatedly. (The fan may not operate in freezing temperatures.)

**7** If the fan is not operating:  
Stop the engine immediately and contact your Toyota dealer.

If the fan is operating:  
Have the vehicle inspected at the nearest Toyota dealer.

**8** Check if "Engine Coolant Temp High Stop in a Safe Place See Owner's Manual" is shown on the multi-information display.

If the message does not disappear:  
Stop the engine and contact your Toyota dealer.

If the message is not displayed:  
Have the vehicle inspected at the nearest Toyota dealer.

**⚠ WARNING**

**■ When inspecting under the hood of your vehicle**

Observe the following precautions. Failure to do so may result in serious injury such as burns.

- If steam is seen coming from under the hood, do not open the hood until the steam has subsided. The engine compartment may be very hot.

 **WARNING**

- Keep hands and clothing (especially a tie, a scarf or a muffler) away from the fan and belts. Failure to do so may cause the hands or clothing to be caught, resulting in serious injury. Also, it may operate for several minutes even after the engine switch is turned off.
- Do not loosen the radiator cap and the coolant reservoir caps while the engine and radiator are hot. High temperature steam or coolant could spray out.

 **NOTICE**

- **When adding engine coolant**  
Add coolant slowly after the engine has cooled down sufficiently. Adding cool coolant to a hot engine too quickly can cause damage to the engine.
- **To prevent damage to the cooling system**  
Observe the following precautions:
  - Avoid contaminating the coolant with foreign matter (such as sand or dust, etc.).
  - Do not use any coolant additive.

**If the vehicle becomes stuck**

**Carry out the following procedures if the tires spin or the vehicle becomes stuck in mud, dirt or snow:**

**Recovering procedure**

- 1 Stop the engine. Set the parking brake and change the shift position to P.  
Do not press the shift release button after shifting the shift position to P.
- 2 Remove the mud, snow or sand from around the front wheels.
- 3 Place wood, stones or some other material under the front wheels to help provide traction.
- 4 Restart the engine.
- 5 Change the shift position to D or R and release the parking brake. Then, while exercising caution, depress the accelerator pedal.

■ **When it is difficult to free the vehicle**

Press  to turn off TRAC.

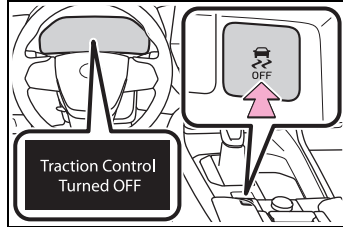

**⚠ WARNING**

■ **When attempting to free a stuck vehicle**

If you choose to push the vehicle back and forth to free it, make sure the surrounding area is clear to avoid striking other vehicles, objects or people. The vehicle may also lunge forward or lunge back suddenly as it becomes free. Use extreme caution.

■ **When changing the shift position**

Be careful not to change the shift position with the accelerator pedal depressed. This may lead to unexpected rapid acceleration of the vehicle that may cause an accident resulting in death or serious injury.

**⚠ NOTICE**

■ **To avoid damage to the transmission and other components**

- Avoid spinning the front wheels and depressing the accelerator pedal more than necessary.
- If the vehicle remains stuck even after these procedures are performed, the vehicle may require towing to be freed.



## Vehicle specifications

8

517

### 8-1. Specifications

- Maintenance data (fuel, oil level, etc.) ..... 518
- Fuel information ..... 526
- Tire information ..... 528

### 8-2. Customization

- Customizable features ..... 538

### 8-3. Initialization

- Items to initialize ..... 552

8

Vehicle specifications

## Maintenance data (fuel, oil level, etc.)

## Dimensions and weight

Overall length	201.4 in. (5115 mm)	
Overall width	78.3 in. (1990 mm)	
Overall height <sup>*1</sup>	70.1 in. (1780 mm)	
Wheelbase	116.1 in. (2950 mm)	
Tread	Front	67.5 in. (1715 mm) <sup>*2</sup> 67.1 in. (1705 mm) <sup>*3</sup>
	Rear	67.9 in. (1725 mm) <sup>*2</sup> 67.5 in. (1715 mm) <sup>*3</sup>
Vehicle capacity weight (Occupants + luggage)	1245 lb. (565 kg) <sup>*4</sup>	
	1410 lb. (640 kg) <sup>*5</sup>	
Trailer Weight Rating (Trailer weight + cargo weight)	5000 lb. (2268 kg)	

<sup>\*1</sup>: Unladen vehicle

<sup>\*2</sup>: Vehicles with 18-inch tires

<sup>\*3</sup>: Vehicles with 20-inch tires

<sup>\*4</sup>: For 7-passenger models

<sup>\*5</sup>: For 8-passenger models

## Seating capacity

Seating capacity	7-passenger models	8-passenger models
	7 (Front 2, Rear 5)	8 (Front 2, Rear 6)

## Vehicle identification

### ■ Vehicle identification number

The vehicle identification number (VIN) is the legal identifier

for your vehicle. This is the primary identification number for your Toyota. It is used in registering the ownership of your

vehicle.

This number is stamped on the top left of the instrument panel.

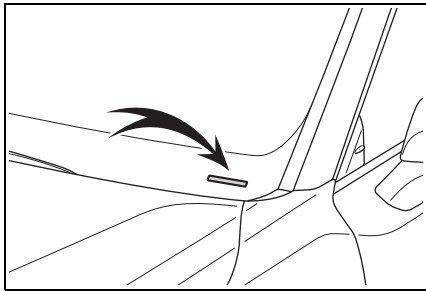

This number is also on the Certification Label.

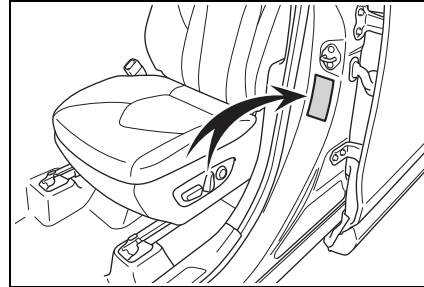

■ Engine number

The engine number is stamped on the engine block as shown.

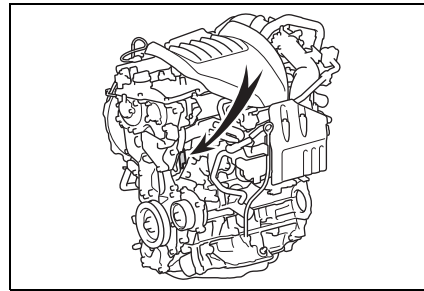

**Engine**

Model	T24A-FTS
Type	4-cylinder in line, 4-cycle, gasoline (with turbocharger)
Bore and stroke	3.44 × 3.92 in. (87.5 × 99.5 mm)
Displacement	146.0 cu. in. (2393 cm <sup>3</sup> )
Valve clearance (engine cold)	Automatic adjustment
Drive belt tension	Automatic adjustment

**Fuel**

Fuel type	Unleaded gasoline only
-----------	------------------------

Octane Rating	87AKI (Research Octane Number 91) or higher
Fuel tank capacity (Reference)	17.8 gal. (67.5 L, 14.8 Imp. gal.)

### Lubrication system

#### Oil capacity (Drain and refill—reference\*)

With filter	5.6 qt. (5.3 L, 4.7 Imp. qt.)
Without filter	5.3 qt. (5.0 L, 4.4 Imp. qt.)

\*: The engine oil capacity is a reference quantity to be used when changing the engine oil. When actually adding the engine oil, make sure that the oil level is between the low level mark and refill upper limit mark (→P.437). Warm up and turn off the engine, wait about 5 minutes, and check the oil level on the dipstick.

#### Engine oil selection

“Toyota Genuine Motor Oil” is used in your Toyota vehicle. Use Toyota approved “Toyota Genuine Motor Oil” or equivalent to satisfy the following grade and viscosity.

Oil grade: ILSAC GF-6A multi-grade engine oil

Recommended viscosity: SAE 0W-20

SAE 0W-20 is the best choice for good fuel economy and good starting in cold weather.

If SAE 0W-20 is not available,

SAE 5W-20 oil may be used. However, it must be replaced with SAE 0W-20 at the next oil change.

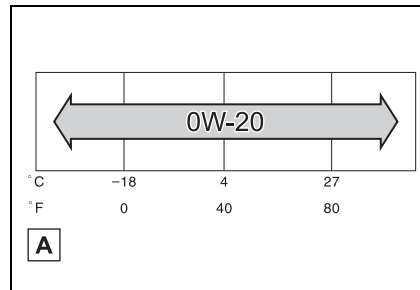

#### A Outside temperature

Oil viscosity (0W-20 is explained here as an example):

- The 0W in 0W-20 indicates the characteristic of the oil which allows cold startability. Oils with a lower value before the W allow for easier starting of the engine in cold weather.
- The 20 in 0W-20 indicates the viscosity characteristic of the oil when the oil is at high temperature. An oil with a higher viscosity (one with a higher value) may be better suited if the vehicle is operated at high speeds, or under extreme load conditions.

How to read oil container label:



The International Lubricant Specification Advisory Committee (ILSAC) Certification Mark is added to some oil containers to help you select the oil you should use.



### Cooling system

Capacity *	<ul style="list-style-type: none"> <li>▶ Gasoline engine 12.2 qt. (11.5 L, 10.1 Imp. qt.)</li> <li>▶ Intercooler 3.3 qt. (3.1 L, 2.7 Imp. qt.)</li> </ul>
Coolant type	<p>Use either of the following:</p> <ul style="list-style-type: none"> <li>• “Toyota Super Long Life Coolant”</li> <li>• Similar high-quality ethylene glycol-based non-silicate, non-amine, non-nitrite, and non-borate coolant with long-life hybrid organic acid technology</li> </ul> <p>Do not use plain water alone.</p>

\*: The coolant capacity is a reference quantity.  
If replacement is necessary, contact your Toyota dealer.

### Ignition system (spark plug)

Make	NGK DILZKAR8E7H
Gap	0.03 in. (0.7 mm)

**NOTICE**

**■ Iridium-tipped spark plugs**

Use only iridium-tipped spark plugs. Do not adjust the spark plug gap.

### Electrical system (battery)

Specific gravity reading at 68°F (20°C):	12.3 V or higher (Turn the engine switch off and turn on the headlights for 30 seconds.)
Charging rates: Slow charge	5 A max.

### Transmission

Fluid capacity *	7.7 qt. (7.3 L, 6.4 Imp. qt.)
Fluid type	Toyota Genuine ATF WS

\*: The fluid capacity is a reference quantity.  
If replacement is necessary, contact your Toyota dealer.

 NOTICE

#### ■ Transmission fluid type

Using transmission fluid other than the above type may cause abnormal noise or vibration, or damage the transmission of your vehicle.

### Transfer (AWD models)

Oil capacity *	0.48 qt. (0.45 L, 0.40 Imp. qt.)
Oil type and viscosity	Toyota Genuine Differential gear oil LT 75W-85 GL-5 or equivalent

\*: The fluid capacity is a reference quantity.  
If replacement is necessary, contact your Toyota dealer.

 NOTICE

#### ■ Transfer oil type precaution

Using transfer oil other than the specified oil may cause abnormal noise or vibration, or damage the transfer of your vehicle.

**Rear differential (AWD models)**

Oil capacity*	0.5 qt. (0.5 L, 0.4 Imp. qt.)
Oil type and viscosity	Toyota Genuine Differential gear oil LT 75W-85 GL-5 or equivalent

\*: The oil capacity is a reference quantity.  
If replacement is necessary, contact your Toyota dealer.

 NOTICE**■ Differential gear oil type precaution**

Using differential gear oil other than the specified oil may cause abnormal noise or vibration, or damage the differential gear of your vehicle.

**Brakes**

Pedal clearance* <sup>1</sup>	4.1 in. (105 mm) Min.
Pedal free play	0.04 — 0.24 in. (1 — 6 mm)
Brake pad wear limit	0.04 in. (1 mm)
Parking brake indicator* <sup>2</sup>	When pulling the parking brake switch for 1 to 2 seconds: comes on When pushing the parking brake switch for 1 to 2 seconds: turns off
Fluid type	FMVSS No. 116 DOT 3 or SAE J1703 FMVSS No. 116 DOT 4 or SAE J1704

\*<sup>1</sup>: Minimum pedal clearance when depressed with a force of 67.5 lbf (300 N, 30.6 kgf) while the engine is running.

\*<sup>2</sup>: Make sure to confirm that the brake warning light (yellow) does not illuminate. (If the brake warning light illuminates, refer to P.477.)

**Steering**

Free play	Less than 1.2 in. (30 mm)
-----------	---------------------------

### Tires and wheels

#### ► Type A

Tire size	255/65R18 111H, T165/90D18 107M (spare)
Tire inflation pressure (Recommended cold tire inflation pressure)	► Front 35 psi (240 kPa, 2.4 kgf/cm <sup>2</sup> or bar) ► Rear 35 psi (240 kPa, 2.4 kgf/cm <sup>2</sup> or bar) ► Spare 60 psi (420 kPa, 4.2 kgf/cm <sup>2</sup> or bar)
Wheel size	18 × 7.5J, 18 × 4T (spare)
Wheel nut torque	103 ft•lbf (140 N•m, 14.3 kgf•m)

#### ► Type B

Tire size	255/55R20 107V, T165/90D18 107M (spare)
Tire inflation pressure (Recommended cold tire inflation pressure)	► Front 35 psi (240 kPa, 2.4 kgf/cm <sup>2</sup> or bar) ► Rear 35 psi (240 kPa, 2.4 kgf/cm <sup>2</sup> or bar) ► Spare 60 psi (420 kPa, 4.2 kgf/cm <sup>2</sup> or bar) Driving at high speeds (above 100 mph [160 km/h]) (in countries where such speeds are per- mitted by law) Add 1 psi (10 kPa, 0.10 kgf/cm <sup>2</sup> or bar) to the front and rear tires. Never exceed the maximum cold tire inflation pressure indicated on the tire sidewall.
Wheel size	20 × 8J, 18 × 4T (spare)
Wheel nut torque	103 ft•lbf (140 N•m, 14.3 kgf•m)

**Light bulbs**

	Light bulbs	Bulb No.	W	Type
Exterior	Front turn signal/parking lights (bulb type)	7444NA	28/8	A

A: Wedge base bulbs (amber)

## Fuel information

**You must only use unleaded gasoline.**

**Select octane rating 87 (Research Octane Number of 91) or higher. Use of unleaded gasoline with an octane rating lower than 87 may result in engine knocking. Persistent knocking can lead to engine damage.**

At minimum, the gasoline you use should meet the specifications of ASTM D4814 in the U.S.A.

### ■ Gasoline quality

In very few cases, driveability problems may be caused by the brand of gasoline you are using. If driveability problems persist, try changing the brand of gasoline. If this does not correct the problem, consult your Toyota dealer.

### ■ Recommendation of the use of gasoline containing detergent additives

- Toyota recommends the use of gasoline that contains detergent additives to avoid the build-up of engine deposits.
- All gasoline sold in the U.S.A. contains minimum detergent additives to clean and/or keep clean intake systems, per EPA's lowest additives concentration program.
- Toyota strongly recommends the use of Top Tier Detergent Gasoline. For more information on Top Tier Detergent Gasoline and a list of marketers, please go to the official website [www.toptiergas.com](http://www.toptiergas.com).

### ■ Recommendation of the use of low emissions gasoline

Gasolines containing oxygenates such as ethers and ethanol, as well as reformulated gasolines, are available in some cities. These fuels are typically acceptable for use, providing they meet other fuel requirements.

Toyota recommends these fuels, since the formulations allow for reduced vehicle emissions.

### ■ Non-recommendation of the use of blended gasoline

- Use only gasoline containing up to 15% ethanol.  
DO NOT use any flex-fuel or gasoline that could contain more than 15% ethanol, including from any pump labeled E30 (30% ethanol [A]), E50 (50% ethanol [B]), E85 (85% ethanol [C]) (which are only some examples of fuel containing more than 15% ethanol).

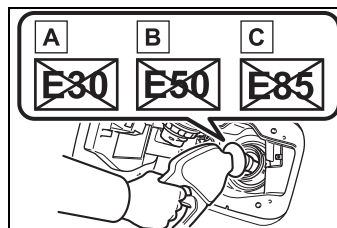

- If you use gasohol in your vehicle, be sure that it has an octane rating no lower than 87.
- Toyota does not recommend the use of gasoline containing methanol.

### ■ Non-recommendation of the use of gasoline containing MMT

Some gasoline contains an octane enhancing additive called MMT (Methylcyclopentadienyl Manganese Tricarbonyl).

Toyota does not recommend the use of gasoline that contains MMT. If fuel containing MMT is used, your emission control system may be

adversely affected.

The malfunction indicator lamp on the instrument cluster may come on. If this happens, contact your Toyota dealer for service.

■ **If your engine knocks**

- Consult your Toyota dealer.
- You may occasionally notice light knocking for a short time while accelerating or driving uphill. This is normal and there is no need for concern.

■ **Fuel-related poor driveability**

If poor driveability (poor hot starting, vaporization, engine knocking, etc.) is encountered after using a different type of fuel, discontinue the use of that type of fuel.



**NOTICE**

■ **Notice on fuel quality**

- Do not use improper fuels. If improper fuels are used, the engine will be damaged.
- Do not use leaded gasoline. Leaded gasoline can cause damage to your vehicle's three-way catalytic converters causing the emission control system to malfunction.
- Do not use gasohol other than the type previously stated. Other gasohol may cause fuel system damage or vehicle performance problems.
- Using unleaded gasoline with an octane number or rating lower than the level previously stated may cause persistent heavy knocking. At worst, this may lead to engine damage and will void the vehicle warranty.

■ **When refueling with gasohol**

Take care not to spill gasohol. It can damage your vehicle's paint.

Tire information

Typical tire symbols

► Full-size tire

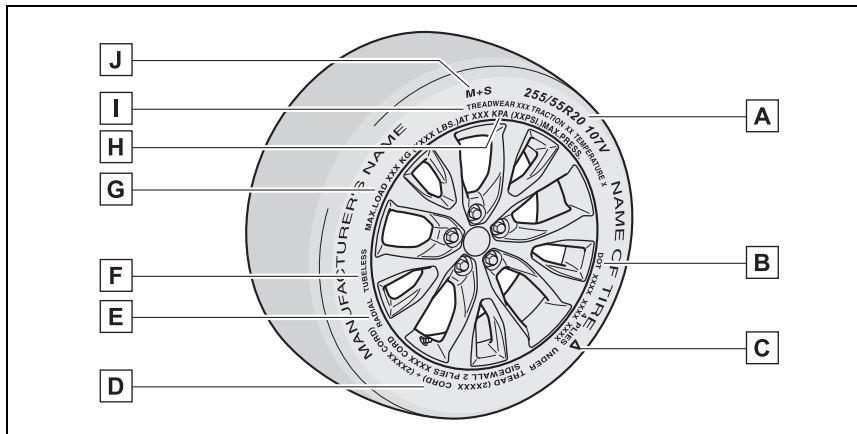

► Compact spare tire

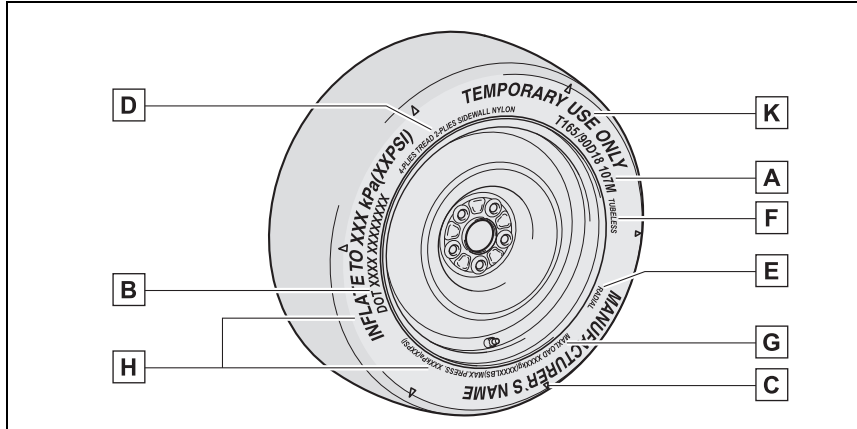

- A** Tire size (→P.530)
- B** DOT and Tire Identification Number (TIN) (→P.529)
- C** Location of treadwear indicators (→P.443)
- D** Tire ply composition and materials  
 Plies are layers of rubber-coated parallel cords. Cords are the strands which form the plies in a tire.
- E** Radial tires or bias-ply tires



A radial tire has "RADIAL" on the sidewall. A tire not marked "RADIAL" is a bias-ply tire.

**F** TUBELESS or TUBE TYPE

A tubeless tire does not have a tube and air is directly put into the tire. A tube type tire has a tube inside the tire and the tube maintains the air pressure.

**G** Load limit at maximum cold tire inflation pressure (→P.443)

**H** Maximum cold tire inflation pressure (→P.524)

This means the pressure to which a tire may be inflated.

**I** Uniform tire quality grading

For details, see "Uniform Tire Quality Grading" that follows.

**J** Summer tires or all season tires (→P.444)

An all season tire has "M+S" on the sidewall. A tire not marked "M+S" is a summer tire.

**K** "TEMPORARY USE ONLY"

A compact spare tire is identified by the phrase "TEMPORARY USE ONLY" molded on its sidewall. This tire is designed for temporary emergency use only.

**Typical DOT and Tire Identification Number (TIN)**

► Type A

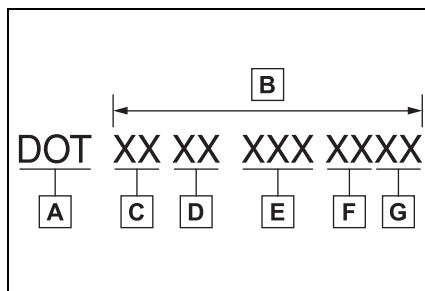

- A** DOT symbol\*
- B** Tire Identification Number (TIN)
- C** Tire manufacturer's identification mark

**D** Tire size code

**E** Manufacturer's optional tire type code (3 or 4 letters)

**F** Manufacturing week

**G** Manufacturing year

\*: The DOT symbol certifies that the tire conforms to applicable Federal Motor Vehicle Safety Standards.

► Type B

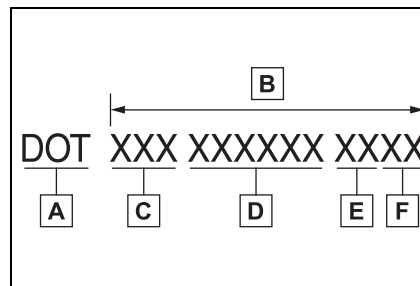

- A** DOT symbol\*
- B** Tire Identification Number (TIN)
- C** Tire manufacturer's identification mark
- D** Manufacturer's code
- E** Manufacturing week
- F** Manufacturing year

\*: The DOT symbol certifies that the tire conforms to applicable Federal Motor Vehicle Safety Standards.

### Tire size

#### Typical tire size information

The illustration indicates typical tire size.

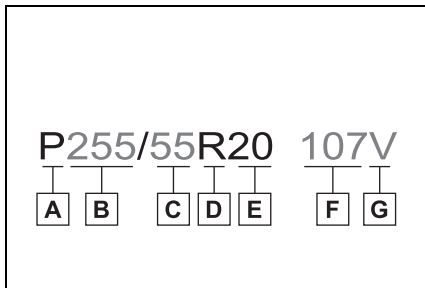

- A** Tire use (P = Passenger car, T = Temporary use)
- B** Section width (millimeters)
- C** Aspect ratio (tire height to section width)
- D** Tire construction code (R = Radial, D = Diagonal)
- E** Wheel diameter (inches)
- F** Load index (2 digits or 3 digits)

- G** Speed symbol (alphabet with one letter)

#### Tire dimensions

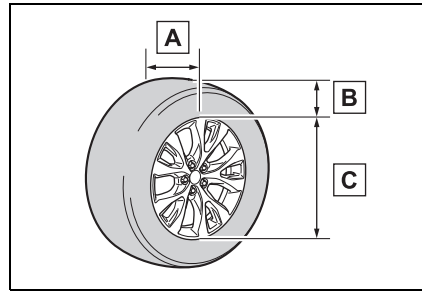

- A** Section width
- B** Tire height
- C** Wheel diameter

### Tire section names

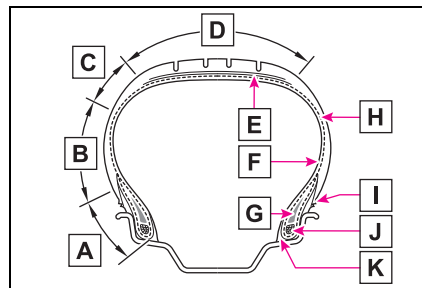

- A** Bead
- B** Sidewall
- C** Shoulder
- D** Tread
- E** Belt
- F** Inner liner
- G** Reinforcing rubber
- H** Carcass
- I** Rim lines
- J** Bead wires

**K** Chafer

### Uniform Tire Quality Grading

This information has been prepared in accordance with regulations issued by the National Highway Traffic Safety Administration of the U.S. Department of Transportation.

It provides the purchasers and/or prospective purchasers of Toyota vehicles with information on uniform tire quality grading.

Your Toyota dealer will help answer any questions you may have as you read this information.

#### ■ DOT quality grades

All passenger vehicle tires must conform to Federal Safety Requirements in addition to these grades. Quality grades can be found where applicable on the tire sidewall between tread shoulder and maximum section width.

For example: Treadwear 200 Traction AA Temperature A

#### ■ Treadwear

The treadwear grade is a comparative rating based on the wear rate of the tire when tested under controlled conditions on a specified government test course.

For example, a tire graded 150

would wear one and a half (1 - 1/2) times as well on the government course as a tire graded 100.

The relative performance of tires depends upon the actual conditions of their use. Performance may differ significantly from the norm due to variations in driving habits, service practices and differences in road characteristics and climate.

#### ■ Traction AA, A, B, C

The traction grades, from highest to lowest, are AA, A, B and C, and they represent the tire's ability to stop on wet pavement as measured under controlled conditions on specified government test surfaces of asphalt and concrete.

A tire marked C may have poor traction performance.

Warning: The traction grade assigned to this tire is based on braking (straight ahead) traction tests and does not include cornering (turning) traction.

#### ■ Temperature A, B, C

The temperature grades are A (the highest), B, and C, representing the tire's resistance to the generation of heat and its ability to dissipate heat when tested under controlled conditions on a specified indoor laboratory test wheel.

Sustained high temperature can cause the material of the tire to degenerate and reduce tire life, and excessive temperature can lead to sudden tire failure.

Grade C corresponds to a level of performance which all passenger car tires must meet under the Federal Motor Vehicle Safety Standard No. 109.

Grades B and A represent higher levels of performance on the laboratory test wheel than the minimum required by law.

Warning: The temperature grades of a tire assume that it is properly inflated and not overloaded.

Excessive speed, underinflation, or excessive loading, either separately or in combination, can cause heat buildup and possible tire failure.

### Glossary of tire terminology

Tire related term	Meaning
Cold tire inflation pressure	Tire pressure when the vehicle has been parked for three hours or more, or has not been driven more than 1 mile or 1.5 km under that condition
Maximum inflation pressure	The maximum cold inflated pressure to which a tire may be inflated, shown on the sidewall of the tire
Recommended inflation pressure	Cold tire inflation pressure recommended by a manufacturer
Accessory weight	The combined weight (in excess of those standard items which may be replaced) of automatic transmission, power steering, power brakes, power windows, power seats, radio and heater, to the extent that these items are available as factory-installed equipment (whether installed or not)
Curb weight	The weight of a motor vehicle with standard equipment, including the maximum capacity of fuel, oil and coolant, and if so equipped, air conditioning and additional weight optional engine

Tire related term	Meaning
Maximum loaded vehicle weight	The sum of: (a) Curb weight (b) Accessory weight (c) Vehicle capacity weight (d) Production options weight
Normal occupant weight	150 lb. (68 kg) times the number of occupants specified in the second column of Table 1* that follows
Occupant distribution	Distribution of occupants in a vehicle as specified in the third column of Table 1* below
Production options weight	The combined weight of installed regular production options weighing over 5 lb. (2.3 kg) in excess of the standard items which they replace, not previously considered in curb weight or accessory weight, including heavy duty brakes, ride levelers, roof rack, heavy duty battery, and special trim
Rim	A metal support for a tire or a tire and tube assembly upon which the tire beads are seated
Rim diameter (Wheel diameter)	Nominal diameter of the bead seat
Rim size designation	Rim diameter and width
Rim type designation	The industry manufacturer's designation for a rim by style or code
Rim width	Nominal distance between rim flanges
Vehicle capacity weight (Total load capacity)	The rated cargo and luggage load plus 150 lb. (68 kg) times the vehicle's designated seating capacity
Vehicle maximum load on the tire	The load on an individual tire that is determined by distributing to each axle its share of the maximum loaded vehicle weight, and dividing by two

Tire related term	Meaning
Vehicle normal load on the tire	The load on an individual tire that is determined by distributing to each axle its share of curb weight, accessory weight, and normal occupant weight (distributed in accordance with Table 1* below), and dividing by two
Weather side	The surface area of the rim not covered by the inflated tire
Bead	The part of the tire that is made of steel wires, wrapped or reinforced by ply cords and that is shaped to fit the rim
Bead separation	A breakdown of the bond between components in the bead
Bias ply tire	A pneumatic tire in which the ply cords that extend to the beads are laid at alternate angles substantially less than 90 degrees to the centerline of the tread
Carcass	The tire structure, except tread and sidewall rubber which, when inflated, bears the load
Chunking	The breaking away of pieces of the tread or sidewall
Cord	The strands forming the plies in the tire
Cord separation	The parting of cords from adjacent rubber compounds
Cracking	Any parting within the tread, sidewall, or innerliner of the tire extending to cord material
CT	A pneumatic tire with an inverted flange tire and rim system in which the rim is designed with rim flanges pointed radially inward and the tire is designed to fit on the underside of the rim in a manner that encloses the rim flanges inside the air cavity of the tire

Tire related term	Meaning
Extra load tire	A tire designed to operate at higher loads and at higher inflation pressures than the corresponding standard tire
Groove	The space between two adjacent tread ribs
Innerliner	The layer(s) forming the inside surface of a tubeless tire that contains the inflating medium within the tire
Innerliner separation	The parting of the innerliner from cord material in the carcass
Intended outboard sidewall	(a) The sidewall that contains a whitewall, bears white lettering, or bears manufacturer, brand, and/or model name molding that is higher or deeper than the same molding on the other sidewall of the tire, or (b) The outward facing sidewall of an asymmetrical tire that has a particular side that must always face outward when mounted on a vehicle
Light truck (LT) tire	A tire designated by its manufacturer as primarily intended for use on lightweight trucks or multipurpose passenger vehicles
Load rating	The maximum load that a tire is rated to carry for a given inflation pressure
Maximum load rating	The load rating for a tire at the maximum permissible inflation pressure for that tire
Maximum permissible inflation pressure	The maximum cold inflation pressure to which a tire may be inflated
Measuring rim	The rim on which a tire is fitted for physical dimension requirements
Open splice	Any parting at any junction of tread, sidewall, or innerliner that extends to cord material
Outer diameter	The overall diameter of an inflated new tire
Overall width	The linear distance between the exteriors of the sidewalls of an inflated tire, including elevations due to labeling, decorations, or protective bands or ribs

Tire related term	Meaning
Passenger car tire	A tire intended for use on passenger cars, multipurpose passenger vehicles, and trucks, that have a gross vehicle weight rating (GVWR) of 10,000 lb. or less.
Ply	A layer of rubber-coated parallel cords
Ply separation	A parting of rubber compound between adjacent plies
Pneumatic tire	A mechanical device made of rubber, chemicals, fabric and steel or other materials, that, when mounted on an automotive wheel, provides the traction and contains the gas or fluid that sustains the load
Radial ply tire	A pneumatic tire in which the ply cords that extend to the beads are laid at substantially 90 degrees to the centerline of the tread
Reinforced tire	A tire designed to operate at higher loads and at higher inflation pressures than the corresponding standard tire
Section width	The linear distance between the exteriors of the sidewalls of an inflated tire, excluding elevations due to labeling, decoration, or protective bands
Sidewall	That portion of a tire between the tread and bead
Sidewall separation	The parting of the rubber compound from the cord material in the sidewall
Snow tire	A tire that attains a traction index equal to or greater than 110, compared to the ASTM E-1136 Standard Reference Test Tire, when using the snow traction test as described in ASTM F-1805-00, Standard Test Method for Single Wheel Driving Traction in a Straight Line on Snow-and Ice-Covered Surfaces, and which is marked with an Alpine Symbol (  ) on at least one sidewall



Tire related term	Meaning
Test rim	The rim on which a tire is fitted for testing, and may be any rim listed as appropriate for use with that tire
Tread	That portion of a tire that comes into contact with the road
Tread rib	A tread section running circumferentially around a tire
Tread separation	Pulling away of the tread from the tire carcass
Treadwear indicators (TWI)	The projections within the principal grooves designed to give a visual indication of the degrees of wear of the tread
Wheel-holding fixture	The fixture used to hold the wheel and tire assembly securely during testing

\*: Table 1 -Occupant loading and distribution for vehicle normal load for various designated seating capacities

Designated seating capacity, Number of occupants	Vehicle normal load, Number of occupants	Occupant distribution in a normally loaded vehicle
2 through 4	2	2 in front
5 through 10	3	2 in front, 1 in second seat
11 through 15	5	2 in front, 1 in second seat, 1 in third seat, 1 in fourth seat
16 through 20	7	2 in front, 2 in second seat, 2 in third seat, 1 in fourth seat

### Customizable features



Your vehicle includes a variety of electronic features that can be personalized to your preferences. The settings of these features can be changed by using the multi-information display, the Multimedia Display or at your Toyota dealer.

Some of the customizable features are changed in conjunction with the settings of My Settings. (→P.175)

### Customizing vehicle features

#### ■ Changing by using the Multimedia Display

- 1 Select  on the main menu.
- 2 Select "Vehicle customize"
- 3 Select the item to change the settings of from the list.

For functions that can be turned on/off, select  (ON) /  (OFF).

For functions whose level can be adjusted, such as volume, sensor sensitivity, etc., slide the icon on the bar.

#### ■ Changing by using the meter control switches

- 1 Select  of the multi-information display.
- 2 Operate the meter control switches to select the desired item to be customized.
- 3 According to the display, select the desired setting.

#### ■ During customization

Stop the vehicle in a safe place, apply the parking brake, and change the shift position to P. Also, to prevent battery discharge, leave the engine operating while customizing the features.

#### WARNING

##### ■ During customization

As the engine needs to be running during customization, ensure that the vehicle is parked in a place with adequate ventilation. In a closed area such as a garage, exhaust gases including harmful carbon monoxide (CO) may collect and enter the vehicle. This may lead to death or a serious health hazard.

#### NOTICE

##### ■ During customization

To prevent battery discharge, ensure that the engine is running while customizing features.

### Customizable Features

Some function settings are changed simultaneously with other functions being customized. Contact your Toyota dealer for further

details.

- A** Settings that can be changed using the Multimedia Display
- B** Settings that can be changed using the meter control switches
- C** Settings that can be changed by your Toyota dealer

Definition of symbols: O = Available, — = Not available

■ **Gauges, meters and multi-information display (→P.76, 81, P.84, 89, 95)**

Function	Default setting	Customized setting	<b>A</b>	<b>B</b>	<b>C</b>
Language* <sup>1</sup>	English	French	O	O	—
		Spanish			
Units* <sup>2</sup>	miles (MPG)	km (km/L)	—	O	—
		km (L/100 km)			
		miles (MPG Imperial)			
Meter Type* <sup>1,3</sup>	2-dial	1-dial* <sup>4</sup>	—	O	—
		non-dial* <sup>4</sup>			
Meter Style* <sup>1,3</sup>	Smart	Casual	—	O	—
		Tough			
		Sporty			
Meter Style* <sup>1,5</sup>	Smart	Tough	—	O	—
		Sporty			
Dial Type* <sup>1,6</sup>	Tachometer	Speedometer	—	O	—
Dial Type* <sup>1,5</sup>	Tachometer	Speedometer	—	O	—
		Simple (non-dial)			
Eco Driving Indicator Light* <sup>1</sup>	On	Off	—	O	—

Function	Default setting	Customized setting	A	B	C
Fuel economy	Total average (Average fuel consumption [after reset])	Trip average (Average fuel consumption [after start])	—	O	—
		Tank average (Average fuel consumption [after refuel]) <sup>*5</sup>	—	O	—
Audio system linked display <sup>*5</sup>	On	Off	—	O	—
AWD operation status display <sup>*5,7</sup>	On	Off	—	O	—
Drive information type <sup>*5</sup>	After start	After reset	—	O	—
Drive information items (First item) <sup>*1</sup>	Distance	Average vehicle speed	—	O	—
		Elapsed time	—	O	—
Drive information items (Second item) <sup>*1</sup>	Elapsed time	Distance	—	O	—
		Average vehicle speed	—	O	—
TRIP A Items (First item) <sup>*1,3</sup>	Distance	Average vehicle speed	—	O	—
		Elapsed time	—	O	—
TRIP A Items (Second item) <sup>*1,3</sup>	Average vehicle speed	Distance	—	O	—
		Elapsed time	—	O	—
TRIP B Items (First item) <sup>*1,3</sup>	Distance	Average vehicle speed	—	O	—
		Elapsed time	—	O	—
TRIP B Items (Second item) <sup>*1,3</sup>	Average vehicle speed	Distance	—	O	—
		Elapsed time	—	O	—
Pop-up display <sup>*1</sup>	On	Off	—	O	—

Function	Default setting	Customized setting	A	B	C
Suggestion function	On	On (when the vehicle is stopped)	O	—	—
		Off			
Stop light indicator	On	Off	—	O	—

\*1: This setting changes in accordance with My Settings

\*2: The default setting varies according to country.

\*3: 12.3-inch display

\*4: The on/off operation of the widget can be changed.

\*5: 7-inch display

\*6: 12.3-inch display when 1-dial display is selected

\*7: AWD models

■ **Head-up Display** \*1 (→P.102)

Function	Default setting	Customized setting	A	B	C
Head-up display *2	On	Off	—	O	—
Head-up display type *2	Standard	Full	—	O	—
		Minimum			

\*1: If equipped

\*2: This setting changes in accordance with My Settings

■ **Door lock** (→P.115, 506)

Function	Default setting	Customized setting	A	B	C
Unlocking using a mechanical key	Driver's door unlocked in one step, all doors unlocked in two step	All doors unlocked in one step	—	—	O

Function	Default setting	Customized setting	A	B	C
Automatic door locking function *	Shift position linked door locking operation	OFF			
		Speed linked door locking operation	O	—	O
Automatic door unlocking function *	Shift position linked door unlocking operation	OFF			
		Driver's door linked door unlocking operation	O	—	O

\*: This setting changes in accordance with My Settings

#### ■ Power back door (→P.119)

Function	Default setting	Customized setting	A	B	C
Power back door	On	Off	—	O	—
Power back door opening position	5	1 to 5	—	O	—
		User setting * <sup>1</sup>			
Buzzer volume	Level 3	Level 1	—	O	—
		Level 2			
Kick sensor* <sup>2</sup>	On	Off	—	O	—
Kick operation buzzer* <sup>2</sup>	On	Off	—	—	O
The function that validates the  switch of the wireless remote control when locking the door	On	Off	—	—	O
Close & lock (walk away) function	Off	On	—	—	O
Hands free close & lock function* <sup>2</sup>	Off	On	—	—	O

\*<sup>1</sup>: Configured by operating the  switch of the lower back door.

\*2: If equipped

■ Smart key system and wireless remote control (→P.115, 136)

Function	Default setting	Customized setting	A	B	C
Operation buzzer volume*	5	Off	○	—	○
		1 to 7			
Operation signal (Emergency flashers)*	On	Off	○	—	○
Time elapsed before automatic door lock function is activated if door is not opened after being unlocked*	60 seconds	Off	○	—	○
		30 seconds			
		120 seconds			
Open door warning buzzer	On	Off	—	—	○

\*: This setting changes in accordance with My Settings

■ Smart key system (→P.115, 136)

Function	Default setting	Customized setting	A	B	C
Smart key system	On	Off	—	—	○
The doors that are unlocked using the smart key system can be selected	Driver's door	All the doors	○	—	○
Number of consecutive door lock operations	2 times	As many as desired	—	—	○
Time elapsed before unlocking all the door when gripping and holding the driver's door handle	2 seconds	Off	—	—	○
		1.5 seconds			
		2.5 seconds			

### ■ Wireless remote control (→P.110, 115, 119)

Function	Default setting	Customized setting	A	B	C
Unlocking operation*	Driver's door unlocked in one step, all doors unlocked in two step	All doors unlocked in one step	O	—	O
Panic function	On	Off	—	—	O
Power back door unlocking operation	Press and hold (long)	One short press	—	—	O
		Push twice			
		Press and hold (short)			
		Off			
Locking operation when door opened*	On	Off	O	—	O

\*: This setting changes in accordance with My Settings

### ■ Outside rear view mirrors (→P.161)

Function	Default setting	Customized setting	A	B	C
Automatic mirror folding and extending operation*	Linked to the locking/unlocking of the doors	Off	—	—	O
		Linked to operation of the engine switch			

\*: If equipped

### ■ Power windows or panoramic moon roof\* (→P.164, 167)

Function	Default setting	Customized setting	A	B	C
Mechanical key linked operation	Off	On	—	—	O
Wireless remote control linked operation	Off	On (open only)	—	—	O

\*: If equipped



■ Automatic light control system (→P.218)

Function	Default setting	Customized setting	A	B	C
Light sensor sensitivity*	Normal	Brighter	O	—	O
		Bright			
		Dark			
		Darker			
Time elapsed before headlights automatically turn off after doors are closed*	30 seconds	Off	O	—	O
		60 seconds			
		90 seconds			
Windshield wiper linked headlight illumination	On	Off	—	—	O

\*: This setting changes in accordance with My Settings

■ Lights (→P.218)

Function	Default setting	Customized setting	A	B	C
Welcome lighting	On	Off	—	—	O

■ Pre-Collision System (→P.245)

Function	Customized setting	A	B	C
Pre-Collision System	ON/OFF	—	O	—
Warning timing*	Later/Default/Earlier	—	O	—

\*: This setting changes in accordance with My Settings

■ Front Cross Traffic Alert\*<sup>1</sup>(→P.277)

Function	Customized setting	A	B	C
Front Cross Traffic Alert	ON/OFF	—	O	—
Alert timing* <sup>2</sup>	Later/Default/Earlier	—	O	—

\*<sup>1</sup>: If equipped

\*<sup>2</sup>: This setting changes in accordance with My Settings

### ■ Lane Departure Alert system (→P.265)

Function	Customized setting	A	B	C
Lane Departure Alert system*	ON/OFF	—	O	—
Alert timing*	Default/Earlier	—	O	—
Alert options*	Vibration/Audible	—	O	—

\*: This setting changes in accordance with My Settings

### ■ Lane Change Assist\*<sup>1</sup> (→P.262)

Function	Customized setting	A	B	C
Lane Change Assist* <sup>2</sup>	ON/OFF	—	O	—

\*<sup>1</sup>: If equipped

\*<sup>2</sup>: This setting changes in accordance with My Settings

### ■ Dynamic Radar Cruise Control (→P.282)

Function	Customized setting	A	B	C
Extended Resume Time*	ON/OFF	—	O	—
Acceleration setting*	High/Mid/Low	—	O	—
Guide message*	ON/OFF	—	O	—
Curve speed reduction*	High/Mid/Low/OFF	—	O	—

\*: This setting changes in accordance with My Settings

### ■ Proactive Driving Assist (→P.271)

Function	Customized setting	A	B	C
Proactive Driving Assist (PDA)*	ON/OFF	—	O	—
Support sensitivity*	Low/Mid/High	—	O	—
Steering Assist (SA)*	ON/OFF	—	O	—

Function	Customized setting	A	B	C
Deceleration Assist (DA)*	ON/OFF	—	O	—
Obstacle Anticipation Assist (OAA)*	ON/OFF	—	O	—

\*: This setting changes in accordance with My Settings

■ Road Sign Assist\*<sup>1</sup> (→P.280)

Function	Customized setting	A	B	C
Road Sign Assist* <sup>2</sup>	ON/OFF	—	O	—
Excess speed notification method* <sup>2</sup>	None/Visual/Visual&Audible	—	O	—
Other notifications method* <sup>2</sup>	None/Visual/Visual&Audible	—	O	—
Excess speed notification level* <sup>2</sup>	5 mph (10 km/h) / 3 mph (5 km/h) / 1 mph (2 km/h)	—	O	—

\*<sup>1</sup>: If equipped

\*<sup>2</sup>: This setting changes in accordance with My Settings

■ Driver break suggestion (→P.268)

Function	Customized setting	A	B	C
Driver break suggestion	ON/OFF	—	O	—

■ Traffic Jam Assist\*<sup>1</sup> (→P.301)

Function	Customized setting	A	B	C
Traffic Jam Assist* <sup>2</sup>	ON/OFF	—	O	—
Driver Monitor Camera Recording* <sup>2</sup>	ON/OFF	—	O	—

\*<sup>1</sup>: If equipped

\*<sup>2</sup>: This setting changes in accordance with My Settings

### ■ Driver monitor <sup>\*1</sup> (→P.243)

Function	Customized setting	A	B	C
Warning function <sup>*2</sup>	ON/OFF	—	O	—

<sup>\*1</sup>: If equipped

<sup>\*2</sup>: This setting changes in accordance with My Settings

### ■ Stop & Start system (→P.307)

Function	Default setting	Customized setting	A	B	C
Change the Stop & Start system duration when the A/C is on	Standard	Extended	—	O	—

### ■ BSM (Blind Spot Monitor) (→P.313)

Function	Customized setting	A	B	C
BSM (Blind Spot Monitor)	On/Off	—	O	—
Outside rear view mirror indicator brightness <sup>*</sup>	Dim/Bright	—	O	—
Alert timing for presence of approaching vehicle (sensitivity) <sup>*</sup>	Late/Default/Early	—	O	—
Buzzer warning <sup>*</sup>	On/Off	—	O	—

<sup>\*</sup>: This setting changes in accordance with My Settings

### ■ Intuitive parking assist <sup>\*1</sup> (→P.322)

Function	Customized setting	A	B	C
Intuitive parking assist <sup>*2</sup>	On/Off	—	O	—
Buzzer volume of Intuitive parking assist when operating <sup>*2,3</sup>	Level1/Level2/Level3	—	O	O

<sup>\*1</sup>: If equipped

<sup>\*2</sup>: This setting changes in accordance with My Settings

\*3: The sound volume is linked among the intuitive parking assist\*<sup>2</sup>, RCTA, and RCD.

■ **RCTA (Rear cross traffic alert) function (→P.328)**

Function	Customized setting	A	B	C
RCTA (Rear cross traffic alert) function	On/Off	—	O	—
Buzzer volume of RCTA when operating* <sup>1, 2</sup>	Level1/Level2/Level3	—	O	—

\*1: This setting changes in accordance with My Settings

\*2: The sound volume is linked among the intuitive parking assist\*<sup>1</sup>, RCTA, and RCD.

■ **RCD (Rear Camera Detection) function\* (→P.334)**

Function	Customized setting	A	B	C
RCD (Rear Camera Detection) function	ON/OFF	—	O	—

\*: If equipped

■ **PKSB (Parking Support Brake)\*<sup>1</sup> (→P.338)**

Function	Customized setting	A	B	C
PKSB (Parking Support Brake) function* <sup>2</sup>	ON/OFF	—	O	—

\*1: If equipped

\*2: This setting changes in accordance with My Settings

■ **Safe Exit Assist (→P.318)**

Function	Customized setting	A	B	C
Safe Exit Assist	On/Off	—	O	—
Outside rear view mirrors display*	On/Off	—	O	—
Detection sensitivity*	Low/Mid/High	—	O	—

\*: This setting changes in accordance with My Settings

### ■ Engine switch (→P.203)

Function	Customized setting	A	B	C
ACC customization Enabling/Disabling ACC mode	On/Off	O	—	O

### ■ Rear seat reminder (→P.115)

Function	Default setting	Customized setting	A	B	C
Rear seat reminder function*	On	Off	—	O	—

\*: This setting changes in accordance with My Settings

### ■ Front automatic air conditioning system (→P.368)

Function	Default setting	Customized setting	A	B	C
Switching between outside air and recirculated air mode linked to "AUTO" switch operation*	On	Off	O	—	O
A/C auto switch operation*	On	Off	O	—	O

\*: This setting changes in accordance with My Settings

### ■ Illumination (→P.384)

Function	Default setting	Customized setting	A	B	C
Time elapsed before the interior lights turn off*	15 seconds	Off	O	—	O
		7.5 seconds			
		30 seconds			
Operation after the engine switch is turned off	On	Off	—	—	O

Function	Default setting	Customized setting	A	B	C
Operation when you approach the vehicle with the electronic key on your person	On	Off	—	—	O
Operation when the doors are unlocked	On	Off	—	—	O
Footwell lights	On	Off	—	—	O
Time elapsed before the outer foot lights turn off*	15 seconds	Off	O	—	O
		7.5 seconds			
		30 seconds			
Operation of the outer foot lights when you approach the vehicle with the electronic key on your person	On	Off	—	—	O
Operation of the outer foot lights when the doors are unlocked	On	Off	—	—	O
Operation of the outer foot lights when a door is opened	On	Off	—	—	O

\*: This setting changes in accordance with My Settings

■ **Vehicle customization**

- When the doors remain closed after unlocking the doors and the timer activated automatic door lock function activates, signals will be generated in accordance with the operation buzzer volume and operational signal (Emergency flashers) function settings.

### Items to initialize

**The following items must be initialized for normal system operation after such cases as the battery being reconnected, or maintenance being performed on the vehicle:**

#### List of items to initialize

Item	When to initialize	Reference
Message indicating maintenance is required (U.S.A. only)	<ul style="list-style-type: none"> <li>• After the maintenance is performed</li> </ul>	P.426
Tire pressure warning system	<ul style="list-style-type: none"> <li>• When the specified tire inflation pressure has changed, such as due to carried load, etc.</li> <li>• When the tire inflation pressure is changed such as when the tire size is changed.</li> </ul>	P.449
Oil maintenance	<ul style="list-style-type: none"> <li>• After the maintenance is performed</li> </ul>	P.437
Power back door	<ul style="list-style-type: none"> <li>• After reconnecting or changing the battery</li> </ul>	P.130







**9-1. For owners**

- Reporting safety defects for U.S. owners..... 554
- Reporting safety defects for Canadian owners ..... 554
- Seat belt instructions for Canadian owners (in French)..... 555
- SRS airbag instructions for Canadian owners (in French)..... 556
- Headlight aim instructions for Canadian owners (in French)..... 562

### Reporting safety defects for U.S. owners

If you believe that your vehicle has a defect which could cause a crash or could cause injury or death, you should immediately inform the National Highway Traffic Safety Administration (NHTSA) in addition to notifying Toyota Motor Sales, U.S.A., Inc. (Toll-free: 1-800-331-4331).

If NHTSA receives similar complaints, it may open an investigation, and if it finds that a safety defect exists in a group of vehicles, it may order a recall and remedy campaign. However, NHTSA cannot become involved in individual problems between you, your dealer, or Toyota Motor Sales, U.S.A., Inc.

To contact NHTSA, you may call the Vehicle Safety Hotline toll-free at 1-888-327-4236 (TTY: 1-800-424-9153); go to <http://www.safercar.gov>; or write to: Administrator, NHTSA, 1200 New Jersey Ave. SE., Washington, DC 20590. You can also obtain other information about motor vehicle safety from <http://www.safercar.gov>.

### Reporting safety defects for Canadian owners

Canadian customers who wish to report a safety-related defect to Transport Canada, Defects Investigations and Recalls, may telephone the toll-free hotline 1-800-333-0510, mail Transport Canada - ASFAD, 330 Sparks Street, Ottawa, ON, K1A 0N5, or complete the online form at <https://www.tc.gc.ca/recalls>.

### Seat belt instructions for Canadian owners (in French)

The following is a French explanation of seat belt instructions extracted from the seat belt section in this manual.

See the seat belt section for more detailed seat belt instructions in English.

### Utilisation correcte des ceintures de sécurité

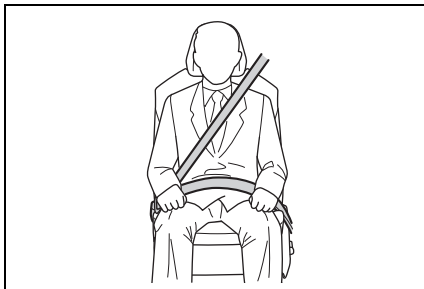

- Déroulez la sangle diagonale de telle sorte qu'elle passe bien sur l'épaule, sans pour autant être en contact avec le cou ou glisser de l'épaule.
- Placez la sangle abdominale le plus bas possible sur les hanches.
- Réglez la position du dossier de siège. Asseyez-vous le dos droit et calez-vous bien dans le siège.
- Ne vrillez pas la ceinture de

sécurité.

### Entretien et soin

#### ■ Traitement des ceintures de sécurité

Nettoyez avec un chiffon ou une éponge humidifiés avec de l'eau savonneuse tiède. Vérifiez régulièrement que les ceintures ne sont pas usées, effilochées ou entaillées excessivement.

#### ⚠ AVERTISSEMENT

##### ■ Détérioration et usure des ceintures de sécurité

Inspectez le système de ceintures de sécurité régulièrement. Contrôlez l'absence de coupures, d'effilochages et de pièces desserrées. N'utilisez pas une ceinture de sécurité endommagée avant qu'elle ne soit remplacée. Une ceinture de sécurité endommagée ne permet pas de protéger un occupant de blessures graves ou mortelles.

## SRS airbag instructions for Canadian owners (in French)

The following is a French explanation of SRS airbag instructions extracted from the SRS airbag section in this manual.

See the SRS airbag section for more detailed SRS airbag instructions in English.

### Système de coussins gonflables SRS

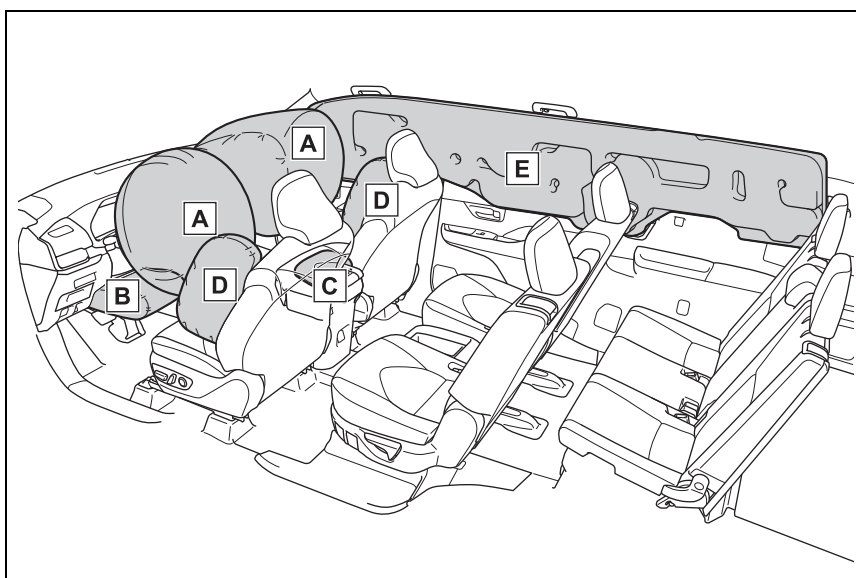

**A** Coussin gonflable conducteur/coussin gonflable du passager avant SRS

Contribuent à réduire l'impact au niveau de la tête et du thorax du conducteur et du passager avant

**B** Coussin gonflable de genoux SRS

Contribue à réduire l'impact subi par le conducteur

**C** Coussin gonflable de coussin de siège SRS

Contribue à réduire l'impact subi par le passager avant

**D** Coussins gonflables latéraux SRS

Contribuent à réduire l'impact au niveau du thorax des occupants des sièges avant

**E** Coussins gonflables rideaux SRS

- Contribuent à réduire l'impact au niveau de la tête des occupants des sièges avant et des sièges arrière latéraux
- Peut contribuer à empêcher les occupants d'être éjectés du véhicule en cas de tonneau

Votre véhicule est équipé de COUSSINS GONFLABLES INTELLIGENTS conçus selon les normes de sécurité américaines applicables aux véhicules à moteur (FMVSS208). L'ensemble des capteurs de coussins gonflables (ECU) régule le déploiement des coussins gonflables sur la base des informations qu'il reçoit des capteurs, etc., indiqués ci-dessus dans le schéma illustrant les composants du système. Parmi ces informations figurent la gravité du choc et l'occupation du véhicule par les passagers. Le déploiement rapide des coussins gonflables est obtenu au moyen d'une réaction chimique dans les dispositifs pyrotechniques, qui produit un gaz inoffensif permettant d'amortir le mouvement des occupants.

**AVERTISSEMENT****■ Précautions relatives aux coussins gonflables SRS**

Respectez les précautions suivantes.

Le non-respect de ces précautions peut occasionner des blessures graves, voire mortelles.

- Le conducteur et tous les passagers doivent porter correctement leur ceinture de sécurité. Les coussins gonflables SRS sont des dispositifs supplémentaires à utiliser avec les ceintures de sécurité.

**⚠ AVERTISSEMENT**

- Le coussin gonflable conducteur SRS se déploie avec une force considérable et peut occasionner des blessures graves, voire mortelles, tout particulièrement si le conducteur se trouve très près du coussin gonflable. L'autorité fédérale chargée de la sécurité routière aux États-Unis (NHTSA) conseille:

La zone à risque du coussin gonflable conducteur se situant dans les premiers 2 à 3 in. (50 à 75 mm) de déploiement, vous placer à 10 in. (250 mm) de votre coussin gonflable conducteur vous garantit une marge de sécurité suffisante. Cette distance est à mesurer entre le centre du volant et le sternum. Si votre position de conduite actuelle vous place à moins de 10 in. (250 mm) du coussin gonflable conducteur, vous pouvez changer votre position de conduite de plusieurs façons:

- Reculez votre siège le plus possible, de manière à pouvoir encore atteindre confortablement les pédales.
- Inclinez légèrement le dossier de siège. Bien que les véhicules aient une conception différente, un grand nombre de conducteurs peuvent s'asseoir à une distance de 10 in. (251 mm), même avec le siège conducteur complètement avancé, simplement en inclinant un peu le dossier de siège. Si vous avez des difficultés à voir la route après avoir incliné le dossier de votre siège, utilisez un coussin ferme et antidérapant pour vous rehausser ou remontez le siège si votre véhicule est équipé de cette fonction.

- Si votre volant est réglable, inclinez-le vers le bas. Cela a pour effet d'orienter le coussin gonflable en direction de votre poitrine plutôt que de votre tête et de votre cou. Réglez votre siège selon les recommandations de la NHTSA, tout en conservant le contrôle du véhicule avec les pédales et le volant, et en préservant la vue des commandes du tableau de bord.

- Si vous attachez une rallonge de ceinture de sécurité à une boucle de ceinture de sécurité du passager avant sans l'attacher au pêne de la ceinture de sécurité, le système de coussins gonflables SRS détermine que le passager avant a attaché sa ceinture de sécurité, bien que la ceinture de sécurité ne soit pas bouclée. Dans ce cas, les coussins gonflables frontaux SRS du passager avant peuvent ne pas se déployer correctement lors d'une collision, pouvant occasionner des blessures graves, voire mortelles. Veillez à porter la ceinture de sécurité correctement en cas d'utilisation d'une rallonge de ceinture de sécurité.

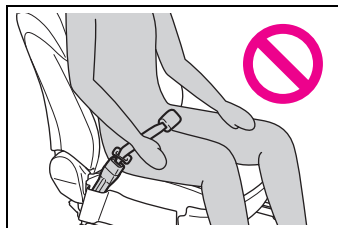



**⚠ AVERTISSEMENT**

- Le coussin gonflable frontal SRS se déploie avec une force considérable et peut occasionner des blessures graves, voire mortelles, tout particulièrement si le passager avant se trouve très près du coussin gonflable. Le siège du passager avant doit être éloigné le plus possible du coussin gonflable, avec le dossier réglé de façon à ce que le passager avant soit assis bien droit dans le siège.
- Les nourrissons et les enfants qui ne sont pas correctement assis et/ou attachés peuvent être grièvement blessés ou tués par le déploiement d'un coussin gonflable. Un nourrisson ou un enfant trop petit pour utiliser une ceinture de sécurité doit être correctement attaché au moyen d'un siège de sécurité enfant. Toyota recommande vivement d'installer tous les nourrissons et enfants sur les sièges arrière du véhicule et de prévoir pour eux des systèmes de retenue adaptés. Les sièges arrière sont plus sûrs pour les nourrissons et les enfants que le siège du passager avant. (→P.51)
- Ne vous asseyez pas sur le bord du siège et ne vous appuyez pas contre la planche de bord.

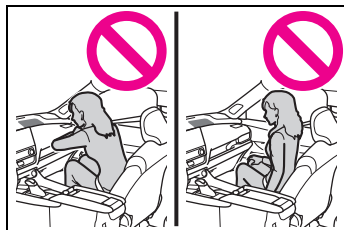

- Ne laissez pas un enfant rester debout devant le coussin gonflable passager avant SRS ou s'asseoir sur les genoux du passager avant.
- Les occupants des sièges avant ne doivent en aucun cas tenir d'objets sur leurs genoux.

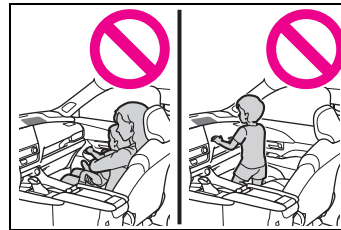

- Ne vous appuyez pas contre la porte, le rail latéral de toit ou les montants avant, latéraux ou arrière.

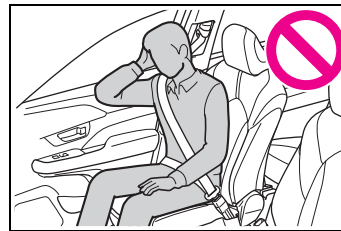

- Ne laissez personne s'agenouiller sur un siège en appui contre la porte ou sortir la tête ou les mains à l'extérieur du véhicule.

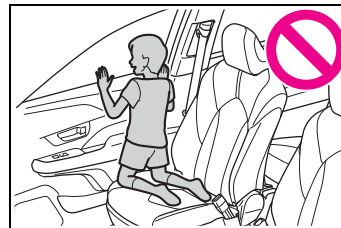

### AVERTISSEMENT

- Ne fixez rien et ne posez rien sur des emplacements tels que la planche de bord, la garniture du volant et la partie inférieure du tableau de bord.

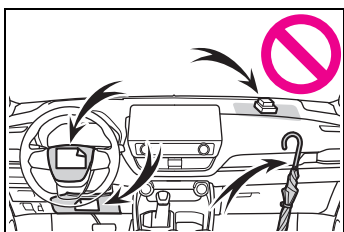

- Ne fixez rien à des emplacements tels que les portes, la vitre du pare-brise, les vitres latérales, les montants avant ou arrière, des rails latéraux de toit et des poignées de maintien.

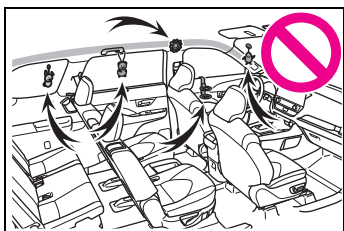

- Ne suspendez aucun cintre ou objet dur aux crochets à vêtements. Ces éléments peuvent se transformer en projectiles si les coussins gonflables rideaux SRS se déploient, le choc pouvant entraîner des blessures graves, voire mortelles.
- Si un cache en vinyle est fixé sur la zone où le coussin gonflable de genoux SRS se déploie, veillez à le retirer.

- N'utilisez aucun accessoire de siège recouvrant les zones de déploiement des coussins gonflables SRS, car il risque de gêner le déploiement des coussins gonflables SRS. De tels accessoires peuvent empêcher les coussins gonflables SRS de se déployer correctement, peuvent désactiver le système ou entraîner le déploiement involontaire des coussins gonflables SRS, ce qui peut éventuellement occasionner des blessures graves, voire mortelles.
- Évitez de faire subir des chocs ou des pressions excessives aux composants des systèmes de coussins gonflables SRS, aux portes avant ou à leur zone adjacente. En effet, cela pourrait entraîner un dysfonctionnement des coussins gonflables SRS.
- Ne touchez aucun composant des coussins gonflables SRS immédiatement après leur déploiement (gonflage), car ils peuvent être chauds.
- Si vous avez des difficultés à respirer après le déploiement des coussins gonflables SRS, ouvrez une porte ou une vitre pour faire entrer de l'air frais, ou bien descendez du véhicule si cela ne présente pas de danger. Essayez tout résidu dès que possible afin d'éviter d'éventuelles irritations de la peau.
- Si un composant renfermant un coussin gonflable SRS est endommagé ou fissuré, faites-le remplacer par votre concessionnaire Toyota.

**⚠ AVERTISSEMENT**

- Ne placez rien sur le siège du passager avant, comme un coussin par exemple. Cela a pour conséquence de répartir le poids du passager sur toute la surface du siège, ce qui empêche le capteur de détecter correctement le poids du passager. En conséquence, les coussins gonflables frontaux SRS du siège du passager avant risquent de ne pas se déployer en cas de collision.

■ **Modification et mise au rebut des composants du système de coussins gonflables SRS**

Ne mettez pas votre véhicule au rebut et ne procédez à aucune des modifications suivantes sans consulter votre concessionnaire Toyota. Les coussins gonflables SRS peuvent ne pas fonctionner correctement ou se déployer involontairement, ce qui peut provoquer des blessures graves, voire mortelles.

- Dépose, repose, démontage ou réparation des coussins gonflables SRS
- Réparation, dépose ou modification des pièces suivantes ou de leurs alentours
  - Volant
  - Tableau de bord
  - Planche de bord
  - Sièges
  - Garnissage des sièges
  - Montants avant
  - Montants latéraux
  - Montants arrière
  - Rails latéraux de toit

- Panneaux de portes avant
- Garniture de porte avant
- Haut-parleurs de porte avant
- Modifications des panneaux de portes avant (par exemple, perçage de trous dans les panneaux)
- Réparation ou modification des pièces suivantes ou de leurs alentours
- Aile avant
- Pare-chocs avant
- Côtés de l'intérieur du véhicule
- Installation des pièces suivantes ou accessoires
- Pare-buffle ou pare-kangourou
- Chasse-neige
- Treuils
- Porte-bagages de toit
- Modifications de la suspension du véhicule
- Installation d'appareils électroniques, tels que des émetteurs/récepteurs radios mobiles (émetteurs RF) et des lecteurs CD
- Modifications apportées à votre véhicule pour les personnes atteintes d'un handicap physique

Headlight aim instructions for Canadian owners (in French)

The following is a French explanation of headlight aim instructions from the headlight aim section in this manual.

Boulons de réglage du mouvement vertical

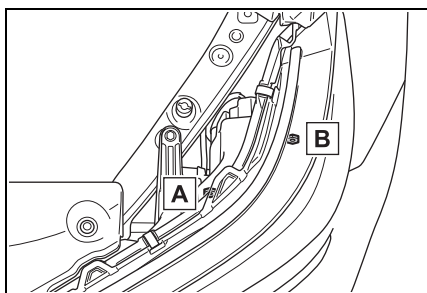

- A** Boulon de réglage A
- B** Boulon de réglage B

Avant de vérifier le réglage des phares

- 1 Vérifiez que le réservoir de carburant du véhicule est plein et que la zone autour des phares n'est pas déformée.
- 2 Stationnez le véhicule sur une surface plane.
- 3 Assurez-vous que la pression de gonflage des pneus est au niveau recommandé.

- 4 Faites asseoir quelqu'un dans le siège conducteur.
- 5 Balancez le véhicule plusieurs fois.

Réglage du faisceau des phares

- 1 À l'aide d'un tournevis cruciforme, tournez le boulon A dans n'importe quel sens.

Mémorez le sens dans lequel vous avez tourné et le nombre de tours.

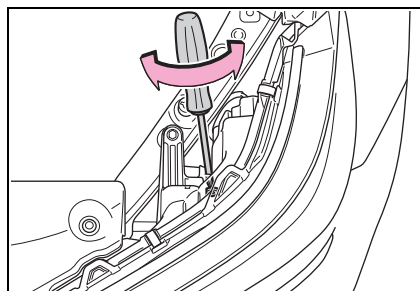

- 2 Tournez le boulon B du même nombre de tours dans le même sens qu'à l'étape 1.

Si vous n'arrivez pas à régler le phare en procédant de la sorte, confiez le véhicule à votre concessionnaire Toyota pour qu'il règle le faisceau des phares.

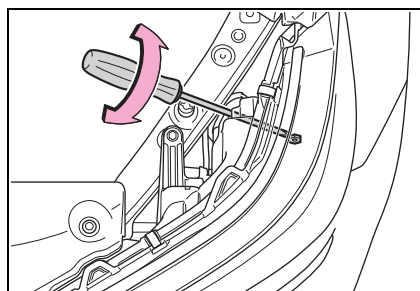

**Index**

563

What to do if... (Trouble-  
shooting) ..... 564  
Alphabetical Index..... 567

## What to do if... (Troubleshooting)

**If you have a problem, check the following before contacting your Toyota dealer.**

**The doors cannot be locked, unlocked, opened or closed**



### You lose your keys

- If you lose your mechanical keys, new genuine mechanical keys can be made by your Toyota dealer. (→P.505)
- If you lose your electronic keys, the risk of vehicle theft increases significantly. Contact your Toyota dealer immediately. (→P.505)



### The electronic key does not operate properly

- Is the electronic key battery weak or depleted? (→P.460)



### The doors cannot be locked or unlocked

- Is the engine switch in ON?

When locking the doors, turn the engine switch off. (→P.205)

- Is the electronic key left inside the vehicle?

When locking the doors, make sure that you have the electronic key on your person.

- The function may not operate properly due to the condition of the radio wave. (→P.137)



### The rear door cannot be opened

- Is the child-protector lock set?

The rear door cannot be opened from inside the vehicle when the lock is set. Open the rear door from outside and then unlock the child-protector lock. (→P.118)

**If you think something is wrong**



### The engine does not start

- Did you press the engine switch while firmly depressing the brake pedal? (→P.203)
- Is the shift lever in P? (→P.203)
- Is the electronic key anywhere detectable inside the vehicle? (→P.136)
- Is the electronic key battery weak or depleted?

In this case, the engine can be started in a temporary way. (→P.507)

- Is the battery discharged?  
(→P.508)



**The shift lever cannot be shifted from P even if you depress the brake pedal**

- Is the engine switch in ON?

If you cannot release the shift lever by depressing the brake pedal with the engine switch in ON (→P.209)



**The windows do not open or close by operating the power window switches**

- Is the window lock switch pressed?

The power window except for the one at the driver's seat cannot be operated if the window lock switch is pressed. (→P.166)



**The engine switch is turned off automatically**

- The auto power off function will be operated if the vehicle is left in ACC or ON (the engine is not running) for a period of time. (→P.206)



**A warning buzzer sounds during driving**

- The seat belt reminder light is flashing

Are the driver and the passengers wearing the seat belts? (→P.480, 480)

- The parking brake indicator is

on

Is the parking brake released?  
(→P.212)

Depending on the situation, other types of warning buzzer may also sound. (→P.477, 488)



**An alarm is activated and the horn sounds**

- Did anyone inside the vehicle open a door during setting the alarm?

The sensor detects it and the alarm sounds. (→P.73)

Do one of the following to deactivate or stop the alarms:

- Unlock the doors.
- Turn the engine switch to ACC or ON, or start the engine. (The alarm will be deactivated or stopped after a few seconds.)



**A warning buzzer sounds when leaving the vehicle**

- Is the message displayed on the multi-information display?

Check the message on the multi-information display. (→P.488)



**A warning light turns on or a warning message is displayed**

- When a warning light turns on or a warning message is displayed

played, refer to P.477, 488.

### When a problem has occurred



#### If you have a flat tire

- Stop the vehicle in a safe place and replace the flat tire with the spare tire. (→P.495)



#### The vehicle becomes stuck

- Try the procedure for when the vehicle becomes stuck in mud, dirt, or snow. (→P.514)



## Alphabetical Index

### A

<b>A/C</b> .....	<b>368</b>
Air conditioning filter .....	459
Automatic air conditioning system .....	368
Eco air conditioning mode ....	373
Front seat concentrated airflow mode (S-FLOW) .....	374
Rear automatic air conditioning system .....	377
<b>ABS (Anti-lock Brake System)</b> .....	<b>354</b>
Warning light .....	479
<b>ACA (Active Cornering Assist)</b> .....	<b>355</b>
<b>Active Cornering Assist (ACA)</b> .....	<b>355</b>
<b>Air conditioning filter</b> .....	<b>459</b>
<b>Air conditioning system</b> .....	<b>368</b>
Air conditioning filter .....	459
Automatic air conditioning system .....	368
Eco air conditioning mode ....	373
Front seat concentrated airflow mode (S-FLOW) .....	374
Rear automatic air conditioning system .....	377
<b>Airbags</b>	
Airbag operating conditions ..	38, 39
Airbag precautions for your child .....	41
Correct driving posture .....	29
Curtain shield airbag precautions .....	41
Front passenger occupant classification system .....	44
General airbag precautions ....	41
Modification and disposal of airbags .....	43
Side airbag precautions .....	41

Side and curtain shield airbags precautions .....	41
SRS airbags .....	37
SRS warning light .....	478
<b>Alarm</b> .....	<b>73</b>
Warning buzzer .....	477
<b>Anchor brackets</b> .....	<b>53, 65</b>
<b>Antennas (smart key system)</b>	<b>136</b>
<b>Anti-lock Brake System (ABS)</b> .....	<b>354</b>
Warning light .....	479
<b>Approach warning</b> .....	<b>288</b>
<b>Armrest</b> .....	<b>406</b>
<b>Assist grips</b> .....	<b>406</b>
<b>Audio system-linked display</b> ..	<b>92, 100</b>
<b>Automatic air conditioning system</b> .....	<b>368</b>
Eco air conditioning mode ....	373
<b>Automatic light control system</b> .....	<b>218</b>
<b>Automatic transmission</b> .....	<b>207</b>
If the shift lever cannot be shifted from P .....	209
M mode .....	210
Paddle shift switches .....	209
<b>Auxiliary boxes</b> .....	<b>390</b>
<b>Average fuel economy</b> .....	<b>90, 98</b>
<b>Average vehicle speed</b> .....	<b>92</b>

### B

<b>Back door</b> .....	<b>119</b>
<b>Back-up light</b>	
Wattage .....	525
<b>Back-up lights</b>	
Replacing light bulbs .....	466
<b>Battery</b>	
Battery checking .....	440
If the battery is discharged ...	508
Preparing and checking before winter .....	360
Replacing .....	510

Warning light ..... 478  
**Blind Spot Monitor (BSM)..... 313**  
**Brake**  
 Brake hold ..... 216  
 Fluid ..... 439, 523  
 Parking brake ..... 212  
 Warning light ..... 477  
**Brake assist ..... 354**  
**Break-in tips ..... 180**  
**Brightness control**  
 Instrument panel light control 83,  
 88  
**BSM (Blind Spot Monitor)..... 313**  
**Buzzer**  
 Driver monitor..... 243

## C

**Camera**  
 Driver monitor..... 243  
**Care**  
 Exterior ..... 420  
 Interior ..... 423  
 Seat belts ..... 423  
 Wheels and wheel ornaments  
 ..... 420  
**Cargo capacity ..... 186, 189**  
**Cargo net hooks ..... 393**  
**Chains ..... 362**  
**Child restraint system**  
 Fixed with a LATCH system ... 62  
 Fixed with a seat belt ..... 57  
 Front passenger occupant clas-  
 sification system..... 44  
 Points to remember ..... 51  
 Riding with children ..... 50  
 Types of child restraint system  
 installation method ..... 53  
 Using an anchor bracket ..... 65  
**Child safety**  
 Airbag precautions ..... 41  
 Battery precautions ..... 441, 511  
 Child restraint system..... 53

Heated steering wheel and seat  
 heater precautions..... 381  
 How your child should wear the  
 seat belt..... 32  
 Panoramic moon roof precau-  
 tions..... 169  
 Power back door precautions 119  
 Power window lock switch .... 166  
 Power window precautions... 165  
 Rear door child-protectors .... 118  
 Seat belt extender precautions  
 ..... 33  
 Seat belt precautions..... 50  
**Child-protectors..... 118**  
**Cleaning**  
 Exterior ..... 420  
 Interior ..... 423  
 Radar sensor ..... 237  
 Seat belts ..... 423  
 Wheels and wheel ornaments  
 ..... 420  
**Clock..... 81, 83, 84, 88**  
**Coat hooks ..... 407**  
**Compact spare tire**  
 Storage location ..... 496  
**Condenser ..... 439**  
**Console box ..... 388**  
**Consumption screen..... 106**  
**Cooling system..... 438**  
 Engine overheating ..... 512  
**Cruise control**  
 Dynamic radar cruise control 282  
**Cup holders..... 389**  
**Current fuel consumption.. 90, 98**  
**Curtain shield airbags..... 37**  
**Customizable features ..... 538**

## D

**Daytime running light system 218**  
**Daytime running lights**  
 Replacing light bulbs ..... 466  
**Deck board ..... 396**

**Deck under tray** ..... 396

**Defogger**  
 Outside rear view mirrors ..... 370  
 Rear window ..... 370  
 Windshield..... 370

**Differential**  
 Rear differential oil ..... 523

**Digital Rear-view Mirror** ..... 152

**Dimension**..... 518

**Dinghy towing** ..... 201

**Display**  
 Dynamic radar cruise control 285  
 Head-up display ..... 102  
 Intuitive parking assist..... 322  
 Multi-information display .. 89, 95  
 Parking Support Brake function  
 (pedestrians rear of the vehicle)  
 ..... 347  
 RCD (Rear Camera Detection)  
 ..... 335  
 RCTA..... 329  
 Warning message ..... 488

**Distance until next engine oil  
 change**..... 82

**Do-it-yourself maintenance**... 427

**Door courtesy lights** ..... 384  
 Wattage ..... 525

**Door lock**  
 Power back door ..... 119  
 Side doors ..... 115  
 Smart key system..... 136  
 Wireless remote control ..... 111

**Doors**  
 Automatic door locking and  
 unlocking system..... 118  
 Door glasses ..... 164  
 Open door warning buzzer. 116,  
 118  
 Outside rear view mirrors ..... 161  
 Rear door child-protectors.... 118

**Downhill assist control system**  
 ..... 352

**Drive distance** ..... 92

**Drive information**..... 92

**Driver's seat position memory**  
 Driving position memory ..... 171  
 Memory recall function ..... 172

**Drive-Start Control (DSC)** ..... 185

**Driving**  
 Break-in tips ..... 180  
 Correct driving posture ..... 29  
 Driving mode select switch ... 348  
 Procedures ..... 179  
 Winter drive tips..... 360

**Driving information display** .... 90

**Driving mode select switch** ... 348

**Driving position memory** ..... 171  
 Memory recall function ..... 172

**Driving range** ..... 81, 90, 91, 98

**Driving support system informa-  
 tion display**..... 91, 96

**DSC (Drive-Start Control)** ..... 185

**Dynamic radar cruise control** 282  
 Warning message..... 288

**Dynamic Torque Control AWD  
 system** ..... 355

**E**

**Eco drive mode**..... 348

**Eco Driving Indicator** .91, 99, 105

**Eco Driving Indicator Light** 91, 99

**EDR (Event data recorder)**..... 10

**Elapsed time** ..... 92

**Electric Power Steering (EPS)**  
 ..... 355  
 Warning light..... 479

**Electronic key** ..... 110, 113  
 Battery-saving function ..... 137  
 If the electronic key does not  
 operate properly ..... 506  
 Replacing the battery ..... 460

**Electronic sunshade**  
 Jam protection function ..... 168  
 Operation..... 167

<b>Emergency Driving Stop System</b>	
.....	<b>298</b>
<b>Emergency flashers</b>	<b>470</b>
<b>Emergency, in case of</b>	
If a warning buzzer sounds ..	477
If a warning light turns on ....	477
If a warning message is displayed.....	488
If the battery is discharged ...	508
If the electronic key does not operate properly .....	506
If the engine will not start .....	503
If the fuel filler door cannot be opened .....	505
If the vehicle is submerged or water on the road is rising ..	471
If you have a flat tire .....	495
If you lose your keys .....	505
If you think something is wrong .....	475
If your vehicle becomes stuck .....	514
If your vehicle has to be stopped in an emergency.....	470
If your vehicle needs to be towed .....	473
If your vehicle overheats .....	512
<b>Engine</b>	
ACCESSORY mode.....	205
Compartment .....	435
Engine switch .....	203
Fuel pump shut off system ...	476
Hood.....	433
How to start the engine .....	203
Identification number.....	519
If the engine will not start .....	503
If your vehicle has to be stopped in an emergency.....	470
Ignition switch (engine switch) .....	203
Overheating.....	512
Tachometer .....	81, 84

<b>Engine coolant</b>	
Capacity .....	521
Checking .....	438
Preparing and checking before winter.....	360
<b>Engine coolant temperature gauge</b> .....	<b>81, 84</b>
<b>Engine immobilizer system</b> .....	<b>72</b>
<b>Engine oil</b>	
Capacity .....	520
Checking .....	435
Preparing and checking before winter.....	360
Warning light.....	478
<b>Engine oil maintenance data</b> .....	<b>437</b>
<b>Engine switch</b> .....	<b>203</b>
Auto power off function.....	206
Changing the engine switch modes.....	205
If your vehicle has to be stopped in an emergency.....	470
<b>EPS (Electric Power Steering)</b> .....	<b>355</b>
Warning light.....	479
<b>Event data recorder (EDR)</b> .....	<b>10</b>

## F

<b>FCTA (Front Cross Traffic Alert)</b> .....	<b>277</b>
<b>Flat tire</b>	
Tire pressure warning system .....	445
Vehicles with a spare tire.....	495
<b>Floor mats</b> .....	<b>28</b>
<b>Fluid</b>	
Brake .....	523
Transmission .....	522
Washer .....	442
<b>Fog lights</b>	
Switch.....	223
<b>Footwell light</b> .....	<b>384</b>

**Front Cross Traffic Alert (FCTA)**  
.....277

**Front fog lights**  
Replacing light bulbs ..... 466

**Front passenger occupant classification system** ..... 44

**Front seats**  
Adjustment ..... 141  
Cleaning ..... 423  
Correct driving posture ..... 29  
Driving position memory ..... 171  
Head restraints ..... 147  
Memory recall function ..... 172  
Seat heaters ..... 381  
Seat position memory ..... 171  
Seat ventilators ..... 381

**Front side marker light**  
Light switch ..... 218  
Replacing light bulbs ..... 466

**Front side marker lights**  
Wattage ..... 525

**Front turn signal lights**  
Replacing light bulbs .... 466, 467  
Turn signal lever ..... 211  
Wattage ..... 525

**Fuel**  
Capacity ..... 519  
Fuel gauge ..... 81, 84  
Fuel pump shut off system ... 476  
Information ..... 526  
Refueling ..... 231  
Type ..... 519  
Warning light ..... 479

**Fuel consumption**  
Average fuel economy ..... 90, 98  
Current fuel consumption . 90, 98

**Fuel economy** ..... 90, 98

**Fuel filler door**  
If the fuel filler door cannot be opened ..... 505  
Refueling ..... 231

**Fuel gauge** ..... 81, 84

**Fuel pump shut off system**....476

**Fuses** .....462

**G**

**Garage door opener** ..... 411

**Gauges** ..... 81, 84

**Glove box** ..... 388

**Glove box light**.....388

**H**

**Hands Free Power Back Door**124

**Head restraints** ..... 147

**Headlight aim** ..... 465

**Headlights**  
Light switch ..... 218  
Replacing light bulbs ..... 466

**Head-up display** ..... 102  
Driving information display area ..... 102  
Driving support system information display ..... 105  
Eco Driving Indicator ..... 105  
Pop-up display ..... 105  
Settings ..... 104

**Heated steering wheel**.....381

**Heaters**  
Automatic air conditioning system ..... 368  
Heated steering wheel ..... 381  
Outside rear view mirrors .... 370  
Rear automatic air conditioning system ..... 377  
Seat heaters ..... 381

**High mounted stoplight**  
Replacing light bulbs ..... 466

**Hill-start assist control**.....355

**Hood**  
Open ..... 433

**Hooks**  
Cargo net hooks ..... 393  
Coat hooks ..... 407

Retaining hooks (floor mat) ....28  
**Horn**..... 150

**I**

**I/M test**..... 430  
**Identification**  
 Engine ..... 519  
 Vehicle..... 518  
**If your vehicle has to be stopped  
 in an emergency**..... 470  
**Ignition switch (engine switch)**  
 ..... 203  
 Auto power off function ..... 206  
 Changing the engine switch  
 modes ..... 205  
 If your vehicle has to be stopped  
 in an emergency..... 470  
**Indicators** ..... 78  
**Initialization**  
 Items to initialize..... 552  
 Maintenance..... 427, 437  
 Power windows ..... 164  
**Inside rear view mirror**... 151, 152  
**Instrument panel light control**83,  
 88  
**Intercooler**..... 439  
**Intercooler coolant**  
 Capacity ..... 521  
 Checking ..... 438  
**Interior lights** ..... 384  
**Intuitive parking assist**  
 Function ..... 322

**J**

**Jack**  
 Positioning a floor jack ..... 434  
 Vehicle-equipped jack ..... 496  
**Jack handle**..... 496  
**Jam protection function**  
 Electronic sunshade ..... 168  
 Panoramic moon roof..... 168

Power back door .....127  
 Power windows ..... 164

**K**

**Keyless entry**  
 Smart key system .....136  
 Wireless remote control..... 111  
**Keys**  
 Battery-saving function .....137  
 Electronic key ..... 110  
 Engine switch .....203  
 If the electronic key does not  
 operate properly .....506  
 If you lose your keys.....505  
 Key number plate ..... 110  
 Keyless entry..... 111, 115, 136  
 Mechanical key..... 110  
 Replacing the battery .....460  
 Warning buzzer .....136  
 Wireless remote control..... 111  
**Knee airbag**.....37

**L**

**Lane change Assist (LCA)** .....262  
**Lane Departure Alert (LDA)** ...265  
**Lane Tracing Assist (LTA)**  
 Operation.....257  
**Language (multi-information display)** .....93  
**LATCH anchors**.....62  
**LCA (Lane change Assist)** .....262  
**LDA (Lane Departure Alert)** ...265  
**Lever**  
 Auxiliary catch lever .....433  
 Hood lock release lever.....433  
 Shift lever .....207  
 Turn signal lever.....211  
 Wiper lever .....224  
**License plate lights**  
 Light switch.....218  
 Replacing light bulbs .....466

**Light bulbs**  
 Replacing ..... 466

**Lights**  
 Automatic High Beam system  
 ..... 220  
 Fog light switch ..... 223  
 Front personal lights ..... 385  
 Headlight switch ..... 218  
 Interior lights ..... 384  
 Interior lights list ..... 384  
 Rear personal lights ..... 385  
 Replacing light bulbs ..... 466  
 Turn signal lever ..... 211  
 Vanity lights ..... 409  
 Wattage ..... 525

**LTA (Lane Tracing Assist)**  
 Operation ..... 257

**Luggage cover ..... 393**

**M**

**Maintenance**  
 Do-it-yourself maintenance .. 431  
 General maintenance ..... 427  
 Maintenance data ..... 518  
 Maintenance requirements... 426

**Malfunction indicator lamp.... 478**

**Menu icons ..... 89**

**Meter**  
 Clock ..... 81, 83, 84  
 Indicators ..... 78  
 Instrument panel light control 83,  
 88  
 Meter control switches .... 90, 95  
 Meters ..... 81, 84  
 Multi-information display .. 89, 95  
 Settings ..... 93  
 Warning lights ..... 477  
 Warning message ..... 488

**Mirrors**  
 Digital Rear-view Mirror ..... 152  
 Inside rear view mirror ..... 151

Outside rear view mirror defog-  
 gers ..... 370  
 Outside rear view mirrors ..... 161  
 Vanity mirrors ..... 409

**Moon roof**  
 Door lock linked panoramic  
 moon roof operation ..... 168

**Mud & Sand mode ..... 349**

**Multi-information display**  
 Audio system-linked display .92,  
 100  
 Clock ..... 88  
 Driving information display ..... 90  
 Driving support system informa-  
 tion display ..... 91, 96  
 Dynamic radar cruise control 285  
 Eco Driving Indicator ..... 91, 99  
 Fuel economy ..... 90, 98  
 Menu icons ..... 89  
 Meter control switches ..... 90, 95  
 Navigation system-linked display  
 ..... 91, 96  
 Settings ..... 93  
 Suggestion function ..... 94, 101  
 Tire pressure ..... 445  
 Vehicle information display ..... 92  
 Warning message ..... 488

**Multi-terrain Select ..... 349**

**My Settings ..... 175**

**N**

**Navigation system-linked display**  
 ..... 91, 96

**Noise from under vehicle ..... 6**

**Normal mode ..... 348, 349**

**O**

**“ODO TRIP” switch ..... 83**

**“ODO” switch ..... 88**

**Odometer ..... 82, 87**

**Odometer and trip meter display**  
 Display items ..... 82, 87  
 “ODO TRIP” switch ..... 83  
 “ODO” switch ..... 88

**Oil**  
 Engine oil ..... 520  
 Rear differential oil ..... 523

**Opener**  
 Fuel filler door ..... 231  
 Hood ..... 433

**Outer foot lights**  
 Replacing light bulbs ..... 466

**Outside rear view mirrors**  
 Adjustment ..... 161  
 BSM (Blind Spot Monitor) ... 313  
 Folding ..... 162  
 Linked mirror function when  
 reversing ..... 162  
 Mirror position memory ..... 171  
 Outside rear view mirror defog-  
 gers ..... 370  
 RCTA function ..... 328  
 Safe Exit Assist ..... 318

**Outside temperature** ..... 81, 84

**Overheating** ..... 512

**P**

**Paddle shift switches** ..... 209

**Panic mode** ..... 112

**Panoramic moon roof**  
 Jam protection function ..... 168  
 Operation ..... 167

**Parking assist sensors (intuitive  
 parking assist)** ..... 322

**Parking brake**  
 Operation ..... 212  
 Parking brake engaged warning  
 buzzer ..... 214  
 Warning light ..... 484  
 Warning message ..... 214

**Parking lights**  
 Light switch ..... 218

Replacing light bulbs ..... 466

**Parking Support Brake function  
 (moving vehicles rear of the  
 vehicle)** ..... 345  
 Function ..... 345

**Parking Support Brake function  
 (pedestrians rear of the vehicle)**  
 ..... 346  
 Function ..... 346

**Parking Support Brake function  
 (static objects front and rear of  
 the vehicle)** ..... 342  
 Function ..... 342

**PCS (Pre-Collision System)**  
 Function ..... 245  
 Warning light ..... 481

**PDA (Proactive driving assist)**  
 ..... 271

**Personal lights** ..... 384

**PKSB (Parking Support Brake)**  
 ..... 338

**Power back door** ..... 119  
 Hands Free Power Back Door  
 ..... 124  
 Smart key system ..... 121

**Power outlets** ..... 407, 408

**Power steering (Electric power  
 steering system)** ..... 355  
 Warning light ..... 479

**Power windows**  
 Door lock linked window opera-  
 tion ..... 165  
 Jam protection function ..... 164  
 Operation ..... 164  
 Window lock switch ..... 166

**Pre-Collision System (PCS)**  
 Function ..... 245  
 Warning light ..... 481

**R**

**Radar cruise control (dynamic  
 radar cruise control)** ..... 282



**Radiator** ..... 439

**RCD (Rear Camera Detection)**  
 Function ..... 334

**RCTA**  
 Function ..... 328

**RCTA function**..... 329

**Rear automatic air conditioning system**..... 377

**Rear Cross Traffic Alert (RCTA)**  
 ..... 328

**Rear door sunshades** ..... 409

**Rear seats** ..... 142  
 Head restraints ..... 147  
 Seat heaters ..... 381

**Rear side marker lights**  
 Light switch ..... 218  
 Replacing light bulbs ..... 466

**Rear turn signal lights**  
 Replacing light bulbs ..... 466  
 Turn signal lever ..... 211  
 Wattage ..... 525

**Rear view mirror**  
 Digital Rear-view Mirror ..... 152  
 Inside rear view mirror ..... 151  
 Outside rear view mirrors ..... 161

**Rear window defogger** ..... 370

**Rear window wiper** ..... 229

**Refueling**  
 Capacity ..... 519  
 Fuel types ..... 519  
 If the fuel filler door cannot be opened ..... 505  
 Opening the fuel tank cap ..... 231

**Replacing**  
 Electronic key battery ..... 460  
 Fuses ..... 462  
 Light bulbs ..... 466  
 Tires ..... 495

**Resetting the message indicating maintenance is required** 427

**Road Sign Assist (RSA)** ..... 280

**Rock & Dirt mode** ..... 349

**RSA (Road Sign Assist)** ..... 280

**S**

**Safe Exit Assist**..... 318

**Safety Connect** ..... 68

**Seat belt reminder light**..... 480

**Seat belts**..... 31  
 Automatic Locking Retractor .. 32  
 Child restraint system installation ..... 53  
 Cleaning and maintaining the seat belt ..... 423  
 Emergency Locking Retractor 32  
 How to wear your seat belt ..... 32  
 How your child should wear the seat belt ..... 32  
 Pregnant women, proper seat belt use ..... 31  
 Reminder light and buzzer ... 480  
 Seat belt extender ..... 32  
 Seat belt pretensioners ..... 35  
 SRS warning light ..... 478

**Seat heaters** ..... 381

**Seat position memory** ..... 171

**Seat ventilators** ..... 381

**Seating capacity** ..... 189

**Seats**  
 Adjustment ..... 141  
 Adjustment precautions ..... 141  
 Child seats/child restraint system installation ..... 51  
 Cleaning ..... 423  
 Driving position memory ..... 171  
 Head restraints ..... 147  
 Properly sitting in the seat ..... 29  
 Seat heaters ..... 381  
 Seat position memory ..... 171  
 Seat ventilators ..... 381

**Sensor**  
 Automatic headlight system . 218  
 Automatic High Beam system ..... 220

- Digital Rearview Mirror ..... 156
- Inside rear view mirror..... 151
- Intuitive parking assist..... 322
- LDA (Lane Departure Alert with steering control) ..... 265
- LTA (Lane Tracing Assist)..... 257
- Parking Support Brake function (moving vehicles rear of the vehicle)..... 345
- Parking Support Brake function (static objects front and rear of the vehicle)..... 343
- Radar sensor..... 236, 314, 319
- Rain-sensing windshield wipers ..... 226
- RCTA..... 329
- Service reminder message.... 427**
- Shift lever**
  - Automatic transmission ..... 207
  - If the shift lever cannot be shifted from P..... 209
- Shift lever light ..... 384**
- Shift lock system..... 208**
- Shopping bag hooks..... 393**
- Side airbags..... 37**
- Side doors**
  - Door lock..... 115
- Side marker lights**
  - Light switch ..... 218
  - Replacing light bulbs ..... 466
- Side mirrors**
  - Adjustment ..... 161
  - BSM (Blind Spot Monitor) ... 313
  - Folding ..... 162
  - Heaters..... 370
  - Linked mirror function when reversing ..... 162
  - Mirror position memory ..... 171
  - RCTA function ..... 328
- Side turn signal lights**
  - Replacing light bulbs ..... 466
  - Turn signal lever..... 211
- Side windows..... 164**
- Smart key system**
  - Antenna location..... 136
  - Entry functions..... 115, 121
  - Starting the engine ..... 203
- Snow mode switch ..... 352**
- Snow tires ..... 360**
- Spare tire ..... 495**
- Spark plug ..... 521**
- Specifications ..... 518**
- Speedometer ..... 81, 84**
- Sport mode..... 348**
- Steering wheel**
  - Adjustment ..... 150
  - Heated steering wheel..... 381
  - Meter control switches..... 90, 95
- Stop & Start system ..... 307**
  - Warning light..... 481
- Stop lights**
  - Replacing light bulbs ..... 466
- Storage features ..... 387**
- Stuck**
  - If the vehicle becomes stuck 514
- Suggestion function..... 94, 101**
- Sun visors ..... 409**
- Sunshade**
  - Panoramic moon roof ..... 167
- Switches**
  - Automatic High Beam system ..... 220
  - Brake Hold switch..... 216
  - Digital Rear-view Mirror control switches..... 152
  - Door lock switches ..... 118
  - Driving mode select switch... 348
  - Driving position memory switches..... 171
  - Dynamic radar cruise control switch ..... 285
  - Electronic sunshade switch .. 167
  - Emergency flashers switch... 470
  - Engine switch ..... 203

Fog light switch .....223  
 Garage door opener switches  
 ..... 411  
 Heated steering wheel switch  
 .....381  
 Ignition switch.....203  
 Instrument panel light control  
 switches ..... 83, 88  
 Intuitive parking assist switch323  
 Light switches.....218  
 Meter control switches ..... 90, 95  
 “ODO TRIP” switch ..... 83  
 “ODO” switch.....88  
 Outside rear view mirror  
 switches ..... 161  
 Paddle shift switches.....209  
 Panoramic moon roof switches  
 ..... 167  
 Parking brake switch .....212  
 PKSB (Parking Support Brake)  
 switch .....339  
 Power door lock switch ..... 118  
 Power window switches ..... 164  
 RCD (Rear Camera Detection)  
 switch .....335  
 RCTA switch.....329  
 Rear window and outside rear  
 view mirror defoggers switch  
 .....370  
 Seat heater switches .....381  
 Seat ventilator switches .....381  
 Snow mode switch .....352  
 “SOS” button ..... 68  
 Stop & Start cancel switch ...308  
 Tilt and telescopic steering con-  
 trol switch ..... 150  
 Vehicle-to-vehicle distance  
 switch ..... 285  
 VSC OFF switch.....355  
 Window lock switch ..... 166  
 Windshield defogger switch .370

Windshield wiper and washer  
 switch .....224  
 Windshield wiper de-icer switch  
 .....370

**T**

**Tachometer .....81, 84**  
**Tail lights**  
 Light switch.....218  
 Replacing light bulbs .....466  
**The Secondary Collision Brake  
 .....355**  
**Theft deterrent system**  
 Alarm .....73  
 Engine immobilizer system.....72  
**Tire inflation pressure**  
 Maintenance data .....524  
 Tire inflation pressure display  
 function .....445  
 Warning light.....481  
**Tire information .....528**  
 Glossary .....532  
 Size .....530  
 Tire identification number .....529  
 Uniform Tire Quality Grading531  
**Tire pressure display .....445**  
**Tire pressure warning system**  
 Function.....445  
 Installing tire pressure warning  
 valves and transmitters .....447  
 Registering ID codes .....451  
 Registering the position of each  
 wheel .....448  
 Selecting wheel set .....453  
 Setting the tire pressure .....449  
 Warning light.....481  
**Tires**  
 Chains .....362  
 Checking .....443  
 If you have a flat tire .....495  
 Inflation pressure .....455  
 Information .....528

- Replacing ..... 495
  - Rotating tires ..... 445
  - Size ..... 524
  - Snow tires ..... 360
  - Spare tire ..... 495
  - Tire inflation pressure display  
function ..... 445
  - Tire pressure warning system  
..... 445
  - Warning light ..... 481
  - Tools ..... 496**
  - Top tether strap ..... 65**
  - Total load capacity ..... 518**
  - Towing**
    - Dinghy towing ..... 201
    - Emergency towing ..... 473
    - Trailer towing ..... 190, 191
  - Toyota Safety Sense 3.0**
    - AHB (Automatic High Beam) 220
    - Cruise control ..... 294
    - Driver monitor ..... 243
    - Dynamic radar cruise control 282
    - Emergency Driving Stop System  
..... 298
    - FCTA (Front Cross Traffic Alert)  
..... 277
    - LCA (Lane change Assist) ... 262
    - LDA (Lane Departure Alert) .. 265
    - LTA (Lane Tracing Assist) ..... 257
    - PCS (Pre-Collision System) . 245
    - PDA (Proactive driving assist)  
..... 271
    - RSA (Road Sign Assist) ..... 280
    - Traffic Jam Assist ..... 301
  - TRAC (Traction Control) ..... 355**
  - Traction Control (TRAC) ..... 355**
  - Traffic Jam Assist ..... 301**
  - Trailer Sway Control ..... 355**
  - Trailer towing ..... 190, 191**
  - Transmission**
    - Automatic transmission ..... 207
    - Driving mode select switch ... 348
    - If the shift lever cannot be shifted  
from P ..... 209
    - M mode ..... 210
    - Paddle shift switches ..... 209
  - Trip meters ..... 82, 87**
  - Turn signal lights**
    - Replacing light bulbs ..... 466
    - Turn signal lever ..... 211
    - Wattage ..... 525
- U**
- USB charging ports ..... 397**
- V**
- Vanity lights ..... 409**
    - Wattage ..... 525
  - Vanity mirrors ..... 409**
  - Vehicle data recording ..... 7**
  - Vehicle identification number 518**
  - Vehicle information display ..... 92**
  - Vehicle Stability Control (VSC)  
..... 354**
  - Ventilators (seat ventilators) . 381**
  - VSC (Vehicle Stability Control)  
..... 354**
- W**
- Warning buzzers**
    - ABS ..... 479
    - Airbags ..... 478
    - Approach warning ..... 288
    - Brake hold ..... 484
    - Brake Override System ..... 479
    - Brake system ..... 477
    - Charging system ..... 478
    - Cruise control ..... 482
    - Downshifting ..... 210, 211
    - Drive-Start Control ..... 479
    - Dynamic radar cruise control 482
    - Electric power steering ..... 479

Engine .....	478
High coolant temperature .....	477
Intuitive parking assist..	327, 483
LDA (Lane Departure Alert) ..	482
Low engine oil pressure .....	478
LTA (Lane Tracing Assist) ...	257, 481
Open door .....	116, 118
Open window .....	165
PDA (Proactive Driving Assist) .....	482
Pre-collision warning .....	246
Seat belt .....	480
<b>Warning lights .....</b>	<b>477</b>
ABS .....	479
Brake hold operated indicator .....	484
Brake Override System .....	479
Brake system .....	477
Charging system .....	478
Cruise control indicator .....	482
Drive-Start Control .....	479
Driving assist information indicator .....	483
Dynamic radar cruise control indicator .....	482
Electric power steering .....	479
High coolant temperature .....	477
Intuitive parking assist OFF indicator .....	483
LDA indicator .....	482
Low engine oil pressure .....	478
Low fuel level .....	479
LTA indicator .....	481
Malfunction indicator lamp ...	478
Parking brake indicator .....	484
PDA indicator .....	482
Pre-collision system .....	481
Seat belt reminder light .....	480
Slip indicator .....	484
SRS .....	478
Stop & Start cancel indicator	481
Tire pressure .....	481
<b>Warning messages .....</b>	<b>488</b>
<b>Washer</b>	
Adding .....	442
Preparing and checking before winter .....	360
Switch .....	224
<b>Washing and waxing .....</b>	<b>420</b>
<b>Weight</b>	
Cargo capacity .....	186, 189
Load limits .....	189
Weight .....	518
<b>Wheels .....</b>	<b>457</b>
Size .....	524
<b>Window lock switch .....</b>	<b>166</b>
<b>Windows</b>	
Power windows .....	164
Rear window defogger .....	370
Washer .....	224
<b>Windshield defogger .....</b>	<b>370</b>
<b>Windshield wiper de-icer .....</b>	<b>370</b>
<b>Windshield wipers</b>	
Position .....	227
Rain-sensing windshield wipers .....	224
<b>Winter driving tips .....</b>	<b>360</b>
<b>Wireless charger .....</b>	<b>398</b>
<b>Wireless remote control</b>	
Battery-Saving Function .....	137
Locking/Unlocking .....	111
Replacing the battery .....	460

---

For information regarding the equipment listed below, refer to the "MULTIMEDIA OWNER'S MANUAL".

- Voice control system
- Navigation system

- Audio/visual system
- Panoramic view monitor
- Toyota parking assist monitor

## Certifications

### ► Smart key system

US

FCC ID:HYQ23ABN  
FCC ID:HYQ14FBX

#### NOTE:

This device complies with part 15 of the FCC Rules. Operation is subject to the following two conditions: (1) This device may not cause harmful interference, and (2) this device must accept any interference received, including interference that may cause undesired operation.

#### FCC WARNING:

Changes or modifications not expressly approved by the party responsible for compliance could void the user's authority to operate the equipment.

#### <For 14FBX>

The FCC ID is affixed inside the equipment. You can find the ID when replacing the battery.

00

CA

**NOTE:**

This device contains licence-exempt transmitter(s)/receiver(s) that comply with Innovation, Science and Economic Development Canada's licence-exempt RSS(s).

Operation is subject to the following two conditions:

- (1) This device may not cause interference.
- (2) This device must accept any interference, including interference that may cause undesired operation of the device.

<For 14FBX>

The IC Certification number is affixed inside the equipment. You can find the number when replacing the battery.

02

CA

**NOTE:**

L'émetteur/récepteur exempt de licence contenu dans le présent appareil est conforme aux CNR d'Innovation, Sciences et Développement économique Canada applicables aux appareils radio exempts de licence.

L'exploitation est autorisée aux deux conditions suivantes :

- (1) L'appareil ne doit pas produire de brouillage;
- (2) L'appareil doit accepter tout brouillage radioélectrique subi, même si le brouillage est susceptible d'en compromettre le fonctionnement.

<Pour 14FBX>

Le numéro d'accréditation IC est apposé à l'intérieur de l'appareil. Ce numéro est visible au remplacement de la pile.

03



---

► Digital Key

US

FCC ID:HYQ17EAA

NOTE

This device complies with part 15 of the FCC Rules. Operation is subject to the following two conditions: (1) This device may not cause harmful interference, and (2) this device must accept any interference received, including interference that may cause undesired operation.

FCC WARNING

Changes or modifications not expressly approved by the party responsible for compliance could void the user's authority to operate the equipment.

CAUTION : Radio Frequency Radiation Exposure

This equipment complies with FCC radiation exposure limits set forth for an uncontrolled environment and meets the FCC radio frequency (RF) Exposure Guidelines. This equipment should be installed and operated keeping the radiator at least 20cm or more away from person's body.

Co-location: This transmitter must not be co-located or operated in conjunction with any other antenna or transmitter.

00

This device contains licence-exempt transmitter(s)/receiver(s) that comply with Innovation, Science and Economic Development Canada's licence-exempt RSS(s). Operation is subject to the following two conditions:

- (1) This device may not cause interference.
- (2) This device must accept any interference, including interference that may cause undesired operation of the device.

The antenna cannot be removed (and changed) by user.

**Co-location:** This transmitter must not be co-located or operated in conjunction with any other antenna or transmitter.

**CAUTION: Radio Frequency Radiation Exposure**

This equipment complies with ISED radiation exposure limits set forth for an uncontrolled environment and meets RSS-102 of the ISED radio frequency (RF) Exposure rules. This equipment should be installed and operated keeping the radiator at least 20 cm or more away from person's body.

L'émetteur/récepteur exempt de licence contenu dans le présent appareil est conforme aux CNR d'Innovation, Sciences et Développement économique Canada applicables aux appareils radio exempts de licence. L'exploitation est autorisée aux deux conditions suivantes :

- (1) L'appareil ne doit pas produire de brouillage;
- (2) L'appareil doit accepter tout brouillage radioélectrique subi, même si le brouillage est susceptible d'en compromettre le fonctionnement.

L'utilisateur n'est pas autorisé à retirer (ou modifier) l'antenne.

**Emplacement** : Cet émetteur ne doit pas être installé ou utilisé conjointement avec d'autres antennes ou émetteurs.

**ATTENTION : exposition aux radiofréquences**

Cet équipement est conforme aux limites d'exposition aux rayonnements d'ISDE établies pour un environnement non contrôlé ainsi que la norme CNR-102 de la réglementation d'ISDE relative à l'exposition aux radiofréquences (RF). Cet équipement doit être installé et utilisé avec un minimum de 20 cm de distance entre la source de rayonnement et le corps.

## ► Millimeter wave radar sensor

FCC ID: HYQDNMWR011

D11 US 01

## NOTE:

This device complies with part 15 of the FCC Rules. Operation is subject to the following two conditions: (1) This device may not cause harmful interference, and (2) this device must accept any interference received, including interference that may cause undesired operation.

## FCC WARNING:

Changes or modifications not expressly approved by the party responsible for compliance could void the user's authority to operate the equipment.

US 01

## Radiofrequency radiation exposure Information:

This equipment complies with FCC radiation exposure limits set forth for an uncontrolled environment. This equipment should be installed and operated with minimum distance of 20 cm between the radiator (antenna) and your body. This transmitter must not be co-located or operating in conjunction with any other antenna or transmitter.

US 02

## NOTE:

This device contains licence-exempt transmitter(s)/receiver(s) that comply with Innovation, Science and Economic Development Canada's licence-exempt RSS(s). Operation is subject to the following two conditions:

- (1) This device may not cause interference.
- (2) This device must accept any interference, including interference that may cause undesired operation of the device.

This equipment complies with ISED radiation exposure limits set forth for an uncontrolled environment and meets RSS-102 of the ISED radio frequency (RF) Exposure rules. This equipment should be installed and operated keeping the radiator at least 20 cm or more away from person's body.

CA 01

**NOTE:**

L'émetteur/récepteur exempt de licence contenu dans le présent appareil est conforme aux CNR d'Innovation, Sciences et Développement économique Canada applicables aux appareils radio exempts de licence. L'exploitation est autorisée aux deux conditions suivantes :

- (1) L'appareil ne doit pas produire de brouillage;
- (2) L'appareil doit accepter tout brouillage radioélectrique subi, même si le brouillage est susceptible d'en compromettre le fonctionnement.

Cet équipement est conforme aux limites d'exposition aux rayonnements énoncées pour un environnement non contrôlé et respecte les règles d'exposition aux fréquences radioélectriques (RF) CNR-102 de l'ISDE. Cet équipement doit être installé et utilisé en gardant une distance de 20 cm ou plus entre le dispositif rayonnant et le corps.

CA 02

► Smart key system and engine immobilizer system

FCC ID: NI4TMLF19D-3

US

**NOTE**

This device complies with part 15 of the FCC Rules. Operation is subject to the following two conditions: (1) This device may not cause harmful interference, and (2) this device must accept any interference received, including interference that may cause undesired operation.

**FCC WARNING**

Changes or modifications not expressly approved by the party responsible for compliance could void the user's authority to operate the equipment.

93

**NOTE**

CA

This device contains licence-exempt transmitter(s)/receiver(s) that comply with Innovation, Science and Economic Development Canada's licence-exempt RSS(s). Operation is subject to the following two conditions:

- (1) This device may not cause interference.
- (2) This device must accept any interference, including interference that may cause undesired operation of the device.

811

**NOTE**

CA

L'émetteur/récepteur exempt de licence contenu dans le présent appareil est conforme aux CNR d'Innovation, Sciences et Développement économique Canada applicables aux appareils radio exempts de licence. L'exploitation est autorisée aux deux conditions suivantes:

- (1) L'appareil ne doit pas produire de brouillage;
- (2) L'appareil doit accepter tout brouillage radioélectrique subi, même si le brouillage est susceptible d'en compromettre le fonctionnement.

811

**► Intuitive parking assist**

Product name : Intuitive parking assist

Compliance statement : This device complies with part 18 of the FCC Rules.

Responsible Party : DENSO International America, Inc.

24777 Denso Drive, P.O. Box 5047, Southfield, Michigan 48033-5244, U.S.A.

<https://www.denso.com/us-ca/en/about-us/company-information/diam/>

This ISM device complies with Canadian ICES-001.

Cet appareil ISM est conforme à la norme NMB-001 du Canada.

**► BSM (Blind Spot Monitor)**

Radiofrequency radiation exposure Information:

This equipment complies with FCC and IC radiation exposure limits set forth for an uncontrolled environment. This equipment should be installed and operated with minimum distance of 20 cm between the radiator and your body.

This transmitter must not be co-located or operating in conjunction with any other antenna or transmitter.

FCC Notice:

Changes or modifications not expressly approved by the party responsible for compliance could void the user's authority to operate the equipment.

C5-002

This device contains licence-exempt transmitter(s)/receiver(s) that comply with Innovation, Science and Economic Development Canada's licence-exempt RSS(s). Operation is subject to the following two conditions:

- (1) This device may not cause interference.
- (2) This device must accept any interference, including interference that may cause undesired operation of the device.

Radiofrequency radiation exposure information:

This equipment complies with radiation exposure limits set forth for an uncontrolled environment. This equipment should be installed and operated with minimum distance of 20 cm between the radiator and your body.

C5-003

L'émetteur/récepteur exempt de licence contenu dans le présent appareil est conforme aux CNR d'Innovation, Sciences et Développement économique Canada applicables aux appareils radio exempts de licence. L'exploitation est autorisée aux deux conditions suivantes :

- (1) L'appareil ne doit pas produire de brouillage;
- (2) L'appareil doit accepter tout brouillage radioélectrique subi, même si le brouillage est susceptible d'en compromettre le fonctionnement.

Informations sur l'exposition aux rayonnements radiofréquences:

Cet équipement est conforme aux limites d'exposition aux rayonnements définies pour un environnement non contrôlé. Cet équipement doit être installé et utilisé avec un minimum de 20 cm de distance entre la source de rayonnement et votre corps.

C5-004

## ▶ Tire pressure warning system

FCC ID: PAXPMVG001

NOTE

This device complies with part 15 of the FCC Rules.

Operation is subject to the following two conditions:

- (1) This device may not cause harmful interference, and
- (2) this device must accept any interference received, including interference that may cause undesired operation.

FCC WARNING

Changes or modifications not expressly approved by the party responsible for compliance could void the user's authority to operate the equipment.

NOTE

This device contains licence-exempt transmitter(s)/ receiver(s) that comply with Innovation, Science and Economic Development Canada's licence-exempt RSS(s).

Operation is subject to the following two conditions:

- (1) This device may not cause interference.
- (2) This device must accept any interference, including interference that may cause undesired operation of the device.

NOTE

L'émetteur/récepteur exempt de licence contenu dans le présent appareil est conforme aux CNR d'Innovation, Sciences et Développement économique Canada applicables aux appareils radio exempts de licence.

L'exploitation est autorisée aux deux conditions suivantes :

- (1) L'appareil ne doit pas produire de brouillage;
- (2) L'appareil doit accepter tout brouillage radioélectrique subi, même si le brouillage est susceptible d'en compromettre le fonctionnement.



► Garage door opener

This device complies with FCC rules part 15 and Innovation, Science, and Economic Development Canada RSS-210. Operation is subject to the following two conditions: (1) This device may not cause harmful interference, and (2) This device must accept any interference that may be received including interference that may cause undesired operation. WARNING: The transmitter has been tested and complies with FCC and ISSED rules. Changes or modifications not expressly approved by the party responsible for compliance could void the user's authority to operate the device.

This equipment complies with FCC and ISSED radiation exposure limits set forth for an uncontrolled environment. End Users must follow the specific operating instructions for satisfying RF exposure compliance. This transmitter must be at least 20 cm from the user and must not be co-located or operating in conjunction with any other antenna or transmitter.

This device complies with FCC rules part 15 and Innovation, Science, and Economic Development Canada RSS-210. Operation is subject to the following two conditions: (1) This device may not cause harmful interference, and (2) This device must accept any interference that may be received including interference that may cause undesired operation. WARNING: The transmitter has been tested and complies with FCC and ISSED rules. Changes or modifications not expressly approved by the party responsible for compliance could void the user's authority to operate the device.

This equipment complies with FCC and ISSED radiation exposure limits set forth for an uncontrolled environment. End Users must follow the specific operating instructions for satisfying RF exposure compliance. This transmitter must be at least 20 cm from the user and must not be co-located or operating in conjunction with any other antenna or transmitter.

Cet appareil est conforme aux règlements de la FCC, section 15, et au CNR-210 d'Innovation, Sciences et Développement économique Canada. Le fonctionnement est assujéti aux deux conditions suivantes : (1) cet appareil ne doit pas causer d'interférences nuisibles et (2) cet appareil doit accepter toute interférence reçue, y compris celle qui pourrait entraîner un dysfonctionnement. MISE EN GARDE : L'émetteur a subi des tests et est conforme aux règlements de la FCC et d'ISDE. Les changements ou modifications non approuvés explicitement par la partie responsable de la conformité pourraient rendre caduque l'autorisation de l'utilisateur de se servir du dispositif.

Cet appareil est conforme aux limites d'exposition aux radiations de la FCC et d'ISDE établies pour un environnement non contrôlé. Les utilisateurs finaux doivent respecter les instructions d'utilisation spécifiques pour satisfaire aux exigences de conformité aux expositions de RF. L'émetteur doit se trouver à 20 cm au minimum de l'utilisateur et ne doit pas être situé au même endroit que tout autre émetteur ou antenne ni fonctionner avec un autre émetteur ou antenne.

---

► Wireless charger

FCC ID : ACJ932AT2301

NOTE:

This device complies with part 15 and part 18 of the FCC Rules. Operation is subject to the following two conditions: (1) This device may not cause harmful interference, and (2) this device must accept any interference received, including interference that may cause undesired operation.

FCC CAUTION

Changes or modifications not expressly approved by the party responsible for compliance could void the user's authority to operate the equipment. This equipment has been tested and found to comply with the limits for a wireless power charger, pursuant to part 18 of the FCC Rules. This equipment generates, uses and can radiate radio frequency energy and,

if not installed and used in accordance with the instructions, may cause harmful interference to radio communications. However, there is no guarantee that interference will not occur in a particular installation. If this equipment does cause harmful interference to radio communications, which can be determined by turning the equipment off and on, the user is encouraged to try to correct the interference by one or more of the following measures:

- Reorient or relocate the receiving antenna.
- Increase the separation between the equipment and receiver.
- Connect the equipment into an outlet on a circuit different from that to which the receiver is connected.

This equipment complies with FCC radiation exposure limits set forth for an uncontrolled environment and meets the FCC radio frequency (RF) Exposure Guidelines. This equipment should be installed and operated keeping the radiator at least 20cm or more away from person's body.

NOTE:

This device contains licence-exempt transmitter(s)/receiver(s) that comply with Innovation, Science and Economic Development Canada's licence-exempt RSS(s). Operation is subject to the following two conditions: (1) This device may not cause interference. (2) This device must accept any interference, including interference that may cause undesired operation of the device.

L'émetteur/récepteur exempt de licence contenu dans le présent appareil est conforme aux CNR d'Innovation, Sciences et Développement économique Canada applicables aux appareils radio exempts de licence. L'exploitation est autorisée aux deux conditions suivantes :

- 1) L'appareil ne doit pas produire de brouillage;
- 2) L'appareil doit accepter tout brouillage radioélectrique subi, même si le brouillage est susceptible d'en compromettre le fonctionnement.

**CAUTION:**

This equipment complies with ISED radiation exposure limits set forth for an uncontrolled environment and meets RSS-102 of the ISED radio frequency (RF) Exposure rules. This equipment should be installed and operated keeping the radiator at least 20cm or more away from person's body.

Cet équipement est conforme aux limites d'exposition aux rayonnements énoncées pour un environnement non contrôlé et respecte les règles d'exposition aux fréquences radioélectriques (RF) CNR-102 de l'ISDE.

Cet équipement doit être installé et utilisé en gardant une distance de 20 cm ou plus entre le radiateur et le corps humain.

**► Safety Connect**

FCC ID : BEJTL21BNN

This device complies with part 15 of the FCC Rules and RSS-Gen of IC Rules.

Operation is subject to the following two conditions:

- (1) This device may not cause harmful interference, and
- (2) this device must accept any interference received, including interference that may cause undesired operation.

Changes or modifications not expressly approved by the manufacturer (or party responsible) for compliance could void the user's authority to operate the equipment.

This equipment complies with FCC RF Radiation exposure limits set forth for an uncontrolled environment. This device and its antenna must not be co-located or operating in conjunction with any other antenna or transmitter. This equipment should be installed and operated with a minimum distance of 20 cm between the radiator and your body

IC : 2703H-TL21BNN

IC Radiation Exposure Statement:

This equipment complies with IC radiation exposure limits set forth for an uncontrolled environment.

This equipment should be installed and operated with minimum distance 20 cm between the radiator & your body.

Operation is subject to the following two conditions:

- (1) This device may not cause interference.
- (2) This device must accept any interference, including interference that may cause undesired operation of the device.

**NOTE: THE MANUFACTURER IS NOT RESPONSIBLE FOR ANY RADIO OR TV INTERFERENCE CAUSED BY UNAUTHORIZED MODIFICATIONS TO THIS EQUIPMENT. SUCH MODIFICATIONS COULD VOID THE USER'S AUTHORITY TO OPERATE THE EQUIPMENT.**

IC : 2703H-TL21BNN

Avis d'Industrie Canada sur l'exposition aux rayonnements

Cet appareil est conforme aux limites d'exposition aux rayonnements d'Industrie Canada pour un environnement non contrôlé.

Il doit être installé de façon à garder une distance minimale de 20 centimètres entre la source de rayonnements et votre corps.

L'exploitation est autorisée aux deux conditions suivantes :

1. L'appareil ne doit pas produire de brouillage;
2. L'appareil doit accepter tout brouillage radioélectrique subi, même si le brouillage est susceptible d'en compromettre le fonctionnement.

**REMARQUE: LE FABRICANT N'EST PAS RESPONSABLE DES INTERFÉRENCES RADIOÉLECTRIQUES CAUSÉES PAR DES MODIFICATIONS NON AUTORISÉES APPORTÉES À CET APPAREIL. DE TELLES MODIFICATIONS POURRAIT ANNULER L'AUTORISATION ACCORDÉE À L'UTILISATEUR DE FAIRE FONCTIONNER L'APPAREIL.**



## GAS STATION INFORMATION

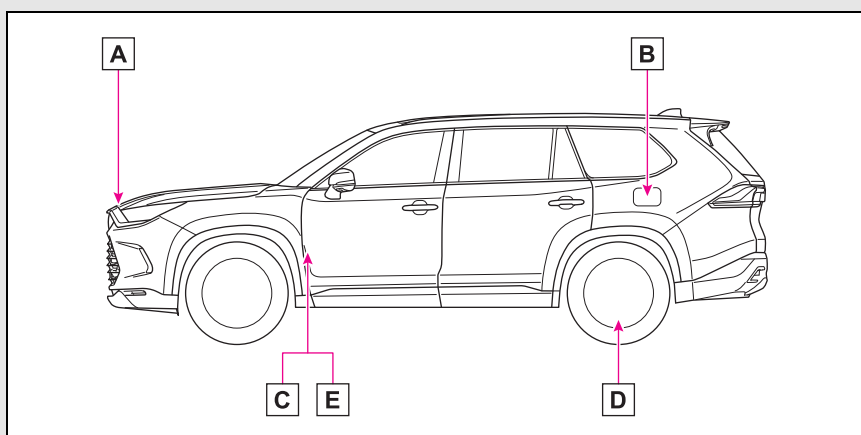

- A** Auxiliary catch lever (→P.433)
- B** Fuel filler door (→P.232)
- C** Hood lock release lever (→P.433)
- D** Tire inflation pressure (→P.524)
- E** Fuel filler door opener (→P.232)

Fuel tank capacity (Reference)	17.8 gal. (67.5 L, 14.8 Imp. gal.)	
Fuel type	Unleaded gasoline only	P.519 P.526
Cold tire inflation pressure		P.524
Engine oil capacity (Drain and refill — reference)		P.520
Engine oil type		P.520