

Contents

The Quick Guide is not intended as a substitute for your *OWNER'S MANUAL*. We strongly encourage you to review the *OWNER'S MANUAL* and supplementary manuals so you will have a better understanding of your vehicle's capabilities and limitations.

AHB (Automatic High Beam)	42
Audio System *	
Audio control screen	62
Selecting an audio source	62
Steering switch operation	63
Radio	64
CD	65
DVD	66
iPod	67
Brake Hold	36
Center Display	48
Door Locks	92
Driving Mode Select Switch	45
Driving Position Memory	23
Energy Monitor/Consumption Screen	51
EV Drive Mode	28
Floor Mat Installation	11
Front Automatic Air Conditioning System *	
Control panel	69
Air conditioning control screen	70
Using automatic mode	72
Front Seats	19
Fuel Tank Cap	96
Garage Door Opener	83
Hands-free System For Cellular Phone *	
Registering/connecting a Bluetooth® device	58
Contacts transfer	59
Registering the contacts in the favorites list	60
Calling by favorites list	60
Calling the message sender	60
Receiving a call	61
Steering switches	61

*: This feature may be operated by Voice command (See P.74)

Headlight Switch	41
Head-up Display	39
Hybrid System	12
Hybrid Transmission	29
Keys	15
Lexus Climate Concierge	68
Lexus Enform Remote	89
Lexus Enform Safety Connect	87
Lexus Enform Service Connect	90
Moon Roof	95
Multi-information Display	37
Navigation System *	
Registering home	54
Destination search	54
Voice Command System	74
Parking Brake	34
Power (Ignition) Switch	25
Power Rear Seat	22
Power Windows	94
Rear Air Conditioning System	
Rear air conditioning control screen	73
Using automatic mode	73
Remote Touch	47
SiriusXM Satellite Radio	91
Smart Access System with Push-button Start	17
Trunk	97
Turn Signal Lever	33
USB/AUX Ports	82
Voice Command System *	
Basic operation	74
Command list	76
Windshield Wipers and Washer	44

*: This feature may be operated by Voice command (See P.74)

Pictorial Index

Instrument panel

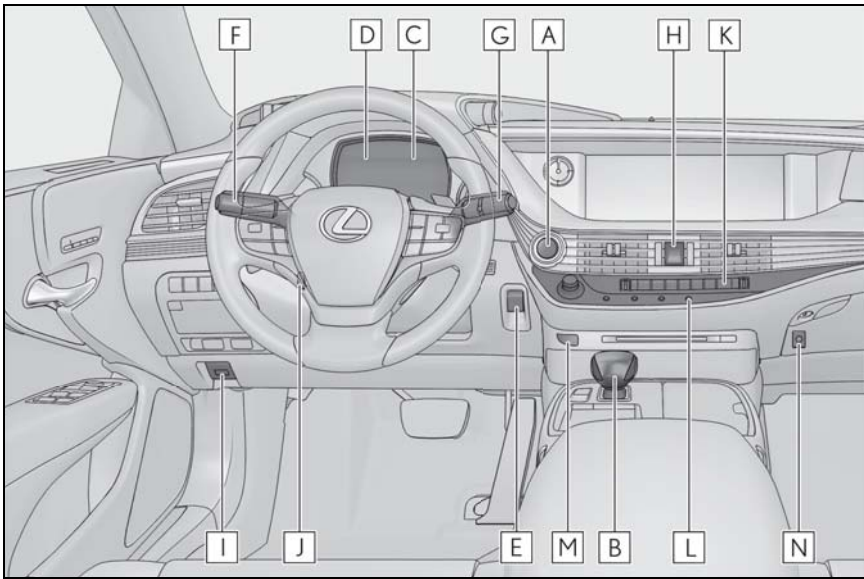

A	Power switch	P.25
	Starting the hybrid system/changing the modes	P.25
	Emergency stop of the hybrid system	P.27
	When the hybrid system will not start.....	P.105
	Warning messages*	
B	Shift lever	P.29
	Changing the shift position.....	P.29
	Precautions for towing*	
C	Meters *	
	Reading the meters/adjusting the instrument panel light*	
	Warning lights/indicator lights	P.99
	When a warning light turns on*	
D	Multi-information display	P.37
	Display.....	P.37
	Energy monitor.....	P.51
	When a warning messages is displayed*	

E	Parking brake switch	P.34
	Applying/releasing the parking brake	P.34
	Precautions for winter season*	
	Warning buzzer/messages*	
F	Turn signal lever	P.33
	Headlight switch	P.41
	Headlights/parking lights/tail lights/license plate lights/ daytime running lights	P.41
	AHB (Automatic High Beam)	P.42
G	Windshield wiper and washer switch	P.44
	Usage	P.44
	Adding washer fluid*	
	Warning messages*	
H	Emergency flasher switch *	
I	Hood lock release lever *	
J	Tilt and telescopic steering control switch *	
	Adjustment*	
	Driving position memory	P.23
K	Air conditioning system	P.69
	Usage	P.69
	Rear window defogger	P.69
L	Audio system	P.62
M	Brake hold switch	P.36
N	Trunk opener main switch *	

*: Refer to the "OWNER'S MANUAL".

■ Switches

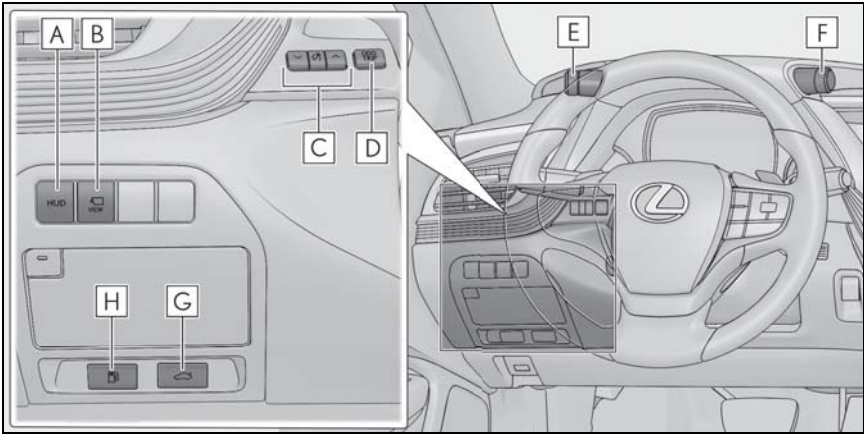

A	HUD (Head-up display) switch *1	P.39
B	Camera switch *1,2	
C	Instrument panel light control switches *3	
D	“ODO TRIP” switch *3	
E	VSC OFF switch *3	
	Snow mode switch.....	P.31
F	Driving mode select switch	P.45
G	Trunk opener switch.....	P.97
H	Fuel filler door opener switch.....	P.96

*1: If equipped

*2: Refer to “NAVIGATION AND MULTIMEDIA SYSTEM OWNER’S MANUAL”.

*3: Refer to the “OWNER’S MANUAL”.

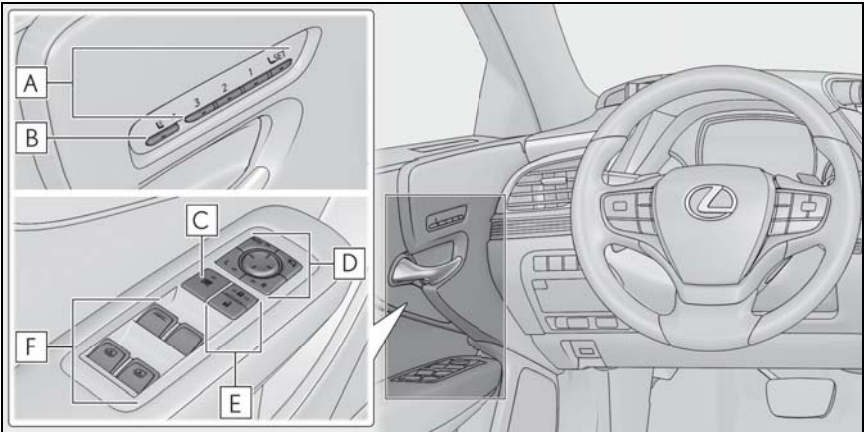

A	Position memory buttons	P.23
B	Mode change button	P.20
C	Window lock switch	P.94
D	Outside rear view mirror switches *1	
E	Door lock switches	P.92
F	Power window switches	P.94
	Rear door sunshade switches *1,2	

*1: Refer to the "OWNER'S MANUAL".

*2: If equipped

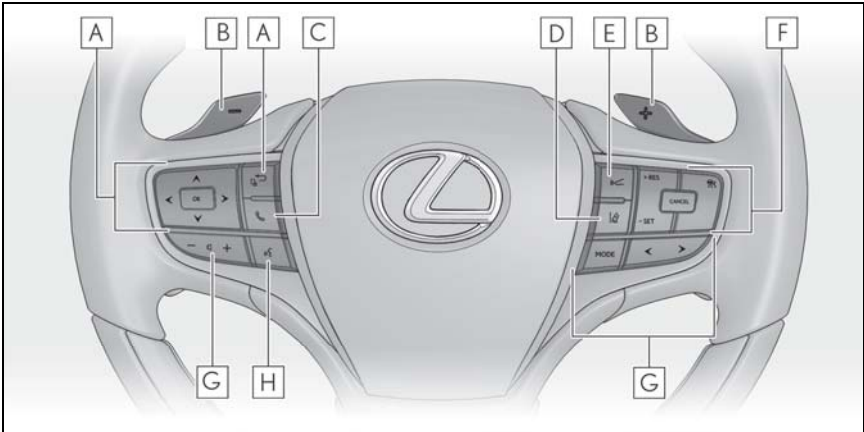

- A** Meter control switches P.38
- B** Paddle shift switches P.31, 32
- C** Phone switch P.61
- D** LTA (Lane Tracing Assist) switch *
- E** Vehicle-to-vehicle distance switch *
- F** Cruise control switches *
- G** Audio remote control switches P.63
- H** Talk switch P.61

*: Refer to the “OWNER’S MANUAL”.

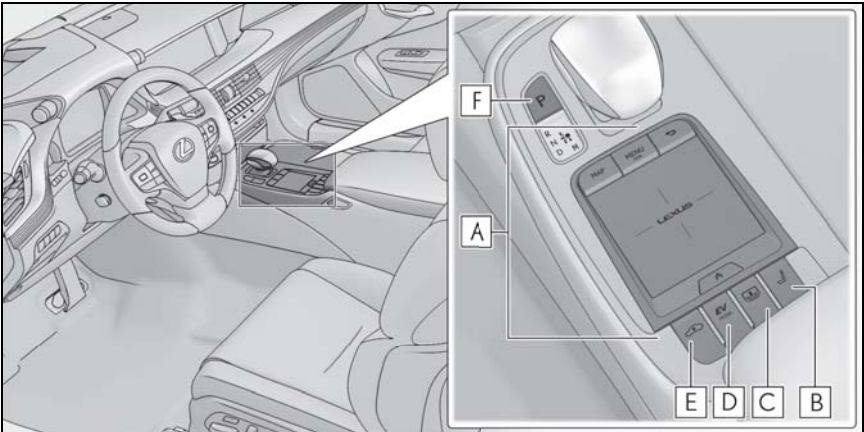

A	Remote Touch	P.47
B	Seat switch	P.19
C	Rear sunshade switch *1,2	
D	EV drive mode switch	P.28
E	Vehicle height adjustment switch *1,2	
F	P position switch	P.30

*1: If equipped

*2: Refer to the "OWNER'S MANUAL".

Interior

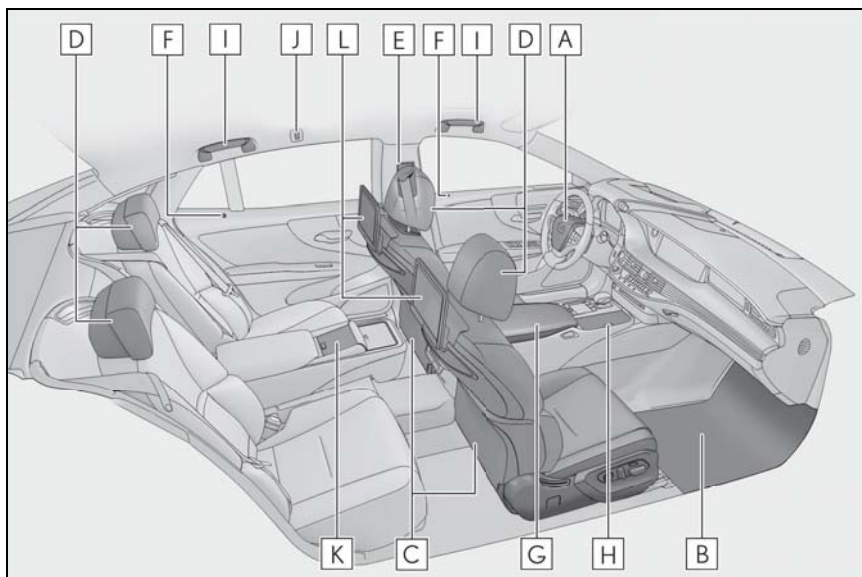

- A** SRS airbags *1
- B** Floor mats P.11
- C** Front seats P.19
- D** Head restraints *1
- E** Seat belts *1
- F** Inside lock buttons P.92
- G** Console box *1
- H** Cup holders *1
- I** Assist grips *1
- J** Coat hooks *1
- K** Rear Multi Operation Panel *1,2
- L** Rear seat entertainment system *2,3

*1: Refer to the "OWNER'S MANUAL".

*2: If equipped

*3: Refer to "NAVIGATION AND MULTIMEDIA SYSTEM OWNER'S MANUAL".

■ Ceiling

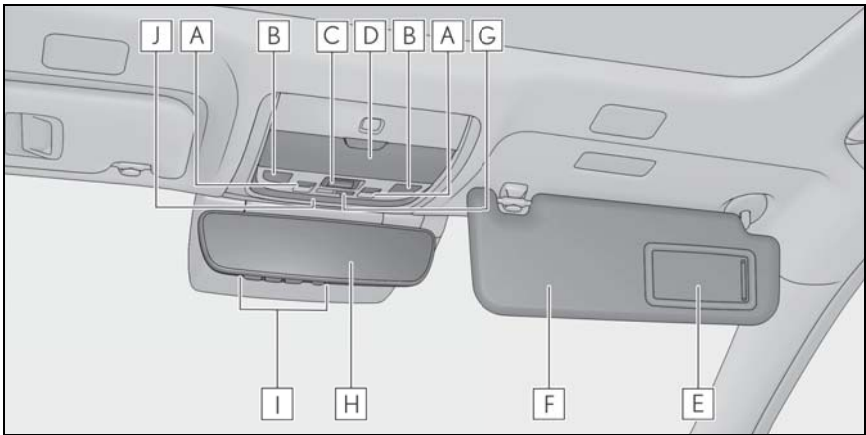

- A** Moon roof switches P.95
- B** Personal lights *¹
- C** “SOS” button *² P.87
- D** Auxiliary box *¹
- E** Vanity mirrors *¹
- F** Sun visors *¹
- G** Door-linked interior light switch *¹
- H** Inside rear view mirror *¹
- I** Garage door opener buttons P.83
- J** Interior light *¹

*¹: Refer to the “OWNER’S MANUAL”.

*²: If equipped

Floor Mat Installation

Use only floor mats designed specifically for vehicles of the same model and model year as your vehicle. Fix them securely in place onto the carpet.

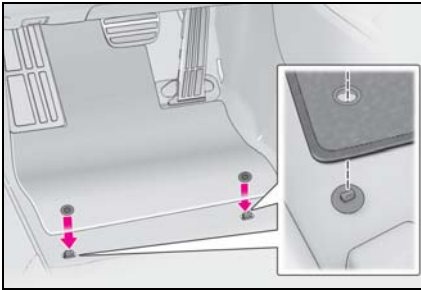

- 1 Insert the retaining hooks (clips) into the floor mat eyelets.

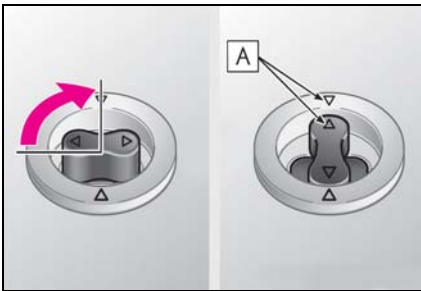

- 2 Turn the upper knob of each retaining hook (clip) to secure the floor mats in place.

Always align the \triangle marks **A**.

The shape of the retaining hooks (clips) may differ from that shown in the illustration.

Hybrid System

Your vehicle is a hybrid vehicle. It has characteristics different from conventional vehicles. Be sure you are closely familiar with the characteristics of your vehicle, and operate it with care.

The hybrid system combines the use of a gasoline engine and an electric motor (traction motor) according to driving conditions, improving fuel efficiency and reducing exhaust emissions.

For details, refer to the “OWNER’S MANUAL”.

Hybrid System Indicator

► Except F SPORT models

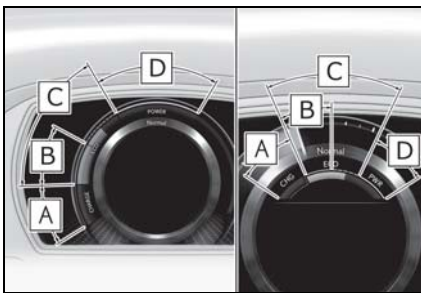

► F SPORT models

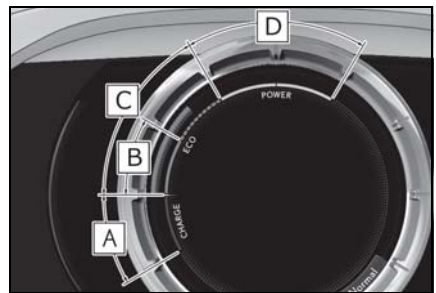

A Charge area

Shows regeneration* status.

Regenerated energy will be used to charge the hybrid battery (traction battery).

B Hybrid Eco area

Shows that gasoline engine power is not being used very often.

The gasoline engine will automatically stop and restart under various conditions.

C Eco area

Shows that the vehicle is being driven in an Eco-friendly manner.

By keeping the bar display within Eco area, more Eco-friendly driving can be achieved.

D Power area

Shows that an Eco-friendly driving range is being exceeded (during full power driving etc.)

*: When used in this manual, regeneration refers to the conversion of energy created by the movement of the vehicle into electrical energy.

Vehicle proximity notification system

When driving with the gasoline engine stopped, a sound, which changes in accordance with the driving speed, will be played in order to warn people nearby of the vehicle's approach. The sound will stop when the vehicle speed exceeds approximately 22 mph (35 km/h).

Hybrid battery (traction battery) charge

If the shift position is in N, the hybrid battery (traction battery) will not be charged. To help prevent the battery from discharging, avoid leaving the N position selected for an extended period of time.

Regenerative braking

In the following situations, kinetic energy is converted to electric energy and deceleration force can be obtained in conjunction with the recharging of the hybrid battery (traction battery).

- The accelerator pedal is released while driving with the shift position in D or M.
- The brake pedal is depressed while driving with the shift position in D or M.

Sounds and vibrations specific to a hybrid vehicle

There may be no engine sound or vibration even though the vehicle is able to move with the "READY" indicator is illuminated. For safety, apply the parking brake and make sure to shift the shift position to P when parked.

The following sounds or vibrations may occur when the hybrid system is operating and are not a malfunction:

- Motor sounds may be heard from the engine compartment.
- Relay operating sounds such as a snap or soft clank will be emitted from the hybrid battery (traction battery), behind the rear seats, when the hybrid system is started or stopped.
- Sounds may be heard from the hybrid battery (traction battery) behind the rear seats when the hybrid system starts or stops.
- Sounds from the hybrid system may be heard when the trunk lid is open.
- Sounds may be heard from the transmission when the gasoline engine starts or stops, when driving at low speeds, or during idling.
- Engine sounds may be heard when accelerating sharply.
- Sounds may be heard due to regenerative braking when the brake pedal is depressed or as the accelerator pedal is released.
- Vibration may be felt or sounds may be heard when the gasoline engine starts or stops.
- Cooling fan sounds may be heard from the air intake vents on the both sides of the rear seatback.

Running out of fuel

When the vehicle has run out of fuel and the hybrid system cannot be started, refuel the vehicle with at least enough gasoline to make the low fuel level warning light go off. If there is only a small amount of fuel, the hybrid system may not be able to start. (The standard amount of fuel is about 3.4 gal. [13 L, 2.8 Imp. gal.], when the vehicle is on a level surface. This value may vary when the vehicle is on a slope. Add extra fuel when the vehicle is inclined.)

Hybrid warning message

A message is automatically displayed when a malfunction occurs in the hybrid system or an improper operation is attempted.

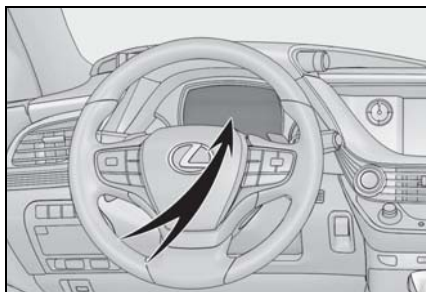

If a warning message is shown on the multi-information display, read the message and follow the instructions.

Keys

The keys

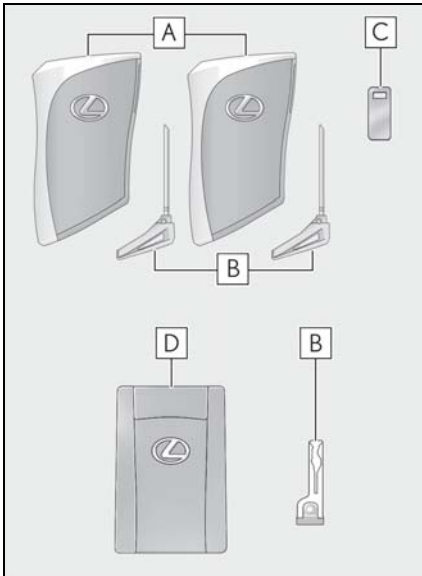

- A** Electronic keys
 - Operating the smart access system with push-button start (→P.17)
 - Operating the wireless remote control function
 - B** Mechanical keys
 - C** Key number plate
 - D** Card key (electronic key) (if equipped)
- Operating the smart access system with push-button start (→P.17)

Wireless remote control

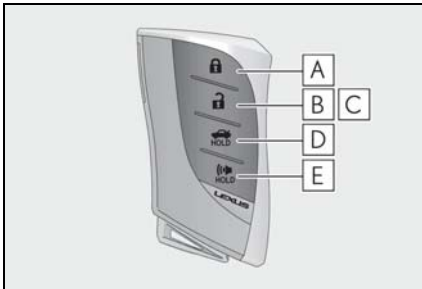

- A** Locks the doors
- B** Unlocks the doors
- C** Opens the windows and moon roof (press and hold)*
- D** Opens the trunk
- E** Sounds the alarm

*: This setting must be customized at your Lexus dealer.

Mechanical key

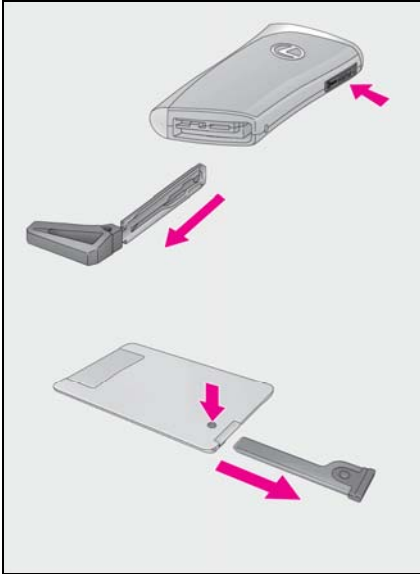

To take out the mechanical key, push the release button and take the key out.

The mechanical key can only be inserted in one direction, as the key only has grooves on one side. If the key cannot be inserted in a lock cylinder, turn it over and re-attempt to insert it.

After using the mechanical key, store it in the electronic key. Carry the mechanical key together with the electronic key. If the electronic key battery is depleted or the entry function does not operate properly, you will need the mechanical key.

Smart Access System with Push-button Start

The following operations can be performed simply by carrying the electronic key (including the card key) on your person, for example in your pocket. The driver should always carry the electronic key.

For details on starting the hybrid system, see page 25.

Unlocking and locking the doors from the outside

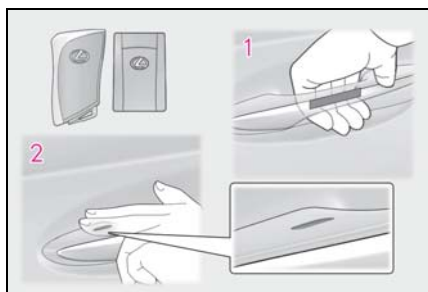

- 1** Grip the driver's door handle to unlock the door. Holding the driver's door handle for approximately 2 seconds unlocks all the doors. Grip any passenger door handle to unlock all the doors.*

Make sure to touch the sensor on the back of the handle.

The doors cannot be unlocked for 3 seconds after the doors are locked.

*: The door unlock settings can be changed.

- 2** Touch the lock sensor (indentation on the upper part of the door handle) to lock all the doors.

Check that the door is securely locked.

Opening the trunk

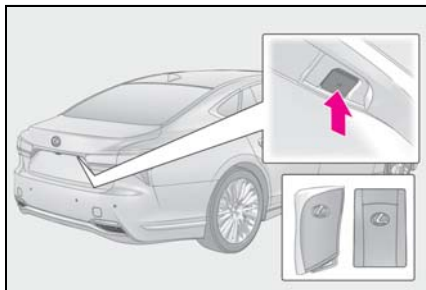

Press the button.

The trunk lid will fully open.

If the button is pressed while the trunk lid is opening, the trunk lid will stop moving.

When all the doors are unlocked using one of the following methods, the trunk can be opened without the electronic key:

- Entry function
- Wireless remote control
- Door lock switches
- Automatic door unlocking system
- Mechanical key

For details on what to do when the electronic key does not operate properly, see page 103.

Front Seats

Adjustment procedure

Seat adjustment switches

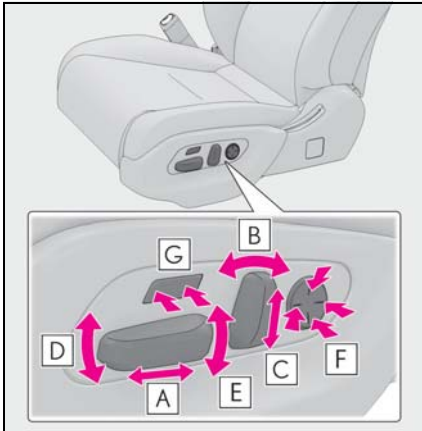

- A** Seat position adjustment
- B** Seatback angle adjustment
- C** Head restraint height adjustment (if equipped)
- D** Seat cushion (front) angle adjustment
- E** Vertical height adjustment
- F** Lumbar support adjustment
- G** Seat cushion length adjustment (if equipped)

Center Display

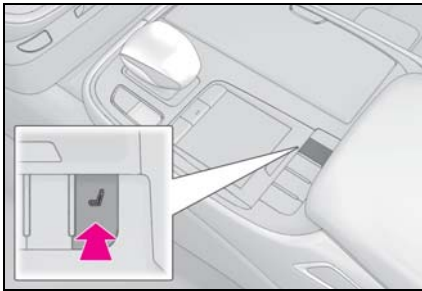

- 1** Press the seat switch.

- 2** Using the Remote Touch pad, select “Driver Seat Adjustment” or “Passenger Seat Adjustment”.

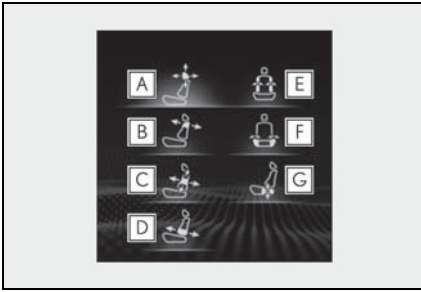

3 Select the button for the desired adjustment.

- A** Head restraint adjustment
- B** Shoulder bolster adjustment (if equipped)
- C** Lumbar support adjustment
- D** Pelvic support adjustment
- E** Seatback side bolster adjustment (if equipped)
- F** Seat cushion side bolster adjustment (if equipped)
- G** Hip support adjustment (if equipped)

4 Perform adjustment using the displayed buttons.

The seat will move while a button is selected.

Operating the front passenger's seat from the driver's seat

■ Using the driver's seat adjustment switches to adjust the front passenger's seat (front passenger mode)

The mode of the driver's seat adjustment switches can be changed to adjust the front passenger's seat.

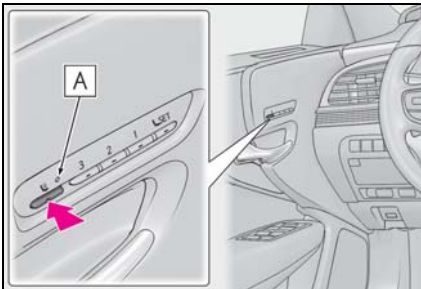

1 Press the mode change button on the driver's side door.

The indicator **A** will illuminate when front passenger mode is selected.

2 Using the seat adjustment switches on the driver's seat, adjust the front passenger's seat.

To cancel front passenger mode, press the mode change button again.

Front passenger mode will be canceled automatically if the driver's seat adjustment switches are not operated for approximately 30 seconds.

■ Using the Center Display (vehicles with a foldable head restraint)

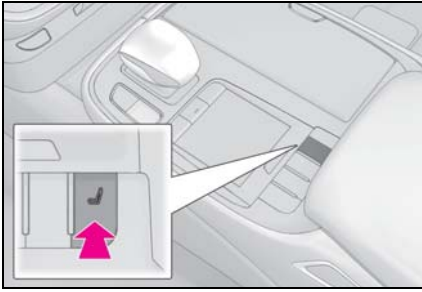

1 Press the seat switch.

2 Press the sub function button of the Remote Touch. (→P.47)



3 Select the button for the desired operation.

A Moves the front passenger's seat forward and folds the seatback and head restraint forward

B Moves the front passenger's seat backward and the seatback and head restraint to the upright position

If the rear seat behind the front passenger's seat is not in the upright position, it will move to the upright position before the front passenger's seat moves to its upright position.

To stop the front passenger seat while it is moving, select the **A** or **B** button or press the seat switch.

Power Rear Seat (if equipped)

Returning the rear seat from the front seats

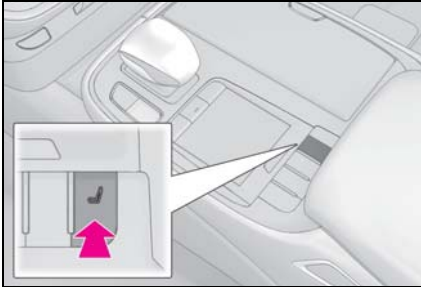

- 1 Press the seat switch.

- 2 Press the sub function button of the Remote Touch. (→P.47)

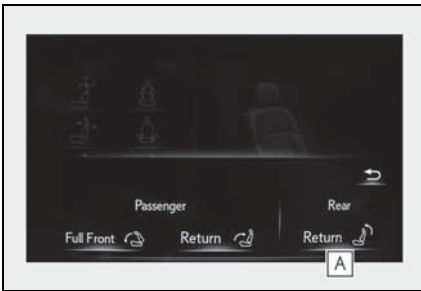

- 3 Select **A**.

The rear seat will move to the upright position.

Driving Position Memory

This feature automatically adjusts the positions of the front seats, steering wheel, outside rear view mirrors and head-up display (if equipped) to make entering and exiting the vehicle easier or to suit your preferences.

Up to 3 different driving positions can be recorded.

Recording a driving position into memory

- 1 Turn the power switch to ON mode.
- 2 Check that the shift position is in P.
- 3 Adjust the driver's seat, steering wheel, outside rear view mirrors and head-up display (if equipped) to the desired positions.

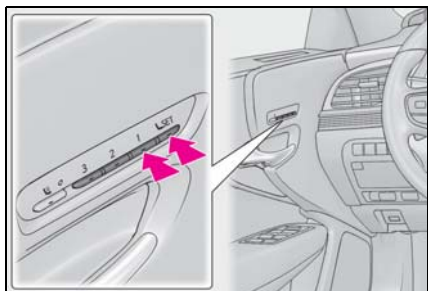

- 4 While pressing the "SET" button, or within 3 seconds after the "SET" button is pressed, press button "1", "2" or "3" until the buzzer sounds.

If the selected button has already been preset, the previously recorded position will be overwritten.

When the driver's seat adjustment switches are in front passenger mode (→P.20), the position of the driver's seat cannot be registered.

To record the position of the front passenger's seat, adjust the front passenger's seat to the desired position and perform step 4 using the buttons on the front passenger's side.

Recalling a driving position

- 1 Turn the power switch to ON mode.
- 2 Check that the shift position is in P.

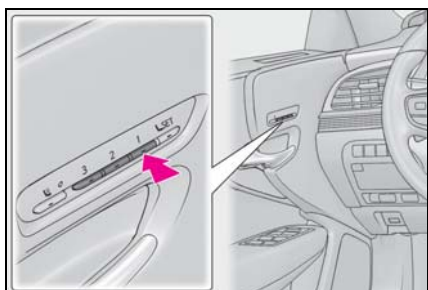

- 3 Press one of the buttons for the driving position you want to recall until the buzzer sounds.

When the driver's seat adjustment switches are in front passenger mode (→P.20), a driving position cannot be recalled.

Memory recall function (driver's side only)

Each electronic key (including a card key) can be registered to recall your preferred driving position.

■ Registering procedure

Record your driving position to button "1", "2" or "3" before performing the following:

Carry only the key you want to register, and then close the driver's door.

If 2 or more keys are in the vehicle, the driving position cannot be recorded properly.

- 1 Turn the power switch to ON mode.
- 2 Check that the shift position is in P.
- 3 Recall the driving position that you want to record.

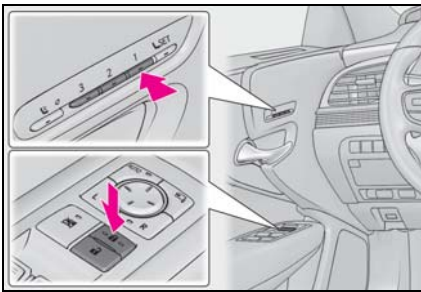

- 4 While pressing the recalled button, press and hold the door lock switch (either lock or unlock) until the buzzer sounds.

If the button could not be registered, the buzzer sounds continuously for approximately 3 seconds.

Power (Ignition) Switch

Performing the following operations when carrying the electronic key on your person starts the hybrid system or changes power switch modes.

Starting the hybrid system

- 1 Press the parking brake switch to check that the parking brake is set.

The parking brake indicator will come on.

- 2 Firmly depress the brake pedal.



and a message will be displayed on the multi-information display.

If it is not displayed, the hybrid system cannot be started.

When the shift position is N, the hybrid system cannot start. Shift the shift position to P when starting the hybrid system.

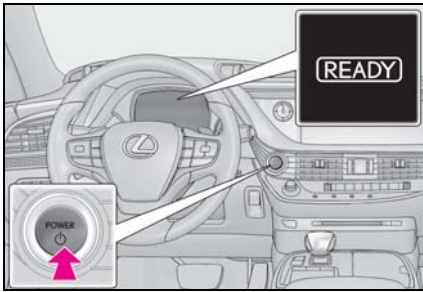

- 3 Press the power switch shortly and firmly.

When operating the power switch, one short, firm press is enough. It is not necessary to press and hold the switch.

If the “READY” indicator turns on, the hybrid system will operate normally.

Continue depressing the brake pedal until the “READY” indicator is illuminated.

The hybrid system can be started from any power switch mode.

- 4 Check that the “READY” indicator is illuminated.

The vehicle cannot be driven if the “READY” indicator is off.

Stopping the hybrid system

- 1 Stop the vehicle completely.
- 2 If the parking brake is in manual mode, set the parking brake.
- 3 Shift the shift position to P. (→P.29)
Check that the shift position indicator shows P and the parking brake indicator is illuminated.
- 4 Press the power switch.
- 5 Release the brake pedal and check that "ACCESSORY" or "IGNITION ON" is not shown on the meter.

Changing power switch modes

Modes can be changed by pressing the power switch with the brake pedal released. (The mode changes each time the switch is pressed.)

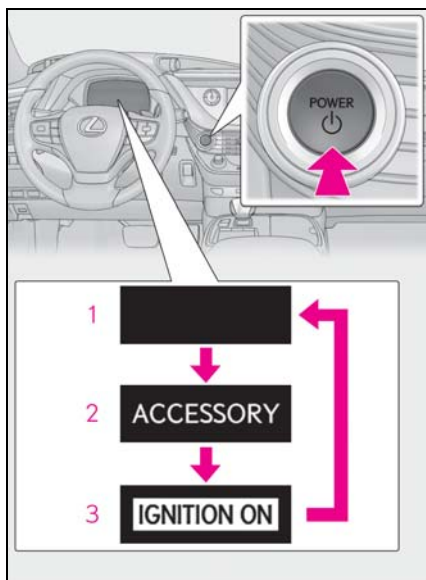

- 1 Off
The emergency flashers can be used.
- 2 ACCESSORY mode
Some electrical components such as the audio system can be used.
"ACCESSORY" will be displayed on the meter.
- 3 ON mode
All electrical components can be used.
"IGNITION ON" will be displayed on the meter.

If your vehicle has to be stopped in an emergency

Only in an emergency, such as if it becomes impossible to stop the vehicle in the normal way, stop the vehicle using the following procedure:

- 1** Steadily step on the brake pedal with both feet and firmly depress it.
Do not pump the brake pedal repeatedly as this will increase the effort required to slow the vehicle.
- 2** Shift the shift position to N.
- ▶ **If the shift position is shifted to N**
- 3** After slowing down, stop the vehicle in a safe place by the road.
- 4** Stop the hybrid system.
- ▶ **If the shift position cannot be shifted to N**
- 3** Keep depressing the brake pedal with both feet to reduce vehicle speed as much as possible.

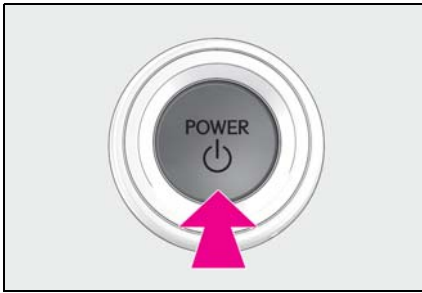

- 4** To stop the hybrid system, press and hold the power switch for 2 consecutive seconds or more, or press it briefly 3 times or more in succession.

- 5** Stop the vehicle in a safe place by the road.

EV Drive Mode

In EV drive mode, electric power is supplied by the hybrid battery (traction battery), and only the electric motor (traction motor) is used to drive the vehicle.

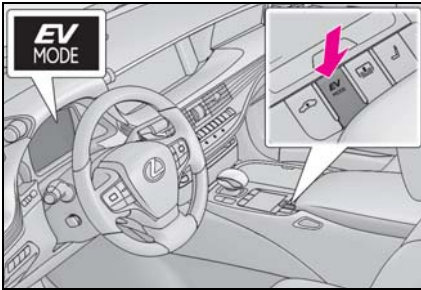

Turns EV drive mode on/off

When EV drive mode is turned on, the EV drive mode indicator will come on. Pressing the switch when in EV drive mode will return the vehicle to normal driving (using the gasoline engine and electric motor [traction motor]).

Hybrid Transmission

Shifting the shift lever

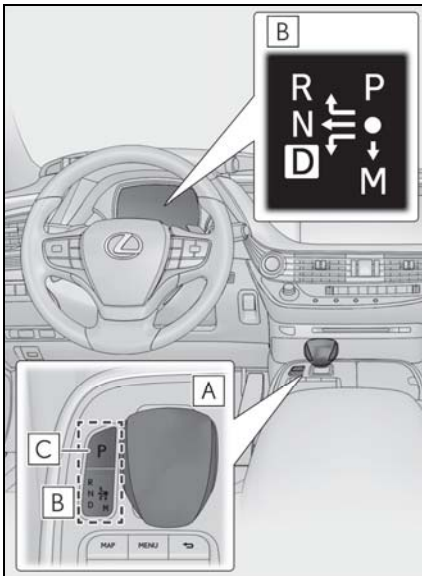

A Shift lever

Operate the shift lever gently and securely in the direction of the arrow on the shift position indicator.

To shift to N, slide the shift lever in the direction of the arrow and hold it.

Release the shift lever after each shifting operation to allow it to return to its regular position (●).

Shifting to M is only possible when the shift position is in D.

When shifting from P to N, D or R, from N, D, M or R to P, from D or M to R, or from R to D, ensure that the brake pedal is being depressed and the vehicle is stationary.

B Shift position indicator

Meter display:

The current shift position is highlighted.

When any shift position other than D or M is selected, the arrow toward M and the M position indicator are displayed in gray.

Shift lever display:

The current shift position is illuminated.

When selecting the shift position, make sure that the shift position has been changed to the desired position by checking the shift position indicator provided on the instrument cluster.

C P position switch

Shift position purpose and functions

Shift position	Objective or function
P	Parking the vehicle/starting the hybrid system
R	Reversing
N	Neutral (Condition in which the power is not transmitted)
D	Normal driving ^{*1}
M	M mode driving ^{*2}

*1: To improve fuel efficiency and reduce noise, set the shift position in D for normal driving. You can choose gear range suitable for your driving situation by operating the paddle shift switches.

*2: Any gear range can be fixed when driving in M mode.

P position switch

■ When shifting the shift position to P

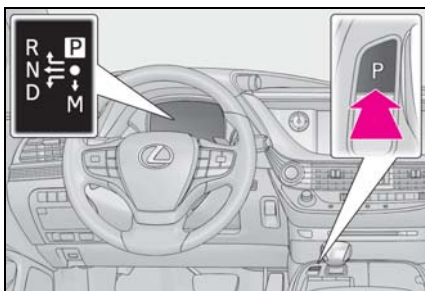

Fully stop the vehicle and set the parking brake, and then press the P position switch.

When the shift position is changed to P, the switch illuminates.

Check that the shift position indicator shows P.

■ Shifting the shift position from P to other positions

- While depressing the brake pedal firmly, operate the shift lever. If the shift lever is operated without depressing the brake pedal, the buzzer will sound and the shifting operation will be disabled.
- When selecting the shift position, make sure that the shift position has been changed to the desired position by checking the shift position indicator provided on the instrument cluster.
- The shift position cannot be changed from P to M directly.

Selecting the driving mode

■ Driving mode

→P.45

■ Snow mode

Snow mode can be selected to suit the conditions when driving on slippery road surfaces, such as on snow.

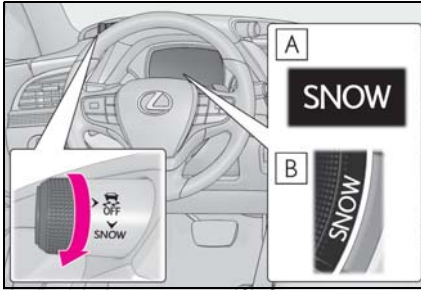

Turn the snow mode switch backward.

The snow mode indicator illuminates.

Turn the snow mode switch backward again to return to normal mode.

A Except F SPORT models

B F SPORT models

Selecting shift ranges in the D position

When the “-” paddle shift switch is operated, the shift range switches to a range that enables engine braking force that is suitable to driving conditions. When the “+” paddle shift switch is operated, the shift range switches to a range that is one range higher than the current range.

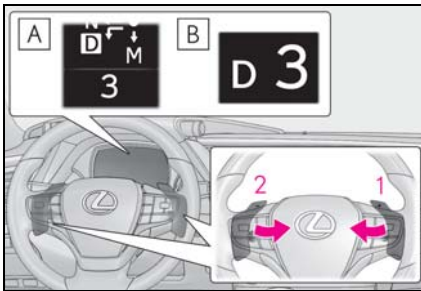

1 Upshifting

2 Downshifting

The selected shift range, from D1 to D10, will be displayed on the meter.

A Except F SPORT models

B F SPORT models

Meter display	Function
D2 - D10	A gear in the range between D1 and the selected shift range is automatically chosen depending on vehicle speed and driving conditions
D1	Setting the shift range at D1

A lower shift range will provide greater engine braking forces than a higher shift range.

Selecting gears in the M position

To enter M mode, shift the shift position to M. Gears can be selected by operating the paddle shift switches, allowing you to drive in the gear of your choosing.

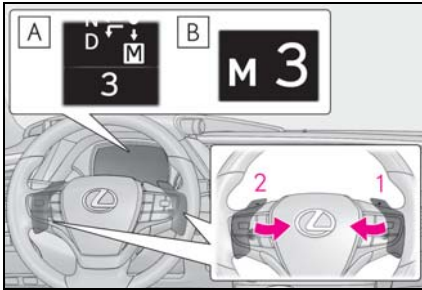

1 Upshifting

2 Downshifting

The gear changes once every time the paddle shift switch is operated.

The selected gear, from M1 to M10, will be fixed and displayed on the meter.

A Except F SPORT models

B F SPORT models

When in the M position, the gear will not change unless the paddle shift switches are operated.

However, even when in the M position, the gears will be automatically changed in the following situations:

- When vehicle speed drops (downshift only).
- When vehicle speed increases (upshift only).
- When the accelerator pedal is firmly depressed.
- When it is necessary to protect the transmission when the transmission fluid temperature is high or low, or other reasons.

Also, the gear will not shift when the vehicle speed is low, even if an upshift operation is performed.

Turn Signal Lever

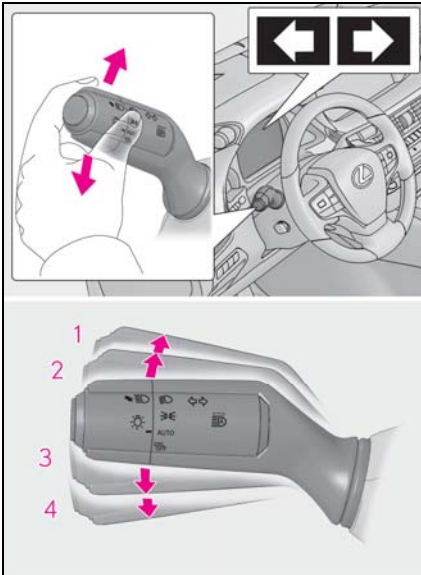

- 1 Right turn
- 2 Lane change to the right (move the lever partway and release it)
The right hand signals will flash 3 times.
- 3 Lane change to the left (move the lever partway and release it)
The left hand signals will flash 3 times.
- 4 Left turn

Parking Brake

The parking brake can be set or released automatically or manually.

Using the manual mode

The parking brake can be set and released manually.

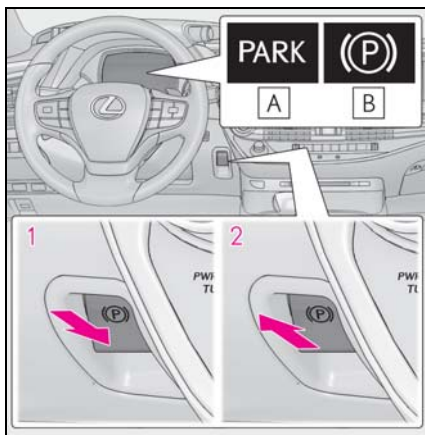

- 1 Push the switch to set the parking brake

The parking brake indicator light will turn on.

Press and hold the parking brake switch if an emergency occurs and it is necessary to operate the parking brake while driving.

- 2 Pull the switch to release the parking brake

- Operate the parking brake switch while depressing the brake pedal.
- Using the parking brake automatic release function, the parking brake can be released by depressing the accelerator pedal. When using this function, slowly depress the accelerator pedal.

Make sure that the parking brake indicator light turn off.

- A** U.S.A.
- B** Canada

Turns automatic mode on

In automatic mode, the parking brake can be set or released automatically according to the shift lever operation. Also, even in automatic mode, the parking brake can be set or released manually.

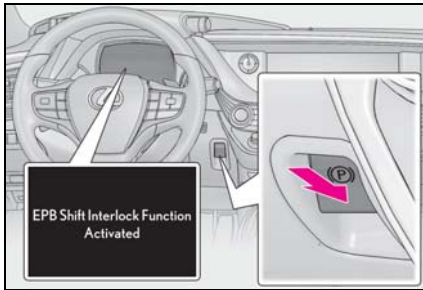

While the vehicle is stopped, press and hold the parking brake switch until a message is shown on the multi-information display.

When the automatic mode is turned on, the parking brake operates as follows.

- When the shift position is shifted from P, the parking brake will be released, and the parking brake indicator light will turn off.
- When the shift position is shifted to P, the parking brake will be set, and the parking brake indicator light will turn on.

Operate the shift lever and P position switch with the vehicle stopped and the brake pedal depressed.

Turns automatic mode off

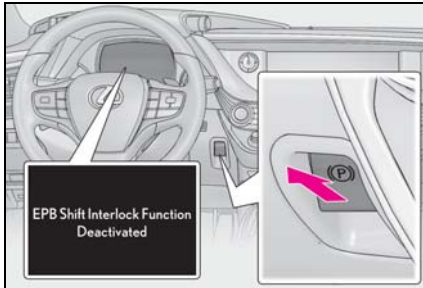

While the vehicle is stopped, pull and hold the parking brake switch until a message is shown on the multi-information display.

Brake Hold

The brake hold system keeps the brake applied when the shift position is in D, M or N with the system on and the brake pedal has been depressed to stop the vehicle. The system releases the brake when the accelerator pedal is depressed with the shift position in D or M to allow smooth start off.

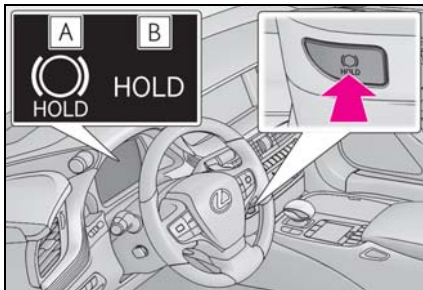

Press the brake hold switch to turn the system on

The brake hold standby indicator (green)

A comes on. While the system is holding the brakes, the brake hold operated indicator (yellow) **B** comes on.

Multi-information Display

Display and menu icons

■ Display (except F SPORT models)



By selecting menu icons on the multi-information display, a variety of driving-related information can be displayed. The multi-information display can also be used to change display settings and other vehicle settings.

Warning or suggestion/advice pop-up displays are also displayed in certain situations.

■ Display (F SPORT models)

▶ Main meter in center position

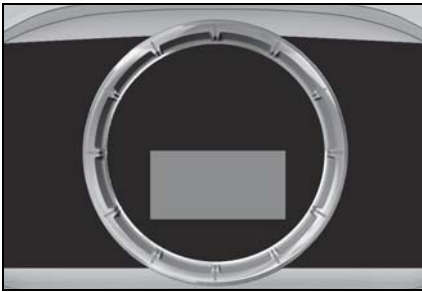

The multi-information display presents the driver with a variety of driving-related information.

Warning or suggestion/advice pop-up displays are also displayed in certain situations.

▶ Main meter moved to the right



By selecting menu icons on the multi-information display, a variety of driving-related information can be displayed. The multi-information display can also be used to change display settings and other vehicle settings.

Warning or suggestion/advice pop-up displays are also displayed in certain situations.

■ Menu icons



Driving information display



Navigation system-linked display (if equipped)



Audio system-linked display



Driving support system information display



Warning message display



Settings display

If a problem is detected in any of the vehicle's systems, a warning message is shown on the multi-information display.

Changing the meter display

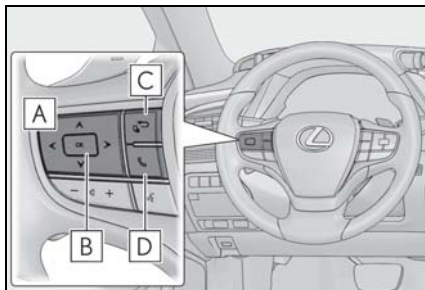

- A** < / > : Select menu icons
&^ / &v : Change displayed content, scroll up/down the screen and move the cursor up/down
- B** Press: Enter/Set
Press and hold: Reset
- C** Move the main meter* and return to the previous screen
- D** Call sending/receiving and history display

*: F SPORT models

Head-up Display (if equipped)

The head-up display projects a variety of driving-related information and the operating state of the driving support systems on the windshield.

System components

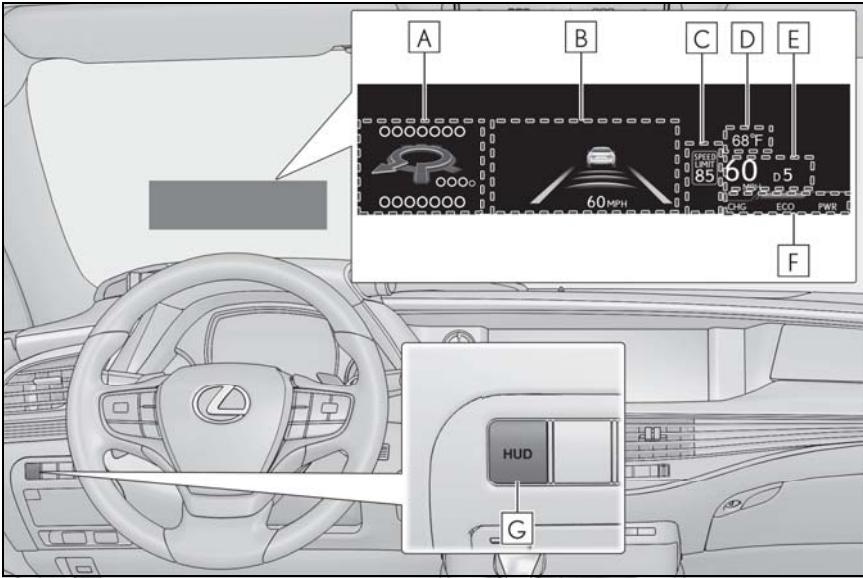

- A** Navigation system-linked display area (if equipped)
- B** Driving support system display area
- C** Speed limit/RSA (Road Sign Assist) display area (if equipped)
- D** Outside temperature display area
- E** Driving information display area
- F** Hybrid System Indicator/tachometer display area
- G** HUD (Head-up display) switch

Using the head-up display

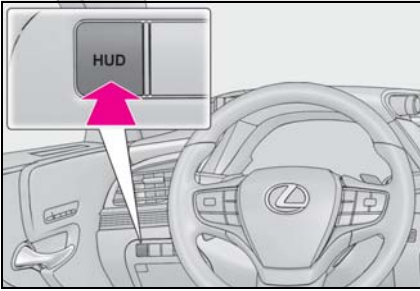

Pressing the switch turns the head-up display on/off.

The head-up display may seem dark or hard to see when viewed through sunglasses, especially polarized sunglasses. Adjust the brightness of the head-up display or remove your sunglasses.

Headlight Switch

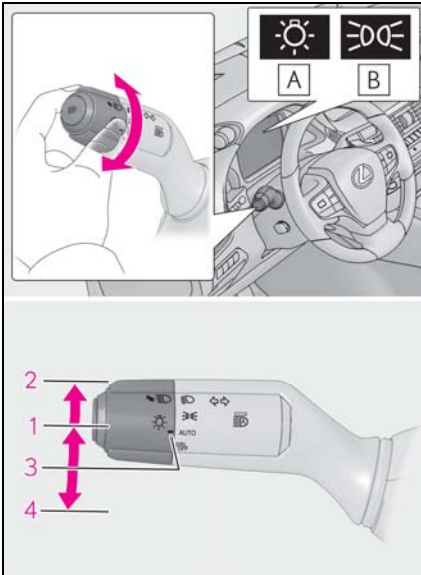

- 1** ☰☑ The side marker, parking, tail, license plate, instrument panel lights, and daytime running lights turn on.
- 2** ☰☑ The headlights and all lights listed above (except daytime running lights) turn on.
- 3** AUTO The headlights, daytime running lights and all the lights listed above turn on and off automatically.
- 4** $\begin{matrix} \text{DRL} \\ \text{OFF} \end{matrix}$ (U.S.A.) Off
○ (Canada) The daytime running lights turn on.

A U.S.A.

B Canada

Turning on the high beam headlights

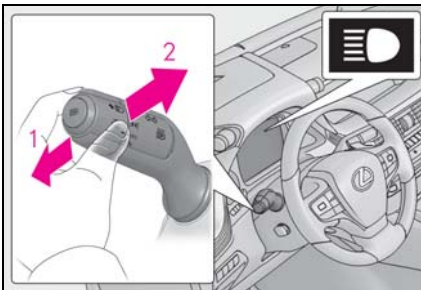

- 1** With the headlights on, push the lever away from you to turn on the high beams.
Pull the lever toward you to the center position to turn the high beams off.
- 2** Pull the lever toward you and release it to flash the high beams once.
You can flash the high beams with the headlights on or off.

AHB (Automatic High Beam)

The Automatic High Beam uses a camera sensor located behind the upper portion of the windshield to assess the brightness of the lights of vehicles ahead, streetlights, etc., and automatically turns the high beams on or off as necessary.

Activating the Automatic High Beam

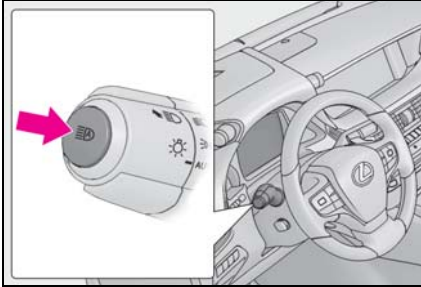

- 1 Press the Automatic High Beam switch.

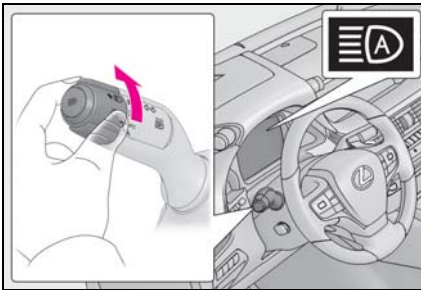

- 2 Turn the headlight switch to the  or AUTO position.

When the headlight switch lever is in the low beam position, the AHB system will be enabled and the AHB indicator will illuminate.

Turning the high beams on/off manually

■ Switching to the low beams

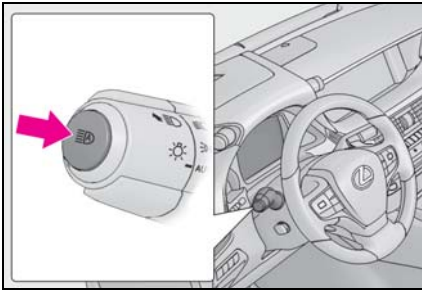

Press the Automatic High Beam switch.

The AHB indicator will turn off.

Press the switch to activate the Automatic High Beam system again.

■ Switching to the high beams

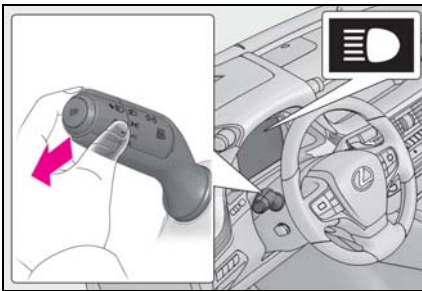

Push the lever away from you.

The AHB indicator will turn off and the high beam indicator will turn on.

Pull the lever to its original position to activate the Automatic High Beam system.

Windshield Wipers and Washer

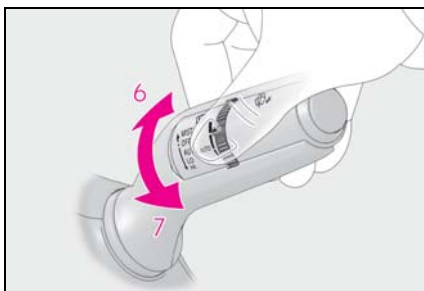
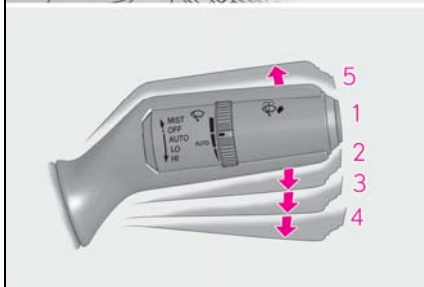
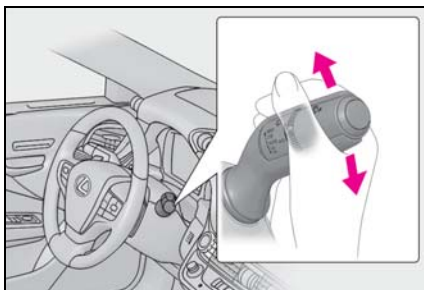

1 OFF (U.S.A.) or ○ (Canada)
Off

2 AUTO Rain-sensing wiper operation

The wipers will operate automatically when the sensor detects falling rain. The system automatically adjusts wiper timing in accordance with rain volume and vehicle speed.

3 LO (U.S.A.) or ▼ (Canada)
Low speed wiper operation

4 HI (U.S.A.) or ▼ (Canada)
High speed wiper operation

5 MIST (U.S.A.) or △ (Canada)
Temporary operation

When AUTO is selected, the sensor sensitivity can be adjusted by turning the switch ring.

6 Increases the sensitivity

7 Decreases the sensitivity

8  Washer/wiper dual operation

Pulling the lever operates the wipers and washer.

(After operating several times, the wipers operate once more time after a short delay to prevent dripping. However, the dripping prevention does not operate while the vehicle is moving.)

Vehicles with headlight cleaners:

When the power switch is in ON mode and the headlights are on, if the lever is pulled, the headlight cleaners will operate once. After this, the headlight cleaners will operate every 5th time the lever is pulled.

Driving Mode Select Switch

The driving modes can be selected to suit driving condition.

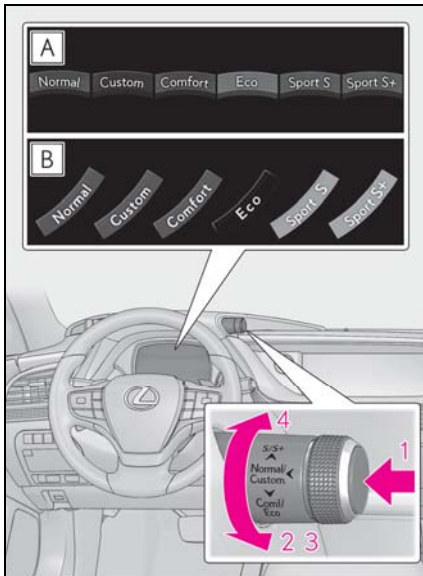

1 Normal mode/Custom mode

Normal mode and custom mode are selected by pressing the driving mode select switch. Each time the switch is pressed, the driving mode changes between normal mode and custom mode.

When normal mode is selected, the normal mode indicator comes on.

When custom mode is selected, the custom mode indicator comes on.

Press the switch to change the driving mode to normal mode when not in normal mode.

• Normal mode

Provides an optimal balance of fuel economy, quietness, and dynamic performance. Suitable for city driving.

When the shift position is in D, an appropriate gear for sporty driving may automatically be selected according to driver performance and driving conditions.

• Custom mode

Allows you to drive with the powertrain, chassis and air conditioning system functions set to your preferred settings. Custom mode settings can only be changed on the drive mode customization display of the Center Display.

2 Comfort mode

By controlling the suspension, riding comfort is further enhanced. Suitable for city driving.

When not in comfort mode and the driving mode select switch is turned backward, the comfort mode indicator comes on.

3 Eco drive mode

Helps the driver accelerate in an eco-friendly manner and improve fuel economy through moderate throttle characteristics and by controlling the operation of the air conditioning system (heating/cooling).

When in comfort mode, if the driving mode select switch is turned backward, the Eco drive mode indicator comes on.

4 Sport mode

- Sport S mode

Controls the hybrid system to provide quick, powerful acceleration. This mode is suitable for when agile driving response is desired, such as when driving on roads with many curves.

When not in Sport S mode, if the driving mode select switch is turned forward, the Sport S mode indicator comes on.

- Sport S+ mode

Helps to ensure steering performance and driving stability by simultaneously controlling the steering and suspension in addition to the hybrid system. Suitable for sportier driving.

When in Sport S mode, if the driving mode select switch is turned forward, the Sport S+ mode indicator comes on.

A Except F SPORT models

B F SPORT models

Remote Touch

The Remote Touch can be used to operate the Center Display.

Remote Touch is the name for the device that includes the “MAP” button, “MENU” button, back button, touchpad and sub function button.

Names and operations of each part

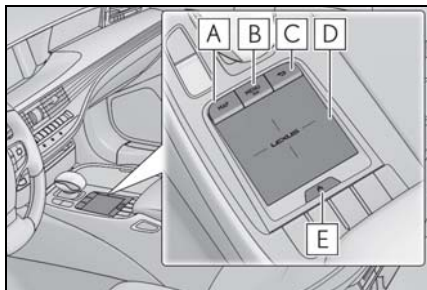

A “MAP” button

Vehicles with navigation function:

Press this button to display the vehicle’s current position.

Vehicles without navigation function:

Press this button to display the compass mode screen.

B “MENU” button

Press this button to display the menu screen.

C Back button

Press this button to display the previous screen.

D Touchpad

Slide your finger on the touchpad and move the pointer to select a function, letter and screen button.

Press the touchpad to enter the selected function, letter or screen button. Certain finger movements on the touchpad can perform functions, such as changing map scalings and scrolling list screens.

E Sub function button









When  is displayed on the screen, a function screen assigned to the screen can be displayed.

Center Display

Menu screen

Press the “MENU” button on the Remote Touch to display the menu screen.



Switch	Function
	Select to display the “Destination” screen. (→P.54)
	Select to display the media control screen or the audio control screen. *2 (→P.64, 65, 66, 67)
	Select to display the hands-free control screen. (→P.60)
	Select to display the “Apps” screen. *1,2
	When an Apple CarPlay connection is established and button displays “Apple CarPlay”, select to display the home screen of Apple CarPlay. *1,2
	Select to display the information screen. (→P.51)
	Select to display the setup screen. *2
	Select to display the air conditioning control screen. (→P.70)

*1: This function is not made available on some models.

*2: Refer to the “NAVIGATION AND MULTIMEDIA SYSTEM OWNER'S MANUAL”.

Split-screen display

Different information can be displayed on the left and right sides of the screen. For example, air conditioning system screen can be displayed and operated while the fuel consumption information screen is being displayed. The large screen on the left of the display is called the main display, and the small screen to the right is called the side display.

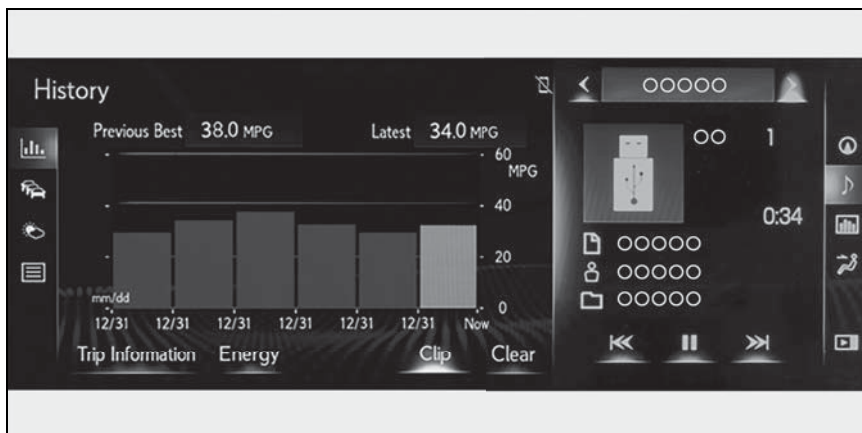

Side display

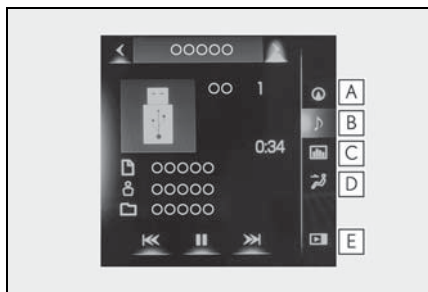

The following functions can be displayed and operated on the side display.

- A** Navigation system (→P.54)
- B** Audio (→P.64, 65, 66, 67)
- C** Vehicle information (→P.53)
- D** Air conditioning system (→P.72)
- E** Show/hide the side display

Screen scroll operation

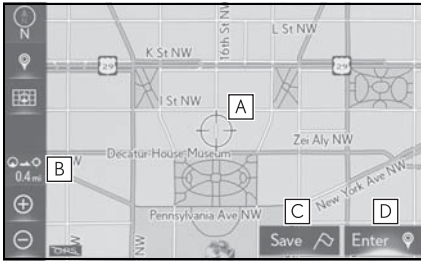

Select the desired point on the map screen.
Move the desired point on the center of the map screen.

- A** Cursor mark
- B** Distance from the current position to the cursor mark
- C** Select to register as a memory point
- D** Select to set as a destination

Press the “MAP” button on the Remote Touch to return to the current position.

Editing route

While route guidance is operating, you can change the route using the following method.

1 Select  on the map screen.

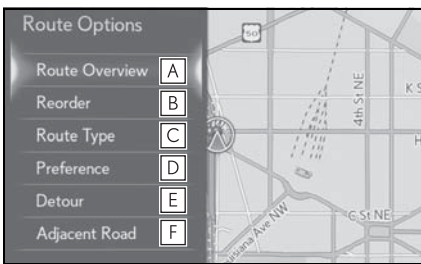

2 Select the desired item to be set.

- A** Select to display the overview of the entire route
- B** Select to reorder destinations
- C** Select to change route type
- D** Select to set route preferences
- E** Select to set detours
- F** Select to start from adjacent road

3 Check that the route overview is displayed.

Some functions are unavailable while the vehicle is in motion. Refer to the “NAVIGATION AND MULTIMEDIA SYSTEM OWNER’S MANUAL”.

Energy Monitor/Consumption Screen

The state of the hybrid system can be viewed on the multi-information display and Center Display.

The energy monitor or consumption screen can be displayed and operated on the side display. For details, refer to the "OWNER'S MANUAL".

Energy monitor

■ How to display on the Center Display

Press the "MENU" button on the Remote Touch, then select  on the menu screen.

If a screen other than "Energy monitor" is displayed, select "Energy".

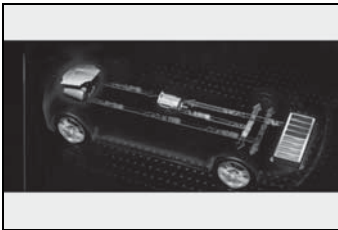

The flow of energy is displayed on the Center Display.





Red: gasoline energy

Amber: electrical energy

Light blue: energy recovery

A light blue arrow appears when regenerative braking occurs.

■ How to display on the multi-information display

Press the  or  meter control switch and select , and then press  or  to select the energy monitor display.



The flow of energy is indicated by the movement of the arrows on the multi-information display.

Red: gasoline energy

Amber: electrical energy

Light blue: energy recovery

A light blue arrow appears when regenerative braking occurs.

The displayed energy flow, battery level, etc. will change in response to the current driving conditions.

Consumption

Press the “MENU” button on the Remote Touch, then select  on the menu screen.

Trip information

If a screen other than “Trip Information” is displayed, select “Trip Information”.

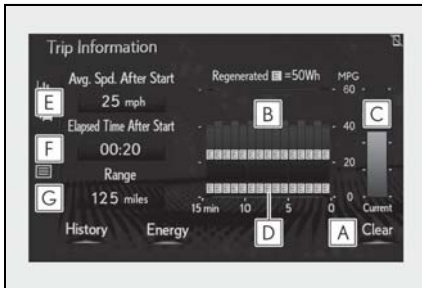

- A** Resetting the consumption data
- B** Fuel consumption in the past 15 minutes
- C** Current fuel consumption
- D** Regenerated energy in the past 15 minutes

One symbol indicates 50 Wh. Up to 5 symbols are shown.

- E** Average vehicle speed since the hybrid system was started.
- F** Elapsed time since the hybrid system was started.
- G** Cruising range

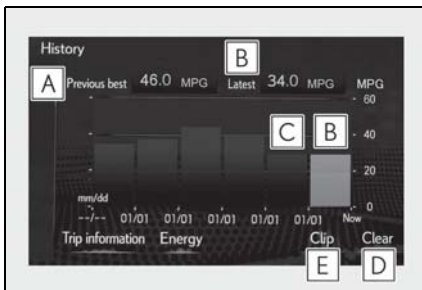

History

If a screen other than “History” is displayed, select “History”.



- A** Best recorded fuel consumption
- B** Latest fuel consumption
- C** Previous fuel consumption record
- D** Resetting the history data
- E** Updating the latest fuel consumption data

Side display

Display the vehicle information on the side display, and then select  or  to display the desired screen.

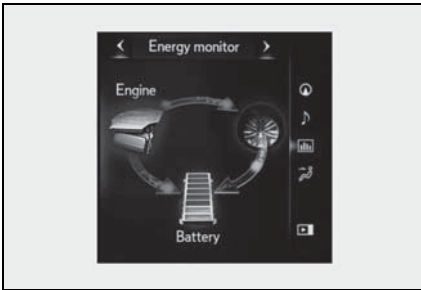

- Trip information (type A/type B)
- History
- Energy monitor

Navigation System (if equipped)

Registering home

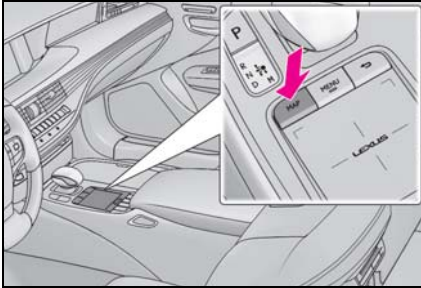

- 1 Press the "MAP" button on the Remote Touch.

Please refer to P.47 for the Remote Touch operation.

- 2 Select .
- 3 Select .
- 4 Select "Yes".
- 5 Select "OK".
Registration of home is complete.

Destination search

■ Searching by address

There are 2 methods to search for a destination by address.

- 1 Display the destination search screen by either operation:

- "MAP" button → 
 - "MENU" button → "Destination"
- 2 Select "Address".

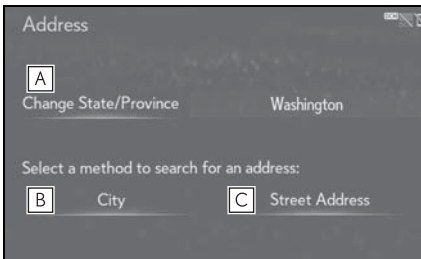

- 3 Select the desired search method.
 - A Select to change the search area.
 - B Select to search by city.
 - C Select to search by street address.

► **Searching by city (B)**

4 Select "City".

5 Enter a city name and select "Search".

"Last 5 Cities": Select the desired city name from the list of the last 5 cities.

6 Select the desired city name.

7 Enter a street name and select "Search".

8 Select the desired street name.

9 Enter a house number and select "Search".

► **Searching by street address (C)**

4 Select "Street Address".

5 Enter a house number and select "Search".

6 Enter a street name and select "Search".

7 Select the desired street name.

8 Enter a city name and select "Search".

9 Select the desired city name.

■ Searching by point of interest

There are 3 methods to search for a destination by Point of Interest.

1 Display the destination search screen by either operation:

- “MAP” button → 
- “MENU” button → “Destination”

2 Select “Point of Interest”.

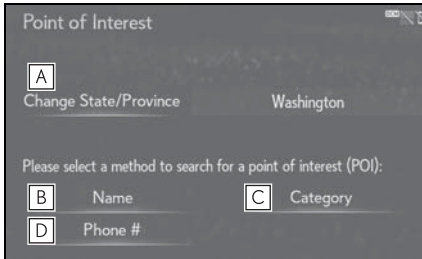

► Searching by name (B)

4 Select “Name”.

5 Enter a POI name and select “Search”.

6 Select the desired POI.

3 Select the desired search method.

A Select to change the search area.

B Select to search by name.

C Select to search by category.

D Select to search by phone number.

► **Searching by category (C)**

4 Select "Category".

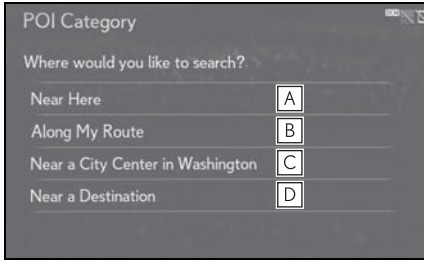

6 Select the desired POI category.

7 Select the desired POI.

► **Searching by phone number (D)**

4 Select "Phone #".

5 Enter a phone number and select "OK".

5 Select the desired search point.

A Select to search for POIs near your current position.

B Select to search for POIs along the set route.

C Select to search for POIs near a specific city center.

D Select to search for POIs near a destination. When more than 1 destination has been set, a list will be displayed on the screen. Select the desired destination.

Hands-free System For Cellular Phone

Registering/connecting a Bluetooth® device

To use the hands-free system, it is necessary to register a Bluetooth® phone with the system. Please refer to the cellular phone manufacturer's user guide for pairing procedures, or go to <http://www.lexus.com/MobileLink> to find approved Bluetooth® phones for this system.

- 1 Turn the Bluetooth® connection setting of your cellular phone on.
- 2 Press the "MENU" button on the Remote Touch.
Please refer to P.47 for the Remote Touch operation.
- 3 Select "Phone".
- 4 Select "Yes" to register a phone.

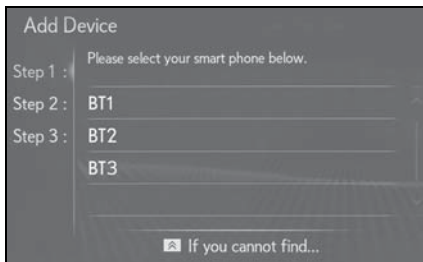

- 5 Select the desired Bluetooth® device.
- 6 Register the Bluetooth® device using your Bluetooth® device.
- 7 Check that the following screen is displayed, indicating pairing was successful.
- 8 Check that "Connected" is displayed and registration is complete.

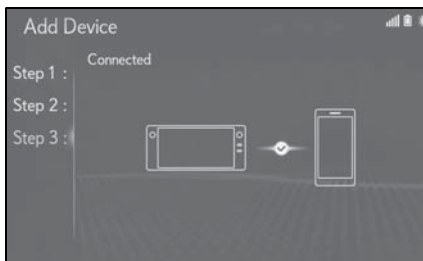

Contacts transfer

- 1** Press the "MENU" button on the Remote Touch.
Please refer to P.47 for the Remote Touch operation.
 - 2** Select "Setup".
 - 3** Select "Phone" on the sub menu.
 - 4** Select "Contacts/Call History".
 - 5** Select "Transfer Contacts from Device".
 - 6** Select "From Phone (Bluetooth*)".
 - 7** Transfer the contact data to the system using a Bluetooth® phone.
 - 8** Check that a confirmation screen is displayed when the operation is complete.
- *: The Bluetooth® word mark and logos are registered trademarks owned by Bluetooth SIG, Inc.

Contacts transfer may not be possible depending on the type of phone.



Registering the contacts in the favorites list

- 1 Press the "MENU" button on the Remote Touch.
Please refer to P.47 for the Remote Touch operation.
- 2 Select "Setup".
- 3 Select "Phone" on the sub menu.
- 4 Select "Contacts/Call History".
- 5 Select "Add Favorite".
- 6 Select the desired contact to add to the favorites list.
- 7 Check that a confirmation screen is displayed when the operation is complete.

Calling by favorites list

- 1 Press the "MENU" button on the Remote Touch.
Please refer to P.47 for the Remote Touch operation.
- 2 Select "Phone".
- 3 Select "Favorites" on the sub menu and select the desired contact.
- 4 Select the desired number.
- 5 Check that the dialing screen is displayed.

Calling the message sender

- 1 Press the "MENU" button on the Remote Touch.
Please refer to P.47 for the Remote Touch operation.
- 2 Select "Phone".
- 3 Select "Message" on the sub menu.
- 4 Select a desired account name that is displayed on the left side of screen.
- 5 Select the desired message from the list.
- 6 Select , or press the  switch on the steering wheel.
- 7 Check that the dialing screen is displayed.

Receiving a call

Select "Answer" or press the  switch on the steering wheel to talk on the phone.

► Main display

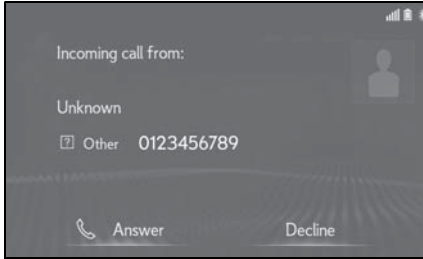

► Side display

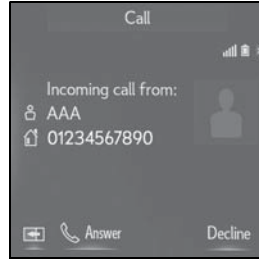

"Decline": Select to refuse to receive the call.

Steering switches

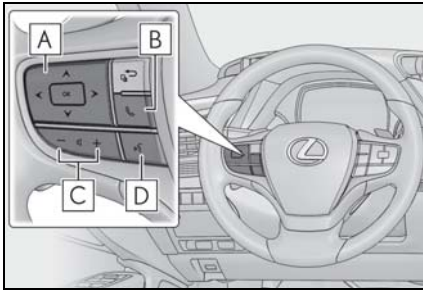

- A** Cursor switch
 - Select and enter the item on the multi-information display.
- B** TEL switch
 - Start talking
 - End talking
 - End dialing
 - If the switch is pressed when an Apple CarPlay connection is established, the Apple CarPlay phone application will be displayed on the system screen.
- C** Volume control switch
 - Press the "+" side to increase the volume.
 - Press the "-" side to decrease the volume.
- D** Talk switch
 - Press the talk switch to start the voice command system.
 - To cancel voice recognition, press and hold the talk switch.

Audio System

Audio control screen

Follow the procedure below to display the audio control screen.

▶ **Using the audio control switch**

Press the “RADIO” or “MEDIA” button.

▶ **Using the Remote Touch**

Press the “MENU” button on the Remote Touch, then select “Radio” or “Media”.

Please refer to P.47 for the Remote Touch operation.

Selecting an audio source

▶ **Using the audio control switch**

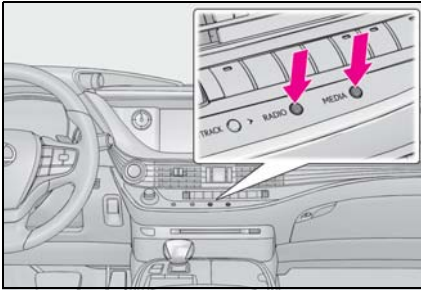

- 1 Press the “RADIO” or “MEDIA” button.

“RADIO” button: Press to change radio modes.

“MEDIA” button: Press to change media modes.

- Each time the “RADIO” or “MEDIA” button is pressed, the audio source changes.

▶ **From the audio source selection screen**

- 1 Display the audio control screen.
- 2 Select “Source” on the sub menu.
- 3 Select the desired source.

Steering switch operation

Some parts of the audio/visual system can be adjusted using the switches on the steering wheel.

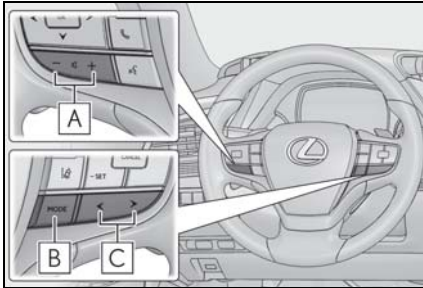

- A** Increases/decreases volume
- B** Press: Change audio modes
Press and hold: Mute/unmute or pause/resume the current operation
- C** AM, FM, HD mode: Selects a radio station
SXM mode: Selects a channel
Audio CD mode: Selects a track
MP3/WMA/AAC disc mode: Selects a file
DVD mode: Selects a chapter
USB mode*: Selects a file/track
iPod mode: Selects a track
Bluetooth® audio mode*: Selects a track

*: When an Apple CarPlay connection is established, this voice commands will be unavailable.

Radio

Audio control switch

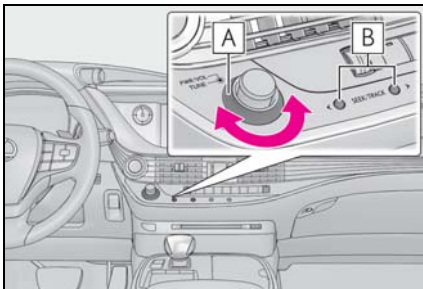

- A** Turn to step up/down frequencies/channels.
- B** Press to seek up/down.
Press and hold for continuous seek.

Control screen

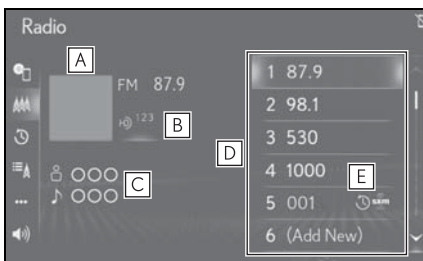

- A** Displays cover art
- B** Select to display HD) multicast channels available
- C** Displays the artist info and song title or album and genre
- D** Select to tune to preset stations/channels
- E** Display items on the channels registered to smart favorites

Presetting a station

- 1** Tune in the desired station.
- 2** Select and hold "(Add New)".

CD

Audio control switch

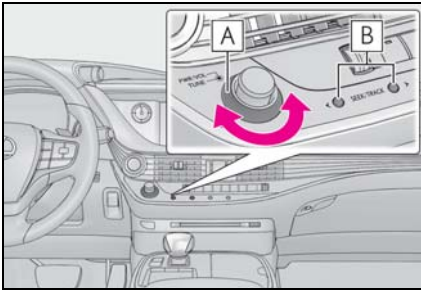

- A** Turn to select a track/file.
- B** Press to select a track/file.
Press and hold to fast forward/rewind.

Control screen

Audio CD

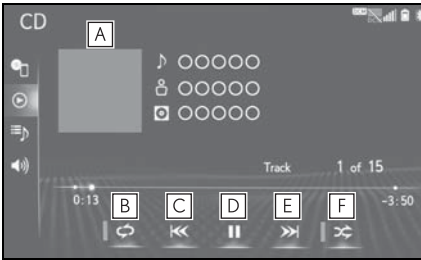

- A** Displays cover art
- B** Select to set repeat playback
- C** Select to change the track.
Select and hold to fast rewind.
- D** Select to play/pause.
- E** Select to change the track.
Select and hold to fast forward.
- F** Select to set random playback

MP3/WMA/AAC disc

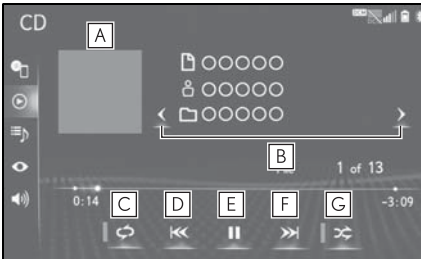

- A** Displays cover art
- B** Select to change the folder
- C** Select to set repeat playback
- D** Select to change the file.
Select and hold to fast rewind.
- E** Select to play/pause.
- F** Select to change the file.
Select and hold to fast forward.
- G** Select to set random playback

DVD

Audio control switch

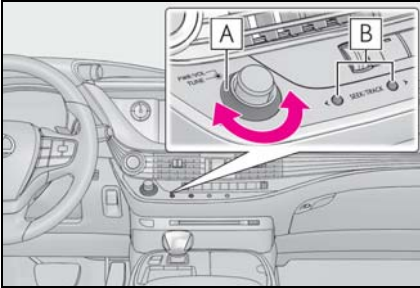

- A** Turn to select a chapter.
- B** Press to select a chapter.
Press and hold to fast forward/rewind.

Control screen

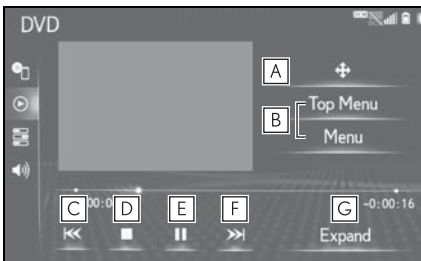

- A** Select to display the menu control key
- B** Select to display the menu screen
- C** Select to change the chapter.
Select and hold to fast rewind.
- D** Select to stop the video screen.
- E** Select to play/pause.
- F** Select to change the chapter.
 - During playback: Select and hold to fast forward.
 - During a pause: Select and hold to slow forward.
- G** Select to display expanded screen video

Audio control switch

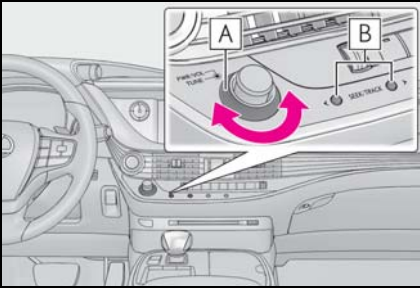

- A** Turn to select a track.
- B** Press to select a track.
Press and hold to fast forward/rewind.

Control screen

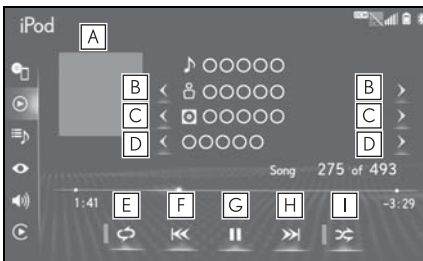



- A** Displays cover art
- B** Select to change the artist.*
- C** Select to change the album.*
- D** Select to change the playlist.*
- E** Select to set repeat playback.
- F** Select to change the track.
Select and hold to fast rewind.
- G** Select to play/pause.
- H** Select to change the track.
Select and hold to fast forward.
- I** Select to set random playback.

*: When an Apple CarPlay connection is established, this switch will not be displayed.

Lexus Climate Concierge

The seat heaters, seat ventilators and heated steering wheel (if equipped) are each automatically controlled according to the set temperature of the air conditioning system, the outside and cabin temperature, etc. Lexus Climate Concierge allows a comfortable condition to be maintained without adjusting each system.

Displaying the Lexus Climate Concierge

Press the “MENU” button on the Remote Touch to display the main menu and move the cursor to  to display the climate control shortcut buttons. Then, select  to display the Lexus Climate Concierge control screen.

Turning on Lexus Climate Concierge



Select 

The indicator on the Lexus Climate Concierge control screen illuminates, and the automatic air conditioning system, seat heaters and ventilators, and heated steering wheel operate in automatic mode.

If any of the system is operated manually, the indicator turns off. However, all other functions continue to operate in automatic mode.

Front Automatic Air Conditioning System

Air outlets and fan speed are automatically adjusted according to the temperature setting.

Control panel

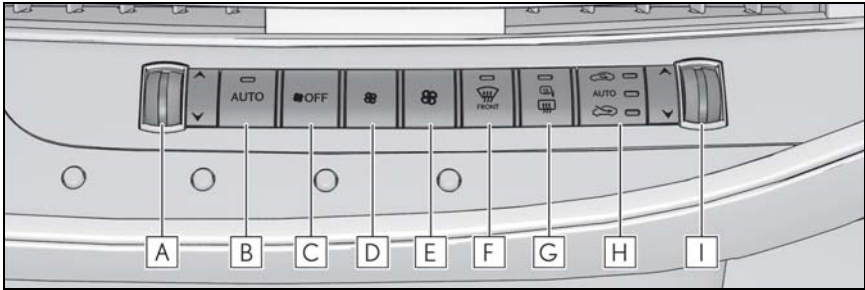

- A** Left-hand side temperature control switch

Operate the temperature control switch upwards to increase the temperature and downwards to decrease the temperature.

- B** Automatic mode switch

- C** Off switch

- D** Fan speed decreases switch

- E** Fan speed increases switch

- F** Windshield defogger switch

- G** Rear window defogger and outside rear view mirror defoggers switch

- H** Outside/recirculated air mode switch

- I** Right-hand side temperature control switch

Operate the temperature control switch upwards to increase the temperature and downwards to decrease the temperature.

Air conditioning control screen

Main control screen

Using the touchpad of the Remote Touch, select the button on the screen.

- Vehicles with DUAL-ZONE climate control ► Vehicles with 4-ZONE climate control

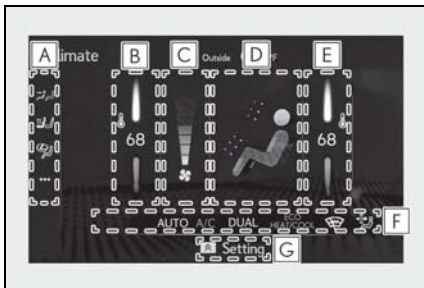

- A** Sub menu
- B** Adjust the left side seat temperature setting
- C** Adjust the fan speed setting
- D** Select the air flow mode
- E** Adjust the right side seat temperature setting
- F** Function on/off indicators
- G** Sub function menu

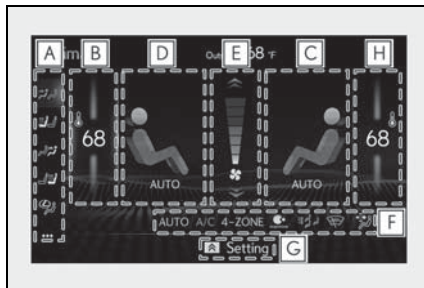

- A** Sub menu
- B** Adjust the left side seat temperature setting
- C** Select the right side seat air flow mode
- D** Select the left side seat air flow mode
- E** Adjust the fan speed setting
- F** Function on/off indicators
- G** Sub function menu
- H** Adjust the right side seat temperature setting

■ Option control screen

Select  on the sub menu to display the option control screen.

The functions can be switched on and off.

When the function is on, the indicator illuminates on the screen.

▶ Vehicles with DUAL-ZONE climate control ▶ Vehicles with 4-ZONE climate control

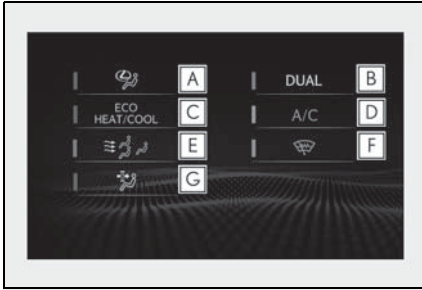

- A** Set Lexus Climate Concierge
- B** Adjusting the temperature for driver and passenger seats separately ("DUAL" mode)
- C** Set eco air conditioning mode
- D** Cooling and dehumidification function
- E** Select front seat concentrated airflow mode
- F** Prevent ice from building up on the windshield and wiper blades (Windshield wiper de-icer) (if equipped)
- G** Removing pollen from the air (Micro dust and pollen filter)

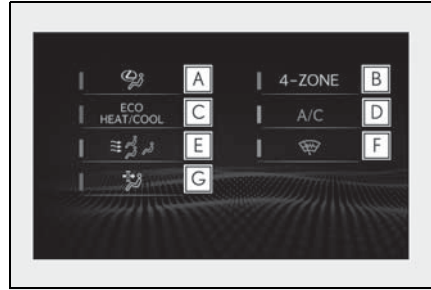

- A** Set Lexus Climate Concierge
- B** Adjust the temperature for driver, passenger and rear seats separately ("4-ZONE" mode)
- C** Set eco air conditioning mode
- D** Cooling and dehumidification function
- E** Select front seat concentrated airflow mode
- F** Prevent ice from building up on the windshield and wiper blades (Windshield wiper de-icer) (if equipped)
- G** Removing pollen from the air (Micro dust and pollen filter)

■ Side display

▶ Vehicles with DUAL-ZONE climate control

▶ Vehicles with 4-ZONE climate control

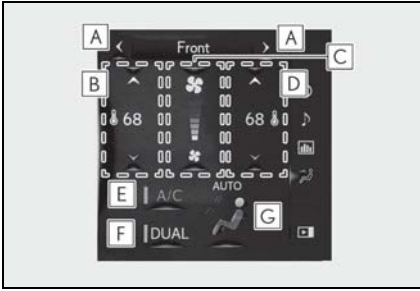

A Display the front seat heaters/front seat ventilators control screen

B Adjust the left side seat temperature setting

C Adjust the fan speed setting

D Adjust the right side seat temperature setting

E Set cooling and dehumidification function on/off

F Adjusting the temperature for driver and passenger seats separately ("DUAL" mode)

G Select the air flow mode

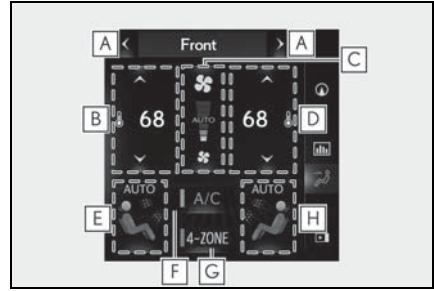

A Display the front seat heaters/front seat ventilators control screen

B Adjust the left side seat temperature setting

C Adjust the fan speed setting

D Adjust the right side seat temperature setting

E Select the left side seat air flow mode

F Set cooling and dehumidification function on/off

G Adjust the temperature for driver, passenger and rear seats separately ("4-ZONE" mode)

H Select the right side seat air flow mode

Using automatic mode

- 1 Press the automatic mode switch or select "AUTO" on the sub function menu.
- 2 Press the outside/recirculated air mode switch to switch to automatic air intake mode.
- 3 Adjust the temperature setting.
- 4 To stop the operation, press the off switch or select "OFF" on the sub function menu.



Rear Air Conditioning System (if equipped)

The air outlets and fan speed are automatically adjusted according to the temperature setting.

The rear air conditioning system can be operated using the Center Display and Rear Multi Operation Panel.

Rear air conditioning control screen

Center Display

Press the "MENU" button on the Remote Touch to display the main menu and move the cursor to  to display the climate control shortcut buttons. Then, select  to display the rear air conditioning control screen.

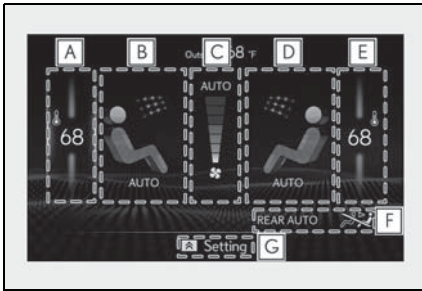

- A** Adjust the left side rear seat temperature setting
- B** Select the left side rear seat air flow mode
- C** Adjust the rear seats fan speed setting
- D** Select the right side rear seat air flow mode
- E** Adjust the right side rear seat temperature setting
- F** Function on/off indicators
- G** Sub function menu

Using automatic mode

Center Display

- 1 Select "Rear AUTO" on the sub function menu.
- 2 To stop the operation, select "Rear off" on the sub function menu.

Voice Command System

Basic operation

NOTE: Wait for the confirmation beep before speaking a command.

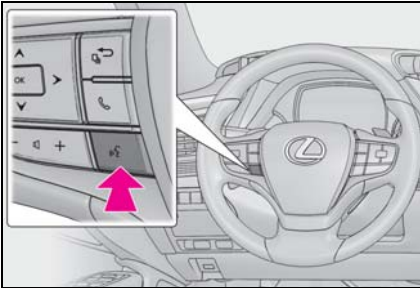

- 1** Press the talk switch on the steering wheel.

Voice guidance for the voice command system can be skipped by pressing the talk switch.

- 2** If “Getting Started with Voice” screen is displayed, select “OK” or press the talk switch.
- 3** After hearing a beep, say a supported command.
 - To display sample commands of the desired function, say the desired function or select the desired function button. To display more commands, select “More Commands”.
 - Selecting “Help” or saying “Help” prompts the voice command system to offer examples of commands and operation methods.

Continue on to pages 76-82 for a detailed list of Voice Commands for the following categories:

- Common..... P.76
- Top menu P.76
- Navi..... P.77
- Phone P.78
- Radio..... P.79
- Audio P.80
- Info..... P.81
- Apps P.81
- Climate..... P.82

- Important voice commands information and tips
 - Voice commands can be used while driving.
 - You must wait until after the beep to say a command.
 - If you know what command to use, you can press the talk switch at any time to interrupt the voice guidance.

Command list

Common

Command	Action
"Help"	Displays examples of some of the available commands
"Go Back"	Returns to the previous screen
"Cancel"	Cancels the voice command system
"Start over"	Returns to top menu screen
"Pause"	Temporarily pauses a voice session until it is resumed by pressing the talk switch again.

Top menu

Command	Action
"Show command examples for <menu>"	Displays the command list of the selected menu
"More Commands"	Displays more commonly used commands
"Voice Settings"	Displays Voice Setting screen
"Train my voice"	Displays Train Voice Recognition screen *

*: Vehicle must be parked

■ Navigation*1

Command	Action
"Get directions to <house #, street, city, state>"*2	Enables setting a destination by saying the address *3,4
"Find a <POI category/POI name>"	Displays a list of <POI category*5/POI name*6> near the current position
"Find a <POI> near my destination"	Displays a list of <POI> near the destination
"Find a <POI category> in a city"*2	Displays a list of <POI> in a specified city and state *4
"Go Home"	Displays the route to home
"Go to Favorite <1-10>"	Sets the location registered to the corresponding favorite number as the destination
"Show Recent Destinations"	Displays recent destinations. Selecting a number from the list will start navigation to the selected recent destination.
"Cancel Route"	Cancels the route guidance
"Delete destinations"	Displays a list of destination to delete *7
"Show <POI category> icons"	Displays the specified point of interest category*5 icons on the map
"Destination Assist"	Connects the system to the Lexus response center

*1: With navigation function

*2: English and French only

*3: Best recognition results occur when saying the full address without the zipcode

*4: When the language is set to French, the supported area is only Quebec Province in Canada

*5: For example; "Gas stations", "Restaurants", etc.

*6: Major national brands are always supported. Local brands are also supported with a subscription to the Lexus Enform. Contact your Lexus dealer for details.

*7: Used when multiple destinations are set on a route

■ Phone*1

Command	Action
"Call <contact>"*2	Places a call to the specified contact from the phone book
"Call <contact> <phonetype>"*2	Places a call to the specified phone type of the contact from the phone book
"Dial <phone number>"	Places a call to the specified phone number
"Redial"	Places a call to the phone number of the latest outgoing call
"Call Back"	Places a call to the phone number of latest incoming call
"Show Recent Calls"	Displays the call history screen
"Send a message to <contacts>"	Sends a text message to specified contact from the phone book

*1: When an Apple CarPlay connection is established, this voice commands will be unavailable.

*2: If the system does not recognize the name of a contact, create a voice tag. The name of a contact can also be recognized by adding a voice tag.

■ While in a phone call*

Command	Action
"Send <digits>"	Sends DTMF tones has specified
"Mute"	Mutes the microphone (far side cannot hear the conversation)
"Unmute"	Unmutes the microphone

*: When an Apple CarPlay connection is established, this voice commands will be unavailable.

■ While incoming message notification is displayed*1,2

Command	Action
"Read Message"	Reads the incoming message over the vehicle speakers
"Ignore"	Ignores the incoming message notification
"Reply"	Initiates sending a reply to the incoming message
"Call"	Places a call to the phone number of incoming message

*1: Full screen message notification must be turned on within the phone settings

*2: When an Apple CarPlay connection is established, this voice commands will be unavailable.

■ Radio

Command	Action
"Tune to <frequency> AM"	Changes the radio to the specified AM frequency
"Tune to <frequency> FM"	Changes the radio to the specified FM frequency
"Play a <genre> station"	Changes the radio to an FM station of the specified genre*1
"Tune to preset <1-36>"	Changes the radio to the specified preset radio station
"Tune to a <genre> satellite station"	Changes the radio to a satellite radio channel of the specified genre*2
"Tune to <satellite channel name>"	Changes the radio to the satellite radio channel with the specified name*2
"Tune to channel <number> on XM"	Changes the radio to a satellite radio channel of the specified number*2

*1: A station list must be built first using the radio screen

*2: Requires a satellite radio subscription

■ Audio*1

Command	Action
"Play Playlist <name>"*2	Plays tracks from the selected playlist
"Play Artist <name>"*2	Plays tracks from the selected artist
"Play Song <name>"*2	Plays the selected track
"Play Album <name>"*2	Plays tracks from the selected album
"Play Genre <name>"*2	Plays tracks from the selected genre
"Play Composer <name>"*2	Plays tracks from the selected composer
"Play Podcast <name>"*2	Plays tracks from the selected podcast
"Play Audiobook <name>"*2	Plays tracks from the selected audiobook
"Audio On"	Turns the audio system on
"Audio Off"	Turns the audio system off
"Change the audio source to <source name>"	Sets the source to the specified audio mode

*1: The audio device must be connected via a USB cable to use the functionality in this section

*2: When an Apple CarPlay connection is established, this voice commands will be unavailable.

■ Info *1

Command	Action
"Get the Forecast"	Displays weather information
"Get the Forecast for <city>"*2	Displays weather for the specified city
"Show Traffic"	Displays traffic information
"Show Traffic near here"	Displays traffic information near your current location
"Get traffic along my route"	Displays traffic information along your current route
"Show Traffic on this street"	Displays traffic information along road you are currently driving on
"Show Traffic for saved route"	Displays traffic information for a saved route
"Show Predictive Traffic"	Displays the predictive traffic map

*1: With navigation function

*2: Only major US cities are supported by voice

■ Apps *1

Command	Action
"Launch <apps>"*2	Activates the Lexus Enform App Suite 2.0 application

*1: When an Apple CarPlay connection is established, this voice commands will be unavailable.

*2: When an application is opened and is in full screen mode, pressing the talk switch will start the voice command system and commands for the currently displayed application will be available

■ Climate

Command	Action
"Turn the AC on/Turn the AC off"	Turns air conditioning system on or off
"Change the Fan speed to <#>"	Changes the set fan speed of the air conditioning system to <#>
"Set temperature to <#> degrees"	Changes the set temperature of the air conditioning system to <#> degrees*
"Increase Temperature/Decrease Temperature"	Increases or decreases the temperature of the air conditioning system
"Increase Fan speed/Decrease Fan Speed"	Increases or decreases the fan speed of the air conditioning system
"Show the front climate control screen"	Displays the screen to control the air conditioning or seat heating system
"Set the steering wheel temperature"	Displays the screen to control the air conditioning or seat heating system
"Show the front seat heater settings"	Displays the screen to control the air conditioning or seat heating system
"Show the concierge screen"	Displays the screen to control the air conditioning or seat heating system
"Concierge Mode On"	Turns Concierge Mode ON

*: Only within the possible temperature range of the air conditioning system

USB/AUX Ports

There are 2 USB ports and an AUX port in the console box.

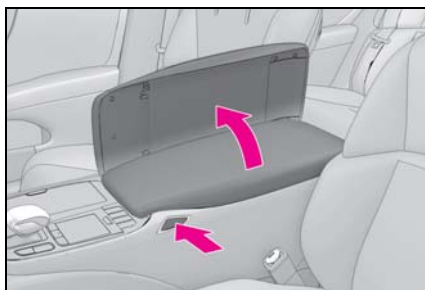

- 1 Push the knob and lift the armrest.

2 Connect a device.

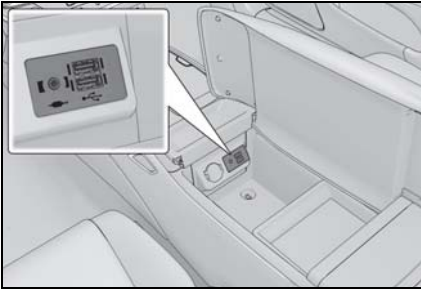

Garage Door Opener

The garage door opener can be programmed using the HomeLink[®] to operate garage doors, gates, entry doors, door locks, home lighting systems, security systems, and other devices.

System components

The HomeLink[®] wireless control system in your vehicle has 3 buttons which can be programmed to operate 3 different devices. Refer to the programming methods on the following pages to determine the method which is appropriate for the device.

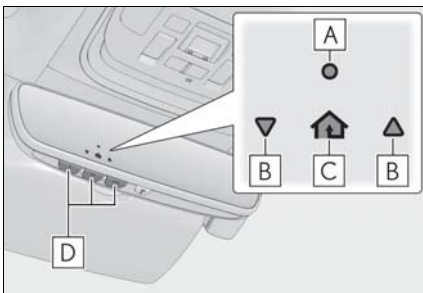

A HomeLink[®] indicator light

B Garage door operation indicators

C HomeLink[®] icon

Illuminates while HomeLink[®] is operating.

D Buttons

■ When support is necessary

Visit on the web at www.homelink.com/lexus or call 1-800-355-3515.

■ Before programming HomeLink[®]

- During programming, it is possible that garage doors, gates, or other devices may operate. For this reason, make sure that people and objects are clear of the garage door or other devices to prevent injury or other potential harm.
- It is recommended that a new battery be placed in the remote control transmitter for more accurate programming.
- Garage door opener motors manufactured after 1995 may be equipped with rolling code protection. If this is the case, you may need a stepladder or other sturdy, safe device to reach the "Learn" or "Smart" button on the garage door opener motor.

■ Programming HomeLink®

Steps **1** through **3** must be performed within 60 seconds, otherwise the indicator light will stop flashing and programming will not be able to be completed.

- 1** Press and release the HomeLink® button you want to program and check that the HomeLink® indicator light flashes (orange).

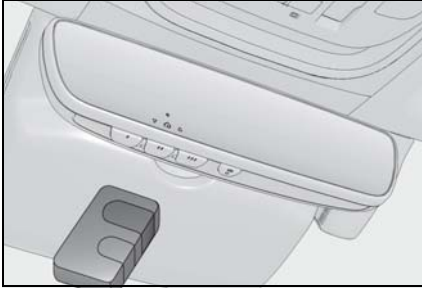

- 2** Point the remote control transmitter for the device at the rear view mirror, 1 to 3 in. (25 to 75 mm) from the HomeLink® buttons.

Keep the HomeLink® indicator light in view while programming.

- 3** Program a device.

▶ Programming a device other than an entry gate (for U.S.A. owners)

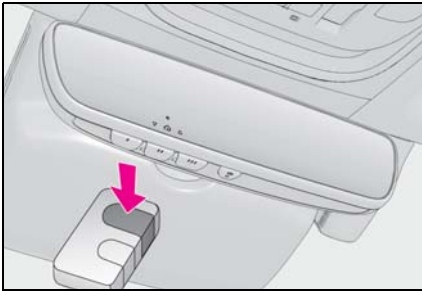

Press and hold the handheld transmitter button until the HomeLink® indicator light changes from slowly flashing orange to rapidly flashing green (rolling code) or continuously lit green (fixed code), then release the button.

▶ Programming an entry gate (for U.S.A. owners)/Programming a device in the Canadian market

Press and release the remote control transmitter button at 2 second intervals, repeatedly, until the HomeLink® indicator light changes from slowly flashing (orange) to rapidly flashing (green) (rolling code) or continuously lit (green) (fixed code).

- 4** Test the HomeLink® operation by pressing the newly programmed button and observing the indicator light:
 - Indicator light illuminates: Programming of a fixed code device has completed. The garage door or other device should operate when a HomeLink® button is pressed and released.
 - Indicator light flashes rapidly: The garage door opener motor or other device is equipped with a rolling code. To complete programming, firmly press and hold the HomeLink® button for 2 seconds then release it.
 - If the garage door or other device does not operate, proceed to "Programming a rolling code system".

- 5** Repeat the steps above to program another device for any of the remaining HomeLink® buttons.

■ Programming a rolling code system

2 or more people may be necessary to complete rolling code programming.

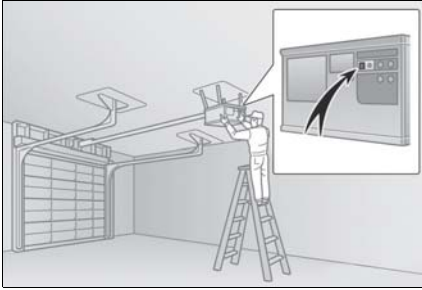

- 1** Locate the “Learn” or “Smart” button on the garage door opener motor in the garage.

This button can usually be found where the hanging antenna wire is attached to the unit. The name and color of the button may vary by manufacturer. Refer to the owner’s manual supplied with the garage door opener motor for details.

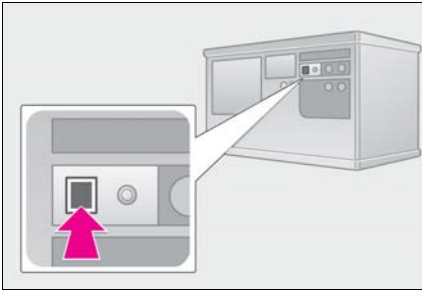

- 2** Press and release the “Learn” or “Smart” button.

Perform **3** within 30 seconds after performing **2**.



- 3** Press and hold the desired HomeLink® button (inside the vehicle) for 2 seconds and release it. Repeat this sequence (press/hold/release) up to 3 times to complete programming.

If the garage door opener motor operates when the HomeLink® button is pressed, the garage door opener motor recognizes the HomeLink® signal.

■ Enabling 2-way communication with a garage door (only available for compatible devices)

When enabled, 2-way communication allows you to check the status of the opening and closing of a garage door through indicators in your vehicle.

2-way communication is only available if the garage door opener motor used is a compatible device. (To check device compatibility, refer to www.homelink.com.)

- 1 Within 5 seconds after programming the garage door opener has been completed, if the garage door opener motor is trained to HomeLink[®], both garage door operation indicators will flash rapidly (green) and the light on the garage door opener motor will blink twice, indicating that 2-way communication is enabled.

If the indicators do not flash, perform **2** and **3** within the first 10 presses of the HomeLink[®] button after programming has been completed.

- 2 Press a programmed HomeLink[®] button to operate a garage door.
- 3 Within 1 minute of pressing the HomeLink[®] button, after the garage door operation has stopped, press the “Learn” or “Smart” button on the garage door opener motor. Within 5 seconds of the establishment of 2-way communication with the garage door opener, both garage door operation indicators in the vehicle will flash rapidly (green) and the light on the garage door opener motor will blink twice, indicating that 2-way communication is enabled.

■ Reprogramming a single HomeLink[®] button

When the following procedure is performed, buttons which already have devices registered to them can be overwritten:

- 1 With one hand, press and hold the desired HomeLink[®] button.
- 2 When the HomeLink[®] indicator starts flashing (orange), continue to hold the HomeLink[®] button and perform “Programming HomeLink[®]” **1** (it takes 20 seconds for the HomeLink[®] indicator to start flashing).

Operating HomeLink[®]

Press the appropriate HomeLink[®] button. The HomeLink[®] indicator light should turn on.

Lexus Enform Safety Connect (if equipped)

Safety Connect is a subscription-based telematics service that uses Global Positioning System (GPS) data and embedded cellular technology to provide safety and security features to subscribers. Safety Connect is supported by Lexus' designated response center, which operates 24 hours per day, 7 days per week.

Safety Connect service is available by subscription on select, telematics hardware-equipped vehicles.

System components

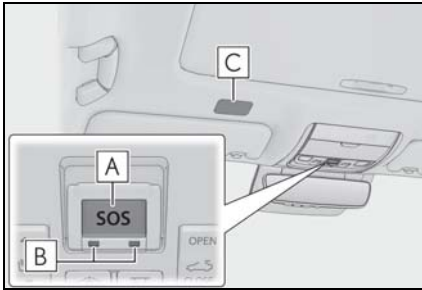

- A** "SOS" button
- B** LED light indicators
- C** Microphone

Services

Subscribers have the following Safety Connect services available:

- **Automatic Collision Notification**

In case of either airbag deployment or severe rear-end collision, the system is designed to automatically call the response center. The responding agent receives the vehicle's location and attempts to speak with the vehicle occupants to assess the level of emergency. If the occupants are unable to communicate, the agent automatically treats the call as an emergency, contacts the nearest emergency services provider to describe the situation, and requests that assistance be sent to the location.

- **Stolen Vehicle Location**

If your vehicle is stolen, Safety Connect can work with local authorities to assist them in locating and recovering the vehicle. After filing a police report, call the Safety Connect response center at 1-800-25-LEXUS (1-800-255-3987) in the United States, 1-877-539-8777 in Puerto Rico or 1-800-265-3987 in Canada, and follow the prompts for Safety Connect to initiate this service.

In addition to assisting law enforcement with recovery of a stolen vehicle, Safety-Connect-equipped vehicle location data may, under certain circumstances, be shared with third parties to locate your vehicle. Further information is available at Lexus.com.

- **Emergency Assistance Button (“SOS”)**

In the event of an emergency on the road, push the “SOS” button to reach the Safety Connect response center. The answering agent will determine your vehicle’s location, assess the emergency, and dispatch the necessary assistance required.

If you accidentally press the “SOS” button, tell the response-center agent that you are not experiencing an emergency.

- **Enhanced Roadside Assistance**

Enhanced Roadside Assistance adds GPS data to the already included warranty-based Lexus roadside service.

Subscribers can press the “SOS” button to reach a Safety Connect response-center agent, who can help with a wide range of needs, such as: towing, flat tire, fuel delivery, etc. For a description of the Roadside Assistance services and their limitations, please see the Safety Connect Terms and Conditions, which are available at Lexus.com.

Subscription

After you have signed the Telematics Subscription Service Agreement and are enrolled, you can begin receiving services.

A variety of subscription terms is available for purchase. Contact your Lexus dealer, call the following or push the “SOS” button in your vehicle for further subscription details.

- **The United States**

1-800-25-LEXUS (1-800-255-3987)

- **Canada**

1-800-26-LEXUS (1-800-265-3987)

- **Puerto Rico**

1-877-539-8777

Lexus Enform Remote (if equipped)

Lexus Enform Remote is a smart phone application that lets you view and remotely control certain aspects of your vehicle.

For details about the functions and services of this application, refer to <http://www.lexus.com/enform/>.

Function of the Lexus Enform Remote is achieved by using DCM (Data Communication Module).

Subscription

After you sign the Telematics Subscription Service Agreement, download the Lexus Enform Remote app from your smart phone's app store, and register within the app (or enroll and complete registration at the dealer), you can begin using these services.

A variety of subscription terms are available. Contact your Lexus dealer, or call 1-800-25-LEXUS (1-800-255-3987) for further subscription details.

Lexus Enform Service Connect (if equipped)

Lexus Enform Service Connect uses DCM (Data Communication Module) to collect and transmit vehicle data that allows Lexus to provide:

- Vehicle Health Report (VHR) (Safety Recalls, Service Campaigns, Current Vehicle Alerts, Required Maintenance, and Vehicle Condition Status)
- Maintenance Notifications
- Vehicle Alert Notifications

For details about this service and how to register, refer to <http://www.lexus.com/enform/>.

The Lexus Enform Service Connect is achieved by using a DCM (Data Communication Module) built in the vehicle.

SiriusXM Satellite Radio

A SiriusXM Satellite Radio is a tuner designed exclusively to receive broadcasts provided under a separate subscription.

For details, refer to the "NAVIGATION AND MULTIMEDIA SYSTEM OWNER'S MANUAL".

Subscription

For SiriusXM Services requiring a subscription (such as SiriusXM Satellite Radio), the following paragraph shall be included.

Required SiriusXM Radio monthly subscriptions sold separately after trial period. Subscription fee is consumer only. All fees and programming subject to change. Subscriptions are subject to the Customer Agreement available at www.siriusxm.com (U.S.A.) or www.siriusxm.ca (Canada) XM service only available in the 48 contiguous United States and 10 Canadian provinces. © 2011 Sirius XM Radio Inc. Sirius, XM and all related marks and logos are trademarks of Sirius XM Radio Inc. All other marks, channel names and logos are the property of their respective owners.

For more information, program schedules, and to subscribe or extend subscription after complimentary trial period; more information is available at:

► **U.S.A. Customers:**

Visit www.siriusxm.com or call 1-877-447-0011

► **Canadian Customers:**

Visit www.siriusxm.ca or call 1-877-438-9677

Door Locks

The vehicle can be locked and unlocked using the entry function, wireless remote control or door lock switches.

For details about the entry function or wireless remote control, refer to P.15, 17.

Unlocking and locking the doors from the inside

■ Door lock switches (to lock/unlock)

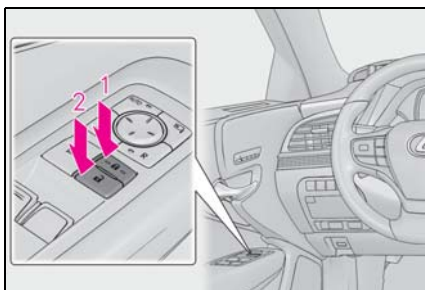

- 1** Locks all the doors
- 2** Unlocks all the doors

■ Inside lock buttons (to lock)

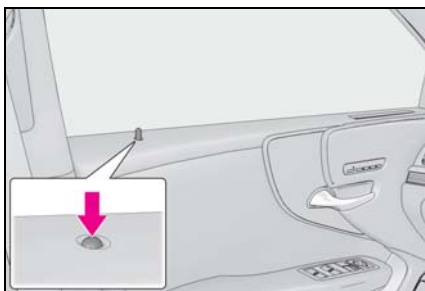

Push down the inside lock button to lock the door.

■ Inside door handles (to unlock)

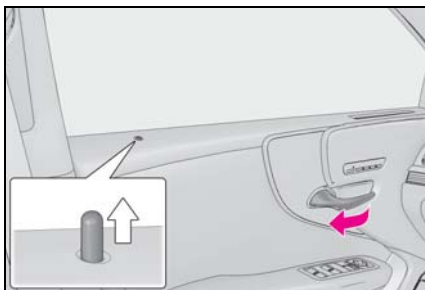

► For the front doors

Pull the handle to unlock and open the door.

When the door is unlocked, the inside lock button will pop up.

► For the rear doors

Pull the handle to unlock the door. Pull the handle a second time to open the door.

When the door is unlocked, the inside lock button will pop up.

Rear door child-protector lock

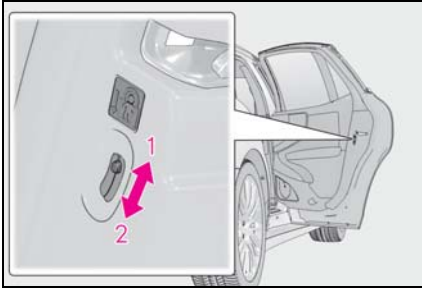

The door cannot be opened from inside the vehicle when the lock is set.

1 Unlock

2 Lock

These locks can be set to prevent children from opening the rear doors. Push down on each rear door switch to lock both rear doors.

Power Windows

Opening and closing the power windows

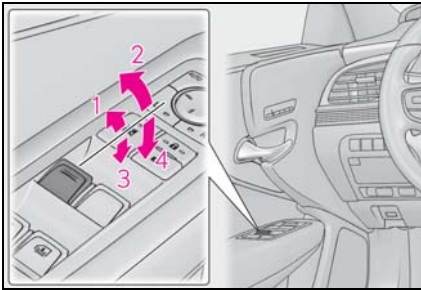

- 1 Closing
- 2 One-touch closing*
- 3 Opening
- 4 One-touch opening*

*: To stop the window partway, operate the switch in the opposite direction.

Preventing accidental operation (window lock switch)

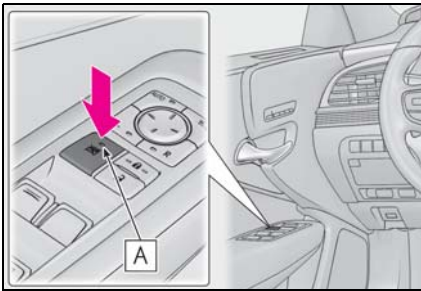

Press the switch.

The indicator **A** will come on and the passenger windows will be locked.

The passenger windows can still be opened and closed using the driver's switch even if the lock switch is on.

This function can be used to prevent children from accidentally opening or closing a passenger window.

Moon Roof

Operating the moon roof

Opening and closing

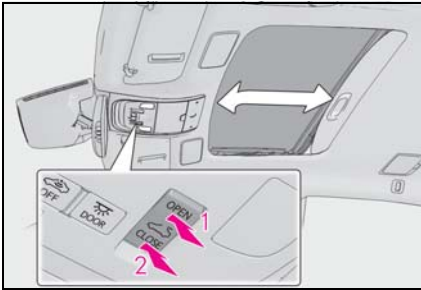

1 Opens the moon roof*
The moon roof tilts up and then fully opens.

2 Closes the moon roof*

*: Lightly press either side of the moon roof switch to stop the moon roof partway.

Tilting up and down

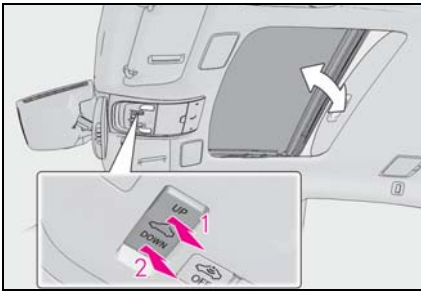

1 Tilts the moon roof up*

2 Tilts the moon roof down*

*: Lightly press either side of the moon roof switch to stop the moon roof partway.

Fuel Tank Cap

Before refueling the vehicle

- Close all the doors and windows, and turn the power switch off.
- Confirm the type of fuel.

Opening the fuel tank cap

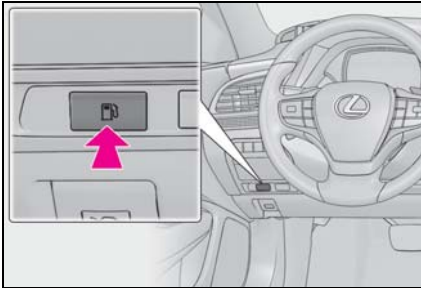

- 1** Press the opener switch.

The fuel filler door will open within about 10 seconds of the switch being pressed. Before refueling is possible, a message will be shown on the multi-information display in the instrument cluster to indicate the progress of the fuel filler door opener.

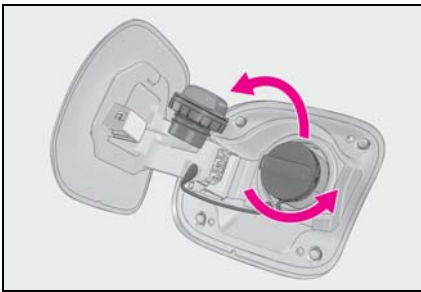

- 2** Turn the fuel tank cap slowly and remove it, then put it into the holder on the fuel filler door.

Trunk

Opening/closing the trunk

■ Trunk opener switch

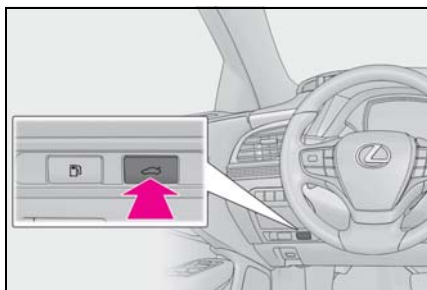

Press the trunk opener switch.
The trunk lid will fully open.

■ Smart access system with push-button start

→P.17

■ Wireless remote control

→P.15

■ Hands Free Power Trunk Lid (if equipped)

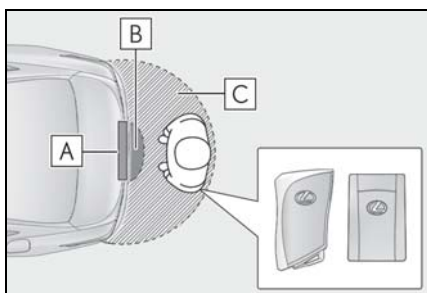

1 While carrying an electronic key, stand within the smart access system with push-button start operation area, approximately 11.8 to 19.7 in. (30 to 50 cm) from the rear bumper.

- A** Kick sensor
- B** Hands Free Power Trunk Lid operation detection area
- C** Smart access system with push-button start operation detection area

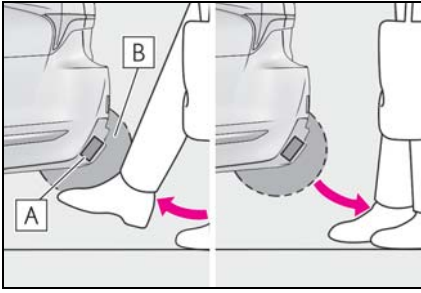

2 Perform a kick operation by moving your foot to within approximately 3.9 in. (10 cm) of the rear bumper and then pulling it back.

- Perform the entire kick operation within 1 second.
- The trunk lid will not start operating while a foot is detected under the rear bumper.
- Operate the Hands Free Power Trunk Lid without contacting the rear bumper with your foot.
- If another electronic key is in the cabin or trunk, it may take slightly longer than normal for the operation to begin.

A Kick sensor

B Hands Free Power Trunk Lid operation detection area

3 When the kick sensor detects that your foot is pulled back, a buzzer will sound and the trunk will automatically fully open/close.

If a foot is moved under the rear bumper while the trunk lid is opening, the trunk lid will stop moving.

If a foot is moved under the rear bumper while the trunk lid is closing, the trunk lid will open.

■ Trunk closer switch

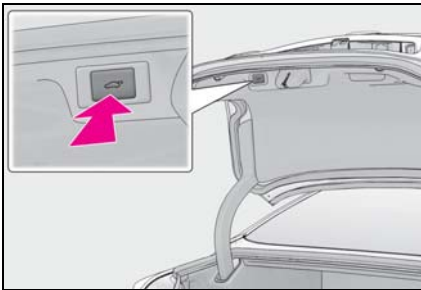

Press the trunk closer switch.

A buzzer will sound and the trunk lid will fully close.

Pressing the switch while the trunk lid is closing opens the trunk lid again.

What to do if...

List of Warning/Indicator Lights

Immediately stop the vehicle in a safe place and contact your Lexus dealer. Continuing to drive the vehicle may be dangerous.

BRAKE

(U.S.A.)

Brake system warning light



(Canada)

(Red)

Immediately stop the vehicle in a safe place and contact your Lexus dealer.



Charging system warning light



(U.S.A.)

Malfunction indicator lamp



Low engine oil pressure warning light



(Canada)

Have the vehicle inspected by your Lexus dealer immediately.



(yellow)

Brake system warning light



(Blinking and then continuously on)

Tire pressure warning light



SRS warning light



Pop Up Hood warning light



Slip indicator

ABS

(U.S.A.)

ABS warning light

PARK

(Flashes)

(U.S.A.)

Parking brake indicator



(Canada)



(Flashes)

(Canada)



(Red or yellow)

Electric power steering system warning light

HOLD

(Flashes)

Brake hold operated indicator

For further information, refer to the "OWNER'S MANUAL".

What to do if...

Follow the correction procedures.



Brake Override System warning light/Drive-Start Control warning light



Low fuel level warning light



Driver's and front passenger's seat belt reminder light



Rear passengers' seat belt reminder lights



(Illuminates without blinking)

Tire pressure warning light*



(orange)

LTA indicator



Intuitive parking assist OFF indicator



RCTA OFF indicator



RCD OFF indicator (if equipped)



PKSB OFF indicator



PCS warning light



Master warning light



Low traction battery warning light

Stop and check.



High coolant temperature warning light



Hybrid system overheat warning light

For further information, refer to the "OWNER'S MANUAL".

What to do if...

See the "OWNER'S MANUAL"



Turn signal indicator



Headlight indicator (U.S.A.)



Tail light indicator (Canada)



Headlight high beam indicator



AHB indicator



PCS warning light



Cruise control indicator



Dynamic radar cruise control indicator



Cruise control "SET" indicator



LTA indicator
(white)



LTA indicator
(green)



LTA indicator
(orange)
(flashes)



BSM outside rear view mirror indicators



BSM indicator



Intuitive parking assist OFF indicator



RCTA OFF indicator



RCD OFF indicator (if equipped)



PKSB OFF indicator



Slip indicator
(flashes)



VSC OFF indicator



High mode indicator (if equipped)



Smart access system with push-button start indicator



"READY" indicator



EV drive mode indicator



(U.S.A.)
Parking brake indicator



(Canada)



Brake hold standby indicator



Brake hold operated indicator



EV indicator



Low outside temperature indicator

For further information, refer to the "OWNER'S MANUAL".

What to do if...

See the "OWNER'S MANUAL"



Security indicator



(U.S.A.)

"AIR BAG ON/
OFF" indicator



(Canada)

● Drive mode indicators

▶ Except F SPORT models



Snow mode indicator



Eco drive mode indicator



Normal mode indicator



Sport S mode indicator



Custom mode indicator



Sport S+ mode indicator



Comfort mode indicator

▶ F SPORT models



Snow mode indicator



Eco drive mode indicator



Normal mode indicator



Sport S mode indicator



Custom mode indicator



Sport S+ mode indicator



Comfort mode indicator

For further information, refer to the "OWNER'S MANUAL".

*: It also comes on due to natural causes such as natural air leaks and tire inflation pressure changes caused by temperature. Adjust the tire inflation pressure to the specified level. The light will turn off after a few minutes. In case the light does not turn off even if the tire inflation pressure is adjusted, have the system checked by your Lexus dealer.

What to do if...

If the electronic key does not operate properly

Locking and unlocking the doors, unlocking the trunk

■ Unlocking the door

Use the mechanical key in order to perform the following operations:

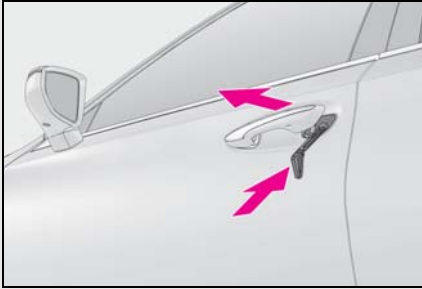

- 1 Pull the driver's door handle and insert the mechanical key

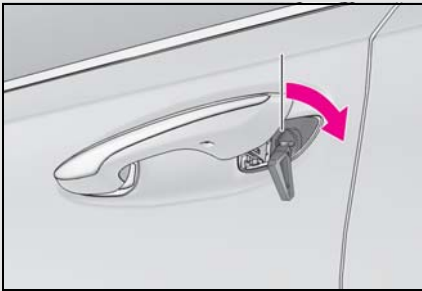

- 2 Unlock the door.

- 3 Remove the key, return the handle, and then pull the handle again.

■ Locking the door

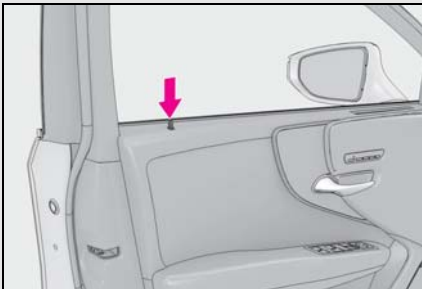

- 1 With the door open, push down the inside lock button.

- 2 Close the door.

What to do if...

■ Trunk

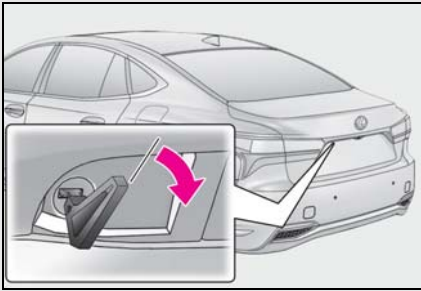

Turn the mechanical key clockwise to open.

Starting the hybrid system

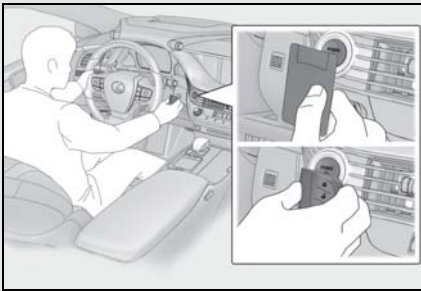

- 1 Depress the brake pedal.
- 2 Touch the Lexus emblem side of the electronic key to the power switch.

When the electronic key is detected, a buzzer sounds and the power switch will turn to ON mode.

When the smart access system with push-button start is deactivated in customization setting, the power switch will turn to ACCESSORY mode.

- 3 Firmly depress the brake pedal and check that  is shown on the multi-information display.
- 4 Press the power switch.

In the event that the hybrid system still cannot be started, contact your Lexus dealer.

If the electronic key battery becomes depleted, a warning message will be shown on the multi-information display. Replace the battery with a new one. For instructions on replacing the battery, refer to the "OWNER'S MANUAL".

If you need further assistance, contact your Lexus dealer.

What to do if...

If the hybrid system doesn't start

Make sure that the correct operating procedures have been followed.

Brake pedal

Make sure that the brake pedal is firmly depressed when attempting to start the hybrid system. (→P.25)

If the hybrid system still does not start, see the "OWNER'S MANUAL" for more information or contact your Lexus dealer.



Your Lexus dealer

Your Lexus dealer will provide quality maintenance and any other assistance you may require.

If there is not a Lexus dealer near you, please call the following number:

■ U.S. OWNERS

- In the U.S. mainland or Canada:

Lexus Roadside Assistance

1-800-25-LEXUS or 1-800-255-3987 (Toll-Free)

- In Hawaii:

Servco Automotive Roadside Assistance/Customer Services

1-800-25-LEXUS or 1-800-255-3987 (Toll-Free)

■ CANADIAN OWNERS

- In Canada or the U.S. mainland:

Lexus Roadside Assistance/Customer Service

1-800-26-LEXUS or 1-800-265-3987 (Toll-Free)

Please access our **websites** for further information.

- The U.S. mainland: **www.lexus.com**

- Hawaii: **www.servcolexus.com**

- Canada: **www.lexus.ca**

©2019 TOYOTA MOTOR CORPORATION

All rights reserved. This material may not be reproduced or copied, in whole or in part, without the written permission of Toyota Motor Corporation.