

FOREWORD

Dear Customer,

Thank you for selecting your new Kia vehicle.

As a global car manufacturer focused on building high-quality vehicles with exceptional value, Kia is dedicated to providing you with a customer service experience that exceeds your expectations.

This Owner's Manual is valid for all variants of your model, and describes all options, features, and equipment available, along with the maintenance needs. This manual may also describe optional equipment not purchased on your vehicle, country specifications, and functions and features not available in your region. Please always keep this manual in the vehicle for your and any subsequent owner's reference.

Authorized Kia Dealerships provide factory-trained technicians, utilize recommended special service tools and supply genuine Kia replacement parts to help you maintain and service your Kia during your ownership.

All information contained in this Owner's Manual was accurate at the time of publication. As Kia continues to make improvements to its products, the company reserves the right to make changes to this manual or any of its vehicles at any time without notice and without incurring any obligations.

Please drive safely and enjoy your Kia vehicle!

© 2024 Kia America, Inc.

All rights reserved. May not be reproduced or translated in whole or in part without the written consent of Kia America, Inc.

Printed in Korea

How to use this manual

We want to help you get the greatest possible driving pleasure from your Kia. Your Owner's Manual can assist you in many ways.

We strongly recommend that you read the entire manual. To minimize the chance of death or injury, you must read the **WARNING** and **CAUTION** sections in the manual.

Illustrations complement the words in this manual to best explain how to enjoy your Kia. By reading your manual, you learn about features, important safety information and driving tips under various road conditions.

The general layout of the manual is provided in the Table of Contents. Use the index when looking for a specific area or subject, it has an alphabetical listing of all information in your manual.

Chapters: This manual has nine chapters plus an index. Each chapter begins with a brief list of contents so you can tell at a glance if that chapter has the information you want.

You will find various **WARNINGS**, **CAUTIONS**, and **NOTICES** in this manual. These **WARNINGS** were prepared to enhance your personal safety. You should carefully read and follow **ALL** procedures and recommendations provided in these **WARNINGS**, **CAUTIONS** and **NOTICES**.

WARNING

A **WARNING** indicates a hazardous situation which, if not avoided, may result in death or serious injury.

CAUTION

A **CAUTION** indicates a hazardous situation which, if not avoided, could result in minor or moderate injury.

NOTICE

A **NOTICE** is used to address practices not related to physical injury.

Table of Contents

Introduction	①
Your vehicle at a glance	②
Safety features of your Kia	③
Features of your vehicle	④
Driving your vehicle	⑤
Driver assistance system	⑥
What to do in an emergency	⑦
Maintenance	⑧
Specifications & Consumer information	⑨
Abbreviation	Ⓐ
Index	Ⓛ

Fuel requirements	1-2
Vehicle modifications.....	1-4
Vehicle break-in process	1-5
Risk of burns when parking or stopping vehicle	1-5
Vehicle handling instructions	1-6
Vehicle data collection and Event Data Recorders.....	1-6

Introduction

Fuel requirements

Your new vehicle is designed to use only unleaded fuel having a pump octane number $((R+M)/2)$ of 87 (Research Octane Number 91) or higher. (Do not use methanol blended fuels.)

Your new vehicle is designed to obtain maximum performance with UNLEADED FUEL, as well as minimize exhaust emissions and spark plug fouling.

Never add any fuel system cleaning agents to the fuel tank other than what has been specified. (Consult an authorized Kia dealer for details.)

- Tighten the cap until it clicks one time, otherwise the Check Engine  light will appear.

WARNING

Refueling

- Do not "top off" after the nozzle automatically shuts off. Attempts to force more fuel into the tank can cause fuel overflow onto you and the ground, causing a risk of fire.
- Always check that the fuel cap is installed securely to prevent fuel spillage, especially in the event of an accident.

Gasoline containing alcohol and methanol

Gasohol, a mixture of gasoline and ethanol (also known as grain alcohol), and gasoline or gasohol containing methanol (also known as wood alcohol) are being marketed along with or instead of leaded or unleaded gasoline.

Do not use gasohol containing more than 15% ethanol, and do not use gasohol or gasohol containing any methanol.

Either of these fuels may cause drivability problems and damage to the fuel system, engine control system and emission control system.

Discontinue using gasohol of any kind if drivability problems occur.

Vehicle damage or drivability problems may not be covered by the manufacturer's warranty if they result from the use of:

1. Gasoline or gasohol containing methanol.
2. Leaded fuel or leaded gasohol.
3. Gasohol containing more than 15% ethanol.

"E85" fuel is an alternative fuel comprised of 85% ethanol and 15% gasoline, and is manufactured exclusively for use in Flexible Fuel Vehicles. "E85" is not compatible with your vehicle. Use of "E85" may result in poor engine performance and damage to your vehicle's engine and fuel system. Kia recommends that customers do not use fuel with an ethanol content exceeding 15%.

NOTICE

Your New Vehicle Limited Warranty does not cover damage to the fuel system or any performance problems caused by the use of "E85" fuel.

NOTICE

Never use any fuel containing methanol. Discontinue use of any methanol containing products which may inhibit proper drivability.

Other fuels

Using fuels that contain Silicone (Si), MMT (Manganese, Mn), Ferrocene (Fe), and Other metallic additives, may cause vehicle and engine damage or cause misfiring, poor acceleration, engine stalling, catalyst melting, clogging, abnormal corrosion, life cycle reduction, etc.

Also, the Malfunction Indicator Lamp (MIL) may appear.

* NOTICE

Damage to the fuel system or performance problems caused by the use of these other fuels may not be covered by your New Vehicle Limited Warranty.

Use of MTBE

Kia recommends avoiding fuels containing MTBE (Methyl Tertiary Butyl Ether) over 15.0% vol. (Oxygen Content 2.7% weight) in your vehicle.

Fuel containing MTBE over 15.0% vol. (Oxygen Content 2.7% weight) may reduce vehicle performance and produce vapor lock or hard starting.

* NOTICE

Your New Vehicle Limited Warranty may not cover damage to the fuel system and any performance problems that are caused by the use of fuels containing methanol or fuels containing MTBE (Methyl Tertiary Butyl Ether) over 15.0% vol. (Oxygen Content 2.7% weight.)

Gasoline containing MMT

Some gasoline contains harmful manganese-based fuel additives Such as MMT (Methylcyclopentadienyl Manganese Tri-carbonyl). Kia does not recommend the

use of gasoline containing MMT. This type of fuel can reduce vehicle performance and affect your emission control system. The Malfunction Indicator Lamp (MIL) on the cluster may come on.

Do not use methanol

Fuels containing methanol (wood alcohol) should not be used in your vehicle. This type of fuel can reduce vehicle performance and damage components of the fuel system, engine control system and emission control system.

Fuel Additives (for Smartstream G1.6 T-GDi)

Kia recommends that you use good quality gasolines treated with detergent additives such as TOP TIER Detergent Gasoline, which help prevent deposit formation in the engine. These gasolines will help the engine run cleaner and enhance performance of the emission control system.

For more information on TOP TIER Detergent Gasoline, please go to the website (www.toptiergas.com) For customers who do not use TOP TIER Detergent Gasoline regularly, and have problems starting or the engine does not run smoothly, additives that you can buy separately may be added to the gasoline.

If TOP TIER Detergent Gasoline is not available, one bottle of additive should be added to the fuel tank at every 13,000 km (8,000 miles) (for Turbo engine) or every engine oil change is recommended. Additives are available from your authorized Kia dealer along with information on how to use them. Do not mix other additives.

Operation in foreign countries

If you are going to drive your vehicle in another country, be sure to:

- Observe all regulations regarding registration and insurance.
- Determine that acceptable fuel is available.

Vehicle modifications

This vehicle should not be modified.

Modification of your vehicle could affect its performance, safety or durability and may even violate governmental safety and emissions regulations.

* NOTICE

Damage or performance problems resulting from any modification may not be covered under warranty.

⚠ CAUTION

If you use unauthorized electronic devices, it may cause the vehicle to operate abnormally, wire damage, battery discharge and fire.

For your safety, do not use unauthorized electronic devices.

Vehicle break-in process

By following a few simple precautions for the first 1,000 km (600 miles) you may add to the performance, economy and life of your vehicle.

- Do not race the engine.
- While driving, keep your engine speed (rpm, or revolutions per minute) between 2,000 rpm and 4,000 rpm.
- Do not maintain a single engine speed for long periods of time, either fast or slow. Varying engine speeds is needed to properly break-in the engine.
- Avoid hard stops, except in emergencies, to allow the brakes to seat properly.
- Don't tow a trailer during the first 2,000 km (1,200 miles) of operation.
- Fuel economy and engine performance may vary depending on vehicle break-in process and be stabilized after 6,000 km (4,000 miles). New engines may consume more oil during the vehicle break-in period.

Risk of burns when parking or stopping vehicle

- Do not park or stop the vehicle near flammable items such as leaves, paper, oil, and tire. Such items placed near the exhaust system can become a fire hazard.
- When an engine idles at a high rpm with the rear side of the vehicle in close proximity of the wall, heat of the exhaust gas can cause discoloration or fire. Keep enough space between the rear part of the vehicle and the wall.
- Be sure not to touch the exhaust/catalytic systems while the engine is running or right after the engine is turned off. There is a risk of burns since the systems are extremely hot.

Vehicle handling instructions

As with other vehicles of this type, failure to operate this vehicle correctly may result in loss of control, an accident or vehicle rollover.

Specific design characteristics (higher ground clearance, track, etc.) give this vehicle a higher center of gravity than other types of vehicles. In other words they are not designed for cornering at the same speeds as conventional 2-wheel drive vehicles.

Avoid sharp turns or abrupt maneuvers. Again, failure to operate this vehicle correctly may result in loss of control, an accident or vehicle rollover.

Be sure to read the "Reducing the risk of a rollover" on page 5-53.

Vehicle data collection and Event Data Recorders

This vehicle is equipped with an Event Data Recorder (EDR). The main purpose of an EDR is to record, in certain crash or near crash-like situations, such as an air bag deployment or hitting a road obstacle, data that will assist in understanding how a vehicle's systems performed. The EDR is designed to record data related to vehicle dynamics and safety systems for a short period of time, typically 30 seconds or less. The EDR in this vehicle is designed to record such data as:

- How various systems in your vehicle were operating;
- Whether or not the driver and passenger safety belts were buckled/fastened;
- How far (if at all) the driver was depressing the accelerator and/or brake pedal; and,
- How fast the vehicle was traveling.

These data can help provide a better understanding of the circumstances in which crashes and injuries occur.

NOTE: EDR data are recorded by your vehicle only if a non-trivial crash situation occurs; no data are recorded by the EDR under normal driving conditions and no personal data (e.g., name, gender, age, and crash location) are recorded. However, other parties, such as law enforcement, could combine the EDR data with the type of personally identifying data routinely acquired during a crash investigation.

To read data recorded by an EDR, special equipment is required, and access to the vehicle or the EDR is needed. In addition to the vehicle

manufacturer, other parties, such as law enforcement, that have the special equipment, can read the information if they have access to the vehicle or the EDR.

Your vehicle at a glance

Exterior overview	2-2
Interior overview	2-4
Instrument panel overview	2-6
Engine compartment.....	2-8

Your vehicle at a glance

Exterior overview

Front view



OSP2N012001

* The actual shape of your Kia may differ from the illustration.

1. Front side marker lamp (Maintenance)	8-59
2. Windows	4-48
3. Hood	4-53
4. Head lamp (Features of your vehicle)	8-104
Head lamp (Maintenance)	8-60
5. Front fog lamp (Features of your vehicle)	8-108
Front fog lamp (Maintenance)	8-60
6. Wheel and tire (Maintenance)	8-35
Wheel and tire (Specification)	9-5
7. Outside rear view mirror	4-66
8. Sunroof	4-58

9. Front windshield wiper blades (Features of your vehicle)	4-111
Front windshield wiper blades (Maintenance)	8-30
10. Roof rack	4-156

Rear view



OSP2N012002

* The actual shape of your Kia may differ from the illustration.

1. Antenna	4-159
2. Door locks	4-31
3. Fuel filler door	4-55
4. Rear combination lamp (Maintenance)	8-61
5. Back up lamp (Maintenance)	8-61
6. High Mounted Stop Lamp (Maintenance)	8-61
7. Rear window wiper (Feature of your vehicle)	4-111
Rear window wiper (Maintenance)	8-30
8. Liftgate	4-38, 4-40
9. Wide-rear view camera	6-94

Interior overview



* The actual shape of your Kia may differ from the illustration.

1. Inside door handle	4-32
2. Driver's memory seat button	4-36
3. Outside rear view mirror control switch	4-66
4. Central door lock/unlock switch	4-32
5. Power window switch	4-48
6. Power window lock button	4-51
7. Instrument panel illumination control switch	4-70
8. Head-Up Display shutter On/Off button	4-103
9. ISG OFF button	5-49
10. Power liftgate open/close button	4-40
11. ESC OFF button	5-40
12. Shift lever	5-17, 5-23
13. Steering wheel	4-62

14.Tilt and telescopic steering control lever	4-63
15.Inner fuse panel	8-45
16.Hood release lever	4-53
17.Fuel filler door open lever	4-55
18.Seat	3-5
19.Brake pedal	5-29

Instrument panel overview



OSP2N014003C

* The actual shape of your Kia may differ from the illustration.

- 1. Audio remote control button
(Refer to "Car Infotainment System Quick Reference Guide".)
- 2. Driver's front air bag 3-45
- 3. Horn 4-64
- 4. Driving Assist button 6-4
- 5. Instrument cluster 4-68
- 6. Light control/Turn signals lever 4-104
- 7. Wiper and washer control lever 4-111
- 8. Ignition switch 5-5
- ENGINE START/STOP button 5-7
- 9. Infotainment System screen
(Refer to "Car Infotainment System Quick Reference Guide".)
- 10. Hazard warning flasher 7-2

11.Climate control system	4-123, 4-128
12.Power outlet	4-150
13.AWD mode button	5-11
14.Drive mode integrated control system knob	5-50
15.Seat warmer and air ventilation seat switch	4-147
16.Parking/View button	6-94
17.Downhill Brake Control (DBC) button	5-44
18.Wireless smart phone charging system	4-151
19.Steering wheel heater button	4-64
20.EPB switch	5-34
21.Auto Hold button	5-37
22.Center console storage box	4-143
23.USB charger	4-149
24.Glove box	4-144
25.Passenger's front air bag	3-45
26.USB port	4-159
27.Parking safety button	6-106, 6-109

Engine compartment

Smartstream G1.6 T-GDi

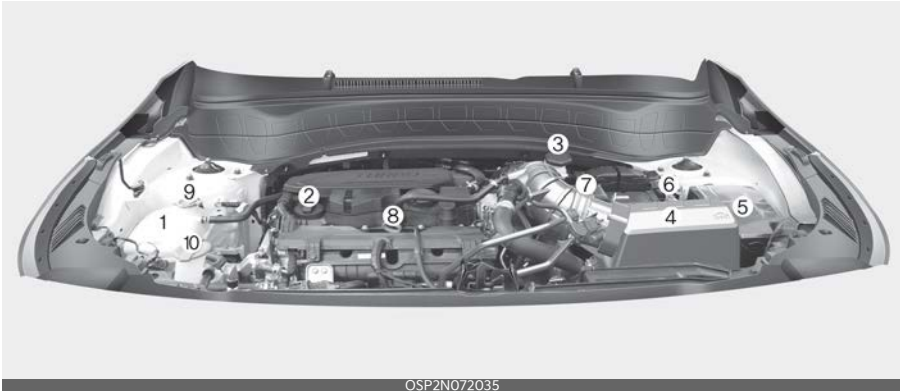

OSP2N072035

* The actual engine room in the vehicle may differ from the illustration.

1. Engine coolant reservoir	8-22
2. Engine oil filler cap	8-20
3. Brake fluid reservoir	8-25
4. Air cleaner	8-28
5. Fuse box	8-45
6. Negative battery terminal	8-32
7. Positive battery terminal	8-32
8. Engine oil dipstick	8-20
9. Radiator cap	8-22
10. Windshield washer fluid reservoir	8-26

(Gasoline) 2.0 MPI



OSP2079088L

* The actual engine compartment in your Kia may differ from the illustration.

1. Engine coolant reservoir	8-22
2. Engine oil filler cap	8-20
3. Brake fluid reservoir	8-25
4. Air cleaner	8-28
5. Fuse box	8-45
6. Negative battery terminal	8-32
7. Positive battery terminal	8-32
8. Engine oil dipstick	8-20
9. Radiator cap	8-22
10. Windshield washer fluid reservoir	8-26

Safety features of your Kia **3**

Important safety precautions	3-3
Seat	3-5
• Feature of Seat Leather.....	3-7
• Front seat adjustment for manual seat.....	3-7
• Front seat adjustment for power seat	3-9
• Headrest for front seat	3-10
• Seatback pocket (if equipped)	3-12
• Headrest for rear seat.....	3-12
• Armrest.....	3-13
• Folding the rear seat.....	3-13
Seat belts	3-16
• Seat belt restraint system.....	3-16
• Driver's seat belt warning.....	3-17
• Front passenger's seat belt warning	3-18
• Seat belt - Driver's 3-point system with emergency locking retractor	3-18
• Seat belts - Front passenger and rear seat 3-point system with combination locking retractor.....	3-20
• Pre-tensioner seat belt	3-22
• Seat belt precautions.....	3-24
• Care of seat belts	3-25
Child Restraint System (CRS).....	3-26
• Children always in the rear.....	3-26
• Selecting a CRS.....	3-27
• Installing a CRS	3-28
Air bag - advanced Supplemental Restraint System	3-34
• How does the air bag system operate?.....	3-35
• Do not install a child restraint on the front passenger's seat.....	3-36
• Air bag warning light	3-36
• Supplemental Restraint System (SRS) components and functions.....	3-37

3 Safety features of your Kia

- Occupant Detection System (ODS).....3-39
- Driver's and passenger's front air bag3-45
- Side air bag.....3-47
- Curtain air bag3-49
- Air bag collision sensors 3-50
- Why didn't my air bag go off in a collision? (Inflation and non-inflation conditions of the air bag).....3-51
- Supplemental Restraint System (SRS) care3-54
- Adding equipment to or modifying your air bag-equipped vehicle.....3-54
- Air bag warning label3-55

Safety features of your Kia

For the safety of the driver and vehicle passengers, you should become familiar with the vehicle's safety features.

Important safety precautions

You will find many safety precautions and recommendations throughout this section, and throughout this manual.

The safety precautions in this section are among the most important.

Always wear your seat belt

A seat belt is your best protection in all types of accidents. Air bags are designed to supplement seat belts, not replace them. So even though your vehicle is equipped with air bags, ALWAYS make sure you and your passengers wear your seat belts, and wear them properly.

Restrain all children

All children under age 13 should ride in your vehicle properly restrained in a rear seat, not the front seat. Infants and small children should be restrained in an appropriate child restraint. Larger children should use a booster seat with the lap/shoulder belt until they can use the seat belt properly without a booster seat.

Air bag hazards

While air bags can save lives, they can also cause serious or fatal injuries to occupants who sit too close to them, or who are not properly restrained. Infants, young children, and shorter adults are at the greatest risk of being injured by an inflating air bag. Follow all instructions and warnings in this manual.

Driver distraction

Driver distraction presents a serious and potentially deadly danger, especially for inexperienced drivers. Safety should be the first concern when behind the wheel and drivers need to be aware of the wide array of potential distractions, such as drowsiness, reaching for objects, eating, personal grooming, other passengers, and using cellular phones.

Drivers can become distracted when they take their eyes and attention off the road or their hands off the wheel to focus on activities other than driving. To reduce your risk of distraction or getting into an accident:

- ALWAYS set up your mobile devices (i.e., MP3 players, phones, navigation units, etc.) when your vehicle is parked or safely stopped.
- ONLY use your mobile device when allowed by laws and when conditions permit safe use. NEVER text or email while driving. Most countries have laws prohibiting drivers from texting. Some countries and cities also prohibit drivers from using handheld phones.
- NEVER let the use of a mobile device distract you from driving. You have a responsibility to your passengers and others on the road to always drive safely, with your hands on the wheel as well as your eyes and attention on the road.

Control your speed

Excessive speed is a major factor in crash injuries and deaths. Generally, the higher the speed, the greater the risk, but serious injuries can also occur at lower speeds. Never drive faster than is safe for current driving conditions,

regardless of the maximum speed posted.

Keep your vehicle in safe condition

Having a tire blowout or a mechanical failure can be extremely hazardous. To reduce the possibility of such problems, check your tire pressures and conditions frequently, and perform all regularly scheduled maintenance.

Seat

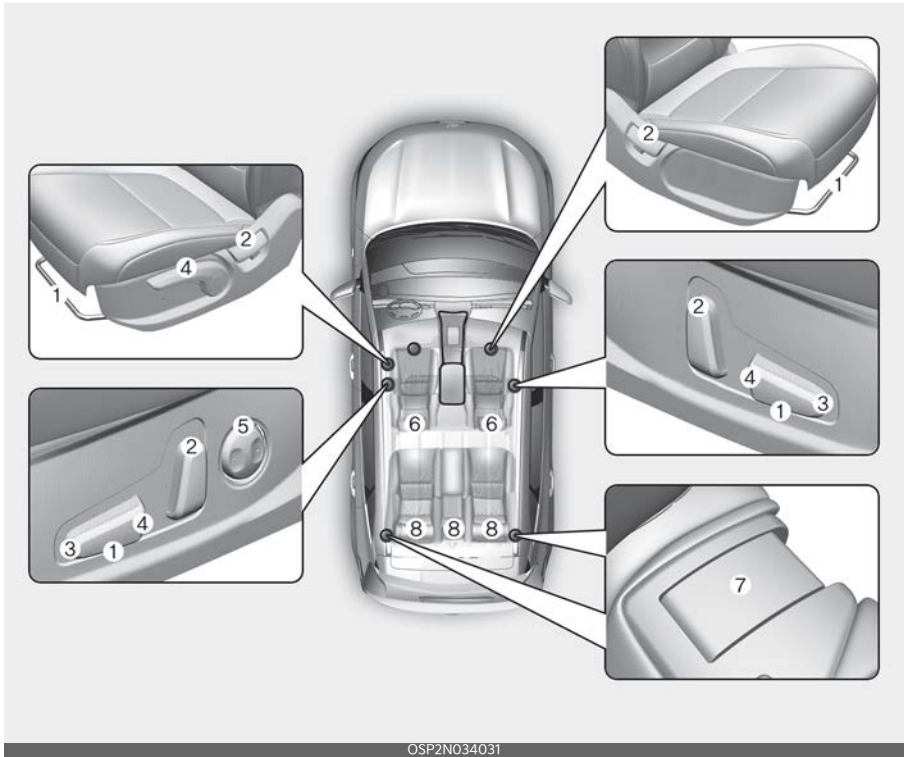

OSP2N034031

Front seat

- 1 Forward and backward
- 2 Seatback angle
- 3 Seat cushion tilt
- 4 Seat cushion height
- 5 Lumbar support*
- 6 Headrest

Rear seat

- 7 Seat back folding/reclining adjustment
 - 8 Headrest
- * if equipped

⚠ WARNING**Loose objects**

Loose objects in the driver's foot area could interfere with the operation of the foot pedals, possibly causing an accident. Do not place anything under the front seats.

⚠ WARNING**Uprighting seat**

Do not press the release lever on a manual seatback without holding and controlling the seatback. The seatback will spring upright, possibly impacting you or other passengers.

⚠ WARNING**Driver responsibility for passengers**

The driver must advise the passengers to keep the seatback in an upright position whenever the vehicle is in motion. If a seat is reclined during an accident, the restraint system's ability to restrain the passenger will be greatly reduced.

⚠ WARNING**Seat cushion**

Occupants should never sit on aftermarket seat cushions or sitting cushions. The

passenger Occupant Detection System may not operate properly, or the passenger's hips may slide under the lap portion of the seat belt during an accident or a sudden stop.

⚠ WARNING**Driver's seat**

- Never attempt to adjust the seat while the vehicle is moving. This could result in loss of control of your vehicle.
- Do not allow anything to interfere with the normal position of the seatback. For example, storing items against the seatback could result in serious or fatal injury in a sudden stop or collision.
- Sit as far back as possible from the steering wheel while still maintaining comfortable control of the your vehicle. A distance of at least 25 cm (10 inches) from your chest to the steering wheel is recommended. Failure to do so can result in air bag inflation injuries to the driver.

⚠ WARNING**Rear seatbacks**

Always lock the rear seatback before driving. Failure to do so could result in passengers or objects being thrown forward, injuring vehicle occupants.

⚠ WARNING**Unexpected Seat Movement**

After adjusting a manual seat, always check that it is locked by shifting your weight to the front and to the back. Sudden or unexpected movement of the driver's seat could cause you to lose control of the vehicle.

⚠ WARNING**Seat adjustment**

- Do not adjust the seat while wearing seat belts. Moving the seat forward will cause strong pressure on the abdomen.
- Do not place your hand near the seat bottom or seat track while adjusting the seat. Your hand could get caught in the seat mechanism.

⚠ WARNING**Luggage and Cargo**

Do not stack or pile luggage or cargo higher than the seatback in the cargo area. In an accident the cargo could strike and injure a passenger. If objects are large, heavy or must be piled, they must be secured in the cargo area.

⚠ WARNING**Cargo Area**

Do not allow passengers to ride in the cargo area under any circumstance. The cargo area is solely for the purpose of transporting luggage or cargo.

⚠ WARNING**Small Objects**

Use extreme caution when picking up small objects trapped under the seats or between the seat and the center console. Your hands might be cut or injured by the sharp edges of the seats mechanism.

Feature of Seat Leather

- Our car seats are upholstered with a combination of artificial and genuine leather. The genuine leather is made

from the outer skin of an animal, which goes through a special process to be available for use. Since it is a natural substance, each part differs in thickness or density. Also, wrinkles could appear depending on the temperature and humidity.

- The seat cover is made of stretchable material to improve comfort of passengers.
- The parts contacting the body are curved and the side supporting area is high which provides driving comfort and stability.

⚠ CAUTION

- Belts with metallic accessories, zippers or keys inside the back pocket may damage the seat fabric.
- Make sure not to wet the seat. It may change the nature of leather.
- Jeans or clothes which could bleed may contaminate the surface of the seat covering fabric.

*** NOTICE**

Wrinkles or abrasions may appear naturally from usage. It is not a fault of product. Wrinkles or abrasions are not covered by warranty.

Front seat adjustment for manual seat (if equipped)

The front seat can be adjusted by using the control levers located on the outside of the seat cushion.

Moving forward and backward



Adjust the seat before driving, and make sure the seat is locked securely by trying to move forward and backward without using the lever. If the seat moves, it is not locked properly.

To move the seat forward or backward:

1. Pull the seat slide adjustment lever up and hold it.
2. Slide the seat to the position you desire.
3. Release the lever and make sure the seat is locked in place.

Reclining seatback

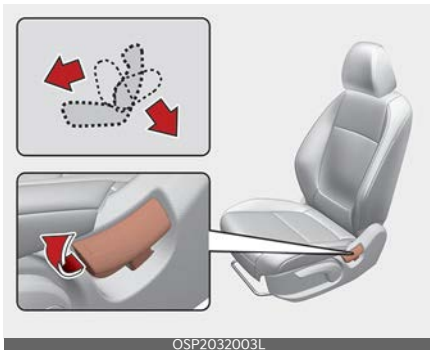

To recline the seatback:

1. Lean forward slightly and lift up the seatback recline lever.

2. Carefully lean back on the seat and adjust the seatback of the seat to the position you desire.
3. Release the lever and make sure the seatback is locked in place. (The lever **MUST** return to its original position for the seatback to lock.)

⚠ WARNING

Reclining seatback

Sitting in a reclined position when the vehicle is in motion can be dangerous. Even with the seat belt fastened, the protections of your restraint system (seat belts and/or air bags) is greatly reduced by reclining your seatback.

Seat belts must be snug against your hips and chest to work properly. When the seatback is reclined, the shoulder belt cannot do its job because it will not be snug against your chest. Instead, it will be in front of you. During an accident, you could be thrown into the seat belt, causing neck or other injuries.

The more the seatback is reclined, the greater chance the passenger's hips will slide under the lap belt or the passenger's neck will strike the shoulder belt.

Changing seat cushion height for driver's seat



To change the height of the seat cushion, push the lever upwards or downwards.

- To lower the seat cushion, push down the lever several times.
- To raise the seat cushion, pull up the lever several times.

Front seat adjustment for power seat (if equipped)

The front seat can be adjusted by using the control switches located on the outside of the seat cushion.

Before driving, adjust the seat to the proper position so you can easily control the steering wheel, pedals and switches on the instrument panel.

⚠ CAUTION

Power seating adjustments

- The power seating controls function by electronic motor. Excessive operation may cause damage to the electrical equipment.
- Do not operate two or more power seat control switches at the same time. Doing so may damage the power seat motor or electrical components.

Moving forward and backward



To move the seat forward or backward:

1. Push the control switch forward or backward to move the seat to the desired position.
2. Release the switch once the seat reaches the desired position.

Reclining seatback

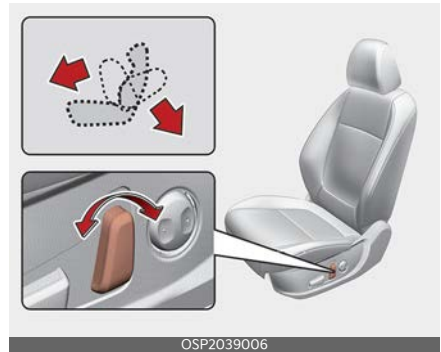

To recline the seatback:

1. Push the control switch forward or backward to move the seatback to the desired angle
2. Release the switch once the seat reaches the desired position.

Changing seat cushion tilt and height

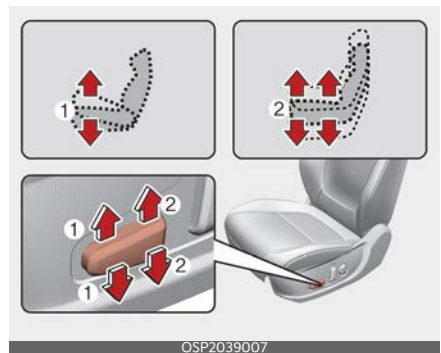

To change the height of the seat:

1. Pull the front portion (1) of the control switch up to raise or press down to lower the front part of the seat cushion.
2. Pull the rear portion (2) of the control switch up to raise or press down to lower the back part of the seat cushion.
3. Release the switch once the seat reaches the desired position.

Adjusting lumbar support for driver's seat (if equipped)

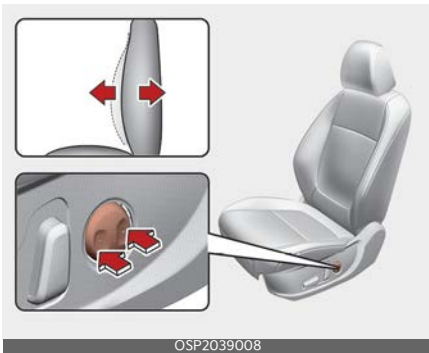

The lumbar support can be adjusted by pressing the lumbar support switch on the side of the seat.

1. Press the front portion of the switch to increase support, or the rear portion of the switch, to decrease support.
2. Release the switch once it reaches the desired position.

Headrest for front seat

The driver's and front passenger's seats are equipped with a headrest for the occupant's safety and comfort.



The headrest not only provides comfort for the driver and front passenger, but also helps protect the head and neck in the event of a rear collision.

For maximum effectiveness in case of an accident, the headrest should be adjusted so the middle of the headrest is as high as the center of gravity of an occupant's head. Generally, the center of gravity of most people's head is similar with the height of the top of their eyes.

Also, adjust the headrest as close to your head as possible. For this reason, the use of a cushion that holds the body away from the seatback is not recommended.

⚠ WARNING

Headrest removal/adjustment

- Do not operate the vehicle with the headrests removed. Headrests can provide critical neck and head support in a crash.
- Do not adjust the headrest height while the vehicle is in motion. Driver may lose control of the vehicle.

⚠ CAUTION

Excessive pulling or pushing may damage the headrest.

Adjusting the height up and down

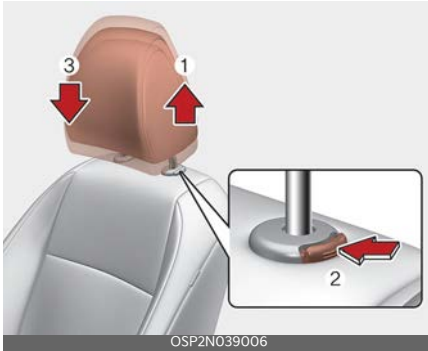

To raise the headrest:

1. Pull it up to the desired position (1).
2. To lower the headrest, push and hold the release button (2) on the headrest support.
3. Lower the headrest to the desired position (3).

* NOTICE

If you recline the seatback towards the front with the headrest and seat cushion raised, the headrest may come in contact with the sun visor or other parts of the vehicle.



Removing headrest

Type A



Type B

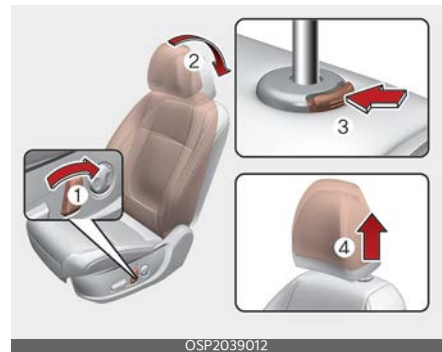

To remove the headrest:

1. Recline the seatback (2) with the recline lever or switch (1).
2. Raise headrest as far as it can go.
3. Press the headrest release button (3) while pulling the headrest up (4).

⚠ WARNING

Removing headrest

NEVER allow anyone to ride in a seat with the headrest removed or reversed. Headrests can provide critical neck and head support in a crash.

Reinstalling headrest

Type A

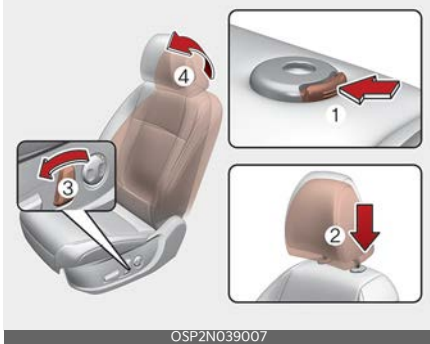

To reinstall the headrest:

1. Put the headrest poles (2) into the holes while pressing the release button (1).
2. Recline the seatback (4) with the recline lever or switch (3).
3. Adjust the headrest to the appropriate height.

⚠ WARNING

Headrest Reinstallation

To reduce the risk of injury to the head or neck, always make sure the headrest is locked into position and adjusted properly after reinstalling.

Seatback pocket (if equipped)

The seatback pocket is provided on the back of the front passenger's seatbacks.

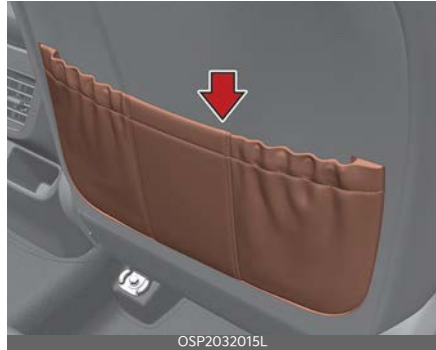

⚠ WARNING

Seatback pockets

Do not put heavy or sharp objects in the seatback pockets. In an accident they could come loose from the pocket and injure vehicle occupants.

Headrest for rear seat

The rear seat is equipped with headrests in all the seating positions for the occupant's safety and comfort.



The headrest not only provides comfort for passengers, but also helps protect the head and neck in the event of a collision.

To maximize the effectiveness in case of accidents, the headrest should be adjusted so the middle of the headrest is as high as the center of gravity of an occupant's head. Generally, the center of gravity of most people's heads is similar with the height as the top of their eyes. Also, adjust the headrest as close to your head as possible. For this reason, the use of a cushion that holds the body away from the seatback is not recommended.

Adjusting the height up and down (if equipped)

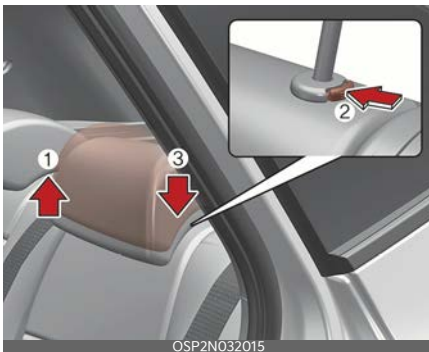

- To raise the headrest, pull it up to the desired position (1).
- To lower the headrest, push and hold the release button (2) on the headrest support and lower the headrest to the desired position (3).

Removal and reinstallation (if equipped)

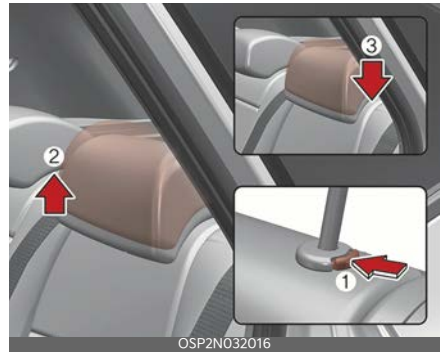

- To remove the headrest, raise it as far as it can go then press the release button (1) While pulling the headrest upward (2).
 - To reinstall the headrest, put the headrest poles (3) into the holes while pressing the release button (1).
- Then adjust it to the appropriate height and ensure that it locks in position.

Armrest (if equipped)



To use the armrest, pull it forward from the seatback.

Folding the rear seat

The rear seatbacks may be folded to facilitate carrying long items or to

increase the luggage capacity of the vehicle.

⚠ WARNING

Folded Seatback

The purpose of the fold-down rear seatbacks is to allow you to carry longer objects that could not otherwise be accommodated.

- Never allow a passenger to sit on top of the folded down seatback while the car is moving. This is not a proper seating position since no seat belts are available for use. This could result in serious injury or death, for example, in case of an accident or sudden stop.

⚠ WARNING

When folding the seatback, be sure to hold the seatback or headrest with your hands.

⚠ CAUTION

When folding or unfolding a rear seat, make sure to lower the seat's headrest as much as possible and put the front seat's seatback in the upright position. If there is any interference when folding or unfolding the seat, the interfered area of the seat may be damaged.

Folding down the rear seatback

1. Set the front seatback to the upright position and, if necessary, slide the front seat forward.
2. Lower the rear headrests to the lowest position.

⚠ WARNING

Objects

Objects carried on the folded down seatback should not extend higher than the

top of the front seatbacks. Otherwise, cargo may slide forward and cause injury or damage during sudden stops.

3. When folding the seatback, insert the rear seat belt buckle in the pocket between the rear seatback and cushion. Make sure both seat belts do not interfere with stowed luggage and cargo. Then, the seat belt webbing should be placed in the webbing guide to prevent the seat belt from being damaged by loaded cargo, etc. If the seat belt is loose, it may cause damage or noise. In that case, return the seatback to the upright position and put the webbing out from the guide to realign it.

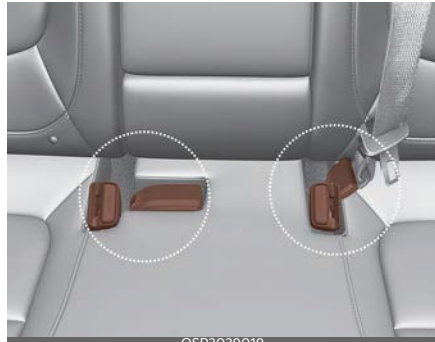

4. Pull on the seatback folding lever, then fold the seat toward the front of

the vehicle. When you return the seatback to its upright position, always be sure it has locked into position by pushing on the top of the seatback.



OSP2N032020

Unfolding the rear seat



OSP2N032021

1. To use the rear seat, lift and pull the seatback backward. Pull the seatback firmly until it clicks into place. Make sure the seatback is locked in place. When you return the seatback to its upright position, always be sure it has locked into position by pushing on the top of the seatback.
2. Return the rear seat belt to the proper position.
3. When the seatback is completely installed, check the seatback folding lever again.

4. If you want to tilt the rear seatback a bit more, while pulling on the seatback folding lever and push the top of the rear seatback towards the rear. Then release the lever and make sure that the rear seat is firmly locked.

⚠ WARNING

Uprighting seat

When you return the seatback to its upright position, hold the seatback and return it slowly. If the seatback is returned without holding it, the back of the seat could spring forward, resulting in injury caused by being struck by the seatback.

⚠ WARNING

Rear seatback

To ensure maximum protection in the event of an accident or sudden stop, when returning the rear seat to the upright position:

- Be careful not to damage the seat belt webbing or buckle.
- Do not allow the seat belt webbing or buckle to become pinched or caught in the rear seat.
- Ensure the seatback is completely locked into its upright position by pushing on the top of the seatback. Failure to adhere to any of these instructions could result in serious injury or death in the event of a crash.

⚠ CAUTION

Damaging rear seat belt buckles

When you fold the rear seatback, insert the buckle between the rear seatback and cushion. Doing so can prevent the

buckle from being damaged by the rear seatback.

⚠ CAUTION

Rear seat belts

When returning the rear seatbacks to the upright position, remember to return the rear shoulder belts to their proper position.

⚠ WARNING

Unless the driver's position is properly set according to the driver's physical figure, do not fold the rear seat. It may increase bodily injuries in a sudden stop or collision.

⚠ CAUTION

Be careful when loading cargo through the rear passenger seats to prevent damage to the vehicle interior.

⚠ WARNING

Cargo

Cargo should always be secured to prevent it from being thrown about the vehicle in a collision and causing injury to the vehicle occupants. Do not place objects in the rear seats, since they cannot be properly secured and may hit the front seat occupants in a collision.

Cargo loading

Make sure the engine is off, the transmission is in P (Park) and the parking brake is securely applied whenever loading or unloading cargo. Failure to take these steps may allow the vehicle to move if the shift lever is inadvertently moved to another position.

Seat belts

Seat belts are designed to bear upon the bony structure of the body, and should be worn low across the front of the pelvis, chest and shoulders.

Seat belt restraint system

For maximum restraint system protection, the seat belts must always be used whenever the vehicle is moving.

- A properly positioned shoulder belt should be positioned midway over your shoulder, across your collarbone.
- Never allow children to ride in the front passenger seat. See "Child Restraint System (CRS)" on page 3-26 for further discussion.

⚠ WARNING

Twisted seat belt

Make sure your seat belt is not twisted when worn. A twisted seat belt may not properly protect you in an accident and could even cut into your body.

⚠ WARNING

Shoulder Belt

- Never wear the shoulder belt under your arm or behind your back. An improperly positioned shoulder belt cannot protect the occupant in the event of a crash, and could even enhance injuries to the occupant.
- Always wear both the shoulder portion and lap portion of the lap/shoulder belt.

⚠ WARNING

Damaged seat belt

Any damage in webbing or hardware may lead to serious injury or death in a crash. For your safety, replace the entire

seat belt assembly when any part of the webbing or hardware is damaged.

Seat belts are designed to bear upon the bony structure of the body, and should be worn low across the front of the pelvis, chest and shoulders, as applicable; wearing the lap section of the belt across the abdominal area must be avoided.

Seat belts should be adjusted as firmly as possible, consistent with comfort, to provide the protection for which they have been designed.

A slack belt will greatly reduce the protection afforded to the wearer.

Care should be taken to avoid contamination of the webbing with polishes, oils and chemicals, and particularly battery acid. Cleaning may safely be carried out using mild soap and water. The belt should be replaced if webbing becomes frayed, contaminated or damaged.

- No modifications or additions should be made by the user which would either prevent the seat belt adjusting devices from operating to remove slack, or prevent the seat belt assembly from being adjusted to remove slack.
- When you fasten the seat belt, be careful not to latch the seat belt in buckles of other seats. It is very dangerous and you may not be protected by the seat belt properly.
- Do not unfasten the seat belt and do not fasten and unfasten the seat belt repeatedly while driving. This could result in loss of control, and an accident causing death, serious injury, or property damage.
- When fastening the seat belt, make sure that the seat belt does not pass

over objects that are hard or can break easily.

⚠ WARNING

Seat belt buckle

Do not allow foreign material (gum, crumbs, coins, liquids, etc.) to obstruct the seat belt buckle. This may prevent the seat belt from fastening securely.

Driver's seat belt warning

As a reminder to the driver, the driver's seat belt warning light (1) will appear for approximately 6 seconds each time you turn the ENGINE START/STOP button ON regardless of belt fastening. If the seatbelt is not fastened, the warning chime will sound for about 6 seconds.

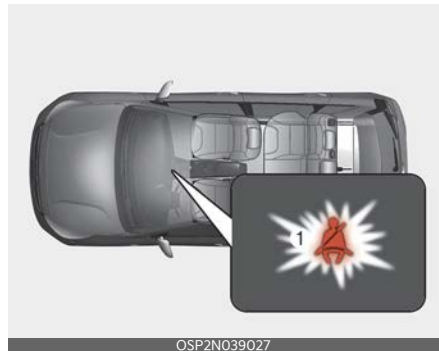

If you start to drive without the seat belt fastened over 9 km/h (5 mph) and less than 20 km/h (12 mph), the corresponding warning light will appear. The warning light will turn off when the vehicle speed drops below 9 km/h (5 mph).

If you start to drive without the seat belt fastened or you unfasten the seat belt when you drive 20 km/h (12 mph) and faster, the warning light will blink and warning chime will sound for approximately 100 seconds. When the seat belt is unfastened during driving, the warn-

ing light will appear when the speed is under 20 km/h (12 mph). When the speed is 20 km/h (12 mph) and faster, the warning light will blink and warning chime will sound for approximately 100 seconds.

Front passenger's seat belt warning

As a reminder to the front passenger, the front passenger's seat belt warning light (1) appear for approximately 6 seconds each time you turn the ENGINE START/STOP button ON regardless of belt fastening. If you start to drive without the passenger seat belt fastened when you drive over 9 km/h (5 mph) and less than 20 km/h (12 mph), the corresponding warning light will appear. The warning light will turn off when the vehicle speed drops below 9 km/h (5 mph).



If you start to drive without the passenger seat belt fastened or you unfasten the seat belt when you drive 20 km/h (12 mph) and faster, the warning light will blink and warning chime will sound for approximately 100 seconds. When the passenger seat belt is unfastened during driving, the warning light will appear when the speed is under 20 km/h (12 mph). When the speed is 20 km/h (12 mph) and faster, the warning light will

blink and warning chime will sound for approximately 100 seconds.

* NOTICE

- Even if the front passenger seat is not occupied, the seat belt warning light will appear for 6 seconds.
- The front passenger's seat belt warning may operate when luggage is placed on the front passenger seat.

Seat belt - Driver's 3-point system with emergency locking retractor

The following explains how to fasten and adjust the driver's seat belt.

Fastening your seat belt:

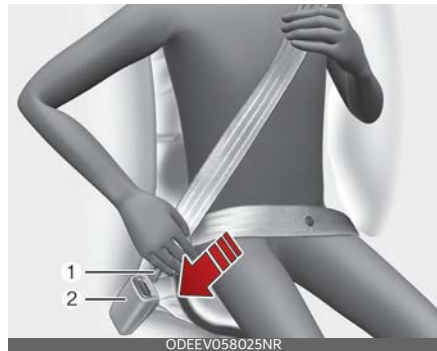

- Pull it out of the retractor and insert the metal tab (1) into the buckle (2). There will be an audible "click" when the tab locks into the buckle.



⚠ WARNING

You should place the lap belt portion as low as possible and snugly across your hips. If the lap belt is located too high on your waist, it may increase the chance of injury in the event of a collision.

The arm closest to the seat belt buckle should be over the belt while the other arm should be under the belt as shown in the illustration. Never wear the seat belt under the arm closest to the door.

The seat belt automatically adjusts to the proper length only after the lap belt portion is adjusted manually so that it fits snugly around your hips. If you lean forward in a slow, easy motion, the belt will extend and let you move around. If there is a sudden stop or impact, however, the belt will lock into position. It will also lock if you try to lean forward too quickly.

* NOTICE

If you are not able to pull out the seat belt from the retractor, firmly pull the belt out and release it. Then you will be able to pull the belt out smoothly.

Adjusting the height of shoulder belt

You can adjust the height of the shoulder belt anchor to one of the 4 positions for maximum comfort and safety.

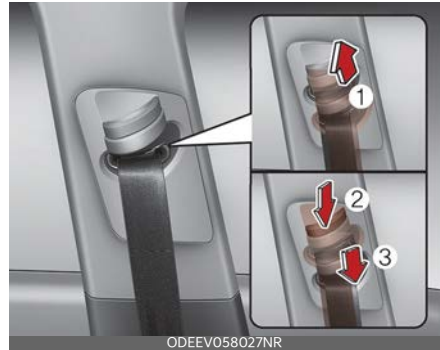

The height of the adjusting seat belt should not be too close to your neck. The shoulder portion should be adjusted so that it lies across your chest and mid-way over your shoulder near the door and not your neck.

To adjust the height of the seat belt anchor, lower or raise the height adjuster into an appropriate position.

- To raise the height adjuster, pull it up (1).
- To lower it, push it down (3) while pressing the height adjuster button (2).

Release the button to lock the anchor into position. Try sliding the height adjuster to make sure that it has locked into position.

Improperly positioned seat belts can cause serious injuries in an accident.

⚠ WARNING

Shoulder belt positioning

Verify the shoulder belt anchor is locked into position at the appropriate height. Never position the shoulder belt across

your neck or face. Improperly positioned seat belts can cause serious injuries in an accident.

⚠ WARNING

Seat belt replacement

After a collision, the seat belt system should be inspected to ensure it is operating normally. Replace any belts that are not functioning appropriately.

Seat belts - Front passenger and rear seat 3-point system with combination locking retractor

The following explains how to fasten the passenger's and rear seat belts.

Fastening your seat belt:

Combination retractor type seat belts are installed in the rear seat positions to help accommodate the installation of Child Restraint System. Although a combination retractor is also installed in the front passenger seat position, it is strongly recommended that children always be seated in the rear seat. NEVER place any infant restraint system in the front seat of the vehicle.

This type of seat belt combines the features of both an emergency locking retractor seat belt and an automatic locking retractor seat belts.

- Pull it out of the retractor and insert the metal tab into the buckle. There will be an audible "click" when the tab locks into the buckle. When not securing a child restraint, the seat belt operates in the same way as the driver's seat belt (emergency locking retractor type).

It automatically adjusts to the proper length only after the lap belt portion of

the seat belt is adjusted manually so that it fits snugly around your hips.

When the seat belt is fully extended from the retractor to allow the installation of a Child Restraint System, the seat belt operation changes to allow the belt to retract, but not to extend (automatic locking retractor type). Refer to "Securing a child restraint with a lap/shoulder belt" on page 3-31.

*** NOTICE**

Although the combination retractor provides the same level of protection for seated passengers in either emergency or automatic locking modes, have the seated passengers use the emergency locking feature for improved convenience. The automatic locking function is intended to facilitate child restraint installation. To convert from the automatic locking feature to the emergency locking operation mode, allow the unbuckled seat belt to fully retract.

⚠ CAUTION

Do NOT fold down the left portion of the rear seatback when the rear center seat belt is buckled. ALWAYS UNBUCKLE the rear center seat belt before folding down the left portion of the rear seatback. If the rear center seat belt is buckled when the left portion of the rear seatback is folded down, distortion and damage to the top portion of the seatback and seat belt garnish may result, causing the seatback to lock into the folded down position.

The seat belt should be locked into the buckle on each seat cushion to be properly fastened.



1. Rear right seat belt fastening buckle
2. Rear center seat belt fastening buckle
3. Rear left seat belt fastening buckle

⚠ WARNING

Prior to fastening the rear seat belts, ensure the latch matches the seat belt buckle. Forcefully fastening the left or right seat belt to the center buckle can result in an improper fastening scenario that will not protect you in an accident.

When using the rear center seat belt, the buckle with the "CENTER" mark must be used.

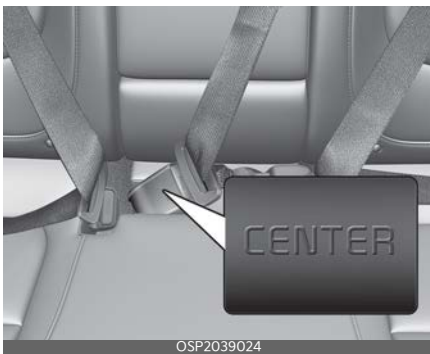

Stowing the rear seat belt

The rear seat belt buckles can be stowed in the pocket between the rear seatback and cushion when not in use.



1. Route the seat belt webbing through the rear seat belt guides. It will help keep the belts from being trapped behind or under the seats.
2. After inserting the seat belt, tighten the belt webbing by pulling it up.

⚠ CAUTION

When pulling out to wear the seat belt, the tongue should be slowly pulled out of the seat belt guide so that the seat belt guide does not come off the trim.

⚠ WARNING

Rear center seat belt



Do not separate the mini tongue (1) and mini buckle (2) even if there is not an occupant.

If it is separated, It may hit the rear seat occupants in a collision or sudden stops.

Releasing the seat belt:



- The seat belt is released by pressing the release button (1) on the locking buckle. When it is released, the belt should automatically draw back into the retractor. If this does not happen, check the belt to make sure it is not twisted, then try again.

Pre-tensioner seat belt

Your vehicle is equipped with driver's and front passenger's pre-tensioner seat belts (retractor pre-tensioner seat belt and EFD (Emergency Fastening Device)).



The pre-tensioner seat belts may be activated, when a frontal collision is severe enough, together with the air bags.

When the vehicle stops suddenly, or if the occupant tries to lean forward too quickly, the retractor pre-tensioner seat belt may lock into position. In certain frontal collisions, the pre-tensioner seat belt will activate and pull the seat belt into tighter contact against the occupant's body.

- 1 Retractor pre-tensioner seat belt**
The purpose of the retractor pre-tensioner seat belt is to make sure that the shoulder belts fit in tightly against the occupant's upper body in certain frontal collisions.
- 2 EFD (Emergency Fastening Device)**
The purpose of the EFD is to make sure that the pelvis belts fit in tightly against the occupant's lower body in certain frontal collisions.

If the system senses excessive tension on the driver or passenger's seat belt when the pre-tensioner seat belt activates, the load limiter inside the retractor pre-tensioner seat belt will release some of the pressure on the affected seat belt.

*** NOTICE**

When the pre-tensioner seat belts are activated, a loud noise may be heard and fine dust, which may appear to be smoke, may be visible in the passenger compartment. These are normal operating conditions and are not hazardous.

The pre-tensioner seat belt consists mainly of the following components. Their locations are shown in the illustration:



* The actual position of pre-tensioner seat belt components may differ from the illustration.

- 1 SRS air bag warning light
- 2 Retractor pre-tensioner seat belt assembly
- 3 SRS control module
- 4 Emergency fastening device (EFD)

⚠ WARNING

Skin Irritation

Wash all exposed skin areas thoroughly after an accident in which the pre-tensioner seat belts were activated. The fine dust from the pre-tensioner seat belt activation may cause skin irritation and should not be inhaled for prolonged periods.

*** NOTICE**

- Both the driver's and front passenger's pre-tensioner seat belt may be activated not only in certain frontal collisions, but also in certain side collisions or rollovers, if the vehicle is equipped with a side or curtain air bag.
- Because the sensor that activates the SRS air bag is connected with the pre-tensioner seat belt, the SRS air bag

warning light  on the instrument panel will appear for approximately 6 seconds after the ignition switch has been turned to the ON position, and then it should turn off.

- If the pre-tensioner seat belt is not working properly, this warning light will appear even if there is not a malfunction with the SRS air bag. If the SRS air bag warning light does not appear when the ignition switch has been turned to the ON position, or if it remains appeared after appearing for approximately 6 seconds, or if it appears while the vehicle is being driven, have an authorized Kia dealer inspect the pre-tensioner seat belt and SRS air bag system as soon as possible.

*** NOTICE**

Do not attempt to service or repair the pre-tensioner seat belt in any manner. Do not attempt to inspect or replace the pre-tensioner seat belts yourself. This must be done by an authorized Kia dealer.

⚠ WARNING

Hot pre-tensioner seat belt

Do not touch the pre-tensioner seat belt assemblies for several minutes after they have been activated. When the pre-tensioner seat belt mechanism fires during a collision the pre-tensioner seat belt becomes hot and can burn you.

Pre-tensioner seat belt are designed to operate only one time. After activation, pre-tensioner seat belt seat belts must be replaced. If the pre-tensioner must be

replaced, contact an authorized Kia dealer.

Seat belt precautions

Take the following precautions when using seat belts.

Infant or small child

Most countries have child restraint laws. You should be aware of the specific requirements in your country. Child and/or infant seats must be properly placed and installed in the rear seat. For more information about the use of these restraints, refer to "Child Restraint System (CRS)" on page 3-26.

* NOTICE

Small children are best protected from injury in an accident when properly restrained in the rear seat by a Child Restraint System that meets the requirements of the Safety Standards of your country. Before buying any Child Restraint System, make sure that it has a label certifying that it meets Safety Standards of your country. The restraint must be appropriate for your child's height and weight. Check the label on the child restraint for this information. Refer to "Child Restraint System (CRS)" on page 3-26.

Larger children

Children who are too large for Child Restraint System should always occupy the rear seat and use the available lap/shoulder belts. The lap portion should be fastened and snug on the hips as low as possible. Check periodically to insure that the belt fits. A child's squirming could put the belt out of position. Children are given the most safety in the

event of an accident when they are restrained by a proper restraint system in the rear seat. If a larger child (over age 13) must be seated in the front seat, the child should be securely restrained by the available lap/shoulder belt and the seat should be placed in the rearmost position. Children age 13 and under should be restrained securely in the rear seat. NEVER place a child age 13 and under in the front seat. NEVER place a rear facing child seat in the front seat of a vehicle.

If the shoulder belt portion slightly touches the child's neck or face, try placing the child closer to the center of the vehicle. If the shoulder belt still touches their face or neck they need to be returned to a Child Restraint System.

⚠ WARNING

Small children

Do not allow small children to ride in the vehicle without an appropriate Child Restraint System. If the shoulder belt comes in contact with your child's neck or face, your child is too small to ride in the vehicle. In a crash, the seat belt will inflict injury to your child's neck, throat and face.

Restraint of pregnant women

Pregnant women should wear lap/shoulder belt assemblies whenever possible according to specific recommendations by their doctors. The lap portion of the belt should be worn AS SECURELY AND LOW AS POSSIBLE.

⚠ WARNING

Pregnant women

Pregnant women must never place the lap portion of the seat belt above or on

the abdomen where the fetus is located. The force of the seat belt during a collision will crush the fetus.

Injured person

A seat belt should be used when an injured person is being transported. When this is necessary, you should consult a physician for recommendations.

One person per belt

Two people (including children) should never attempt to use a single seat belt. This could increase the severity of injuries in case of an accident.

Do not lie down

To reduce the chance of injuries in the event of an accident and to achieve maximum effectiveness of the restraint system, all passengers should be sitting up and the front and rear seats should be in an upright position when the vehicle is moving. A seat belt cannot provide proper protection if the person is lying down in the rear seat or if the front and rear seats are in a reclined position.

Care of seat belts

Seat belt systems should never be disassembled or modified. In addition, care should be taken to assure that seat belts and belt hardware are not damaged by seat hinges, doors or other abuse.

WARNING

Pinched seat belt

Make sure that the webbing and/or buckle does not get caught or pinched in the rear seat when returning the rear seatback to its upright position. A caught or pinched webbing/buckle may

become damaged and could fail during a collision or sudden stop.

WARNING

Seatbelts can become hot in a vehicle that has been closed up in sunny weather. Please handle with care, as they could burn infants and children, if used abruptly.

Periodic inspection

All seat belts should be inspected periodically for wear or damage of any kind. Any damaged parts should be replaced as soon as possible.

Keep belts clean and dry

Seat belts should be kept clean and dry. If belts become dirty, they can be cleaned by using a mild soap solution and warm water. Bleach, dye, strong detergents or abrasives should not be used because they may damage and weaken the fabric.

When to replace seat belts

The entire in-use seat belt assembly or assemblies should be replaced if the vehicle has been involved in an accident. This should be done even if no damage is visible. Additional questions concerning seat belt operation should be directed to an authorized Kia dealer.

Child Restraint System (CRS)

Infants and younger children must be restrained in an appropriate rear-facing or forward-facing Child Restraint System (CRS) that has first been properly secured to the rear seat of the vehicle.

Children always in the rear

Children under age 13 must always ride in the rear seats and must always be properly restrained to minimize the risk of injury in an accident, sudden stop or sudden maneuver.

WARNING

Restraint Location

Never install a child or infant seat on the front passenger's seat. A child riding in the front passenger seat can be forcefully struck by an inflating airbag and get seriously injured.

WARNING

Hot Child Restraint

A Child Restraint System can become very hot if it is left in a closed vehicle on a sunny day. Be sure to check the seat cover, buckles and latches before placing a child in the restraint system.

According to accident statistics, children are safer when properly restrained in the rear seats than in the front seat. Even with air bags, children can be seriously injured or killed. Children too large for a child restraint must use the seat belts provided.

Most countries have child restraint laws which require children to travel in approved child restraint devices. The laws governing the age or height/weight restrictions at which seat belts can be used instead of child restraints differs

among countries, so you should be aware of the specific requirements in your country, and where you are traveling.

The CRS must be properly placed and installed in the rear seat. You must use a commercially available CRS that meets the requirements of the Safety Standards of your country.

A CRS is generally designed to be secured in a vehicle seat by lap belt portion of a lap/shoulder belt, or by a LATCH system in the rear seats of the vehicle.

Child Restraint System (CRS)

Infants and younger children must be restrained in an appropriate rear-facing or forward-facing CRS that has first been properly secured to the rear seat of the vehicle. Read and comply with the instructions for installation and use provided by the manufacturer of the CRS.

WARNING

Child Restraint Installation

An improperly secured child restraint can increase the risk of serious injury or death in an accident. Always take the following precautions when using a Child Restraint System:

- Always follow the Child Restraint System manufacturer's instructions for installation and use.
- Always properly restrain your child in the child restraint.
- If the vehicle head restraint prevents proper installation of a child seat (as described in the Child Restraint System manual), the head restraint of the respective seating position shall be readjusted or entirely removed.

- Do not use an infant carrier or a child safety seat that "hooks" over a seat-back as it may not provide adequate protection in an accident.
- A child restraint in the center seating position may also contact or push up against the safety belt buckles, which can damage the buckles and make them unusable or unsafe. Always check that the child restraint does not contact any of the safety belt buckles. Check the placement of the child restraint regularly to make sure that it has not shifted and come into contact with any of the safety belt buckles.

* NOTICE

After an accident, have a Kia dealer check the Child Restraint System, seat belts, tether anchors and lower anchors.

Selecting a CRS

When selecting a CRS for your child, always:

- Make sure the CRS has a label certifying that it meets applicable Safety Standards of your country.
- Select a child restraint based on your child's height and weight. The required label or the instructions for use typically provide this information.
- Select a child restraint that fits the vehicle seating position where it will be used.
- Read and comply with the warnings and instructions for installation and use provided with the CRS.

⚠ WARNING

Holding Children

Never hold a child in your arms or lap when riding in a vehicle. The violent

forces created during a crash will tear the child from your arms and throw the child against the car's interior. Always use a Child Restraint System which is appropriate for your child's height and weight.

⚠ WARNING

Unattended Children

Never leave children unattended in a vehicle. The car can heat up very quickly, resulting in injuries to the child in the vehicle.

⚠ WARNING

Seat Belt Use

Do not use one seat belt for two occupants at the same time. This will eliminate any safety benefit provided by the seat belt to the occupants.

CRS types

There are three main types of the CRS: rear-facing seats, forward-facing seats, and booster seats. They are classified according to the child's age, height and weight.

Rear-facing child seats

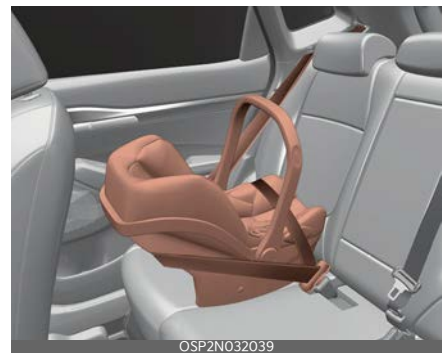

OSP2N032039

A rear-facing child seat provides restraint with the seating surface against the back of the child. The harness system holds the child in place, and in an accident, acts to keep the child positioned in the seat and reduces the stress to the neck and spinal cord.

All children under age one must always ride in a rear-facing infant child restraint. Convertible and 3-in-1 child seats typically have higher height and weight limits for the rear-facing position, allowing you to keep your child rear-facing for a longer period of time.

Continue to use a rear-facing child seat for as long as your child will fit within the height and weight limits allowed by the child seat manufacturer. It's the best way to keep them safe. Once your child has outgrown the rear-facing child restraint, your child is ready for a forward-facing child restraint with a harness.

Forward-facing child restraints



A forward-facing child seat provides restraint for the child's body with a harness. Keep children in a forward-facing child seat with a harness until they reach the top height or weight limit allowed by your child restraint's manufacturer.

Once your child outgrows the forward-facing child restraint, your child is ready for a booster seat.

Booster seats

A booster seat is a restraint designed to improve the fit of the vehicle's seat belt system. A booster seat positions the seat belt so that it fits properly over the lap of your child.

Keep your child in a booster seat until they are big enough to sit in the seat without a booster and still have the seat belt fit properly. For a seat belt to fit properly, the lap belt must lie snugly across the upper thighs, not the stomach. The shoulder belt should lie snug across the shoulder and chest and not across the neck or face. Children under age 13 must always ride in the rear seats and must always be properly restrained to minimize the risk of injury.

Installing a CRS

After selecting a proper child seat for your child, check to make sure it fits properly in your vehicle.

Follow the instructions provided by the manufacturer when installing the child seat. Note these general steps when installing the seat to your vehicle:

- **Properly secure the child restraint to the vehicle.** All child restraints must be secured to the vehicle with the lap part of a lap/shoulder belt or with the LATCH system.
- **Make sure the child restraint is firmly secured.** After installing a child restraint to the vehicle, push and pull the seat forward and from side-to-side to verify that it is securely attached to the seat. A child restraint secured with a seat belt should be installed as firmly as possible. How-

ever, some side-to-side movement can be expected.

- **Secure the child in the child restraint.** Make sure the child is properly strapped in the child restraint according to the manufacturer instructions.

Lower Anchors and Tether for Children (LATCH) system

The LATCH system holds a child restraint during driving and in an accident. This system is designed to make installation of the child restraint easier and reduce the possibility of improperly installing your child restraint. The LATCH system uses anchors in the vehicle and attachments on the child restraint. The LATCH system eliminates the need to use seat belts to secure the child restraint to the rear seats.

Lower anchors are metal bars built into the vehicle. There are two lower anchors for each LATCH seating position that will accommodate a child restraint with lower attachments.

To use the LATCH system in your vehicle, you must have a child restraint with LATCH attachments.

The child seat manufacturer will provide you with instructions on how to use the child seat with its attachments for the LATCH lower anchors.



LATCH anchors have been provided in the left and right outboard rear seating positions. Their locations are shown in the illustration. There are no LATCH anchors provided for the center rear seating position.

⚠ WARNING

LATCH Lower Anchors

Never attempt to attach a LATCH equipped seat in the center seating position. LATCH lower anchors are only to be used in the left and right rear outboard seating positions. You may damage the anchors or the anchors may fail and break in a collision if the seat is in the center seating position.

The lower anchor position indicator symbols are located on the left and right rear seatbacks to identify the position of the lower anchors in your vehicle (see arrows in illustration).

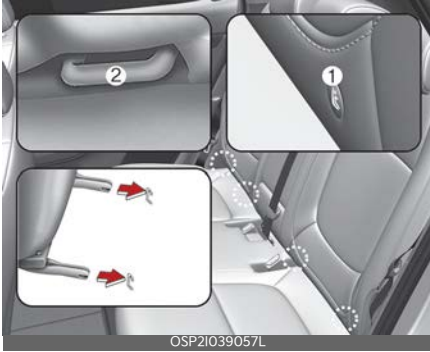

1 Lower Anchor position indicator

2 Lower Anchor

The LATCH anchors are located between the seatback and the seat cushion of the rear seat left and right outboard seating positions.

To use the lower anchor, push the upper portion of the lower anchor cover.

Securing a child restraint with the LATCH anchors system

To install a LATCH-compatible child restraint in either of the rear outboard seating positions:

1. Move the seat belt buckle away from the lower anchors. Otherwise, the webbing or buckle can be damaged by the latch anchor, which can make them become unusable or unsafe.
2. Move any other objects away from the anchors that could prevent a secure connection between the child restraint and the lower anchors.
3. Place the child restraint on the vehicle seat, then attach the seat to the lower anchors according to the instructions provided by the child restraint manufacturer.
4. Follow the child restraint instructions for properly adjusting and tightening

the lower attachments on the child restraint to the lower anchors.

⚠ WARNING

Take the following precautions when using the LATCH system:

- Read and follow all installation instructions provided with your Child Restraint System.
- To prevent the child from reaching and taking hold of the unused seat belts, buckle all unused rear seat belts before the child is placed into the vehicle. Lock each unused seatbelt following the instructions in the "automatic locking mode" subsection, and place the webbing behind the child seat or against an unused seatback. Children can be strangled if a shoulder belt becomes wrapped around their neck and the seat belt tightens.
- NEVER attach more than one child restraint to a single anchor. This could cause the anchor or attachment to come loose or break.
- Always have the LATCH system inspected by your authorized Kia dealer after an accident. An accident can damage the LATCH system and may not properly secure the child restraint.

Securing a child restraint seat with "Tether Anchor" system



First secure the child restraint with the LATCH lower anchors or the seat belt. If the child restraint manufacturer recommends that the top tether strap be attached, attach and tighten the top tether strap to the top tether strap anchor.

Child restraint hook holders are located on the shelf behind the rear seats.

⚠ WARNING

Take the following precautions when installing the tether strap:

- Read and follow all installation instructions provided with your Child Restraint System.
- NEVER attach more than one child restraint to a single tether anchor. This could cause the anchor or attachment to come loose or break.
- Do not attach the tether strap to anything other than the correct tether anchor. It may not work properly if attached to something else.
- Do not use the tether anchors for adult seat belts or harnesses, or for attaching other items or equipment to the vehicle.

- Always fasten the seat belts behind the child restraint seat when they are not used to secure the child seat. Failure to do so may result in child strangulation.

To install the tether anchor:



1. Route the child restraint tether strap over the child restraint seatback. Route the tether strap under the head restraint and between the head restraint posts, or route the tether strap over the top of the vehicle seatback. Make sure the strap is not twisted.
2. Connect the tether strap hook to the tether anchor, then tighten the tether strap according to the child seat manufacturer's instructions to firmly secure the child restraint to the seat.
3. Check that the child restraint is securely attached to the seat by pushing and pulling the seat forward and from side-to-side.

Securing a child restraint with a lap/shoulder belt

When not using the LATCH system, all child restraints must be secured to a vehicle rear seat with the lap part of a lap/shoulder belt.

Automatic locking mode



All passenger seat belts move freely under normal conditions and only lock under extreme or emergency conditions (emergency locking mode). So, in order to secure a child restraint, you must manually pull the seat belt all the way out to shift the retractor to the "automatic locking" mode.

The "automatic locking" mode will help prevent the normal movement of the child in the vehicle from causing the seat belt to loosen and compromise the CRS. To install a CRS on the rear seats, do the following:

1. Place the CRS on a rear seat and route the lap/shoulder belt around or through the child restraint, following the restraint manufacturer's instructions.
Be sure the seat belt webbing is not twisted.
2. Fasten the lap/shoulder belt latch into the buckle. Listen for the distinct "click" sound.
Position the release button so that it is easy to access in case of an emergency.



3. Pull the shoulder portion of the seat belt all the way out. When the shoulder portion of the seat belt is fully extended, it will shift the retractor to the "automatic locking" (child restraint) mode.



4. Slowly allow the shoulder portion of the seat belt to retract and listen for an audible "clicking" or "ratcheting" sound. This indicates that the retractor is in the "automatic locking" mode. If no distinct sound is heard, repeat steps 3 and 4.



5. Remove as much slack from the belt as possible by pushing down on the CRS while feeding the shoulder belt back into the retractor.
6. Push and pull on the CRS to confirm that the seat belt is holding it firmly in place. If it is not, release the seat belt and repeat steps 2 through 6.
7. Double check that the retractor is in the "automatic locking" mode by attempting to pull more of the seat belt out of the retractor. If you cannot, the retractor is in the "automatic locking" mode.

If your CRS manufacturer instructs or recommends you to use a tether anchor with the lap/shoulder belt, refer to "Securing a child restraint with the LATCH anchors system" on page 3-30 for more information.

* NOTICE

When the seat belt is allowed to retract to its fully stowed position, the retractor will automatically switch from the "automatic locking" mode to the emergency lock mode for normal adult usage.

⚠ WARNING

Auto lock mode

Set the retractor to Automatic Lock mode when installing any Child Restraint System. If the retractor is not in the automatic locking mode, the child restraint can move when your vehicle turns or stops suddenly. A child can be seriously injured or killed if the child restraint is not properly anchored in the car.

To remove the child restraint, press the release button on the buckle and then pull the lap/shoulder belt out of the restraint and allow the seat belt to retract fully.

Air bag - advanced Supplemental Restraint System

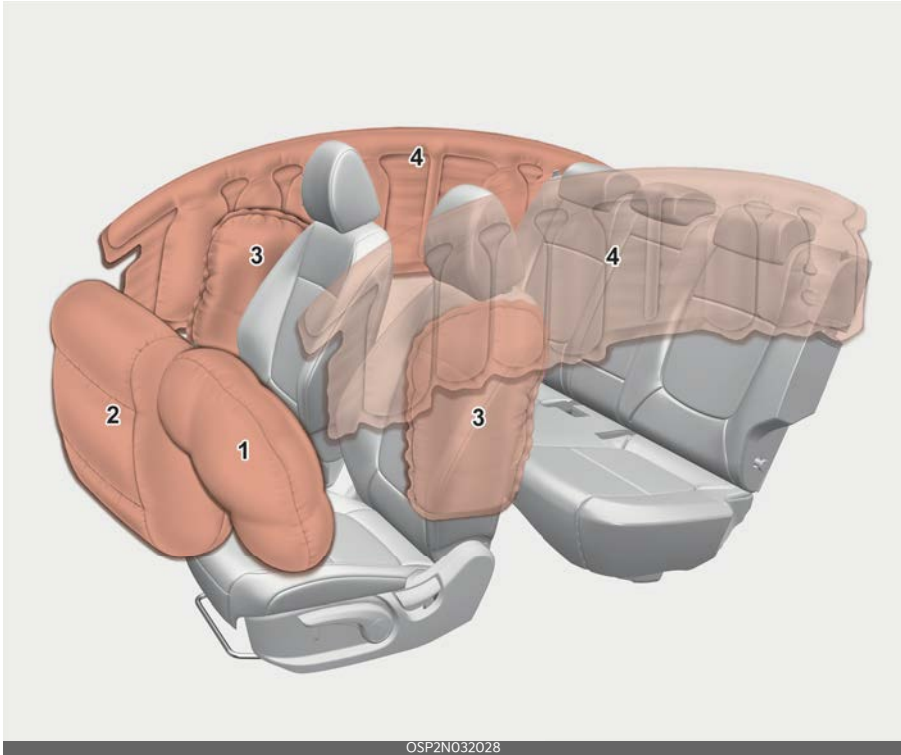

OSP2N032028

* The actual air bags in the vehicle may differ from the illustration.

- 1 Driver's front air bag
- 2 Passenger's front air bag
- 3 Side air bag
- 4 Curtain air bag

Even in vehicles with air bags, you and your passengers must always wear the safety belts provided in order to minimize the risk and severity of injury in the event of a collision or rollover.

How does the air bag system operate?

- Air bags are activated (able to inflate if necessary) only when the ENGINE START/STOP button has been turned to the ON position.
- The appropriate air bags inflate instantly in the event of a serious frontal collision or side collision in order to help protect the occupants from serious physical injury.
- There is no single speed at which the air bags will inflate. Generally, air bags are designed to inflate based upon the severity of a collision and its direction, etc. Several factors determine whether the sensors produce an electronic deployment / inflation signal.
- Air bags will not deploy in every crash or collision situations. Air bag deployment depends on a number of factors including vehicle speed, angles of impact, and, the density and stiffness of the vehicles or objects which your vehicle hits in the collision. The determining factors are not limited to those mentioned above.
- The front air bags will completely inflate and deflate in an instant. It is virtually impossible for you to see the air bags inflate during an accident. It is much more likely that you will simply see the deflated air bags hanging out of their storage compartments after the collision.
- In addition to inflating in serious side collisions, side and/or curtain air bags will inflate if the sensing system detects a rollover.
- When a rollover is detected, side and/or curtain airbags will remain inflated longer. This helps provide protection

from ejection, especially when used in conjunction with the seat belts.

- In order to help provide protection, the air bags must inflate rapidly. The airbag inflates extremely fast between the occupant and the vehicle structures before the occupant impacts the vehicle structures. This speed of inflation reduces the risk of serious or life-threatening injuries and is thus a necessary part of the air bag design. However, airbag inflation can also cause injuries which can include facial abrasions, bruises and broken bones. This is because the rapid inflation also causes the airbags to expand with a great deal of force.
- **There are even circumstances under which contact with the steering wheel or passenger air bag can cause fatal injuries, especially if the occupant is positioned excessively close to the steering wheel or passenger air bag.**

WARNING

Airbag inflation

Sit as far back as possible from the steering wheel while still maintaining comfortable control of the vehicle. A distance of at least 25 cm (10 inches) from your chest to the steering wheel is recommended. Failure to do so can result in airbag inflation injuries to the driver.

Noise and smoke

When inflated, the air bags make a loud noise and leave smoke and powder in the air inside the vehicle. This is normal and is a result of the ignition of the air bag inflator. After the air bag inflates, you may feel substantial discomfort in breathing due to the contact of your

chest with both the seat belt and the air bag, as well as from breathing the smoke and powder. **Open your doors and/or windows as soon as possible after impact in order to reduce discomfort and prevent prolonged exposure to the smoke and powder.**

Though smoke and powder are non-toxic, it may cause irritation to the skin (eyes, nose and throat, etc). If this is the case, wash and rinse with cold water immediately and consult a doctor if the symptom persists.

⚠ WARNING

Hot components

Do not touch the air bag storage area's internal components immediately after airbag inflation. The air bag related parts in the steering wheel, instrument panel and the roof rails above the front and rear doors are very hot. Hot components can result in burn injuries.

⚠ WARNING

Do not install or place any accessories near air bag deployment areas, such as the instrument panel, windows, pillars, and roof rails.

Do not install a child restraint on the front passenger's seat

Never place a rear-facing child restraint in the front passenger's seat.



If the air bag deploys, it would impact the rear-facing child restraint, causing serious or fatal injury.

In addition, do not place front-facing child restraints in the front passenger's seat. If the front passenger air bag inflates, it could cause serious or fatal injuries to the child.

⚠ WARNING

Air bag deployment

When children are seated in the rear outboard seats of a vehicle equipped with side and/or curtain air bags, install the Child Restraint System as far away from the door side as possible. Inflation of the side and/or curtain air bags could impact the child.

Air bag warning light

The purpose of air bag warning light in your instrument panel is to alert you of a potential problem with your air bag system, which could include your side and/or curtain air bags used for rollover protection.



If the air bag warning light appears for more than 6 seconds after the ENGINE START/STOP button has been turned to the ON position, or if it appears during vehicle operation, an SRS component may not be functioning properly and you should have your vehicle checked by an authorized Kia dealer.

If any of the following conditions occur, this indicates a malfunction in the air bag system. Have an authorized Kia dealer inspect the air bag system as soon as possible.

- The light does not turn on briefly when you turn the ENGINE START/STOP button to the ON position.
- The light stays on after appearing for approximately 6 seconds.
- The light comes on while the vehicle is in motion.
- The light blinks when the ENGINE START/STOP button to the ON position.

Supplemental Restraint System (SRS) components and functions

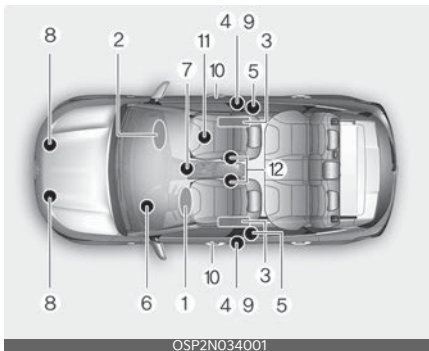

- 2 Passenger's front air bag module
 - 3 Side air bag modules
 - 4 Curtain air bag modules
 - 5 Retractor pre-tensioner seat belt assemblies
 - 6 Air bag warning light
 - 7 SRS control module (SRSCM)/ rollover sensor
 - 8 Front impact sensor
 - 9 Side impact sensors
 - 10 Side pressure sensors
 - 11 Occupant detection system (Front passenger's seat only)
 - 12 Front passenger's seat belt buckle sensor
- *: if equipped

Driver's front air bag (1)



The front air bag modules are located both in the center of the steering wheel and in the front passenger's panel above the glove box. When the SRSCM detects a sufficiently severe impact to the front of the vehicle, it will automatically deploy the front air bags.

* The actual position of SRS components may differ from the illustration.

The SRS consists of the following components:

- 1 Driver's front air bag module

Driver's front air bag (2)



Upon deployment, tear seams molded directly into the pad covers will separate under pressure from the expansion of the air bags. Further opening of the covers then allows full inflation of the air bags.

Driver's front air bag (3)



A fully inflated airbag (with a properly fastened seat belt) slows the forward motion of the driver or passenger, reducing the risk of head and chest injury.

After complete inflation, the air bag immediately starts deflating, enabling the driver to maintain forward visibility and the ability to steer or operate other controls.

Passenger's front air bag



⚠ WARNING

Air bag obstructions

Do not install or place any accessories on the steering wheel, instrument panel, or on the front passenger's panel above the glove box in a vehicle. Such objects may become dangerous projectiles if the air bag deploys.

⚠ WARNING

Flying objects

Do not place any objects (an umbrella, bag, etc.) between the front door and the front seat. Such objects may become dangerous projectiles if the side airbag inflates.

- If an air bag deploys, there may be a loud noise followed by a fine dust released in the vehicle. These conditions are normal and are not hazardous - the air bags are packed in this fine powder. The dust generated during air bag deployment may cause skin or eye irritation as well as aggravate asthma for some persons. Always wash all exposed skin areas thoroughly with cold water and a mild

soap after an accident in which the air bags were deployed.

- The SRS can function only when the ENGINE START/STOP button is in the ON position. The SRS is not working properly if any of the following situations occur:
 - The SRS airbag warning light does not appear
 - The SRS airbag warning light remains on continuously after appearing for about 6 seconds when the ENGINE START/STOP button is turned to the ON position or after the vehicle is in ready mode
 - The SRS airbag warning light comes on while driving

If this occurs, have your vehicle immediately inspected by an authorized Kia dealer.

*** NOTICE**

Before you replace a fuse or disconnect a battery terminal, change the ENGINE START/STOP button to the OFF position. Never remove or replace the air bag related fuse(s) when the ENGINE START/STOP button is ON position. Failure to heed this warning will cause the SRS air bag warning light to appear.

Occupant Detection System (ODS)

Your vehicle is equipped with an Occupant Detection System (ODS) in the front passenger's seat.



The ODS is designed to detect the presence of a properly-seated front passenger and determine if the passenger's front air bag should be enabled (may inflate) or not. Only the front passenger front air bag is controlled by the ODS. Do not put anything in front of the passenger air bag "⊗" indicator.

Main components of the ODS

- A detection device is located within the front passenger seat cushion.
- An electronic system determines whether the passenger air bag systems should be activated or deactivated.
- An indicator light located on the overhead console which appears the words PASSENGER AIR BAG "⊗" indicates the front passenger air bag system is deactivated.
- The overhead console air bag warning light is interconnected with the ODS.

If the front passenger seat is occupied by a person that the system determines to be of appropriate size, and he/she sits properly (sitting upright with the seat-back in an upright position, centered on the seat cushion with their seat belt on, legs comfortably extended and their feet on the floor), the PASSENGER AIR BAG



indicator will turn off and the front passenger's air bag will be able to inflate, if necessary, in frontal crashes.

You will find the PASSENGER AIR BAG indicator on the overhead console.



This system detects the conditions 1-4 in the following table and activates or deactivates the front passenger air bag based on these conditions.

Always be sure that you and all vehicle occupants are seated and restrained properly (sitting upright with the seat in an upright position, centered on the seat cushion, with the person's legs comfortably extended, feet on the floor, and wearing the safety belt properly) for the most effective protection by the air bag and the safety belt.

The ODS may not function properly if the passenger takes actions which can defeat the detection system. These include:

- Failing to sit in an upright position.
- Leaning against the door or center console.
- Sitting towards the sides or the front of the seat.
- Putting legs on the dashboard or resting them on other locations which reduce the passenger weight on the front seat.
- Improperly wearing the safety belt.
- Reclining the seatback.

Conditions and operation of the front passenger ODS

Condition detected by the occupant detection system	Indicator/Warning light		Devices
	"PASSENGER AIR BAG OFF" indicator light	SRS warning light	Front passenger air bag
1. Adult ^{*1}	Off	Off	Activated
2. Child Restraint System (CRS) with child under 12 months old ^{2*3*4}	On	Off	Deactivated
3. Unoccupied	On	Off	Deactivated
4. Malfunction in the system	Off	On	Activated

- *1. The system judges a person of adult size as an adult. When a smaller adult sits in the front passenger seat, the system may recognize him/her as a child depending on his/her physique and posture.
- *2. Do not allow children to ride in the front passenger seat. When a larger child who has outgrown a CRS sits in the front passenger seat, the system may recognize him/her as an adult depending upon his/her physique or sitting position.
- *3. Never install a CRS on the front passenger seat.
- *4. The PASSENGER AIR BAG "" indicator may turn on or off when a child above 12 months to 12 years old (with or without a CRS) sits in the front passenger seat. This is a normal condition.

⚠ WARNING

- Do not install a child restraint seat in the passenger seat when the seat is heavily soaked with any type of liquid.
- Do not alter or remodel the Occupant Detection System (ODS). This may damage the system and prevent its proper function in a collision.

*** NOTICE**

- Do not use car seat cushions that cover up the surface of the seat and aftermarket manufactured passenger seat heaters.
- After conducting car interior cleaning using steam or detergent, the seat should be dried properly. Afterward, check for normal operation of the PASSENGER AIR BAG "OFF" and air bag warning lights.
- Any service related to the passenger seat and the ODS must be done at an authorized Kia dealership.
- After the passenger seat has been removed or installed for repair purposes, check for normal operation of the PASSENGER AIR BAG "⊗" and air bag warning lights with a person seated or not seated in the passenger seat.

⚠ WARNING

When the PASSENGER AIR BAG "⊗" symbol is appears, the passenger air bag system will not operate. The passenger air bag system will operate when necessary if the symbol is not appear.

*** NOTICE**

Do not modify or replace the front passenger seat. Don't place anything on or attach anything such as a blanket, front seat cover or aftermarket seat heater to the front passenger seat. This can adversely affect the Occupant Detection System.

⚠ WARNING

Occupant Detection System

Riding in an improper position adversely affects the Occupant Detection System and may result in the deactivation of the front passenger airbag. It is important for the driver to instruct the passenger as to the proper seating instructions as contained in this manual.

- Do not place a heavy load in the front passenger seatback pocket or on the front passenger seat.



- Do not place feet on the front passenger seatback.



- Never sit with hips shifted towards the front of the seat.



- Never excessively recline the front passenger seatback.



- Never place feet on the dashboard.



- Never lean on the door or center console.
- Never sit on one side of the front passenger seat.



- Do not use car seat accessories such as thick blankets and cushions which cover up the car seat surface.



- Do not place electronic devices such as laptops or DVD players or heavy objects such as a large quantity of water bottles on the passenger seat.



- Wet passenger seat:
Do not spill liquid in the passenger seat. Spilled liquid on the passenger seat may cause the air bag warning light to appear or malfunction. If any liquid is spilled, make sure the seat has been completely dried before driving the vehicle.

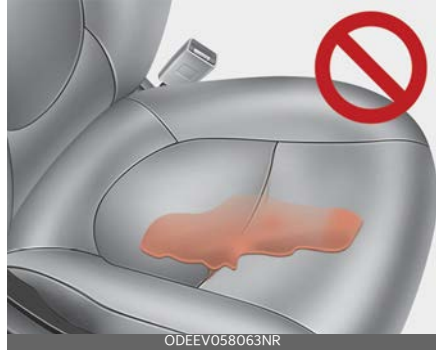

Proper position



When an adult is seated in the front passenger seat, if the PASSENGER AIR BAG "⊗" indicator is on, change the ENGINE START/STOP button to the OFF position and ask the passenger to sit properly (sitting upright with the seatback in an upright position, centered on the seat cushion with their seat belt on, legs comfortably extended and their feet on the floor). Restart the vehicle and have the person remain in that position. This will allow the system to detect the person and to enable the passenger air bag.

If the PASSENGER AIR BAG "⊗" indicator is still on, ask the passenger to move to the rear seat.

WARNING

PASSENGER AIR BAG "⊗₂" light

Do not allow an adult passenger to ride in the front seat when the PASSENGER AIR BAG "⊗₂" indicator appears, because the air bag will not deploy in the event of a crash. The driver must instruct the passenger to reposition himself in the seat. Failure to properly position yourself may lead to air bag deactivation resulting in air bag non-deployment in a collision. If the PASSENGER AIR BAG "⊗₂" indicator remains appeared after the passenger repositions themselves properly and the car is restarted, it is recommended that passenger move to the rear seat because the passenger's front air bag will not deploy.

*** NOTICE**

The PASSENGER AIR BAG "⊗₂" indicator appears for about 4 seconds after the ENGINE START/STOP button is turned to the ON position after the vehicle is started. If the front passenger seat is occupied, the occupant detection sensor will then classify the front passenger after several more seconds.

- Even though your vehicle is equipped with the Occupant Detection System, never install a Child Restraint System in the front passenger's seat. A deploying air bag can forcefully strike a child resulting in serious injuries or death.

Any child age 13 and under should ride in the rear seat. Children too large for child restraints should use the available lap/shoulder belts. No matter what type

of crash, children of all ages are safer when restrained in the rear seat.

If the ODS is not working properly, the Supplemental Restraint System (SRS) air bag warning light on the instrument panel will appear because the passenger's front air bag is connected with the ODS. If there is a malfunction of the ODS the PASSENGER AIRBAG "⊗₂" indicator will not appear. In this case, the passenger's front airbag will inflate in frontal impact crashes even if there is no occupant in the front passenger seat.

Driver's and passenger's front air bag

Your vehicle is equipped with an advanced supplemental restraint (air bag) system and lap/shoulder belts at both the driver and passenger seating position.

Driver's front air bag



Passenger's front air bag

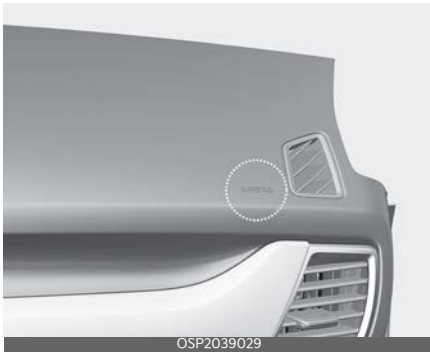

The indication of the system's presence are the letters "AIR BAG" located on the air bag pad cover on the steering wheel and the passenger's side front panel pad above the glove box.

The Supplemental Restraint System (SRS) consists of air bags installed under the pad covers in the center of the steering wheel and the passenger's side front panel above the glove box.

The purpose of the SRS is to provide the vehicle's driver and/or the front passenger with additional protection than that offered by the seat belt system alone in case of a frontal impact of sufficient severity. The SRS uses sensors to gather information about the driver's and front passenger's seat belt usage and impact severity.

The seat belt buckle sensor determines if the front passenger's seat belt is fastened.

These sensors provide the ability to control the SRS deployment based on whether or not the seat belts are fastened, and how severe the impact is.

The advanced SRS offers the ability to control the air bag inflation with two levels. A first stage level is provided for moderate-severity impacts. A second

stage level is provided for more severe impacts.

According to the impact severity and seat belt usage, the SRS Control Module (SRSCM) controls the air bag inflation. Failure to properly wear seat belts can increase the risk or severity of injury in an accident.

Additionally, your vehicle is equipped with an Occupant Detection System (ODS) in the front passenger's seat. The ODS detects the presence of a passenger in the front passenger's seat and will turn off the front passenger's air bag under certain conditions. For more detail, see "Occupant Detection System (ODS)" on page 3-39.

⚠ WARNING

Modification to the seat structure can cause the air bag to deploy at a different level than should be provided.

Manufacturers are required by government regulations to provide a contact point concerning modifications to the vehicle for persons with disabilities, which modifications may affect the vehicle's advanced air bag system. That contact is Kia's toll-free Customer Experience Department at 1-877-KIAAUTO (1-877-542- 2886). However, Kia does not endorse nor will it support any changes to any part or structure of the vehicle that could affect the advanced air bag system, including the ODS.

⚠ WARNING

Replacement/modifications

The front passenger seat, dashboard or door should not be replaced except by an authorized Kia dealer using original Kia parts designed for this vehicle and

model. Any other such replacement or modification could adversely affect the operation of the Occupant Detection System and your advanced air bags.

Advanced air bags are combined with pre-tensioner seat belts to help provide enhanced occupant protection in frontal crashes. Front air bags are not intended to deploy in collisions in which sufficient protection can be provided by the seat belt.

*** NOTICE**

Air bags can only be used once - have an authorized Kia dealer replace the air bag immediately after deployment.

Front air bags are not intended to deploy in side-impact, rear-impact or rollover crashes. However, when frontal deployment threshold is satisfied at side-impact, front air bags may deploy. In addition, front air bags will not deploy in frontal crashes below the deployment threshold.

⚠ WARNING

SRS Wiring

Do not tamper with or disconnect SRS wiring or other components of the SRS system. Doing so could result in injury, due to accidental deployment of the air bags or by rendering the SRS inoperative.

⚠ WARNING

No attaching objects

No objects (such as crash pad cover, cellular phone holder, cup holder, perfume or stickers) should be placed over or near the air bag modules on the steering wheel, instrument panel, windshield glass, and the front passenger's panel

above the glove box. Such objects could cause harm if the vehicle is in a crash severe enough to cause the air bags to deploy.

Do not place any objects over the air bag or between the air bag and yourself.

Additionally, never place or insert any object into any small opening near side airbag labels attached to the vehicle seats.

When the air bag deploys, the object may affect the deployment and result in unexpected accident or bodily harm.

Side air bag

Your vehicle is equipped with a side air bag in each front seat.



* The actual air bags in the vehicle may differ from the illustration.

The purpose of the air bag is to provide the vehicle's driver and/or the front passenger with additional protection than that offered by the seat belt alone.

- The side air bags are designed to deploy during certain side-impact collisions, depending on the crash severity of impact.
- The side air bags may deploy on the side of the impact or on both sides.
- The side and/or curtain air bags on both sides of the vehicle will deploy if a rollover or possible rollover is detected.
- The side air bags are not designed to deploy in all side impact or rollover situations.

⚠ WARNING

Unexpected deployment

Avoid impact to the side impact airbag sensor when the ENGINE START/STOP button is ON to prevent unexpected deployment of the side air bag.

- The side air bag is supplemental to the driver's and the passenger's seat belt systems and is not a substitute for them. Therefore your seat belts must be worn at all times while the vehicle is in operation.
- For best protection from the side air bag system and to avoid being injured by the deploying side air bag, both front seat occupants should sit in an upright position with the seat belt properly fastened. The driver's hands should be placed on the steering wheel at the 9:00 and 3:00 positions. The passenger's arms and hands should be placed on their laps.

⚠ WARNING

Deployment

Do not install any accessories including seat covers, on the side or near the side air bag as this may affect the deployment of the side air bags.

- If the seat or seat cover is damaged, have the vehicle checked and repaired by an authorized Kia dealer. Inform the dealer that your vehicle is equipped with side air bags and an Occupant Detection System (ODS).

⚠ WARNING

Flying objects

Do not place any objects (an umbrella, bag, etc.) between the front door and the front seat. Such objects may become dangerous projectiles if the side airbag inflates.

⚠ WARNING

No attaching objects

- Do not place any objects over the air bag or between the air bag and yourself. Also, do not attach any objects around the area the air bag inflates such as the door, side door glass, front and rear pillar.
- Do not put any objects between the side airbag label and seat cushion. It could cause harm if the vehicle is in a crash severe enough to cause the air bags to deploy.
- Never place or insert any object into any small opening near side airbag labels attached to the vehicle seats. When the air bag deploys, the object may affect the deployment and result in unexpected accident or bodily harm.

- Do not install any accessories on the side or near the side air bags.

Curtain air bag

Curtain air bags are located along both sides of the roof rails above the front and rear doors.

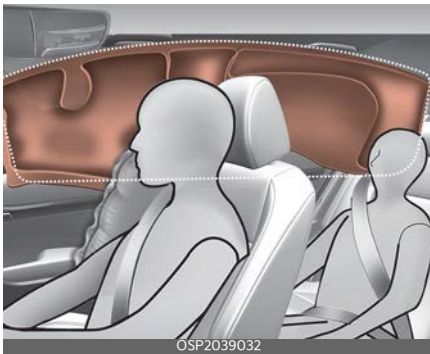

* The actual air bags in the vehicle may differ from the illustration.

They are designed to help protect occupants in certain side impacts and to help prevent them from ejecting out of the vehicle as a result of a rollover, especially when the seatbelts are also in use.

- The curtain air bags are designed to deploy during certain side impact collisions, depending on the severity of impact. However, when side deploy-

- ment threshold is satisfied at front-impact, side air bags may deploy.
- The curtain air bags may deploy on the side of the impact or on both sides.
- Also, the curtain air bags on both sides of the vehicle will deploy in certain rollover situations.
- The curtain air bags are not designed to deploy in all side impact or rollover situations.

Do not allow the passengers to lean their heads or bodies against the doors, put their arms on the doors, stretch their arms out of the window or place objects between the doors and passengers when they are seated on seats equipped with side impact and/or curtain air bags.

* NOTICE

Never try to open or repair any components of the side and curtain air bag system. This should only be done by an authorized Kia dealer.

⚠ WARNING

No attaching objects

- Do not place any objects over the air bag. Also, do not attach any objects around the area the air bag inflates such as the door, side door glass, front and rear pillar, roof side rail.
- Do not hang hard, breakable, or heavy objects on the coat hooks for safety reasons.

Air bag collision sensors

The air bag collision sensors are located in the following positions.



* The actual shape and position of sensors may differ from the illustration.

- 1 Supplemental Restraint System (SRS) control module/rollover sensor
- 2 Front impact sensor
- 3 Side pressure sensors
- 4 Side impact sensor

⚠ WARNING

Air bag sensors

- Do not hit or allow any objects to impact the locations where air bags or sensors are installed.

This may cause unexpected air bag deployment, which could result in serious personal injury or death.

- If the installation location or angle of the sensors is altered in any way, the air bags may deploy when they should not or they may not deploy when they should.

Therefore, do not try to perform maintenance on or around the air bag sensors. Have the vehicle checked and repaired by an authorized Kia dealer.

- Do not arbitrarily touch the front impact sensor. When the angle of the sensor is changed, the air bag system may malfunction.

Problems may arise if the sensor installation angles are changed due to the deformation of the front bumper, front end module, body or front doors where side collision sensors are installed. Have the vehicle checked and repaired by an authorized Kia dealer.

Installing bumper guards (or side step or running board) or replacing a bumper (or front door module) with non-genuine parts may adversely affect your vehicle's collision and air bag deployment performance.

Kia Genuine bumper guards/bumpers are parts we guarantee for quality and performance.

Why didn't my air bag go off in a collision? (Inflation and non-inflation conditions of the air bag)

There are many types of accidents in which the air bag would not be expected to provide additional protection.

These include rear impacts, second or third collisions in multiple impact accidents, as well as low speed impacts.

Air bag inflation conditions

Front air bags



Front air bags are designed to inflate in a frontal collision depending on several factors, including the severity of impact of the front collision.

Side and/or curtain air bags

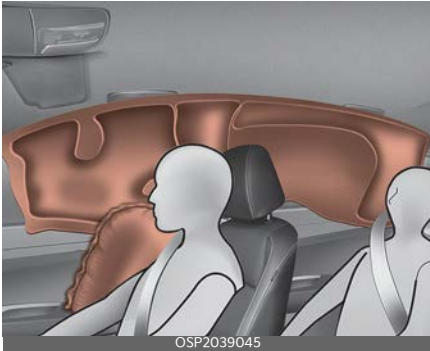

* The actual air bags in the vehicle may differ from the illustration.

Side and/or curtain air bags are designed to inflate when an impact is detected by side collision sensors depending on several factors, including the severity of impact resulting from a side impact collision.

Also, the side and curtain air bags are designed to inflate when a rollover is detected by a rollover sensor.

Although the front air bags (driver's and front passenger's air bags) are primarily designed to inflate in frontal collisions, they may inflate in other types of collisions if the front impact sensors detect a sufficient frontal force in another type of impact.

Similarly, although side and curtain air bags are designed to inflate in certain side impact collisions, they may inflate in other types of collisions where a side force is detected by the sensors. For instance, side air bag and/or curtain air bags may inflate if rollover sensors indicate the possibility of a rollover occurring (even if none actually occurs) or in other situations, including when the vehicle is tilted while being towed.

Even if side and/or curtain air bags do not provide impact protection in a rollover, they will deploy to prevent ejection of occupants, especially those who are restrained with seat belts.

If the vehicle chassis is impacted by bumps or objects on unimproved roads, the air bags may deploy. Drive carefully on unimproved roads or on surfaces not designed for vehicle traffic to prevent unintended air bag deployment.

Air bag non-inflation conditions

- Air bags may not deploy in certain low-speed collisions where the air bag would not add any benefit beyond the protection already offered by the seat belts.



- Air bags are not designed to inflate in rear collisions, because occupants are

moved backward by the force of the impact. In this case, inflated air bags would not be able to provide any additional benefit.



- Front airbags may not inflate in side impact collisions, because passengers move in the direction of the collision. Thus, in side impacts, frontal airbag deployment would not provide additional occupant protection.



- In an angled collision, the force of impact may direct the occupants in a direction where the air bags would not be able to provide any additional benefit, and thus the sensors may not deploy any air bags.



- Just before impact, drivers often brake heavily. Such heavy braking lowers the front portion of the vehicle causing it to "ride" under a vehicle with a higher ground clearance. Air bags may not inflate in this "under-ride" situation because deceleration forces that are detected by sensors may be significantly reduced by such "under-ride" collisions.

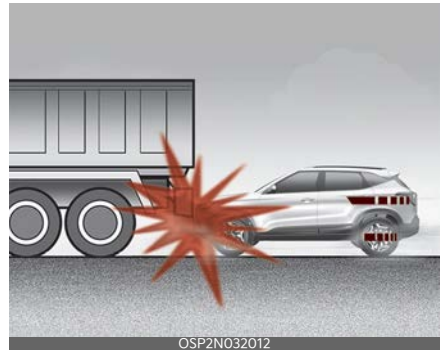

- Front air bags may not inflate in all rollover accidents when the SRS Control Module (SRSCM) indicates that the front air bag deployment would not provide additional occupant protection.



- Airbags may not inflate if the vehicle collides with an object such as a utility pole or tree. This is because the point of impact is concentrated in one area and the full force of the impact is not delivered to the sensors.



Supplemental Restraint System (SRS) care

The Supplemental Restraint System (SRS) is virtually maintenance-free and so there are no parts you can safely service by yourself.

If the SRS air bag warning light does not appear, or continuously remains on, have your vehicle immediately inspected by an authorized Kia dealer.

Any work on the SRS, such as removing, installing, repairing, or any work on the steering wheel, the front passenger's

panel, front seats and roof rails must be performed by an authorized Kia dealer. Improper handling of the SRS may result in serious personal injury.

For cleaning the air bag pad covers, use only a soft, dry cloth or one which has been moistened with plain water. Solvents or cleaners could adversely affect the air bag covers and proper deployment of the system.

If components of the air bag system must be discarded, or if the vehicle must be scrapped, certain safety precautions must be observed. An authorized Kia dealer knows these precautions and can give you the necessary information. Failure to follow these precautions and procedures could increase the risk of bodily injury.

⚠ WARNING

Tampering with SRS

Do not tamper with or disconnect SRS wiring or other components of the SRS system. Doing so could result in the accidental inflation of the air bag or render the SRS inoperative.

⚠ WARNING

Towing Vehicle

Always have the ignition off when your vehicle is being towed. The side air bags may inflate if the vehicle is tilted such as when being towed because of the roll-over sensors in the vehicle.

Adding equipment to or modifying your air bag-equipped vehicle

If you modify your vehicle by changing your vehicle's frame, bumper system, front end or side sheet metal or ride height, this may affect the operation of your vehicle's air bag system.

Air bag warning label

Air bag warning labels, some required by the Canada Motor Vehicle Safety Standards (CMVSS), are attached to the sun visor to alert the driver and passengers of potential risks of the air bag system.



Keys	4-7
Remote keyless entry	4-8
• Battery replacement.....	4-10
• This device complies with Industry Canada licence-exempt RSS standard(s).....	4-12
Smart key	4-12
• Smart key functions.....	4-13
Immobilizer system	4-16
• Folding key immobilizer system.....	4-16
• Limp home (override) procedure.....	4-17
• Smart key immobilizer system.....	4-18
Digital Key 2 Touch	4-19
• Digital Key 2 Touch (Smart Phone).....	4-19
• Digital Key 2 Touch (Card Key).....	4-22
• Personalized Profile and Vehicle Settings	4-25
• Used Vehicle/Digital Key 2 Touch Maintenance	4-28
• Limitations of the System.....	4-28
Theft-alarm system	4-29
• Armed stage.....	4-29
• Theft-alarm stage.....	4-30
• Disarmed stage.....	4-30
Door locks	4-31
• Operating door locks from outside the vehicle	4-31
• Operating door locks from inside the vehicle	4-32
• Door lock/unlock features.....	4-33
• In case of an emergency	4-34
• Child-protector rear door lock.....	4-34
Rear Occupant Alert (ROA) system	4-35
Integrated Memory System	4-36
• Storing memory positions	4-36

4 Features of your vehicle

• Recalling memory positions.....	4-37
• Seat easy access	4-37
• Resetting the System	4-37
Liftgate.....	4-38
• Opening the liftgate.....	4-38
• Closing the liftgate	4-39
• Opening the liftgate in emergency.....	4-39
Power liftgate.....	4-40
• Power liftgate operating conditions	4-40
• Operating the power liftgate	4-42
• Setting the power liftgate.....	4-43
• Resetting the power liftgate.....	4-44
• Emergency liftgate safety release.....	4-45
Smart liftgate	4-45
• How to use the smart liftgate	4-45
• How to deactivate the smart liftgate function using the smart key	4-46
• Detecting area.....	4-47
Windows	4-48
• Window opening and closing	4-49
• Power window lock button.....	4-51
• Remote window opening system	4-52
Hood	4-53
• Opening the hood.....	4-53
• Hood open warning	4-53
• Closing the hood	4-54
Fuel filler door.....	4-55
• Opening the fuel filler door	4-55
• Closing the fuel filler door.....	4-55
Sunroof.....	4-58
• Sunshade.....	4-59

• Tilt open/close	4-59
• Slide open/close.....	4-60
• Automatic reversal.....	4-60
• Resetting the sunroof.....	4-61
• Sunroof open warning.....	4-62
Steering wheel	4-62
• Electric Power Steering (EPS)	4-62
• Tilt & telescopic steering wheel.....	4-63
• Heated steering wheel.....	4-64
• Horn	4-64
Mirrors.....	4-65
• Inside rearview mirror	4-65
• Outside rearview mirror	4-66
Instrument cluster	4-68
• Instrument cluster.....	4-69
• Adjusting instrument cluster illumination	4-70
• Gauges.....	4-70
• Outside temperature gauge.....	4-74
• Transmission shift indicator	4-75
LCD display.....	4-76
• LCD display modes.....	4-77
• Trip information (trip computer)	4-85
Warning and indicator lights	4-92
• Warning lights.....	4-92
• Indicator lights.....	4-98
Infotainment system vehicle settings	4-102
• Setting your vehicle.....	4-102
• Vehicle Settings menu	4-102
Head-Up Display (HUD).....	4-103
• Head Up Display Information	4-103
• Head up Display Setting	4-104

4 Features of your vehicle

Lighting	4-104
• Battery saver function	4-104
• Headlight escort function.....	4-104
• Daytime Running Light (DRL).....	4-105
• Off position	4-105
• Lighting control.....	4-105
• Operating high beam	4-106
• Operating turn signals and lane change signals	4-107
• Operating front fog light	4-108
• High Beam Assist (HBA)	4-108
Wipers and washers	4-111
• Auto control.....	4-112
• Operating windshield washers	4-113
• Operating rear window wiper and washer switch	4-114
• Auto rear wiper	4-114
• Heated washer nozzle	4-114
Interior lights	4-115
• Automatic turn off function.....	4-115
• Map lamp.....	4-115
• Room lamp	4-116
• Luggage room lamp	4-116
• Vanity mirror lamp	4-117
• Glove box lamp.....	4-117
Defroster	4-118
• Rear window defroster	4-118
• Outside rearview mirror defroster.....	4-119
Climate control system	4-119
• System operation.....	4-119
• Climate control air filter.....	4-121
• Air conditioning refrigerant label.....	4-121
• Checking the amount of air conditioner refrigerant and compressor lubricant.....	4-122

Manual climate control system	4-123
• Heating and air conditioning	4-124
Automatic climate control system	4-128
• Heating and air conditioning automatically.....	4-129
• Heating and air conditioning manually.....	4-131
Windshield defrosting and defogging	4-137
• Defogging inside windshield with manual climate control system	4-137
• Defogging inside windshield with the automatic climate control.....	4-138
• Defrosting outside windshield with manual climate control system	4-138
• Defrosting outside windshield with automatic climate control.....	4-139
• Defogging logic.....	4-139
• Automatic Air Ventilation.....	4-141
• Activate upon Washer Fluid Use	4-142
• System cancellation	4-142
• Sunroof inside air recirculation	4-142
Scheduled Ventilation Control	4-143
• Turning Schedule Ventilation Control On or Off.....	4-143
Storage compartment	4-143
• Center console storage	4-143
• Sliding armrest	4-144
• Glove box.....	4-144
• Luggage net holder.....	4-144
Luggage board	4-145
Increase cargo space	4-146
Interior features	4-146
• Cup holder.....	4-146
• Seat warmer	4-147

4 Features of your vehicle

• Air ventilation seat	4-148
• Sun visor	4-149
• USB charger	4-149
• Power outlet	4-150
• Wireless smart phone charging system.....	4-151
• This device complies with Industry Canada licence-exempt RSS standard(s).....	4-154
• Coat hook	4-154
• Floor mat anchor(s).....	4-155
• Cargo area cover.....	4-155
Roof rack.....	4-156
Infotainment system.....	4-159
• Audio system	4-159
• Antenna	4-159
• USB port.....	4-159
• How vehicle radio works.....	4-159
Declaration of Conformity.....	4-162
• IC	4-162

Features of your vehicle

Keys

Record your key number



The key code number is stamped on the key code tag attached to the key set. Should

you lose your keys, this number will enable an authorized Kia dealer to duplicate the keys easily. Remove the key code tag and store it in a safe place. Also, record the key code number and keep it in a safe and handy place, but not in the vehicle.

⚠ WARNING

Aftermarket keys

Use only Kia original parts for the ignition key in your vehicle. If an aftermarket key is used, the ignition switch may not return to ON after START. If this happens, the starter will continue to operate causing possible fire due to excessive current in the wiring.

Key operations

Folding key

To unfold the key, press the release button then the key will unfold automatically.



OKA4040570N

To fold the key, fold the key manually while pressing the release button.

⚠ CAUTION

Key button operation

Do not fold the key without pressing the release button. This may damage the key.

Smart key

To remove the mechanical key, press and hold the release button (1) and remove the mechanical key (2).



OSP2N049051

To reinstall the mechanical key, put the key into the hole and push it until a click sound is heard.

⚠ WARNING

Ignition key

Never leave the keys in your vehicle with unsupervised children. Leaving children unattended in a vehicle with a manual ignition key or a smart key is dangerous. Children copy adults and they could place the key in the ignition switch or press the start button. The key would enable children to operate power windows or other controls, or even make the vehicle move, which could result in serious bodily injury or death.

Remote keyless entry

Using the remote keyless entry, you can lock and unlock the doors remotely.

Remote keyless entry system operations

Folding key



Smart key - Type A



Smart key - Type B



OSP2NO42068

Lock (1)

All doors are locked if the lock button is pressed. If all doors are closed, the hazard warning lights will blink and the chime will sound once (for smart key) to indicate that all doors are locked.

Also, if the lock button is pressed once more within 4 seconds, the hazard warning lights will blink and the chime will sound once to confirm that the door is locked.

However, if any door remains open, the hazard warning lights (and/or the chime) will not operate. But if all doors are closed after the lock button is pressed, the hazard warning lights will blink once.

Unlock (2)

The driver's door is unlocked if the unlock button is pressed once. The hazard warning lights will blink twice and the chime will sound twice (for smart key) to indicate that the driver's door is unlocked.

All doors are unlocked if the unlock button is pressed once more within 4 seconds. The hazard warning lights will blink (for smart key, the chime also

sounds) twice again to indicate that all doors are unlocked.

To activate or deactivate 2 Press Unlock, select 'User Settings → Door → 2 Press Unlock' on the instrument cluster or 'Setup → Vehicle → Door → 2 Press Unlock' on the infotainment system.

After pressing this button, the doors will lock automatically unless you open any door within 30 seconds.

If you attempt to lock or unlock the door by pressing the door lock/unlock button in any of the following states, the door will not be locked or unlocked.

- When you want to lock or unlock the door in the ACC or ON state.
- When you want to lock a door in a car with one or more doors open.

*** INFORMATION**

The infotainment system may change after software updates. For more information, refer to the user's manual provided in the infotainment system and the quick reference guide.

*** NOTICE**

If the keyless entry system is inoperative due to exposure to water or liquids, it will not be covered by your manufacturer's vehicle warranty.

Panic alarm (3)

The horn sounds and the hazard warning lights blink for about 30 seconds if this button is pressed for more than 0.5 seconds. To stop the horn and lights, press any button on the transmitter.

Remote start (4) (if equipped)

You can start the vehicle using the remote start button (4) of the smart key. To start the vehicle remotely:

- Lock the doors by pressing the door lock button (1) within 10 m (32 feet) distance from the vehicle.
- Press the remote start button for over 2 seconds within 4 seconds after locking the doors and the hazard warning will blink.

Press the remote start button once to turn off the vehicle.

If no further action for operating/driving the vehicle is taken, the vehicle will be turned off 10 minutes after starting the vehicle remotely.

Liftgate open/close (5) (for power liftgate, if equipped)

If you press this button for longer than a second the liftgate will be opened. When the power liftgate is opened, press and hold the power liftgate open/close button to close the liftgate. If you release the button while the liftgate is closing, power liftgate operation will stop with a warning sound for 5 seconds. Once the liftgate is opened and then closed, the liftgate will lock automatically when all doors are locked.

Remote keyless entry precautions

The remote keyless entry will not work if any of the following occurs:

- The ignition key is in the ignition switch. (if equipped)
- You exceed the operating distance limit (about 10 m [32 feet]).
- The battery in the remote keyless entry is weak.

- Other vehicles or objects may be blocking the signal.
- The weather is extremely cold.
- The remote keyless entry is close to a radio transmitter such as a radio station or an airport which can interfere with normal operation of the transmitter.

When the remote keyless entry does not work properly, open and close the door with the ignition key. If you have a problem with the remote keyless entry, contact an authorized Kia dealer.

- If the remote keyless entry is in close proximity to your cell phone or smart phone, the signal from the remote keyless entry could be blocked by normal operation of your cell phone or smart phone. This is especially important when the phone is active such as making calls, receiving calls, text messaging, and/or sending/receiving emails. Avoid placing the remote keyless entry and your cell phone or smart phone in the same pants or jacket pocket and maintain adequate distance between the two devices.

Battery replacement

A battery should last for several years, but if the remote keyless entry is not working properly, try replacing the battery with a new one.

Folding key



OSP2N042069

Smart key



OSP2N049054

If you are unsure how to use or replace the battery, contact an authorized Kia dealer.

1. Remove the mechanical key (for smart key).
2. Insert a slim tool into the slot and gently pry open the key cover.
3. Loosen the retaining screw of the battery cover and then remove the cover (for folding key).
4. Replace the battery with a new battery (CR2032). When replacing the battery, make sure the battery position is correct.

If the battery is assembled with incorrect polarity, it will discharge, rendering the key unusable.

5. Install the battery in the reverse order of removal.

The remote keyless entry is designed to give you years of trouble-free use, however it can malfunction if exposed to moisture or static electricity. If you are unsure how to use or replace the battery, contact an authorized Kia dealer.

Using the wrong battery can cause the remote keyless entry to malfunction. Be sure to use the correct battery.



An inappropriately disposed battery can be harmful to the environment and human health. Dispose the battery according to your local law(s) or regulation.

⚠ WARNING

THIS PRODUCT CONTAINS A BUTTON BATTERY

If swallowed, a lithium button battery can cause severe or fatal injuries within 2 hours.

Keep batteries out of reach of children.

If you think batteries may have been swallowed or placed inside any part of the body, seek immediate medical attention.

⚠ CAUTION

Remote keyless entry damage

The remote keyless entry can malfunction if dropped, exposed to moisture, static electricity, heat or direct sunlight.

This device complies with Industry Canada licence-exempt RSS standard(s).

Operation is subject to the following two conditions:

1. This device may not cause interference, and
2. This device must accept any interference, including interference that may cause undesired operation of the device.

*** NOTICE**

Changes or modifications not expressly approved by the party responsible for compliance could void the user's authority to operate the equipment. If the keyless entry system is inoperative due to changes or modifications not expressly approved by the party responsible for compliance, it will not be covered by your manufacturer's vehicle warranty.

⚠ WARNING

IC WARNING

This device complies with Industry Canada licence-exempt RSS standard(s).

Operation is subject to the following two conditions:

1. This device may not cause interference, and
2. This device must accept any interference, including interference that may cause undesired operation of the device.

Smart key (if equipped)

Type A



Type B



With a smart key, you can lock or unlock a door and even start the engine without inserting the key.

The functions of buttons on a smart key are similar to the folding key.

Refer to "Remote keyless entry" on page 4-8.

⚠ WARNING

Smart key

Never leave the keys in your vehicle with unsupervised children. Leaving children unattended in a vehicle with the smart key is dangerous even if the ENGINE START/STOP button is not in the ACC or

ON position. Children copy adults and they could press the ENGINE START/STOP button. The key would enable children to operate power windows or other controls, or even make the vehicle move, which could result in serious bodily injury or death.

Smart key functions

Carrying the smart key, you may lock and unlock the vehicle doors (and liftgate). Also, you may start the engine.

Locking

Button type



Touch sensor type



Pressing the button (for button type) or touching the door lock sensor (for touch

sensor type) of the front driver side door handle with all doors (and liftgate) closed and any door unlocked, locks all the doors (and liftgate). If all doors (and liftgate) and engine hood are closed, the hazard warning lights will blink once and the chime will sound once to indicate.

The button/touch sensor will only operate when the smart key is within 0.7~1 m (28~40 inches) from the driver side door handle. If you want to make sure that a door has locked or not, you should check pull the driver side door handle.

Even though you press the driver side door handle button/touch sensor, the doors will not lock and the chime will sound for 3 seconds if any of following occur:

- The smart key is in the vehicle.
- The ENGINE START/STOP button is in the ACC or ON position.
- Any door except the liftgate is open.

Unlocking

Button type



Touch sensor type

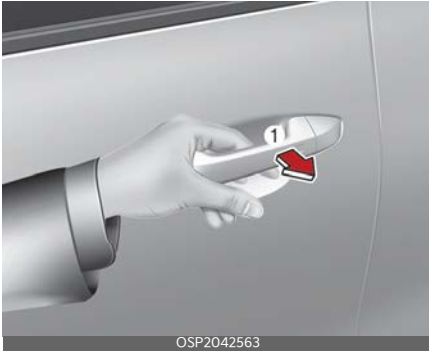

Pressing the button of the front outside door handle (for button type) or put your hand inside the door handle pocket (1) and touch the door unlock sensor on the inside of the outside door handle (for touch sensor type), with all doors (and liftgate) closed and locked, unlocks all the doors (and liftgate), if the 2 Press Unlock function is deactivated.

The button/touch sensor will only operate when the smart key is within 0.7~1 m (28~40 inches) from the outside door handle.

When the 2 Press Unlock function is activated:

- If you press the Door Unlock button on the smart key, the driver's door will unlock.
- If you press the Door Unlock button on the smart key within four seconds again, then all the doors will unlock.
- If you press the driver's outside door handle button or touch the door unlock sensor, the driver's door will unlock.
- If you press the driver's outside door handle button or touch the door unlock sensor, within four seconds again, then all the doors will unlock.

To activate or deactivate 2 Press Unlock, select 'User Settings → Door → 2 Press Unlock' on the instrument cluster or 'Setup → Vehicle → Door → 2 Press Unlock' on the infotainment system.

* INFORMATION

The infotainment system may change after software updates. For more information, refer to the user's manual provided in the infotainment system and the quick reference guide.

Liftgate open

Press the liftgate handle switch carrying the smart key with you and open the liftgate. Once the liftgate is opened and then closed, the liftgate will lock automatically when all doors are locked.

Start-up

You can start the vehicle without inserting the key.

* For more information, refer to "ENGINE START/STOP button (if equipped)" on page 5-7.

* NOTICE

Loss of the smart key

A maximum of 2 smart keys can be registered to a single vehicle.

If you happen to lose your smart key, you will not be able to start the vehicle. You should immediately take the vehicle and remaining key to your authorized Kia dealer (tow the vehicle, if necessary) to protect it from potential theft.

*** NOTICE****Smart key precautions**

The smart key may not work if any of the following occur:

- The smart key is close to a radio transmitter such as a radio station or an airport which can interfere with normal operation of the smart key.
- The smart key is near a mobile two-way radio system or a cellular phone.
- Another vehicle's smart key is being operated close to your vehicle.

When the smart key does not work correctly, open and close the door with the mechanical key and contact an authorized Kia dealer.

If the smart key is in close proximity to your cell phone or smart phone, the signal from the smart key could be blocked by normal operation of your cell phone or smart phone. This is especially important when the phone is active, such as when making calls, receiving calls, text messaging, and/or sending/receiving emails. Avoid placing the smart key and your cell phone or smart phone in the same pants or jacket pocket and maintain adequate distance between the two devices.

Tinting the vehicle windows with film, especially metalized film, may interfere with receiving frequency transmitted by the smart key, reducing its operating range.

*** NOTICE**

To prevent the electronic key from becoming damaged by magnetic fields, do not leave it near the following electrical appliances:

- TVs
- Personal computers

- Cellular phones, cordless phones and battery chargers
- Table lamps
- Induction cookers

*** NOTICE**

If you have to leave the vehicle's key with a parking attendant, remove the mechanical key for your own use and provide the attendant with the electronic key only.

*** NOTICE**

When bringing a smart key onto an airplane, make sure you do not press any button on the key while inside the cabin. If you are carrying the key in your bag etc., make sure that the buttons cannot be pressed accidentally. If you press a button, the key may emit radio waves that could interfere with the operation of the aircraft.

This device complies with Industry Canada licence-exempt RSS standard(s).

Operation is subject to the following two conditions:

1. This device may not cause interference, and
2. This device must accept any interference, including interference that may cause undesired operation of the device.

* NOTICE

Changes or modifications not expressly approved by the party responsible for compliance could void the user's authority to operate the equipment. If the keyless entry system is inoperative due to changes or modifications not expressly approved by the party responsible for compliance, it will not be covered by your manufacturer's vehicle warranty.

Immobilizer system (if equipped)

Folding key immobilizer system

Your vehicle may be equipped with an electronic engine immobilizer system to reduce the risk of unauthorized vehicle use.

Your immobilizer system is comprised of a small transponder in the ignition key and electronic devices inside the vehicle.

With the immobilizer system, whenever you insert your ignition key into the ignition switch and turn it to ON, it checks and determines and verifies that the ignition key is valid.

If the key is determined to be valid, the engine will start.

If the key is determined to be invalid, the engine will not start.

To deactivate the immobilizer system:

Insert the ignition key into the key cylinder and turn it to the ON position.

To activate the immobilizer system:

Turn the ignition key to the OFF position. The immobilizer system activates automatically. Without a valid ignition key for your vehicle, the engine will not start.

Your Immobilizer password is a customer unique password and should be kept confidential. Do not leave this number anywhere in your vehicle.

* NOTICE

Keep each key separately in order to avoid a starting malfunction.

*** NOTICE**

In order to prevent theft of your vehicle, do not leave spare keys anywhere in your vehicle. Your immobilizer password is a customer unique password should be kept confidential. Do not leave this number anywhere in your vehicle.

Do not put metal accessories near the ignition switch.

Metal accessories may interrupt the transponder signal and may prevent the engine from being started.

If you need additional keys or lose your keys, consult an authorized Kia dealer.

⚠ CAUTION**Immobilizer damage**

Do not expose your immobilizer system to moisture, static electricity or rough handling. This may damage your immobilizer.

⚠ CAUTION**Immobilizer alterations**

Do not change, alter or adjust the immobilizer system because it could cause the immobilizer system to malfunction.

This device complies with Industry Canada licence-exempt RSS standard(s).

Operation is subject to the following two conditions:

1. This device may not cause interference, and
2. This device must accept any interference, including interference that may cause undesired operation of the device.

*** NOTICE**

Changes or modifications not expressly approved by the party responsible for compliance could void the user's authority to operate the equipment. If the keyless entry system is inoperative due to changes or modifications not expressly approved by the party responsible for compliance, it will not be covered by your manufacturer's vehicle warranty.

Limp home (override) procedure

When you turn the ignition switch to the ON position, if the immobilizer indicator () goes off after blinking 5 times, your transponder equipped in the ignition key is out of order. You cannot start the engine without the limp home procedure. To start the engine, you have to input your password by using the ignition switch. Your password is only available from an authorized Kia dealership. Contact an authorized dealer for more information. The following procedure is how to input your password of "2345" as an example.

1. Turn the ignition switch to the ON position. The immobilizer indicator () will blink 5 times and go off indicating the beginning of the limp home procedure.
2. Turn the ignition switch to the ACC position.
3. To enter the first digit (in this example "2"), turn the ignition switch to the ON and ACC position twice. Perform the same procedure for the next digits between 3 seconds and 10 seconds (for example, for "3", turn the ignition ON and ACC 3 times).
4. If all of the digits have been input successfully, you have to start the engine within 30 seconds. If you attempt to

start the engine after 30 seconds, the engine will not start and you will have to input your password again.

After performing the limp home procedure, you have to see an authorized Kia dealer immediately to inspect and repair your ignition key or immobilizer system.

Smart key immobilizer system

The immobilizer system protects your vehicle from theft. If an improperly coded key (or other device) is used, the vehicle's power system is disabled.

When the ENGINE START/STOP button is placed in the ON position, the immobilizer system indicator should come on briefly, then go off. If the indicator starts to blink, the system does not recognize the coding of the key.

Place the ENGINE START/STOP button in the OFF position, then place the ENGINE START/STOP button in the ON position again.

If the system repeatedly does not recognize the coding of the key, it is recommended that you contact your Kia dealer.

Do not attempt to alter this system or add other devices to it. Electrical problems could result that may make your vehicle inoperable.

If the following objects are placed near the ENGINE START/STOP button, there may be a problem with starting the engine.

1. Metal accessories
2. Another registered key
3. Keys registered in other vehicles
4. Electronic device

* NOTICE

When starting the vehicle, do not use the key with other immobilizer keys around. Otherwise, the vehicle may not start or may stop soon after it starts. Keep each key separate in order to avoid a starting malfunction.

This device complies with Industry Canada licence-exempt RSS standard(s).

Operation is subject to the following two conditions:

1. This device may not cause interference, and
2. This device must accept any interference, including interference that may cause undesired operation of the device.

* NOTICE

Changes or modifications not expressly approved by the party responsible for compliance could void the user's authority to operate the equipment. If the keyless entry system is inoperative due to changes or modifications not expressly approved by the party responsible for compliance, it will not be covered by your manufacturer's vehicle warranty.

Digital Key 2 Touch (if equipped)

Digital Key 2 Touch provides convenience to the driver, which the driver can use to lock or unlock the driver and passenger doors or the liftgate and turn on the vehicle.

Digital Key 2 Touch (Smart Phone)

How to register Digital Key 2 Touch (Smart phone)

To use the smart phone as a digital key (smart phone) follow the following procedure.

The driver can confirm supported/compatible devices on our website.

Services are expected to be provided according to policy change.

Smart Phone Set Up

In order to use Digital Key 2 Touch (Smart phone) function, install Kia Access app on your smart phone and register your information.

For more details, please refer to Navigation Quick Reference Guide.

Smart Phone Registration

1. Turn the vehicle on with the Smart key and make sure to keep the smart key inside the vehicle during digital key registration.
2. With the vehicle on, touch 'Setup → Vehicle → Digital Key → Smartphone Key → My Smartphone Key' on the infotainment system.

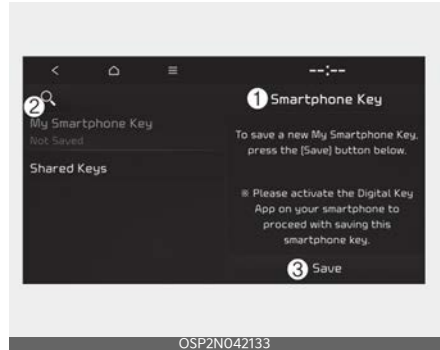

- 1) **Smartphone Key**
 - 2) **My Smartphone Key**
 - 3) **Save**
3. After pressing 'Digital Key Settings → Register' on Kia Access app, place the backside of the smart phone on the in-vehicle authentication pad.



[A]: Charging pad

- As long as the device is supported from additional vehicle services, the Digital Key can be registered wirelessly.
4. Select 'Save' menu on the instrument cluster or on the infotainment system screen. The saving process will begin automatically.
 5. When the digital key (smart phone) is saved, a message will appear on the

instrument cluster or the infotainment system screen.

- Remove the smart phone from the pad and complete the saving process under the guidance of the smart phone screen.

*** INFORMATION**

- The infotainment system may change after software updates. For more information, refer to the user's manual provided in the infotainment system and the quick reference guide.

- Vehicle

When there is a digital key (smart phone) already saved in the vehicle, the 'Save' menu is disabled. If you want to save a digital key again, refer to "How to delete Digital Key (Smart Phone)" on page 4-21 and follow the deleting procedure first before saving a digital key.

- Smart Phone

The digital key cannot be saved again while the vehicle's digital key is saved in the owner's smart phone. Save the digital key after deleting the digital key from the Kia Access App.

- During the digital key saving process, the process will cancel when:
 - The smart phone is removed from the in-vehicle authentication pad (wireless charging pad)
 - Changing the infotainment system or instrument cluster screen
 - The vehicle is turned off
 - The gear is shifted
 - There is no smart key (saving process will not begin)

How to Use the Digital Key 2 Touch (Smart Phone)

Smart Phone Touch Control

The driver can lock and unlock the door by touching the smart phone on the door handle without activating the Kia Access App. Also, the vehicle can be started by placing the smart phone on the in-vehicle authentication pad (wireless charging pad).



[A]: Door handle authentication pad
 [B]: NFC antenna (Backside of the smart phone) (The antenna position differs depending on models.)

Locking/Unlocking the doors

- If the driver touches the smart phone NFC antenna to the driver's or passenger's door handle authentication pad for more than 2 seconds, the door will lock or unlock.
- If 2 Press Unlock function is set, only the driver's door will be unlocked by touching the smart phone on the driver's door handle. Touch the smart phone once more within 4 seconds to unlock all doors.
- After unlocking the doors, the doors will automatically re-lock after 30 seconds unless a door is opened.

- If the smart phone digital key does not operate, move the smart phone more than 10 cm (4 inches) from the door handle authentication pad and try it again.

*** NOTICE**

Note that you cannot lock your vehicle using the smart phone NFC antenna if any of the following occur:

- The Smart Key is in the vehicle
- The ENGINE START/STOP button is in ACC or ON position
- Attempting to lock the door when more than one door, or hood, liftgate is opened

Starting the vehicle

After placing your registered smart phone on the in-vehicle authentication pad (wireless charging pad), depress the brake pedal and press the ENGINE START/STOP button.

- Once the vehicle is started, you can remove the smart phone from the pad.

For more details, refer to "ENGINE START/STOP button (if equipped)" on page 5-7.

▲ WARNING

The vehicle can be started when the registered smart phone is placed on the in-vehicle authentication pad (wireless charging pad). Therefore, do not leave unsupervised children or people who are not aware of the system since it can result in serious injury or death. In addition, always have the registered smart phone with you to prevent vehicle theft when leaving the vehicle.

*** NOTICE**

The operation time of Digital Key 2 Touch for shared user may extend during first time use.

Approach your Digital Key 2 Touch (smartphone) on the authentication pad located in the outside door handle until the vehicle door lock/unlock function operates.

If the inner authentication pad is used for the first time, 1st vehicle start function may not operate.

How to delete Digital Key (Smart Phone)

Turn the vehicle on with the smart key and make sure to keep the smart key inside the vehicle during the digital key (smart phone) deleting process.

1. Delete All digital Key (Smart Phone)

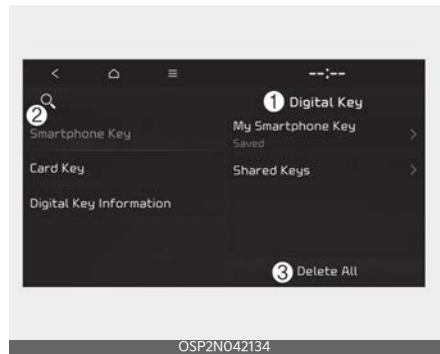

- 1) Digital Key
- 2) Smartphone Key
- 3) Delete All

With the vehicle on, touch 'Setup → Vehicle → Digital Key → Smartphone Key → Delete All' on the infotainment system.

- The key of owner and the shared user will be deleted.

- If there is no registered key, the menu cannot be selected.

2. Delete My Smartphone Key

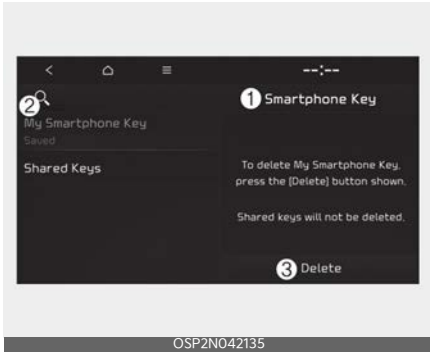

- 1) Smartphone Key
- 2) My Smartphone Key
- 3) Delete

If the owner's smart phone has been changed, the new smart phone can be registered after only deleting the previous Digital Key 2 Touch (Smart Phone).

With the vehicle on, touch 'Setup → Vehicle → Digital Key → Smartphone Key → My Smartphone Key → Delete' on the infotainment system.

- If the shared key is registered in the vehicle, the shared key is not deleted.
- After deleting 'My Smartphone Key', the new smart phone can be registered.

*** NOTICE**

- If digital key (smart phone) is deleted, the digital key saved in the smart-phone is also deleted.
- If digital key (smart phone) is deleted on the smart phone, the digital key saved in the vehicle is also deleted.

- The function to delete shared user's key is not provided from the infotainment system.
- Digital key (smart phone) is not deleted even if Kia Access app is deleted on the smart phone.
- Digital key can be activated or deactivated within the Kia Access app provided from the smart phone manufacturer.

*** INFORMATION**

The infotainment system may change after software updates. For more information, refer to the user's manual provided in the infotainment system and the quick reference guide.

Digital Key 2 Touch (Card Key) (if equipped)

How to register Digital Key 2 Touch (Card Key)

To use the card key as a digital key, follow the following procedure.

1. Get in the vehicle with two smart keys.
2. Check if 'Enable Card Key' menu is activated.

With the vehicle on, touch 'Setup → Vehicle → Digital Key → Card Key → Enable Card Key' on the infotainment system.

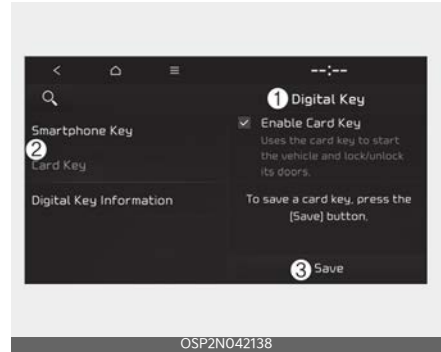
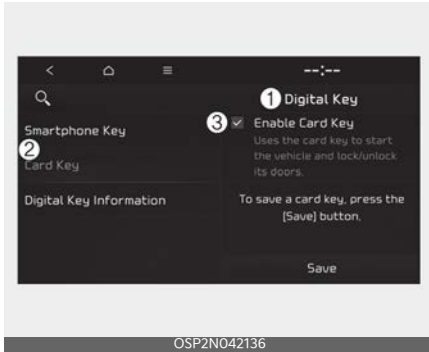

- 1) Digital Key
 - 2) Card Key
 - 3) Enable Card Key
3. With the vehicle on, place the card key on the in-vehicle authentication pad. The saving process will begin automatically.

- 1) Digital Key
 - 2) Card Key
 - 3) Save
4. When the digital key (card key) is saved, a message will appear on the infotainment system screen.

4



[A]: Charging pad

*** INFORMATION**

- The infotainment system may change after software updates. For more information, refer to the user's manual provided in the infotainment system and the quick reference guide.
- When there is a digital key (card key) already saved in the vehicle, the 'Save' menu is disabled. If you want to save a digital key again, refer to "How to delete Digital Key 2 Touch (Card key)" on page 4-25 and follow the deleting procedure first before saving a digital key.
- To register the digital key (card key), the two smart keys must be in the vehicle.
- The registered digital key (card key) cannot be used for another vehicle.

How to use the Digital Key 2 Touch (Card key)

Card key touch control

The driver can lock and unlock the door by touching the card key on the door handle. Also, the vehicle can be started by placing the card key on the in-vehicle authentication pad (wireless charging pad).



[A]: Door handle authentication pad,
[B]: Card key NFC antenna

Locking/Unlocking the doors

- If the driver touches the card key on the driver's or passenger's door handle authentication pad for more than 2 seconds, the door will lock or unlock.
- If 2 Press Unlock function is set, only the driver's door will be unlocked by touching the card key on the driver's door handle. Touch the card key once more within 4 seconds to unlock all doors.
- After unlocking the doors, the doors will automatically re-lock after 30 seconds unless a door is opened.

* NOTICE

When approaching smartphone NFC antenna to the outside door handle authentication pad, the doors will not lock with an audible warning in following conditions:

- The Smart Key is in the vehicle
- The ENGINE START/STOP button is in ACC or ON position
- Any of the doors are open except for the vehicle hood or liftgate

Starting the vehicle

After placing your registered card key on the in-vehicle authentication pad (wireless charger pad), depress the brake pedal and press the ENGINE START/STOP button.

- Once the vehicle is started, you can remove the card key from the pad.

For more details, refer to "ENGINE START/STOP button (if equipped)" on page 5-7.

⚠ WARNING

The vehicle can be started when the registered card key is placed on the in-vehicle authentication pad (wireless charging pad). Therefore, do not leave unsupervised children or people who are not aware of the system since it can result in serious injury or death. In addition, always have the registered card key with you to prevent vehicle theft when leaving the vehicle.

⚠ CAUTION

- The digital key (card key) may not work under the following conditions:
 - The digital key (card key) is not touching the center of the door

handle authentication pad or in-vehicle authentication pad (wireless charging pad) correctly.

- The digital key (card key) is used overlapped with NFC-enabled cards such as credit card or smart phone.
 - If the digital key (card key) does not work, move the card key approximately 10 cm (4 inches) away from the authentication pad and then touch it again.
- The digital key (card key) can be damaged by impacts. If the digital key (card key) is damaged, replace the digital key (card key) with a new one and register it again.
 - Long-time exposure to high temperature may cause the card key to malfunction. Be careful not to expose the key to direct sunlight or high temperature.

How to delete Digital Key 2 Touch (Card key)

1. Turn the vehicle on with the smart key and make sure to keep the smart key inside the vehicle during the digital key (card key) deleting process.
2. With the vehicle on, place the card key on the in-vehicle authentication pad. With the vehicle on, touch 'Setup → Vehicle → Digital Key → Card Key → Delete' on the infotainment system. The 'Delete' menu will be disabled if there is no digital key (card key) saved.

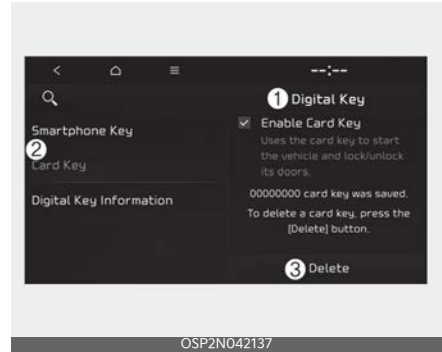

- 1) **Digital Key**
 - 2) **Card Key**
 - 3) **Delete**
3. When the digital key (card key) is deleted, a message will appear on the infotainment screen or cluster.

* INFORMATION

The infotainment system may change after software updates. For more information, refer to the user's manual provided in the infotainment system and the quick reference guide.

Personalized Profile and Vehicle Settings (if equipped)

When the registered digital key is linked with user profile, the vehicle will automatically operate (door lock/unlock with digital key, etc.) according to the user profile setting. User profile linking and personalization are available for a total of two drivers.

Linking / Unlinking profile

How to link user profile

1. Select 'Setup → User Profile → Profile Setting → Link Digital Key (Smart-

phone)' on the infotainment system settings menu.

2. If you select 'Link', the registered phone number's digital key and the user profile will link. Select 'Link' according to the instruction.
3. When the process is complete, the message 'Digital Key Link Complete.' will appear on the infotainment system screen.

How to unlink user profile

1. Unlink digital key in the User Profile settings. Unlinking is possible only when user profile is linked.
2. When unlinking is complete, the message 'Digital key is unlinked.' will appear on the infotainment system screen.

* INFORMATION

- The infotainment system may change after software updates. For more information, refer to the user's manual provided in the infotainment system and the quick reference guide.
- Use profile cannot be linked to both Driver 1 and Driver 2 that are connected to a single smart phone. Personalization will operate with the recently linked user profile, and the previously linked user profile will be automatically canceled.
- User profile can be linked when a digital key is registered on the smart phone and the vehicle. The smart phone with another vehicle's digital key cannot be linked.
- If you remove the smart phone from the in-vehicle authentication pad (wireless charging pad) before completing the user profile link, the linking

process will not be completed normally.

- Once the user profile linked digital key in the smart phone is deleted, the digital key should be re-registered and personalized by linking the user profile again.
- NFC card key cannot be linked with personalized profile.

Vehicle personalization operation

The personalization function linked with Digital Key 2 Touch works under the following conditions:

- Touch the driver's door handle with the profile linked smart phone to lock or unlock the doors (Personalization does not operate when locking or unlocking the front passenger door.).
- The personalization function using the digital key can be operated after linking the digital key in the infotainment system profile menu.
- The personalization function works only when the vehicle is OFF or when the vehicle is started remotely. If the vehicle is not started remotely, personalization function does not work with the digital key.

* INFORMATION

User profile operation according to door lock/unlock system is as follows.

Item	Personalization operation
Initial value	Guest
Profile linked smart phone key	Linked profile
Profile unlinked smart phone key	Recently activated profile
NFC card key	
Smart key	

Vehicle personalization with Digital Key 2 Touch (if equipped)

The available personalization function in the vehicle is as follows.

System	Personalization Item	
User Settings menu	Head-Up Display (HUD)	Position adjustment of image, Information display selection
	Lamp	Blink number of one-touch signal lamps
	Cluster	Information display on the cluster, Voice volume, Welcome sound
	Seat	Seat position
	Door	Automatic door lock/unlock, 2 Press Unlock
	Smart phone wireless charging	Wireless charging On/Off
	Air conditioning	Setting up temperature unit, Block air inflow/ Automatic ventilation/Window defroster On/Off
Infotainment Settings menu	Navigation	Preferred volume of the navigation system
		Recent destination
	User preset	My menu list settings, Radio preset
	Phone connectivity	Bluetooth preferential connection
CarPlay/Android Auto/MirrorLink On/Off		
Air conditioning	Operating condition	Latest operation setup of the following functions: Temperature (AUTO), air flow direction, air volume, air conditioner, air intake control, Front windshield defroster, OFF

For more information of personalization, refer to the infotainment system manual.

⚠ CAUTION

If you leave the digital key in the vehicle after locking or unlocking the doors or starting the vehicle with the smart key, the doors can be locked with the central door lock. Have the digital key with you at all times.

Used Vehicle/Digital Key 2 Touch Maintenance

Purchasing used vehicle

If you purchased a used car, please delete the smart phone key and card key (if equipped) registered by the previous user.

Please let us know the purchase of a used vehicle through an authorized Kia dealer. Check whether the card key (if equipped) that came with the used vehicle operates properly. If the digital key (card key) (if equipped) does not work properly, delete the card key (if equipped) and register the smart phone key, and then re-register the card key (if equipped).

Digital Key 2 Touch Maintenance

If you need to have your Digital Key 2 Touch System repaired or replaced, the registered digital key (smart phone)/digital key (card key) (if equipped) can be deleted.

Limitations of the System

- Digital Key 2 Touch may not work if any of the following occurs:
 - Smart phone battery or the vehicle battery is discharged
 - NFC or Bluetooth is turned off in the smart phone settings
 - A credit card is overlapped in the back of your smart phone, or metal or thick smart phone case is used
 - Using the card key (if equipped) with other cards, or using it in a wallet or card holder
 - There is electronic interference by other vehicles, objects, etc.

- There may be a communication error with Digital Key 2 Touch NFC function if the metallic cover or communication device is attached to the smart phone. If there is a malfunction, remove the cover attached to the smartphone and try again.
- The vehicle may not be controlled by the smart phone if any of the following occurs:
 - Basic and necessary functions of the smart phone are operating (general call, urgent call, audio or NFC payment)
 - Using wireless earphone (general call, urgent call, audio)
 - When Digital Key 2 Touch app function is being limited due to smartphone default settings or app launch priority policy per manufacturer

Theft-alarm system

This system is designed to provide protection from unauthorized entry into the vehicle.

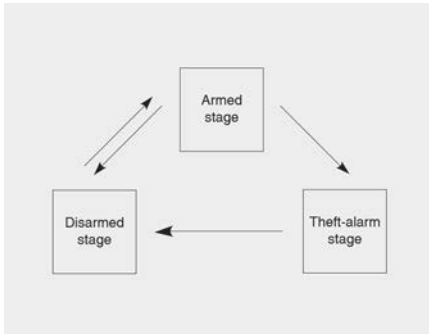

ODEEV068006NR

This system is operated in three stages: the first is the "Armed" stage, the second is the "Theft-alarm" stage, and the third is the "Disarmed" stage. If triggered, the system provides an audible alarm with blinking of the hazard warning lights.

⚠ CAUTION

Do not attempt to alter this system or add other devices to it.

Armed stage

Using the smart key

Park the vehicle and stop the engine. Arm the system as described below.

1. Turn off the engine.
2. Make sure that all doors, the hood and liftgate are closed and latched.
3. Do one of the following:
 - Lock the doors by pressing the button of the front outside door handle with the smart key in your possession.

The system can also be armed by locking the doors with the key from the front doors; however, the haz-

ard warning lights will not blink using this method.

- Lock the doors by pressing the lock button on the smart key.

After completion of the steps above, the hazard warning lights will operate once to indicate that the system is armed.

If any door (or liftgate) or hood remains open, the hazard warning lights and the chime will not operate and the theft-alarm will not arm. If all doors and liftgate and hood are closed after the lock button is pressed, the hazard warning lights blink once.

Using the folding key

Park the vehicle and stop the engine. Arm the system as described below.

1. Turn off the engine and remove the ignition key from the ignition switch.
2. Make sure that all doors (and liftgate) and the engine hood are closed and latched.
3. Lock the doors by pressing the lock button on the folding key.

After completion of the steps above, the hazard warning lights will blink once to indicate that the system is armed.

If any door (and liftgate) or engine hood remains open, the hazard warning lights won't operate and theft-alarm will not arm. After this, if all doors (and liftgate) and engine hood are closed, the hazard warning lights blink once.

* NOTICE

Do not arm the system until all passengers have left the vehicle. If the system is armed while a passenger(s) remains in the vehicle, the alarm may be activated when the remaining passenger(s) leaves the vehicle. If any door (or liftgate) or hood is opened within 30 seconds after

the system enters the armed stage, the system will be disarmed to prevent unnecessary alarm.

Theft-alarm stage

The alarm will be activated if any of the following occurs while the system is armed.

- A front or rear door is opened without using the folding key (or smart key).
- The liftgate is opened without using the folding key (or smart key).
- The hood is opened.

The horn will sound and the hazard warning lights will blink continuously for approximately 27 seconds, and repeat the horn 3 times unless the system is disarmed. To turn off the system, unlock the doors with the folding key or smart key.

Disarmed stage

The system will be disarmed when:

Folding key

- The door unlock button is pressed.
- The engine is started. (within 3 seconds)
- The ignition switch is in the "ON" position for 30 seconds or more.

Smart key

- The door unlock button is pressed.
- The button of the front outside door is pressed while carrying the smart key.
- The engine is started. (within 3 seconds)

After pressing the unlock button, the hazard warning lights will blink and the chime will sound twice (in smart key) to indicate that the system is disarmed.

After pressing the unlock button, if any door (or liftgate) is not opened within 30 seconds, the system will be rearmed.

* NOTICE

- Avoid trying to start the engine while the alarm is activated. The vehicle starting motor is disabled during the theft-alarm stage.

If the system is not disarmed with the folding key, insert the key into the ignition switch (if equipped), turn the ignition switch to the ON position and wait for 30 seconds. Then the system will be disarmed.

- If you lose your keys, consult your authorized Kia dealer.

⚠ CAUTION

Adjusting alarm system

Do not change, alter or adjust the theft alarm system in your vehicle. Improper installation of the alarm system could damage the vehicle or cause the system to malfunction.

* NOTICE

Malfunctions caused by improper alterations, adjustments or modifications to the theft-alarm system are not covered by your vehicle manufacturer warranty.

Door locks

Know how to use the door lock so that you can lock or unlock the door if necessary.

Operating door locks from outside the vehicle



1. Pull out the door handle.
2. Press the lever (1) located inside the bottom part of the cover with a key or flat-head screwdriver.
3. Push out the cover (2) while pressing the lever.
4. Turn the key (3) toward the rear of the vehicle to unlock and toward the front of the vehicle to lock.
 - If you lock the driver's door with a key, only the driver's door will lock/unlock.
 - From the driver's door, turn the key toward the rear of the vehicle once to unlock the driver's door and once more within 4 seconds to unlock all doors.
 - Doors can also be locked and unlocked with the folding key/smart key.
 - Once the doors are unlocked, they may be opened by pulling the door handle.

- When closing the door, push the door by hand. Make sure the doors are closed securely.
- Before pulling the outside door handle, remove the key to avoid damaging the paintwork.

* NOTICE

- In cold and wet climates, door lock and door mechanisms may not work properly due to freezing conditions.
- If the door is locked/unlocked multiple times in rapid succession with either the vehicle key or central door lock switch, the system may stop operating temporarily in order to protect the circuit and prevent damage to system components.

⚠ WARNING

- Securely close your door before you begin driving. Failure to fully close your door may cause it to be opened during vehicle operation.
- Keep your body out of the way of the closing door to prevent injuries.

⚠ WARNING

If any passengers must remain in the vehicle while it is very hot or cold outside, there is risk of injuries or danger to life. Do not lock the vehicle from the outside when there are passengers in the vehicle.

⚠ CAUTION

Do not unnecessarily open and close the door repeatedly or with excessive force. Such action can damage the vehicle door.

*** NOTICE**

Always place the ignition switch or ENGINE START/STOP button in the OFF position, engage the parking brake, close all windows, and lock all doors when leaving your vehicle unattended.

Operating door locks from inside the vehicle

You can operate door locks with the central door lock switch.

With the door handle



- Front door:
If the inner door handle (1) is pulled when the door is locked, the door will unlock and open.
- Rear door:
If the inner door handle is pulled once when the door is locked, the door will unlock.
If the inner door handle is pulled once more, the door will open.

Door lock malfunction

If a power door lock ever fails to function while you are in the vehicle, try one or more of the following techniques to exit:

- Operate the door unlock feature repeatedly (both electronic and manual) while simultaneously pulling on the door handle.
- Operate the other door locks and handles, front and rear.
- Lower a front window and use the key to unlock the door from outside.

⚠ WARNING

Do not pull the inner door handle while the vehicle is moving.

With central door lock switch

Driver side



Passenger side



Operate by pressing the central door lock switch.

- To lock all vehicle doors, press the central door lock switch (1) of driver and passenger side.
- To unlock all vehicle doors, press the central door unlock switch (2) of driver and passenger side.

Any door is opened, the doors will not lock even though the central door lock switch is pressed.

WARNING

Doors

- The doors should always be fully closed and locked while the vehicle is in motion to prevent accidental opening of a door.
- Be careful when opening doors and watch out for vehicles, motorcycles, bicycles or pedestrians approaching the vehicle in the path of the door. Opening a door when something is approaching can result in an accident to cause vehicle damage or serious injury.

WARNING

Unlocked vehicles

Leaving your vehicle unlocked can increase the risk of vehicle theft or any possible criminal harm caused by someone hiding in your vehicle while you are gone. Always turn off the vehicle, engage the parking brake, close all windows and lock all doors when leaving your vehicle unattended.

WARNING

Unattended children, the elderly or pets

An enclosed vehicle can become extremely hot, causing death or severe injury such as heatstroke to unattended

children, the elderly or pets who cannot escape the vehicle. When left or trapped in a hot vehicle, make sure to stay hydrated and avoid sun exposure through the vehicle's windshield. Furthermore, children might operate features of the vehicle that could injure them, or they could encounter other harm, possibly from someone gaining entry to the vehicle. Never leave children or animals unattended in your vehicle.

Door lock/unlock features

The vehicle is equipped with door lock/unlock features for the safety and convenience of passengers.

Impact sensing door unlock system

All doors will automatically unlock when an impact causes the air bags to deploy.

Speed sensing door lock system

All doors will automatically lock after the vehicle speed exceeds 15 km/h(10 mph).

To activate or deactivate the auto door lock/unlock features, select 'User Settings → Door → Auto Lock/Auto Unlock' on the instrument cluster or 'Setup → Vehicle → Door → Auto Lock/Auto Unlock' on the infotainment system.

INFORMATION

The infotainment system may change after software updates. For more information, refer to the user's manual provided in the infotainment system and the quick reference guide.

In case of an emergency

If the electrical power door lock switch is not operating (ex. dead car battery) the only way to lock the door(s) is with the mechanical key from the outside key hole.

Doors without an outside key hole can be locked as follows:

1. Open the door.
2. Insert the key into the emergency door lock hole and turn the key horizontally to lock.



3. Close the door securely.

* NOTICE

If the electrical power to door lock switch is not operating (ex. dead car battery) and the liftgate is closed, you will not be able to open the liftgate until power is restored.

Child-protector rear door lock

The child safety lock is provided to help prevent children from accidentally opening the rear doors from inside the vehicle.



The rear door safety locks should be used whenever children are in the vehicle.

The child safety lock is located on the edge of each rear door. When the child safety lock is in the lock position (1), the rear door will not open if the inner door handle is pulled.

To lock the child safety lock, insert a key (or screwdriver) into the hole and turn it to the lock position.

To allow a rear door to be opened from inside the vehicle, unlock the child safety lock.

To open the rear door, pull the outside door handle (2).

⚠ WARNING

Rear door locks

If children accidentally open the rear doors while the vehicle is in motion, they could fall out and be severely injured or killed. To prevent children from opening the rear doors from the inside, the rear door safety locks should be used whenever children are in the vehicle.

Rear Occupant Alert (ROA) system

The Rear Occupant Alert (ROA) is provided to help prevent exiting the vehicle with a rear passenger left in the vehicle.

- When you open the front door after opening and closing the rear door and turning off the engine, the "Check rear seat for passengers and belongings" warning message appears on the cluster.



OSP2042508L

You can activate or deactivate the Rear Occupant Alert (ROA) from the User Settings mode in the cluster LCD display. The option can be found under the following menu:

1. Press the MODE button (📄) several times on the steering wheel until 'User Settings' menu appears on the LCD.
2. Select 'Convenience → Rear Occupant Alert' with the MOVE switch (∧/∨) and the OK button on the steering wheel.

If your vehicle is equipped with the infotainment system, the option can be found under the following menu:

1. Press the SETUP button of the infotainment system.
2. Select 'Vehicle → Convenience → Rear Occupant Alert' on the infotainment system screen.

* INFORMATION

The infotainment system may change after software updates. For more information, refer to the user's manual provided in the infotainment system and the quick reference guide.

⚠ WARNING

The Rear Occupant Alert (ROA) system does not actually detect objects or people in the rear seat. By using a rear door opened and closed history, the system informs the driver that there may be something in the rear seat.

⚠ CAUTION

- The Rear Occupant Alert (ROA) system uses a rear door opened and closed history.
- The history is reset after the driver turns off ignition normally, exits the vehicle and locks the door remotely using the remote keyless entry. So even if a rear door does not reopen, the ROA system warning can occur.
- For example, after the ROA system warning occur, if the driver does not lock the door, and drives again, the alert can occur.

⚠ WARNING

The door lock system may not work if the electrical system is compromised. Accordingly, please train children passengers regarding how to open the car door manually before an emergency situation arises. That way, they would be able to open the door manually in the event an emergency situation arises.

Integrated Memory System (if equipped)

Integrated Memory System for the driver's seat is provided to store and recall the following memory settings with a simple button operation.



- Driver's seat position
- Head-Up Display (HUD): position

⚠ WARNING

Never attempt to operate the integrated memory system while the vehicle is moving.

This could result in loss of control, and an accident causing death, serious injury, or property damage.

*** NOTICE**

- If the battery is disconnected, the memory settings will be erased.
- If integrated memory system does not operate normally, visit an authorized Kia dealer.

Storing memory positions

1. Shift to P (Park) while the ignition switch or ENGINE START/STOP button is in the ON position.

- Adjust the driver's seat position and head-up display height to the desired position.
- Hold the button (1 or 2). The system will beep once and notify you 'Driver 1 (or 2) settings saved' will appear on the infotainment screen.

Recalling memory positions

- Shift to P (Park) while the ignition switch or ENGINE START/STOP button is in the ON position.
- Press the desired memory button (1 or 2). The system will beep once, and then driver's seat position and head-up display height will automatically adjust to the stored positions.
- 'Driver 1 (or 2) settings applied' will appear on the infotainment screen.

Seat easy access

Exiting the vehicle:

The driver's seat will move as follows when the Start/Stop button is in the OFF position with the gear in P (Park) and the driver's door open.

- Driver seat: Moves rearward depending on the distance selected from the Settings menu in the infotainment system.

However, the driver's seat may not move rearward if there is not enough space between the driver's seat and the rear seats.

Entering the vehicle:

The driver's seat will move as follows when the Start/Stop button is pressed to the ACC, ON or START position or while carrying the smart key, the driver's door is closed with the ignition switch or

ENGINE START/STOP button in the OFF position.

- Driver seat: Moves back to its original position.

You can set the Seat Easy Access function from the Settings menu in the infotainment system screen.

- Driver seat: Select Settings → Vehicle → Seat → Seating Easy Access → Driver Seat Easy Access → Normal/Extended/Off

Resetting the System

Take the following procedures to reset the integrated memory system, when it does not operate properly.

Resetting integrated memory system

- Stop the vehicle and open the driver's door with the ignition switch or ENGINE START/STOP button in the ON position and the vehicle shifted to P (Park).
- Adjust the driver's seat and seatback to the foremost position.
- Press the memory button 1 (or 2) and push forward the driver's seat movement switch over 2 seconds simultaneously.

While integrated memory system

- Resetting starts with a notification sound.
- The driver's seat and seatback is adjusted to the rearward position with the notification sound.
- The driver's seat and seatback is re-adjusted to the default position (central position) with the notification sound.

However, in the following cases, the resetting procedure and the notification sound may stop.

- The memory button is pressed.
- The seat control switch is operated.
- The gear is shifted out of P (Park).
- The driving speed exceeds 3 km/h (2 mph).
- The driver's door is closed.

*** NOTICE**

- While integrated memory system is being reset, if the resetting and notification sound stops incompletely, restart the resetting procedure again.
- Make sure that there are no objects around the driver's seat in advance of resetting the integrated memory system.
- After resetting the integrated memory system, the adjustment for the driver seat must be stored again to recall the memory position.



Liftgate

When you open the liftgate, you will see a space where you can load the cargo.

Opening the liftgate

The liftgate is locked or unlocked when all doors are locked or unlocked with the key or central door lock/unlock switch.

⚠ CAUTION

Liftgate lift

Make certain that you close the liftgate before driving your vehicle. Possible damage may occur to the liftgate gas lifters and attached hardware if the liftgate is not closed prior to driving.



To open the liftgate, press the handle and pull it up.

Once the liftgate is opened and then closed, the liftgate locks automatically. (All doors must be locked.)

*** NOTICE**

In cold and wet climates, door lock and door mechanisms may not work properly due to freezing conditions.

⚠ WARNING

The liftgate swings upward. Make sure no objects or people are near the rear of the vehicle when opening the liftgate.

Closing the liftgate

1. Lower and push down the liftgate firmly.
2. Make sure that the liftgate is securely latched.

Make sure your hands, feet and other parts of your body are safely out of the way before closing the liftgate.

⚠ WARNING**Exhaust Fumes**

The liftgate should always be kept completely closed while the vehicle is in motion. If it is left open or ajar, poisonous exhaust gases may enter the car and serious illness or death may result.

Opening the liftgate in emergency

Your vehicle is equipped with the emergency liftgate safety release lever located on the bottom of the liftgate. When someone is inadvertently locked in the luggage compartment.

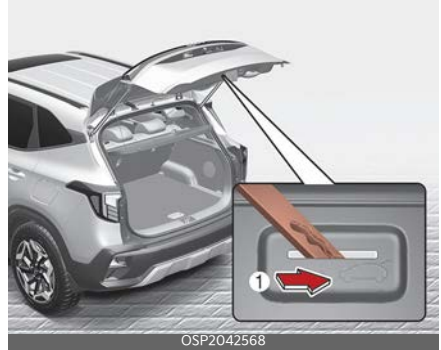

The liftgate can be opened by doing as follows:

1. Input the mechanical key into the hole.
2. Push the mechanical key to the right (1).
3. Push the liftgate upwards.

⚠ WARNING

- No one should be allowed to occupy the cargo area of the vehicle at any time. The cargo area is a very dangerous location in the event of a crash.
- Use the release lever for emergencies only. Use with extreme caution, especially while the vehicle is in motion.

⚠ CAUTION

Make sure there are no people or objects around the liftgate before opening or closing the liftgate. Wait until the liftgate is open fully and stopped before loading or unloading cargo from the vehicle.

⚠ WARNING

Do not grasp the part supporting the liftgate (gas lifter), as this may cause serious injury.

**Power liftgate (if equipped)****Power liftgate operating conditions**

The power liftgate operates when the gear is in P (Park) with the engine running. However, the power liftgate will operate regardless of the gear position when the engine is off. Also, the liftgate can be opened only when vehicle speed is below 3 km/h (1.8 mph). For safety, before attempting to open or close the liftgate, make sure the vehicle is in P (Park).

⚠ WARNING

- Never leave children or animals unattended in your vehicle. Children may operate the power liftgate. Doing so can result in injury to themselves or others and can damage the vehicle.
- Make sure that there are no people or objects in the path of the power liftgate or smart liftgate prior to use. Serious injury, damage to the vehicle or damage to surrounding objects (for example, walls, ceilings, vehicles, etc.) may result if contact with the liftgate occurs.



- A liftgate covered with snow or equipped with heavy objects (e.g. bike racks, ladders) may not be opened;

with the liftgate open, it may be accidentally closed, causing injuries to anyone around the vehicle.

- Do not open the liftgate if the liftgate is covered with snow or equipped with heavy objects.
- Make sure to remove snow and heavy objects before opening the liftgate.

* NOTICE

- Do not close or open the liftgate manually. This may cause damage to the power liftgate. If it is necessary to close or open the liftgate manually when the battery is discharged or disconnected, do not apply excessive force.
- Do not operate the power liftgate more than 10 times continuously when the engine is not running. Use the power liftgate with the engine running when the power liftgate is used repeatedly to prevent battery discharge.
- Do not leave the power liftgate open for a long period of time. This may drain the battery.
- Do not apply excessive force when the power liftgate is operating. Doing so could result in vehicle damage.
- Do not grab or hold on to the liftgate support struts at any time. Damage to the liftgate support struts could result. Deformation of the liftgate support struts may cause vehicle damage and personal injury may occur.



- Do not modify or repair any part of the power liftgate by yourself. This must be done by an authorized Kia dealer.
- Do not operate the power liftgate under the following conditions. The power liftgate may not operate properly.
 - One side of the vehicle is lifted to inspect the vehicle or change a tire
 - Parking on an uneven road such as a slope, etc.
- Close the liftgate completely and lock all doors and liftgate using the central door lock switch before using an automatic car wash.
- Do not spray high pressure water directly on the power liftgate outside open/close switch. The liftgate may open unintentionally.

* INFORMATION

- If the liftgate is not fully closed and vehicle speed is at or above 3 km/h (1.8 mph), a warning will sound 10 times. Immediately park the vehicle at a safe place, close the liftgate, and check that the liftgate open warning on the instrument cluster is turned off.

- In cold and wet climates, the outside power liftgate open/close switch may not work properly due to freezing conditions. If this occurs, remove the ice before using the outside power liftgate open/close switch or use the power liftgate open/close button on the smart key or the instrument panel.
- Operating the power liftgate more than 5 times continuously could cause damage to the operating motor. If this occurs, the power liftgate will not operate to prevent the motor from overheating. If any of the power liftgate buttons are pressed to try to open the liftgate, the chime will sound 3 times, but the liftgate will remain closed. Allow the power liftgate system to cool for about 1 minute before operating the system again.

Operating the power liftgate

Power liftgate open/close button (Smart key, Instrument panel)



OSP2042621



OSP2N042075

When the liftgate is closed, press the power liftgate open/close button for 1 second. The power liftgate opens with a warning sound.

When the power liftgate is opened, press and hold the power liftgate open/close button to close the liftgate.

If you release the button while the liftgate is closing, power liftgate operation will stop with a warning sound for 5 seconds.

Also, if the smart key is not within operation range (approximately 10 m) from the vehicle, power liftgate operation will stop with a warning sound for 5 seconds.

Power liftgate open/close switch (Outside the power liftgate)



OSP2042511

When the liftgate is closed, press the power liftgate open/close switch to open the liftgate.

If the vehicle is locked, press the power liftgate open/close switch with the smart key in your possession.

If the liftgate is unlocked, the liftgate will open or close with a warning sound when the power liftgate open/close switch is pressed without carrying the smart key.

Power liftgate open/close button (Inside the power liftgate)



Press the power liftgate open/close button. The liftgate opens or closes with a warning sound.

Automatic reverse

During power liftgate operation if the power liftgate senses any obstacle, the liftgate will stop or will fully open. The automatic reverse feature may not operate properly, or it may operate unexpectedly under the following circumstances:

- The automatic reverse feature may not detect the resistance if the detected resistance is below a certain level, or if the liftgate is almost fully closed near the latched position.

- The automatic reverse feature may operate if a strong impact is applied with no obstructions placed.

⚠ WARNING

Never intentionally place any object or part of your body in the path of the power liftgate to make sure the automatic reverse feature operates. Serious injury, or damage to the vehicle or object may occur.

* INFORMATION

The power liftgate may stop operating if the automatic reverse feature operates more than two times while attempting to open or close the liftgate. If this occurs, carefully open or close the liftgate manually, and then after 30 seconds try to operate the power liftgate automatically again.

Setting the power liftgate

To use each feature, you must select the opening speed or opening height from the settings menu. Deselect the settings when you do not want to use the feature.

Power liftgate opening speed

To adjust the power liftgate speed, select 'User Settings → Door → Power Liftgate Opening Speed → Fast/Normal' in the instrument cluster or 'Setup → Vehicle → Door → Power Liftgate Opening Speed → Fast/Normal' in the infotainment system. (Default setting is Fast)

Power liftgate opening height

To adjust the power liftgate opening height, select 'User Settings → Door → Power Liftgate Opening Height → Full Open/Level 3/Level 2/Level 1/User Height Setting' in the instrument cluster

or 'Setup → Vehicle → Door → Power Liftgate Opening Height → Full Open/Level 3/Level 2/Level 1/User Height Setting' in the infotainment system.

*** INFORMATION**

The infotainment system may change after software updates. For more information, refer to the user's manual provided in the infotainment system and the quick reference guide.

User height setting

1. Position the liftgate manually to the height you prefer.
2. Press the power liftgate open/close button located inside the liftgate for more than 3 seconds.

If 'User Height Setting' is selected for the power liftgate opening height, the power liftgate will automatically open to the height manually set by you.

*** INFORMATION**

- If the power liftgate opening height has not been manually set, the power liftgate will fully open when 'User Height Setting' from the infotainment system is selected.
- If one of the height setting (Full Open/Level 3/Level 2/Level 1) is selected from the settings menu in the infotainment system, and then 'User Height Setting' is selected, the liftgate will open to the height manually set by you.
- The power liftgate opening speed and opening height settings change according to the linked User Profile. If the User Profile is changed, power liftgate opening speed and opening height settings will change accordingly.

Resetting the power liftgate

In some circumstances resetting the power liftgate operation may need to be performed. Some instances where resetting the power liftgate may be required include:

- When the 12-volt battery is recharged
- When the 12-volt battery is reinstalled after removal or replacement
- When the related fuse is reinstalled after removal or replacement

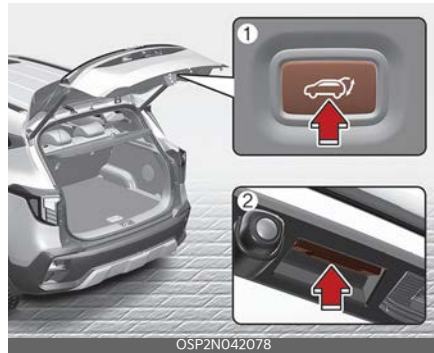

1. With the engine off or running, put the gear in P (Park).
2. Press the power liftgate open/close inner button (1) and outer switch (2) simultaneously until a chime sounds.
3. Slowly close the liftgate manually.
4. Press the power liftgate open/close outer switch. The power liftgate will open with a chime sound.

Wait until the liftgate fully opens to complete resetting. If the liftgate stops before it is fully open, resetting cannot be completed.

*** INFORMATION**

If the power liftgate does not operate properly after the above procedure, have the system inspected by an authorized Kia dealer.

Emergency liftgate safety release

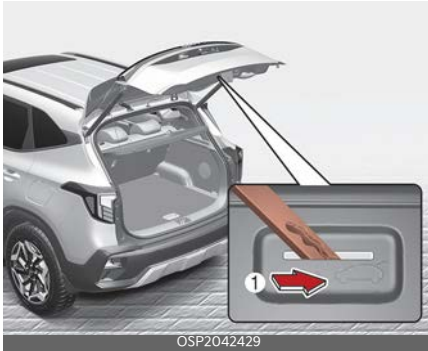

To unlock and open the liftgate manually from inside the luggage compartment, perform the following procedure:

1. Insert a long, flat object, such as a key into the opening at the bottom of the liftgate.
2. Slide the latch in the direction of the arrow (1) to unlock the liftgate.
3. Push the liftgate to open.

⚠ WARNING

- For emergencies, be fully aware of the location of the emergency liftgate safety release latch in the vehicle and how to open the liftgate if you are accidentally locked in the luggage compartment.
- No one, including animals, should be allowed to occupy the luggage compartment of the vehicle at any time. The luggage compartment is a very dangerous location in the event of an accident.
- Use the release latch for emergencies only. Use extreme caution, especially while the vehicle is in motion.

Smart liftgate (if equipped)



On the vehicle equipped with a smart key, the liftgate can be opened with no-touch activation using the smart liftgate system.

How to use the smart liftgate

The liftgate can be opened with notouch activation satisfying all the conditions below.

- After 15 seconds when all doors are closed and locked
- Positioned in the detecting area for more than 3 seconds.

*** NOTICE**

The smart liftgate does not operate when:

- The smart key is detected within 15 seconds after the doors are closed and locked, and is continuously detected.
- A door is not locked or closed.
- The smart key is in the vehicle.

1. Setting

- Instrument cluster
Select 'User Settings → Door → Smart Liftgate'.

- Infotainment system (if equipped)
Select 'Setup → Vehicle → Door → Smart Liftgate'.

*** INFORMATION**

The infotainment system may change after software updates. For more information, refer to the user's manual provided in the infotainment system and the quick reference guide.

2. Detect and Alert



If you are positioned in the detecting area (50 ~ 100 cm (20 ~ 39 inches) behind the vehicle) carrying a smart key, the hazard warning lights will blink and chime will sound for about 3 seconds to alert you the smart key has been detected and the liftgate will open.

*** NOTICE**

Do not approach the detecting area if you do not want the liftgate to open. If you have unintentionally entered the detecting area and the hazard warning lights and chime starts to operate, leave the detecting area with the smart key. The liftgate will stay closed.

3. Automatic opening

The hazard warning lights will blink and chime will sound 2 times and then the liftgate will slowly open.

⚠ WARNING

- Make certain that you close the liftgate before driving your vehicle.
- Make sure nobody or objects around the liftgate before opening or closing the liftgate.
- Make sure objects in the rear cargo area do not fall out when opening the liftgate on a slope way. It may cause serious injury.
- Make sure to deactivate the smart liftgate function when washing your vehicle. Otherwise, the liftgate may open inadvertently.
- The key should be kept out of reach of children. Children may inadvertently open the smart liftgate while playing around the rear area of the vehicle.

How to deactivate the smart liftgate function using the smart key



1. Door lock
2. Door unlock

3. Liftgate open/close

4. Panic

5. Remote start

If you press any button of the smart key during the Detect and Alert stage, the smart liftgate function will be deactivated.

Make sure to be aware of how to deactivate the smart liftgate function for emergency situations.

* NOTICE

- If you press the door unlock button (2), the smart liftgate function will be deactivated temporarily. But, if you do not open any door for 30 seconds, the smart liftgate function will be activated again.
- If you press the liftgate open button (3) for more than 1 second, the liftgate opens.
- If you press the door lock button (1) or liftgate open button (3) when the smart liftgate function is not in the Detect and Alert stage, the smart liftgate function will not be deactivated.
- In case you have deactivated the smart liftgate function by pressing the smart key button and opened a door, the smart liftgate function can be activated again by closing and locking all doors.

Detecting area



- The smart liftgate operates with a welcome alert if the smart key is detected within 50 ~ 100 cm (20 ~ 39 inches) from the liftgate.
- The alert stops at once if the smart key is positioned outside the detecting area during the Detect and Alert stage.

* NOTICE

- The smart liftgate function will not work if any of the following occurs:
 - The smart key is close to a radio transmitter such as a radio station or an airport which can interfere with normal operation of the transmitter.
 - The smart key is near a mobile two way radio system or a cellular phone.
 - Another vehicle's smart key is being operated close to your vehicle.
- The detecting range may decrease or increase when:
 - One side of the tire is raised to replace a tire or to inspect the vehicle.
 - The vehicle is slantingly parked on a slope or unpaved road, etc.

Windows

The doors of this vehicle are equipped with power windows that can be operated by a switch.

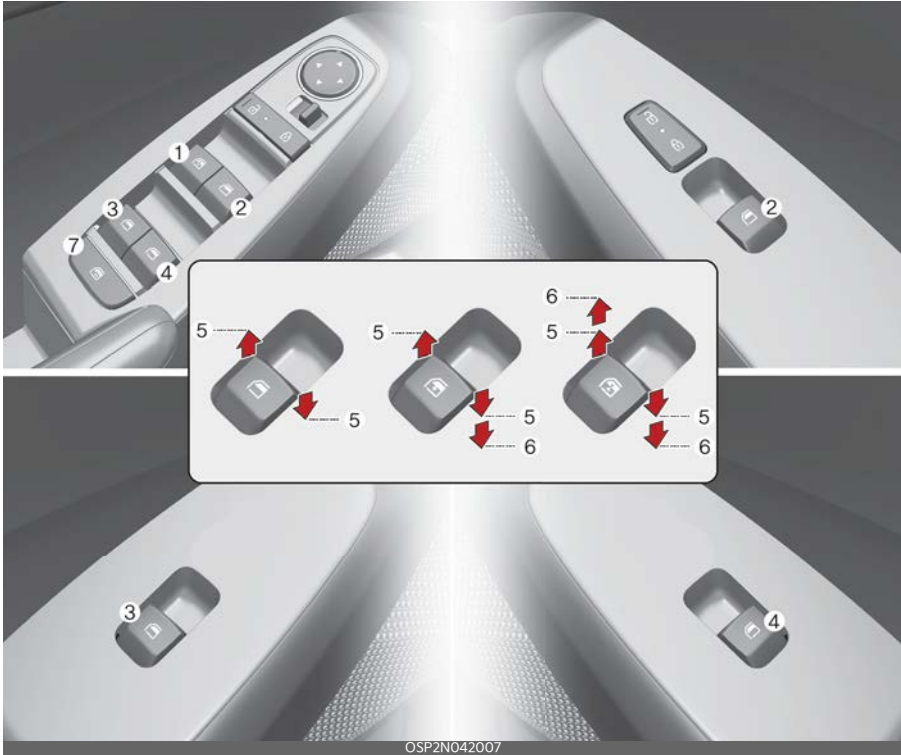

OSP2N042007

1. Driver's door power window switch
2. Front passenger's door power window switch
3. Rear door (left) power window switch
4. Rear door (right) power window switch
5. Window opening and closing
6. Automatic power window up*/down*
7. Power window lock switch

*: if equipped

*** NOTICE**

In cold and wet climates, power windows may not work properly due to freezing conditions.

The ignition switch or ENGINE START/STOP button must be in the ON position for power windows to operate.

Each door has a power window switch that controls the door's window. The driver has a power window lock switch which can block the operation of rear passenger windows. The power windows can be operated for approximately 3 minutes after the ENGINE START/STOP button or the ignition switch has been placed in the ACC or LOCK/OFF position. However, if the front doors are opened, the power windows cannot be operated even within the 3 minutes period.

The driver's door has a master power window switch that controls all the windows in the vehicle.

If the window cannot be closed because it is blocked by objects, remove the objects and close the window.

*** NOTICE**

While driving with the rear windows down or with the sunroof (if equipped) in an open (or partially open position), your vehicle may demonstrate a wind buffeting or pulsation noise. This noise is a normal occurrence and can be reduced or eliminated by taking the following actions. If the noise occurs with one or both of the rear windows down, partially lower both front windows approximately 2.5 cm (1 inch). If you experience the noise with the sunroof open, slightly reduce the size of the sunroof opening.

⚠ CAUTION

Do not install any accessories in the vehicle that extend into the open window area. Such objects will impact the proper function of the Automatic reversal "jam protection" feature.

*** NOTICE**

If you press the one-touch window button for micro adjustment, the glass will go down to a specific location to improve your convenience.

Window opening and closing

You can open and close windows using the power window switch.

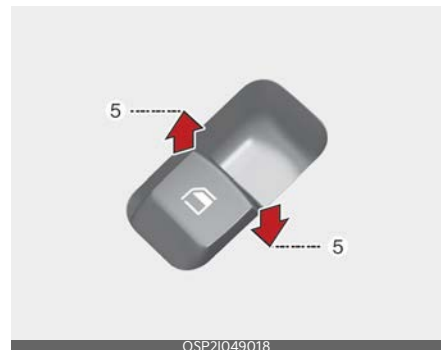
Type A

To open or close a window, press down or pull up the front portion of the corresponding switch to the first detent position (5).

Type B - Auto down window (if equipped)



Pressing the power window switch momentarily to the second detent position (6) completely lowers the window even when the switch is released. To stop the window at the desired position while the window is in operation, pull up the switch briefly to the opposite direction of the window movement.

Type C - Auto up/down window (if equipped)

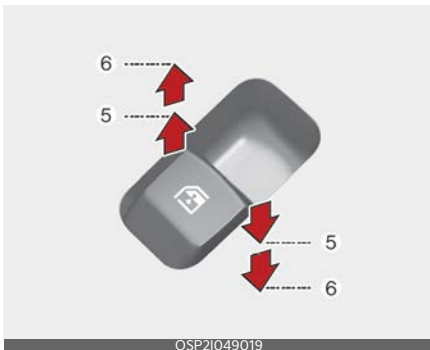

Pressing or pulling up the power window switch momentarily to the second detent position (6) completely lowers or raises the window even when the switch is released. To stop the window at the

desired position while the window is in operation, pull up or press down and release the switch.

To reset the power windows

If the power window does not operate normally, the automatic power window system must be reset as follows:

1. Turn the ignition switch to the ON position.
2. Close the window and continue pulling up the power window switch for at least 1 second after the window is completely closed.

Automatic reversal (if equipped)

If the upward movement of the window is blocked by an object or part of the body, the window will detect the resistance and will stop upward movement. The window will then lower approximately 30 cm (11.8 inches) to allow the object to be cleared.



If the window detects the resistance while the power window switch is pulled up continuously, the window will stop upward movement then lower approximately 2.5 cm (1 inch).

If the power window switch is being continuously pulled up again within 5 sec-

onds after the window was lowered by the automatic window reversal feature, the automatic window reversal will not operate.

* NOTICE

The automatic reverse feature for the window is only active when the "auto up" feature is used by fully pulling up the switch. The automatic reverse feature will not operate if the window is raised using the halfway position on the power window switch.

⚠ WARNING

Always check for obstructions before raising any window to avoid injuries or vehicle damage. If an object less than 4 mm (0.16 of an inch) in diameter is caught between the window glass and the upper window channel, the automatic reverse window may not detect the resistance and will not stop and reverse direction.

⚠ WARNING

The automatic reverse feature doesn't activate while resetting the power window system. Make sure body parts or other objects are safely out of the way before closing the windows to avoid injuries.

⚠ WARNING

Do not install any accessories in the vehicle that extend into the open window area. Such objects could prevent the automatic reverse feature from functioning.

Power window lock button

The driver can disable the power window switches on the rear passengers' doors by pressing the power window lock button to the lock position (pressed).



OSP2N042008

When the power window lock button is pressed:

- The driver's master control can operate all passengers' power windows.
- The front passenger's control can operate the front passenger's power window.
- The rear passengers' control cannot operate the rear passenger's power window.

Always double check to make sure all arms, hands, head and other obstructions are safely out of the way before closing a window.

If the window cannot be closed because it is blocked by objects, remove the objects and close the window.

⚠ WARNING

Power windows

- Do not allow children to play with the power windows. Keep the power window lock switch (on the driver's door) in the LOCK (pressed) position.

- Do not extend a face or arms outside the window opening while the vehicle is in motion. Doing so could result in significant bodily injury.

⚠ WARNING

- When exiting the vehicle, turn the engine switch off, take the key with you, and make sure that all children have also exited the vehicle. If a child is left alone inside the vehicle, they may accidentally operate the vehicle, which could lead to an accident or injury.
- Do not leave children, seniors, or animals in your vehicle with the doors and windows closed.
- Do not allow a child to hold both the remote control key and the mechanical key together.

Remote window opening system (if equipped)



You can still control the windows movement with the engine turned off.

- Press the door unlock button (1) for more than 3 seconds. The window moves down after the doors are unlocked, as long as you press the door unlock button (1).

- The window movement stops, when you release the door unlock button (1).
- Remote window operation can be activated or deactivated from the Settings menu.

- Instrument cluster
Select 'User Settings → Door → Remote Window Control'.
- Infotainment system (if equipped)
Select 'Setup → Vehicle → Door → Remote Window Control'.

⚠ CAUTION

- The remote window opening function may abruptly stop, when you move away from your vehicle during operation. Stay in close proximity from your vehicle, while monitoring the window movement.
- Be careful when using the remote window opening function, as the doors will be unlocked.

*** INFORMATION**

The infotainment system may change after software updates. For more information, refer to the user's manual provided in the infotainment system and the quick reference guide.

Hood

The hood serves as a cover for the engine compartment. Open the hood if maintenance work needs to be performed in the engine compartment or if you need to look at the compartment.

Opening the hood

1. Pull the release lever to unlatch the hood. The hood should pop open slightly.



* NOTICE

Open the hood after turning off the engine on a flat surface, shifting the shift lever to the P (Park) position and setting the parking brake.

2. Go to the front of the vehicle, raise the hood slightly, push the secondary hood release lever (1) sideways and lift the hood (2).



3. Pull out the support rod.



4. Hold the hood opened with the support rod.

⚠ WARNING

HOT parts

Grasp the support rod in the area wrapped in rubber. The rubber will help prevent you from being burned by hot metal when the engine is hot.

Hood open warning

A warning message will appear on the LCD display when hood is open.



The warning chime will operate when the vehicle is being driven above 7 km/h (4 mph) with the hood open.

Closing the hood

1. Before closing the hood, check the following:
 - All filler caps in the engine compartment must be correctly installed.
 - Gloves, rags or any other combustible material must be removed from the engine compartment.
2. Lower the hood halfway (approximately 30 cm (12 inches)) and push down to securely lock in place.



3. Check that the hood has engaged properly.

- If the hood can be raise slightly, it is not properly engaged.
- Open it again and close it with a little more force.

⚠ CAUTION

Hood obstruction

Before closing the hood, ensure that all obstructions are removed from the hood opening. Closing the hood with an obstruction present in the hood opening may result in severe personal injury or property damage.

⚠ WARNING

Fire risk

Do not leave gloves, rags or any other combustible material in the motor compartment. Doing so may cause a heat-induced fire.

⚠ WARNING

Unsecured hood

Always double check to be sure that the hood is firmly latched before driving away. If it is not latched, the hood could fly open while the vehicle is being driven, causing a total loss of visibility, which may result in an accident.

Fuel filler door

The vehicle's fuel filler door must be opened inside the vehicle by pulling up on the fuel-filler door opener located on the front floor area on the driver's seat.

Opening the fuel filler door

If the fuel filler door does not open because ice has formed around it, tap lightly or push on the lid to break the ice and release the lid. Do not apply excessive force to open the lid. If necessary, spray around the lid with an approved de-icer fluid (do not use radiator anti-freeze) or move the vehicle to a warm place and allow the ice to melt.

1. Stop the engine.
2. To open the fuel filler door, pull up the fuel filler door opener.



3. Pull the fuel filler door (1) out to fully open.

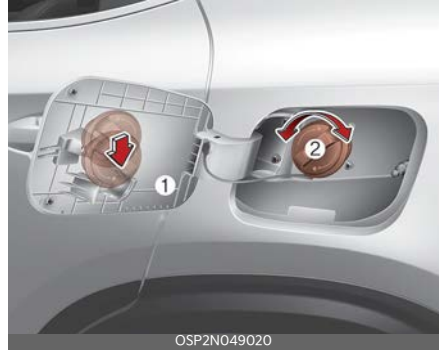

4. To remove the fuel tank cap (2), turn it counterclockwise. You may hear a hissing noise as the pressure inside the tank equalizes.
5. Place the cap on the fuel filler door.

⚠ CAUTION

Before refueling, be sure to check what type of fuel is used for your vehicle. If you put diesel fuel into a gasoline-powered vehicle or gasoline into a diesel-powered vehicle, it may affect the fuel system and cause serious damage to the vehicle.

Closing the fuel filler door

1. To install the cap, turn it clockwise until it "clicks" one time. This indicates that the cap is securely tightened.
2. Close the fuel filler door and push on it lightly gently to make sure that it is securely closed.

⚠ WARNING

Refueling

Always remove the fuel cap carefully and slowly. If the cap is venting fuel or if you hear a hissing sound, wait until the condition stops before completely removing the cap.

If pressurized fuel sprays out, it can cover your clothes or skin and subject you to the risk of fire and burns.

* NOTICE

When refueling on unlevel ground, the fuel gauge may not point to the F position. It is not a malfunction. If you move your vehicle to a level ground, the fuel gauge will move to the full position.

* NOTICE

Tighten the cap until it clicks one time, otherwise, the engine warning indicator light will appear.

Always check that the fuel cap is installed securely to prevent fuel spillage in the event of an accident.

⚠ WARNING

Fire/explosion risk

Read and follow all warnings posted at the gas station facility. Failure to follow all warnings will result in severe personal injury, severe burns or death due to fire or explosion.

⚠ WARNING

Static electricity

- Before touching the fuel nozzle, you should eliminate potentially dangerous static electricity discharge by touching another metal part of the vehicle, a safe distance away from the fuel filler neck, nozzle, or other gas source.
- Do not get back into a vehicle once you have begun refueling since you can generate static electricity by touching, rubbing or sliding against any item or fabric (polyester, satin,

nylon, etc.) capable of producing static electricity. Static electricity discharge can ignite fuel vapors resulting in rapid burning. If you must reenter the vehicle, you should once again eliminate potentially dangerous static electricity discharge by touching a metal part of the vehicle, away from the fuel filler neck, nozzle or other gasoline source.

⚠ WARNING

Portable fuel container

When using an approved portable fuel container, be sure to place the container on the ground prior to refueling. Static electricity discharge from the container can ignite fuel vapors causing a fire. Once refueling has begun, contact with the vehicle should be maintained until the filling is complete. Use only approved portable plastic fuel containers designed to carry and store gasoline.

⚠ WARNING

Cell phone fires

Do not use cellular phones while refueling. Electric current and/or electronic interference from cellular phones can potentially ignite fuel vapors causing a fire.

⚠ WARNING

Refueling & Vehicle fires

When refueling, always shut the engine off. Sparks produced by electrical components related to the engine can ignite fuel vapors causing a fire. Once refueling is complete, check to make sure the filler cap and filler door are securely closed, before starting the engine.

⚠ WARNING**Smoking**

DO NOT use matches or a lighter and DO NOT SMOKE or leave a lit cigarette in your vehicle while at a gas station especially during refueling. Automotive fuel is highly flammable and can result in fire when ignited.

Make sure to refuel your vehicle according to "Fuel requirements" on page 1-2. If the fuel filler cap requires replacement, use only a genuine Kia cap or the equivalent specified for your vehicle. An incorrect fuel filler cap can result in a serious malfunction of the fuel system or emission control system.

⚠ CAUTION**Exterior paint**

Do not spill fuel on the exterior surfaces of the vehicle. Any type of fuel spilled on painted surfaces may damage the paint.

⚠ WARNING

- Do not allow anyone that has not discharged static electricity from their body to come close to an open fuel tank.
- Do not inhale vaporized fuel.

⚠ WARNING**Risk of injury from fuel**

Fuels are poisonous and harmful to your health.

- Fuel contains substances that are harmful if inhaled.
- Do not swallow fuel or let it come into contact with skin, eyes or clothing.
- Do not inhale fuel vapors.
- Keep children away from fuel.

If you or other people come into contact with fuel, observe the following:

- Immediately rinse fuel off your skin with soap and water.
- If fuel comes into contact with your eyes, immediately rinse them thoroughly with clean water. Seek medical attention immediately.
- If you swallow fuel, seek medical attention immediately. Do not induce vomiting.
- Change immediately out of clothing that has come into contact with fuel.

*** NOTICE****Damage caused by the wrong fuel**

Fuel that does not conform to the required quality can lead to increased wear as well as damage to the engine and exhaust system. Only use the fuel recommended.

*** NOTICE****Damage caused by the wrong fuel**

Vehicles with a gasoline engine:
Even small amounts of the wrong fuel could result in damage to the fuel system, the engine and the emission control system.

*** NOTICE**

Do not use diesel to refuel vehicles with a gasoline engine.

*** NOTICE**

Do not switch on the ignition if you accidentally refuel with the wrong fuel. Otherwise, fuel can enter the fuel system. Even small amounts of the wrong fuel could result in damage to the fuel sys-

tem and the engine. Have the system serviced by an authorized Kia dealer.

* NOTICE

Do not overfill the fuel tank

Do not overfill the fuel tank; otherwise fuel may slide, causing harm to the environment and damaging the vehicle.

Sunroof (if equipped)

If your vehicle is equipped with a sunroof, you can slide or tilt your sunroof with the sunroof switch located on the overhead console.



The sunroof can only be operated when the ignition switch or the ENGINE START/STOP button is in the ON or START position. The sunroof can be operated for approximately 3 minutes after the ignition switch or the ENGINE START/STOP button is in the ACC or LOCK/OFF position. However, if the front door is open, the sunroof cannot be operated even within the 3 minutes period.

⚠ WARNING

- Be sure to operate the sunroof while the car is stationary. If you operate the sunroof while driving, it may interfere with driving and cause an accident.
- Even when leaving the vehicle for a short time, turn off the ignition and carry the key to prevent children from operating the sunroof.
- Do not sit on the roof. Sitting on a roof or lifting heavy objects can damage the sunroof.

*** NOTICE**

Do not operate the sunroof when roof bars are installed on the vehicle or when there is luggage on the on the roof.

Sunshade



Use the sunshade to block direct sunlight coming through the sunroof glass. Open or close the sunshade by hand.

*** INFORMATION**

The sunshade will open automatically when the sunroof glass moves, but the sunshade does not close automatically when the sunroof glass is closed. Also, only the sunshade cannot be closed when the sunroof glass is opened.

*** NOTICE**

Do not pull the sunshade up or down, or apply excessive force as such action may damage the sunshade or cause it to malfunction.

Tilt open/close

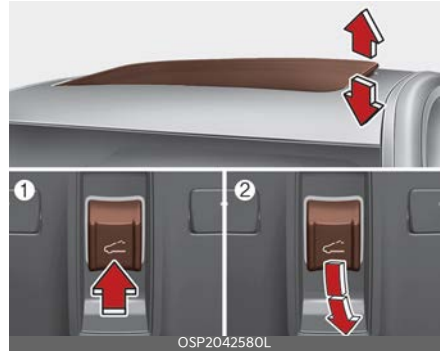

1. Tilt open
2. Tilt close

- Push the sunroof switch upward, the sunroof glass will tilt open.
- Push the sunroof switch forward when the sunroof glass is tilt opened, the sunroof glass closes.

The sunroof glass tilts open or closes while the switch is pushed.

*** INFORMATION**

The sunroof glass cannot slide open and tilt open at the same time. You cannot tilt the sunroof glass open while the sunroof glass is slide open. Also, you cannot slide the sunroof glass open while the sunroof is tilt open. Slide open or tilt open the sunroof glass when the sunroof glass is completely closed.

Slide open/close



- Push the sunroof switch rearward, the sunshade and sunroof glass will slide open. Push the sunroof switch forward, only the sunroof glass closes.
- Push the sunroof switch forward or rearward to the first detent position, the sunroof glass moves until the switch is released.
- Push the sunroof switch forward or rearward to the second detent position, the sunroof glass will operate automatically (auto slide feature). To stop the sunroof movement at any point, push the sunroof switch in any direction.
- The sunroof glass stops halfway (first detent position) before it is fully opened. To fully open the sunroof glass, push the sunroof switch rearward once more. At this time, the sunroof glass opens only while the switch is pushed.

* INFORMATION

To reduce wind noise while driving, we recommend you to drive at the recommended position (first detent position) before the maximum slide open position.

Automatic reversal



If the sunroof glass senses any obstacle while it is closing automatically, it will reverse direction then stop at a certain position. The auto reverse function may not work if an object thin or soft is caught between the sliding sunroof glass and sunroof sash.

⚠ WARNING

- Make sure heads, hands, arms or any other body parts or objects are out of the way before operating the sunroof. Body parts or objects may get caught causing injuries or vehicle damage.
- Never deliberately use your body parts to test the automatic reversal function. The sunroof glass may reverse direction, but there is a risk of injury.

* NOTICE

- Do not continue to push the sunroof switch after the sunroof is fully opened, closed, or tilted. Damage to the sunroof motor could occur.
- Continuous operations such as slide open/close, tilt open/close, etc. may cause the motor or sunroof system to malfunction.

- Regularly remove any accumulated dust on the sunroof rail.
- Dust accumulated between the sunroof and roof panel can make noise. Open the sunroof and remove dust regularly using a clean cloth.
- Do not try to open the sunroof when the temperature is below freezing or when the sunroof is covered with snow or ice. The sunroof may not work properly and may break if opened by force.
- Do not open or drive with the sunroof glass open immediately after rain or washing the vehicle. Water may wet the interior of the vehicle.
- Do not extend any luggage outside the sunroof while driving. Vehicle damage may occur if the vehicle suddenly stops.

⚠ WARNING

Do not extend your head, arms, body parts or objects outside the sunroof while driving. Injuries may occur if the vehicle suddenly stops.

Resetting the sunroof



In some circumstances resetting the sunroof operation may need to be per-

formed. Some instances where resetting the sunroof may be required include:

- When the 12-volt battery is either disconnected or discharged
- When the sunroof fuse is replaced
- If the sunroof one-touch AUTO OPEN/CLOSE operation is not functioning properly

Sunroof resetting procedure:

1. It is recommended to perform the reset procedure with the vehicle engine running. Start the vehicle in P (Park).
2. Make sure the sunroof glass is in the fully closed position. If the sunroof glass is open, push the switch forward until the sunroof glass is fully closed.
3. Release the switch when the sunroof glass is fully closed.
4. Push the switch forward until the sunroof glass moves slightly. Then release the switch.
5. Once again push and hold the sunroof switch forward until the sunroof glass slides open and close. Do not release the switch until the operation is completed. If you release the switch during operation, start the procedure again from step 2.

*** INFORMATION**

If the sunroof does not reset when the vehicle battery is disconnected or discharged, or the sunroof fuse is blown, the sunroof may not operate normally.

Sunroof open warning

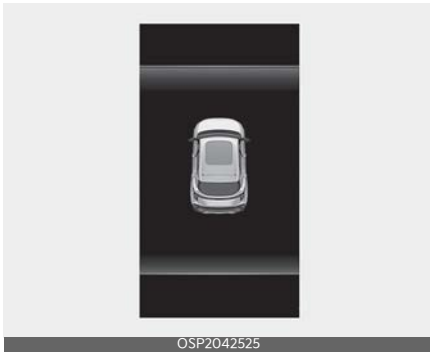

If the driver turns off the engine when the sunroof is not fully closed, the warning chime will sound for several seconds and the sunroof open warning will appear on the cluster LCD display. Close the sunroof securely when leaving your vehicle.

⚠ CAUTION

Make sure the sunroof is closed fully when leaving your vehicle. If the sunroof is left open, rain or snow may wet the interior of the vehicle. Also, leaving the sunroof open when the vehicle is unattended may invite theft.

Steering wheel

The steering wheel of this vehicle is equipped with the Electric Power Steering (EPS) system.

Electric Power Steering (EPS)

Power steering uses the motor to assist you in steering the vehicle.

If the engine is off or if the power steering system becomes inoperative, the vehicle may still be steered, but it will require increased steering effort.

The EPS is controlled by the power steering control unit which senses the steering wheel torque and vehicle speed to command the motor.

The steering effort becomes heavier as the vehicle's speed increases and becomes lighter as the vehicle's speed decreases for better control of the steering wheel.

Should you notice any change in the effort required to steer during normal vehicle operation, have the power steering checked by an authorized Kia dealer.

* NOTICE

The following symptoms may occur during normal vehicle operation:

- The EPS warning light does not illuminate.
- The steering effort is high immediately after turning the ignition switch or ENGINE START/STOP button on. This happens as the EPS system performs the diagnostics. When the diagnostics is completed, the steering effort will return to its normal condition.
- A click noise may be heard from the EPS relay after the ignition switch or ENGINE START/STOP button is

turned to the ON or LOCK/OFF position.

- A motor noise may be heard when the vehicle is at a stop or at a low driving speed.
- The steering effort increases if the steering wheel is rotated continuously when the vehicle is not in motion. However, after a few minutes, it will return to its normal conditions.
- When the charging system warning light comes on due to low voltage (when the alternator or battery do not operate normally or malfunction), the steering wheel may require increased steering effort.
- When you operate the steering wheel in low temperature, abnormal noise could occur. If temperature rises, the noise will disappear. This is a normal condition.
- When jump starting the vehicle after battery discharge, the steering wheel may not function properly. It is a temporary situation due to low battery voltage, and upon stable battery charging, the steering wheel will function normally again. Please move the steering wheel around to make sure the steering wheel is functioning properly before driving the vehicle.
- The steering effort can suddenly increase, if the operation of the EPS system is stopped to prevent serious accident when EPS control unit detects malfunction of the EPS system by self-diagnosis.

If the Electric Power Steering System does not operate normally, the warning light will illuminate on the instrument cluster. The power steering system will not operate and steering effort can

increase. Take your vehicle to an authorized Kia dealer and have the vehicle checked as soon as possible.

Tilt & telescopic steering wheel

A tilt and telescopic steering wheel allows you to adjust the steering wheel before you drive.

You can also raise it to give your legs more room when you exit and enter the vehicle.

The steering wheel should be positioned so that it is comfortable for you to drive, while permitting you to see the instrument panel warning lights and gauges.

⚠ WARNING

Steering wheel adjustment

- Never adjust the angle and height of the steering wheel while driving. You may lose steering control.
- While adjusting the steering wheel angle and height, please do not push or pull it hard since the fixture can be damaged.

Adjusting steering wheel angle and height

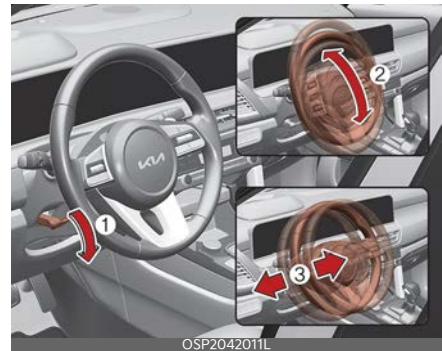

1. To change the steering wheel angle, pull down the lock release lever (1).

2. Adjust the steering wheel to the desired angle (2) and height (3).
3. Pull up the lock-release lever to lock the steering wheel in place.
4. Be sure to adjust the steering wheel to the desired position before driving.

* NOTICE

After adjustment, sometimes the lock-release lever may not lock the steering wheel.

It is not a malfunction. This occurs when two gears engage. In this case, adjust the steering wheel again and then lock the steering wheel.

Heated steering wheel (if equipped)

With the ignition switch in the ON position or the ENGINE START/STOP button in the ON position, pressing the heated steering wheel button warms the steering wheel. The indicator on the button will appear.



OSP2042012L

To turn the heated steering wheel off, press the button once again. The indicator on the button will turn off.

* NOTICE

The heated steering wheel will turn off automatically approximately 30 minutes after the heated steering wheel is turned on.

⚠ CAUTION

- Do not install any type of grip cover for the steering wheel, it may impair the function of the heated steering wheel system.
- When cleaning the heated steering wheel, do not use an organic solvent such as paint thinner, benzene, alcohol and gasoline. Doing so may damage the surface of the steering wheel.
- If the surface of the steering wheel is damaged by a sharp object, damage to the heated steering wheel components could occur.

⚠ WARNING

If the steering wheel becomes too warm, turn the system off. The heated steering wheel may cause burns even at low temperatures, especially if used for long periods of time.

Horn

To sound the horn, press the area indicated by the horn symbol on your steering wheel (see illustration).



OSP2042527

The horn will operate only when this area is pressed. Check the horn regularly to be sure it operates properly.

Mirrors

This vehicle is equipped with inside and outside rearview mirrors to provide views of objects behind the vehicle.

Inside rearview mirror

Adjust the rearview mirror so that the center view through the rear window is seen. Make this adjustment before you start driving.

Do not place objects in the rear seat or cargo area which would interfere with your vision through the rear window.

⚠ WARNING

Mirror adjustment

Do not adjust the rearview mirror while the vehicle is moving. This could result in loss of control.

*** NOTICE**

Do not modify the inside mirror in any manner, including installing a wide mirror. Doing so could result in injury during an accident or deployment of the air bag.

⚠ CAUTION

Cleaning mirror

When cleaning the mirror, use a paper towel or similar material dampened with glass cleaner. Do not spray glass cleaner directly on the mirror. It may cause the liquid cleaner to enter the mirror housing.

Day/night rearview mirror

Make this adjustment before you start driving and while the day/night lever is in the day position (1).

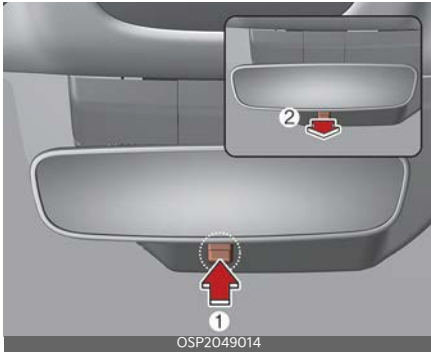

* (1): Day, (2): Night

Pull the day/night lever toward you (2) to reduce the glare from the headlights of the vehicles behind you when driving at night.

Remember that you lose some rearview clarity in the night position.

Electric Chromic Mirror (ECM) (if equipped)

The electric rearview mirror automatically controls the glare from the headlights of the vehicles behind you at night or in low-light driving conditions.

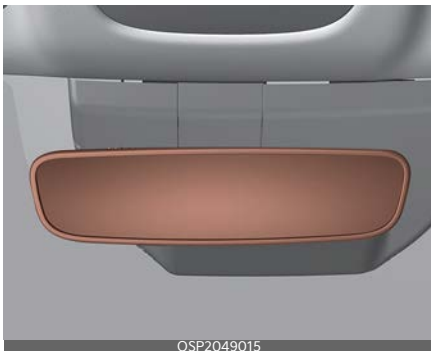

The sensor mounted in the mirror senses the light level around the vehicle, and automatically controls the headlight glare from the vehicles behind you.

When the engine is running, the glare is automatically controlled by the sensor mounted in the rearview mirror. Whenever the shift lever is shifted into reverse (R), the mirror will automatically go to the brightest setting in order to improve the drivers view behind the vehicle.

⚠ CAUTION

Cleaning mirror

When cleaning the mirror, use a paper towel or similar material dampened with glass cleaner. Do not spray glass cleaner directly on the mirror. It may cause the liquid cleaner to enter the mirror housing.

This device complies with Industry Canada licence-exempt RSS standard(s).

Operation is subject to the following two conditions:

1. This device may not cause interference, and
2. This device must accept any interference, including interference that may cause undesired operation of the device.

The transceiver has been tested and complies with FCC and Industry Canada rules. Changes or modifications not expressly approved by the party responsible for compliance could void the user's authority to operate the device.

Outside rearview mirror

Your vehicle is equipped with both left-hand and right-hand outside rearview mirrors.

Be sure to adjust the mirror angles before driving.

The mirrors can be adjusted remotely with the remote switch. The mirror

heads can be folded back to prevent damage during an automatic car wash or when passing through a narrow street.

⚠ WARNING

Estimating distances accurately

Objects reflected in the mirror are closer than they appear in the mirror. Do not estimate the distance of vehicles behind you based on what you see in the mirror, as this could increase your risk of accident. (The convex mirrors are only used for the passenger side rearview mirrors.)

If the mirror is jammed with ice, do not adjust the mirror by force. Use an approved spray de-icer (not radiator antifreeze) to release the frozen mechanism or move the vehicle to a warm place and allow the ice to melt.

⚠ WARNING

Mirror adjustment

Do not adjust or fold the outside rearview mirrors while the vehicle is moving. This could result in loss of control.

Adjusting the outside rearview mirrors

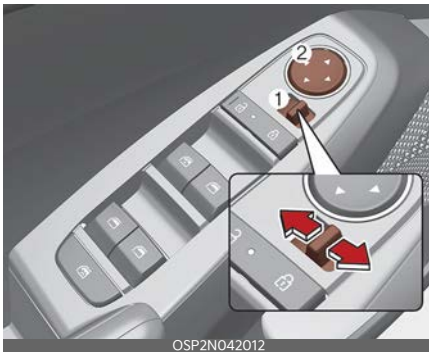

Adjusting the rearview mirrors:

1. Move the L (Front left side) or R (Front right side) switch (1) to select the rearview mirror you would like to adjust.
2. Press a corresponding point (▲) on the mirror adjustment control (2) to position the selected mirror up, down, left or right.

⚠ CAUTION

- The mirrors stop moving when they reach the maximum adjusting angles, but the motor continues to operate while the switch is pressed. Do not press the switch longer than necessary, the motor may be damaged.
- Do not attempt to adjust the outside rearview mirror by hand. Doing so may damage the parts.
- When the mirror control, press exactly "▲" (2) marking area. Otherwise, the mirror will move to unintended direction or malfunction.

Folding the outside rear view mirror

To fold the outside rearview mirror, grasp the housing of the mirror and then fold it toward the rear of the vehicle.



OSP2042016

Instrument cluster

Type A



Type B



* The actual cluster in the vehicle may differ from the illustration.

1. Speedometer
2. Tachometer
3. Fuel gauge
4. Engine coolant temperature gauge
5. LCD display
6. Warning and indicator lights

Instrument cluster (if equipped)

The Type B cluster provides two themes.

Theme A/B/C

Theme A/B/C is the basic theme of the full LCD type cluster and provides different graphic styles depending on drive mode.



OSP2042530L

Dynamic Theme

Dynamic Theme is set by the user and provides digital display. The background screen changes according to the weather and time.



OSP2042531

- Weather: clear, cloudy, rainy, snowy, foggy, lightning, clear up (7 types)
- Time: night, day, sunrise and sunset (4 types)

You can change the theme by selecting "Vehicle → Cluster → Theme Selection" on the menu.

*** NOTICE**

The information is displayed after getting information from a weather information provider via GPS. Depending on conditions of GPS reception, the information may be different from the current weather in your area.

If no information is received via GPS (e.g., not subscribed to Kia Connect service), the weather and time will be displayed as 'sunny' and 'night' on the cluster.

Adjusting instrument cluster illumination



OSP2N042084

⚠ WARNING

Never adjust the instrument cluster while driving. This could result in loss of control and lead to an accident that may cause DEATH, SERIOUS INJURY, or property damage.

The brightness of the instrument panel illumination is changed by pressing the illumination control switch ("+" or "-") when the ignition switch or ENGINE START/STOP button is ON, or the tail lights are turned on.

- If you hold the illumination control switch ("+" or "-"), the brightness will be changed continuously.



ODL3049124L

- If the brightness reaches to the maximum or minimum level, an alarm will sound.

Gauges

The gauges display various information such as the speed of the vehicle, and so on.

Speedometer

Type A



OSP2042554

Type B

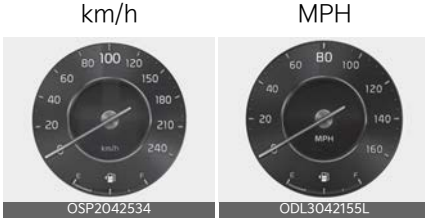

The speedometer indicates the speed of the vehicle and is calibrated in kilometers per hour (km/h) and/or miles per hour (mph).

Tachometer

Type A



Type B



The tachometer indicates the approximate number of engine revolutions per minute (rpm).

Use the tachometer to select the correct shift points and to prevent lugging and/or over-revving the engine.

CAUTION

Do not operate the engine within the tachometer's RED ZONE. This may cause severe engine damage.

Engine coolant temperature gauge

Type A



Type B



This gauge indicates the temperature of the engine coolant when the ignition switch or ENGINE START/STOP button is ON.

⚠ CAUTION

If the gauge pointer moves beyond the normal range area (between the C-H) toward the "H" position, it indicates overheating that may damage the engine. Do not continue driving with an overheated engine. If your vehicle overheats, refer to "If the engine overheats" on page 7-6.

⚠ WARNING

Never remove the radiator cap when the engine is hot. The engine coolant is under pressure and could severely burn. Wait until the engine is cool before adding coolant to the reservoir.

Fuel gauge

Type A



Type B

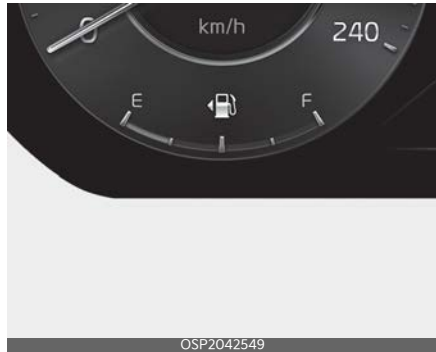

This gauge indicates the approximate amount of fuel remaining in the fuel tank.

*** NOTICE**

- The fuel tank capacity is given in "Recommended lubricants and capacities" on page 9-6.
- The fuel gauge is supplemented by a low fuel warning light, which will appear when the fuel tank is nearly empty.
- On inclines or curves, the fuel gauge pointer may fluctuate or the low fuel warning light may come on earlier than usual due to the movement of fuel in the tank.

⚠ WARNING

Fuel Gauge

Running out of fuel can expose vehicle occupants to danger.

You must stop and obtain additional fuel as soon as possible after the warning light comes on or when the gauge indicator comes close to the "E" level.

CAUTION

Avoid driving with an extremely low fuel level. Running out of fuel could cause the engine to misfire, which could damage the catalytic converter.

*** NOTICE**

The fuel display may not be accurate if the vehicle is on an incline.

Odometer

Type A



Type B



The odometer indicates the total distance that the vehicle has been driven and should be used to determine when

periodic maintenance should be performed.

- Odometer range: 0 ~ 1599999 km or 0 ~ 999999 miles

Distance to empty

Type A

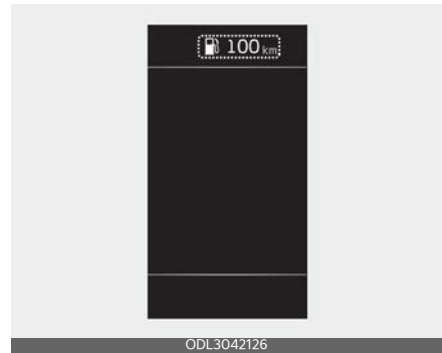

Type B



- The distance to empty is the estimated distance the vehicle can be driven with the remaining fuel.
 - Distance range: 1 ~ 9,999 km or 1 ~ 9,999 miles
- If the estimated distance is below 1 km (1 mile), the trip computer will display "---" as distance to empty.
- If the level of the remaining fuel is more than three-quarters, more than 3 liters (0.8 gallons) of fuel must be

4

refilled for the fuel gauge to change. In other cases, more than 6 liters (1.6 gallons) of fuel must be refilled for the vehicle to change the fuel gauge.

*** NOTICE**

- If the vehicle is not on level ground or the battery power has been interrupted, the distance to empty function may not operate correctly.
- The distance to empty may differ from the actual driving distance as it is an estimate of the available driving distance.
- The trip computer may not register additional fuel if less than 6 liters (1.6 gallons) of fuel are added to the vehicle.
- The fuel economy and distance to empty may vary significantly based on driving conditions, driving habits, and condition of the vehicle.

Outside temperature gauge

Type A



OSP2042533

Type B



OSP2042551

This gauge indicates the current outside air temperatures by 1 °C (1 °F).

- Temperature range: -40 °C ~ 60 °C (-40 °F ~ 140 °F)

The outside temperature on the display may not change immediately like a general thermometer to prevent the driver from being inattentive.

To change the temperature unit (from °F to °C or from °C to °F)

The temperature unit can be changed by using the "User Settings" mode of the LCD Display.

* For more details, refer to "LCD display" on page 4-76.

Fuel economy (for Type B)

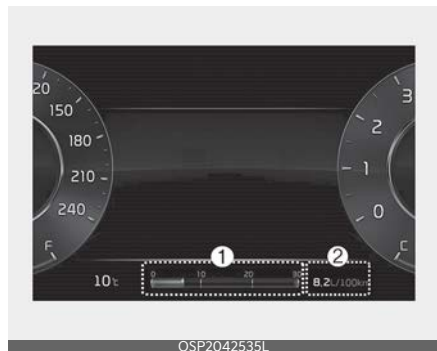

OSP2042535L

The instant fuel economy (1) and average fuel economy (2) is displayed at the bottom of the cluster.

Automatic reset

To automatically reset the average fuel economy, select 'Setup → Vehicle → Cluster → Fuel Economy Auto Reset' from the Settings menu in the infotainment system screen.

Transmission shift indicator

Transmission shift indicator displays gear information depending on your vehicle's transmission type.

Automatic Transmission/Intelligent Variable Transmission shift indicator

Type A

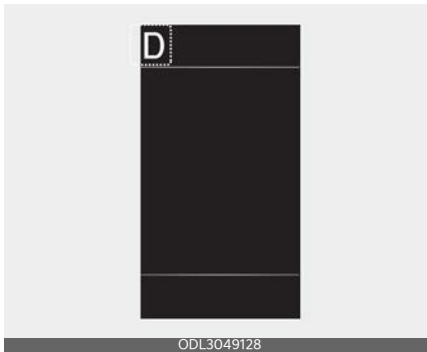

Type B



This indicator displays which Automatic Transmission/Intelligent Variable Transmission shift lever is selected.



- Park: P
- Reverse: R
- Neutral: N
- Drive: D
- Sports Mode: 1, 2, 3, 4, 5, 6, 7, 8

LCD display

The LCD display modes can be changed by using the control buttons.







LCD Display Control



1. : MODE button for changing modes
2. : MOVE switch for changing items
3. : SELECT/RESET button for setting or resetting the selected item

LCD display modes

You can switch modes by pressing the Mode button.

Mode						
	 Driving Assist	 Trip Computer	 Turn By Turn (TBT)*	 User Settings ¹	 Information	 Master warning
 Up/Down	Lane Keeping Assist/Smart Cruise Control/Lane Following Assist/Highway Driving Assist*	Drive Info	Route Guidance	Driver Assistance	Driving force distribution (AWD)*	The Master Warning mode displays warning messages related to the vehicle when one or more systems is not operating normally.
		Since Refueling	Destination Info	Cluster	Tire Pressure	
		Accumulated Info		Lights		
		Auto Stop		Door		
		Digital Speedometer*		Convenience		
		Units				
	Language					
	Reset					

The information provided may differ depending on which functions are applicable to your vehicle.

*: if equipped

* 1. for Type A cluster

*** NOTICE**

Keep the engine running when configuring the display settings to prevent the battery from discharging.

Driving Assist mode



This mode displays the state of:

- Lane Keeping Assist
- Smart Cruise Control (if equipped)
- Lane Following Assist
- Highway Driving Assist (if equipped)

* For more details, refer to each system information in "Lane Keeping Assist (LKA) (if equipped)" on page 6-28, "Smart Cruise Control (SCC) (if equipped)" on page 6-64, "Lane Following Assist (LFA)" on page 6-83, "Highway Driving Assist (HDA) (if equipped)" on page 6-87.

Trip computer mode



The trip computer mode displays information related to vehicle driving param-

eters including fuel economy, tripmeter information and total driving time.

* For more details, refer to "Trip information (trip computer)" on page 4-85.

Turn By Turn (TBT) mode (if equipped)

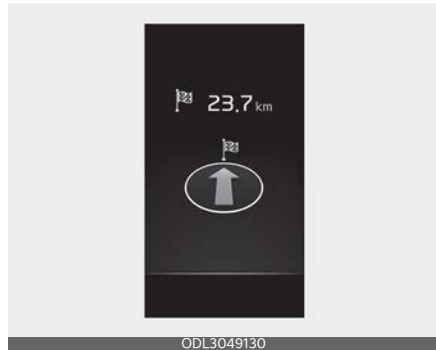

This mode displays the state of the navigation.

Information mode

Driving force distribution (AWD) (if equipped)

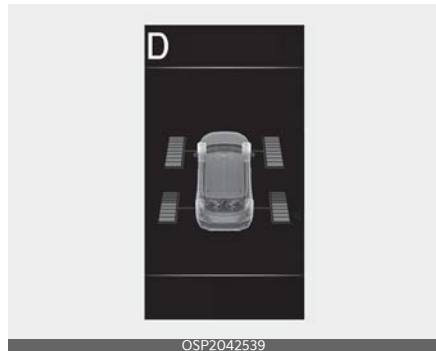

This mode displays information related to Driving force distribution.

* For more details, refer to "All Wheel Drive (AWD) system (if equipped)" on page 5-11.

Tire Pressure



This mode displays information related to Tire Pressure.

* For more details, refer to "Tire Pressure Monitoring System (TPMS)" on page 7-7.

Master warning mode

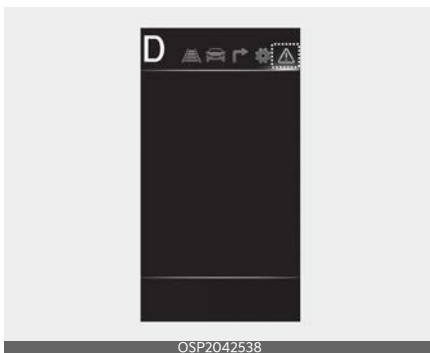

This warning light informs the driver the following situations.

- Forward Collision-Avoidance Assist malfunction*
- Forward Collision-Avoidance Assist radar blocked*

- Blind-Spot Collision-Avoidance Assist malfunction
- Blind-Spot Collision-Avoidance Assist radar blocked
- High Beam Assist malfunction*
- Smart Cruise Control malfunction*
- Smart Cruise Control radar blocked*
- LED headlamp malfunction*
- Lamp malfunction, etc.

At this time, a Master Warning icon (⚠) will appear on the LCD display.

If the warning situation is solved, the master warning light will be turned off and the Master Warning icon will disappear.

* : if equipped

User Settings mode (if equipped)

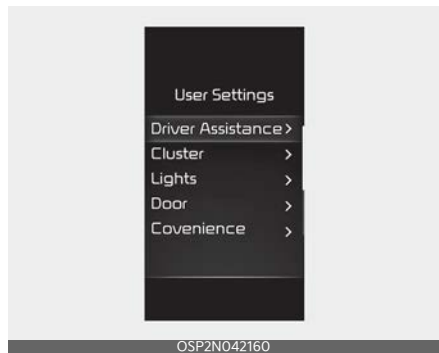

In this mode, you can change the settings of the instrument cluster, doors, lamps, etc.

1. Driver Assistance
2. Cluster
3. Lights
4. Door
5. Convenience
6. Units
7. Language

8. Reset

The information provided may differ depending on which functions are applicable to your vehicle.

1. Driver Assistance (if equipped)

Items	Explanation
Speed Limit	<ul style="list-style-type: none"> • Select Country • Speed Limit Offset • Speed Limit Assist/Speed Limit Warning/Speed Limit Information/Off <p>To select the function.</p> <p>* For more details, refer to "Intelligent Speed Limit Assist (ISLA) (if equipped)" on page 6-51.</p>
Warning Volume	<ul style="list-style-type: none"> • High/Medium/Low <p>To select the Warning Volume.</p>
Driver Attention Warning	<ul style="list-style-type: none"> • Leading Vehicle Departure Alert <p>To select the function.</p> <p>* For more details, refer to "Driver Attention Warning (DAW) (if equipped)" on page 6-56.</p>
Driving Safety	<ul style="list-style-type: none"> • Forward Safety • Forward Safety Warning Timing - Normal/Late <p>To select the function.</p> <p>* For more details, refer to "Forward Collision-Avoidance Assist (FCA) (Front view camera only) (if equipped)" on page 6-4 or "Forward Collision-Avoidance Assist (FCA) (Sensor fusion) (if equipped)" on page 6-15.</p> <ul style="list-style-type: none"> • Lane Safety <p>To select the function.</p> <p>* For more details, refer to "Lane Keeping Assist (LKA) (if equipped)" on page 6-28.</p> <ul style="list-style-type: none"> • Blind-Spot Safety <p>To select the function.</p> <p>* For more details, refer to "Blind-Spot Collision-Avoidance Assist (BCA) (if equipped)" on page 6-35.</p> <ul style="list-style-type: none"> • Safe Exit <p>To select the function.</p> <p>* For more details, refer to "Safe Exit Warning (SEW) (if equipped)" on page 6-44.</p>
Parking Safety	<ul style="list-style-type: none"> • Rear Cross-Traffic Safety <p>To select the function.</p> <p>* For more details, refer to "Rear Cross-Traffic Collision-Avoidance Assist (RCCA) (if equipped)" on page 6-97.</p>

* The information provided may differ depending on which systems are applicable to your vehicle.

2. Cluster (if equipped)

Items	Explanation
Cluster Theme	<ul style="list-style-type: none"> Link to Drive Mode/Theme A/Theme B/Theme C To select the theme of the instrument cluster.
Wiper/Lights Display	To activate or deactivate the wiper/lights display.
Icy Road Warning	To activate or deactivate the icy road warning.
Welcome Sound	To activate or deactivate the welcome sound.

* The information provided may differ depending on which systems are applicable to your vehicle.

3. Lights (if equipped)

Items	Explanation
Illumination	<ul style="list-style-type: none"> Level 1~20 To select the brightness for the instrument panel illumination.
One Touch Turn Signal	<ul style="list-style-type: none"> Off: The one touch turn signal function will be deactivated. 3, 5, 7 flashes: The turn signal indicator will blink 3, 5, or 7 times when the turn signal lever is moved slightly. * For more details, refer to "Lighting" on page 4-104.
Headlight Delay	If this item is checked, the headlight escort function will be activated.
High Beam Assist	If this item is checked, High Beam Assist will be activated. * For more details, refer to "High Beam Assist (HBA) (if equipped)" on page 4-108.

* The information provided may differ depending on which functions are applicable to your vehicle.

4. Door (if equipped)

Items	Explanation
Auto Lock	<ul style="list-style-type: none"> Enable on Shift : All doors will be automatically locked if the vehicle is shifted from the P (Park) position to the R (Reverse), N (Neutral), or D (Drive) position (with engine ON, it is activated). Enable on speed: All doors will be automatically locked when the vehicle speed exceeds 15 km/h (9.3 mph).
Auto Unlock	<ul style="list-style-type: none"> On shift to P : All doors will be automatically unlocked if the gear is shifted to the P (Park) position (with engine ON, it is activated). On key out/Vehicle Off (if equipped): All doors will be automatically unlocked when the ENGINE START/STOP button is set to the OFF position or the ignition key is removed from the ignition switch. Off: The auto door unlock operation will be canceled.

Items	Explanation
2 Press Unlock	To activate or deactivate the 2 press unlock function. Press the door unlock button once to unlock the driver's door, and press the button once more within 4 seconds to unlock the rest of the doors.
Horn Feedback	To activate or deactivate the horn feedback when door is locked with the folding key.
Power Liftgate	To activate or deactivate the power liftgate. * For more details, refer to "Power liftgate (if equipped)" on page 4-40.
Power Liftgate Opening Speed	<ul style="list-style-type: none"> Fast/Normal To adjust the power liftgate opening speed. * For more details, refer to "Power liftgate (if equipped)" on page 4-40.
Power Liftgate Opening Height	<ul style="list-style-type: none"> Full Open/Level 3, 2, 1/User Height Setting To adjust the power liftgate opening height. * For more details, refer to "Power liftgate (if equipped)" on page 4-40.
Smart Liftgate	To activate or deactivate the smart liftgate. * For more details, refer to "Smart liftgate (if equipped)" on page 4-45.
Remote Window Control	To activate or deactivate the remote window control. * For more details, refer to "Remote window opening system (if equipped)" on page 4-52.

* The information provided may differ depending on which systems are applicable to your vehicle.

5. Convenience (if equipped)

Items	Explanation
Rear Occupant Alert	If this item is checked, the Rear Occupant Alert (ROA) display will be activated. * For more details, refer to "Rear Occupant Alert (ROA) system" on page 4-35.
Service Interval	<ul style="list-style-type: none"> Enable Service Interval/Adjust Interval/Reset
Oil Change Reminder	If this item checked, the oil change reminder will be activated.
Auto Rear Wiper (in R)	If this item checked, the auto rear wiper will be activated.
Vehicle Auto-Shut Off	<ul style="list-style-type: none"> 60min/30min: To set the vehicle auto shut-off timer. Off: The vehicle auto-shut off operation will be canceled. * For more details, refer to "Vehicle Auto Shut-off system (if equipped)" on page 5-10.

* The information provided may differ depending on which functions are applicable to your vehicle.

6. Units (if equipped)

Items	Explanation
Speed Unit	<ul style="list-style-type: none"> km/h or MPH To select the Speedometer unit.
Temperature Unit	<ul style="list-style-type: none"> °C/°F To select the Temperature unit.
Fuel Economy Unit	<ul style="list-style-type: none"> L/100km, km/L or US gallon, UK gallon To select the Fuel economy unit. * For more details, refer to "Trip information (trip computer)" on page 4-85.
Tire Pressure Unit	<ul style="list-style-type: none"> kPa, psi, bar To select the Tire Pressure Unit

* The information provided may differ depending on which functions are applicable to your vehicle.

7. Language

Items	Explanation
Language	To select language.

8. Reset

Items	Explanation
Reset	You can reset the menus in the User Settings mode. All menus in the User Settings mode are reset to factory settings, except language and service interval.

Trip information (trip computer)

The trip computer is a microcomputer-controlled driver information system that displays information related to driving.

*** NOTICE**

Some driving information stored in the trip computer resets if the battery is disconnected.

Trip Modes

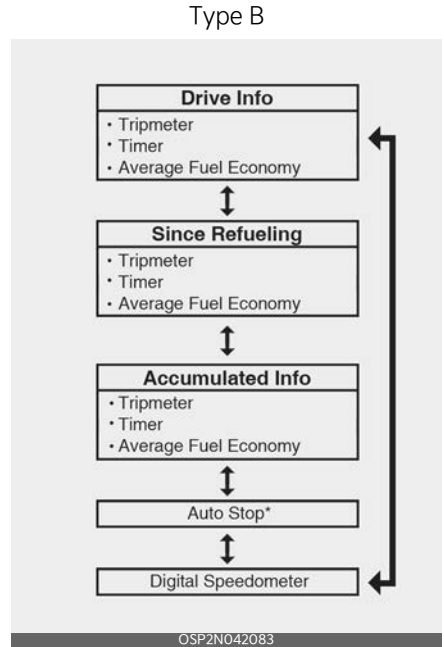
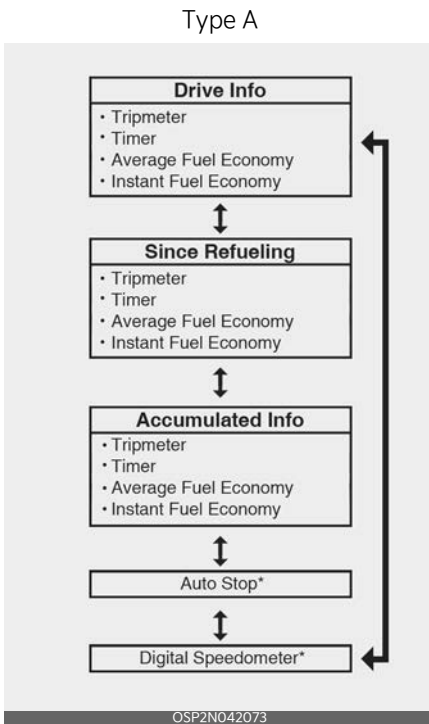

*: if equipped

To change the trip mode, scroll the toggle the switch (∧ / ∨) on the steering wheel.

Drive Info mode

This display shows the trip distance (1), the total driving time (2), the average fuel efficiency (3), and the instant fuel economy (4, if equipped) information once per one ignition cycle.

4

Type A



Type B



- Fuel efficiency is calculated after the vehicle has run for more than 300 meters (0.2 miles).
- If opening the driver's door after turning off the engine or 3 minutes passes after restarting the engine, Driving Information is reset.
- If you press "OK" button for more than 1 second after the Driving Information is displayed, the information will be reset.
- If the engine is running, even when the vehicle is not in motion, the information will be accumulated.

Since Refueling mode

This display shows the trip distance (1), the total driving time (2), the average fuel efficiency (3), and the instant fuel economy (4, if equipped) after the vehicle has been refueled.

Type A



Type B

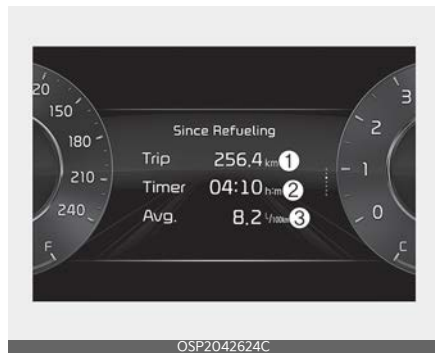

- Fuel efficiency is calculated after the vehicle has run for more than 300 meters (0.2 miles).
- After refueling more than 6 liters (1.6 gallons) and driving over 1 km/h (1 mph), the Since Refueling will reset to default automatically.
- If you press "OK" button for more than 1 second after the Driving Information

is displayed, the information will be reset.

- If the engine is running, even when the vehicle is not in motion, the information will be accumulated.

Accumulated driving information mode

This display shows the accumulated trip distance (1), the total driving time (2), the average fuel efficiency (3), and the instant fuel economy (4, if equipped).

Type A



Type B



- Accumulated information is calculated after the vehicle has run for more than 0.2 miles (300 meters).

- If you press "OK" button for more than 1 second after the Cumulative Information is displayed, the information will be reset.
- If the engine is running, even when the vehicle is not in motion, the information will be accumulated.

Auto Stop timer



This mode displays the elapsed time of Auto Stop by "Idle stop and go system". For more details, refer to "Idle Stop and Go (ISG) system (if equipped)" on page 5-47.

Digital speedometer

Type A



4

Type B



This mode displays the current speed of the vehicle.

For Type A cluster

This mode displays the current speed of the vehicle in km/h when the unit of speedometer is selected in MPH. This mode is not displayed when km/h is selected for the speedometer units.

Service interval

This reminds you of scheduled maintenance information.

*** NOTICE**

To use the service interval menu, consult an authorized Kia dealer.

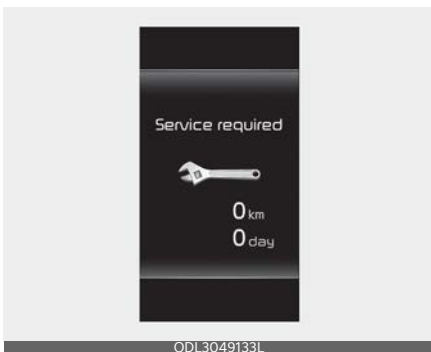

Service in

It calculates and displays when you need a scheduled maintenance service (mileage or days).

If the remaining mileage or time reaches 1,500 km (900 miles) or 30 days, "Service in" message is displayed for several seconds each time you set the ignition switch or ENGINE START/STOP button to the ON position.

Service required

If you do not have your vehicle serviced according to the already inputted service interval, "Service required" message is displayed for several seconds each time you set the ignition switch or ENGINE START/STOP button to the ON position.

To reset the service interval to the mileage and days you inputted before:

- Press the OK button (Reset) for more than 1 second.

*** NOTICE**

If any of the following conditions occurs, the mileage and days may be incorrect.

- The battery cable is disconnected.
- The battery is discharged.

LCD display messages

Door, hood, liftgate open

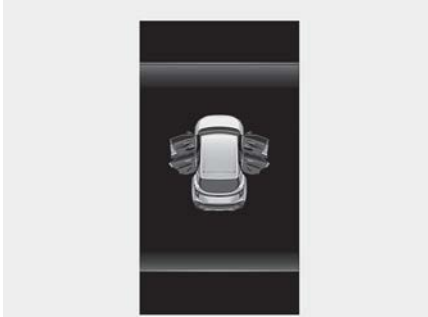

OSP2042487

- This warning is displayed indicating which door, hood or liftgate is open.

* NOTICE

Before driving the vehicle, you should confirm that the door/hood/liftgate is fully closed. Also, check there is no door/hood/liftgate open warning light or message displayed on the instrument cluster.

Sunroof open (if equipped)

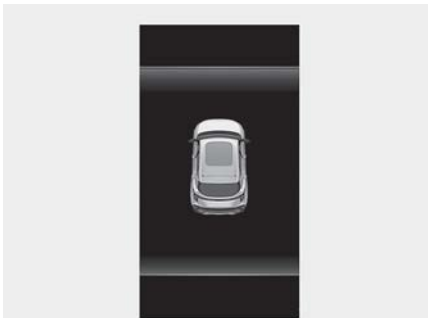

OSP2042525

This warning is displayed if you turn off the engine when the sunroof is open.

Lights mode



ODL3049164L

This indicator displays which exterior light is selected using the lighting control.

You can activate or deactivate Wiper/Lights Display function from the User Settings mode in the cluster LCD display or the Settings in the Infotainment system screen.

Wiper mode



ODL3049166L

This indicator displays which wiper speed is selected using the wiper control.

You can activate or deactivate Wiper/Lights Display function from the User Settings mode in the cluster LCD display

or the Settings in the Infotainment system screen.

Low washer fluid

- This warning message illuminates when the washer fluid reservoir is nearly empty.
- It means that you should refill the washer fluid.

Engine Overheated

- This warning message illuminates when the engine coolant temperature is above 120 °C (248 °F). This means that the engine is overheated and may be damaged.

* If your vehicle is overheated, refer to "If the engine overheats" on page 7-6.

Low engine oil

- This warning message illuminates when the engine oil level is insufficient.
- Refill the engine oil.

* For more details, refer to "Engine oil and filter" on page 8-20.

WARNING

When the engine oil level warning light occurs, it is necessary to check whether maintenance schedule (Engine oil replacement) in owner's manual has been followed before replenishing the oil, and if not followed, the engine oil must be replaced first.

Engine oil change due soon. Reset oil life after oil change (for Smartstream G1.6 T-GDi)

- This warning message illuminates when the remaining engine oil life reaches 5% or below.
- Replace engine oil from an authorized Kia dealer. After that, select 'Convenience → Oil Change Reminder' from the User Settings menu on the cluster or 'Vehicle → Cluster → Oil Change Reminder' from Setup menu on the infotainment system screen to reset the remaining oil life.

* For more details, refer to "Engine oil and filter" on page 8-20.

INFORMATION

The infotainment system may change after software updates. For more information, refer to the user's manual provided in the infotainment system and the quick reference guide.

Engine oil change due now. Reset oil life after oil change (for Smartstream G1.6 T-GDi)

- This warning message illuminates when the remaining engine oil life reaches 1% or below.
- Replace engine oil immediately from an authorized Kia dealer. After that, select 'Convenience → Oil Change Reminder' from the User Settings menu on the cluster or 'Vehicle → Cluster → Oil Change Reminder' from Setup menu on the infotainment system screen to reset the remaining oil life.

* For more details, refer to "Engine oil and filter" on page 8-20.

* INFORMATION

The infotainment system may change after software updates. For more information, refer to the user's manual provided in the infotainment system and the quick reference guide.

Shift to P (for smart key system)

- This warning message illuminates if you try to turn off the engine without the gear in P (Park) position.
- At this time, the ENGINE START/STOP button turns to the ACC position.

Low key battery (for smart key system)

- This warning message illuminates if the battery of the smart key is discharged when the ENGINE START/STOP button changes to the OFF position.

Press START button while turning wheel (for smart key system)

- This warning message illuminates if the steering wheel does not unlock normally when the ENGINE START/STOP button is pressed.
- It means that you should press the ENGINE START/STOP button while turning the steering wheel right and left.

Key not in vehicle (for smart key system)

- This warning message illuminates if the smart key is not in the vehicle when you press the ENGINE START/STOP button.

- It means that you should always have the smart key with you.

Key not detected (for smart key system)

- This warning message illuminates if the smart key is not detected when you press the ENGINE START/STOP button.

Shift to P or N to start engine (for smart key system)

- This warning message illuminates if you try to start the engine with the shift lever not in the P (Park) or N (Neutral) position.

Press brake pedal to start engine (for smart key system)

- This warning message illuminates if the ENGINE START/STOP button changes to the ACC position twice by pressing the button repeatedly without depressing the brake pedal.
- It means that you should depress the brake pedal to start the engine.

Battery discharging due to external electrical devices (if equipped)

The vehicle can detect self-discharge of the battery due to over-current that is generated by unauthorized electrical devices such as dashboard camera (dash cam) mounting during parking. Please note that functions such as Idle Stop and Go (ISG) are limited and battery discharge problems may occur. If the warning continues even after external electrical devices are removed,

have your vehicle inspected by an authorized Kia dealer.

Press START button again (for smart key system)

- This warning message illuminates if you cannot operate the ENGINE START/STOP button when there is a problem with the ENGINE START/STOP button system.
- It means that you could start the engine by pressing the ENGINE START/STOP button once more.
- If the warning illuminates each time you press the ENGINE START/STOP button, have the vehicle inspected by an authorized Kia dealer.

Press START button with key (for smart key system)

- This warning message illuminates if you press the ENGINE START/STOP button while the warning message "Key not detected" is illuminating.
- At this time, the immobilizer indicator light blinks.

Check BRAKE SWITCH fuse (for smart key system)

- This warning message illuminates if the brake switch fuse is disconnected.
- It means that you should replace the fuse with a new one. If that is not possible, you can start the engine by pressing the ENGINE START/STOP button for 10 seconds in the ACC position.

Warning and indicator lights

The warning light and indicator light indicate a situation where the driver should be careful and whether the various functions are activated.

Warning lights

The warning light indicates situations that require the driver to pay attention.

* NOTICE

Warning lights

Make sure that all warning lights are OFF after starting the engine. If any light is still ON, this indicates a situation that needs attention.

Air bag warning light

This warning light appears:

- Once you set the ignition switch or ENGINE START/STOP button to the ON position.
 - It appears for approximately 6 seconds and then goes off.
- When there is a malfunction with the SRS.

In this case, have the vehicle inspected by an authorized Kia dealer.

- * For more details, refer to "Air bag - advanced Supplemental Restraint System" on page 3-34.

Seat belt warning light

This warning light informs the driver that the seat belt is not fastened.

- * For more details, refer to "Seat belts" on page 3-16.

Parking brake & brake fluid warning light

This warning light appears:

- Once you set the ignition switch or ENGINE START/STOP button to the ON position.
 - It appears for approximately 3 seconds.
 - It remains on if the parking brake is applied.
- When the parking brake is applied.
- When the brake fluid level in the reservoir is low.
 - If the warning light appears with the parking brake released, it indicates the brake fluid level in reservoir is low.

If the brake fluid level in the reservoir is low:

1. Drive carefully to the nearest safe location and stop your vehicle.
2. With the engine stopped, check the brake fluid level immediately and add fluid as required (For more details, refer to "Brake fluid" on page 8-25). Then check all brake components for fluid leaks. If any leak on the brake system is still found, the warning light remains on, or the brakes do not operate properly, do not drive the vehicle.

In this case, have the vehicle towed to an authorized Kia dealer.

Dual-diagonal braking system

Your vehicle is equipped with dual-diagonal braking systems. This means you still have braking on two wheels even if one of the dual systems should fail.

With only one of the dual systems working, more than normal pedal travel and greater pedal pressure are required to stop the vehicle.

Also, the vehicle will not stop in as short a distance with only a portion of the brake system working.

If the brakes fail while you are driving, shift to a lower gear for additional engine braking and stop the vehicle as soon as it is safe to do so.

WARNING

Parking Brake & Brake Fluid Warning Light

Driving the vehicle with a warning light ON is dangerous. If the Parking Brake & Brake Fluid Warning Light appears with the parking brake released, it indicates that the brake fluid level is low.

In this case, have the vehicle inspected by an authorized Kia dealer.

Anti-lock Brake System (ABS) warning light

This warning light appears:

- Once you set the ignition switch or ENGINE START/STOP button to the ON position.
 - It appears for approximately 3 seconds and then goes off.
- When there is a malfunction with the ABS (The normal braking system will still be operational without the assistance of the anti-lock brake system).

In this case, have the vehicle inspected by an authorized Kia dealer.

Electronic Brake Force Distribution (EBD) system warning light



These two warning lights appear at the same time while driving:

- When the ABS and regular brake system may not work normally.

In this case, have the vehicle inspected by an authorized Kia dealer.

⚠ WARNING

Electronic Brake Force Distribution (EBD) System Warning Light

When both ABS and Parking Brake & Brake Fluid Warning Lights are on, the brake system will not work normally and you may experience an unexpected and dangerous situation during sudden braking.

In this case, avoid high speed driving and abrupt braking.

Have the vehicle inspected by an authorized Kia dealer as soon as possible.

*** NOTICE**

Electronic Brake Force Distribution (EBD) System Warning Light

When the ABS Warning Light is on or both ABS and Parking Brake & Brake Fluid Warning Lights are on, the speedometer, odometer, or tripmeter may not work. Also, the MDPS Warning Light may appear and the steering effort may increase or decrease.

In this case, have the vehicle inspected by an authorized Kia dealer.

Electronic Parking Brake (EPB) warning light  (if equipped)

This warning light appears:

- Once you set the ENGINE START/STOP button to the ON position.
 - It appears for approximately 3 seconds and then goes off.
- When there is a malfunction with the EPB.

In this case, have the vehicle inspected by an authorized Kia dealer.

* For more details, refer to "Electronic Parking Brake (EPB) (if equipped)" on page 5-34.

*** NOTICE**

Electronic Parking Brake (EPB) Warning Light

The Electronic Parking Brake (EPB) Warning Light may appear when the Electronic Stability Control (ESC) Indicator Light comes on to indicate that the ESC is not working properly (This does not indicate malfunction of the EPB).

Motor Driven Power Steering (MDPS) warning light 

This warning light appears:

- Once you set the ignition switch or ENGINE START/STOP button to the ON position.
 - It appears for approximately 3 seconds and then goes off.
- When there is a malfunction with the MDPS.

In this case, have the vehicle inspected by an authorized Kia dealer.

Charging system warning light



This warning light appears:

- When there is a malfunction with either the alternator or electrical charging system.

If there is a malfunction with either the alternator or electrical charging system:

1. Drive carefully to the nearest safe location and stop your vehicle.
2. Turn the engine off and check the alternator drive belt for looseness or breakage.
In this case, have the vehicle inspected by an authorized Kia dealer.

Malfunction Indicator Lamp (MIL)



This warning light appears:

- When you set the ignition switch or the ENGINE START/STOP button to the ON position.
 - The malfunction indicator light appears for about 3 seconds and then goes off.
- Whenever there is a malfunction with either the emission control system or the engine or the vehicle powertrain.
In this occurs, have the vehicle inspected by an authorized Kia dealer.

CAUTION

Malfunction Indicator Lamp (MIL)
Driving with the Malfunction Indicator Lamp (MIL) on may cause damage to

the emission control system which could affect drivability and/or fuel economy.

CAUTION

For Smartstream G1.6 T-GDi

If the enhanced engine protection system becomes activated due to lack of engine oil, engine power will be limited. If such condition continues repeatedly, the Malfunction Indicator Lamp will appear.

CAUTION

If the Malfunction Indicator Lamp (MIL) appears, potential catalytic converter damage is possible which could result in loss of engine power. In this case, have the vehicle inspected by an authorized Kia dealer.

Engine oil pressure warning light



This warning light appears:

- When the engine oil pressure is low.
- Drive carefully to the nearest safe location and stop your vehicle.
- Turn the engine off and check the engine oil level (For more details, refer to "Engine oil and filter" on page 8-20). If the level is low, add oil as required.
- If the warning light remains on after adding oil or if oil is not available, have the vehicle inspected by an authorized Kia dealer as soon as possible. Continued driving with the warning light on may cause engine failure.

* NOTICE

- When the engine oil pressure decreases due to insufficient engine oil, etc., the Engine Oil Pressure warning light will appear.
- For Smartstream G1.6 T-GDi, the enhanced engine protection system which limits engine power will be activated. When the engine oil pressure is restored, the engine oil pressure warning light and the enhanced engine protection system will turn off after the engine is restarted.

Low fuel level warning light

This warning light appears:

- When the fuel tank is nearly empty.

If the fuel tank is nearly empty:

- Add fuel as soon as possible.

▲ CAUTION

Low Fuel Level

Driving with the Low Fuel Level warning light on or with the fuel level below "E" can cause the engine to misfire.

Master warning light

This warning light appears:

- This warning light informs the driver the following situations
 - Forward Collision-Avoidance Assist malfunction*
 - Forward Collision-Avoidance Assist radar blocked*

- Blind-Spot Collision-Avoidance Assist malfunction
- Blind-Spot Collision-Avoidance Assist radar blocked
- High Beam Assist malfunction*
- Smart Cruise Control malfunction*
- Smart Cruise Control radar blocked*
- LED headlamp malfunction*
- Lamp malfunction, etc.

To identify the details of the warning look at the LCD display.

If the warning situation is solved, the master warning light will turn off.

*: if equipped

Low Tire Pressure warning light



This warning light appears:

- Once you set the ignition switch or ENGINE START/STOP button to the ON position.
 - It appears for approximately 3 seconds and then goes off.
- When one or more of your tires are significantly under inflated. (The location of the underinflated tires are displayed on the LCD display).

* For more details, refer to "Tire Pressure Monitoring System (TPMS)" on page 7-7.

This warning light remains on after blinking for approximately 70 seconds or repeats blinking on and off at the intervals of approximately 3 seconds:

- When there is a malfunction with the TPMS.

In this case, have the vehicle inspected by an authorized Kia dealer as soon as possible.

- * For more details, refer to "Tire Pressure Monitoring System (TPMS)" on page 7-7.

WARNING

Low tire pressure

- Significantly low tire pressure makes the vehicle unstable and can contribute to loss of vehicle control and increased braking distances.
- Continued driving on low pressure tires will cause the tires to overheat and fail.

WARNING

Safe Stopping

- The TPMS cannot alert you to severe and sudden tire damage caused by external factors.
- If you notice any vehicle instability, immediately take your foot off the accelerator pedal, apply the brakes gradually with light force, and slowly move to a safe position off the road.

LED headlamp warning light (if equipped)

This warning light appears:

- When there is a malfunction with the LED headlamp.

In this case, have the vehicle inspected by an authorized Kia dealer.

Forward Safety warning light (if equipped)

This warning light appears:

- Yellow:
 - When you set the ignition switch or ENGINE START/STOP button to the ON position, it appears for approximately 3 seconds and then goes off.
 - When Forward Collision-Avoidance Assist is Off/disable/malfunction. In this case, have the vehicle inspected by an authorized Kia dealer.
- Red:
 - When Forward Collision-Avoidance Assist is operating, it appears blinking.

- * For more details, refer to "Forward Collision-Avoidance Assist (FCA) (Front view camera only) (if equipped)" on page 6-4 or "Forward Collision-Avoidance Assist (FCA) (Sensor fusion) (if equipped)" on page 6-15.

Icy Road warning light (if equipped)

- This warning light is to warn the driver the road may be icy.
- When the temperature on the outside temperature gauge is approximately below 4 °C (39 °F), the Icy Road Warning Light and Outside Temperature Gauge blinks and then appears. Also, the warning chime sounds 1 time.

*** NOTICE**

If the icy road warning light appears while driving, you should drive more attentively and safely, refraining from over-speeding, rapid acceleration, sudden braking or sharp turning, etc.

Indicator lights

Electronic stability control (ESC) indicator light 

This indicator light appears:

- Once you set the ignition switch or ENGINE START/STOP button to the ON position.
 - It appears for approximately 3 seconds and then goes off.
- When there is a malfunction with the ESC system.
In this case, have the vehicle inspected by an authorized Kia dealer.

This indicator light blinks:

- While the ESC is operating.
- * For more details, refer to "Electronic Stability Control (ESC) system" on page 5-40.

Electronic stability control (ESC) OFF indicator light 

This indicator light appears:

- Once you set the ignition switch or ENGINE START/STOP button to the ON position.
 - It appears for approximately 3 seconds and then goes off.

- When you deactivate the ESC system by pressing the ESC OFF button.
- * For more details, refer to "Electronic Stability Control (ESC) system" on page 5-40.

Immobilizer indicator light (with-out smart key) 

This indicator light appears:

- When the vehicle detects the immobilizer in your key properly while the ignition switch is ON.
 - At this time, you can start the engine.
 - The indicator light goes off after starting the engine.

This indicator light blinks:

- When there is a malfunction with the immobilizer system.
In this case, have the vehicle inspected by an authorized Kia dealer.

Immobilizer indicator light (with smart key) 

This indicator light appears for up to 30 seconds:

- When the vehicle detects the smart key in the vehicle properly while the ENGINE START/STOP button is ACC or ON.
 - At this time, you can start the engine.
 - The indicator light goes off after starting the engine.

This indicator light blinks for a few seconds:

- When the smart key is not in the vehicle.
 - At this time, you can not start the engine.

This indicator light appears for 2 seconds and goes off:

- When the vehicle can not detect the smart key which is in the vehicle while the ENGINE START/STOP button is ON.

In this case, have the vehicle inspected by an authorized Kia dealer.

This indicator light blinks:

- When the battery of the smart key is weak.
 - At this time, you can not start the engine. However, you can start the engine if you press the ENGINE START/STOP button with the smart key. (For more details, refer to "ENGINE START/STOP button (if equipped)" on page 5-7).
- When there is a malfunction with the immobilizer system.

In this case, have the vehicle inspected by an authorized Kia dealer.

Auto stop indicator light **This indicator light appears:**

- When the engine enters the Idle Stop mode of the Idle Stop and Go (ISG) system.
- When the automatic starting occurs, the auto stop indicator on the cluster will blink for 5 seconds.

* For more details, refer to "Idle Stop and Go (ISG) system (if equipped)" on page 5-47.

*** NOTICE**

When the engine automatically starts by the ISG system, warning lights (ABS, ESC, ESC OFF, MDPS or Parking brake warning light) may turn on for a few seconds.

This happens because of the low battery voltage. It does not mean the system is malfunctioning.

Turn signal indicator light **This indicator light blinks:**

- When you turn the turn signal light on.
- If any of the following occurs, there may be a malfunction with the turn signal system. In this case, have the vehicle inspected by an authorized Kia dealer.
 - The indicator light does not blink but appears.
 - The indicator light blinks more rapidly.
 - The indicator light does not appear at all.

Low beam indicator light  (if equipped)**This indicator light appears:**

- When the headlights are on.

High beam indicator light

This indicator light appears:

- When the headlights are on and in the high beam position.
- When the turn signal lever is pulled into the Flash-to-Pass position.

High Beam Assist indicator light

(if equipped)

This indicator light appears:

- When the high beam is on with the light switch in the AUTO light position.
- If your vehicle detects oncoming or preceding vehicles, High Beam Assist will switch the high beam to low beam automatically.

* For more details, refer to "High Beam Assist (HBA) (if equipped)" on page 4-108.

Lane Safety indicator light

This indicator light appears:

- Green: When Lane Keeping Assist operating conditions are satisfied.
- Gray: When Lane Keeping Assist operating conditions are not satisfied.
- Yellow: Whenever there is a malfunction with Lane Keeping Assist.

In this case, have the vehicle inspected by an authorized Kia dealer.

* For more details, refer to "Lane Keeping Assist (LKA) (if equipped)" on page 6-28.

Light ON indicator light

This indicator light appears:

- When the tail lights or headlights are on.

Front fog indicator light

This indicator light appears:

- When the front fog lights are on.

Cruise indicator light CRUISE (if equipped)

This indicator light appears:

- When Cruise Control is enabled.
- * For more details, refer to "Cruise Control (CC) (if equipped)" on page 6-61.

AUTO HOLD indicator light

(AUTO HOLD) (if equipped)

This indicator light appears:

- White: When you activate the auto hold system by pressing the AUTO HOLD button.
- Green: When you stop the vehicle completely by depressing the brake pedal with the auto hold system activated.
- Yellow: When there is a malfunction with the auto hold system.

In this case, have your vehicle inspected by an authorized Kia dealer.

* For more details, refer to "AUTO HOLD (if equipped)" on page 5-37.

SPORT mode indicator light**SPORT****This indicator light appears:**

- When you select "SPORT" mode as drive mode.
- * For more details, refer to "Drive mode integrated control system" on page 5-50.

SMART mode indicator light**SMART****This indicator light appears:**

- When you select "SAMRT" mode as drive mode.
- * For more details, refer to "Drive mode integrated control system" on page 5-50.

Downhill Brake Control (DBC)**Indicator Light** **This indicator light appears:**

- When you set the ignition switch or ENGINE START/STOP button to the ON position.
 - It appears for approximately 3 seconds and then goes off.
- When you activate the system by pressing the DBC button.

This indicator light blinks:

- When the DBC is operating.

This indicator light appears yellow:

- When there is a malfunction with the DBC system.

If this occurs, have your vehicle inspected by an authorized Kia dealer.

- * For more details, refer to "Downhill Brake Control (DBC)" on page 5-44.

All Wheel Drive (AWD) LOCK indicator light  (if equipped)**This indicator light appears:**

- When you select AWD lock mode by pressing the AWD LOCK button.
 - The AWD lock mode is to increase the drive power when driving on wet pavement, snow covered roads and/or off-road.

*** NOTICE****AWD Lock Mode**

Do not use AWD LOCK mode on dry paved roads or highway, it can cause noise, vibration or damage of AWD related parts.

- * For more details, refer to "All Wheel Drive (AWD) system (if equipped)" on page 5-11.

Infotainment system vehicle settings (if equipped)



OSP2N042151

Vehicle Settings in the infotainment system provide user options for the settings including door lock/unlock, convenience features, and driver assistance.

⚠ WARNING

Do not operate the 'Vehicle Settings' while driving. This may cause distraction resulting in an accident.

Setting your vehicle



OSP2N042152

[A]: SETUP

1. Press 'SETUP' button on the head unit of the infotainment system.



OSP2N042153

[A]: Vehicle

2. Select 'Vehicle' and change the settings for features.

Vehicle Settings menu

1. Driver Assistance
2. Head-Up Display
3. Cluster
4. Climate
5. Seat
6. Lights
7. Door
8. Digital Key
9. Convenience

*** NOTICE**

The information provided may differ depending on which features are applicable to your vehicle.

*** INFORMATION**

The infotainment system may change after software updates. For more information, refer to the user's manual provided in the infotainment system and the quick reference guide.

Head-Up Display (HUD) (if equipped)

The head up display is a transparent display which projects a shadow of some information of the instrument cluster and navigation on the HUD screen.



- 1 Combiner
- 2 Shutter

The hidden screen will go up when you press the screen operation switch on the left side of the lower part of crash pad and if you press the switch again, the screen will return to its original hidden position.

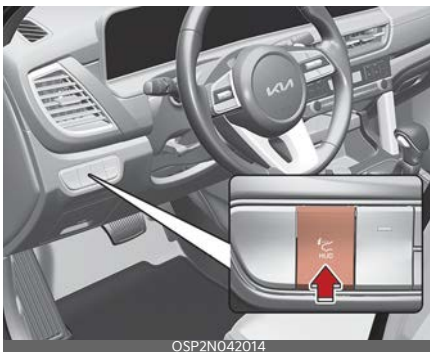

- The head up display image on the HUD screen may be invisible when:
 - Sitting posture is bad.
 - Wearing a polarized sunglasses.

- There is an object on the cover of the head up display.
- Driving on a wet road.
- An inadequate lighting is turned on inside the vehicle.
- Any light comes from the outside.
- Wearing an inadequate glasses to your eyesight.
- If the head up display image is not shown well, adjust the height, rotation or illumination of the head up display in the cluster.
- When the head up display needs inspection or repair, consult an authorized Kia dealer.

⚠ WARNING

Head-Up Display

- Do not place any accessories on the Head Up Display shutter. It might fall into Head Up Display and can damage to Head Up Display.

Head Up Display Information



- 1 Turn By Turn navigation information
- 2 Road signs
- 3 Speedometer
- 4 SCC set speed information (if equipped)

- 5 SCC vehicle distance information (if equipped)
- 6 Lane Safety information
- 7 Blind-Spot Safety information
- 8 Warning lights (Low fuel)
- 9 Infotainment system information
- 10 Highway Driving Assist information (if equipped)
- 11 Lane Following Assist information
- 12 Highway Auto Speed Change information (if equipped)

* NOTICE

Road Signs and Turn By Turn navigation information are available depending on the region.

Head up Display Setting

On the LCD display, you can change the head up display settings as follows.

1. Display height
2. Rotation
3. Brightness
4. Content selection

Select 'Setup → Vehicle → Head-Up Display' from the Settings menu in the Infotainment System screen while the ENGINE START/ STOP button is in the ON position.

* INFORMATION

The infotainment system may change after software updates. For more information, refer to the user's manual provided in the infotainment system and the quick reference guide.

Lighting

This vehicle is equipped with a variety of lights to appear the interior and exterior of the vehicle.

⚠ CAUTION

To prevent the battery from being discharged, do not leave the headlight and interior light on for a prolonged period of time while the engine is not running.

Battery saver function

The purpose of this feature is to prevent the battery from being discharged if the lights are left in the ON position. The system automatically shuts off the parking lights after the engine is off and the driver's door is opened. However, the position lamps stay ON even when the driver-side door is opened if the light switch is operated after the engine is turned off. If necessary, to keep the lamps on turn the position lamps OFF and ON again using the headlamp switch on the steering column after the engine is turned off.

Headlight escort function

If you turn the ENGINE START/STOP button to the ACC or OFF position with the headlights ON, the headlights remain on for about 5 minutes. However, if the driver's door is opened and closed, the headlights are turned off after 15 seconds.

The headlights can be turned off by pressing the lock button on the transmitter (or smart key) twice or turning the light switch to the OFF position. Headlight escort function is activated or deactivated when you select 'User Settings → Lights → Headlight Delay' on the LCD display or 'Setup → Vehicle → Lights →

Headlight Delay' on the infotainment system.

*** INFORMATION**

The infotainment system may change after software updates. For more information, refer to the user's manual provided in the infotainment system and the quick reference guide.

Daytime Running Light (DRL)

The Daytime Running Light (DRL) can make it easier for others to see the front of your vehicle during the day.

The DRL can be helpful in many different driving conditions, and it is especially helpful after dawn and before sunset.

The DRL will turn the dedicated lamp OFF when:

- The headlight switch is on.
- The vehicle is off.
- The front fog light is on.
- Engaging the Parking Brake.

Off position



The parking light and headlight will turn ON or OFF automatically depending on the amount of daylight as measured by the ambient light sensor on the center dash when the parking brake is not engaged.

The parking light and headlight will be turned OFF when the vehicle speed is less than 5 km/h and parking brake is engaged.

Lighting control

The light switch has a headlight and a position lamp position.



To operate the lights, turn the knob at the end of the control lever to one of the following positions:

1. OFF position / DRL off position.
2. Auto light position
3. Position & Tail lamp
4. Headlight position

Position & Tail lamp



When the light switch is in the position lamp position, the tail, license and instrument panel lights will turn ON.

Head light (Low Beam)



When the light switch is in the head light position, head light (low beam), tail, license light will turn ON.

* NOTICE

The ENGINE START/STOP button must be in the ON position to turn on the headlights.

Auto light

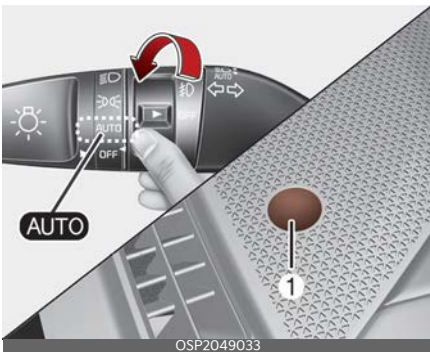

When the light switch is in the AUTO light position, the taillights and head-

lights will turn ON or OFF automatically depending on the amount of light outside the vehicle.

⚠ CAUTION

- Never place anything over the sensor (1) located on the instrument panel as this will ensure better auto-light system control.
- Don't clean the sensor using a window cleaner, the cleaner may leave a light film which could interfere with sensor operation.
- If your vehicle has window tint or other types of metallic coating on the front windshield, the Auto light system may not work properly.

Operating high beam



To turn on the high beam headlamp:

- Push the lever away from you.
The lever will return to its original position.
The high beam indicator will light when the headlight high beams are switched on.

⚠ WARNING

High beams

Do not use high beam when there are other vehicles in front of or approaching your vehicle. Using high beam could obstruct the other driver's vision.

To flash the headlights:

- Pull the lever towards you.



OSP2049036

It will return to the normal (low beam) position when released. The headlight switch does not need to be on to use this flashing feature.

Operating turn signals and lane change signals

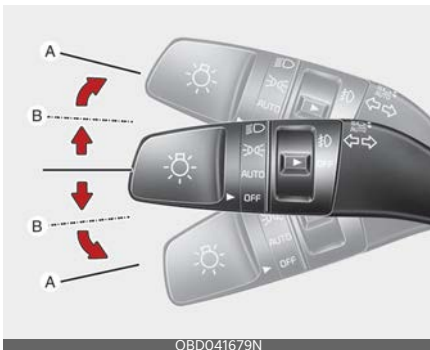

OBD041679N

The ENGINE START/STOP button must be on for the turn signals to function.

To turn on the turn signals:

- Move the lever up or down (A).

The green arrow indicators on the instrument panel indicate which turn signal is operating.

They will self-cancel after a turn is completed. If the indicator continues to flash after a turn, manually return the lever to the OFF position.

To signal a lane change:

- Move the turn signal lever slightly and hold it in position (B).

The lever will return to the OFF position when released.

If an indicator stays on and does not flash or if it flashes abnormally, one of the turn signal bulbs may be burned out and will require replacement.

* NOTICE

If an indicator flash is abnormally quick or slow, a bulb may be burned out or have a poor electrical connection in the circuit. The bulb may require replacement.

One-touch lane change function

To activate a one-touch lane change function, move the turn signal lever slightly and then release it. The lane change signals will blink 3, 5 or 7 times.

You can activate or deactivate the One Touch Turn Signal function or choose the number of blinking (3, 5, or 7) by selecting 'Lights → One Touch Turn signal'.(User Settings → Lights → One Touch Turn signal' on the LCD display or 'Setup → Vehicle → Lights → One Touch Turn Signal' on the infotainment system)

* INFORMATION

The infotainment system may change after software updates. For more information, refer to the user's manual pro-

vided in the infotainment system and the quick reference guide.

*** NOTICE**

If the turn signal indicator stays on and does not flash, or if it flashes abnormally, a bulb may be burned out or have a poor electrical connection in the circuit. The bulb may require replacement.

Operating front fog light \neq (if equipped)

Fog lights are designed to provide improved visibility when visibility is poor due to fog, rain or snow, etc.



The fog lights will turn on when the fog light switch (1) is turned to the on position after the headlight is turned on.

To turn off the fog lights:

- Turn the fog light switch (1) to the OFF position.

High Beam Assist (HBA) (if equipped)



High Beam Assist is a function that automatically adjusts the headlamp range (switches between high beam and low beam) depending on the brightness of detected vehicles and certain road conditions.

Detecting sensor

[1]: Front view camera



The front view camera is used as a detecting sensor to detect ambient light and brightness while driving.

Refer to the picture for the detailed location of the detecting sensor.

* NOTICE

- Always keep the front view camera in good condition to maintain optimal performance of High Beam Assist.
- For more details on the precautions of the front view camera, refer to "Forward Collision-Avoidance Assist (FCA) (Sensor fusion) (if equipped)" on page 6-15.

High Beam Assist setting

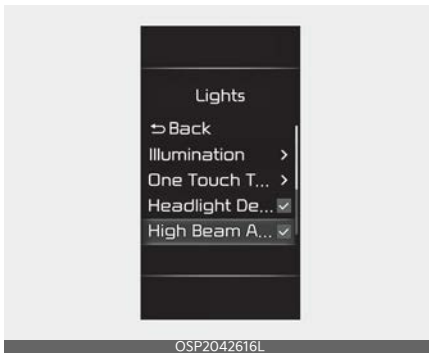

With the ignition switch or ENGINE START/STOP button in the ON position, select 'Lights → High Beam Assist' from the Settings menu to turn on High Beam Assist and deselect to turn off the function.



(User Settings → Lights → High Beam Assist' on the LCD display or 'Setup → Vehicle → Lights → High Beam Assist' on the infotainment system)

⚠ WARNING

For your safety, change the Settings after parking the vehicle at a safe location.

High Beam Assist operation

Display and control

- After selecting 'High Beam Assist' in the Settings menu, High Beam Assist will operate by following the procedure below.
 - Place the headlamp switch in the AUTO position and push the headlamp lever towards the instrument cluster. High Beam Assist  indicator light will appear on the cluster and the function will be enabled.
 - When the function is enabled, high beam will turn on when vehicle speed is above 30 km/h (20 mph). When vehicle speed is below 20 km/h (12 mph), high beam will not turn on.
 - The High Beam  indicator light will appear on the cluster when high beam is on.
- When High Beam Assist is operating, if the headlamp lever or switch is used, the function operates as follow:
 - If the headlamp lever is pulled towards you when the high beam is off, the high beam will turn on without High Beam Assist canceled. When you let go of the headlamp lever, the lever will move to the middle and the high beam will turn off.
 - If the headlamp lever is pulled towards you when the high beam is on by High Beam Assist, low beam will be on and the function will turn off.
 - If the headlamp switch is placed from AUTO to another position (headlamp/position/off), High

Beam Assist will turn off and the corresponding lamp will turn on.

- When High Beam Assist is operating, high beam switches to low beam if any of the following conditions occur:
 - When the headlamp of an oncoming vehicle is detected.
 - When the tail lamp of a vehicle in front is detected.
 - When the headlamp or tail lamp of a motorcycle or a bicycle is detected.
 - When the surrounding ambient light is bright enough that high beams are not required.
 - When streetlights or other lights are detected.

High Beam Assist malfunction and limitations

High Beam Assist malfunction

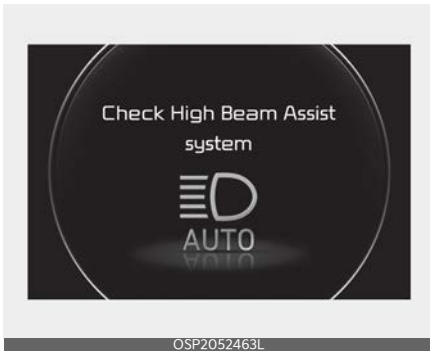

When High Beam Assist is not working properly, the 'Check High Beam Assist system' warning message will appear and (⚠️) warning light will appear on the cluster. If this occurs, we recommended that the function be inspected by an authorized Kia dealer

Limitations of High Beam Assist

High Beam Assist may not work properly in the following situations:

- Light from a vehicle is not detected because of lamp damage, or because it is hidden from sight, etc.
- Headlamp of a vehicle is covered with dust, snow or water.
- A vehicle's headlamps are off but the fog lamps are on and etc.
- There is a lamp that has a similar shape as a vehicle's lamp.
- Headlamps have been damaged or not repaired properly.
- Headlamps are not aimed properly.
- Driving on a narrow curved road, rough road, uphill or downhill.
- Vehicle in front is partially visible on a crossroad or curved road.
- There is a traffic light, reflecting sign, flashing sign or mirror ahead.
- There is a temporary reflector or flash ahead (construction area).
- The road conditions are bad such as being wet, iced or covered with snow.
- A vehicle suddenly appears from a curve.
- The vehicle is tilted from a flat tire or is being towed.
- Light from a vehicle is not detected because of exhaust fume, smoke, fog, snow, etc.

* NOTICE

For more details on the limitations of the front view camera, refer to "Forward Collision-Avoidance Assist (FCA) (Sensor fusion) (if equipped)" on page 6-15.

WARNING

- At times, High Beam Assist may not work properly. The function is for your convenience only. It is the responsibility of the driver for safe driving practices and always check the road conditions for your safety.
- When High Beam Assist does not operate normally, change the headlamp position manually between high beam and low beam.

Wipers and washers

The wipers and washers remove foreign substances from the windshield and rear window, helping to maintain visibility.

Front windshield wiper/washer

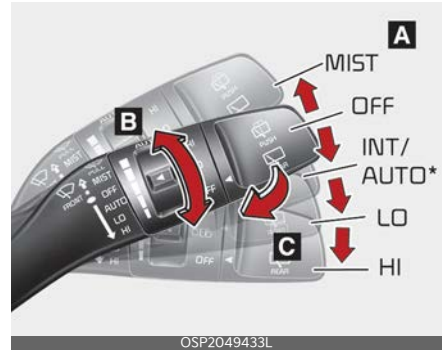

Rear windshield wiper/washer



A: Wiper speed control (front)

- MIST - Single wipe
- OFF - Off
- INT - Intermittent wipe
AUTO* - Auto control wipe
- LO - Low wiper speed
- HI - High wiper speed

B: Intermittent control wipe time adjustment

C: Wash with brief wipes (front)

D: Rear wiper/washer control

- HI - Continuous wipe
- LO - Intermittent wipe
- OFF - Off

E: Wash with brief wipes (rear)

* if equipped

Windshield washers

Operates as follows when the ENGINE START/STOP button is turned ON.

MIST: For a single wiping cycle, move the lever to this (MIST) position and release it. The wipers will operate continuously if the lever is held in this position.

OFF: Wiper is not in operation

INT: Wiper operates intermittently at the same wiping intervals. Use this mode in light rain or mist. To vary the speed setting, turn the speed control switch.

AUTO (if equipped): The rain sensor located on the upper end of the windshield glass senses the amount of rainfall and controls the wiping cycle for the proper interval. The more it rains, the faster the wiper operates. When the rain stops, the wiper stops. To vary the speed setting, turn the speed control knob (B).

LO: Normal wiper speed

HI: Fast wiper speed

* NOTICE

If there is heavy accumulation of snow or ice on the windshield, defrost the windshield for about 10 minutes, or until the snow and/or ice is removed before using the windshield wipers to ensure proper operation. If you do not remove the snow and/or ice before using the wiper and washer, it may damage the wiper and washer system.

⚠ WARNING

Do not use the washer in freezing temperatures without first warming the windshield with the defrosters; the washer solution could freeze on the windshield and obscure your vision.

* INFORMATION

If you operate the wipers while driving on snowy roads, the wipers may stop due to snow buildup on your windshield. This is normal and not a failure because it is one of our safety features to prevent vehicle accidents and wiper damage from overloading the wiper motor. If the wipers stop, remove snow accumulated on the top or bottom of windshield before using them.

Auto control (if equipped)

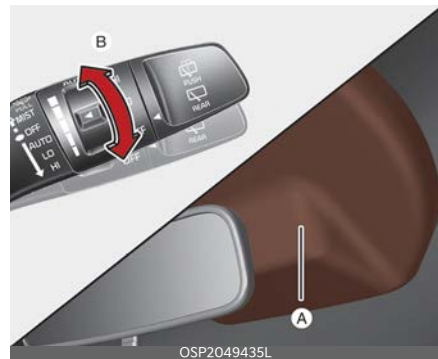

The rain sensor (A) located on the upper end of the windshield glass senses the amount of rainfall and controls the wiping cycle for the proper interval. The more it rains, the faster the wiper operates. When the rain stops, the wiper stops.

To vary the speed setting, turn the speed control knob (B).

If the wiper switch is set in AUTO mode when the ignition switch is ON, the wiper will operate once to perform a self-check of the system. Set the wiper to OFF position when the wiper is not in use.

⚠ WARNING

When the ENGINE START/STOP button is in the ON position and the windshield wiper switch is placed in AUTO mode, use caution in the following situations to avoid any injury to the hands or other parts of the body:

- Do not touch the upper end of the windshield glass facing the rain sensor.
- Do not wipe the upper end of the windshield glass with a damp or wet cloth.
- Do not put pressure on the windshield glass.

⚠ CAUTION

- When washing the vehicle, set the wiper switch in the OFF position to stop the auto wiper operation. The wiper may operate and be damaged if the switch is set in AUTO mode while washing the vehicle.
- Do not remove the sensor cover located on the upper end of the passenger side windshield glass. Damage to system parts could occur and may not be covered by your vehicle warranty.
- When starting the vehicle in winter, set the wiper switch in the OFF position. Otherwise, wipers may operate and ice may damage the windshield wiper blades. Always remove all snow and ice and defrost the windshield

properly prior to operating the windshield wipers.

Operating windshield washers



1. Move the wiper speed control switch to In OFF position.
2. Pull the lever gently toward you to spray washer fluid on the windshield and to run the wipers 1-3 cycles. Use this function when the windshield is dirty. The spray and wiper operation will continue until you release the lever.

If the washer does not work, check the washer fluid level. If the fluid level is not sufficient, you will need to add appropriate non-abrasive windshield washer fluid to the washer reservoir.

The reservoir filler neck is located in the front of the engine compartment on the passenger side.

⚠ CAUTION

Washer pump

To prevent possible damage to the washer pump, do not operate the washer when the fluid reservoir is empty.

⚠ CAUTION

Wipers & windshields

- To prevent possible damage to the wipers or windshield, do not operate the wipers when the windshield is dry.
- To prevent damage to the wiper blades, do not use gasoline, kerosene, paint thinner, or other solvents on or near them.
- To prevent damage to the wiper arms and other components, do not attempt to move the wipers manually.

Operating rear window wiper and washer switch

The rear window wiper and washer switch is located at the end of the wiper and washer switch lever.

- Turn the switch to the desired position to operate the rear wiper and washer.

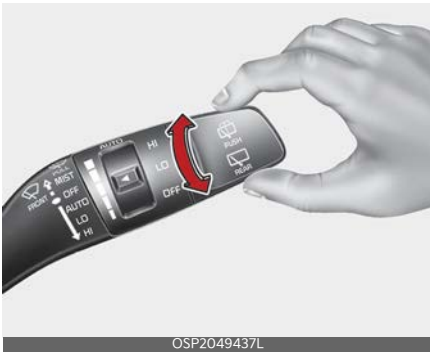

- HI - Normal wiper operation
- LO - Intermittent wiper operation
- OFF - Wiper is not in operation
- Push the lever away from you to spray rear washer fluid and to run the rear wipers 1~3 cycles.



The spray and wiper operation will continue until you release the lever.

Auto rear wiper

The rear wiper will operate while the vehicle is in reverse with the front wiper ON by selecting the function on the LCD display or the infotainment system.

With the ignition switch or ENGINE START/STOP button in the ON position, and select 'User Settings → Convenience → Auto Rear Wiper (in R)' on the LCD display or 'Setup → Vehicle → Convenience → Auto Rear Wiper (in R)' on the infotainment system.

*** INFORMATION**

The infotainment system may change after software updates. For more information, refer to the user's manual provided in the infotainment system and the quick reference guide.

Heated washer nozzle

The heated washer nozzle function defreeze the washer nozzles in freezing weather.

The heated washer nozzle will turn on and off automatically when the ignition switch is in ON or when the engine is running in following conditions:

- Turn ON when the outside temperature is below 5 °C, and OFF when it is over 10 °C.
- The washer fluid defreezing speed may be slower when the ignitions is in ON, than compared to when the engine is running.
- When the ignition is in ON, after 20 minutes of operation, the system will turn off automatically to prevent possible battery discharge.
- After the engine is running, the washer fluid will defrost after 5 to 10 minutes.
- If the engine has been started within the operating temperature, the heated nozzle remains ON even after 20 minutes.

*** NOTICE**

In below conditions, the heated washer nozzle may not function properly.

- The washer fluids in the washer reservoir is frozen.
- Outside temperature sensor is malfunctioning.

Interior lights

This vehicle is equipped with lights throughout the vehicle to appear the interior.

Automatic turn off function

The interior lights automatically turn off approximately 20 minutes after the ENGINE START/STOP button is turned off, if the lights are in the ON position.

If your vehicle is equipped with the theft alarm system, the interior lights automatically turn off approximately 5 seconds after the system is armed.

Map lamp

Type A





OSP2N042043

Type B



OSP2N042094

- Touch the position (1) to turn on the map lamp. (Type A)
- Press the position (1) to turn on the map lamp. (Type B)
To turn the map lamp OFF press the lens (1) again.
-  (2): DOOR mode
 - The map lamp and room lamp come on when a door is opened. The lamps go out after approximately 30 seconds.
 - The map lamp and room lamp come on for approximately 30 seconds when doors are unlocked with a smart key as long as the doors are not opened.
 - The map lamp and room lamp will stay on for approximately 20 minutes if a door is opened with the ENGINE START/STOP button in the ACC or OFF position.
 - The map lamp and room lamp will stay on continuously if the door is opened with the ENGINE START/STOP button in the ON position.
 - The map lamp and room lamp will go out immediately if the ENGINE START/STOP button is changed to the ON position or all doors are locked.
 - To turn off the DOOR mode, press the DOOR button (2) once again (not pressed).
-  (3): Press this switch to turn the front and rear room lamps on and off.

*** NOTICE**

The DOOR mode and ROOM mode can not be selected at the same time.

Room lamp

Type A



Type B



Press the switch to turn the room lamp on and off.

Luggage room lamp



The luggage room lamp comes on when the liftgate is opened.

⚠ CAUTION

The luggage room lamp comes on as long as the liftgate opens. To prevent unnecessary charging system drain, close the liftgate securely after using the luggage room.

Vanity mirror lamp (if equipped)



Push the switch to turn the light on or off.

- ☰: The lamp will turn on if this button is pressed.
- ○: The lamp will turn off if this button is pressed.

⚠ CAUTION

Vanity mirror lamp

Always close the lid of the vanity mirror in the off position when the vanity mirror lamp is not in use. If the sun visor is closed without the lamp off, it may discharge the battery or damage the sun visor.

Glove box lamp (if equipped)

The glove box lamp comes on when the glove box is opened.



⚠ CAUTION

To prevent unnecessary charging system drain, close the glove box securely after using the glove box.

Defroster

The vehicle is equipped with a defroster for removing frost or fog from the rear window.

⚠ CAUTION

To prevent damage to the conductors bonded to the inside surface of the rear window, never use sharp instruments or window cleaners containing abrasives to clean the window.

If you want to defrost and defog the front windshield, refer to "Windshield defrosting and defogging" on page 4-137.

Rear window defroster

The defroster heats the window to remove frost, fog and thin ice from the rear window, while the engine is running. To activate the rear window defroster, press the rear window defroster button.

The indicator on the rear window defroster button illuminates when the defroster is ON.

If there is heavy accumulation of snow on the rear window, brush it off before operating the rear defroster.

Type A



Type B



Type C

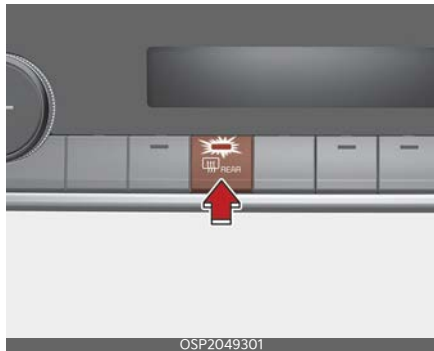

To activate the rear window defroster:

- Press the rear window defroster button located in the heater control panel. The indicator on the rear window defroster button appears when the defroster is ON.

The rear window defroster automatically turns off after approximately 20 minutes or when the ENGINE START/STOP button is turned off.

To turn off the defroster:

- Press the rear window defroster button again.

Outside rearview mirror defroster

If your vehicle is equipped with the outside rearview mirror defrosters, they will operate at the same time you turn on the rear window defroster.

Climate control system



The climate control system uses cooling and heating to help maintain a pleasant environment inside the vehicle.

System operation

Ventilation

1. Set the mode to the  position.
2. Set the air intake control to the outside (fresh) air position.
3. Set the temperature control to the desired position.
4. Set the fan speed control to the desired speed.

Heating

1. Set the mode to the  position.
2. Set the air intake control to the outside (fresh) air position.
3. Set the temperature control to the desired position.
4. Set the fan speed control to the desired speed.
5. If dehumidified heating is desired, turn the air conditioning system on.
 - If the windshield fogs up, set the mode to the  or  position.

Operation tips

- To keep dust or unpleasant fumes from entering the vehicle through the ventilation system, temporarily set the air intake control to the recirculated air position. Be sure to return the control to the fresh air position when the irritation has passed to keep fresh air in the vehicle. This will help keep the driver alert and comfortable.

- Air for the heating/cooling system is drawn in through the grilles just at the base of the windshield. Care should be taken that these are not blocked by leaves, snow, ice or other obstructions.
- To prevent fog from forming on the inside of the windshield:
 - Set the air intake control to the fresh air position and the fan speed to the desired position.
 - Turn on the air conditioning system, and adjust the temperature control to desired temperature.

Air conditioning

Kia Air Conditioning Systems are filled with environmentally friendly refrigerant.

1. Start the engine. Push the air conditioning button.
2. Set the mode to the  position.
3. Set the air intake control to the outside air or recirculated air position.
4. Adjust the fan speed control and temperature control to maintain maximum comfort.

CAUTION

- The refrigerant system should only be serviced by trained and certified technicians to insure proper and safe operation.
- The refrigerant system should be serviced in a well-ventilated place.
- The air conditioning evaporator (cooling coil) shall never be repaired or replaced with one removed from a used or salvaged vehicle and new replacement MAC evaporators shall be certified (and labeled) as meeting SAE Standard J2842.

* NOTICE

- When using the air conditioning system, monitor the temperature gauge closely while driving up hills or in heavy traffic when outside temperatures are high. Air conditioning system operation may cause engine overheating. Continue to use the blower fan but turn the air conditioning system off if the temperature gauge indicates engine overheating.
- When opening the windows in humid weather air conditioning may create water droplets inside the vehicle. Since excessive water droplets may cause damage to electrical equipment, air conditioning should only be used with the windows closed.

Air conditioning system operation tips

- If the vehicle has been parked in direct sunlight during hot weather, open the windows for a short time to let the hot air inside the vehicle escape.
- To help reduce moisture inside of the windows on rainy or humid days, decrease the humidity inside the vehicle by operating the air conditioning system.
- During air conditioning system operation, you may occasionally notice a slight change in engine speed as the air conditioning compressor cycles. This is a normal system operation characteristic.
- Use the air conditioning system every month only for a few minutes to

ensure maximum system performance.

- When using the air conditioning system, you may notice clear water dripping (or even puddling) on the ground under the passenger side of the vehicle. This is a normal system operation characteristic.
- Operating the air conditioning system in the recirculated air position provides maximum cooling, however, continual operation in this mode may cause the air inside the vehicle to become stale.
- During cooling operation, you may occasionally notice a misty air flow because of rapid cooling and humid air intake. This is a normal system operation characteristic.

Climate control air filter

The climate control air filter installed behind the glove box filters the dust or other pollutants that come into the vehicle from the outside through the heating and air conditioning system.

If dust or other pollutants accumulate in the filter over a period of time, the air flow from the air vents may decrease. This leads to moisture accumulating on the inside of the windshield even when the outside (fresh) air position is selected. If this happens, have the climate control air filter replaced by an authorized Kia dealer.

* NOTICE

- Replace the filter according to the Maintenance Schedule. If the vehicle is being driven in severe conditions, such as dusty or rough roads, more frequent air conditioner filter inspections and changes are required.
- When the air flow rate suddenly decreases, the system should be checked at an authorized Kia dealer.

Air conditioning refrigerant label

Example



* The actual air conditioning refrigerant label in the vehicle may differ from the illustration.

Each symbol and specification on the air conditioning refrigerant label is represented below:

1. Classification of refrigerant
2. Amount of refrigerant
3. Classification of Compressor lubricant
4. Caution
5. Flammable Refrigerant
6. To requires Registered Technician to Service Air Conditioning system



You can find out which air conditioning refrigerant is applied your vehicle at the label inside of the engine compartment.

Checking the amount of air conditioner refrigerant and compressor lubricant

When the amount of refrigerant is low, the performance of the air conditioning is reduced. Overfilling also has a negative impact on the air conditioning system.

Therefore, if abnormal operation is found, have the system inspected by an authorized Kia dealer.

⚠ WARNING

The oil and refrigerant in your vehicle's air conditioning system is under very high pressure. If proper service procedures are not followed, an explosion may result. To reduce the risk of serious injury or death, the air conditioning system in your vehicle should only be serviced by trained and certified technicians.

⚠ CAUTION

It is important that the correct type and amount of oil and refrigerant is used, otherwise damage to the vehicle may

occur. To prevent damage, the air conditioning system in your vehicle should only be serviced by trained and certified technicians.

⚠ WARNING

Vehicles equipped with R-1234yf

 Since the refrigerant is mildly flammable and operated at high pressure, the air conditioning system should only be serviced by trained and certified technicians. (Refer to the SAE J2845)

It is important that the correct type and amount of oil and refrigerant are used.

All refrigerants should be reclaimed with proper equipment. Venting refrigerants directly to the atmosphere is harmful to individuals and environment.

Failure to heed these warnings can lead to serious injuries.

Manual climate control system (if equipped)

The manual climate control system uses cooling and heating to help maintain a pleasant environment inside the vehicle.



1. Fan speed control knob
2. Air intake control button
3. Mode selection knob
4. Rear window defroster
5. Temperature control knob
6. Air conditioning (A/C) button

CAUTION

Operating the blower when the ignition switch is in the ON position could cause the battery to discharge. Operate the blower when the engine is running.

Heating and air conditioning

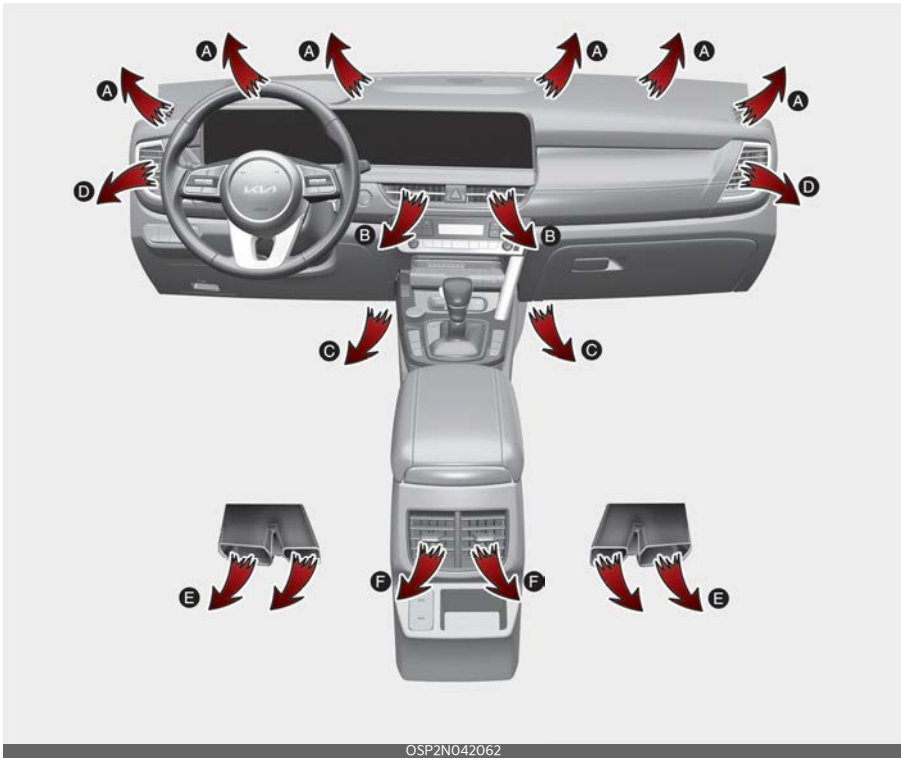

1. Start the engine.
2. Set the mode to the desired position.
For improving the effectiveness of heating and cooling;
 - Heating:
 - Cooling:
3. Set the temperature control to the desired position.
4. Set the air intake control to the outside (fresh) air position.
5. Set the fan speed control to the desired speed.
If air conditioning is desired, turn the air conditioning system on.

Mode selection

The mode selection buttons control the direction of the air flow through the ventilation system.



OSP21049302

Air can be directed to the floor, dashboard outlets, or windshield. Five symbols are used to represent Face, Bi-Level, Floor, Floor-Defrost and Defrost air position.

Face-Level (B, D, F)

Air flow is directed toward the upper body and face. Additionally, each outlet can be controlled to direct the air discharged from the outlet.

Bi-Level (B, C, D, E, F)

Air flow is directed towards the face and the floor.

Floor-Level (A, C, D, E, F)

Most of the air flow is directed to the floor, with a small amount of the air being directed to the windshield, side window defrosters and side air vents.

Floor/Defrost-Level (A, C, D, E, F)

Most of the air flow is directed to the floor and the windshield with a small amount directed to the side window defrosters and side air vents.

Defrost-Level (A, D)

Most of the air flow is directed to the windshield with a small amount of air directed to the side window defrosters and side air vents.

Instrument panel vents



OSP2042330L

You can adjust the direction of air delivered from these vents using the vent control lever as shown.

Temperature control

The temperature control knob allows you to control the temperature of the air flowing from the ventilation system.



OSP2042306

To change the air temperature in the passenger compartment, turn the knob

to the right for warm and hot air or to the left for cooler air.

*** NOTICE**

When starting the vehicle in cold weather a more efficient way to heat the passenger compartment is to do the following.

- Turn off or lower the blower, right after starting the engine.
- Engine temperature is still low and the air flow from the heater is still cold.
- After a few minutes of engine warm up, turn on or set the fan to a higher level and adjust the temperature setting to hot.

Controlling air intake

The air intake control is used to select the outside (fresh) air position or recirculated air position.



To change the air intake control position.

- Push the desired control button

Recirculated air position



The indicator light on the button appears when the recirculated air position is selected.

With the recirculated air position selected, air from the passenger com-

partment will be drawn through the heating system and heated or cooled according to the function selected.

Outside (fresh) air position



The indicator light on the button will turn off when the outside (fresh) air position is selected.

With the outside (fresh) air position selected, air enters the vehicle from outside and is heated or cooled according to the function selected.

*** NOTICE**

Prolonged operation of the heater in the recirculated air position (without air conditioning selected) may cause fogging of the windshield and side windows, and the air within the passenger compartment may become stale.

In addition, prolonged use of the air conditioning with the recirculated air position selected will result in excessively dry air in the passenger compartment.

⚠ WARNING

- Continuously using the climate control system in the recirculated air position may allow humidity to increase inside the vehicle, which may fog the glass and obscure visibility.
- Do not sleep in a vehicle with the air conditioning or heating system on. It may cause serious harm or death due to a drop in the oxygen level and/or body temperature.
- Continuously using the climate control system in the recirculated air position can cause drowsiness or sleepiness, and loss of vehicle control. Set the air intake control to the outside (fresh) air

position as much as possible while driving.

Controlling fan speed

The fan speed control knob allows you to control the fan speed of the air flowing from the ventilation system.

The ENGINE START/STOP button must be in the ON position for fan operation.

To change the fan speed:

- Turn the knob to the right for higher speed or left for lower speed.



OSP2042324

Turning off the blowers

To turn off the blowers:

- Turn the fan speed control knob to the "0" position.

Air conditioning (A/C)

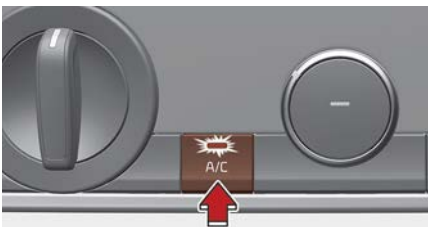

OSP2049308

- Press the A/C button to turn the air conditioning system on (indicator light will appear).
- Press the button again to turn the air conditioning system off.

Automatic climate control system

The automatic climate control system uses cooling and heating to help maintain a pleasant environment inside the vehicle.

Type A



Type B



- 1. Fan speed control button
- 2. Air intake control button
- 3. Mode selection button
- 4. Rear window defroster button
- 5. Temperature control knob
- 6. Air conditioning (A/C) button
- 7. OFF button
- 8. Front windshield defroster button
- 9. AUTO (automatic control) button

10. Climate control display

*** NOTICE**

Operating the blower when the ignition switch is in the ON position could cause the battery to discharge. Operate the blower when the engine is running.

Heating and air conditioning automatically

1. Press the AUTO button.

The modes, fan speeds, air intake and air-conditioning will be controlled automatically by setting the temperature.

Type A



Type B



2. Press the temperature control button and turn the temperature control switch to the desired temperature.

The climate control system is automatically controlled according to the desired temperature.

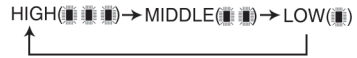

* NOTICE

- To turn the automatic operation off, select any of the following buttons or switches:
 - Mode selection button
 - Air conditioning (A/C) button
 - Front windshield defroster button (Press the button one more time to deselect the front windshield defroster function. The 'AUTO' sign will appear on the information display once again.)
 - Fan speed control switch

The selected function will be controlled manually while other functions operate automatically.
- For your convenience and to improve the effectiveness of the climate control, use the AUTO button and set the temperature to 72 °F (22 °C).

*** NOTICE**

Do not place anything over the sensor located on the instrument panel to ensure better control of the heating and cooling system.



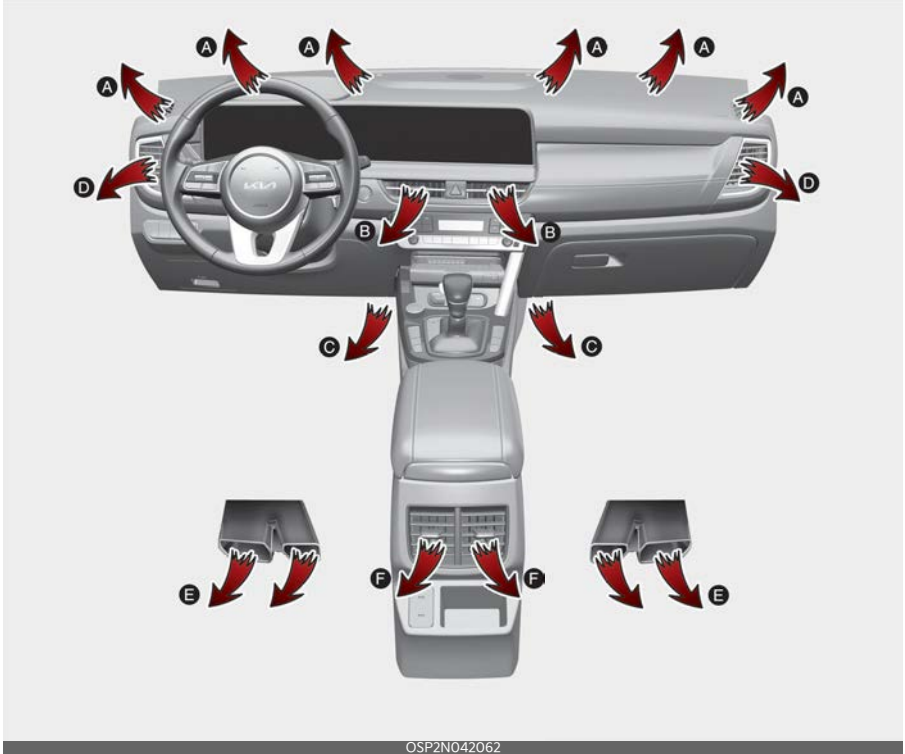

Heating and air conditioning manually

The heating and cooling system can be controlled manually by pressing buttons other than the AUTO button.



In this case, the system works sequentially according to the order of buttons selected.

1. Start the vehicle.
2. Set the mode to the desired position.
 - For improving the effectiveness of heating and cooling;
 - Heating: 
 - Cooling: 
3. Set the temperature control to the desired position.
4. Set the air intake control to the outside (fresh) air position.
5. Set the fan speed control to the desired speed.
6. If air conditioning is desired, turn the air conditioning system on.

Press the AUTO button in order to convert to fully automatic control of the system.

Mode selection

The mode selection button controls the direction of the air flow through the ventilation system.

Type A



Type B



The air flow outlet ports are switched in the following sequence:



Face-Level (B, D, F)

Air flow is directed toward the upper body and face. Additionally, each outlet can be controlled to direct the air discharged from the outlet.

Bi-Level (B, C, D, E, F)

Air flow is directed towards the face and the floor.

Floor-Level (A, C, D, E)

Most of the air flow is directed to the floor, with a small amount of the air being directed to the windshield, side window defrosters and side air vents.

Floor/Defrost-Level (A, C, D, E)

Most of the air flow is directed to the floor and the windshield with a small amount directed to the side window defrosters and side air vents.

Defrost-Level (A, D)

Most of the air flow is directed to the windshield with a small amount of air directed to the side window defrosters and side air vents.

Defrost mode

Type A



Type B



When you select the defrost mode, the following system settings will be made automatically:

- The air conditioning system will be turned on.
- The outside (fresh) air position will be selected.
- The fan speed will be set to the high speed.

To turn the defrost mode off, press the mode button or defrost button again or AUTO button.

Instrument panel vents

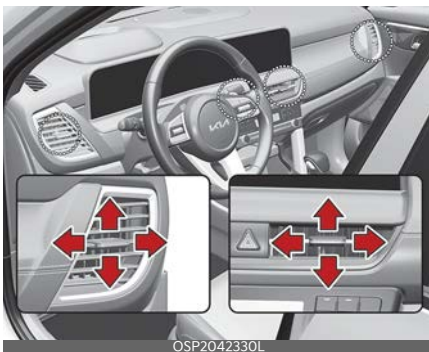

You can adjust the direction of air delivery from these vents using the vent control lever as shown.

Temperature control

Type A

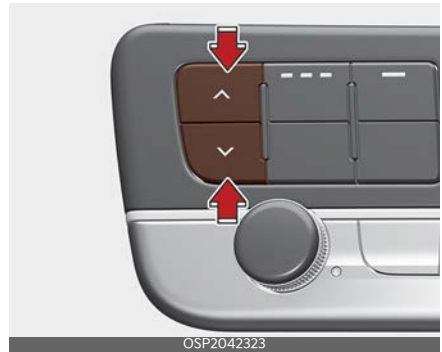

Type B



Press the temperature control button and turn the temperature control switch to the desired temperature.

When pressing the button, the temperature will increase or decrease by 1 °F (0.5 °C). When set to the lowest temperature setting, the air conditioning will operate continuously. (for type A)

When rotating the knob, the temperature will increase or decrease by 1 °F (0.5 °C). When set to the lowest temperature setting, the air conditioning will operate continuously. (for type B)

*** NOTICE**

When starting the vehicle in cold weather using manual temperature control, operate the system in the following method to improve heating.

- Turn off or lower the blower, right after starting the engine.
- Allow the engine to warm up during this time since the air flow from the heater is still cold.
- After a few minutes of engine warm up, turn on or set the fan to a higher level and adjust the temperature setting to hot.

Changing temperature scale

You can switch the temperature mode from Centigrade to Fahrenheit as follows:

- While pressing the OFF button, press the AUTO button for 3 seconds or more.

The display will change from Centigrade to Fahrenheit, or from Fahrenheit to Centigrade. If the battery has been discharged or disconnected, the temperature mode display will reset to Fahrenheit.

Controlling air intake

This is used to select the outside (fresh) air position or recirculated air position. To change the air intake control position:

- Push the desired control button.

Recirculated air position



With the recirculated air position selected, air from the passenger compartment will be drawn through the heating system and heated or cooled according to the function selected.

Outside (fresh) air position



With the outside (fresh) air position selected, air enters the vehicle from outside and is heated or cooled according to the function selected.

*** NOTICE**

Prolonged operation of the heater in the recirculated air position (without air conditioning selected) may cause fogging of the windshield and side windows and the air within the passenger compartment may become stale.

In addition, prolonged use of the air conditioning with the recirculated air position selected will result in excessively dry air in the passenger compartment.

⚠ WARNING

- Continued climate control system operation in the recirculated air position may allow humidity to increase inside the vehicle which may fog the glass and obscure visibility.
- Do not sleep in a vehicle with the air conditioning or heating system on. It may cause serious harm or death due to a drop in the oxygen level and/or body temperature.
- Continued climate control system operation in the recirculated air position can cause drowsiness or sleepiness, and loss of vehicle control. Set the air intake control to the outside (fresh) air position as much as possible while driving.

Controlling fan speed

The fan speed can be set to the desired speed by operating the fan speed control button.

To change the fan speed:

- The higher the fan speed, the more air is delivered.

Type A



Type B

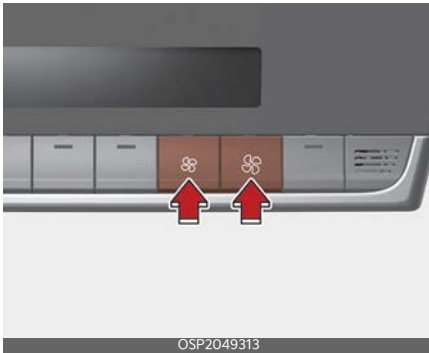

To turn the fan speed control off:

- Press the OFF button.

Air conditioning (A/C)

Type A



Type B



- Press the A/C button to turn the air conditioning system on (indicator light will appear).
- Press the button again to turn the air conditioning system off.

⚠ WARNING

Reduced Visibility

Continuous use of the climate control system in the recirculated air position may allow humidity to increase inside the vehicle, which may fog the glass and obscure visibility.

⚠ WARNING

Recirculated Air

Continued use of the climate control system in the recirculated air position can cause drowsiness or sleepiness, and loss of vehicle control. Set the air intake control to the outside (fresh) air position as much as possible while driving.

⚠ WARNING

Sleeping with A/C on

Do not sleep in a vehicle with the air conditioning or heating on as this may cause serious harm or death due to a drop in the oxygen level and/or body temperature.

Turning off the front air climate control

Type A



Type B

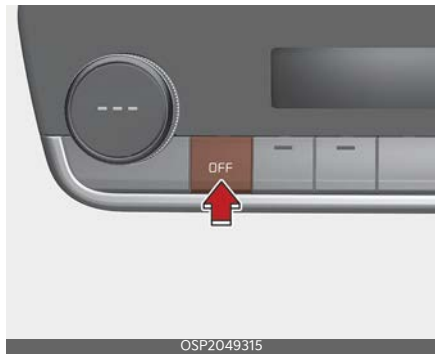



- Press the OFF button to turn off the front and rear air climate control system. However, you can still operate the mode and air intake buttons as long as the ENGINE START/STOP button is in the ON position.

Windshield defrosting and defogging

When the windshield is covered with frost or moisture, the front view is blurred, you should remove the frost and moisture.

⚠ WARNING

Windshield heating

Do not use the  or  position during cooling operation in extremely humid weather. The difference between the temperature of the outside air and the windshield could cause the outer surface of the windshield to fog up, causing loss of visibility. In this case, set the mode selection to the  position and fan speed control to the lower speed.

- To speed up the defrosting process, turn the temperature control all the way to the right and set the fan speed to the highest.
- If you want warm air to flow towards the floor while defrosting or defogging, set the mode to the floor-defrost position.
- Before driving, clear all snow and ice from the windshield, rear window, outside rear view mirrors, and all side windows.
- Clear all snow and ice from the hood and air inlet in the cowl grill to improve heater and defroster efficiency and to reduce the probability of fogging up the inside of the windshield.

⚠ CAUTION

Do not place anything on the instrument panel which may cover the air outlets.

Otherwise, air flow may be obstructed, preventing the windshield defoggers from defogging.



4

Defogging inside windshield with manual climate control system



1. Select any fan speed except "0" position.
2. Select desired temperature.
3. Select the  or  position.

The outside (fresh) air and air conditioning will be selected automatically. If the air conditioning and outside (fresh) air position are not selected automatically, press the corresponding button manually.

Defogging inside windshield with the automatic climate control

Type A

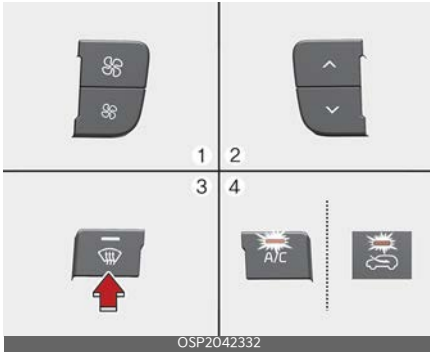

Type B

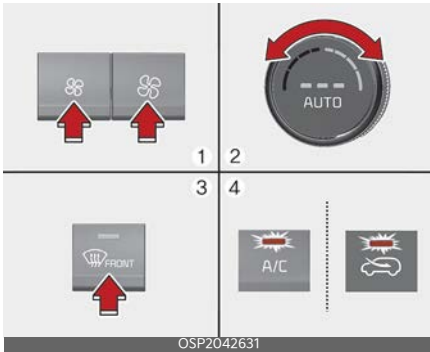

1. Set the fan speed to the desired position.
2. Select desired temperature.
3. Press the defroster button ().

The outside (fresh) air position will be selected automatically and the air conditioning will turn on according to the detected ambient temperature.

If the air conditioning and outside (fresh) air position are not selected automatically, adjust the corresponding button manually. If the  position is

selected, lower fan speed is adjusted to a higher fan speed.

Defrosting outside windshield with manual climate control system



1. Set the fan speed to the highest (extreme right) position.
2. Set the temperature to the extreme hot position.
3. Select the  position.

The outside (fresh) air and air conditioning will be selected automatically. When starting the vehicle in cold weather a more efficient way to heat the passenger compartment is to do the following.

- Turn off or lower the blower, right after starting the engine.
- Engine temperature is still low and the air flow from the heater is still cold.
- After a few minutes of engine warm up, turn on or set the fan to a higher level and with adjust the temperature setting to hot.

* NOTICE

If the engine temperature is still cold after starting, then a brief engine warm

up period may be required for the vented air flow to become warm or hot.

Defrosting outside windshield with automatic climate control

Type A

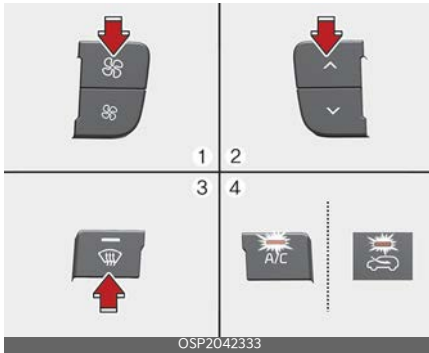

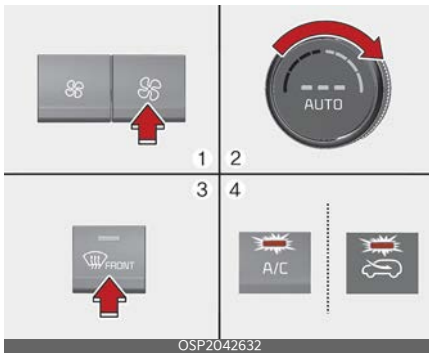

Type B



1. Set the fan speed to the highest position.
2. Set the temperature to the extreme hot (HI) position.
3. Press the defroster button ().

The outside (fresh) air position will be selected automatically and the air conditioning will turn on according to the detected ambient temperature.

Defogging logic (if equipped)

To reduce the possibility of fogging up the inside of the windshield, the air intake or air conditioning is controlled automatically according to certain conditions such as  or  position.

To cancel automatic defogging logic or return to the automatic defogging logic, do the following.

Canceling/returning automatic defogging logic on manual climate control system



1. Turn the ENGINE START/STOP button to the ON position.
2. Select the  position.
3. Press the air intake control button at least 5 times within 3 seconds.

The indicator light in the air intake control button will blink 3 times. It indicates that the defogging logic is canceled or returned to the programmed status.

If the battery has been discharged or disconnected, it resets to the defog logic status.

Canceling/returning automatic defogging logic on automatic climate control system

Type A

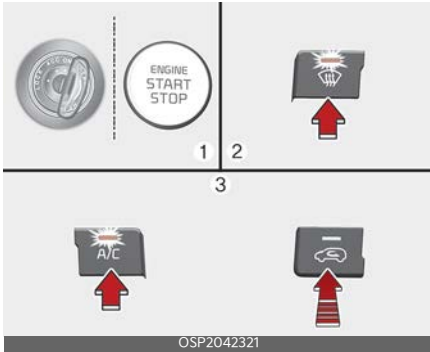

Type B

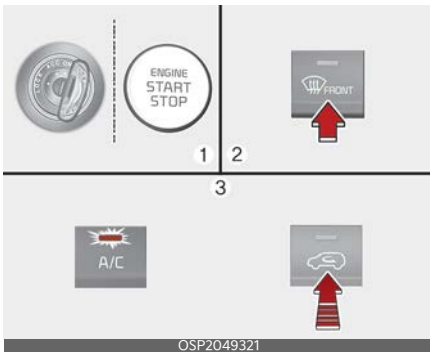

1. Turn the ENGINE START/STOP button to the ON position.
2. Press the defroster button (🚗).
3. While pressing the air conditioning (A/C) button, press the air intake control button at least 5 times within 3 seconds.
The recirculation indicator blinks 3 times in 0.5 second of intervals. It indicates that the defogging logic is canceled or returned to the programmed status.

If the battery has been discharged or disconnected, it resets to the defog logic status.

Auto defogging system (if equipped)



Auto defogging reduces the possibility of fogging up the inside of the windshield by automatically sensing the moisture of inside the windshield. Auto Defog System is activated when you select 'Setup → Vehicle → Climate → Defog/Defrost Options → Auto Defog' from the Settings in the infotainment system screen.

* INFORMATION

The infotainment system may change after software updates. For more information, refer to the user's manual provided in the infotainment system and the quick reference guide.

⚠ CAUTION

Do not remove the sensor cover located on the upper end of the passenger side windshield glass. Damage to the system parts could occur and may not be covered by your vehicle warranty.

To cancel or reset the Auto Defogging System

Press the front windshield defroster button for 3 seconds when the ENGINE START/STOP button is in the ON position.

When the ADS system is canceled, Indicator on the button will blink 3 times per 0.5 sec and the position "ADS OFF" will be displayed on the climate control information screen.

When the ADS system is reset, Indicator on the button will blink 6 times per 0.25 sec and the position "ADS OFF" will be disappeared on the climate control information screen.

You can set or release the Auto Defogging System on the Climate Information selection screen.

Auto Defog System is activated when you select 'Setup → Vehicle → Climate → Defog/Defrost Options → Auto Defog' from the Settings in the infotainment system screen.

* INFORMATION

The infotainment system may change after software updates. For more information, refer to the user's manual provided in the infotainment system and the quick reference guide.

If the battery is discharged or detached, the auto defogging system will be reset. Adjust the feature accordingly.

▲ CAUTION

- Pressing one of Air intake recirculation, A/C OFF, Wind Direction Mode selection Buttons will deactivate the Auto Defogging System. To secure a driver's vision, never push air recirculation, A/C OFF, Wind Direction But-

tons while the Auto Defogging System is running.

- Do not forcibly remove the sensor cover on the top of windshield glass on the driver's side in the car. Removing the cover can damage the sensor.

Automatic Air Ventilation

When operating heater and air conditioner for the vehicle ventilation, if you maintain the Recirculation mode for 30 minutes or over at low temperature, it automatically changes to Fresh mode.

Automatic Air Ventilation control procedure

When set up or release the automatic air ventilation function, select the Mode Selection  button at heater or air conditioner on. And press the Air Intake Control button for 5 times or over within 3seconds together within 3 seconds together within 3 seconds together with pressing the Air conditioning button.

When release the automatic ventilation function, the Recirculation mode indicator will blink 3 times at 0.5 second intervals and air direction, air volume, Recirculation/Fresh mode, and air conditioner is automatically controlled.

When it set the automatic ventilation function, the Recirculation mode indicator will blink 6 times at 0.25 seconds intervals and air direction, air volume, Recirculation/Fresh mode, and air conditioner is automatically controlled.

Auto Dehumidify is activated when you select 'Setup → Vehicle → Climate → Automatic Ventilation → Auto Dehumidify' from the Settings in the infotainment system screen.

* INFORMATION

The infotainment system may change after software updates. For more information, refer to the user's manual provided in the infotainment system and the quick reference guide.

Activate upon Washer Fluid Use

To prevent the odor from entering to inside the vehicle, the ventilation system changes to Recirculated Air Mode for a while when the windshield washer fluid sprayed.

System setting

1. ENGINE START/STOP button is ON.
2. Select Floor-Level () air flow direction by pressing Mode Selection button.
3. With pressing Air Conditioning button, press the Recirculated Air button more than 4 times within 2 seconds.
4. If the system is set up, the indicator on Recirculated Air button will blink 6 times.

System cancellation

1. ENGINE START/STOP button is ON.
2. Select Floor-Level () air flow direction by pressing Mode Selection button.
3. With pressing Air Conditioning button, press the Recirculated Air button more than 4 times within 2 seconds.
4. If the system is cancelled, the indicator on Recirculated Air button will blink 3 times.

Activation on washer fluid is activated when you select 'Settings → Vehicle → Climate → Recirculate Air → Activate upon Washer Fluid Use' from the Settings in the infotainment system screen.

* INFORMATION

The infotainment system may change after software updates. For more information, refer to the user's manual provided in the infotainment system and the quick reference guide.

Sunroof inside air recirculation (if equipped)

The outside (fresh) air position is automatically selected, when the sunroof is opened. When you select the recirculated air position, the system maintains the recirculated air position for 3 minutes and then automatically converts to the outside (fresh) air position.

When the sunroof is closed, the air intake position will return to the original position that was selected.

Scheduled Ventilation Control

The Scheduled Ventilation Control releases hot air in the vehicle to lower cabin temperature before getting in the vehicle. Depending on the outside ambient temperature, the blower is operated for 5 to 15 minutes while the vehicle is parked.

Turning Schedule Ventilation Control On or Off

Turning Schedule Ventilation Control On or Off The Schedule Ventilation Control can be turned on and off by selecting 'Setup → Vehicle → Automatic Ventilation → Scheduled Ventilation' from the infotainment system screen. Also, the starting time can be set within 24 hours. Schedule Ventilation Control operates only once when the feature is set.

* INFORMATION

The infotainment system may change after software updates. For more information, refer to the user's manual provided in the infotainment system and the quick reference guide.

Storage compartment

These compartments can be used to store small items required by the driver or passengers.

- To avoid possible theft, do not leave valuables in the storage compartment.
- Always keep the storage compartment covers closed while driving. Do not place too many items in the storage compartment to make sure that the compartment can be closed securely.

⚠ WARNING

Flammable materials

Do not store, propane cylinders or other flammable/explosive materials in the vehicle. These items may catch fire and/or explode if the vehicle is exposed to hot temperatures for extended periods.

Center console storage

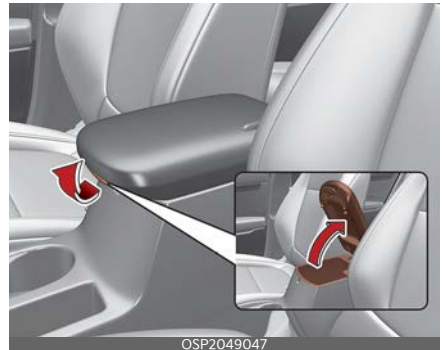

To open the center console storage:

- Pull up the lever.

Sliding armrest (if equipped)

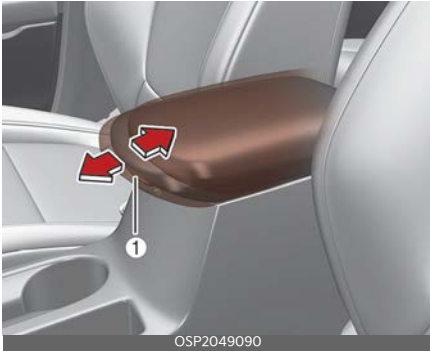

To move forward:

- Grab the lever (1) in front portion of the armrest and pull it forward.

To move rearward:

- Grab the lever (1) in front portion of the armrest and push it rearward.

⚠ WARNING

Do not grab the front portion of the armrest when moving the armrest rearward. It may pinch your fingers.

Glove box



To open the glove box:

- Pull the handle and the glove box will automaticall open.

Close the glove box after use.

⚠ WARNING

Glove Box

To reduce the risk of injury in an accident or sudden stop, always keep the glove box door closed while driving.

*** NOTICE**

If the temperature control switch is in the warm or hot position, warm or hot air will flow into the glove box.

Luggage net holder



To keep items from shifting in the cargo area, you can use the 4 holders located in the cargo area to attach the luggage net. (if equipped)

If necessary, contact an authorized Kia dealer.

⚠ CAUTION

To prevent damage to the goods or the vehicle, be careful when carrying fragile or bulky objects in the luggage compartment.

⚠ WARNING

DO NOT over-stretch the luggage net and ALWAYS keep your face and body out of the luggage net's recoil path. Failure to comply with these instructions may result in severe facial injuries. DO NOT use the luggage net when the strap has visible signs of wear or damage.

Luggage board

You can place reflector triangle and etc. under the luggage board.



1. Grasp the handle on the top of the cover and lift it.
2. Fold the rear part of luggage board forward.
3. Lift up luggage board forward. (Luggage board stand itself)

Increase cargo space

If you want to increase cargo space:

1. Grasp the handle on the top of the cover and lift it.
2. Fold the rear part of the luggage board frontward.
3. Pull the luggage board hinge to the end of sliding slot and it will fall down lower to increase cargo space.

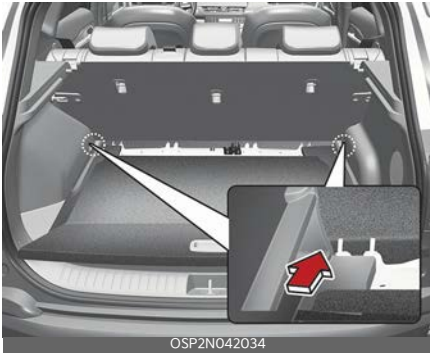

4. Slide it frontward (refer to the above pictures).

Interior features

There are various features inside the vehicle for the convenience of the occupants.

Cup holder

The front and rear seats of the vehicle have cup holders to accommodate cups.

⚠ WARNING

Hot liquids

Do not place uncovered cups with hot liquid in the cup holder while the vehicle is in motion. If the hot liquid spills, you may burn yourself. Such a burn to the driver could lead to loss of control of the vehicle.

⚠ CAUTION

- Keep your drinks sealed while driving to prevent spilling your drink. If liquid spills, it may get into the vehicle's electrical/electronic system and damage electrical/electronic parts.
- When cleaning spilled liquids, do not use heat to dry the cup holders. This may damage the cup holder.

Front



Rear (if equipped)



OSP2N032017

Cups or small beverage cans may be placed in the cup holders.

Seat warmer

The seat warmer is provided to warm the front seats during cold weather.

Front seat



OSP2042059L

Rear seat (if equipped)

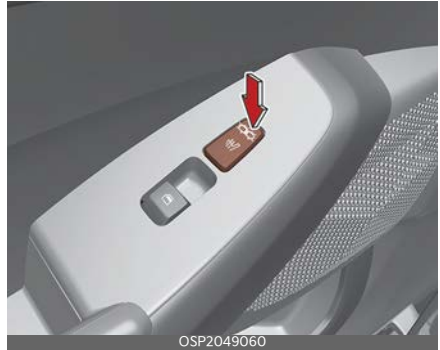

OSP2049060

With the ignition switch in the ON position:

- Push either of the switches to warm the driver's seat or the front passenger's seat.

During mild weather or under conditions where the operation of the seat warmer is not needed, keep the switches in the "OFF" position.

Temperature control (Manual)

Each time you press the switch, the temperature setting of the seat will change as follows:

Front seat

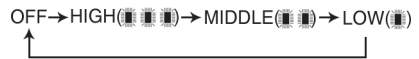

Rear seat (if equipped)



Temperature control (Automatic)

The seat warmer starts to automatically control the seat temperature in order to

prevent low-temperature burns after being manually turned ON.

Front seat



Rear seat (if equipped)

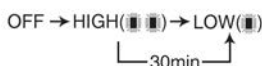

You may manually press the button to increase the seat temperature. However, it soon returns to the automatic mode again.

- When pressing the switch for more than 1.5 seconds with the seat warmer operating, the seat warmer will turn OFF.
- The seat warmer defaults to the OFF position whenever the ignition switch or ENGINE START/STOP button is in the ON position.

* NOTICE

With the seat warmer switch in the ON position, the heating system in the seat turns off or on automatically depending on the seat temperature.

⚠ CAUTION

- When cleaning the seats, do not use an organic solvent such as paint thinner, benzene, alcohol and gasoline. Doing so may damage the surface of the heater or seats.
- To prevent overheating the seat warmer, do not place anything on the seats that insulates against heat, such as blankets, cushions or seat covers while the seat warmer is in operation.

- Do not place heavy or sharp objects on seats equipped with seat warmers. Damage to the seat warming components could occur.
- Do not change the seat cover. It may damage the seat warmer or air ventilation system.

⚠ WARNING

Seat warmer burns

The seat warmer may cause burns, even at low temperature, if used over a long period of time. Never allow passengers who may not be able to take care of themselves to be exposed to the risk of seat heater burns. These include:

1. Infants, children, elderly or disabled persons, or hospital outpatients
2. Persons with sensitive skin or those that burn easily
3. Fatigued individuals
4. Intoxicated individuals
5. Individuals taking medication that can cause drowsiness or sleepiness (sleeping pills, cold tablets, etc.)

Air ventilation seat (if equipped)

Front seat



OSP2042058L

The temperature setting of the seat changes according to the switch position.

- To ventilate your seat cushion, press the switch.

Each time you press the switch, the airflow will change as follows:

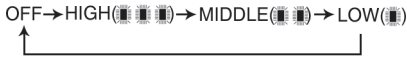

The seat warmer (with air ventilation) defaults to the OFF position whenever the ENGINE START/STOP button is turned on.

⚠ CAUTION

Seat damage

- When cleaning the seats, do not use an organic solvent such as paint thinner, benzene, alcohol and gasoline. Doing so may damage the air ventilation seat.
- Do not place heavy or sharp objects on the seat. Those things may damage the air ventilation seat.
- Be careful not to spill liquid such as water or beverages on the seat. If you spill some liquid, wipe the seat with a dry towel. Before using the air ventilation seat, dry the seat completely.

Sun visor

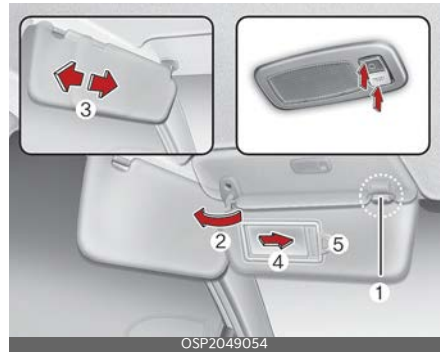

Use the sun visor to shield direct light through the front or side windows.

- To use the sun visor, pull it downward.
 - To use the sun visor for the side window, pull it downward, unsnap it from the bracket (1) and swing it to the side (2). You can slide the sun visor if necessary (3).
 - To use the vanity mirror, pull down the visor and slide the mirror cover (4).
- The ticket holder (5) is provided for holding a tollgate ticket.

⚠ WARNING

For your safety, do not block your view when using the sun visor.

* NOTICE

Do not put several tickets in the ticket holder at one time. This could cause damage to the ticket holder.

USB charger

The USB car charger allows drivers to charge their digital devices like smartphones, and PC tablets. Plug the cable into the USB port, and charging will begin.

Front



Rear (if equipped)



The USB car charger is available with either the ACC on or the ignition on. We recommend you connect the USB port and digital devices with the engine running. See the display screen of the device to check its charging process completion. Your smartphone or tablet PC could get heated up while charging. This is no reason to worry, as it doesn't impact life or functions of the device. For safety, charging can be stopped if the battery gets heated up to a certain point of temperature that the devices can be negatively affected. Charging some digital devices is not available or requires special dedicated adapters if their

charging methods don't fit the way the USB car charger works.

⚠ CAUTION

- Use the USB car charger with the ignition on. Otherwise, vehicle battery can be discharged.
- Use the official USB cable of the manufacturer of the digital device to be charged.
- Make sure that no foreign objects, drinks, and water come into contact with the USB car charger. Water or foreign objects can damage the USB charger.
- Do not connect an electrical device that generates excessive electromagnetic noise to the USB car port. If you do so, noise can be caused or vehicle electronic devices can be interrupted while audio or AV is on.
- If the charger is connected incorrectly, it can cause serious damage on the devices. Please note that damages due to incorrect usage are not covered by warranty service.

Power outlet

The power outlet is designed to provide power for mobile telephones or other devices designed to operate with vehicle electrical systems.

Type A



Type B

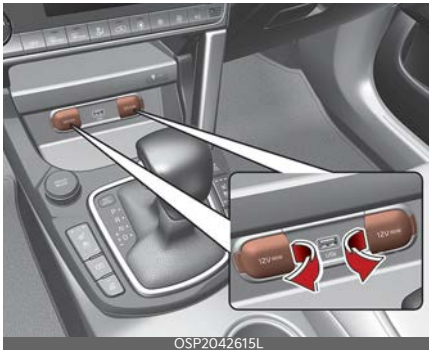

The devices should draw less than 15 amps with the vehicle on.

- Use the power outlet only when the vehicle is on and remove the accessory plug after use. Using the accessory plug for prolonged periods of time with the vehicle off could cause the battery to discharge.
- Only use 12 V electric accessories which are less than 15 A in electric capacity.
- Adjust the air-conditioner or heater to the lowest operating level when using the power outlet.
- Close the cover when not in use.

- Some electronic devices can cause electronic interference when plugged into a vehicle's power outlet. These devices may cause excessive audio static and malfunctions in other electronic systems or devices used in your vehicle.
- Push the plug in as far as it will go. If the plug is not properly inserted into the outlet, the plug may overheat and the fuse may open.
- For electronic devices equipped with batteries, only plug in the devices with reverse current protection. The current from the battery may flow into the vehicle's electrical/electronic system and cause system malfunction.

⚠ WARNING

Electric shock

Do not put a finger or a foreign object (pen, etc.) into a power outlet and do not touch it with a wet hand. You may get an electric shock.

⚠ CAUTION

Do not connect another vehicle's Tire Mobility Kit (TMK) to the power outlet. The unmatched power requirement between the vehicle power outlet and the tire mobility kit can cause fire or circuit damage within the vehicle and the Tire Mobility Kit.

Wireless smart phone charging system (if equipped)

A wireless smart phone charging system is located in front of the center console.



Firmly close all doors, and ignition switch is ON. To start wireless charging, place the smart phone equipped with wireless charging function on the wireless charging pad.

For best wireless charging results, place the smart phone on the center of the charging pad.

The wireless charging system is designed for one smart phone equipped with Qi only. Please refer to the smart phone accessory cover or the smart phone manufacturer homepage to check whether your smart phone supports Qi function.

⚠ WARNING

If any metallic object such as coins is located between the wireless charging system and the smart phone, the charging may be disrupted. Also, the metallic object may heat up.

Wireless smart phone charging

1. Remove any object on the smart phone charging pad including the smart key. If there is any foreign object on the pad other than a smart phone, the wireless charging function may not operate properly.

2. Place the smart phone on the center of the wireless charging pad.
3. The indicator light will change to orange once the wireless charging begins. After the charging is complete, the orange light will change to green.
4. You can choose to turn the wireless charging function to either ON or OFF by selecting the Settings in the Infotainment System screen.

You may activate or deactivate this function from the Settings in the Infotainment System screen as 'Setup → Vehicle → Convenience → Wireless Charging System',

*** INFORMATION**

The infotainment system may change after software updates. For more information, refer to the user's manual provided in the infotainment system and the quick reference guide.

If the wireless charging does not work, gently move your smart phone around the pad until the charging indicator light turns yellow. Depending on the smart phone, the charging indicator light may not turn green even after the charging is complete.

If the wireless charging is not functioning properly, the orange light will blink and flash for ten seconds then turn off. In such cases, remove the smart phone from the pad and replace it on the pad again, or double check the charging status.

If you leave the smart phone on the charging pad when the vehicle ignition is in OFF, the vehicle will alert you through warning messages and sound (applicable for vehicles with voice guidance

function) after the 'Good bye' function on the instrument cluster ends.

* NOTICE

For some manufacturers' smart phones, the system may not warn you even though the smart phone is left on the wireless charging unit. This is due to the particular characteristic of the smart phone and not a malfunction of the wireless charging.

▲ WARNING

Distracted driving

Driving while distracted can result in a loss of vehicle control that may lead to an accident, severe bodily injury, or death. The driver's primary responsibility is in the safe and legal operation of a vehicle, and use of any handheld devices, other equipment, or vehicle systems which take the driver's eyes, attention and focus away from the safe operation of a vehicle, or which are not permissible by law, should never be used during the operation of the vehicle.

▲ CAUTION

Liquid in Wireless Smart Phone Charger

To prevent liquid from damaging the wireless smart phone charging system in your vehicle, be sure not to spill liquid over the charging system.

▲ CAUTION

Metal in Wireless Charging system

If any metallic object such as a coin is located between the wireless charging system and the smart phone, the charging may be disrupted. Also, the metallic object may heat up and poten-

tially damage the charging system. If there is any metallic object between the smart phone and the charging pad, immediately remove the smart phone. Remove the metallic object after it has cooled down.

* NOTICE

- When the interior temperature of the wireless charging system rises above a set temperature, the wireless charging will cease to function. After the interior temperature drops below the threshold, the wireless charging function will resume.
- The wireless charging may not function properly when there is a heavy accessory cover on the smart phone.
- The wireless charging will stop when using the wireless smart key search function to prevent radio wave disruption.
- The wireless charging will stop when the smart key is moved out of the vehicle with the vehicle in ON.
- The wireless charging will stop when any of the doors are opened (applicable for vehicles equipped with smart keys).
- The wireless charging will stop when the vehicle is turned OFF.
- The wireless charging will stop when the smart phone is not in complete contact with the wireless charging pad.
- Items equipped with magnetic components such as credit card, telephone card, bankbook or any transportation ticket may become damaged during wireless charging.
- Place the smart phone on the center of the charge pad for best results. The

smart phone may not charge when placed near the rim of the charging pad. When the smart phone does get charged, it may heat up excessively.

- For smart phones without built-in wireless charging system, an appropriate accessory has to be equipped in order to use the vehicle's wireless charging system.
- Certain smart phones may display messages on a weak current. This is due to the particular characteristics of that smart phone, and does not imply a malfunction of the wireless charging function.
- The indicator light of some manufacturers' smart phones may still be orange after the smart phone is fully charged. This is due to the particular characteristic of the smart phone and not a malfunction of the wireless charging.
- When any smart phone without a wireless charging function or a metallic object is placed on the charging pad, a small noise may sound. This small noise is due to the vehicle discerning compatibility of the object placed on the charging pad. It does not affect your vehicle or the smart phone in any way.
- The wireless smart phone charging system may not support certain smart phones which are not verified for Qi specification **qi**.
- When placing your smart phone on the charging pad, position the phone in the middle of the pad for maximum efficiency.

If your smart phone is off to the side, the charging speed may slow down, and in some cases, your phone may experience higher heat conduction.

- When charging some smart phones with a self-protection feature, the wireless charging speed may decrease, and the charging may stop.
- A smart phone that supports the wireless charging can only be charged wirelessly.
- The wireless charging pad has an internal cooling system which can create noise to keep your phone cool while it charges.

This device complies with Industry Canada licence-exempt RSS standard(s).

Operation is subject to the following two conditions:

1. This device may not cause interference, and
2. This device must accept any interference, including interference that may cause undesired operation of the device

Coat hook

A Coat hook is next to the rear grab handle.



* This actual feature may differ from the illustration.

⚠ CAUTION**Hanging clothing**

Do not hang heavy clothes, since they may damage the hook.

⚠ WARNING

Do not hang objects, such as hangers or hard objects, other than clothes. Also, do not put heavy, sharp or breakable objects in the clothing's pockets. In an accident or when the curtain air bag is inflated, it may cause vehicle damage or body injury.

**Floor mat anchor(s) (if equipped)**

When using a floor mat on the front floor carpet, make sure it attaches to the floor

mat anchor(s) in your vehicle. This keeps the floor mat from sliding forward.

⚠ WARNING**After market floor mat**

- Do not install after market floor mats that are not capable of being securely attached to the vehicle's floor mat anchors. Unsecured floor mats can interfere with pedal operation.
- Use floor mats not too thick and designed to be properly secured on the floor to avoid the interference with pedals. Make sure that installing the floor mats without removing plastic films on carpets may damage or break floor mat fix rings, resulting in the mats to be unsecured. Especially for a driver's seat, the unsecured mats may cause unintended acceleration/brake. Ensure to remove all the plastic films on the carpets before installing the mats.

The following must be observed when installing ANY floor mat to the vehicle.

- Ensure that the floor mats are securely attached to the vehicle's floor mat anchor(s) before driving the vehicle.
- Do not use ANY floor mat that cannot be firmly attached to the vehicle's floor mat anchors.
- Do not stack floor mats on top of one another (e.g., all-weather rubber mat on top of a carpeted floor mat). Only a single floor mat should be installed in each position.

Cargo area cover (if equipped)

Use the cargo area cover to hide items stored in the cargo area.

Removal and installation

To remove the cargo area cover:

1. Remove straps from both sides of the cargo area cover.



2. While lifting the cover up, hold the area near the front slots. Then, pull up the cover at approximately 45° angle.

⚠ WARNING

Folded cover may block the rear view. Put the folded cover in the appropriate position.

⚠ WARNING

Do not place objects on the cargo area cover. Such objects may be thrown about inside the vehicle and possibly injure vehicle occupants during an accident or when braking.

⚠ CAUTION

Since the cargo area cover may be damaged or malformed, do not put luggage on it when it is used.

Roof rack (if equipped)

If your vehicle has a roof rack, you can load cargo and accessories (e.g., cargo carrier, roof tent) on top of your vehicle.



* The actual shape may differ from the illustration.

Cargo and accessories can be attached directly to the roof rack or to Kia cross members (available from an authorized Kia dealer).

*** NOTICE**

- The crossbars (if equipped) should be placed in the proper load carrying positions prior to placing items onto the roof rack.
- When the roof rack is not being used to carry cargo, the crossbars may need to be repositioned if wind noise is detected.

⚠ CAUTION

- When carrying cargo on the roof rack, make sure the cargo does not damage the roof of the vehicle.
- When carrying large objects on the roof rack, make sure they do not exceed the overall roof length or width.
- When carrying cargo on the roof rack, do not operate the sunroof. (if equipped)

- Never place load directly on the sunroof or the roof panels. They are not designed to carry loads and may break. Never let anything interfere with the movement of the sunroof.
- Do not operate the sunroof when carrying cargo or roof accessories.

Load limits

The Kia roof rack can support up to 880 lbs. (400 kg.), evenly distributed (i.e., side to side and front to back), but only when the vehicle is parked.

Never drive the vehicle with more than 220 lbs. (100 kg) of cargo and accessories on the roof racks.

Never allow the combined weight of occupants and cargo to exceed the Gross Vehicle Weight Rating (GVWR) of your vehicle.

WARNING

- Never drive your vehicle when combined weight of occupants and cargo exceeds GVWR. That can cause loss of control and an accident.
- Never drive your vehicle with more than 220 lbs. (100 kg) of cargo on the roof rack. Heavier loads may result in loss of control and rollover.
- Loads on the roof rack raise your vehicle's center of gravity and may change the ways in which your vehicle handles. Avoid sudden starts and braking, sharp turns, abrupt maneuvers, and high speeds that may result in loss of control or rollover.
- Always drive slowly and turn corners carefully when carrying items on the roof rack. Severe wind updrafts, caused by passing vehicles or natural causes, can cause sudden upward

pressure on items loaded on the roof rack. This is especially true when carrying large, flat items such as wood panels or mattresses. This could cause the items to fall off the roof rack and cause damage to your vehicle or others around you.

- Failure to heed these warnings may lead to serious injury and death.

CAUTION

- Overloading the roof racks may also damage them.
- Overloading the vehicle may also damage the vehicle.

Securing items to the roof rack

Plan carefully before attempting to put cargo and accessories on the roof racks. Be sure the items can be secured and that you have the equipment to do so. Get help from those close to you whenever appropriate.

Be sure that the cargo and accessories will not extend too far forward, rearward, or sideways.

Do not allow anything to obscure the view out the windshield or the front view camera. Do not allow anything to obscure the High Mounted Stop Lamp. Obey applicable laws regarding flags and signals on cargo extending beyond the rear of your vehicle.

Be careful to account for the effects that wind may have on the cargo and accessories while moving. Flexible cargo, such as a mattress, can bend under wind loads. Wind effects from driving, passing vehicles, or natural causes can cause sudden upward or downward pressure, resulting in damage to the items, dam-

age to the cross members or roof rack, damage to attachments, loss of visibility, distraction, and loss of control.

Park your vehicle on solid, level ground, place it in P (Park) and set the parking brake before loading and securing items.

If your cargo is covered, be sure that the cover is secure and will not blow off or distract the driver.

Check the security of the attachments after driving for a short distance, and from time to time during your journey.

Securing accessories

Before installing an accessory such as a cargo carrier or roof tent, make sure that the item is compatible with your Kia's roof racks.

Check the accessory manufacturer's manual and online information. Do not attempt to connect an accessory that the manufacturer deems incompatible. Contact the manufacturer or your Kia dealer if you need additional information.

Follow the accessory manufacturer's instructions, warnings, and cautions in addition to those above.

Roof tents

In addition, when using a roof tent:

- Be sure that the weight of occupants does not exceed the load capacity of the roof racks.
- Confirm the roof tent is securely fastened to the cross bars and roof rails before using it.
- Never move the vehicle with occupants in a roof tent.
- Never leave the engine running with occupants in a roof tent. Never run an internal combustion engine (such as a generator), gas stove, gas lantern, or other device that burns fuel near an occupied roof tent or awning. Those emit carbon monoxide, which is colorless, odorless, and deadly.
- Follow the roof tent manufacturer's instructions, warnings, and cautions.

WARNING

Failure to follow the instructions, warnings and cautions above, and those of the accessory manufacturer, could result in damage to your vehicle, to your cargo, and to other road users. It could also result in an accident and in serious injury and death.

Infotainment system

Audio system

* NOTICE

If you install an aftermarket HID head lamp, your vehicle's audio and electronic device may malfunction.

* INFORMATION

If your vehicle is equipped with Infotainment system, refer to a separately supplied manual for detailed information.

Antenna

Shark fin antenna

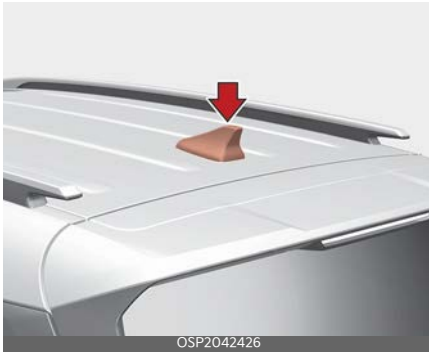

- Shark-fin antenna transmit and receive signals such as AM/FM and GPS.
- Additional signals are sent and received according to vehicle options.

⚠ CAUTION

- Be careful of antenna damage by checking the height of the vehicle before entering low-ceiling spaces such as automated parking lots or automated washing machines.
- Be careful not to contact the antenna when loading cargo on the roof rack.

Antenna transmission/reception performance may be degraded.

USB port

You can use a USB port to plug in a USB.



How vehicle radio works

FM reception

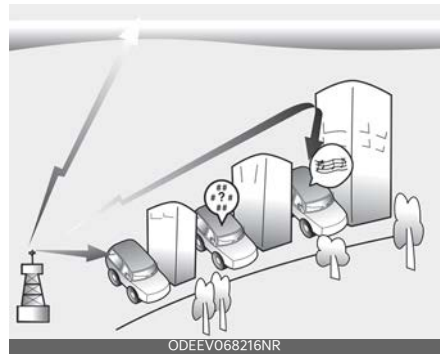

AM and FM radio signals are broadcast from transmitter towers located around your city. They are intercepted by the radio antenna on your vehicle. This signal is then processed by the radio and sent to your vehicle speakers.

However, in some cases the signal coming to your vehicle may not be strong and clear.

This can be due to factors, such as the distance from the radio station, closeness of other strong radio stations or the presence of buildings, bridges or other large obstructions in the area.

AM reception

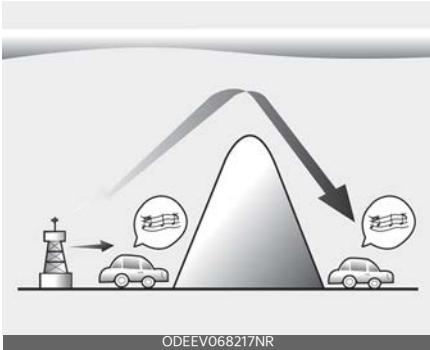

AM broadcasts can be received at greater distances than FM broadcasts. This is because AM radio waves are transmitted at low frequencies. These long distance, low frequency radio waves can follow the curvature of the earth rather than traveling straight. In addition, they curve around obstructions resulting in better signal coverage.

FM radio station

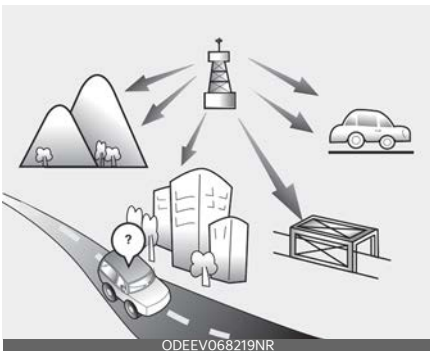

FM broadcasts are transmitted at high frequencies and do not bend to follow the earth's surface. Because of this, FM broadcasts generally begin to fade within short distances from the station. Also, FM signals are easily affected by buildings, mountains, and obstructions. This can lead to undesirable or unpleasant listening conditions which might lead you to believe a problem exists with your radio.

The following conditions are normal and do not indicate radio trouble:

- **Fading** - As your vehicle moves away from the radio station, the signal will weaken and sound will begin to fade. When this occurs, we suggest that you select another station with a stronger signal.

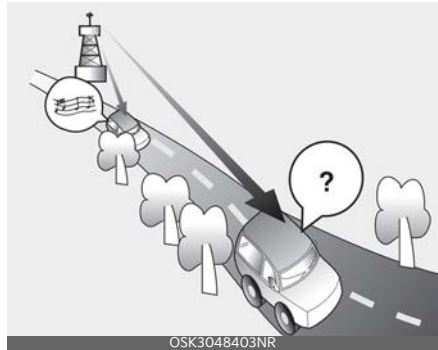

- **Flutter/Static** - Weak FM signals or large obstructions between the transmitter and your radio can disturb the signal causing static or fluttering noises to occur. Reducing the treble level may lessen this effect until the disturbance clears.
- **Station Swapping** - As an FM signal weakens, another more powerful signal near the same frequency may begin to play. This is because your radio is designed to lock onto the

clearest signal. If this occurs, select another station with a stronger signal.

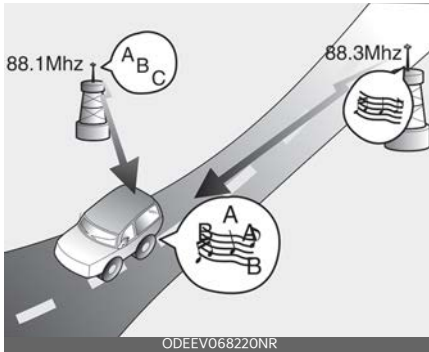

- Multi-Path Cancellation - Radio signals being received from several directions can cause distortion or fluttering. This can be caused by a direct and reflected signal from the same station, or by signals from two stations with close frequencies. If this occurs, select another station until the condition has passed.

⚠ CAUTION

When using a communication system, such as a cellular phone or a radio set, inside the vehicle, a separate external antenna must be fitted. When a cellular phone or a radio set is used with only the internal antenna, it may interfere with the vehicle's electrical system and adversely affect the safe operation of the vehicle.

⚠ WARNING

Cell phone use

Do not use a cellular phone while driving. Stop at a safe location to use a cellular phone.

⚠ WARNING

Distracted driving

Driving while distracted can result in a loss of vehicle control that may lead to an accident, severe bodily injury, or death. The driver's primary responsibility is in the safe and legal operation of a vehicle. Any use of handheld devices, other equipment, or vehicle systems that take the driver's eyes, attention, and focus away from the safe operation of a vehicle are not permissible by law. These should never be used during the operation of the vehicle.

Declaration of Conformity

IC

This device complies with Industry Canada's licence-exempt RSSs.

Operation is subject to the following two conditions:

- (1) This device may not cause interference; and
- (2) This device must accept any interference, including interference that may cause undesired operation of the device.

Le présent appareil est conforme aux CNR d'Industrie Canada applicables aux appareils radio exempts de licence.

L'exploitation est autorisée aux deux conditions suivantes:

- (1) l'appareil ne doit pas produire de brouillage, et
- (2) l'utilisateur de l'appareil doit accepter tout brouillage radioélectrique subi, même si le brouillage est susceptible d'en compromettre le fonctionnement

Be sure the exhaust system does not leak.....	5-3
Before driving	5-3
Key positions.....	5-5
• Illuminated ignition switch	5-5
• Ignition switch position	5-5
• Starting the engine.....	5-6
ENGINE START/STOP button	5-7
• Illuminated ENGINE START/STOP button.....	5-7
• ENGINE START/STOP button position	5-7
• Starting the engine.....	5-8
Vehicle Auto Shut-off system.....	5-10
• Requirements for activation.....	5-10
• Setting Shut-off Time	5-10
• Resetting the time.....	5-10
• Canceling the Vehicle Auto Shut-off system.....	5-10
All Wheel Drive (AWD) system	5-11
• AWD mode	5-11
• For safe All Wheel Drive (AWD) operation.....	5-13
Automatic transmission	5-17
• Automatic transmission operation	5-17
• Shift lock system	5-20
• Good driving practices	5-21
Intelligent variable transmission (IVT).....	5-23
• Intelligent Variable Transmission (IVT) operation	5-23
• Shift lock system	5-26
• Good driving practices	5-27
Brake system.....	5-29
• Power brakes.....	5-29
• Parking Brake (Hand type).....	5-31
• Anti-lock Brake System (ABS)	5-32

5 Driving your vehicle

• Electronic Parking Brake (EPB).....	5-34
• AUTO HOLD	5-37
• Electronic Stability Control (ESC) system.....	5-40
• Vehicle Stability Management (VSM) system	5-42
• Hill-start Assist Control (HAC)	5-44
• Downhill Brake Control (DBC)	5-44
• Good braking practices.....	5-46
Idle Stop and Go (ISG) system	5-47
• Auto stop	5-47
• Auto start	5-47
• Operating conditions.....	5-48
• Deactivating the ISG	5-49
• ISG malfunction	5-49
Drive mode integrated control system	5-50
Economical operation.....	5-52
Special driving conditions	5-53
Winter driving	5-57
Trailer towing	5-59
Vehicle load limit	5-60
• Steps For Determining Correct Load Limit —	5-61
• Certification label	5-63
Vehicle weight.....	5-64

Driving your vehicle

Be sure the exhaust system does not leak.

The exhaust system should be checked whenever the vehicle is raised to change the oil or for any other purpose.

If you hear a change in the sound of the exhaust or if you drive over something that strikes the underneath side of the vehicle, have the exhaust system checked as soon as possible by an authorized Kia dealer.

WARNING

Engine exhaust

Do not inhale exhaust fumes or leave your engine running in an enclosed area for a prolonged time. Exhaust fumes contain carbon monoxide, a colorless and odorless gas that can cause unconsciousness and death by asphyxiation.

WARNING

Open liftgate

Do not drive with the liftgate open. Poisonous exhaust gases can enter the passenger compartment. If you must drive with the liftgate open proceed as follows:

1. Close all windows.
2. Open side vents.
3. Set the air intake control at "Fresh", the air flow control at "Floor" or "Face", and the fan at the highest speed.

Before driving

Before getting into the vehicle, you should examine the car and its surroundings. After getting into the vehicle, you should check a number of things before driving.

Before entering vehicle

- Be sure that all windows, outside mirror(s), and outside lights are clean.
- Check the condition of the tires.
- Check under the vehicle for any sign of leaks.
- Be sure there are no obstacles behind you if you intend to back up.

Necessary inspections

Fluid levels, such as engine oil, engine coolant, brake fluid, and washer fluid should be checked on a regular basis, at the exact interval depending on the fluid. Further details are provided in "Maintenance" on page 8-4.

WARNING

Distracted driving

Focus on the road while driving. The driver's primary responsibility is in the safe and legal operation of the vehicle. Use of any hand-held devices, other equipment or vehicle systems that distract the driver should not be used during vehicle operation.

Before starting

- Close and lock all doors.
- Position the seat so that all controls are easily reached.
- Buckle your seat belt.
- Adjust the inside and outside rear view mirrors.
- Be sure that all lights work.
- Check all gauges.
- Check the operation of warning lights when the ENGINE START/STOP button is turned to the ON position.
- Release the parking brake and make sure the brake warning light is not on.

For safe operation, be sure you are familiar with your vehicle and its equipment.

WARNING

When you intend to park or stop the vehicle with the engine on, be careful not to depress the accelerator pedal for a long period of time. It may overheat the engine or exhaust system and cause fire.

WARNING

Check surroundings

Always check the surrounding areas near your vehicle for people, especially children, before putting a vehicle into D (Drive) or R (Reverse).

WARNING

Loose objects

Securely store items in your vehicle. When you make a sudden stop or turn the steering wheel rapidly, loose objects may drop on the floor and it could interfere with the operation of the foot pedals, possibly causing an accident.

WARNING

Driving under the influence

Do not drive while under the influence of alcohol, drugs, or other impairing substances. Drinking and driving is dangerous. Even a small amount of alcohol will affect your reflexes, perceptions and judgment.

Driving while under the influence of drugs or other impairing substances is as dangerous as or more dangerous than driving drunk.

WARNING

Proper footwear

Always wear appropriate shoes when operating your vehicle. Unsuitable shoes (high heels, ski boots, sandals, etc.) may interfere with your ability to use the brake and accelerator pedals.

Key positions (if equipped)

Your vehicle is equipped with four different ignition positions.

Illuminated ignition switch (if equipped)

Whenever a front door is opened, the ignition switch will illuminate for your convenience, provided the ignition switch is not in the ON position.



The light will go off immediately when the ignition switch is turned on. It will also go off after about 30 seconds when the door is closed.

Ignition switch position

Your vehicle is equipped with four different ignition positions.



LOCK (1)

The ignition key can be removed only in the LOCK position.

ACC (Accessory) (2)

The electrical accessories are operative. If difficulty is experienced turning the ignition switch to the ACC position, turn the key while turning the steering wheel right and left to release the tension.

ON (3)

The warning lights can be checked before the engine is started. This is the normal running position after the engine is started.

Do not leave the ignition switch ON if the engine is not running to prevent battery discharge.

START (4)

Turn the ignition switch to the START position to start the engine. The engine will crank until you release the key; then it returns to the ON position. The brake warning light can be checked in this position.

Before leaving the driver's seat, always make sure the shift lever is engaged in P (Park) for intelligent variable transmission, set the parking brake fully and shut the engine off. Unexpected and sudden vehicle movement may occur if these precautions are not taken.

⚠ WARNING**Ignition switch**

Never turn the ignition switch to LOCK or ACC while the vehicle is moving. This would result in loss of directional control and braking function, which could cause an accident.

*** NOTICE**

If you leave the ignition switch to the ACC or ON position for a long time, the battery may discharge.

⚠ WARNING**Key holder**

Do not attach small purses, multiple keys, or any other heavy accessories to the driver's key chain used to start the vehicle. This may cause the driver to accidentally make the key inserted in the vehicle to change the ignition position to the ACC position while the vehicle is moving thereby increasing the risk of an accident and causing the deactivation of several safety features.

⚠ WARNING**Leaving the Vehicle**

To avoid unexpected or sudden vehicle movement, never leave your vehicle if the transmission is not locked in the P (Park) position and the parking brake is fully engaged. Before leaving the driver's seat, always make sure the shift lever is engaged in P (Park), set the parking brake fully and shut the engine off.

Starting the engine

1. Make sure the parking brake is applied.

2. Place the transmission shift lever in P (Park). Depress the brake pedal fully. You can also start the engine when the shift lever is in the N (Neutral) position.
3. Turn the ignition switch to START and hold it there until the engine starts (a maximum of 10 seconds), then release the key.
It should be started **without depressing the accelerator**.
4. Do not wait for the engine to warm up while the vehicle remains stationary. Start driving at moderate engine speeds. (Steep accelerating and decelerating should be avoided.)

⚠ WARNING**Steering wheel**

Never reach for any controls through the steering wheel while the vehicle is in motion. The presence of your hand or arm in this area could cause a loss of vehicle control.

If the engine stalls while you are in motion, do not attempt to move the shift lever to the P (Park) position. If traffic and road conditions permit, you may put the shift lever in the N (Neutral) position while the vehicle is still moving and turn the ignition switch to the START position in an attempt to restart the engine.

⚠ CAUTION**Starter**

Do not engage the starter for more than 10 seconds. If the engine stalls or fails to start, wait 5 to 10 seconds before reengaging the starter. Improper use of the starter may damage it.

ENGINE START/STOP button (if equipped)

Illuminated ENGINE START/STOP button (if equipped)



OSP2N052284

The light will go off after about 30 seconds when the door is closed. It will also go off immediately when the theft-alarm system is armed.

ENGINE START/STOP button position

Your vehicle is equipped with four different ignition positions.

OFF

To turn off the engine (START/RUN position) or vehicle power (ON position), press the ENGINE START/STOP button with the shift lever in the P (Park) position. When you press the ENGINE START/STOP button without the shift lever in the P (Park) position, the ENGINE START/STOP button will not change to the OFF position but to the ACC position.

* NOTICE

You are able to turn off the engine (START/RUN) or vehicle power (ON), only when the vehicle is not in motion.

⚠ CAUTION

In an emergency situation while the vehicle is in motion, you are able to turn the engine off and to the ACC position by pressing the ENGINE START/STOP button for more than 2 seconds or 3 times repeatedly within 3 seconds.

If the vehicle is still moving, to restart the vehicle:

- Press the ENGINE START/STOP button when vehicle speed is 5 km/h (3 mph) or over.

ACC (Accessory)



OSP2052505L

Press the ENGINE START/STOP button while it is in the OFF position without depressing the brake pedal.

The steering wheel unlocks and electrical accessories are operational.

If the ENGINE START/STOP button is in the ACC position for more than 1 hour, the button is turned off automatically to prevent battery discharge.

ON

Press the ENGINE START/STOP button while it is in the ACC position without depressing the brake pedal.

The warning lights can be checked before the engine is started. Do not leave the ENGINE START/STOP button in the ON position for a long time. The battery may discharge, because the engine is not running.

START/RUN

To start the engine, depress the brake pedal and press the ENGINE START/STOP button with the shift lever in the P (Park) or the N (Neutral) position. For your safety, start the engine with the shift lever in the P (Park) position.

* NOTICE

If you press the ENGINE START/STOP button without pressing the brake pedal, the engine will not start and the ENGINE START/STOP button changes as follow: OFF → ACC → ON → OFF or ACC

⚠ WARNING

- Never press the ENGINE START/STOP button while the vehicle is in motion. This would result in loss of directional control and braking function, which could cause an accident.
- Before leaving the driver's seat, always make sure the shift lever is engaged in P (Park), set the parking brake fully and shut the engine off. Unexpected and sudden vehicle movement may occur if these precautions are not taken.
- Never reach for the ENGINE START/STOP button or any other controls through the steering wheel while the

vehicle is in motion. The presence of your hand or arm in the area could cause loss of vehicle control, an accident and serious bodily injury or death.

- Do not place any movable objects around the driver's seat as they may move while driving, interfere with the driver and lead to an accident.

Starting the engine

⚠ WARNING

- Do not start the vehicle with the accelerator pedal engaged. The vehicle can move and lead to an accident.
- Wait until the engine rpm is normal. The vehicle may suddenly move if the brake pedal is released when the rpm is high.

Starting the engine

1. Make sure the smart key is located inside the vehicle and close the driver seat. The vehicle may not start if it is not located near the driver seat.
2. Make sure the parking brake is applied.
3. Make sure the shift lever in P (Park).
 - Press the brake pedal fully.
 You can also start the engine when the shift lever is in the N (Neutral) position.
4. Press the ENGINE START/STOP button.

Make sure that the accelerator pedal is not pressed.
5. Do not wait for the engine to warm up while the vehicle remains stationary. Start driving at moderate engine speeds. (Steep accelerating and decelerating should be avoided.)

Starting the engine with smart key

At the time that the vehicle doors are opened or when the ENGINE START/STOP button is pressed, the vehicle will check for the smart key.

If the smart key is not in the vehicle, the "🚗" indicator and a message "Key is not in the vehicle" will appear on the instrument cluster and LCD display. And if all doors are closed, the chime will sound for 5 seconds. The indicator or warning will turn off while the vehicle is moving. Always have the smart key with you.

⚠️ WARNING

The engine will start, only when the smart key is in the vehicle. Never allow children or any person who is unfamiliar with the vehicle touch the ENGINE START/STOP button or related parts. Pushing the ENGINE START/STOP button while the smart key is in the vehicle may result in unintended engine activation and/or unintended vehicle movement.

⚠️ CAUTION

If the engine stalls while the vehicle is in motion, do not attempt to move the shift lever to the P (Park) position. If the traffic and road conditions permit, you may put the shift lever in the N (Neutral) position while the vehicle is still moving and press the ENGINE START/STOP button in an attempt to restart the engine.

* NOTICE

- If the battery is weak or the smart key does not work correctly, you can start the engine by pressing the ENGINE START/STOP button with the smart key.

When you press the ENGINE START/STOP button directly with the smart key, the smart key should contact the button at a right angle.



- When the stop lamp fuse is blown, you cannot start the engine normally. Replace the fuse with a new one. If it is not possible, you can start the engine by pressing the ENGINE START/STOP button for 10 seconds while it is in the ACC position. The engine can start without pressing the brake pedal. But for your safety, always press the brake pedal before starting the engine.

⚠️ CAUTION

Do not press the ENGINE START/STOP button for more than 10 seconds, except when the stop lamp fuse is blown.

Vehicle Auto Shut-off system (if equipped)

The vehicle auto shut-off system is designed to automatically shut off the vehicle after a certain time the driver sets to reduce fuel consumption and energy consumption of the vehicle and to prevent carbon monoxide (CO) poisoning.

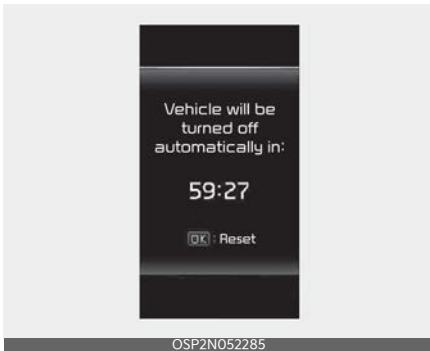

Requirements for activation

This system can be activated, when the following all requirements are satisfied.

- The ignition switch is ON.
- The transmission is in the P (Park) position.
- The vehicle stops.
- The vehicle speed is under 3 km/h (2 mph).
- The driver's seat belt is unfastened.
- The door is opened.
- The passenger's seat is not occupied.

Setting Shut-off Time

The driver can set the shut-off time on the cluster LCD display or the infotainment system screen (if equipped).

The option can be found under the following menu:

With the ignition switch or ENGINE START/STOP button in the ON position,

select 'User Settings → Convenience → Vehicle Auto-Shut Off → 60 min./30 min./Off' on the LCD display or 'Setup → Vehicle → Convenience → Vehicle Auto-Shut Off → 60min/30min/Off' on the Infotainment system screen to set whether to use the function.

* NOTICE

- The default setting will be retained until the timer is reset.
- The timer will revert back to the previous setting at the next startup if the driver selects 'Off' in the User Settings mode.

* NOTICE

- The default setting is 30 minutes.

Resetting the time

The system can be initialized and restarted under the following conditions:

- When pressing and releasing the brake pedal.
- When the accelerator pedal is depressed.
- When the driver manually resets the timer.
- When the driver manually press the OK button on the steering wheel.

Canceling the Vehicle Auto Shut-off system

The system will be canceled automatically when:

- The vehicle speed is over 3 km/h (2 mph).
- The vehicle is shifted to D (Drive), R (Reverse) or N (Neutral).
- The driver's seat belt is fastened.

All Wheel Drive (AWD) system (if equipped)

The All Wheel Drive (AWD) system delivers engine power to front and rear wheels for maximum traction.

AWD is useful when extra traction is required, such as when driving slippery, muddy, wet, or snow-covered roads.

If the system determines there is a need for four wheel drive, the engine's driving power will be distributed to all four wheels automatically.

LCD display for warning message



If the AWD system malfunctions, a warning message will be displayed. Have your vehicle checked by an authorized Kia dealer as soon as possible.

⚠ WARNING

To reduce the risk of SERIOUS INJURY or DEATH:

- Do not drive in conditions that exceed the vehicle's intended design, such as challenging off-road conditions.
- Avoid high speeds when cornering or turning.
- Do not make quick steering wheel movements, such as sharp lane changes or fast, sharp turns.

- The risk of a rollover is greatly increased if you lose control of your vehicle at highway speeds.
- Loss of control often occurs if two or more wheels drop off the roadway and the driver over steers to reenter the roadway.
- In the event your vehicle leaves the roadway, do not steer sharply. Instead, slow down before pulling back into the travel lanes.



AWD mode

AWD helps the vehicle's performance by controlling 4 wheels.



You can switch from AWD AUTO mode to AWD Lock mode by pressing AWD Lock mode switch.

AWD transfer mode selection

Transfer mode	Selection button	Indicator light	Description
AWD AUTO	-		<ul style="list-style-type: none"> • AWD AUTO is used when driving on roads in normal conditions, roads in urban areas, and on highways. • All wheels are in operation when a vehicle travels at a constant speed. Required tractions are applied on front and rear wheels vary depending on road and driving conditions, which will be automatically controlled by the computing system. • When the cluster's AWD Auto display mode is selected, the cluster displays the status of how four wheel's traction forces are distributed.
AWD LOCK			<ul style="list-style-type: none"> • The main goal of AWD Lock mode is to allow a driver to maximize the vehicle's traction under extreme driving conditions, such as unpaved off-road, sandy roads, and muddy roads. • When AWD Lock mode appears, the cluster does not display the front/rear wheel traction force distribution status. • Press the AWD Lock mode switch again to switch back to AWD Auto.

* NOTICE

Normal road conditions

- Maintain AWD Auto mode when driving on roads in normal conditions.
- When driving under normal road conditions (especially when cornering) in AWD Lock mode, a driver may find minor mechanical vibration or noise, which is an extremely normal phenomenon, not a malfunction. When AWD Lock mode is released, such noise or vibration will be immediately gone.

* NOTICE

AWD (All Wheel Drive) vehicle must be towed with all wheels off the ground, either on a flatbed tow truck or using dollies.

⚠ CAUTION

The AWD vehicle should never be towed with the wheels on the ground. This can cause serious damage to the transmission or the AWD system.

For safe All Wheel Drive (AWD) operation

⚠ WARNING

All Wheel Drive

The conditions of on-road or off-road that demand All Wheel Drive means all functions of your vehicle is exposed to extreme stress than under normal road conditions. Slow down and be ready for changes in the composition and traction of the surface under your tires. If you have any doubt about the safety of the conditions you are facing, stop and consider the best way to proceed.

- Do not try to drive in deep standing water or mud since such conditions can stall your engine and clog your exhaust pipes. Do not drive down steep hills since it requires extreme skill to maintain control of the vehicle.



- When you are driving up or down hills drive as straight as possible. Use extreme caution in going up or down steep hills, since you may flip your vehicle over depending on the grade, terrain and water/mud conditions.



⚠ WARNING

Hills

Driving across the contour of steep hills can be extremely dangerous. This danger can come from slight changes in the wheel angle, which can destabilize the vehicle or, even if the vehicle is maintaining stability under power, it can lose that stability if the vehicle stops its forward motion. Your vehicle may roll over without warning and without time for you to correct a mistake that could cause serious injury or death.

- You must learn how to corner in a AWD vehicle. Do not rely on your experience in conventional FWD vehicles when cornering the vehicle in AWD mode. For starters, you must drive slower in AWD.

⚠ WARNING

All Wheel Drive (AWD)

Reduce speed when you turn corners. The center of gravity of AWD vehicles is higher than that of conventional FWD vehicles, making them more likely to roll over when you turn corners too fast.

⚠ WARNING**Steering wheel**

Do not grab the inside of the steering wheel when you are driving on unpaved roads. You may hurt your arm by a sudden steering maneuver or from steering wheel rebound due to impact with objects on the ground. You could lose control of the steering wheel.

- Always hold the steering wheel firmly when you are driving on unpaved roads.
- Make sure all passengers are wearing seat belts.

⚠ WARNING**Wind danger**

If you are driving in heavy wind, drive more slowly, as the vehicle's higher center of gravity decreases your steering control capacity.

- If you need to drive in the water, stop your vehicle, set your transfer to the AWD LOCK mode and drive at less than 8 km/h (5 mph).

⚠ WARNING**Driving through water**

Drive slowly. If you are driving too fast in water, the water can get into the engine compartment and wet the ignition system, causing your vehicle to suddenly stop. If this happens and your vehicle is in a tilted position, your vehicle may roll over.

*** NOTICE**

- Do not drive in water if the level is higher than the bottom of the vehicle.
- Check your brake condition once you are out of mud or water. Press the brake pedal several times as you move slowly until you feel normal braking forces return.
- Shorten your scheduled maintenance interval if you drive in offroad conditions, such as sand, mud or water (refer to "Severe Driving Conditions" on page 8-13). Always wash your vehicle thoroughly after off-road use, especially the bottom of the vehicle.
- Since the driving torque is always applied to the 4 wheels the performance of the AWD vehicle is greatly affected by the condition of the tires. Be sure to equip the vehicle with four tires of the same size and type.
- A full time All Wheel Drive vehicle cannot be towed by an ordinary tow truck. Make sure that the vehicle is placed on a flat bed truck for moving.

⚠ WARNING**All Wheel Drive (AWD) driving**

- Avoid high cornering speed.
- Do not make quick steering wheel movements, such as sharp lane changes or fast, sharp turns.
- The risk of rollover is greatly increased if you lose control of your vehicle at high speed.
- In a collision, an unbelted person is significantly more likely to die compared to a person wearing a seat belt.
- Loss of control often occurs if two or more wheels drop off the roadway and the driver over-steers to re-enter the roadway. In the event your vehicle leaves the roadway, do not steer sharply. Instead, slow down before pulling back into the travel lanes.

⚠ CAUTION**Mud or snow**

If one of the front or rear wheels begins to spin in mud, snow, etc. the vehicle can sometimes be driven out by engaging the accelerator pedal further; however avoid running the engine continuously at high rpm because doing so could damage the AWD system.

Driving in sand or mud

- Maintain slow and constant speed. Operate the accelerator pedal slowly to ensure safe driving (wheel-slip prevention).
- Keep sufficient distance between your vehicle and the vehicle in front of you.
- Reduce vehicle speed and always check the road condition.

- Avoid speeding, rapid acceleration, sudden brake applications, and sharp turns to prevent getting stuck.
- When the vehicle is stuck in snow, sand or mud, the tires may not operate.
- This is to protect the transmission and not a malfunction.

*** NOTICE**

Moving the car forcibly to get out of mud or sand can cause damage/overheat of the engine or damage/breakdown of the transmission, differential or AWD system as well as damage to tires. If excessive wheel slip occurs after entering a sandy/muddy road, the vehicle may fall into the sand/mud. When this happens, put a stone or a tree branch under the tire, and then try to pull out the car, or try to get it unstuck by repeatedly moving forwards and backwards.

⚠ WARNING

Your vehicle is equipped with tires designed to provide safe riding and handling capability. Do not use tires and wheels that are different in size and type from the originally installed ones. It can affect the safety and performance of your vehicle, which could lead to steering failure or rollover and serious injury. When replacing the tires, be sure to equip all four tires with the tire and wheel of the same size, type, tread, brand and load-carrying capacity.

⚠ WARNING**Jacked vehicle**

While the full-time AWD vehicle is being raised on a jack, never start the engine or cause the tires to rotate.

There is the danger that rotating tires touching the ground could cause the jack to go off the vehicle and to jump forward.

- Full-time AWD vehicles must be tested on a special four wheel chassis dynamometer.

* NOTICE

Never engage the parking brake while performing these tests.

- A full-time AWD vehicle should not be tested on a FWD roll tester. If a FWD roll tester must be used, perform the following:

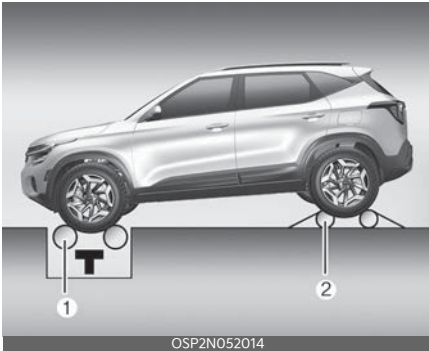

1. Place the front wheels on the roll tester (1) for a speedometer test as shown in the illustration.
2. Release the parking brake.
3. Place the rear wheels on the temporary free roller (2) as shown in the illustration.

⚠ WARNING

Dynamometer testing

Keep away from the front of the vehicle while the vehicle is in gear on the dynamometer. This is very dangerous as the vehicle can jump forward and cause serious injury or death.



⚠ CAUTION

- When lifting up the vehicle, do not operate front and rear wheels separately. All four wheels should be operated.
- If you need to operate the front wheel and rear wheels when lifting up the vehicle, you should release the parking brake.

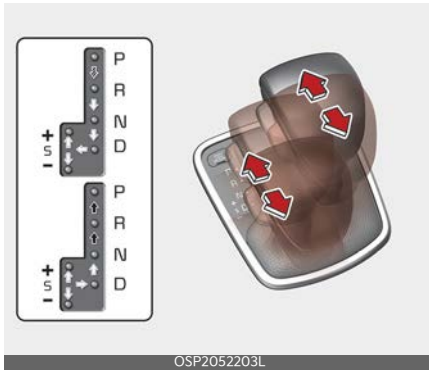
Automatic transmission (if equipped)



OSP2052203L

-  Depress the brake pedal and the lock release button when shifting.
-  Press the lock release button when shifting.
-  The shift lever can be shifted freely.

Automatic transmission operation

The automatic transmission has 8 forward speeds and one reverse speed. The individual speeds are selected automatically, depending on the position of the shift lever.

* NOTICE

The first few shifts on a new vehicle, if the battery has been disconnected, may be somewhat abrupt. This is a normal condition, and the shifting sequence will adjust after shifts are cycled a few times by the TCM (Transmission Control Module) or PCM (Powertrain Control Module).

For smooth operation, depress the brake pedal when shifting from N (Neutral) to a forward or reverse gear.

⚠ WARNING

Automatic transmission

- Always check the surrounding areas near your vehicle for people, especially children, before shifting a vehicle into D (Drive) or R (Reverse).
- Before leaving the driver's seat, always make sure the shift lever is in the P (Park) position; then set the parking brake fully and shut the engine off. Unexpected and sudden vehicle movement can occur if these precautions are not followed in the order identified.
- Do not use the engine brake (shifting from a high gear to lower gear) rapidly on slippery roads. The vehicle may slip causing an accident.

⚠ CAUTION

- To avoid damage to your transmission, do not accelerate the engine in R (Reverse) or any forward gear position with the brakes on.
- When stopped on an incline, do not hold the vehicle stationary with engine power. Use the service brake or the parking brake.
- Do not shift from N (Neutral) or P (Park) into D (Drive), or R (Reverse) when the engine is above idle speed.

LCD display for warning message

A warning message is displayed on the LCD in a warning condition.

Transmission overheated

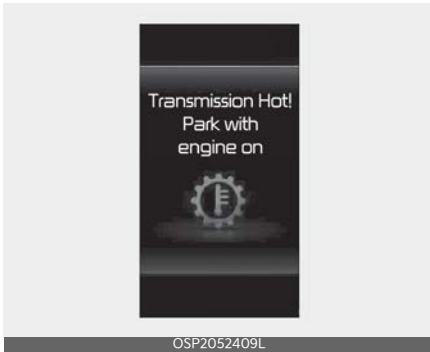

- When driving under severe conditions such as repeated sudden starts and sudden acceleration, the transmission may overheat, and a warning sound and a warning message appear on the instrument cluster due to the self-protection mode.
- If this occurs, pull over to a safe location, stop the vehicle with the engine running, apply brakes and shift the gear to P (Park), and allow the transmission to cool.
- If the warning message continues to appear, have the system checked by an authorized Kia dealer to prevent unexpected accidents.

- If the transmission continues to drive overheating and reaches its maximum temperature, the above warning message appears. In this case, the vehicle limits transmission power by its self protection mode.
- When such a situation occurs, normal driving is restricted until the transmission goes down to normal temperature, so after moving the vehicle to a safe place, shift the gear to P (Park) with the engine running and wait several minutes until the warning on the screen disappears.
- If the warning message continues to appear, have the system checked by an authorized Kia dealer to prevent unexpected accidents.

Transmission cooled

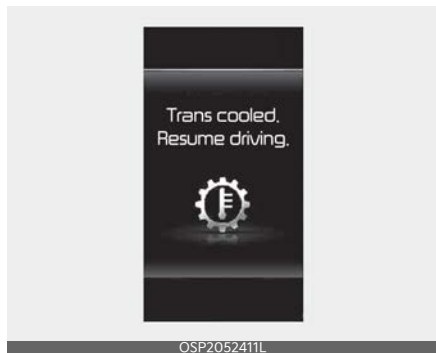

- When the message "Trans cooled. Resume driving" appears you can continue to drive your vehicle.

Vehicle power limited



Transmission ranges

The indicator in the instrument cluster displays the shift lever position when the ignition switch is in the ON position.

P (Park)

Always come to a complete stop before shifting into P (Park). This position locks the transmission and prevents the front wheels from rotating.

⚠ WARNING

- Shifting into P (Park) while the vehicle is in motion will cause the drive wheels to lock which will cause you to lose control of the vehicle.
- Do not use the P (Park) position in place of the parking brake. Always make sure the shift lever is latched in the P (Park) position and set the parking brake fully.
- Never leave a child unattended in a vehicle.

⚠ CAUTION

The transmission may be damaged if you shift into P (Park) while the vehicle is in motion.

R (Reverse)

Use this position to drive the vehicle backward.

⚠ CAUTION

Always come to a complete stop before shifting into or out of R (Reverse); you may damage the transmission if you shift into R while the vehicle is in motion, except as explained in "Rocking the vehicle" on page 5-54.

N (Neutral)

The wheels and transmission are not engaged. The vehicle will roll freely even on the slightest incline unless the parking brake or service brakes are applied.

⚠ WARNING

Do not drive with the shift lever in N (Neutral).

The engine brake will not work and lead to an accident.

⚠ CAUTION

- After the ignition switch has been turned off, the electronic parking brake cannot be disengaged.
- For EPB (Electronic Parking Brake) equipped vehicles with AUTO HOLD function used while driving, if the ignition button has been turned OFF, the electronic parking brake will be engaged automatically. Therefore, AUTO HOLD function should be turned off before the ignition button is turned off.

D (Drive)

This is the normal forward driving position. The transmission will automatically shift through a 8 gear sequence, providing the best fuel economy and power.

For extra power when passing another vehicle or climbing grades, depress the accelerator fully, at which time the transmission will automatically downshift to the next lower gear.

* NOTICE

Always come to a complete stop before shifting into D (Drive).

Sports mode



OSP2N052334

Whether the vehicle is stationary or in motion, sports mode is selected by pushing the shift lever from the D (Drive) position into the manual gate. To return to D (Drive) range operation, push the shift lever back into the main gate.

In sports mode, moving the shift lever backwards and forwards will allow you to make gearshifts rapidly. In contrast to a manual transmission, the sports mode allows gearshifts with the accelerator pedal depressed.

- Up (+): Push the lever forward once to shift up one gear.
- Down (-): Pull the lever backwards once to shift down one gear.

* NOTICE

- In sports mode, the driver must execute upshifts in accordance with road conditions, taking care to keep the engine speed below the red zone.
- In sports mode, only the 8 forward gears can be selected. To reverse or park the vehicle, move the shift lever to the R (Reverse) or P (Park) position as required.

- In sports mode, downshifts are made automatically when the vehicle slows down. When the vehicle stops, 1st gear is automatically selected.
- In sports mode, when the engine rpm approaches the red zone shift points are varied to upshift automatically.
- To maintain the required levels of vehicle performance and safety, the system may not execute certain gearshifts when the shift lever is operated.

Shift lock system

For your safety, the automatic transmission has a shift lock system which prevents shifting the transmission from P (Park) into R (Reverse) unless the brake pedal is depressed.

To shift the transmission from P (Park) into R (Reverse):

1. Depress and hold the brake pedal.
2. Start the engine or turn the ignition switch to the ON position.
3. Move the shift lever.

If the brake pedal is repeatedly depressed and released with the shift lever in the P (Park) position, a chattering noise near the shift lever may be heard. This is a normal condition.

⚠ WARNING

Always fully depress the brake pedal before and while shifting out of the P (Park) position into another position to avoid inadvertent motion of the vehicle which could injure persons in or around the vehicle.

Shift-lock override

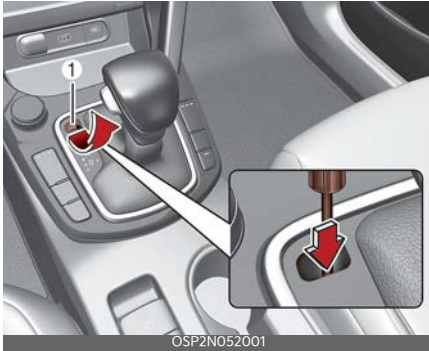

If the shift lever cannot be moved from the P (Park) position into R (Reverse) position with the brake pedal depressed, continue depressing the brake, and then do the following:

1. Place the ignition switch in the LOCK/OFF position.
2. Apply the parking brake.
3. Carefully remove the cap covering (1) the shift-lock release access hole.
4. Insert a tool (e.g., flathead screwdriver) into the access hole and press down on the tool.
5. Move the shift lever.
6. Remove the tool from the shift-lock override access hole then install the cap.

If the shift lever does not move even after performing this procedure, have the system inspected by an authorized Kia dealer.

Ignition key interlock system (if equipped)

The ignition key cannot be removed unless the shift lever is in the P (Park) position.

Good driving practices

- Never move the shift lever from P (Park) or N (Neutral) to any other position with the accelerator pedal depressed.
- Never move the shift lever into P (Park) when the vehicle is in motion.
- Be sure the vehicle is completely stopped before you attempt to shift into R (Reverse) or D (Drive).
- Never take the vehicle out of gear and coast down a hill. This may be extremely hazardous. Always leave the vehicle in gear when moving.
- Do not "ride" the brakes. This can cause them to overheat and malfunction. Instead, when you are driving down a long hill, slow down and shift to a lower gear. When you do this, engine braking will help slow down the vehicle.
- Slow down before shifting to a lower gear. Otherwise, the lower gear may not be engaged.
- Always use the parking brake. Do not depend on placing the transmission in P (Park) to keep the vehicle from moving.
- Exercise extreme caution when driving on a slippery surface. Be especially careful when braking, accelerating or shifting gears. On a slippery surface, an abrupt change in vehicle speed can cause the drive wheels to lose traction and the vehicle to go out of control.
- Optimum vehicle performance and economy is obtained by smoothly depressing and releasing the accelerator pedal.

⚠ WARNING

- When driving uphill or downhill, always shift to D (Drive) for driving forward or shift to R (Reverse) for driving backwards, and check the gear position indicated on the cluster before driving.
Driving in the opposite direction of the selected gear can lead to a dangerous situation by shutting off the engine and affecting the braking performance.
- Always buckle-up! In a collision, an unbelted occupant is significantly more likely to be seriously injured or killed than a properly belted occupant.
- Avoid high speeds when cornering or turning.
- Do not make quick steering wheel movements, such as sharp lane changes or fast, sharp turns.
- The risk of rollover is greatly increased if you lose control of your vehicle at highway speeds.
- Loss of control often occurs if two or more wheels drop off the roadway and the driver oversteers to reenter the roadway.
- In the event your vehicle leaves the roadway, do not steer sharply. Instead, slow down before pulling back into the travel lanes.
- Never exceed posted speed limits.

⚠ WARNING

If your vehicle becomes stuck in snow, mud, sand, etc., then you may attempt to rock the vehicle free by moving it forward and backward. Do not attempt this procedure if people or objects are anywhere near the vehicle. During the rocking operation the vehicle may suddenly move forward or backward as it becomes unstuck, causing injury or damage to nearby people or objects.

Moving up a steep grade from a standing start

To move up a steep grade from a standing start, depress the brake pedal, shift the shift lever to D (Drive). Select the appropriate gear depending on load weight and steepness of the grade, and release the parking brake. Depress the accelerator gradually while releasing the service brakes.

When accelerating from a stop on a steep hill, the vehicle may have a tendency to roll backwards.

Intelligent variable transmission (IVT) (if equipped)

The Intelligent Variable Transmission (IVT) automatically shifts depending on speed, accelerate pedal position. The individual speeds are selected automatically, depending on the position of the shift lever.

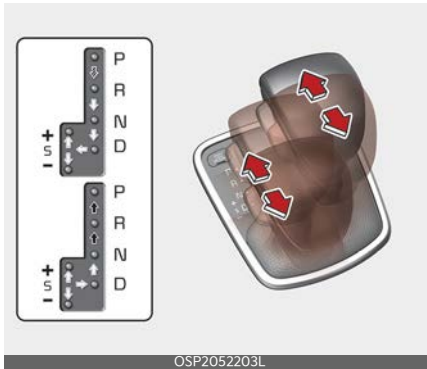

➡ Depress the brake pedal and the lock release button when shifting.

➡ Press the lock release button when shifting.

⇄ The shift lever can be shifted freely.

Intelligent Variable Transmission (IVT) operation

For smooth operation, depress the brake pedal when shifting from N (Neutral) to a forward or reverse gear.

⚠ WARNING

Intelligent Variable Transmission (IVT)

- Always check the surrounding areas near your vehicle for people, especially children, before shifting a car into D (Drive) or R (Reverse).
- Before leaving the driver's seat, always make sure the shift lever is in

the P (Park) position; then set the parking brake fully and shut the engine off. Unexpected and sudden vehicle movement can occur if these precautions are not followed in the order identified.

- Do not use the engine brake (shifting from a high gear to lower gear) rapidly on slippery roads.

The vehicle may slip causing an accident.

⚠ CAUTION

- To avoid damage to your transmission, do not accelerate the engine in R (Reverse) or any forward gear position with the brakes on.
- When stopped on an incline, do not hold the vehicle stationary with engine power. Use the service brake or the parking brake.
- Do not shift from N (Neutral) or P (Park) into D (Drive) or R (Reverse) when the engine is above idle speed.

LCD display for warning message

A warning message is displayed on the LCD in a warning condition.

Transmission overheated

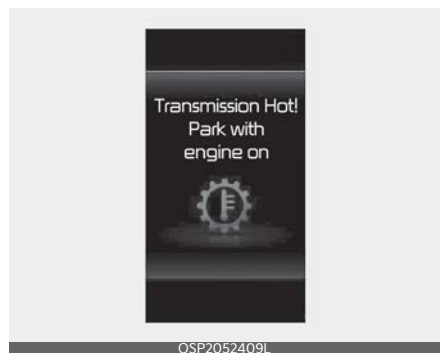

- When driving under severe conditions such as repeated sudden starts and sudden acceleration, the transmission may overheat, and a warning sound and a warning message appear on the instrument cluster due to the self-protection mode.
- If this occurs, pull over to a safe location, stop the vehicle with the engine running, apply brakes and shift the gear to P (Park), and allow the transmission to cool.
- If the warning message continues to appear, have the system checked by an authorized Kia dealer to prevent unexpected accidents.

Vehicle power limited



- If the transmission continues to drive overheating and reaches its maximum temperature, the above warning message appears. In this case, the vehicle limits transmission power by its self-protection mode.
- When such a situation occurs, normal driving is restricted until the transmission goes down to normal temperature, so after moving the vehicle to a safe place, shift the gear to P (Park) with the engine running and wait sev-

eral minutes until the warning on the screen disappears.

- If the warning message continues to appear, have the system checked by an authorized Kia dealer to prevent unexpected accidents.

Transmission cooled



- When the message "Trans cooled. Resume driving" appears you can continue to drive your vehicle.

Transmission ranges

The indicator in the instrument cluster displays the shift lever position when the ignition switch is in the ON position.

P (Park)

Always come to a complete stop before shifting into P (Park). This position locks the transmission and prevents the front wheels from rotating.

⚠ WARNING

- Shifting into P (Park) while the vehicle is in motion will cause the drive wheels to lock which will cause you to lose control of the vehicle.

- Do not use the P (Park) position in place of the parking brake. Always make sure the shift lever is latched in the P (Park) position and set the parking brake fully.
- Never leave a child unattended in a vehicle.

⚠ CAUTION

The transmission may be damaged if you shift into P (Park) while the vehicle is in motion.

R (Reverse)

Use this position to drive the vehicle backward.

⚠ CAUTION

Always come to a complete stop before shifting into or out of R (Reverse); you may damage the transmission if you shift into R while the vehicle is in motion, except as explained in "Rocking the vehicle" on page 5-54.

N (Neutral)

The wheels and transmission are not engaged. The vehicle will roll freely even on the slightest incline unless the parking brake or service brakes are applied.

⚠ WARNING

Do not drive with the shift lever in N (Neutral).

The engine brake will not work and may lead to an accident.

⚠ CAUTION

- Always park the vehicle in "P" (Park) for safety and engage the parking brake.

⚠ CAUTION

- After the ignition switch has been turned off, the electronic parking brake cannot be disengaged.
- For EPB (Electronic Parking Brake) equipped vehicles with AUTO HOLD function used while driving, if the ignition button has been turned "OFF", the electronic parking brake will be engaged automatically. Therefore, AUTO HOLD function should be turned off before the ignition button is turned off.

D (Drive)

This is the normal forward driving position. The transmission will automatically shift, providing the best fuel economy and power.

For extra power when passing another vehicle or climbing grades, depress the accelerator fully, at which time the transmission will automatically downshift to the next lower gear.

*** NOTICE**

Always come to a complete stop before shifting into D (Drive).

Sports mode



Whether the vehicle is stationary or in motion, sports mode can be selected by pushing the shift lever from the D (Drive) position into the manual gate. To return to D (Drive) range operation, push the shift lever back into the main gate.

SPORT mode manages the driving dynamics by automatically adjusting the steering effort, and the engine and transmission control logic for enhanced driver performance.

In sports mode, moving the shift lever backwards and forwards will allow you to select the desired range of gears for the current driving conditions.

- Up (+): Push the lever forward once to shift up one gear.
- Down (-): Pull the lever backwards once to shift down one gear.

* NOTICE

- In sports mode, the driver must execute upshifts in accordance with road conditions, taking care to keep the engine speed below the red zone.
- In sports mode, only the 8 forward gears can be selected. To reverse or park the vehicle, move the shift lever to the R (Reverse) or P (Park) position as required.

- In sports mode, downshifts are made automatically when the vehicle slows down. When the vehicle stops, 1st gear is automatically selected.
- In sports mode, when the engine rpm approaches the red zone shift points are varied to upshift automatically.
- To maintain the required levels of vehicle performance and safety, the system may not execute certain gear-shifts when the shift lever is operated.
- When SPORT mode is activated:
 - The engine rpm will tend to remain raised over a certain length of time even after releasing the accelerator.
 - Upshifts are delayed when accelerating.
- In SPORT mode, the fuel efficiency may decrease.

Shift lock system

For your safety, the Intelligent Variable Transmission (IVT) has a shift lock system which prevents shifting the transmission from P (Park) into R (Reverse) unless the brake pedal is depressed.

To shift the transmission from P (Park) into R (Reverse):

1. Depress and hold the brake pedal.
2. Start the engine or turn the ignition switch to the ON position.
3. Move the shift lever.

If the brake pedal is repeatedly depressed and released with the shift lever in the P (Park) position, a chattering noise near the shift lever may be heard. This is a normal condition.

⚠ WARNING

Always fully depress the brake pedal before and while shifting out of the P (Park) position into another position to avoid inadvertent motion of the vehicle which could injure persons in or around the vehicle.

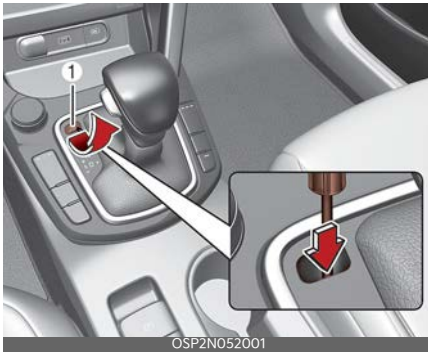
Shift-lock override

If the shift lever cannot be moved from the P (Park) position into R (Reverse) position with the brake pedal depressed, continue depressing the brake, and then do the following:

1. Place the ignition switch in the LOCK/OFF position.
2. Apply the parking brake.
3. Carefully remove the cap covering (1) the shift-lock release access hole.
4. Insert a tool (e.g., flathead screwdriver) into the access hole and press down on the tool.
5. Move the shift lever.
6. Remove the tool from the shift-lock override access hole then install the cap.

If the shift lever does not move even after performing this procedure, have

the system inspected by an authorized Kia dealer.

Good driving practices

- Never move the shift lever from P (Park) or N (Neutral) to any other position with the accelerator pedal depressed.
- Never move the shift lever into P (Park) when the vehicle is in motion.
- Be sure the vehicle is completely stopped before you attempt to shift into R (Reverse) or D (Drive).
- Never take the vehicle out of gear and coast down a hill. This may be extremely hazardous. Always leave the vehicle in gear when moving.
- Do not "ride" the brakes. This can cause them to overheat and malfunction. Instead, when you are driving down a long hill, slow down and shift to a lower gear. When you do this, engine braking will help slow down the vehicle.
- Always use the parking brake. Do not depend on placing the transmission in P (Park) to keep the vehicle from moving.

⚠ WARNING

Exercise extreme caution when driving on a slippery surface. Be especially careful when braking, accelerating or shifting gears. On a slippery surface, an abrupt change in vehicle speed can cause the drive wheels to lose traction and the vehicle to go out of control.

- Optimum vehicle performance and economy is obtained by smoothly depressing and releasing the accelerator pedal.

⚠ WARNING

- When driving uphill or downhill, always shift to D (Drive) for driving forward or shift to R (Reverse) for driving backwards, and check the gear position indicated on the cluster before driving. Driving in the opposite direction of the selected gear can lead to a dangerous situation by shutting off the engine and affecting the braking performance.
- Always buckle-up! In a collision, an unbelted occupant is significantly more likely to be seriously injured or killed than a properly belted occupant.
- Avoid high speeds when cornering or turning.
- Do not make quick steering wheel movements, such as sharp lane changes or fast, sharp turns.
- The risk of a rollover is greatly increased if you lose control of your vehicle at highway speeds.
- In the event your vehicle leaves the roadway, do not steer sharply. Instead, slow down before pulling back into the travel lanes.
- Never exceed posted speed limits.

⚠ WARNING

If your vehicle becomes stuck in snow, mud, sand, etc., then you may attempt to rock the vehicle free by moving it forward and backward. Do not attempt this procedure if people or objects are anywhere near the vehicle. During the rocking operation the vehicle may suddenly move forward or backward as it becomes unstuck, causing injury or damage to nearby people or objects.

Moving up a steep grade from a standing start

To move up a steep grade from a standing start:

1. Depress the brake pedal, shift the shift lever to D (Drive).
2. Select the appropriate gear depending on load weight and steepness of the grade, and release the parking brake.
3. Depress the accelerator gradually while releasing the service brakes.

When accelerating from a stop on a steep hill, the vehicle may have a tendency to roll backwards.

Brake system

Your vehicle has power-assisted brakes, parking brake, and various braking systems for safe driving.

Power brakes

Your vehicle has power-assisted brakes that adjust automatically through normal usage.

In the event that the power-assisted brakes lose power because of a stalled engine or some other reason, you can still stop your vehicle by applying greater force to the brake pedal than you normally would. The stopping distance, however, will be longer.

When the engine is not running, the reserve brake power is partially depleted each time the brake pedal is applied. Do not pump the brake pedal when the power assist has been interrupted.

Pump the brake pedal only when necessary to maintain steering control on slippery surfaces.

* NOTICE

- When stepping on the brake pedal under a certain driving or weather condition you may witness your car make a sound of squealing or some other noises. This is not a brake malfunction but a normal phenomenon.
- When driving on the road to which deicing chemicals are applied, the vehicle may witness noises from the brake or abnormal abrasion of tires because of such deicing chemicals. You should operate brake additionally so that you would be able to remove the deicing chemicals on the brake disk and pad under a safe traffic condition.

⚠ CAUTION

Brake Pedal

Do not drive with your foot resting on the brake pedal. This will create abnormally high brake temperatures which can cause excessive brake lining and pad wear.

⚠ WARNING

Steep hill braking

Avoid continuous application of the brakes when descending a long or steep hill by shifting to a lower gear. Continuous brake application will cause the brakes to overheat and could result in a temporary loss of braking performance.

Wet brakes may impair the vehicle's ability to safely slow down; the vehicle may also pull to one side when the brakes are applied. Applying the brakes lightly will indicate whether they have been affected in this way. Always test your brakes in this fashion after driving through deep water. To dry the brakes, apply them lightly while maintaining a safe forward speed until brake performance returns to normal.

In the event of brake failure

If service brakes fail to operate while the vehicle is in motion, you can make an emergency stop with the parking brake. The stopping distance, however, will be much greater than normal.

⚠ WARNING**Parking brake**

Avoid applying the parking brake to stop the vehicle while it is moving except in an emergency situation. Applying the parking brake while the vehicle is moving at normal speeds can cause a sudden loss of control of the vehicle. If you must use the parking brake to stop the vehicle, use great caution in applying the brake.

Brake Over Accelerator

In the event the accelerator pedal becomes stuck or entrapped, apply steady and firm pressure to the brake pedal to slow the vehicle and reduce engine power.

If you experience this condition, take the following steps:

1. Apply the brakes and bring your vehicle to a safe stop.
2. Move the transmission to P (Park), switch the engine off and apply the parking brake.
3. Inspect the accelerator pedal for any interference.

If none are found and the condition persists, have your vehicle towed to an authorized Kia dealer and inspected.

Disc brakes wear indicator

When your brake pads are worn and new pads are required, you will hear a high-pitched warning sound from your front brakes or rear brakes. You may hear this sound come and go or it may occur whenever you press the brake pedal.

Always replace the front or rear brake pads as pairs.

⚠ CAUTION**Replace brake pads**

Do not continue to drive with worn brake pads. Continuing to drive with worn brake pads can damage the braking system and result in costly brake repairs.

⚠ WARNING**Brake wear**

Do not ignore high pitched wear sounds from your brakes. If you ignore this audible warning, you will eventually lose braking performance, which could lead to a serious accident.

*** NOTICE**

Brake dust may accumulate on the wheels, even under normal driving conditions. Some dust is inevitable as the brakes wear and contribute to brake noise.

Parking Brake (Hand type) (if equipped)

After parking the vehicle, apply the parking brake to prevent the vehicle from being moved by the external force.

Applying the parking brake

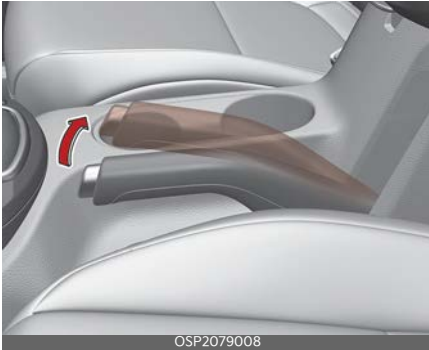

To engage the parking brake:

1. Apply the foot brake and then pull up the parking brake lever as far as possible.

In addition it is recommended that when parking the vehicle on a incline, the shift lever should be in P (Park).

CAUTION

- Driving with the parking brake applied will cause excessive brake pad and brake rotor wear.
- Do not operate the parking brake while the vehicle is moving except in an emergency situation. It could damage the vehicle system and endanger driving safety.

Releasing the parking brake



To release the parking brake:

1. Apply the foot brake and pull the parking brake lever slightly.
2. Depress the release button (1) and lower the parking brake lever (2) while holding the button.

If the parking brake does not release or does not release all the way, have the system checked by an authorized Kia dealer.

- Be cautious when parking on a hill. Firmly engage the parking brake and place the shift lever in P (Park). If your vehicle is facing downhill, turn the front wheels into the curb to help keep the vehicle from rolling. If your vehicle is facing uphill, turn the front wheels away from the curb to help keep the vehicle from rolling. If there is no curb or if it is required by other conditions to keep the vehicle from rolling, block the wheels.

- Under some conditions your parking brake can freeze in the engaged position. This is most likely to happen when there is an accumulation of snow or ice around or near the rear brakes or if the brakes are wet. If there is a risk that the parking brake may freeze, apply it only temporarily while you put the shift lever in P (Park) and block the rear wheels so the vehicle cannot roll. Then release the parking brake.
- Do not hold the vehicle on the upgrade with the accelerator pedal. This can cause the transmission to overheat. Always use the brake pedal or parking brake.

WARNING

- Never allow a passenger to touch the parking brake. If the parking brake is released unintentionally, serious injury may occur.
- All vehicles should always have the parking brake fully engaged when parking to avoid inadvertent movement of the vehicle which can injure occupants or pedestrians.

BRAKE

Check the brake warning light by turning the ignition switch ON (do not start the engine). This light will be appear when the parking brake is applied with the ignition switch in the START or ON position.

Before driving, be sure the parking brake is fully released and the brake warning light is off.

If the brake warning light remains on after the parking brake is released while engine is running, there may be a malfunction in the brake system. Immediate attention is necessary.

If at all possible, cease driving the vehicle immediately. If that is not possible, use extreme caution while operating the vehicle and only continue to drive the vehicle until you can reach a safe location or repair shop.

Anti-lock Brake System (ABS)

The Anti-lock Brake System (ABS) prevents the wheels from locking. So the vehicle remains stable and can still be steered.

ABS (or ESC) will not prevent accidents due to improper or dangerous driving maneuvers. Even though vehicle control is improved during emergency braking, always maintain a safe distance between you and objects ahead. Vehicle speeds should always be reduced during extreme road conditions. The vehicle should be driven at reduced speeds in the following circumstances:

- When driving on rough, gravel or snow-covered roads
- When driving with tire chains installed
- When driving on roads where the road surface is pitted or has different surface heights.

Driving in these conditions increases the stopping distance for your vehicle.

The ABS continuously senses the speed of the wheels. If the wheels are going to lock, the ABS repeatedly modulates the hydraulic brake pressure to the wheels.

When you apply your brakes under conditions which may lock the wheels, you may hear a "tik-tik" sound from the brakes, or feel a corresponding sensation in the brake pedal. This is normal and it means your ABS is active.

In order to obtain the maximum benefit from your ABS in an emergency situation, do not attempt to modulate your brake pressure and do not try to pump your brakes. Press your brake pedal as hard as possible to allow the ABS to control the force being delivered to the brakes.

* NOTICE

A click sound may be heard in the vehicle compartment when the vehicle begins to move after the vehicle is started. These conditions are normal and indicate that the Anti-lock Brake System is functioning properly.

Even with the Anti-lock Brake System, your vehicle still requires sufficient stopping distance. Always maintain a safe distance from the vehicle in front of you. Always slow down when cornering. The Anti-lock Brake System cannot prevent accidents resulting from excessive speeds.

On loose or uneven road surfaces, operation of the Anti-lock Brake System may result in a longer stopping distance than for vehicles equipped with a conventional brake system.

The ABS warning light will stay on for approximately 3 seconds after the ENGINE START/STOP button is ON.

Type A



Type B

ABS

During that time, the ABS will go through self-diagnosis and the light will go off if everything is normal. If the light stays on, you may have a problem with your ABS. Contact an authorized Kia dealer as soon as possible.

When you drive on a road having poor traction, such as an icy road, and have operated your brakes continuously, the ABS will be active continuously and the ABS warning light may appear. Pull your vehicle over to a safe place and stop the vehicle.

Restart the vehicle. If the ABS warning light goes off, then your ABS is normal. Otherwise, you may have a problem with the ABS. Contact an authorized Kia dealer as soon as possible.

* NOTICE

When you jump start your vehicle because of a drained battery, the vehicle may not run as smoothly and the ABS warning light may turn on at the same time. This happens because of low battery voltage. It does not mean your ABS has malfunctioned.

- Do not pump your brakes!
- Have the battery recharged before driving the vehicle.

Electronic Parking Brake (EPB) (if equipped)

Applying the parking brake



OSP2N052286

To apply the EPB (electronic parking brake) manually:

1. Stop the vehicle.
2. Depress the brake pedal and pull up the EPB switch. Make sure the warning light comes on.

EPB may be automatically applied when:

- Requested by other systems.
- If the driver applies the AUTO HOLD function while the engine is ON then turn the engine off, the EPB may be applied again automatically.

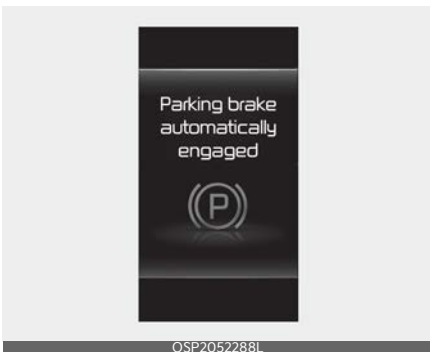

OSP2052288L

- If the driver turns the engine off by mistake while Auto Hold (if equipped) is operating, EPB will be automatically applied. But if the driver turns the engine off and push the EPB switch in 1 second, the EPB does not apply.

Emergency braking

- If there is a problem with the brake pedal while driving, emergency braking is possible by pulling up and holding the EPB switch. Braking is possible only while you are holding the EPB switch. If you hand off the EPB switch, the braking force is lost. If you hold the EPB switch and the vehicle stop, the EPB is applied.
 - The braking distance may be longer than under normal braking conditions.
- * EPB stands for Electronic Parking Brake.

⚠ WARNING

Do not operate the parking brake while the vehicle is moving except in an emergency situation. It could damage the vehicle system and endanger driving safety.

⚠ CAUTION

If you continuously notice a noise or burning smell when the EPB is used for emergency braking, have the system checked by an authorized Kia dealer.

Releasing the parking brake



To release the EPB manually:

Press the EPB switch in the following condition.

1. Have the ignition switch or ENGINE START/STOP button in the ON position.
2. Depress the brake pedal.
Make sure the brake warning light goes off.

To release EPB automatically (automatic transmission):

1. Close the driver's door, engine hood and liftgate.
2. Fasten the driver's seat belt.
3. Start the engine.
4. If the shift lever is in P (Park), depress the brake pedal and shift out of P (Park) to R (Rear) or D (Drive), the EPB is released automatically. Make sure the brake warning light goes off.
5. If the shift lever is in N (Neutral), depress the brake pedal and shift out of N (Neutral) to R (Rear) or D (Drive), the EPB is released automatically. Make sure the brake warning light goes off.

- If you try to drive off depressing the accelerator pedal with the EPB applied, but doesn't release automatically, a warning will sound once and a message will appear.



- If the driver's seat belt is not fastened, driver's door is opened, the engine hood is opened in D or the liftgate is opened in D or R, a warning will sound once and a message will appear.
- If there is a problem with the vehicle, a warning may sound once and a message may appear. If the above situation occurs, depress the brake pedal and release EPB by pressing the EPB switch.

⚠ WARNING

- Never allow anyone who is unfamiliar with the vehicle to touch the parking brake. If the parking brake is released unintentionally, serious injury may occur.
- Do not place any objects around the EPB switch. They could release the EPB switch.

⚠ CAUTION

- To prevent unintentional movement when stopped and leaving the vehicle, do not use the shift lever in place of the parking brake. Set the parking brake and make sure the shift lever is securely positioned in P (Park). Use wheel chokes if necessary.
- In winter or cold conditions, the EPB may freeze. Park the vehicle with the shift lever in P on the even and safe place without applying the EPB. And use wheel chokes.
- Do not drive your vehicle with the EPB applied. It may cause excessive wear of brake pad and brake rotor.
- A click sound may be heard while operating or releasing the EPB, but these conditions are normal and indicate that the EPB is functioning properly.
- When leaving your keys with a parking lot attendant or valet, make sure to inform him/her how to operate the EPB.
- When the battery is drained, the EPB does not apply or release. In this case, jump start your vehicle.

Malfunction of EPB

Type A



Type B



If the EPB malfunction indicator remains on, it indicates that the EPB may have malfunctioned. If this occurs, have the system checked by an authorized Kia dealer.

The EPB malfunction indicator may appear when the ESC indicator comes on to indicate that the ESC is not working properly, but it does not indicate a malfunction of the EPB.

⚠ CAUTION

- The EPB warning light may appear if the EPB switch operates abnormally. Shut the engine off and turn it on

again after a few minutes. The warning light will go off and the EPB switch will operate normally. However, if the EPB warning light is still on, have the system checked by an authorized Kia dealer.

- If the parking brake warning light does not appear or blinks even though the EPB switch was pulled up, the EPB is not applied. If the parking brake warning light blinks when the EPB warning light is on, press the switch, then pull it up. Once more press it back to its original position and pull it back up. If the EPB warning does not go off, have the system checked by an authorized Kia dealer.

AUTO HOLD (if equipped)

The Auto Hold is designed to maintain the vehicle in a standstill even though the brake pedal is not pressed after the driver brings the vehicle to a complete stop by pressing the brake pedal.

Applying Auto Hold function

1. Press the brake pedal and start the vehicle.
2. Press the Auto Hold button. The white AUTO HOLD indicator will come on indicating the system is in standby.

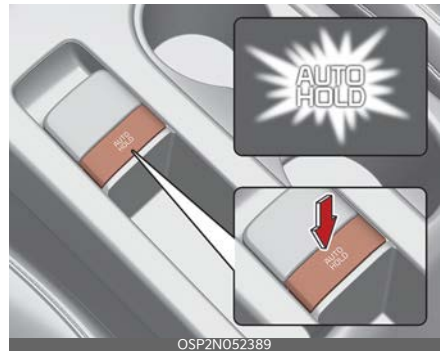

Before the Auto Hold will engage, the driver's door and engine hood must be closed and the liftgate must be closed.

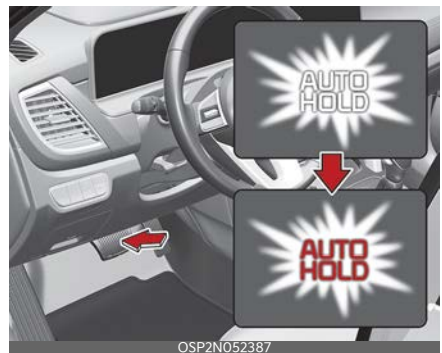

When coming to a complete stop by pressing the brake pedal, the AUTO

HOLD indicator changes from white to green indicating the AUTO HOLD is engaged. The vehicle will remain at a standstill even if you release the brake pedal.

If EPB is applied, Auto Hold will be released.

If you press the accelerator pedal with the shift lever in D (Drive) or Manual mode, the Auto Hold will be released automatically and the vehicle will start to move. The indicator changes from green to white indicating the Auto Hold is in standby and the EPB is released.

When driving off from Auto Hold by pressing the accelerator pedal, always check the surrounding area near your vehicle.

Slowly press the accelerator pedal for a smooth launch.

Canceling Auto Hold function

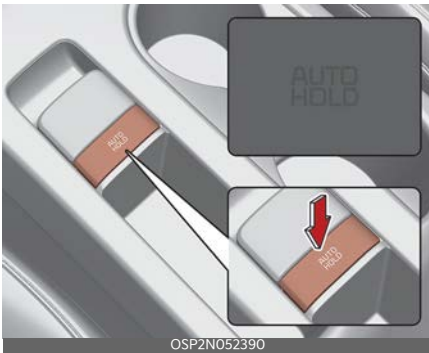

- To cancel the Auto Hold operation, press the Auto Hold switch. The AUTO HOLD indicator will go out.
- To cancel the Auto Hold operation when the vehicle is at a standstill, press the Auto Hold switch while pressing the brake pedal.

* NOTICE

- The following are conditions when the Auto Hold will not engage (Auto Hold light will not turn green and the Auto Hold system remains in stand by):
 - The driver's door is opened
 - The engine hood is opened
 - The shift lever is in P (Park) or R (Reverse)
 - The EPB is applied
- For your safety, the Auto Hold automatically switches to EPB under any of the following conditions (Auto Hold light remains white and the EPB automatically applies):
 - The driver's door is opened.
 - The engine hood or liftgate is opened.
 - The vehicle is in a standstill for more than 10 minutes.
 - The vehicle is standing on a steep slope.
 - The vehicle moved for a few seconds.

In these cases, the brake warning light comes on, the AUTO HOLD indicator changes from green to white, and a warning sounds and a message will appear to inform you that EPB has been automatically engaged. Before driving off again, press foot brake pedal, check the surrounding area near your vehicle and release parking brake manually with the EPB switch.

- If the AUTO HOLD indicator lights up yellow, the Auto Hold is not working properly. Take your vehicle to an authorized Kia dealer and have the system checked.

⚠ WARNING

To reduce the risk of an accident, do not activate Auto Hold while driving downhill, backing up or parking your vehicle.

If there is a malfunction with the driver's door or engine hood or liftgate open detection system, the Auto Hold may not work properly.

Take your vehicle to an authorized Kia dealer and have the system checked.

*** NOTICE**

A click or electric brake motor whine sound may be heard while operating or releasing the EPB, but these conditions are normal and indicate that the EPB is functioning properly.

Warning messages

The Auto Hold function will display a warning message with sound under certain conditions.

When the EPB is applied from Auto Hold, a warning will sound and a message will appear.

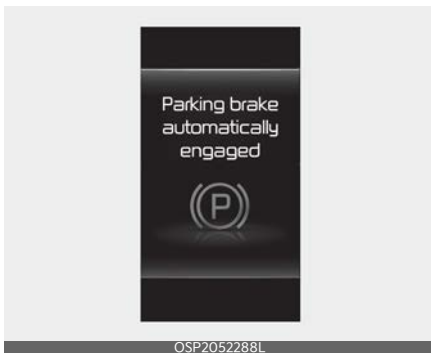

When the conversion from Auto Hold to EPB is not working properly a warning will sound and a message will appear.



*** NOTICE**

When this message is displayed, the Auto Hold and EPB may not operate. For your safety, press the brake pedal.

If you do not apply the brake pedal when you release the Auto Hold by pressing the [AUTO HOLD] switch, a warning will sound and a message will appear.

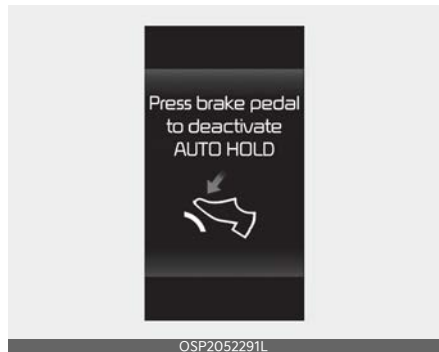

Electronic Stability Control (ESC) system

The Electronic Stability Control (ESC) is designed to stabilize the vehicle during cornering maneuvers.



ESC applies the brakes on individual wheels and intervenes with the vehicle management system to stabilize the vehicle.

ESC will not prevent accidents. Excessive speed in turns, abrupt maneuvers and hydroplaning on wet surfaces can still result in serious accidents.

Only a safe and attentive driver can prevent accidents by avoiding maneuvers that cause the vehicle to lose traction. Even with ESC installed, always follow all the normal precautions for driving - including driving at safe speeds for the conditions.

⚠ WARNING

For maximum protection, always wear your seat belt. No system, no matter how advanced, can compensate for all driver error and/or driving conditions. Always drive responsibly.

The ESC system is an electronic system designed to help the driver maintain vehicle control under adverse conditions. It is not a substitute for safe driving practices. Factors including speed, road conditions and driver steering input can all affect whether ESC will be effective in preventing a loss of control. It is still your responsibility to drive and corner at reasonable speeds and to leave a sufficient margin of safety.

When you apply your brakes under conditions which may lock the wheels, you may hear a "tik-tik" sound from the brakes, or feel a corresponding sensation in the brake pedal. This is normal and it means your ESC is active.

*** NOTICE**

A click sound may be heard in the vehicle compartment when the vehicle begins to move after the vehicle is started. These conditions are normal and indicate that the Electronic Stability Control system is functioning properly.

ESC operation

ESC ON condition

- When the ENGINE START/STOP button is turned ON, ESC and ESC OFF indicator lights appear for approximately 3 seconds, then ESC is turned on.
- Press the ESC OFF button for at least half a second after turning the vehicle ON to turn ESC off. (ESC OFF indicator will appear). To turn the ESC on, press the ESC OFF button (ESC OFF indicator light will go off).
- When starting the vehicle, you may hear a slight ticking sound. This is the ESC performing an automatic system self-check and does not indicate a problem.

When operating



When the ESC is in operation, the ESC indicator light blinks.

When the Electronic Stability Control is operating properly, you can feel a slight pulsation in the vehicle. This is only the effect of brake control and indicates nothing unusual.

When moving out of the mud or driving on a slippery road, pressing the accelerator pedal may not cause the vehicle rpm (revolutions per minute) to increase.

ESC operation off





This car has 2 kinds of ESC off states.

If the vehicle stops when ESC is off, ESC remains off. Upon restarting the vehicle, the ESC will automatically turn on again.





ESC off state 1

To turn off the traction control function and only operate the brake control function of the ESC, press the ESC OFF button (ESC OFF ) for less than 3 seconds and the ESC OFF indicator light (ESC OFF ) will appear.



ESC off state 2

To turn off the traction control function and the brake control function of the ESC, press the ESC OFF button (ESC OFF ) for more than 3 seconds. ESC OFF indicator light (ESC OFF ) will appear and ESC OFF warning chime will

sound. At this state, the car stability control function does not operate any more.

Indicator light

ESC indicator light



ESC OFF indicator light



When ENGINE START/STOP button is turned to ON, the indicator light appear, then goes off if the ESC system is operating normally.

The ESC indicator light blinks whenever ESC is operating or appear when ESC fails to operate.

The ESC OFF indicator light comes on when the ESC is turned off with the button.

⚠ WARNING

Electronic Stability Control

Drive carefully even though your vehicle has Electronic Stability Control. It can only assist you in maintaining control under certain circumstances.

ESC OFF usage

When driving

- ESC should be turned on for daily driving whenever possible.
- To turn ESC off while driving, press the ESC OFF button while driving on a flat road surface.

⚠ WARNING

Operating ESC

Never press the ESC OFF button while ESC is operating (ESC indicator light blinks).

If ESC is turned off while ESC is operating, the vehicle may slip out of control.

*** NOTICE**

- When operating the vehicle on a dynamometer, ensure that the ESC is turned off (ESC OFF light appeared). If the ESC is left on, it may prevent the vehicle speed from increasing, and result in false diagnosis.
- Turning the ESC off does not affect ABS or brake system operation.

Vehicle Stability Management (VSM) system

The Vehicle Stability Management (VSM) provides further enhancements to vehicle stability and steering responses under the following condition:

- when driving on a slippery road or
- when a change in the coefficient of friction between left and right wheels is detected.

⚠ WARNING

Tire/Wheel size

When replacing tires and wheels, make sure they are the same size as the original tires and wheels installed. Driving with varying tire or wheel sizes may diminish any supplemental safety benefits of the VSM system.

VSM operation

When the VSM is operating properly, you can feel a slight pulsation in the vehicle and/or abnormal steering responses (Electric Power Steering (EPS)). This is only the effect of brake and EPS control and indicates nothing unusual.

The VSM does not operate when:

- Driving on a sloping road such as a gradient or incline
- Driving in reverse
- ESC OFF indicator light () remains on the instrument cluster
- EPS indicator light remains on the instrument cluster

VSM operation off

If you press the ESC OFF button to turn off the ESC, the VSM will also cancel and the ESC OFF indicator light () appears.

To turn on the VSM, press the button again. The ESC OFF indicator light goes out.

WARNING

Vehicle Stability Management

Drive carefully even though your vehicle has Vehicle Stability Management. It can only assist you in maintaining control of the vehicle under certain circumstances.

Malfunction indicator

The VSM can be deactivated even if you don't cancel the VSM operation by pressing the ESC OFF button. It indicates that a malfunction has been detected somewhere in the Electric Power Steering system or VSM system. If the ESC indicator light () or EPS warning light

() remains on, take your vehicle to an authorized Kia dealer and have the system checked.

The VSM is not a substitute for safe driving practices but a supplementary function only. It is the responsibility of the driver to always check the speed and the distance to the vehicle ahead. Always hold the steering wheel firmly while driving.

Your vehicle is designed to activate according to the driver's intention, even with installed VSM. Always follow all the normal precautions for driving at safe speeds for the conditions - including driving in clement weather and on a slippery road.

WARNING

For maximum protection, always wear your seat belt. No system, no matter how advanced, can compensate for all driver error and/or driving conditions. Always drive responsibly.

Hill-start Assist Control (HAC)

A vehicle has the tendency to roll back on a steep hill when it starts to go after stopping. The Hill-start Assist Control (HAC) prevents the vehicle from rolling back by applying the brakes automatically for about 2 seconds.

The brakes are released when the accelerator pedal is engaged or after about 2 seconds.

The HAC is activated only for about 2 seconds, so when the vehicle is starting off always engaged the accelerator pedal.

⚠ WARNING

Maintaining Brake Pressure on Incline

HAC does not replace the need to apply brakes while stopped on an incline. While stopped, make sure you maintain brake pressure sufficient to prevent your vehicle from rolling backward and causing an accident. Don't release the brake pedal until you are ready to accelerate forward.

Downhill Brake Control (DBC)



The Downhill Brake Control (DBC) feature assists the driver to descend down a steep hill without having to depress the brake pedal.

The system automatically applies the brakes to maintain the vehicle speed 4 km/h (2.5 mph) ~ 40 km/h (25 mph) and allows the driver to concentrate on steering the vehicle down hill.

Always turn off the DBC on normal roads. The DBC might activate inadvertently from the stand by mode when driving through speed bumps or making sharp curves.





*** NOTICE**

The DBC defaults to the OFF position whenever the ignition switch is placed in the ON position.

Noise or vibration may occur from the brakes when the DBC is activated.

The rear stop light comes on when DBC is activated.

DBC operation

Mode	Indicator light	Description
Standby	 appear	Press the DBC button when vehicle speed is under 60 km/h (38 mph). The DBC system will turn ON and enter the standby mode. The system does not turn ON if vehicle speed is over 60 km/h (38 mph).
Activated	 blinks	In the standby mode, It enters the operating mode when the following conditions are met. <ul style="list-style-type: none"> • The road surface should be more than a certain angle of inclination • The accelerator pedal must not be depressed. • The vehicle speed should be within 4 km/h (2.5 mph) ~ 40 km/h (25 mph) <ul style="list-style-type: none"> - 2.5 km/h (1.5 mph) ~ 8 km/h (5 mph) in case of backward movement Within operating vehicle speed [4 km/h (2.5 mph) ~ 40 km/h (25 mph)], the driver can lower or raise the vehicle speed by stepping on the brake pedal or accelerator pedal.
Temporarily deactivated	 appear	In the activated mode, the DBC will temporarily deactivate under the following conditions: <ul style="list-style-type: none"> • The hill is not steep enough. • The accelerator pedal is depressed. • When the vehicle speed is in the range of 40 km/h (25 mph) ~ 60 km/h (38 mph) If the above conditions are not met, the DBC will automatically activate again.
OFF	 not appeared	The DBC will turn OFF under the following conditions: <ul style="list-style-type: none"> • The DBC button is pressed again. • When the accelerator pedal is depressed and the vehicle speed exceeds 60 km/h (38 mph)

WARNING

If the DBC yellow indicator light appears, the system may have overheated or have malfunctioned. When the warning light appears even though the DBC system has cooled off, have your vehicle checked by an authorized Kia dealer as soon as possible.

NOTICE

- The DBC may not deactivate on steep inclines even though the brake or accelerator pedal is depressed.
- The DBC does not operate when:
 - The shift lever is in P (Park).
 - The ESC is activated.

Good braking practices

Good braking practices help keep occupants safe and extend brake life.

- Check to be sure the parking brake is not engaged and the parking brake indicator light is out before driving away.
- Driving through water may get the brakes wet. They can also get wet when the vehicle is washed. Wet brakes can be dangerous! Your vehicle will not stop as quickly if the brakes are wet. Wet brakes may cause the vehicle to pull to one side. To dry the brakes, apply the brakes lightly until the braking action returns to normal, taking care to keep the vehicle under control at all times. If the braking action does not return to normal, stop as soon as it is safe to do so and call an authorized Kia dealer for assistance.
- Don't coast down hills with the vehicle out of gear. This is extremely hazardous. Keep the vehicle in gear at all times, use the brakes to slow down, then shift to a lower gear so that vehicle braking will help you maintain a safe speed.
- Don't "ride" the brake pedal. Resting your foot on the brake pedal while driving can be dangerous because the brakes might overheat and lose their effectiveness. It also increases the wear of the brake components.
- If a tire goes flat while you are driving, apply the brakes gently and keep the vehicle pointed straight ahead while you slow down. When you are moving slowly enough for it to be safe to do so, pull off the road and stop in a safe place.
- Be cautious when parking on a hill. Firmly engage the parking brake and place the shifter dial in P. If your vehicle is facing downhill, turn the front wheels into the curb to help keep the vehicle from rolling. If your vehicle is facing uphill, turn the front wheels away from the curb to help keep the vehicle from rolling. If there is no curb or if it is required by other conditions to keep the vehicle from rolling, block the wheels.
- Under some conditions your parking brake can freeze in the engaged position. This is most likely to happen when there is an accumulation of snow or ice around or near the rear brakes or if the brakes are wet. If there is a risk that the parking brake may freeze, apply it only temporarily while you put the shifter dial in P and block the rear wheels so the vehicle cannot roll. Then release the parking brake.
- Do not hold the vehicle on an incline with the accelerator pedal. This can cause the transmission to overheat. Always use the brake pedal or parking brake.

Idle Stop and Go (ISG) system (if equipped)

The Idle Stop and Go (ISG) system reduces fuel consumption by automatically shutting down the engine when the vehicle is at a standstill. (For example: red light, stop sign and traffic jam)

The engine starts automatically as soon as the starting conditions are met.

The ISG is ON whenever the engine is running.

* NOTICE

When the engine automatically starts by the ISG system, some warning lights (ABS, ESC, ESC OFF, EPS or Parking brake warning light) may turn on for a few seconds.

This happens because of low battery voltage. It does not mean the system has malfunctioned.

Auto stop

If you depress the brake pedal and the vehicle comes to a stop with the ISG ON, the engine will stop automatically.

Stop the vehicle completely by pressing the brake pedal when the shift lever is in the D (Drive) or N (Neutral) position.



The engine will stop and the green AUTO STOP (A) indicator on the instrument cluster will appear.

* NOTICE

If you open the engine hood in auto stop mode, the following will happen:

- The ISG system will deactivate (the light on the ISG OFF button will appear).
- A message will appear on the LCD display.

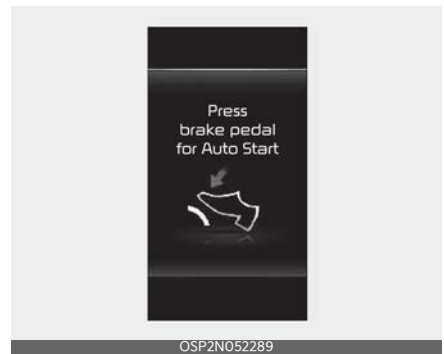

- If you move the transmission lever from N to D (Manual mode) or R without depressing the brake pedal after stopping engine automatically, the engine does not restart automatically and a warning chime alarms. When this happens, press the brake pedal for auto start.

Auto start

When the engine stops automatically by ISG, the engine will restart if one of the following driver actions occur.

- Release the brake pedal.
- Move the shift gear to the R (Reverse) position or the Manual mode while depressing the brake pedal.



The engine will start and the green AUTO STOP indicator ((A)) on the instrument cluster will go out.

The engine will also restart automatically without any driver actions if the following occurs:

- The brake vacuum pressure is low.
- The engine has stopped for about 5 minutes.
- A certain period of time elapsed with air condition ON.
- The front defroster is ON.
- The battery is weak.
- The cooling and heating performance of the climate control system is unsatisfactory.
- The vehicle is shifted to P (Park) when Auto Hold is activated.
- The door is opened or the seatbelt is unfastened when Auto Hold is activated.
- The EPB switch is pressed when Auto Hold is activated.

Operating conditions

The ISG will operate under the following condition:

- The driver's seatbelt is fastened.
- The driver's door and hood are closed.
- The brake vacuum pressure is adequate.
- The battery sensor is activated and the battery is sufficiently charged.
- Outside temperature is not too low or too high.
- The vehicle is driven over a constant speed and stops.
- The climate control system satisfies the conditions.
- The vehicle is sufficiently warmed up.
- The incline is gradual.
- The steering wheel is turned less than 180 degrees and then the vehicle stops.

*** NOTICE**

- If the ISG system does not meet the operation condition, the ISG system is deactivated. The light on the ISG OFF button will appear and a message "Auto Stop conditions not met" will appear on the LCD display.
- If the light or warning message comes on continuously, please check the operation condition.

Deactivating the ISG



- If you wish to deactivate the ISG, press the ISG OFF button. The light on the ISG OFF button will appear.
- If you press the ISG OFF button again, the ISG will be activated and the light on the ISG OFF button will turn off.

ISG malfunction

The ISG may not operate when:



The ISG may not operate when an ISG related sensor or system error occurs.

The following will happen:

- The yellow AUTO STOP (A) indicator on the instrument cluster will stay on after blinking for 5 seconds.

- The light on the ISG OFF button will appear.

When the engine is in Idle Stop mode, it's possible to restart the engine without the driver taking any action. Before leaving the car or doing anything in the engine compartment, stop the engine by the ENGINE START/STOP button to the OFF position.

* NOTICE

If the AGM battery is reconnected or replaced, ISG system will not operate immediately. If you want to use the ISG system, the battery sensor needs to be calibrated for approximately 4 hours with the ignition off. After calibration, turn the engine on and off 2 or 3 times.

Drive mode integrated control system

The drive mode may be selected according to the driver's preference or road condition.



The Drive mode is activated by turning the knob.

The Drive mode will be changed as you turn the knob.

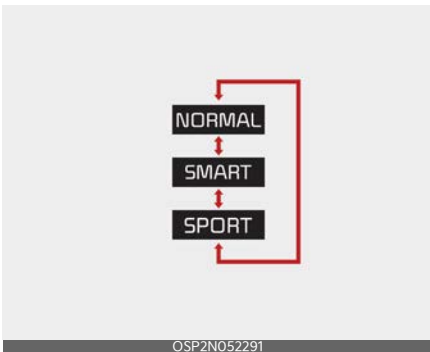

- **NORMAL mode:** NORMAL mode provides soft driving and comfortable riding.
- **SMART mode:** SMART mode automatically adjusts the driving mode (SMART ↔ SPORT) in accordance with the driver's driving habits.
- **SPORT mode:** SPORT mode provides sporty but firm riding.

The driving mode will be set to NORMAL mode when the engine is restarted. If it is in NORMAL/SPORT mode, NORMAL mode will be set, when the engine is restarted.

SMART mode

In SMART mode, an appropriate driving mode will be selected between NORMAL and SPORT according to the driver's driving habits.

- Turning the knob activates SMART mode. When the SMART mode is activated, the indicator appears on the instrument cluster (blue color).
- The vehicle starts in SMART mode, when the engine was turned OFF in SMART mode.
- SMART mode automatically controls the vehicle driving, such as gear shifting patterns, engine torque, in accordance with the driver's driving habits.

* NOTICE

- When you drive smoothly the vehicle in SMART mode, the driving mode changes to NORMAL mode to improve fuel efficiency. However, the actual fuel efficiency may differ in accordance with your driving situations (i.e., uphill/downhill, vehicle deceleration/acceleration).
- When you drive dynamically the vehicle such as rapid acceleration, heavy deceleration or taking sharp turn, the mode should be changed to SPORT mode. Therefore it may have an adverse effect on the fuel economy.

Various driving situations, which you may encounter in SMART mode

- The driving mode will be automatically changed to SMART NORMAL mode after a certain period of time, when you gently press the accelerator pedal (Your driving is categorized to be economical.).
- The driving mode will be automatically changed to SMART SPORT, when you rapidly accelerate the vehicle or repetitively operate the steering wheel. (Your driving is categorized to be aggressive.) In this mode, your vehicle drives in a lower gear for rapid accelerating/decelerating and increases the engine brake performance.
- You may still sense the engine brake performance, even when you release the accelerator pedal in SMART SPORT mode. It is because your vehicle remains to be in a lower gear over a certain period of time for next acceleration. Thus, it is a normal driving situation, not indicating any malfunction.
- The driving mode automatically changes to SMART SPORT mode only in harsh driving situations. In most of the normal driving situations, the driving mode sets to be in SMART NORMAL mode.

Limitation of SMART mode

The SMART mode may be limited in following situations. (The OFF indicator appear in those situations.)

- The driver manually moves the shift lever: It deactivates SMART mode. The vehicle moves, as the driver manually moves the shift lever.

- Cruise Control is activated: Cruise Control may deactivate the SMART mode. When a higher system is set by Cruise Control, it starts to control vehicle speed and deactivates SMART mode. (SMART mode is not deactivated just by activating Cruise Control.)
- The transmission oil temperature is either extremely low or extremely high: The SMART mode can be active in most of the normal driving situations. However, an extremely high/low transmission oil temperature may temporarily deactivate the SMART mode, because the transmission condition is out of normal operation condition.

SPORT mode

SPORT mode manages the driving dynamics by automatically adjusting the steering effort, and the engine and transmission control logic for enhanced driver performance.

- When SPORT mode is selected by turning the knob, the SPORT indicator (red color) will appear.
- Whenever the engine is restarted, the Drive Mode will revert back to NORMAL mode. If SPORT mode is desired, re-select SPORT mode from the knob.
- When SPORT mode is activated:
 - The engine RPM will tend to remain high over a certain period of time even after releasing the accelerator.
 - Upshifts are delayed when accelerating.

* NOTICE

In SPORT mode, the fuel efficiency may decrease.

Economical operation

Your vehicle's fuel economy depends mainly on your style of driving, where you drive and when you drive.

Each of these factors affects how many miles (kilometers) you can get from a gallon (liter) of fuel. To operate your vehicle as economically as possible, use the following driving suggestions to help save money in both fuel and repairs:

- Drive smoothly. Accelerate at a moderate rate. Don't make "jackrabbit" starts or full-throttle shifts and maintain a steady cruising speed. Don't race between stoplights. Try to adjust your speed to the traffic so you don't have to change speeds unnecessarily. Avoid heavy traffic whenever possible.

Always maintain a safe distance from other vehicles so you can avoid unnecessary braking. This also reduces brake wear.

- Drive at a moderate speed. The faster you drive, the more fuel your vehicle uses. Driving at a moderate speed, especially on the highway, is one of the most effective ways to reduce fuel consumption.
- Take care of your tires. Keep them inflated to the recommended pressure. Incorrect inflation, either too much or too little, results in unnecessary tire wear. Check the tire pressures at least once a month.
- Be sure that the wheels are aligned correctly. Improper alignment can result from hitting curbs or driving too fast over irregular surfaces. Poor alignment causes faster tire wear and may also result in other problems as well as greater fuel consumption.

- Keep your car in good condition. For better fuel economy and reduced maintenance costs, maintain your car in accordance with the maintenance schedule in "Scheduled maintenance service" on page 8-9. If you drive your car in severe conditions, more frequent maintenance is required (Refer to "Severe Driving Conditions" on page 8-13 for details).
- Travel lightly. Don't carry unnecessary weight in your car. Weight reduces fuel economy.
- Don't let the engine idle longer than necessary. If you are waiting (and not in traffic), turn off your engine and restart only when you're ready to go.
- Don't "lug" or "over-rev" the engine. Lugging is driving too slowly in too high a gear resulting in the engine bucking. If this happens, shift to a lower gear. Over-revving is racing the engine beyond its safe limit. This can be avoided by shifting at the recommended speeds.
- Open windows at high speeds can reduce fuel economy.
- Fuel economy is less in crosswinds and headwinds. To help offset some of this loss, slow down when driving in these conditions.

Keeping a vehicle in good operating condition is important both for economy and safety.

Therefore, have an authorized Kia dealer perform scheduled inspections and maintenance.

WARNING

Engine off during motion

Never turn the engine off to coast down hills or anytime the vehicle is in motion. The power steering and power brakes

will not function properly without the engine running. In addition, turning off the ignition while driving could engage the steering wheel lock resulting in loss of vehicle steering. Keep the engine on and downshift to an appropriate gear for engine braking effect.

Special driving conditions

If driving conditions deteriorate due to poor weather or road conditions, you should pay even more attention than usual to your driving.

Hazardous driving conditions

When hazardous driving conditions are encountered such as water, snow, ice, mud, sand, or similar hazards, follow these suggestions:

- Drive cautiously and allow extra distance for braking.
- Avoid sudden braking or steering.
- When braking with non-ABS brakes pump the brake pedal with a light up-and-down motion until the vehicle is stopped.
- Do not pump the brake pedal on a vehicle equipped with ABS.
- If stalled in snow, mud, or sand, use the second gear. Accelerate slowly to avoid spinning the drive wheels.
- Use sand, rock salt, or other nonslip material under the drive wheels to provide traction when stalled in ice, snow, or mud.

Reducing the risk of a rollover

This multi-purpose passenger vehicle is defined as a Sports Utility Vehicle (SUV). SUV's have higher ground clearance and a narrower track to make them capable of performing in a wide variety of road applications. Specific design characteristics give them a higher center of gravity than ordinary vehicles. An advantage of the higher ground clearance is a better view of the road, which allows you to anticipate problems. They are not designed for cornering at the same speeds as conventional passenger vehi-

cles. Due to this risk, driver and passengers are strongly recommended to buckle their seat belts. In a rollover crash, an unbelted person is more likely to die than a person wearing a seat belt. There are steps that a driver can make to reduce the risk of a rollover. If at all possible, avoid sharp turns or abrupt maneuvers, do not load your roof rack with heavy cargo, and never modify your vehicle in any way.

⚠ WARNING

Rollover

As with other Sports Utility Vehicle (SUV), failure to operate this vehicle correctly may result in loss of control, an accident or vehicle rollover.

- Utility vehicles have a significantly higher rollover rate than other types of vehicles.
- Specific design characteristics (higher ground clearance, narrower track, etc.) give this vehicle a higher center of gravity than ordinary vehicles.
- A SUV is not designed for cornering at the same speeds as conventional vehicles.
- Avoid sharp turns or abrupt maneuvers.
- In a rollover crash, an unbelted person is significantly more likely to die than a person wearing a seat belt. Make sure everyone in the vehicle is properly buckled up.

⚠ WARNING

Your vehicle is equipped with tires designed to provide safe riding and handling capability. Do not use tires and wheels that are different in size and type from the originally installed ones. It can affect the safety and performance of

your vehicle, which could lead to steering failure or rollover and serious injury. When replacing the tires, be sure to equip all four tires with the tire and wheel of the same size, type, tread, brand and load-carrying capacity.

Rocking the vehicle

If it is necessary to rock the vehicle to free it from snow, sand, or mud, first turn the steering wheel right and left to clear the area around your front wheels. Then, shift back and forth between R (Reverse) and any forward gear.

Do not race the engine, and spin the wheels as little as possible. If you are still stuck after a few tries, have the vehicle pulled out by a tow vehicle to avoid engine overheating and possible damage to the transmission.

⚠ WARNING

Sudden Vehicle Movement

Do not attempt to rock the vehicle if people or objects are nearby. The vehicle may suddenly move forward or backwards as it becomes unstuck.

⚠ CAUTION

Vehicle rocking

Prolonged rocking may cause vehicle overheating, reduction gear damage or failure, and tire damage.

⚠ CAUTION

Spinning tires

Do not spin the wheels, especially at speeds more than 56 km/h (35 mph). Spinning the wheels at high speeds when the vehicle is stationary could overheat and damage tires, and the

rotating wheels may fly away and injure bystanders.

The Electronic Stability Control (ESC) should be turned OFF prior to rocking the vehicle.

Smooth cornering

Avoid braking or gear changing in corners, especially when roads are wet. Ideally, corners should always be taken under gentle acceleration. If you follow these suggestions, tire wear will be held to a minimum.

Driving at night

Because night driving presents more hazards than driving in the daylight, here are some important tips to remember:

- Slow down and keep more distance between you and other vehicles, as it may be more difficult to see at night, especially in areas where there may not be any street lights.
- Adjust your mirrors to reduce the glare from other driver's headlights.
- Keep your headlights clean and properly aimed. (On vehicles not equipped with the automatic headlight aiming feature.) Dirty or improperly aimed headlights will make it much more difficult to see at night.
- Avoid staring directly at the headlights of oncoming vehicles. You could be temporarily blinded, and it will take several seconds for your eyes to readjust to the darkness.

Driving in the rain

Rain and wet roads can make driving dangerous, especially if you're not prepared for the slick pavement.

Here are a few things to consider when driving in the rain:

- A heavy rainfall will make it harder to see and will increase the distance needed to stop your vehicle, so slow down.
- Keep your windshield wiping equipment in good shape. Replace your windshield wiper blades when they show signs of streaking or missing areas on the windshield.
- If your tires are not in good condition, making a quick stop on wet pavement can cause a skid and possibly lead to an accident. Be sure your tires are in good shape.
- Turn on your headlights to make it easier for others to see you.
- Driving too fast through large puddles can affect your brakes. If you must go through puddles, try to drive through them slowly.
- If you believe you may have gotten your brakes wet, apply them lightly while driving until normal braking operation returns.

Driving in flooded areas

Avoid driving through flooded areas unless you are sure the water is no higher than the bottom of the wheel hub. Drive through any water slowly. Allow adequate stopping distance because brake performance may be affected.

After driving through water, dry the brakes by gently applying them several times while the vehicle is moving slowly.

Driving on unpaved roads

Drive carefully on unpaved roads because your vehicle may be damaged by rocks or roots of trees. Become familiar with the on unpaved roads conditions where you are going to drive before you begin driving.

Highway driving

Tires

Adjust the tire inflation pressures to specification. Low tire inflation pressures will result in overheating and possible failure of the tires.

Avoid using worn or damaged tires which may result in reduced traction or tire failure.

Never exceed the maximum tire inflation pressure shown on the tires.

WARNING

Under/over inflated tires

Always check the tires for proper inflation before driving. Underinflated or overinflated tires can cause poor handling, loss of vehicle control, and sudden tire failure, leading to accidents, injuries, and even death. For proper tire pressures, refer to "Tires and wheels" on page 9-5.

WARNING

Tire tread

Always check the tire tread before driving your vehicle. Worn-out tires can result in loss of vehicle control. Worn-out tires should be replaced as soon as possible. For further information and tread limits, refer to "Tires and wheels" on page 9-5.

Fuel, engine coolant and engine oil

High speed travel consumes more fuel than urban motoring. Do not forget to check both the engine coolant and engine oil.

Drive belt

A loose or damaged drive belt may result in overheating of the engine.

Winter driving

Severe weather conditions in the winter result in greater wear and other problems.

To minimize the problems of winter driving, you should follow these suggestions:

Snowy or icy conditions

To drive your vehicle in deep snow, it may be necessary to use snow tires on your tires.

If snow tires are needed, it is necessary to select tires equivalent in size and type of the original equipment tires. Failure to do so may adversely affect the safety and handling of your vehicle. Furthermore, speeding, rapid acceleration, sudden brake applications, and sharp turns are potentially very hazardous practices.

During deceleration, use vehicle braking to the fullest extent. Sudden brake applications on snowy or icy roads may cause skids to occur. You need to keep sufficient distance between the vehicle in operation in front of your vehicle. Also, apply the brake gently.

Snow tires

If you mount snow tires on your vehicle, make sure they are radial tires of the same size and load range as the original tires. Mount snow tires on all four wheels to balance your vehicle's handling in all weather conditions. Keep in mind that the traction provided by snow tires on dry roads may not be as high as your vehicle's original equipment tires. You should drive cautiously even when the roads are clear. Check with the tire dealer for maximum speed recommendations.

Do not install studded tires without first checking local, state and municipal regulations for possible restrictions against their use.

WARNING

Snow tire size

Snow tires should be equivalent in size and type to the vehicle's standard tires. Otherwise, the safety and handling of your vehicle may be adversely affected.

Use high quality ethylene glycol coolant

Your vehicle is delivered with high quality ethylene glycol coolant in the cooling system. It is the only type of coolant that should be used because it helps prevent corrosion in the cooling system, lubricates the water pump and prevents freezing. Be sure to replace or replenish your coolant refer to "Normal Maintenance Schedule - Turbo Models (For Smartstream G1.6 T-GDi)" on page 8-10. Before winter, have your coolant tested to assure that its freezing point is sufficient for the temperatures anticipated during the winter.

Check battery and cables

Winter puts additional burdens on the battery system. Visually inspect the battery and cables (refer to "For best battery service" on page 8-32). The level of charge in your battery can be checked by an authorized Kia dealer or a service station.

Change to "winter weight" oil if necessary

In some climates it is recommended that a lower viscosity "winter weight" oil be

used during cold weather. Refer to "Recommended lubricants and capacities" on page 9-6 for recommendations. If you aren't sure what weight oil you should use, consult an authorized Kia dealer.

Check spark plugs and ignition system

Inspect your spark plugs as described in "Scheduled maintenance service" on page 8-9 and replace them if necessary. Also, check all ignition wiring and components to be sure they are not cracked, worn or damaged in any way.

To keep locks from freezing

To keep the locks from freezing, squirt an approved de-icer fluid or glycerine into the key opening. If a lock is covered with ice, squirt it with an approved de-icing fluid to remove the ice. If the lock is frozen internally, you may be able to thaw it out by using a heated key. Handle the heated key with care to avoid injury.

Use approved window washer anti-freeze in system

To keep the water in the window washer system from freezing, add an approved window washer anti-freeze solution in accordance with instructions on the container. Window washer anti-freeze is available from an authorized Kia dealer and most auto parts outlets. Do not use vehicle coolant or other types of anti-freeze as these may damage the paint finish.

Don't let your parking brake freeze

Under some conditions your parking brake can freeze in the engaged position. This is most likely to happen when there is an accumulation of snow or ice around or near the rear brakes or if the brakes are wet. If there is a risk the parking brake may freeze, apply it only temporarily while you put the gear shift dial in P (Park) and block the rear wheels so the vehicle cannot roll. Then release the parking brake.

Don't let ice and snow accumulate underneath

Under some conditions, snow and ice can build up under the fenders and interfere with the steering. In severe winter conditions you should periodically check underneath the vehicle to be sure the movement of the front wheels and the steering components are not obstructed.

Carry emergency equipment

Depending on the severity of the weather, you should carry appropriate emergency equipment. Some of the items you may want to carry include tow straps or chains, flashlight, emergency flares, sand, shovel, jumper cables, window scraper, gloves, ground cloth, coveralls, blanket, etc.

Drive your vehicle when water vapor condenses and accumulates inside the exhaust pipes

When the vehicle is stopped for a long time in winter while the engine is running, water vapor may condense and accumulate inside the exhaust pipes.

Water in the exhaust pipes may cause noise, etc., but it is drained driving at medium to high speed.

Trailer towing

We do not recommend using this vehicle for trailer towing.

Vehicle load limit

The vehicle load limit is displayed on the tire and loading information label on the driver's door.

Tire and loading information label

The label located on the driver's door sill gives the original tire size, cold tire pressures recommended for your vehicle, the number of people that can be in your vehicle and vehicle capacity weight.

Vehicle capacity weight:

390 kg (860 lbs.)

Vehicle capacity weight is the maximum combined weight of occupants and cargo. If your vehicle is equipped with a trailer, the combined weight includes the tongue load.

Seating capacity:

Total: 5 persons (Front seat: 2 persons, Rear seat: 3 persons)

Seating capacity is the maximum number of occupants including a driver, your vehicle may carry.

However, the seating capacity may be reduced based upon the weight of all of the occupants, and the weight of the cargo being carried or towed.

Do not overload the vehicle as there is a limit to the total weight, or load limit including occupants and cargo, the vehicle can carry.

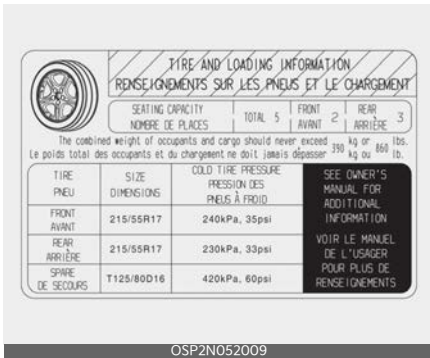

Towing capacity:

We do not recommend using this vehicle for trailer towing.

Cargo capacity:

The cargo capacity of your vehicle will increase or decrease depending on the weight and the number of occupants.

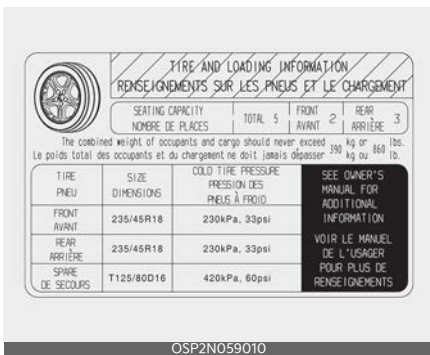

Steps For Determining Correct Load Limit —

1. Locate the statement "The combined weight of occupants and cargo should never exceed XXX kg or XXX lbs." on your vehicle's placard.
2. Determine the combined weight of the driver and passengers that will be riding in your vehicle.
3. Subtract the combined weight of the driver and passengers from XXX kg or XXX lbs.
4. The resulting figure equals the available amount of cargo and luggage load capacity. For example, if the "XXX" amount equals 635 kg (1400 lbs.) and there will be five 68 kg (150 lbs.) passengers in your vehicle, the amount of available cargo and luggage load capacity is 295 kg (650 lbs.).
 $(635 - 340 (5 \times 68)) = 295 \text{ kg}$ or $(1400 - 750 (5 \times 150)) = 650 \text{ lbs.}$
5. Determine the combined weight of luggage and cargo being loaded on the vehicle. That weight may not safely exceed the available cargo and luggage load capacity calculated in Step 4.
6. If your vehicle will be towing a trailer, load from your trailer will be transferred to your vehicle. Consult this manual to

determine how this reduces the available cargo and luggage load capacity of your vehicle.

⚠ WARNING

Loose cargo

Do not travel with unsecured blunt objects in the passenger compartment of your vehicle (e.g. suit cases or unsecured child seats). These items may strike an occupant during a sudden stop or crash.

Example 1

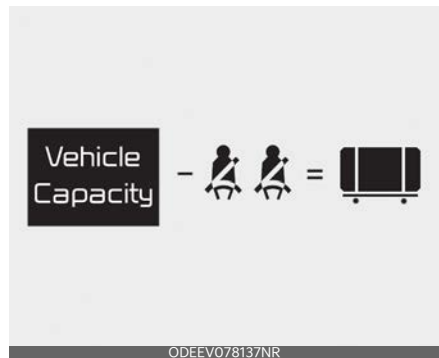

Item	Description	Total
A	Vehicle Capacity Weight	385 kg (849 lbs.)
B	Subtract Occupant Weight 68 kg (150 lbs.)x2	136 kg (300 lbs.)

Item	Description	Total
C	Available Cargo and Luggage weight	249 kg (549 lbs.)

Example 2

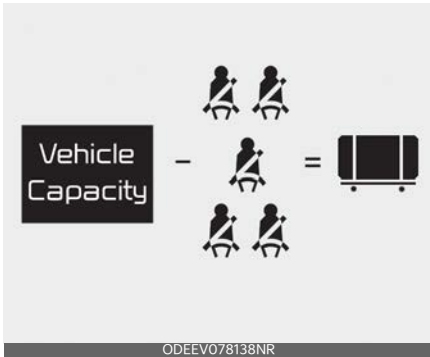

Item	Description	Total
A	Vehicle Capacity Weight	385 kg (849 lbs.)
B	Subtract Occupant Weight 68 kg (150 lbs.)x5	340 kg (750 lbs.)
C	Available Cargo and Luggage weight	45 kg (99 lbs.)

Example 3

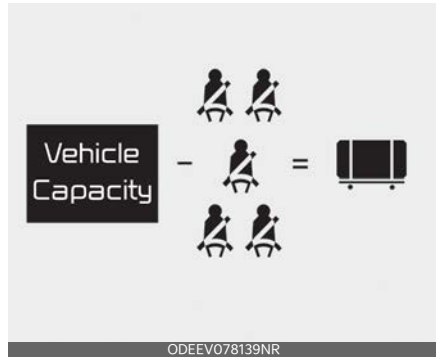

Item	Description	Total
A	Vehicle Capacity Weight	385 kg (849 lbs.)
B	Subtract Occupant Weight 73 kg (161 lbs.)x5	365 kg (805 lbs.)
C	Available Cargo and Luggage weight	20 kg (44 lbs.)

Refer to your vehicle's tire and loading information label for specific information about your vehicle's capacity weight and seating positions. The combined weight of the driver, passengers and cargo should never exceed your vehicle's capacity weight.

Certification label

The certification label is located on the driver's door sill at the center pillar.

This label shows the maximum allowable weight of the fully loaded vehicle. This is called the GVWR (Gross Vehicle Weight Rating). The GVWR includes the weight of the vehicle, all occupants and cargo.

This label also tells you the maximum weight that can be supported by the front and rear axles, called Gross Axle Weight Rating (GAWR).

To find out the actual loads on your front and rear axles, you need to go to a weigh station and weigh your vehicle. Your dealer can help you with this. Be sure to spread out your load equally on both sides of the centerline.

WARNING

Over loading

Never exceed the GVWR for your vehicle, the GAWR for either the front or rear axle and vehicle capacity weight. Exceeding these ratings can affect your vehicle's handling and braking ability.

The label will help you decide how much cargo and installed equipment your vehicle can carry.

If you carry items inside your vehicle - like suitcases, tools, packages, or anything else - they are moving as fast as the vehicle. If you have to stop or turn quickly, or if there is a crash, the items will keep going and can cause an injury if they strike the driver or a passenger.

WARNING

Over loading

Do not overload your vehicle. Overloading your vehicle can cause heat buildup in your vehicle's tires and possible tire failure, increased stopping distances and poor vehicle handling--all of which may result in a crash.

* NOTICE

Overloading your vehicle may cause damage. Repairs would not be covered by your warranty. Do not overload your vehicle.

Vehicle weight

This chapter will guide you in the proper loading of your vehicle and/or trailer, to keep your loaded vehicle weight within its design rating capability, with or without a trailer.

Properly loading your vehicle will provide maximum return of the vehicle design performance. Before loading your vehicle, familiarize yourself with the following terms for determining your vehicle's weight ratings, with or without a trailer, from the vehicle's specifications and the compliance label:

Base curb weight This is the weight of the vehicle including a full tank of fuel and all standard equipment. It does not include passengers, cargo, or optional equipment.

Vehicle curb weight This is the weight of your new vehicle when you picked it up from your dealer plus any aftermarket equipment.

Cargo weight This figure includes all weight added to the Base Curb Weight, including cargo and optional equipment.

GAW (Gross Axle Weight) This is the total weight placed on each axle (front and rear) - including vehicle curb weight and all payload.

GAWR (Gross Axle Weight Rating) This is the maximum allowable weight that can be carried by a single axle (front or rear).

These numbers are shown on the compliance label. The total load on each axle must never exceed its GAWR.

GVW (Gross Vehicle Weight)

This is the Base Curb Weight plus actual Cargo Weight plus passengers.

GVWR (Gross Vehicle Weight Rating)

This is the maximum allowable weight of the fully loaded vehicle (including all options, equipment, passengers and cargo). The GVWR is shown on the certification label located on the driver's door sill.

⚠ CAUTION

Do not use replacement tires with lower load carrying capacities than the original tires because they may lower your vehicle's GVWR and GAWR limitations. Replacement tires with a higher limit than the original tires do not increase the GVWR and GAWR limitations.

Forward Collision-Avoidance Assist (FCA)	
(Front view camera only)	6-4
• Forward Collision-Avoidance Assist settings	6-5
• Forward Collision-Avoidance Assist operation	6-6
• Forward Collision-Avoidance Assist malfunction and limitations.....	6-8
Forward Collision-Avoidance Assist (FCA) (Sensor fusion) ..	6-15
• Detecting sensor.....	6-15
• Forward Collision-Avoidance Assist settings	6-16
• Forward Collision-Avoidance Assist operation	6-18
• Forward Collision-Avoidance Assist malfunction and limitations.....	6-21
Lane Keeping Assist (LKA)	6-28
• Detecting sensor.....	6-28
• Lane Keeping Assist settings	6-29
• Lane Keeping Assist operation.....	6-29
• Lane Keeping Assist malfunction and limitations.....	6-32
Blind-Spot Collision-Avoidance Assist (BCA)	6-35
• Detecting sensor.....	6-36
• Blind-Spot Collision-Avoidance Assist settings.....	6-36
• Blind-Spot Collision-Avoidance Assist operation	6-38
• Blind-Spot Collision-Avoidance Assist malfunction and limitations.....	6-40
Safe Exit Warning (SEW)	6-44
• Detecting sensor.....	6-44
• Safe Exit Warning settings	6-45
• Safe Exit Warning operation	6-46
• Safe Exit Warning malfunction and limitations	6-47
• Limitations of Safe Exit Warning	6-48
Manual Speed Limit Assist (MSLA)	6-48
• Manual Speed Limit Assist operation.....	6-48

6 Driver assistance system

Intelligent Speed Limit Assist (ISLA)	6-51
• Intelligent Speed Limit Assist settings	6-51
• Intelligent Speed Limit Assist operation.....	6-52
• Auto set speed change (if Infotainment system equipped).....	6-53
• Intelligent Speed Limit Assist malfunction and limitations.....	6-54
Driver Attention Warning (DAW)	6-56
• Driver Attention Warning settings	6-57
• Driver Attention Warning operation	6-57
• Driver Attention Warning malfunction and limitations	6-58
Cruise Control (CC)	6-61
• Cruise Control operation	6-61
Smart Cruise Control (SCC)	6-64
• Detecting sensor	6-64
• Smart Cruise Control settings	6-65
• Smart Cruise Control operation.....	6-66
• Smart Cruise Control malfunction and limitations.....	6-73
Navigation-based Smart Cruise Control (NSCC)	6-78
• Navigation-based Smart Cruise Control settings	6-78
• Navigation-based Smart Cruise Control operation	6-78
• Limitations of Navigation-based Smart Cruise Control	6-80
Lane Following Assist (LFA)	6-83
• Detecting sensor	6-83
• Lane Following Assist settings	6-84
• Lane Following Assist malfunction and limitations.....	6-86
• Limitations of Lane Following Assist	6-86
Highway Driving Assist (HDA)	6-87
• Highway Driving Assist settings	6-88
• Highway Driving Assist operation	6-89
• Highway Driving Assist malfunction and limitations.....	6-91

Rear View Monitor (RVM)	6-94
• Detecting sensor.....	6-94
• Rear View Monitor operation.....	6-95
• Rear View Monitor malfunction and limitations.....	6-96
Rear Cross-Traffic Collision-Avoidance Assist (RCCA).....	6-97
• Rear Cross-Traffic Collision-Avoidance Assist settings.....	6-97
• Rear Cross-Traffic Collision-Avoidance Assist operation.....	6-98
• Rear Cross-Traffic Collision-Avoidance Assist malfunction and limitations.....	6-102
Reverse Parking Distance Warning (PDW)	6-106
• Detecting sensor.....	6-106
• Reverse Parking Distance Warning Operation.....	6-106
• Reverse Parking Distance Warning settings.....	6-106
Forward/Reverse Parking Distance Warning (PDW)	6-109
• Forward/Reverse Parking Distance Warning Settings.....	6-109
Declaration of conformity	6-114
• The radio frequency components (Front radar) (if equipped) complies:.....	6-114
• The radio frequency components (Rear corner radar) (if equipped) complies:.....	6-114

Driver assistance system

* INFORMATION

The description of the driver assistance system displayed on the screen may differ from the content of the owner's manual depending on the infotainment software version. If the infotainment system (genuine Kia parts) is installed separately, refer to the manual provided in the infotainment system and follow instructions for set-up.

Forward Collision-Avoidance Assist (FCA) (Front view camera only) (if equipped)

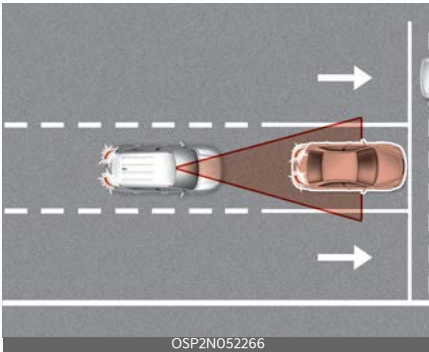

Forward Collision-Avoidance Assist is designed to help detect and monitor the vehicle ahead or help detect a pedestrian or cyclist in the roadway and warn the driver that a collision is imminent with a warning message, audible warning and apply emergency braking.

Detecting sensor

[1]: Front view camera



Refer to the picture above for the detailed location of the detecting sensors.

⚠ CAUTION

- Never disassemble the detecting sensor or sensor assembly, or cause any damage to it.
- If the detecting sensor has been replaced or repaired, have the vehicle inspected by an authorized Kia dealer.
- Never install any accessories or stickers on the front windshield, or tint the front windshield.
- Pay extreme caution to keep the front view camera dry.
- Never place any reflective objects (for example, white paper, mirror) over the dashboard.
- Do not place any objects near the front windshield or install any accessories on the front windshield. It can affect the performance of the defogging and defrosting function of the climate control system, which may prevent the Driver Assistance systems from operating.

Forward Collision-Avoidance Assist settings

Forward Safety



With the ignition switch or ENGINE START/STOP button in the ON position, select 'User Settings → Driver Assistance → Driving Safety' on the LCD display or 'Setup → Vehicle → Driver Assistance → Driving Safety' on the Infotainment system screen to set whether to use the function.

- Forward Safety : Depending on the collision risk levels, an audible warning will sound and the braking will be assisted. If the following menu is deactivated, Forward Collision-Avoidance Assist will turn off and the warn-

ing light  will appear on the cluster.

The driver can monitor Forward Collision-Avoidance Assist On/Off status from the settings menu. If the warning light  remains on when Forward Collision-Avoidance Assist is on, have the vehicle inspected by an authorized Kia dealer.

⚠ WARNING

When the vehicle is restarted, Forward Collision-Avoidance Assist will always turn on. However, if Forward Safety is deselected, the driver should always be aware of the surroundings and drive safely.

* INFORMATION

The infotainment system may change after software updates. For more information, refer to the user's manual provided in the infotainment system and the quick reference guide.

Forward Safety Warning Timing



With the ignition switch or ENGINE START/STOP button in the ON position, select User Settings → Driver Assistance → Driving Safety → Forward Safety Warning Timing on the LCD display or Setup → Vehicle → Driver Assistance → Driving Safety → Forward Safety Warning Timing on the Infotainment system screen to change the initial warning activation timing for Forward Collision-Avoidance Assist.

- Use 'Standard' in normal driving conditions. If the Warning Timing seems sensitive, change it to 'Late'.

- If 'Late' is selected, Forward Collision-Avoidance Assist warns the driver more slowly.

⚠ CAUTION

- Even though 'Standard' is selected for Warning Timing, if the front vehicle suddenly stops, the initial warning activation time may seem late.
- Select 'Late' for Warning Timing when traffic is light and when driving speed is slow.

*** NOTICE**

The warning timing you have set will be maintained even if the vehicle is restarted.

Warning Methods

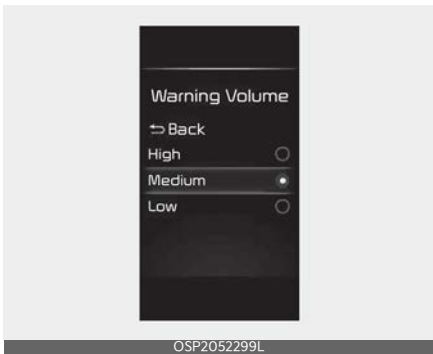

You can adjust the Warning Methods with the ignition switch or ENGINE START/STOP button in the ON position.

- Warning Volume : Select 'User Settings → Driver Assistance → Warning Volume' on the LCD display or 'Setup → Vehicle → Driver Assistance → Warning Methods' on the Infotainment system.
- Driving Safety Priority : Select 'Setup → Vehicle → Driver Assistance →

Warning Methods → Driving Safety Priority' on the Infotainment system. For safe driving, the audio volume will temporarily decrease to warn the driver with the audible warning.

*** NOTICE**

- Ensure that Warning Methods you have set may apply to the warning volume of other Driver Assistance systems.
- Warning Methods will maintain its last setting even if the vehicle is restarted.
- The setting menu may not be available for your vehicle depending on the vehicle features and specifications.

Forward Collision-Avoidance Assist operation

Basic function

The basic function for Forward Collision-Avoidance Assist is to warn and help control the vehicle depending on the collision risk level.

- Collision Warning
- Emergency Braking
- Stopping vehicle and ending brake control

Collision Warning



Collision warning will alert the driver with a warning message and an audible warning. Collision Warning will be activated in your driving speed and the following conditions.

- For vehicle: 10~180 km/h (6~112 mph)
- For pedestrian or cyclist: 10~80 km/h (6~50 mph)

Emergency Braking

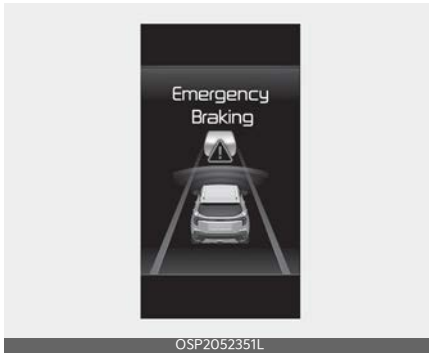

The warning message and an audible warning to warn the driver that emergency braking will be assisted. The brake assist will be activated and it helps avoiding collision of a vehicle, pedestrian and cyclist. Emergency braking will be activated in your driving speed and the following conditions.

- For vehicle: 10~60 km/h (6~37 mph)
- For pedestrian or cyclist: 10~60 km/h (6~37 mph)

CAUTION

The function operation range may decrease due to the front traffic condition or the surroundings of the vehicle.

Stopping vehicle and ending brake control



When the vehicle is stopped due to Emergency Braking, the 'Drive carefully' warning message will appear on the cluster.

For your safety, the driver should depress the brake pedal immediately and check the surroundings.

- Brake control will end after the vehicle is stopped by emergency braking for approximately 2 seconds.

WARNING

- For your safety, only change the settings after parking the vehicle at a safe location.
- The driver should hold the responsibility to control the vehicle. Do not solely depend on Forward Collision-Avoidance Assist. Rather, maintain a safe braking distance, and if necessary, depress the brake pedal to reduce driving speed or to stop the vehicle.
- Never deliberately test Forward Collision-Avoidance Assist on people, objects, etc. It may cause serious injury or death.
- Forward Collision-Avoidance Assist may not operate if the driver

depresses the brake pedal to avoid collision.

- Depending on the road and driving conditions, Forward Collision-Avoidance Assist may warn the driver late or may not warn the driver.
- During Forward Collision-Avoidance Assist operation, the vehicle may stop suddenly injuring passengers and shifting loose objects. Always have the seat belt on and keep loose objects secured.
- If any other function's warning message is displayed or audible warning is generated, Forward Collision-Avoidance Assist warning message may not be displayed and audible warning may not be generated.
- You may not hear the warning sound of Forward Collision-Avoidance Assist if the surrounding is noisy.
- Forward Collision-Avoidance Assist may turn off or may not operate properly or may operate unnecessarily depending on the road conditions and the surroundings.
- Even if there is a problem with Forward Collision-Avoidance Assist, the vehicle's basic braking performance will operate properly.
- During emergency braking, braking control by Forward Collision-Avoidance Assist will automatically cancel when the driver excessively depresses the accelerator pedal or sharply steers the vehicle.

⚠ CAUTION

Depending on the condition of the vehicle, pedestrian and cyclist in front and the surroundings, the speed range to operate Forward Collision-Avoidance Assist may reduce. Forward Collision-

Avoidance Assist may only warn the driver, or it may not operate.

*** NOTICE**

- In a situation where collision is imminent, braking may be assisted by Forward Collision-Avoidance Assist when braking is insufficient by the driver.
- The images and colors in the instrument cluster may differ depending on the cluster type or theme selected from the settings menu.

Forward Collision-Avoidance Assist malfunction and limitations

Forward Collision-Avoidance Assist malfunction





When Forward Collision-Avoidance Assist is not working properly, the warning message will appear and the 

and  warning lights will appear on the cluster. In this case, have your vehicle inspected by an authorized Kia dealer.

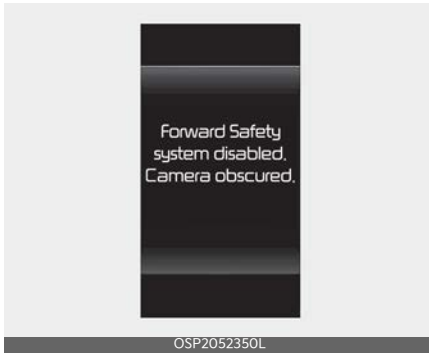
Forward Collision-Avoidance Assist disabled



When the front windshield where the front view camera is located, is covered with foreign material, such as snow or rain, it can reduce the detecting performance and temporarily limit or disable Forward Collision-Avoidance Assist.

If this occurs, the warning message will appear and the  and  warning lights will appear on the cluster.

Forward Collision-Avoidance Assist will operate properly when snow, rain or foreign matter is removed. Always keep it clean.

If Forward Collision-Avoidance Assist does not operate properly after obstruction (snow, rain, or foreign material) is removed, have the vehicle inspected by an authorized Kia dealer.

WARNING

- Even though the warning message or warning light does not appear on the cluster, Forward Collision-Avoidance Assist may not properly operate.
- Forward Collision-Avoidance Assist may not properly operate in an area (for example, open terrain), where any

objects are not detected after turning ON the engine.

Limitations of Forward Collision-Avoidance Assist

Forward Collision-Avoidance Assist may not operate properly or it may operate unexpectedly under the following circumstances:

- The detecting sensor or the surroundings are contaminated or damaged
- The temperature around the front view camera is high or low due to the external environment.
- The camera lens is contaminated due to tinted, filmed or coated windshield, damaged glass, or sticky foreign material (sticker, bug, etc.) on the glass
- Moisture is not removed or frozen on the windshield
- Washer fluid is continuously sprayed, or the wiper is on
- Driving in heavy rain or snow, or thick fog
- The field of view of the front view camera is obstructed by sun glare
- Street light or light from an oncoming traffic is reflected on the wet road surface, such as a puddle on the road
- An object is placed on the dashboard
- Your vehicle is being towed
- The surrounding is very bright
- The surrounding is very dark, such as in a tunnel, etc.
- The brightness changes suddenly, for example when entering or exiting a tunnel
- The brightness outside is low, and the headlamps are not on or are not bright

- Driving through steam, smoke or shadow
- Only part of the vehicle, pedestrian or cyclist is detected
- The vehicle in front is a bus, heavy truck, truck with an unusually shaped cargo, trailer, etc.
- The vehicle in front has no tail lights, tail lights are located unusually, etc.
- The brightness outside is low, and the tail lamps are not on or are not bright
- The rear of the front vehicle is small or the vehicle does not look normal, such as when the vehicle is tilted, overturned, or the side of the vehicle is visible, etc.
- The front vehicle's ground clearance is low or high
- A vehicle, pedestrian or cyclist suddenly cuts in front
- The vehicle in front is detected late
- The vehicle in front is suddenly blocked by an obstacle
- The vehicle in front suddenly changes lanes or suddenly reduces speed
- The vehicle in front is bent out of shape
- The front vehicle's speed is fast or slow
- The vehicle in front steers in the opposite direction of your vehicle to avoid a collision
- With a vehicle in front, your vehicle changes lanes at low speed
- The vehicle in front is covered with snow
- You are departing or returning to the lane
- You are driving unstably
- You are on a roundabout and the vehicle in front is not detected

- You are continuously driving in a circle
- The vehicle in front has an unusual shape
- The vehicle in front is driving uphill or downhill.
- The pedestrian or cyclist is not fully detected, for example, if the pedestrian is leaning over or is not fully walking upright
- The pedestrian or cyclist is wearing clothing or equipment that makes it difficult to detect

Following image shows the image the sensor recognizes as a vehicle, pedestrian and cyclist



- The pedestrian or cyclist in front is moving very quickly
- The pedestrian or cyclist in front is short or is posing a low posture
- The pedestrian or cyclist in front has impaired mobility
- The pedestrian or cyclist in front is moving intersected with the driving direction
- There is a group of pedestrians, cyclists or a large crowd in front
- The pedestrian or cyclist is wearing clothing that easily blends into the background, making it difficult to detect

- The pedestrian or cyclist is difficult to distinguish from the similarly shaped structure in the surroundings
- You are driving by a pedestrian, cyclist, traffic signs, structures, etc. near the intersection
- You are driving by a pedestrian, cyclist, traffic signs, structures, etc. near the intersection
- Driving in a parking lot
- Driving through a tollgate, construction area, unpaved road, partial paved road, uneven road, speed bumps, etc.
- Driving on an incline road, curved road, etc.
- Driving through a roadside with trees or streetlights
- The adverse road conditions cause excessive vehicle vibrations while driving
- Your vehicle height is low or high due to heavy loads, abnormal tire pressure, etc.
- Driving through a narrow road where trees or grass are overgrown
- There is interference by electromagnetic waves, such as driving in an area with strong radio waves or electrical noise
- The adverse road conditions cause excessive vehicle vibrations while driving
- Your vehicle height is low or high due to heavy loads, abnormal tire pressure, etc.

⚠ WARNING

- Driving on a curved road

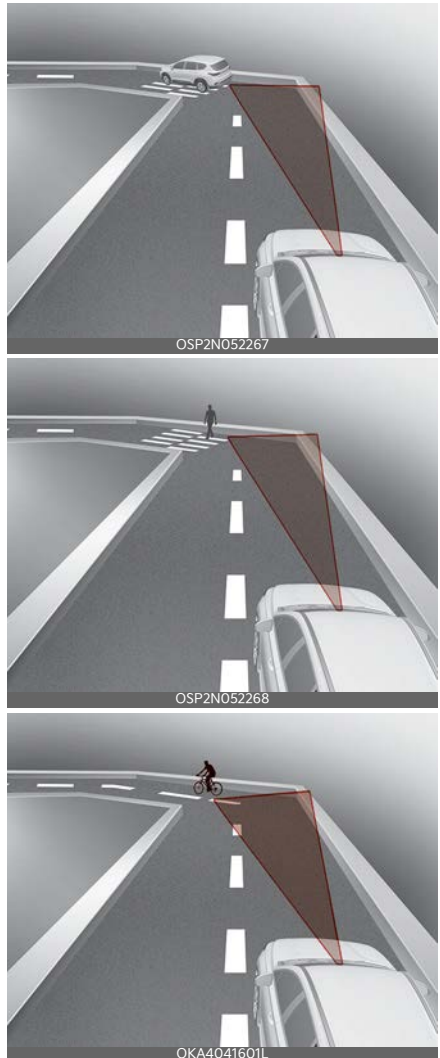

Forward Collision-Avoidance Assist may not detect other vehicle, pedestrian or cyclist in front of you when driving on curved roads adversely affecting the performance of the sen-

sors. This may result in no warning or no braking assist when necessary. When driving on a curve, you must maintain a safe braking distance, and if necessary, steer the vehicle and depress the brake pedal to reduce your driving speed in order to maintain a safe distance.

Forward Collision-Avoidance Assist may detect a vehicle, pedestrian or cyclist in the next lane or outside the lane when driving on a curved road. If this occurs, Forward Collision-Avoidance Assist may unnecessarily warn the driver and control the brake or steering wheel. Always check the traffic conditions around the vehicle.

- **Driving on an inclined road**

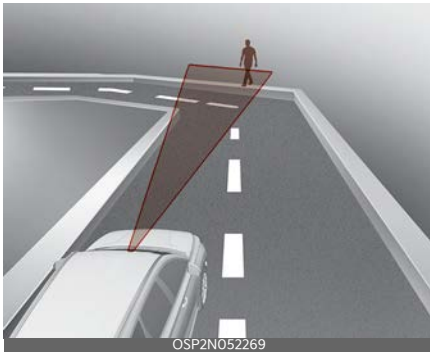
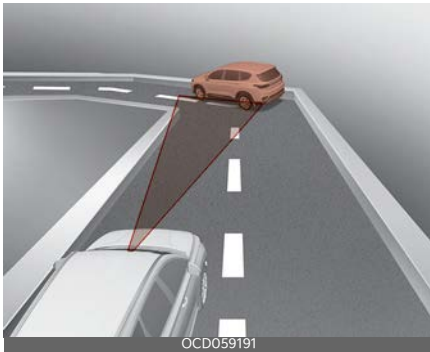



Forward Collision-Avoidance Assist may not detect other vehicle, pedestrian or cyclist in front of you while driving uphill or downhill adversely affecting the performance of the sensors.

This may result in unnecessary warning, braking assist or no warning or no braking assist when necessary.

Also, vehicle speed may rapidly decrease when a vehicle or pedestrian ahead is suddenly detected.

Always have your eyes on the road while driving uphill or downhill and if necessary, steer your vehicle and depress the brake pedal to reduce your driving speed in order to maintain a safe distance.

- Changing lanes

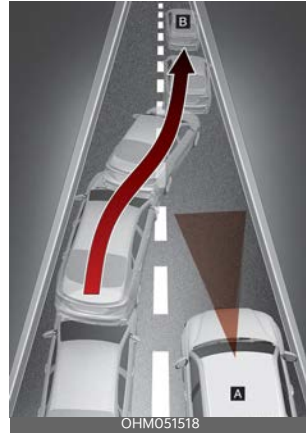

[A]: Your vehicle

[B]: Lane changing vehicle

When a vehicle [B] moves into your lane from an adjacent lane, it cannot be detected by the sensor until it is in the sensor's detection range. Forward Collision-Avoidance Assist may not immediately detect the vehicle when the vehicle changes lanes abruptly. In this case, you must maintain a safe braking distance, and if necessary, steer your vehicle and depress the brake pedal to reduce your driving speed in order to maintain a safe distance.

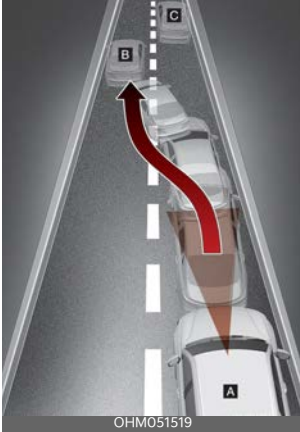

- [A]: Your vehicle
- [B]: Lane changing vehicle,
- [C]: Same lane vehicle

When a vehicle [B] in front of you merges out of the lane, Forward Collision-Avoidance Assist may not immediately detect the vehicle [C] that is now in front of you. In this case, you must maintain a safe braking distance, and if necessary, steer your vehicle and depress the brake pedal to reduce your driving speed in order to maintain a safe distance.

• **Detecting vehicle**

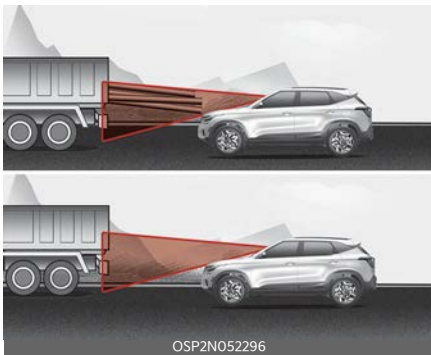

If the vehicle in front of you has cargo that extends rearward from the cab,

or when the vehicle in front of you has higher ground clearance, additional special attention is required. Forward Collision-Avoidance Assist may not be able to detect the cargo extending from the vehicle. In these instances, you must maintain a safe braking distance from the rearmost object, and if necessary, steer your vehicle and depress the brake pedal to reduce your driving speed in order to maintain distance.

WARNING

- When you are towing a trailer or another vehicle, we recommend that Forward Collision-Avoidance Assist is turned off due to safety reasons.
- Forward Collision-Avoidance Assist may operate if objects that are similar in shape or characteristics to vehicles and pedestrians are detected.
- Forward Collision-Avoidance Assist does not operate on bicycles, motorcycles, or smaller wheeled objects, such as luggage bags, shopping carts, or strollers that are dragged by a pedestrian.
- Forward Collision-Avoidance Assist may not operate properly if interfered with by strong electromagnetic waves.
- Forward Collision-Avoidance Assist may not operate for approximately 15 seconds after the vehicle is started, or the front view camera is initialized.

Forward Collision-Avoidance Assist (FCA) (Sensor fusion) (if equipped)

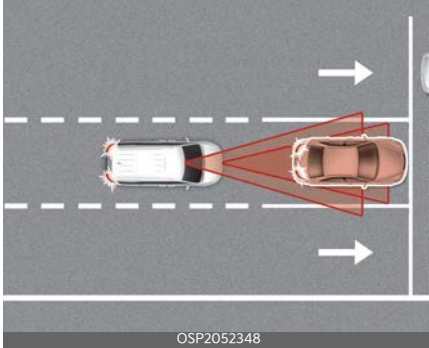

Forward Collision-Avoidance Assist is designed to help detect and monitor the vehicle ahead or help detect a pedestrian or cyclist in the roadway and warn the driver that a collision is imminent with a warning message, audible warning and apply emergency braking.

Junction Turning function



Junction Turning function can help avoid a collision with an oncoming vehicle in an adjacent lane when turning left at a crossroad with the turn signal on by applying emergency braking.

Detecting sensor

[1]: Front view camera, [2]: Front radar



Refer to the picture above for the detailed location of the detecting sensors.

⚠ CAUTION

- Never disassemble the detecting sensor or sensor assembly, or cause any damage to it.
- If the detecting sensor has been replaced or repaired, have the vehicle inspected by an authorized Kia dealer.
- Never install any accessories or stickers on the front windshield, or tint the front windshield.
- Pay extreme caution to keep the front view camera dry.

- Never place any reflective objects (for example, white paper, mirror) over the dashboard.
- Do not apply license plate frame or objects, such as a bumper sticker, film or a bumper guard, near the front radar cover.
- Always keep the front radar and cover clean and free of dirt and debris. Use only a soft cloth to wash the vehicle. Do not spray pressurized water directly on the sensor or sensor cover.
- If the radar or around the radar has been damaged or impacted in any way, Forward Collision-Avoidance Assist may not properly operate even though a warning message does not appear on the cluster. Have the vehicle inspected by an authorized Kia dealer.
- The genuine Kia front radar sensor covers are parts with quality and performance ensured. If arbitrarily applying paint on or changing the cover, Forward Collision-Avoidance Assist may not function properly. Use only Kia Genuine Parts or those of an equivalent standard with proven quality and performance to repair or replace the radar sensor covers.

Forward Collision-Avoidance Assist settings

Forward Safety



With the ignition switch or ENGINE START/STOP button in the ON position, select 'User Settings → Driver Assistance → Driving Safety' on the LCD display or 'Setup → Vehicle → Driver Assistance → Driving Safety' on the Infotainment system screen to set whether to use the function.

- Forward Safety : Depending on the collision risk levels, an audible warning will sound and the braking will be assisted. If the following menu is deactivated, Forward Collision-Avoidance Assist will turn off and the warning light (🚗) will appear on the cluster.

The driver can monitor Forward Collision-Avoidance Assist On/Off status from the settings menu. If the warning light (🚗) remains on when Forward Collision-Avoidance Assist is on, have the vehicle inspected by an authorized Kia dealer.

⚠ WARNING

When the vehicle is restarted, Forward Collision-Avoidance Assist will always turn on. However, if Forward Safety is deselected, the driver should always be aware of the surroundings and drive safely.

*** INFORMATION**

The infotainment system may change after software updates. For more information, refer to the user's manual provided in the infotainment system and the quick reference guide.

Forward Safety Warning Timing

OSP2054405L

With the ignition switch or ENGINE START/STOP button in the ON position, select User Settings → Driver Assistance → Driving Safety → Forward Safety Warning Timing on the LCD display or Setup → Vehicle → Driver Assistance → Driving Safety → Forward Safety Warning Timing on the Infotainment system screen to change the initial warning activation timing for Forward Collision-Avoidance Assist.

- Use 'Standard' in normal driving conditions. If the Warning Timing seems sensitive, change it to 'Late'.

- If 'Late' is selected, Forward Collision-Avoidance Assist warns the driver more slowly.

⚠ CAUTION

- Even though 'Standard' is selected for Warning Timing, if the front vehicle suddenly stops, the initial warning activation time may seem late.
- Select 'Late' for Warning Timing when traffic is light and when driving speed is slow.

*** NOTICE**

The warning timing you have set will be maintained even if the vehicle is restarted.

Warning Methods

OSP2052299L

You can adjust the Warning Methods with the ignition switch or ENGINE START/STOP button in the ON position.

- Warning Volume : Select 'User Settings → Driver Assistance → Warning Volume' on the LCD display or 'Setup → Vehicle → Driver Assistance → Warning Methods' on the Infotainment system.
- Driving Safety Priority : Select 'Setup → Vehicle → Driver Assistance →

Warning Methods → Driving Safety Priority' on the Infotainment system. For safe driving, the audio volume will temporarily decrease to warn the driver with the audible warning.

*** NOTICE**

- Ensure that Warning Methods you have set may apply to the warning volume of other Driver Assistance systems.
- Warning Methods will maintain its last setting even if the vehicle is restarted.
- The setting menu may not be available for your vehicle depending on the vehicle features and specifications.

Forward Collision-Avoidance Assist operation

Basic function

The basic function for Forward Collision-Avoidance Assist is to warn and help control the vehicle depending on the collision risk level.

- Collision Warning
- Emergency Braking
- Stopping vehicle and ending brake control

Collision Warning



Collision warning will alert the driver with a warning message and an audible warning. Collision Warning will be activated in your driving speed and the following conditions.

- For vehicle: 10~180 km/h (6~112 mph)
- For pedestrian or cyclist: 10~85 km/h (6~53 mph)

Emergency Braking

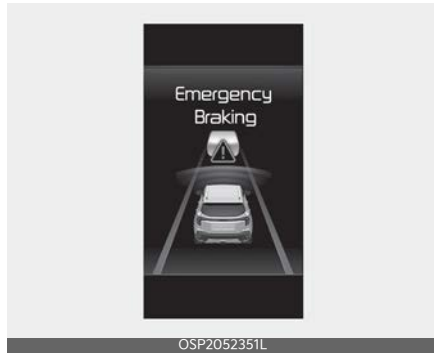

The warning message and an audible warning to warn the driver that emergency braking will be assisted. The brake assist will be activated and it helps avoiding collision of a vehicle, pedestrian and cyclist. Emergency braking will be activated in your driving speed and the following conditions.

- For vehicle:

	Driving target	Stopped target
Weak braking power	10~180 km/h (6~112 mph)	
Strong braking power	10~130 km/h (6~80 mph)	10~75 km/h (6~47 mph)

- For pedestrian or cyclist: 10~65 km/h (6~40 mph)

⚠ CAUTION

The function operation range may decrease due to the front traffic condition or the surroundings of the vehicle.

Stopping vehicle and ending brake control

OSP2052307L

When the vehicle is stopped due to emergency braking, the 'Drive carefully' warning message will appear on the cluster.

For your safety, the driver should depress the brake pedal immediately and check the surroundings.

- Brake control will end after the vehicle is stopped by emergency braking for approximately 2 seconds.

Junction Turning function

The basic function for Junction turning function is to warn and help control the vehicle depending on the collision risk level.

- Collision Warning
- Emergency Braking
- Stopping vehicle and ending brake control

Collision Warning

OSP2052344L

Collision warning will alert the driver with a warning message and an audible warning. Collision warning will be activated in the following conditions.

- Your driving speed: 10~30 km/h (6~19 mph)
- Oncoming vehicle speed: 30~70 km/h (19~44 mph)

Emergency Braking

OSP2052345L

The warning message and an audible warning to warn the driver that emergency braking will be assisted. The brake assist will be activated and it helps avoiding collision of a vehicle. Emergency braking will be activated in the following conditions.

- Your driving speed: 10~30 km/h (6~19 mph)
- Oncoming vehicle speed: 30~70 km/h (19~44 mph)

Stopping vehicle and ending brake control



When the vehicle is stopped due to emergency braking, the warning message will appear on the cluster. For your safety, the driver should depress the brake pedal immediately and check the surroundings.

- Brake control will end after the vehicle is stopped by emergency braking for approximately 2 seconds.

⚠ WARNING

- For your safety, change the settings after parking the vehicle at a safe location.
- The driver should hold the responsibility to control the vehicle. Do not solely depend on Forward Collision-Avoidance Assist. Rather, maintain a safe braking distance, and if necessary, depress the brake pedal to reduce driving speed or to stop the vehicle.
- Never deliberately operate Forward Collision-Avoidance Assist on people, objects, etc. It may cause serious injury or death.
- Forward Collision-Avoidance Assist may not operate if the driver depresses the brake pedal to avoid collision.
- Depending on the road and driving conditions, Forward Collision-Avoidance Assist may warn the driver late or may not warn the driver.
- During Forward Collision-Avoidance Assist operation, the vehicle may stop suddenly injuring passengers and shifting loose objects. Always have the seat belt on and keep loose objects secured.
- If any other function's warning message is displayed or audible warning is generated, Forward Collision-Avoidance Assist warning message may not be displayed and audible warning may not be generated.
- You may not hear the warning sound of Forward Collision-Avoidance Assist if the surrounding is noisy.
- Forward Collision-Avoidance Assist may turn off or may not operate properly or may operate unnecessarily depending on the road conditions and the surroundings.
- Even if there is a problem with Forward Collision-Avoidance Assist, the vehicle's basic braking performance will operate properly.
- During emergency braking, braking control by Forward Collision-Avoidance Assist will automatically cancel when the driver excessively depresses the accelerator pedal or sharply steers the vehicle.

⚠ CAUTION



- Depending on the condition of the vehicle, pedestrian and cyclist in front and the surroundings, the speed range to operate Forward Collision-Avoidance Assist may reduce. Forward Collision-Avoidance Assist may only warn the driver, or it may not operate.
- Forward Collision-Avoidance Assist will operate under certain conditions by judging the risk level based on the condition of the oncoming vehicle, driving direction, speed and surroundings.
- Driving at excessively higher or lower speed than other vehicles can temporarily limit or disable Forward Collision-Avoidance Assist.

*** NOTICE**

- In a situation where collision is imminent, braking may be assisted by Forward Collision-Avoidance Assist when braking is insufficient by the driver.
- The images and colors in the instrument cluster may differ depending on the cluster type or theme selected from the settings menu.

Forward Collision-Avoidance Assist malfunction and limitations**Forward Collision-Avoidance Assist malfunction**

When Forward Collision-Avoidance Assist is not working properly, the warning message will appear and the

and  and  warning lights will appear on the cluster. In this case, have your vehicle inspected by an authorized Kia dealer.

Forward Collision-Avoidance Assist disabled

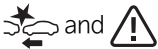

When the front windshield where the front view camera is located, front radar cover or sensor is covered with foreign material such as snow or rain, it can reduce the detecting performance and temporarily limit or disable Forward Collision-Avoidance Assist. If this occurs the warning message will appear and the

 warning lights will appear on the cluster.

Forward Collision-Avoidance Assist will operate properly when snow, rain or foreign matter is removed. If Forward Collision-Avoidance Assist does not operate properly after it is removed, have the vehicle inspected by an authorized Kia dealer.

WARNING

- Even though the warning message or warning light does not appear on the cluster, Forward Collision-Avoidance Assist may not properly operate.
- Forward Collision-Avoidance Assist may not properly operate in an area (for example, open terrain), where any objects are not detected after turning ON the engine.

Limitations of Forward Collision-Avoidance Assist

Forward Collision-Avoidance Assist may not operate properly or it may operate unexpectedly under the following circumstances:

- The detecting sensor or the surroundings are contaminated or damaged
- The temperature around the front view camera is high or low due to the external environment
- The camera lens is contaminated due to tinted, filmed or coated windshield, damaged glass, or sticky foreign matters (sticker, bug, etc.) on the glass
- Moisture is not removed or frozen on the windshield
- Washer fluid is continuously sprayed, or the wiper is on
- Driving in heavy rain or snow, or thick fog
- The field of view of the front view camera is obstructed by sun glare
- Street light or light from an oncoming traffic is reflected on the wet road surface, such as a puddle on the road
- An object is placed on the dashboard
- Your vehicle is being towed
- The surrounding is very bright
- The surrounding is very dark, such as in a tunnel, etc.
- The brightness changes suddenly, for example when entering or exiting a tunnel
- The brightness outside is low, and the headlamps are not on or are not bright
- Driving through steam, smoke or shadow
- Only part of the vehicle, pedestrian or cyclist is detected

- The vehicle in front is a bus, heavy truck, truck with an unusually shaped cargo, trailer, etc.
- The vehicle in front has no tail lights, tail lights are located unusually, etc.
- The brightness outside is low, and the tail lamps are not on or are not bright
- The rear of the front vehicle is small or the vehicle does not look normal, such as when the vehicle is tilted, overturned, or the side of the vehicle is visible, etc.
- The front vehicle's ground clearance is low or high
- A vehicle, pedestrian or cyclist suddenly cuts in front
- The bumper around the front radar is impacted, damaged or the front radar is out of position
- The temperature around the front radar is high or low
- Driving through a tunnel or iron bridge
- Driving in large areas where there are few vehicles or structures (for example, desert, meadow, suburb, etc.)
- Driving near areas containing metal substances, such as a construction zone, railroad, etc.
- A material is near that reflects very well on the front radar, such as a guardrail, nearby vehicle, etc.
- The cyclist in front is on a bicycle made of material that does not reflect on the front radar
- The vehicle in front is detected late
- The vehicle in front is suddenly blocked by an obstacle
- The vehicle in front suddenly changes lane or suddenly reduces speed
- The vehicle in front is bent out of shape
- The front vehicle's speed is fast or slow
- The vehicle in front steers in the opposite direction of your vehicle to avoid a collision
- With a vehicle in front, your vehicle changes lane at low speed
- The vehicle in front is covered with snow
- You are departing or returning to the lane
- You are driving unstably
- You are on a roundabout and the vehicle in front is not detected
- You are continuously driving in a circle
- The vehicle in front has an unusual shape
- The vehicle in front is driving uphill or downhill
- The pedestrian or cyclist is not fully detected, for example, if the pedestrian is leaning over or is not fully walking upright
- The pedestrian or cyclist is wearing clothing or equipment that makes it difficult to detect as a pedestrian or cyclist

Following image shows the image the sensor recognizes as vehicle, pedestrian, and cyclist.



- The pedestrian or cyclist in front is moving very quickly
- The pedestrian or cyclist in front is short or is posing a low posture
- The pedestrian or cyclist in front has impaired mobility
- The pedestrian or cyclist in front is moving intersected with the driving direction
- There is a group of pedestrians, cyclists or a large crowd in front
- The pedestrian or cyclist is wearing clothing that easily blends into the background, making it difficult to detect
- The pedestrian or cyclist is difficult to distinguish from the similarly shaped structure in the surroundings
- You are driving by a pedestrian, cyclist traffic signs, structures, etc. near the intersection
- Driving in a parking lot
- Driving through a tollgate, construction area, unpaved road, partial paved road, uneven road, speed bumps, etc.
- Driving on an incline road, curved road, etc.
- Driving through a roadside with trees or streetlights
- The adverse road conditions cause excessive vehicle vibrations while driving
- Your vehicle height is low or high due to heavy loads, abnormal tire pressure, etc.
- Driving through a narrow road where trees or grass are overgrown
- There is interference by electromagnetic waves, such as driving in an area with strong radio waves or electrical noise

- The adverse road conditions cause excessive vehicle vibrations while driving
- Your vehicle height is low or high due to heavy loads, abnormal tire pressure, etc.

⚠ WARNING

- **Driving on a curved road**

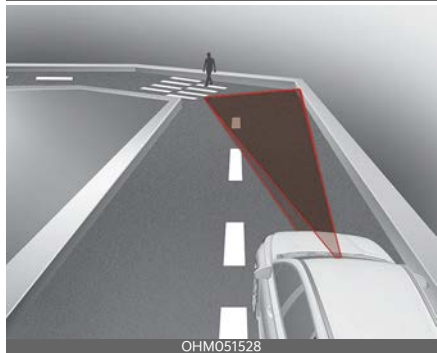
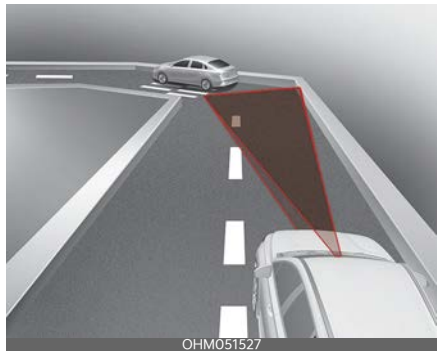



OHM051529

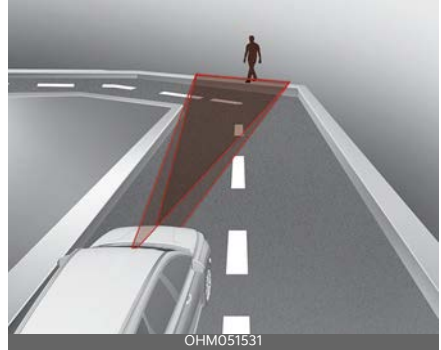

OHM051531

Forward Collision-Avoidance Assist may not detect the vehicle, pedestrian or cyclist traveling in front on a curved road.

Always pay attention to road and driving conditions, and if necessary, depress the brake pedal to reduce your driving speed in order to maintain a safe distance.

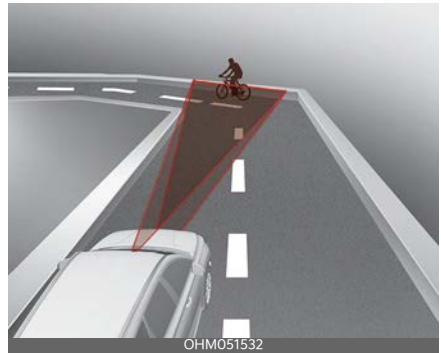

OHM051532

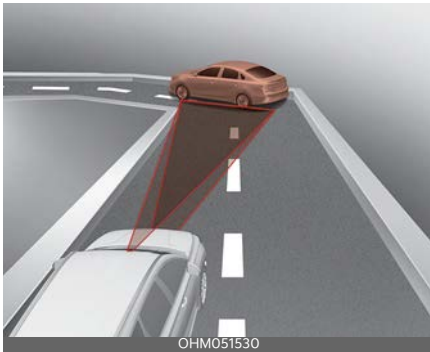

OHM051530

Forward Collision-Avoidance Assist may detect the vehicle, pedestrian or cyclist in the next lane or outside the lane when driving on a curved road. If this occurs, Forward Collision-Avoidance Assist may unnecessarily warn the driver and control the brake. Always check the traffic conditions around the vehicle.

- **Driving on an inclined road**



Forward Collision-Avoidance Assist may not detect other vehicle, pedestrian or cyclist in front while driving uphill or downhill and this may result in no warning, or braking assist when necessary.

When Forward Collision-Avoidance Assist suddenly recognizes the vehicle, pedestrian or cyclist in front while passing over a slope, you may experience sharp deceleration.

Always keep your eyes forward while driving upward or downward on a slope, and, if necessary, depress the brake pedal to reduce your driving speed in order to maintain distance.

- **Changing lanes**



[A]: Your vehicle

[B]: Lane changing vehicle

When a vehicle changes lanes in front of you, Forward Collision-Avoidance Assist may not immediately detect the vehicle, especially if the vehicle changes lanes abruptly. In this case, you must maintain a safe braking distance, and if necessary, depress the brake pedal to reduce your driving speed in order to maintain a safe distance.

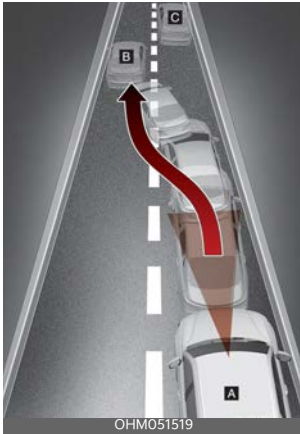

- [A]: Your vehicle
- [B]: Lane changing vehicle
- [C]: Same lane vehicle

When driving in stop-and-go traffic, and a stopped vehicle in front of you merges out of the lane, Forward Collision-Avoidance Assist may not immediately detect the new vehicle that is now in front of you. In this case, you must maintain a safe braking distance, and if necessary, depress the brake pedal to reduce your driving speed in order to maintain a safe distance.

• **Detecting vehicle**



When the vehicle in front has heavy loading extended rearward, or when the vehicle in front has higher ground clearance, it may induce a hazardous situation. Always pay attention to road and driving conditions, while driving and, if necessary, depress the brake pedal to reduce your driving speed in order to maintain distance.

⚠ WARNING

- When you are towing a trailer or another vehicle, we recommend that Forward Collision-Avoidance Assist is turned off due to safety reasons.
- Forward Collision-Avoidance Assist may operate if objects that are similar in shape or characteristics to vehicles, pedestrians or cyclists are detected.
- Forward Collision-Avoidance Assist does not operate on bicycles, motorcycles, or smaller wheeled objects, such as luggage bags, shopping carts, or strollers that are dragged by a pedestrian or a cyclist.
- Forward Collision-Avoidance Assist may not operate properly if interfered by strong electromagnetic waves.
- Forward Collision-Avoidance Assist may not operate for 15 seconds after the vehicle is started, or the front view camera is initialized.

This device complies with Industry Canada licence-exempt RSS standard(s).

Operation is subject to the following conditions:

1. This device may not cause interference, and
2. This device must accept any interference, including interference that may

cause undesired operation of the device.

- 3. Changes or modifications not expressly approved by the party responsible for compliance could void the user's authority to operate the device.

Lane Keeping Assist (LKA) (if equipped)

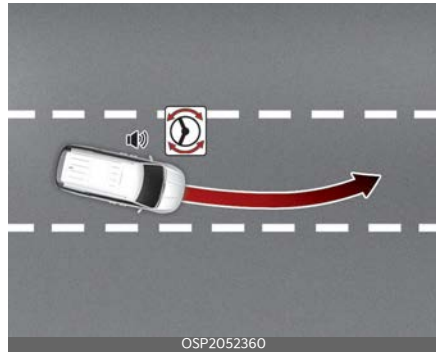

Lane Keeping Assist is designed to help detect lane markings (or road edges) while driving over a certain speed. Lane Keeping Assist will warn the driver if the vehicle leaves the lane without using the turn signal, or will automatically assist the driver's steering to help prevent the vehicle from departing the lane.

Detecting sensor

[1]: Front view camera



The front view camera is used as a detecting sensor to detect lane markings (or road edges).

Refer to the picture above for the detailed location of the detecting sensor.

CAUTION

For more details on the precautions of the front view camera, refer to "Forward Collision-Avoidance Assist (FCA) (Sensor fusion) (if equipped)" on page 6-15.

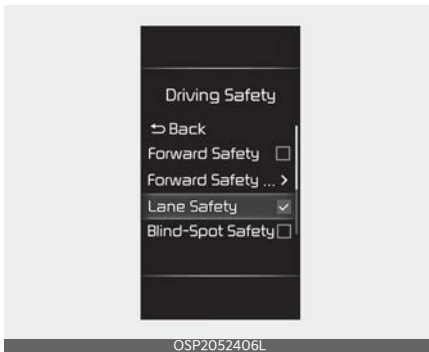
Lane Keeping Assist settings**Lane Safety**

With the ignition switch or ENGINE START/STOP button in the ON position, select 'User Settings → Driver Assistance → Driving Safety' on the LCD display or 'Setup → Vehicle → Driver Assistance → Driving Safety' on the Infotainment system screen to set whether to use the function.

- Lane Safety : If Lane Safety is selected, Lane Keeping Assist will automatically assist the driver's steering when lane departure is detected to help prevent the vehicle from moving out of its lane. If Lane Safety is deselected, the indicator light () will be turned off.

WARNING

- Lane Keeping Assist does not control the steering wheel when the vehicle is driven in the middle of the lane.

- The driver should always be aware of the surroundings and steer the vehicle if Lane Safety is deselected.

Lane Keeping Assist operation**Warning Methods**

You can adjust the Warning Methods with the ignition switch or ENGINE START/STOP button in the ON position.

- Warning Volume : Select 'User Settings → Driver Assistance → Warning Volume' on the LCD display or 'Setup → Vehicle → Driver Assistance → Warning Methods' on the Infotainment system.
- Driving Safety Priority : Select 'Setup → Vehicle → Driver Assistance → Warning Methods → Driving Safety Priority' on the Infotainment system. For safe driving, the audio volume will temporarily decrease to warn the driver with the audible warning.

*** NOTICE**

- Ensure that Warning Methods you have set may apply to the warning volume of other Driver Assistance systems.
- Warning Methods will maintain its last setting even if the vehicle is restarted.

- The setting menu may not be available for your vehicle depending on the vehicle features and specifications.

Turning Lane Keeping Assist On/Off



- With the vehicle on, press and hold the Lane Driving Assist button to turn on/off Lane Keeping Assist. If Lane Keeping Assist is activated, the indicator () will be displayed on the cluster.

*** NOTICE**

When the Lane Driving Assist button is pressed shortly, Lane Following Assist (if equipped) will turn on and off.

Warning and control

Lane Keeping Assist will warn and control the vehicle with Lane Departure Warning and Lane Keeping Assist.

Lane Departure Warning

Right



Left



- To warn the driver that the vehicle is departing from the projected lane in front, the green () indicator light will blink on the cluster, the lane line will blink on the cluster depending on which direction the vehicle is veering, and an audible warning will sound.
- Lane Departure Warning will operate when your driving speed is between approximately 60~200 km/h (40~120 mph).

Lane Keeping Assist

- To warn the driver that the vehicle is departing from the projected lane in front, the green () indicator light will blink on the cluster, and the steering wheel will make adjustments to keep vehicle inside the lane.
- Lane Keeping Assist will operate when your driving speed is between approximately 60~200 km/h (40~120 mph).

Hands-off warning



If the driver takes their hands off the steering wheel for several seconds, the warning message will appear on the cluster, and an audible warning will sound in stages.

WARNING

- The steering wheel may not be assisted if the steering wheel is held very tight or the steering wheel is steered over a certain degree.
- Lane Keeping Assist does not operate at all times. It is the responsibility of the driver to safely steer the vehicle and to maintain the vehicle in its lane.
- The hands-off warning message may appear late depending on road condi-

tions. Always have your hands on the steering wheel while driving.

- If the steering wheel is held very lightly, the hands off warning message may appear because Lane Keeping Assist may not recognize that the driver has their hands on the steering wheel.
- If you attach objects to the steering wheel, the hands-off warning may not work properly.

* NOTICE

- For more details on setting the functions in the infotainment system, refer to "LCD display modes" on page 4-77.
- When lane markings (or road edges) are detected, the lane lines on the cluster will change from gray to the green () indicator light will appear if Lane Keeping Assist is operable.

Lane undetected

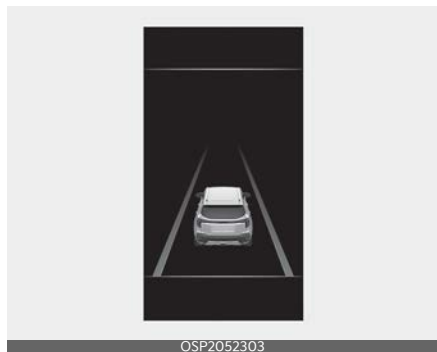

Lane detected



- The images and colors in the instrument cluster may differ depending on the cluster type or theme selected from the settings menu.
- Even though the steering is assisted by Lane Keeping Assist, the driver may control the steering wheel.
- The steering wheel may feel heavier or lighter when the steering wheel is assisted by Lane Keeping Assist than when it is not.

Lane Keeping Assist malfunction and limitations

Lane Keeping Assist malfunction



When Lane Keeping Assist is not working properly, the warning message will appear and the yellow () indicator light will appear on the cluster. If this occurs, have the function inspected by an authorized Kia dealer.

Lane Keeping Assist disabled



If foreign materials such as snow or rain block the sensors or the windshield where the front view camera is located, the detecting performance may be reduced, resulting in Lane Keeping Assist temporarily limited or disabled.

In this case, a warning message is displayed with the master warning light

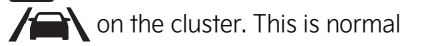

and the Lane safety warning lights on the cluster. This is normal operation. Lane Keeping Assist will operate properly after cleaning snow, rain or foreign materials. Always keep it clean.

If Lane Keeping Assist still does not operate properly after cleaning foreign materials (snow, rain, etc.) or removing obstructions (including trailer, carrier, etc. from the rear bumper), have the vehicle inspected by an authorized Kia dealer.

⚠ WARNING

- Lane Keeping Assist may not properly operate without displaying any warning messages or warning lights on the cluster.
- Even if restarting the vehicle with the sensors blocked or malfunctioned, Lane Keeping Assist may not properly operate as the function maintains the last setting.

Limitations of Lane Keeping Assist

Lane Keeping Assist may not operate properly or may operate unexpectedly under the following circumstances:

- The lane is contaminated or difficult to detect because,
 - The lane markings (or road edges) are covered with rain, snow, dirt, oil, etc.
 - The color of the lane markings (or road edges) is not distinguishable from the road
 - There are markings (or road edges) on the road near the lane or the markings on the road look similar to the lane markings (or road edges)
 - The lane markings (or road edges) is indistinct or damaged
 - The shadow is on the lane markings (or road edges) by a median strip, trees, guardrail, noise barriers, etc.
- There are more than two lane markings (or road edges) on the road
- The lane number increases or decreases, or the lane markings (or road edges) are crossing

- The lane markings (or road edges) are complicated or a structure substitutes for the lines, such as a construction area
- There are road markings (or road edges), such as zigzag lanes, cross-walk markings and road signs
- The lane suddenly disappears, such as at the intersection
- The lane (or road width) is very wide or narrow
- There is a road edge without a lane
- There is a boundary structure in the roadway, such as a tollgate, sidewalk, curb, etc.
- The distance to the front vehicle is extremely short or the vehicle in front is covering the lane markings (or road edges)

*** NOTICE**

For more details on the limitations of the front view camera, refer to "Forward Collision-Avoidance Assist (FCA) (Sensor fusion) (if equipped)" on page 6-15.

⚠ WARNING

- The driver should hold the responsibility to safely drive and control the vehicle. Do not solely rely on Lane Keeping Assist and drive dangerously.
- The operation of Lane Keeping Assist can be canceled or not work properly depending on road conditions and surroundings. Always be cautious while driving.
- Refer to "Limitations of Lane Keeping Assist" on page 6-33, if the lane is not detected properly.
- When you are towing a trailer or another vehicle, we recommend that

Lane Keeping Assist is turned off due to safety reasons.

- If the vehicle is driven at high speed, the steering wheel will not be controlled. The driver must always follow the speed limit when using Lane Keeping Assist.
- If any other function's warning message is displayed or audible warning is generated, Lane Keeping Assist warning message may not be displayed and audible warning may not be generated.
- You may not hear the warning sound of Lane Keeping Assist if the surrounding is noisy.
- If you attach objects to the steering wheel, steering may not be assisted properly.
- Lane Keeping Assist may not operate for 15 seconds after the vehicle is started, or the front view camera is initialized.
- Lane Keeping Assist will not operate when:
 - The turn signal or hazard warning flasher is turned on
 - The vehicle is not driven in the center of the lane when Lane Keeping Assist is turned on or right after changing a lane
 - ESC (Electronic Stability Control) or VSM (Vehicle Stability Management) is activated
 - The vehicle is driven on a sharp curve
 - Vehicle speed is below 55 km/h (35 mph) or above 200 km/h (120 mph)
 - The vehicle makes sharp lane changes

- The vehicle is suddenly stopped
-

Blind-Spot Collision-Avoidance Assist (BCA) (if equipped)

Blind-Spot Collision-Avoidance Assist is designed to help detect and monitor approaching vehicles in the driver's blind spot area and warn the driver of a possible collision with a warning message and audible warning.

In addition, if there is a risk of collision when driving forward out of a parking space, Blind-Spot Collision-Avoidance Assist can help avoid collision by applying the emergency braking.

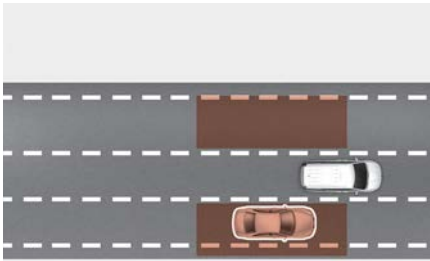

OSP2052358

Blind-Spot Collision-Avoidance Assist helps detect and informs the driver that a vehicle is in the blind spot.

⚠ CAUTION

The detecting range may vary depending on the speed of your vehicle. Even if there is a vehicle in the blind spot area, Blind-Spot Collision-Avoidance Assist may not warn you when you pass by at high speeds.

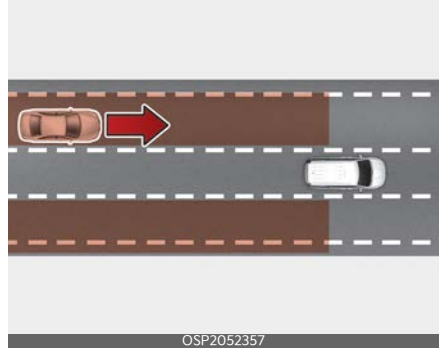

OSP2052357

Blind-Spot Collision-Avoidance Assist helps detect and informs the driver that a vehicle is approaching at high speed from the blind spot area.

⚠ CAUTION

Warning Timing may vary depending on the speed of the vehicle approaching at high speed.

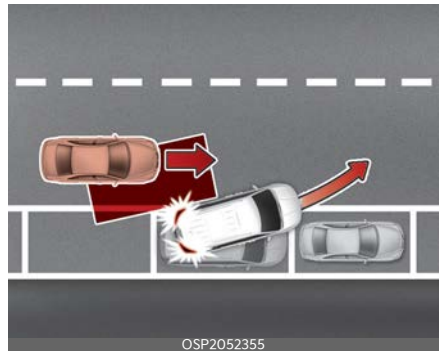

OSP2052355

When you are driving forward out of a parking space, if Blind-Spot Collision-Avoidance Assist judges that there is a collision risk with an approaching vehicle in the blind spot, it can help avoid collisions by applying the brake.

Detecting sensor

[1]: Rear corner radar



OSP2052496

Refer to the picture above for the detailed location of the detecting sensors.

⚠ CAUTION

- Never disassemble the rear corner radar or radar assembly, or cause any damage to it.
- If the rear corner radar or near the radar has been damaged or impacted in any way, even though the warning message does not appear on the cluster, Blind-Spot Collision-Avoidance Assist may not operate properly. Have the function inspected by an authorized Kia dealer.
- If the rear corner radars have been replaced or repaired, have the vehicle inspected by an authorized Kia dealer.
- The genuine Kia rear bumpers which the Rear corner radar sensors are mounted are parts with quality and performance ensured. If arbitrarily applying paint on or changing the bumper, Blind-Spot Collision-Avoidance Assist may not function properly. Use only Kia Genuine Parts or those of an equivalent standard with proven

quality and performance to repair or replace the bumper.

- Do not apply license plate frame or objects, such as a bumper sticker, film or a bumper guard near the rear corner radar.
- Blind-Spot Collision-Avoidance Assist may not work properly if the bumper has been replaced, or the surroundings of the rear corner radar have been damaged or paint has been applied.
- If a trailer, carrier, etc. is installed, it may adversely affect the performance of the rear corner radar or Blind-Spot Collision-Avoidance Assist may not operate.

Blind-Spot Collision-Avoidance Assist settings

Blind-Spot Safety

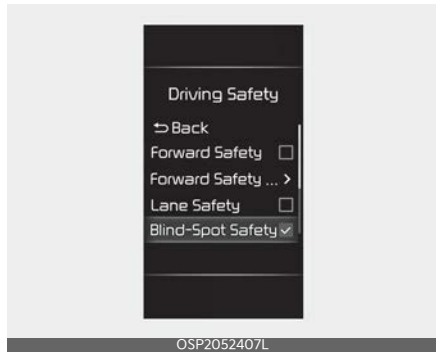

OSP2052407L

With the ignition switch or ENGINE START/STOP button in the ON position, select 'User Settings → Driver Assistance → Driving Safety' on the LCD display or 'Setup → Vehicle → Driver Assistance → Driving Safety' on the Infotainment system screen to set whether to use the function.

- Blind-Spot Safety : Blind-Spot Collision-Avoidance Assist will warn and braking assist will be applied depending on the collision risk levels.



When activating Blind-Spot Collision-Avoidance Assist or restarting the vehicle with this function activated, the warning light on the side mirrors will appear for approximately 3 seconds. When the vehicle is restarted with Blind-Spot Collision-Avoidance Assist inactivated, the warning message will appear on the cluster.

⚠ WARNING

If Blind-Spot Safety is deselected, the driver should always be aware of the surroundings and drive safely.

*** NOTICE**

If the engine is restarted, Blind-Spot Collision-Avoidance Assist will maintain the last setting.

Warning Methods

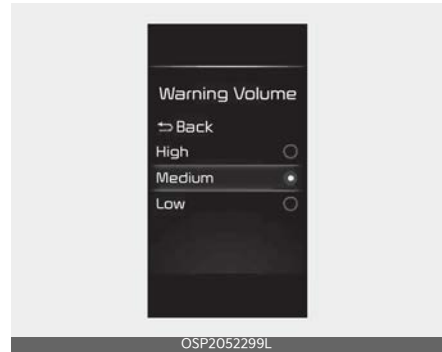

You can adjust the Warning Methods with the ignition switch or ENGINE START/STOP button in the ON position.

- Warning Volume : Select 'User Settings → Driver Assistance → Warning Volume' on the LCD display or 'Setup → Vehicle → Driver Assistance → Warning Methods' on the Infotainment system.
- Driving Safety Priority : Select 'Setup → Vehicle → Driver Assistance → Warning Methods → Driving Safety Priority' on the Infotainment system. For safe driving, the audio volume will temporarily decrease to warn the driver with the audible warning.

*** NOTICE**

- Ensure that Warning Methods you have set may apply to the warning volume of other Driver Assistance systems.
- Warning Methods will maintain its last setting even if the vehicle is restarted.
- The setting menu may not be available for your vehicle depending on the vehicle features and specifications.

Blind-Spot Collision-Avoidance Assist operation

Blind-Spot Collision-Avoidance Assist will warn and control as following operation.

- Vehicle detection
- Collision Warning
- Collision-Avoidance Assist

Vehicle detection

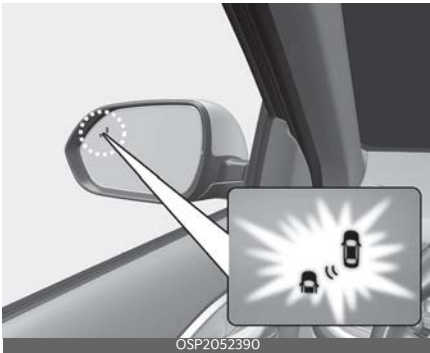

The warning light on the outside rear view mirror and head-up display (if equipped) will appear when the vehicle on both lanes is detected from the rear. A Vehicle detection will operate in the following conditions.

- Your driving speed: Above 20 km/h (12 mph)
- The speed of the vehicle in your blind spot area: Above 10 km/h (7 mph)

Collision Warning

With the vehicle detection state, collision warning will alert the driver when the turn signal is activated to make a lane change with an adjacent car in the blind spot area.

- Collision warning will alert the driver with the warning light on the outside rear view mirrors and head-up display (if equipped), audible warning.

- When the turn signal is turned off or you move away from the lane, the collision warning will be canceled and Blind-Spot Collision-Avoidance Assist will return to vehicle detection state.
- Collision warning will operate when your vehicle speed is above 20km/h (12 mph) and the speed of the vehicle in the blind spot area is above 10km/h (7 mph).

⚠ WARNING

- The detecting range of the rear corner radar is determined by a standard road width, therefore, on a narrow road, Blind-Spot Collision-Avoidance Assist may detect other vehicles two lanes over and warn you. In contrast, on a wide road, Blind-Spot Collision-Avoidance Assist may not be able to detect a vehicle driving in the next lane and may not warn you.
- When the hazard warning flasher is on, the collision warning by the turn signal will not operate.

* NOTICE

- If the driver's seat is on the left side, the collision warning may occur when you turn left. If the driver's seat is on the right side, the collision warning may occur when you turn right. Maintain a proper distance with the vehicles in the lane.
- Images or colors may be displayed differently depends on the instrument cluster specifications or theme.

Collision-Avoidance Assist (while departing)

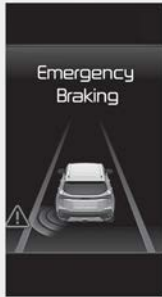

OSP2052347L

The warning light on the outside rear view mirror, head-up display (if equipped) and an audible warning will warn the driver of a collision. It assists in braking control to prevent a collision with a vehicle approaching from the blind spot area. Collision-Avoidance Assist will be activated in the following conditions.

- Your driving speed: Below 3 km/h (2 mph)
- Speed of the vehicle in your blind spot area: Above 5 km/h (3 mph)



OSP2052307L

When the vehicle is stopped due to emergency braking, the 'Drive carefully' warning message will appear on the cluster.

For your safety, the driver should depress the brake pedal immediately and check the surroundings.

- Brake control will end after the vehicle is stopped by emergency braking for approximately 2 seconds.

⚠ WARNING

- For your safety, change the settings after parking the vehicle at a safe location.
- If any other function's warning message is displayed or audible warning is generated, Blind-Spot Collision-Avoidance Assist's warning message may not be displayed and audible warning may not be generated.
- You may not hear the warning sound of Blind-Spot Collision-Avoidance Assist if the surrounding is noisy.
- Blind-Spot Collision-Avoidance Assist may not operate if the driver applies the brake pedal to avoid collision.
- When Blind-Spot Collision-Avoidance Assist is operating, braking control by the function will automatically cancel when the driver excessively depresses the accelerator pedal or sharply steers the vehicle.
- If changing the gear quickly during reversing the vehicle, Blind-Spot Collision-Avoidance Assist may not work or may operate unnecessarily.
- During Blind-Spot Collision-Avoidance Assist operation, the vehicle may stop suddenly injuring passengers and shifting loose objects. Always have the seat belt on and keep loose objects secured.
- Even if there is a problem with Blind-Spot Collision-Avoidance Assist, the vehicle's basic braking performance will operate properly.

- Blind-Spot Collision-Avoidance Assist does not operate in all situations or cannot avoid all collisions.
- Blind-Spot Collision-Avoidance Assist may warn the driver late or may not warn the driver depending on the road and driving conditions.
- Driver should maintain control of the vehicle at all times. Do not depend on Blind-Spot Collision-Avoidance Assist. Maintain a safe braking distance, and if necessary, depress the brake pedal to reduce driving speed or to stop the vehicle.
- Never test Blind-Spot Collision-Avoidance Assist on people, animal, objects, etc. It may cause serious injury or death.

⚠ WARNING

The brake control may not operate properly depending on the status of ESC (Electronic Stability Control).

There will only be a warning when:

- The ESC (Electronic Stability Control) warning light is on.
- ESC (Electronic Stability Control) is engaged in a different function.

Blind-Spot Collision-Avoidance Assist malfunction and limitations

Blind-Spot Collision-Avoidance Assist malfunction



When Blind-Spot Collision-Avoidance Assist is not working properly, the warning message will appear for several seconds and  warning light will appear on the cluster. If this occurs, have Blind-Spot Collision-Avoidance Assist inspected by an authorized Kia dealer.



When the warning light on the side view mirror is not working properly, the warning message will appear for several seconds and  warning light will appear on the cluster. If this occurs, have Blind-

Spot Collision-Avoidance Assist inspected by an authorized Kia dealer.

Blind-Spot Collision-Avoidance Assist disabled



When the rear bumper around the rear corner radar or sensor is covered with foreign material, such as snow or rain, or installing a trailer or carrier, it can reduce the detecting performance and temporarily limit or disable Blind-Spot Collision-Avoidance Assist.

If this occurs, the warning message will appear on the cluster.

Blind-Spot Collision-Avoidance Assist will operate properly when such foreign material or trailer, etc. is removed, and then the engine is restarted.

If Blind-Spot Collision-Avoidance Assist does not operate properly after it is removed, have Blind-Spot Collision-Avoidance Assist inspected by an authorized Kia dealer.

⚠ WARNING

- Even though the warning message does not appear on the cluster, Blind-Spot Collision-Avoidance Assist may not properly operate.
- Blind-Spot Collision-Avoidance Assist may not properly operate in an area (for example, open terrain), where any

objects are not detected right after the engine is turned on, or when the detecting sensor is blocked with foreign material right after the engine is turned on.

⚠ CAUTION

Turn off Blind-Spot Collision-Avoidance Assist to install a trailer, carrier, etc., or remove the trailer, carrier, etc. to use Blind-Spot Collision-Avoidance Assist.

Limitations of Blind-Spot Collision-Avoidance Assist

Blind-Spot Collision-Avoidance Assist may not operate properly or it may operate unexpectedly under the following circumstances:

- There is inclement weather, such as heavy snow, heavy rain, etc.
- The rear corner radar is covered with snow, rain, dirt, etc.
- The temperature around the rear corner radar is high or low
- Driving on a highway (or motorway) ramp
- The road pavement (or the peripheral ground) abnormally contains metallic components (for example, possibly due to subway construction).
- There is a fixed object near the vehicle, such as sound barriers, guardrails, central dividers, entry barriers, street lamps, signs, tunnels, walls, etc. (including double structures)
- Driving in vast areas where there are few vehicles or structures (for example, desert, meadow, suburb, etc.)
- Driving through a narrow road where trees or grass are overgrown

- Driving on a wet road surface, such as a puddle on the road
- The other vehicle drives very close behind your vehicle, or the other vehicle passes by your vehicle in close proximity
- The speed of the other vehicle is very fast that it passes by your vehicle in a short time
- Your vehicle passes by the other vehicle
- Your vehicle change lane
- Your vehicle has started at the same time as the vehicle next to you and has accelerated
- The vehicle in the next lane moves two lanes away from you, or when the vehicle two lanes away moves to the next lane from you
- A trailer or carrier is installed around the rear corner radar
- The bumper around the rear corner radar is covered with objects, such as a bumper sticker, bumper guard, bike rack, etc.
- The bumper around the rear corner radar is impacted, damaged or the radar is out of position
- Your vehicle height is low or high due to heavy loads, abnormal tire pressure, etc.

Blind-Spot Collision-Avoidance Assist may not operate properly or it may operate unexpectedly when the following objects are detected:

- A motorcycle or bicycle is detected
- A vehicle such as a flat trailer is detected
- A big vehicle such as a bus or truck is detected

- A moving obstacle such as a pedestrian, animal, shopping cart or a baby stroller is detected
- A vehicle with low height such as a sports car is detected

⚠ WARNING

- **Driving on a curved road**

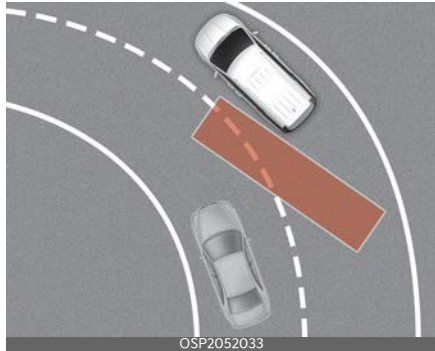

Blind-Spot Collision-Avoidance Assist may not operate properly when driving on a curved road. Blind-Spot Collision-Avoidance Assist may not detect the vehicle in the next lane.

Always pay attention to road and driving conditions while driving.



Blind-Spot Collision-Avoidance Assist may not operate properly when driving on the curved road. Blind-Spot Collision-

Avoidance Assist may recognize the vehicle in the same lane.

Always pay attention to road and driving conditions while driving.

- **Driving on an inclined road**

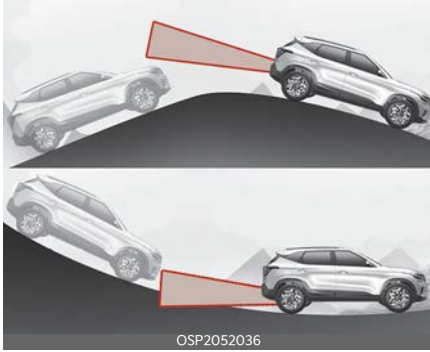

Blind-Spot Collision-Avoidance Assist may not operate properly when driving on a slope. Blind-Spot Collision-Avoidance Assist may not detect the vehicle in the next lane or may incorrectly detect the ground or structure.

Always pay attention to road and driving conditions while driving.

- **Driving where the road is merging/dividing**

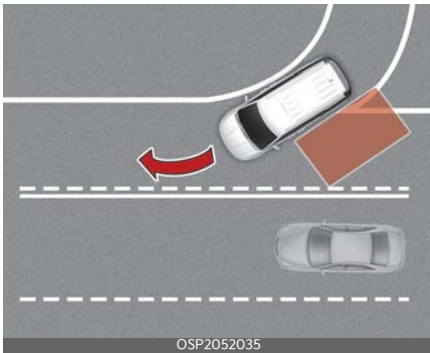

Blind-Spot Collision-Avoidance Assist may not operate properly when driving where the road merges or divides. Blind-Spot Collision-Avoidance Assist may not

detect the vehicle in the next lane. Always pay attention to road and driving conditions while driving.

- **Driving where the heights of the lanes are different**

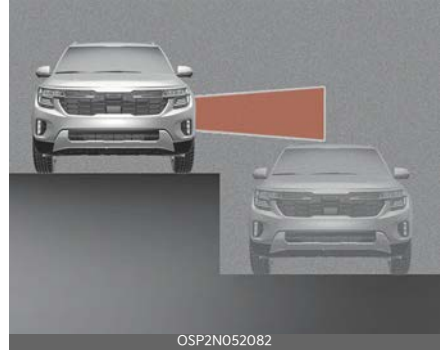

Blind-Spot Collision-Avoidance assist may not operate properly when driving where the heights of the lanes are different. Blind-Spot Collision-Avoidance Assist may not detect the vehicle on a road with different lane heights (underpass joining section, grade separated intersections, etc.).

Always pay attention to road and driving conditions while driving.

⚠ WARNING

- When you are towing a trailer or another vehicle, make sure that you turn off Blind-Spot Collision-Avoidance Assist.
- Blind-Spot Collision-Avoidance Assist may not operate properly if interfered with by strong electromagnetic waves.
- Blind-Spot Collision-Avoidance Assist may not operate for 15 seconds after the vehicle is started, or the rear corner radars are initialized.

This device complies with Industry Canada licence-exempt RSS standard(s).

Operation is subject to the following conditions:

1. This device may not cause interference, and
2. This device must accept any interference, including interference that may cause undesired operation of the device.

Safe Exit Warning (SEW) (if equipped)

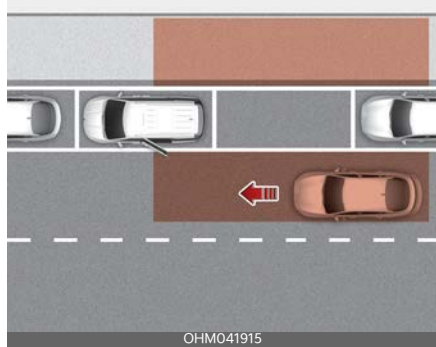

After the vehicle stops, when an approaching vehicle from the rear area is detected as soon as a passenger opens a door, Safe Exit Warning will warn the driver with a warning message and an audible warning to help prevent a collision.

⚠ CAUTION

The timing of the warning may vary depending on the speed of the approaching vehicle.

Detecting sensor

[1]: Rear corner radar



Refer to the picture for the detailed location of the detecting sensors.

* NOTICE

For more details on the precautions of the rear corner radars, refer to "Blind-Spot Collision-Avoidance Assist (BCA) (if equipped)" on page 6-35.

Safe Exit Warning settings

Safe Exit



OSP2042548L

With the ignition switch or ENGINE START/STOP button in the ON position, and select 'User Settings → Driver Assistance → Driving Safety → Safe Exit' on the instrument cluster or 'Setup → Vehicle → Driver Assistance → Driving Safety → Exit Safety' on the infotainment system.

▲ WARNING

If 'Safe Exit' is deselected, Safe Exit Warning cannot warn you. The driver should always be aware of unexpected and sudden situations from occurring.

* NOTICE

If the engine is restarted, Safe Exit Warning will maintain the last setting.

Warning Methods



ODL3A051372

You can adjust the Warning Methods with the ignition switch or ENGINE START/STOP button in the ON position.

- Warning Volume: Select 'User Settings → Driver Assistance → Warning Volume' on the instrument cluster or 'Setup → Vehicle → Driver Assistance → Warning Methods' on the infotainment system.
- Driving Safety Priority: Select 'Setup → Vehicle → Driver Assistance → Warning Methods → Driving Safety Priority' on the infotainment system. For safe driving, the audio volume will temporarily decrease to warn the driver with the audible warning.

* INFORMATION

- Ensure that Warning Methods you have set may apply to the Warning volume of other Driver Assistance systems.
- Warning Methods will maintain its last setting even if the vehicle is restarted.
- The setting menu may not be available for your vehicle depending on the vehicle features and specifications.

Safe Exit Warning operation

Safe Exit Warning warns the following actions.

- Collision warning when exiting vehicle

Collision warning when exiting vehicle

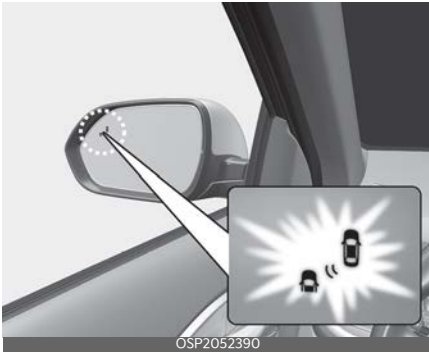

The warning light on the side view mirror will blink and the warning message will appear on the cluster, and an audible warning will sound.

- Safe Exit Warning will warn under the following circumstances:
 - Your driving speed: below 3 km/h (2 mph)
 - The speed of the approaching vehicle from the rear: above 6 km/h (4 mph)

⚠ WARNING

- For your safety, change the Settings after parking the vehicle at a safe location.
- If any other function's warning message is displayed or audible warning is generated, Safe Exit Warning message may not be displayed and audible warning may not be generated.
- You may not hear the warning sound of Safe Exit Warning if the surrounding is noisy.
- Safe Exit Warning does not operate in all situations or cannot prevent all collisions.
- Safe Exit Warning may warn the driver late or may not warn the driver depending on the road and driving conditions. Always check vehicle surroundings.
- The driver and passengers are responsible for accidents that occurs while exiting the vehicle. Always check the surroundings before you exit the vehicle.

* NOTICE

- After the engine is turned off, Safe Exit Warning operates approximately for 3 minutes, but turns off immediately if the doors are locked.
- Images or colors may be displayed differently depends on the instrument cluster specifications or theme.

Safe Exit Warning malfunction and limitations

Safe Exit Warning malfunction



When Safe Exit Warning is not working properly, the warning message will appear on the cluster, and the master warning light (⚠️) will appear on the cluster. Have Safe Exit Warning be inspected by an authorized Kia dealer.



When the outside rear view mirror warning light is not working properly, the warning message will appear on the cluster for several seconds, and the master warning light (⚠️) will appear on the cluster. Have Safe Exit Warning be inspected by an authorized Kia dealer.

Safe Exit Warning disabled



When the rear bumper around the rear-side radar or sensor is covered with foreign matters, such as snow or rain, or installing a trailer or carrier, it can reduce the detecting performance and temporarily limit or disable Safe Exit Warning.

If this occurs, the 'Blind-Spot Safety system disabled. Radar blocked' warning message will appear on the cluster.

Safe Exit Warning will operate normally when such foreign matters or trailer, etc. is removed, and then the vehicle is restarted.

If Safe Exit Warning does not operate normally after it is removed, have your vehicle inspected by an authorized Kia dealer.

⚠️ WARNING

- Even though the warning message does not appear on the cluster, Safe Exit Warning may not properly operate.
- Safe Exit Warning may not properly operate in an area (e.g., open terrain), where any substance are not detected right after the vehicle is turned on, or when the detecting sensor is blocked

with foreign material right after the vehicle is turned on.

CAUTION

Turn off Safe Exit Warning to install a trailer, carrier, etc., or remove the trailer, carrier, etc. to use Safe Exit Warning.

Limitations of Safe Exit Warning

Safe Exit Warning may not operate normally, or it may operate unexpectedly under the following circumstances:

- Getting out of the vehicle where trees or grass are overgrown.
- Getting out of the vehicle where the road is wet.
- The approaching vehicle is very fast or very slow.

CAUTION

For more details on the limitations of the rear corner radar, refer to "Blind-Spot Collision-Avoidance Assist (BCA) (if equipped)" on page 6-35.

WARNING

- Safe Exit Warning may not operate normally if interfered by strong electromagnetic waves.
- Safe Exit Warning may not operate for 3 seconds after the vehicle is started, or the rear corner radars are initialized.

Manual Speed Limit Assist (MSLA)

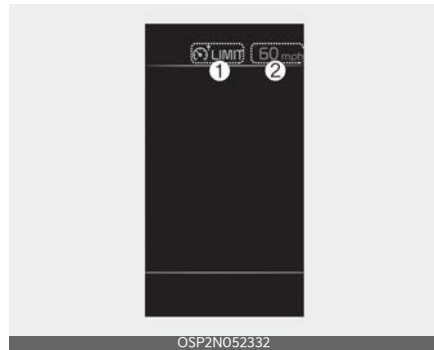

OSP2N052332

1. Speed Limit indicator
2. Set speed

You can set the speed limit when you do not want to drive over a specific speed. If you drive over the preset speed limit, Manual Speed Limit Assist will operate (set speed limit will blink and chime will sound) until the vehicle speed returns within the speed limit.

Manual Speed Limit Assist operation

Setting the speed limit

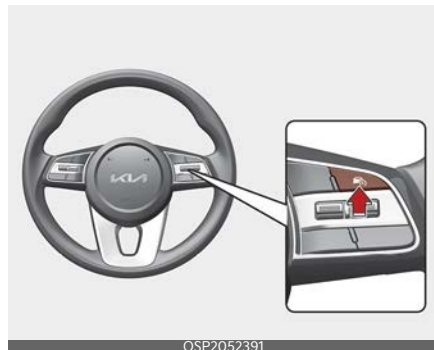

OSP2052391

1. Press and hold the Driving Assist button on the steering wheel, at the

desired speed. The Speed Limit indicator will appear on the cluster.

2. Push the + switch up or - switch down, and release it at the desired speed.

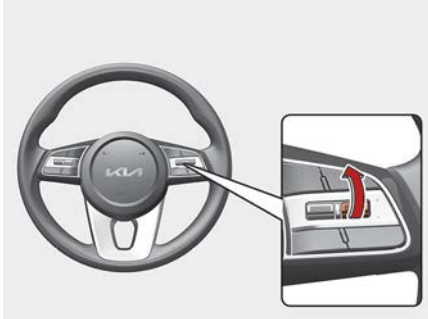

OSP2052261

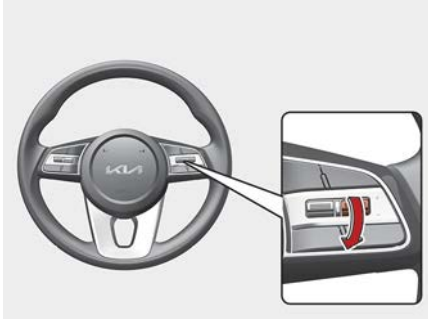

OSP2052260

Push the + switch up or - switch down and hold it. The speed will increase or decrease to the nearest multiple of ten (multiple of five in mph) at first, and then increase or decrease by 10 km/h (5 mph).

3. The set speed limit will be displayed on the cluster. If you would like to drive over the preset speed limit, depress the accelerator pedal beyond the pressure point to activate the kick-down function.

The set speed limit will blink and chime will sound until you return the vehicle speed within the speed limit.

* NOTICE

- When the accelerator pedal is not depressed beyond the pressure point, vehicle speed will maintain within the speed limit.
- Depending on the vehicle specifications, the set maximum speed is different. You cannot increase the set speed above the set maximum speed.

Temporarily pausing Manual Speed Limit Assist

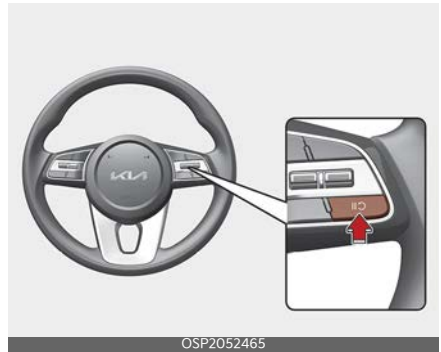

OSP2052465

Press the || ⌂ switch to temporarily pause the set speed limit. The set speed limit will turn off but the Speed Limit indicator will stay on.

Resuming Manual Speed Limit Assist

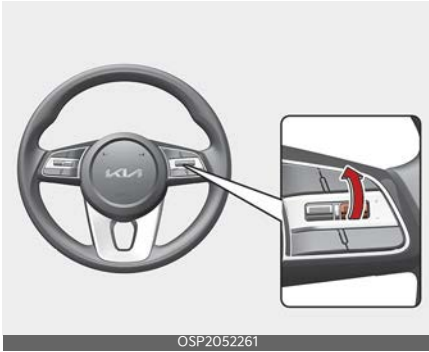

To resume Manual Speed Limit Assist after the function was paused, operate the +, - or || ◂ switch.

If you push the + switch up or - switch down, set speed will be set to the current speed on the cluster. If you press the || ◂ switch, set speed will resume to the preset speed.

Turning off Manual Speed Limit Assist



Press the Driving Assist button to turn Manual Speed Limit Assist off. The Speed Limit indicator will go off. Always press the Driving Assist button to turn

Manual Speed Limit Assist off when not in use.

⚠ WARNING

Take the following precautions when using Manual Speed Limit Assist:

- Always set the vehicle speed to the speed limit in your country.
- Keep Manual Speed Limit Assist off when the function is not in use, to avoid inadvertently setting a speed. Check that the Speed Limit indicator is off.
- Manual Speed Limit Assist does not substitute for proper and safe driving. It is the responsibility of the driver to always drive safely and should always be aware of unexpected and sudden situations from occurring. Pay attention to the road conditions at all times.

Intelligent Speed Limit Assist (ISLA) (if equipped)

Intelligent Speed Limit Assist uses information from the detected road sign and navigation system to inform the driver of the speed limit and additional information of the current road. Also, Intelligent Speed Limit Assist helps the driver to maintain within the speed limit of the road.

⚠ CAUTION

- Intelligent Speed Limit Assist may not operate properly if the function is used in other countries.
- If a navigation is applied to your vehicle, the navigation needs to be regularly updated for Intelligent Speed Limit Assist to operate properly. For more information, refer to the user's manual provided in the infotainment system and the quick reference guide.

Detecting sensor

[1]: Front view camera



Refer to the picture above for the detailed location of the detecting sensor.

⚠ CAUTION

For more details on the precautions of the front view camera, refer to "Forward Collision-Avoidance Assist (FCA) (Front view camera only) (if equipped)" on page 6-4.

Intelligent Speed Limit Assist settings

Speed Limit



With the ignition switch or ENGINE START/STOP button in the ON position, select 'User Settings → Driver Assistance → Speed Limit' on the LCD display or 'Setup → Vehicle → Driver Assistance → Speed Limit' on the Infotainment system.

- **Select country:** If the vehicle is not equipped with navigation system, a settings menu will be provided to select the country manually. For Intelligent Speed Limit Assist to operate properly, select the country where the vehicle is currently being driven.
- **Speed Limit Offset:** The tolerance for Speed limit can be adjusted. The vehicle will warn the speed limit or adjust the driving speed when the current driving speed is higher than the rec-

ognized speed limit added with set tolerance value.

- Speed Limit Assist: Intelligent Speed Limit Assist will inform the driver of speed limit and additional road signs. In addition, Intelligent Speed Limit Assist will inform the driver to change set speed of Manual Speed Limit Assist or Smart Cruise Control (If equipped) to help the driver stay within the speed limit.
- Speed Limit Warning: Intelligent Speed Limit Assist will inform the driver of speed limit and additional road signs. In addition, Intelligent Speed Limit Assist will warn the driver when the vehicle is driven faster than the speed limit. Manual Speed Limit Assist or Smart Cruise Control (If equipped) set speed will not be automatically adjusted. The driver should adjust the speed manually.
- Off: Intelligent Speed Limit Assist will turn off.

⚠ WARNING

For your safety, change the settings after parking the vehicle at a safe location.

*** NOTICE**

- Speed limit and Speed warning function operates based on an offset value added with the speed limit. Set the offset value to '0' to change or warn the speed according to the recognized speed limit.
- The setting of Speed limit offset is not reflected in Navigation-based Smart Cruise Control.

Intelligent Speed Limit Assist operation

Warning and control

Intelligent Speed Limit Assist is warned and controlled by the following action.

- Displaying speed limit
- Warning overspeed
- Changing set speed
- Auto set speed change

*** NOTICE**

Intelligent Speed Limit Assist warning and control are described based on the Offset adjust to '0'. For details on Offset setting, refer to "Intelligent Speed Limit Assist settings" on page 6-51.

Displaying speed limit

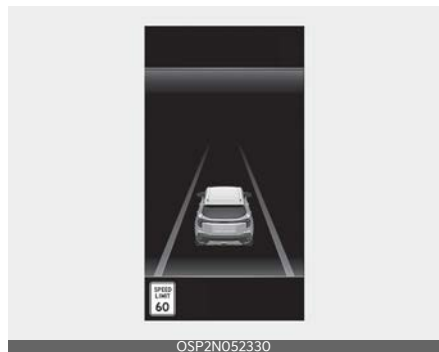

Speed limit information is displayed on the instrument cluster.

*** NOTICE**

- If speed limit information of the road cannot be recognized, '---' sign will be displayed. Please refer to "Intelligent Speed Limit Assist malfunction and limitations" on page 6-54 if the road signs are difficult to recognize.

- Intelligent Speed Limit Assist provides additional road sign information in addition to speed limit. The additional road sign information provided may vary according to your country.
- The images and colors in the instrument cluster may differ depending on the cluster type or theme selected from the settings menu.

Warning overspeed



When driving at a speed higher than the displayed speed limit, the road sign indicator will be red.

Changing set speed



If the speed limit of the road changes during the operation of Manual Speed Limit Assist or Smart Cruise Control, an arrow in the direction of up or down is displayed to inform the driver that the set speed needs to be changed. At this time, the driver can change the set speed according to the speed limit by using the (+) or (-) switch on the steering wheel.

Auto set speed change (if Infotainment system equipped)



When operating Manual Speed Limit Assist or Smart Cruise Control, if the speed set by the driver is the same as the speed limit on the road, the set speed is automatically adjusted accordingly even if the speed limit changes

afterwards. The auto set speed change function operates on roads with a speed limit of above 70 km/h (45 mph). When the function is activated, the set speed on the instrument cluster is displayed in green.

⚠ WARNING

- When driving at a speed lower than the speed limit, set the offset under '0', or push the - switch down to decrease your set speed.
- Even after changing the set speed according to the speed limit of the road, the vehicle can still be driven over the speed limit. If necessary, depress the brake pedal to reduce your driving speed.
- If the speed limit of the road is under 30 km/h (20 mph), the set speed change function will not work.
- Intelligent Speed Limit Assist operates using the speed unit in the instrument cluster set by the driver. If the speed unit is set to a unit other than the speed unit used in your country, Intelligent Speed Limit Assist may not operate properly.

*** NOTICE**

- For more details on Manual Speed Limit Assist operation, refer to "Manual Speed Limit Assist (MSLA)" on page 6-48.
- For more details on Smart Cruise Control operation, refer to "Smart Cruise Control (SCC) (if equipped)" on page 6-64.

Intelligent Speed Limit Assist malfunction and limitations

Intelligent Speed Limit Assist malfunction



When Intelligent Speed Limit Assist is not working properly, the warning message will appear on the cluster for several seconds, and the master (⚠) warning light and speed limit warning light (⏏) will appear on the cluster. In this case, have the vehicle inspected by an authorized Kia dealer.

Intelligent Speed Limit Assist disabled



When the front windshield where the front view camera is located is covered with foreign material, such as snow or

rain, it can reduce the detecting performance and temporarily limit or disable Intelligent Speed Limit Assist. If this occurs, the warning message and speed limit warning light () will appear on the cluster.

Intelligent Speed Limit Assist will operate properly when snow, rain or foreign material is removed. Always keep it clean.

If Intelligent Speed Limit Assist does not operate properly after it is removed, have the vehicle inspected by an authorized Kia dealer.

WARNING

Even though the warning message or warning light does not appear on the cluster, Intelligent Speed Limit Assist may not operate properly.

Limitations of Intelligent Speed Limit Assist

Intelligent Speed Limit Assist may not operate properly, or it may operate unexpectedly under the following circumstances:

- The road sign is contaminated or indistinguishable
 - The road sign is difficult to see due to bad weather, such as rain, snow, fog, etc.
 - The road sign is partially obscured by surrounding objects or shadow
- The road signs do not conform to the standard
 - The text or picture on the road sign is different from the standard
 - The road sign is installed between the main line and the exit road or between diverging roads
- A sign is attached to another vehicle
- The distance between the vehicle and the road signs is far
- The vehicle encounters appearing road signs
- Intelligent Speed Limit Assist incorrectly recognizes numbers or pictures in the street signs or other signs as the speed limit
- A road sign near the road you are driving is detected
- Multiple signs are installed close together
- Other Auxiliary signs or commercial signs are placed around the speed limit signs.
- The minimum speed limit sign is mis-recognized
- The minimum speed limit sign is on the road
- The brightness changes suddenly, for example when entering or exiting a tunnel or passing under a bridge
- Headlamps are not used or the brightness of the headlamps are weak at night or in the tunnel
- The field of view of the front view camera is obstructed by sun glare
- Road signs are difficult to recognize due to the reflection of sunlight, street lights, or oncoming vehicles
- The navigation information or GPS information contain errors.
- The driver does not follow the guide of the navigation.
- Driving on a road that is sharply curved or continuously curved.
- Driving through speed bumps, or driving up and down or left to right on steep inclines

- The vehicle is shaking heavily
- Driving on a newly opened road
- The navigation is updated while driving
- The navigation is restarted while driving

⚠ WARNING

- Intelligent Speed Limit Assist is a supplemental function that helps the driver to comply with the speed limit on the road, and may not display the correct speed limit or control the driving speed properly.
- It is the responsibility of the driver to keep the speed limit.
- When initializing (rebooting) the camera or restarting the vehicle, the function may not operate for approximately 15 seconds.

*** NOTICE**

For more details on the limitations of the front view camera, refer to "Forward Collision-Avoidance Assist (FCA) (Front view camera only) (if equipped)" on page 6-4.

Driver Attention Warning (DAW) (if equipped)

Driver Attention Warning can help determine the driver's attention level by analyzing driving pattern and driving time while the vehicle is driven. Driver Attention Warning will recommend a break when the driver's attention level falls below a certain level to help drive safely.

Leading Vehicle Departure Alert

Leading Vehicle Departure Alert will inform the driver when a detected vehicle in front departs from a stop.

Detecting sensor

[1]: Front view camera



The front view camera is used as a detecting sensor to help detect driving patterns and front vehicle departure while vehicle is being driven.

Refer to the picture above for the detailed location of the detecting sensor.

⚠ CAUTION

- Always keep the front view camera in good condition to maintain optimal performance of Driver Attention Warning.

- For more details on the precautions of the front view camera, refer to "Forward Collision-Avoidance Assist (FCA) (Sensor fusion) (if equipped)" on page 6-15.

Driver Attention Warning settings

Leading Vehicle Departure Alert



With the ignition switch or ENGINE START/STOP button in the ON position, select 'User Settings → Driver Assistance → Driver Attention Warning' on the LCD display or 'Setup → Vehicle → Driver Assistance → Driver Attention Warning' on the Infotainment system screen.

If 'Leading Vehicle Departure Alert' is selected, the function will inform the driver when a detected vehicle in front departs from a stop.

Driver Attention Warning operation

Basic function

The basic function of Driver Attention Warning is to inform the driver 'Consider taking a break'.

Taking a break



The warning message will appear on the cluster and an audible warning will sound to suggest that the driver take a break, when the driver's attention level is below a certain level.

- Driver Attention Warning will not suggest a break when the total driving time is shorter than 4 minutes or 4 minutes has not passed after the last break was suggested.

Driver Attention Warning operates under the following conditions:

- Your driving speed: Approximately 0~200 km/h (0~120 mph)

⚠ WARNING

For your safety, only change the settings after parking the vehicle at a safe location.

⚠ CAUTION

- Driver Attention Warning may suggest a break depending on the driver's driving pattern or habits, even if the driver doesn't feel fatigue.
- Driver Attention Warning is a supplemental function and may not be able to determine whether the driver is inattentive.

- The driver who feels fatigued should take a break at a safe location, even though there is no break suggestion by Driver Attention Warning.

*** NOTICE**

For more details on vehicle settings, refer to "Instrument cluster" on page 4-68.

Leading Vehicle Departure Alert



When a detected vehicle in front departs from a stop, Leading Vehicle Departure Alert will inform the driver by displaying the warning message on the cluster and an audible warning will sound.

⚠ WARNING

- If any other functions warning message is displayed or audible warning is generated, Leading Vehicle Departure Alert's warning message may not be displayed and audible warning may not be generated.
- The driver should hold the responsibility to safely drive and control the vehicle.

⚠ CAUTION

- Leading Vehicle Departure Alert is a supplemental function and may not warn the driver whenever the front vehicle departs from a stop.
- Always check the front of the vehicle and road conditions before departure.

*** NOTICE**

The images and colors in the instrument cluster may differ depending on the cluster type or theme selected from the settings menu.

Driver Attention Warning malfunction and limitations

Driver Attention Warning malfunction



When Driver Attention Warning is not working properly, the warning message will appear for several seconds and (⚠) warning light will appear on the cluster. If this occurs, have Driver Attention Warning inspected by an authorized Kia dealer.

Driver Attention Warning disabled



When the front view camera is located is covered with foreign material, such as snow or rain, it can reduce the detecting performance and temporarily limit or disable Driver Attention Warning. If this occurs the warning message, and (⚠️) warning light will appear on the cluster. Driver Attention Warning will operate normally when snow, rain or foreign material is removed. Always keep it clean.

If Driver Attention Warning does not operate normally after obstruction (snow, rain, or foreign material) is removed, have the vehicle inspected by an authorized Kia dealer.

⚠️ WARNING

- Driver Attention Warning may not work properly in areas where substances are not detected after turning ON the vehicle (e.g. in open terrain) or if the recognition sensor is contaminated.
- If restarting the vehicle with the sensors blocked or malfunctioned, Driver Attention Warning may not properly

operates as the function maintains the last setting.

Limitations of Driver Attention Warning

Driver Attention Warning may not work properly in the following situations:

- The vehicle is driven violently
- The vehicle intentionally crosses over lanes frequently
- The vehicle is controlled by Driver Assistance system, such as Lane Keeping Assist.

Leading Vehicle Departure Alert

- When the vehicle cuts in

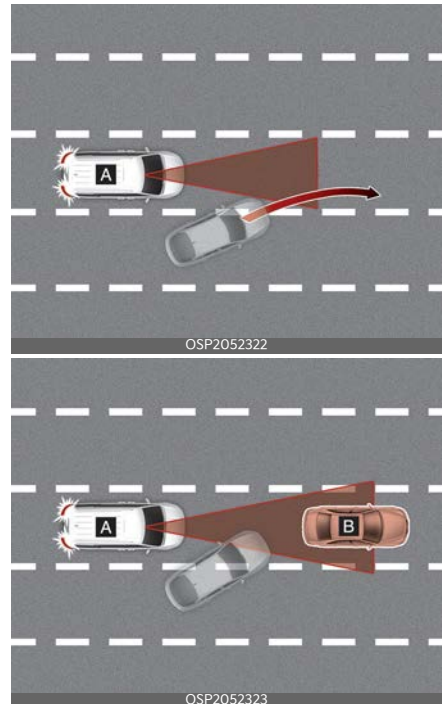

[A]: Your vehicle, [B]: Front vehicle

If a vehicle cuts in front of your vehicle, Leading Vehicle Departure Alert may not operate properly.

- When the vehicle ahead sharply steers

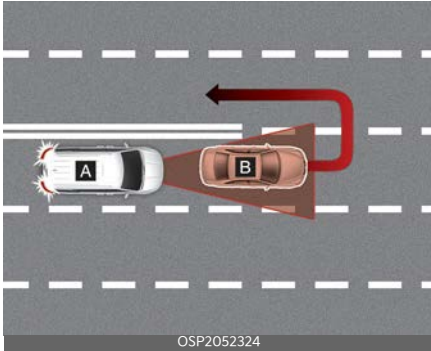

[A]: Your vehicle, [B]: Front vehicle

If the vehicle in front makes a sharp turn, such as to turn left or right or make a U-turn, etc., Leading Vehicle Departure Alert may not operate properly.

- When the vehicle ahead abruptly departs

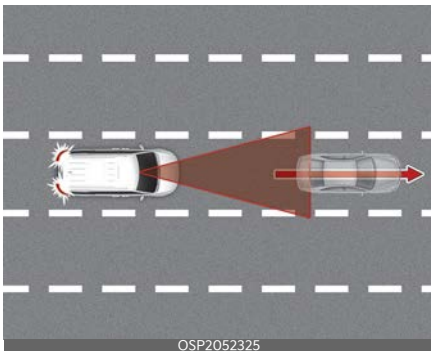

If the vehicle in front abruptly departs, Leading Vehicle Departure Alert may not operate properly.

- When a pedestrian or cyclist is between you and the vehicle ahead



If there is a pedestrian or cyclist in between you and the vehicle in front, Leading Vehicle Departure Alert may not operate properly.

- When in a parking lot

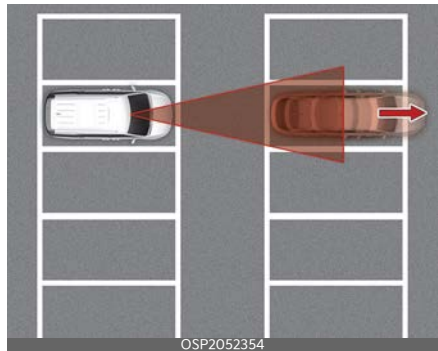

If a vehicle parked in front drives away from you, Leading Vehicle Departure Alert may warn you that the parked vehicle is driving away.

- When driving at a tollgate or intersection, etc.

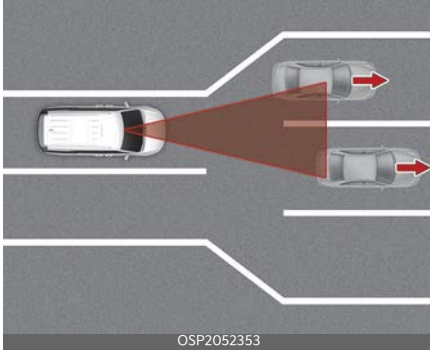

If you pass a tollgate or intersection with lots of vehicles or you drive where lanes are merged or divided frequently, Leading Vehicle Departure Alert may not operate properly.

⚠ WARNING

Driver Attention Warning may not operate for 15 seconds after the vehicle is started, or the front view camera is initialized.

*** NOTICE**

For more details on the precautions of the front view camera, refer to "Forward Collision-Avoidance Assist (FCA) (Sensor fusion) (if equipped)" on page 6-15.

Cruise Control (CC) (if equipped)



1. Cruise indicator
2. Set speed

Cruise Control will allow you to drive at speeds above 30 km/h (20 mph) without depressing the accelerator pedal.

Cruise Control operation

Setting set speed

1. Accelerate to the desired speed, which must be more than 30 km/h (20 mph).

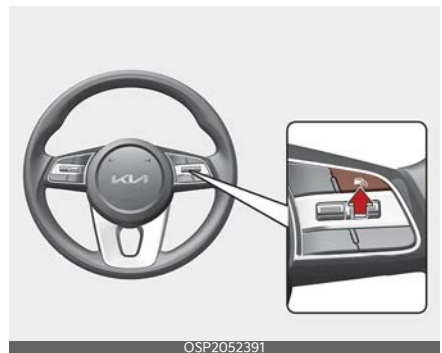

2. Press the Driving Assist button at the desired speed. The set speed and Cruise (CRUISE) indicator will appear on the cluster.

- Release the accelerator pedal.
Vehicle speed will maintain the set speed even when the accelerator pedal is not depressed.

* NOTICE

On a steep slope, the vehicle may slightly slow down or speed up while driving uphill or downhill.

Increasing set speed

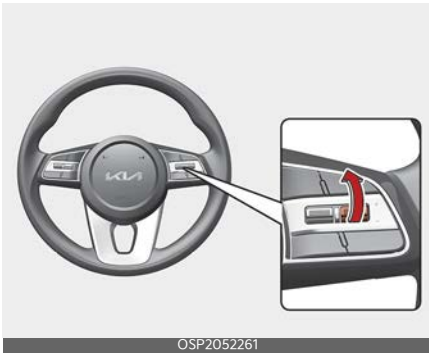

- Push the + switch up and release it immediately. The set speed will increase by 1 km/h (1 mph) each time the switch is operated in this manner.
- Push the + switch up and hold it while monitoring the set speed on the cluster. The set speed will increase to the nearest multiple of five (multiple of ten in km/h) at first, and then increase by 10 km/h (5 mph) each time the switch is operated in this manner.
Release the switch when the desired speed is shown and the vehicle will accelerate to that speed.

* NOTICE

Depending on the vehicle specifications, the set maximum speed is different. You

cannot increase the set speed above the set maximum speed.

Decreasing set speed

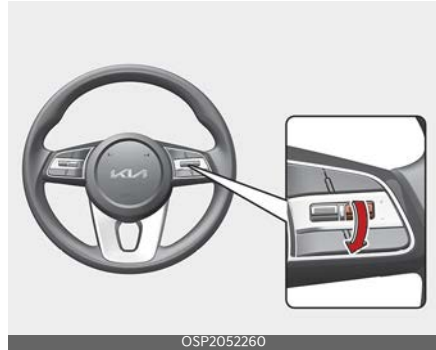

- Push the - switch down and release it immediately. The set speed will decrease by 1 km/h (1 mph) each time the switch is operated in this manner.
- Push the - switch down and hold it while monitoring the set speed on the cluster. The set speed will decrease to the nearest multiple of five (multiple of ten in km/h) at first, and then decrease by 10 km/h (5 mph) each time the switch is operated in this manner.
Release the switch at the speed you want to maintain.

Temporarily pausing Cruise Control

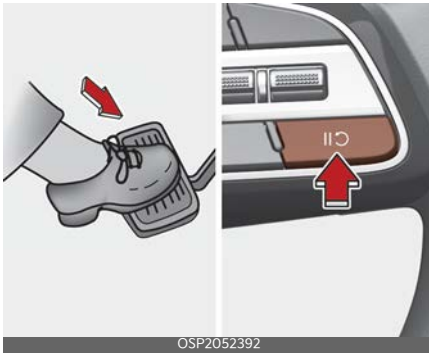

Cruise Control will be paused when:

- Depressing the brake pedal.
- Pressing the || ⏪ button.
- Shifting the gear to N (Neutral).
- Decreasing vehicle speed to less than 30 km/h (20 mph).
- ESC (Electronic Stability Control) is operating.
- The vehicle speed is above 180 km/h (110 mph).

The set speed will turn off but the Cruise (⏪ CRUISE) indicator will stay on.

Resuming Cruise Control

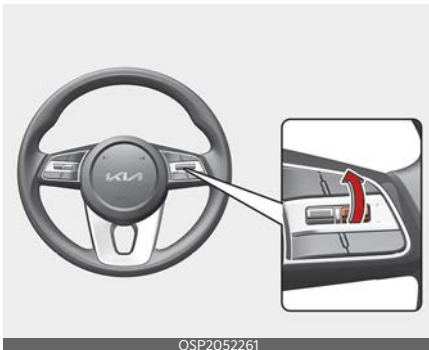

Operate the +, - switch or || ⏪ button. If you push the + switch up or - switch down, set speed will be set to the current speed on the cluster.

If you press the || ⏪ button, vehicle speed will resume to the preset speed. Vehicle speed must be above 30 km/h (20 mph) for the function to resume.

Turning off Cruise Control



Press the Driving Assist button to turn Cruise Control off. The Cruise indicator will go off.

Always press the Driving Assist button to turn Cruise Control off when not in use.

* NOTICE

Take the following precautions when using Cruise Control:

- Always set the set speed under the speed limit in your country.
- Keep Cruise Control off when the function is not in use, to avoid inadvertently setting a speed. Check that the Cruise (⏪ CRUISE) indicator is off.
- Cruise Control does not substitute for proper and safe driving. It is the responsibility of the driver to always drive safely and should always be

aware of unexpected and sudden situations from occurring.

- Always drive cautiously to prevent unexpected and sudden situations from occurring. Pay attention to the road conditions at all times.
 - Do not use Cruise Control when it may be unsafe to keep the vehicle at a constant speed:
 - When driving in heavy traffic, or when traffic conditions make it difficult to drive at a constant speed
 - When driving on rainy, icy, or snow-covered roads
 - When driving on hilly or windy roads
 - When driving in windy areas
 - When driving with limited view (possibly due to bad weather, such as fog, snow, rain and sandstorm)
 - Do not use Cruise Control when towing a trailer.
-

Smart Cruise Control (SCC) (if equipped)

Smart Cruise Control allows you to program the vehicle to maintain constant speed and distance detecting the vehicle ahead without depressing the accelerator or brake pedal.

Overtaking Acceleration Assist

While Smart Cruise Control is operating, if the function judges that the driver is determined to overtake the vehicle in front, acceleration will be assisted.

Detecting sensor

[1]: Front view camera, [2]: Front radar



The front view camera and front radar are used as a detecting sensor to detect vehicles in front. Refer to the picture for

the detailed location of the detecting sensor.

⚠ CAUTION

- Always keep the front view camera and front radar in good condition to maintain optimal performance of Smart Cruise Control.
- For more details on the precautions of the front view camera and front radar, refer to "Forward Collision-Avoidance Assist (FCA) (Sensor fusion) (if equipped)" on page 6-15.

Smart Cruise Control settings

Based on Drive Mode

Smart Cruise Control will change acceleration based on the drive mode selected from Drive mode integrated control system. Refer to the following chart.

Drive Mode	Smart Cruise Control
NORMAL	Normal
SMART	Normal
SPORT	Fast

*** NOTICE**

- For more details on Drive Mode, refer to "Drive mode integrated control system" on page 5-50.
- In vehicles without Drive Mode, Smart Cruise Control accelerate the vehicle in 'Normal' level.

Warning Methods

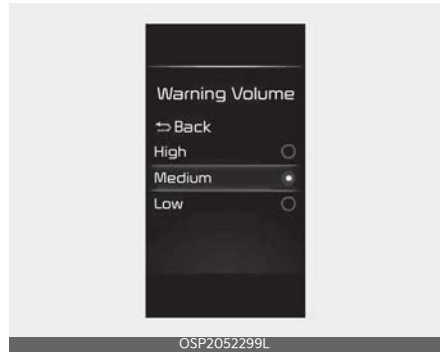

You can adjust the Warning Methods with the ignition switch or ENGINE START/STOP button in the ON position.

- Warning Volume : Select 'User Settings → Driver Assistance → Warning Volume' on the LCD display or 'Setup → Vehicle → Driver Assistance → Warning Methods' on the Infotainment system.
- Driving Safety Priority : Select 'Setup → Vehicle → Driver Assistance → Warning Methods → Driving Safety Priority' on the Infotainment system. For safe driving, the audio volume will temporarily decrease to warn the driver with the audible warning.

*** NOTICE**

- Ensure that Warning Methods you have set may apply to the warning volume of other Driver Assistance systems.
- Warning Methods will maintain its last setting even if the vehicle is restarted.
- The setting menu may not be available for your vehicle depending on the vehicle features and specifications.

Smart Cruise Control operation

Operating conditions for basic function

Basic function

Smart Cruise Control operates when the following conditions are satisfied.

- The gear is in D (Drive)
- Your driving speed is within the operating speed range
10~180 km/h (5~110 mph): when there is no vehicle in front
0~180 km/h (0~110 mph): when there is a vehicle in front
- ESC (Electronic Stability Control) or ABS is on

Smart Cruise Control does not operate in the following conditions.

- The driver's door is opened
- Engine RPM is high
- EPB (Electronic Parking Brake) is applied
- ESC (Electronic Stability Control) or ABS is controlling the vehicle
- Forward Collision-Avoidance Assist brake control is operating

* NOTICE

When stopped behind another vehicle, the driver can turn on Smart Cruise Control while the brake pedal is depressed.

Operating conditions for Acceleration Assist

Overtaking Acceleration Assist will operate when the turn signal indicator is turned on to the left (left-hand drive) or turned on to the right (right-hand drive) while Smart Cruise Control is operating,

and the following conditions are satisfied:

- Your driving speed is above 60 km/h (40 mph)
- A vehicle is detected in front of your vehicle

Overtaking Acceleration Assist does not operate in the following conditions.

- The hazard warning flasher is on
- Vehicle speed is reduced to maintain distance with the vehicle in front

⚠ WARNING

- When the turn signal indicator is turned on to the left (left-hand drive) or turned on to the right (right-hand drive) while there is a vehicle ahead, the vehicle may accelerate temporarily. Pay attention to the road conditions at all times.
- Regardless of your country's driving direction, Overtaking Acceleration Assist will operate when the conditions are satisfied. When using the function in countries with different driving direction, always check the road conditions at all times.

Turning on Smart Cruise Control

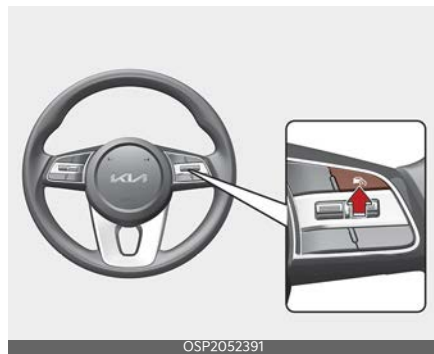

Press the Driving Assist button to turn on Smart Cruise Control. The set speed will be set to the current speed on the cluster.

- If there is no vehicle in front of you, the set speed will be maintained, but if there is a vehicle in front of you, the speed may decrease to maintain the distance to the vehicle ahead. If the vehicle ahead accelerates, your vehicle will travel at a steady cruising speed after accelerating to the set speed.

*** NOTICE**

- If your vehicle speed is between 0~30 km/h (0~20 mph) when you press the Driving Assist button, Smart Cruise Control will set speed to 30 km/h (20 mph).
- If driver shifts to a lower gear, the driving speed may not reach the set speed.

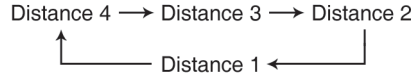

*** NOTICE**

- If you drive at 90 km/h (56 mph), the distance is maintained as follows:
 - Distance 4 - approximately 52.5 m (172 ft)
 - Distance 3 - approximately 40 m (130 ft)
 - Distance 2 - approximately 32.5 m (106 ft)
 - Distance 1 - approximately 25 m (82 ft)
- The distance is set to the last set distance when the engine is restarted, or when Smart Cruise Control was temporarily canceled.

Setting Vehicle Distance

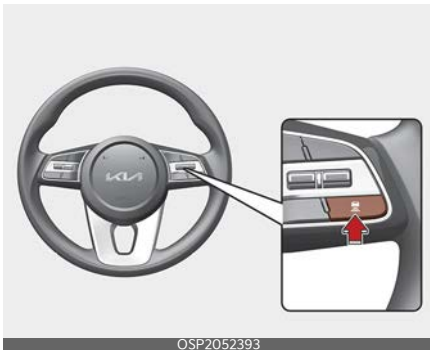

Each time the Vehicle Distance button is pressed, the Vehicle Distance changes as follows:

Increasing set speed



Push up the + switch, and release it immediately. The set speed will increase by 1 km/h (1 mph) each time the switch is operated in this manner.

- Push up the + switch, and hold it while monitoring the set speed on the cluster. The set speed will increase by 5 mph or 10 km/h each time the switch is operated in this manner. Release

the switch when the desired speed is shown, and the vehicle will accelerate to that speed. Speed can increase the set speed to 180 km/h (110 mph).

⚠ WARNING

Check the driving condition before using the + switch. Driving speed may sharply increase when you push up and hold the + switch.

Decreasing set speed



Push down the - switch, and release it immediately. The set speed will decrease by 1 km/h (1 mph) each time the switch is operated in this manner.

- Push down the - switch, and hold it while monitoring the set speed on the cluster. The set speed will decrease by 5 mph or 10 km/h each time the switch is operated in this manner. Release the switch at the set speed you want to maintain. Set speed can decrease to 30 km/h (20 mph).

Temporarily canceling Smart Cruise Control

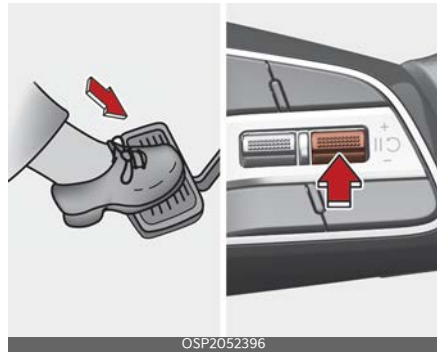

Press the || Ⓞ switch or depress the brake pedal to temporarily cancel Smart Cruise Control.

Resuming Smart Cruise Control

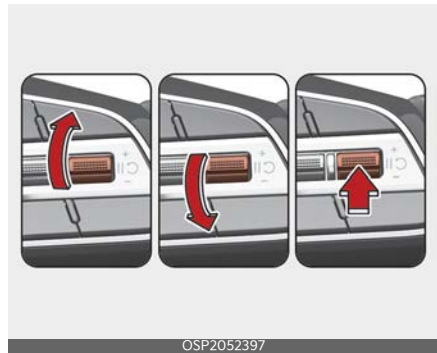

To resume Smart Cruise Control after the function was canceled, operate the +, - or || Ⓞ switch.

If you push the + switch up or - switch down, the set speed will be set to the current speed on the cluster.

If you press the || Ⓞ switch, vehicle speed will resume to the preset speed.

⚠ WARNING

Check the driving condition before press the || Ⓞ switch. Driving speed may

sharply increase or decrease when you press the  switch.

Turning off Smart Cruise Control

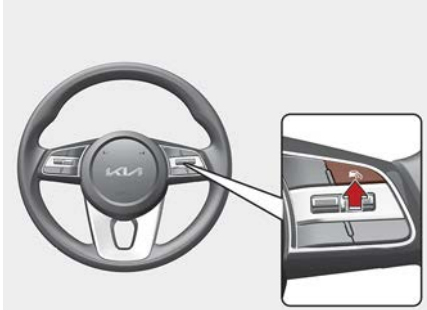

OSP2052391

Press the Driving Assist button to turn Smart Cruise Control off.

* NOTICE

If your vehicle is equipped with Manual Speed Limit Assist, press and hold the Driving Assist button to turn off Smart Cruise Control. However Manual Speed Limit Assist will turn on.

⚠ CAUTION

Do not use the switches and buttons at the same time. Smart Cruise Control may not operate properly.

Displaying operating status

You can see the status of Smart Cruise Control operation in the Driving Assist view on the cluster. Refer to "Instrument cluster" on page 4-68.

Operating



OSP2N052304

Temporarily canceled



OSP2N054305

Smart Cruise Control will be displayed as below depending on the status of the function.

- When operating
 1. Whether there is a vehicle ahead and the selected distance level
 2. Set speed
 3. Whether there is a vehicle ahead and the target vehicle distance
- When temporarily canceled
 1. Vehicle (shaded)
 2. Previous set speed (shaded)

* NOTICE

- The actual distance with the front vehicle is displayed.

- The target distance may vary according to the vehicle speed and the set distance level. If the vehicle speed is low, even though the vehicle distance have changed, the change of the target vehicle distance may be small.
- The images and colors in the instrument cluster may differ depending on the cluster type or theme selected from the settings menu.

Accelerating temporarily



If you want to speed up temporarily when Smart Cruise Control is on, depress the accelerator pedal for a certain amount. While depressing the accelerator pedal for a certain amount, the set speed, distance level and target distance will blink on the cluster. However, if the accelerator pedal is insufficiently depressed, the vehicle may slow down.

⚠ WARNING

Be careful when accelerating temporarily, because the speed is not controlled automatically even if there is a vehicle in front of you.

Temporarily canceling Smart Cruise Control

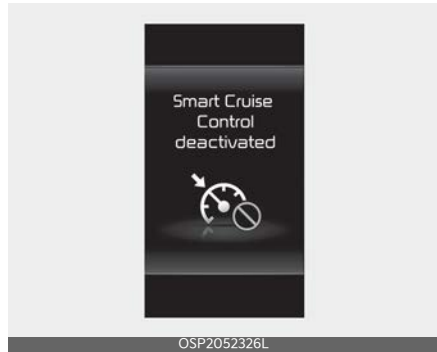

Smart Cruise Control will be temporarily canceled automatically when:

- The vehicle speed is above 190 km/h (120 mph)
- The accelerator pedal is continuously depressed for a certain period of time
- The conditions for Smart Cruise Control to operate is not satisfied

If Smart Cruise Control is temporarily canceled, the warning message will appear on the cluster, and an audible warning will sound to warn the driver.

*** NOTICE**

If Smart Cruise Control is temporarily canceled while the vehicle is at a standstill with the function operating, EPB (Electronic Parking Brake) may be applied.

⚠ WARNING

When Smart Cruise Control is temporarily canceled, distance with the front vehicle will not be maintained. Always have your eyes on the road while driving, and if necessary, depress the brake pedal to

reduce your driving speed in order to maintain a safe distance.

Smart Cruise Control conditions not satisfied

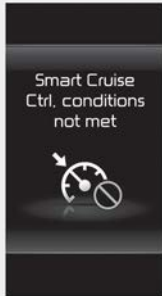

OSP2052327L

If the Driving Assist button, +, - or  switch is operated when Smart Cruise Control's operating conditions are not satisfied, the warning message will appear on the cluster, and an audible warning will sound.

In traffic situation



OSP2052331L

In traffic, your vehicle will stop if the vehicle ahead of you stops. Also, if the vehicle ahead of you starts moving, your vehicle will start as well. In addition, after the vehicle has stopped and a certain time has passed, the warning message

will appear on the cluster. Depress the accelerator pedal or operate the + switch, - switch or  switch to start driving.

Warning road conditions ahead



OSP2052330L

In the following situation, the warning message will appear on the cluster, and an audible warning will sound to warn the driver of road conditions ahead.

WARNING

Always pay attention to vehicles or objects that may suddenly appear in front of you, and if necessary, depress the brake pedal to reduce your driving speed in order to maintain a safe distance.

Forward Collision Warning

If there is a high risk of a collision while Smart Cruise Control is operating, the risk of a collision is high when Forward Collision-Avoidance Assist is activated.

Confirm road conditions and driving conditions immediately. Press the brake pedal to adjust the speed if necessary.

For details on this function, refer to "Forward Collision-Avoidance Assist (FCA) (Sensor fusion) (if equipped)" on page 6-

15 for detailed information, warnings, cautions and notice.

WARNING

- Smart Cruise Control does not substitute for proper and safe driving. It is the responsibility of the driver to always check the speed and distance to the vehicle ahead.
- Smart Cruise Control may not recognize unexpected and sudden situations or complex driving situations, so always pay attention to driving conditions and control your vehicle speed.
- Keep Smart Cruise Control off when the function is not in use to avoid inadvertently setting a speed.
- Do not open the door or leave the vehicle when Smart Cruise Control is operating, even if the vehicle is stopped.
- Always be aware of the selected speed and vehicle distance.
- Keep a safe distance according to road conditions and vehicle speed. If the vehicle distance is too close during high-speed driving, a serious collision may result.
- When maintaining distance with the vehicle ahead, if the front vehicle disappears, Smart Cruise Control may suddenly accelerate to the set speed. Always be aware of unexpected and sudden situations from occurring.
- Vehicle speed may decrease on an upward slope and increase on a downward slope.
- Always be aware of situations such as when a vehicle cuts in suddenly.
- When you are towing a trailer or another vehicle, we recommend that Smart Cruise Control is turned off due to safety reasons.
- Turn off Smart Cruise Control when your vehicle is being towed.
- Smart Cruise Control may not operate properly if interfered with by strong electromagnetic waves.
- Smart Cruise Control may not detect an obstacle in front and lead to a collision. Always look ahead cautiously to prevent unexpected and sudden situations from occurring.
- Vehicles moving in front of you with a frequent lane change may cause a delay in Smart Cruise Control's reaction or may cause Smart Cruise Control to react to a vehicle actually in an adjacent lane. Always drive cautiously to prevent unexpected and sudden situations from occurring.
- Always be aware of the surroundings and drive safely, even though a warning message does not appear or an audible warning does not sound.
- If any other function's warning message is displayed or warning sound is generated, Smart Cruise Control warning message may not be displayed and warning sound may not be generated.
- You may not hear the warning sound of Forward Collision-Avoidance Assist if the surrounding is noisy.
- The vehicle manufacturer is not responsible for any traffic violation or accidents caused by the driver.
- Always set the vehicle speed under the speed limit in your state.

NOTICE

- Smart Cruise Control may not operate in few seconds after the vehicle is started or the front view camera or front radar is initialized.

- You may hear a sound when the brake is controlled by Smart Cruise Control.

Smart Cruise Control malfunction and limitations

Smart Cruise Control malfunction



OSP2052328L

When Smart Cruise Control is not working properly, the warning message will appear for several seconds and the  warning light will appear on the cluster. In this case, have Smart Cruise Control inspected by an authorized Kia dealer.

Smart Cruise Control disabled

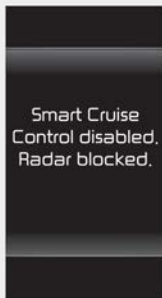

OSP2052329L

When the front radar cover or sensor is covered with snow, rain, or foreign mat-

ters, it can reduce the detecting performance and temporarily limit or disable Smart Cruise Control.

If this occurs, the warning message will appear for a certain period of time on the cluster.

Smart Cruise Control will operate properly when such snow, rain or foreign matter is removed. Always keep it clean.

WARNING

Even though the warning message does not appear on the cluster, Smart Cruise Control may not properly operate.

CAUTION

Smart Cruise Control may not properly operate in an area (for example, open terrain), where any objects are not detected after turning ON the engine.

Limitations of Smart Cruise Control

Smart Cruise Control may not operate properly or it may operate unexpectedly under the following circumstances:

- The detecting sensor or the surroundings are contaminated or damaged
- Washer fluid is continuously sprayed, or the wiper is on
- The camera lens is contaminated due to tinted, filmed or coated windshield, damaged glass, or stuck of foreign matters (sticker, bug, etc.) on the glass
- Moisture is not removed or frozen on the windshield
- The field of view of the front view camera is obstructed by sun glare
- Street light or light from an oncoming vehicle is reflected on the wet road surface, such as a puddle in the road

- The temperature around the front view camera is high or low
- An object is placed on the dashboard
- The surrounding is very bright
- The surrounding is very dark, such as in a tunnel, etc.
- The brightness changes suddenly, for example when entering or exiting a tunnel
- The brightness outside is low, and the headlamps are not on or are not bright
- Driving in heavy rain or snow, or thick fog
- Driving through steam, smoke or shadow
- Only part of the vehicle is detected
- The vehicle in front has no tail lights, tail lights are located unusually, etc.
- The brightness outside is low, and the tail lamps are not on or are not bright
- The rear of the front vehicle is small or does not look normal (for example, tilted, overturned, etc.)
- The front vehicle's ground clearance is low or high
- Your vehicle is being towed
- A vehicle suddenly cuts in front
- Driving through a tunnel or railroad bridge
- An object reflecting off the front radar such as a guardrail, nearby vehicle, etc.
- The bumper around the front radar is impacted, damaged or the front radar is out of position
- The temperature around the front radar is high or low
- Driving in vast areas where there are few vehicles or structures (for example, desert, meadow, suburb, etc.)
- The vehicle in front is made of material that does not reflect on the front radar
- Driving near a highway (or motorway) interchange or tollgate
- Driving on a slippery surface due to snow, water puddle, ice, etc.
- Driving on a curved road
- The vehicle in front is detected late
- The vehicle in front is suddenly blocked by an obstacle
- The vehicle in front suddenly changes lane or suddenly reduces speed
- The vehicle in front is bent out of shape
- The front vehicle's speed is fast or slow
- With a vehicle in front, your vehicle changes lane at low speed
- The vehicle in front is covered with snow
- You are driving unstably
- You are on a roundabout and the vehicle in front is not detected
- You are continuously driving in a circle
- Driving in a parking lot
- Driving through a construction area, unpaved road, partial paved road, uneven road, speed bumps, etc.
- Driving on an incline road, curved road, etc.
- Driving through a roadside with trees or streetlights
- The adverse road conditions cause excessive vehicle vibrations while driving
- Your vehicle height is low or high due to heavy loads, abnormal tire pressure, etc.

- Driving through a narrow road where trees or grass are overgrown
- There is interference by electromagnetic waves, such as driving in an area with strong radio waves or electrical noise
- **Driving on a curved road**

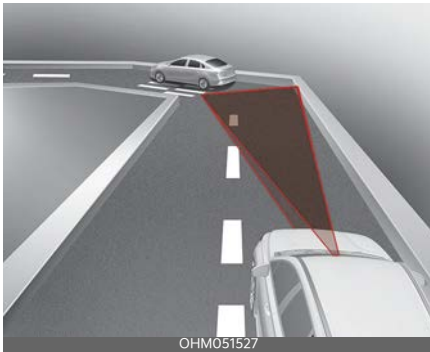

On curves, Smart Cruise Control may not detect a vehicle in the same lane, and may accelerate to the set speed. Also, vehicle speed may rapidly decrease when the vehicle ahead is detected suddenly.

Select the appropriate set speed on curves and apply the brake pedal or accelerator pedal according to the road and driving conditions ahead.

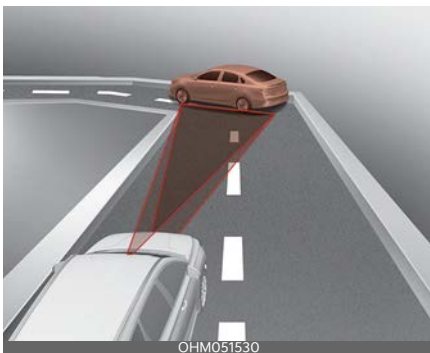

Your vehicle speed can be reduced due to a vehicle in the adjacent lane.

Apply the accelerator pedal and select the appropriate set speed. Check to be sure that the road conditions permit safe operation of Smart Cruise Control.

- **Driving on an inclined road**



During uphill or downhill driving, Smart Cruise Control may not detect a moving vehicle in your lane, and cause your vehicle to accelerate to the set speed. Also, vehicle speed will rapidly decrease when the vehicle ahead is detected suddenly.

Select the appropriate set speed on inclines and apply the brake pedal or accelerator pedal according to the road and driving conditions ahead.

• Changing lanes

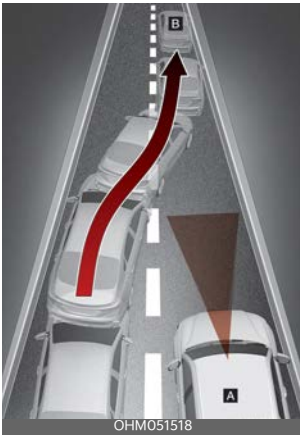

[A]: Your vehicle, [B]: Lane changing vehicle

When a vehicle moves into your lane from an adjacent lane, it cannot be detected by the sensor until it is in the sensor's detection range.

Smart Cruise Control may not immediately detect the vehicle when the vehicle changes lanes abruptly. In this case, you must maintain a safe braking distance, and if necessary, depress the brake pedal to reduce your driving speed in order to maintain a safe distance.

• Detecting vehicle

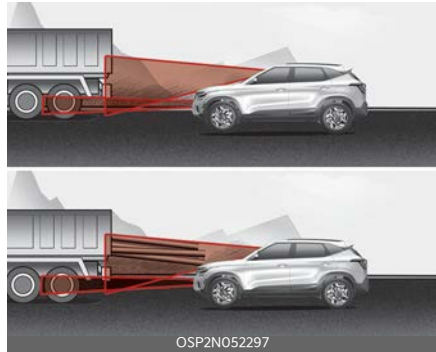
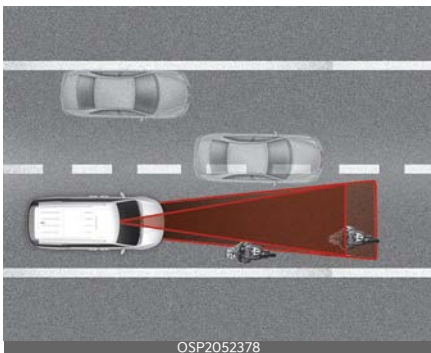

In the following cases, some vehicles in your lane cannot be detected by the sensor:

- Vehicles offset to one side
- Slow-moving vehicles or sudden-decelerating vehicles
- Oncoming vehicles
- Stopped vehicles
- Vehicles with small rear profile, such as trailers
- Narrow vehicles, such as motorcycles or bicycles
- Special vehicles
- Animals and pedestrians

In the following cases, the vehicle in front cannot be detected by the sensor:

- Vehicles with higher clearance or vehicles carrying loads that stick out of the back of the vehicle
- Vehicles that have the front lifted due to heavy loads
- You are steering your vehicle
- Driving on narrow or sharply curved roads

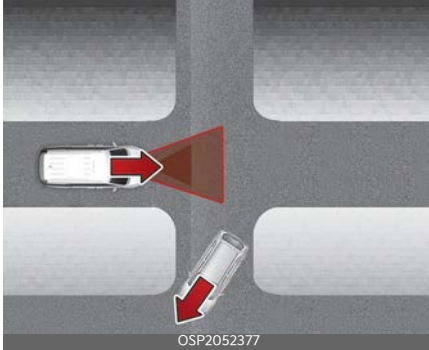

When a vehicle ahead disappears at an intersection, your vehicle may accelerate. Always pay attention to road and driving conditions while driving.

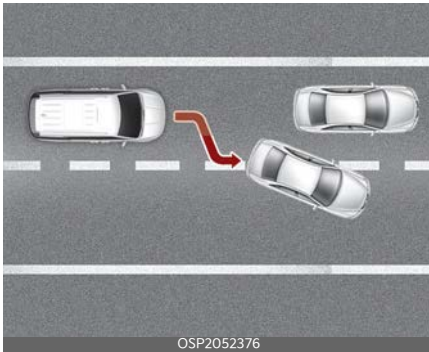

When a vehicle in front of you merges out of the lane, Smart Cruise Control may not immediately detect the new vehicle that is now in front of you. Always pay attention to road and driving conditions while driving.



Always look out for pedestrian when your vehicle is maintaining a distance with the vehicle ahead.

This device complies with Industry Canada licence-exempt RSS standard(s).

Operation is subject to the following conditions:

1. This device may not cause interference, and
2. This device must accept any interference, including interference that may cause undesired operation of the device.
3. Changes or modifications not expressly approved by the party responsible for compliance could void the user's authority to operate the device.

Navigation-based Smart Cruise Control (NSCC) (if equipped)

Navigation-based Smart Cruise Control can help drive at a certain speed according to the road conditions when driving on highways (or motorways) by using road information from the navigation system while Smart Cruise Control is operating.

* NOTICE

- Navigation-based Smart Cruise Control is available only on controlled access road of certain highways.
- * Controlled access road indicates roads with limited entrances and exits that allow uninterrupted high speed traffic flow. Only passenger cars and motorcycles are allowed on controlled access roads.

Available highway (Controlled access road)

USA	Select Interstate Highway and U.S. (Federal) and State Highways
Canada	Select Provincial and Territorial Highways

- Additional highways may be expanded by future navigation updates.

* NOTICE

Navigation-based Smart Cruise Control operates on main roads of highways (or motorways), and does not operate on interchanges or junctions.

Highway Curve Zone Auto Slowdown

If vehicle speed is high, Highway Curve Zone Auto Slowdown function will temporarily decelerate your vehicle or limit

acceleration to help you drive safely on a curve based on the curve information from the navigation.

Navigation-based Smart Cruise Control settings

Highway Auto Speed Change



With the ignition switch or ENGINE START/STOP button in the ON position, select 'Setup → Vehicle → Driver Assistance → Driving Convenience → Highway Auto Speed Change' on the Infotainment system screen to set whether to use the function.

* NOTICE

When there is a problem with Navigation-based Smart Cruise Control, the function cannot be set from the Settings menu.

Navigation-based Smart Cruise Control operation

Operating conditions

Navigation-based Smart Cruise Control is ready to operate if all of the following conditions are satisfied:

- Smart Cruise Control is operating

- Driving on main roads of highways (or motorways)

*** NOTICE**

For more details on how to operate Smart Cruise Control, refer to "Smart Cruise Control (SCC) (if equipped)" on page 6-64.

Navigation-based Smart Cruise Control display and control

When Navigation-based Smart Cruise Control operates, it will be displayed on the cluster as follows:

Navigation-based Smart Cruise Control standby



If the operating conditions are satisfied, the green (NAV) symbol will appear.

Navigation-based Smart Cruise Control operating



If temporary deceleration is required in the standby state and Navigation-based Smart Cruise Control is operating, the green (NAV) symbol will blink on the cluster.

Navigation-based Smart Cruise Control temporarily canceling or driver intervention

If Smart Cruise Control is temporarily canceled or rerouted, etc., that cannot control, the gray (NAV) symbol will appear on the cluster.

If the driver pressed the accelerator pedal, the white (NAV) symbol will blink on the cluster.

WARNING

The warning message will appear in the following circumstances:

- Navigation-based Smart Cruise Control is not able to slow down your vehicle to a safe speed

*** NOTICE**

- Highway Curve Zone Auto Slowdown and Highway Set Speed Auto Change function uses the same (NAV) symbol.
- The images and colors in the instrument cluster may differ depending on the cluster type or theme selected from the settings menu.

Highway Curve Zone Auto Slowdown

- Depending on the curve ahead on the highway (or motorway), the vehicle will decelerate, and after passing the curve, the vehicle will accelerate to Smart Cruise Control set speed.

*** NOTICE**

Vehicle deceleration time may differ depending on the vehicle speed and the degree of the curve on the road. The

higher the driving speed, deceleration will start faster.

Limitations of Navigation-based Smart Cruise Control

Navigation-based Smart Cruise Control may not operate properly under the following circumstances:

- The navigation is not working properly
- Speed limit and road information in the navigation is not updated
- Map information is not transmitted due to infotainment system's abnormal operation
- The map information and the actual road is different because of real-time GPS data or map information error
- The navigation searches for a route while driving
- GPS signals are blocked in areas such as a tunnel
- A road that divides into two or more roads and joins again
- The driver goes off course the route set in the navigation
- The route to the destination is changed or canceled by resetting the navigation
- The vehicle enters a service area or rest area
- Android Auto or Car Play is operating
- The navigation cannot detect the current vehicle position (for example, elevated roads including overpass adjacent to general roads or nearby roads exist in a parallel way)
- The navigation is being updated while driving
- The navigation is being restarted while driving

- The speed limit of some sections changes according to the road situations
- Driving on a road under construction
- Driving on a road that is controlled

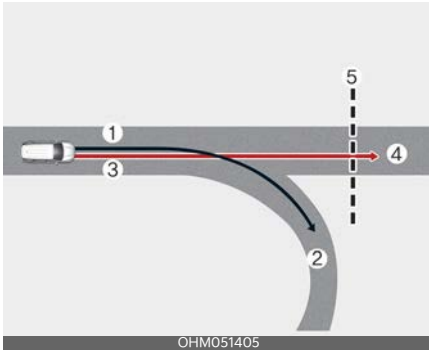

[1]: Set route, [2]: Branch line, [3]: Driving route, [4]: Main road, [5]: Curved road section

- When there is a difference between the navigation set route (branch line) and the driving route (main road), Highway Curve Zone Auto Slowdown function may not operate until the driving route is recognized as the main road.
- When the vehicle's driving route is recognized as the main road by maintaining the main road instead of the navigation set route, Highway Curve Zone Auto Slowdown function will operate. Depending on the distance to the curve and the current vehicle speed, vehicle deceleration may not be sufficient or may decelerate rapidly.

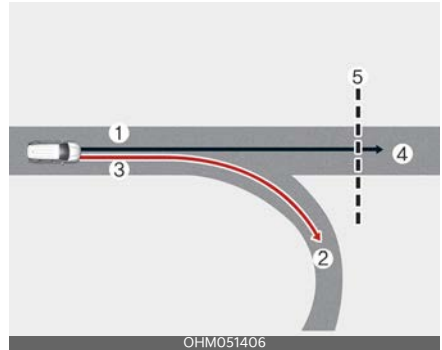

[1]: Main road, [2]: Branch line, [3]: Driving route, [4]: Set route, [5]: Curved road section

- When there is a difference between the navigation route (main road) and the driving route (branch line), Highway Curve Zone Auto Slowdown function will operate based on the curve information on the main road.
- When it is judged that you are driving out of the route by entering the highway interchange, junction or service area, Highway Curve Zone Auto Slowdown function will not operate.

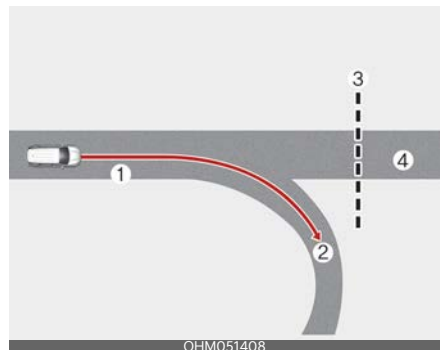

[1]: Driving route, [2]: Branch line, [3]: Curved road section, [4]: Main road

- If there is no destination set on the navigation, Highway Curve Zone Auto Slowdown function will operate based

on the curve information on the main road.

- Even if you depart from the main road, Highway Curve Zone Auto Slow-down function may temporarily operate due to navigation information of the highway curve section.

⚠ WARNING

- Navigation-based Smart Cruise Control is not a substitute for safe driving practices, but a convenience function. Always have your eyes on the road, and it is the responsibility of the driver to avoid violating traffic laws.
- The navigation's speed limit information may differ from the actual speed limit information on the road. It is the driver's responsibility to check the speed limit on the actual driving road or lane.
- Navigation-based Smart Cruise Control will automatically be canceled when you leave the highway (or motorway) main road. Always pay attention to road and driving conditions while driving.
- Navigation-based Smart Cruise Control may not operate due to the existence of leading vehicles and the driving conditions of the vehicle. Always pay attention to road and driving conditions while driving.
- When you are towing a trailer or another vehicle, turn off Navigation-based Smart Cruise Control for safety reasons.
- After you pass through a tollgate on a highway (or motorway), Navigation-based Smart Cruise Control will operate based on the first lane. If you enter one of the other lanes, Navigation-based Smart Cruise Control might not operate properly.

- The vehicle will accelerate if the driver depresses the accelerator pedal while Navigation-based Smart Cruise Control is operating, and the function will not decelerate the vehicle. However, if the accelerator pedal is depressed insufficiently, the vehicle may decelerate.
- If the driver accelerates and releases the accelerator pedal while Navigation-based Smart Cruise Control is operating, the vehicle may not decelerate sufficiently or may rapidly decelerate to a safe speed.
- If the curve is too large or too small, Navigation-based Smart Cruise Control may not operate.

*** NOTICE**

- A time gap could occur between the navigation's guidance and when Navigation-based Smart Cruise Control operation starts and ends.
- The speed information on the cluster and navigation may differ.
- Even if you are driving at a speed lower than Smart Cruise Control set speed, acceleration may be limited by the curve sections ahead.
- If Navigation-based Smart Cruise Control is operating while leaving the main road to enter an interchange, junction, service area, etc., the function may operate for a certain period of time.
- Deceleration by Navigation-based Smart Cruise Control may feel it is not sufficient due to road conditions such as uneven road surfaces, narrow lanes, etc.

This device complies with Industry Canada licence-exempt RSS standard(s).

Operation is subject to the following conditions:

1. This device may not cause interference, and
2. This device must accept any interference, including interference that may cause undesired operation of the device.
3. Changes or modifications not expressly approved by the party responsible for compliance could void the user's authority to operate the device.

Lane Following Assist (LFA)

Lane Following Assist is designed to detect lane markings or vehicles on the road, and assists the driver's steering to help center the vehicle in the lane.

Detecting sensor

[1]: Front view camera



The front view camera is used as a detecting sensor to detect lane markings and front vehicles. Refer to the picture above for the detailed location of the detecting sensor.

⚠ CAUTION

For more details on the precautions of the front view camera, refer to "Forward Collision-Avoidance Assist (FCA) (Sensor fusion) (if equipped)" on page 6-15.

Lane Following Assist settings

Warning Methods



You can adjust the Warning Methods with the ignition switch or ENGINE START/STOP button in the ON position.

- Warning Volume : Select 'User Settings → Driver Assistance → Warning Volume' on the LCD display or 'Setup → Vehicle → Driver Assistance → Warning Methods' on the Infotainment system.
- Driving Safety Priority : Select 'Setup → Vehicle → Driver Assistance → Warning Methods → Driving Safety Priority' on the Infotainment system. For safe driving, the audio volume will temporarily decrease to warn the driver with the audible warning.

* NOTICE

- Ensure that Warning Methods you have set may apply to the warning volume of other Driver Assistance systems.
- Warning Methods will maintain its last setting even if the vehicle is restarted.
- The setting menu may not be available for your vehicle depending on

the vehicle features and specifications.

Lane Following Assist operation

Turning Lane Following Assist ON/OFF



With the ignition switch or ENGINE START/STOP button in the ON position, press the Lane Driving Assist button located on the steering wheel to turn on Lane Following Assist. The white or green (🚗) indicator light will appear on the cluster.

Press the Lane Driving Assist button again to turn off the function.

Warning and control

Lane Following Assist



OSP2052373

If the vehicle ahead or both lane markings are detected and your vehicle speed is below 180 km/h (110 mph), the green (🚦) indicator light will appear on the cluster, and the function will help center the vehicle in the lane by controlling the steering wheel.

⚠ CAUTION

When the steering wheel is not controlled, the green (🚦) indicator light will blink and change to white.

Hands-off warning



OSP2052302L

If the driver takes their hands off the steering wheel for several seconds, the warning message will appear and an audible warning will sound in stages.

- First stage: Warning message
- Second stage: Warning message (red steering wheel) and audible warning

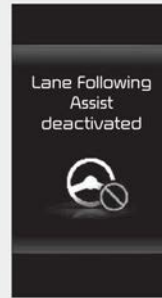

OSP2052334L

If the driver still does not have their hands on the steering wheel after the hands-off warning, the warning message will appear and Lane Following Assist will be automatically canceled.

⚠ WARNING

- The steering wheel may not be assisted if the steering wheel is held very tight or the steering wheel is steered over a certain degree.
- Lane Following Assist does not operate at all times. It is the responsibility of the driver to safely steer the vehicle and to maintain the vehicle in its lane.
- The hands-off warning message may appear late depending on road conditions. Always have your hands on the steering wheel while driving.
- If the steering wheel is held very lightly the hands-off warning message may appear because the function may not recognize that the driver has their hands on the steering wheel.

- If you attach objects to the steering wheel, the hands-off warning may not work properly.

*** NOTICE**

- For more details on setting the functions in the infotainment system, refer to "LCD display modes" on page 4-77.
- When both lane markings are detected, the lane lines on the cluster will change from gray to white.

Lane undetected



Lane detected

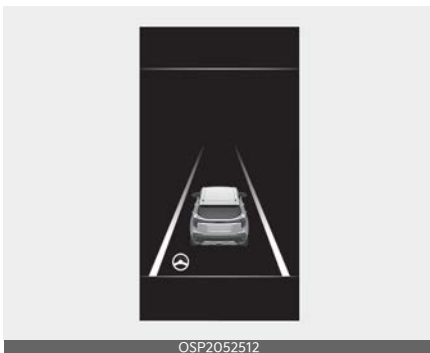

- The images and colors in the instrument cluster may differ depending on the cluster type or theme selected from the settings menu.

- If lane markings are not detected, steering wheel control by Lane Following Assist can be limited depending on whether a vehicle is in front or the driving conditions of the vehicle.
- Even though the steering is assisted by Lane Following Assist, the driver may control the steering wheel.
- The steering wheel may feel heavier or lighter when the steering wheel is assisted by Lane Following Assist than when it is not.

Lane Following Assist malfunction and limitations

Lane Following Assist malfunction

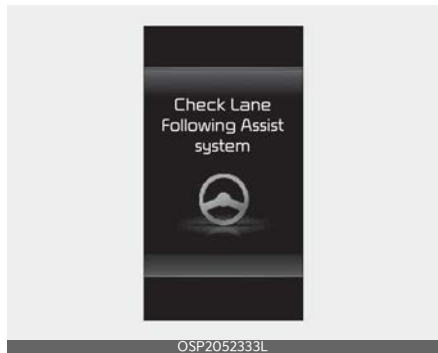

When Lane Following Assist is not working properly, the warning message will appear for several seconds and (⚠) warning light will appear on the cluster. If this occurs, have the vehicle inspected by an authorized Kia dealer.

Limitations of Lane Following Assist

For more details on system limitations, refer to "Limitations of Lane Keeping Assist" on page 6-33.

⚠ WARNING

For more details on the function precautions, refer to "Lane Keeping Assist (LKA (if equipped))" on page 6-28.

Highway Driving Assist (HDA) (if equipped)

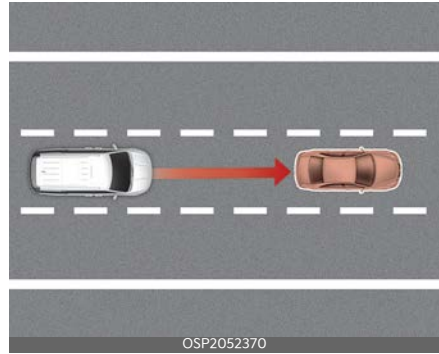

Highway Driving Assist is designed to help detect vehicles and lanes ahead, and help maintain distance from the vehicle ahead, maintain the set speed, help center the vehicle in the lane while driving on the highway (or motorway).

*** NOTICE**

- Highway Driving Assist is available only on controlled access road of certain highways.
 - * Controlled access road indicates roads with limited entrances and exits that allow uninterrupted high speed traffic flow. Only passenger cars and motorcycles are allowed on controlled access roads.

Available highway (Controlled access road)	
USA	Select Interstate Highway and U.S. (Federal) and State Highways
Canada	Select Provincial and Territorial Highways

- Additional highways may be expanded by future navigation updates.
- Highway Driving Assist operates on main roads of highways (or motor-

ways), and does not operate on interchanges or junctions.

Detecting sensor

[1]: Front view camera, [2]: Front radar



Refer to the picture above for the detailed location of the detecting sensors.

⚠ CAUTION

For more details on the precautions of the detecting sensors, refer to "Forward Collision-Avoidance Assist (FCA) (Sensor fusion) (if equipped)" on page 6-15.

Highway Driving Assist settings

Highway Driving Assist

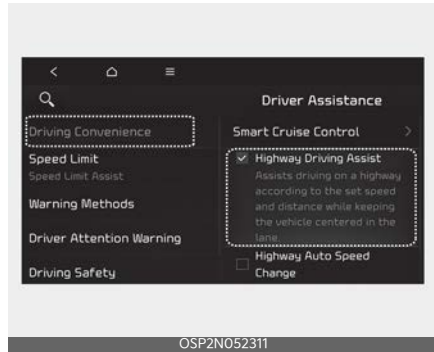

With the ignition switch or ENGINE START/STOP button in the ON position, select 'Setup → Vehicle → Driver Assistance → Driving Convenience → Highway Driving Assist' on the Infotainment system screen to set whether to use the function.

- If 'Highway Driving Assist' is selected, it helps maintain distance from the vehicle ahead, maintain the set speed, and helps center the vehicle in the lane.

⚠ WARNING

For your safety, change the Settings after parking the vehicle at a safe location.

* NOTICE

- If there is a problem with the functions, the settings cannot be changed. Have the vehicle inspected by an authorized Kia dealer.
- If the vehicle is restarted, the functions will maintain the last setting.

Warning Methods

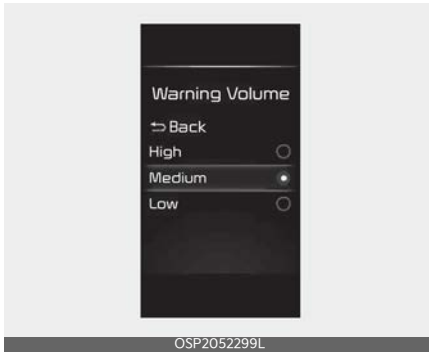

You can adjust the Warning Methods with the ignition switch or ENGINE START/STOP button in the ON position.

- Warning Volume : Select 'User Settings → Driver Assistance → Warning Volume' on the LCD display or 'Setup → Vehicle → Driver Assistance → Warning Methods' on the Infotainment system.
- Driving Safety Priority : Select 'Setup → Vehicle → Driver Assistance → Warning Methods → Driving Safety Priority' on the Infotainment system. For safe driving, the audio volume will temporarily decrease to warn the driver with the audible warning.

* NOTICE

- Ensure that Warning Methods you have set may apply to the warning volume of other Driver Assistance systems.
- Warning Methods will maintain its last setting even if the vehicle is restarted.
- The setting menu may not be available for your vehicle depending on the vehicle features and specifications.

Highway Driving Assist operation

Displaying operating status

You can see the status of the Highway Driving Assist operation in the Driving Assist view on the cluster. Refer to "LCD display modes" on page 4-77.

Operating State

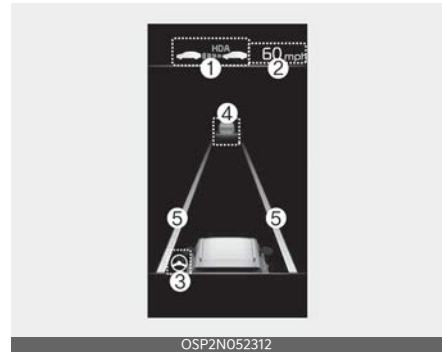

Standby State

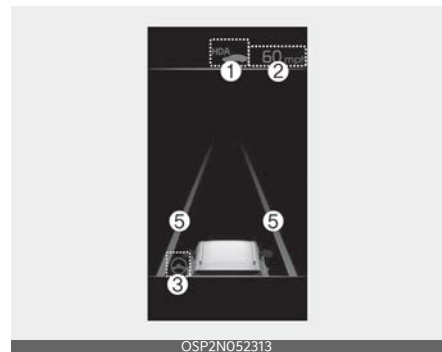

Highway Driving Assist will be displayed as below depending on the status of the function.

1. Highway Driving Assist indicator, whether there is a vehicle ahead and the selected distance level are displayed.
 - Highway Driving Assist indicator
 - Green (HDA): Operating state

- Gray (HDA): Standby state
 - White (HDA) blink: Accelerator depressed state
2. Set speed
 3. Lane Following Assist indicator
 4. Whether there is a vehicle ahead and the selected vehicle distance
 5. Whether the lane is detected or not

*** NOTICE**

- For more details on the display refer to "Smart Cruise Control (SCC) (if equipped)" on page 6-64.
- For more details on the display, refer to "Lane Following Assist (LFA)" on page 6-83.
- The images and colors in the instrument cluster may differ depending on the cluster type or theme selected from the settings menu.

Highway Driving Assist operating

Highway Driving Assist operates when:

- When driving on available road, press Drive Assist button to turn on Highway Driving Assist.
- When entering the main roads of highways (or motorways) while Smart Cruise Control is operating, Driving Assist will not turn on if Lane Following Assist is turned off.

Restarting after stopping

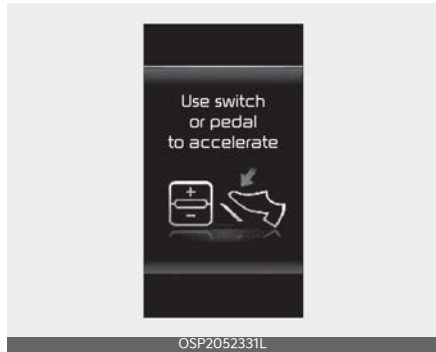

When Highway Driving Assist is operating, your vehicle will stop if the vehicle ahead of you stops. Also, if the vehicle ahead of you starts moving within 30 seconds after the stop, your vehicle will start as well. In addition, after the vehicle has stopped and 30 seconds have passed, the message will appear on the cluster. Depress the accelerator pedal or operate the + switch, - switch or || Ⓞ switch to start driving.

Hands-off warning

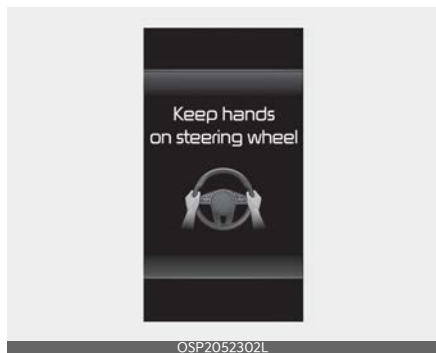

If the driver takes their hands off the steering wheel for several seconds, the warning message will appear and an audible warning will sound in stages.

- First stage: Warning message

- Second stage: Warning message (red steering wheel) and audible warning



OSP2N052315

If the driver still does not have their hands on the steering wheel after the hands-off warning, warning message will appear and Highway Driving Assist will be automatically canceled.

Driving speed limit



OSP2N052316

When Highway Driving Assist is canceled by the hands-off warning, The driving speed will be limited.

While Driving Speed Limit function is operating, the warning message will appear on the cluster, and an audible warning will sound continuously.

Highway Driving Assist standby

When the Smart Cruise Control is temporarily canceled while Highway Driving

Assist is operating, Highway Driving Assist will be in the standby state. At this time, Lane Following Assist will operate properly.

* NOTICE

- Driving Speed Limit helps you drive below 60 km/h (40 mph). At this time, the vehicle decelerates due to the vehicle ahead. After the vehicle has decelerated, it cannot automatically accelerate.
- Driving Speed Limit will cancel in the following circumstances:
 - When the driver grabs the steering wheel again
 - When the driver turns on Lane Following Assist by pressing the Lane Driving Assist button
 - When (+), (-), (|| ↻) switch or the Vehicle Distance button is operated, or the accelerator pedal or the brake pedal is depressed.

Highway Driving Assist malfunction and limitations

Highway Driving Assist malfunction



OSP2N052317

When Highway Driving Assist is not working properly, the warning message

will appear, and the (⚠) warning light will appear on the cluster. Have Highway Driving Assist be inspected by an authorized Kia dealer.

WARNING

- The driver is responsible for controlling the vehicle for safe driving.
 - Always have your hands on the steering wheel while driving.
 - Highway Driving Assist is a supplemental function that assists the driver in driving the vehicle and is not a complete autonomous driving system. Always check road conditions, and if necessary, take appropriate actions to drive safely.
 - Always have your eyes on the road, and it is the responsibility of the driver to avoid violating traffic laws. The vehicle manufacturer is not responsible for any traffic violation or accidents caused by the driver.
 - Highway Driving Assist may not be able to recognize all traffic situations. Highway Driving Assist may not detect possible collisions due to limitations of the function. Always be aware of the limitations of the function. Obstacles such as vehicles, motorcycles, bicycles, pedestrians, or unspecified objects or structures such as guardrails, tollgate, etc., that may collide with the vehicle may not be detected.
 - Highway Driving Assist will turn off automatically under the following situations:
 - Driving on roads that Highway Driving Assist does not operate, such as a service area, intersection, junction, etc.
 - The navigation does not operate properly such as when the navigation is being updated or restarted
- Highway Driving Assist may inadvertently operate or turn off depending on road conditions (navigation information) and surroundings.
 - Lane Following Assist may be temporarily disabled when the front view camera cannot detect lanes properly or the hands-off warning is on.
 - You may not hear the warning sound of Highway Driving Assist if the surrounding is noisy.
 - If the vehicle is driven at high speed above a certain speed at a curve, your vehicle may drive to one side or may depart from the driving lane.
 - When you are towing a trailer or another vehicle, turn off Highway Driving Assist for safety reasons.
 - The hands-off warning message may appear early or late depending on how the steering wheel is held or road conditions. Always have your hands on the steering wheel while driving.
 - For your safety, please read the owner's manual before using Highway Driving Assist.
 - Highway Driving Assist will not operate when the vehicle is started, or when the detecting sensors or navigation is being initialized.

Limitations of Highway Driving Assist

Highway Driving Assist may not operate properly, or it may not operate under the following circumstances:

- The map information and the actual road is different because the navigation is not updated

- The map information and the actual road is different because of real-time GPS data or map information error
 - The infotainment system is overloaded by simultaneously performing functions such as route search, video playback, voice recognition, etc.
 - GPS signals are blocked in areas such as a tunnel
 - The driver goes off course, or resetting the navigation route by changing the destination (including route change according to real-time road traffic information), or canceling the route to the destination
 - The vehicle enters a service area or rest area
 - Android Auto or Car Play is operating
 - The navigation cannot detect the current vehicle position (for example, elevated roads including overpass adjacent to general roads or nearby roads exist in a parallel way)
3. Changes or modifications not expressly approved by the party responsible for compliance could void the user's authority to operate the device.

* NOTICE

For more details on the limitations of the front view camera and front radar, refer to "Forward Collision-Avoidance Assist (FCA) (Sensor fusion) (if equipped)" on page 6-15.

This device complies with Industry Canada licence-exempt RSS standard(s).

Operation is subject to the following conditions:

1. This device may not cause interference, and
2. This device must accept any interference, including interference that may cause undesired operation of the device.

Rear View Monitor (RVM)

Rear View Monitor will activate when the back-up light is ON with the ignition switch ON and the shift lever in the R (Reverse) position. Rear View Monitor is a supplemental function that shows behind the vehicle through Infotainment system while backing-up.

* NOTICE

After a display audio system or an additional infotainment system (genuine Kia parts) installation, Rear View Monitor may not operate as described in the owner's manual. In this case, refer to the web manual for further information on setting up and operating Rear View Monitor.

Detecting sensor

[1]: Wide-rear view camera



Refer to the picture above for the detailed location of the detecting sensor.

Rear View Monitor settings

Camera settings



You can change Rear View Monitor 'Display Contents' and 'Display Settings' or by touching the setup icon (⚙️) on the screen while Rear View Monitor is operating, or selecting 'Setup → Vehicle → Driver Assistance → Parking Safety → Camera Settings' from the Settings menu while the engine is on.

- Display Contents: To change the settings of Extended Rear View Monitor and Rear View Parking Lines
- Display Settings: To change the screen's brightness and contrast.

Warning Methods

You can adjust the Warning Methods with the ignition switch or ENGINE START/ STOP button in the ON position. Parking Safety Priority : Select 'Setup → Vehicle → Driver Assistance → Warning Methods → Parking Safety Priority' on the Infotainment system for safe parking. The audio volume will temporarily decrease while Rear View Monitor is operating.

* NOTICE

- Ensure that Warning Methods you have set may apply to the Warning volume of other Driver Assistance systems.
- Warning Methods will maintain its last setting even if the vehicle is restarted.
- The setting menu may not be available for your vehicle depending on the vehicle features and specifications.

Rear View Monitor operation

Parking/View button



Press the Parking/View button to turn on Rear View Monitor.

Press the button again to turn off the function.

Rear view



Operating conditions

- Shift the gear to R (Reverse), the image will appear on the screen.
- Press the Parking/View button while the gear is in P (Park), the image will appear on the screen.
- Pressing the View icon with the Rear top view on the screen.

Off conditions

- The rear view cannot be turned off when the gear is in R (Reverse).
- Press the Parking/View button again while the gear is in P (Park) with the rear view on the screen, the rear view will turn off.
- Shift the gear from R (Reverse) to P (Park), the rear view will turn off.

Rear top view



When you touch the () icon, the top view is displayed on the screen and shows the distance from the vehicle in the back of your vehicle while parking.

Extended Rear View Monitor

The rear view will maintain showing on the screen to help you when parking.

Operating conditions

- Shift the gear from R (Reverse) to N (Neutral) or D (Drive), the rear view will appear on the screen.
- The vehicle speed is below approximately 10 km/h (6 mph).

Off conditions

- When vehicle speed is above 10 km/h (6 mph), the rear view will turn off.
- Press the Parking/View button, the rear view will turn off.
- Shift the gear to P (Park), the rear view will turn off.

Rear View Monitor malfunction and limitations

Rear View Monitor malfunction

When Rear View Monitor is not working properly, or the screen flickers, or the camera image does not display normally, have the function be inspected by an authorized Kia dealer.

Limitations of Rear View Monitor

When the vehicle is stopped for a long time in winter or when the vehicle is parked in an indoor parking lot, the exhaust fumes may temporarily blur the image.

WARNING

- The rear view camera does not cover the complete area behind the vehicle. The driver should always check the rear area directly through the inside and outside rearview mirror before parking or backing up.
- The image shown on the screen may differ from the actual distance of the object. Make sure to directly check the vehicle's surroundings for safety.
- Always keep the rear view camera lens clean. If the lens is covered with foreign material, it may adversely affect camera performance and Rear View Monitor may not operate normally. However, do not use chemical solvents such as strong detergents containing high alkaline or volatile organic solvents (gasoline, acetone etc.). This may damage the camera lens.

Rear Cross-Traffic Collision-Avoidance Assist (RCCA) (if equipped)

Rear Cross-Traffic Collision-Avoidance Assist is designed to detect vehicles approaching from the rear left and right side while your vehicle is reversing, and warning the driver that a collision is imminent with a warning message and an audible warning. Also, to help prevent collisions, braking assist may be applied.

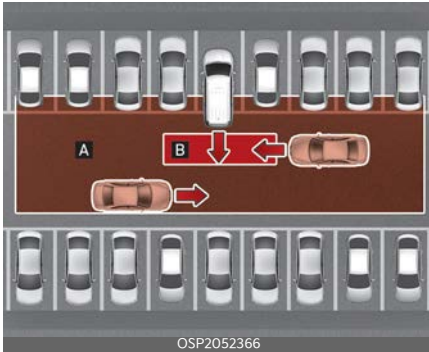

[A]: Rear Cross-Traffic Collision Warning operating range

[B]: Rear Cross-Traffic Collision-Avoidance Assist operating range

CAUTION

Warning Timing may vary depending on vehicle speed of the approaching vehicle.

Detecting sensor

[1]: Rear corner radar



Refer to the picture above for the detailed location of the detecting sensor.

CAUTION

For more details on the precautions of the rear corner radar, refer to "Blind-Spot Collision-Avoidance Assist (BCA) (if equipped)" on page 6-35.

6

Rear Cross-Traffic Collision-Avoidance Assist settings

Rear Cross-Traffic Safety

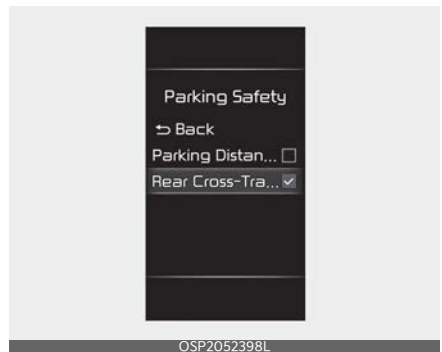

With the ignition switch or ENGINE START/STOP button in the ON position, select 'User Settings → Driver Assistance → Parking Safety' on the LCD display or

'Setup → Vehicle → Driver Assistance → Parking Safety' on the Infotainment system screen to turn on Rear Cross-Traffic Collision-Avoidance Assist.

⚠ WARNING

When the engine is restarted, Rear Cross-Traffic Collision-Avoidance Assist will always turn on. However, if Rear Cross-Traffic Safety is deselected after the vehicle is restarted, the driver should always be aware of the surroundings and drive safely.

*** NOTICE**

Settings for Rear Cross-Traffic Collision-Avoidance Assist include Rear Cross-Traffic Collision Warning and Rear Cross-Traffic Collision-Avoidance Assist.

*** NOTICE**

If the engine is restarted, Warning Timing and Warning Volume will maintain the last setting.

Warning Methods

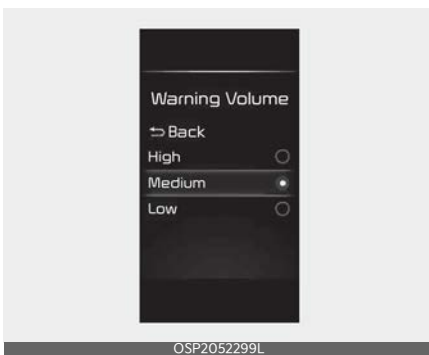

You can adjust the Warning Methods with the ignition switch or ENGINE START/STOP button in the ON position.

- Warning Volume : Select 'User Settings → Driver Assistance → Warning Volume' on the LCD display or 'Setup → Vehicle → Driver Assistance → Warning Methods' on the Infotainment system.

*** NOTICE**

- Ensure that Warning Methods you have set may apply to the warning volume of other Driver Assistance systems.
- Warning Methods will maintain its last setting even if the vehicle is restarted.
- The setting menu may not be available for your vehicle depending on the vehicle features and specifications.

Rear Cross-Traffic Collision-Avoidance Assist operation

Rear Cross-Traffic Collision-Avoidance Assist will provide a warning and control the vehicle depending on collision level.

- Collision Warning
- Emergency Braking
- Stopping vehicle and ending brake control

Collision Warning

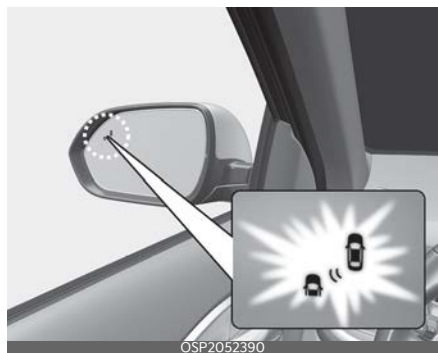

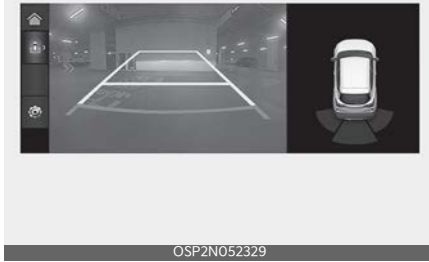

- To warn the driver of an approaching vehicle from the rear left/right side of your vehicle, the warning light on the side view mirror will blink and a warning message will appear on the cluster. At the same time, an audible warning will sound.
- Rear Cross-Traffic Collision-Avoidance Assist will operate when the following conditions are satisfied:
 - Your vehicle gear is shifted to R (Reverse)
 - Your vehicle speed is below 8 km/h (5 mph)
 - The approaching vehicle is within approximately 25 m (82 ft.) from the left or right side of your vehicle

- The speed of the vehicle approaching from the left or right side is above 5 km/h (3 mph)

*** NOTICE**

- If the operating conditions are satisfied, there will be a warning whenever the vehicle approaches from the left or right side even though your vehicle speed is 0 km/h (0 mph).
- The images and colors in the instrument cluster may differ depending on the cluster type or theme selected from the settings menu.

Emergency Braking





- Your vehicle, the warning light on the side view mirror will blink and a warning message will appear on the cluster. At the same time, an audible warning will sound.
- Rear Cross-Traffic Collision-Avoidance Assist will operate when the following conditions are satisfied:
 - Your vehicle gear is shifted to R (Reverse)
 - Your vehicle speed is below 8 km/h (5 mph)
 - The approaching vehicle is within approximately 1.5 m (5 ft.) from the left or right side of your vehicle
 - The speed of the vehicle approaching from the left or right side is above 5 km/h (3 mph)
- Emergency braking will be assisted to help prevent collision with approaching vehicles from the left and right.

⚠ WARNING

- Brake control will end when:
 - The approaching vehicle is out of the detecting range
 - The approaching vehicle passes behind your vehicle
 - The approaching vehicle does not drive toward your vehicle

- The approaching vehicle speed slows down
- The driver depresses the brake pedal with sufficient power

Stopping vehicle and ending brake control



When the vehicle is stopped due to emergency braking, the 'Drive carefully' warning message will appear on the cluster.

For your safety, the driver should depress the brake pedal immediately and check the surroundings.

- Brake control will end after the vehicle is stopped by emergency braking for approximately 2 seconds.
- During emergency braking, braking control by Rear Cross-Traffic Collision-Avoidance Assist will automatically cancel when the driver excessively depresses the brake pedal.

⚠ WARNING

- For your safety, change the settings after parking the vehicle at a safe location.
- If any other function's warning message is displayed or audible warning

is generated, Rear Cross-Traffic Collision-Avoidance Assist warning message may not be displayed and audible warning may not be generated.

- You may not hear the warning sound of Rear Cross-Traffic Collision-Avoidance Assist if the surrounding is noisy.
- Rear Cross-Traffic Collision-Avoidance Assist may not operate if the driver applies the brake pedal to avoid collision.
- During Rear Cross-Traffic Collision-Avoidance Assist operation, the vehicle may stop suddenly injuring passengers and shifting loose objects. Always have the seat belt on and keep loose objects secured.
- Even if there is a problem with Rear Cross-Traffic Collision-Avoidance Assist, the vehicle's basic braking performance will operate normally.

⚠ WARNING

- During emergency braking, braking control by the function will automatically cancel when the driver excessively depresses the accelerator pedal.
- Rear Cross-Traffic Collision-Avoidance Assist does not operate in all situations and cannot avoid all collisions.
- Rear Cross-Traffic Collision-Avoidance Assist may warn the driver late or may not warn the driver depending on the road and driving conditions.
- The driver should hold the responsibility to control the vehicle. Do not solely depend on Rear Cross-Traffic Collision-Avoidance Assist. Rather, maintain a safe braking distance, and if necessary, depress the brake pedal

to reduce driving speed or to stop the vehicle.

- Never deliberately test Rear Cross-Traffic Collision-Avoidance Assist on people, animal, objects, etc. It may cause serious injury or death.

⚠ CAUTION

The brake control may not operate properly depending on the status of ESC (Electronic Stability Control). There will only be a warning when:

- The ESC (Electronic Stability Control) warning light is on
- ESC (Electronic Stability Control) is engaged in a different function

*** NOTICE**

- If braking is assisted by Rear Cross-Traffic Collision-Avoidance Assist, the driver must immediately depress the brake pedal and check vehicle surroundings.
- After shifting the gear to R (Reverse), braking control will operate once for left and right vehicle approach.

Rear Cross-Traffic Collision-Avoidance Assist malfunction and limitations

Rear Cross-Traffic Collision-Avoidance Assist malfunction



When Rear Cross-Traffic Collision-Avoidance Assist is not working properly, the warning message will appear for several seconds and the  warning light will appear on the cluster. If this occurs, have the vehicle inspected by an authorized Kia dealer.



When the warning light on the side view mirror (outside mirror) is not working properly, the warning message will appear for several seconds and the 

warning light will appear on the cluster. If this occurs, have the vehicle inspected by an authorized Kia dealer.

Rear Cross-Traffic Collision-Avoidance Assist disabled



When the rear bumper around the rear corner radar or sensor is covered with foreign matters, such as snow or rain, or installing a trailer or carrier, it can reduce the detecting performance and temporarily limit or disable Rear Cross-Traffic Collision-Avoidance Assist.

If this occurs, the warning message will appear on the cluster. It is not a malfunction.

Rear Cross-Traffic Collision-Avoidance Assist will operate properly when such foreign matters or trailer, etc. is removed.

Always keep the rear view camera and rear ultrasonic sensors clean.

If Rear Cross-Traffic Collision-Avoidance Assist does not operate normally after it is removed, have the vehicle inspected by an authorized Kia dealer.

 **WARNING**

Rear Cross-Traffic Collision-Avoidance Assist may not properly operate in an area (for example, open terrain), where

any objects are not detected after turning ON the engine.

⚠ WARNING

Even though the warning message does not appear on the cluster, Rear Cross-Traffic Collision-Avoidance Assist may not properly operate.

⚠ CAUTION

Turn off Rear Cross-Traffic Collision-Avoidance Assist to install a trailer, carrier, etc., and remove the trailer, carrier, etc. to use Rear Cross-Traffic Collision-Avoidance Assist.

Limitations of Rear Cross-Traffic Collision-Avoidance Assist

Rear Cross-Traffic Collision-Avoidance Assist may not operate properly or it may operate unexpectedly under the following circumstances:

- Departing from where trees or grass is overgrown
- Departing from where roads are wet
- Speed of the approaching vehicle is fast or slow

Braking control may not work in the following circumstances:

- The vehicle severely vibrates while driving over a bumpy road, uneven road or concrete patch
- Driving on a slippery surface due to snow, water puddle, ice, etc.
- The tire pressure is low or a tire is damaged
- The brake is reworked

*** NOTICE**

For more details on the limitations of the rear corner radar, refer to "Blind-Spot

Collision-Avoidance Assist (BCA) (if equipped)" on page 6-35.

⚠ WARNING

- **Driving near a vehicle or structure**

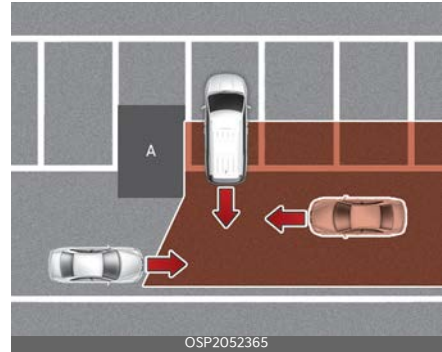

[A]: Structure

Rear Cross-Traffic Collision-Avoidance Assist may be limited when driving near a vehicle or structure, and may not detect the vehicle approaching from the left or right. If this occurs, Rear Cross-Traffic Collision-Avoidance Assist may not warn the driver or control the brakes when necessary.

Always check your surroundings while backing up.

- **When the vehicle is in a complex parking environment**

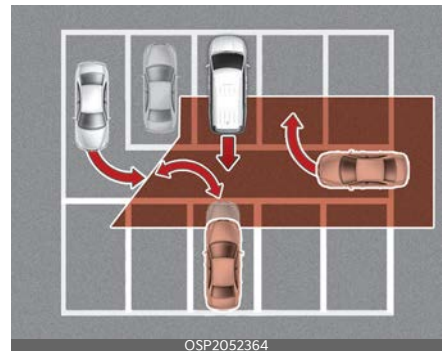

Rear Cross-Traffic Collision-Avoidance Assist may detect vehicles which are parking or pulling out near your vehicle (for example, a vehicle leaving beside your vehicle, a vehicle parking or pulling out in the rear area, a vehicle approaching your vehicle making a turn, etc.). If this occurs, Rear Cross-Traffic Collision-Avoidance Assist may unnecessarily warn the driver and control the brake. Always check your surroundings while backing up.

- **When the vehicle is parked diagonally**

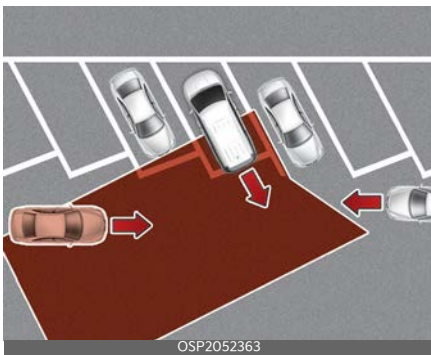

Rear Cross-Traffic Collision-Avoidance Assist may be limited when backing up diagonally, and may not detect the vehicle approaching from the left or right. If this occurs, Rear Cross-Traffic Collision-Avoidance Assist may not warn the driver or control the brakes when necessary.

Always check your surroundings while backing up.

- **When the vehicle is on or near a slope**

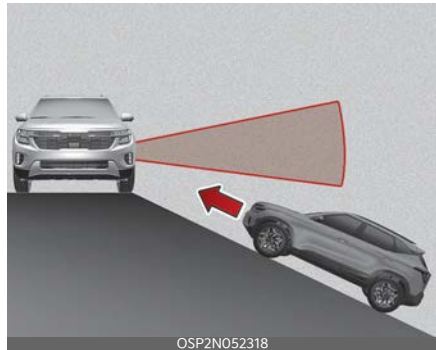

Rear Cross-Traffic Collision-Avoidance Assist may be limited when the vehicle is on an uphill or downhill slope, or near it, and may not detect the vehicle approaching from the left or right. If this occurs, Rear Cross-Traffic Collision-Avoidance Assist may not warn the driver or control the brakes when necessary.

Always check your surroundings while backing up.

- **Pulling into the parking space where there is a structure**

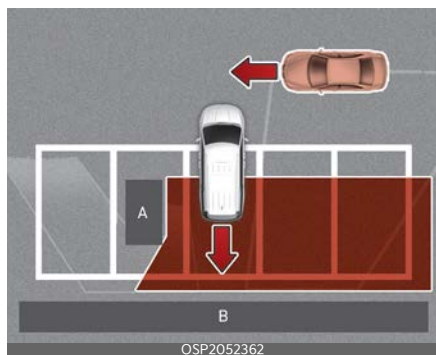

[A]: Structure, [B]: Wall

Rear Cross-Traffic Collision-Avoidance Assist may detect vehicles passing by in front of you when parking backwards

into a parking space with a wall or structure in the rear or side area. If this occurs, Rear Cross-Traffic Collision-Avoidance Assist may unnecessarily warn the driver and control the brake. Always check your surroundings while backing up.

- **When the vehicle is parked rearward**

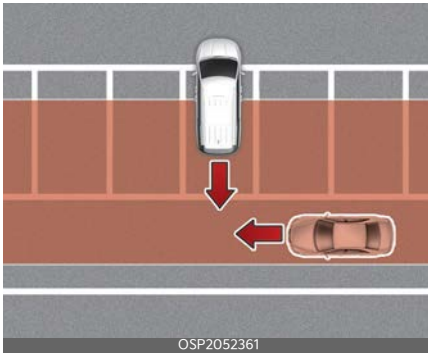

Rear Cross-Traffic Collision-Avoidance Assist may detect vehicles passing by behind you when parking backwards into a parking space. If this occurs, Rear Cross-Traffic Collision-Avoidance Assist may unnecessarily warn the driver and control the brake.

Always check your surroundings while backing up.

WARNING

- When you are towing a trailer or another vehicle, we recommend that Rear Cross-Traffic Collision-Avoidance Assist is turned off due to safety reasons.
- Rear Cross-Traffic Collision-Avoidance Assist may not operate normally if interfered with by strong electromagnetic waves.

- Rear Cross-Traffic Collision-Avoidance Assist may not operate for 3 seconds after the vehicle is started, or the rear corner radars are initialized.

This device complies with Industry Canada licence-exempt RSS standard(s).

Operation is subject to the following conditions:

1. This device may not cause interference, and
2. This device must accept any interference, including interference that may cause undesired operation of the device.
3. Changes or modifications not expressly approved by the party responsible for compliance could void the user's authority to operate the device.

Reverse Parking Distance Warning (PDW) (if equipped)

Reverse Parking Distance Warning will help warn the driver if a person, an animal or an object is detected within a certain distance when the vehicle is moving in reverse.

Detecting sensor

[1]: Rear ultrasonic sensors



OSP2052437L

Refer to the picture above for the detailed location of the detecting sensors.

Reverse Parking Distance Warning Operation

Parking Safety button



OSP2052440L

- Press Parking Safety (P▲) button to turn Reverse Parking Distance Warning on and off.
- Reverse Parking Distance Warning will turn on automatically when the gear is shifted to R (Reverse).

Reverse Parking Distance Warning settings

Warning Methods



OSP2052299L

You can adjust the Warning Methods with the ignition switch or ENGINE START/ STOP button in the ON position.

- Warning Volume : Select 'User Settings → Driver Assistance → Warning Volume' on the LCD display or 'Settings → Vehicle → Driver Assistance → Warning Methods' on the Infotainment system.

* NOTICE

- Ensure that Warning Methods you have set may apply to the Warning volume of other Driver Assistance systems.
- Warning Methods will maintain its last setting even if the vehicle is restarted.
- The setting menu may not be available for your vehicle depending on



the vehicle features and specifications.

Operation of Reverse Parking Distance Warning

Reverse Parking Distance Warning

Reverse Parking Distance Warning will operate under the following conditions.

- Shift the gear to R (Reverse).

Distance from object	Warning indicator	Warning sound
60-120 cm (24-48 in)		Buzzer beeps intermittently
30-60 cm (12-24 in)		Beeps more frequently
within 30 cm (12 in)		Beeps continuously

Reverse Parking Distance Warning Malfunction and Precautions

Reverse Parking Distance Warning malfunction

After starting the vehicle, a beep will sound once when the gear is shifted to R (Reverse) to indicate Reverse Parking Distance Warning is operating normally. However, if one or more of the following occurs, first check whether the ultrasonic sensor is damaged or blocked with foreign material. If it still does not work properly, Kia recommends visiting an authorized Kia dealer.

- The audible warning does not sound.
- The buzzer sounds intermittently.

- The warning message appears on the cluster.



Limitations of Reverse Parking Distance Warning

Reverse Parking Distance Warning may not operate normally when:

- Moisture is frozen to the sensor (Reverse Parking Distance Warning will operate normally when it is melted.)
- Sensor is covered with foreign material, such as snow or water (Reverse Parking Distance Warning will operate normally when such foreign material are removed.)
- The weather is extremely hot or cold
- The sensor or sensor assembly is disassembled

- The surface of the sensor is pressed hard or an impact is applied with a hard object
- The surface of the sensor is scratched with a sharp object
- The sensors or its surrounding area is directly sprayed with high pressure washer

Reverse Parking Distance Warning may malfunction when:

- Heavy rain or water spray is present
- Water flows on the surface of the sensor
- Affected by another vehicle's sensors
- The sensor is covered with snow
- Driving on uneven road, gravel roads or bushes
- Objects that generates ultrasonic waves are near the sensor
- Installing the license plate differently from the original location
- The vehicle bumper height or ultrasonic sensor installation has been modified
- Attaching equipments or accessories around the ultrasonic sensors

The following objects may not be detected:

- Sharp or slim objects, such as ropes, chains or small poles.
- Objects, which tend to absorb sensor frequency, such as clothes, spongy material or snow.
- Objects smaller than 100 cm (40 in) in length and narrower than 14 cm (6 in) in diameter.
- Pedestrians, animals or objects that are very close to the ultrasonic sensors

WARNING

- Reverse Parking Distance Warning is a supplemental function. The operation of Reverse Parking Distance Warning can be affected by several factors (including environmental conditions). It is the responsibility of the driver to always check the rear view before and while parking.
- Your vehicle warranty does not cover any accidents or damage to the vehicle due to the malfunction of Reverse Parking Distance Warning.
- Pay close attention when driving near objects, pedestrians, and especially children. Some objects may not be detected by the ultrasonic sensors, due to the objects distance, size material, all of which can limit the effectiveness of the sensor.
- Parking Distance Warning indicator may not occur sequentially depending on vehicle speed or obstacle shape.
- If Reverse Parking Distance Warning needs repair, Kia recommends visiting an authorized Kia dealer.

Forward/Reverse Parking Distance Warning (PDW) (if equipped)

Forward/Reverse Parking Distance Warning will help warn the driver if a person, an animal or an object is detected within a certain distance from the ultrasonic sensors when the vehicle is moving forward or in reverse.

[1]: Front ultrasonic sensors



[2]: Rear ultrasonic sensors



Refer to the picture above for the detailed location of the detecting sensor.

Forward/Reverse Parking Distance Warning Settings

Warning Methods



You can adjust the Warning Methods with the ignition switch or ENGINE START/ STOP button in the ON position.

- Warning Volume : Select 'User Settings → Driver Assistance → Warning Volume' on the LCD display or 'Settings → Vehicle → Driver Assistance → Warning Methods' on the Infotainment system.

* NOTICE

- Ensure that Warning Methods you have set may apply to the Warning volume of other Driver Assistance systems.
- Warning Methods will maintain its last setting even if the vehicle is restarted.
- The setting menu may not be available for your vehicle depending on the vehicle features and specifications.

Parking Distance Warning Auto On

You can set the Parking Distance Warning to be ON at low speeds. To use Parking Distance Warning Auto On function, select 'User Settings → Driver Assistance → Parking Safety → Parking Distance Warning Auto On' on the LCD display or 'Settings → Vehicle → Driver Assistance → Parking Safety → Parking Distance Warning Auto On' on the infotainment system with the Engine ON.

Forward/Reverse Parking Distance Warning Operation

Parking Safety button



- When Forward/Reverse Parking Distance Warning is off (button indicator light off), if you shift the gear to R (Reverse), Forward/Reverse Parking Distance Warning will automatically turn on.
- If you shift the gear to R (Reverse), Forward/Reverse Parking Distance Warning will not turn off even if you press the Parking Safety (P) button for your safety.

Forward Parking Distance Warning

Forward Parking Distance Warning will operate when one of the condition is satisfied.

- The gear is shifted from R (Reverse) to D (Drive)
- The gear is in D (Drive) and the Parking Safety (P) button indicator light is on
- Parking Distance Warning Auto On is selected from the Settings menu and the gear is in D (Drive)
- This function warns when Parking Distance Warning Auto On is selected and the gear is in D (Drive).

('User Settings → Driver Assistance → Parking Safety → Parking Distance Warning Auto On' on the LCD display or 'Settings → Vehicle → Driver Assistance → Parking Safety → Parking Distance Warning Auto On' on the infotainment system)

- Vehicle speed is below 10 km/h (6 mph)

*** NOTICE**

- Forward Parking Distance Warning does not operate when the vehicle's forward speed is above 10 km/h (6 mph) even when the function is on (Parking Safety button indicator is on). Forward Parking Distance Warning will operate again when the vehicle's forward speed decreases below 10 km/h (6 mph).
- When the vehicle's forward speed is above 30 km/h (18 mph), the Forward Parking Distance Warning will turn off (Parking Safety button indicator off). Although you drive below 10 km/h (6 mph) again, Forward Parking Distance Warning will not automatically turn on.

- Distance from object may be detected differently when obstacles are not located in front of the sensor.
- The shape of the indicator in the illustration may differ from the actual vehicle.



Reverse Parking Distance Warning



Reverse Parking Distance Warning will operate when one of the condition is satisfied.

- The gear is shifted to R (Reverse).

*** NOTICE**

When the vehicle's rearward speed is below 10 km/h (6 mph), both the front and rear ultrasonic sensors will detect objects. However, the front ultrasonic sensors can detect a person, animal or object when it is within 60 cm (24 in) from the sensors.

Distance from object	Warning indicator	Warning sound
60-100 cm (24-40 in)		Buzzer beeps intermittently
30-60 cm (12-24 in)		Beeps more frequently
within 30 cm (12 in)		Beeps continuously

Distance from object	Warning indicator	Warning sound
60-120 cm (24-48 in)		Buzzer beeps intermittently
30-60 cm (12-24 in)		Buzzer beeps frequently
within 30 cm (12 in)		Buzzer beeps continuously

- The corresponding indicator will appear on the cluster or infotainment system screen whenever each ultrasonic sensor detects a person, animal or object in its sensing range. Also an audible warning will sound.
- When more than two objects are detected at the same time, the closest one will be warned with an audible warning.

- The corresponding indicator will appear on the cluster or infotainment system screen whenever each ultrasonic sensor detects a person, animal or object in its sensing range. Also an audible warning will sound.
- When more than two objects are detected at the same time, the closest

one will be warned with an audible warning.

- Distance from object may be detected differently when obstacles are not located in front of the sensor.
- The shape of the indicator in the illustration may differ from the actual vehicle.

Forward/Reverse Parking Distance Warning malfunction and precautions

Forward/Reverse Parking Distance Warning malfunction

After starting the vehicle, a beep will sound once when the gear is shifted to R (Reverse) to indicate Forward/Reverse Parking Distance Warning is operating normally.

However, if one or more of the following occurs, first check whether the ultrasonic sensor is damaged or blocked with foreign material. If it still does not work properly, Kia recommends visiting an authorized Kia dealer.

- The audible warning does not sound.
- The buzzer sounds intermittently.
- The warning message appears on the cluster.

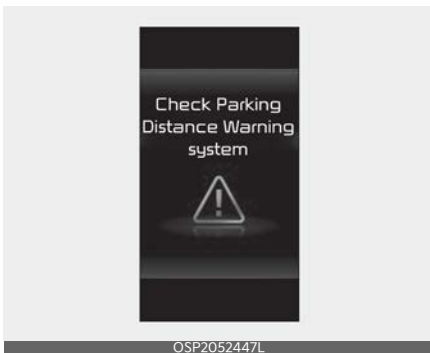

Limitations of Forward/Reverse Parking Distance Warning

Forward/Reverse Parking Distance Warning may not operate normally when:

- Moisture is frozen to the sensor (Forward/Reverse Parking Distance Warning will operate normally when it is melted.)
- Sensor is covered with foreign material, such as snow or water (Forward/Reverse Parking Distance Warning will operate normally when such foreign material are removed.)
- The weather is extremely hot or cold
- The sensor or sensor assembly is disassembled
- The surface of the sensor is pressed hard or an impact is applied with a hard object
- The surface of the sensor is scratched with a sharp object
- The sensors or its surrounding area is directly sprayed with high pressure washer

Forward/Reverse Parking Distance Warning may malfunction when:

- Heavy rain or water spray is present
- Water flows on the surface of the sensor

- Affected by another vehicle's sensors
- The sensor is covered with snow
- Driving on uneven road, gravel roads or bushes
- Objects that generates ultrasonic waves are near the sensor
- Installing the license plate differently from the original location
- The vehicle bumper height or ultrasonic sensor installation has been modified
- Attaching equipments or accessories around the ultrasonic sensors

The following objects may not be detected:

- Sharp or slim objects, such as ropes, chains or small poles.
- Objects, which tend to absorb sensor frequency, such as clothes, spongy material or snow.
- Objects smaller than 100 cm (40 in) in length and narrower than 14 cm (6 in) in diameter.
- Pedestrians, animals or objects that are very close to the ultrasonic sensors

WARNING

Forward/Reverse Parking Distance Warning is a supplemental function. The operation of Forward/Reverse Parking Distance Warning can be affected by several factors (including environmental conditions). It is the responsibility of the driver to always check the front and rear views before and while parking.

- Your vehicle warranty does not cover any accidents or damage to the vehicle due to the malfunction of Forward/Reverse Parking Distance Warning.
- Pay close attention when driving near objects, pedestrians, and especially children. Some objects may not be detected by the ultrasonic sensors, due to the objects distance, size or material, all of which can limit the effectiveness of the sensor.
- Parking Distance Warning indicator may not occur sequentially depending on vehicle speed or obstacle shape.
- If Forward/Reverse Parking Distance Warning needs repair, Kia recommends visiting an authorized Kia dealer.

Declaration of conformity

The radio frequency components (Front radar) (if equipped) complies:

For United States and United States territories



FCC ID : 2A30Z-MRR20
This device complies with Part 15 of the FCC Rules. Operation is subject to the following two conditions:
(1) this device may not cause harmful interference, and
(2) this device must accept any interference received, including interference that may cause undesired operation.

CAUTION TO USERS
Changes or modifications not expressly approved by the party responsible for compliance could void the user's authority to operate the equipment.

OSP2052513L

The radio frequency components (Rear corner radar) (if equipped) complies:

For United States and United States territories



OYB060040L

This device complies with Part 15 of the FCC Rules. Operation is subject to the following two conditions:

- (1) this device may not cause harmful interference, and
- (2) this device must accept any interference received, including interference that may cause undesired operation.

CAUTION TO USERS

Changes or modifications not expressly approved by the party responsible for compliance could void the user's authority to operate the equipment.

OYB060041L

For Canada

Model: MRR-20
IC: 27992-MRR20

This device complies with Industry Canada licence-exempt RSS standard(s). Operation is subject to the following two conditions:

- (1) this device may not cause interference, and
- (2) this device must accept any interference, including interference that may cause undesired operation of the device.

Le présent appareil est conforme aux CNR d'Industrie Canada applicables aux appareils radio exempts de licence. L'exploitation est autorisée

aux deux conditions suivantes:

- (1) l'appareil ne doit pas produire de brouillage, et
- (2) l'utilisateur de l'appareil doit accepter tout brouillage radioélectrique subi, même si le brouillage est susceptible d'en compromettre le fonctionnement.

OSP2052514L

For Canada

Model: RS4
IC: 2694A – RS4

This device contains licence-exempt transmitter(s)/receiver(s) that comply with Innovation, Science and Economic Development Canada's licence-exempt RSS(s). Operation is subject to the following two conditions:

- (1) This device may not cause interference.
- (2) This device must accept any interference, including interference that may cause undesired operation of the device.;

Le présent appareil est conforme aux CNR d'Industrie Canada applicables aux appareils radio exempts de licence. L'exploitation est autorisée aux deux conditions suivantes:

- (1) l'appareil ne doit pas produire de brouillage, et
- (2) l'utilisateur de l'appareil doit accepter tout brouillage radioélectrique subi, même si le brouillage est susceptible d'en compromettre le fonctionnement.

This equipment complies with ISED radiation exposure limits set forth for an uncontrolled environment. This equipment should be installed and operated with minimum distance of 20 cm between the radiator and your body. This transmitter must not be co-located or operating in conjunction with any other antenna or transmitter.

Cet équipement est conforme aux limites d'exposition aux rayonnements ISED établies pour un environnement non contrôlé. Cet équipement doit être installé et utilisé avec un minimum de 20 cm de distance entre la source de rayonnement et votre corps. Ce transmetteur ne doit pas être placé au même endroit ou utilisé simultanément avec un autre transmetteur ou antenne.

OYB060042L

What to do in an emergency

Road warning	7-2
• Hazard warning flasher.....	7-2
In case of an emergency while driving	7-2
• If the vehicle stalls while driving.....	7-2
• If the engine stalls at a crossroad or crossing.....	7-2
• If you have a flat tire while driving.....	7-2
If the engine will not start	7-3
• If engine doesn't turn over or turns over slowly.....	7-3
• If engine turns over normally but does not start.....	7-3
Emergency starting	7-4
• Jump-starting.....	7-4
• Push-starting.....	7-5
If the engine overheats	7-6
Tire Pressure Monitoring System (TPMS)	7-7
• Effective use of the TPMS.....	7-7
• Low tire pressure telltale.....	7-8
• TPMS malfunction indicator.....	7-9
• Tire replacement with TPMS.....	7-10
• This device complies with Industry Canada licence-exempt RSS standard(s).....	7-11
If you have a flat tire (with spare tire)	7-11
• Jack and tools.....	7-12
• Changing tires.....	7-13
• Important - use of compact spare tire.....	7-18
• Jack label.....	7-20
Towing	7-22
• Towing without wheel dollies when using a towing service.....	7-23
• Using removable towing hook.....	7-23
• Emergency towing.....	7-24

What to do in an emergency

Road warning

When in an emergency situation occurs while driving or when you park by the edge of the roadway, you must alert approaching or passing vehicles to be careful as they pass. For this, you should use the hazard warning flasher.

Hazard warning flasher

The hazard warning flasher serves as a warning to other drivers to exercise extreme caution when approaching, overtaking, or passing your vehicle.

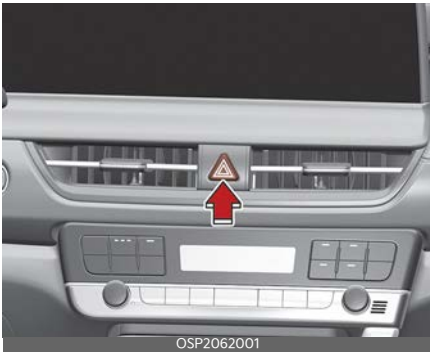

It should be used whenever emergency repairs are being made or when the vehicle is stopped near the edge of a roadway.

Depress the flasher switch with the ENGINE START/STOP button in any position. The flasher switch is located in the center fascia panel. All turn signal lights will flash simultaneously.

- The hazard warning flasher operates whether your vehicle is running or not.
- The turn signals do not work when the hazard flasher is on.
- Care must be taken when using the hazard warning flasher while the vehicle is being towed.

In case of an emergency while driving

If an emergency situation occurs while driving, stay calm and take the following steps.

If the vehicle stalls while driving

1. Reduce your speed gradually, keeping a straight line.
2. Move cautiously off the road to a safe place.
3. Turn on your hazard warning flasher.
4. Try to start the vehicle again. If your vehicle will not start, contact an authorized Kia dealer or seek other qualified assistance.

If the engine stalls at a crossroad or crossing

- If the engine stalls at a crossroad or crossing, set the shift lever in the N (Neutral) position and then push the vehicle to a safe place.

If you have a flat tire while driving

1. Take your foot off the accelerator pedal and let the vehicle slow down while driving straight ahead.
Do not apply the brakes immediately or attempt to pull off the road as this may cause a loss of control.
2. When the vehicle has slowed to such a speed that it is safe to do so, brake carefully and pull off the road.
3. Drive off the road as far as possible and park on firm level ground.

If you are on a divided highway, do not park in the median area between the two traffic lanes.

4. When the vehicle is stopped, turn on your emergency hazard flashers, set

the parking brake and put the transmission in P.

5. Have all passengers get out of the vehicle. Be sure they all get out on the side of the vehicle that is away from traffic.
6. When changing a flat tire, follow the instruction provided later in this section.

If the engine will not start

When the engine doesn't start, first check to see how much fuel there is and whether the battery is discharged.

If engine doesn't turn over or turns over slowly

1. Be sure the shift lever is in N (Neutral) or P (Park) and the emergency brake is set.
2. Check the battery connections to be sure they are clean and tight.
3. Turn on the interior light. If the light dims or goes out when you operate the starter, the battery is discharged.
4. Check the starter connections to be sure they are securely tightened.

Do not push or pull the vehicle to start it. This could cause damage to your vehicle. Refer to "Jump-starting" on page 7-4.

WARNING

Push/pull start

Do not push or pull the vehicle to start it. Push or pull starting may cause the catalytic converter to overload and create a fire hazard.

If engine turns over normally but does not start

1. Check the fuel level.
2. With the ENGINE START/STOP button in the OFF position, check all connectors at the ignition coils and spark plugs. Reconnect any that may be disconnected or loose.
3. Check the fuel line in the engine compartment.
4. If the engine still does not start, call an authorized Kia dealer or seek other qualified assistance.

Emergency starting

When the vehicle will not start because of low battery power, you may need to jump start the vehicle.

Jump-starting

Connect cables in numerical order and disconnect in reverse order.

(Gasoline) 1.6 T-GDi



(Gasoline) 2.0 MPI

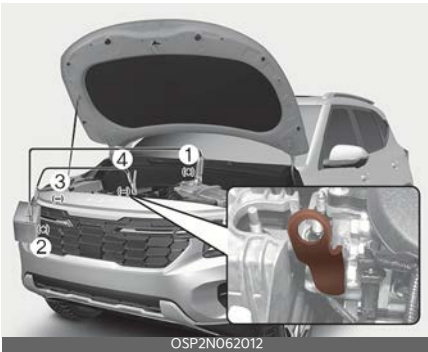

Jump-starting can be dangerous if done incorrectly. Therefore, to avoid harm to yourself or damage to your vehicle or battery, follow these jump-starting procedures. If in doubt, we strongly recommend that you have a competent technician or towing service jump-start your vehicle.

⚠ WARNING

Battery

Never attempt to check the electrolyte level of the battery, as this may cause the battery to rupture or explode.

⚠ WARNING

Frozen batteries

Do not attempt to jump start the vehicle if the discharged battery is frozen, as the battery may rupture or explode.

⚠ WARNING

Battery

Keep all flames or sparks away from the battery. The battery produces hydrogen gas, which will explode if exposed to flame or sparks.

⚠ WARNING

Battery cables

Do not connect the jumper cable from the negative terminal of the booster battery to the negative terminal of the discharged battery, directly. This can cause the discharged battery to overheat and crack or degrade.

Make sure to connect one end of the jumper cable to the negative terminal of the booster battery, and the other end to a metallic point, far away from the battery.

⚠ WARNING

Sulfuric acid risk

Automobile batteries contain sulfuric acid. When jump starting your vehicle, be careful not to get sulfuric acid on yourself, your clothing, or on the vehicle.

This acid is poisonous and highly corrosive.

Jump-starting

1. Make sure the booster battery is 12-volt and that its negative terminal is grounded.

If the booster battery is in another vehicle, do not allow the vehicles to come in contact.

2. Turn off all unnecessary electrical loads.
3. Connect the jumper cables in the exact sequence shown in the illustration.
 - 1) Connect one end of a jumper cable to the positive terminal of the discharged battery (1).
 - 2) Connect the other end to the positive terminal of the booster battery (2).
 - 3) Proceed to connect one end of the other jumper cable to the negative terminal of the booster battery (3), then the other end to a solid, stationary, metallic point away from the battery (4).

Do not allow the jumper cables to contact anything except the correct battery terminals or the correct ground. Do not lean over the battery when making connections.

4. Start vehicle with the booster battery and let it run at 2,000 rpm, then start the vehicle with the discharged battery.

If the cause of your battery discharging is not apparent, you should have your vehicle checked by an authorized Kia dealer.

* NOTICE

Make sure to connect one end of the jumper cable to the negative terminal of the booster battery, and the other end to a metallic point, far away from the battery.

Push-starting

Vehicles equipped with automatic transmission cannot be push-started, and only jump starting can be applied. Follow the directions in this section for "Jump-starting" on page 7-4.

⚠ WARNING

Tow starting vehicle

Never tow a vehicle to start it.

When the engine starts, the vehicle can suddenly surge forward and could cause a collision with the tow vehicle.

If the engine overheats

If your temperature gauge indicates overheating, you experience a loss of power, or hear a loud pinging or knocking, the engine will probably be too hot.

If this happens, you should:

1. Pull off the road and stop as soon as it is safe to do so.
2. Place the shift lever in P and set the parking brake.
3. If the air conditioning is on, turn it off.
4. If engine coolant is running out under the vehicle or steam is coming out from underneath the hood, stop the engine. Do not open the hood until the coolant has stopped running or the steaming has stopped.
5. If there is no visible loss of engine coolant and no steam, leave the engine running and check to be sure the engine cooling fan is operating.
 - 1) If the fan is not running, turn the engine off.
6. Check to see if the water pump drive belt is missing.
 - 1) If it is not missing, check to see that it is tight.
 - 2) If the drive belt seems to be satisfactory, check for coolant leaking from the radiator, hoses or under the vehicle. (If the air conditioning had been in use, it is normal for cold water to be draining from it when you stop).

WARNING

Under the hood



While the engine is running, keep hair, hands and clothing away from moving parts, such as the



fan and drive belts, to prevent injury.

7. If the water pump drive belt is broken or engine coolant is leaking out, stop the engine immediately and call the nearest authorized Kia dealer for assistance.
8. If you cannot find the cause of the overheating, wait until the engine temperature has returned to normal. If coolant has been lost, carefully add coolant to the reservoir to bring the fluid level in the reservoir up to the halfway mark.
9. Proceed with caution, keeping alert for further signs of overheating. If overheating happens again, call an authorized Kia dealer for assistance.

WARNING

Radiator cap



Do not remove the radiator cap when the engine is hot. This may result in coolant being blown out of the opening and cause serious burns.

NOTICE

- Serious loss of coolant indicates there is a leak in the cooling system and this should be checked as soon as possible by an authorized Kia dealer.
- When the engine overheats from low engine coolant, suddenly adding engine coolant may cause cracks in the engine. To prevent damage, add engine coolant slowly in small quantities.

Tire Pressure Monitoring System (TPMS)

The Tire Pressure Monitoring System (TPMS) detects the pressure of vehicle's tires and displays it on the LCD display.



OSP2N052388



OSP2052343L

1. Low tire pressure telltale / TPMS malfunction indicator
2. Low tire pressure position telltale (Shown on the LCD display)

Tire Pressure Indicator

- You can check the tire pressure in the Information (i) mode on the cluster.
 - Refer to "LCD display modes" on page 4-77.
- Tire pressure is displayed 1~2 minutes later after driving.

- If tire pressure is not displayed when the vehicle is stopped, "Drive to display" message displays. After driving, check the tire pressure.
- You can change the tire pressure unit in the user settings mode on the cluster.
 - psi, kPa, bar (Refer to "User Settings mode (if equipped)" on page 4-79).

* NOTICE

- The tire pressure may change due to factors such as parking condition, driving style, and altitude above sea level.
- The tire pressure shown on the dashboard may differ from the tire pressure measured by tire pressure gauge.

Effective use of the TPMS

⚠ WARNING

Over-inflation or under-inflation can reduce tire life, adversely affect vehicle handling, and lead to sudden tire failure that may cause loss of vehicle control resulting in an accident

Each tire, including the spare (if provided), should be checked monthly when cold and inflated to the inflation pressure recommended by the vehicle manufacturer on the vehicle placard or tire inflation pressure label.

(If your vehicle has tires of a different size than the size indicated on the vehicle placard or tire inflation pressure label, you should determine the proper tire inflation pressure for those tires.)

As an added safety feature, your vehicle has been equipped with a tire pressure

monitoring system (TPMS) that illuminates a low tire pressure telltale when one or more of your tires is significantly under-inflated. Accordingly, when the low tire pressure telltale illuminates, you should stop and check your tires as soon as possible, and inflate them to the proper pressure. Driving on a significantly under-inflated tire causes the tire to overheat and can lead to tire failure. Under-inflation also reduces fuel efficiency and tire tread life, and may affect the vehicle's handling and stopping ability.

Please note that the TPMS is not a substitute for proper tire maintenance, and it is the driver's responsibility to maintain correct tire pressure, even if under-inflation has not reached the level to trigger illumination of the TPMS low tire pressure telltale.

Your vehicle has also been equipped with a TPMS malfunction indicator to indicate when the system is not operating properly. The TPMS malfunction indicator is combined with the low tire pressure telltale. When the system detects a malfunction, the telltale will flash for approximately one minute and then remain continuously illuminated. This sequence will continue upon subsequent vehicle start-ups as long as the malfunction exists. When the malfunction indicator is illuminated, the system may not be able to detect or signal low tire pressure as intended. TPMS malfunctions may occur for a variety of reasons, including the installation of replacement or alternate tires or wheels on the vehicle that prevent the TPMS from functioning properly.

Always check the TPMS malfunction telltale after replacing one or more tires or wheels on your vehicle to ensure that

the replacement or alternate tires and wheels allow the TPMS to continue to function properly.

*** NOTICE**

If any of the below happens, have the system checked by an authorized Kia dealer.

1. The low tire pressure telltale/TPMS malfunction indicator does not appear for 3 seconds when the ENGINE START/STOP button is turned to the ON position or engine is running.
2. The TPMS malfunction indicator remains illuminated after blinking for approximately 1 minute.
3. The Low tire pressure position telltale remains illuminated.

Low tire pressure telltale (!)

Low tire pressure position telltale

When the TPMS warning indicators are illuminated, one or more of your tires is significantly under-inflated.



If the telltale illuminates, immediately reduce your speed, avoid hard cornering and anticipate increased stopping distances. You should stop and check your tires as soon as possible.

Inflate the tires to the proper pressure as indicated on the vehicle's placard or tire inflation pressure label located on the driver's side center pillar outer panel. If you cannot reach a service station or if the tire cannot hold the newly added air, replace the low pressure tire with the spare tire.

Then the TPMS malfunction indicator and the Low Tire Pressure telltale may turn on and illuminate after restarting and about 20 minutes of continuous driving before you have the low pressure tire repaired and replaced on the vehicle.

In winter or cold weather, the low tire pressure telltale may be illuminated if the tire pressure was adjusted to the recommended tire inflation pressure in warm weather. It does not mean your TPMS is malfunctioning because the decreased temperature leads to a proportional lowering of tire pressure.

You should check the tire inflation pressure and adjust the tires to the recommended tire inflation pressure when driving your vehicle in the following conditions.

- from a warm area to a cold area
- from a cold area to a warm area
- the outside temperature is extremely high or low

When filling tires with more air, conditions to turn off the low tire pressure telltale may not be met. This is because a tire inflator has a margin of error in performance. The low tire pressure telltale will be turned off if the tire pressure is above the recommended tire inflation pressure.

WARNING

Low pressure damage

Do not drive on low pressure tires. Significantly low tire pressure can cause the tires to overheat and fail, making the vehicle unstable, resulting in increased braking distances and a loss of vehicle control.

TPMS malfunction indicator

The low tire pressure telltale will illuminate after it blinks for approximately one minute when there is a problem with the TPMS.

If the system is able to correctly detect an underinflation warning at the same time as system failure, it will illuminate both the TPMS malfunction and the low tire pressure position telltales. For example, if the Front Left sensor fails, the TPMS malfunction indicator illuminates, but if the Front Right, Rear Left, or Rear Right tire is underinflated, the low tire pressure position telltales may illuminate together with the TPMS malfunction indicator.

Have the system checked by an authorized Kia dealer as soon as possible to determine the cause of the problem.

- The TPMS malfunction indicator may be illuminated if the vehicle is moving around electric power supply cables or radios transmitters such as at police stations, government and public offices, broadcasting stations, military installations, airports, or transmitting towers, etc. This can interfere with normal operation of the TPMS.
- The TPMS malfunction indicator may illuminate if the vehicle is equipped with snow chains or some personal

electronic devices (such as a laptop computer, mobile charger, remote starter or navigation) are being used in the vehicle. This can interfere with normal operation of the TPMS.

Tire replacement with TPMS

If you have a flat tire, the Low Tire Pressure telltale will come on. Have the flat tire repaired by an authorized Kia dealer as soon as possible or replace the flat tire with the spare tire.

CAUTION

Repair Agents

Never use a puncture-repairing agent not approved by Kia to repair and/or inflate a low pressure tire. Sealant that is not approved by Kia may damage the tire pressure sensor.

Each wheel is equipped with a tire pressure sensor mounted inside the tire behind the valve stem. You must use TPMS specific wheels. Have always your tires serviced by an authorized Kia dealer.

Even if you replace the low pressure tire with the spare tire, the Low Tire Pressure telltale will remain on until the low pressure tire is repaired and placed on the vehicle.

After you replace the low pressure tire with the spare tire, the TPMS malfunction indicator may illuminate after a few minutes. This is because the TPMS sensor mounted on the spare wheel is not yet activated.

Once the low pressure tire is inflated again to the recommended pressure and installed on the vehicle or the TPMS sensor mounted on the replaced spare wheel is initiated by an authorized Kia dealer, the TPMS malfunction indicator

and the low tire pressure telltale will turn off within a few minutes of driving.

If the indicator has not disappeared after a few minutes of driving, please visit an authorized Kia dealer.

If an original mounted tire is replaced with the spare tire, the TPMS sensor on the replaced spare wheel should be initiated and the TPMS sensor on the original mounted wheel should be deactivated. If the TPMS sensor on the original mounted wheel located in the spare tire carrier still activates, the Tire Pressure Monitoring System may not operate properly. Have the tire with TPMS serviced or replaced by an authorized Kia dealer.

You may not be able to identify a low tire by simply looking at it. Always use a good quality tire pressure gauge to measure the tire's inflation pressure. Please note that a tire that is hot (from being driven) will have a higher pressure measurement than a tire that is cold (from sitting stationary for at least 3 hours and driven less than 1.6 km (1 mile) during that 3 hour period).

Allow the tire to cool before measuring the inflation pressure. Always be sure the tire is cold before inflating to the recommended pressure.

A cold tire means the vehicle has been sitting for 3 hours and driven for less than 1.6 km (1 mile) in that 3 hour period.

Never use tire sealant if your vehicle is equipped with a TPMS. The liquid sealant can damage the tire pressure sensors.

- The TPMS cannot alert you to severe and sudden tire damage caused by external factors such as nails or road debris.

- If you feel any vehicle instability, immediately take your foot off the accelerator, apply the brakes gradually and with light force, and slowly move to a safe position off the road.

*** NOTICE**

Protecting TPMS

Tampering with, modifying, or disabling the Tire Pressure Monitoring System (TPMS) components may interfere with the system's ability to warn the driver of low tire pressure conditions and/or TPMS malfunctions. Tampering with, modifying, or disabling the Tire Pressure Monitoring System (TPMS) components may void the warranty for that portion of the vehicle.

This device complies with Industry Canada licence-exempt RSS standard(s).

Operation is subject to the following conditions:

1. This device may not cause interference, and
2. This device must accept any interference, including interference that may cause undesired operation of the device.
3. Changes or modifications not expressly approved by the party responsible for compliance could void the user's authority to operate the device.

If you have a flat tire (with spare tire)

If you have a flat tire, you can change the flat tire to a spare tire using tools.

⚠ WARNING

Driving on a flat tire will cause permanent damage to the tire. Re-inflating a tire after it has been driven on while severely underinflated or flat may cause a blowout and a serious crash. Never attempt to re-inflate a tire that has been driven on while severely underinflated or flat. In this case, repair or replace the flat tire as soon as possible.

⚠ WARNING

Changing a tire can be dangerous. Follow the instructions in this section when changing a tire to reduce the risk of serious injury or death.

⚠ CAUTION

Be careful as you use the jack handle to stay clear of the flat end. The flat end has sharp edges that could cause cuts.

Jack and tools (if equipped)



1. Jack handle
2. Jack
3. Wheel lug nut wrench

The jack and tools are stored in the luggage side trim.

Remove the tray cover indicated in the illustration.

Jacking instructions

The jack is provided for emergency tire changing only.

- To prevent the jack from "rattling" while the vehicle is in motion, store it properly.
- Follow jacking instructions to reduce the possibility of personal injury.

⚠ WARNING

Changing tires

- Never attempt vehicle repairs in the traffic lanes of a public road or highway.
- Always move the vehicle completely off the road and onto the shoulder before trying to change a tire. The jack should be used on firm level ground. If you cannot find a firm level place off the road, call a towing service company for assistance.

- Be sure to use the correct front and rear jacking positions on the vehicle; never use the bumpers or any other part of the vehicle for jacking support.
- The vehicle can roll off the jack causing serious injury or death.
- Do not go under a vehicle that is supported by a jack.
- Do not start or run the engine while the vehicle is on the jack.
- Do not allow anyone to remain in the vehicle while it is on the jack.
- Make sure any children present are in a secure place, away from the road and from the vehicle to be raised with the jack.

⚠ WARNING

Tire jack

Do not place any portion of your body under a vehicle that is only supported by a jack since the vehicle can easily roll off the jack. Use vehicle support stands.

⚠ WARNING

Changing tires

Never attempt vehicle repairs in the traffic lanes of a public road or highway.

⚠ WARNING

Running vehicle on jack

Do not start or run the engine of the vehicle while the vehicle is on the jack as this may cause the vehicle to fall off the jack.

To prevent the jack from "rattling" while the vehicle is in motion, store it properly.

*** NOTICE**

Retreaded tires

Substantial design variations and the age of the retreaded tire casing structure can limit service life and have negative impact on road safety.

Removing and storing the spare tire



- Turn the tire hold-down wing bolt counterclockwise to remove.
- Store the tire in the reverse order of removal.
- To prevent the spare tire and tools from "rattling" while the vehicle is in motion, store them properly.

⚠ WARNING

Touching surface of the luggage room floor

Do not touch the metal surface of the luggage room floor while the engine is operating or hot. Doing so could result in serious bodily injury.

Turn the engine off and wait until it cools down or wear gloves to remove the spare tire from the luggage room.

If it is hard to loosen the tire hold-down wing bolt by hand, you can loosen it easily using the jack handle.



- Put the jack handle (1) inside of the tire hold-down wing bolt.
- Turn the tire hold-down wing bolt counterclockwise with the jack handle. Use caution when utilizing the sharp jack handle.

Changing tires

⚠ WARNING

A vehicle can slip or roll off of a jack causing serious injury or death to you or those nearby. Take the following safety precautions:

- Never place any portion of your body under a vehicle that is supported by a jack.
- NEVER attempt to change a tire in the lane of traffic. ALWAYS move the vehicle completely off the road on level, firm ground away from traffic before trying to change a tire. If you cannot find a level, firm place off the road, call a towing service for assistance.
- Be sure to use the jack provided with the vehicle.

- ALWAYS place the jack on the designated jacking positions on the vehicle and NEVER on the bumpers or any other part of the vehicle for jacking support.
- Do not start or run the engine while the vehicle is on the jack.
- Do not allow anyone to remain in the vehicle while it is on the jack.
- Keep children away from the road and the vehicle.

1. Park on a level surface and apply the parking brake firmly.
2. Place the transmission shift lever in P (Park).
3. Activate the hazard warning flashers.



4. Remove the wheel lug nut wrench, jack and spare tire from the vehicle.



5. Block both the front and rear of the wheel that is diagonally opposite from the jack position.

⚠ WARNING

Jack location

To reduce the possibility of injury, be sure to only use the jack provided with the vehicle in the correct jack position; never use any other part of the vehicle for jack support.

⚠ WARNING

Changing a tire

- To prevent vehicle movement while changing a tire, always set the parking brake fully, and always block the wheel diagonally, opposite the wheel being changed.
- We recommend that the wheels of the vehicle be blocked, and that no person remain in a vehicle that is being jacked.

6. Loosen the wheel lug nuts counter-clockwise one turn each, but do not remove any nut until the tire has been raised off the ground.



7. Place the jack at the front (1) or rear (2) jacking position closest to the tire you are changing. Place the jack at the designated locations under the frame. The jacking positions are plates welded to the frame with two tabs and a raised dot to line up with the jack.

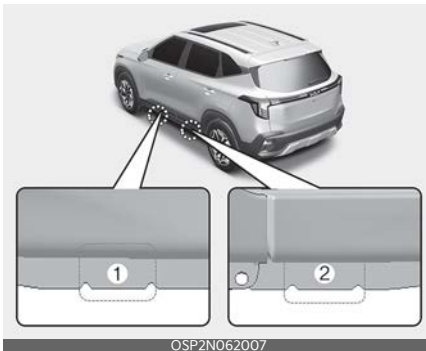
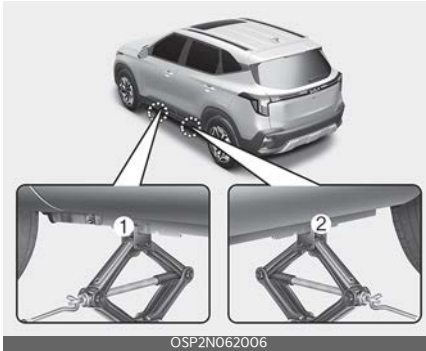

8. Insert the wheel lug nut wrench into the jack and turn it clockwise, raising the vehicle until the tire just clears the ground. This measurement is approximately 1 in (25 mm).



Before removing the wheel lug nuts, make sure the vehicle is stable and that there is no chance for movement or slippage.

9. Loosen the wheel nuts and remove them with your fingers.
10. Slide the wheel off the studs and lay it flat so it cannot roll away.
11. To put the wheel on the hub, pick up the spare tire, line up the holes with the studs and slide the wheel onto them. If this is difficult, tip the wheel slightly and get the top hole in the wheel lined up with the top stud.
12. Jiggle the wheel back and forth until the wheel can slide over the other studs.

Wheels may have sharp edges. Handle them carefully to avoid possible severe injury. Before putting the wheel into place, be sure that there is nothing on the hub or wheel (such as mud, tar, gravel, etc.) that prevents the wheel from fitting solidly against the hub.

⚠ WARNING

Installing a wheel

- When you install a wheel, always remove any corrosion, dirt or foreign materials present on the mounting surfaces of the wheel or the surface of the wheel hub, brake drum or brake disc that contacts the wheel. Make sure to secure any fasteners that attach the rotor to the hub so they do not interfere with the mounting surfaces of the wheel. Installing wheels without correct metal-to-metal contact at the wheel mounting surfaces can cause the wheel nuts to loosen and the wheel to come off while your vehicle is in motion, resulting in loss of vehicle control, personal injury or death.
- Make sure the wheel makes good contact with the hub when installed. If the contact of the mounting surface between the wheel and hub is not good, the wheel nuts could come loose and cause the loss of a wheel. Loss of a wheel may result in loss of control of the vehicle.

⚠ WARNING

Wheel covers will not fit on the vehicle's compact spare. If you try to put a wheel cover on the compact spare, the cover or the spare could be damaged.

13. To install the wheel, hold it on the studs, put the wheel nuts on the studs and tighten them finger tight.
14. Jiggle the tire to be sure it is completely seated, then tighten the nuts as much as possible with your fingers again.

15. Insert the wrench into the jack and lower the vehicle to the ground by turning the wheel nut wrench counterclockwise.
16. Position the wrench as shown in the drawing and tighten the wheel nuts. Be sure the socket is seated completely over the nut. Do not stand on the wrench handle or use an extension pipe over the wrench handle.
17. Go around the wheel, tightening every nut following the numerical sequence shown in the image until they are all tight. Double-check each nut for tightness.



18. After changing wheels, have an authorized Kia dealer tighten the wheel nuts to their proper torque as soon as possible.
19. To prevent the jack, wheel lug nut wrench and spare tire from rattling while the vehicle is in motion, store them properly.
20. Check the inflation pressures as soon as possible after installing the spare tire. Adjust it to the specified pressure, if necessary. Refer to "Tires and wheels" on page 9-5.

Wheel nut tightening torque:

79~94 lbf-ft (11~13 kgf-m)

If you have a tire gauge, remove the valve cap and check the air pressure. If the pressure is lower than recommended, drive slowly to the nearest service station and inflate to the correct pressure. If it is too high, adjust it until it is correct. Always reinstall the valve cap after checking or adjusting the tire pressure. If the cap is not replaced, dust and dirt may get into the tire valve and air may leak from the tire. If you lose a valve cap, buy another and install it as soon as possible.

After you have changed the wheels, always secure the flat tire in its place and return the jack and tools to their proper storage locations.

⚠ CAUTION**Reusing lug nuts**

Make certain during wheel removal that the same nuts that were removed are reinstalled - or, if replaced, that nuts with metric threads and the same chamfer configuration are used. Your vehicle has metric threads on the wheel studs and nuts. Installation of a non-metric thread nut on a metric stud will not secure the wheel to the hub properly and will damage the stud so that it must be replaced.

Note that most lug nuts do not have metric threads. Be sure to use extreme care in checking for thread style before installing aftermarket lug nuts or wheels. If in doubt, consult an authorized Kia dealer.

⚠ WARNING**Wheel studs**

If the studs are damaged, they may lose their ability to retain the wheel. This could lead to the loss of the wheel and a collision resulting in serious injuries.

⚠ WARNING

Never use oil or grease on bolts or nuts because the nuts might come loose. The vehicle's wheel could fall off, causing a crash.

Important - use of compact spare tire

Your vehicle is equipped with a compact spare tire. This compact spare tire takes up less space than a regular-size tire. This tire is smaller than a conventional tire and is designed for temporary use only.

- You should drive carefully when the compact spare is in use. The compact spare should be replaced by the proper conventional tire and rim at the first opportunity.
- The operation of this vehicle is not recommended with more than one compact spare tire in use at the same time.

WARNING

Spare tire

The compact spare tire is for emergency use only. Do not operate your vehicle on this compact spare at speeds over 80 km/h (50 mph). The original tire should be repaired or replaced as soon as possible to avoid failure of the spare, possibly leading to bodily injury or death.

The compact spare should be inflated to 420 kPa (60 psi).

NOTICE

Check the inflation pressure after installing the spare tire. Adjust it to the specified pressure, as necessary.

When using a compact spare tire, observe the following precautions:

- Ensure that you drive slowly enough for the road conditions to avoid all hazards. Any road hazard, such as a pothole or debris, could seriously damage the compact spare.
- Any continuous road use of this tire could result in tire failure, loss of vehicle control, and possible personal injury.
- Do not exceed the vehicle's maximum load rating or the load-carrying capacity shown on the sidewall of the compact spare tire.
- Avoid driving over obstacles. The compact spare tire diameter is smaller than the diameter of a conventional tire and reduces the ground clearance approximately 1 in (25 mm), which could result in damage to the vehicle.
- Do not take this vehicle through an automatic vehicle wash while the compact spare tire is installed.
- Do not use the compact spare tire on any other vehicle because this tire has been designed especially for your vehicle.
- The compact spare tire's tread life is shorter than a regular tire. Inspect your compact spare tire regularly and replace worn compact spare tires with the same size and design, mounted on the same wheel.

- The compact spare tire should not be used on any other wheels, nor should standard tires, snow tires, wheel covers or trim rings be used with the compact spare wheel. If such use is attempted, damage to these items or other vehicle components may occur.
- Do not use more than one compact spare tire at a time.
- Do not tow a trailer while the compact spare tire is installed.
- Do not suddenly accelerate or decelerate (0 ↔ 40 km/h) (0 ↔ 25 mph) in any driving mode. It may cause leakage of transfer oil.
- When using the compact spare tire be sure to turn off the AWD Lock/AWD Auto Lock mode in the vehicle.

Jack label (if equipped)

	Model : 000 1		<p>DATE OF MANUFACTURE (YYYYMMDD)</p> <table border="1"> <tr> <td> 11 12 10 CO., LTD. </td> </tr> </table>	11 12 10 CO., LTD.
	11 12 10 CO., LTD.			
2 kg max. 0000 kg	3 (P) 4 5 6 7 8 9 10			

OSP2062063L

	2 kg Max. 1 0000 kg	00000000	<p>DATE OF MANUFACTURE (YYYYMMDD)</p> <table border="1"> <tr> <td> 11 12 10 CO., LTD. </td> </tr> </table>	11 12 10 CO., LTD.
	11 12 10 CO., LTD.			
4 3 (P) 8 P R	5 6 7 9 12 REPRESENTATIVE : 000000000000			

OSP2062064L

●MAX. WEIGHT 0000kg(0000 lb) ●USE ONLY TO SPECIFIED CAR(지정 차량에만 사용할 것) ●CARGA MAXIMA 0000kg(0000 lb) ●USELO SOLO PARA EL VEHICULO ESPECIFICADO ●Максимальная использовать только для грузоподъемность 0000kg данного автомобиля ●最大質量 0000kg(0000lb), 仅适用于指定车型 ●الوزن الأقصى 0000 كجم - تستخدم فقط للسيارة المحددة			
--	--	--	--

OSP3068045NR

HYUNDAI MOTOR COMPANY	KIA CORPORATION
• THIS JACK FOR USE WITH KIA 0000 MODELS. • TURN OFF IGNITION & SET PARKING BRAKE, PUT GEARSHIFT IN PARK (FOR AUTOMATIC) OR IN REVERSE GEAR (FOR MANUAL TRANSMISSION). THE VEHICLE OWNER'S MANUAL SHOULD BE CONSULTED FOR JACKING AND TYRE CHANGING INSTRUCTIONS (INCLUDING WHEEL JACKING POSITIONS) PRIOR TO THE JACKING OF VEHICLE. • THE JACK SHOULD BE USED ON LEVEL FIRM GROUND WHEREVER POSSIBLE. • IT IS RECOMMENDED THAT THE WHEELS OF THE VEHICLE BE CHOCKED AND THAT NO PERSON SHOULD REMAIN IN THE VEHICLE THAT IS BEING JACKED.	
WARNING : DO NOT GET UNDER A VEHICLE THAT IS SUPPORTED BY A JACK.	

OSP2052213L

* The actual jack label in the vehicle may differ from the illustration. For more detailed specifications, refer to the label attached to the jack.

1. Model Name
2. Maximum allowable load
3. When using the jack, set your parking brake.
4. When using the jack, stop the engine.
5. Do not get under a vehicle that is supported by a jack.
6. The designated locations under the frame
7. When supporting the vehicle, the base plate of jack must be vertical under the lifting point.

8. Move the shift lever to the P position on vehicles with intelligent variable transmission.
9. The jack should be used on firm level ground.
10. Jack manufacturer
11. Production date
12. Representative company and address

Towing

If emergency towing is necessary, have it done by an authorized Kia dealer or a commercial tow-truck service.

Towing service

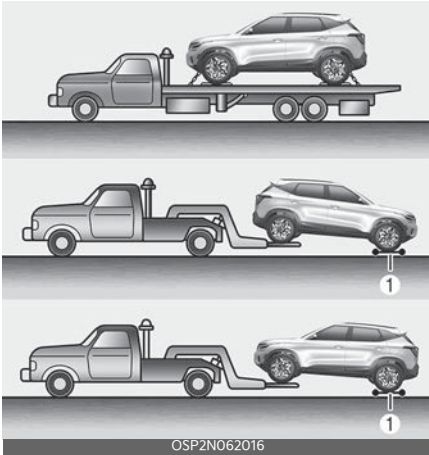

1. dollies

Proper lifting and towing procedures are necessary to prevent damage to the vehicle. The use of wheel dollies (1) or flatbed is recommended.

On Front Wheel Drive (FWD) vehicles, it is acceptable to tow the vehicle with the rear wheel on the ground (without dollies) and the front wheels off the ground. If any of the loaded wheels or suspension components are damaged or the vehicle is being towed with the front wheels on the ground, use a towing dolly under the front wheels. When being towed by a commercial tow truck and wheel dollies are not used, the front of the vehicle should always be lifted, not the rear.

On All Wheel Drive (AWD) vehicles, your vehicle must be towed with a wheel lift and dollies or flatbed equipment with all the wheels off the ground.

⚠ CAUTION

An AWD vehicle should never be towed with the wheels on the ground. This can cause serious damage to the transmission or the AWD system.

⚠ WARNING

Side and curtain Air bag

If your vehicle is equipped with side and curtain air bag, set the ENGINE START/STOP button to ACC position when the vehicle is being towed.

The side and curtain air bag may deploy when the ENGINE START/STOP button to ON position and the rollover sensor detects the situation as a rollover.

* NOTICE

If the EPB does not release normally, take your vehicle to an authorized Kia dealer by loading the vehicle on a flatbed tow truck and have the system checked.

⚠ CAUTION

Towing





- Do not tow the vehicle backwards with the front wheels on the ground, as this may cause damage to the transmission.
- Do not tow with sling-type equipment. Use wheel lift or flatbed equipment.
- Do not tow the vehicle with four wheels in contact with the ground if it is the vehicle equipped with Intelligent Variable Transmission. Otherwise, the transmission will be seriously damaged. Also, make sure not to tow the vehicle connecting it with other vehicles including camper vans.

⚠ WARNING

- If you tow the vehicle while the front wheels are touching the ground, the vehicle motor may generate electricity and the motor components may be damaged or a fire may occur.
- When a vehicle fire occurs due to the battery, there is a risk of a second fire. Contact the fire department when towing the vehicle.

Towing without wheel dollies when using a towing service

When towing your vehicle in an emergency without wheel dollies:

1. Set the ENGINE START/STOP button to ACC position.
2. Place the transmission shift lever in N (Neutral).
3. Release the parking brake.

⚠ CAUTION

Towing gear position

Failure to shift to N (Neutral) may cause internal damage to the vehicle.

Using removable towing hook (if equipped)

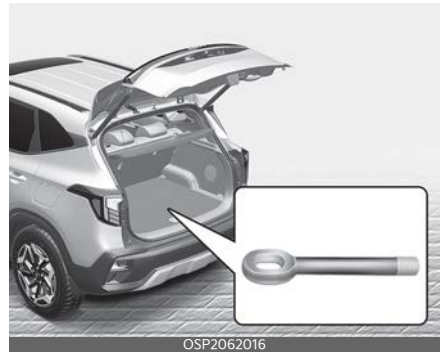

Front

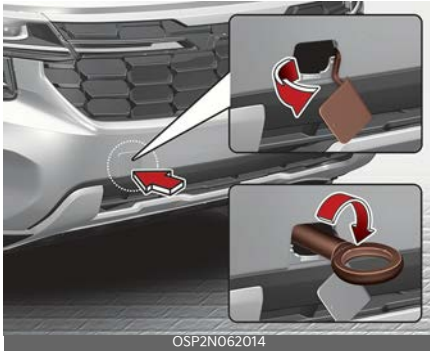

Front

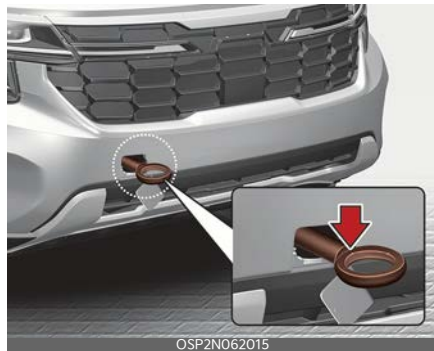

Rear

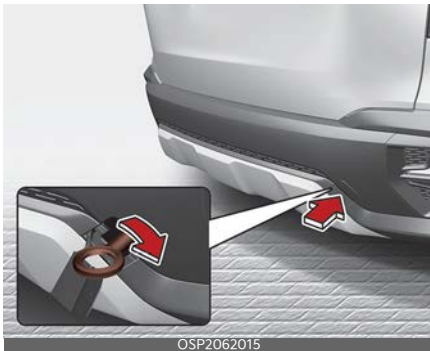

Rear

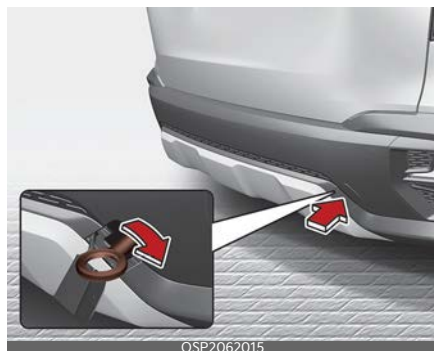

1. Open the liftgate, and remove the towing hook from the tool case.
2. Remove the hole cover pressing the upper part of the cover on the bumper.
3. Install the towing hook by turning it clockwise into the hole until it is fully secured.
4. Remove the towing hook and install the cover after use.

Emergency towing

If towing service is not available in an emergency, your vehicle may be temporarily towed using a cable or chain secured to the emergency towing hook under the front (or rear) of the vehicle.

If towing is necessary, have it done by an authorized Kia dealer or a commercial tow truck service.

Use extreme caution when towing the vehicle. A driver must be in the vehicle to steer it and operate the brakes.

Towing in this manner may be done only on hard-surfaced roads for a short distance and at a low speed. Also, the wheels, axles, power train, steering and brakes must all be in good condition.

- Do not use the tow hooks to pull a vehicle out of mud, sand or other conditions from which the vehicle cannot be driven out under its own power.
- Avoid towing a vehicle heavier than the vehicle doing the towing.

- The drivers of both vehicles should communicate with each other frequently.

⚠ CAUTION

Using a portion of the vehicle other than the tow hooks for towing may damage the body of your vehicle.

- Accelerate or decelerate the vehicle in a slow and gradual manner while maintaining tension on the tow rope or chain to start or drive the vehicle. Otherwise tow hooks and the vehicle may be damaged.
- Attach a towing strap to the tow hook.
- Use only a cable or chain specifically intended for use in towing vehicles. Securely fasten the cable or chain to the towing hook provided.
- Before emergency towing, check if the hook is not broken or damaged.
- Fasten the towing cable or chain securely to the hook.
- Do not jerk the hook. Apply it steadily and with even force.
- To avoid damaging the hook, do not pull from the side or at a vertical angle. Always pull straight ahead.
- Use a towing strap less than 16 ft (5 m) long. Attach a white or red cloth (about 12 in (30 cm) wide) in the middle of the strap for easy visibility.

Front

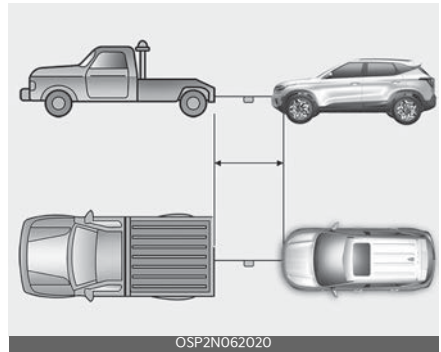

Rear

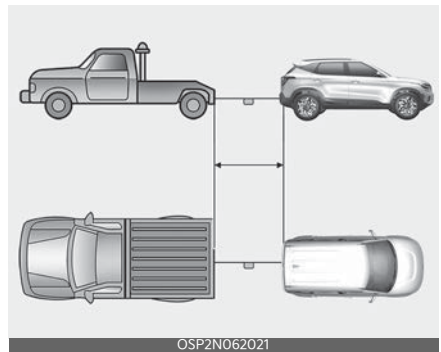

- Drive carefully so that the towing strap is not loosened during towing.
- The driver must be in the vehicle for steering and braking operations when the vehicle is towed and passengers other than the driver must not be allowed to be on board.

⚠ WARNING

Emergency Towing Precautions

Use extreme caution when towing the vehicle.

- Avoid sudden starts or erratic driving maneuvers which would place excessive stress on the emergency towing hook and towing cable or chain. The hook and towing cable or chain may

break and cause serious injury or damage.

- If the disabled vehicle is unable to be moved, do not forcibly continue the towing. Contact an authorized Kia dealer or a commercial tow truck service for assistance.
 - Tow the vehicle as straight ahead as possible.
 - Keep away from the vehicle during towing.
-

Emergency towing precautions

1. Turn the ignition switch to ACC so the steering wheel isn't locked.
2. Release the parking brake.
3. Press the brake pedal with more force than normal since you will have reduced brake performance.
4. More steering effort will be required because the power steering system will be disabled.
5. If you are driving down a long hill, the brakes may overheat and brake performance will be reduced. Stop often and let the brakes cool off.
6. If the car is being towed with all four wheels on the ground, it can be towed only from the front. Be sure that the reduction gear is in neutral. Be sure the steering is unlocked by the ignition switch in the ACC position. A driver must be in the towed vehicle to operate the steering and brakes.
7. To avoid serious damage to the Automatic transmission and Intelligent variable transmission, limit the vehicle speed to 15 km/h (10 mph) and drive less than 1.5 km (1 mile) when towing. (for Automatic transmission and Intelligent variable transmission vehicle)

CAUTION

Automatic transmission (AT)/Intelligent variable transmission (IVT)

Vehicles with Automatic transmission (AT)/Intelligent variable transmission (IVT) can only be towed to by ordinary vehicle when there is no AT/IVT transmission oil leakage. If the vehicle is being towed an ordinary vehicle in the event of oil leakage, the transmission may be damaged. If towing to an ordinary vehicle in the event of oil leakage, the transmission may be damaged.

CAUTION

Automatic transmission/Intelligent variable transmission

- If the car is being towed with all four wheels on the ground, it can be towed only from the front.
Be sure that the transmission is in neutral. Be sure the steering is unlocked by placing the ignition switch in the ACC position. A driver must be in the towed vehicle to operate the steering and brakes.
 - Before towing, check the Automatic transmission/Intelligent variable transmission for fluid leaks under your vehicle. If the Automatic transmission/Intelligent variable transmission fluid is leaking, flatbed equipment or a towing dolly must be used.
-

Engine compartment	8-4
Maintenance services	8-6
Owner maintenance	8-7
Scheduled maintenance service	8-9
Explanation of scheduled maintenance items	8-17
Engine oil and filter	8-20
• Checking the engine oil level.....	8-20
• Changing the engine oil and filter.....	8-21
Engine coolant	8-22
• Checking the coolant level.....	8-24
• Changing the coolant.....	8-25
Brake fluid	8-25
• Checking the brake fluid level.....	8-25
Washer fluid	8-26
• Checking the washer fluid level.....	8-26
Parking brake	8-27
• Checking the parking brake.....	8-27
Air cleaner filter	8-28
• Replacing air cleaner filter.....	8-28
Climate control air filter	8-29
• Inspecting and replacing climate control air filter.....	8-29
Wiper blades	8-30
• Front windshield wiper blade.....	8-31
• Replacing front windshield wiper blade.....	8-31
• Replacing rear window wiper blade.....	8-31
Battery	8-32
Tires and wheels	8-35
• Checking tire inflation pressure.....	8-36

8 Maintenance

• Tire rotation.....	8-36
• Wheel alignment and tire balance	8-37
• Tire replacement	8-37
• Wheel replacement	8-38
• Tire traction	8-38
• Tire maintenance	8-38
• Tire sidewall labeling.....	8-38
• Tire terminology and definitions.....	8-41
• All season tires	8-43
• Summer tires.....	8-43
• Snow tires.....	8-43
• Radial-ply tires	8-43
• Low aspect ratio tire	8-44
Fuses.....	8-45
• Replacing inner panel fuse.....	8-46
• Replacing engine compartment fuse.....	8-47
• Fuse/relay panel description	8-49
Light bulbs	8-59
• Headlamp bulb	8-63
• Headlamp (High/Low)/Turn signal lamp/Position lamp/Daytime running lamp (Bulb type) bulb replacement - Headlamp Type A	8-63
• Headlamp (High/Low)/Turn signal lamp (Bulb type) bulb replacement - Headlamp Type B.....	8-64
• Position lamp/Daytime running lamp (LED type) bulb replacement - Headlamp Type B.....	8-64
• Headlamp (High/Low/Low assist)/Turn signal lamp/Position lamp/Daytime running lamp (LED type) bulb replacement - Headlamp Type C	8-65
• Front fog lamp (Bulb type) bulb replacement	8-65
• Front fog lamp (LED type) bulb replacement	8-66
• Position lamp (auxiliary) (LED type) bulb replacement	8-66

• Side repeater lamp (Bulb type) bulb replacement.....	8-66
• Front side marker lamp (Bulb type) bulb replacement.....	8-67
• Front side marker lamp (LED type) bulb replacement.....	8-67
• Tail and stop lamp/Rear turn signal lamp/Side marker lamp (Bulb type) bulb replacement	8-67
• Tail lamp/Tail and stop lamp/Side marker lamp (LED type) bulb replacement.....	8-68
• Back up lamp (Bulb type) bulb replacement.....	8-68
• High mounted stop lamp (LED type) bulb replacement	8-68
• License plate lamp (Bulb type) bulb replacement	8-69
• Map lamp (Bulb type) bulb replacement	8-69
• Map lamp (LED type) bulb replacement.....	8-70
• Vanity mirror lamp (Bulb type) bulb replacement	8-70
• Room lamp (Bulb type) bulb replacement	8-71
• Room lamp (LED type) bulb replacement.....	8-71
• Glove box lamp (Bulb type) replacement	8-71
• Luggage room lamp (Bulb type) bulb replacement.....	8-72
Appearance care.....	8-72
• Exterior care	8-72
• Interior care	8-76
Emission control system	8-79

Maintenance

Engine compartment

Open the hood to see the engine compartment.

Smartstream G1.6 T-GDi



OSP2N072035

* The actual engine room in the vehicle may differ from the illustration.

1. Engine coolant reservoir
2. Engine oil filler cap
3. Brake fluid reservoir
4. Air cleaner
5. Fuse box
6. Negative battery terminal
7. Positive battery terminal
8. Engine oil dipstick
9. Radiator cap
10. Windshield washer fluid reservoir

(Gasoline) 2.0 MPI



OSP2079088L

* The actual engine room in the vehicle may differ from the illustration.

1. Radiator cap
2. Engine oil filler cap
3. Brake fluid reservoir
4. Air cleaner
5. Fuse box
6. Negative battery terminal
7. Positive battery terminal
8. Engine oil dipstick
9. Engine coolant reservoir
10. Windshield washer fluid reservoir

Maintenance services

You should exercise the utmost care to prevent damage to your vehicle and injury to yourself whenever performing any maintenance or inspection procedures.

Should you have any doubts concerning the inspection or servicing of your vehicle, have an authorized Kia dealer perform this work.

An authorized Kia dealer has factory-trained technicians and genuine Kia parts to service your vehicle properly. For expert advice and quality service, see an authorized Kia dealer.

Inadequate, incomplete or insufficient servicing may result in operational problems with your vehicle that could lead to vehicle damage, an accident, or personal injury.

Owner's responsibility

* NOTICE

Maintenance Service and Record Retention are the owner's responsibility.

You should retain documents that show proper maintenance has been performed on your vehicle in accordance with the scheduled maintenance service charts shown on the following pages. You need this information to establish your compliance with the servicing and maintenance requirements of your vehicle warranties.

Detailed warranty information is provided in your Warranty & Consumer Information manual.

Repairs and adjustments required as a result of improper maintenance or a lack of required maintenance are not covered.

Have your vehicle maintained and repaired by an authorized Kia dealer. Authorized Kia dealers meet Kia's high service quality standards and receive technical support from Kia in order to provide you with a high level of service satisfaction.

Owner maintenance precautions

Improper or incomplete service may result in problems. This section gives instructions only for the maintenance items that are easy to perform.

As explained earlier in this section, several procedures can be done only by an authorized Kia dealer with special tools.

* NOTICE

Improper owner maintenance during the warranty period may affect warranty coverage. For details, read the separate Warranty & Consumer Information manual provided with the vehicle. If you're unsure about any servicing or maintenance procedure, have it done by an authorized Kia dealer.

⚠ WARNING

Maintenance work

Do not wear jewelry or loose clothing while working under the hood of your vehicle with the engine running. These items can become entangled in moving parts. If you must run the engine while working under the hood, make certain that you remove all jewelry (especially rings, bracelets, watches, and necklaces) and all neckties, scarves, and similar loose clothing before getting near cooling fans.

⚠ WARNING**Touching metal parts**

Do not touch metal parts (including strut bars) while the vehicle is operating or hot. Doing so could result in serious bodily injury. Turn the vehicle off and wait until the metal parts cool down to perform maintenance work on the vehicle.

Owner maintenance

The following lists are vehicle checks and inspections that should be performed by the owner or an authorized Kia dealer at the frequencies indicated to help ensure safe, dependable operation of your vehicle.

Any adverse conditions should be brought to the attention of your dealer as soon as possible.

These owner maintenance checks are generally not covered by warranties and you may be charged for labor, parts and lubricants used.

When you stop for fuel:

- Check the coolant level in coolant reservoir.
- Check the windshield washer fluid level.
- Look for low or under-inflated tires.
- Check if the front of the radiator and condenser are clean and not blocked with leaves, dirt or insects etc. If any of the above parts are extremely dirty or you are not sure of their condition, take your vehicle to an authorized Kia dealer.

⚠ WARNING**Hot coolant**

Be careful when checking your engine coolant level when the engine is hot. Scalding hot coolant and steam may blow out under pressure.

While operating your vehicle:

- Note any changes in the sound of the exhaust or any smell of exhaust fumes in the vehicle.

- Check for vibrations in the steering wheel. Notice any increased steering effort or looseness in the steering wheel, or change in its straight-ahead position.
- Notice if your vehicle constantly turns slightly or "pulls" to one side when traveling on smooth, level road.
- When stopping, listen and check for unusual sounds, pulling to one side, increased brake pedal travel or "hard-to-push" brake pedal.
- If any slipping or changes in the operation of your transmission occurs, take your vehicle to an authorized Kia dealer.
- Check the Intelligent Variable Transmission (IVT) P (Park) function.
- Check the parking brake.
- Check for fluid leaks under your vehicle (water dripping from the air conditioning system during or after use is normal).

At least monthly:

- Check the coolant level in the coolant reservoir.
- Check the operation of all exterior lights, including the stoplights, turn signals and hazard warning flashers.
- Check the inflation pressures of all tires including the spare for tires that are worn, show uneven wear, or are damaged.
- Check for loose wheel lug nuts.

At least once every 6 months :

- Check the radiator, heater and air conditioning hoses for leaks or damage.

- Check the windshield washer spray and wiper operation. Clean the wiper blades with clean cloth dampened with washer fluid.
- Check the headlight alignment.
- Check the muffler, exhaust pipes, shields and clamps.
- Check the lap/shoulder belts for wear and function.

At least once a year:

- Clean the body and door drain holes.
- Lubricate the door hinges and check the hood hinges.
- Lubricate the door and hood locks and latches.
- Lubricate the door rubber weatherstrips.
- Check the air conditioning system.
- Inspect and lubricate Intelligent Variable Transmission (IVT) linkage and controls.
- Clean the battery and terminals.
- Check the brake fluid level.
- Visually inspect steering, suspension, and chassis components for damaged, loose, or missing parts or signs of wear.

Scheduled maintenance service

Follow the Normal Maintenance Schedule if the vehicle is usually operated where none of the following conditions apply.

Follow the Maintenance Under Severe Usage Conditions if any of the following conditions apply.

- Repeated driving short distance of less than 8 km (5 miles) in normal temperature or less than 16 km (10 miles) in freezing temperature.
- Extensive engine idling or low speed driving for long distances.
- Driving on rough, dusty, muddy, unpaved, graveled or salt-spread roads.
- Driving in areas using salt or other corrosive materials or in very cold weather.
- Driving in heavy dust condition.
- Driving in heavy traffic area.
- Driving on uphill, downhill, or mountain road repeatedly.
- Using for towing or camping and driving with loading on the roof.
- Driving as a patrol car, taxi, other commercial use of vehicle towing.
- Frequently driving under high speed or rapid acceleration/deceleration.
- Frequently driving in stop-and-go condition.

If your vehicle is operated in any of the prior listed conditions, you should inspect, replace or refill more frequently, using the severe usage maintenance schedule instead of the normal usage maintenance schedule.

* NOTICE

For Smartstream G1.6 T-GDi

The vehicle may be equipped with the Oil Life Management System that predicts engine oil life based on the driver's driving history and alerts the driver to change engine oil.

- If the deterioration of the engine oil increases depending on the driver's driving severity, the remaining oil life alert appears on the instrument cluster before the normal engine oil replacement interval. Have the engine oil and filter be changed by an authorized Kia dealer.
- Oil Life Management System works when the recommended engine oil is used. So, if recommended engine oil is not used, replace the engine oil according to the maintenance schedule under severe usage condition. Also, check the amount of engine oil regularly as this system assumes that the engine oil is being filled normally.
- Always reset the remaining engine oil life whenever the engine oil is changed. Otherwise, the Oil Life Management System will not be correct.
- If there is no alert until the maximum maintenance interval, have vehicle be checked by an authorized Kia dealer.

Normal Maintenance Schedule - Turbo Models (For Smartstream G1.6 T-GDi)

The following maintenance services must be performed to ensure good emission control and performance. Keep receipts for all vehicle services to protect your warranty. Where both mileage and date are shown, the frequency of service is determined by whichever occurs first.

I: Inspect and if necessary, adjust, correct, clean or replace.

R: Replace or change.

		Number of months or driving distance, whichever comes first															
Months		12	24	36	48	60	72	84	96	108	120	132	144	156	168	180	
Miles x 1,000		8	16	24	32	40	48	56	64	72	80	88	96	104	112	120	
Km x 1,000		13	26	39	52	65	78	91	104	117	130	143	156	169	182	195	
Tire rotation		Rotate every 13,000 km (8,000 miles) or 12 months															
Fuel additives ¹	Smartstream G1.6 T-GDi	Add every 13,000 km (8,000 miles) or 12 months															
Engine oil and engine oil filter ²	Smartstream G1.6 T-GDi	R	R	R	R	R	R	R	R	R	R	R	R	R	R	R	
Climate control air filter		I	R	I	R	I	R	I	R	I	R	I	R	I	R	I	
Air cleaner filter (Engine)		I	I	R	I	I	R	I	I	R	I	I	R	I	I	R	
Brake fluid		Inspect every 13,000 km (8,000 miles) or 12 months Replace every 48,000 km (30,000 miles) or 48 months															
Spark plugs	Smartstream G1.6 T-GDi	Replace every 78,000 km (48,000 miles)															
Coolant (Engine) ³		At first, replace at 195,000 km (120,000 miles) or 120 months After that, replace every 39,000 km (24,000 miles) or 24 months															
Air conditioner refrigerant																	
Air conditioner compressor																	
Battery condition																	
Vacuum hoses																	
Brake discs and pads																	
Brake lines, hoses and connections		I	I	I	I	I	I	I	I	I	I	I	I	I	I	I	
Suspension ball joints																	
Steering gear rack, linkage and boots																	
Exhaust system																	
Cooling system																	
Intercooler in/out hose, air intake hose	Smartstream G1.6 T-GDi	I	-	I	-	I	-	I	-	I	-	I	-	I	-	I	
Drive shaft and boots																	
Propeller shaft	AWD																
Parking brake	Hand type	-	I	-	I	-	I	-	I	-	I	-	I	-	I	-	
Fuel tank and fuel cap																	
Fuel tank air filter																	
Fuel lines, hoses and connections																	

Number of months or driving distance, whichever comes first																
Months	12	24	36	48	60	72	84	96	108	120	132	144	156	168	180	
Miles x 1,000	8	16	24	32	40	48	56	64	72	80	88	96	104	112	120	
Km x 1,000	13	26	39	52	65	78	91	104	117	130	143	156	169	182	195	
Drive belts (Engine) ⁴	-	-	-	-	-											
Differential oil (rear) ⁵	AWD	Inspect every 65,000 km (40,000 miles) or 48 months														
Transfer case oil ⁶	AWD	Inspect every 65,000 km (40,000 miles) or 48 months														
Automatic transmission (AT) fluid [*]	Smartstream G1.6 T-GDi	No service required														

***1 Fuel additives**

If TOP TIER Detergent Gasoline is not available, one bottle of additive is recommended. Additives are available from your authorized Kia dealer along with information on how to use them. Do not mix other additives.

***2 Engine oil and engine oil filter**

As it is normal for engine oil to be consumed during driving, the engine oil level should be checked on regular basis.

The engine oil change interval for normal operating conditions is based on the use of the recommended engine specification. If the recommended engine oil specification is not used, then replace the engine oil according to the maintenance schedule under severe operating conditions.

Never add any additives to the engine oil. Engine oil additives can change its properties of engine oil and may cause serious engine failure.

***3 Coolant**

When adding coolant, use only deionized water or soft water for your vehicle and never mix hard water in the coolant filled at the factory. An improper coolant

mixture can result in serious malfunction or engine damage.

***4 Drive belts (Engine)**

Inspect alternator, water pump and air conditioner drive belt and if necessary, repair or replace. Inspect drive belt tensioner, idler and alternator pulley and if necessary correct or replace.

***5 Differential oil**

If the vehicle has been submerged in water or in a flooded area, the fluids should be changed as a precaution.

***6 Transfer case oil**

If the vehicle has been submerged in water or in a flooded area, the fluids should be changed as a precaution.

*** Transmission fluid**

If the vehicle has been submerged in water or in a flooded area, the fluids should be changed as a precaution.

Fuel filter (Gasoline engine)

The fuel filter is normally maintenance free but periodic inspection is recommended during scheduled maintenance

to look for conditions caused by poor fuel quality.

- If there are safety risks such as fuel flow restriction, surging, loss of power, hard starting problem etc, replace the fuel filter immediately regardless of maintenance schedule and consult an authorized Kia dealer for details.

Maintenance Under Severe Usage Conditions - Turbo Models (For Smartstream G1.6 T-GDi)

I: Inspect and if necessary, adjust, correct, clean or replace.

R: Replace or change.

Maintenance item		Maintenance operation	Maintenance intervals	Driving condition
Engine oil and engine oil filter	Smartstream G1.6 T-GDi	R	Every 8,000 km (5,000 miles) or 6 months	D, H, I
Air cleaner filter		R	More frequently	C, E
Climate control air filter		R	More frequently	C, E, G
Automatic transmission (AT) fluid	Smartstream G1.6 T-GDi	R	Every 91,000 km (56,000 miles)	A, C, F, G, H, I, J, K
Differential oil (rear)	AWD	R	Every 117,000 km (72,000 miles)	C, E, G, H, I, J
Transfer case oil	AWD	R	Every 117,000 km (72,000 miles)	C, E, G, H, I, J
Spark plugs	Smartstream G1.6 T-GDi	R	More frequently	A, B, F, G, H, I, K
Steering gear rack, linkage and boots		I	More frequently	C, D, E, F, G, H, I
Suspension ball joints		I	More frequently	C, D, E, G, H, I
Brake discs, pads and calipers		I	More frequently	C, D, E, G, H, I, J, K
Parking brake	Hand type	I	More frequently	C, D, G, H
Drive shaft and boots		I	More frequently	C, D, E, F, G, H, I, J
Propeller shaft	AWD	I	More frequently	C, D, E, F, G, H, I, J

Severe Driving Conditions

A: Repeatedly driving short distance of less than 8 km (5 miles) in normal temperature or less than 16 km (10 miles) in freezing temperature.

B: Extensive low speed driving for long distances.

C: Driving on rough, dusty, muddy, unpaved, graveled or salt-spread roads.

D: Driving in areas using salt or other corrosive materials or in very cold weather.

E: Driving in heavy dust condition.

F: Driving in heavy traffic area.

G: Driving on uphill, downhill, or mountain road repeatedly.

H: Using for towing or camping and driving with loading on the roof.

I: Driving as a patrol car, taxi, other commercial use of vehicle towing

J: Frequently driving under high speed or rapid acceleration/deceleration.

K: Frequently driving in stop-and-go conditions.

Normal maintenance schedule - Non Turbo Models (For (Gasoline) 2.0 MPI)

The following maintenance services must be performed to ensure good emission control and performance. Keep receipts for all vehicle services to protect your warranty. Where both mileage and date are shown, the frequency of service is determined by whichever occurs first.

I: Inspect and if necessary, adjust, correct, clean or replace.

R: Replace or change.

		Number of months or driving distance, whichever comes first															
Months		12	24	36	48	60	72	84	96	108	120	132	144	156	168	180	
Miles x 1,000		7.5	15	22.5	30	37.5	45	52.5	60	67.5	75	82.5	90	97.5	105	112.5	
Km x 1,000		12	24	36	48	60	72	84	96	108	120	132	144	156	168	180	
Tire rotation		Rotate every 12,000 km (7,500 miles) or 12 months															
Engine oil and engine oil filter ¹	(Gasoline) 2.0 MPI	R	R	R	R	R	R	R	R	R	R	R	R	R	R	R	
Climate control air filter		I	R	I	R	I	R	I	R	I	R	I	R	I	R	I	
Air cleaner filter		I	I	I	R	I	I	I	R	I	I	I	R	I	I	I	
Brake fluid		Inspect every 12,000 km (7,500 miles) or 12 months Replace every 48,000 km (30,000 miles) or 48 months															
Spark plugs		Replace every 156,000 km (97,500 miles)															
Coolant (Engine) ²		At first, replace at 192,000 km (120,000 miles) or 120 months, After that, replace every 36,000 km (25,000 miles) or 24 months															
Air conditioner refrigerant																	
Air conditioner compressor																	
Battery condition																	
Vacuum hose																	
Brake discs and pads																	
Brake lines, hoses and connections		I	I	I	I	I	I	I	I	I	I	I	I	I	I	I	
Suspension ball joints																	
Steering gear rack, linkage and boots																	
Exhaust system																	
Cooling system																	
Drive shaft and boots																	
Propeller shaft	AWD																
Parking brake	Hand type	-	I	-	I	-	I	-	I	-	I	-	I	-	I	-	
Fuel tank and fuel cap																	
Fuel tank air filter																	
Fuel lines, hoses and connections																	
Drive belts (Engine) ⁵		At first, inspect at 96,000 km (60,000 miles) or 72 months After that, inspect every 24,000 km (15,000 miles) or 24 months															
Differential oil (rear) ³	AWD	Inspect every 60,000 km (37,500 miles) or 48 months															
Transfer case oil ⁴	AWD																

Number of months or driving distance, whichever comes first																
Months	12	24	36	48	60	72	84	96	108	120	132	144	156	168	180	
Miles x 1,000	7.5	15	22.5	30	37.5	45	52.5	60	67.5	75	82.5	90	97.5	105	112.5	
Km x 1,000	12	24	36	48	60	72	84	96	108	120	132	144	156	168	180	
Intelligent Variable Transmission (IVT) fluid*	No service required															

***1 Engine oil and engine oil filter**

As it is normal for engine oil to be consumed during driving, the engine oil level should be checked on regular basis.

The engine oil change interval for normal operating conditions is based on the use of the recommended engine specification. If the recommended engine oil specification is not used, then replace the engine oil according to the maintenance schedule under severe operating conditions.

Never add any additives to the engine oil. Engine oil additives can change its properties of engine oil and may cause serious engine failure.

***2 Coolant**

When adding coolant, use only deionized water or soft water for your vehicle and never mix hard water in the coolant filled at the factory. An improper coolant mixture can result in serious malfunction or engine damage.

***3 Differential oil**

If the vehicle has been submerged in water or in a flooded area, the fluids should be changed as a precaution.

***4 Transfer case oil**

If the vehicle has been submerged in water or in a flooded area, the fluids should be changed as a precaution.

***5 Drive belts (Engine)**

Inspect alternator, water pump and air conditioner drive belt and if necessary, repair or replace. Inspect drive belt tensioner, idler and alternator pulley and if necessary correct or replace.

*** Transmission fluid**

If the vehicle has been submerged in water or in a flooded area, the fluids should be changed as a precaution.

Fuel filter (Gasoline engine)

The fuel filter is normally maintenance free but periodic inspection is recommended during scheduled maintenance to look for conditions caused by poor fuel quality.

- If there are safety risks such as fuel flow restriction, surging, loss of power, hard starting problem etc, replace the fuel filter immediately regardless of maintenance schedule and consult an authorized Kia dealer for details.

Maintenance Under Severe Usage Conditions (For (Gasoline) 2.0 MPI)

The following items must be serviced more frequently on cars mainly used under severe driving conditions. Refer to the chart below for the appropriate maintenance intervals.

I: Inspect and if necessary, adjust, correct, clean or replace.

R: Replace or change.

Maintenance item		Maintenance operation	Maintenance intervals	Driving condition
Engine oil and engine oil filter	(Gasoline) 2.0 MPI	R	Every 6,000 km (3,750 miles) or 6 months	A, B, C, D, E, F, G, H, I, J, K
Air cleaner filter		R	More frequently	C, E
Climate control air filter		R	More frequently	C, E, G
Intelligent Variable Transmission (IVT) fluid	(Gasoline) 2.0 MPI	R	Every 96,000 km (60,000 miles)	A, C, F, G, H, I, J, K
Differential oil (rear)	AWD	R	Every 120,000 km (75,000 miles)	C, E, G, H, I, J
Transfer case oil	AWD	R	Every 120,000 km (75,000 miles)	C, E, G, H, I, J
Spark plugs	(Gasoline) 2.0 MPI	R	More frequently	A, B, F, G, H, I, K
Steering gear rack, linkage and boots		I	More frequently	C, D, E, F, G
Suspension ball joints		I	More frequently	C, D, E, G, H, I
Brake discs, pads and calipers		I	More frequently	C, D, E, G, H, I, J, K
Parking brake	Hand type	I	More frequently	C, D, G, H
Drive shafts and boots		I	More frequently	C, D, E, F, G, H, I, J
Propeller shaft	AWD	I	More frequently	C, D, E, F, G, H, I, J

Severe Driving Conditions

A: Repeatedly driving short distance of less than 8 km (5 miles) in normal temperature or less than 16 km (10 miles) in freezing temperature.

B: Extensive low speed driving for long distances.

C: Driving on rough, dusty, muddy, unpaved, graveled or salt-spread roads.

D: Driving in areas using salt or other corrosive materials or in very cold weather.

E: Driving in heavy dust condition.

F: Driving in heavy traffic area.

G: Driving on uphill, downhill, or mountain road repeatedly.

H: Using for towing or camping and driving with loading on the roof.

I: Driving as a patrol car, taxi, other commercial use of vehicle towing

J: Frequently driving under high speed or rapid acceleration/deceleration.

K: Frequently driving in stop-and-go conditions.

Explanation of scheduled maintenance items

The following parts require scheduled maintenance.

Engine oil and filter

The engine oil and filter should be changed at the intervals specified in the maintenance schedule. If the vehicle is being driven in severe conditions, more frequent oil and filter changes are required.

Drive belts

Inspect all drive belts for evidence of cuts, cracks, excessive wear or oil saturation and replace if necessary. Drive belts should be checked periodically for proper tension and adjusted as necessary.

Fuel filter

Kia gasoline vehicles are equipped with a lifetime fuel filter that is integrated with the fuel tank. Regular maintenance or replacement is generally not needed. This may vary depending on fuel quality. If you experience any of the following: fuel flow restriction, surging, loss of power, or a hard starting issue, inspection and, if necessary, replacement may be needed. Have the fuel filter inspected or replaced by an authorized Kia dealer.

Fuel lines, fuel hoses and connections

Check the fuel lines, fuel hoses and connections for leakage and damage. Have an authorized Kia dealer replace any damaged or leaking parts immediately.

Fuel tank and fuel cap

The fuel tank and fuel cap should be inspected at those intervals specified in the maintenance schedule. Make sure that a new fuel tank and fuel cap is correctly replaced.

Vacuum crankcase ventilation hoses

Inspect the surface of hoses for evidence of heat and/or mechanical damage. Hard and brittle rubber, cracking, tears, cuts, abrasions, and excessive swelling indicate deterioration. Particular attention should be paid to examine those hose surfaces nearest to high heat sources, such as the exhaust manifold. Inspect the hose routing to assure that the hoses do not come in contact with any heat source, sharp edges or moving components which might cause heat damage or mechanical wear. Inspect all hose connections, such as clamps and couplings, to make sure they are secure, and that no leaks are present. Hoses should be replaced immediately if there is any evidence of deterioration or damage.

Air cleaner filter

A Genuine Kia air cleaner filter is recommended when the filter is replaced.

Spark plugs

Make sure to install new spark plugs of the correct heat range.

When assembling parts, be sure to wipe the inside and outside of the boot bottom of the ignition coil and the insulator of the spark plug with a soft cloth to prevent contamination of the spark plug insulator.

Valve clearance (if equipped)

Inspect for excessive valve noise and/or engine vibration and adjust if necessary. An authorized Kia dealer should perform the operation.

Cooling system

Check the cooling system components, such as the radiator, coolant reservoir, hoses and connections for leakage and damage. Replace any damaged parts.

Coolant

The coolant should be changed at the intervals specified in the maintenance schedule.

Automatic transmission (AT) fluid (if equipped)

Automatic transmission fluid should not be checked under normal usage conditions. Have the automatic transmission fluid changed by an authorized Kia dealer.

* NOTICE

Automatic transmission fluid color is basically red.

As the vehicle is driven, the automatic transmission fluid will begin to look darker. It is normal condition and you should not judge the need to replace the fluid based upon the changed color.

⚠ CAUTION

The use of a non-specified fluid could result in transmission malfunction and failure.

Use only specified automatic transmission fluid. (Refer to "Recommended lubricants and capacities" on page 9-6.)

Intelligent Variable Transmission (IVT) fluid (if equipped)

Intelligent Variable Transmission (IVT) fluid should not be checked under normal usage conditions. But in severe conditions, the fluid should be changed at an authorized Kia dealer in accordance to the scheduled maintenance at the beginning of this section.

* NOTICE

Intelligent Variable Transmission (IVT) fluid color is usually light amber. As the vehicle is driven, the Intelligent Variable Transmission (IVT) fluid will begin to look darker.

This is a normal condition and you should not feel the need to replace the fluid based upon the changed color.

⚠ CAUTION

Transmission fluids

The use of non-specified fluid (even marked as compatible with genuine) could result in a shift of quality deterioration and vibrations, and eventually, transmission failure. Use only specified Intelligent Variable Transmission (IVT) fluid. (Refer to "Recommended lubricants and capacities" on page 9-6)

Brake hoses and lines

Visually check for proper installation, chafing, cracks, deterioration and any leakage. Replace any deteriorated or damaged parts immediately.

Brake fluid

Check the brake fluid level in the brake fluid reservoir. The level should be between "MIN" and "MAX" marks on the side of the reservoir. Use only hydraulic brake fluid conforming to DOT 4 specification.

Parking brake

Inspect the parking brake system including the parking brake lever (or pedal) and cables.

Exhaust pipe and muffler

Visually inspect the exhaust pipes, muffler and hangers for cracks, deterioration, or damage. Start the engine and listen carefully for any exhaust gas leakage. Tighten connections or replace parts as necessary.

Brake discs, pads and calipers

Check the pads for excessive wear, discs for run out and wear, and calipers for fluid leakage.

Suspension mounting bolts

Check the suspension connections for looseness or damage. Retighten to the specified torque.

Steering gear box, linkage & boots/lower arm ball joint

With the vehicle stopped and off, check for excessive free-play in the steering wheel.

Check the linkage for bends or damage. Check the dust boots and ball joints for deterioration, cracks, or damage. Replace any damaged parts.

Drive shafts and boots

Check the drive shafts, boots and clamps for cracks, deterioration, or damage. Replace any damaged parts and, if necessary, repack the grease.

Air conditioning refrigerant

Check the air conditioning lines and connections for leakage and damage.

Checking fluid levels

When checking engine oil, engine coolant, brake fluid, and washer fluid, always be sure to clean the area around any filler plug, drain plug, or dipstick before checking or draining any lubricant or fluid. This is especially important in dusty or sandy areas and when the vehicle is used on unpaved roads. Cleaning the plug and dipstick areas will prevent dirt and grit from entering the engine and other mechanisms that could be damaged.

Engine oil and filter

Checking the engine oil level

Engine oil is used for lubricating, cooling, and operating various hydraulic components in the engine. Engine oil consumption while driving is normal, and it is necessary to check and refill the engine oil regularly. Also, check and refill the oil level within the recommended maintenance schedule to prevent deterioration of oil performance.

Check the engine oil following the below procedure.

Smartstream G1.6 T-GDi

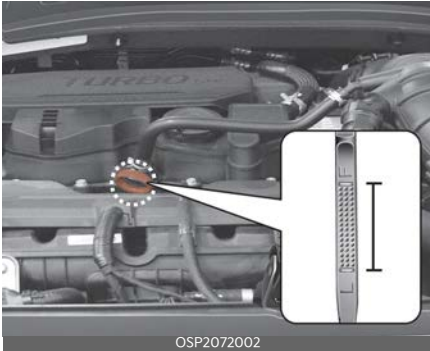

(Gasoline) 2.0 MPI

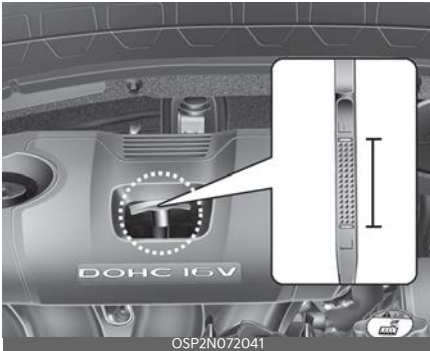

1. Be sure the vehicle is on level ground.

2. Start the engine and allow it to reach normal operating temperature.
3. Turn the engine off, remove the oil filler cap and pull the dipstick out. Wait for 15 minutes for the oil to return to the oil pan.
4. Wipe the dipstick clean and reinsert it fully.
5. Pull the dipstick out again and check the level. Check if the oil level is between the F-L line, and if it is below the L line, add enough oil to bring the level to F line.

⚠ WARNING

Radiator hose

Be very careful not to touch the radiator hose when checking or adding the engine oil as it may be hot enough to burn you.

⚠ CAUTION

When you wipe the oil level gauge, you should wipe it with a clean cloth. When mixed with debris, it can cause engine damage.

Smartstream G1.6 T-GDi

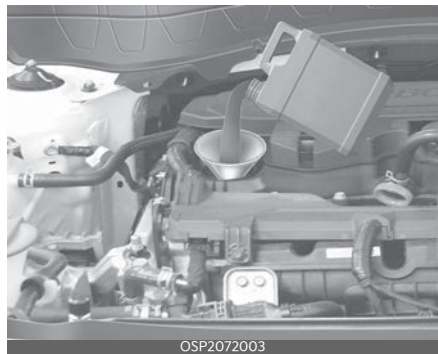

(Gasoline) 2.0 MPI



Use a funnel to help prevent oil from being spilled on engine components.

Use only the specified engine oil. (Refer to "Recommended lubricants and capacities" on page 9-6.)

- Do not spill engine oil when adding or changing engine oil. Wipe off spilled oil immediately.
- The engine oil consumption may increase while you break in a new vehicle and it will be stabilized after driving 6,000 km (4,000 miles).
- The engine oil consumption can be affected by driving habits, climate conditions, traffic conditions, oil quality, etc. Therefore, it is recommended that you inspect the engine oil level regularly and refill it if necessary.

Changing the engine oil and filter

Have engine oil and filter changed by an authorized Kia dealer according to the Maintenance Schedule at the beginning of this chapter. (For (Gasoline) 2.0 MPI)

The lubrication, rust prevention, cooling, and cleaning effect of the engine oil will gradually degrade during its use. Have the engine oil and filter changed by an authorized Kia dealer according to the Engine Oil Life Management System

instructions or the maintenance schedule. (For Smartstream G1.6 T-GDi)

- If the maintenance schedule to replace engine oil is exceeded, the engine oil performance may deteriorate, and the engine condition may be affected. Therefore, replace the engine oil according to the maintenance schedule.
- To keep the engine in optimal condition, use the recommended engine oil and filter. If the recommended engine oil and filter are not used replace it according to the maintenance schedule under severe usage conditions.
- The purpose of the maintenance schedule for engine oil replacement is to prevent oil deterioration and it is irrelevant to oil consumption. Check and refill engine oil regularly.

⚠ WARNING

Used engine oil

Used engine oil may cause irritation or cancer of the skin if left in contact with the skin for prolonged periods of time. Always protect your skin by washing your hands thoroughly with soap and warm water as soon as possible after handling used oil. Do not leave used engine oil within the reach of children.

* NOTICE

For Smartstream G1.6 T-GDi engine

When the oil pressure is low due to insufficient engine oil, the Engine Oil Pressure (🛢️) warning light will appear.

In addition, the enhanced engine protection system, which limits the engine's power is activated and the Malfunction Indicator Lamp (🛠️) will appear when

the vehicle is driven in this state continuously.

When the engine oil pressure is restored, the Engine Oil Pressure warning light and the enhanced engine protection system will turn off after the engine is restarted.

CAUTION

The engine oil is very hot immediately after the vehicle has been driven and can cause burns during replacement. Replace the engine oil after the engine oil has cooled down.

NOTICE

Never add any additives to the engine oil. Engine oil additives can change its properties of engine oil and may cause serious engine failure.

Engine coolant

The high-pressure cooling system has a reservoir filled with year round anti-freeze coolant. The reservoir is filled at the factory.

Check the antifreeze protection and coolant level at least once a year, at the beginning of the winter season, and before traveling to a colder climate.

WARNING

Radiator/Inverter cap

Never attempt to remove the radiator or inverter cap while the engine is operating or hot. Doing so might lead to damage to the cooling system and engine, and could result in serious bodily injury from the escaping hot coolant or steam.

Recommended coolant

When adding coolant, use only deionized water or soft water for your vehicle and never mix hard water in the coolant filled at the factory. An improper coolant mixture can result in serious malfunction or damage.

- The engine in your vehicle has aluminum engine parts and must be protected by an phosphate based ethylene-glycol coolant to prevent corrosion and freezing.
- Do not use alcohol or methanol coolant or mix them with the specified coolant.
- Do not use a solution that contains more than 60% antifreeze or less than 35% antifreeze, which would reduce the effectiveness of the solution.
- The cooling circuit of a vehicle equipped with a heat pump system may freeze in extremely low tempera-

ture when the concentration of the antifreezing liquid is below 45%. For mixture percentage, refer to the following table.

Ambient Temperature	Mixture Percentage (volume)	
	Antifreeze	Water
-15 °C (5 °F)	35	65
-25 °C (-13 °F)	40	60
-35 °C (-31 °F)	50	50
-45 °C (-49 °F)	60	40

WARNING

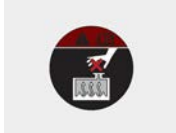

Radiator cap

Do not remove the radiator cap when the engine and radiator are hot. Scalding hot

coolant and steam may blow out under pressure which may result in serious injury.

Smartstream G1.6 T-GDi



(Gasoline) 2.0 MPI

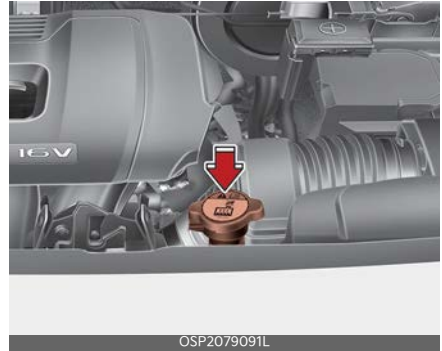

*** NOTICE**

Make sure the coolant cap is properly closed after refill or coolant. Otherwise the engine could be overheated while driving.

1. Check if the radiator cap label is straight in front.

Engine room front view



2. Make sure that the tiny protrusions inside the coolant cap are securely interlocked.

Engine room rear view

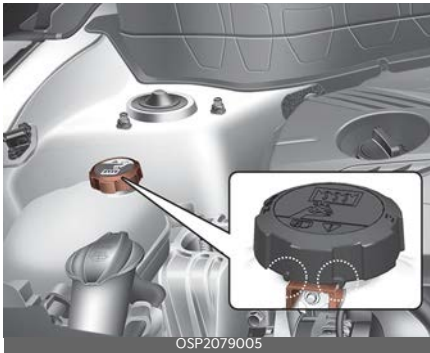

Checking the coolant level

⚠ WARNING



Removing radiator cap

Never attempt to remove the radiator cap while the engine is operating or hot. Doing so might lead to cooling system damage and could result in serious personal injury from the escaping hot coolant or steam.

1. Turn the vehicle off and wait until it cools down.
2. Use extreme care when removing the radiator cap. Wrap a thick towel around it, and turn it counterclockwise slowly to the first stop.
3. Step back while the pressure is released from the cooling system.
4. When you are sure all the pressure has been released, press down on the cap, using a thick towel, and continue turning counterclockwise to remove it.

⚠ WARNING



Cooling fan

Use caution when working near the blade of the cooling fan. The electric motor (cooling fan) is controlled by coolant temperature, refrigerant pressure and vehicle speed. It may sometimes operate even when the vehicle is not running.

5. Check the condition and connections of all cooling system hoses and heater hoses.
6. Replace any swollen or deteriorated hoses.
7. Check the coolant level. The coolant level should be filled between F and L marks on the side of the coolant reservoir when the engine room is cool.

Smartstream G1.6 T-GDi

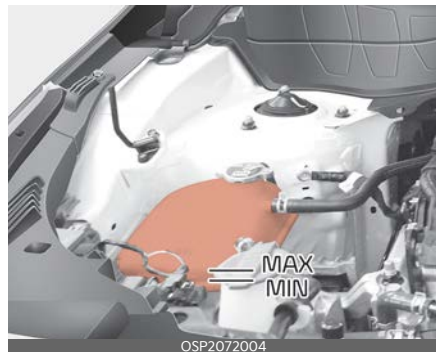

(Gasoline) 2.0 MPI

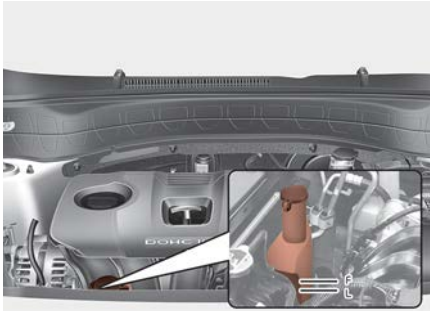

OSP2079092L

- If the coolant level is low, add enough specified coolant to provide protection against freezing and corrosion. Bring the level to F, but do not overfill.

If frequent additions are required, see an authorized Kia dealer for a cooling system inspection.

Changing the coolant

Have the coolant changed by an authorized Kia dealer according to the Maintenance Schedule at the beginning of this chapter.

CAUTION

Put a thick cloth or fabric around the radiator cap before refilling the coolant in order to prevent the coolant from overflowing into engine parts such as the alternator.

Brake fluid

The brake fluid acts to transmit force to the brake when the driver depresses the brake pedal. Brake fluid must be maintained periodically to ensure that the brakes operate smoothly.

Checking the brake fluid level

Check the fluid level in the reservoir periodically. The fluid level should be between MAX and MIN marks on the side of the reservoir.

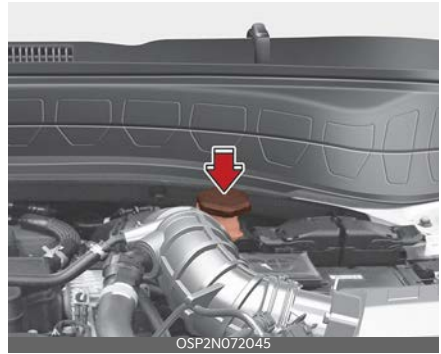

OSP2N072045

- Before removing the reservoir cap and adding brake fluid, clean the area around the reservoir cap thoroughly to prevent brake fluid contamination.

CAUTION

Proper fluid

Only use brake fluid in the brake system. Even small amounts of improper fluids can cause damage to the brake system.

- Periodically check that the fluid level in the brake fluid reservoir is between MIN and MAX. The level will fall with accumulated mileage. This is a normal condition associated with the wear of the brake linings. If the fluid level is excessively low, have the brake system checked by an authorized Kia dealer.

Use only the specified brake fluid. (Refer to "Recommended lubricants and capacities" on page 9-6.)

Never mix different types of fluid.

In the event the brake system requires frequent additions of fluid, the vehicle should be inspected by an authorized Kia dealer.

When changing and adding brake fluid, handle it carefully. Do not let it come in contact with your eyes. If brake fluid should come in contact with your eyes, immediately flush them with a large quantity of fresh tap water. Have your eyes examined by a doctor as soon as possible.

⚠ CAUTION

Brake fluid

Do not allow brake fluid to contact the vehicle's body paint, as paint damage will result.

Brake fluid, which has been exposed to open air for an extended time should never be used as its quality cannot be guaranteed. It should be disposed of properly.

⚠ CAUTION

To maintain your vehicle's best brake and ABS/ESC performance, use Kia genuine brake fluid or those of an equivalent standard brake fluid as in the specification. (Classification : SAE J1704 DOT4 LV, ISO4925 CLASS-6, FMVSS116 DOT-4)

Washer fluid

Washer fluid is used when wiping the windshield of the vehicle with a windshield wiper. You should check and refill washer fluid periodically to make sure that it doesn't run out.

Checking the washer fluid level



OSP2072007

The reservoir is translucent so that you can check the level with a quick visual inspection.

- Check the fluid level in the washer fluid reservoir and add fluid if necessary. Plain water may be used if washer fluid is not available. However, use washer solvent with antifreeze characteristics in cold climates to prevent freezing.

⚠ WARNING

Flammable Fluid

Do not allow the washer fluid to come in contact with open flames or sparks. The windshield washer fluid reservoir is flammable under certain circumstances. This can result in a fire.

⚠ WARNING

Coolant

- Do not use radiator coolant or anti-freeze in the washer fluid reservoir.

- Radiator coolant can severely obscure visibility when sprayed on the windshield and may cause loss of vehicle control.

⚠ WARNING

Windshield fluid

Do not drink the windshield washer fluid. The windshield washer fluid is poisonous to humans and animals.

Parking brake

Inspect the parking brake system including the parking brake lever (if equipped) and cables.

Checking the parking brake

1. Check the stroke of the parking brake by counting the number of "clicks" heard while fully applying it from the released position.

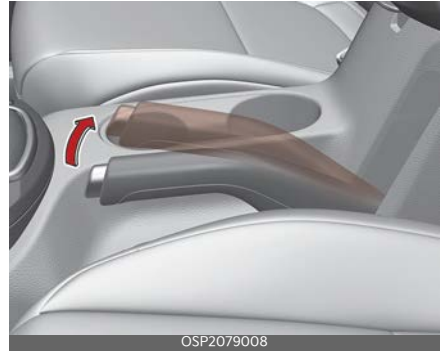

Also, the parking brake alone should securely hold the vehicle on a fairly steep grade.

2. If the stroke is more or less than specified, have the parking brake adjusted by an authorized Kia dealer.

Stroke: 5~7 "clicks" at a force of 44 lbs. (20 kg, 196 N)

Air cleaner filter

Replacing air cleaner filter

Air cleaner filter must be replaced when necessary, and should not be washed.

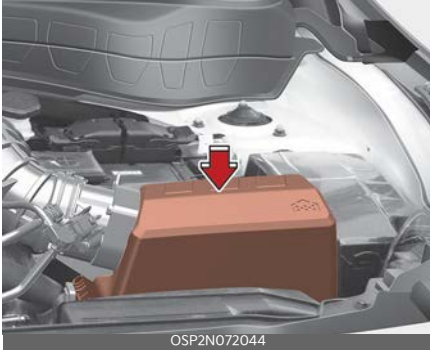

You can clean the filter when inspecting the air cleaner compartment. Clean the filter by using compressed air.

1. Loosen the air cleaner cover attaching clips and open the cover.

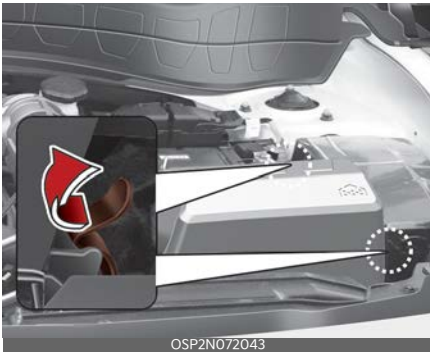

2. Wipe the inside of the air cleaner.
3. Replace the air cleaner filter.



4. Insert the air cleaner cover in the hinge (1) and close the cover, then lock the cover with attaching clips.



5. Check that the cover is firmly installed.

Replace the filter according to the Maintenance Schedule.

If the vehicle is operated in extremely dusty or sandy areas, replace the element more often than the usual recommended intervals. (Refer to "Severe Driving Conditions" on page 8-13.)

CAUTION

Air filter maintenance

- Do not drive with the air cleaner removed; this will result in excessive engine wear.

- When removing the air cleaner filter, be careful that dust or dirt does not enter the air intake, or damage may result.
- Use a genuine Kia part. Use of a non-genuine part could damage the air flow sensor.

Climate control air filter

The climate control air filter should be replaced according to the maintenance schedule. If the vehicle is operated in severely air-polluted cities or on dusty rough roads for a long period, it should be inspected more frequently and replaced earlier.

Inspecting and replacing climate control air filter

When you replace the climate control air filter, replace it performing the following procedure. Be careful to avoid damaging other components.

1. Open the glove box.

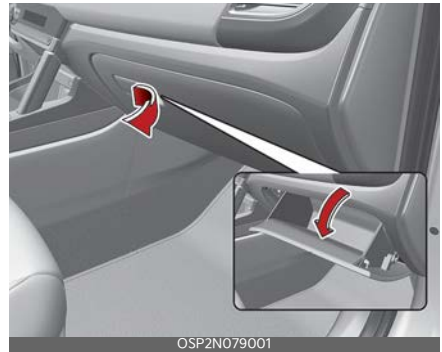

2. Remove the support rod.

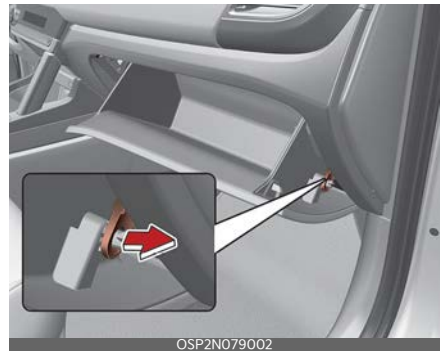

3. Remove the climate control air filter cover by pulling out right side of the cover.

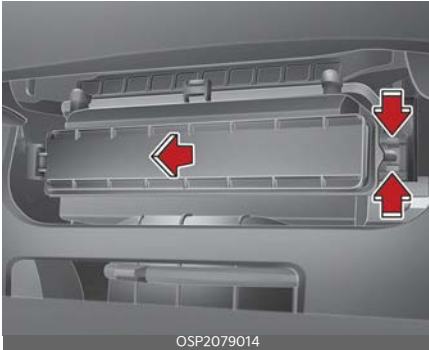

4. Replace the climate control air filter.

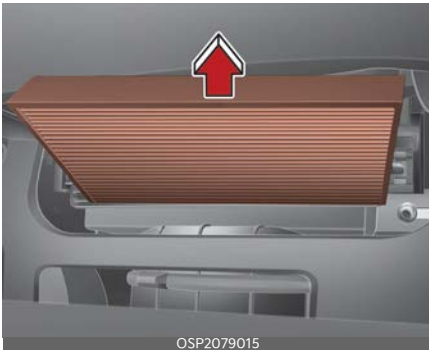

5. Reassemble in the reverse order of disassembly.

When replacing the climate control air filter, install it properly. Otherwise, the system may produce noise and the effectiveness of the filter may be reduced.

Wiper blades

When the wipers no longer clean adequately, the blades may be worn or cracked, and require replacement.

To prevent damage to the wiper arms or other components, do not attempt to move the wipers manually.

The use of a non-specified wiper blade could result in wiper malfunction and failure.

Blade inspection



Commercial hot waxes applied by automatic vehicle washes have been known to make the windshield difficult to clean. Contamination of either the windshield or the wiper blades with foreign matter can reduce the effectiveness of the windshield wipers. Common sources of contamination are insects, tree sap, and hot wax treatments used by some commercial vehicle washes. If the blades are not wiping properly, clean both the window and the blades with a good cleaner or mild detergent, and rinse thoroughly with clean water.

Front windshield wiper blade



To inspect or replace the windshield wiper blades and to prevent damaging the hood, move the windshield wiper blades as follows:

Replacing front windshield wiper blade

1. Raise the wiper arm and turn the wiper blade assembly to expose the plastic locking clip.



⚠ CAUTION

Wiper arms

- Do not allow the wiper arm to fall against the windshield, since it may chip or crack the windshield.
- Do not pull the wiper arm forward, since arm could chip hood paint.

2. Compress the clip and slide the blade assembly downward.

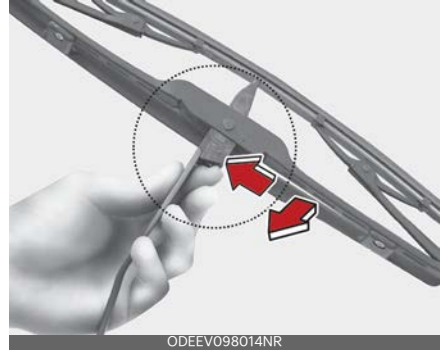

3. Lift it off the arm.



4. Install the blade assembly in the reverse order of removal.

Replacing rear window wiper blade

1. Raise the wiper arm and pull out the wiper blade assembly (1).

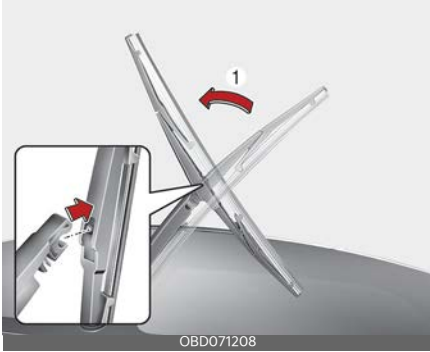

2. Install the new blade assembly by inserting the center part into the slot in the wiper arm until it clicks into the place.

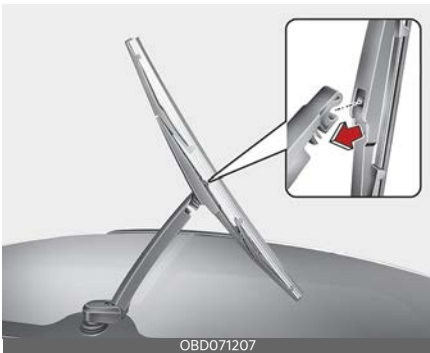

3. Make sure the blade assembly is installed firmly by trying to pull it slightly. To prevent damage to the wiper arms or other components, have the wiper blade replaced by an authorized Kia dealer.

Battery

The battery powers the engine in order to move the vehicle as well as supplying power to the various devices installed in the vehicle.

For best battery service

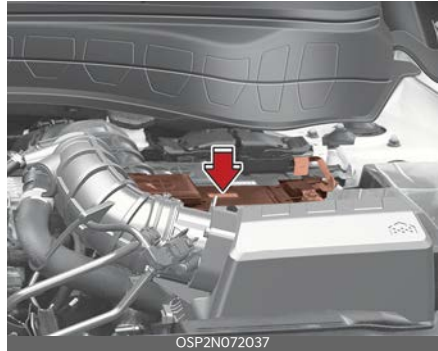

- Keep the battery securely mounted.
- Keep the battery top clean and dry.
- Keep the terminals and connections clean, tight, and coated with petroleum jelly or terminal grease.
- Rinse any spilled electrolyte from the battery immediately with a solution of water and baking soda.
- If the vehicle is not going to be used for an extended time, disconnect the battery cables.

⚠ WARNING

Risk of explosion



Keep lit cigarettes and all other flames or sparks away from the battery.



The battery contains hydrogen -- a highly combustible gas which will explode if it comes in contact with a flame or

spark.



Keep batteries out of the reach of children because batteries contain highly corrosive SULFURIC ACID and electrolytes.

Do not allow battery acid to contact your skin, eyes, clothing or paint finish.



Wear eye protection when charging or working near a battery. Always provide ventilation when working in an

enclosed space.



Always read the following instructions carefully when handling a battery.



If any electrolyte gets into your eyes, flush your eyes with clean water for at least 15 minutes and get immediate medi-

cal attention. If electrolyte gets on your skin, thoroughly wash the contacted area. If you feel pain or burning sensation, get medical attention immediately.



An inappropriately disposed battery can be harmful to the environment and human health. Dispose the battery

according to your local law(s) or regulation.



The battery contains lead. Do not dispose of it after use. Please return the battery to an authorized Kia dealer to be

recycled.

Never attempt to recharge the battery when the battery cables are connected.

⚠ WARNING

Risk of electrocution

Never touch the electrical ignition system while the vehicle is running. This system works with high voltage, which can "zap" you.

*** NOTICE**

If you connect unauthorized electronic devices to the battery, the battery may be discharged. Never use unauthorized devices.

⚠ WARNING

Recharging battery

Never attempt to recharge the battery when the battery cables are connected.

⚠ WARNING

Battery lead compound

Battery posts, terminals, and related accessories contain lead and lead compounds. Wash hands after handling.

Battery recharging

Your vehicle has a maintenance-free, calcium-based battery.

- If the battery becomes discharged in a short time (because, for example, the headlights or interior lights were left on while the vehicle was not in use), recharge it by slow charging (trickle) for 10 hours.
- If the battery gradually discharges because of high electric load while the vehicle is being used, recharge it at 20~30 A for two hours.

When recharging the battery, observe the following precautions:

- The battery must be removed from the vehicle and placed in an area with good ventilation.
- Do not allow cigarettes, sparks, or flame near the battery.
- Watch the battery during charging, and stop or reduce the charging rate in following cases:

1. the battery cells begin gassing (boiling) violently.
 2. the electrolyte temperature of any cell exceeds 49 °C (120 °F).
- Wear eye protection when checking the battery during charging.
 - Disconnect the battery charger in the following order.
 1. Turn off the battery charger main switch.
 2. Unhook the negative clamp from the negative battery terminal.
 3. Unhook the positive clamp from the positive battery terminal.
 - Before performing maintenance or recharging the battery, turn off all accessories and stop the vehicle.
 - The negative battery cable must be removed first and installed last when the battery is disconnected.

CAUTION

AGM battery

- Absorbent Glass Mat (AGM) batteries are maintenance free and have the AGM battery serviced by an authorized Kia dealer.

For charging your AGM battery, use only fully automatic battery chargers that are specially developed for AGM batteries.

- When replacing the AGM battery, use parts for replacement from an authorized Kia dealer.
 - Do not open or remove the cap on top of the battery. This may cause leaks of internal electrolyte that could result in severe injury.
-

Reset items

The following items should be reset after the battery has been discharged or the battery has been disconnected.

- Auto up/down window (Refer to "Windows" on page 4-48)
- Trip computer (Refer to "Trip information (trip computer)" on page 4-85)
- Climate control system (Refer to "Automatic climate control system" on page 4-128)
- Sunroof (Refer to "Sunroof (if equipped)" on page 4-58)

Tires and wheels

For proper maintenance, safety, and maximum fuel economy, you must always maintain the recommended tire inflation pressures and stay within the load limits and weight distribution recommended for your vehicle.

Recommended cold tire inflation pressures

All tire pressures should be checked when the tires are cold. "Cold Tires" means the vehicle has not been driven for at least three hours or driven less than 1.6 km (1 mile).

Recommended pressures must be maintained for the best ride, vehicle handling, and minimum tire wear.

For recommended inflation pressure, refer to "Tires and wheels" on page 9-5. All specifications (sizes and pressures) can be found on a label attached to the driver's side center pillar.



⚠ WARNING

Tire underinflation

Inflate your tires consistent with the instructions provided in this manual. Regularly check the tire inflation pressure, and correct it as needed; at least twice a month and before any long trips

on the road. If you fail to observe this precaution, you may be driving on underinflated tires, which may not only compromise your vehicle's driving stability, but may also lead to tire damage and the risk of an accident. This risk is much higher on hot days and when driving for long periods at high speeds.

Failure to maintain specified pressure may result in excessive wear, poor handling, reduced fuel economy, deformation of tire and/or wheel, harsh ride conditions, possibility for additional damage from road hazards, or result in tire failure.

Tire pressure

Always observe the following:

- Check tire pressure when the tires are cold. (After vehicle has been parked for at least three hours or hasn't been driven more than 1.6 km (1 mile) since startup.)
- Check the pressure of your spare tire each time you check the pressure of other tires.
- Never overload your vehicle. Be careful not to overload a vehicle luggage rack if your vehicle is equipped with one.
- Warm tires normally exceed recommended cold tire pressures by 28~41 kPa (4~6 psi). Do not release air from warm tires to adjust the pressure or the tires will be underinflated.

⚠ WARNING

Tire Inflation

Overinflation or underinflation can reduce tire life, adversely affect vehicle handling, and lead to sudden tire failure.

This could result in loss of vehicle control and potential injury.

Checking tire inflation pressure

Check your tires once a month or more. Use a good quality gauge to check tire pressure. You cannot tell if your tires are properly inflated simply by looking at them. Radial tires may look properly inflated even when they're underinflated.

Check the tire's inflation pressure when the tires are cold. "Cold" means your vehicle has been sitting or at least three hours or driven no more than 1.6 km (1 mile).

1. Remove the valve cap from the tire valve stem.
2. Press the tire gauge firmly onto the valve to get a pressure measurement. If the cold tire inflation pressure matches the recommended pressure on the tire and loading information label, no further adjustment is necessary.
3. If the pressure is low, add air until you reach the recommended amount.
4. If you overfill the tire, release air by pushing on the metal stem in the center of the tire valve.
5. Recheck the tire pressure with the tire gauge.
6. Be sure to put the valve caps back on the valve stems. They help prevent leaks by keeping out dirt and moisture.

Inspect your tires frequently for proper inflation as well as wear and damage. Always use a tire pressure gauge.

Tires with too much or too little pressure wear unevenly. This could result in poor handling, loss of vehicle control, and

sudden tire failure leading to accidents, injuries, and even death. The recommended cold tire pressure for your vehicle can be found in this manual and on the tire label located on the driver's side center pillar.

Tire rotation

To equalize tread wear, it is recommended that the tires be rotated every 13,000 km (8,000 miles) or sooner if irregular wear develops.

During rotation, check the tires for correct balance.

When rotating tires, check for uneven wear and damage. Abnormal wear is usually caused by incorrect tire pressure, improper wheel alignment, out-of-balance wheels, severe braking or severe cornering. Look for bumps or bulges in the tread or side of tire. Replace the tire if you find either of these conditions. Replace the tire if fabric or cord is visible. After rotation, be sure to bring the front and rear tire pressures to specification and check lug nut tightness. (proper torque is 11~13 kgf·m [79~94 lbf·ft])

Refer to "Tires and wheels" on page 9-5. Disc brake pads should be inspected for wear whenever tires are rotated.

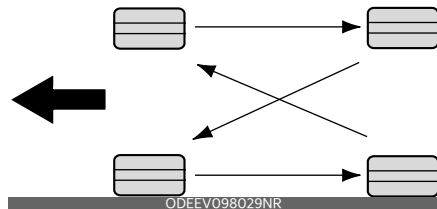

Rotate radial tires that have an asymmetric tread pattern only from front to rear and not from right to left.

⚠ WARNING

Mixing tires

- Do not use the compact spare tire (if equipped) for tire rotation.
- Do not mix bias ply and radial ply tires under any circumstances. This may cause unusual handling characteristics.

Wheel alignment and tire balance

The wheels on your vehicle were aligned and balanced carefully at the factory to give you the longest tire life and best overall performance.

In most cases, you will not need to have your wheels aligned again. However, if you notice unusual tire wear or your vehicle pulling one way or the other, the alignment may need to be reset.

If you notice your vehicle vibrating when driving on a smooth road, your wheels may need to be rebalanced.

⚠ CAUTION

Wheel weight

Improper wheel weights can damage your vehicle's aluminum wheels. Use only approved wheel weights.

Tire replacement

If the tire is worn evenly, a tread wear indicator (A) will appear as a solid band across the tread.



This shows there is less than 1.6 mm (1/16 inch) of tread left on the tire. Replace the tire when this happens.

Do not wait for the band to appear across the entire tread before replacing the tire.

The Anti-lock Brake System (ABS) works by comparing the speed of the wheels. The tire size affects wheel speed. When replacing tires, all 4 tires must use the same size originally supplied with the vehicle. Using tires of a different size can cause the ABS and Electronic Stability Control (ESC) to work irregularly.

It is best to replace all four tires at the same time. If that is not possible, or necessary, then replace the two front or two rear tires as a pair. Replacing just one tire can seriously affect your vehicle's handling.

*** NOTICE**

We recommend that when replacing tires, use the same ones as those that were originally supplied with the vehicles. If not, that affects driving performance.

Compact spare tire replacement

A compact spare tire has a shorter tread life than a regular size tire.

Replace it when you can see the tread wear indicator bars on the tire. The replacement compact spare tire should be the same size and design tire as the one provided with your new vehicle and should be mounted on the same compact spare tire wheel. The compact spare tire is not designed to be mounted on a regular size wheel, and the compact spare tire wheel is not designed for mounting a regular size tire.

Wheel replacement

When replacing the metal wheels for any reason, make sure the new wheels are equivalent to the original factory units in diameter, rim width and offset.

A wheel with an incorrect size may adversely affect many things: wheel and bearing life, braking and stopping abilities, handling characteristics, ground clearance, body-to-tire clearance, snow chain clearance, speedometer and odometer calibration, headlight aiming and bumper height.

CAUTION

Wheels

Wheels that do not meet Kia specifications may fit poorly and result in damage to the vehicle or unusual handling and poor vehicle control.

Tire traction

Tire traction can be reduced if you drive on worn tires, tires that are improperly inflated or on slippery road surfaces.

Tires should be replaced when tread wear indicators appear. Slow down whenever there is rain, snow or ice on the road to reduce the possibility of losing control of the vehicle.

Tire maintenance

In addition to proper inflation, correct wheel alignment helps to decrease tire wear.

If you find a tire is worn unevenly, have your dealer check the wheel alignment.

When you have new tires installed, make sure they are balanced. This will increase vehicle ride comfort and tire life. Additionally, a tire should always be rebalanced if it is removed from the wheel.

Tire sidewall labeling

This information identifies and describes the fundamental characteristics of the tire and also provides the Tire Identification Number (TIN) for safety standard certification.

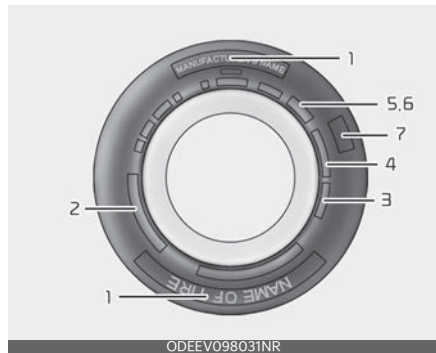

The TIN can be used to identify the tire in case of a recall.

1. Manufacturer or brand name

Manufacturer or Brand name is shown.

2. Tire size designation

A tire's sidewall is marked with a tire size designation. You will need this information when selecting replacement tires for your vehicle. The following explains

what the letters and numbers in the tire size designation mean.

Example tire size designation:

(These numbers are provided as an example only; your tire size designator could vary depending on your vehicle.)

P235/45R18 94V

- P: Applicable vehicle type (tires marked with the prefix "P" are intended for use on passenger vehicles or light trucks; however, not all tires have this marking).
- 235: Tire width in millimeters.
- 45: Aspect ratio. The tire's section height as a percentage of its width.
- R: Tire construction code (Radial).
- 18: Rim diameter in inches.
- 94: Load Index, a numerical code associated with the maximum load the tire can carry.
- V: Speed Rating Symbol. See the speed rating chart in this section for additional information.

Wheel size designation

Wheels are also marked with important information that you need if you ever have to replace one. The following explains what the letters and numbers in the wheel size designation mean.

Example wheel size designation:

7.0JX17

- 7.0: Rim width in inches.
- J: Rim contour designation.
- 17: Rim diameter in inches.

Tire speed ratings

The chart below lists many of the different speed ratings currently being used for passenger vehicle tires. The speed rating is part of the tire size designation

on the sidewall of the tire. This symbol corresponds to that tire's designed maximum safe operating speed.

Speed Rating Symbol	Maximum Speed
S	180 km/h (112 mph)
T	190 km/h (118 mph)
H	210 km/h (130 mph)
V	240 km/h (149 mph)
W	270 km/h (168 mph)
Y	300 km/h (186 mph)

3. Checking tire life

Any tires that are over 6 years old, based on the manufacturing date, should be replaced by new ones. You can find the manufacturing date on the tire sidewall (possibly on the inside of the wheel), displaying the DOT code. The DOT code is a series of numbers on a tire consisting of numbers and English letters. The manufacturing date is designated by the last four digits (characters) of the DOT code.

DOT: XXXX XXXX OOOO

The front part of the DOT means a plant code number, tire size and tread pattern and the last four numbers indicate week and year manufactured.

For example:

DOT XXXX XXXX 1624 represents that the tire was produced in the 16th week of 2024.

⚠ WARNING

Tire age

Replace tires within the recommended time frame. Failure to replace tires as recommended can result in sudden tire failure, which could lead to a loss of control and an accident.

4. Tire ply composition and material

The number of layers or plies of rubber-coated fabric in the tire. Tire manufacturers also must indicate the materials in the tire, which include steel, nylon, polyester, and others. The letter "R" means radial ply construction; the letter "D" means diagonal or bias ply construction; and the letter "B" means belted-bias ply construction.

5. Maximum permissible inflation pressure

This number is the greatest amount of air pressure that should be put in the tire. Do not exceed the maximum permissible inflation pressure. Refer to "Tire and loading information label" on page 5-60 for recommended inflation pressure.

6. Maximum load rating

This number indicates the maximum load in kilograms and pounds that can be carried by the tire. When replacing the tires on the vehicle, always use a tire that has the same load rating as the factory installed tire.

7. Uniform tire quality grading

Quality grades can be found where applicable on the tire sidewall between tread shoulder and maximum section width.

For example:

- Treadwear 200
- Traction AA
- Temperature A

Tires degrade over time, even when they are not being used. Regardless of the

remaining tread, we recommend that tires be replaced after approximately six (6) years of normal service. Heat caused by hot climate or frequent high loading conditions can accelerate the aging process.

Tread wear

The tread wear grade is a comparative rating based on the wear rate of the tire when tested under controlled conditions on a specified government test course. For example, a tire graded 150 would wear one-and-a-half times (1½) as well on the government course as a tire graded 100.

The relative performance of tires depends upon the actual conditions of their use. Performance may depart significantly from the norm due to variations in driving habits, service practices and differences in road characteristics and climate.

These grades are molded on the sidewalls of passenger vehicle tires. The tires available as standard or optional equipment on your vehicle may vary with respect to grade.

Traction - AA, A, B & C

The traction grades, from highest to lowest, are AA, A, B and C. Those grades represent the tire's ability to stop on wet pavement as measured under controlled conditions on specified government test surfaces of asphalt and concrete. A tire marked C may have poor traction performance.

The traction grade assigned to this tire is based on straight-ahead braking traction tests, and does not include acceleration, cornering, hydroplaning, or peak traction characteristics.

Temperature -A, B & C

The temperature grades are A (the highest), B and C representing the tire's resistance to the generation of heat and its ability to dissipate heat when tested under controlled conditions on a specified indoor laboratory test wheel.

Sustained high temperature can cause the material of the tire to degenerate and reduce tire life, and excessive temperature can lead to sudden tire failure. Grades B and A represent higher levels of performance on the laboratory test wheel than the minimum required by law.

Tire terminology and definitions

Refer to the following for detailed definitions of the terms that are found in the tire description.

Air Pressure The amount of air inside the tire pressing outward on the tire. Air pressure is expressed in kilopascal (kPa) or pounds per square inch (psi).

Accessory Weight The combined weight of optional accessories. Some examples of optional accessories are automatic transmission, power seats, and air conditioning.

Aspect Ratio The relationship of a tire's height to its width.

Belt A rubber coated layer of cords that is located between the plies and the tread. Cords may be made from steel or other reinforcing materials.

Bead The tire bead contains steel wires wrapped by steel cords that hold the tire onto the rim.

Bias Ply Tire A pneumatic tire in which the plies are laid at alternate angles less than 90 degrees to the centerline of the tread.

Cold Tire Pressure The amount of air pressure in a tire, measured in kilopascal (kPa) or pounds per square inch (psi) before a tire has built up heat from driving.

Curb Weight The weight of a motor vehicle with standard and optional equipment (including the maximum capacity of fuel, oil and coolant), but without passengers and cargo.

DOT Markings The DOT code includes the Tire Identification Number (TIN), an alphanumeric designator which can also identify the tire manufacturer, production plant, brand and date of production.

GVWR Gross Vehicle Weight Rating

GAWR FRT Gross Axle Weight Rating for the Front axle.

GAWR RR Gross Axle Weight Rating for the Rear axle.

Intended Outboard Sidewall The side of an asymmetrical tire that must always face outward when mounted on a vehicle.

Kilopascal (kPa) The metric unit for air pressure.

Light truck (LT) tire A tire designated by its manufacturer as primarily intended for use on lightweight trucks or multipurpose passenger vehicles.

Load ratings The maximum load that a tire is rated to carry for a given inflation pressure.

Load Index An assigned number ranging from 1 to 279 that corresponds to the load carrying capacity of a tire.

Maximum Inflation Pressure The maximum air pressure to which a cold tire may be inflated. The maximum air pressure is molded onto the sidewall.

Maximum Load Rating The load rating for a tire at the maximum permissible inflation pressure for that tire.

Maximum Loaded Vehicle Weight The sum of curb weight; accessory weight; vehicle capacity weight; and production options weight.

Normal Occupant Weight The number of occupants a vehicle is designed to seat multiplied by 68 kg (150 lbs.).

Occupant Distribution Designated seating positions.

Outward Facing Sidewall The side of an asymmetrical tire that has a particular side that faces outward when mounted on a vehicle. The outward facing sidewall bears white lettering or bears manufacturer, brand, and/or model name molding that is higher or deeper than the same moldings on the inner facing sidewall.

Passenger (P-Metric) Tire A tire used on passenger cars and some light duty trucks and multipurpose vehicles.

Ply A layer of rubber-coated parallel cords.

Pneumatic tire A mechanical device made of rubber, chemicals, fabric and steel or other materials, that, when mounted on an automotive wheel, provides the traction and contains the gas or fluid that sustains the load.

Production options weight The combined weight of installed regular production options weighing over 2.3 kg (5 lbs.) in excess of the standard items which they replace, not previously considered in curb weight or accessory weight. Examples include heavy duty brakes, ride levelers, roof rack, heavy duty battery, and special trim.

Recommended Inflation Pressure Vehicle manufacturer's recommended

tire inflation pressure and shown on the tire placard.

Radial Ply Tire A pneumatic tire in which the ply cords that extend to the beads are laid at 90 degrees to the centerline of the tread.

Rim A metal support for a tire and upon which the tire beads are seated.

Sidewall The portion of a tire between the tread and the bead.

Speed Rating An alphanumeric code assigned to a tire indicating the maximum speed at which a tire can operate.

Traction The friction between the tire and the road surface. The amount of grip provided.

Tread The portion of a tire that comes into contact with the road.

Treadwear Indicators Narrow bands, sometimes called "wear bars," that show across the tread of a tire when only 1.6 mm (2/32 inch) of tread remains.

UTQGS Uniform Tire Quality Grading Standards, a tire information system that provides consumers with ratings for a tire's traction, temperature and treadwear. Ratings are determined by tire manufacturers using government testing procedures. The ratings are molded into the sidewall of the tire.

Vehicle Capacity Weight The weight of designated seating positions multiplied by 68 kg (150 lbs.) plus the rated cargo and luggage load.

Vehicle Maximum Load on the Tire Load on an individual tire due to curb and accessory weight plus maximum occupant and cargo weight.

Vehicle Normal Load on the Tire Load on an individual tire that is determined by distributing to each axle its share of the curb weight, accessory weight, and

normal occupant weight and driving by 2.

Vehicle Placard A label permanently attached to a vehicle showing the original equipment tire size and recommended inflation pressure.

All season tires

Kia specifies all season tires on some models to provide good performance for use all year round, including snowy and icy road conditions.

All season tires are identified by ALL SEASON and/or M+S (Mud and Snow) on the tire sidewall. Snow tires have better snow traction than all season tires and may be more appropriate in some areas.

Summer tires

Kia specifies summer tires on some models to provide superior performance on dry roads.

Summer tire performance is substantially reduced in snow and ice. Summer tires do not have the tire traction rating M+S (Mud and Snow) on the tire sidewall. If you plan to operate your vehicle in snowy or icy conditions, Kia recommends the use of snow tires or all season tires on all four wheels.

Snow tires

If you equip your vehicle with snow tires, they should be the same size and have the same load capacity as the original tires.

Snow tires should be installed on all four wheels; otherwise, poor handling may result.

Snow tires should carry 28 kPa (4 psi) more air pressure than the pressure recommended for the standard tires on the tire label on the driver's side of the cen-

ter pillar, or up to the maximum pressure shown on the tire sidewall, whichever is less.

Do not drive faster than 120 km/h (75 mph) when your vehicle is equipped with snow tires.

WARNING

Do not use summer tires at temperatures below 7 °C (45 °F) or when driving on snow or ice. At temperatures below 7 °C (45 °F), summer tires can lose elasticity, and therefore traction and braking power as well. Change the tires on your vehicle to winter or all-weather tires of the same size as the standard tires of the vehicle. Both types of tires are identified by the M+S (Mud and Snow) marking. Using summer tires at very cold temperatures could cause cracks to form, thereby damaging the tires permanently.

Radial-ply tires

Radial-ply tires provide improved tread life, road hazard resistance and smoother high speed ride.

The radial-ply tires used on this vehicle are of belted construction, and are selected to complement the ride and handling characteristics of your vehicle. Radial-ply tires have the same load carrying capacity, as bias-ply or bias belted tires of the same size, and use the same recommended inflation pressure.

Mixing of radial-ply tires with bias-ply or bias belted tires is not recommended. Any combinations of radial-ply and bias-ply or bias belted tires when used on the same vehicle will seriously deteriorate vehicle handling. The best rule to follow is: Identical radial-ply tires should always be used as a set of four.

Longer wearing tires can be more susceptible to irregular tread wear. It is very important to follow the tire rotation interval shown in this section to achieve the tread life potential of these tires. Cuts and punctures in radial-ply tires are repairable only in the tread area, because of sidewall flexing. Consult your tire dealer for radial-ply tire repairs.

Low aspect ratio tire (if equipped)

Low aspect ratio tires, whose aspect ratio is lower than 50, are provided for sporty looks.

Because the low aspect ratio tires are optimized for handling and braking, it may be more uncomfortable to ride in and there is more noise compare with normal tires.

CAUTION

Because the sidewall of the low aspect ratio tire is shorter than normal, the wheel and tire of the low aspect ratio tire is more easily damaged. So, follow the instructions below.

- When driving on a rough road or off road, drive cautiously because tires and wheels may be damaged. And after driving, inspect tires and wheels.
- When passing over a pothole, speed bump, manhole, or curb stone, drive slowly so that the tires and wheels are not damaged.
- If the tire is impacted, we recommend that you inspect the tire condition or contact an authorized Kia dealer.
- To prevent damage to the tire, inspect the tire condition and pressure every 3,000 km (1,900 miles).

there is the slightest hint of tire damage, even though you cannot see the tire damage with your own eyes, have the tire checked or replaced because the tire damage may cause air leakage from the tire.

- If the tire is damaged by driving on a rough road, off road, pothole, manhole, or curb stone, it will not be covered by the warranty.
- You can find out the tire information on the tire sidewall.

-
- It is not easy to recognize the tire damage with your own eyes. But if

Fuses

A vehicle's electrical system is protected from electrical overload damage by fuses.

Blade type



Cartridge type



Multi fuse

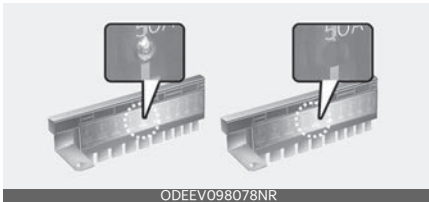

BFT



* Left side: Normal, Right side: Blown
This vehicle has 2 (or 3) fuse panels, one located in the driver's side panel bolster, the other in the engine compartment near the battery.

If any of your vehicle's lights, accessories, or controls do not work, check the appropriate circuit fuse. If a fuse has blown, the element inside the fuse will melt.

If the electrical system does not work, first check the driver's side fuse panel. If the replacement fuse blows, this indicates an electrical problem. Avoid using the system involved and immediately consult an authorized Kia dealer.

Three kinds of fuses are used: blade type for lower amperage rating, cartridge type, and multi fuse for higher amperage ratings.

⚠ WARNING

Fuse replacement

- Never replace a fuse with anything but another fuse of the same rating.
- A higher capacity fuse could cause damage and possibly a fire.
- Never install a wire or aluminum foil instead of the proper fuse - even as a temporary repair. It may cause extensive wiring damage and a possible fire.
- Do not arbitrarily modify or add-on electric wiring to the vehicle.

* NOTICE

- When replacing a fuse, turn the ignition 'OFF' and turn off switches of all electrical devices, then remove battery (-) terminal.
- The actual fuse/relay panel label may differ from equipped items.

⚠ WARNING

Electrical Fire

Always ensure replacement fuses and relays are securely fastened when

installed. Failure to do so can result in a vehicle fire.

Do not remove fuses, relays and terminals fastened with bolts or nuts. The fuses, relays and terminals may be fastened incompletely, and it may cause a possible fire. If fuses, relays and terminals fastened with bolts or nuts are blown, consult with an authorized Kia dealer.

⚠ CAUTION

When replacing a blown fuse or relay, make sure the new fuse or relay fits tightly into the clips. Failure to tightly install the fuse or relay may cause damage to the wiring and electric systems.

⚠ CAUTION

- Do not input any other objects except fuses or relays into fuse/relay terminals, such as a screwdriver or wiring. It may cause contact failure and system malfunction.
- Do not plug in screwdrivers or after-market wiring into the terminal originally designed for fuse and relays only. The electrical system and wiring of the vehicle interior may be damaged or burned due to contact failure.
- If you directly connect the wire on the taillight or replace the bulb, which is over the regulated capacity to install trailers etc., the inner junction block can get burned.

⚠ WARNING

Electrical wiring repairs

All electrical repairs should be performed by authorized Kia dealerships using approved Kia parts. Using other wiring components, especially when re-

fitting multimedia or theft alarm system, car phone or radio may cause vehicle damage and increase the risk of a vehicle fire.

* NOTICE

Remodeling Prohibited

Do not rewire your vehicle in any way, as doing so may affect the performance of several safety features in your vehicle. Rewiring your vehicle may also void your warranty and cause you to be responsible for any subsequent vehicle damage, which may result.

Replacing inner panel fuse

1. Turn the ignition 'OFF' and all other switches off.
2. Open the fuse panel cover.



3. Pull the suspected fuse straight out. Use the removal tool provided on the engine fuse panel cover.

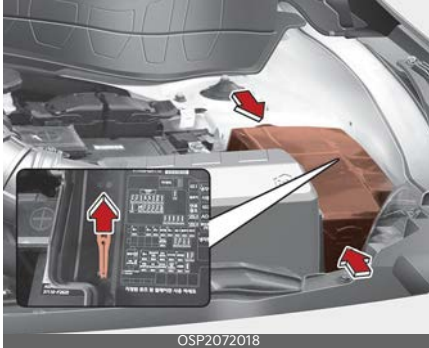

4. Check the removed fuse; replace it if it is blown.

Spare fuses are provided in the engine compartment fuse panel.

5. Push in a new fuse of the same rating, and make sure it fits tightly in the clips.

If it fits loosely, consult an authorized Kia dealer.

If you do not have a spare, use a fuse of the same rating from a circuit you may not need for operating the vehicle, such as the power outlet fuse.

If the head lamp, turn signal lamp, stop signal lamp, fog lamp, DRL, tail lamp, High Mounted Stop Lamp (HMSL) do not work and the fuses are OK, check the fuse panel in the engine compartment. If a fuse is blown, it must be replaced.

* NOTICE

If the headlamp, fog lamp, turn signal lamp, or tail lamp malfunctions, even without any problem to the lamps, have the vehicle checked by an authorized Kia dealer for assistance.

Replacing engine compartment fuse

1. Turn the ignition 'OFF' and all other switches off.

2. Remove the fuse panel cover by pressing the tab and pulling the cover up.

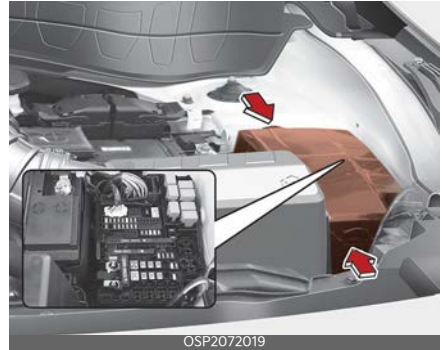

3. Check the removed fuse; replace it if it is blown. To remove or insert the fuse, use the fuse puller in the engine compartment fuse panel.

4. Push in a new fuse of the same rating, and make sure it fits tightly in the clips. If it fits loosely, consult an authorized Kia dealer.

⚠ CAUTION

Always securely install the fuse panel cover in the engine compartment to protect against electrical failure which may occur from water contact. Listen for the audible clicking sound to ensure fuse panel cover is securely fastened.

Multi fuse

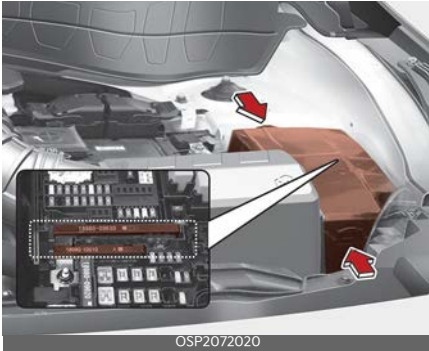

If the multi fuse is blown, it must be removed as follows:

1. Turn the ignition 'OFF' and all other switches off.
2. Disconnect the negative battery cable.
3. Remove the nuts shown in the picture above.
4. Replace the fuse with a new one of the same rating.
5. Reverse these steps to reinstall the multi fuse.

* NOTICE

Do not disassemble nor assemble the multi fuse when it is secured with nuts and bolts. Incorrect or partial assembly torque may cause a fire. Have the vehicle checked by an authorized Kia dealer.

Main fuse

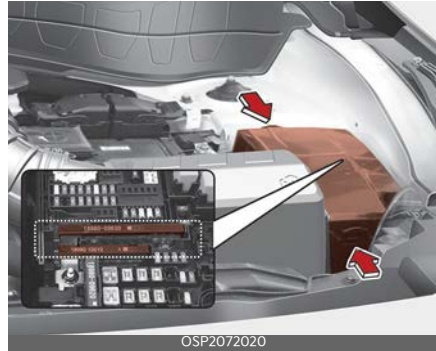

If the main fuse is blown, it must be removed as follows:

1. Turn the ignition 'OFF' and all other switches off.
2. Disconnect the negative battery cable.
3. Remove the nuts shown in the picture above.
4. Replace the fuse with a new one of the same rating.
5. Reverse these steps to reinstall the multi fuse.

* NOTICE

The electronic system may not function correctly even when the engine compartment and internal fuse box's individual fuses are not disconnected. In such cases, the cause of the problem may be disconnection of the main fuse (BFT type), which is located inside the positive battery terminal (+) cap.

Since the main fuse is designed more intricately than other parts, have the vehicle checked by an authorized Kia dealer.

*** NOTICE**

Do not disassemble nor assemble the main fuse when it is secured with nuts and bolts. Incorrect or partial assembly torque may cause a fire. Have the vehicle checked by an authorized Kia dealer.

Battery fuse

If the battery fuse is blown, it must be removed as follows:

1. Disconnect the negative battery cable.
2. Remove the nuts shown in the picture below.



3. Replace the fuse with a new one of the same rating.
4. Reinstall in the reverse order of removal.

*** NOTICE**

If the battery fuse is blown, have the vehicle checked by an authorized Kia dealer.

⚠ CAUTION

Visually inspect the battery cap to ensure it is securely closed. If the battery cap is not securely closed, moisture may enter the system and damage the electrical components.

Fuse/relay panel description

Inside the fuse/relay panel covers, you can find the fuse/relay label describing fuse/relay name and capacity.

*** NOTICE**

Not all fuse panel descriptions in this manual may be applicable to your vehicle. It is accurate at the time of printing. When you inspect the fuse panel in your vehicle, refer to the fuse panel label on the inside of the fuse cover. This diagram will provide you with the specific information for your vehicles.



Driver's side fuse panel



OSP2N072040

P/SEAT PASS	30A	W/FR FR	15A				1	W/FR FR	8	MODLE	10A	15G	15A	MOPS	6	MODLE	75A
P/SEAT DRV	30A		S/HEATER FR	15A	1	BU	15A	2	AR BAG	10A	10A	2	BU	A/BAG NO	2	A/C	10A
AMP	25A	S/HEATER FR	20A	1	MODLE	START	75A					5	MODLE	CLUSTER	7	MODLE	75A
R/WINDOW RH	25A	SUNROOF	20A	2	MEMORY		2	MEMORY	4	MODLE	75A	3	MODLE	1	A/C		
R/WINDOW LH	25A	TALGATE OPEN	10A	10A	DOOR LOCK	10A	10A	10A	MULTI MEDIA	15A	HEATED MIRROR	10A	1	AR BAG	15A	POWER OUTLET	20A
													2	W/FR FR	25A	2	MODLE

91990-05520
 USE THE DESIGNATED FUSE ONLY
 UTILISEZ SEULEMENT LE FUSIBLE DÉSIGNÉS

OSP2N072036

Refer to the following table for a description of the fuse.

Instrument panel (Driver's side fuse panel)

Fuse Name	Fuse rating	Circuit Protected
P/SEAT (PASS)	30 A	Passenger Seat Manual Switch
P/SEAT (DRV)	30 A	IMS (Driver's memory seat) Control Module, Driver Seat Manual Switch
AMP	25 A	Low DC-DC Converter (AMP (Amplifier))
P/WINDOW RH	25 A	Power Window Right Handle Side Relay
P/WINDOW LH	25 A	Power Window Left Handle Side Relay, Driver Safety Power Window Module
WIPER RR	15 A	Rear Wiper Motor, ICM (Integrated Circuit Module) Relay Box (Rear Wiper Relay)
S/HEATER FRT	20 A	Front Air Ventilation Seat Control Module Front Seat Warmer Control Module
SUNROOF	20 A	Sunroof Unit
TAILGATE OPEN	10 A	Tailgate (Liftgate) Relay
S/HEATER RR	15 A	Rear Seat Warmer Control Module
MODULE 1	7.5 A	Hazard Switch, Data Link Connector, Passenger Power Window Switch, Power Window Main Switch, Power Liftgate Module, IMS (Driver's memory seat) Control Module, Key Interlock
BRAKE SWITCH	10 A	Stop Lamp Switch, IBU (Integrated Body Control Unit)
DOOR LOCK	20 A	Door Lock Relay, Door Unlock Relay, ICM (Integrated Circuit Module) Relay Box (Two Turn Unlock Relay)
IBU 1	15 A	IBU (Integrated Body Control Unit)
START	7.5 A	ICM (Integrated Circuit Module) Relay Box (Burglar Alarm Relay) [Smartstream G1.6 T-GDI] Transmission Range Switch [(Gasoline) 2.0 MPI] Position Switch
IAU	10 A	IAU (Identity Authentication Unit), Driver/Passenger_Handle_NFC Module
WIPER FRT 1	10 A	IBU (Integrated Body Control Unit)
AIR BAG 2	10 A	SRS (Supplemental Restraint System) Control Module
MEMORY 2	10 A	Air Conditioner Control Module, Crash Pad Switch, Mood Lamp Unit, Head-Up Display
MULTIMEDIA	15 A	Low DC-DC Converter
MODULE 8	10 A	IAU (Identity Authentication Unit)
IG1	25 A	PCB Block (Fuse Name - ABS 3/EPB 3, ECU 5, TCU3)
MODULE 4	7.5 A	Front Radar, IBU (Integrated Body Control Unit), Crash Pad Switch, AWD ECM (Engine Control Module), Front View Camera
HEATED MIRROR	10 A	ECM (Engine Control Module), Air Conditioner Control Module, Driver/Passenger Power Outside Mirror
ISG	15 A	Sound Mood Lamp, Driver/Passenger Door Mood Lamp, Low DC-DC Converter (AMP (Amplifier)), Rear Corner Radar LH/RH, Infotainment System Head Unit/Audio, Air Conditioner Control Module, Instrument Cluster, Wireless Charger, Head-Up Display
IBU 2	7.5 A	IBU (Integrated Body Control Unit)

Fuse Name	Fuse rating	Circuit Protected
MODULE 5	10 A	Electro Chromic Mirror, Wireless Charger, Automatic Transmission Shift Lever Indicator, Console Switch Left Handle Side Relay, Audio/Infotainment System Head Unit, Air Conditioner Control Module, AMP (Amplifier), Front Air Ventilation Seat Control Module, Rear Seat Warmer Control Module, Front Seat Warmer Control Module, Data Link Connector, IMS (Driver's memory seat) Control Module, Low DC-DC Converter
MODULE 3	7.5 A	Stop Lamp Switch, Automatic Transmission Shift Lever
AIR BAG 1	15 A	SRS (Supplemental Restraint System) Control Module, Passenger Occupant Detection Sensor
WIPER FRONT 2	25 A	PCB Block (Front Wiper (Low) Relay), Front Wiper Motor
MDPS	7.5 A	MDPS (Motor Driven Power Steering) Unit
A/BAG IND	7.5 A	Overhead Console Lamp, Instrument Cluster
CLUSTER	7.5 A	Instrument Cluster, Head-Up Display
A/C 1	7.5 A	Engine Room Junction Block (Blower Relay, PTC Heater #1/#2 Relay), Air Conditioner Control Module
POWER OUTLET	20 A	Front Power Outlet #2 (USB)
MODULE 2	10 A	IBU (Integrated Body Control Unit), Front Power Outlet #2 (USB), Power Outside Mirror Switch, ICM (Integrated Circuit Module) Relay Box (Power Outlet Relay), Low DC-DC Converter, Rear USB Charger
MODULE 6	7.5 A	IBU (Integrated Body Control Unit)
A/C 2	10 A	[Auto Air Conditioner] Blower Motor, Engine Room Junction Block (Blower Relay) [Manual Air Conditioner] Blower Resistor, Air Conditioner Control Module
MODULE 7	7.5 A	Front Deicer Box (Front Deicer Left Handle Side/Right Handle Side Relay)
WASHER	15 A	Multifunction Switch

Engine Room Junction Block

Fuse	Fuse Name	Fuse rating	Circuit Protected
MULTI FUSE-1	ALT	150 A	Alternator, Engine Room Junction Block (Fuse Name - EPB 1, ABS 1/EPB 2, ABS 2, POWER TAILGATE, 4WD)
		200 A	
	MDPS	80 A	MDPS (Motor Driven Power Steering) Unit
MULTI FUSE-2	B+3	60 A	Instrument Panel Junction Block (IPS1, IPS2, IPS3, IPS7, IPS10, IPS13, IPS20)
	B+4	60 A	Instrument Panel Junction Block (Fuse Name - P/SEAT (DRV/PASS), AMP, P/WINDOW RH, P/WINDOW LH, S/HEATER FRT, SUNROOF, TAILGATE OPEN)
	B+2	50 A	Instrument Panel Junction Block (IPS4, IPS5, IPS6, IPS8, IPS9, IPS11, IPS12)
	B+5	50 A	PCB Block (Main Relay, Fuse Name - A/C, B/ALARM HORN, ECU3, ECU4, HORN)
	IG1	40 A	[With Smart Key] Engine Room Junction Block (IG1 Relay, ACC Relay) [Without Smart Key] Ignition Switch
	BLOWER	40 A	Engine Room Junction Block (Blower Relay)
	IG2	40 A	[With Smart Key] Engine Room Junction Block (Start Relay, IG2 Relay) [Without Smart Key] Engine Room Junction Block (Start Relay), Ignition Switch
MULTI FUSE-3	COOLING FAN 1	80 A	[Smartstream G1.6 T-GDI] Cooling Fan Motor
	PTC HEATER 1	50 A	Engine Room Junction Block (PTC Heater 1 Relay)
	PTC HEATER 2	50 A	Engine Room Junction Block (PTC Heater 2 Relay)
FUSE	POWER OUT-LET	25 A	ICM (Integrated Circuit Module) Relay Box (Power Outlet Relay)
	TCU 2	15 A	[Smartstream G1.6 T-GDI] TCM (Transmission Control Module)
	HEAD LAMP LH	15 A	Head Lamp Left Handle Side
	HEAD LAMP RH	15 A	Head Lamp Right Handle Side
	B+1	50 A	Instrument Panel Junction Block (Long Term Load Auto Cut Relay, Fuse Name - S/HEATER RR, MODULE 1, BRAKE SWITCH, DOOR LOCK, IBU1, IAU, AIR BAG 2)
	REAR HEATED	30 A	Engine Room Junction Block (Rear Heated Relay)
	CVVD/EOP	40 A	[Smartstream G1.6 T-GDI] CVVD (Continuous Variable Valve Duration) Actuator [[Gasoline] 2.0 MPI] Electronic Oil Pump Module (ISG)
	COOLING FAN 2	40 A	Engine Room Junction Block (Cooling Fan 1 Relay, Cooling Fan 2 Relay)
	FUEL PUMP	20 A	Engine Room Junction Block (Fuel Pump Relay)

Fuse	Fuse Name	Fuse rating	Circuit Protected
FUSE	TCU 1	15 A	PCM (Power train Control Module)/ TCM (Transmission Control Module)
	EPB 1	60 A	[With EPB (Electronic parking brake)] ESC (Electronic Stability Control) Module
	POWER TAIL-GATE	40 A	Power Tailgate (Liftgate) Module
	ABS 1/EPB 2	40 A	[ABS] ESC (Electronic Stability Control) Module (Without EPB (Electronic parking brake)) [EPB] ESC (Electronic Stability Control) Module (With EPB (Electronic parking brake))
	ABS 2	30 A	[Without EPB (Electronic parking brake)] ESC (Electronic Stability Control) Module
	4WD	20 A	AWD ECM (Engine Control Module)

PCB Block

Fuse Name	Fuse rating	Circuit Protected
ECU 1	20 A	[Smartstream G1.6 T-GDI] ECM (Engine Control Module) [[Gasoline] 2.0 MPI] PCM (Power train Control Module)
ECU 2	10 A	[Smartstream G1.6 T-GDI] ECM (Engine Control Module)
O2 SENSOR	15 A	Oxygen Sensor (Up/Down)
SENSOR 1	10 A	[All] Oil Control Valve #1, Oil Control Valve #2, Air Conditioner Relay, Purge Control Solenoid Valve, Canister Close Valve [Smartstream G1.6 T-GDI] Cooling Fan Motor, RCV (Recirculation Valve Control) Control Solenoid Valve, Variable Oil Pump Valve, Oil Level Sensor [[Gasoline] 2.0 MPI] Variable Intake Solenoid Valve, Oil Control Valve #3, Engine Room Junction Block (Cooling Fan 2 Relay, Cooling Fan 1 Relay)
SENSOR 2	10 A	Engine Room Junction Block (Fuel Pump Relay)
IGN COIL	20 A	Ignition Coil #1~#4
A/C	10 A	Air Conditioner Relay
B/ALARM HORN	10 A	Burglar Alarm Horn Relay
INJECTOR	15 A	[[Gasoline] 2.0 MPI] Injector #1~#4
ABS 3	10 A	[Without EPB (Electronic parking brake)] ESC (Electronic Stability Control) Module
EPB 3		[With EPB (Electronic parking brake)] ESC (Electronic Stability Control) Module
TCU 3	15 A	[Smartstream G1.6 T-GDI] TCM (Transmission Control Module) [[Gasoline] 2.0 MPI] Electric Oil Pump (ISG)
ECU 5	10 A	[Smartstream G1.6 T-GDI] ECM (Engine Control Module), CVVD (Continuous Variable Valve Duration) Actuator [[Gasoline] 2.0 MPI] PCM (Power train Control Module)
ECU 3	15 A	[Smartstream G1.6 T-GDI] ECM (Engine Control Module) [[Gasoline] 2.0 MPI] PCM (Power train Control Module)
ECU 4	15 A	[Smartstream G1.6 T-GDI] ECM (Engine Control Module)
HORN	15 A	Horn Relay

Relay

Refer to the following table for the relay type.

Relay NO.	Relay Name	Type
E61	IG1 Relay	MICRO
E62	BLOWER Relay	MICRO
E63	FUEL PUMP Relay	MICRO
E64	COOLING FAN 2 Relay	MICRO
E65	START Relay	MICRO
E66	IG2 Relay	MICRO
E67	ACC Relay	MICRO
E69	COOLING FAN 1 Relay	MINI
E70	REAR HEATED Relay	MINI
E71	PTC HEATER 1 Relay	MICRO
E72	PTC HEATER 2 Relay	MICRO

Battery terminal cover



Type A

 91971-F2100

지정된 퓨즈만 사용하세요
 USE THE DESIGNATED FUSE ONLY
 используйте только предназначенные предохранители
 USE SOLO LOS FUSIBLES ESPECIFICADOS
 استخدم الفيوز ذو القياس المناسب

OSP2072027

Type B

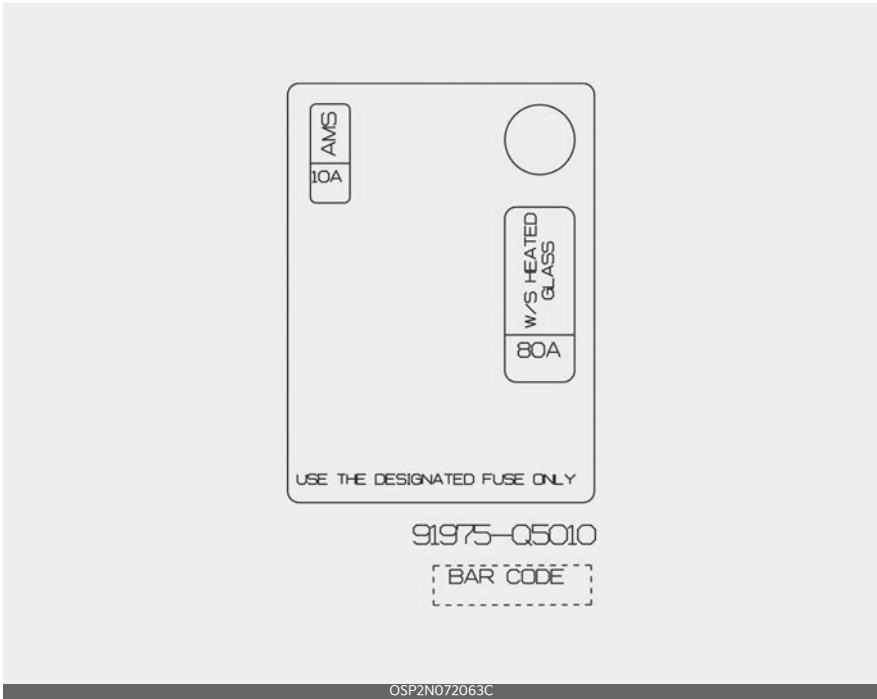

*** NOTICE**

Not all fuse panel descriptions in this manual may be applicable to your vehicle. It is accurate at the time of printing. When you inspect the fuse panel in your vehicle, refer to the fuse panel label.

Light bulbs

Light bulbs are installed in various parts of the vehicle to provide lighting inside and outside the vehicle as well as to alert other vehicles.

Bulb replacement precaution

Please keep extra bulbs on hand with appropriate wattage ratings in case of emergencies.

Refer to "Bulb wattage" on page 9-4.

When changing lamps, first turn off the vehicle at a safe place, firmly apply the parking brake and detach the battery's negative (-) terminal.

⚠ WARNING

Working on the lights

Prior to working on the light, firmly apply the parking brake, ensure that turn the ignition switch and turn off the lights to avoid sudden movement of the vehicle and burning your fingers or receiving an electric shock.

Use only bulbs of the specified wattage.

⚠ CAUTION

Light replacement

Be sure to replace the burned-out bulb with one of the same wattage rating. Otherwise, it may cause damage to the fuse or electric wiring system.

Fully install light bulbs and any parts used to secure them. Failure to do so may result in heat damage, fire, or water entering the headlight unit. This may damage the headlights or cause condensation to build up on the lens. To prevent damage or fire, make sure bulbs are fully seated and locked.

⚠ CAUTION

Headlamp Lens

To prevent damage, do not clean the headlamp lens with chemical solvents or strong detergents.

* NOTICE

- If the light bulb or lamp connector is removed while the lamp is still on, the fuse box's electronic system may log it as a malfunction. Therefore, a lamp malfunction incident may be recorded as a Diagnostic Trouble Code (DTC) in the fuse box.
- It is normal for an operating lamp to flicker momentarily. This is due to a stabilization function of the vehicle's electronic control device. If the lamp lights up normally after momentarily blinking, then it is functioning as normal.

However, if the lamp continues to flicker several times or turns off completely, there may be an error in the vehicle's electronic control device. Please have the vehicle checked by an authorized Kia dealer immediately.

* NOTICE

Have the headlight aiming adjusted by an authorized Kia dealer after an accident or after the headlight assembly is reinstalled.

* NOTICE

You can find moisture inside the lens of lamps after a car wash or driving in the rain. It is a natural event caused by the temperature difference between the inside and the outside of the lamp and does not mean there is a problem with

its functions. The moisture inside the lamp would disappear if you drive the vehicle with the headlamp turned on. However, the level at which the moisture is removed may differ depending on the size/location/condition of the lamp. If the moisture continues to stay inside the lamp, have the vehicle checked by an authorized Kia dealer.

If you don't have the necessary tools, the correct bulbs and the expertise, consult an authorized Kia dealer. In many cases, it is difficult to replace vehicle light bulbs because other parts of the vehicle must be removed before you can get to the bulb. This is especially true if you have to remove the headlamp assembly to get to the bulb(s).

Removing/installing the headlamp assembly can result in damage to the vehicle. If non-genuine parts or standard bulbs are used, it may lead to blowing a fuse or other wiring damages. Kia Genuine Parts we guarantee for quality and performance.

Do not install extra lamps or LEDs to the vehicle. If additional lights are installed, it may lead to lamp malfunctions and flickering. Additionally, the fuse box and other wiring may be damaged.

Light bulb position (Front)

Headlamp - Type A



Headlamp - Type B

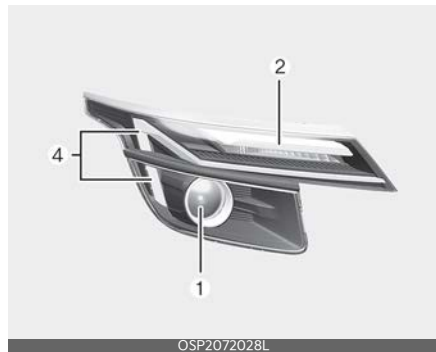

Headlamp - Type C

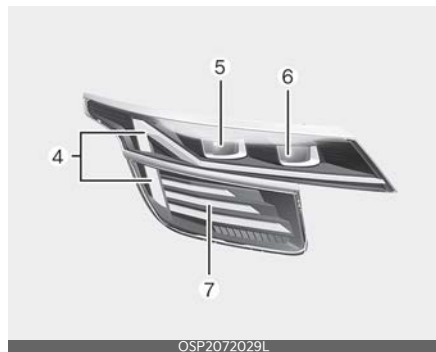

Fog lamp - Type A



Fog lamp - Type B



Position lamp

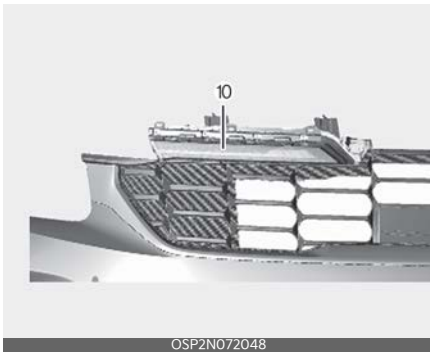

- 1 Headlamp (High/Low) (Bulb type)
- 2 Turn signal lamp (Bulb type)

- 3 Position lamp/Daytime running lamp (Bulb type)
- 4 Position lamp/Daytime running lamp (LED type)
- 5 Headlamp (Low/Low assist) (LED type)
- 6 Headlamp (High) (LED type)
- 7 Turn signal lamp (LED type)
- 8 Front fog lamp (Bulb type)
- 9 Front fog lamp (LED type)
- 10 Position lamp (auxiliary) (LED type)

Light bulb position (Rear)

Rear combination lamp - Type A

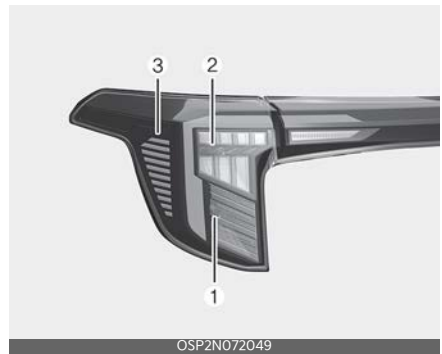

Rear combination lamp - Type B



Back-up lamp



License Plate lamp



High Mounted Stop Lamp



- 3 Side marker lamp (Bulb type)
- 4 Tail lamp (LED type)
- 5 Tail lamp/Stop lamp & Side marker lamp (LED type)
- 6 Side marker lamp (LED type)
- 7 Back up lamp (Bulb type)
- 8 License plate lamp (Bulb type)
- 9 High mounted stop lamp (LED type)

Light bulb position (Side)



- 1 Side repeater lamp (Bulb type)
- 2 Front side marker lamp

- 1 Tail lamp/Stop lamp & Side marker lamp (Bulb type)
- 2 Rear turn signal lamp (Bulb type)

Headlamp bulb



WARNING

Halogen bulbs

Handle halogen bulbs with care.

- Halogen bulbs contain pressurized gas that will produce flying pieces of glass if broken.
- Always handle them carefully, and avoid scratches and abrasions. If the bulbs are lit, avoid contact with liquids. Never touch the glass with bare hands. Residual oil may cause the bulb to overheat and burst when lit. A bulb should be operated only when installed in a headlamp.
- If a bulb becomes damaged or cracked, replace it immediately and carefully dispose of it.
- Wear eye protection when changing a bulb. Allow the bulb to cool down before handling it.

Headlamp (High/Low)/Turn signal lamp/Position lamp/Daytime running lamp (Bulb type) bulb replacement - Headlamp Type A

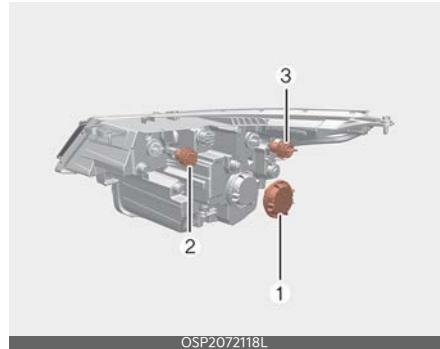

- 1 Headlamp (low and high)
- 2 Turn signal lamp
- 3 Position lamp / daytime running lamp

To prepare replacing the lamp bulb:

1. Open the hood.

To replace the headlamp (low/high) bulb:

1. Remove the headlight bulb cover by turning it counterclockwise.
2. Disconnect the headlight bulb socket-connector.
3. Unsnap the headlight bulb retaining wire by depressing the end and pushing it upward.
4. Remove the bulb from the headlight assembly.
5. Install a new headlight bulb and snap the headlight bulb retaining wire into position by aligning the wire with the groove on the bulb.
6. Connect the headlight bulb socket connector.
7. Install the headlight bulb cover by turning it clockwise.

To replace the turn signal lamp, position lamp, daytime running lamp bulb:

1. Remove the socket from the assembly by turning the socket counterclockwise until the tabs on the socket align with the slots on the assembly.
2. Insert a new bulb by inserting it into the socket and rotating it until it locks into place.
3. Install the socket in the assembly by aligning the tabs on the socket with the slots in the assembly.
4. Push the socket into the assembly and turn the socket clockwise.

Headlamp (High/Low)/Turn signal lamp (Bulb type) bulb replacement - Headlamp Type B

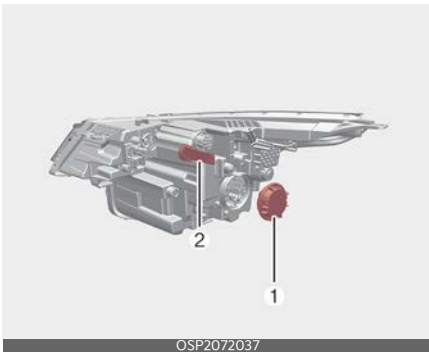

- 1** Headlamp (High/Low)
2 Turn signal lamp

To prepare replacing the lamp bulb:

1. Open the hood.

To replace the headlamp (low/high) bulb:

1. Remove the headlight bulb cover by turning it counterclockwise.
2. Disconnect the headlight bulb socket-connector.

3. Unsnap the headlight bulb retaining wire by depressing the end and pushing it upward.
4. Remove the bulb from the headlight assembly.
5. Install a new headlight bulb and snap the headlight bulb retaining wire into position by aligning the wire with the groove on the bulb.
6. Connect the headlight bulb socket connector.
7. Install the headlight bulb cover by turning it clockwise.

To replace the turn signal lamp:

1. Remove the socket from the assembly by turning the socket counterclockwise until the tabs on the socket align with the slots on the assembly.
2. Insert a new bulb by inserting it into the socket and rotating it until it locks into place.
3. Install the socket in the assembly by aligning the tabs on the socket with the slots in the assembly.
4. Push the socket into the assembly and turn the socket clockwise.

Position lamp/Daytime running lamp (LED type) bulb replacement - Headlamp Type B

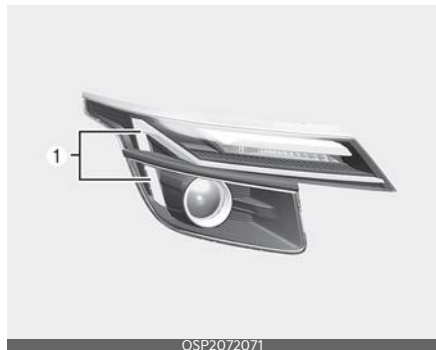

If the position lamp/daytime running lamp (LED) (1) is not functioning, please have your vehicle inspected by an authorized Kia dealer. The LED lamp cannot be replaced as a single unit because it is an integrated component. Instead, the entire LED lamp unit must be replaced. It's essential to have a skilled technician check or repair the position lamp/daytime running lamp (LED) to prevent any damage to related vehicle parts.

Headlamp (High/Low/Low assist)/Turn signal lamp/Position lamp/Daytime running lamp (LED type) bulb replacement - Headlamp Type C

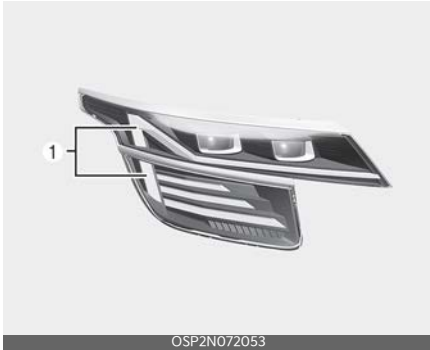

If the position lamp/daytime running lamp (LED) (1) is not functioning, please have your vehicle inspected by an authorized Kia dealer. The LED lamp cannot be replaced as a single unit because it is an integrated component. Instead, the entire LED lamp unit must be replaced. It's essential to have a skilled technician check or repair the position lamp/daytime running lamp (LED) to prevent any damage to related vehicle parts.

Front fog lamp (Bulb type) bulb replacement



1. Disconnect the negative (-) battery terminal.
2. Remove the engine under cover.
3. Disconnect the front fog lamp connector.
4. Remove the socket from the assembly by turning the socket counterclockwise until the tabs on the socket align with the slots on the assembly.
5. Remove the bulb from the socket by pressing it in and rotating it counterclockwise until the tabs on the bulb align with the slots in the socket. Pull the bulb out of the socket.
6. Insert a new bulb by inserting it into the socket and rotating it until it locks into place.
7. Install the socket in the assembly by aligning the tabs on the socket with the slots in the assembly. Push the socket into the assembly and turn the socket clockwise.
8. Connect the front fog lamp connector.
9. Install the engine under cover assembly to the body of the vehicle.

Front fog lamp (LED type) bulb replacement (if equipped)



If the front fog lamp (LED) is not functioning, please have your vehicle inspected by an authorized Kia dealer. The LED lamp cannot be replaced as a single unit because it is an integrated component. Instead, the entire LED lamp unit must be replaced. It's essential to have a skilled technician check or repair the front fog lamp (LED) to prevent any damage to related vehicle parts.

Position lamp (auxiliary) (LED type) bulb replacement (if equipped)

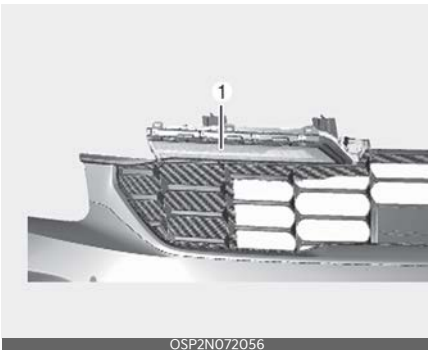

If the auxiliary lamp (LED) (1) is not functioning, please have your vehicle inspected by an authorized Kia dealer.

The LED lamp cannot be replaced as a single unit because it is an integrated component. Instead, the entire LED lamp unit must be replaced. It's essential to have a skilled technician check or repair the auxiliary lamp (LED) to prevent any damage to related vehicle parts.

Side repeater lamp (Bulb type) bulb replacement

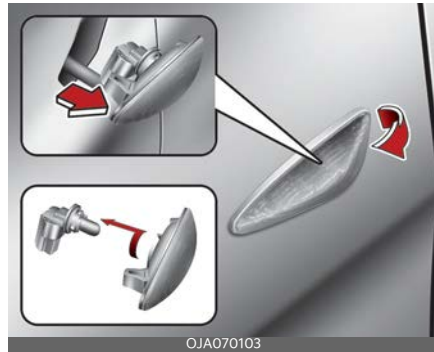

1. Remove the lamp assembly from the vehicle by prying the lens and pulling the assembly out.
2. Disconnect the bulb electrical connector.
3. Separate the socket and the lens parts by turning the socket counterclockwise until the tabs on the socket align with the slots on the lens part.
4. Remove the bulb by pulling it straight out.
5. Insert a new bulb in the socket.
6. Reassemble the socket and the lens part.
7. Connect the bulb electrical connector.
8. Reinstall the lamp assembly to the body of the vehicle.

Front side marker lamp (Bulb type) bulb replacement



1. Remove the lamp assembly from the vehicle by prying the cover and pulling the assembly out.
2. Disconnect the bulb electrical connector.
3. Remove the bulb by pulling it straight out.
4. Insert a new bulb in the socket.
5. Connect the bulb electrical connector.
6. Reinstall the lamp assembly to the body of the vehicle.

Front side marker lamp (LED type) bulb replacement



If the front side marker lamp (LED) (1) is not functioning, please have your vehi-

cle inspected by an authorized Kia dealer. The LED lamp cannot be replaced as a single unit because it is an integrated component. Instead, the entire LED lamp unit must be replaced. It's essential to have a skilled technician check or repair the front side marker lamp (LED) to prevent any damage to related vehicle parts.

Tail and stop lamp/Rear turn signal lamp/Side marker lamp (Bulb type) bulb replacement

Rear combination lamp - Type A

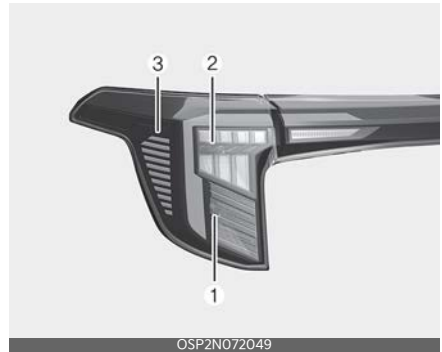

- 1 Tail and stop lamp/Side marker lamp
- 2 Rear turn signal lamp
- 3 Side marker lamp

To place the lamp bulb:

1. Open the liftgate.
2. Loosen the light assembly retaining screws with a cross-tip screwdriver.
3. Remove the rear combination light assembly from the body of the vehicle.
4. Remove the socket from the assembly by turning the socket counterclockwise until the tabs on the socket align with the slots on the assembly.
5. Remove the bulb from the socket by pressing it in and rotating it counter-

clockwise until the tabs on the bulb align with the slots in the socket.

6. Pull the bulb out of the socket.
7. Insert a new bulb by inserting it into the socket and rotating it until it locks into place.



8. Install the socket in the assembly by aligning the tabs on the socket with the slots in the assembly.
9. Push the socket into the assembly and turn the socket clockwise.
10. Reinstall the light assembly to the body of the vehicle.

Tail lamp/Tail and stop lamp/Side marker lamp (LED type) bulb replacement



If the tail lamp (1)/tail and stop lamp&side marker lamp (2)/side marker

lamp (3) is not functioning, please have your vehicle inspected by an authorized Kia dealer. The LED lamp cannot be replaced as a single unit because it is an integrated component. Instead, the entire LED lamp unit must be replaced. It's essential to have a skilled technician check or repair the tail lamp (1)/tail and stop lamp&side marker lamp (2)/side marker lamp (3) to prevent any damage to related vehicle parts.

Back up lamp (Bulb type) bulb replacement



If the back up lamp (1) does not operate, have the vehicle checked by an authorized Kia dealer.

High mounted stop lamp (LED type) bulb replacement



If the high-mounted stop lamp (LED) (1) is not functioning, please have your vehicle inspected by an authorized Kia dealer. The LED lamp cannot be replaced as a single unit because it is an integrated component. Instead, the entire LED lamp unit must be replaced. It's essential to have a skilled technician check or repair the high-mounted stop lamp (LED) to prevent any damage to related vehicle parts.

License plate lamp (Bulb type) bulb replacement



1. Using a screwdriver, gently pry the lamp assembly from interior.
2. Remove the bulb by pulling it straight out.
3. Install a new bulb in the socket.
4. Install the lamp assembly to interior.

Map lamp (Bulb type) bulb replacement



1. Using a flat-blade screwdriver, gently pry the lens cover from lamp housing.
2. Remove the bulb (1) by pulling it straight out.
3. Install a new bulb in the socket.
4. Align the lens cover tabs with the lamp housing notches and snap the lens into place.

⚠ WARNING

Prior to working on the Interior lamps, ensure that the "OFF" button is depressed to avoid burning your fingers or receiving an electric shock.

⚠ CAUTION

Be careful not to dirty or damage the lens, lens tab, and plastic housings.

Map lamp (LED type) bulb replacement

Type A



Type B



If the map lamp bulb (1) is not functioning, please have your vehicle inspected by an authorized Kia dealer. The LED lamp cannot be replaced as a single unit because it is an integrated component. Instead, the entire LED lamp unit must be replaced. It's essential to have a skilled technician check or repair the map lamp (LED) to prevent any damage to related vehicle parts.

Vanity mirror lamp (Bulb type) bulb replacement



WARNING

Interior lamps

Prior to working on the Interior lamps, ensure that the "OFF" button is depressed to avoid burning your fingers or receiving an electric shock.

1. Using a flat-blade screwdriver, gently pry the lamp assembly from interior.
2. Remove the bulb by pulling it straight out.
3. Install a new bulb in the socket.
4. Install the lamp assembly to interior.

*** NOTICE**

Be careful not to dirty or damage the lens, lens tab, and plastic housings.

Room lamp (Bulb type) bulb replacement

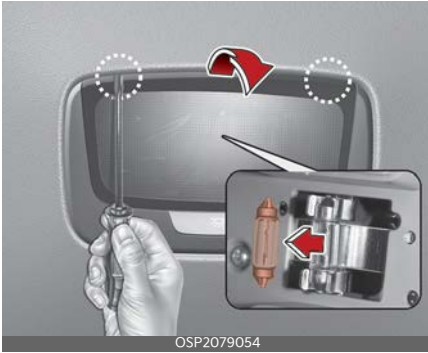

⚠ WARNING

Prior to working on the Interior lamps, ensure that the "OFF" button is depressed to avoid burning your fingers or receiving an electric shock.

1. Using a flat-blade screwdriver, gently pry the lens cover from lamp housing.
2. Remove the bulb by pulling it straight out.
3. Install a new bulb in the socket.
4. Align the lens cover tabs with the lamp housing notches and snap the lens into place.

*** NOTICE**

Be careful not to dirty or damage the lens, lens tab, and plastic housings.

Room lamp (LED type) bulb replacement

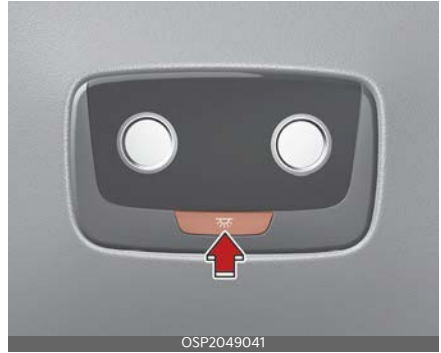

If the room lamp (LED) is not functioning, please have your vehicle inspected by an authorized Kia dealer. The LED lamp cannot be replaced as a single unit because it is an integrated component. Instead, the entire LED lamp unit must be replaced. It's essential to have a skilled technician check or repair the room lamp (LED) to prevent any damage to related vehicle parts.

Glove box lamp (Bulb type) replacement



1. Using a flat-blade screwdriver, gently pry the lamp assembly from interior.
2. Remove the bulb by pulling it straight out.

3. Install a new bulb in the socket.
4. Install the lamp assembly to interior.

⚠ CAUTION

Be careful not to damage the lens, lens tab, and plastic housings or get them dirty.

Luggage room lamp (Bulb type) bulb replacement



1. Using a flat-blade screwdriver, gently pry the lens cover from lamp housing.
2. Remove the bulb by pulling it straight out.
3. Install a new bulb in the socket.
4. Align the lens cover tabs with the lamp housing notches and snap the lens into place.

⚠ CAUTION

Be careful not to dirty or damage the lens, lens tab, and plastic housings.

Appearance care

Use the information in the following sections to keep the exterior and interior of your vehicle clean.

Exterior care

Use the information in the following sections to maintain the exterior of your vehicle. Keeping the exterior clean is not only aesthetically pleasing, but it also helps to prolong the life of the vehicle.

* NOTICE

If you park the vehicle around a stainless signboard or windshield building etc., the plastic exterior trim (bumper, spoiler, garnish, lamp, outside mirror etc.) may be damaged by reflected sunlight from the external structure. To avoid damaging the plastic exterior trim, park the vehicle away from the areas where the reflected light may occur or use a vehicle cover (Depending on the vehicle, the type of exterior trim applied such as spoiler may differ).

Exterior general caution

It is very important to follow the label directions when using any chemical cleaner or polish. Read all warning and caution statements that appear on the label.

Finish maintenance

Washing

To help protect your vehicle's finish from rust and deterioration, wash it thoroughly and frequently at least once a month with lukewarm or cold water.

If you use your vehicle for off-road driving, you should wash it after each off-

road trip. Pay special attention to the removal of any accumulation of salt, dirt, mud, and other foreign materials. Make sure the drain holes in the lower edges of the doors and rocker panels are kept clear and clean.

Insects, tar, tree sap, bird droppings, industrial pollution and similar deposits can damage your vehicle's finish if not removed immediately.

Even prompt washing with plain water may not completely remove all these deposits. A mild soap, safe for use on painted surfaces, may be used.

After washing, rinse the vehicle thoroughly with lukewarm or cold water. Do not allow soap to dry on the finish.

After washing the vehicle, test the brakes while driving slowly to see if they have been affected by water. If braking performance is impaired, dry the brakes by applying them lightly while maintaining a slow forward speed.

⚠ CAUTION

- Do not use strong soap, chemical detergents or hot water, and do not wash the vehicle in direct sunlight or when the body of the vehicle is warm.
- Be careful when washing the side windows of your vehicle, especially with high-pressure water. Water may leak through the windows and wet the interior.
- To prevent damage to the plastic parts and lamps, do not clean with chemical solvents or strong detergents.

⚠ WARNING

After washing the vehicle, test the brakes while driving slowly to see if they have been affected by water. If braking

performance is impaired, dry the brakes by applying them lightly while maintaining a slow forward speed.

High-pressure washing

When using high-pressure washers, make sure to maintain sufficient distance from the vehicle.

Insufficient clearance or excessive pressure can lead to component damage or water penetration.

Do not spray the camera, sensors or its surrounding area directly with a high pressure washer. Shock applied from high pressure water may cause the device to not operate normally.

Do not bring the nozzle tip close to boots (rubber or plastic covers) or connectors as they may be damaged if they come into contact with high pressure water.

⚠ CAUTION

Wetting engine compartment



- Water washing in the engine compartment including high pressure water washing may cause the failure of electrical circuits located in the engine compartment.
- Never allow water or other liquids to come in contact with electrical/elec-

tronic components and air duct inside the vehicle as this may damage them.

Waxing

Wax the vehicle when water will no longer bead on the paint.

Always wash and dry the vehicle before waxing. Use a good quality liquid or paste wax, and follow the manufacturer's instructions. Wax all metal trim to protect it and to maintain its luster.

Removing oil, tar, and similar materials with a spot remover will usually strip the wax from the finish. Be sure to re-wax these areas even if the rest of the vehicle does not yet need waxing.

Be careful not to touch the lens when waxing the lamps.

⚠ CAUTION

Drying vehicle

- Wiping dust or dirt off the body with a dry cloth will scratch the finish.
 - Do not use steel wool, abrasive cleaners, acid detergents or strong detergents containing high alkaline or caustic agents on chrome-plated or anodized aluminum parts. This may result in damage to the protective coating and cause discoloration or paint deterioration.
-

Finish damage repair

Deep scratches or stone chips in the painted surface must be repaired promptly. Exposed metal will quickly rust and may develop into a major repair expense.

* NOTICE

If your vehicle is damaged and requires any metal repair or replacement, be sure the body shop applies anti-corrosion materials to the parts repaired or replaced.

Bright-metal maintenance

To remove road tar and insects, use a tar remover, not a scraper or other sharp object.

To protect the surfaces of bright metal parts from corrosion, apply a coating of wax or chrome preservative and rub to a high luster.

During winter weather or in coastal areas, cover the bright metal parts with a heavier coating of wax or preservative. If necessary, coat the parts with non-corrosive petroleum jelly or other protective compound.

Underbody maintenance

Corrosive materials used for ice and snow removal and dust control may collect on the underbody. If these materials are not removed, accelerated rusting can occur on underbody parts such as the fuel lines, frame, floor pan and exhaust system, even though they have been treated with rust protection.

Thoroughly flush the vehicle underbody and wheel openings with lukewarm or cold water once a month, after off-road driving and at the end of each winter. Pay special attention to these areas because it is difficult to see all the mud and dirt. It will do more harm than good to wet down the road grime without removing it. The lower edges of the doors, rocker panels, and frame mem-

bers have drain holes that should not clog with dirt; trapped water in these areas can cause rusting.

Aluminum wheel maintenance

The aluminum wheels are coated with a clear protective finish.

- Do not use any abrasive cleaner, polishing compound, solvent, or wire brushes on aluminum wheels. They may scratch or damage the finish.
- Clean the wheel when it has cooled.
- Use only a mild soap or neutral detergent, and rinse thoroughly with water. Also, be sure to clean the wheels after driving on salted roads. This helps prevent corrosion.
- Avoid washing the wheels with high speed vehicle wash brushes.
- Do not use any alkaline or acid detergents. It may damage and corrode the aluminum wheels coated with a clear protective finish.

Corrosion protection

Protecting your vehicle from corrosion

By using the most advanced design and construction practices to combat corrosion, we produce vehicles of the highest quality. However, this is only part of the job. To achieve the long-term corrosion resistance your vehicle can deliver, the owner's cooperation and assistance is also required.

Common causes of corrosion

The most common causes of corrosion on your vehicle are:

- Road salt, dirt and moisture that is allowed to accumulate underneath the vehicle.
- Removal of paint or protective coatings by stones, gravel, abrasion or minor scrapes and dents which leave unprotected metal exposed to corrosion.

High-corrosion areas

If you live in an area where your vehicle is regularly exposed to corrosive materials, corrosion protection is particularly important. Some of the common causes of accelerated corrosion are road salts, dust control chemicals, ocean air and industrial pollution.

Moisture breeds corrosion

Moisture creates the conditions in which corrosion is most likely to occur. For example, corrosion is accelerated by high humidity, particularly when temperatures are just above freezing. In such conditions, the corrosive material is kept in contact with the vehicle's surface by moisture that evaporates slowly.

Mud is particularly corrosive because it dries slowly and holds moisture in contact with the vehicle. Although the mud appears to be dry, it can still retain the moisture and promote corrosion.

High temperatures can also accelerate corrosion of parts that are not properly ventilated so the moisture can be dispersed. For all these reasons, it is particularly important to keep your vehicle clean and free of mud or accumulations of other materials. This applies not only to the visible surfaces but particularly to the underside of the vehicle.

To help prevent corrosion

You can help prevent corrosion from beginning by observing the following:

Keep your vehicle clean

The best way to prevent corrosion is to keep your vehicle clean and free of corrosive materials. Attention to the underside of the vehicle is particularly important.

If you live in a high-corrosion area — where road salts are used, near the ocean, areas with industrial pollution, acid rain, etc.—, you should take extra care to prevent corrosion. In winter, hose off the underside of your vehicle at least once a month and be sure to clean the underside thoroughly when winter is over.

When cleaning underneath the vehicle, give particular attention to the components under the fenders and other areas that are hidden from view. Do a thorough job; just dampening the accumulated mud rather than washing it away will accelerate corrosion rather than prevent it. Water under high pressure and steam are particularly effective in removing accumulated mud and corrosive materials.

When cleaning lower door panels, rocker panels and frame members, be sure that drain holes are kept open so that moisture can escape and not be trapped inside to accelerate corrosion.

Keep your garage dry

Don't park your vehicle in a damp, poorly ventilated garage. This creates a favorable environment for corrosion. This is particularly true if you wash your vehicle in the garage or drive it into the

garage when it is still wet or covered with snow, ice or mud. Even a heated garage can contribute to corrosion unless it is well ventilated so moisture is dispersed.

Keep paint and trim in good condition

Scratches or chips in the finish should be covered with "touch-up" paint as soon as possible to reduce the possibility of corrosion. If bare metal is showing through, the attention of a qualified body and paint shop is recommended.

Bird droppings: Bird droppings are highly corrosive and may damage painted surfaces in just a few hours. Always remove bird droppings as soon as possible.

Don't neglect the interior

Moisture can collect under the floor mats and carpeting and cause corrosion. Check under the mats periodically to be sure the carpeting is dry. Use particular care if you carry fertilizers, cleaning materials or chemicals in the vehicle.

These should be carried only in proper containers and any spills or leaks should be cleaned up, flushed with clean water and thoroughly dried.

Interior care

Use the information in the following sections to maintain the interior of your vehicle.

Interior general precautions

Prevent chemicals such as perfume, cosmetic oil, sun cream, hand cleaner, and air freshener from contacting the interior parts because they may cause damage

or discoloration. If they do contact the interior parts, wipe them off immediately. If necessary, use a mixture of warm water and mild non-detergent cleaner (test all cleaners on a concealed area before use). Use proper car cleaner to clean interior parts.

CAUTION

Electrical components

Never allow water or other liquids to come in contact with electrical/electronic components inside the vehicle as this may damage them.

CAUTION

Leather

When cleaning leather products (steering wheel, seats etc.), use neutral detergents or low alcohol content solutions. If you use high alcohol content solutions or acid/alkaline detergents, the color of the leather may fade or the surface may get stripped off.

Taking care of leather seats

- Vacuum the seat periodically to remove dust and sand on the seat. It will prevent abrasion or damage of the leather and maintain its quality.
- Wipe the leather seat cover often with dry or soft cloth.
- Sufficient use of a leather protective may prevent abrasion of the cover and helps maintain the color. Be sure to read the instructions and consult a specialist when using leather coating or protective agents.
- Leather with bright colors (beige, cream beige) is easily contaminated and clear in appearance. Clean the seats frequently.

- Avoid wiping with wet cloth. It may cause the surface to crack.

Cleaning the leather seats

Remove all contaminations instantly. Refer to instructions below for removal of each contaminant.

- Cosmetic products (sunscreen, foundation, etc.)
 - Apply cleansing cream on a cloth and wipe the contaminated point. Wipe off the cream with a wet cloth and remove water with a dry cloth.
- Beverages (coffee, soft drink, etc.)
 - Apply a small amount of neutral detergent and wipe until contaminations do not smear.
- Oil
 - Remove oil instantly with absorbable cloth and wipe with stain remover for leather only.
- Chewing gum
 - Harden the gum with ice and remove gradually.

Fabric seat cover (if equipped)

Please clean the fabric seats regularly with a vacuum cleaner in consideration of fabric material characteristics. If they are heavily soiled with beverage stains, etc., use a suitable interior cleaner. To prevent damage to seat covers, wipe off the seat covers down to the seams with a large wiping motion and moderate pressure using a soft sponge or microfiber cloth.

Velcro closures on clothing or sharp objects may cause snagging or scratches on the surface of the seats.

Make sure not to rub such objects against the surface.

Cleaning the upholstery and interior trim

Car interior surfaces

Remove dust and loose dirt from interior surfaces with a whisk broom or a vacuum cleaner. If necessary, clean interior surfaces with a mixture of warm water and mild non-detergent cleaner (test all cleaners on a concealed area before use).

Fabric

Remove dust and loose dirt from fabric with a whisk broom or vacuum cleaner. Clean with a mild soap solution recommended for upholstery or carpets. Remove fresh spots immediately with a fabric spot cleaner. If fresh spots do not receive immediate attention, the fabric can be stained and its color can be affected. Also, its fire-resistant properties can be reduced if the material is not properly maintained.

Using anything but recommended cleaners and procedures may affect the fabric's appearance and fire-resistant properties.

Cleaning the lap/shoulder belt webbing

Clean the belt webbing with any mild soap solution recommended for cleaning upholstery or carpet. Follow the instructions provided with the soap. Do not bleach or re-dye the webbing because this may weaken it.

Cleaning the interior window glass

If the interior glass surfaces of the vehicle become fogged (that is, covered with

an oily, greasy or waxy film), they should be cleaned with a glass cleaner. Follow the directions on the glass cleaner container.

CAUTION

Rear window

Do not scrape or scratch the inside of the rear window. This may result in damage of the rear window defroster grid.

Emission control system

The emission control system of your vehicle is covered by a written limited warranty. Please see the warranty information contained in the Warranty & Consumer Information manual in your vehicle.

Your vehicle is equipped with an emission control system to meet all applicable emission regulations. There are three emission control systems, as follows.

1. Crankcase emission control system
2. Evaporative emission control system
3. Exhaust emission control system

In order to assure the proper function of the emission control systems, have your vehicle inspected and maintained by an authorized Kia dealer in accordance with the maintenance schedule in this manual.

Caution for the Inspection and Maintenance Test (With Electronic Stability Control (ESC) system)

- To prevent the vehicle from misfiring during dynamometer testing, turn the ESC off by pressing the ESC switch.
- After dynamometer testing is completed, turn the ESC back on by pressing the ESC switch again.

1. Crankcase emission control system

The Positive Crankcase Ventilation system is employed to prevent air pollution caused by blow-by gases being emitted from the crankcase. This system supplies fresh filtered air to the crankcase through the air intake hose. Inside the

crankcase, the fresh air mixes with blow-by gases, which then pass through the Positive Crankcase Ventilation (PCV) valve into the induction system.

2. Evaporative emission control (including Onboard Refueling Vapor Recovery (ORVR)) system

The evaporative emission control system is designed to prevent fuel vapors from escaping into the atmosphere. (The ORVR system is designed to allow the vapors from the fuel tank to be loaded into a canister while refueling at the gas station, preventing the escape of fuel vapors into the atmosphere.)

Canister

Fuel vapors generated inside the fuel tank are absorbed and stored in the onboard canister. When the engine is running, the fuel vapors absorbed in the canister are drawn into the surge tank through the Purge Control Solenoid Valve.

Purge Control Solenoid Valve (PCSV)

The Purge Control Solenoid Valve (PCSV) is controlled by the Engine Control Module (ECM); when the engine coolant temperature is low during idling, the PCSV closes so that evaporated fuel is not taken into the engine. After the engine warms up during ordinary driving, the PCSV opens to introduce evaporated fuel to the engine.

3. Exhaust emission control system

The exhaust emission control system is a highly effective system which controls

exhaust emissions while maintaining good vehicle performance.

Vehicle modifications

This vehicle should not be modified. Modification of your vehicle could affect its performance, safety or durability and may even violate governmental safety and emissions regulations. In addition, damage or performance problems resulting from any modification may not be covered under warranty.

- If you use authorized electronic devices, it may cause the vehicle to operate abnormally, wire damage, battery discharge and fire. For your safety, do not use unauthorized electronic devices.

Engine exhaust gas precautions (carbon monoxide)

- Carbon monoxide can be present with other exhaust fumes. Therefore, if you smell exhaust fumes of any kind inside your vehicle, have it inspected and repaired immediately. If you ever suspect exhaust fumes are coming into your vehicle, drive it only with all the windows fully open. Have your vehicle checked and repaired immediately.

WARNING

Exhaust

Engine exhaust gases contain carbon monoxide (CO). Though colorless and odorless, it is dangerous and could be lethal if inhaled. Follow the instructions on this page to avoid CO poisoning.

- Do not operate the engine in confined or closed areas (such as garages) any more than what is necessary to move the vehicle in or out of the area.
- When the vehicle is stopped in an open area for more than a short time with the engine running, adjust the ventilation system (as needed) to draw outside air into the vehicle.
- Never sit in a parked or stopped vehicle for any extended time with the engine running.
- When the engine stalls or fails to start, excessive attempts to restart the engine may cause damage to the emission control system.

Operating precautions for catalytic converters

WARNING

Catalytic converter

Keep away from the catalytic converter and exhaust system while the vehicle is running or immediately thereafter. The exhaust and catalytic systems are very hot and may burn you.

WARNING

Fire

- Do not park, idle or drive the vehicle over or near flammable objects, such as grass, vegetation, paper, leaves, etc. A hot exhaust system can ignite flammable items under your vehicle.
- Also, do not remove the heat sink around the exhaust system, do not seal the bottom of the vehicle or do not coat the vehicle for corrosion control. It may present a fire risk under certain conditions.

Your vehicle is equipped with a catalytic converter emission control device.

Therefore, the following precautions must be observed:

- Use only UNLEADED FUEL for gasoline engines.
- Do not operate the vehicle when there are signs of engine malfunction, such as misfire or a noticeable loss of performance.
- Do not misuse or abuse the engine. Examples of misuse are coasting with the ignition off and descending steep grades in gear with the ignition off.
- Do not operate the engine at high idle speed for extended periods (5 minutes or more).
- Do not modify or tamper with any part of the engine or emission control system. All inspections and adjustments must be made by an authorized Kia dealer.
- Avoid driving with an extremely low fuel level. Running out of fuel could cause the engine to misfire, damaging the catalytic converter.

Failure to observe these precautions could result in damage to the catalytic converter and to your vehicle. Additionally, such actions could void your warranties.

Specifications & Consumer information

Dimensions	9-2
Engine	9-3
Gross Vehicle Weight	9-3
Luggage volume	9-3
Air conditioning system	9-3
Bulb wattage	9-4
Tires and wheels	9-5
Recommended lubricants and capacities	9-6
• Recommended SAE viscosity number.....	9-7
Vehicle Identification Number (VIN)	9-8
Vehicle certification	9-8
Tire specification and pressure label	9-9
Engine Number	9-9
Refrigerant label	9-10
REPORTING SAFETY DEFECTS	9-11

Specifications & Consumer information

Dimensions

Item			mm (in)
Overall length			4,385 (172.6)
Overall width			1,800 (70.9)
Overall height	With roof rack	205/60 R16	1,625 (64.0)
		215/55 R17	1,630 (64.2)
		235/45 R18	
	Without roof rack	205/60 R16	1,610 (63.4)
		215/55 R17	1,615 (63.6)
		235/45 R18	
Tread	Front	205/60 R16	1573.6 (62.0)
		215/55 R17	1561.7 (61.5)
		235/45 R18	1557.7 (61.3)
	Rear (FWD)	205/60 R16	1584.1 (62.4)
		215/55 R17	1572.4 (61.9)
		235/45 R18	1568.4 (61.7)
	Rear (AWD)	205/60 R16	1585.1 (62.4)
		215/55 R17	1573.4 (62.0)
		235/45 R18	1569.5 (61.8)
Wheelbase			2,630 (103.5)

Engine

Item	Smartstream G1.6 T-GDi	(Gasoline) 2.0 MPI
Displacement [cc (cu in)]	1,598 (97.5)	1,999 (122.0)
Bore x Stroke [mm (in)]	75.6 x 89.0 (2.98 x 3.50)	81.0 x 97.0 (3.2 x 3.8)
Firing order	1-3-4-2	1-3-4-2
No. of cylinders	4, In-line	4, In-line

Gross Vehicle Weight

Item	Smartstream G1.6 T-GDi		(Gasoline) 2.0 MPI	
	AT		IVT	
	AWD		FWD	AWD
Gross vehicle weight [kg (lbs.)]	1,930 (4,256)		1,780 (3,925)	1,910 (4,212)

Luggage volume

Item	Smartstream G1.6 T-GDi, (Gasoline) 2.0 MPI
SAE [L (cu. ft.)]	Min: 752 (26.6) Max: 1,778 (62.8)

- Min: Behind rear seat to upper edge of the seat back.
- Max: Behind front seat to roof.

Air conditioning system

Item	Weight of volume [g (oz)]	Classification
Refrigerant	450 ± 25 (15.9±0.9)	R-1234yf
Compressor lubricant	120±10 (4.2±0.4)	PAG 30

Contact an authorized Kia dealer for more details.

Bulb wattage

Light bulb			Wattage	Type	
Front	Headlamps	High	Bulb type	HB3	5.8W
			LED type	LED	LED
		Low	Bulb type	HB3	60W
			LED type	LED	LED
	Position lamp/Daytime running lamp	Bulb type	P21W/5W	21W/5W	
		LED type	LED	LED	
	Turn signal lamp	Bulb type	PY28W/2357NA	28W	
		LED type	LED	LED	
	Front fog lamp	Bulb type	HB4	51W	
		LED type	LED	LED	
	Position lamp (auxiliary)			LED	LED
	Side repeater lamp			WY5W	5W
	Side marker lamp	Bulb type	W5W	5W	
		LED type	LED	LED	
Rear	Tail lamp/Stop lamp & Side marker lamp	Bulb type	P21/5W	21W	
		LED type	LED	LED	
	Tail lamp	LED type	LED	LED	
	Rear turn signal lamp			PY21W	21W
	Side marker lamp	Bulb type	W5W	5W	
		LED type	LED	LED	
	Back up lamp			W16W	16W
	License plate lamp			W5W	5W
High mounted stop lamp			LED	LED	
Interior	Map lamp	Bulb type	W10W 10	10W	
		LED type	LED	LED	
	Vanity mirror lamp			FESTOON	5W
	Room lamp	Bulb type	FESTOON	10W	
		LED type	LED	LED	
	Luggage lamp			FESTOON	10W
Glove box lamp			FESTOON	8W	

Tires and wheels

Item	Tire size	Wheel size	Load capacity		Speed capacity		Inflation pressure [kPa (psi)]				Wheel lug nut torque kgf·m, (lbf·ft N·m)
			L1 ¹	kg (lbs.)	SS ²	km/h (mph)	Normal load		Maximum load		
							Front	Rear	Front	Rear	
Full size tire	205/60R16	6.5Jx16	92	630 (1,389)	H	210 (130)	230 (33)		230 (33)		11~13 (79~94, 107~127)
	215/ 55R17	7.0Jx17	94	670 (1,477)	V	240 (149)	240 (35)	230 (33)	240 (35)	230 (33)	
	235/45R18	7.5Jx18	94	670 (1,477)	V	240 (149)	230 (33)		230 (33)		
Compact size tire (spare tire)	T125/80D16	4.0Tx16	97	730 (1,609)	M	130 (80)	420 (60)				

*1. Load Index

*2. Speed Symbol

* NOTICE

- We recommend that when replacing tires, use the same tires as the originally supplied ones.
If not, that affects driving performance.
- When driving in high altitude grades, it is natural for the atmospheric pressure to decrease.
Therefore, please check the tire pressure and add more air when necessary.
Additionally required tire air pressure per km above sea level: 10.5 kPa (1.5 psi)/km

▲ CAUTION

When replacing tires, use the same size as the ones originally supplied with the vehicle.

Using tires of a different size can damage the related parts or make it work irregularly.

Recommended lubricants and capacities

To help achieve proper engine and powertrain performance and durability, use only lubricants of the proper quality.

Using the right lubricants help reduce engine friction and improve fuel efficiency.

These lubricants and fluids are recommended for use in your vehicle.

Lubricant		Volume	Classification
Engine oil ¹ (drain and refill) Recommends	Smartstream G1.6 T-GDi	4.8 L (5.07 US qt.)	Full synthetic SAE 0W-20, API SN PLUS/SP or ILSAC GF-6
Kia  TotalEnergies	(Gasoline) 2.0 MPI	4.0 L (4.23 US qt.)	Full synthetic SAE 0W-20, API SN PLUS/SP or ILSAC GF-6
Automatic transmission fluid ²	Smartstream G1.6 T-GDi	6.5 L (6.87 US qt.)	SK ATF SP4M-1, MICHANG ATF SP4M-1, S-OIL ATF SP4M-1, Kia Genuine ATF SP4M-1
Intelligent Variable Transmission (IVT) fluid ²	(Gasoline) 2.0 MPI	6.7 L (7.08 US qt.)	MICHANG SP-CVT1, Kia genuine oil ATF SP-CVT1
Coolant ³	Smartstream G1.6 T-GDi	7.0 L (7.4 US qt.)	An Phosphate based ethylene glycol based coolant
	(Gasoline) 2.0 MPI	6.0 L (6.34 US qt.)	
Brake fluid ⁴	Smartstream G1.6 T-GDi	0.7 L (0.74 US qt.)	SAE J1704 DOT-4 LV, FMVSS 116 DOT-4, ISO 4925 CLASS-6
	(Gasoline) 2.0 MPI		
Fuel		50 L (13.2 US gal.)	-
Rear differential oil (AWD)		0.5 L (0.53 US qt.)	HYPOID GEAR OIL API GL-5, SAE 75W/85 (Recommended: SK HCT-5 GEAR OIL 75W/85 or equivalent)
Transfer case oil (AWD)		0.4 L (0.42 US qt.)	

*1. Refer to "Recommended SAE viscosity number" on page 9-7.

*2. Use only specified genuine transmission fluid. The use of non-specified (even marked as compatible with genuine) could result in shift quality deterioration and vibrations, eventually, the transmission failure. (Refer to "Explanation of scheduled maintenance items" on page 8-17.)

*3. Different type of coolant or water may damage the electrical component.

*4. To maintain your vehicle's best brake and ABS/ESC performance, use Kia genuine brake fluid as in the specification.

Recommended SAE viscosity number

⚠ CAUTION

Always be sure to clean the area around any filler plug, drain plug, or dipstick before checking or draining any lubricant. This is especially important in dusty or sandy areas and when the vehicle is used on unpaved roads. Cleaning the plug and dipstick areas will prevent dirt and grit from entering the engine and other mechanisms that could be damaged.

Engine oil viscosity (thickness) has an effect on fuel economy and cold weather operating (engine start and engine oil flowability). Lower viscosity engine oils can provide better fuel economy and cold weather performance, however, higher viscosity engine oils are required for satisfactory lubrication in hot weather.

Using oils of any viscosity other than those recommended could result in engine damage.

*** NOTICE**

Never add any additives to the engine oil. Engine oil additives can change its properties of engine oil and may cause serious engine failure.

When choosing an oil, consider the range of temperature your vehicle will be operated in before the next oil change. Proceed to select the recommended oil viscosity from the chart.

Temperature Range for SAE Viscosity Numbers

A: Smartstream G1.6 T-GDi & (Gasoline) 2.0 MPI

TEMP.	°C	-30	-20	-10	0	10	20	30	40	50
	°F	-10	0	20	40	60	80	100	120	
A	0W-20									

Nu_2gen_MPI_Atkinson_NorthAmerica_SK3_SP2



An engine oil displaying this American Petroleum Institute (API) Certification Mark conforms to the International Lubricant Specification Advisory Committee (ILSAC). It is recommended to only use engine oils that uphold this API Certification Mark.

Vehicle Identification Number (VIN)

The Vehicle Identification Number (VIN) is the number used in registering your vehicle and in all legal matters pertaining to its ownership, etc.

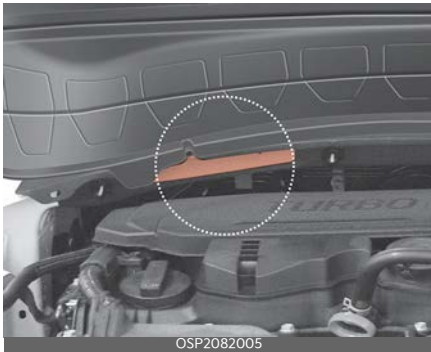

The number is punched on the engine compartment frame as shown in the drawing. To check the number, open the cover.

VIN label (if equipped)



The VIN is also on a plate attached to the top of the dashboard. The number on the plate can easily be seen through the windshield from outside.

Vehicle certification

The vehicle certification label attached on the driver's (or front passenger's) side center pillar gives the Vehicle Identification Number (VIN).



Tire specification and pressure label (if equipped)

The tires supplied on your new vehicle are chosen to provide the best performance for normal driving.



The tire label located on the driver's side center pillar gives the tire pressures recommended for your vehicle.

Engine Number

The engine number is stamped on the engine block as shown in the drawing.

Smartstream G1.6 T-GDi

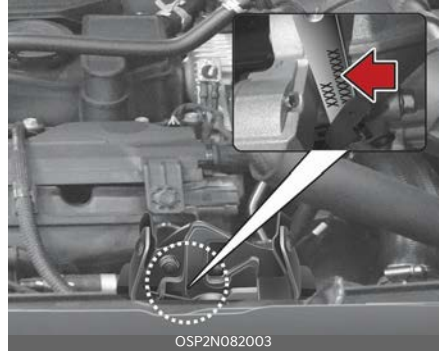

(Gasoline) 2.0 MPI

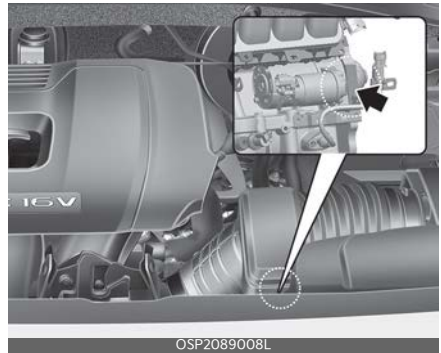

Refrigerant label

The refrigerant label is located inside of the engine compartment.



* For more details, refer to "Air conditioning refrigerant label" on page 4-121.

REPORTING SAFETY DEFECTS

If you believe that your vehicle has a defect which could cause a crash or could cause injury or death, you should immediately inform Transport Canada (TC) in addition to notifying **Kia Canada Inc.**

Mailing Address:

Transport Canada - ASFAD
330 Sparks Street
Ottawa, ON
K1A 0N5

Telephone: 819-420-4300 (Ottawa-Gatineau area or internationally)

Toll free: 1-800-333-0510 (in Canada)

Online:

<http://www.tc.gc.ca/recalls>

If TC receives similar complaints, it may open an investigation, and if it finds that a safety defect exists in a group of vehicles, it may order a recall and remedy campaign. However, TC cannot become involved in individual problems between you, your dealer, or **Kia Canada Inc.**

Abbreviation **A**

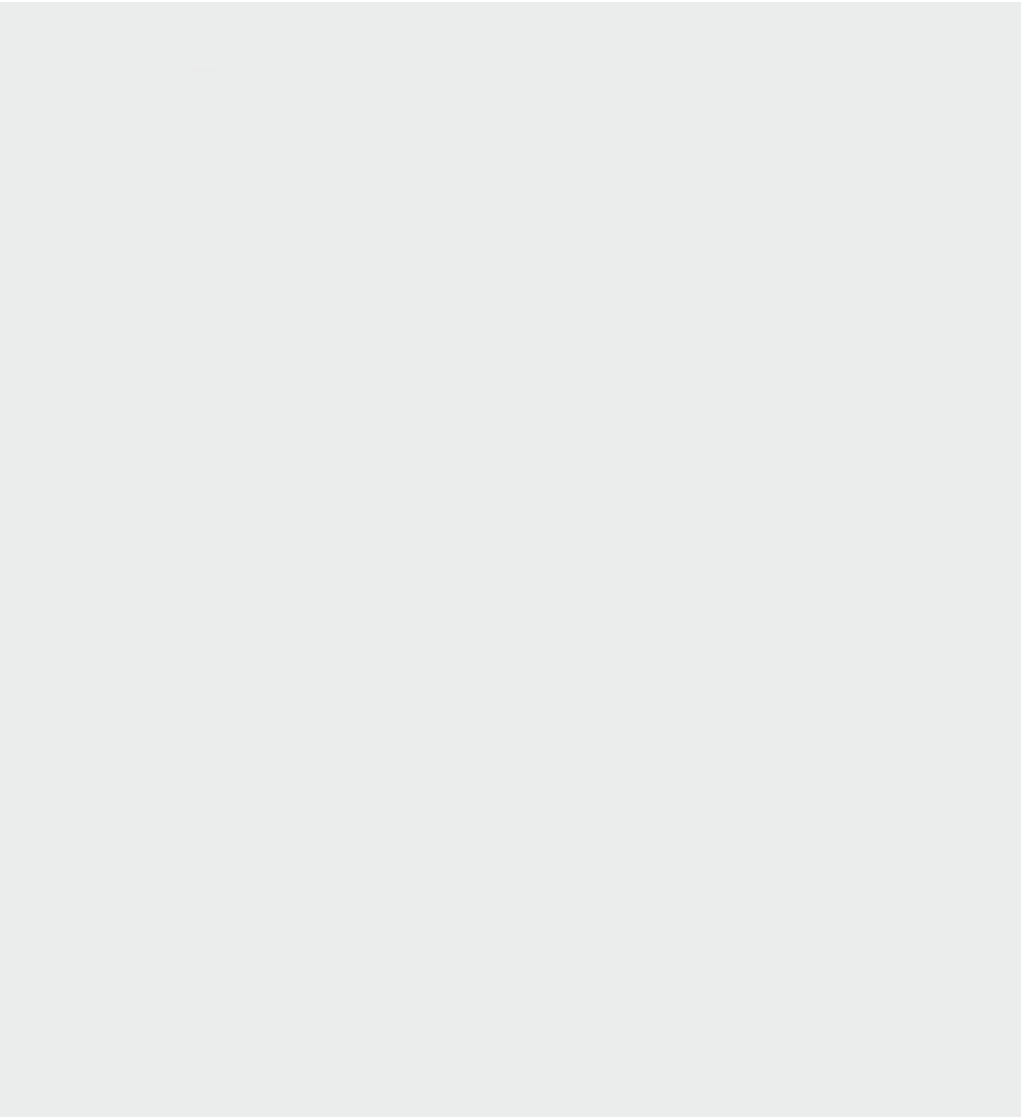

Abbreviation

AWD

All Wheel Drive

ABS

Anti-Lock Brake System

ACC

Accessory

ACC

Accessory

ADS

Auto Defogging System

CC

Cruise Control

CO

carbon monoxide

CRS

Child Restraint System

BCW

Blind-Spot Collision Warning

BCA

Blind-Spot Collision-Avoidance Assist

DAW

Driver Attention Warning

DBC

Downhill Brake Control

DRL

Daytime Running Light

DRVM

Driving Rear View Monitor

DTC

Diagnostic Trouble Code

ECM

Electric Chromic Mirror

EDR

Event Data Recorder

EFD

Emergency Fastening Device

EPB

Electronic Parking Brake

ESC

Electronic Stability Control

FCA

Forward Collision-Avoidance Assist

FMVSS

Federal Motor Vehicle Safety Standards

FWD

Front Wheel Drive

GPF

Gasoline Particulate Filter

GAW

Gross Axle Weight

GAWR

Gross Axle Weight Rating

GVW

Gross Vehicle Weight

GVWR

Gross Vehicle Weight Rating

HAC

Hill-start Assist Control

Abbreviation

HBA

High Beam Assist

HDA

Highway Driving Assist

HID

High-Intensity Discharge

HMSL

High Mounted Stop Lamp

HUD

Head-Up Display

ISG

Idle Stop and Go

IVT

Intelligent variable transmission

LFA

Lane Following Assist

LKA

Lane Keeping Assist

LNT

Lean NOx Trap

MDPS

Motor Driven Power Steering

MIL

Malfunction Indicator Lamp

MMT

Methylcyclopentadieny Manganese
Tricarbonyl

MPH

Miles Per Hour

NSCC

Navigation-based Smart Cruise Control

ODO

Odometer

ODS

Occupant Detection System

ORVR

Onboard Refueling Vapor Recovery

PCM

Powertrain Control Module

PCSV

Purge Control Solenoid Valve

PCV

Positive Crankcase Ventilation

PDW

Parking Distance Warning

RCCA

Rear Cross-Traffic Collision-Avoidance Assist

ROA

Rear Occupant Alert

RON

Research Octane Number

RPM

Revolution Per Minute

RVM

Rear View Monitor

SCC

Smart Cruise Control

Abbreviation

SEA

Safe Exit Assist

SEW

Safe Exit Warning

SRS

Supplemental Restraint System

SRSCM

SRS Control Module

SUV

Sports Utility Vehicle

TBT

Turn By Turn

TCI

Turbo Charger Intercooler

TCM

Transmission Control Module

TPMS

Tire Pressure Monitoring System

VIN

Vehicle Identification Number

VSM

Vehicle Stability Management

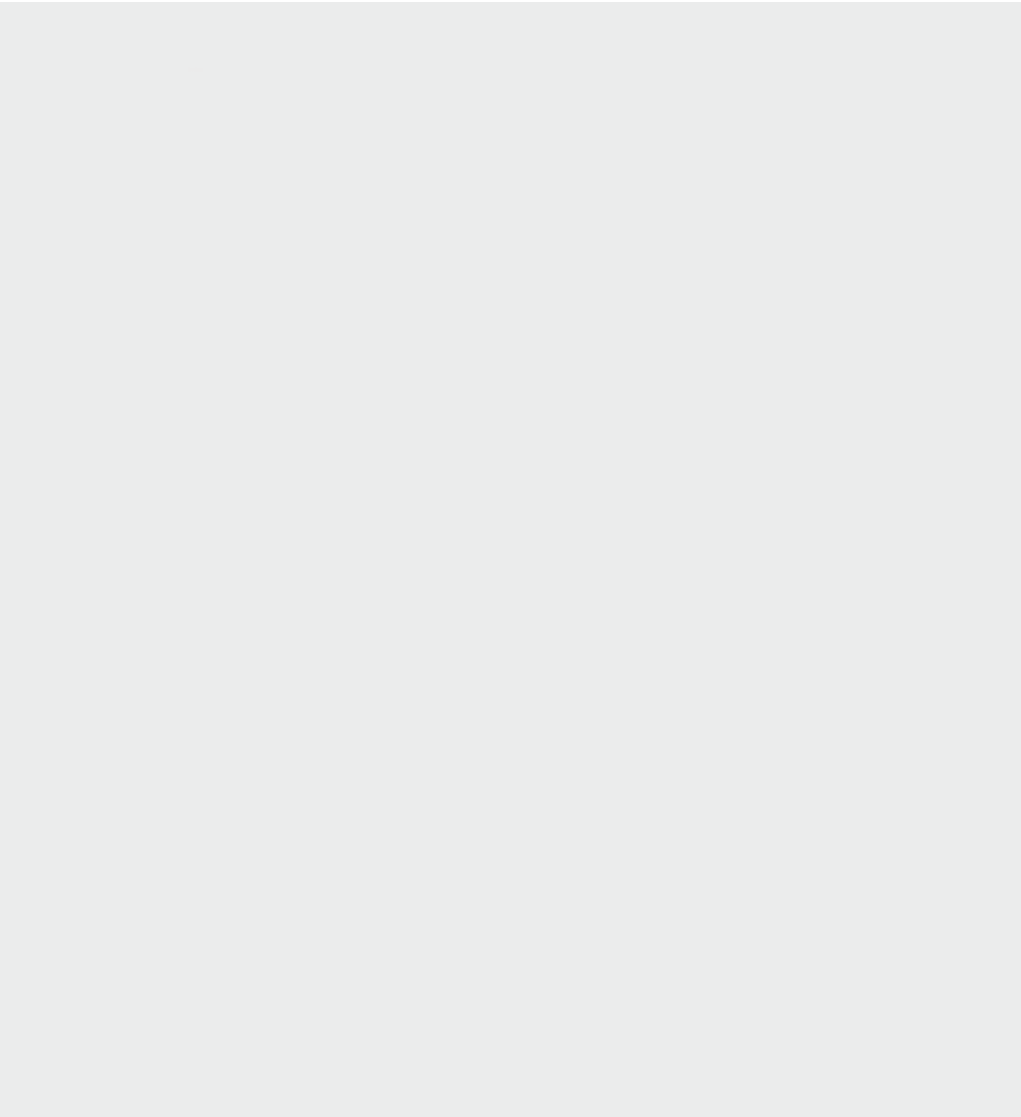

Index

A

- activate upon washer fluid use** 4-142
- air bag collision sensors** 3-50
- air bag warning label** 3-55
- air bags** 3-34
 - air bag collision sensors 3-50
 - air bag warning label 3-55
 - curtain air bag 3-49
 - driver's and passenger's front air bag 3-45
 - inflation conditions 3-51
 - non-inflation conditions 3-52
 - occupant detection system (ODS) 3-39
 - operation of the system 3-35
 - side air bag 3-47
 - SRS components and functions 3-37
 - supplemental restraint system (SRS) 3-54
 - warning light 3-36
- air cleaner filter** 8-28
- air conditioning refrigerant label** 4-121
- air conditioning system (specifications)** 9-3
- air ventilation seat** 4-148
- all wheel drive (AWD) system** 5-11
 - AWD mode 5-11
 - safe operation 5-13
- antenna** 4-159
- anti-lock brake system (ABS)** 5-32
- appearance care** 8-72
 - exterior care 8-72
 - interior care 8-76
- applying the parking brake** 5-31
- armrest** 3-13
- audio system** 4-159
- auto defogging system** 4-140
- auto light** 4-106
- automatic air ventilation** 4-141
- automatic climate control system** 4-128
 - air conditioning 4-135
 - checking the amount of air conditioner refrigerant and compressor lubricant 4-122
 - controlling air intake 4-134
 - controlling fan speed 4-134
 - heating and air conditioning automatically 4-129
 - heating and air conditioning manually 4-131
 - mode selection 4-132
 - temperature control 4-133
 - turning off the front air climate control 4-136
- automatic transmission** 5-17
 - automatic transmission operation 5-17
 - good driving practices 5-21
 - LCD display for warning message 5-17
 - shift lock system 5-20
 - shift-lock override 5-21
 - transmission ranges 5-18

B

- battery** 8-32
 - for best battery service 8-32
 - recharging the battery 8-33
 - reset items 8-34
- battery saver function** 4-104
- before driving** 5-3
- blind-spot collision-avoidance assist (BCA)** 6-35
 - blind-spot collision-avoidance assist malfunction 6-40
 - blind-spot collision-avoidance assist operation 6-38
 - blind-spot collision-avoidance assist settings 6-36
 - detecting sensor 6-36
 - limitations of blind-spot collision-avoidance assist 6-41
- brake fluid** 8-25
 - checking the brake fluid level 8-25
- brake system** 5-29
 - anti-lock brake system (ABS) 5-32
 - auto hold 5-37
 - downhill brake control (DBC) 5-44
 - electronic parking brake (EPB) 5-34
 - electronic stability control (ESC) system 5-40
 - hill-start assist control (HAC) 5-44
 - parking brake (hand type) 5-31

power brakes	5-29
vehicle stability management (VSM) system	5-42
bulb wattage	9-4

C

care of seat belts	3-25
cargo area cover	4-155
center console storage	4-143
check exhaust system	5-3
child restraint system (CRS)	3-26
types	3-27
child-protector rear door lock	4-34
climate control air filter	8-29
inspecting and replacing climate control air filter	8-29
climate control system	4-119
air conditioning	4-120
air conditioning refrigerant label	4-121
checking the amount of air conditioner refrigerant and compressor lubricant	4-122
climate control air filter	4-121
heating	4-119
system operation	4-119
ventilation	4-119
closing the hood	4-54
coat hook	4-154
cruise control (CC)	6-61
decreasing set speed	6-62
increasing set speed	6-62
resuming cruise control	6-63
setting set speed	6-61
temporarily pausing cruise control	6-63
turning off cruise control	6-63
cup holder	4-146
curtain air bag	3-49

D

day/night rearview mirror	4-65
daytime running light (DRL)	4-105
declaration of conformity	4-162, 6-114
the radio frequency components (front radar) complies	6-114

the radio frequency components (rear corner radar) complies	6-114
defogging logic	4-139
defroster	4-118
outside rearview mirror defroster	4-119
rear window defroster	4-118
digital key 2 touch	4-19
card key	4-22
personalized profile and vehicle settings	4-25
smart phone	4-19
used vehicle/digital key 2 touch maintenance	4-28
dimensions (specifications)	9-2
door lock	4-31
central door lock switch	4-32
child-protector rear door lock	4-34
door lock/unlock feature	4-33
from inside the vehicle	4-32
from outside the vehicle	4-31
in case of an emergency	4-34
rear occupant alert (ROA) system	4-35
downhill brake control (DBC)	5-44
drive mode integrated control system	5-50
driver attention warning (DAW)	6-56
detecting sensor	6-56
driver attention warning malfunction	6-58
driver attention warning operation	6-57
driver attention warning settings	6-57
leading vehicle departure alert	6-58
limitations of driver attention warning	6-59
driver's and passenger's front air bag	3-45
driving assist mode	4-78
driving at night	5-55
driving in flooded areas	5-55
driving in the rain	5-55
driving on unpaved roads	5-56

E

economical operation	5-52
electric chromic mirror (ECM)	4-66
electronic stability control (ESC) system	5-40

emergency	7-2	forward collision-avoidance assist (FCA) (sensor fusion)	6-15
hazard warning flasher	7-2	detecting sensor	6-15
if the engine will not start	7-3	forward collision-avoidance assist malfunction	6-21
in case of an emergency while driving	7-2	forward collision-avoidance assist operation	6-18
road warning	7-2	forward collision-avoidance assist settings	6-16
emergency starting	7-4	limitations of forward collision-avoidance assist	6-22
jump-starting	7-4	forward/reverse parking distance warning (PDW)	6-109
push-starting	7-5	forward/reverse parking distance warning malfunction and precautions	6-112
emission control system	8-79	forward/reverse parking distance warning operation	6-110
engine compartment	8-4	forward/reverse parking distance warning settings	6-109
engine coolant	8-22	parking distance warning auto on	6-110
changing the coolant	8-25	front fog light	4-108
checking the coolant level	8-24	front seat adjustment for power seat	3-9
recommended coolant	8-22	front seat headrest	3-10
engine number	9-9	fuel filler door	4-55
engine oil and filter	8-20	fuel requirements	1-2
changing the engine oil and filter	8-21	fuses	8-45
checking the engine oil level	8-20	fuse/relay panel description	8-49
engine overheats	7-6	replacing engine compartment fuse	8-47
engine (specifications)	9-3	replacing inner panel fuse	8-46
engine start/stop button	5-7		
illuminated engine start/stop button position	5-7	G	
starting the engine	5-8	glove box	4-144
starting the engine with smart key	5-9	glove box lamp	4-117
exterior features		gross vehicle weight	9-3
roof rack	4-156		
<hr/>			
F			
flat tire	7-11		
changing tires	7-13		
jack and tools	7-12		
jack label	7-20		
removing and storing the spare tire	7-13		
using of compact spare tire	7-18		
floor mat anchor(s)	4-155		
forward collision-avoidance assist (FCA) (front view camera only)	6-4		
detecting sensor	6-4		
forward collision-avoidance assist malfunction	6-8		
forward collision-avoidance assist operation	6-6		
forward collision-avoidance assist settings	6-5		
limitations of forward collision-avoidance assist	6-9		
<hr/>			
		H	
		hazardous driving conditions	5-53
		head light (low beam)	4-106
		headlight escort function	4-104
		headrest	3-10
		front seat headrest	3-10
		rear seat headrest	3-12
		head-up display (HUD)	4-103
		head up display information	4-103

head up display setting	4-104	tachometer	4-71
heated steering wheel	4-64	transmission shift indicator	4-75
high beam assist (HBA)	4-108	integrated memory system	4-36
highway driving	5-56	recalling positions	4-37
highway driving assist (HDA)	6-87	reset	4-37
malfunction and limitations	6-91	seat easy access	4-37
operation	6-89	storing positions	4-36
settings	6-88	intelligent speed limit assist (ISLA)	6-51
hill-start assist control (HAC)	5-44	auto set speed change	6-53
hood	4-53	changing set speed	6-53
closing the hood	4-54	detecting sensor	6-51
hood open warning	4-53	intelligent speed limit assist malfunction and limitations	6-54
opening the hood	4-53	intelligent speed limit assist operation	6-52
horn	4-64	intelligent speed limit assist settings	6-51
<hr/>			
I		intelligent variable transmission (IVT)	5-23
idle stop and go (ISG)	5-47	operation	5-23
deactivating	5-49	ranges	5-24
malfunction	5-49	shift lock system	5-26
operation	5-48	interior features	4-146
illuminated engine start/stop button	5-7	air ventilation seat	4-148
immobilizer system	4-16	cargo area cover	4-155
indicator lights	4-98	coat hook	4-154
information mode	4-78	cup holder	4-146
infotainment system	4-159	floor mat anchor(s)	4-155
antenna	4-159	power outlet	4-150
audio system	4-159	seat warmer	4-147
radio	4-159	sun visor	4-149
USB port	4-159	USB charger	4-149
infotainment system vehicle settings	4-102	wireless smart phone charging system	4-151
setting your vehicle	4-102	interior light	4-115
vehicle settings menu	4-102	automatic turn off function	4-115
inside rearview mirror	4-65	glove box lamp	4-117
installing a CRS	3-28	luggage room lamp	4-116
instrument cluster	4-68	map lamp	4-115
adjusting instrument cluster illumination	4-70	room lamp	4-116
distance to empty	4-73	vanity mirror lamp	4-117
engine coolant temperature gauge	4-71		
fuel economy (for type B)	4-75		
fuel gauge	4-72		
odometer	4-73		
outside temperature gauge	4-74		
speedometer	4-70		
<hr/>			
J		jump-starting	7-4

K

key

digital key 2 touch	4-7
immobilizer system	4-19
remote keyless entry	4-16
smart key	4-8
smart key	4-12

key positions

ignition switch position	5-5
illuminated ignition switch	5-5
starting the engine	5-6

L

lane following assist (LFA)

detecting sensor	6-83
lane following assist malfunction	6-83
lane following assist operation	6-86
lane following assist settings	6-84
limitations of lane following assist	6-84

lane keeping assist (LKA)

detecting sensor	6-28
Lane Keeping Assist disabled	6-28
lane keeping assist malfunction	6-32
lane keeping assist operation	6-32
lane keeping assist settings	6-29
limitations of lane keeping assist	6-29

LCD display

LCD display control	4-76
LCD display messages	4-76
LCD display modes	4-89
user settings mode	4-77

LCD display messages

LCD display modes

driving assist mode	4-77
information mode	4-78
master warning mode	4-78
trip computer mode	4-79
turn by turn (TBT) mode	4-78
user settings mode	4-78

liftgate

non-power liftgate	4-38
power liftgate	4-38
smart liftgate	4-40

light bulbs

back up lamp (bulb type) bulb replacement	8-59
bulb replacement precaution	8-68

front fog lamp (bulb type) bulb replacement	8-65
front fog lamp (LED type) bulb replacement	8-66
front side marker lamp (bulb type) bulb replacement	8-67
front side marker lamp (LED type) bulb replacement	8-67
glove box lamp (bulb type) replacement	8-71
headlamp (high/low/low assist)/turn signal lamp/position lamp/daytime running lamp (LED type) bulb replacement - headlamp type C	8-71
headlamp (high/low)/turn signal lamp (bulb type) bulb replacement - headlamp type B	8-64
headlamp (high/low)/turn signal lamp/position lamp/daytime running lamp (bulb type) bulb replacement - headlamp type A	8-63
high mounted stop lamp (LED type) bulb replacement	8-68
license plate lamp (bulb type) bulb replacement	8-69
light bulb position (front)	8-60
light bulb position (rear)	8-61
light bulb position (side)	8-62
luggage room lamp (bulb type) bulb replacement	8-72
map lamp (bulb type) bulb replacement	8-69
map lamp (LED type) bulb replacement	8-70
position lamp (auxiliary) (LED type) bulb replacement	8-66
position lamp/daytime running lamp (LED type) bulb replacement - headlamp type B	8-64
room lamp (bulb type) bulb replacement	8-71
room lamp (LED type) bulb replacement	8-71
side repeater lamp (bulb type) bulb replacement	8-66
tail and stop lamp/rear turn signal lamp/side marker lamp (bulb type) bulb replacement	8-67

tail lamp/tail and stop lamp/side marker lamp (LED type) bulb replacement	8-68
vanity mirror lamp (bulb type) bulb replacement	8-70
lighting	4-104
auto light	4-106
battery saver function	4-104
daytime running light (DRL)	4-105
front fog light	4-108
head light (low beam)	4-106
headlight escort function	4-104
high beam assist (HBA)	4-108
high beam assist malfunction and limitations	4-110
lighting control	4-105
one-touch lane change	4-107
operating high beam	4-106
operating turn signals	4-107
position and tail lamp	4-106
lighting control	4-105
lubricants and capacities (specifications)	9-6
luggage net holder	4-144
luggage room lamp	4-116
luggage volume (specifications)	9-3

M

maintenance services	8-6
owner maintenance precautions	8-6
owner's responsibility	8-6
manual climate control system	4-123
air conditioning	4-127
controlling air intake	4-126
controlling fan speed	4-127
heating and air conditioning	4-124
mode selection	4-125
temperature control	4-125
manual speed limit assist (MSLA)	6-48
resuming manual speed limit assist	6-50
setting the speed limit	6-48
temporarily pausing manual speed limit assist	6-49
turning off manual speed limit assist	6-50
map lamp	4-115
master warning mode	4-79
mirrors	4-65

adjusting the outside rearview mirrors	4-67
day/night rearview mirror	4-65
electric chromic mirror (ECM)	4-66
folding the outside rear view mirror	4-67
inside rearview mirror	4-65
outside rearview mirror	4-66

N

navigation-based smart cruise control (NSCC)	6-78
limitations	6-80
operation	6-78
settings	6-78

O

occupant detection system (ODS)	3-39
one-touch lane change	4-107
opening the hood	4-53
operating high beam	4-106
outside rearview mirror	4-66
overview	2-2
engine compartment	2-8
exterior	2-2
instrument panel	2-6
interior	2-4
owner maintenance	8-7

P

parking brake	8-27
checking the parking brake	8-27
parking brake (hand type)	5-31
applying the parking brake	5-31
releasing the parking brake	5-31
position and tail lamp	4-106
power brakes	5-29
power liftgate	4-40
emergency liftgate safety release	4-45
operating the power liftgate	4-42
power liftgate operating conditions	4-40
resetting the power liftgate	4-44
setting the power liftgate	4-43
smart liftgate	4-45
power outlet	4-150

power window lock button	4-51
pre-tensioner seat belt	3-22
push-starting	7-5

R

rear cross-traffic collision-avoidance assist (RCCA)	6-97
detecting sensor	6-97
limitations of rear cross-traffic collision-avoidance assist	6-103
rear cross-traffic collision-avoidance assist malfunction	6-102
rear cross-traffic collision-avoidance assist operation	6-98
rear cross-traffic collision-avoidance assist settings	6-97
rear occupant alert (ROA) system	4-35
rear seat headrest	3-12
rear view monitor (RVM)	6-94
rear view monitor malfunction and limitations	6-96
rear view monitor operation	6-95
rear view monitor settings	6-94
reducing the risk of a rollover	5-53
refrigerant label	9-10
releasing the parking brake	5-31
remote keyless entry	4-8
battery replacement	4-10
remote keyless entry system operation	4-8
transmitter precautions	4-10
remote window opening system	4-52
reporting safety defects	9-11
reverse parking distance warning (PDW)	6-106
operating condition	6-107
reverse parking distance warning malfunction and precautions	6-107
reverse parking distance warning settings	6-106
risk of burns when parking or stopping vehicle	1-5
rocking the vehicle	5-54
roof rack	4-156

room lamp	4-116
------------------	-------

S

safe exit warning (SEW)	6-44
detecting sensor	6-44
malfunction and limitations	6-47
operation	6-46
settings	6-45
warning methods	6-45
safety precautions	3-3
scheduled maintenance items	8-17
air cleaner filter	8-17
air conditioning refrigerant	8-19
automatic transmission fluid	8-18
brake discs, pads and calipers	8-19
brake fluid	8-19
brake hoses and lines	8-18
checking fluid levels	8-19
coolant	8-18
cooling system	8-18
drive belts	8-17
drive shafts and boots	8-19
engine oil and filter	8-17
exhaust pipe and muffler	8-19
fuel filter	8-17
fuel lines, fuel hoses and connections	8-17
fuel tank and fuel cap	8-17
intelligent variable transmission (IVT) fluid	8-18
parking brake	8-19
spark plugs	8-17
steering gear box, linkage and boots/lower arm ball joint	8-19
suspension mounting bolts	8-19
vacuum crankcase ventilation hoses	8-17
valve clearance	8-18
scheduled maintenance service	8-9
normal maintenance schedule	8-10, 8-14
scheduled ventilation control	4-143
seat	3-5
armrest	3-13
folding the rear seat	3-13
front seat adjustment for manual seat	3-7
front seat adjustment for power seat	3-9
seat leather	3-7
seatback pocket	3-12
unfolding the rear seat	3-15

seat belts	3-16	lubricants and capacities	9-6
3-point system with emergency locking		luggage volume	9-3
retractor	3-18	recommended SAE viscosity number	9-7
care of seat belts	3-25	tires and wheels	9-5
child restraint system (CRS)	3-26	starting the engine	5-8
installing a CRS	3-28	starting the engine with smart key	5-9
precautions	3-24	steering wheel	4-62
pre-tensioner seat belt	3-22	electric power steering (EPS)	4-62
warning	3-17	heated steering wheel	4-64
seat leather	3-7	horn	4-64
seat warmer	4-147	tilt and telescopic steering	4-63
seatback pocket	3-12	storage compartment	4-143
side air bag	3-47	center console storage	4-143
sliding armrest	4-144	glove box	4-144
smart cruise control (SCC)	6-64	luggage board	4-145
detecting sensor	6-64	luggage net holder	4-144
displaying operating status	6-69	sliding armrest	4-144
limitations of smart cruise control	6-73	sun visor	4-149
smart cruise control malfunction	6-73	sunroof	4-58
smart cruise control operation	6-66	automatic reversal	4-60
smart cruise control settings	6-65	resetting the sunroof	4-61
smart key	4-12	slide open/close	4-60
functions	4-13	sunroof open warning	4-62
immobilizer system	4-18	sunshade	4-59
smart liftgate	4-45	tilt open/close	4-59
detecting area	4-47	sunroof inside air recirculation	4-142
how to deactivate the smart liftgate		supplemental restraint system (SRS)	3-54
function using the smart key	4-46		
how to use the smart liftgate	4-45		
smooth cornering	5-55		
snow tires	5-57		
snowy or icy conditions	5-57		
special driving conditions	5-53		
driving at night	5-55		
driving in flooded areas	5-55		
driving in the rain	5-55		
driving on unpaved roads	5-56		
hazardous driving conditions	5-53		
highway driving	5-56		
reducing the risk of a rollover	5-53		
rocking the vehicle	5-54		
smooth cornering	5-55		
specifications	9-2		
air conditioning system	9-3		
bulb wattage	9-4		
dimensions	9-2		
engine	9-3		
gross vehicle weight	9-3		

T

theft-alarm system	4-29
armed stage	4-29
disarmed stage	4-30
theft-alarm stage	4-30
tilt and telescopic steering	4-63
tire and loading information	
label	5-60
tire pressure indicator	7-7
tire pressure monitoring system (TPMS)	7-7
low tire pressure telltale	7-8
malfunction indicator	7-9
tire pressure indicator	7-7
tire replacement with TPMS	7-10

tire specification and pressure label	9-9
tires and wheels	8-35
recommended cold tire inflation pressures	8-35
snow tires	8-43
tire maintenance	8-38
tire pressure	8-35
tire replacement	8-37
tire rotation	8-36
tire sidewall labeling	8-38
tire terminology and definitions	8-41
tire traction	8-38
wheel alignment and tire balance	8-37
wheel replacement	8-38
tires and wheels (specifications)	9-5
towing	7-22
emergency towing	7-24
removable towing hook	7-23
towing service	7-22
without wheel dollies	7-23
trip information (trip computer)	4-85
turn by turn (TBT) mode	4-78
turn signals	4-107

U

USB charger	4-149
USB port	4-159
user settings mode	4-79

V

vanity mirror lamp	4-117
vehicle break-in process	1-5
vehicle certification label	9-8
vehicle data collection and event data recorders	1-6
vehicle handling instructions	1-6
vehicle identification number (VIN)	9-8
vehicle load limit	5-60
certification label	5-63
tire and loading information label	5-60
vehicle modifications	1-4

vehicle stability management (VSM) system	5-42
vehicle weight	5-64

W

warning and indicator lights	4-92
indicator lights	4-98
warning lights	4-92
warning lights	4-92
washer fluid	8-26
checking the washer fluid level	8-26
windows	4-48
power window lock button	4-51
remote window opening system	4-52
window opening and closing	4-49
windshield defrosting and defogging	4-137
auto defogging system	4-140
defogging logic	4-139
winter driving	5-57
snow tires	5-57
snowy or icy conditions	5-57
wiper blades	8-30
blade inspection	8-30
replacing front windshield wiper blade	8-31
replacing rear window wiper blade	8-31
wipers and washers	4-111
auto control	4-112
auto rear wiper	4-114
operating rear window wiper and washer switch	4-114
operating windshield washer	4-113
windshield washers	4-112
wireless smart phone charging system	4-151