

- ACURALINK®
- BLUETOOTH® HANDSFREELINK®
- AUDIO AND CONNECTIVITY
- VEHICLE CONTROLS
- INSTRUMENT PANEL
- SAFETY INFORMATION
- VISUAL INDEX
- TABLE OF CONTENTS

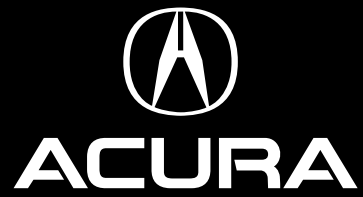

owners.acura.com (U.S.)  
myacura.ca (Canada)

BOG01980  
31TX4G10  
00X31-TX4-G100

2016 Acura RDX Owner's Guide (Ver 2)  
©2015 Honda Motor Co., Ltd. — All Rights Reserved

Printed in U.S.A.



# RDX

- INDEX
- VOICE COMMAND INDEX
- CLIENT INFORMATION
- SPECIFICATIONS
- MAINTENANCE
- HANDLING THE UNEXPECTED
- DRIVING
- NAVIGATION

**2016**  
**OWNER'S GUIDE**

# DISCLOSURES

## ■ Devices That Emit Radio Waves

The following products and systems on your vehicle emit radio waves when in operation:

- AcuraLink®
- Audio system
- Blind spot information system
- Bluetooth® Audio
- Bluetooth® HandsFreeLink®
- Collision Mitigation Braking System™ (CMBS™)
- HomeLink® Universal Transceiver
- Immobilizer system
- Remote engine starter
- Remote transmitter
- Keyless Access System
- Tire Pressure Monitoring System

Each of the above complies with the appropriate requirements or the required standards of FCC (Federal Communications Commission) and Industry Canada, described below:

*As required by the FCC:*

*This device complies with Part 15 of the FCC rules. Operation is subject to the following two conditions: (1) This device may not cause harmful interference, and (2) this device must accept any interference received, including interference that may cause undesired operation.*

*Changes or modifications not expressly approved by the party responsible for compliance could void the user's authority to operate the equipment.*

*As required by Industry Canada:*

*This device complies with Industry Canada Standard RSS-Gen/210/251/310. Operation is subject to the following two conditions: (1) this device may not cause interference, and (2) this device must accept any interference, including interference that may cause undesired operation of the device.*

## ■ California Perchlorate Contamination Prevention Act

The airbags, seat belt tensioners, and CR-type batteries in this vehicle may contain perchlorate materials—special handling may apply. See [www.dtsc.ca.gov/hazardouswaste/perchlorate/](http://www.dtsc.ca.gov/hazardouswaste/perchlorate/) for more information.

## ■ California Proposition 65 Warning

WARNING: This product contains or emits chemicals known to the state of California to cause cancer and birth defects or other reproductive harm.

## ■ Event Data Recorders

**This vehicle is equipped with an event data recorder (EDR).** The main purpose of an EDR is to record, in certain crash or near crash-like situations, such as an air bag deployment or hitting a road obstacle, data that will assist in understanding how a vehicle's systems performed. **The EDR is designed to record data related to vehicle dynamics and safety systems for a short period of time, typically 30 seconds or less. The EDR in this vehicle is designed to record such data as:**

- How various systems in your vehicle were operating;
- Whether or not the driver and passenger safety belts were buckled/ fastened;
- How far (if at all) the driver was depressing the accelerator and/or brake pedal; and,
- How fast the vehicle was traveling.

These data can help provide a better understanding of the circumstances in which crashes and injuries occur. NOTE: EDR data are recorded by your vehicle only if a non-trivial crash situation occurs; no data are recorded by the EDR under normal driving conditions and no personal data (e.g., name, gender, age, and crash location) are recorded. However, other parties, such as law enforcement, could combine the EDR data with the type of personally identifying data routinely acquired during a crash investigation.

To read data recorded by an EDR, special equipment is required, and access to the vehicle or the EDR is needed. In addition to the vehicle manufacturer, other parties such as law enforcement that have the special equipment can read the information if they have access to the vehicle or the EDR.

The data belong to the vehicle owner and may not be accessed by anyone else except as legally required or with the permission of the vehicle owner.

## ■ Service Diagnostic Recorders

This vehicle is equipped with service-related devices that record information about powertrain performance. The data can be used to verify emissions law requirements and/or help technicians diagnose and solve service problems. It may also be combined with data from other sources for research purposes, but it remains confidential.

# INTRODUCTION

This Owner's Guide is intended to help you quickly get acquainted with your **2016 Acura RDX**. It provides basic information and instructions on technology and convenience features, as well as emergency procedures and how to get assistance.

This guide is for vehicles sold in the United States and Canada. It covers all RDX models, so you may find descriptions of features and equipment that are not in your vehicle.

Images throughout this guide are from U.S. vehicles and represent features and equipment that are available on some, but not all, models. Images shown in this guide should be considered examples and used for demonstration purposes only.

This guide is not intended to be a substitute for the Owner's Manual. The Owner Information CD enclosed in your glove box kit includes the Owner's Manual, Navigation Manual, and vehicle and tire warranties in electronic format. This information can be viewed on a computer (PC or Mac platform) and saved or printed for your reference. In addition, you can visit [owners.acura.com](http://owners.acura.com) (U.S.) or [myacura.ca](http://myacura.ca) (Canada) to view the complete and most current information.

If you are the first registered owner of your vehicle, you may request a complimentary printed copy of the Owner's Manual, Navigation Manual, or Vehicle Warranty within the first six months of vehicle purchase. To request a copy, visit [owners.acura.com](http://owners.acura.com) and create or log in to your account. In Canada, please request a copy from your Acura dealer.

American Honda Motor Company strives to be proactive in protecting our environment and natural resources. By using electronic delivery for a considerable portion of the information typically found in a vehicle owner's manual, we are further reducing our impact on the environment.

## ■ Acura Total Luxury Care Roadside Assistance

Your Acura TLC Roadside Assistance representative is here to help you 24 hours a day, 7 days a week. Under your 4-year/50,000-mile (80,000 km) warranty, the following benefits are available:

- Towing services—full cost of towing to the closest Acura dealer
- Roadside assistance—jump starting, fuel delivery, lockout, and flat tire
- Trip planning—detailed trip routing, emergency services, and more

Call (800) 594-8500 (U.S.) or (800) 565-7587 (Canada)

## ■ Acura Client Relations

Your authorized Acura dealer should be able to answer any questions you have about your vehicle. However, if you are dissatisfied with the information you receive, you can call Acura Client Relations (see page 145).

Call (800) 382-2238 (U.S.) or (888) 922-8729 (Canada)

# TABLE OF CONTENTS

VISUAL INDEX.....	1	Customized Settings*.....	48
Steering Wheel and Nearby Controls.....	1	Setting the Clock.....	49
Dashboard and Ceiling Controls.....	2	AUDIO AND CONNECTIVITY .....	50
SAFETY INFORMATION.....	3	Basic Audio Operation.....	50
Important Safety Information .....	3	<i>Models without navigation</i>	
Seat Belts .....	5	Color Information Display.....	52
Airbags.....	9	FM/AM Radio.....	53
Child Safety .....	15	SiriusXM® Radio.....	54
Safety Label Locations .....	22	Compact Disc (CD).....	55
Reporting Safety Defects.....	23	iPod®.....	56
INSTRUMENT PANEL .....	24	USB Flash Drive.....	57
Malfunction Indicators.....	24	<i>Bluetooth® Audio</i> .....	58
Condition Indicators.....	26	Pandora®.....	59
On/Off Indicators .....	27	<i>Models with navigation</i>	
Multi-Information Display .....	28	On-Demand Multi-Use Display™ (ODMD™).....	60
VEHICLE CONTROLS.....	30	FM/AM Radio.....	61
Using the Remote Transmitter.....	30	SiriusXM® Radio.....	62
Keyless Access System.....	31	Compact Disc (CD) or USB Flash Drive.....	63
Power Tailgate Operation.....	32	Hard Disc Drive (HDD) Audio.....	64
Door Operation from Inside the Vehicle.....	33	iPod®.....	65
Power Window Operation.....	34	<i>Bluetooth® Audio</i> .....	66
Power Moonroof Operation .....	35	Pandora®.....	67
Interior and Exterior Lights.....	36	AcuraLink featuring Aha™.....	68
One-Touch Turn Signal.....	37	<i>BLUETOOTH® HANDSFREELINK®</i> ... <td>69</td>	69
Wiper Operation .....	38	Basic HFL Operation .....	69
Adjusting the Seats.....	40	<i>Models without navigation</i>	
Adjusting the Steering Wheel .....	43	Pairing a Phone.....	70
Driving Position Memory System... <td>43</td> <td>Making a Call .....</td> <td>71</td>	43	Making a Call .....	71
Adjusting the Mirrors.....	44	SMS Text Messaging .....	72
HomeLink® Garage Opener.....	45	<i>Models with navigation</i>	
Climate Control System.....	46	Pairing a Phone.....	75
Seat Heaters or Ventilation*.....	47	Making a Call .....	76

\*if equipped

# VISUAL INDEX

Quickly locate items in the vehicle's interior.

## Steering Wheel and Nearby Controls

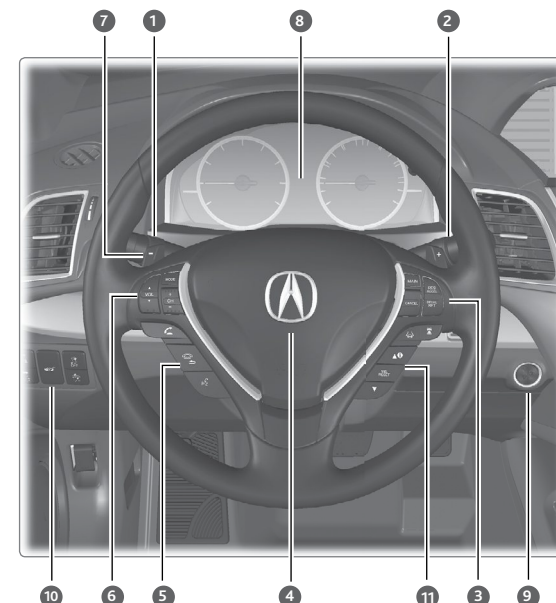

- ① Lights/turn signals p. 36, p. 37
- ② Wipers/washers p. 38
- ③ Cruise control\*/Adaptive Cruise Control (ACC)\* buttons p. 69, p. 73, p. 83
- ④ Horn
- ⑤ Bluetooth® HandsFreeLink®/voice recognition buttons p. 69, p. 73, p. 83
- ⑥ Audio controls p. 51
- ⑦ Paddle shifters p. 99
- ⑧ Instrument panel p. 24  
Multi-information display p. 28
- ⑨ ENGINE START/STOP button p. 97
- ⑩ Vehicle Stability Assist (VSA®) OFF button p. 109  
Lane Departure Warning (LDW) button\* p. 104  
Collision Mitigation Braking System™ (CMBST™) OFF button\* p. 107  
Parking sensor system button\* p. 109  
Power tailgate button p. 32
- ⑪ INFO (▲/▼) buttons p. 28  
SEL/RESET button p. 28  
Distance (ACC) button\* p. 102  
Lane Keeping Assist System (LKAS) button\* p. 105

*\*if equipped*

SMS Text Messaging and E-Mail ... 79	Shift Lever Does Not Move ..... 113
Siri™ Eyes Free ..... 80	Jump Starting.....114
ACURALINK®* ..... 81	Overheating ..... 115
AcuraLink Messages..... 81	Emergency Engine Stop.....116
Subscription Features..... 82	Emergency Towing ..... 116
NAVIGATION* ..... 83	Tire Pressure Monitoring System (TPMS) ..... 117
Basic Navigation Operation ..... 83	Tire Repair Kit* ..... 119
Entering a Destination ..... 86	Changing a Flat Tire ..... 120
Routing ..... 88	Fuse Locations ..... 123
DRIVING..... 90	MAINTENANCE..... 126
Before Driving..... 90	Safety Precautions..... 126
Maximum Load Limit ..... 92	Maintenance Minder™ ..... 127
Towing a Trailer ..... 94	Under the Hood..... 129
Remote Engine Start* ..... 96	Engine Oil ..... 130
Starting to Drive..... 97	Engine Coolant ..... 132
Shifting ..... 98	Window Washer Fluid ..... 133
Braking..... 100	Brake Fluid..... 133
Cruise Control* ..... 101	Checking the Battery..... 133
Adaptive Cruise Control (ACC)* ... 102	Changing Wiper Blades ..... 134
Lane Departure Warning (LDW)* ... 104	Tire Information ..... 136
Lane Keeping Assist System (LKAS)* ..... 105	Tire Labeling..... 139
Blind Spot Information (BSI)* .... 106	DOT Tire Quality Grading ..... 140
Collision Mitigation Braking System™ (CMBST™)* ..... 107	Testing of Readiness Codes ..... 142
Vehicle Stability Assist (VSA®), aka Electronic Stability Control (ESC) System..... 109	SPECIFICATIONS ..... 143
Parking Sensor System* ..... 109	CLIENT INFORMATION ..... 144
Multi-View Rear Camera..... 110	Frequently Asked Questions/ Troubleshooting ..... 144
Rear Cross Traffic Monitor* ..... 111	Contact Us ..... 145
Refueling ..... 112	Acura Total Luxury Care Roadside Assistance ..... 146
HANDLING THE UNEXPECTED... 113	Warranty Coverages..... 146
Keyless Access Remote Battery Strength..... 113	VOICE COMMAND INDEX ..... 147
	INDEX ..... 153

*\*if equipped*

## Dashboard and Ceiling Controls

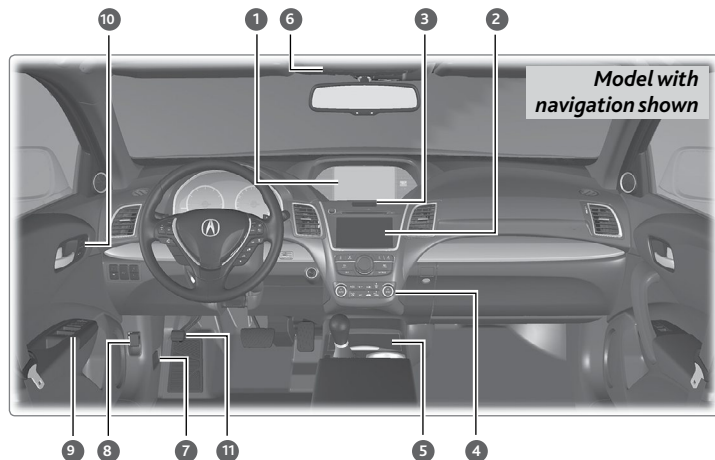

- |   |   |
|---|---|
| <ul style="list-style-type: none"> <li>1 Color information display p. 52</li> <li>2 On-Demand Multi-Use Display™ (ODMD™)* p. 60</li> <li>3 Hazard warning button</li> <li>4 Climate control p. 46</li> <li>5 Accessory power socket p. 50<br/>USB port p. 50<br/>Auxiliary input jack p. 50</li> <li>6 Moonroof switch p. 35<br/>Interior lights p. 34</li> </ul> | <ul style="list-style-type: none"> <li>7 Hood release handle p. 129</li> <li>8 Fuel fill door handle p. 112</li> <li>9 Power window switches p. 34<br/>Door lock switches p. 33<br/>Door mirror controls p. 44</li> <li>10 Driving Position Memory System buttons p. 43</li> <li>11 Parking brake p. 100</li> </ul> |
|---|---|

## SAFETY INFORMATION

Your safety—and the safety of others—is very important, and operating this vehicle safely is an important responsibility. While we strive to help you make informed decisions about safety, it is not practical or possible to warn you about all the hazards associated with operating or maintaining your vehicle. Therefore, you must use your own good judgment.

### Important Safety Information

This guide explains many of your vehicle's safety features and how to use them. Please read this information carefully. Following the instructions below will also help to keep you and your passengers safe.

#### ■ Important Safety Precautions

- Always wear your seat belt.
- Secure all children in the proper restraint system.
- Be aware of airbag hazards.
- Don't drink and drive.
- Pay appropriate attention to the task of driving safely.
- Control your speed.
- Keep your vehicle in safe condition.

Engaging in cell phone conversation or other activities that keep you from paying close attention to the road, other vehicles, and pedestrians could lead to a crash. Remember, situations can change quickly, and only you can decide when it is safe to divert some attention away from driving.

#### ■ Important Handling Information

Your vehicle has a higher ground clearance than a passenger vehicle designed for use only on pavement. Higher ground clearance has many advantages for off-highway driving. It allows you to travel over bumps, obstacles, and rough terrain. It also provides good visibility so you can anticipate problems earlier.

These advantages come at some cost. Because your vehicle is taller and rides higher off the ground, it has a higher center of gravity, making it more susceptible to tipping or rollover if you make abrupt turns. Utility vehicles have a significantly higher rollover rate than other types of vehicles. In a rollover crash, an unbelted person is significantly more likely to die than a person wearing a seat belt. As a reminder, make sure you and your passengers always wear seat belts.

\*if equipped

TABLE OF CONTENTS

VISUAL INDEX

SAFETY INFORMATION

INSTRUMENT PANEL

VEHICLE CONTROLS

AUDIO AND CONNECTIVITY

BLUETOOTH® HANDSFREELINK®

ACURALINK®

NAVIGATION

DRIVING

HANDLING THE UNEXPECTED

MAINTENANCE

SPECIFICATIONS

CLIENT INFORMATION

VOICE COMMAND INDEX

INDEX

## ■ Safety Messages

When you see the following messages throughout this guide, pay close attention.

**⚠ DANGER** You **WILL** be **KILLED** or **SERIOUSLY HURT** if you don't follow instructions.

**⚠ WARNING** You **CAN** be **KILLED** or **SERIOUSLY HURT** if you don't follow instructions.

**⚠ CAUTION** You **CAN** be **HURT** if you don't follow instructions.

**NOTICE** This information is intended to help you avoid damage to your vehicle, other property, or the environment.

## ■ Carbon Monoxide Gas

The engine exhaust from this vehicle contains carbon monoxide, a colorless, odorless, and highly toxic gas. As long as you properly maintain your vehicle and follow the instructions set forth below, you will not accumulate dangerous levels of carbon monoxide gas in the vehicle interior.

Have the exhaust system inspected for leaks whenever:

- The exhaust system is making an unusual noise.
- The exhaust system may have been damaged.
- The vehicle is raised for an oil change.

When you operate a vehicle with the tailgate open, airflow can pull exhaust gas into the interior and create a hazardous condition. If you must drive with the tailgate open, open all the windows and set the climate control system as shown below.

1. Select the fresh air mode.
2. Select the  mode.
3. Set the fan speed to high.
4. Set the temperature control to a comfortable setting.

Adjust the climate control system in the same manner if you sit in your parked vehicle with the engine running.

### ⚠ WARNING

Carbon monoxide gas is toxic. Breathing it can cause unconsciousness and even kill you.

Avoid any enclosed areas or activities that expose you to carbon monoxide.

An enclosed area such as a garage can quickly fill up with carbon monoxide gas. Do not run the engine with the garage door closed. Even when the garage door is open, drive out of the garage immediately after starting the engine.

## Seat Belts

A seat belt is your best protection in all types of collisions. Airbags are designed to supplement seat belts, not replace them. So even though your vehicle is equipped with airbags, make sure you and your passengers always wear your seat belts and wear them properly.

### ■ Lap/Shoulder Seat Belts

All five seating positions are equipped with lap/shoulder seat belts with emergency locking retractors. In normal driving, the retractor lets you move freely while keeping some tension on the belt. During a collision or sudden stop, the retractor locks to restrain your body. The front passenger's and rear seat belts also have a lockable retractor for use with child seats.

The front seats are equipped with automatic seat belt tensioners to enhance safety. The tensioners automatically tighten the front seat belts during a moderate to severe frontal collision, sometimes even if the collision is not severe enough to inflate the front airbags.

### ■ Proper Use of Seat Belts

Follow these guidelines for proper use:

- All occupants should sit upright, well back in the seat, and remain in that position for the duration of the trip. Slouching and leaning reduces the effectiveness of the belt and can increase the chance of serious injury in a crash.
- Never place the shoulder part of a lap/shoulder seat belt under your arm or behind your back. This could cause very serious injuries in a crash.
- Two people should never use the same seat belt. If they do, they could be very seriously injured in a crash.
- Do not put any accessories on the seat belts. Devices intended to improve comfort or reposition the shoulder part of a seat belt can reduce the protective capability and increase the chance of serious injury in a crash.
- No one should sit in a seat with an inoperative seat belt or one that does not appear to be working correctly. Using a seat belt that is not working properly may not protect the occupant in a crash. Have a dealer check the belt as soon as possible.

### ⚠ WARNING

Not wearing a seat belt properly increases the chance of a serious injury or death in a crash, even though your vehicle has airbags.

Be sure you and your passengers always wear seat belts and wear them properly.

## ■ Seat Belt Inspection

Regularly check the condition of your seat belts as follows:

- Pull each belt out fully, and look for frays, cuts, burns, and wear.
- Check that the latches work smoothly and the belts retract easily. If a belt does not retract easily, cleaning the belt may correct the problem. Only use a mild soap and warm water. Do not use bleach or cleaning solvents. Make sure the belt is completely dry before allowing it to retract.

Any belt that is not in good condition or working properly will not provide proper protection and should be replaced as soon as possible.

A belt that has been worn during a crash may not provide the same level of protection in a subsequent crash. Have your seat belts inspected by a dealer after any collision.

### ⚠ WARNING

Not checking or maintaining seat belts can result in serious injury or death if the seat belts do not work properly when needed.

Check your seat belts regularly and have any problem corrected as soon as possible.

## ■ Fastening a Seat Belt

Adjust your seat to the proper position (see page 40), and then follow the below steps.

1. Pull the seat belt out slowly.
2. Insert the latch plate into the buckle, then tug on the belt to make sure the buckle is secure. Make sure that the belt is not twisted or caught on anything.
3. Position the lap part of the belt as low as possible across your hips, then pull up on the shoulder part of the belt so the lap part fits snugly. This lets your strong pelvic bones take the force of a crash and reduces the chance of internal injuries.

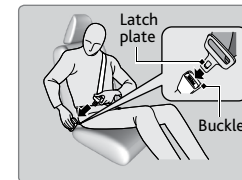

4. If necessary, pull up on the belt again to remove any slack, then make sure that the belt rests across the center of your chest and over your shoulder. This spreads the forces of a crash over the strongest bones in your upper body.



To release the belt, push the red PRESS button then guide the belt by hand until it has retracted completely.

### ⚠ WARNING

Improperly positioning the seat belts can cause serious injury or death in a crash.

Make sure all seat belts are properly positioned before driving.

## ■ Adjusting the Shoulder Anchor

The front seats have adjustable shoulder anchors to accommodate taller and shorter occupants.

1. Move the anchor up and down while holding the release button.
2. Position the anchor so that the belt rests across the center of your chest and over your shoulder.

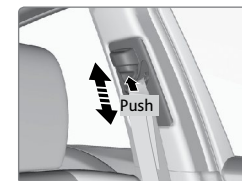

## ■ Seat Belt with Detachable Anchor

The seat belt for the second-row center seat is located in the ceiling.

1. Pull out the seat belt's small latch plate and the latch plate from each holding slot in the ceiling.
2. Line up the triangle marks on the small latch plate and anchor buckle. Make sure the seat belt is not twisted. Attach the belt to the anchor buckle.
3. Insert the latch plate into the buckle. Properly fasten the seat belt the same way you fasten the lap/shoulder seat belt.

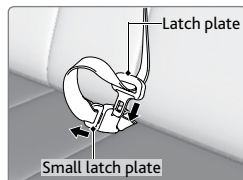
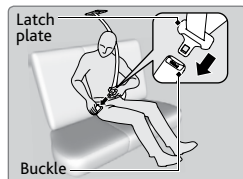
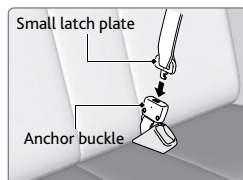
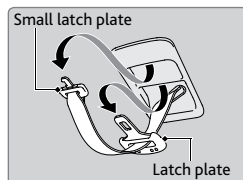

To unlatch the detachable anchor, insert the latch plate into the slot on the side of the anchor buckle.

### ⚠️ WARNING

Using the seat belt with the detachable anchor unlatched increases the chance of serious injury or death in a crash.

Before using the seat belt, make sure the detachable anchor is correctly latched.

## Airbags

Your vehicle is equipped with three types of airbags: front airbags, side airbags, and side curtain airbags.

### ■ Front Airbags (SRS)

The front SRS airbags inflate in a moderate-to-severe frontal collision to help protect the head and chest of the driver and/or front passenger. They are housed in the center of the steering wheel for the driver, and in the dashboard for the front passenger. Both airbags are marked **SRS AIRBAG**.

SRS (Supplemental Restraint System) indicates that the airbags are designed to supplement seat belts, not replace them. Seat belts are the occupant's primary restraint system.

### ■ Advanced Airbags

Your front airbags have advanced features to help reduce the likelihood of airbag-related injuries to smaller occupants.

The driver's advanced front airbag system includes a seat position sensor. If the seat is too far forward, the airbag inflates with less force, regardless of the severity of the impact.

If there is a problem with the driver's seat position sensor, the SRS indicator will come on and the airbag will inflate with full (normal) force, regardless of the driver's seating position.

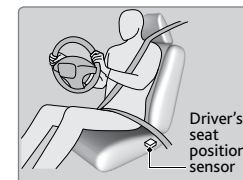

The passenger's advanced front airbag system has weight sensors. Although Acura recommends against carrying an infant or small child in front, if the sensors detect the weight of a child (up to 65 lbs or 29 kg), the system will automatically turn off the passenger's front airbag.

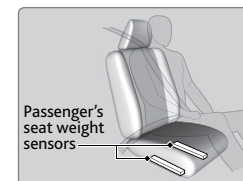

For both advanced front airbags to work properly:

- Do not spill any liquid on or under the seats.
- Do not put any object under the passenger's seat.
- Make sure any objects are positioned properly on the floor. Improperly positioned objects can interfere with the advanced airbag sensors.
- All occupants should sit upright and wear their seat belts properly.
- Do not place any cover over any part of the passenger side dashboard.



## ■ Side Airbags

The side airbags help protect the upper torso and pelvis of the driver or a front passenger during a moderate-to-severe side impact. They are housed in the outside edge of the driver's and front passenger's seat-backs. Both are marked **SIDE AIRBAG**.

## ■ Side Curtain Airbags

Side curtain airbags help protect the head and torso of the driver and passengers in outer seating positions during a moderate-to-severe side impact. The side curtain airbags equipped in this vehicle are also designed to help reduce the likelihood of partial and complete ejection of vehicle occupants through side windows in crashes, particularly rollover crashes.

The side curtain airbags are located in the ceiling above the side windows on both sides of the vehicle.

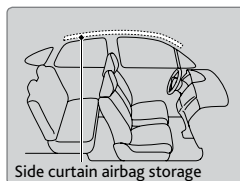

The side curtain airbags are designed to deploy in a rollover or moderate-to-severe side impact. If the SRS control unit senses that your vehicle is about to roll over, it immediately deploys both side curtain airbags and activates both front seat belt tensioners. If the impact is on the passenger's side, the passenger's side curtain airbag will inflate even if there are no occupants on that side of the vehicle.

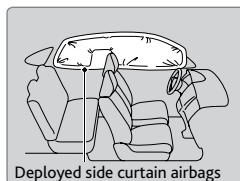

To get the best protection from the side curtain airbags, occupants should wear their seat belts properly and sit upright and well back in their seats.

Do not attach any objects to the side windows or roof pillars, as they can interfere with the proper operation of the side curtain airbags.

### When side curtain airbags deploy in a frontal collision

One or both side curtain airbags may inflate in a moderate-to-severe angled frontal collision. In this case, the side curtain airbags will deploy slightly after the front airbags.

## ■ Important Facts About Your Airbags

Always wear your seat belt properly, and sit upright and as far back from the steering wheel as possible while allowing full control of the vehicle. A front passenger should move their seat as far back from the dashboard as possible.

### Do not place hard or sharp objects between yourself and a front airbag.

Carrying hard or sharp objects on your lap, or driving with a pipe or other sharp object in your mouth, can result in injuries if your front airbag inflates.

**Do not attach or place objects on the front airbag covers.** Objects on the covers marked **SRS AIRBAG** could interfere with the proper operation of the airbags or be propelled inside the vehicle and hurt someone if the airbags inflate.

**Do not attach accessories on or near the side airbags.** They can interfere with the proper operation of the airbags, or hurt someone if an airbag inflates.

**Do not attach any objects to the side windows or roof pillars.** They can interfere with the proper operation of the side curtain airbags.

**Do not cover or replace the front seat-back covers.** This can prevent your side airbags from properly deploying during a side impact.

### ⚠️ WARNING

An open glove box can cause serious injury to your passenger in a crash, even if the passenger is wearing the seat belt.

Always keep the glove box closed while driving.

## ■ Airbag System Indicators

If a problem occurs in the airbag system, the SRS indicator will come on and a message appears on the multi-information display.

### SRS (Supplemental Restraint System) Indicator

If the indicator comes on at any other time besides vehicle start-up, or does not come on at all, have the system checked by a dealer as soon as possible. If you don't, your airbags and seat belt tensioners may not work properly when they are needed.

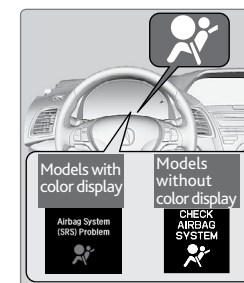

### ⚠️ WARNING

Ignoring the SRS indicator can result in serious injury or death if the airbag systems or tensioners do not work properly.

Have your vehicle checked by a dealer as soon as possible if the SRS indicator alerts you to a possible problem.

### Passenger Airbag Off Indicator

The indicator comes on to alert you that the front passenger's front airbag has been turned off. This occurs when the front passenger's weight sensors detect 65 lbs (29 kg) or less, the weight of an infant or small child, on the seat.

Infants and small children should always ride properly restrained in a back seat.

Objects placed on the seat can also cause the indicator to come on.

If the front passenger's seat is empty, the passenger's front airbag will not deploy and the indicator will not come on.

If the indicator comes on with no occupant or objects in the front passenger's seat, something may be interfering with the weight sensors, such as:

- An object hanging on the seat or in the seat-back pocket.
- A child seat or other object pressing against the rear of the seat-back.
- A rear passenger pushing or pulling on the back of the front passenger's seat.
- The front seat or seat-back is forced against an object on the seat or floor behind it.
- An object placed under the front passenger's seat.

If none of these conditions exist, have your vehicle checked by a dealer as soon as possible.

The passenger airbag off indicator may go on and off repeatedly if the total weight on the seat is near the airbag cutoff threshold.

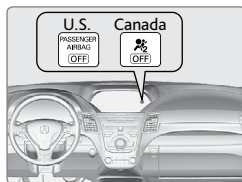

### Airbag System Components

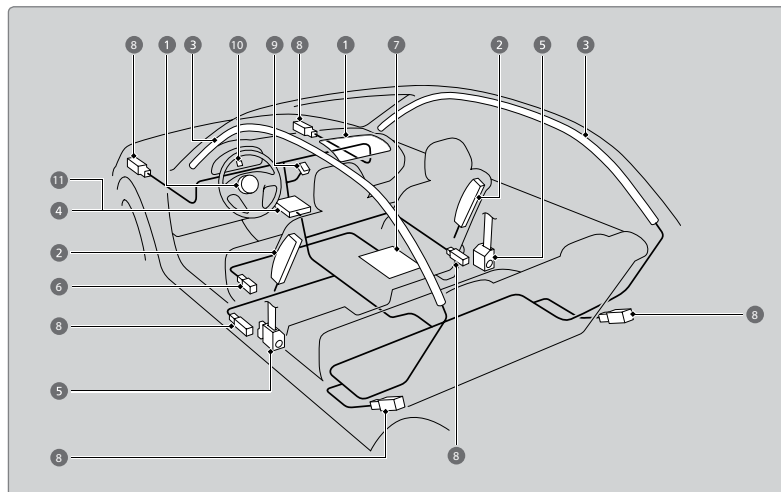

- 1 Two SRS (Supplemental Restraint System) front airbags. The driver's airbag is stored in the center of the steering wheel; the front passenger's airbag is stored in the dashboard. Both are marked **SRS AIRBAG**.
- 2 Two side airbags, one for the driver and one for the front passenger. The airbags are stored in the outer edges of the seat-backs. Both are marked **SIDE AIRBAG**.
- 3 Two side curtain airbags, one for each side of the vehicle. The airbags are stored in the ceiling, above the side windows. The front and rear pillars are marked **SIDE CURTAIN AIRBAG**.
- 4 An electronic control unit that continually monitors and can record information about the sensors, the airbag activators, the seat belt tensioners, and driver and front passenger seat belt use when the vehicle is on.
- 5 Automatic front seat belt tensioners. The driver's and front passenger's seat belts incorporate sensors that detect whether or not they are fastened.
- 6 A driver's seat position sensor. If the seat is too far forward, the airbag will inflate with less force.
- 7 Weight sensors in the front passenger's seat. The front passenger's airbag will be turned off if the weight on the seat is 65 lbs (29 kg) or less (the weight of an infant or small child).
- 8 Impact sensors that can detect a moderate-to-severe front or side impact.
- 9 An indicator on the dashboard that alerts you that the front passenger's front airbag has been turned off.

- 10 An indicator on the instrument panel that alerts you to a possible problem with your airbag system or seat belt tensioners.
- 11 A rollover sensor that detects whether the vehicle is about to roll over.

### ■ Airbag Care

You do not need to, and should not, perform any maintenance on or replace any airbag system components yourself. However, you should have your vehicle inspected by a dealer in the following situations:

#### When the airbags have deployed

If an airbag has inflated, the control unit and other related parts must be replaced. Similarly, once an automatic seat belt tensioner has been activated, it must be replaced.

#### When the vehicle has been in a moderate-to-severe collision

Even if the airbags did not inflate, have your dealer inspect the following: the driver's seat position sensor, weight sensors in the passenger's seat, front seat belt tensioners, and each seat belt that was worn during the crash.

#### Do not remove or modify a front seat without first consulting a dealer

This would likely disable the driver's seat position sensor or the weight sensors in the passenger's seat. If it is necessary to remove or modify a front seat to accommodate a person with disabilities, contact an Acura dealer. For U.S. vehicles, call Acura Client Relations at (800) 382-2238. For Canadian vehicles, call Acura Client Services at (888) 922-8729.

## Child Safety

Each year, many children are injured or killed in vehicle crashes because they are either unrestrained or not properly restrained. In fact, vehicle collisions are the number one cause of death of children ages 12 and under.

The National Highway Traffic Safety Administration and Transport Canada recommend that all children ages 12 and under be properly restrained in a rear seat. Some states or provinces/territories have laws restricting where children may ride.

To reduce the number of child deaths and injuries, every state, Canadian province and territory requires that infants and children be properly restrained when they ride in a vehicle.

### ■ Protecting Child Passengers

- An inflating front or side airbag can injure or kill a child sitting in the front seat.
- A child in the front seat is more likely to interfere with the driver's ability to safely control the vehicle.
- Statistics show that children of all sizes and ages are safer when they are properly restrained in a rear seat.
- Any child who is too small to wear a seat belt correctly must be restrained in an approved child seat that is properly secured to the vehicle using either the lap belt portion of the lap/shoulder belt or the lower anchors of the LATCH system.
- Never hold a child on your lap because it is impossible to protect them in the event of a collision.
- Never put a seat belt over yourself and a child. During a crash, the belt would likely press deep into the child and cause serious or fatal injuries.
- Never let two children use the same seat belt. Both children could be very seriously injured in a crash.
- Do not allow children to operate the doors, windows, or seat adjustments.
- Do not leave children in the vehicle unattended, especially in hot weather when the inside of the vehicle can get hot enough to kill them. They could also activate vehicle controls, causing it to move unexpectedly.

### WARNING

Children who are unrestrained or improperly restrained can be seriously injured or killed in a crash.

Any child too small for a seat belt should be properly restrained in a child seat. A larger child should be properly restrained with a seat belt, using a booster seat if necessary.

**⚠️WARNING**

Allowing a child to play with a seat belt or wrap one around their neck can result in serious injury or death.

Instruct children not to play with any seat belt and make sure any unused seat belt a child can reach is buckled, fully retracted, and locked.

**■ Protecting Infants**

An infant must be properly restrained in a rear-facing, reclining child seat until the infant reaches the seat manufacturer's weight or height limit for the seat, and the infant is at least one year old. Many experts recommend use of a rear-facing seat for a child up to two years old if the child's height and weight are appropriate for a rear-facing seat.

Child seats must be placed and secured in a rear seating position. Rear-facing child seats should never be installed in a forward-facing position.



When properly installed, a rear-facing child seat may prevent the driver or a front passenger from moving their seat all the way back, or from locking their seat-back in the desired position. It can also interfere with proper operation of the front passenger's advanced front airbag system. If this occurs, we recommend that you install the child seat directly behind the front passenger's seat, move the seat as far forward as needed, and leave it unoccupied. Or, you may wish to get a smaller rear-facing child seat.

**⚠️WARNING**

Placing a rear-facing child seat in the front seat can result in serious injury or death during a crash.

Always place a rear-facing child seat in the rear seat, not the front.

**■ Protecting Smaller Children**

If a child is at least one year old and within the weight range indicated by the child seat manufacturer, the child should be properly restrained in a firmly secured forward-facing child seat.

We strongly recommend placing a forward-facing child seat in a rear seating position.

Placing a forward-facing child seat in the front seat can be hazardous, even with advanced front airbags that automatically turn the passenger's front airbag off. A rear seat is the safest place for a child.

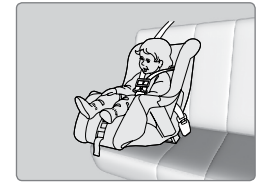
**⚠️WARNING**

Placing a forward-facing child seat in the front seat can result in serious injury or death if the front airbag inflates.

If you must place a forward-facing child seat in front, move the vehicle seat as far back as possible, and properly restrain the child.

**■ Selecting a Child Seat**

Most child seats are LATCH-compatible (Lower Anchors and Tethers for Children). Some have a rigid-type connector, while others have a flexible-type connector. Both are equally easy to use. Some existing and previously owned child seats can only be installed using the seat belt. Whichever type you choose, follow the child seat manufacturer's use and care instructions as well as the instructions in this manual. Proper installation is key to maximizing your child's safety.

In seating positions and vehicles not equipped with LATCH, a LATCH-compatible child seat can be installed using the seat belt and a top tether for added security. This is because all child seats are required to be designed so that they can be secured with a lap belt or the lap part of a lap/shoulder belt. In addition, the child seat manufacturer may advise that a seat belt be used to attach a LATCH-compatible seat once a child reaches a specified weight. Please read the child seat owner's manual for proper installation instructions.

**Important consideration when selecting a child seat**

Make sure the child seat meets the following three requirements:

- The child seat is the correct type and size for the child.
- The child seat is the correct type for the seating position.
- The child seat is compliant with Federal Motor Vehicle Safety Standard 213 or Canadian Motor Vehicle Safety Standard 213.

## ■ Installing a LATCH-Compatible Child Seat

A LATCH-compatible child seat can be installed in either of the two outer rear seats. A child seat is attached to the lower anchors with either the rigid or flexible type of connectors.

1. Locate the lower anchors under the marks.
2. Place the child seat on the vehicle seat, then attach the child seat to the lower anchors according to the instructions that came with the child seat. Make sure that the lower anchors are not obstructed by the seat belt or any other object.
3. Raise the head restraint to its highest position, then route the tether strap between the head restraint legs, and secure the tether strap hook onto the anchor.
4. Tighten the tether strap as instructed by the child seat manufacturer.
5. Make sure the child seat is firmly secured by rocking it forward and back and side to side; little movement should be felt.
6. Make sure any unused seat belt that a child can reach is buckled, the lockable retractor is activated, and the belt is fully retracted and locked.

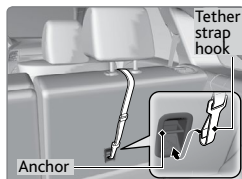
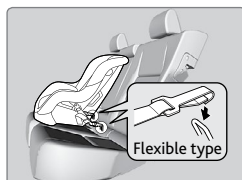
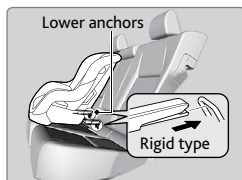
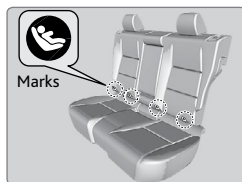

## ■ Installing a Child Seat with a Lap/Shoulder Seat Belt

1. Place the child seat on the vehicle seat.
2. Route the seat belt through the child seat according to the seat manufacturer's instructions, and insert the latch plate into the buckle. Insert the latch plate fully until it clicks.
3. Slowly pull the shoulder part of the belt all the way out until it stops. This activates the lockable retractor.
4. Let the seat belt completely wind up into the retractor, then try to pull it out to make sure the retractor is locked. If you are able to pull the shoulder belt out, the lockable retractor is not activated. Pull the seat belt all the way out, and repeat steps 3–4.
5. Grab the shoulder part of the seat belt near the buckle, and pull up to remove any slack from the lap part of the belt. When doing this, place your weight on the child seat and push it into the vehicle seat.
6. Make sure the child seat is firmly secured by rocking it forward and back and side to side; little movement should be felt.
7. Make sure any unused seat belt that a child can reach is buckled, the lockable retractor is activated, and the belt is fully retracted and locked.



To deactivate a lockable retractor, release the buckle and allow the seat belt to wind up all the way.

## ■ Adding Security with a Tether

Since a tether can provide additional security to the lap/shoulder seat belt installation, we recommend using a tether whenever one is available.

Two tether anchorage points are provided behind the rear outer seating positions and one in the ceiling for the rear center. A child seat that is installed with a seat belt and comes with a tether can use the tether for additional security.

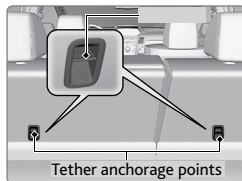

### Using an outer anchor

1. Raise the head restraint to its highest position, then route the tether strap through the head restraint legs. Make sure the strap is not twisted.
2. Secure the tether strap hook onto the anchor.
3. Tighten the tether strap as instructed by the child seat manufacturer.

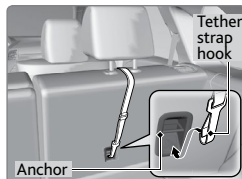

### Using the center anchor

1. Lower the head restraint to its lowest position.
2. Open the anchor cover.
3. Route the tether strap over the head restraint. Make sure the strap is not twisted.
4. Secure the tether strap hook onto the anchor.
5. Tighten the tether strap as instructed by the child seat manufacturer.

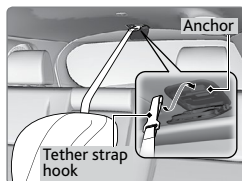

## ■ Protecting Larger Children

When a child is too big for a child seat, secure the child in a rear seat using the lap/shoulder seat belt.

Have the child sit upright and all the way back, then ensure the following:

- The child's knees bend comfortably over the edge of the seat.
- The shoulder belt crosses between the child's neck and arm.
- The lap part of the seat belt is as low as possible, touching the child's thighs.
- The child can stay seated for the whole trip.



If a lap/shoulder belt cannot be used properly, position the child in a booster seat in a rear seating position. For the child's safety, check that the child meets the booster seat manufacturer's recommendations.

Some U.S. states and Canadian provinces/territories require children to use a booster seat until they reach a given age or weight (e.g., 6 years or 60 lbs). Be sure to check current laws in the state or province/territory where you intend to drive.

### **⚠️ WARNING**

Allowing a child age 12 or under to sit in the front can result in injury or death if the passenger's front airbag inflates.

If a larger child must ride in front, move the vehicle seat as far to the rear as possible, have the child sit up properly and wear the seat belt properly, using a booster seat if needed.

## Safety Label Locations

Safety labels are in the locations shown. They warn you of potential hazards that can cause serious injury or death. Read these labels carefully.

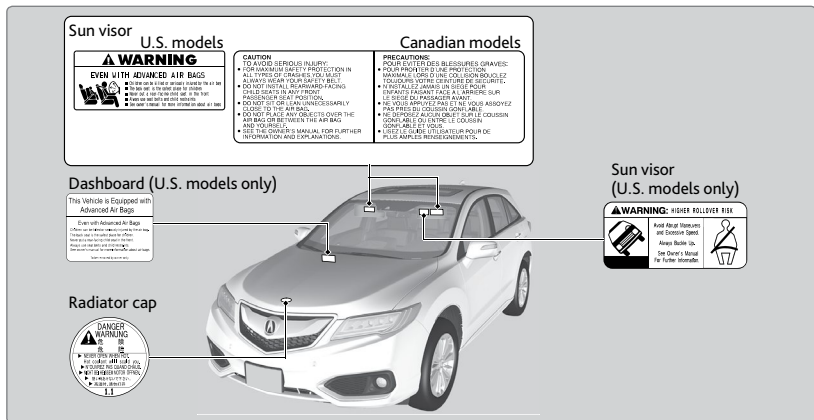

## Reporting Safety Defects

### In the U.S.

If you believe that your vehicle has a defect which could cause a crash or could cause injury or death, you should immediately inform the National Highway Traffic Safety Administration (NHTSA) in addition to notifying American Honda Motor Co., Inc.

If NHTSA receives similar complaints, it may open an investigation, and if it finds that a safety defect exists in a group of vehicles, it may order a recall and remedy campaign. However, NHTSA cannot become involved in individual problems between you, your dealer, or American Honda Motor Co., Inc.

To contact NHTSA, you may call the Vehicle Safety Hotline toll-free at (888) 327-4236 (TTY: 1-800-424-9153); go to <http://www.safercar.gov>; or write to: Administrator, NHTSA, 1200 New Jersey Avenue, SE., Washington, DC 20590. You can also obtain other information about motor vehicle safety from <http://www.safercar.gov>.

### In Canada

If you believe that your vehicle has a defect which could cause a crash or could cause injury or death, you should immediately inform Honda Canada, Inc., and you may also inform Transport Canada.

If Transport Canada receives similar complaints, it may open an investigation, and if it finds that a safety defect exists in a group of vehicles, it may lead to a recall and remedy campaign. However, Transport Canada cannot become involved in individual problems between you, your dealer, or Honda Canada, Inc.

To contact Transport Canada's Defect Investigations and Recalls Division, you may call (800) 333-0510. For more information on reporting safety defects or about motor vehicle safety, go to <http://www.tc.gc.ca/roadsafety>.

# INSTRUMENT PANEL

Learn about the indicators, gauges, and displays related to driving the vehicle.

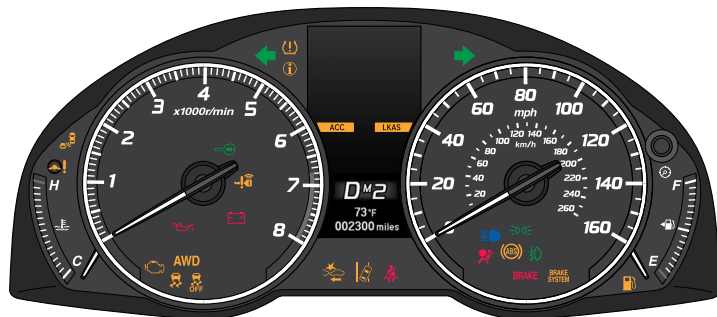

Indicators briefly appear with each engine start and then go out. Red and amber indicators are most critical. Blue and green indicators are used for general information.

## Malfunction Indicators

These are the most critical indicators. If they come on and stay lit while driving or at any other time, there may be a problem. See your dealer if necessary.

### **BRAKE** Brake system

- Brake fluid is low.
- There is a malfunction in the brake system.

Press the brake pedal lightly to check pedal pressure. If normal, check the brake fluid level when you stop. If abnormal, take immediate action. If necessary, downshift the transmission to slow the vehicle using engine braking. Have your vehicle repaired immediately.

### **Low oil pressure**

Engine oil pressure is low. Stop in a safe place. Open the hood and check the oil level, and add oil if necessary. If the indicator does not turn off, have your vehicle repaired immediately.

### **Malfunction indicator lamp (check engine light)**

- The emissions control system may have a problem, or the fuel cap is missing or loose.
- (Blinks) A misfire in the engine's cylinders is detected. Stop in a safe place, and wait for the engine to cool down.

### **Charging system**

The battery is not charging. Turn off all electrical items, but do not turn off the vehicle to prevent further battery discharge. Have your vehicle repaired immediately.

### **ABS** Anti-Lock Brake System (ABS)

There is a problem with the anti-lock brake system. Your vehicle still has normal braking ability, but no anti-lock function.

### **SRS** Supplemental Restraint System (SRS)

There is a problem with one of the airbag systems or seat belt tensioners.

### **EPS** Electric Power Steering (EPS)

There is a problem with the electric power steering system.

### **TPMS** Tire Pressure Monitoring System (TPMS)

(Blinks and stays on) There is a problem with the tire pressure monitoring system, or the vehicle is fitted with the spare tire.

### **Keyless Access system**

There is a problem with the keyless access system.

### **AWD** All-Wheel Drive (AWD) system\*

- There is a problem with the AWD system. Only the front wheels are powered.
- (Blinks) The AWD system has overheated and is inactive. Stop in a safe place, shift to Park (P), and idle the engine until the indicator goes off.

### **VSA** Vehicle Stability Assist (VSA®) system

There is a problem with the VSA system or the hill start assist system.

### **BRAKE SYSTEM** Brake system

There is a problem with the hydraulic brake boost system.

### **BSI** Blind spot information (BSI)\*

There is a problem with the system, or the sensor is blocked.

### **LDW** Lane Departure Warning (LDW)\*

There is a problem with the system, the temperature is too high, or the camera is blocked.

### **ACC** Adaptive Cruise Control (ACC)\*

There is a problem with the system.

### **LKAS** Lane Keeping Assist System (LKAS)\*

There is a problem with the system.

### **CMBS** Collision Mitigation Braking System™ (CMBS™)\*

There is a problem with the system, the temperature is too high, or the camera or sensor is blocked.

\*if equipped







### Condition Indicators

These indicators may require you to perform an action.

**U.S.**  
**Canada**  
**BRAKE** Parking brake

 Release the parking brake before driving. You will hear a beep if you drive with it not fully released.

**Seat belt reminder**

 Make sure seat belts are fastened for you and all passengers. The indicator blinks and beeps sound continuously if you or your front passenger has not fastened your seat belts when you begin driving. If the indicator remains on after seat belts are fastened, see your dealer.

**Low fuel**

 Refuel as soon as possible. If the indicator blinks, there is a problem with the fuel gauge. See your dealer.

**Door/tailgate open\***

 Close any open doors or the tailgate. A beep sounds if any doors or the tailgate is opened while driving.

**Low tire pressure**

 Stop in a safe place, check tire pressures, and inflate tire(s) if necessary.

**System message**

 When a condition or malfunction indicator comes on, a message also appears on the multi-information display. Check the display for more information.

**Immobilizer**

 Your remote transmitter cannot be recognized by the vehicle. If the indicator blinks, you may not be able to start the engine. Turn the vehicle off and then on again. If it continues to blink, there may be a problem with the system. See your dealer.

*\*if equipped*

### On/Off Indicators

These indicators remind you when an item is on or off.

 VSA off

 VSA engaged (blinks)

 CRUISE MAIN on\*

 CRUISE CONTROL on\*

 Turn signals/hazards on

 Exterior lights on

 Fog lights on\*

 High beams on

 BSI off\*

 ACC on\*

 LKAS on\*

 CMBSTM off\*

TABLE OF CONTENTS

VISUAL INDEX

SAFETY INFORMATION

INSTRUMENT PANEL

VEHICLE CONTROLS

AUDIO AND CONNECTIVITY

BLUETOOTH® HANDSFREELINK®

ACURALINK®

NAVIGATION

DRIVING

HANDLING THE UNEXPECTED

MAINTENANCE

SPECIFICATIONS

CLIENT INFORMATION

VOICE COMMAND INDEX

INDEX

## Multi-Information Display

Consists of several displays that provide you with useful information.

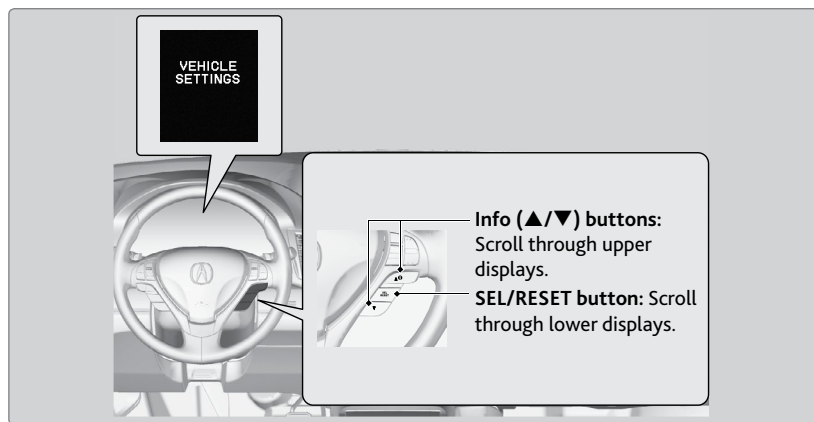

### Models with black-and-white display

#### Main Displays

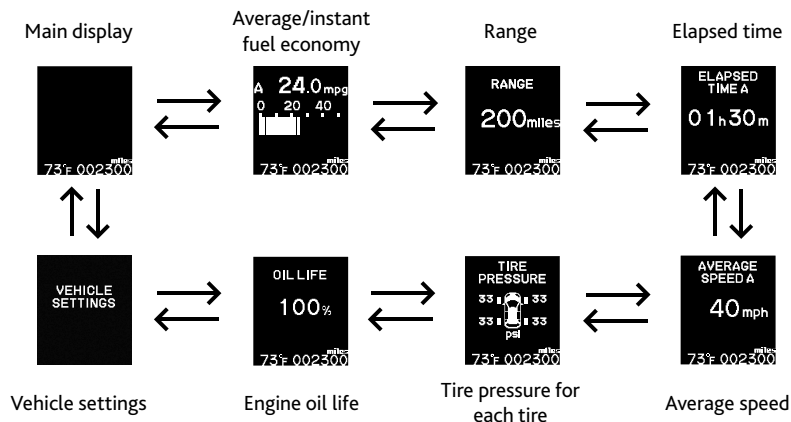

#### Lower Displays

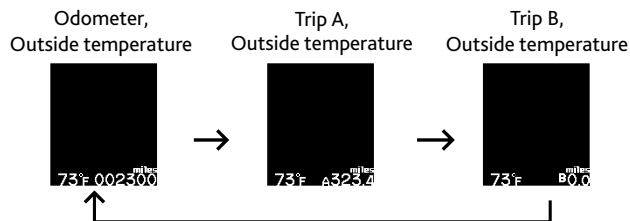

### Models with color display

#### Main Displays

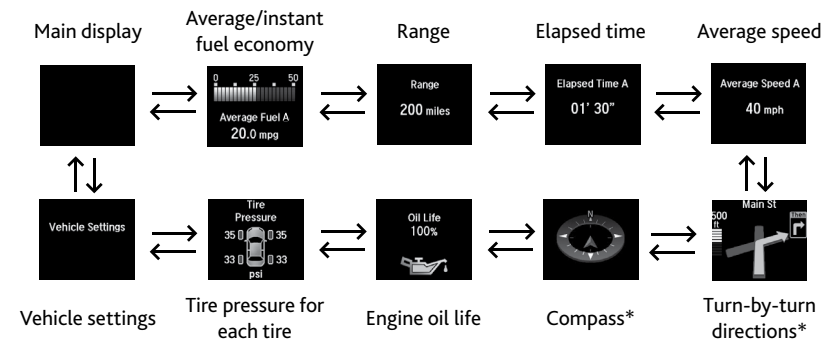

#### Lower Displays

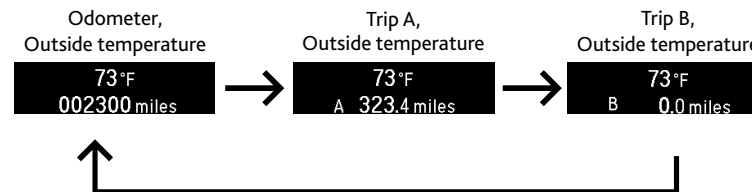

#### Vehicle Settings

Use the MID to customize certain vehicle features when the vehicle is in Park (P). You can also use the SETTINGS button\* (see page 48).

An example of how to change the Trip A reset timing setting is below. Use the Info and SEL/RESET buttons to make and enter selections.

1. Scroll to the Vehicle Settings menu and select it.
2. Scroll to Meter Setup and select it.
3. Scroll to "Trip A" Reset Timing and select it.
4. Scroll through the options, and select the one you want.
5. Scroll to Exit, and select it to exit the menus.



\*if equipped

# VEHICLE CONTROLS

Learn about the various controls necessary for operating and driving the vehicle.

## Using the Remote Transmitter

Lock or unlock the doors and tailgate.

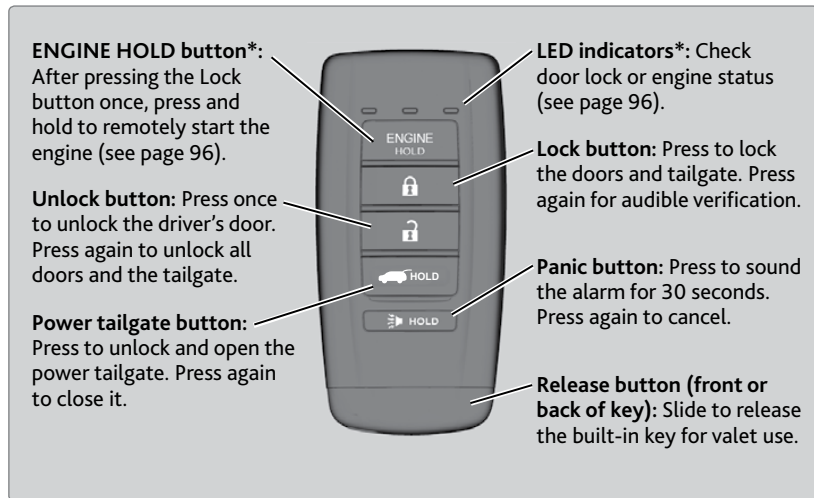

### NOTICE

Leaving the keyless access remote in the vehicle can result in theft or accidental movement of the vehicle. Always take the key with you whenever you leave the vehicle unattended.

## Keyless Access System

When you carry the remote transmitter (for example, in a pocket or purse) and it is outside the vehicle and within range (about 32 inches or 80 cm), you can lock or unlock the doors and tailgate without handling the transmitter.

### ■ Unlocking/Locking the Doors

**To unlock:** Grab either front door handle when the vehicle is off.

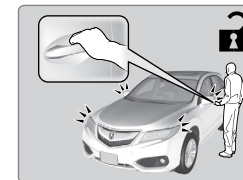

**To lock:** Press the door lock button on either front door handle when the vehicle is off. If the remote transmitter is inside the vehicle, the doors will not lock.

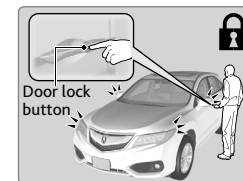

### ■ Unlocking/Locking the Tailgate

**To unlock:** Press and hold the tailgate release button under the tailgate handle to unlock the tailgate and all doors. The vehicle can be on or off.

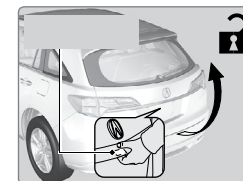

**To lock:** Press the tailgate lock button to lock the tailgate and all doors. If the remote transmitter is inside the vehicle, the tailgate and doors will not lock.

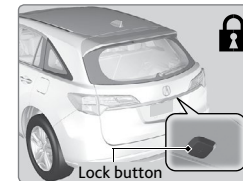

TABLE OF CONTENTS

VISUAL INDEX

SAFETY INFORMATION

INSTRUMENT PANEL

VEHICLE CONTROLS

AUDIO AND CONNECTIVITY

BLUETOOTH® HANDSFREELINK®

ACURALINK®

NAVIGATION

DRIVING

HANDLING THE UNEXPECTED

MAINTENANCE

SPECIFICATIONS

CLIENT INFORMATION

VOICE COMMAND INDEX

INDEX

## Power Tailgate Operation

Use these methods to operate the power tailgate.

### ■ Power Tailgate Button (interior)

The vehicle must be in Park (P).

Press and hold the power tailgate button on the dashboard to the left of the steering column to open the tailgate. Press it again at any time to close it.

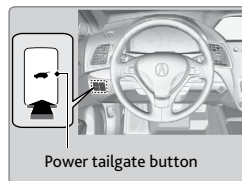

Power tailgate button

### ■ Power Tailgate Button (exterior)

#### Automatic operation

Press the tailgate release button. You will hear one beep, and the tailgate opens automatically.

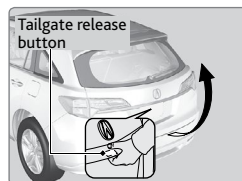

Tailgate release button

#### Manual operation

If there is not enough clearance for the tailgate to fully open, press and hold the tailgate release button until you hear two beeps. The tailgate unlatches, and you can open it manually.

To automatically close the tailgate once it is open, press the power tailgate button located at the bottom of the hatch. Press it again to stop the tailgate operation and reverse its direction.

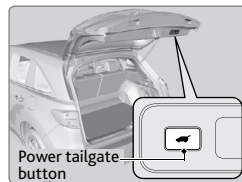

Power tailgate button

## ⚠️ WARNING

Closing the power tailgate while anyone is in the path of the tailgate can cause serious injury.

Make sure everyone is clear before closing the tailgate.

## NOTICE

Do not push or pull on the power tailgate when it is being automatically opened or closed. Forcibly opening or closing the power tailgate while in operation can deform the tailgate frame.

## Door Operation from Inside the Vehicle

Use several methods to lock or unlock the doors.

### ■ Using the Lock Tab

**To unlock:** Pull the lock tab rearward. When you unlock either front door using the lock tab, the specific door (driver's or passenger's) unlocks.

**To lock:** Push the lock tab forward. When you lock the door using the lock tab on the driver's door, all the other doors and tailgate lock at the same time. When you lock the door using the lock tab on the front passenger's door, only that door locks.

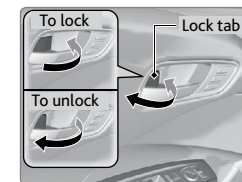

To lock

To unlock

Lock tab

### ■ Using the Master Door Lock Switch

**To unlock:** Press the unlock side of the switch to unlock all doors and the tailgate.

**To lock:** Press the lock side of the switch to lock all doors and the tailgate.

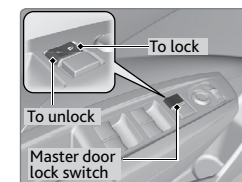

To lock

To unlock

Master door lock switch

### ■ Using the Front Door Inner Handle

Pull the front door inner handle. The door unlocks and opens in one motion.

Do not pull a front door inner handle while the vehicle is moving.

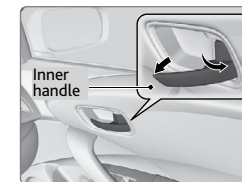

Inner handle

### ■ Childproof Door Locks

The childproof door locks prevent the rear doors from being opened from the inside regardless of the position of the lock tab.

Slide the lever in the rear door to the lock position, and close the door.

Open the door using the outer door handle.

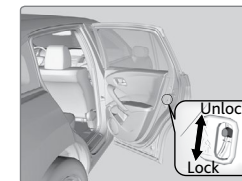

Unlock

Lock

## Power Window Operation

The power windows can be opened and closed when the vehicle is on by using the switches on the doors. The switches on the driver's side can be used to open and close all the windows.

### Automatic Operation

**To open:** Push the switch down firmly.

**To close:** Pull the switch up firmly.

The window opens or closes completely. To stop the window at any time, push or pull the switch again briefly.

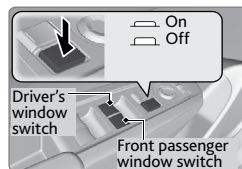

### Manual Operation

**To open:** Push the switch down lightly.

**To close:** Pull the switch up lightly.

Release the switch when the windows reach the desired position.

### Power Window Lock

Push in the power window lock button so only the driver's window can be operated.

### ⚠ WARNING

Closing a power window on someone's hands or fingers can cause serious injury.

Make sure your passengers are away from the windows before closing them.

## Power Moonroof Operation

The moonroof can be opened and closed when the vehicle is on by using the switch on the ceiling.

### Automatic Operation

**To open:** Push the switch back firmly, then release.

**To close:** Push the switch forward firmly, then release.

The moonroof opens or closes completely. To stop the moonroof at any time, push the switch briefly.

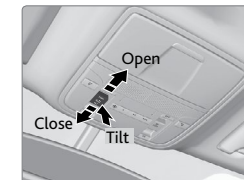

### Manual Operation

**To open:** Push and hold the switch back until the desired position is reached.

**To close:** Push and hold the switch forward until the desired position is reached.

### Moonroof Tilt

**To tilt:** Push the center of the switch.

**To close:** Push the switch forward firmly, then release.

### NOTICE

Opening the moonroof in below freezing temperature or when it is covered with snow or ice can damage the moonroof panel or motor.

### ⚠ WARNING

Opening or closing the moonroof on someone's hands or fingers can cause serious injury.

Make sure your passengers are away from the moonroof before closing it.

## Interior and Exterior Lights

Operate interior and exterior lights when the vehicle is on or off.

### Exterior Lights

Rotate the switches on the lever to operate the exterior lights. Push the lever forward to turn on high beams. Return the lever to its original position for low beams.

**OFF** All exterior lights are off.

 Turn on exterior lights except headlights.

**AUTO** Turn on the automatic lighting feature. Headlights turn on or off depending on ambient brightness when the vehicle is on. Headlights automatically come on after the wipers are engaged for a certain time.

 Turn on all exterior lights including headlights.

 Turn fog lights\* on or off.

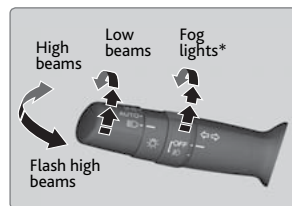

### Brightness Control

Adjust instrument panel brightness when the vehicle is on.

**To brighten:** Turn the knob to the right.

**To dim:** Turn the knob to the left.

A beep sounds when the brightness reaches minimum or maximum.

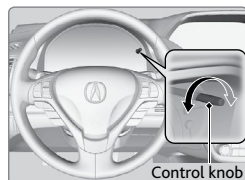

### Interior Lights

Located on the ceiling in the front and rear.

**ON position:** Interior lights remain on.

**Door activated position:** Interior lights come on when any of the doors are opened, the driver's door is unlocked, or the vehicle is turned off.

**OFF position:** Interior lights remain off.

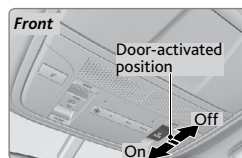

\*if equipped

### Map Lights

Press the map lights in the ceiling to turn them on or off.

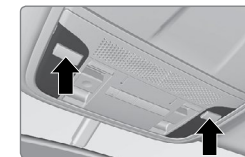

### Cargo Lights

Located on the inside of the tailgate.

**On position:** The light comes on when you open the tailgate, and goes off when closed.

**Off position:** The light stays off.

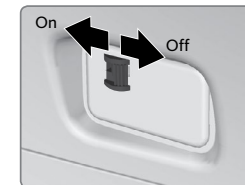

## One-Touch Turn Signal

Use this quick and convenient method to signal a lane change.

Lightly push the turn signal lever up or down for a three-blink sequence.

For a continuous signal, push the lever up or down until it locks into place.

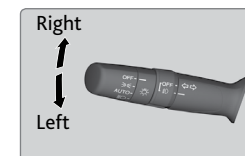

## Wiper Operation

The windshield wipers and washers can be used when the vehicle is on.

### Front Wipers

Move the wiper lever up or down to the desired position.

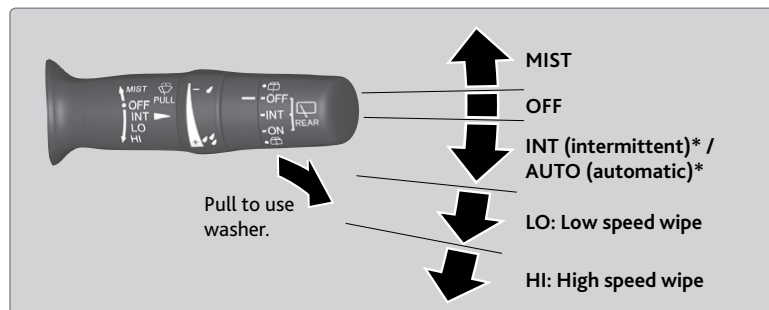

### Intermittent (INT) wipers\*

When you move the lever to the INT position, the wipers operate based on the wiper delay. Rotate the adjustment ring to adjust the wiper delay.

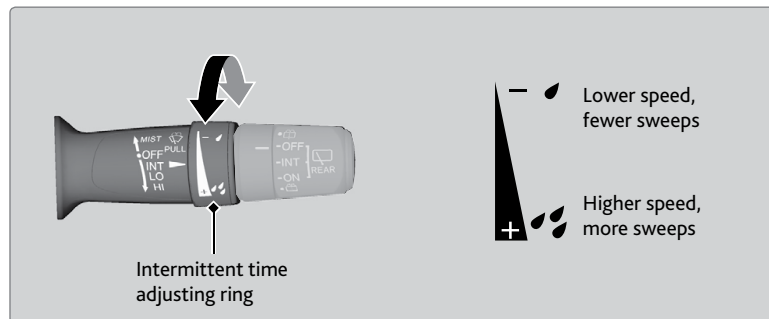

### Headlight-Wiper Integration\*

When the headlights are in the AUTO position, they automatically turn on when the front wipers operate for a certain number of intervals. The headlights turn off shortly after the wipers are turned off, or if there is enough ambient light.

\*if equipped

### Automatic rain-sensing (AUTO) wipers\*

When you move the lever to the AUTO position while driving in rainy weather, the wipers operate based on the amount of detected rainfall.

Put the lever in the AUTO position only when driving in rainy weather. Return the lever to the OFF position when rain stops.

Rotate the adjustment ring to adjust the rainfall sensor sensitivity.

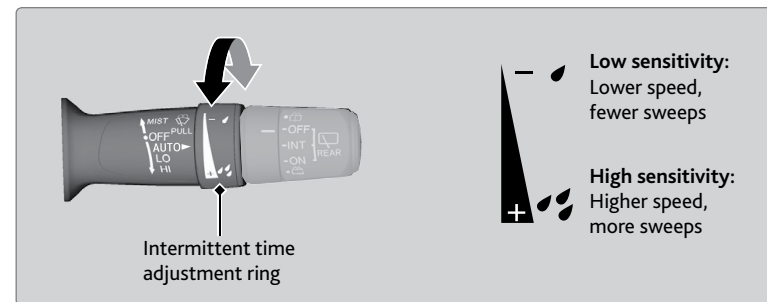

### NOTICE

Always ensure the wiper lever is in the OFF position before entering a car wash to prevent severe damage to the windshield wiper system.

### Rear Wiper

When you shift to Reverse (R) and the front wipers are activated, the rear wiper activates even if the switch is off.

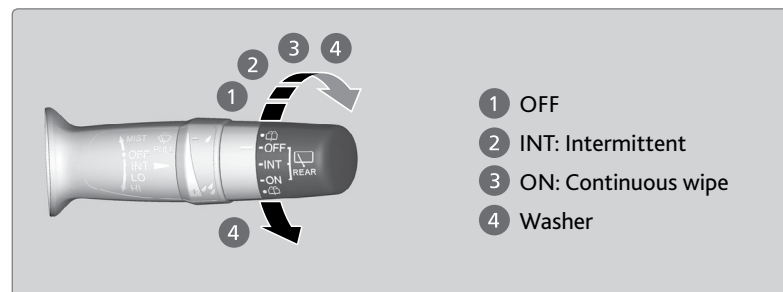

### NOTICE

Do not use the wipers when the windshield is dry. The windshield will get scratched, or the rubber blades will get damaged.

In cold weather, the blades may freeze to the windshield, becoming stuck. Operating the wipers in this condition may damage the wipers. Use the defroster to warm the windshield, then turn the wipers on.

\*if equipped

## Adjusting the Seats

Make seat adjustments before driving to ensure the best comfort and safety.

### ■ Adjusting the Front Seats

Adjust the driver's seat as far back as possible while allowing you to maintain full control of the vehicle. You should be able to sit upright and well back in the seat, adequately press the pedals without leaning forward, and grip the steering wheel comfortably. The passenger's seat should be adjusted so that it is as far back from the front airbag in the dashboard as possible.

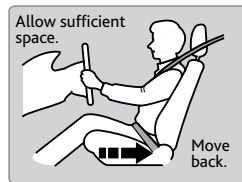

The National Highway Traffic Safety Administration and Transport Canada recommend that drivers allow at least 10 inches (25 cm) between the center of the steering wheel and the chest.

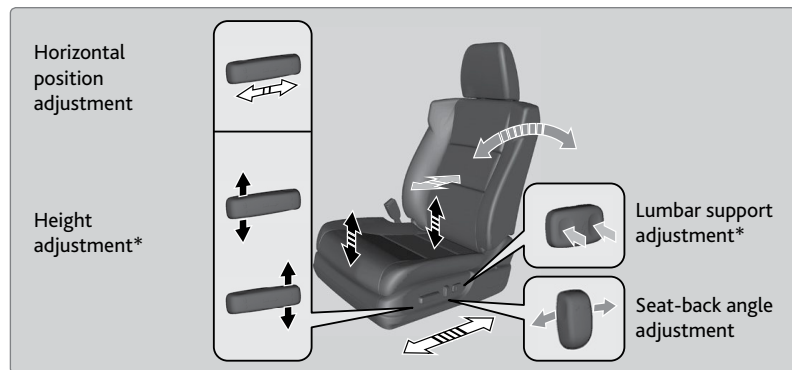

### ⚠️ WARNING

Sitting too close to a front airbag can result in serious injury or death if the front airbags inflate. Always sit as far back from the front airbags as possible while maintaining control of the vehicle.

### ⚠️ WARNING

Reclining the seat-back too far can result in serious injury or death in a crash. Adjust the seat-back to an upright position, and sit well back in the seat.

*\*if equipped*

### ⚠️ WARNING

Sitting improperly or out of position can result in serious injury or death in a crash. Always sit upright, well back in the seat, with your feet on the floor.

### ■ Adjusting the Head Restraints

Your vehicle is equipped with head restraints in all seating positions. Head restraints are most effective for protection against whiplash and other rear-impact crash injuries.

The center of the back of the occupant's head should rest against the center of the restraint. The tops of the occupant's ears should be level with the center height of the restraint.

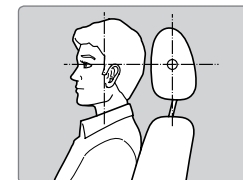

**To raise the head restraint:** Pull it upward.

**To lower the head restraint:** Push it down while pressing the release button.

**To remove the head restraint:** Pull the restraint up as far as it will go. Then push the release button, and pull the restraint up and out.

**To reinstall a head restraint:** Insert the legs back in place, then adjust the head restraint to an appropriate height while pressing the release button. Pull up on the restraint to make sure it is locked in position.

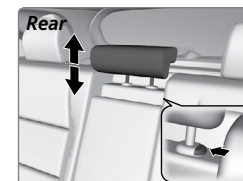
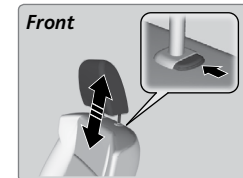

For a head restraint system to work properly:

- Do not hang any items on the head restraints or from the restraint legs.
- Do not place any object between an occupant and the seat-back.
- Install each restraint in its proper location.

### ⚠️ WARNING

Improperly positioning head restraints reduces their effectiveness and increases the likelihood of serious injury in a crash. Make sure head restraints are in place and positioned properly before driving.



**⚠ WARNING**

Failure to reinstall, or correctly reinstall, the head restraints can result in severe injury during a crash.

Always replace the head restraints before driving.

**■ Floor Mats**

Position the front and rear seat floor mats properly and anchor them. If they are not properly positioned, the floor mats can interfere with the front seat functions.

**Do not put additional floor mats on top of the anchored mats.**

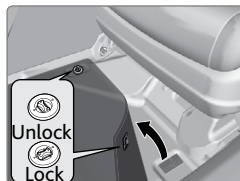
**■ Rear Seats**

Separately fold down the left and right halves of the rear seat to make room for cargo.

1. Store the center seat belt by inserting the latch plate into the slot on the side of the anchor buckle.
2. Retract the seat belt into the holder on the ceiling.
3. Lower the center head restraint to its lowest position. Put the armrest back into the seat-back.
4. From the rear door side or cargo area side, pull the release lever.

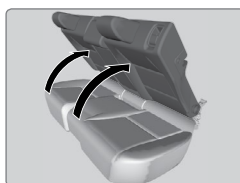
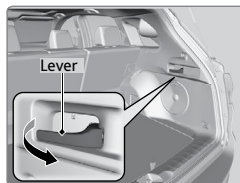
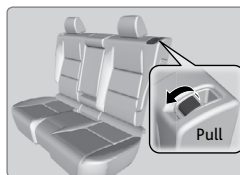

To return the seat to its original position, pull up the seat-back to an upright position until it is securely latched into place. Reposition the seat belts as necessary.

**Adjusting the Steering Wheel**

The steering wheel height and distance from your body can be adjusted so that you can comfortably grip the steering wheel in an appropriate driving posture.

1. Pull up the steering wheel adjustment lever.
2. Move the steering wheel up or down, and in or out.
3. Push down the steering wheel adjustment lever to lock the steering wheel in position.

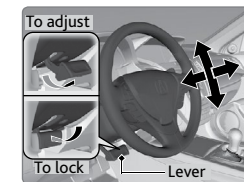
**⚠ WARNING**

Adjusting the steering wheel position while driving may cause you to lose control of the vehicle and be seriously injured in a crash.

Adjust the steering wheel only when the vehicle is stopped.

**Driving Position Memory System**

You can store two driver's seat and door mirror positions into memory when the vehicle is on. When you unlock and open the driver's door with a remote transmitter, the seat and door mirrors adjust automatically to the corresponding preset positions.

1. Adjust the seat and mirrors to your preferred positions.
2. Press SET.
3. Press and hold memory button 1 or 2. You will hear two beeps when the memory is set.
4. Press one of the memory buttons to recall previously stored positions.  
Lumbar positions cannot be stored.

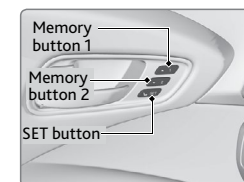

## Adjusting the Mirrors

Adjust the angle of the mirrors for the best visibility when you are sitting in the correct driving position.

### Automatic Dimming Rearview Mirror

When driving after dark, the automatic dimming function reduces the glare in the rearview mirror (and power door mirrors\*) from headlights behind you.

The function cancels when the shift lever is in Reverse (R).

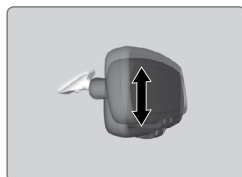

### Power Door Mirrors

Adjust the power door mirrors using the switches on the driver's door when the vehicle is on.

**L/R selector switch:** Select the left or right mirror. After adjusting the mirror, return the switch to the center position.

**Mirror position adjustment switch:** Press the switch left, right, up, or down to move the mirror.

**Folding door mirror button\*:** Press to fold the door mirrors in or out.

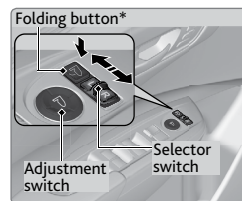

### Reverse Tilt Door Mirrors

Either side door mirror can tilt downward when you shift to Reverse (R) to improve visibility on the selected side of the vehicle when reversing.

When in Reverse, slide the selector switch on the driver's door to the left or right side.

The mirror returns to its original position when you shift out of Reverse.

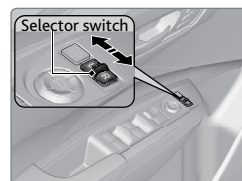

\*if equipped

## HomeLink® Garage Opener

Program your vehicle to operate up to three remote-controlled devices around your home—such as garage doors, lighting, or home security systems—using the buttons on the ceiling.

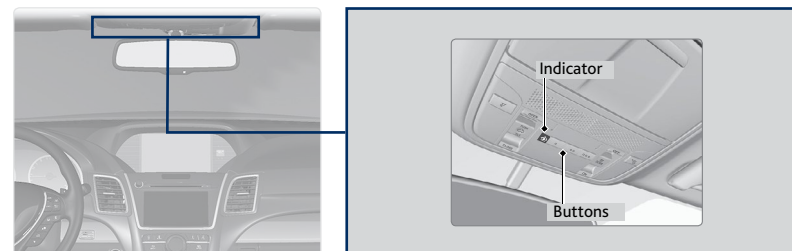

### Training a Button

Park near the system you want to program, and follow the instructions in the flowchart below.

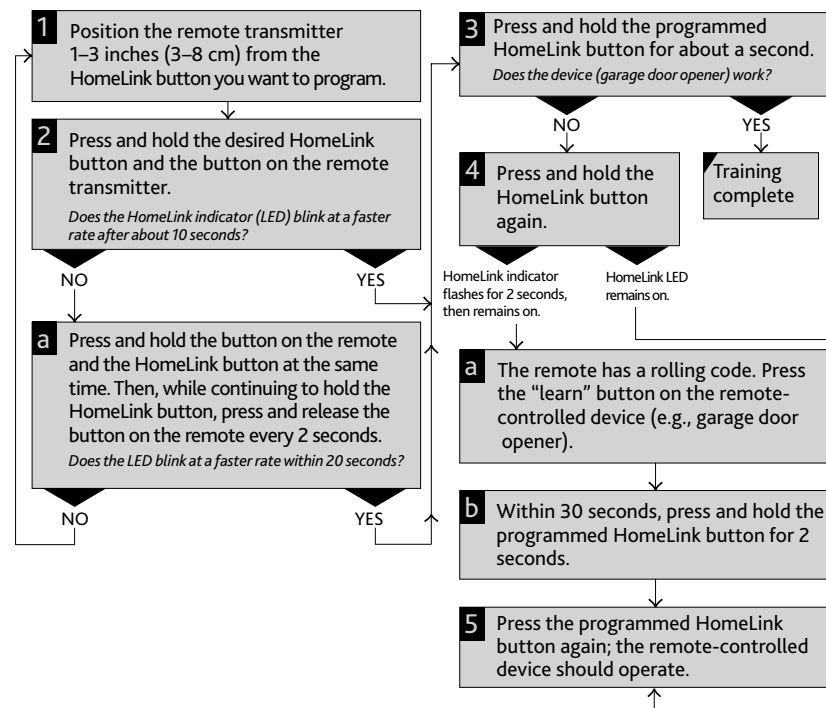

To retrain a button or erase codes, see the Owner's Manual on the Owner Information CD or visit [owners.acura.com](http://owners.acura.com) (U.S.) or [www.myacura.ca](http://www.myacura.ca) (Canada). If you need help, call (800) 355-3515 or visit [www.homelink.com](http://www.homelink.com).

TABLE OF CONTENTS

VISUAL INDEX

SAFETY INFORMATION

INSTRUMENT PANEL

VEHICLE CONTROLS

AUDIO AND CONNECTIVITY

BLUETOOTH® HANDSFREELINK®

ACURALINK®

NAVIGATION

DRIVING

HANDLING THE UNEXPECTED

MAINTENANCE

SPECIFICATIONS

CLIENT INFORMATION

VOICE COMMAND INDEX

INDEX

## Climate Control System

The automatic climate control system can maintain your preferred interior temperature by selecting the proper mix of heated or cooled air and fan speed.

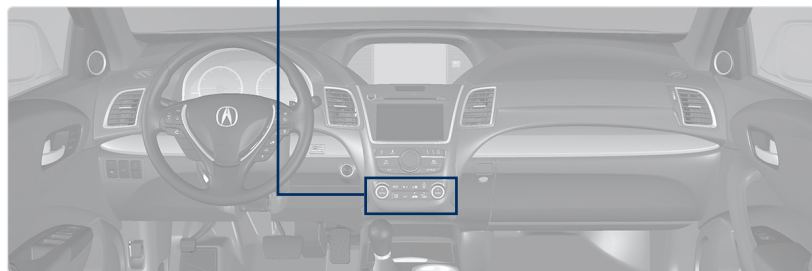
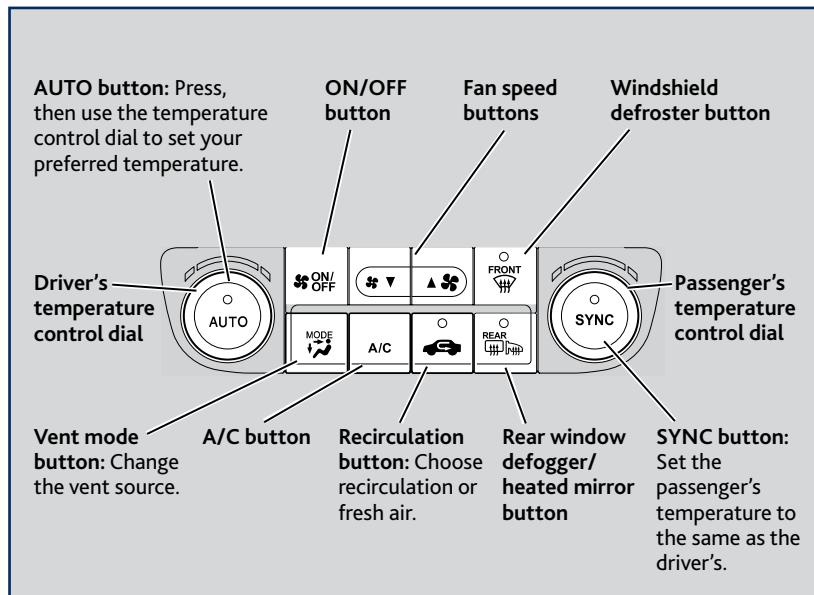

On vehicles with ODMD, climate information is displayed on the screen, but cannot be selected via touch. Adjust the climate settings using the dials and buttons.

## Seat Heaters or Ventilation\*

Quickly warm or ventilate the seats when the vehicle is on.

### ■ Front Seat Heaters\*

Press the switch for the desired setting. An indicator in the switch appears for the selected setting.

**LO button:** Press to slowly warm the seat, or to maintain continuous heating.

**HI button:** Press to quickly warm the seat. If left in HI, the heater cycles on and off.

Return the switch to the center to turn the seat heaters off.

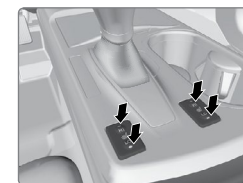

### ■ Front Seat Heaters and Ventilation\*

Press the seat heater or ventilation button. An indicator (red for heater, blue for ventilation) appears for the selected setting.

**Once:** HI setting (three indicators)

**Twice:** MID setting (two indicators)

**Three times:** LO setting (one indicator)

**Four times:** OFF setting (no indicators)

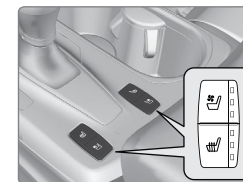

### ■ Rear Seat Heaters\*

You can heat the two outer rear seats. An indicator in the button appears for the selected setting.

**LO button:** Press to slowly warm the seat, or to maintain continuous heating.

**HI button:** Press to quickly warm the seat. If left in HI, the heater cycles on and off.

Press the button again to turn off.

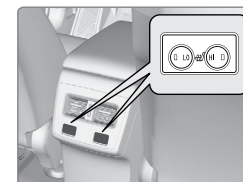

## ⚠ WARNING

Heat-induced burns are possible when using seat heaters.

Persons with a diminished ability to sense temperature (e.g., persons with diabetes, lower-limb nerve damage, or paralysis) or with sensitive skin should not use the seat heaters.

\*if equipped

## Customized Settings\*

You can easily customize many features of your vehicle. The customized settings are recalled every time you unlock the driver's door with the remote (Driver 1 or Driver 2). Settings are unique to each remote.

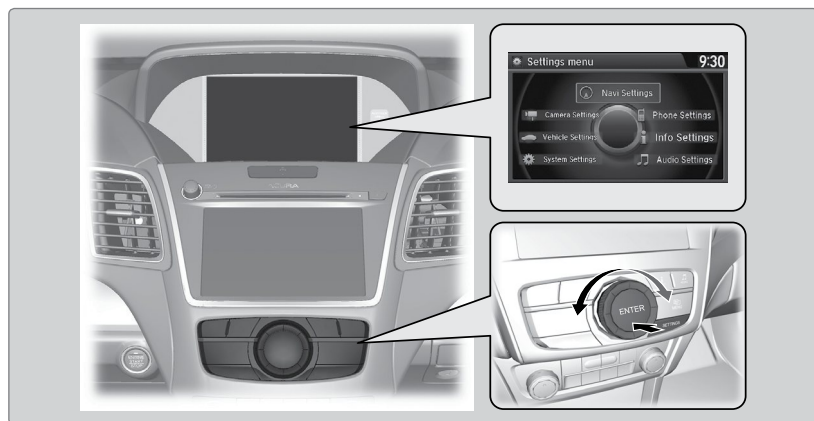

### How to Change a Setting

The vehicle must be in Park (P) to select Vehicle Settings. Use the interface dial to make and enter selections.

1. Press the SETTINGS button.
2. Select an option (System, Vehicle, Camera, Audio, Phone, Info, or Navi).
3. Select a setting option, and make your preferred changes.
4. Press BACK to exit out of the menus.

*\*vehicles with navigation*

## Setting the Clock

Adjust the time in the clock display.

### Models without navigation

Use the selector knob to make and enter selections.

1. Press the SETUP button.
2. Select Adjust Clock.
3. Select the item to change (12/24 hour mode, hour, or minute).
4. Make the necessary changes for each item.
5. Select Set to set the time.
6. Press SETUP to return to the main display.

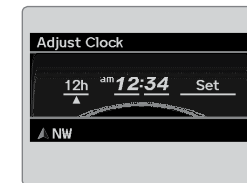

### Models with navigation

Use the interface dial to make and enter selections.

1. Press the SETTINGS button.
2. Select System Settings.
3. Select Clock.
4. Select Clock Adjustment.
5. Rotate the interface dial to change the hour value. Press the interface dial to select minutes, and rotate to change the value. Press the interface dial to exit the screen.
6. Press the BACK button to exit out of the menus.

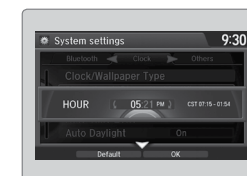

# AUDIO AND CONNECTIVITY

Learn how to operate the vehicle's audio system.

## Basic Audio Operation

Connect audio devices in the front console, and operate buttons and displays for the audio system.

### ■ USB Port

Connect a USB flash drive or other audio device, such as an iPod® or iPhone®.

1. Open the USB cover.
2. Install the iPod dock connector or the USB flash drive into the USB port.

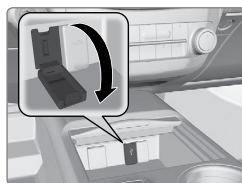

*iPod and iPhone are trademarks of Apple, Inc.*

*State or local laws may prohibit the operation of handheld electronic devices while operating a vehicle.*

### ■ Auxiliary Input Jack

Connect standard audio devices with a 1/8-inch (3.5 mm) stereo miniplug.

1. Open the AUX cover.
2. Insert the miniplug attached to the audio device into the jack. The audio system switches to AUX mode. Use the device to control the audio.

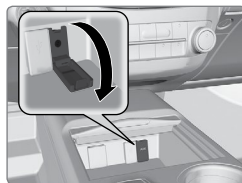

### ■ Accessory Power Socket

Located in the front and center consoles. Open the socket cover to use power when the vehicle is on.

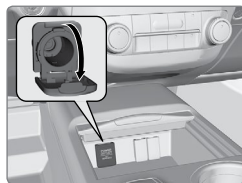

### NOTICE

Do not insert an automotive type cigarette lighter element. This can overheat the power socket.

### ■ Steering Wheel Controls

Operate certain functions of the audio system using the steering wheel controls.

**MODE button:** Cycle through available audio modes.

**VOL (▲/▼) buttons:** Adjust audio volume.

**CH (+/-) button:** Change presets, tracks, albums, or folders.



#### FM/AM/XM® Radio

Press (+) or (-) for the next or previous station.

Press and hold (+) or (-) for the next or previous strong station.

#### CD/HDD\*/iPod®/USB/Bluetooth® Audio

Press (+) or (-) for the next or previous track.

Press and hold (+) or (-) for the next or previous folder (CD/USB).

#### Pandora®

Press (+) for the next song.

Press and hold (+) or (-) for the next or previous station.

### ■ Adjusting the Sound

Adjust various sound settings.

#### Models without navigation

Use the selector knob to make and enter selections.

1. Press the SETUP button.
2. Select Sound Settings.
3. Select the setting you want, and adjust it to the desired level.
4. Press the BACK button to exit the menu.



#### Models with navigation

Use the interface dial to make and enter selections.

1. From the audio screen, press the MENU button.
2. Select Sound.
3. Select the setting you want, and adjust it to the desired level.
4. Press the BACK button to exit the menu.



You can also adjust the sound using the ODDM touchscreen. Select More, select Sound, and select the + or - icons to adjust settings. Select X to exit the screen.

*\*if equipped*

Models without navigation

### Color Information Display

Display audio information. Use the buttons to operate the system.

**Selector knob:** Rotate to scroll through options, and press to enter a selection.

**BACK button:** Go back to the previous display.

**\* button:** Change screen brightness. Use the selector knob to make adjustments.

**DISPLAY button:** Choose the audio, wallpaper, or blank display mode.

**SETUP button:** Select various audio mode options, sound settings, and clock adjustment.

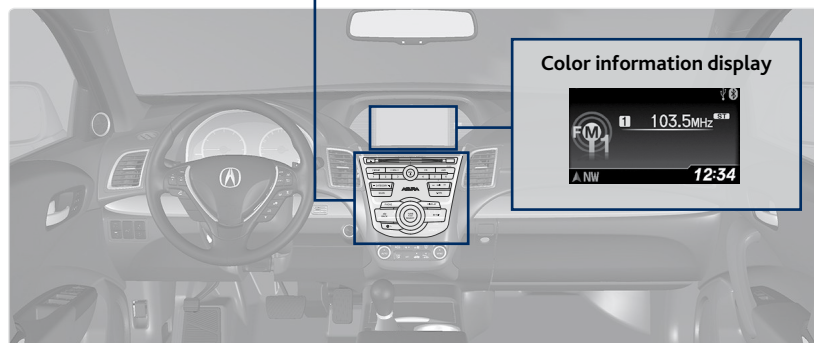

Models without navigation

### FM/AM Radio

Play FM or AM radio stations.

**FM/AM button:** Select a band.

**CATEGORY bar:** Display and select an RDS category.

**SCAN button:** Press to hear a 10-second sample of each strong station on the selected band. Press again to turn off scan.

**Selector knob:** Press and rotate to tune radio frequency.

**SETUP button:** Choose RDS options to display station text if available.

**Preset buttons (1-6):** Press and hold a preset button to store the current station. Press a preset button to select a previously stored station.

**SKIP bar:** Search the selected band for a station with a strong signal.

**A.SEL (Auto Select) button:** Press to scan bands and store the strongest stations in each preset. Press again to turn off scan and restore your original presets.

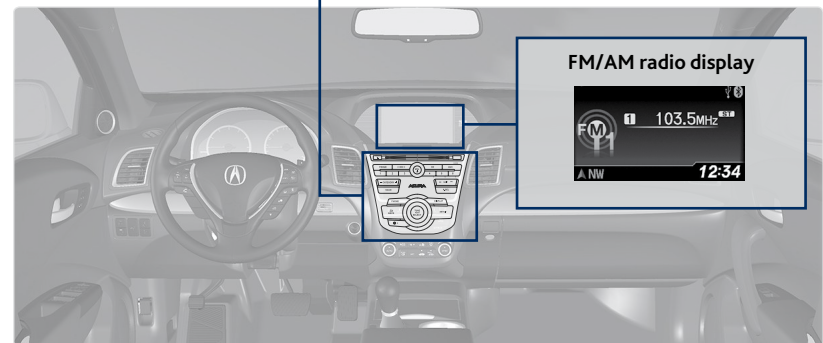

TABLE OF CONTENTS

VISUAL INDEX

SAFETY INFORMATION

INSTRUMENT PANEL

VEHICLE CONTROLS

AUDIO AND CONNECTIVITY

BLUETOOTH® HANDSFREELINK®

ACURALINK®

NAVIGATION

DRIVING

HANDLING THE UNEXPECTED

MAINTENANCE

SPECIFICATIONS

CLIENT INFORMATION

VOICE COMMAND INDEX

INDEX

Models without navigation

### SiriusXM® Radio

Available on a subscription basis only. For more information or to subscribe, contact your dealer, or visit [www.siriusxm.com](http://www.siriusxm.com) (U.S.) or [www.siriusxm.ca](http://www.siriusxm.ca) (Canada).

**XM button:** Select XM1 or XM2.

**CATEGORY bar:** Display and select an XM category.

**SCAN button:** Press to hear a 10-second sample of each channel. Press again to turn off scan.

**Selector knob:** Press and rotate to change channels.

**Preset buttons (1-6):** Press and hold a preset button to store the current channel. Press a preset button to select a previously stored station.

**SKIP bar:** Go to the previous or next channel.

**SETUP button:** Choose Channel Mode or Category Mode.

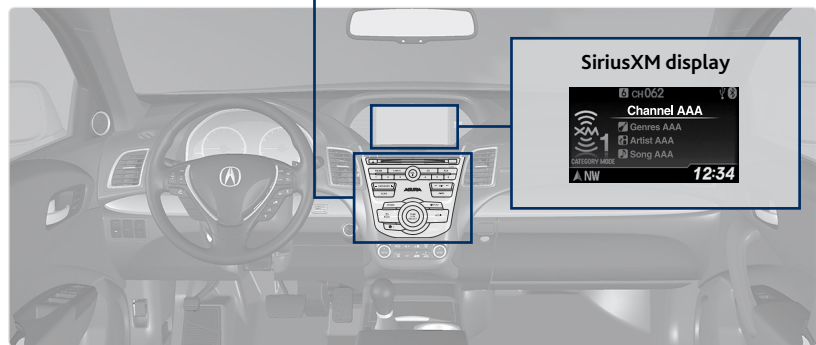

Available in the U.S. and Canada, except Hawaii, Alaska, and Puerto Rico. XM® is a registered trademark of Sirius XM Radio, Inc.

Models without navigation

### Compact Disc (CD)

Insert a CD to begin playing. The audio system supports audio CDs, CD-Rs, and CD-RWs in MP3, WMA, or AAC formats.

**CD eject button:** Eject the CD.

**CATEGORY bar:** Skip to the next folder or the beginning of the previous folder.

**SCAN button:** Press to hear a 10-second sample of each song. Press again to turn off scan.

**Selector knob:** Rotate to change tracks. Press and rotate to display folders.

**CD slot:** Insert a CD.

**CD button:** Play a CD.

**SKIP bar:** Change tracks, or rewind or fast forward within a track.

**SETUP button:** Choose various play modes, such as repeat and random.

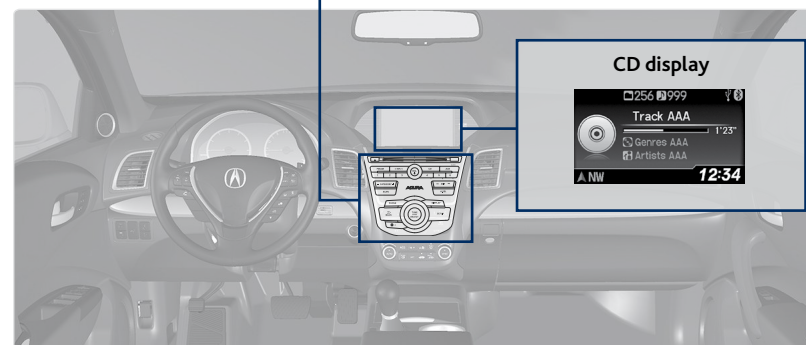

**NOTICE**

Do not use CDs with adhesive labels or insert a damaged CD. Inserting these types of CDs may cause them to get stuck or damage the audio unit.

TABLE OF CONTENTS

VISUAL INDEX

SAFETY INFORMATION

INSTRUMENT PANEL

VEHICLE CONTROLS

AUDIO AND CONNECTIVITY

BLUETOOTH® HANDSFREE LINK®

ACURALINK®

NAVIGATION

DRIVING

HANDLING THE UNEXPECTED

MAINTENANCE

SPECIFICATIONS

CLIENT INFORMATION

VOICE COMMAND INDEX

INDEX

Models without navigation

iPod®

Play and operate an iPod through the vehicle's audio system. Connect your device to the USB port (see page 50).

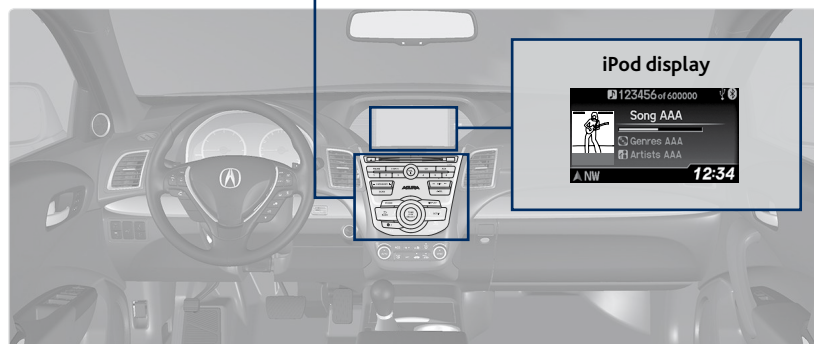
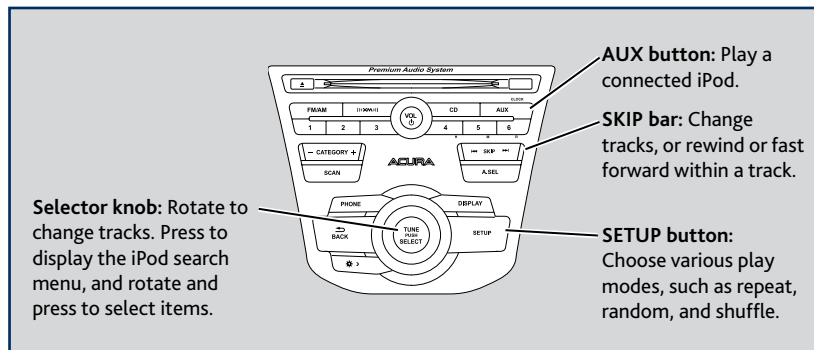

■ Searching for Music

Use the selector knob to search for tracks stored on the iPod using several methods.

1. From the audio screen, press the selector knob to enter the iPod menu.
2. Select a search type (artist, album, track, etc.).
3. Select the song you want to play.



iPod is a trademark of Apple, Inc.

State or local laws may prohibit the operation of handheld electronic devices while operating a vehicle. Only launch streaming audio on your phone when it is safe to do so.

Models without navigation

USB Flash Drive

Play and operate a USB flash drive through the vehicle's audio system. Connect your USB flash drive to the USB port (see page 50).

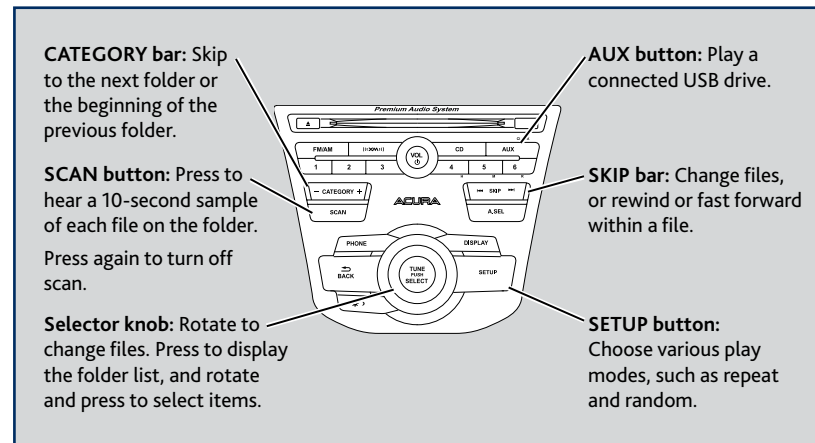

■ Searching for Music

Use the selector knob to search for tracks stored on the USB drive using several methods.

1. Press the selector knob to enter the USB menu.
2. Select a folder or file.
3. Select the song you want to play.





Models without navigation

**Bluetooth® Audio**

Play streaming or stored audio from your compatible phone through your vehicle's audio system. Connect your phone to *Bluetooth® HandsFreeLink®* (see page 70). Visit [www.acura.com/handsfreelink](http://www.acura.com/handsfreelink) (U.S.) or [www.handsfreelink.ca](http://www.handsfreelink.ca) (Canada) to check phone compatibility. Standard data rates apply.

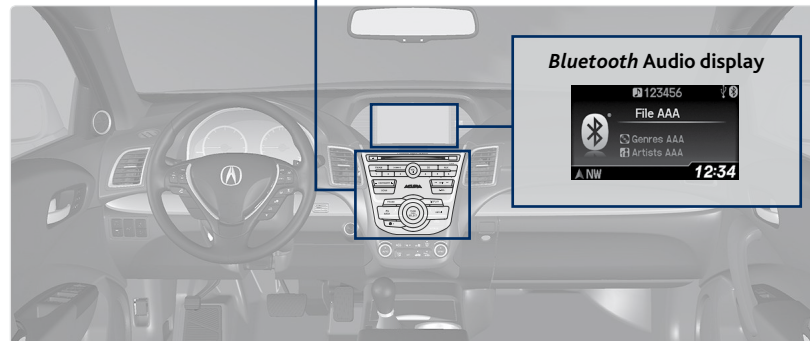
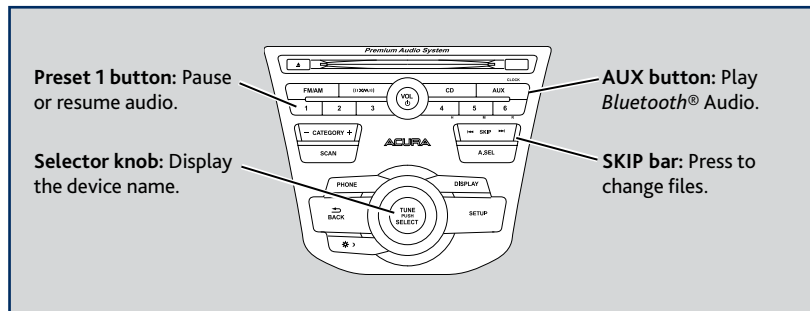

- Notes:**
- Make sure the volume on your phone is properly adjusted.
  - You may need to enable additional settings on your phone for playback.
  - The resume/pause function and remote audio controls are not supported on all phones.

*State or local laws may prohibit the operation of handheld electronic devices while operating a vehicle. Only launch streaming audio on your phone when it is safe to do so.*

Models without navigation

**Pandora®**

Play and operate Pandora from your compatible iPhone through the vehicle's audio system. Visit [www.acura.com/handsfreelink](http://www.acura.com/handsfreelink) to check phone compatibility. Standard data rates apply. **Available in the U.S. only.**

- Connect your phone to the USB port (see page 50).
- A pop-up may appear on your phone requesting you to allow access for Pandora to be launched.
- If you cannot operate Pandora through the audio system, it may be streaming through *Bluetooth®* Audio. Make sure Pandora mode on the audio system is selected.
- If Pandora still does not operate, you may have to reconnect the cable.

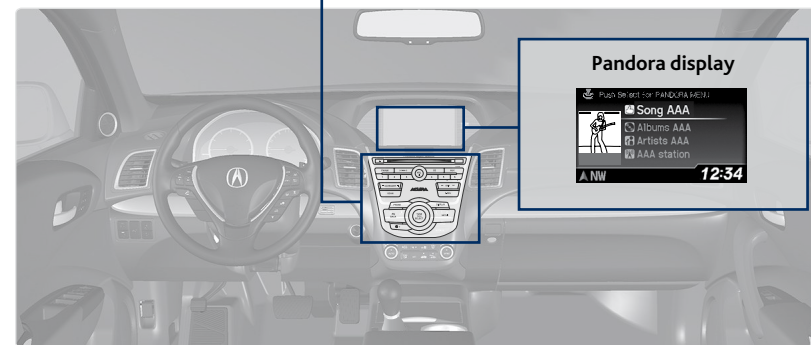
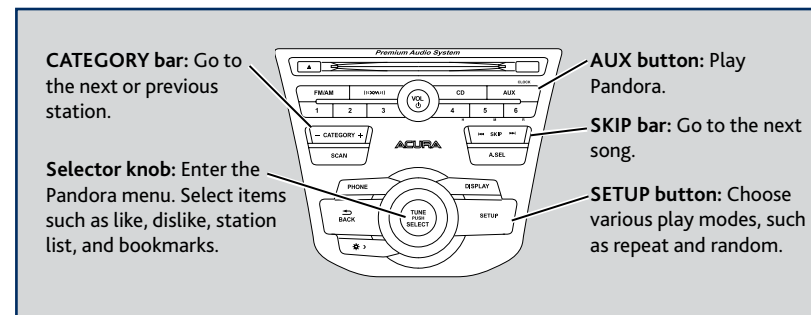

*State or local laws may prohibit the operation of handheld electronic devices while operating a vehicle. Only launch streaming audio on your phone when it is safe to do so.*

TABLE OF CONTENTS

VISUAL INDEX

SAFETY INFORMATION

INSTRUMENT PANEL

VEHICLE CONTROLS

AUDIO AND CONNECTIVITY

BLUETOOTH® HANDSFREELINK®

ACURALINK®

NAVIGATION

DRIVING

HANDLING THE UNEXPECTED

MAINTENANCE

SPECIFICATIONS

CLIENT INFORMATION

VOICE COMMAND INDEX

INDEX

Models with navigation

### On-Demand Multi-Use Display™ (ODMD™)

Operate the audio system using either the touchscreen or dashboard buttons.

The functions shown here can be used with most audio sources. Refer to subsequent audio pages for more specific functions. Options that appear depend on the selected audio source.

**ODMD controls**



**Power/volume knob:** Adjust volume.

**Sound:** Adjust sound settings.

**Shortcuts (Audio tab):** Store or select up to six AM, FM, or SiriusXM stations or HDD tracks.

**More:** Change screen and sound settings, or display menu options.

**Audio Source:** Change the audio source. Select Edit Order to arrange audio icons to your preference.

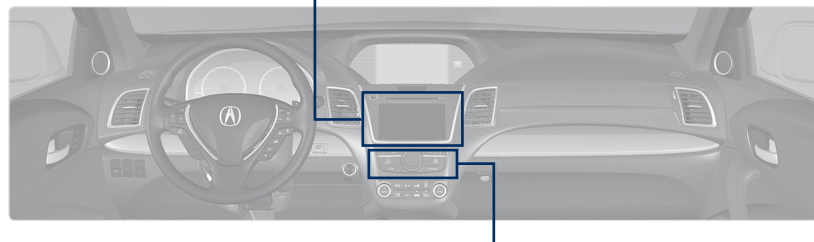

**Audio buttons**



**BACK button:** Return to the previous display.

**AUDIO button:** Display the audio screen.

**MENU button:** Display menu items.

**SETTINGS button:** Choose Audio Settings.

**Interface dial (from the audio screen):** Move up, down, left, and right. Rotate and press ENTER to make selections in the upper display.

**button:** Adjust the upper screen brightness.

Models with navigation

### FM/AM Radio

Play FM or AM radio stations.

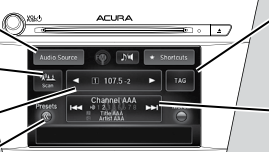

**Audio Source:** Select the FM or AM icon.

**Scan:** Scan for stations with a strong signal.

**Tune bar:** Change the station.

**Presets:** To store a station, tune to the desired station, select Presets, and select and hold the desired preset number. Select a preset station once stored.

**TAG\*:** Tag songs from HD Radio and store to a connected iPod or iPhone.

**Skip/seek bar:** Find a station with a strong signal.

**Interface dial (from the Audio screen):** Select from the station list or presets in the upper display.



TABLE OF CONTENTS

VISUAL INDEX

SAFETY INFORMATION

INSTRUMENT PANEL

VEHICLE CONTROLS

AUDIO AND CONNECTIVITY

BLUETOOTH® HANDSFREE LINK®

ACURALINK®

NAVIGATION

DRIVING

HANDLING THE UNEXPECTED

MAINTENANCE

SPECIFICATIONS

CLIENT INFORMATION

VOICE COMMAND INDEX

INDEX

Models with navigation

**SiriusXM® Radio**

Available on a subscription basis only. For more information or to subscribe, contact your dealer, or visit [www.siriusxm.com](http://www.siriusxm.com) (U.S.) or [www.siriusxm.ca](http://www.siriusxm.ca) (Canada).

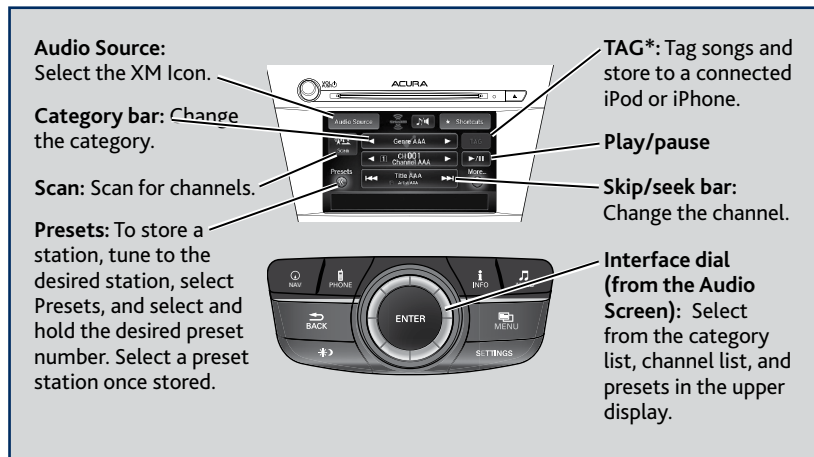

To learn about additional features—such as multi-channel preset, replay, or SportsFlash—see your Navigation Manual on the Owner Information CD or visit [owners.acura.com](http://owners.acura.com) (U.S.) or [myacura.ca](http://myacura.ca) (Canada).

Available in the U.S. and Canada, except Hawaii, Alaska, and Puerto Rico.  
 XM® is a registered trademark of Sirius XM Radio, Inc.

Models with navigation

**Compact Disc (CD) or USB Flash Drive**

Insert a CD to begin playing. The audio system supports audio CDs, CD-Rs, and CD-RWs in MP3, WMA, or AAC formats.

Connect your USB flash drive using the USB port (see page 50). The audio system supports MP3, WMA, or AAC files.

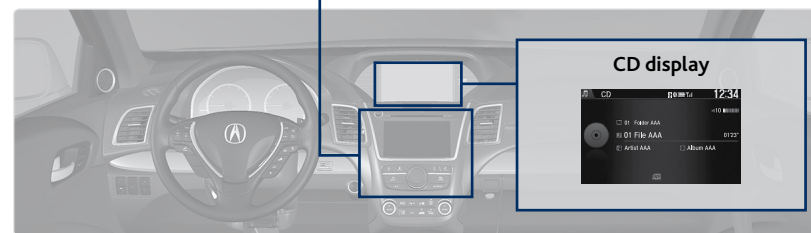
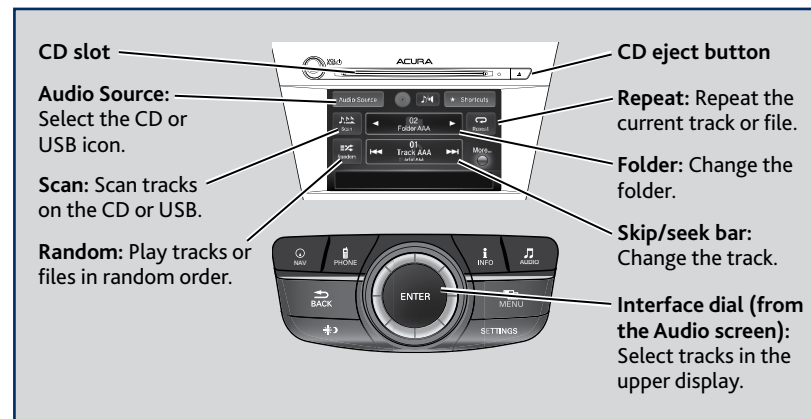

■ **Searching for Music**

Use the interface dial to search for tracks on the CD or USB.

1. From the audio screen, press MENU.
2. Select Music Search.
3. Select a search type (artist, album, track, etc.) or folder.
4. Select the song you want to play.



**NOTICE**

Do not use CDs with adhesive labels or insert a damaged CD. Inserting these types of CDs may cause them to get stuck inside or damage the audio unit.

Models with navigation

### Hard Disc Drive (HDD) Audio

When music CDs are inserted, they are automatically recorded by system default onto the built-in HDD for later playback.

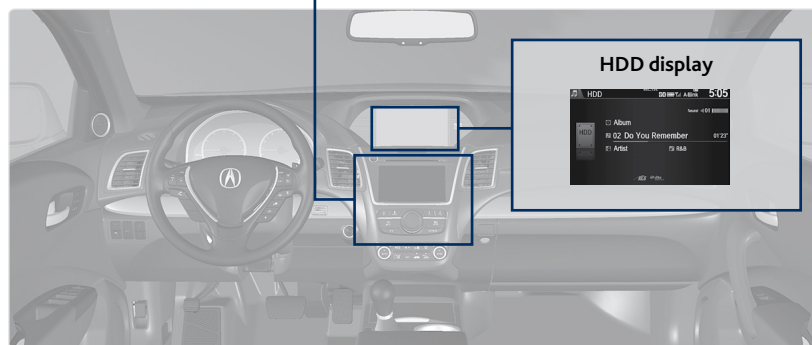
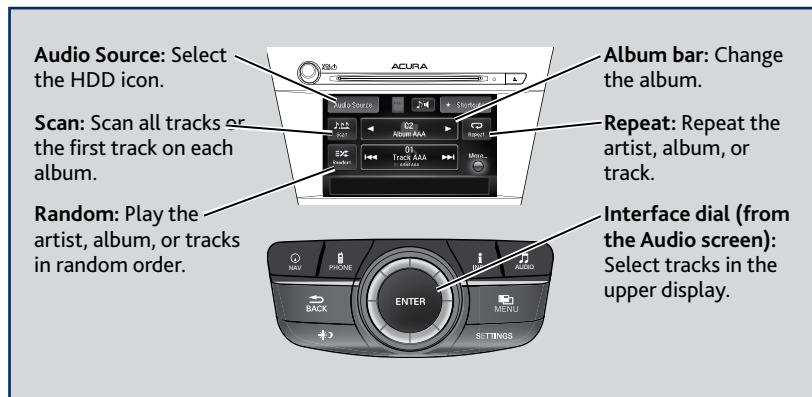

#### ■ Searching for Music

Use the interface dial to search for tracks using several methods.

1. From the audio screen, press MENU.
2. Select Music Search.
3. Select a search type (artist, album, track, etc.).
4. Select the song you want to play.



You can also search for and play HDD music using Song By Voice™ (see page 151).

Models with navigation

### iPod®

Play and operate an iPod through the vehicle's audio system. Connect your device to the USB port (see page 50).

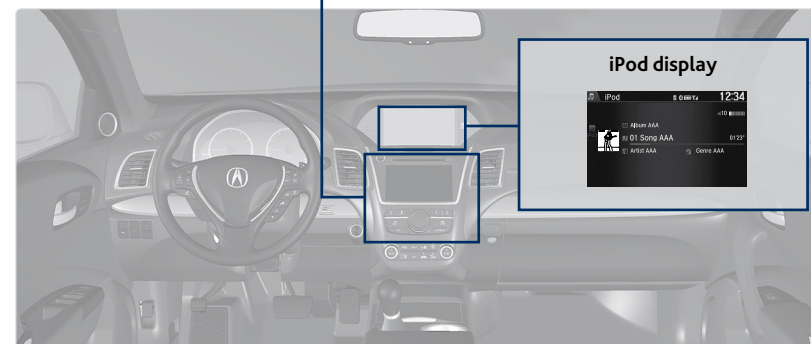
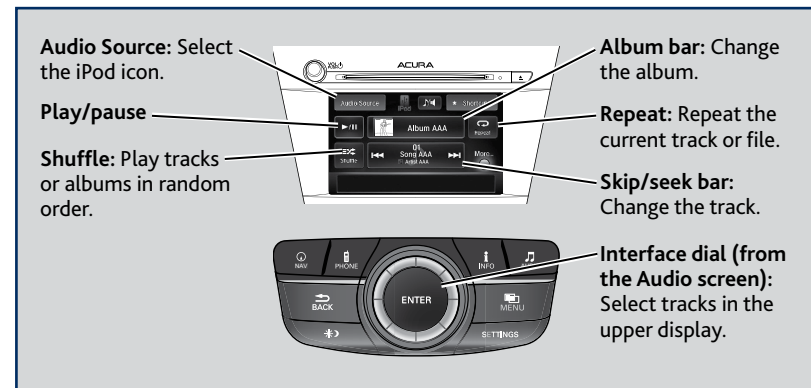

#### ■ Searching for Music

Use the interface dial to search for tracks using several methods.

1. From the audio screen, press MENU.
2. Select Music Search.
3. Select a search type (artist, album, track, etc.).
4. Select the song you want to play.



You can also search for and play iPod music using Song By Voice™ (see page 151).

*iPod is a trademark of Apple, Inc.*

Models with navigation

**Bluetooth® Audio**

Play streaming or stored audio from your compatible phone through your vehicle's audio system. Connect your phone to *Bluetooth® HandsFreeLink®* (see page 75).

Visit [www.acura.com/handsfreelink](http://www.acura.com/handsfreelink) (U.S.) or [www.handsfreelink.ca](http://www.handsfreelink.ca) (Canada) to check phone compatibility. Standard data rates apply.

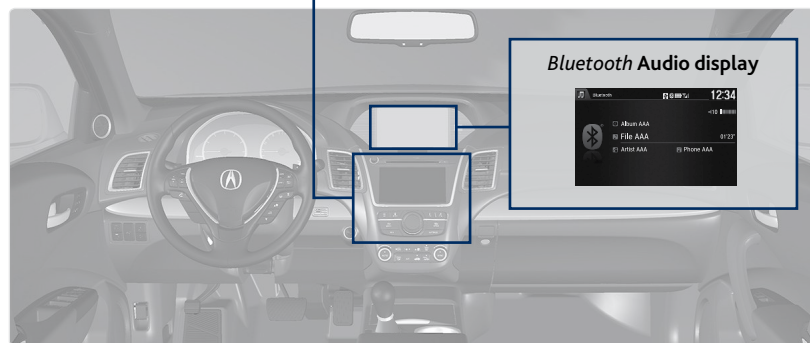
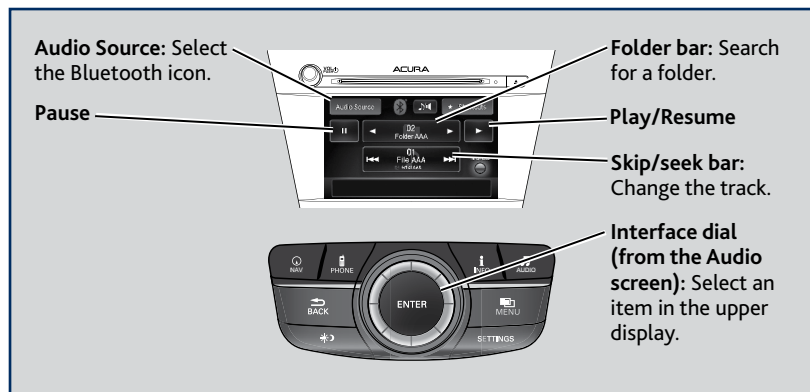

**Notes:**

- Make sure the volume on your phone is properly adjusted.
- You may need to enable additional settings on your phone for playback.
- The resume/pause function and remote audio controls are not supported on all phones.

*State or local laws may prohibit the operation of handheld electronic devices while operating a vehicle. Only launch streaming audio on your phone when safe to do so.*

Models with navigation

**Pandora®**

Play and operate Pandora from your compatible phone through the vehicle's audio system. Connect your phone when the vehicle is stopped.

Visit [www.acura.com/handsfreelink](http://www.acura.com/handsfreelink) to check phone compatibility. Standard data rates apply. **Available in the U.S. only.**

**For iPhone:**

- Connect via *Bluetooth® HandsFreeLink®* (see page 75) or USB (see page 50).
- If you cannot operate Pandora through the audio system, it may be streaming through *Bluetooth® Audio*. Make sure Pandora mode on the audio system is selected.
- If Pandora still does not operate, you may have to reconnect the cable.
- A pop-up may appear on your phone requesting you to allow access for Pandora to be launched.

**For other compatible smartphones:**

- Connect via *Bluetooth® HandsFreeLink®* (see page 75).

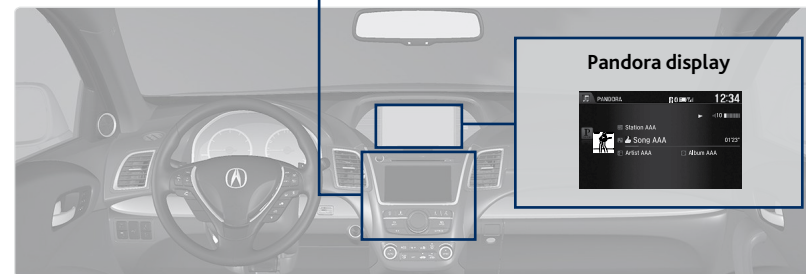
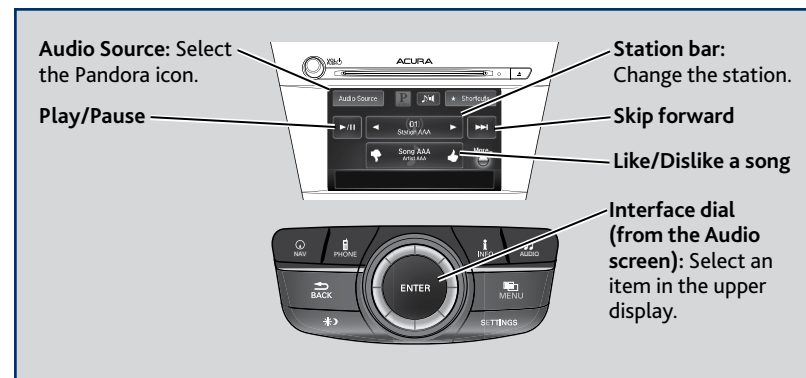

*State or local laws may prohibit the operation of handheld electronic devices while operating a vehicle. Only launch streaming audio on your phone when it is safe to do so.*

TABLE OF CONTENTS

VISUAL INDEX

SAFETY INFORMATION

INSTRUMENT PANEL

VEHICLE CONTROLS

AUDIO AND CONNECTIVITY

BLUETOOTH® HANDSFREELINK®

ACURALINK®

NAVIGATION

DRIVING

HANDLING THE UNEXPECTED

MAINTENANCE

SPECIFICATIONS

CLIENT INFORMATION

VOICE COMMAND INDEX

INDEX

Models with navigation

**AcuraLink featuring Aha™**

Access music and information programming, location-based services, and social media through the vehicle's audio system. Visit [www.acura.com/handsfreelink](http://www.acura.com/handsfreelink) (U.S.) or [www.handsfreelink.ca](http://www.handsfreelink.ca) (Canada) to check phone compatibility. Standard data rates apply.

Visit [owners.acura.com](http://owners.acura.com) (U.S.) or [www.myacura.ca](http://www.myacura.ca) (Canada) and download the AcuraLink app to your phone prior to using this feature. Make sure you have an active Aha account. Connect your phone when the vehicle is stopped.

**For iPhone:**

- Connect via *Bluetooth®* HandsFreeLink® (see page 75) or USB (see page 50).
- A pop-up may appear on your phone requesting you to allow access for Aha to be launched.
- If Aha still does not operate, try rebooting the phone and reconnecting the cable if necessary.

**For other compatible smartphones:**

- Connect via *Bluetooth®* HandsFreeLink® (see page 75).

**Audio source:** Select the aha icon.

**15-second skip back**

**30-second skip forward**

**Favorites:** View and select 16 previously favorited stations.

**Like/dislike**

**Play/pause**

**Interface dial (from the Audio screen):** Select an item in the upper display.

**Station/track bar**

**MENU button:** View the complete station list.

**Aha display**

*State or local laws may prohibit the operation of handheld electronic devices while operating a vehicle. Only launch streaming audio on your phone when it is safe to do so.*

**BLUETOOTH® HANDSFREELINK®**

Learn how to operate the vehicle's hands-free calling system.

Models without navigation

**Basic HFL Operation**

Make and receive phone calls using the vehicle's audio system, without handling your phone.

Visit [www.acura.com/handsfreelink](http://www.acura.com/handsfreelink) (U.S.) or [www.handsfreelink.ca](http://www.handsfreelink.ca) (Canada) to check phone compatibility.

■ **HFL Displays and Controls**

Use the controls to enter information and make selections.

**To reduce the potential for driver distraction, certain manual functions may be inoperable or grayed out while the vehicle is moving.**

**PHONE button:** Go to the phone screen.

**BACK button:** Go back to the previous display or cancel an operation.

**Selector knob:** Rotate and press to make and enter selections.

**HFL display**

Incoming Call  
John  
Answer  
Ignore  
12:34

**Pick-Up button:** Go to the Phone screen, or answer an incoming call.

**Hang-Up button:** End a call.

**Talk button:** Call a number with a stored voice tag.

**Back button:** Go back to the previous screen.

*State or local laws may prohibit the operation of handheld electronic devices while operating a vehicle.*

TABLE OF CONTENTS

VISUAL INDEX

SAFETY INFORMATION

INSTRUMENT PANEL

VEHICLE CONTROLS

AUDIO AND CONNECTIVITY

BLUETOOTH® HANDSFREELINK®

ACURALINK®

NAVIGATION

DRIVING

HANDLING THE UNEXPECTED

MAINTENANCE

SPECIFICATIONS

CLIENT INFORMATION

VOICE COMMAND INDEX

INDEX

Models without navigation

### Pairing a Phone

To use hands-free phone and streaming audio functions, you must first pair your phone to the system. This can only be done when the vehicle is stopped. Use the selector knob to make and enter selections.

#### ■ Pairing the First Phone

1. Press the PHONE button. A prompt appears. Select Yes.
2. Make sure your phone is in discovery mode. Select OK.
3. HFL searches for your phone. Select your phone when it appears on the list.  
*If your phone does not appear:* Select Phone Not Found, and search for HandsFreeLink from your phone. Connect when prompted.
4. HFL gives you a four-digit code. Enter it on your phone when prompted. The phone is now paired.

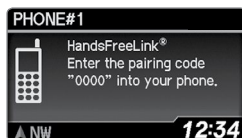

#### ■ Pairing an Additional Phone

1. Press the PHONE button to go to the Phone screen. If a prompt appears asking to connect to a phone, select No.
2. Select Phone Setup.
3. Select Connection.
4. Select Add a New Phone.
5. Select an empty location for the phone.
6. Make sure your phone is in discovery mode. Select OK.
7. HFL searches for your phone. Select your phone when it appears on the list.  
*If your phone does not appear:* Select Phone Not Found, and search for HandsFreeLink from your phone. Connect when prompted.
8. HFL gives you a four-digit code. Enter it on your phone when prompted. The phone is now paired.

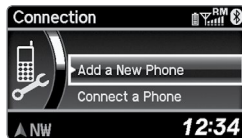
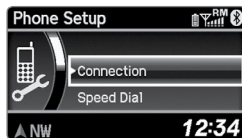

Models without navigation

### Making a Call

You can make calls using several methods.

#### ■ Dialing a Number

Enter a 10-digit phone number to call. Use the selector knob to make and enter selections. This feature is inoperable while the vehicle is moving.

1. Press the PHONE button to go to the Phone screen.
2. Select Dial.
3. Enter the phone number. Select the green Dial icon, or press the Pick-Up button to begin the call.



#### ■ Using the Phonebook

When your phone is paired, its entire phonebook is automatically imported to the system. Use the selector knob to make and enter selections. This feature is inoperable while the vehicle is moving.

1. Press the PHONE button to go to the Phone screen.
2. Select Phonebook.
3. Scroll through the list to find the name and number you want to call, and select it to begin the call.

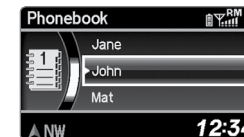

#### ■ Storing Speed Dial Entries

Store up to 15 numbers for quick dialing. Use the selector knob to make and enter selections.

1. Press the PHONE button to go to the Phone screen.
2. Select Phone Setup.
3. Select Speed Dial.
4. Select Add New.
5. Select an entry method.
6. If desired, you can create a voice tag for the number. Follow the prompts.

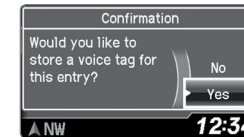
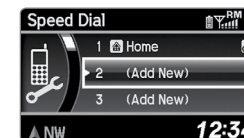

TABLE OF CONTENTS

VISUAL INDEX

SAFETY INFORMATION

INSTRUMENT PANEL

VEHICLE CONTROLS

AUDIO AND CONNECTIVITY

BLUETOOTH® HANDSFREELINK®

ACURALINK®

NAVIGATION

DRIVING

HANDLING THE UNEXPECTED

MAINTENANCE

SPECIFICATIONS

CLIENT INFORMATION

VOICE COMMAND INDEX

INDEX

### ■ Using Speed Dial

Make calls quickly using stored speed dial entries. Use the selector knob to make and enter selections.

1. Press the PHONE button to go to the Phone screen.
2. Select Speed Dial.
3. Select the entry you want to begin the call.



If an entry has a stored voice tag, you can call it at any time. Press the Talk button and follow the prompts.

### Models without navigation

### SMS Text Messaging

Receive and send text messages from your paired and linked phone.

Visit [www.acura.com/handsfreelink](http://www.acura.com/handsfreelink) (U.S.) or [www.handsfreelink.ca](http://www.handsfreelink.ca) (Canada) to check phone compatibility. Standard message rates apply. This feature is limited while the vehicle is moving.

### ■ Receiving and Responding to Messages

When you receive a new message, a pop-up appears on the display. Use the selector knob to view the message when the vehicle is stopped. You can also reply to it using fixed phrases or call the sender.

1. When the pop-up appears, select Yes.
2. The message is displayed, and the system reads it aloud.

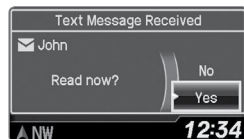

**To reply:** Select Reply, and choose one of the six available responses. Select Send to send the message.

**To call the sender:** Select Call.

### Models with navigation

### ■ HFL Displays and Controls

Use the controls or ODDM to enter information and make selections.

To reduce the potential for driver distraction, certain manual functions may be inoperable or grayed out while the vehicle is moving. Voice commands are always available.

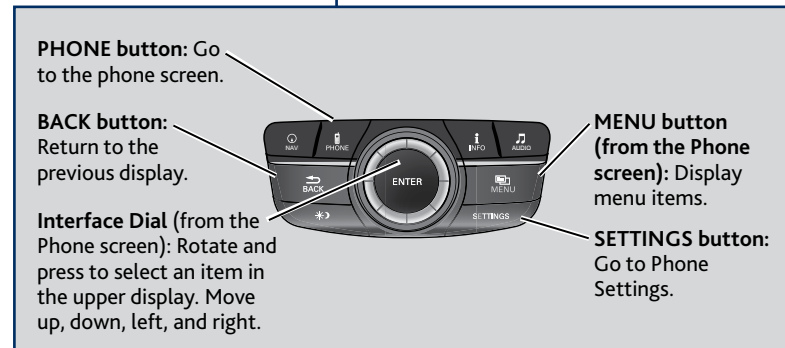
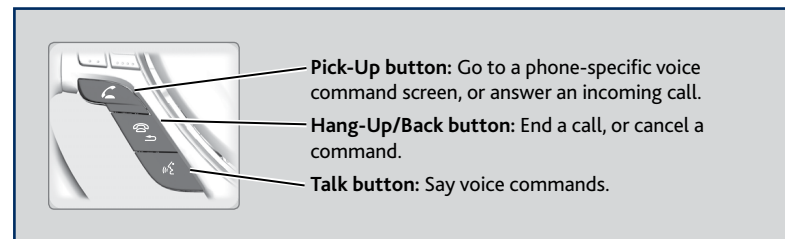





When there is an incoming call, select the green Pick-Up or red Hang-Up icon.



When a number keypad is displayed, select numbers to enter.



When an alphabet keyboard is displayed, select letters to enter.

**Talk Button Tips**

For a list of phone-related voice commands, see page 152.

- When using the Talk button, wait until you hear a beep before speaking.
- To bypass the system prompts, simply press the Talk button again to say your command.
- When the Talk button is pressed, all available voice commands are highlighted in yellow.
- Speak in a clear, natural voice.
- Reduce all background noise.
- Adjust the dashboard and side vents away from the microphone in the ceiling.
- Close the windows and moonroof.

Models with navigation

**Pairing a Phone**

To use hands-free phone and streaming audio functions, you must first pair your phone to the system. This can only be done when the vehicle is stopped. Use the interface dial to make and enter selections.

1. Press the SETTINGS button.
2. Select Phone Settings.
3. Select Bluetooth Device List (if no phone has been paired) or Connect Phone (if pairing an additional phone).
4. Select Add Bluetooth Device.
5. Make sure your phone is in discovery mode.
6. HFL searches for your phone. Select your phone when it appears on the list.  
*If your phone does not appear:* Select Device Not Found and search for HandsFreeLink from your phone.
7. HFL gives you a pairing code. Compare it to the code that appears on your phone. Connect to HFL from your phone.
8. The system asks if you want to enable Automatic Phone Sync, which imports your phone's call history and phonebook. Select On.
9. Press BACK to exit the menu.



Models with navigation

### Making a Call

You can make calls using several methods.

#### ■ Dialing a Number

Enter a 10-digit phone number to call.

##### Using voice commands

Press the Talk button before saying each command.

1. Say "Dial by number."
2. Say the phone number. For example, "3-1-0-5-5-5-1-2-3-4." Say "Dial" if necessary.
3. The system begins to dial.

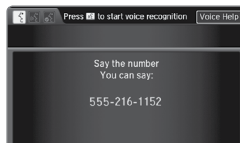

##### Using the menu

Use the interface dial to make and enter selections. This is inoperable while the vehicle is moving.

1. Press the PHONE button.
2. Press the MENU button.
3. Select Dial.
4. In the upper display or ODMD, enter the phone number. Select the green phone icon to call.



##### Using the ODMD

Select items on the screen by touching them. This is inoperable while the vehicle is moving.

1. Select Shortcuts.
2. Select Phone.
3. Select Dial.
4. Enter the phone number and select the green phone icon to call.



Models with navigation

#### ■ Using the Phonebook

When your phone is paired, its entire phonebook can be automatically imported to the system if you select On for Phone Synchronization.

##### Using voice commands

Press the Talk button before saying each command.

1. Say "Call by name."
2. Say the phonebook name and phone type. For example, "John Smith mobile."

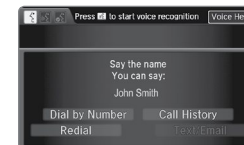

##### Using the menu

Use the interface dial to make and enter selections.

1. Press the PHONE button.
2. Press the MENU button.
3. Select Phonebook.
4. Scroll through the list to find the name and number you want to call, and select it to call.



#### ■ Storing Speed Dial Entries

Store up to 20 numbers for quick dialing.

1. Press the PHONE button.
2. Press the MENU button.
3. Select Speed Dial, then select New Entry.
4. Choose an entry method.
5. If desired, you can create a voice tag for the number. Follow the prompts.



When a voice tag is created, you can press the Talk button and say "Call" and the stored voice tag.

When speed dial entries are stored, you can add them to the Shortcuts (Phone tab) in the ODMD for quick access.

Models with navigation

■ Using Speed Dial and Call History

Make calls quickly using stored speed dial entries or call history numbers.

Using voice commands

Press the Talk button before saying each command.

1. Say "Call by name."
2. Say the name of the stored voice tag.
3. The system begins to dial.



Using the phone screen

Use the interface dial to make and enter selections.

1. Press the PHONE button.
2. For Speed Dial, use the interface dial to scroll through the list to find the entry you want to call, and select it to call.  
For Call History, move the interface dial to the right and scroll through the list.



Using the ODMD

Select items on the screen by touching them.

1. Select Shortcuts.
2. Select Phone.
3. Select Speed Dial or Call History. Speed dial entries must be previously stored to the Shortcuts menu. Select Edit and follow the prompts.
4. Select the desired entry to call.



Models with navigation

SMS Text Messaging and E-Mail

Receive and send text messages and e-mails from your paired and linked phone.

Visit [www.acura.com/handsfreelink](http://www.acura.com/handsfreelink) (U.S.) or [www.handsfreelink.ca](http://www.handsfreelink.ca) (Canada) to check phone compatibility. Standard message rates apply. This feature is limited while the vehicle is moving.

■ Selecting an Account

If your phone has both text message and mail accounts, you can select only one of them at a time to be active and receive notifications.

1. Press the SETTINGS button.
2. Select Phone Settings.
3. Select Select Account.
4. Select Text Messages or an e-mail account.



■ Receiving and Responding to Messages

When you receive a new message, a pop-up appears in the upper display. Use the interface dial to view the message when the vehicle is stopped. You can also reply to it using fixed phrases or call the sender.

1. When the prompt appears, select Read.
2. The message is displayed, and the system reads it aloud.
3. **To reply:** Select Reply, and choose one of the six available responses. Select Send to send the message. You cannot create a new message.  
**To call the sender:** Select Call.



TABLE OF CONTENTS

VISUAL INDEX

SAFETY INFORMATION

INSTRUMENT PANEL

VEHICLE CONTROLS

AUDIO AND CONNECTIVITY

BLUETOOTH® HANDSFREELINK®

ACURALINK®

NAVIGATION

DRIVING

HANDLING THE UNEXPECTED

MAINTENANCE

SPECIFICATIONS

CLIENT INFORMATION

VOICE COMMAND INDEX

INDEX

## Models with navigation

## Siri™ Eyes Free

Activate Siri through your vehicle when an iPhone® is paired to the system.

Visit [www.acura.com/handsfreelink](http://www.acura.com/handsfreelink) (U.S.) or [www.handsfreelink.ca](http://www.handsfreelink.ca) (Canada) to check phone compatibility.

**Back button:** Exit Siri Eyes Free mode, or cancel a command.

**Talk button:** Press and hold to activate Siri Eyes Free mode. The Smartphone screen appears. Say your command after you hear the Siri tone. If you only press and release the Talk button, the standard voice recognition system is activated.

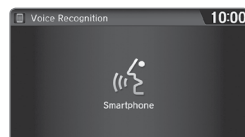

Here are some examples of Siri commands:

"Call John Smith"

"Remind me to pick up dinner"

"Read my new text message"

"Set up a meeting today at 3 p.m."

"Find a nearby sushi restaurant"

"Play song XYZ"

**Notes:**

- Any requests that include visual feedback from Siri on your phone are not displayed in the vehicle.
- Certain commands rely on the iPhone's features and existing apps.
- To hear turn-by-turn directions or songs through the vehicle, set the audio source to *Bluetooth®* Audio.

*Siri and iPhone are trademarks of Apple, Inc.*

## ACURALINK®\*

Learn about Acura's advanced connectivity services.

## AcuraLink Messages

Receive messages on vehicle features, safety and emissions recall campaigns, maintenance reminders, and diagnostic information.

Some message features require a phone connection. Visit [www.acura.com/handsfreelink](http://www.acura.com/handsfreelink) (U.S.) or [www.handsfreelink.ca](http://www.handsfreelink.ca) (Canada) to check phone compatibility.

## ■ Viewing Messages

When you receive a new message, an icon appears on the upper right corner of the upper screen. Use the interface dial to make and enter selections.

1. Press INFO.
2. Select AcuraLink Messages.
3. Select a message category.
4. Select a message.
5. Select Voice to hear the entire message details read aloud.

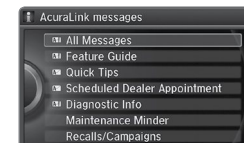

## ■ Message Options

When you receive certain messages, you can call your dealer if your phone is paired to the system, find the nearest dealer, or schedule service appointments. A current AcuraLink subscription is required to set up this feature and modify your message preferences.



\*if equipped

## Subscription Features

A subscription-based service that provides convenient features, such as collision notification, emergency assistance, online security, and important messages about your vehicle.

To subscribe or get more information, contact a dealer or visit [owners.acura.com](http://owners.acura.com) (U.S.) or [www.myacura.ca](http://www.myacura.ca) (Canada). Requires enrollment and privacy agreement.

### ■ Emergency Assistance

If your vehicle's airbags deploy or if the unit detects that the vehicle is severely impacted, your vehicle automatically attempts to connect to the AcuraLink operator if there is sufficient cellular coverage. Once connected, information about your vehicle, its positioning, and its condition will be sent to the operator. You can also speak to the operator when connected.

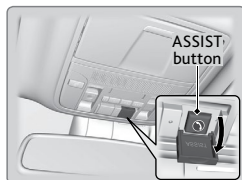

To manually connect to the operator, open the cover on the ceiling console and press ASSIST when the vehicle is on.

### ■ Security Features

To use security features, you need your user ID and personal identification number (PIN). Some of these features are also available with the AcuraLink smartphone app. Visit [owners.acura.com/apps](http://owners.acura.com/apps) to download the app.

- *Stolen vehicle tracking*: Searches and tracks down your vehicle position.
- *Remote door lock/unlock*: Remotely lock or unlock doors.
- *Vehicle finder*: Locate your vehicle in large areas, such as a parking lot.
- *Security alarm notification*: If your vehicle's security system detects tampering, the provider notifies you.

### ■ Operator Assistance

Connect to the AcuraLink operator when trying to find a destination or for roadside assistance.

Press LINK to connect to an operator.

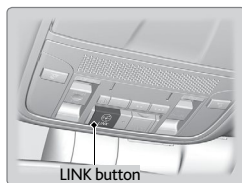

## NAVIGATION\*

Learn how to enter a destination and operate the navigation system.

### Basic Navigation Operation

A real-time navigation system uses GPS and a map database to show your current location and help guide you to a desired destination. You can operate the system using voice commands or the system controls.

**To reduce the potential for driver distraction, certain manual functions may be inoperable or grayed out while the vehicle is moving. Voice commands are always available.**

### ■ Steering Wheel Controls

Use the steering wheel controls to give voice commands.

**Talk button:** Press to give navigation commands.

**Back button:** Press to cancel a command or operation.

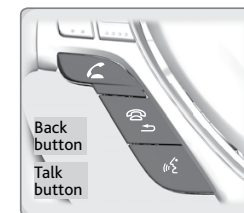

### ■ Talk Button Tips

For a full list of navigation voice commands, see page 147.

- When using the Talk button, wait for a beep before saying a command.
- To bypass the system prompts, simply press the Talk button again to say your command.
- When the Talk button is pressed, all available voice commands are highlighted in yellow.
- Speak in a clear, natural voice.
- Reduce all background noise.
- Adjust the dashboard and side vents away from the microphone in the ceiling.
- Close the windows and moonroof.

### ⚠ WARNING

Using the navigation system while driving can take your attention away from the road, causing a crash in which you could be seriously injured or killed. Only operate system controls when the conditions permit you to safely do so.

\*if equipped

### Navigation Display and Controls

Use the controls to enter information and make selections. Some manual functions are inoperable while driving.

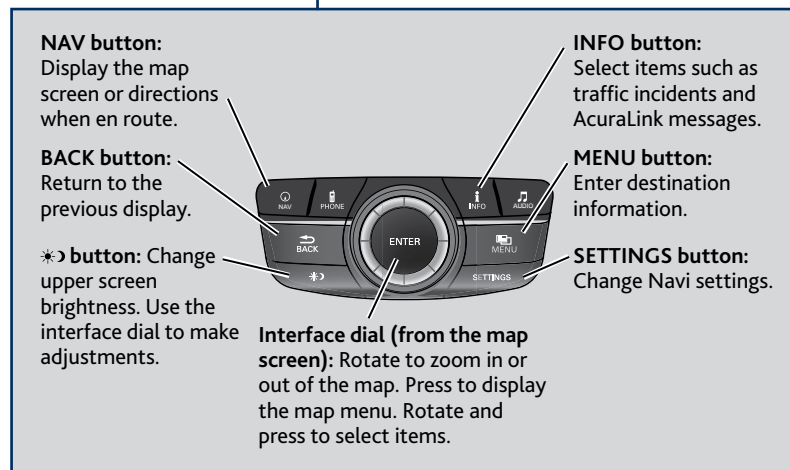
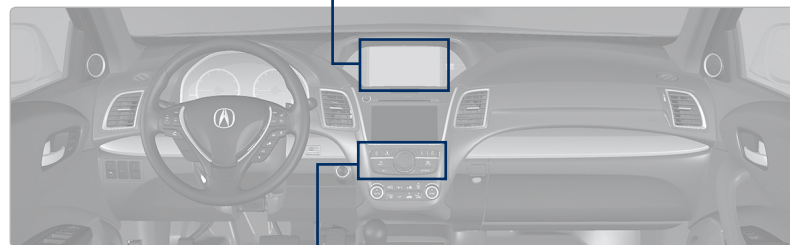
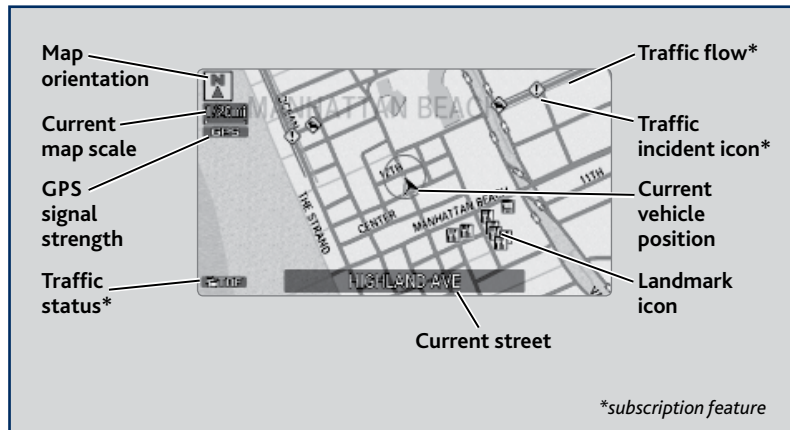

### Interface Dial Feedback

Configure the system to read aloud selections made using the interface dial. Use the interface dial to make and enter selections.

1. Press **SETTINGS**.
2. Select System Settings.
3. Select Interface Dial Feedback.
4. Select Off, Auto, or On.

**On:** Always reads the selection.  
**Auto:** Reads the selection only when the vehicle is moving.  
**Off:** Turns interface dial feedback off.



### System Guidance Volume

Adjust the navigation system guidance volume. Use the interface dial to make and enter selections. You can also adjust the volume during guidance using the volume knob or steering wheel controls.

1. From the map screen, press the interface dial to display the map menu.
2. Select Guidance Volume.
3. Adjust the volume to your preferred level.
4. Press **BACK** to exit the menu.



### Voice Prompt

Turn the voice prompt feature on or off. Use the interface dial to make and enter selections.

1. Press **SETTINGS**.
2. Select System Settings.
3. Select Voice Prompt.
4. Select Off or On.  
**On:** Provides voice prompts.  
**Off:** Voice prompts are disabled.



## Entering a Destination

Use several methods to enter a destination.

### Home Address

Store your home address in the system so you can easily route to it. Use the interface dial to make and enter selections.

1. Press SETTINGS.
2. Select Navi Settings.
3. Select Edit Go Home.
4. Enter the address and select OK.

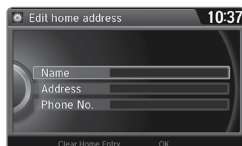

When your home address is stored, you can press the Talk button and say "Go home" at any time. You can also select Go Home from the destination menu.

### Street Address

Enter a street address using voice commands. Press the Talk button before saying each command.

You can also enter the address manually when the vehicle is stopped. While on the map screen, press MENU and use the interface dial to select Address. Follow the prompts.

#### U.S. models

1. From the Voice Portal screen, say "Address."
2. The system prompts you to say the entire address. For example, say "1-2-3-4 Main Street, Los Angeles, California."
3. The system interprets the address by state, city, street, and address number. If necessary, you may have to clarify similar matches.
4. Say "Set as destination" to set the route.

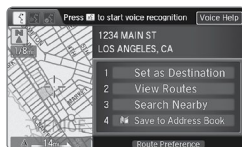
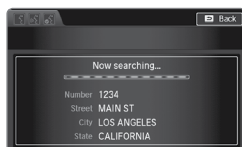

#### Canadian models

From the map screen, say "Display Menu," followed by "Address." Follow the prompts.

### Place Name

Enter a place name stored in the navigation database using voice commands. Press the Talk button before saying each command.

1. From the Voice Portal, say "Place name."
2. Say a category. For example, "ATM/Bank."
3. Say the name of the point of interest. For example, "ABC Bank."
4. The system interprets the name. If necessary, you may have to clarify similar matches.



If there is more than one point of interest with the name, a list of matches appears in order of closest distance. Say the number next to the place you want.

5. Say "Set as destination" to set the route.

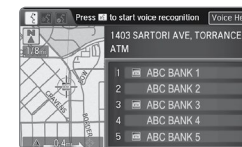

If the system does not recognize the specific name, you can enter it manually when the vehicle is stopped. While on the map screen, press MENU and use the interface dial to select Place Name. Enter the name one letter at a time, and follow the prompts.

### Find Nearest Place

Enter a destination by category and distance using voice commands. Press the Talk button before saying each command.

1. Say "Find nearest" and a place. For example, "Find nearest ATM."
2. A list of the nearest places in your area is displayed by shortest distance to destination.
3. Say the number next to the destination you want to select.
4. Say "Set as destination" to set the route.



### ODMD Shortcuts

You can add up to six destinations to the Shortcuts (Places tab) in the ODMD. The addresses must be previously stored in the navigation system address book.

1. Select Shortcuts.
2. Select Places.
3. Select No Entry to store a previously stored address book entry, or select a stored entry to route to it.



## Routing

After a destination is set, you can alter or cancel your route.

### Map Legend

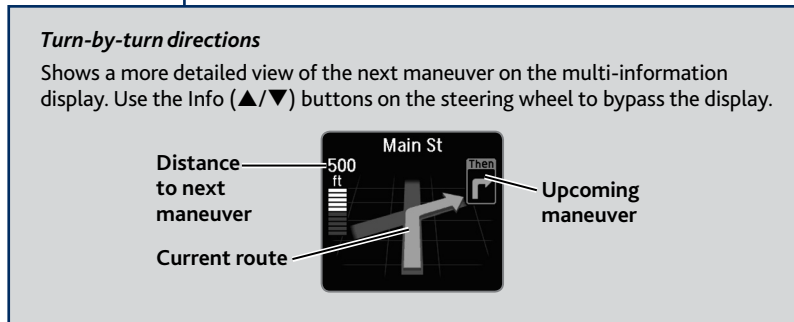
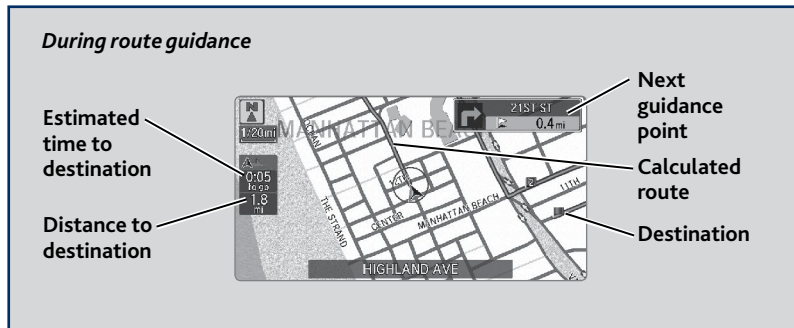

### Taking a Detour

You can calculate a detour route manually if you encounter a road closure or other obstacle. Use the interface dial to make and enter selections.

1. When en route, press MENU.
2. Select Detour. The system attempts to calculate a new route by avoiding the next 5 miles (8 km) while on a freeway or 1 mile (1 km) while on a surface street.



### AcuraLink Real-Time Traffic™

View traffic flow, incidents, and construction in major metro areas if you have an active AcuraLink® subscription (see page 82). You can also route around congestion or incidents using voice commands. Press the Talk button before saying each command.

1. When en route, say “Display traffic on my route.” A list of incidents on your route appears.
2. Say the number of the incident you want to avoid.
3. Say “Avoid” and the incident list returns.
4. Say “Reroute” to set the new route.



### Canceling Your Route

You can cancel your route at any time. Press the Talk button and say “Cancel route.” You can also use the interface dial to make and enter selections.

1. When en route, press MENU.
2. Select Cancel Route. The route is cleared and the map screen returns.





# DRIVING

Learn about preparation for driving and other features.

## Before Driving

Check the following items before you begin driving.

### ■ Exterior Checks

- Make sure there are no obstructions on the windows, door mirrors, exterior lights, or other parts of the vehicle.
- Remove any frost, snow, or ice.
- Make sure the hood is securely closed.
- Heat from the engine and exhaust can ignite flammable materials left under the hood, causing a fire. If you've parked your vehicle for an extended period, inspect and remove any debris that may have collected, such as dried grass and leaves that have fallen or have been carried in for use as a nest by a small animal. Also check under the hood for leftover flammable materials after you or someone else has performed maintenance on your vehicle.
- Make sure the tires are in good condition.
- Make sure there are no people or objects behind or around the vehicle.

### NOTICE

If the doors are frozen shut, use warm water around the door edges to melt any ice. Do not try to force them open, as this can damage the rubber trim around the doors. When done, wipe dry to avoid further freezing.

### ■ Interior Checks

- Store or secure all items on board properly.
- Do not pile items higher than the seat height.
- Do not place anything in the front seat footwells. Make sure to secure the floor mats.
- If you have any animals on board, do not let them move freely in the vehicle.
- Securely close and lock all doors and the tailgate.
- Adjust your seating position, mirrors, and steering wheel properly.
- Be sure items placed on the floor behind the front seats cannot roll under the seats.
- Everyone in the vehicle must fasten their seat belt.

Make sure that the indicators in the instrument panel come on when you start the vehicle, and go off soon after.

### ■ Driving Guidelines for Your Utility Vehicle

Utility vehicles have a significantly higher rollover rate than other types of vehicles. To prevent rollovers or loss of control:

- Take corners at slower speeds than you would with a passenger vehicle.
- Avoid sharp turns and abrupt maneuvers whenever possible.
- Do not modify your vehicle in any way that raises its center of gravity.
- Never carry more than 165 lbs (75 kg) of cargo on the roof rack (Acura accessory).

In addition:

- During the first 600 miles (1,000 km) of operation, avoid sudden acceleration or full throttle operation so as not to damage the engine or powertrain.
- Avoid hard braking for the first 200 miles (300 km). You should also follow this when the brake pads are replaced.

### ⚠ WARNING

Improperly operating this vehicle on or off pavement can cause a crash or rollover in which you and your passengers can be seriously injured or killed. Follow all instructions and guidelines in this guide. Keep your speed low, and don't drive faster than conditions permit.

### ⚠ WARNING

Improper accessories or modifications can affect your vehicle's handling, stability, and performance, and cause a crash in which you can be seriously hurt or killed. Follow all instructions in the vehicle owner's manual regarding accessories and modifications.

### ■ AWD (All-Wheel Drive) with Intelligent Control System\*

When the AWD system senses a loss of front wheel traction, it automatically transfers some power to the rear wheels. This allows you to utilize all available traction and may increase mobility.

You still need to exercise the same care when accelerating, steering, and braking that you would in a two-wheel drive vehicle.

If you excessively spin all four wheels and overheat the system, only the front wheels receive power. Stop until the system cools down.

### NOTICE

Do not continuously spin the front tires of your vehicle. Continuously spinning the front tires can cause transmission or rear differential damage.

*\*if equipped*

### Maximum Load Limit

Carrying too much cargo or improperly storing it can affect your vehicle's handling, stability, stopping distance, and tires, and make it unsafe.

The maximum load for your vehicle is 870 lbs (395 kg). See the Tire and Loading Information label on the driver's doorjamb.

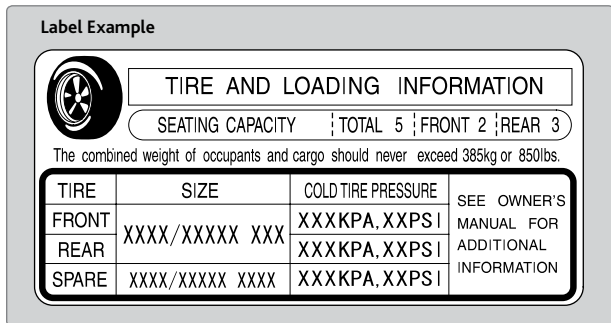

This figure includes the total weight of all occupants, cargo, and accessories, and the tongue load if you are towing a trailer. Below are the steps for determining the correct load limit:

1. Locate the statement "The combined weight of occupants and cargo should never exceed XXX kg or XXX lbs." on your vehicle's placard.
2. Determine the combined weight of the driver and passengers that will be riding in your vehicle.
3. Subtract the combined weight of the driver and passengers from XXX kg or XXX lbs.
4. The resulting figure equals the available amount of cargo and luggage load capacity. For example, if the "XXX" amount equals 1,400 lbs. and there will be five 150 lb. passengers in your vehicle, the amount of available cargo and luggage load capacity is 650 lbs. (1,400 - 750 (5 x 150) = 650 lbs.)
5. Determine the combined weight of luggage and cargo being loaded on the vehicle. That weight may not safely exceed the available cargo and luggage load capacity calculated in step 4.
6. If your vehicle will be towing a trailer, load from your trailer will be transferred to your vehicle. Consult the Owner's Manual to determine how this reduces the available cargo and luggage load capacity of your vehicle.

In addition, the total weight of the vehicle, all occupants, accessories, cargo, and trailer tongue load must not exceed the Gross Vehicle Weight Rating (GVWR) or the Gross Axle Weight Rating (GAWR). Both are on a label on the driver's doorjamb.

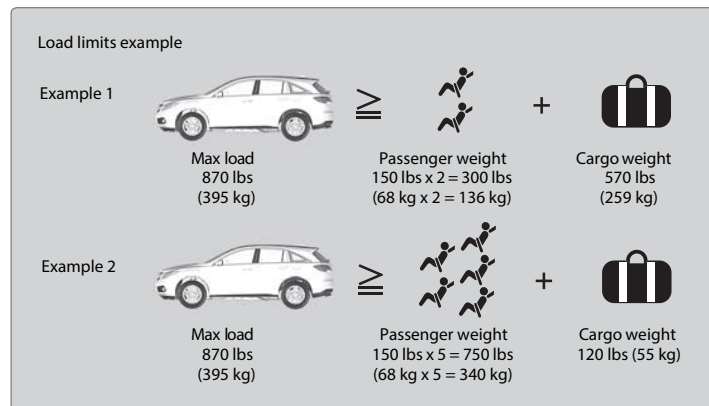

**⚠ WARNING**

Overloading or improper loading can affect handling and stability and cause a crash in which you can be hurt or killed. Follow all load limits and other loading guidelines in this guide.

The headlight aim on your vehicle was set by the factory, and does not need to be adjusted. However, if you regularly carry heavy items in the cargo area or pull a trailer, have the aiming readjusted at your dealer or by a qualified technician.

TABLE OF CONTENTS

VISUAL INDEX

SAFETY INFORMATION

INSTRUMENT PANEL

VEHICLE CONTROLS

AUDIO AND CONNECTIVITY

BLUETOOTH® HANDSFREELINK®

ACURALINK®

NAVIGATION

DRIVING

HANDLING THE UNEXPECTED

MAINTENANCE

SPECIFICATIONS

CLIENT INFORMATION

VOICE COMMAND INDEX

INDEX

## Towing a Trailer

Your vehicle can tow a trailer if you carefully observe the load limits, use the proper equipment, and follow the towing guidelines. See the Owner's Manual on the Owner Information CD or visit [owners.acura.com](http://owners.acura.com) (U.S.) or [www.myacura.ca](http://www.myacura.ca) (Canada) for more information.

### ■ Towing Load Limits

#### Total trailer weight

Maximum allowable weight of the trailer, cargo, and everything in or on it must not exceed 1,500 lbs (680 kg). Towing loads in excess of this can seriously affect vehicle handling and performance and can damage the engine and drivetrain.

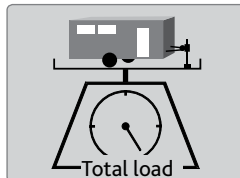

#### Tongue load

The weight of the tongue with a fully loaded trailer on the hitch should be approximately 10% of the total trailer weight.

- Excessive tongue load reduces front tire traction and steering control. Too little tongue load can make the trailer unstable and cause it to sway.
- To achieve a proper tongue load, start by loading 60% of the load toward the front of the trailer and 40% toward the rear. Readjust the load as needed.

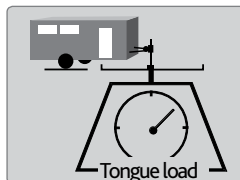

### **⚠ WARNING**

Exceeding any load limit or improperly loading your vehicle and trailer can cause a crash in which you can be seriously hurt or killed.

Check the loading of your vehicle and trailer carefully before starting to drive.

### Pre-tow checklist

When preparing to tow, and before driving away, be sure to check the following:

- Avoid towing a trailer during your vehicle's first 600 miles (1,000 km).
- The vehicle has been properly serviced, and the suspension and the cooling system are in good operating condition.
- The trailer has been properly serviced and is in good condition.
- All weights and loads are within limits. Never exceed the gross weight ratings.
- Check if all loads are within limits at a public scale. If a public scale is not available, add the estimated weight of your cargo load to the weight of your trailer (as quoted by the manufacturer) and the tongue load.
- The hitch, safety chains, and any other attachments are secure.
- All items in or on the trailer are properly secured and cannot shift while you drive.

## Remote Engine Start\*

Start your vehicle's engine using the two-way remote transmitter from extended distances before you enter the vehicle.

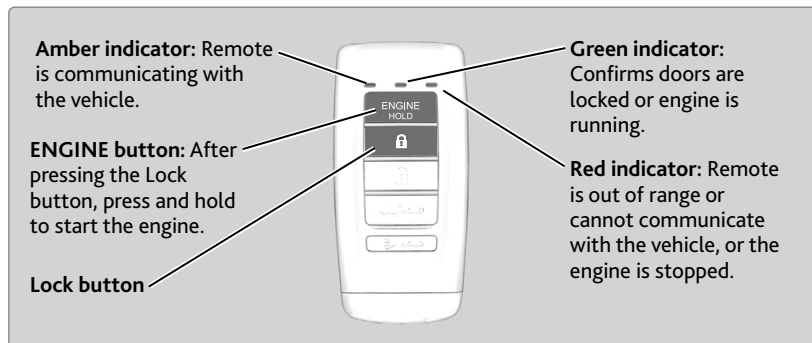

Make sure the vehicle is in a safe location when using remote engine start (i.e., a well ventilated area, away from flammable materials).

### Starting the Engine

Press the Lock button, then press and hold the ENGINE button.

The engine runs for up to 10 minutes. To extend the time for another 10 minutes, repeat the procedure during the initial 10 minutes.

While the engine is running, the climate control system adjusts the interior temperature, the security system remains on, and lights and accessories remain off.

### Stopping the Engine

Press and hold the ENGINE button.

The engine will also stop if it has been running for more than 10 minutes, or if any door is opened without using the remote transmitter or keyless access.

### ⚠ WARNING

Engine exhaust contains toxic carbon monoxide.

Breathing carbon monoxide can kill you or cause unconsciousness.

Never use the remote engine starter when the vehicle is parked in a garage or other area with limited ventilation.

## Starting to Drive

The keyless access system allows simple push-button start.

### Before Starting the Engine

Check that the shift lever is in Park (P), then depress the brake pedal. Keep your foot firmly on the brake pedal when starting the engine.

The engine is harder to start in cold weather and in thinner air found at altitudes above 8,000 feet (2,400 m). When starting the engine in cold weather, turn off all electrical accessories such as the lights, climate control system, and rear defogger in order to reduce battery drain.

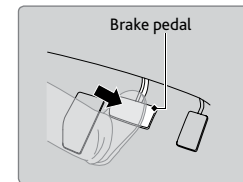

### Changing the Power Mode

**Accessory or On mode:** Press the ENGINE START/STOP button once without pressing the brake pedal for Accessory mode. Press it again for On mode.

**Starting the engine:** Press and hold the brake pedal, then press the ENGINE START/STOP button. Keep your foot firmly on the brake pedal when starting the engine.

If you press the button and the shift lever is not in Park (P), the vehicle goes into Accessory mode.

**Turning the vehicle off:** Shift to Park (P), then press the ENGINE START/STOP button.



\*if equipped

## Shifting

Change your vehicle's gears to begin driving.

### Shift Lever

**Park (P):** Used for parking or starting/stopping the engine. Press the brake pedal, then press the release button to shift.

**Reverse (R):** Used for reversing.

**Neutral (N):** Used for idling.

**Drive (D):** Used for normal driving or temporarily driving in sequential mode.

**Drive (S):** Used for driving in sequential mode. Press the release button, and use the paddle shifters to change gears (see page 85).

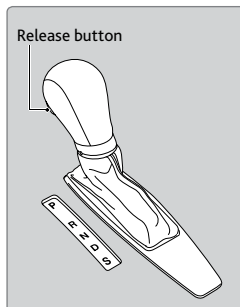

### NOTICE

When you change the shift lever from D to R and vice versa, come to a complete stop and keep the brake pedal depressed. Operating the shift lever before the vehicle has come to a complete standstill can damage the transmission.

Do not operate the shift lever while pressing the accelerator pedal. You could damage the transmission.

### Sequential Shift Mode

Use the paddle shifters to change gears without removing your hands from the steering wheel.

**(-) Paddle shifter:**  
Pull to shift down to a lower gear.

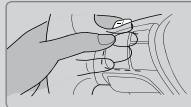

**(+) Paddle shifter:**  
Pull to shift up to a higher gear.

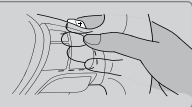

**Recommended shift points**

Shift up	Normal acceleration
1st to 2nd	15 mph (24 km/h)
2nd to 3rd	25 mph (40 km/h)
3rd to 4th	40 mph (64 km/h)
4th to 5th	45 mph (72 km/h)
5th to 6th	50 mph (80 km/h)

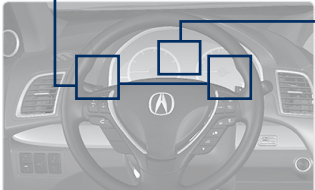
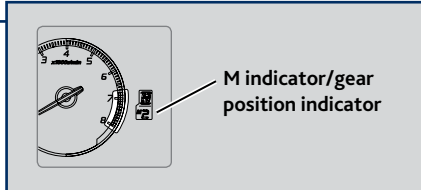
**When the shift lever is in D:** The vehicle goes into sequential shift mode momentarily, and the gear position indicator comes on. When you start traveling at a constant speed, sequential shift mode automatically switches off, and the gear position indicator goes off. You can also hold the (+) paddle shifter for two seconds to return to normal drive.

**When the shift lever is in S:** The vehicle goes into sequential shift mode, and the M (sequential shift mode) indicator and gear position indicator come on. At speeds of 6 mph (10 km/h) or less, the vehicle automatically shifts down into 1st gear. It does not automatically shift up, even if vehicle speed increases. You can pull away only in 1st or 2nd gear.

When switching out of sequential shift mode, move the shift lever from S to D. When sequential shift mode is canceled, the M indicator and gear position indicator go off.

**Second gear lock mode:** If you pull the (+) paddle shifter while stopped or driving at 6 mph (10 km/h) or less, the gear position is locked in 2nd gear. This makes it easier to pull away on slippery surfaces such as snow-covered roads. To cancel 2nd gear lock mode, pull the (-) paddle shifter or move the shift lever from S to D.

## Braking

Slow down or stop your vehicle, and keep it from moving when parked.

### ■ Foot Brake

Press the brake pedal to slow down or stop your vehicle from moving.

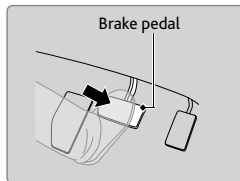

### ■ Brake Assist System

During hard or emergency braking, the system increases braking force. The brake pedal may move slightly or make a noise; this is normal. Continue to hold the brake pedal firmly down.

### ■ Anti-Lock Brake System (ABS)

During hard or emergency braking, the system rapidly pumps the brakes to prevent wheel lockup and help you maintain steering control. The brake pedal may pulsate slightly during ABS operation; this is normal. Do not pump the brake pedal, and continue to hold it firmly down.

#### NOTICE

The ABS may not function correctly if you use an incorrect tire type and size.

### ■ Parking Brake

Keep the vehicle from moving when it is parked.

**To apply:** Press the parking brake with your foot.

**To release:** Press the brake pedal, then press the parking brake until it releases.

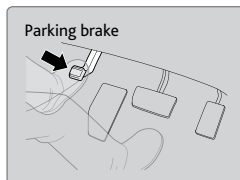

#### NOTICE

Release the parking brake fully before driving. The rear brakes and axle can be damaged if you drive with the parking brake applied.

## Cruise Control\*

Maintain a constant vehicle speed without having to keep your foot on the accelerator pedal. Use cruise control on freeways or open roads where you can travel at a constant speed with little acceleration or deceleration.

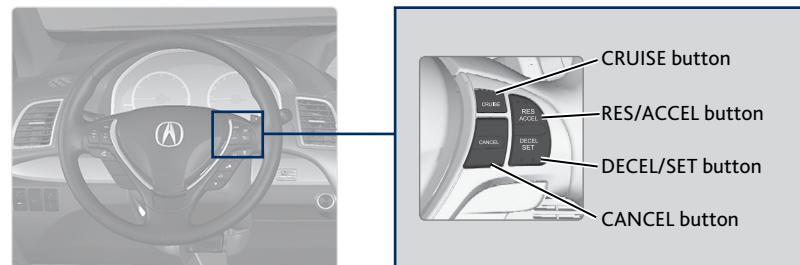

### ■ Activating and Setting the Vehicle Speed

1. Press the CRUISE button.
2. Accelerate to the desired speed (above 25 mph). Press the DECEL/SET button and take your foot off the pedal to set the speed.



### ■ Adjusting the Vehicle Speed

Press the RES/ACCEL button to increase speed or the DECEL/SET button to decrease speed.

Each time you press the button, the vehicle speed is increased or decreased by about 1 mph (1.6 km/h). If you keep the button pressed, the vehicle speed increases or decreases until you release it.



### ■ Canceling Cruise Control

Press the CANCEL button or the brake pedal.

After cruise control has been canceled, you can still resume the prior set speed by pressing RES/ACCEL while driving at a speed of at least 25 mph (40 km/h).

Press the CRUISE button to turn the system off.

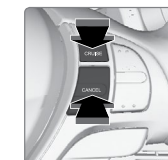

#### ⚠ WARNING

Improper use of the cruise control can lead to a crash.  
Use cruise control only when traveling on open highways in good weather.

\*if equipped

## Adaptive Cruise Control (ACC)\*

Helps maintain a constant vehicle speed and a set following interval behind a vehicle detected ahead of yours.

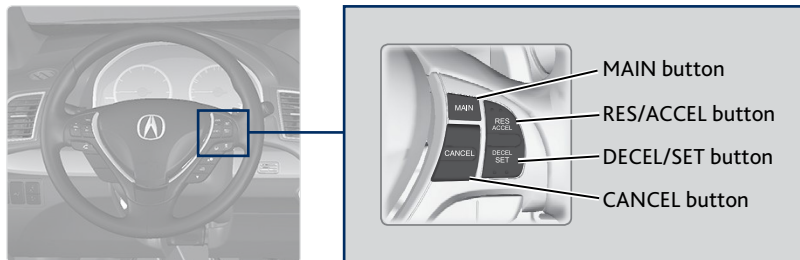

### ■ Activating and Setting the Vehicle Speed

1. Press the MAIN button.
2. Accelerate to the desired speed above 25 mph (40 km/h). Press the DECEL/SET button and take your foot off the pedal to set the speed.



### ■ Adjusting the Vehicle Speed

Press the RES/ACCEL button to increase speed or the DECEL/SET button to decrease speed.

Each time you press the button, the vehicle speed is increased or decreased by about 1 mph (1 km/h). If you keep the button pressed, the vehicle speed increases or decreases by 5 mph (5 km/h) until you release it.

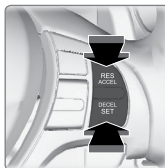

### ■ Adjusting the Vehicle Distance

Press the Distance button to change the following distance. Each time you press the button, the following distance setting cycles through short, middle, long, and extra long.

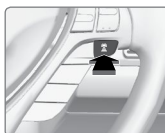

### ■ Switching to Standard Cruise Control

Press and hold the Distance button. Cruise Mode appears in the multi-information display. Press and hold the button again to switch back to ACC.

### ■ When in Operation

If a vehicle is detected ahead of you when ACC is turned on and your vehicle is traveling at or below the set speed, the system maintains, accelerates, or decelerates your vehicle's set speed to keep your vehicle's set following distance from the vehicle ahead.

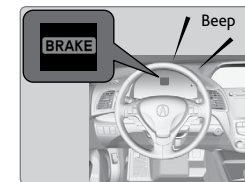

If a vehicle detected ahead of you slows down abruptly, or if another vehicle cuts in front of you, a beep sounds and BRAKE appears on the multi-information display to alert you.

### ⚠ WARNING

ACC has limited braking capability.

When your vehicle speed drops below 22 mph (35 km/h), ACC will automatically cancel and no longer will apply your vehicle's brakes.

Always be prepared to apply the brake pedal when conditions require.

### ■ Canceling ACC

You can press CANCEL or MAIN, or press the brake pedal. The ACC indicator goes off.

Certain conditions may cause ACC to cancel automatically. When this happens, the amber ACC indicator appears on the multi-information display (see page 24).



After cruise control has been canceled, you can still resume the prior set speed by pressing RES/ACCEL when your vehicle speed is over 25 mph (40 km/h).

### ⚠ WARNING

Improper use of ACC can lead to a crash.

Use ACC only when traveling on open highways in good weather.

\*if equipped

## Lane Departure Warning (LDW)\*

Alerts you if the system detects a possibility of your vehicle unintentionally crossing over detected lane markings while driving between 45–90 mph (72–145 km/h).

If your vehicle is getting too close to detected left or right side lane markings without a turn signal activated, the system provides audible and visual alerts.

A Lane Departure message appears on the MID, and a beep sounds. Take appropriate action to stay within your driving lane.

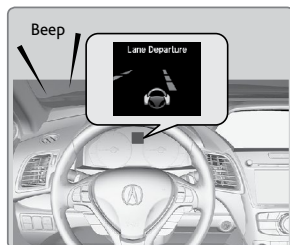

### ■ Turning LDW On or Off

Press the LDW button to turn the system on or off. A green indicator light appears on the button when the system is on.

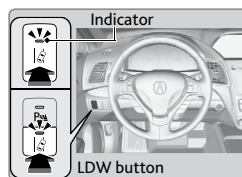

### Important Safety Reminder

Like all assistance systems, LDW has limitations. Over-reliance on LDW may result in a collision. It is always your responsibility to keep the vehicle within your lane.

## Lane Keeping Assist System (LKAS)\*

Alerts you and provides steering input if the system detects a possibility of your vehicle unintentionally crossing over detected lane markings while driving between 45–90 mph (72–145 km/h).

If you begin to cross a detected lane marking without a turn signal activated, the system provides visual and audible alerts.

A Lane Departure message appears on the MID, and a beep sounds. The system also applies steering assistance to keep your vehicle in the center of the lane. Take appropriate action to stay within your driving lane.

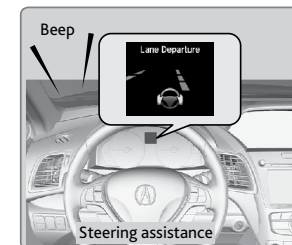

### ■ Turning LKAS On or Off

1. Press MAIN. LKAS appears in the MID.
2. Press the LKAS button. Lane outlines appear in the MID. Dotted lane lines turn solid when the system operates.
3. Press MAIN or the LKAS button to turn the system off.

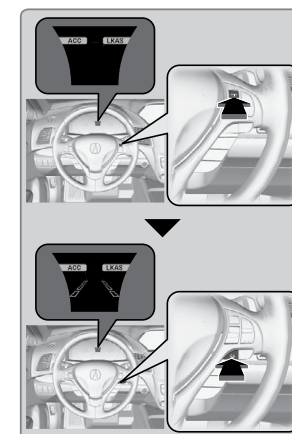

### Important Safety Reminder

The LKAS is for your convenience only. It is not a substitute for your vehicle control. The system does not work if you take your hands off the steering wheel or fail to steer the vehicle.

\*if equipped

\*if equipped



## Blind Spot Information (BSI)\*

Alerts you to a detected vehicle in your left or right blind spot while driving 20 mph (32 km/h) or higher.

When a vehicle is detected in your blind spot, the blind spot indicator turns on and stays lit until the area is clear.

When your turn signal is on and a vehicle is detected, the blind spot indicator blinks and a beep sounds until the area is clear or the turn signal is off.

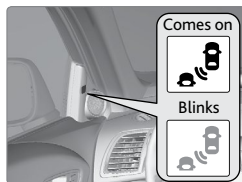

### ■ Changing Settings

Change the alert type, or turn the system on or off. Use the interface dial to make selections.

1. Press **SETTINGS**.
2. Select **Vehicle Settings**. The vehicle must be in Park (P).
3. Select **Blind Spot Info**.
4. Select an alert type, or **Off**.
5. Press **BACK** to exit the menu.



## ⚠ WARNING

Failure to visually confirm that it is safe to change lanes before doing so may result in a crash and serious injury or death. Do not rely only on the blind spot information system when changing lanes.

Always look in your mirrors, to either side of your vehicle, and behind you for other vehicles before changing lanes.

### Important Safety Reminder

Like all assistance systems, BSI has limitations. Overreliance on BSI may result in a collision. The system is for your convenience only.

\*if equipped

## Collision Mitigation Braking System™ (CMBS™)\*

Can assist you when there is a possibility of your vehicle colliding with a vehicle or a pedestrian detected in front of yours.

The system can alert you when a potential collision is determined, and reduce your vehicle speed to help minimize collision severity when a collision is deemed unavoidable.

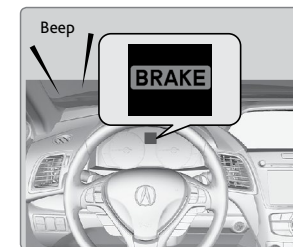

The system activates when:

- The speed difference between your vehicle and a vehicle or pedestrian detected in front of you is about 3 mph (5 km/h) and over with a chance of a collision.
- Your vehicle speed is about 62 mph (100 km/h) or less and there is a chance of a collision with an oncoming detected vehicle or a pedestrian in front of you.

### ■ Alert Stages

The system has three alert stages for a possible collision. Depending on the circumstances or CMBS settings, CMBS may not go through all of the stages before initiating the last stage.

- Stage 1:** Visual warning and audible warning
- Stage 2:** Visual warning, audible warning, and light brake application
- Stage 3:** Visual warning, audible warning, and strong brake application

### ■ Changing Settings

Determine the warning timing. Use the interface dial to make selections.

1. Press **SETTINGS**.
2. Select **Vehicle Settings**. The vehicle must be in Park (P).
3. Select **Forward Collision Warning Distance**.
4. Select **Long**, **Normal** (default), or **Short**
5. Press **BACK** to exit the menu.

\*if equipped

### ■ Turning CMBS On or Off

Press and hold the CMBS OFF button. A beep sounds and a message appears in the MID. The CMBS indicator appears when the system is off.

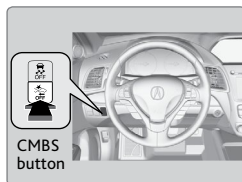

### Important Safety Reminder

CMBS™ is designed to reduce the severity of an unavoidable collision. It does not prevent collision nor stop the vehicle automatically. It is still your responsibility to operate the brake pedal and steering wheel appropriately according to the driving conditions.

## Vehicle Stability Assist (VSA®), aka Electronic Stability Control (ESC) System

Helps to stabilize the vehicle during cornering if the vehicle turns more or less than what was intended. It assists in maintaining traction on slippery surfaces by regulating engine output and selectively applying the brakes.

### ■ Turning VSA On or Off

VSA is turned on every time you turn on the vehicle, even if you previously turned it off. If you turn VSA off, your vehicle has normal braking and cornering ability, but not VSA traction and stability enhancement.

Press and hold the VSA OFF button until you hear a beep to turn VSA on or off. The VSA OFF indicator appears when the system is off.

Traction control stops functioning, which may make it easier when trying to free your vehicle if it is stuck in mud or snow.

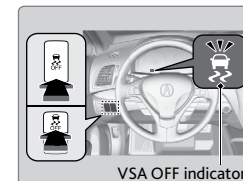

## Parking Sensor System\*

When the system senses an object when you are parking or backing up, indicators appear on the upper display and a series of beeps sound. As you get closer to the object(s), the beep rate increases.

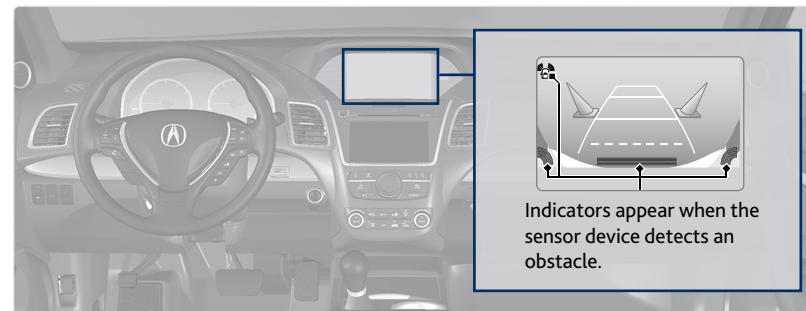

### ■ Turning the System On or Off

Press the parking sensor button. A green indicator light appears on the button when the system is on.

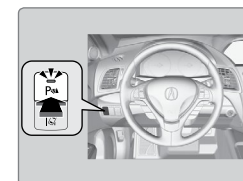

\*if equipped

## Multi-View Rear Camera

When you shift into Reverse (R), a real-time image of the area behind your vehicle is shown in the display, along with helpful parking guidelines.

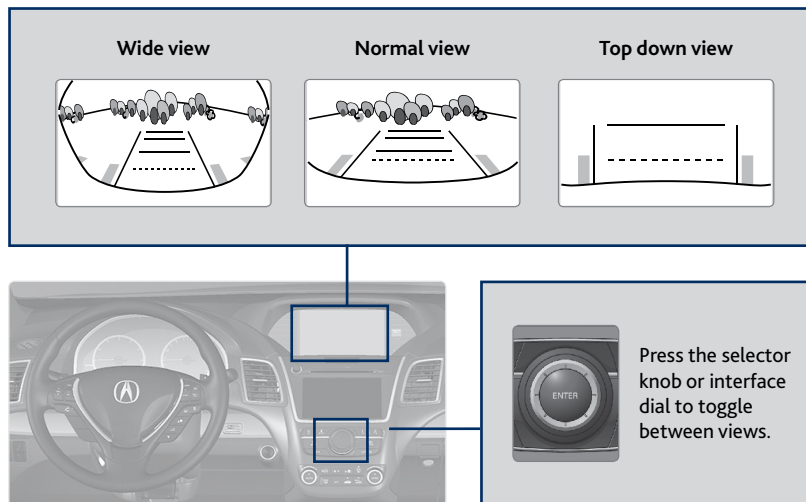

### ■ Changing Guidelines

Change the type of guidelines shown, or turn them off. Use the interface dial to make selections.

1. Press the SETTINGS button.
2. Select Camera Settings.
3. Select Rear Camera.

4. Select one of the options.

**Fixed Guideline:** Guidelines appear when you shift into Reverse. Select On or Off.

**Dynamic Guideline:** Guidelines move as you turn the steering wheel. Select On or Off.

5. Press BACK to exit the menu.

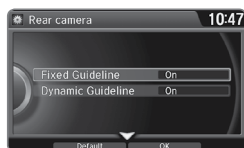

*The rear camera view is restricted. You cannot see the corner ends of the bumper or what is underneath the bumper. Its unique lens also makes objects appear closer or farther than they actually are.*

*Visually confirm that it is safe to drive before backing up. Certain conditions (such as weather, lighting, and high temperatures) may also restrict the rear view. Do not rely on the rearview display, which does not give you all information about conditions at the rear of your vehicle.*

## Rear Cross Traffic Monitor\*

Alerts you if a detected vehicle is approaching from a rear corner when your vehicle is in Reverse (R) at speeds of 3 mph (5 km/h) or lower, which can be helpful when backing out of parking spaces.

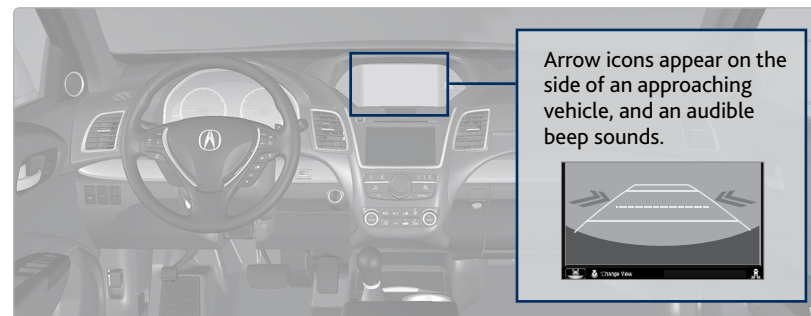

The system does not detect or provide alerts for a vehicle that is moving away from your vehicle, and it may not detect pedestrians, bicycles, or stationary objects.

### ■ Turning the System On or Off

Use the interface dial to make selections.

1. Press the SETTINGS button.
2. Select Camera Settings.
3. Select Cross Traffic Monitor.
4. Select On or Off.
5. Press BACK to exit the menu.



### ⚠ CAUTION

This system cannot detect all approaching vehicles and may not detect an approaching vehicle at all.

Failure to visually confirm that it is safe to back up the vehicle before doing so may result in a collision.

Do not solely rely on the system when reversing; always also use your mirrors, and look behind and to the sides of your vehicle before reversing.

\*if equipped

## Refueling

Use the proper fuel and refueling procedure to ensure the best performance and safety of your vehicle.

### Fuel Information

**Use of unleaded gasoline of 91 octane or higher is recommended.**

- Acura recommends TOP TIER Detergent Gasoline where available.
- Do NOT use gasoline containing more than 15% ethanol.
- Do NOT use gasoline containing methanol.
- Do NOT use gasoline containing MMT.

### NOTICE

We recommend quality gasoline containing detergent additives that help prevent fuel system and engine deposits. In addition, in order to maintain good performance, fuel economy, and emissions control, we strongly recommend the use of gasoline that does NOT contain harmful manganese-based fuel additives such as MMT, if such gasoline is available.

### How to Refuel

1. The fuel fill door is located at the left rear of the vehicle. Park next to the service pump that is most accessible.
2. Turn off the engine.
3. Pull the fuel fill door release handle near the parking brake. The fuel fill door opens.
4. Turn the fuel fill cap slowly to open. Place the fuel fill cap in the holder.
5. Insert the filler nozzle fully. When the tank is full, the fuel nozzle clicks off automatically.
6. Replace the fuel fill cap. Tighten it until you hear at least one click. Close the fuel fill door.

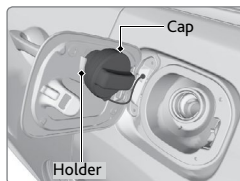
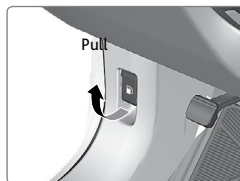

### ⚠️ WARNING

Gasoline is highly flammable and explosive. You can be burned or seriously injured when handling fuel.

- Stop the engine, and keep heat, sparks, and flame away.
- Handle fuel only outdoors.
- Wipe up spills immediately.

## HANDLING THE UNEXPECTED

Learn about what to do in critical or emergency situations.

### Keyless Access Remote Battery Strength

If the battery life in your keyless access remote is weak, a message appears in the multi-information display (MID) with information on how to start the engine.

1. Touch the back of the keyless access remote to the ENGINE START/STOP button while the indicator is flashing.
2. With the brake pedal pressed, press the ENGINE START/STOP button within 10 seconds.

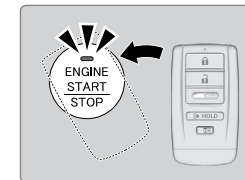

### Shift Lever Does Not Move

Follow the procedure below if you cannot move the shift lever out of Park (P).

1. Set the parking brake.
2. Remove the built-in key from the keyless access remote.
3. Wrap a cloth around the tip of a small flat-tip screwdriver to remove the cover of the shift lock release slot. Put the tip of the flat-tip screwdriver into the slot and remove it as shown in the image.
4. Insert the key into the shift lock release slot.
5. While pushing the key down, press the shift lever release button and place the shift lever into Neutral. The lock is now released. Have the shift lever checked by a dealer as soon as possible.

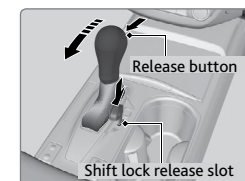
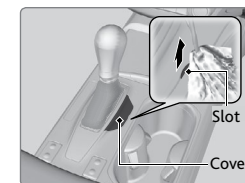

## Jump Starting

Turn off the power to electric devices, such as audio and lights. Turn off the engine, then open the hood.

1. Connect the first jumper cable to your vehicle's battery (+) terminal.
2. Connect the other end of the first jumper cable to the booster battery (+) terminal. Use a 12-volt booster battery only.
3. Connect the second jumper cable to the booster battery (-) terminal.
4. Connect the other end of the second jumper cable to the engine hanger as shown. Do not connect this jumper cable to any other part.
5. If your vehicle is connected to another vehicle, start the assisting vehicle's engine and increase its rpm slightly.
6. Attempt to start your vehicle's engine. If it turns over slowly, make sure the jumper cables have good metal-to-metal contact.

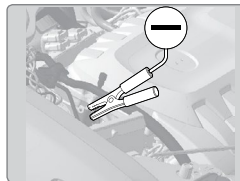
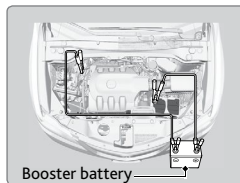

**WARNING:** Battery posts, terminals, and related accessories contain lead and lead compounds. **Wash your hands after handling.**

### ⚠️ WARNING

A battery can explode if you do not follow the correct procedure, seriously injuring anyone nearby.  
Keep all sparks, open flames, and smoking materials away from the battery.

#### ■ After the Engine Starts

Once your vehicle's engine has started, remove the jumper cables in the following order:

1. Disconnect the jumper cable from your vehicle's ground.
2. Disconnect the other end of the jumper cable from the assisting vehicle's (-) terminal.
3. Disconnect the jumper cable from your vehicle's (+) terminal.
4. Disconnect the other end of the jumper cable from the assisting vehicle's (+) terminal.

Have your vehicle inspected by a nearby service station or a dealer.

## Overheating

If the temperature gauge needle is at the H mark, the engine suddenly loses power, or steam or spray comes out from under the hood, your engine is overheating.

1. Immediately park the vehicle in a safe place. Turn off all accessories and turn on the hazard warning lights.
2. **If no steam or spray is present:** Keep the engine running and open the hood.  
**If steam or spray is present:** Turn off the engine and wait until it subsides. Then, open the hood.
3. Check that the cooling fan is operating and stop the engine once the temperature gauge needle comes down. If the cooling fan is not operating, immediately stop the engine.
4. Once the engine has cooled down, inspect the coolant level and check the cooling system components for leaks. If the coolant level in the reserve tank is low, add coolant until it reaches the MAX mark. If there is no coolant in the reserve tank, make sure the radiator is cool, then cover the radiator cap with a heavy cloth and open the cap. If necessary, add coolant up to the base of the filler neck, and put the cap back on.

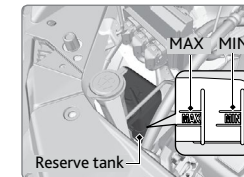

Once the engine has cooled sufficiently, restart it and check the temperature gauge. If the temperature needle has gone down, resume driving. If it has not gone down, contact a dealer for repairs.

### ⚠️ WARNING

Steam and spray from an overheated engine can seriously scald you.  
Do not open the hood if steam is coming out.

### ⚠️ WARNING

Removing the radiator cap while the engine is hot can cause the coolant to spray out, seriously scalding you.  
Always let the engine and radiator cool down before removing the radiator cap.

### NOTICE

Continuing to drive with the temperature gauge needle at the H mark may damage the engine.

## Emergency Engine Stop

The ENGINE START/STOP button may be used to stop the engine due to an emergency situation even while driving. If you must stop the engine, choose one of the following operations:

- Press and hold the ENGINE START/STOP button for two seconds, **OR**
- Firmly press the ENGINE START/STOP button two times.

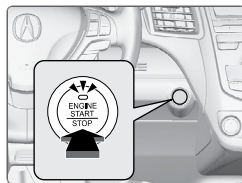

The steering wheel will not lock. The power mode changes to ACCESSORY, unless the shift lever is in Park (P), in which case the power mode changes to VEHICLE OFF. Because turning off the engine also disables the power assist the engine provides to the steering and braking systems, it will require significantly more physical effort and time to steer and slow the vehicle. Downshift gears and use both feet on the brake pedal, if necessary, to slow the vehicle and stop immediately in a safe place.

### NOTICE

Do not press the button while driving unless it is absolutely necessary for the engine to be switched off.

## Emergency Towing

Call a professional towing service if you need to tow your vehicle.

### All models

Flat bed equipment: The operator loads your vehicle on the back of a truck. **This is the best way to transport your vehicle.**

### 2WD models

Wheel lift equipment: The tow truck uses two pivoting arms that go under the front tires and lift them off the ground. The rear tires remain on the ground. **This is an acceptable way to tow your vehicle.**

### NOTICE

Trying to lift or tow your vehicle by the bumpers will cause serious damage. The bumpers are not designed to support the vehicle's weight.

Improper towing such as towing behind a motorhome or other motor vehicle can damage the transmission.

## Tire Pressure Monitoring System (TPMS)

Monitors the tire pressure while you are driving.

If your vehicle's tire pressure becomes significantly low, the low tire pressure indicator comes on and a message appears on the multi-information display. Press the Info button on the steering wheel to view the tire pressure monitor to see pressure readings for each tire (see page 28).

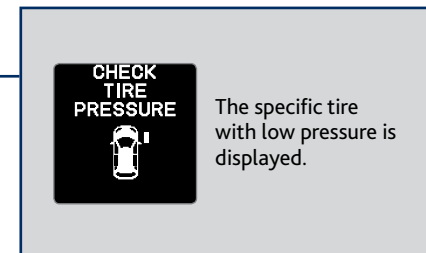
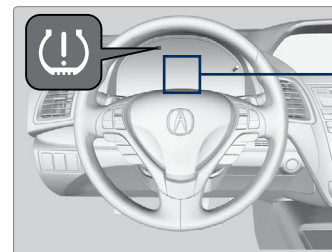

### ■ What to Do

Stop your vehicle in a safe place. Check the tire pressure and adjust the pressure to the specified level. The specified tire pressure is on a label on the driver's doorjamb.

### NOTICE

Driving on an extremely underinflated tire can cause it to overheat. An overheated tire can fail. Always inflate your tires to the specified pressure.

## ■ Tire Pressure Monitoring System (TPMS) - Required Federal Explanation

Each tire, including the spare (if provided), should be checked monthly when cold and inflated to the inflation pressure recommended by the vehicle manufacturer on the vehicle placard or tire inflation pressure label.

(If your vehicle has tires of a different size than the size indicated on the vehicle placard or tire inflation pressure label, you should determine the proper tire inflation pressure for those tires.)

As an added safety feature, your vehicle has been equipped with a tire pressure monitoring system (TPMS) that illuminates a low tire pressure telltale when one or more of your tires is significantly under-inflated.



Accordingly, when the low tire pressure telltale illuminates, you should stop and check your tires as soon as possible, and inflate them to the proper pressure.

Driving on a significantly under-inflated tire causes the tire to overheat and can lead to tire failure. Under-inflation also reduces fuel efficiency and tire tread life, and may affect the vehicle's handling and stopping ability.

Please note that the TPMS is not a substitute for proper tire maintenance, and it is the driver's responsibility to maintain correct tire pressure, even if under-inflation has not reached the level to trigger illumination of the TPMS low tire pressure telltale.

Your vehicle has also been equipped with a TPMS malfunction indicator to indicate when the system is not operating properly. The TPMS malfunction indicator is combined with the low tire pressure telltale. When the system detects a malfunction, the telltale will flash for approximately one minute and then remain continuously illuminated. This sequence will continue upon subsequent vehicle start-ups as long as the malfunction exists.

When the malfunction indicator is illuminated, the system may not be able to detect or signal low tire pressure as intended.

TPMS malfunctions may occur for a variety of reasons, including the installation of replacement or alternate tires or wheels on the vehicle that prevent the TPMS from functioning properly.

Always check the TPMS malfunction telltale after replacing one or more tires or wheels on your vehicle to ensure that the replacement or alternate tires and wheels allow the TPMS to continue to function properly.

## Tire Repair Kit\*

If a tire has a small puncture, you can use the tire repair kit to temporarily repair it. The puncture must be smaller than 3/16-inch (4 mm) and not in the tire sidewall. Go to a dealer to have the full-size tire permanently repaired or replaced.

### ■ Before Repairing the Tire

1. Park the vehicle on firm, level, non-slippery surface.
2. Make sure the vehicle is in Park (P), and apply the parking brake.
3. Turn on the hazard warning lights, and turn the vehicle off.

### ■ Getting Ready to Repair the Tire

1. Open the cargo area floor lid.
2. Take the kit out of the tool box.
3. Place the kit face up on flat ground near the punctured tire and away from traffic. Do not place the kit on its side.
4. Follow the instructions in the kit to repair the tire.

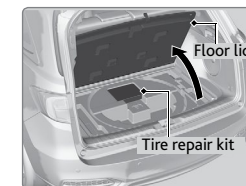

### NOTICE

Do not use an unapproved puncture-repairing agent other than the one provided in the kit that came with your vehicle. If a different agent is used, you may permanently damage the tire pressure sensor.

\*if equipped

## Changing a Flat Tire

If a tire goes flat while driving, grasp the steering wheel firmly, and brake gradually to reduce speed. Stop in a safe place. Replace the flat tire with the compact spare tire\*. Go to a dealer as soon as possible to have the full-size tire repaired or replaced.

### ■ Getting Ready to Change the Tire

Park the vehicle on a firm, level, non-slippery surface. Move the shift lever to Park (P), and apply the parking brake. Turn the hazard warning lights on and turn the vehicle off.

1. Open the tailgate. Turn on the cargo lights on the inside of the tailgate, if necessary (see page 34). Open the cargo area floor lid.

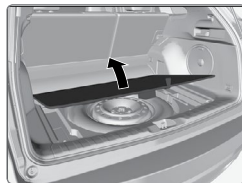

2. Take the wheel nut wrench and jack handle bar out of the cargo area.

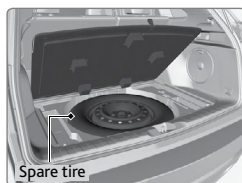

3. Unscrew the wing bolt, and remove the spacer cone. Then, remove the spare tire.

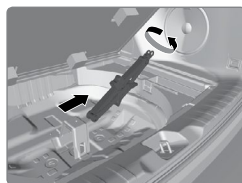

4. Take the jack out of the spare tire area.



5. Loosen each wheel nut about one turn using the wheel nut wrench.



\*if equipped

### ■ Setting Up the Jack

1. Place the jack under the jacking point closest to the tire to be changed.
2. Turn the end bracket (as shown in the image) clockwise until the top of the jack contacts the jacking point. Make sure that the jacking point tab is resting in the jack notch.
3. Raise the vehicle, using the jack handle bar and the jack handle, until the tire is off the ground.

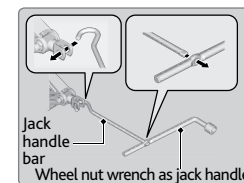
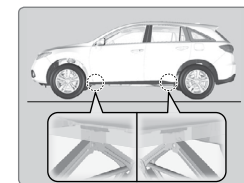

### ⚠ WARNING

The vehicle can easily roll off the jack, seriously injuring anyone underneath. Follow the directions for changing a tire exactly, and never get under the vehicle when it is supported only by the jack.

The following instructions must be followed to use the jack safely:

- Do not use the jack with people or luggage in the vehicle.
- Use the jack provided in your vehicle. Other jacks may not support the weight ("load") or fit the jacking point.
- Do not use while the engine is running.
- Use only where the ground is firm and level.
- Use only at the jacking points.
- Do not get in the vehicle while using the jack.
- Do not put anything on top of or underneath the jack.



### ■ Replacing the Flat Tire

1. Remove the wheel nuts and flat tire.
2. Mount the compact spare tire. Replace the wheel nuts, and lightly tighten them.
3. Lower the vehicle and remove the jack. Tighten the wheel nuts in the order indicated in the image. Go around, tightening the nuts, two to three times in this order. Do not overtighten the wheel nuts.

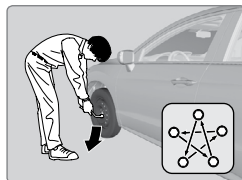

If you drive with the spare tire installed, the low tire pressure/TPMS indicator appears. The indicator stays on until a regular tire is installed.

### ■ Storing the Flat Tire

1. Remove the center cap and place the flat tire face up in the spare tire well.
2. Remove the spacer cone from the wing bolt for the spare tire, and insert the wing bolt for the regular tire back on the bolt. Secure the flat tire with the wing bolt.
3. Securely store the jack and wheel nut wrench back in the tool case. Store the case in the cargo area.

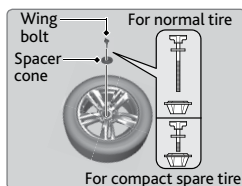

### ⚠ WARNING

Loose items can fly around the interior in a crash and can seriously injure the occupants.

Store the wheel, jack, and tools securely before driving.

### Fuse Locations

If any electrical devices are not working, turn the vehicle off and check to see if any applicable fuse is blown. Fuse locations are shown on the fuse box cover. Locate the fuse by the fuse number and box cover number.

#### ■ Engine Compartment Fuse Box

Located near the brake fluid reservoir. Push the tabs to open the box.

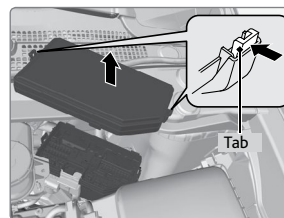

	Circuit Protected	Amps
1	EPS	70 A
	Power Tailgate Motor	(40 A)
	ABS/VSA FSR	20 A
	ABS/VSA Motor	40 A
	E-DPS	(30 A)
	Main Fuse	120 A
	-	50 A
	Fuse Box Main 1	60 A
	Fuse Box Main 2	60 A
	IG Main	50 A
2	Headlight Washer *	(30 A)
	Sub Fan Motor	30 A
	Rear Defogger	40 A
	Main Fan Motor	30 A
	Headlight Main	30 A
	Blower	40 A
	ST CUT1	40 A
3	IG MAIN1	30 A
	SUB FUSE MAIN	(40 A)
	IG MAIN2	30 A

	Circuit Protected	Amps
4	Rear Seat Heaters *	(20 A)
5	STR Diagnosis Fuse	7.5 A
6	AUDIO (ODMD) *	(15 A)
7	-	-
8	-	-
9	-	-
10	-	-
11	Oil Level	7.5 A
12	Fog Lights *	(20 A)
13	Power Tailgate Closer	(20 A)
14	Hazard	10 A
15	IGP2	15 A
16	IG Coil	15 A
17	Stop	10 A
18	Horn	10 A
19	ACM	20 A
20	Right Headlight Low Beam	15 A
21	MG Clutch	7.5 A
22	DBW	15 A
23	Left Headlight Low Beam	15 A
24	DRL	(10 A)
25	FI Main	15 A
26	Trailer	(20 A)
27	Small	20 A
28	Interior Lights	7.5 A
29	Back Up	10 A

\*if equipped

■ Interior Fuse Box

Located under the dashboard.

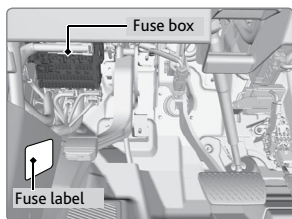

	Circuit Protected	Amps
1	-	-
2	ACG	15 A
3	ODS	7.5 A
4	Fuel Pump	15 A
5	Meter	7.5 A
6	Rear Wiper	10 A
7	VB SOL	10 A
8	Front Right Side Door Lock Motor (Unlock)	15 A
9	Rear Left Side Door Lock Motor (Unlock)	15 A
10	Power Lumbar	7.5 A
11	Moonroof	20 A
12	Accessory Power Socket (Center Console)	20 A
13	Washer Main	15 A
14	Seat Heaters	20 A
15	Driver's Door Lock Motor (Unlock)	10 A
16	Driver's Power Seat Sliding	20 A
17	Driver's Power Seat Reclining	20 A
18	Passenger's Power Seat Sliding	20 A
19	ACC	7.5 A
20	ACC Key Lock	7.5 A
21	Daytime Running Lights	7.5 A
22	A/C	7.5 A

	Circuit Protected	Amps
23	Option	10 A
24	ABS/VSA	7.5 A
25	IDAS (10 A)	
26	Audio Amp	20 A <sup>*1</sup> 30 A <sup>*2</sup>
27	Accessory Power Socket (Front)	20 A
28	-	-
29	SRS	10 A
30	Driver's Door Lock Motor (Lock)	10 A
31	Smart	10 A
32	Front Right Side Door Lock Motor (Lock)	15 A
33	Rear Left Side Door Lock Motor (Lock)	15 A
34	Small Lights	7.5 A
35	Illumination	7.5 A
36	Rear Wiper Main	10 A
37	Passenger's Power Seat Reclining	20 A
38	Left Headlight High Beam	10 A
39	Right Headlight High Beam	10 A
40	-	-
41	Door Lock	20 A
42	Driver's Power Window	20 A
43	Rear Right Side Power Window	20 A
44	Front Right Side Power Window	20 A
45	Rear Left Side Power Window	20 A
46	Wiper	30 A

\*1: Models without navigation system  
\*2: Models with navigation system

■ Inspecting and Changing Fuses

1. Turn the vehicle off, including the headlights and accessories.
2. Remove the fuse box cover.
3. Check the large fuse in the engine compartment.

If the fuse is blown, use a Phillips-head screwdriver to remove the screws and replace the fuse with a new one. Reinstall the screws.

4. Inspect the small fuses in the engine compartment and the vehicle interior.

If there is a burned out fuse, remove it with the fuse puller and replace it with a new one.

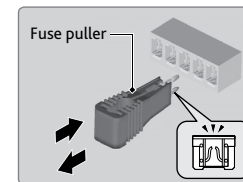
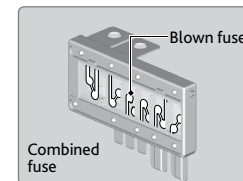

**NOTICE**

Replacing a fuse with one that has a higher rating greatly increases the chances of damaging the electrical system.

TABLE OF CONTENTS

VISUAL INDEX

SAFETY INFORMATION

INSTRUMENT PANEL

VEHICLE CONTROLS

AUDIO AND CONNECTIVITY

BLUETOOTH® HANDSFREELINK®

ACURALINK®

NAVIGATION

DRIVING

HANDLING THE UNEXPECTED

MAINTENANCE

SPECIFICATIONS

CLIENT INFORMATION

VOICE COMMAND INDEX

INDEX

# MAINTENANCE

Learn about basic maintenance that you can perform on the vehicle yourself, as well as information about how to best maintain the vehicle.

## Safety Precautions

Some of the most important safety precautions are listed below; however, we cannot warn you of every conceivable hazard that can arise in performing maintenance. Only you can decide whether or not you should perform a given task.

### ■ Maintenance Safety

- To reduce the possibility of fire or explosion, keep cigarettes, sparks, and flames away from the battery and all fuel-related parts.
- Never leave rags, towels, or other flammable objects under the hood.
- To clean parts, use a commercially available degreaser or parts cleaner, not gasoline.
- Wear eye protection and protective clothing when working with the battery or compressed air.
- Do not run the engine in confined spaces where carbon monoxide gas can accumulate.

### ■ Vehicle Safety

- The vehicle must be stationary, and parked on level ground with the parking brake set and the engine off.
- Be aware that hot parts can burn you.
- Be aware that moving parts can injure you.

### ⚠ WARNING

Improperly maintaining this vehicle or failing to correct a problem before driving can cause a crash in which you can be seriously hurt or killed. Always follow the inspection and maintenance recommendations according to the schedules in this guide.

### ⚠ WARNING

Failure to properly follow maintenance instructions and precautions can cause you to be seriously hurt or killed. Always follow the procedures and precautions in this guide.

## Maintenance Minder™

When maintenance is due, the system message indicator comes on and the Maintenance Minder appears on the multi-information display every time you turn the vehicle on. Press the Info (▲/▼) buttons on the steering wheel to change displays.

See page 128 to check the indicated maintenance service(s).

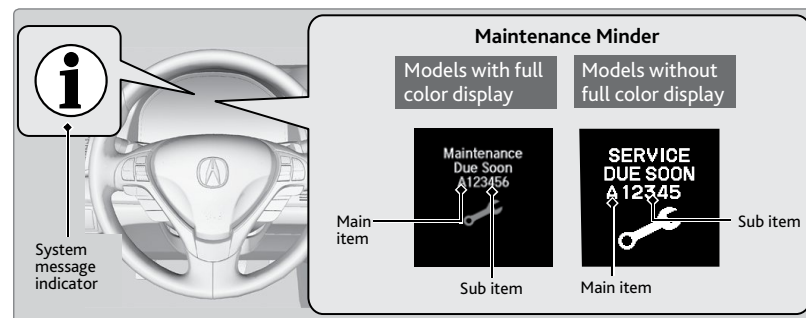

- Independent of the Maintenance Minder information, replace the brake fluid every 3 years.
- Inspect idle speed every 160,000 miles (256,000 km).
- Adjust the valves during services A, B, 1, 2, or 3 if they are noisy.

### U.S. models

**Maintenance, replacement, or repair of emissions control devices and systems may be done by any automotive repair establishment or individuals using parts that are certified to EPA standards.**

According to state and federal regulations, failure to perform maintenance on the maintenance main items marked with # will not void your emissions warranties. However, all maintenance services should be performed in accordance with the intervals indicated by the multi-information display.

TABLE OF CONTENTS

VISUAL INDEX

SAFETY INFORMATION

INSTRUMENT PANEL

VEHICLE CONTROLS

AUDIO AND CONNECTIVITY

BLUETOOTH® HANDSFREELINK®

ACURALINK®

NAVIGATION

DRIVING

HANDLING THE UNEXPECTED

MAINTENANCE

SPECIFICATIONS

CLIENT INFORMATION

VOICE COMMAND INDEX

INDEX

■ Maintenance Minder Service Codes

These codes indicate what services are due on your vehicle.

CODE	Maintenance Main Items
A	Replace engine oil *1
B	Replace engine oil *1 and oil filter Inspect front and rear brakes Check parking brake adjustment Check expiration date for temporary tire repair kit bottle (if equipped) Inspect tie rod ends, steering gearbox, and boots Inspect suspension components Inspect driveshaft boots Inspect brake hoses and lines (including ABS/VSA) Inspect all fluid levels and condition of fluids Inspect exhaust system # Inspect fuel lines and connections #

\*1: If the message SERVICE DUE NOW does not appear more than 12 months after the display is reset, change the engine oil every year.

#: See information on maintenance and emissions warranty.

CODE	Maintenance Sub Items
1	Rotate tires
2	Replace air cleaner element *2 Replace dust and pollen filter *3 Inspect drive belt
3	Replace transmission fluid *4
4	Replace spark plugs Replace timing belt and inspect water pump *5 Inspect valve clearance
5	Replace engine coolant
6	Replace rear differential fluid *

\*2: If you drive in dusty conditions, replace the air cleaner element every 15,000 miles (24,000 km).

\*3: If you drive primarily in urban areas that have high concentrations of soot in the air from industry and diesel-powered vehicles, replace the dust and pollen filter every 15,000 miles (24,000 km).

\*4: Driving in mountainous areas at very low vehicle speeds or trailer towing results in higher transmission and transfer temperatures. This requires transmission and transfer fluid changes more frequently than recommended by the Maintenance Minder. If you regularly drive your vehicle under these conditions, have the transmission fluid changed at 60,000 miles (100,000 km), then every 30,000 miles (48,000 km).

Under the Hood

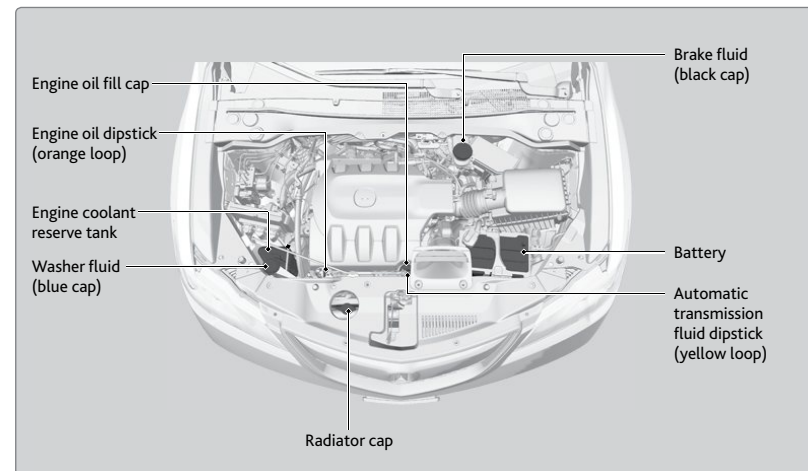

■ Opening the Hood

1. Park the vehicle on a level surface, and set the parking brake.
2. Pull the hood release handle under the lower left corner of the dashboard.
3. Slide the hood latch lever in the center of the hood to release the lock mechanism, and open the hood.
4. Lift the hood up most of the way. The hydraulic supports will lift it up the rest of the way and hold it up.

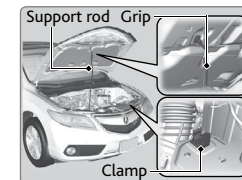
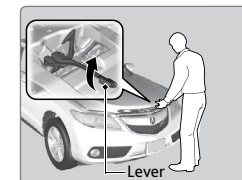
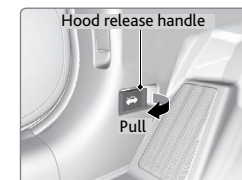

NOTICE

Do not open the hood when the wiper arms are raised. The hood will strike the wipers, and may damage the hood or the wipers.

## Engine Oil

Park the vehicle on level ground, and wait approximately three minutes after turning the engine off before you check the oil.

### ■ Checking the Oil

1. Remove the dipstick (orange loop).
2. Wipe the dipstick with a clean cloth or paper towel.
3. Insert the dipstick all the way back into its hole.
4. Remove the dipstick again, and check the level. It should be between the upper and lower marks. Add oil if necessary.

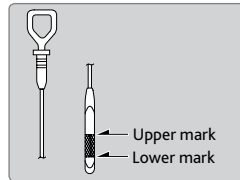
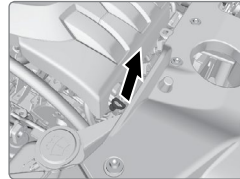

### ■ Recommended Engine Oil

- **Genuine Acura Motor Oil**
- **Premium-grade 0W-20 detergent oil with an API Certification Seal on the container**

This seal indicates the oil is energy conserving and that it meets the American Petroleum Institute's latest requirements.



Use Genuine Acura Motor Oil or another commercial engine oil of suitable viscosity for the ambient temperature as shown.

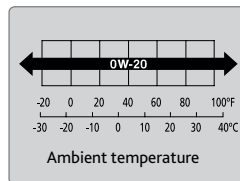

You may also use synthetic motor oil if it is labeled with the API Certification Seal and is of the specified viscosity grade.

### ■ Adding Oil

1. Unscrew and remove the engine oil fill cap.
2. Add oil slowly.
3. Reinstall the engine oil fill cap, and tighten it securely.
4. Wait for three minutes and recheck the engine oil dipstick.

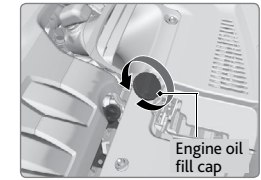

### NOTICE

Do not fill the engine oil above the upper mark. Overfilling the engine oil can result in leaks and engine damage.

### ■ Resetting the Engine Oil Life

If you change or replace the vehicle's engine oil yourself, you must reset the engine oil life. Use the Info (▲/▼) and SEL/RESET buttons on the steering wheel to make selections in the multi-information display.

1. Scroll to Vehicle Settings, and select it.
2. Scroll to Maintenance Info, and select it. The oil life reset mode is displayed.
3. Select Reset. The maintenance items disappear, and the engine oil life display returns to 100%.

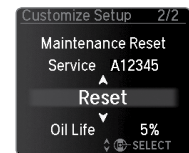

### NOTICE

Failure to reset the engine oil life after a maintenance service results in the system showing incorrect maintenance intervals, which can lead to serious mechanical problems.

## Engine Coolant

Park the vehicle on level ground. Check the reserve tank and the coolant level in the radiator. **We recommend Acura Long Life Antifreeze/Coolant Type 2.**

### ■ Checking the Reserve Tank

1. Check the amount of coolant in the reserve tank.
2. If the coolant level is below the MIN mark, add the specified coolant until it reaches the MAX mark.
3. Inspect the cooling system for leaks.

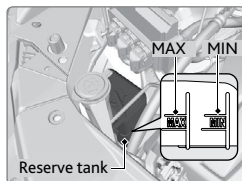

#### NOTICE

If temperatures consistently below  $-22^{\circ}\text{F}$  ( $-30^{\circ}\text{C}$ ) are expected, the coolant mixture should be changed to a higher concentration. Consult your dealer for more information.

### ■ Adding Coolant

1. Make sure the engine and radiator are cool.
2. Turn the radiator cap counterclockwise and relieve any pressure in the coolant system. Do not push the cap down when turning.
3. Push down and turn the radiator cap counterclockwise to remove it.
4. The coolant level should be up to the base of the filler neck. Add coolant if it is low.
5. Put the radiator cap back on, and tighten it fully.
6. Pour coolant into the reserve tank until it reaches the MAX mark. Put the cap back on the reserve tank.

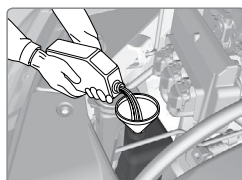
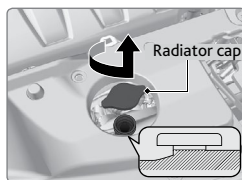

#### ⚠ WARNING

Removing the radiator cap while the engine is hot can cause the coolant to spray out, seriously scalding you. Always let the engine and radiator cool down before removing the radiator cap.

#### NOTICE

Pour the fluid slowly and carefully so you do not spill any. Clean up any spills immediately; they can damage components in the engine compartment.

## Window Washer Fluid

Check the amount of window washer fluid using the 1/2 mark on the reservoir. If the level is low, fill the washer reservoir. Pour the washer fluid carefully. Do not overflow the reservoir.

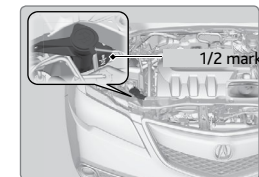

### Canadian models

If the washer fluid is low, a message appears on the multi-information display.

#### NOTICE

Do not use engine antifreeze or a vinegar/water solution in the windshield washer reservoir. Antifreeze can damage your vehicle's paint. A vinegar/water solution can damage the windshield washer pump.

## Brake Fluid

The fluid level should be between the MIN and MAX marks on the side of the reservoir. **We recommend using Acura Heavy Duty Brake Fluid DOT 3.**

Pour the fluid carefully.

If the fluid level is at or below the MIN mark, have a dealer inspect for leaks or worn brake pads as soon as possible.

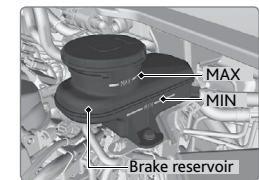

#### NOTICE

Brake fluid marked DOT 5 is not compatible with your vehicle's braking system and can cause extensive damage.

## Checking the Battery

Check the battery terminals for corrosion monthly.

For jump starting, see page 114.

#### ⚠ WARNING

The battery gives off explosive hydrogen gas during normal operation. A spark or flame can cause the battery to explode with enough force to kill or seriously hurt you. When conducting any battery maintenance, wear protective clothing and a face shield, or have a skilled technician do it.

**WARNING:** Battery posts, terminals, and related accessories contain lead and lead compounds. **Wash your hands after handling.**

## Changing Wiper Blades

If the wiper blades leave streaks across the windshield, try cleaning them first with a paper towel or soft cloth and wiper fluid. If the wiper blade rubber has deteriorated, you should change the wiper blades.

### ■ Front Wiper Blades

1. Lift the driver side wiper arm first, then the passenger side.
2. Place a cloth on the edge of the lock tab. Push the lock tab up with a flat-tip screwdriver.
3. Slide the blade from the wiper arm.
4. Slide the wiper blade out from its holder by pulling the tabbed end out.
5. Remove the retainers from the rubber blade that has been removed, and mount to a new rubber blade. Correctly align the rubber protrusion and the retainer grooves.
6. Slide the new wiper blade onto the holder from the bottom end. The tab on the holder should fit in the indent of the wiper blade.
7. Slide the wiper blade onto the wiper arm, then push down the lock tab.
8. Lower the passenger side wiper arm first, then the driver side.

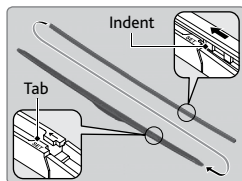
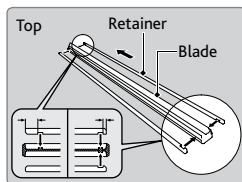
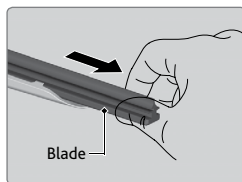
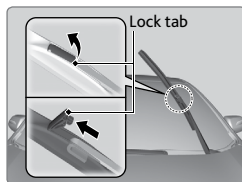
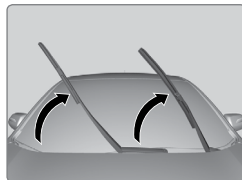

### ■ Rear Wiper Blade

1. Raise the wiper arm off.
2. Slide the wiper blade out from the end with the indent.
3. Remove the retainers from wiper blade and mount to a new rubber blade.
4. Slide the wiper blade onto the holder. Make sure it is engaged correctly, then install the wiper blade assembly onto the wiper arm.

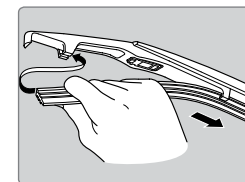
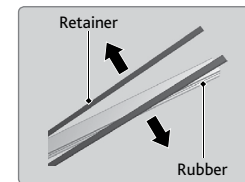
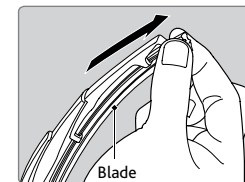

### NOTICE

Avoid dropping the wiper arm, as it may damage the windshield.

## Tire Information

To safely operate your vehicle, your tires must be of the proper type and size, in good condition with adequate tread, and properly inflated.

### Inflation Guidelines

- Properly inflated tires provide the best combination of handling, tread life, and comfort. Refer to the driver's doorjamb label or the specifications (see page 143) for the specified pressure.
- Underinflated tires wear unevenly, adversely affect handling and fuel economy, and are more likely to fail from overheating.
- Overinflated tires make your vehicle ride harshly, are more prone to road hazards, and wear unevenly.
- Every day before you drive, look at each of the tires. If one looks lower than the others, check the pressure with a tire gauge.
- Measure the air pressure when tires are cold. This means the vehicle has been parked for at least 3 hours, or driven less than 1 mile (1.6 km). If necessary, add or release air until the specified pressure is reached. If checked when hot, tire pressure can be as much as 4-6 psi (30-40 kPa, 0.3-0.5 kgf/cm<sup>2</sup>) higher than checked when cold.
- At least once a month or before long trips, use a gauge to measure the pressure in all tires, including the spare. Even tires in good condition can lose 1-2 psi (10-20 kPa, 0.1-0.2 kgf/cm<sup>2</sup>) per month.

### Inspection Guidelines

Every time you inflate the tires, check for the following:

- Any damage to tires, including bumps, bulges, cuts, splits, or cracks in the side or tread. Remove any foreign objects and inspect for air leaks. Replace tires if you see fabric or cord.
- Uneven or excessive tread wear. Have a dealer check the wheel alignment.
- Cracks or other damage around the valve stems.

### Wear Indicators

The groove where the wear indicator is located is 1/16 inch (1.6 mm) shallower than elsewhere on the tire. If the tread has worn so low that the indicator is exposed, replace the tire. **Worn out tires have poor traction on wet roads.**

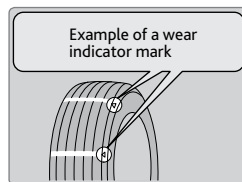

## ⚠️ WARNING

Using tires that are excessively worn or improperly inflated can cause a crash in which you can be seriously hurt or killed.

Follow all instructions in this owner's manual regarding tire inflation and maintenance.

### Tire and Loading Information Label

The label attached to the driver's doorjamb provides necessary tire and loading information.

Original tire sizes      Number of people your vehicle can carry      Proper cold tire pressure      Total weight your vehicle can carry (do not exceed)

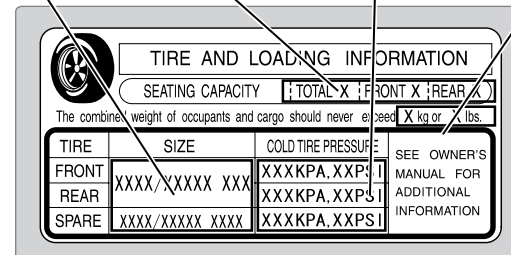

### Tire and Wheel Replacement

Replace your tires with radials of the same size, load range, speed rating, and maximum cold tire pressure rating (as shown on the tire's sidewall). Using tires of a different size or construction can cause certain vehicle systems to work incorrectly. It is best to replace all four tires at the same time. If that isn't possible, replace the front or rear tires in pairs.

If you change or replace a wheel, make sure that the wheel's specifications match those of the original wheels. Only use TPMS-specified wheels approved for your vehicle.

## ⚠️ WARNING

Installing improper tires on your vehicle can affect handling and stability. This can cause a crash in which you can be seriously hurt or killed. Always use the size and type of tires recommended in the owner's manual.



**Tire Service Life**

The life of your tires is dependent on many factors, including driving habits, road conditions, vehicle loading, inflation pressure, maintenance history, speed, and environmental conditions (even when the tires are not in use).

In addition to regular inspections and inflation pressure maintenance, it is recommended that you have annual inspections performed once the tires reach five years old. All tires, including the spare, should be removed from service after 10 years from the date of manufacture, regardless of their condition or state of wear.

**Winter Tires**

If driving on snowy or frozen roads, mount all season tires marked "M+S", snow tires, or tire chains; reduce speed; and maintain sufficient distance between vehicles when driving. For winter tires, select the size and load ranges that are the same as the original tires, and mount them to all four wheels.

**Tire Chains**

Install tire chains on the front tires only. Because your vehicle has limited tire clearance, we strongly recommend using the following chains:

**Cable type: SCC Radial Chain TC2212MM**

Mount chains as tightly as you can, and make sure that they do not touch the brake lines or suspension.

**NOTICE**

Traction devices that are the wrong size or improperly installed can damage your vehicle's brake lines, suspension, body, and wheels. Stop driving if they are hitting any part of the vehicle.

**⚠ WARNING**

Using the wrong chains, or not properly installing chains, can damage the brake lines and cause a crash in which you can be seriously injured or killed. Follow all instructions in this guide regarding the selection and use of tire chains.

**Tire Labeling**

The tires that came on your vehicle have a number of markings. Those you should be aware of are described below.

Here is an example of what each marking means:

**P235/60R18 102V**

- P: vehicle type (passenger)
- 235: tire width in millimeters
- 60: aspect ratio (tire section height as a percentage of its width)
- R: tire construction code (radial)
- 18: rim diameter in inches
- 102: load index (code indicating maximum load tire can carry)
- V: speed symbol (code indicating maximum speed rating)

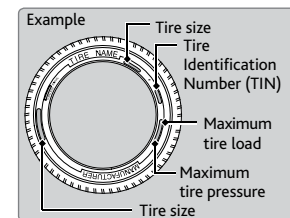

**Tire Identification Number (TIN)**

The tire identification number (TIN) is a group of numbers and letters that look like the example shown. TIN is located on the sidewall of the tire.

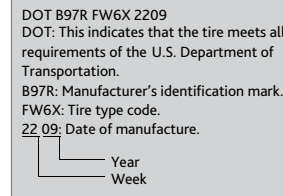

**Glossary of Tire Terminology**

**Cold Tire Pressure** – The tire air pressure when the vehicle has been parked for at least three hours or driven less than 1 mile (1.6 km).

**Load Rating** – The maximum load that a tire is rated to carry for a given inflation pressure.

**Maximum Inflation Pressure** – The maximum tire air pressure that the tire can hold.

**Maximum Load Rating** – The load rating for a tire at the maximum permissible inflation pressure for that tire.

**Recommended Inflation Pressure** – The cold tire inflation pressure recommended by the manufacturer.

**Treadwear Indicators (TWI)** – The projections within the principal grooves designed to give a visual indication of the degrees of wear of the tread.

TABLE OF CONTENTS

VISUAL INDEX

SAFETY INFORMATION

INSTRUMENT PANEL

VEHICLE CONTROLS

AUDIO AND CONNECTIVITY

BLUETOOTH® HANDSFREELINK®

ACURALINK®

NAVIGATION

DRIVING

HANDLING THE UNEXPECTED

MAINTENANCE

SPECIFICATIONS

CLIENT INFORMATION

VOICE COMMAND INDEX

INDEX

## DOT Tire Quality Grading

The tires on your vehicle meet all U.S. Federal Safety Requirements. All tires are also graded for treadwear, traction, and temperature performance according to Department of Transportation (DOT) standards. The following explains these gradings.

### ■ Uniform Tire Quality Grading

Quality grades can be found where applicable on the tire sidewall between tread shoulder and maximum section width.

For example:

**Treadwear 200**

**Traction AA**

**Temperature A**

All passenger car tires must conform to Federal Safety Requirements in addition to these grades.

### ■ Treadwear

The treadwear grade is a comparative rating based on the wear rate of the tire when tested under controlled conditions on a specified government test course. For example, a tire graded 150 would wear one and one-half (1 1/2) times as well on the government course as a tire graded 100. The relative performance of tires depends upon the actual conditions of their use, however, and may depart significantly from the norm due to variations in driving habits, service practices, and differences in road characteristics and climate.

### ■ Traction

The traction grades, from highest to lowest, are AA, A, B, and C. Those grades represent the tire's ability to stop on wet pavement as measured under controlled conditions on specified government test surfaces of asphalt and concrete. A tire marked C may have poor traction performance.

**WARNING:** The traction grade assigned to this tire is based on straight-ahead braking traction tests, and does not include acceleration, cornering, hydroplaning, or peak traction characteristics.

### ■ Temperature

The temperature grades are A (the highest), B, and C, representing the tire's resistance to the generation of heat and its ability to dissipate heat when tested under controlled conditions on a specified indoor laboratory test wheel. Sustained high temperature can cause the material of the tire to degenerate and reduce tire life, and excessive temperature can lead to sudden tire failure. The grade C corresponds to a level of performance which all passenger car tires must meet under the Federal Motor Vehicle Safety Standard No. 109. Grades B and A represent higher levels of performance on the laboratory test wheel than the minimum required by law.

**WARNING:** The temperature grade for this tire is established for a tire that is properly inflated and not overloaded. Excessive speed, underinflation, or excessive loading, either separately or in combination, can cause heat buildup and possible tire failure.

## Testing of Readiness Codes

Your vehicle has “Readiness Codes” as part of the onboard self-diagnostic system. Some states refer to these codes as a test to see if your vehicle’s emissions components are working properly. The codes may not be read if you go through the testing just after the battery has gone dead or been disconnected.

To check if they are set, turn the vehicle on without starting the engine. The malfunction indicator lamp will come on for several seconds. If it goes off, the readiness codes are set. If it blinks five times, the readiness codes are not set.

If you are required to have your vehicle tested before the readiness codes are set, prepare the vehicle for retesting by doing the following:

1. Fill the gas tank to approximately 3/4 full.
2. Park the vehicle and leave the engine off for 6 hours or more.
3. Make sure the ambient temperature is between 40°F and 95°F (4°C and 35°C).
4. Start the engine without touching the accelerator pedal, and let it idle for 20 seconds.
5. Keep the vehicle in Park (P). Increase the engine speed to 2,000 rpm, and hold it there for about 3 minutes.
6. Let the engine idle with your foot off the accelerator for 20 seconds.
7. Select a nearby, lightly traveled major highway where you can maintain a speed of 50 to 60 mph (80 to 97 km/h) for at least 20 minutes. Drive on the highway with the vehicle in Drive. Do not use cruise control. When traffic allows, drive for 90 seconds without using the accelerator pedal. (Vehicle speed may vary slightly; this is OK.) If you cannot do this for a continuous 90 seconds because of traffic conditions, drive for at least 30 seconds, then repeat two more times (for a total of 90 seconds).
8. Drive in city/suburban traffic for at least 10 minutes. When traffic conditions allow, let the vehicle coast for several seconds without using the accelerator pedal or the brake pedal.
9. Park the vehicle and leave the engine off for 30 minutes.

The readiness codes are erased when the battery is disconnected, and set again only after several days of driving under a variety of conditions.

If a testing facility determines that the readiness codes are not set, you may be requested to return at a later date to complete the test, or see your dealer.=

## SPECIFICATIONS

### Vehicle

Model	Acura RDX	
No. of Passengers:		
Front	2	
Rear	3	
Total	5	
Weights:		
Gross Vehicle Weight Rating	U.S.:	4,850 lbs (2,200 kg <sup>1</sup> )
		4,982 lbs (2,260 kg <sup>2</sup> )
	Canada:	2,260 kg
Gross Axle Weight Rating (Front)	U.S.:	2,557 lbs (1,160 kg <sup>1</sup> )
		2,623 lbs (1,190 kg <sup>2</sup> )
	Canada:	1,190 kg
Gross Axle Weight Rating (Rear)	U.S.:	2,293 lbs (1,040 kg <sup>1</sup> )
		2,381 lbs (1,080 kg <sup>2</sup> )
	Canada:	1,080 kg
Gross Combined Weight Rating	U.S.:	6,349 lbs (2,880 kg <sup>1</sup> )
		6,482 lbs (2,940 kg <sup>2</sup> )
	Canada:	2,940 kg
Air Conditioning:		
Refrigerant Type	HFC-134a (R-134a)	
Charge Quantity	15.2 – 16.9 oz (430 – 480 g)	
Lubricant Type	ND-OIL8	

\*1: 2WD models  
\*2: AWD models

### Engine and Fuel

Engine Specifications		
Displacement	211.8 cu-in (3,471 cm <sup>3</sup> )	
	NGK	ILZKR7B11
Spark Plugs	DENSO	SXU22HCR11
Fuel		
Type	Unleaded premium gasoline, Pump octane number of 91 or higher	
Fuel Tank Capacity	16 US gal (60.5 ℓ)	

### Tires

	Size	P235/60R18 102V	
Regular	Pressure	Front	35 [240 [2.4]]
	psi (kPa[kgf/cm <sup>2</sup> ])	Rear	33 [230 [2.3]]
Compact Spare*	Size	T165/90R17 105M	
	Pressure	60 (420 [4.2])	
Wheel Size	Regular	18 x 7.5J	
	Compact Spare*	17 x 4T	

### Light Bulbs

Headlights (High Beams)	LED
Headlights (Low Beams)	LED
Fog Lights*	55W (H11)
Front turn signal/Parking lights/Daytime running lights	LED
Side Turn Signal Lights (on Door Mirrors)	LED
Front Side Marker Lights	3CP
Rear Side Marker/Brake/Taillight	LED
Back-Up Lights	16W
Rear Turn Signal Lights	21W (Amber)
High-Mount Brake Light	LED
Rear License Plate Light	5W
Cargo Area Lights	5W
Vanity Mirror Lights	1.4W
Interior Lights	
Map Lights	LED
Ceiling Light	8W
Door Courtesy Lights	2CP
Console Compartment Light	1.4W
Glove Box Light	1.4W
Center Pocket Light	LED

### Fluids

Engine Oil		
Recommended	Genuine Acura Motor Oil 0W-20 -API Premium-grade 0W-20 detergent oil	
	Change	4.23 US qt (4.0 ℓ)
Capacity	Change including filter	4.55 US qt (4.3 ℓ)
Engine Coolant		
Specified Ratio	Acura Long Life Antifreeze/Coolant Type2 50/50 with distilled water	
Capacity	1.96 US gal (7.4 ℓ) (change including the remaining 0.193 US gal (0.73 ℓ) in the reserve tank)	

### Automatic Transmission Fluid

Specified Capacity	Acura Automatic Transmission Fluid ATF DW-1 Change 3.3 US qt (3.1 ℓ)	
--------------------	---	--

### Rear Differential Fluid\*

Specified Capacity	Acura DPSF-II Change 1.32 US qt (1.25 ℓ)	
--------------------	---	--

### Transfer Assembly Fluid\*

Specified Capacity	Acura Hypoid Gear Oil HGO-11 Change 0.43 US qt (0.41 ℓ)	
--------------------	--	--

### Brake Fluid

Specified	Acura Heavy Duty Brake Fluid DOT 3	
-----------	------------------------------------	--

### Washer Fluid

Tank Capacity	U.S.: 2.6 US qt (2.5 ℓ) Canada: 5.1 US qt (4.85 ℓ)	
---------------	---	--

\*if equipped

# CLIENT INFORMATION

Learn about information specific to you as an Acura client and how to get help.

## Frequently Asked Questions/Troubleshooting

Below are some frequently asked questions and troubleshooting items that you may have about the vehicle.

**Q:** *How do I set the vehicle clock?*

**A:** For vehicles without navigation, see page 49. For vehicles with navigation, the time is automatically set using GPS signals.

**Q:** *Why doesn't the vehicle start when I press the ENGINE START/STOP button?*

**A:** The brake pedal must be pressed to start the engine.

**Q:** *What is the AUTO setting on my headlight lever?*

**A:** When in the AUTO position, the vehicle's exterior lights will automatically turn on or off depending on the ambient lighting.

**Q:** *Only the driver's door unlocks when I shift to Park (P). Can all doors unlock?*

**A:** You can change door lock or unlock settings in the multi-information display using the Vehicle Settings menu (see page 29), or using the SETTINGS button (see page 48).

**Q:** *Why won't the driver's door unlock when I grab the door handle, even though the keyless access remote is within range?*

**A:** If you pull the handle too quickly, the system may not have time to confirm the door is unlocked. Wait to hear a beep to confirm the door is unlocked. If you are wearing gloves, the system may be slow to respond.

**Q:** *After my battery was disconnected or went dead, the audio system is asking for a code. Where do I find this?*

**A:** In most cases, you do not need to enter a code. Turn on the vehicle and the audio system, and press and hold the power button until the system reactivates.

**Q:** *Why can't I operate Pandora through the audio system?*

**A:** Audio may be streaming through Bluetooth® Audio. Make sure Pandora mode is selected and the phone cable is properly connected to the USB port. Some phones may prompt you to "Allow" a connection.

**Q:** *Is my phone compatible with Bluetooth features?*

**A:** Visit [www.acura.com/handsfreelink](http://www.acura.com/handsfreelink) (U.S) or [www.handsfreelink.ca](http://www.handsfreelink.ca) (Canada) to check phone compatibility for Bluetooth® Audio, Bluetooth® HandsFreeLink®, and SMS text messaging.

**Q:** *Every time I press the Talk button, the system gives me voice prompts. Can I turn these off?\**

**A:** Press the SETTINGS button. Use the interface dial to select System Settings, and then Voice Prompt. Select Off.

**Q:** *Why can't I select an item using the interface dial?\**

**A:** To prevent driver distraction, certain items are limited or inoperable while the vehicle is moving. Use voice commands or pull over to select the items.

**Q:** *Where can I find the vehicle identification number (VIN)?*

**A:** Check the label on the driver's doorjamb.

## Contact Us

Acura dealer personnel are trained professionals. They should be able to answer all your questions. If you encounter a problem that your dealership does not solve to your satisfaction, please discuss it with the dealership's service manager or general manager. If you are dissatisfied with the decision made by the dealership's management, contact Acura Client Relations/Services.

### U.S. owners:

American Honda Motor Co., Inc.  
Acura Client Relations  
1919 Torrance Blvd.  
Mail Stop 500-2N-7E  
Torrance, CA 90501-2746  
Tel: (800) 382-2238

### In Puerto Rico and the U.S. Virgin Islands:

Bella International  
P.O. Box 190816  
San Juan, PR 00919-0816  
Tel: (787) 620-7546

### Canadian owners:

Honda Canada, Inc.  
Acura Client Services  
180 Honda Blvd.  
Markham, ON  
L6C 0H9  
Tel: (888) 922-8729  
Fax: (877) 939-0909  
e-mail: [acura\\_cr@ch.honda.com](mailto:acura_cr@ch.honda.com)

When you call or write, please give us the following information:

- Vehicle Identification Number
- Date of purchase
- Odometer reading of your vehicle
- Your name, address, and telephone number
- A detailed description of the problem
- Name of the dealer who sold the vehicle to you

\*if equipped

## Acura Total Luxury Care Roadside Assistance

Your Acura TLC Roadside Assistance representative is here to help you 24 hours a day, 7 days a week by calling (800) 594-8500 (U.S.) or (800) 565-7587 (Canada). Under your 4-year/50,000-mile (80,000 km) warranty, the following benefits are available:

- Towing services—full cost of towing to the closest Acura dealer
- Roadside assistance—jump starting, fuel delivery, lockout, and flat tire
- Trip planning—detailed trip routing, emergency services, and more

## Warranty Coverages

Below is a brief summary of the warranties covering your new vehicle.

**New Vehicle Limited Warranty:** Covers your new vehicle, except for the emissions control system and accessories, against defects in materials and workmanship.

**Emissions Control Systems Defects Warranty and Emissions Performance Warranty:** Covers your vehicle's emissions control systems. Time, mileage, and coverage are conditional.

**Seat Belt Limited Warranty:** Covers seat belts that fail to function properly.

**Rust Perforation Limited Warranty:** Covers all exterior body panels that rust through from the inside.

**Accessory Limited Warranty:** Covers Acura accessories.

**Replacement Parts Limited Warranty:** Covers all Acura replacement parts against defects in materials and workmanship.

**Replacement Battery Limited Warranty:** Provides prorated coverage for a replacement battery purchased from an Acura dealer.

**Replacement Muffler Lifetime Limited Warranty:** Covers a replacement muffler for the duration of the ownership.

Restrictions and exclusions apply to all these warranties. See the Owner Information CD or visit [owners.acura.com](http://owners.acura.com) (U.S.) or [www.myacura.ca](http://www.myacura.ca) (Canada) for complete descriptions of each warranty, including time, mileage, and other conditional limitations.

Your vehicle's original tires are covered by their manufacturer. Tire warranty information can be found on the Owner Information CD or [owners.acura.com](http://owners.acura.com) (U.S.) or [www.myacura.ca](http://www.myacura.ca) (Canada).

## VOICE COMMAND INDEX

Learn about all available voice commands to help you operate the certain features. Press the Talk button before you say a command. Available on vehicles with navigation.

To view a list of available commands in the vehicle, press the INFO button and use the interface dial to select Voice Info. Select a category to hear the commands read aloud.

### ■ Global Commands

The system accepts these commands on most screens.

- Voice help
- Display voice portal
- Display phone (or PHONE button)
- Display audio (or AUDIO button)
- Display information (or INFO button)
- Display menu (or MENU button)
- Display setting (or SETTINGS button)
- Display map
- Display navigation
- Back (returns to previous screen)
- Cancel
- What is today's date?
- What time is it?
- Messages
- Trip computer
- Display clock

### ■ Navigation Commands

The system accepts these commands on the map/guidance screen.

#### Route Commands

The system accepts these commands when a route is set.

- How long to the destination?
- How far to the destination?
- Display destination map
- Display entire route
- Cancel route
- Go home

#### Map Display Commands

- Display/Hide (specify icon type):
  - ATM
  - gas station
  - restaurant
  - post office
  - grocery store
  - lodging (hotel, motel)
  - parking lot
  - school
  - hospital
  - traffic
  - traffic speeds
  - traffic icons
  - traffic incidents
- Display current location
- Display north up
- Display heading up
- Display 3D map
- Display zoom in
- Display zoom out

■ Navigation Commands (continued)

Find Place Commands

- Find nearest (specify place):

Fuel and auto	Performing arts
Acura dealer	Sports complex
Gas station	Tourist attraction
Auto parts & electronics	Restaurant
Auto repair & maintenance	American restaurant
Car wash & detailing	Californian restaurant
Motorcycle dealer	Chinese restaurant
Other car dealer	Coffee shop
Roadside assistance	Continental restaurant
Banking center	Fast food
ATM and bank	French restaurant
ATM	German restaurant
Bank	Greek restaurant
Check cashing	Indian restaurant
Currency exchange	Italian restaurant
Community	Japanese restaurant
Business	Korean restaurant
City hall	Mexican restaurant
Civic center	Pizza
Convention center	Seafood restaurant
Court house	Thai restaurant
Higher education	Vegetarian restaurant
Library	Vietnamese restaurant
Post office	Other restaurant
School	Shopping
Emergency room	Shopping area
Hospital	Accessory store
Police station	Book store
Veterinarian	Clothing store
Lodging	Grocery store
Bed & breakfast	Home improvement store
Hotel	Mall
Resort	Office supply store
Recreation	Pharmacy
Amusement park	Pet food store
Golf course	Sewing store
Historical monument	Shoe store
Marina	Sporting goods store
Movie theater	Toy store
Museum	Travel center
Park	Airport

■ Navigation Commands (continued)

Find Place Commands (continued)

- Find nearest (specify place):

Automobile club	Parking lot
Bus station	Rental car agency
Camping	Rest area
Commuter rail station	Ski area
Ferry terminal	Tourist information center
Named place	Train station
Park & ride	Travel agency
Parking garage	Truck stop

■ Climate Control Commands

The system accepts these commands on most screens.

- |                                     |   |
|-------------------------------------|---|
| • Climate control automatic*        | • Fan automatic   |
| • Climate control on*               | • Temperature # degrees (#: 57 to 87°F / 15 to 29 °C)           |
| • Climate control off*              | • Driver temperature # degrees (#: 57 to 87°F / 15 to 29 °C)    |
| • Air conditioner on*               | • Passenger temperature # degrees (#: 57 to 87°F / 15 to 29 °C) |
| • Air conditioner off*              | • Temperature up  |
| • Climate control defrost on*       | • Temperature down  |
| • Climate control defrost off*      | • Driver temperature up   |
| • Rear defrost on*                  | • Driver temperature down                                       |
| • Rear defrost off*                 | • Passenger temperature up                                      |
| • Climate control fresh air         | • Passenger temperature down                                    |
| • Climate control recirculate       | • Temperature max heat  |
| • Climate control sync on*          | • Temperature max cool  |
| • Climate control sync off*         | • Driver temperature max heat                                   |
| • Climate control vent              | • Driver temperature max cool                                   |
| • Climate control bi-level          | • Passenger temperature max heat                                |
| • Climate control floor             | • Passenger temperature max cool                                |
| • Climate control floor and defrost |   |
| • Fan speed up                      |   |
| • Fan speed down                    |   |
| • Fan speed # (#: 1 to 7)           |   |

\* These commands toggle the function on and off, so the command may not match your intended action.

TABLE OF CONTENTS

VISUAL INDEX

SAFETY INFORMATION

INSTRUMENT PANEL

VEHICLE CONTROLS

AUDIO AND CONNECTIVITY

BLUETOOTH® HANDSFREELINK®

ACURALINK®

NAVIGATION

DRIVING

HANDLING THE UNEXPECTED

MAINTENANCE

SPECIFICATIONS

CLIENT INFORMATION

VOICE COMMAND INDEX

INDEX

■ Audio Commands

The system accepts these commands on most screens. Audio volume levels cannot be controlled using voice commands.

**FM/AM Radio Commands**

- Audio on\*
- Audio off\*
- Radio on\*
- Radio off\*
- Radio select FM
- Radio select AM
- Radio tune to # FM (#: frequency, e.g., 95.5)
- Radio tune to # AM (#: frequency, e.g., 1020)
- Radio seek up
- Radio seek down
- Radio next station
- Radio preset # (#: 1 to 12)
- Radio FM preset # (#: 1 to 12)
- Radio AM preset # (#: 1 to 6)
- Radio FM tag song\*\*
- Radio AM tag song\*\*
- Radio scan\*

**SiriusXM Radio Commands**

- Radio select SiriusXM
- SiriusXM channel # (#: 0 to 999)
- SiriusXM channel up
- SiriusXM channel down
- SiriusXM category up
- SiriusXM category down
- SiriusXM preset # (#: 1 to 6)
- SiriusXM scan\*
- SiriusXM category mode
- SiriusXM channel mode
- SiriusXM skip forward
- SiriusXM skip back
- SiriusXM scan songs
- SiriusXM play
- SiriusXM pause
- SiriusXM go to live
- SiriusXM tag song\*\*

**Compact Disc (CD) Commands**

- Disc play
- Disc play track # (#: 1 to 30)
- Disc skip forward
- Disc skip back
- Disc track random\*
- Disc track repeat\*
- Disc track scan\*
- Disc folder up
- Disc folder down
- Disc folder random\*
- Disc folder repeat\*
- Disc folder scan\*
- Disc normal play

**Hard Disc Drive (HDD) Commands**

- Hard disc drive play
- Hard disc drive play track # (#: 1-30)
- Hard disc drive skip forward
- Hard disc drive skip back
- Hard disc drive album up
- Hard disc drive album down
- Hard disc drive track up
- Hard disc drive track down
- Hard disc drive playlist up
- Hard disc drive playlist down
- Hard disc drive track random\*
- Hard disc drive track repeat\*
- Hard disc drive track scan\*
- Hard disc drive normal play
- What am I listening to?
- Who am I listening to?
- Who is this?
- What's playing?
- Who's playing?
- What album is this?

\* These commands toggle the function on and off, so the command may not match your intended action.

\*\*if equipped

■ Audio Commands (continued)

**USB Commands**

- USB play
- USB play track # (#: 1 to 30)
- USB skip forward
- USB skip back
- USB track random\*
- USB track repeat\*
- USB track scan\*
- USB folder up
- USB folder down
- USB folder random\*
- USB folder repeat\*
- USB folder scan\*
- USB normal play

**iPod® Commands**

- iPod play
- iPod pause
- iPod play track # (#: 1-30)
- iPod skip forward
- iPod skip back
- iPod track shuffle\*
- iPod album shuffle\*
- iPod track repeat\*
- iPod normal play
- What am I listening to?
- Who am I listening to?
- Who is this?
- What's playing?
- Who's playing?
- What album is this?

**Pandora® Commands (U.S. only)**

- Pandora play
- Pandora skip forward
- Pandora station up
- Pandora station down
- Pandora pause
- Pandora resume
- Pandora thumbs up
- Pandora thumbs down

**Aha™ Radio Commands**

- Aha radio play
- Aha radio skip forward
- Aha radio skip back
- Aha radio station up
- Aha radio station down
- Aha radio pause
- Aha radio resume
- Aha radio like
- Aha radio dislike

**Bluetooth® Audio Commands**

- Bluetooth audio play
  - Bluetooth audio skip forward
  - Bluetooth audio skip back
  - Bluetooth audio pause
  - Bluetooth audio resume
  - Bluetooth audio group up
  - Bluetooth audio group down
- Commands may not work on some phones or devices.

**AUX Commands**

- Auxiliary play

**Song By Voice™ Commands**

These commands can be used for iPod and HDD operation.

- Music search
- What am I listening to?
- Who am I listening to?
- Who is this?
- What's playing?
- Who's playing?
- What album is this?

\* These commands toggle the function on and off, so the command may not match your intended action.

TABLE OF CONTENTS

VISUAL INDEX

SAFETY INFORMATION

INSTRUMENT PANEL

VEHICLE CONTROLS

AUDIO AND CONNECTIVITY

BLUETOOTH® HANDSFREELINK®

ACURALINK®

NAVIGATION

DRIVING

HANDLING THE UNEXPECTED

MAINTENANCE

SPECIFICATIONS

CLIENT INFORMATION

VOICE COMMAND INDEX

INDEX

**Phone Commands**

The system accepts these commands on most screens.

- Call by number
- Call by name
- Call (phone number)
- Call (contact name)

**On-screen Commands**

The system accepts these commands on any screen where applicable. All available on-screen voice commands are highlighted in yellow when you press the Talk button.

- Next (or Down)
- Previous (or Up)
- Return
- OK (excluding Startup Confirmation screen)
- Delete

**INDEX**

ABS .....	25, 100	Siri™ Eyes Free .....	80
ACC .....	25, 27, 102	SMS Text Messaging .....	72, 79
Accessory Power Socket .....	50	Speed Dial .....	71, 72, 77, 78
AcuraLink® .....	81	Talk Button Tips .....	74
AcuraLink featuring Aha™ .....	68	Brake Assist System .....	100
AcuraLink Real-Time Traffic™ .....	89	Brake Fluid .....	133
Adaptive Cruise Control (ACC) .....	25, 27, 102	Brake system .....	24, 25
Aha™ .....	68	Braking .....	100
Airbags .....	9	Brightness Control .....	36
Advanced Airbags .....	9	Carbon Monoxide Gas .....	4
Airbag Care .....	14	Cargo Lights .....	37
Airbag System Components .....	13	Change a Setting .....	48
Airbag System Indicators .....	11	Changing a Flat Tire .....	120
Front Airbags (SRS) .....	9	Changing Fuses .....	125
Passenger Airbag Off Indicator .....	12	Changing Wiper Blades .....	134
Side Airbags .....	10	Charging system .....	24
Side Curtain Airbags .....	10	Checking the Battery .....	133
All-Wheel Drive (AWD) .....	25, 91	Childproof Door Locks .....	33
Anti-Lock Brake System (ABS) .....	25, 100	Child Safety .....	15
ASSIST button .....	82	Child Seat .....	17
Audio Operation .....	50	Adding Security with a Tether .....	20
Accessory Power Socket .....	50	Installing a Child Seat with a Lap/Shoulder Seat Belt .....	19
Aha™ .....	68	Installing a LATCH-Compatible Child Seat .....	18
Audio Commands .....	150	Selecting a Child Seat .....	17
Auxiliary Input Jack .....	50	Client Information .....	144
Bluetooth® Audio .....	58, 66	Climate Control .....	46
Color Information Display .....	52	Climate Control Commands .....	149
Compact Disc (CD) .....	55, 63	Clock .....	49
FM/AM Radio .....	53, 61	Collision Mitigation Braking System™ (CMBS™) .....	25, 27, 107
Hard Disc Drive (HDD) Audio .....	64	Color Information Display .....	52
iPod® .....	56, 65	Compact Disc (CD) .....	55, 63
On-Demand Multi-Use Display™ (ODMD™) .....	60	Condition Indicators .....	26
Pandora® .....	59, 67	Contact Us .....	145
SiriusXM® Radio .....	54, 62	Cross Traffic Monitor .....	111
Sound .....	51	Cruise Control .....	27, 101
Steering Wheel Controls .....	51	Customized Settings .....	48
USB Flash Drive .....	57, 63	Dashboard and Ceiling Controls .....	2
USB Port .....	50	Destination .....	86
Automatic Dimming Rearview Mirror .....	44	Detour .....	89
Automatic rain-sensing wipers .....	39	Dialing a Number .....	71, 76
Auxiliary Input Jack .....	50	Door Mirrors .....	44
AWD .....	25, 91	Door Operation .....	31, 33
Battery .....	133	DOT Tire Quality Grading .....	140
Blind spot information (BSI) .....	25, 106	Driving .....	90
Bluetooth® Audio .....	58, 66	Adaptive Cruise Control (ACC) .....	102
Bluetooth® HandsFreeLink® .....	69	Blind spot information (BSI) .....	106
Dialing a Number .....	71, 76	Braking .....	100
E-Mail .....	79	Collision Mitigation Braking System™ (CMBS™) .....	107
Making a Call .....	71, 76		
Pairing a Phone .....	70, 75		
Phonebook .....	71, 77		

TABLE OF CONTENTS

VISUAL INDEX

SAFETY INFORMATION

INSTRUMENT PANEL

VEHICLE CONTROLS

AUDIO AND CONNECTIVITY

BLUETOOTH® HANDSFREELINK®

ACURALINK®

NAVIGATION

DRIVING

HANDLING THE UNEXPECTED

MAINTENANCE

SPECIFICATIONS

CLIENT INFORMATION

VOICE COMMAND INDEX

INDEX



TABLE OF CONTENTS

VISUAL INDEX

SAFETY INFORMATION

INSTRUMENT PANEL

VEHICLE CONTROLS

AUDIO AND CONNECTIVITY

BLUETOOTH® HANDSFREELINK®

ACURALINK®

Cruise Control ..... 101

ENGINE START/STOP button ..... 97

Lane Departure Warning (LDW) ..... 104

Lane Keeping Assist System (LKAS) ..... 105

Multi-View Rear Camera ..... 110

Paddle shifters ..... 99

Parking Sensor System ..... 109

Power Mode ..... 97

Rear Cross Traffic Monitor ..... 111

Refueling ..... 112

Remote Engine Start ..... 96

Sequential Shift Mode ..... 99

Shifting ..... 98

Driving Position Memory System ..... 43

Electric Power Steering (EPS) ..... 25

Electronic Stability Control (ESC) ..... 109

E-Mail ..... 79

Emergency Assistance ..... 82

Emergency Engine Stop ..... 116

Emergency Towing ..... 116

Engine and Fuel ..... 143

Engine Coolant ..... 132

Engine Oil ..... 130

ENGINE START/STOP button ..... 97

Exterior lights ..... 27, 36

Fastening a Seat Belt ..... 7

Find Nearest Place ..... 87

Flat Tire ..... 120

Floor Mats ..... 42

Fluids ..... 143

FM/AM Radio ..... 53, 61

Fog lights ..... 27

Foot Brake ..... 100

Frequently Asked Questions ..... 144

Front Airbags (SRS) ..... 9

Front Door Inner Handle ..... 33

Front Seats ..... 40

Front Wipers ..... 38

Fuel Information ..... 112

Fuse Locations ..... 123

Garage Opener ..... 45

Hard Disc Drive (HDD) Audio ..... 64

Headlight-Wiper Integration ..... 38

Head Restraints ..... 41

High beams ..... 27

Home Address ..... 86

HomeLink® Garage Opener ..... 45

Immobilizer ..... 26

Info buttons ..... 28

Instrument Panel ..... 24

Interface Dial Feedback ..... 85

Interior Lights ..... 36

Intermittent wipers ..... 38

iPod® ..... 56, 65

Jump Starting ..... 114

Keyless Access System ..... 25, 31

Lane Departure Warning (LDW) ..... 25, 104

Lane Keeping Assist System (LKAS) ..... 25, 105

Lap/Shoulder Seat Belts ..... 5

LATCH-Compatible Child Seat ..... 18

Light Bulbs ..... 143

Lights ..... 27, 36

LINK button ..... 82

Lock Tab ..... 33

Low fuel ..... 26

Low oil pressure ..... 24

Low tire pressure ..... 26

Maintenance ..... 126

    Brake Fluid ..... 133

    Changing Wiper Blades ..... 134

    Checking the Battery ..... 133

    Engine Coolant ..... 132

    Engine Oil ..... 130

    Maintenance Minder™ ..... 127

    Opening the Hood ..... 129

    Service Codes ..... 128

    Under the Hood ..... 129

    Window Washer Fluid ..... 133

Making a Call ..... 71, 76

Malfunction Indicators ..... 24

Map Legend ..... 88

Map Lights ..... 37

Master Door Lock Switch ..... 33

Maximum Load Limit ..... 92

Mirrors ..... 44

Moonroof ..... 35

Multi-Information Display ..... 28

Multi-View Rear Camera ..... 110

Navigation ..... 83

    AcuraLink Real-Time Traffic™ ..... 89

    Detour ..... 89

    Display and Controls ..... 84

    Entering a Destination ..... 86

    Find Nearest Place ..... 87

    Home Address ..... 86

    Interface Dial Feedback ..... 85

    Map Legend ..... 88

    Navigation Commands ..... 147

    Place Name ..... 87

    Routing ..... 88

    Steering Wheel Controls ..... 83

    Street Address ..... 86

    System Guidance Volume ..... 85

    Talk Button Tips ..... 83

    Traffic ..... 89

    Turn-by-turn directions ..... 88

    Voice Prompt ..... 85

On-Demand Multi-Use Display™ (ODMD™) ..... 60

One-Touch Turn Signal ..... 37

NAVIGATION

DRIVING

HANDLING THE UNEXPECTED

MAINTENANCE

SPECIFICATIONS

CLIENT INFORMATION

VOICE COMMAND INDEX

INDEX

Opening the Hood ..... 129

Operator Assistance ..... 82

Overheating ..... 115

Paddle shifters ..... 99

Pairing a Phone ..... 70, 75

Pandora® ..... 59, 67

Parking brake ..... 26, 100

Parking Sensor System ..... 109

Passenger Airbag Off Indicator ..... 12

Phone ..... 70, 75

Phonebook ..... 71, 77

Phone Commands ..... 152

Place Name ..... 87

Power Door Mirrors ..... 44

Power Mode ..... 97

Power Moonroof ..... 35

Power Tailgate ..... 32

Power Window Operation ..... 34

Rain-sensing wipers ..... 39

Readiness Codes ..... 142

Rear Camera ..... 110

Rear Cross Traffic Monitor ..... 111

Rear Seats ..... 42

Rearview Mirror ..... 44

Rear Wiper ..... 39

Refueling ..... 112

Remote Battery Strength ..... 113

Remote Engine Start ..... 96

Remote Transmitter ..... 30

Reporting Safety Defects ..... 23

Reverse Tilt Door Mirrors ..... 44

Roadside Assistance ..... 146

Routing ..... 88

Safety Information ..... 3

    Carbon Monoxide Gas ..... 4

    Reporting Safety Defects ..... 23

    Safety Label Locations ..... 22

    Safety Messages ..... 4

Seat Belts ..... 5

    Adjusting the Shoulder Anchor ..... 7

    Fastening a Seat Belt ..... 7

    Lap/Shoulder Seat Belts ..... 5

    Seat Belt Inspection ..... 6

    Seat belt reminder ..... 26

    Seat Belt with Detachable Anchor ..... 8

Seat Heaters or Ventilation ..... 47

Seats ..... 40

SEL/RESET button ..... 28

Sequential Shift Mode ..... 99

Service Codes ..... 128

Setting the Clock ..... 49

Shifting ..... 98

Shift Lever Does Not Move ..... 113

Shoulder Anchor ..... 7

Side Airbags ..... 10

Side Curtain Airbags ..... 10

Siri™ Eyes Free ..... 80

SiriusXM® Radio ..... 54, 62

SMS Text Messaging ..... 72, 79

Song By Voice™ Commands ..... 151

Sound ..... 51

Specifications ..... 143

Speed Dial ..... 71, 72, 77, 78

Steering Wheel ..... 43

Steering Wheel and Nearby Controls ..... 1

Steering Wheel Controls ..... 51, 83

Street Address ..... 86

Supplemental Restraint System (SRS) ..... 11, 25

System Guidance Volume ..... 85

System message ..... 26

Tailgate ..... 31, 32

Talk Button Tips ..... 74, 83

Text Messaging ..... 72, 79

Tire Information ..... 136

    DOT Tire Quality Grading ..... 140

    Tire and Loading Information Label ..... 137

    Tire and Wheel Replacement ..... 137

    Tire Chains ..... 138

    Tire Identification Number (TIN) ..... 139

    Tire Labeling ..... 139

    Tires ..... 143

    Tire Service Life ..... 138

    Tire Terminology ..... 139

    Wear Indicators ..... 136

    Winter Tires ..... 138

Tire Pressure Monitoring System (TPMS) ..... 25, 117

Tire Repair Kit ..... 119

Towing ..... 116

Towing a Trailer ..... 94

Traffic ..... 89

Troubleshooting ..... 144

Turn-by-turn directions ..... 88

Turn Signal ..... 27, 37

Under the Hood ..... 129

USB Flash Drive ..... 57, 63

USB Port ..... 50

Vehicle Controls ..... 30

Vehicle Settings ..... 29

Vehicle Stability Assist (VSA®) ..... 25, 27, 109

Visual Index ..... 1

Voice Command Index ..... 147

Voice Prompt ..... 85

Warranty Coverages ..... 146

Windows ..... 34

Window Washer Fluid ..... 133

Winter Tires ..... 138

Wipers ..... 38

Wiper Blades ..... 134