

Contents

A-Z

Owner's Manual
for Vehicle



The Ultimate
Driving Machine



THE BMW Z4.

OWNER'S MANUAL.

BMW EfficientDynamics
Less emissions. More driving pleasure.

Z4 **Owner's Manual for Vehicle**

Thank you for choosing a BMW.

The more familiar you are with your vehicle, the better control you will have on the road. We therefore strongly suggest:

Read this Owner's Manual before starting off in your new BMW. It contains important information on vehicle operation that will help you make full use of the technical features available in your BMW. The manual also contains information designed to enhance operating reliability and road safety, and to contribute to maintaining the value of your BMW.

Supplementary information can be found in the additional brochures in the onboard literature.

We wish you a safe and enjoyable drive.

BMW AG

© 2014 Bayerische Motoren Werke
Aktiengesellschaft
Munich, Germany
Reprinting, including excerpts, only with the written
consent of BMW AG, Munich.
deutsch X/14, 11 14 500
Printed on environmentally friendly paper, bleached
without chlorine, suitable for recycling.

ADDENDUM TO BMW Z4 OWNER'S MANUAL 1402957403

We wanted to provide you with some updates and clarifications with respect to the printed BMW Owner's Manual. These updates and clarifications will supersede the materials contained in that document.

1. Where the terms "service center," "the service center," "your service center," "service specialist," or "service" are used in the Owner's Manual, we wanted to clarify that the terms refer to a BMW dealer's service center or another service center or repair shop that employs trained personnel that can perform maintenance and repair work on your vehicle in accordance with BMW specifications.
2. Where the text of the Owner's Manual contains an affirmative instruction to contact a "service center" or "your service center," we wanted to clarify that BMW recommends that, if you are faced with one of the situations addressed by that text, you contact or seek the assistance of a BMW dealer's service center or another service center or repair shop that employs trained personnel that can perform maintenance and repair work on your vehicle in accordance with BMW specifications.
3. Where the Owner's Manual makes reference to parts and accessories having been approved by BMW, those references are intended to reflect that those parts and accessories are recommended by BMW of North America LLC. You may elect to use other parts and accessories, but, if you do, we recommend that you make sure that any such parts and/or accessories are appropriate for use on your vehicle.
4. At page 6 and page 7, under the warranty section's discussion of homologation, where it states that you "cannot lodge warranty claims for your vehicle there," the text should read that you "may not be able to lodge warranty claims for your vehicle there."
5. At page 7, in the "Parts and accessories" section, the sentence beginning "For your own safety, it is recommended . . . ," should be disregarded and the following text should be read in lieu thereof: "The manufacturer of your vehicle

While BMW of North America LLC, at no cost to you, will pay for repairs required by the limited warranties provided with respect to your

vehicle and for maintenance under the Maintenance Program during the applicable warranty and maintenance coverage periods, you are free to elect, both during those periods and thereafter, to have maintenance and repair work provided by other service centers or repair shops.

vehicle and for maintenance under the Maintenance Program during the applicable warranty and maintenance coverage periods, you are free to elect, both during those periods and thereafter, to have maintenance and repair work provided by other service centers or repair shops.

vehicle and for maintenance under the Maintenance Program during the applicable warranty and maintenance coverage periods, you are free to elect, both during those periods and thereafter, to have maintenance and repair work provided by other service centers or repair shops.

recommends using genuine parts and accessories approved by BMW.”

In the fifth sentence of that paragraph, the word “cannot” should read “does not.”

6. At page 49, in the “Checking and replacing safety belts” section, the text beginning, “Have the work performed only by your service center . . .” should be disregarded and the following text should be read in lieu thereof: “BMW recommends having this work performed by a service center as it is important that this safety feature functions properly.”
7. At page 130 under the heading: “Objects in the area around the pedals” and at page 258 under the heading: “Carpets and floor mats,” the paragraph that begins: “Only use floor mats . . .” should be disregarded and the following language should be read in lieu thereof: “The manufacturer of your vehicle recommends that you use floor mats that have been identified by it as appropriate for use in your vehicle and that can be properly fixed in place.”
8. At page 134, under the heading: “Have maintenance carried out,” the sentence beginning, “Have the maintenance carried out . . .” should be disregarded and the following text should be read in lieu thereof: “BMW recommends that you have the maintenance carried out by your service center.”
9. At page 192, under “Telephone,” the heading that reads “Approved mobile phones” should read “Compatible mobile phones.”
10. At page 218 and page 219, under the heading “Apps” and subheading “Requirements,” the section that begins, “Use only . . .,” should be disregarded and the following text should be read in lieu thereof: “The manufacturer of your vehicle recommends the use of BMW recommended software; otherwise there may be malfunctions in system operations.”
11. At page 226, under the heading “Pressure specifications,” the sentence beginning, “The inflation pressures apply to the tire sizes” should be disregarded.
12. At page 232, under the heading: “Approved wheels and tires,” the term “Approved” should be disregarded and in lieu thereof, the term “Recommended” should be read in its place. In addition, the text of that section should be disregarded and the following text should be read in lieu thereof:

The manufacturer of your vehicle strongly suggests that you use wheels and tires that have been recommended by the vehicle manufacturer for your vehicle type; otherwise, for example, despite having the same official size ratings, variations can lead to body contact and with it, the risk of severe accidents.

The manufacturer of your vehicle does not evaluate non-recommended wheels and tires to determine if they are suitable for use on your vehicle.

13. At page 233, under the heading: “Snow chains,” the first paragraph should be disregarded and the following text should be read in lieu thereof:

Only certain types of fine-link snow chains have been tested by the manufacturer of your vehicle and are determined by the manufacturer of your vehicle to be road safe and are recommended by the manufacturer of your vehicle.

Information about recommended snow chains is available from a service center.

14. At page 236, under the heading “Hood,” the sentence beginning, “If you are unfamiliar” should be disregarded.
15. At page 239, under the heading: “Approved oil types,” the references to “Approved” should be read as “Suitable.” The reference to “Specification” should be read as “Rating.” Immediately preceding the “Specification” chart, the following sentence should be inserted: “Add engine oils that meet the following oil rating standards: . . .” The reference to “BMW High Performance SAE 5W-30” should be disregarded.

16. At page 239, under the heading: “Alternative oil types,” the text preceding the chart should be disregarded, and in lieu thereof should be read as follows: “If an engine oil suitable for continuous use is not available, up to 1 US quart/liter of an engine oil with the following oil rating can be added: . . .” The reference to “Specification” should be read as “Rating.” At page 239, under the heading: “Oil change,” the text should be disregarded and in lieu thereof should be read as follows:

BMW recommends that you have the oil changed at your BMW dealer’s service center or at another service center that has trained personnel that can perform the work in accordance with BMW specifications

17. At page 241, under the heading: “Service and Warranty Information Booklet for US models and Warranty and Service Guide Booklet for Canadian models,” the second paragraph should be disregarded and the following text read in lieu thereof:

The manufacturer of your vehicle recommends that you have maintenance and repair performed by your BMW dealer’s service center or another service center or repair shop that employs trained personnel that can perform maintenance and repair work on your vehicle in accordance with BMW specifications. The manufacturer of your vehicle

recommends that you maintain records of all maintenance and repair work performed on your vehicle.

messages of these comfort functions are no longer displayed.

- 18.** At page 244, where it reads: “Do not perform work/bulb replacement on xenon headlamps,” that text should be disregarded and in lieu thereof the following text should be read: “Xenon headlamp work or replacement can cause serious and fatal injuries.” In the text that follows, where it reads: “[h]ave any work on the xenon lighting system . . . ,” the following words should be read as preceding that passage: “It is strongly suggested that you”

- 19.** At page 247, under the “Battery replacement” section, the text should be disregarded and in lieu thereof the following text should be read:

Use of recommended vehicle batteries

The manufacturer of your vehicle recommends that you use vehicle batteries that it has tested and recommends for use in your vehicle; otherwise the vehicle could be damaged and systems or functions may not be fully available.

After a battery replacement, the manufacturer of your vehicle recommends that you have the battery registered on your vehicle by a service center to ensure that all comfort functions are fully available, and that any “check control”

Contents

The fastest way to find information on a particular topic or item is by using the index, refer to page 272.

6 Notes

At a glance

12 Cockpit
18 iDrive
25 Voice activation system

Controls

30 Opening and closing
46 Adjusting
53 Transporting children safely
55 Driving
71 Displays
85 Lamps
90 Safety
99 Driving stability control systems
103 Driving comfort
107 Climate
114 Interior equipment
122 Storage compartments

Driving tips

128 Things to remember when driving

Navigation

138 Navigation system
140 Destination entry
149 Destination guidance
157 What to do if...

Entertainment

160 Tone
162 Radio
170 CD/multimedia

Communications

192 Telephone
203 Office
212 Contacts
215 ConnectedDrive

Mobility

222 Refueling
224 Fuel
226 Wheels and tires
235 Engine compartment
241 Maintenance
243 Replacing components
249 Breakdown assistance
255 Care

Reference

262 Technical data
264 Short commands of the voice activation system
272 Everything from A to Z

Notes

Using this Owner's Manual

The fastest way to find information on a particular topic is by using the index.

An initial overview of the vehicle is provided in the first chapter.

Additional sources of information

Should you have any questions, your service center will be glad to advise you at any time.

Information on BMW, e.g., on technology, is available on the Internet: bmwusa.com

Symbols

 Indicates precautions that must be followed precisely in order to avoid the possibility of personal injury and serious damage to the vehicle.

◀ Marks the end of a specific item of information.

"..." Identifies display texts in vehicle used to select individual functions.

»...« Verbal instructions to use with the voice activation system.

»...« Identifies the answers generated by the voice activation system.

 Refers to measures that can be taken to help protect the environment.

Symbols on vehicle components

 Indicates that you should consult the relevant section of this Owner's Manual for information on a particular part or assembly.

Vehicle equipment

This Owner's Manual describes all models, all series equipment, as well as country-specific and special equipment offered in the model

series. Therefore, this Owner's Manual also describes and depicts equipment that may not be contained in your vehicle because of the selected special equipment or country version, for example.

This also applies to safety-related functions and systems.

For options and equipment not described in this Owner's Manual, please refer to the Supplementary Owner's Manuals.

On right-hand drive vehicles, some controls are arranged differently than shown in the illustrations.

Status of this Owner's Manual at time of printing

The manufacturer of your vehicle pursues a policy of constant development that is conceived to ensure that our vehicles continue to embody the highest quality and safety standards. In rare cases, therefore, the features described in this Owner's Manual may differ from those in your vehicle.

Updates made after the editorial deadline

Any updates made after the editorial deadline for the Owner's Manuals are located in the appendix of the printed quick reference for the vehicle.

For your own safety

Warranty

Your vehicle is technically configured for the operating conditions and registration requirements applying in the country of first delivery — homologation. If your vehicle is to be operated in a different country it might be neces-

sary to adapt your vehicle to potentially differing operating conditions and permit requirements. If your vehicle does not comply with the homologation requirements in a certain country you cannot lodge warranty claims for your vehicle there. Further information can be obtained from your Service Center.

Maintenance and repairs

Advanced technology, e.g., the use of modern materials and high-performance electronics, requires suitable maintenance and repair methods.

Therefore, have this work performed only by a BMW center or a workshop that works according to BMW repair procedures with appropriately trained personnel.

If this work is not carried out properly, there is the danger of subsequent damage and related safety hazards.

Parts and accessories

For your own safety, it is recommended that you use genuine parts and accessories approved by BMW. When you purchase accessories tested and approved by BMW and Genuine BMW Parts, you simultaneously acquire the assurance that they have been thoroughly tested by BMW to ensure optimum performance when installed on your vehicle. BMW warrants these parts to be free from defects in material and workmanship. BMW will not accept any liability for damage resulting from installation of parts and accessories not approved by BMW. BMW cannot test every product made by other manufacturers to verify if it can be used on a BMW safely and without risk to either the vehicle, its operation, or its occupants. Genuine BMW Parts, BMW Accessories and other products approved by BMW, together with professional advice on using these items, are available from all BMW centers. Installation and operation of non BMW approved accessories such as alarms, radios, amplifiers, radar detectors, wheels, suspension

components, brake dust shields, telephones, including operation of any mobile phone from within the vehicle without using an externally mounted antenna, or transceiver equipment, for instance, CBs, walkie-talkies, ham radios or similar accessories, may cause extensive damage to the vehicle, compromise its safety, interfere with the vehicle's electrical system or affect the validity of the BMW Limited Warranty. See your BMW center for additional information. Maintenance, replacement, or repair of the emission control devices and systems may be performed by any automotive repair establishment or individual using any certified automotive part.

California Proposition 65 Warning

California laws require us to state the following warning:

Engine exhaust and a wide variety of automobile components and parts, including components found in the interior furnishings in a vehicle, contain or emit chemicals known to the State of California to cause cancer and birth defects and reproductive harm. In addition, certain fluids contained in vehicles and certain products of component wear contain or emit chemicals known to the State of California to cause cancer and birth defects or other reproductive harm. Battery posts, terminals and related accessories contain lead and lead compounds. Wash your hands after handling. Used engine oil contains chemicals that have caused cancer in laboratory animals. Always protect your skin by washing thoroughly with soap and water.

Service and warranty

We recommend that you read this publication thoroughly. Your vehicle is covered by the following warranties:

- ▷ New Vehicle Limited Warranty
- ▷ Rust Perforation Limited Warranty

- ▷ Federal Emissions System Defect Warranty
- ▷ Federal Emissions Performance Warranty
- ▷ California Emission Control System Limited Warranty

Detailed information about these warranties is listed in the Service and Warranty Information Booklet for US models or in the Warranty and Service Guide Booklet for Canadian models.

Your vehicle has been specifically adapted and designed to meet the particular operating conditions and homologation requirements in your country and continental region in order to deliver the full driving pleasure while the vehicle is operated under those conditions. If you wish to operate your vehicle in another country or region, you may be required to adapt your vehicle to meet different prevailing operating conditions and homologation requirements. You should also be aware of any applicable warranty limitations or exclusions for such country or region. In such case, please contact Customer Relations for further information.

Maintenance

Maintain the vehicle regularly to sustain the road safety, operational reliability and the New Vehicle Limited Warranty.

Specifications for required maintenance measures:

- ▷ BMW Maintenance system
- ▷ Service and Warranty Information Booklet for US models
- ▷ Warranty and Service Guide Booklet for Canadian models

If the vehicle is not maintained according to these specifications, this could result in serious damage to the vehicle. Such damage is not covered by the BMW New Vehicle Limited Warranty.

Data memory

Numerous electronic components in your vehicle contain data memories that store technical information on the vehicle condition, events and faults, either temporarily or permanently. This technical information generally documents the state of a component, a module, a system or the environment.

- ▷ Operating conditions of system components, such as filling levels.
- ▷ Status messages from the vehicle and its individual components, such as wheel rpm/speed, motion delay, transverse acceleration.
- ▷ Malfunctions and defects in important system components, such as lights and brakes.
- ▷ Vehicle responses to special driving situations, such as airbag deployment, use of the stability control systems.
- ▷ Ambient conditions, such as the temperature.

These data are of a technical nature only and are used to detect and eliminate faults and to optimize vehicle functions. Travel profiles of routes driven with the vehicle cannot be created from these data. If services are used, for instance in the event of repairs, service processes, warranty cases, quality assurance, etc., this technical information can be read out from the event and fault data memories by service personnel, including the manufacturer, using special diagnosis tools. This service personnel can provide you with more information if needed. After troubleshooting, the information in the fault memory is cleared or overwritten continuously.

Situations are conceivable during the use of the vehicle in which these technical data could become associated with a specific person in combination with other information, such as an accident report, damage to the vehicle, witness accounts, etc., possibly with the involvement of an authorized expert.

Additional functions that are contractually agreed with the customer, such as vehicle localization in the event of an emergency, permit the transfer of certain vehicle data out of the vehicle.

Event Data Recorder EDR

This vehicle is equipped with an event data recorder EDR. The main purpose of an EDR is to record, in certain crash or near crash-like situations, such as an air bag deployment or hitting a road obstacle, data that will assist in understanding how a vehicle's systems performed. The EDR is designed to record data related to vehicle dynamics and safety systems for a short period of time, typically 30 seconds or less.

The EDR in this vehicle is designed to record such data as:

- ▶ How various systems in your vehicle were operating.
- ▶ Whether or not the driver and passenger safety belts were fastened.
- ▶ How far, if at all, the driver was depressing the accelerator and/or brake pedal.
- ▶ How fast the vehicle was traveling.

These data can help provide a better understanding of the circumstances in which crashes and injuries occur.

EDR data are recorded by your vehicle only if a nontrivial crash situation occurs; no data are recorded by the EDR under normal driving conditions and no personal data, e.g., name, gender, age, and crash location, are recorded.

However, other parties, such as law enforcement, could combine the EDR data with the type of personally identifying data routinely acquired during a crash investigation.

To read data recorded by an EDR, special equipment is required, and access to the vehicle or the EDR is needed. In addition to the vehicle manufacturer, other parties, such as law

enforcement, that have the special equipment, can read the information if they have access to the vehicle or the EDR.

Reporting safety defects

For US customers

The following only applies to vehicles owned and operated in the US.

If you believe that your vehicle has a defect which could cause a crash or could cause injury or death, you should immediately inform the National Highway Traffic Safety Administration NHTSA, in addition to notifying BMW of North America, LLC, P.O. Box 1227, Westwood, New Jersey 07675-1227, Telephone 1-800-831-1117.

If NHTSA receives similar complaints, it may open an investigation, and if it finds that a safety defect exists in a group of vehicles, it may order a recall and remedy campaign.

However, NHTSA cannot become involved in individual problems between you, your dealer, or BMW of North America, LLC.

To contact NHTSA, you may call the Vehicle Safety Hotline toll-free at 1-888-327-4236 (TTY: 1-800-424-9153); go to <http://www.safercar.gov>; or write to: Administrator, NHTSA, 400 Seventh Street, SW., Washington, DC 20590. You can also obtain other information about motor vehicle safety from <http://www.safercar.gov>

For Canadian customers

Canadian customers who wish to report a safety-related defect to Transport Canada, Defect Investigations and Recalls, may telephone the toll-free hotline 1-800-333-0510. You can also obtain other information about motor vehicle safety from <http://www.tc.gc.ca/roadsafety>.



At a glance

These overviews of buttons, switches and displays are intended to familiarize you with your vehicle. You will also become quickly acquainted with the available control concepts and options.

Cockpit

Vehicle equipment

This chapter describes all series equipment as well as country-specific and special equipment offered for this model series. Therefore, it also describes equipment that may not be found in your vehicle, for instance due to the selected

special equipment or the country version. This also applies to safety-related functions and systems.





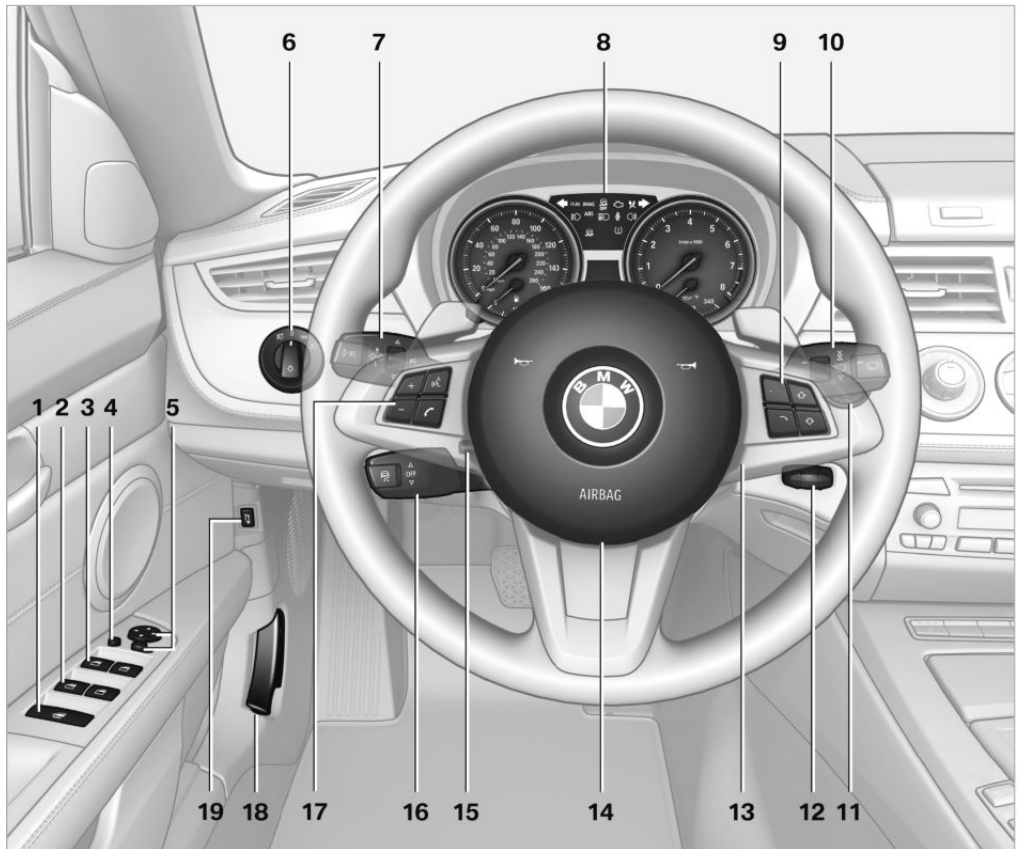



















When using the features and systems described here, adhere to local regulations.

All around the steering wheel



1  Opening and closing windows jointly [41](#)

2  Opening and closing rear windows [41](#)

- 3**  Opening and closing front windows [41](#)
- 4** Exterior mirrors, folding in and out [50](#)
- 5** Adjust the exterior mirrors, Automatic Curb Monitor [50](#)
- 6**  Parking lights [85](#)
-  Low beams [85](#)
-  Automatic headlight control [86](#)
Adaptive Light Control [86](#)
High-beam Assistant [87](#)
- 7**  Turn signal [60](#)
-  High beams, headlight flasher [87](#)
-  High-beam Assistant [87](#)
-  Roadside parking lights [87](#)
-  Computer [73](#)
-  Settings and information about the vehicle [75](#)
- 8** Instrument cluster [14](#)
- 9** Buttons on the steering wheel
-  Change the radio station
-  Select a music track
-  Leaf through the phone book and through lists with stored phone numbers
-  Next entertainment source
-  Recirculated air mode [112](#)
- 10**  Windshield wipers [61](#)
-  Rain sensor [61](#)
- 11**  Start/stop the engine and switch the ignition on/off [55](#)
- 12** Ignition lock [55](#)
- 13**  Steering wheel heating [92](#)
- 14** Horn, the entire surface
- 15** Adjust the steering wheel [52](#)
- 16**  Cruise control [103](#)
- 17** Buttons on the steering wheel
-  Telephone [192](#)
-  Volume
-  Activate/deactivate the voice activation system [25](#)
- 18** Releasing the hood [236](#)
- 19**  Open the trunk lid [36](#)

Instrument cluster

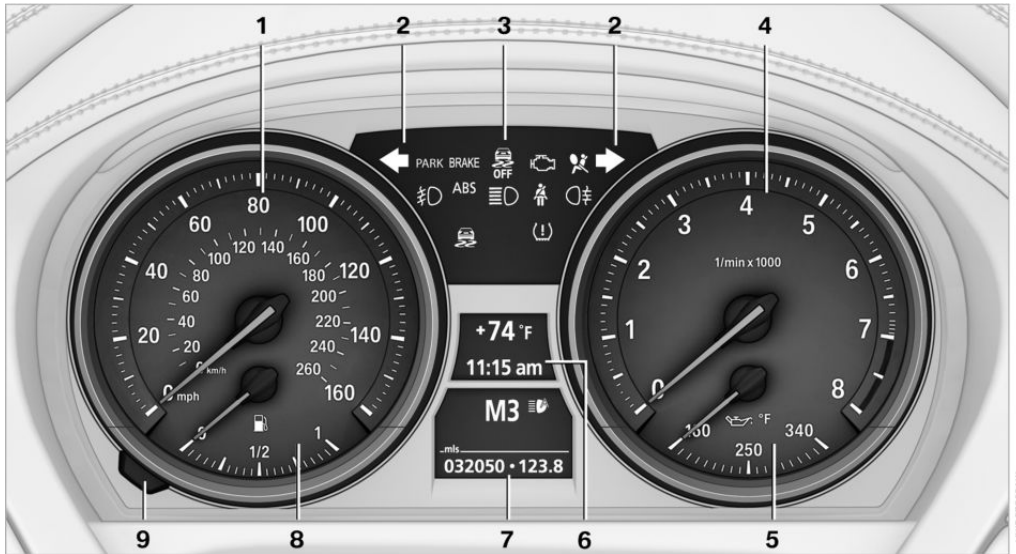

- 1 Speedometer
 - 2 Indicator lamps for turn signals
 - 3 Indicator/warning lamps [15](#)
 - 4 Tachometer [72](#)
 - 5 Engine oil temperature [72](#)
 - 6 Display for
 - ▷ Clock [71](#)
 - ▷ External temperature [71](#)
 - ▷ Indicator/warning lamps [15](#)
 - ▷ Cruise control [103](#)
 - 7 Display for
 - ▷ Gear display, 8-gear Sport automatic transmission [65](#)
 - ▷ Gear display for 7-gear Sport automatic transmission with dual clutch [66](#)
 - 8 Fuel gauge [72](#)
 - 9 Resetting the trip odometer [71](#)
- ▷ Computer [73](#)
 - ▷ Date of next scheduled service, and remaining distance to be driven [78](#)
 - ▷ Odometer and trip odometer [71](#)
 - ▷ Programs for Dynamic Driving Control [100](#)
 - ▷ High-beam Assistant [87](#)
 - ▷ Resetting Tire Pressure Monitor [95](#)
 - ▷ Checking engine oil level [236](#)
 - ▷ Settings and information [75](#)
 - ▷ **▲** Check Control message present [82](#)

Indicator/warning lamps

Instrument cluster



The indicator and warning lamps can light up in a variety of combinations and colors.

Several of the lamps are checked for proper functioning when the engine is started or the ignition is switched on, and light up briefly.

Text messages



Text messages at the upper edge of the Control Display explain the meaning of the displayed indicator and warning lamps.





You can call up more information, e.g., on the cause of a malfunction and on how to respond, via Check Control, refer to page [82](#).

In urgent cases, this information will be shown as soon as the corresponding lamp comes on.

Indicator lamps without text messages





The following indicator lamps notify you that certain functions are active:

Symbol	Function or system
	Turn signal
	High beams/headlamp flasher

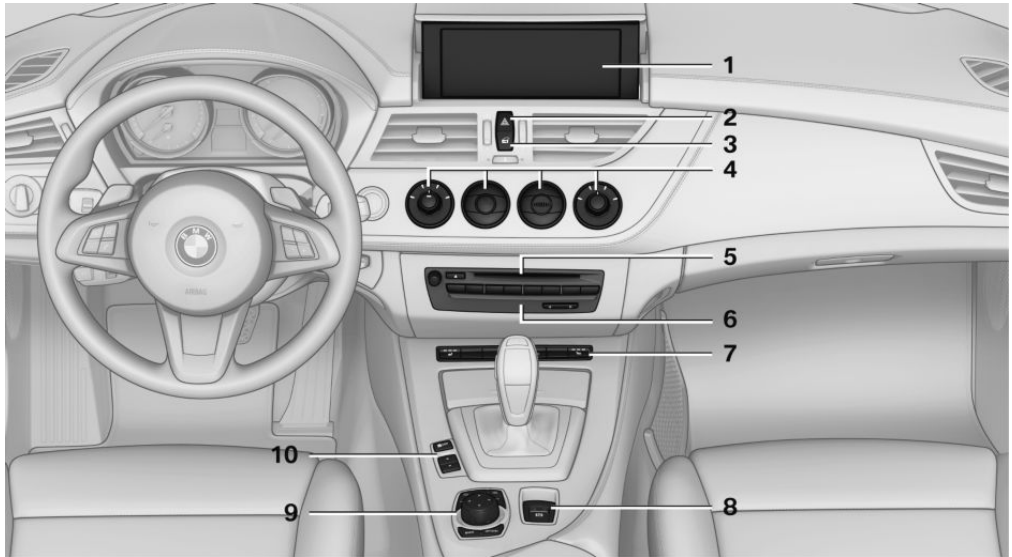
Symbol	Function or system
	Lamp flashes: DSC or DTC is regulating the propulsive forces in order to maintain driving stability
	Parking brake set
	Canada: the parking brake is set.
	Engine malfunction with adverse effect on exhaust emissions
	Canada: engine malfunction with adverse effect on exhaust emissions



All around the center console

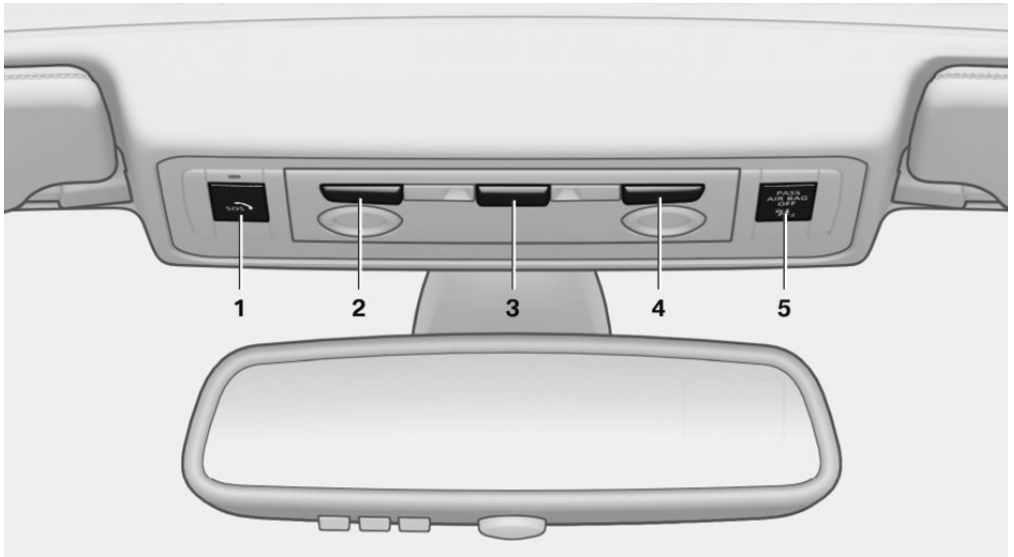

- 1 Control Display 18
- 2 Hazard warning system 249
- 3 Central locking system 35
- 4 > Air conditioner 108
 - > Automatic climate control 110
- 5 Hard drive for
 - > Audio CD/DVD 170
 - > Navigation DVD 138
- 6 Controls for
 - > Radio 162
 - > CD/DVD 170
- 7  Seat heating 48
-  PDC Park Distance Control 105
-  Close the retractable hard-top 42
-  Open the retractable hard-top 42
-  Deactivate the Automatic Engine Start/Stop Function 57
- 8 Parking brake 59
- 9 Controller with buttons 18
- 10 Buttons for Dynamic Driving Control 100

All around the headliner



- 1  Emergency Request [249](#)
- 2 Reading lamp [89](#)
- 3 Interior lamps [89](#)
- 4 Reading lamp [89](#)
- 5  Indicator lamp, front passenger airbag [92](#)

iDrive

Vehicle equipment

This chapter describes all series equipment as well as country-specific and special equipment offered for this model series. Therefore, it also describes equipment that may not be found in your vehicle, for instance due to the selected special equipment or the country version. This also applies to safety-related functions and systems.

When using the features and systems described here, adhere to local regulations.

The concept

The iDrive combines the functions of a multitude of switches. Thus, these functions can be operated from a central location.

 Using the iDrive during a trip

To avoid becoming distracted and posing an unnecessary hazard to your vehicle's occupants and to other road users, never attempt to use the controls or enter information unless traffic and road conditions allow this. ◀

Controls at a glance

Controls

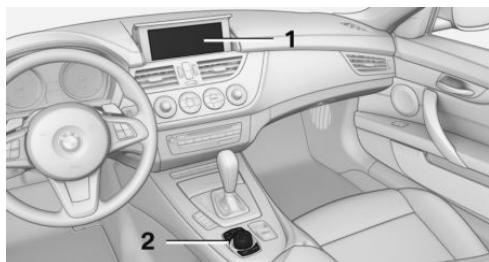

- 1 Control Display
- 2 Controller with buttons

The buttons can be used to open the menu directly. The controller can be used to select menu items and create the settings.

Control Display

Notes

- ▶ To clean the Control Display, follow the care instructions, refer to page 258.
- ▶ Do not place objects close to the Control Display; otherwise, the Control Display can be damaged.

Switching off

1.  Press the button.
2. "Close control display"

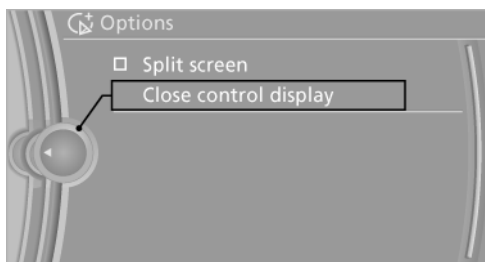

Switching on

Press the controller again to switch the screen back on.

Controller

Select menu items and create settings.

1. Turn.

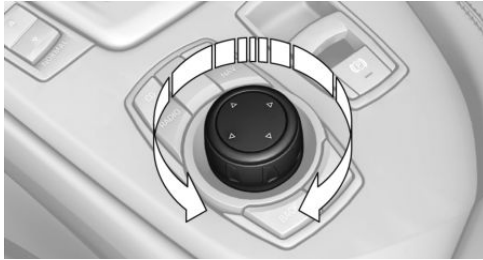

2. Press.



3. Move in four directions.



Buttons on controller

Press the button	Function
MENU	Opens the main menu.
RADIO	Opens the Radio menu.
MEDIA	Opens the CD/Multimedia menu.

Press the button	Function
NAV	Opens the Navigation menu.
TEL	Opens the Telephone menu.
BACK	Displays the previous panel.
OPTION	Opens the Options menu.

Operating concept

Opening the main menu

MENU Press the button.

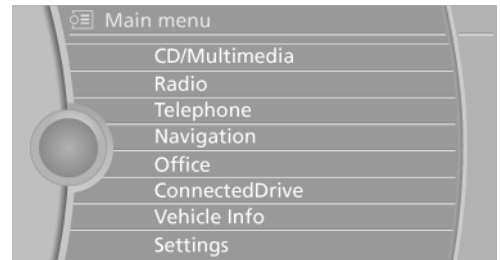

The main menu is displayed.

All iDrive functions can be called up via the main menu.

Selecting menu items

Menu items shown in white can be selected.

1. Turn the controller until the desired menu item is highlighted.

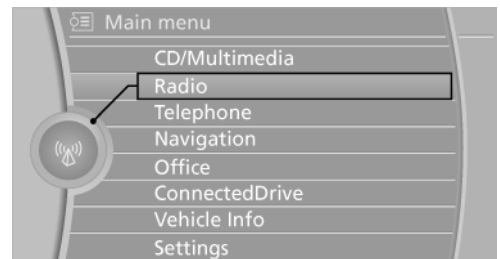

2. Press the controller.

Menu items in the Owner's Manual

In the Owner's Manual, menu items that can be selected are set in quotation marks, e.g., "Settings".

Changing between panels

After a menu item is selected, e.g., "Radio", a new panel is displayed. Panels can overlap.

- ▷ Move the controller to the left.

The current panel is closed and the previous panel is displayed.

The previous panel is opened again by pressing the BACK button. In this case, the current panel is not closed.

- ▷ Move the controller to the right.

A new panel is opened on top of the previous display.

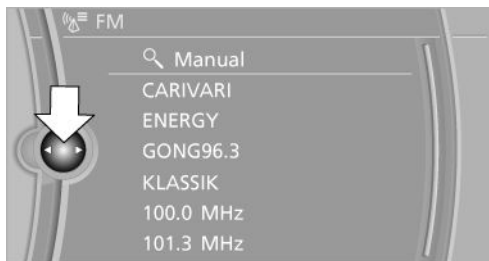

White arrows pointing to the left or right indicate that additional panels can be opened.

View of an opened menu

When a menu is opened, it generally opens with the panel that was last selected in that menu. To display the first panel of a menu:

- ▷ Move the controller to the left repeatedly until the first panel is displayed.
- ▷ Press the menu button on the controller twice.

Opening the Options menu



Press the button.

The "Options" menu is displayed.



Additional options: move the controller to the right repeatedly until the "Options" menu is displayed.

Options menu

The "Options" menu consists of various areas:

- ▷ Screen settings, e.g., "Split screen".
This area remains unchanged.
- ▷ Control options for the selected main menu, e.g., for "Radio".
- ▷ If applicable, further operating options for the selected menu, for instance "Store station".

Changing settings

1. Select a field.
2. Turn the controller until the desired setting is displayed.

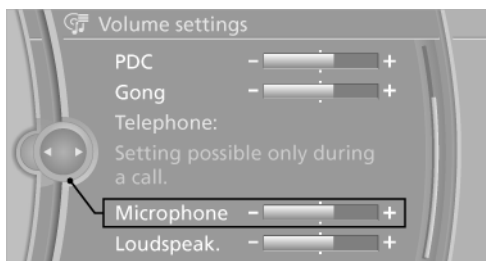

3. Press the controller.

Activating/deactivating the functions

Several menu items are preceded by a check-box. It indicates whether the function is activated or deactivated. Selecting the menu item activates or deactivates the function.

- Function is activated.
- The function is deactivated.

Example: setting the clock

Setting the clock

1.  Press the button. The main menu is displayed.
2. Turn the controller until "Settings" is highlighted, and then press the controller.

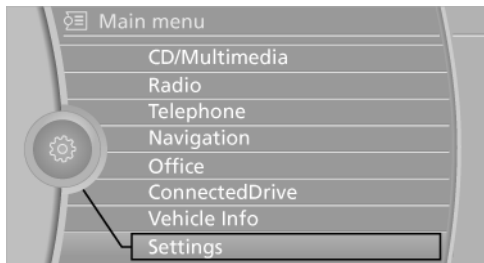

3. If necessary, move the controller to the left to display "Time/Date".
4. Turn the controller until "Time/Date" is highlighted, and then press the controller.



5. Turn the controller until "Time:" is highlighted, and then press the controller.



6. Turn the controller to set the hours and press the controller.
7. Turn the controller to set the minutes and press the controller.

Status information

Status field



The following information is displayed in the status field at the top right:

- ▷ Time.
- ▷ Current entertainment source.
- ▷ Sound output, on/off.
- ▷ Wireless network reception strength.
- ▷ Telephone status.
- ▷ Traffic bulletin reception.











Status field symbols

The symbols are grouped into various categories.







Radio symbols

Symbol	Meaning
	HD Radio™ is switched on.
	Satellite radio is switched on.



Telephone symbols

Symbol	Meaning
	Incoming or outgoing call.
	Missed call.
	Wireless network reception strength Symbol flashes: searching for network.
	Wireless network is not available.
	Bluetooth is switched on.
	Roaming is active.
	Text message, e-mail was received.
	Check the SIM card.
	SIM card is blocked.
	SIM card is missing.
	Enter the PIN.

Entertainment symbols

Symbol	Meaning
	CD/DVD player.
	Music collection.
	Gracenote® database.
	AUX-IN port.
	USB audio interface.
	Mobile phone audio interface.

Additional symbols

Symbol	Meaning
	Spoken instructions are switched off.
	Request of the current vehicle position.

Split screen

General information

Additional information can be displayed on the right side of the split screen, e.g., information from the computer.

In the divided screen view, the so-called split screen, this information remains visible even when you change to another menu.

Switching the split screen on and off

1.  Press the button.
2. "Split screen"

The split screen view is activated.

Selecting the display

1.  Press the button.
2. "Split screen"
3. Move the controller until the split screen is selected.
4. Press the controller or select "Split screen content".
5. Select the desired menu item.

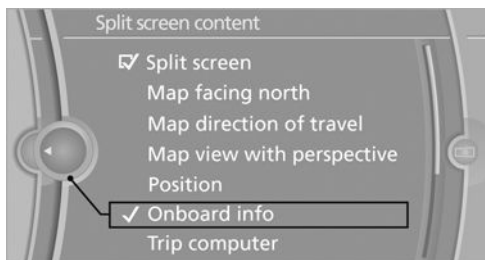

Programmable memory buttons

General information

The iDrive functions can be stored on the programmable memory buttons and called up directly, e.g., radio stations, navigation destina-

tions, phone numbers and entry points into the menu.

The settings are stored for the remote control currently in use.

Saving a function

1. Highlight the function via the iDrive.
2.  Press the desired button for more than two seconds.

Running a function

 Press the button.
The function will run immediately. This means, for example, that the number is dialed when a phone number is selected.

Displaying the button assignment

Use a finger to touch the buttons. Do not wear gloves or use objects.

The key assignment is displayed at the top edge of the screen.





- ▶ To display short information: touch the button.
- ▶ To display detailed information: touch the button for an extended period.

Entering letters and numbers



1. Turn the controller: select letters or numbers.

2. Select additional letters or numbers if needed.
3. "OK": confirm the entry.

Symbol	Function
	Press the controller: delete the letter or number.
	Press the controller for an extended period: delete all letters or numbers.
	Enter a blank space.



Switching between letters and numbers

Depending on the menu, you can switch between entering letters and numbers.

Symbol	Function
	Enter the letters.
	Enter the numbers.

Switching between upper and lower case letters

Depending on the menu, you can switch between entering uppercase and lowercase letters.

Symbol	Function
 abc	Move the controller up: switch from upper to lower case letters.
 ABC	Move the controller up: switch from lower to upper case letters.

Entry comparison

Entry of names and addresses: the selection is narrowed down every time a letter is entered and letters may be added automatically.

The entries are continuously compared to the data stored in the vehicle.

- ▶ Only those letters are offered during the entry for which data is available.

- ▷ Destination search: town/city names can be entered using the spelling of language available on the Control Display.

Voice activation system

Vehicle equipment

This chapter describes all series equipment as well as country-specific and special equipment offered for this model series. Therefore, it also describes equipment that may not be found in your vehicle, for instance due to the selected special equipment or the country version. This also applies to safety-related functions and systems.

When using the features and systems described here, adhere to local regulations.

The concept

- ▷ Most functions that are displayed on the Control Display can be operated with the voice activation system using spoken commands. The system prompts you to make your entries.
- ▷ Functions that can only be used when the vehicle is stationary cannot be operated using the voice activation system.
- ▷ The system uses a special microphone on the driver's side.
- ▷ >...< Verbal instructions in the Owner's Manual to use with the voice activation system.

Requirements

Via the Control Display, set a language that is also supported by the voice activation system so that the spoken commands can be identified.

Set the language, refer to page 78.

Using voice activation

Activating the voice activation system

1.  Press the button on the steering wheel.
2. Wait for the signal.
3. Say the command.
The command appears on the Control Display.

 The symbol on the Control Display indicates that the voice activation system is active.

If no other commands are available, operate the function via iDrive in this case.

Terminating the voice activation system

 Briefly press the button on the steering wheel or >Cancel<.

Possible commands

Most menu items on the Control Display can be voiced as commands.

The available commands depend on the menu that is currently displayed on the Control Display.

The functions of the main menu have short commands.

Some list items, such as the phone book entries, can also be selected via the voice activation system. Say the list items exactly as they are displayed on the list.

Having possible commands read aloud

You can have the system read possible commands aloud: >Voice commands<.

For example, if the "Settings" menu is displayed, the commands for the settings are read out loud.

Executing functions using short commands

Functions on the main menu can be performed directly by means of short commands, usually irrespective of which menu item is currently selected, for instance ›Vehicle status‹.

List of short commands of the voice activation system, refer to page 264.

Help dialog for the voice activation system

Calling up help dialog: ›Help‹

Additional commands for the help dialog:

- ▷ ›Help with examples‹: information about the current operating options and the most important commands for them are announced.
- ▷ ›Help with voice activation‹: information about the principle of operation for the voice activation system is announced.

Example: playing back a CD

Via the main menu

The commands of the menu items are spoken out loud, in the same way as they are selected via the controller.

1. Switch on the Entertainment sound output if necessary.
2.  Press the button on the steering wheel.
3. ›C D and multimedia‹
The medium last played is played back.
4. ›C D‹
5. ›C D drive‹
The CD is played back.

6.  Press the button on the steering wheel again to select a specific track.
7. ›Track ...‹ e.g., CD track 4.

Via short commands

Playback of the CD can also be started using a short command.

1. Switch on the Entertainment sound output if necessary.
2.  Press the button on the steering wheel.
3. ›C D drive Track ...‹ e.g., CD track 4.

Setting the voice dialog

You can set whether the system should use the standard dialog or a shorter version.

In the shorter variant of the voice dialog, the announcements from the system are issued in an abbreviated form.

On the Control Display:

1. "Settings"
2. "Language/Units"
3. "Speech mode:"
4. Select the setting.

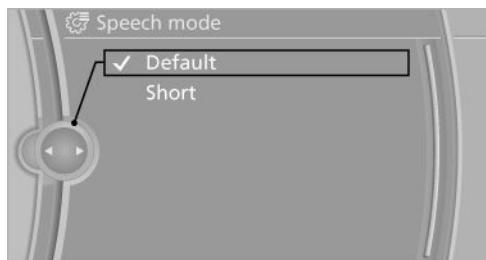

Adjusting the volume

Turn the volume button during the spoken instructions until the desired volume is set.

- ▶ The volume remains constant even if the volume of other audio sources is changed.
- ▶ The volume is stored for the remote control currently in use.

Notes on Emergency Requests

Do not use the voice activation system to initiate an Emergency Request. In stressful situations, the voice and vocal pitch can change. This can unnecessarily delay the establishment of a telephone connection.

Instead, use the SOS button, refer to page [249](#), in the vicinity of the interior mirror.

Environmental conditions

- ▶ Say the commands, numbers, and letters smoothly and with normal volume, emphasis, and speed.
- ▶ Always say commands in the language of the voice activation system.
- ▶ Keep the doors, windows, and retractable hardtop closed to prevent noise interference.
- ▶ Avoid making other noise in the vehicle while speaking.



START
STOP
ENGINE

Controls

This chapter is intended to provide you with information that will give you complete control of your vehicle. All features and accessories that are useful for driving and your safety, comfort and convenience are described here.

Opening and closing

Vehicle equipment

This chapter describes all series equipment as well as country-specific and special equipment offered for this model series. Therefore, it also describes equipment that may not be found in your vehicle, for instance due to the selected special equipment or the country version. This also applies to safety-related functions and systems.

When using the features and systems described here, adhere to local regulations.

Remote control

Buttons on the remote control

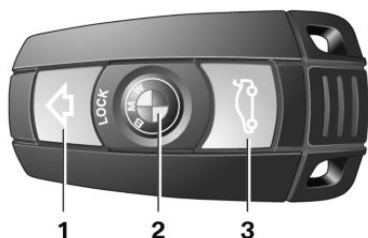

- 1 Unlocking
- 2 Locking
- 3 Opening the trunk lid

General information

The vehicle is supplied with two remote controls with keys.

Each remote control contains a rechargeable battery that is automatically recharged when it is in the ignition lock while the car is being driven. Use each remote control at least twice a year for longer road trips in order to maintain the batteries' charge status.

In vehicles equipped with Comfort Access, the remote control contains a replaceable battery, refer to page 39.

The settings called up and implemented when the vehicle is unlocked depend on which remote control is used to unlock the vehicle, refer to Personal Profile.

In addition, information about service requirements is stored in the remote control, Service data in the remote control, refer to page 241.

Integrated key

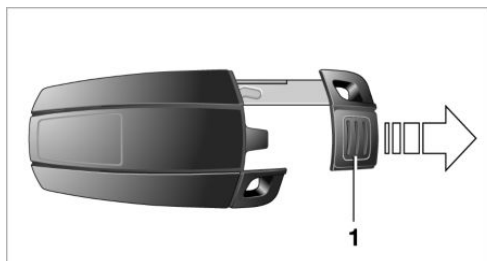

Press button 1 and pull out the key.

The integrated key fits the following locks:

- ▷ Glove compartment, refer to page 122.
- ▷ Driver's door, refer to page 35.

New remote controls

You can obtain new remote controls from your service center.

Loss of the remote controls

Lost remote controls can be blocked by your service center.

Personal Profile

The concept

You can set several of your vehicle's functions to suit your personal needs and preferences.

- ▷ The settings are automatically saved in the profile currently activated.
- ▷ The remote control used is detected when the vehicle is unlocked and the stored profile is called up.
- ▷ Your personal settings will be recognized and called up again even if the vehicle has been used in the meantime by someone else with another remote control.

The individual settings are stored for a maximum of four remote controls. They are stored for two remote controls if Comfort Access is in use.

Personal Profile settings

The following functions and settings can be stored in a profile.

More information on the settings can be found under:

- ▷ Assigning the programmable memory buttons, refer to page 22.
- ▷ Response of the central locking system when the car is being unlocked, refer to page 32.
- ▷ Automatic locking of the vehicle, refer to page 35.
- ▷ Automatic retrieval of the driver's seat and exterior mirror positions after unlocking, refer to page 34.
- ▷ Triple turn signal activation, refer to page 60.
- ▷ Settings for the display on the Control Display and in the instrument cluster:
 - ▷ 12h/24h clock format, refer to page 76.
 - ▷ Date format, refer to page 77.
 - ▷ Brightness of the Control Display, refer to page 78.
 - ▷ Language on the Control Display, refer to page 78.
 - ▷ Split screen, refer to page 22.
- ▷ Units of measure for fuel consumption, distance covered/remaining distances and temperature, refer to page 76.
- ▷ Volume of PDC Park Distance Control, refer to page 106.
- ▷ Light settings:
 - ▷ Welcome lights, refer to page 85.
 - ▷ Headlight courtesy delay feature, refer to page 86.
 - ▷ Daytime running lights, refer to page 86.
 - ▷ High-beam Assistant, refer to page 87.
- ▷ Automatic climate control: AUTO program, cooling function, and automatic recirculated air control activated/deactivated, temperature, air flow rate, and air distribution, refer to page 110.
- ▷ Navigation:
 - ▷ Voice activation, refer to page 151.
 - ▷ Map view settings, refer to page 153.
 - ▷ Route criteria, refer to page 149.
- ▷ Entertainment:
 - ▷ Tone control, refer to page 160.
 - ▷ Radio, stored stations, refer to page 168.
 - ▷ CD/multimedia, audio source listened to last, refer to page 170.
- ▷ Telephone:
 - ▷ Volume, refer to page 196.

Central locking system

The concept

The central locking system becomes active when the driver's door is closed.

The system simultaneously engages and releases the locks on the following:

- ▷ Doors.

- ▷ Trunk lid.
- ▷ Fuel filler flap.
- ▷ Center armrest.

Operating from the outside

- ▷ Via the remote control.
- ▷ Via the driver's door lock.
- ▷ In cars with Comfort Access, via the door handles on the driver's and front passenger sides.

The following takes place simultaneously when locking/unlocking the vehicle via the remote control:

- ▷ The welcome lamps, interior lamps and courtesy lamps are switched on and off.
- ▷ The alarm system is armed or disarmed, refer to page 39.

Operating from the inside

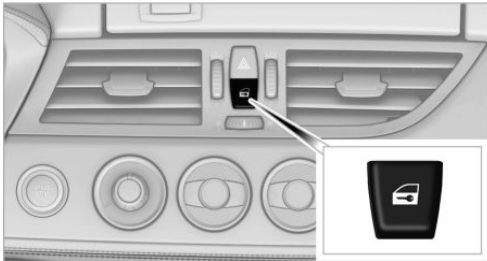

Via the button for the central locking system.

If the vehicle is locked from the inside, the fuel filler flap remains unlocked.

If an accident of a certain severity occurs, the central locking system unlocks automatically.

The hazard warning system and interior lamps come on.

Opening and closing: from the outside

Using the remote control

General information



Take the remote control with you

People or animals left unattended in a parked vehicle can lock the doors from the inside. Always take the remote control with you when leaving the vehicle so that the vehicle can then be opened from the outside. ◀

Conditions for operating the retractable hard-top using the remote control:

- ▷ The doors and trunk lid are closed.
- ▷ The cargo area partition is folded down and engaged on both sides, refer to page 43.

Unlocking



Press the button. The vehicle is unlocked. You can set how the vehicle is to be unlocked. The setting is stored for the remote control currently in use.

1. "Settings"
2. "Door locks"
3. "Unlock button:"

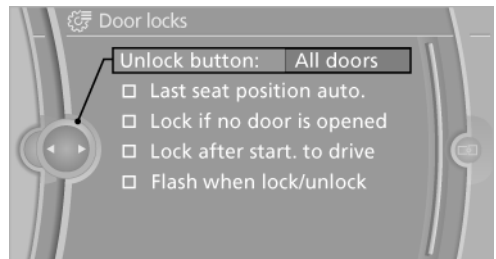

4. Select a menu item:

- ▷ "All doors"



The entire vehicle is unlocked.

- ▷ "Driver's door only"

 Only the driver's door and the fuel filler flap are unlocked. Pressing again unlocks the entire vehicle.

5. Press the controller.

Convenient opening: window and hardtop

When you are close to the vehicle, the remote control for Comfort Access can be used to open the retractable hardtop.

 Press and hold the button on the remote control.

The windows and the retractable hardtop are opened if the doors are closed.

 Hold the button down. When you are close to the vehicle, the windows move up after the hardtop is opened.

 **Monitor the opening process**
Monitor the opening process to ensure that no one becomes trapped; otherwise, injuries may result. Releasing the button interrupts the opening process. ◀

Locking

 **LOCK** Press the button on the remote control.

 **Locking from the outside**
Do not lock the vehicle from the outside if there are people in it, as the vehicle cannot be unlocked from inside without special knowledge. ◀

Convenient closing

When you are close to the vehicle, the remote control for Comfort Access can be used to close the retractable hardtop and the windows.

 **LOCK** Press and hold the button on the remote control.

The retractable hardtop and the windows are closed.

 **Monitor the closing process**
Monitor the closing process to ensure that no one becomes trapped.

Releasing the button stops the motion. ◀

Switching on the interior lamps and courtesy lamps

 **LOCK** Press the button on the remote control with the vehicle locked.

Unlocking the trunk lid

 Press the button on the remote control for approx. one second.

 **Note the opening height of the trunk lid**
During opening, the trunk lid pivots back and up. Ensure that there is sufficient clearance when the trunk lid opens; otherwise, damage may result. ◀

To avoid locking yourself out of the vehicle, do not place the remote control into the cargo area. A previously locked trunk lid is locked again after closing.

Before and after each trip, check that the trunk lid has not been inadvertently unlocked.

Convenient loading

When you are close to the vehicle, the remote control for Comfort Access can be used to partially tilt the open hardtop for more convenient loading of the trunk.

1.  Briefly press the button on the remote control.
Press again within one second and hold until the retractable hardtop stops in an intermediate position. The trunk lid opens slightly.
2. Open the trunk lid, press the cargo area partition upward and stow the cargo in the cargo area.

3. Press down the cargo area partition until it engages on both sides and close the trunk lid.
4.  Press the button on the remote control for an extended period to fold the retractable hardtop back in.

Confirmation signals from the vehicle

1. "Settings"
2. "Door locks"
3. "Flash when lock/unlock"

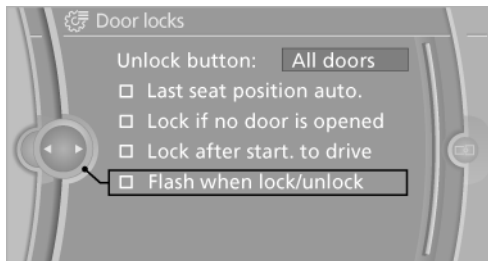

4. Press the controller

Retrieving the seat and mirror settings

The driver's seat and exterior mirror positions used last are stored for the remote control currently in use.

When the vehicle is being unlocked, these positions are automatically retrieved if the setting is activated.

 Keep the footwell behind the driver's seat clear

When this Personal Profile function is used, first make sure that the footwell behind the driver's seat is free of obstacles. Failure to do so could result in damage to the objects if the seat were to move rearward. ◀

The adjustment procedure is interrupted:

- ▷ When a seat position switch is pressed.
- ▷ When a button of the seat and mirror memory is pressed briefly.

1. "Settings"

2. "Door locks"
3. "Last seat position auto."

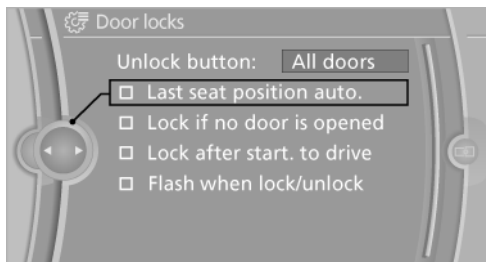

Malfunctions

Local radio waves may interfere with the remote control.

In this case, unlock and lock the car at the door lock with the integrated key.

In vehicles without an alarm system or Comfort Access, only the driver's door can be unlocked and locked using the integrated key in the door lock.

If the car can no longer be locked with a remote control, the battery in the remote control is discharged. Use the remote control during an extended drive in order to recharge the battery, refer to page 30.

The remote control for Comfort Access contains a battery that may need to be replaced, refer to page 39.

For US owners only

The transmitter and receiver units comply with part 15 of the FCC/Federal Communication Commission regulations. Operation is governed by the following:

FCC ID:

LX8766S

LX8766E

LX8CAS

Compliance statement:

This device complies with part 15 of the FCC Rules. Operation is subject to the following two conditions:

- ▶ This device may not cause harmful interference, and
- ▶ this device must accept any interference received, including interference that may cause undesired operation.

Any unauthorized modifications or changes to these devices could void the user's authority to operate this equipment.

Using the door lock

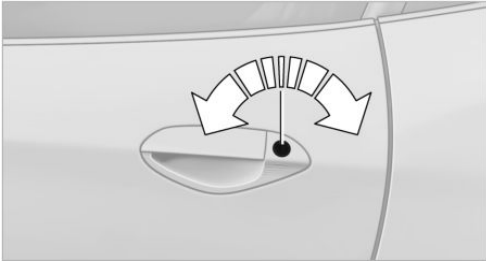

Locking from the outside

Do not lock the vehicle from the outside if there are people in it, as the vehicle cannot be unlocked from inside without special knowledge. ◀

Remove the key before pulling the door handle

Before pulling the outside door handle, remove the key to avoid damaging the paintwork and the key. ◀

Manual operation

If an electrical malfunction occurs, unlock or lock the driver's door using the integrated key in the door lock.

Opening and closing: from the inside

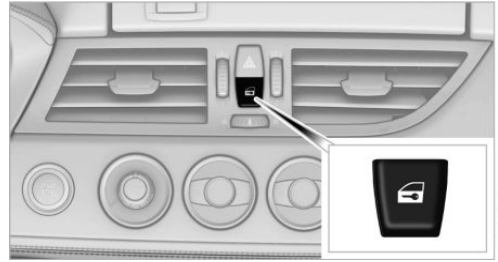

Locking and unlocking



Press the button.

The doors and the trunk lid are locked or unlocked when the front doors are closed, but they are not secured against theft.

The fuel filler flap remains unlocked.

Automatic locking

The setting is stored for the remote control currently in use.

1. "Settings"
2. "Door locks"
3. Select the desired function:
 - ▶ "Lock if no door is opened" The vehicle locks automatically after a short period of time if a door is not opened.
 - ▶ "Lock after start. to drive" The vehicle locks automatically after you drive away.

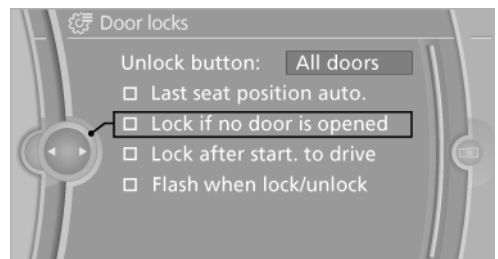

Unlocking and opening doors

- ▷  Press the button. The doors are unlocked. To open, pull the door handle above the armrest.
- ▷ Pull the door handle above the armrest twice: the door is unlocked the first time and opened the second time.

Locking

- ▷  Press the button. The doors are locked.
- ▷ Press the lock button of a door. To prevent you from being locked out, the opened driver's door cannot be locked using the lock button.

 Take the remote control with you. People or animals left unattended in a parked vehicle can lock the doors from the inside. Always take the remote control with you when leaving the vehicle so that the vehicle can then be opened from the outside. ◀

Trunk lid

 Note the opening height of the trunk lid. During opening, the trunk lid pivots back and up. Ensure that there is sufficient clearance when the trunk lid opens; otherwise, damage may result. ◀

Opening from the inside

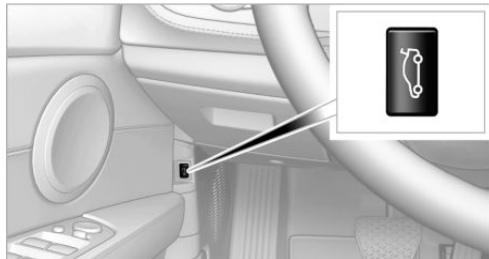

 Press the button.

The trunk lid opens unless it has been locked.

Opening from the outside



- ▷ Press on the top half of the BMW emblem.
- ▷  Press the button on the remote control for approx. one second.

The trunk lid can be opened.

Closing



Recessed grips in the interior trim of the trunk lid make it easier to pull down the lid.

 **Danger of pinching**
Make sure that the closing path of the trunk lid is clear; otherwise, injuries may result. ◀

Press the trunk lid down lightly.
It is closed automatically.

Emergency unlocking



Pull the lever in the cargo area.
The trunk lid unlocks.

Comfort Access

The concept

The vehicle can be accessed without activating the remote control.

All you need to do is to have the remote control with you, e.g., in your jacket pocket.

The vehicle automatically detects the remote control when it is nearby or in the passenger compartment.

Comfort Access supports the following functions:

- Unlocking/locking of the vehicle.
- Convenient closing.
- Convenient opening
- Unlocking of the trunk lid separately.
- Starting the engine.

Functional requirement

- To lock the vehicle, the remote control must be located outside of the vehicle.
- The vehicle cannot be unlocked or locked again for approx. the next two seconds.
- The engine can only be started if the remote control is inside the vehicle.

Comparison to the standard remote control

The specified functions can be controlled by pressing the button or via Comfort Access.

If you notice a brief delay while opening or closing the windows or retractable hardtop, the system is checking whether a remote control is inside the vehicle. Repeat the opening or closing procedure, if necessary.

Unlocking

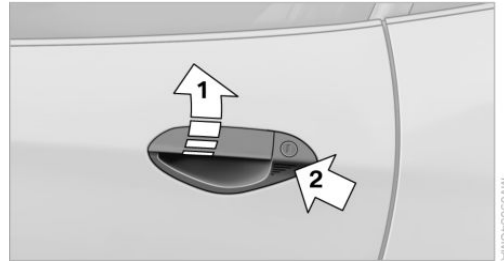

Pull the handle up, arrow 1. This corresponds to pressing the  button.

Locking

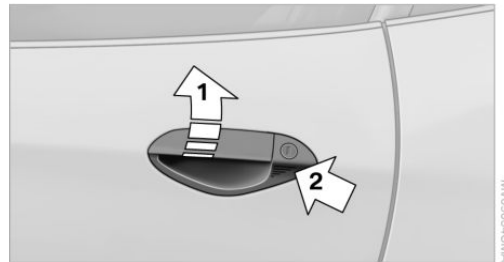

Press on the surface, arrow 2.

This corresponds to pressing the  LOCK button.

To save battery power, ensure that the ignition and all electronic systems and/or power consumers are switched off before locking the vehicle.

Window and convertible top operation

With the ignition in the radio ready state or beyond, the windows and the convertible top can be opened and closed when a remote control is located inside the vehicle.

Unlocking the trunk lid separately

Press on the top half of the BMW emblem. This corresponds to pressing the  button.

If a remote control accidentally left in the cargo area is detected in the locked vehicle, then the trunk lid opens again. The hazard warning system flashes and, depending on the vehicle equipment, a signal sounds.

Switching on the radio ready state

Pressing the Start/Stop button switches on the radio ready state, refer to page [56](#).

Do not depress the brake or the clutch; otherwise, the engine will start.

Starting the engine

The engine can be started or the ignition can be switched on when a remote control is inside the vehicle. It is not necessary to insert a remote control into the ignition lock, refer to page [55](#).

Switching off the engine in cars with Sport automatic transmission

When the engine is switched off, transmission position P is engaged automatically unless N is engaged and the remote control is inserted in the ignition lock.

Driving into an automatic car wash with a Sport automatic transmission

To make it possible for the vehicle to roll, such as in an automatic car wash, follow the instructions in Car washes, refer to page [255](#).

Malfunction

The Comfort Access functions can be disturbed by local radio waves, such as by a mobile

phone in the immediate vicinity of the remote control or when a mobile phone is being charged in the vehicle.

If this occurs, open or close the vehicle using the buttons on the remote control or use the integrated key in the door lock.

To start the engine afterward, insert the remote control into the ignition switch.

Warning lights



The warning light in the instrument cluster lights up when you attempt to start the engine: the engine cannot be started.

The remote control is not inside the vehicle or is malfunctioning. Take the remote control with you inside the vehicle or have it checked. If necessary, insert another remote control into the ignition switch.



The warning light in the instrument cluster lights up while the engine is running: the remote control is no longer inside the vehicle.

After the engine is switched off, the engine can only be restarted within approx. 10 seconds.



The indicator lamp in the instrument cluster comes on and a message appears on the Control Display: replace the remote control battery.

Replacing the battery

The remote control for Comfort Access contains a battery that will need to be replaced from time to time.

1. Take the integrated key out of the remote control, refer to page 30.



2. Remove the cover.
3. Insert a battery of the same type with the positive side facing upwards.
4. Press on the cover to close it.



Return used battery to a recycling center or to your service center.

Alarm system

The concept

The vehicle alarm system responds to:

- ▷ Opening of a door, the hood or the trunk lid.
- ▷ Movements inside the vehicle. Interior motion sensor, refer to page 40.
- ▷ When the car's inclination changes, for instance if an attempt is made to jack it up and steal the wheels or to raise it prior to towing away.
- ▷ Interruptions in battery voltage.

The alarm system signals unauthorized entry attempts for a short time by means of:

- ▷ By sounding an acoustic alarm.
- ▷ By switching on the hazard warning system.

- ▷ By flashing the high beams.

Arming and disarming the alarm system

When you lock or unlock the vehicle, either with the remote control or via Comfort Access, the alarm system is armed or disarmed at the same time.

Trunk lid and armed alarm system

The trunk lid can be opened using the remote control, even if the alarm system is armed.

 Press the button on the remote control for approx. one second.

 Note the opening height of the trunk lid. During opening, the trunk lid pivots back and up. Ensure that there is sufficient clearance when the trunk lid opens; otherwise, damage may result. ◀

After the lid is closed, it is locked and monitored again by the alarm system.

Panic mode

You can trigger the alarm system if you find yourself in a dangerous situation.

 Press the button on the remote control for at least three seconds.

To switch off the alarm: press any button.

Switching off the alarm

- ▷ Unlock the vehicle using the remote control, refer to page 32.
- ▷ Insert the remote control all the way into the ignition lock.
- ▷ With Comfort Access: if you are carrying the remote control with you, pull on the door handle.

Indicator lamp on the interior rearview mirror



- ▷ The indicator lamp flashes briefly every 2 seconds:
The system is armed.
- ▷ The indicator lamp flashes after locking:
The doors, hood or trunk lid is not closed properly, but the rest of the vehicle is secured.
The indicator lamp flashes continuously after approx. 10 seconds. The interior motion sensor and tilt alarm sensor are not active.
- ▷ The indicator lamp goes out after unlocking:
The vehicle has not been tampered with.
- ▷ If the indicator lamp flashes after unlocking until the remote control is inserted in the ignition, but for no longer than approx. 5 minutes:
An alarm has been triggered.

Tilt alarm sensor

The tilt of the vehicle is monitored.

The alarm system responds in situations such as attempts to steal a wheel or tow the car.

Interior motion sensor

The interior of the car is monitored up to the height of the seat cushions. Thus the alarm system is armed together with the interior motion sensor even if the hardtop is open. An alarm can be triggered unintentionally by falling objects such as leaves, refer to Avoiding unintentional alarms.

Avoiding unintentional alarms

The tilt alarm sensor and interior motion sensor can be switched off together, such as in the following situations:

- ▷ In automatic car washes.
- ▷ In duplex garages.
- ▷ During transport on car-carrying trains, at sea or on a trailer.
- ▷ When animals are to remain in the vehicle.

Switching off the tilt alarm sensor and interior motion sensor

LOCK Press the remote control button again within 10 seconds after the vehicle is locked.

The indicator lamp lights up for approx. 2 seconds and then continues flashing.

The tilt alarm sensor and interior motion sensor remain switched off until the vehicle is locked again.

Power windows

General information

 Take the remote control with you
Take the remote control with you when leaving the vehicle so that children, for example, cannot operate the power windows and injure themselves. ◀

 Danger of pinching
Monitor the closing process and make sure that the closing path of the window is clear; otherwise, injuries may result. ◀

Opening, closing

Individually

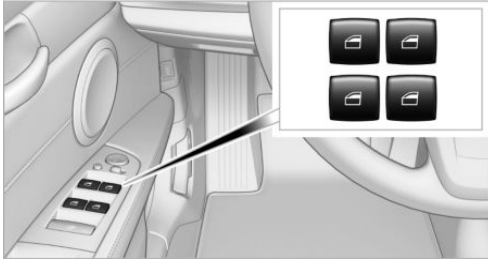

- ▶ Press the switch to the resistance point:
The window opens while the switch is held.
Closing can be performed in the same manner by pulling the switch.
- ▶ Press the switch beyond the resistance point:
The window opens automatically.
Press the switch again to stop the opening movement.

Jointly



- ▶ Press the switch to the resistance point:
All windows open while the switch is held.
Closing can be performed in the same manner by pulling the switch.
- ▶ Press the switch beyond the resistance point:
All windows open automatically.
Press the switch again to stop the opening movement.

Convenient opening and closing

Convenient operation via the remote control, refer to page 32.

Convenient closing with Comfort Access, refer to page 33.

After the ignition is switched off

When the remote control is removed or the ignition is switched off, the windows can continue to be operated for approx. 1 minute as long as no door is opened.

Pinch protection system

If the closing force exceeds a specific value as one of the front side windows closes, the closing action is interrupted.

The window reopens slightly.



Danger of pinching even with pinch protection

Even with the pinch protection system, check that the window's closing path is clear; otherwise, the closing action may not stop in certain situations, e.g., if thin objects are present. ◀



Do not use window accessories

Do not install any accessories in the range of movement of the windows; otherwise, the pinch protection system will be impaired. ◀

Closing without the pinch protection system

For example, if there is an external danger or if ice on the windows prevents a window from closing normally, proceed as follows:

1. Pull the switch past the resistance point and hold it there. Pinch protection is limited and the window reopens slightly if the closing force exceeds a certain value.
2. Pull the switch past the resistance point again within approx. 4 seconds and hold it there.

The window closes without pinch protection.

Retractable hardtop

General information

Adhere to the following instructions:

- ▷ It is advisable that you close the retractable hardtop when you park the vehicle. Not only does the closed hardtop protect the vehicle interior against unanticipated weather damage, it also offers theft protection. However, even when the hardtop is closed, valuables should only be stored in the locked cargo area.
- ▷ Do not attach roof rack systems to the retractable hardtop, and in particular do not attach magnetic racks.
- ▷ Do not attach rack systems to the trunk lid, and in particular do not attach magnetic racks.
- ▷ When the retractable hardtop is operated, the trunk lid swings back and up.
Before operating the retractable hardtop, ensure that there is enough clearance, e.g., in tight parking spaces.
- ▷ If you open the hardtop while it is wet, e.g., after driving in the rain, water may drip into the cargo area.
If necessary, remove items from the cargo area beforehand to avoid water stains or soiling.
- ▷ Opening and closing while the vehicle is moving can cause air turbulence in the cargo area.
Properly stow away objects in the cargo area.
- ▷ At temperatures below 14 °F/-10 °C, the retractable hardtop cannot be moved.
A message appears on the Control Display.

 Do not touch the mechanism and keep the opening path clear.

During opening and closing, do not reach into the mechanism and keep children away from

the opening path of the retractable hardtop; otherwise, there is the risk of injury. ◀

 Do not place objects on the retractable hardtop.

Do not place any objects on the retractable hardtop or on the trunk lid; otherwise, they could fall during movements of the retractable hardtop and cause damage or injury. ◀

Before opening and closing

 Always open or close the hardtop fully.

Do not let the hardtop stop in an intermediate position when opening or closing. Otherwise, there is the danger of personal injury since the hardtop will be lowered automatically after a few minutes. ◀

- ▷ Observe the safety precautions above.
- ▷ Ensure that the trunk lid is closed.
- ▷ The vehicle should be parked on fairly level ground. Excessive angle is indicated by a light.
- ▷ Fold down the cargo area partition and make sure it engages, refer to the instructions below.
- ▷ Do not place any objects next to or on the cargo area partition and close the storage compartment on the left side of the cargo area.
- ▷ Do not exceed the maximum loading height under the cargo area partition; refer to the label in the cargo area showing a line indicating the maximum height.

Folding down the cargo area partition



Before opening the hardtop, close the cargo area partition, arrow, and make sure it engages on both sides.

Opening and closing

In the radio ready state or beyond, refer to page 56, and when the vehicle is stationary:

If possible, conserve the battery by only operating the retractable hardtop when the engine is running.

Before closing the retractable hardtop, remove all foreign objects from the windshield frame as these could prevent the hardtop from closing properly.

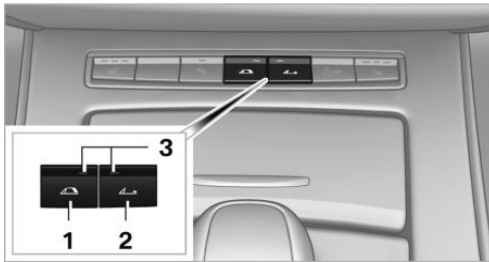

- 1 Press and hold button 1:
The retractable hardtop closes.
- 2 Press and hold button 2:
The retractable hardtop opens.
- 3 LEDs

The side windows move down when the hardtop is opened or closed.

If the windows pause briefly as they move, this is for technical reasons and is not a malfunction.

Operation while driving

The hardtop can be opened or closed at vehicle speeds up to approx. 25 mph/40 km/h.

The procedure stops if the vehicle speed exceeds approx. 25 mph/40 km/h.



When operating the hardtop while driving, pay extra attention to the traffic to avoid an accident. If possible, do not move the hardtop while driving in reverse because your view to the rear is severely limited during the procedure. Do not drive faster than 25 mph/40 km/h, or else damage to the vehicle may occur. Do not operate the hardtop while the vehicle is moving through curves, on uneven road surfaces, or in wind. ◀

LEDs

In the following situations, a message appears on the Control Display or an acoustic signal sounds in addition to the LED lighting up:

- ▷ While the hardtop is being operated, the green LED lights up. It goes out as soon as the top is fully opened or closed.
- ▷ If the red LED flashes when you release the switch, the opening or closing action has not yet finished.
- ▷ If the red LED lights up when the switch is pressed, the cargo area partition is folded up, the trunk lid is not closed, the vehicle is standing on a strong incline or there is a malfunction. The retractable hardtop cannot be moved.

Interruption

The automatic sequence of movements is interrupted if the switch for hardtop operation is released. The sequence can be continued in the desired direction by pushing or pulling the switch.

! Always open or close the hardtop fully.

Open or close the hardtop fully; otherwise, there is a risk of injury or damage when driving. Do not interrupt and resume the closing procedure several times in close succession as this could damage the mechanism. ◀

If the hardtop is not fully opened or closed, the trunk lid cannot be opened and the windows cannot be moved.

Convenient operation via the remote control

Information on convenient operation, refer to page 33.

Wind deflector

The wind deflector keeps air movements in the passenger compartment to a minimum when the hardtop is open and provides an even more comfortable ride, particularly at high speeds.

Installation

1. Insert the wind deflector 1 into the holders 2 on the rollover bars; the arrow should point in the direction of travel.

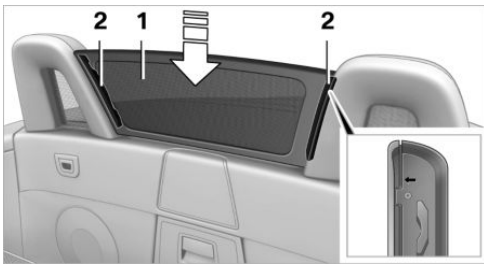

2. Push the wind deflector down, arrow 1, and then push down and forward simultaneously, arrow 2, until it engages.

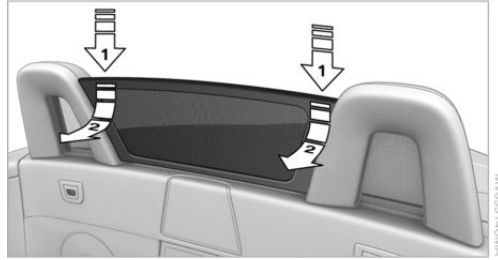

- !** Attach the wind deflector securely
- The wind deflector must engage firmly; otherwise, it could become detached at higher vehicle speeds. ◀

Removing

1. Push the wind deflector down and back simultaneously, arrow 1, to disengage it from the catch mechanism.

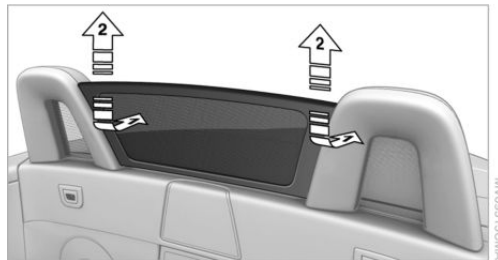

2. Pull the wind deflector upward out of the holders, arrow 2.

Clothes hooks



Coat hooks 1 are located on the wind deflector panels in the rollover bars.



Only hang light objects on the hooks

Do not hang heavy objects on the hooks; otherwise, they could endanger the passengers, such as during braking or evasive maneuvers. ◀

Storage

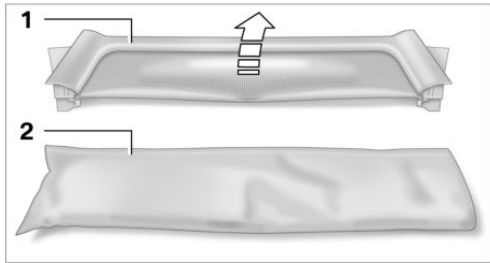

Fold the wind deflector 1 and slide it into the storage pouch 2.

The wind deflector can be stored on the rear storage shelf behind the seats.

Adjusting

Vehicle equipment

This chapter describes all series equipment as well as country-specific and special equipment offered for this model series. Therefore, it also describes equipment that may not be found in your vehicle, for instance due to the selected special equipment or the country version. This also applies to safety-related functions and systems.

When using the features and systems described here, adhere to local regulations.

Sitting safely

The ideal seating position can make a vital contribution to relaxed, fatigue-free driving.

The seating position plays an important role in an accident in combination with:

- ▷ Safety belts, refer to page 48.
- ▷ Head restraints.
- ▷ Airbags, refer to page 90.

Seats

Note before adjusting

 Do not adjust the seat while driving
Never attempt to adjust the driver's seat while driving.

The seat could respond with unexpected movement and the ensuing loss of vehicle control could lead to an accident. ◀

 Do not incline the backrest too far to the rear

Do not incline the backrest on the front passenger side too far to the rear during driving. Otherwise, there is the danger of sliding under the safety belt in an accident. This would elimi-

nate the protection normally provided by the belt. ◀

Also note the information on safety belt damage, refer to page 49.

Adjusting manually

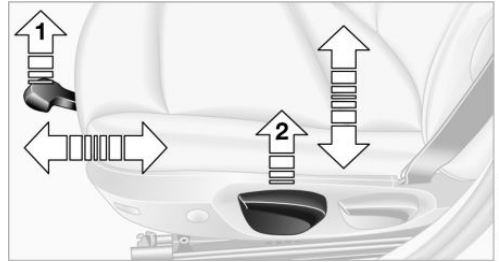

Forward/backward

Pull lever 1 and slide the seat to the desired position.

After releasing the lever, move the seat forward or back slightly to make sure it engages properly.

Height

Pull lever 2 and apply your weight to the seat or lift it off, as necessary.

Backrest tilt

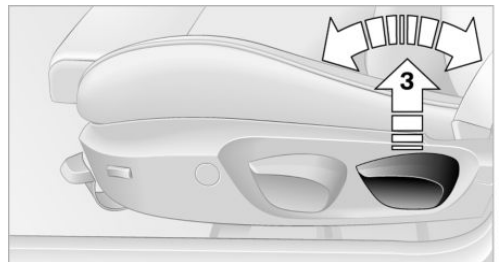

Pull lever 3 and move the backrest to the desired tilt.

Distance:

Adjust the backrest so that the head restraint is as close as possible to the back of the head.

Seat tilt



Pull the lever and move the seat to the desired tilt. After releasing the lever, apply your weight to the seat or lift it off to make sure the seat engages properly.

Thigh support

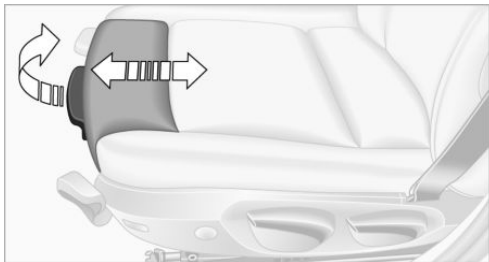

Pull the lever and move the thigh support forward or back.

Adjusting electrically



- 1 Longitudinal direction
- 2 Height
- 3 Seat tilt



- 4 Backrest tilt

Lumbar support

The curvature of the seat backrest can be adjusted in such a way that it supports the lumbar region of the spine.

The lower back and the spine are supported for upright posture.



- Press the front/rear section of the switch. The curvature is increased/decreased.

- ▶ Press the upper/lower section of the switch.

The curvature is shifted up/down.

Backrest width

Change the width of the backrest using the side wings to adjust the lateral support.



Press the front/rear section of the switch.

The backrest width decreases/increases.

Seat heating



 Press the button once for each temperature level.

The maximum temperature is reached when three LEDs are lit.

If the trip is continued within approx. 15 minutes, the seat heating is activated automatically with the temperature set last.

Switching off

Press the button longer.

The LEDs go out.

Safety belts

General information

Always make sure that safety belts are being worn by all occupants before driving away.

Although airbags enhance safety by providing added protection, they are not a substitute for safety belts.

Seats with safety belt

The vehicle has two seats, each of which is equipped with a safety belt.

The shoulder strap's anchorage point will be correct for adult seat occupants of every build if the seat is correctly adjusted.



One person per safety belt

Never allow more than one person to wear a single safety belt. Never allow infants or small children to ride on a passenger's lap. ◀



Putting on the belt

Lay the belt, without twisting, snugly across the lap and shoulders, as close to the body as possible. Make sure that the belt lies low around the hips in the lap area and does not press on the abdomen. Otherwise, the belt can slip over the hips in the lap area in a frontal impact and injure the abdomen.

The safety belt must not lie across the neck, rub on sharp edges, be routed over solid or breakable objects, or be pinched. ◀



Reduction of restraining effect

Avoid wearing clothing that prevents the belt from fitting properly, and pull the shoulder belt periodically to readjust the tension across your lap; otherwise, the retention effect of the safety belt may be reduced. ◀

Buckling the belt

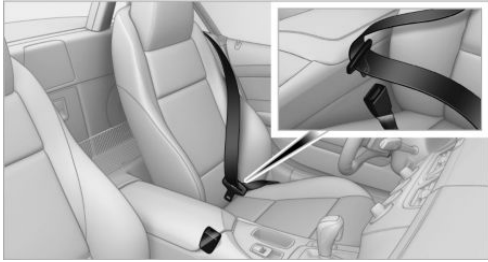

Make sure you hear the latch plate engage in the belt buckle.

Unbuckling the belt

1. Hold the belt firmly.
2. Press the red button in the belt buckle.
3. Guide the belt back into its reel.

Safety belt reminder for driver and passenger



The indicator lamp lights up and a signal sounds. In addition, a message appears on the Control Display.

Check whether the safety belt has been fastened correctly.

The safety belt reminder is active at speeds above approx. 5 mph/8 km/h. It can also be activated if objects are placed on the front passenger seat.

Damage to safety belts

In the case of strain caused by accidents or damage:

Have the safety belts, including the safety belt tensioners, replaced and have the belt anchors checked.

Checking and replacing safety belts

Have the work performed only by your service center; otherwise, it cannot be ensured that this safety feature will function properly. ◀

Seat and mirror memory

General information

Two different driver's seat and exterior mirror positions can be stored and retrieved for each remote control.

Settings for the backrest width and lumbar support are not stored.

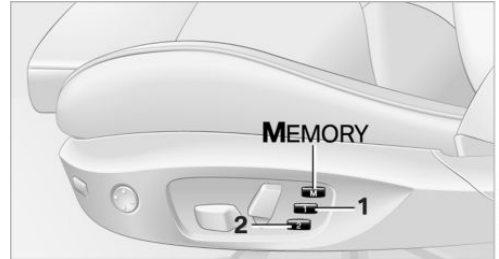

Storing

1. Switch on the radio ready state or the ignition, refer to page 55.
2. Adjust the seat and exterior mirrors to the desired positions.
3.  Press the button. The LED in the button lights up.
4. Press the desired memory button 1 or 2: the LED goes out.

If the M button is pressed accidentally:

-  Press the button again. The LED goes out.

Calling up settings



Do not retrieve the memory setting while driving

Do not retrieve the memory setting while driving, as an unexpected movement of the seat or steering wheel could result in an accident. ◀

Comfort function

1. Open the driver's door or switch on the radio ready state, refer to page 55.
2. Briefly press the desired memory button 1 or 2.

The seat is automatically moved to the stored position.

The procedure stops when a switch for adjusting the seat or one of the buttons is pressed.

Safety mode

1. Close the driver's door and switch the ignition on or off, refer to page 55.
2. Press and hold the desired button 1 or 2 until the adjustment procedure is completed.

Mirrors

Exterior mirrors

General information

The mirror on the passenger side is more curved than the driver's mirror.

 Estimating distances correctly

Objects reflected in the mirror are closer than they appear. Do not estimate the distance to the traffic behind you based on what you see in the mirror, as this will increase your risk of an accident. ◀

The setting for the exterior mirrors is stored for the remote control currently in use. The stored position is called up automatically when the vehicle is unlocked.

At a glance

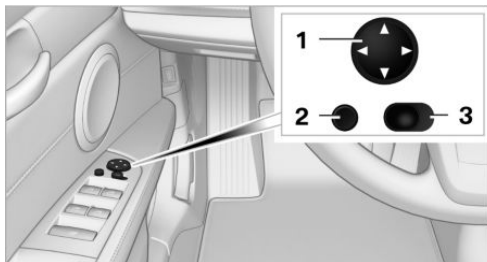

- 1 Adjusting
- 2 Fold in and out
- 3 Left/right, Automatic Curb Monitor

Selecting a mirror

To change over to the other mirror:

Slide over the mirror changeover switch 3.

Adjusting electrically



The setting corresponds to the direction in which the button is pressed.

Saving positions

Seat and mirror memory, refer to page 49.

Adjusting manually

If an electrical malfunction occurs, for example, press the edges of the mirror glass.

Automatic Curb Monitor

When the reverse gear is engaged, the mirror glass tilts downward slightly on the front passenger side. This improves your view of the curb and other low-lying obstacles when parking, for example.

Activating

1. Slide the mirror changeover switch to the driver's side mirror position, arrow 1.

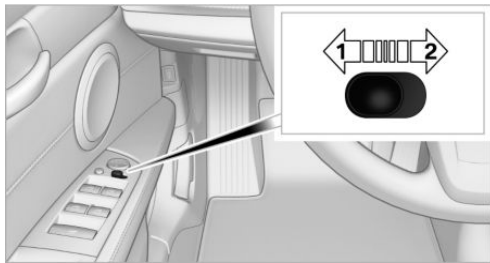

2. Shift into reverse or engage transmission position R.

Deactivating

Slide the mirror changeover switch to the passenger side mirror position, arrow 2.

Fold in and out

Press button 2.

Possible up to approx. 15 mph/20 km/h.

For example, this is advantageous

- In car washes.
- In narrow streets.
- For folding back mirrors that were folded away manually.

Mirrors that were folded in are folded out automatically at a speed of approx. 25 mph/40 km/h.



Fold in the mirror in a car wash

Before entering an automatic car wash, fold in the exterior mirrors by hand or with the button; otherwise, they could be damaged, depending on the width of the vehicle. ◀

Automatic heating

Both exterior mirrors are heated automatically while the engine is running or the ignition is switched on.

Interior rearview mirror

Reducing the blinding effect

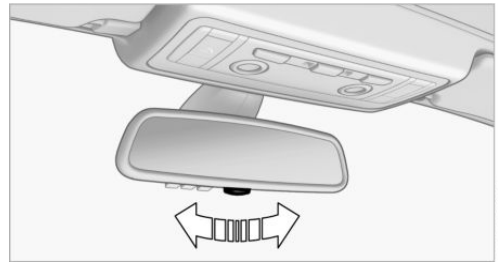

Blinding effect from behind when driving at night: turn the knob.

Interior rearview and exterior mirrors, automatic dimming feature

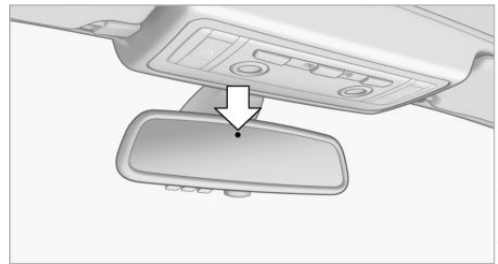

The automatic dimming feature of the interior rearview and exterior mirrors is controlled by two photo cells in the interior rearview mirror. One photo cell is in the mirror frame or in the mirror, see arrow; the other is on the back of the mirror.

For proper operation:

- Keep the photocells clean.
- Do not cover the area between the inside rearview mirror and the windshield.

Steering wheel

General information

 Do not adjust while driving

Do not adjust the steering wheel while driving; otherwise, an unexpected movement could result in an accident. ◀

- ▷ On: the LED lights up.
- ▷ Off: the LED goes out.

Adjusting

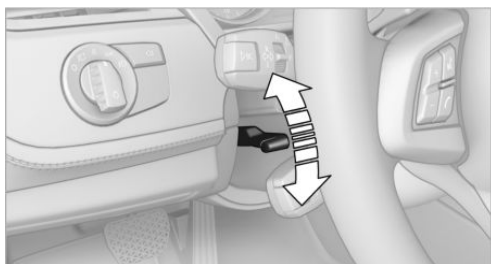

1. Fold the lever down.
2. Move the steering wheel to the preferred height and angle to suit your seating position.
3. Fold the lever back.

 Do not use force to swing the lever back.

Do not use force to swing the lever back up; otherwise, the mechanism will be damaged. ◀

Steering wheel heating

Switching on/off

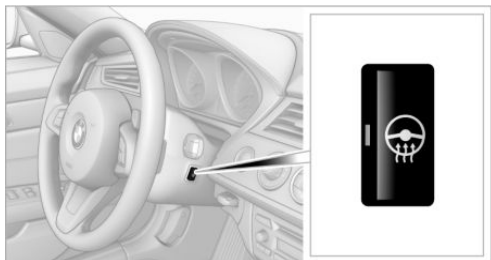

Press the button.

Transporting children safely

Vehicle equipment

This chapter describes all series equipment as well as country-specific and special equipment offered for this model series. Therefore, it also describes equipment that may not be found in your vehicle, for instance due to the selected special equipment or the country version. This also applies to safety-related functions and systems.

When using the features and systems described here, adhere to local regulations.

The right place for children

Note

 Children in the vehicle

Do not leave children unattended in the vehicle; otherwise, they could endanger themselves and other persons, e.g., by opening the doors. ◀

Children on the front passenger seat

Should it be necessary to use a child restraint fixing system on the front passenger seat, make sure that the front and side airbags on the front passenger side are deactivated. Automatic deactivation of front passenger airbags, refer to page 91.

 Deactivating the front passenger airbags

If a child restraint fixing system is used in the front passenger seat, the front passenger airbags must be deactivated; otherwise, there is an increased risk of injury to the child when the airbags are triggered, even with a child restraint fixing system. ◀

 Transport children in suitable child restraint fixing systems

Only transport children younger than 13 years of age or shorter than 5 ft/150 cm in child restraint fixing systems suitable for the age, weight and size of the child; otherwise, there is an increased risk of injury in an accident.

Children 13 years of age or older must wear a safety belt as soon as a suitable child restraint fixing system can no longer be used, due to their age, weight and size. ◀

Installing child restraint fixing systems

Notes

 Manufacturer's information for child restraint fixing systems

To select, mount and use child restraint fixing systems, observe the information provided by the system manufacturer; otherwise, the protective effect can be impaired. ◀

Standard child restraint systems are designed to be secured with a lap belt or with the lap-belt section of a lap-and-shoulder belt. Incorrectly or improperly installed child restraint systems can increase the risk of injury to children. Always follow the installation instructions for the system with the greatest care.

On the front passenger seat

 Check the deactivation of the passenger airbag

After installing a child restraint fixing system on the passenger seat, make sure that the front and side airbags on the passenger side have been deactivated; otherwise, there is an increased risk of injury when the airbags are deployed. ◀

Seat position

Before installing a child restraint fixing system, move the passenger seat as far back and as high as possible to obtain the best possible position for the belt.

Backrest width

1. Adjust the backrest width to its widest setting, refer to page 48.
2. Install the child seat.



Backrest width for the child seat

Before installing a child restraint fixing system in the front passenger seat, the backrest width must be opened completely. Do not change the adjustment after this; otherwise, the stability of the child seat will be reduced. ◀

Child seat security



The safety belt for the passenger can be locked to prevent it from being pulled out when it is used to secure child restraint systems.

To lock the safety belt

1. Secure the child restraint fixing system with the belt.
2. Pull out the belt webbing completely.
3. Allow the belt webbing to be pulled in and pull it taut against the child restraint fixing system.

The safety belt is locked.

To unlock the safety belt

1. Open the belt buckle.

2. Remove the child restraint fixing system.
3. Allow the belt webbing to be pulled in completely.

Child restraint fixing system with tether strap

For Canadian Customers only

The following statement is required by Transport Canada

This vehicle is not equipped with user-ready tether anchorages. As such neither a child restraint system, nor a booster cushion, requiring the use of a tether strap can be properly secured in the vehicle.

Driving

Vehicle equipment

This chapter describes all series equipment as well as country-specific and special equipment offered for this model series. Therefore, it also describes equipment that may not be found in your vehicle, for instance due to the selected special equipment or the country version. This also applies to safety-related functions and systems.

When using the features and systems described here, adhere to local regulations.

Ignition lock

Insert the remote control into the ignition lock

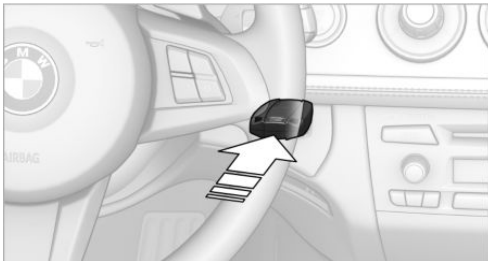

Insert the remote control all the way into the ignition lock.

- ▶ Radio ready state is switched on. Individual electrical consumers can operate.

Comfort Access

If the car is equipped with Comfort Access, the remote control only needs to be inserted in the ignition lock under special circumstances, refer to page 38.

Removing the remote control from the ignition lock



Do not forcibly pull the remote control out of the ignition lock

Do not forcibly pull the remote control out of the ignition lock as this may cause damage. ◀

Before removing the remote control, push it all the way in to release the locking mechanism.

- ▶ The ignition is switched off if it was on.

Sport automatic transmission

When the remote control is removed from the ignition lock, transmission position P is engaged automatically. To make it possible for the vehicle to roll, such as in an automatic car wash, follow the instructions in Car washes, refer to page 255.

Start/Stop button

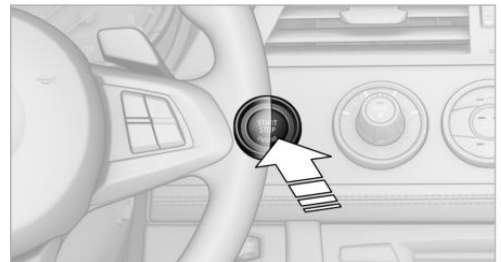

Pressing the Start/Stop button switches the radio ready state or the ignition on and off.

The engine starts when you press the Start/Stop button and, if the car has manual transmission, also depress the clutch, or, if the car has automatic transmission, also depress the brake.

Radio ready state

Individual electrical consumers can operate. The time and the external temperature are displayed in the instrument cluster.

Radio ready state is switched off automatically:

- ▷ When the remote control is removed from the ignition lock.
- ▷ In cars with Comfort Access, by touching the surface above the door lock, locking, refer to page 37.

Ignition on

All electrical consumers can operate. The odometer and trip odometer are displayed in the instrument cluster.

To save battery power when the engine is off, switch off the ignition and any unnecessary electronic systems/power consumers.

Radio ready state and ignition off

All indicator and warning lamps as well as displays in the instrument cluster go out.

Sport automatic transmission

In certain situations, transmission position P is engaged automatically. To make it possible for the vehicle to roll, such as in an automatic car wash, follow the instructions in Car washes, refer to page 255.

Starting the engine

Enclosed areas

Do not let the engine run in enclosed areas; otherwise, breathing of exhaust fumes may lead to loss of consciousness and death. The exhaust gases contain carbon monoxide, an odorless and colorless but highly toxic gas. ◀

Unattended vehicle

Do not leave the car unattended with the engine running; otherwise, it presents a potential source of danger.

Before leaving the car with the engine running, set the parking brake and place the transmission in position P or neutral to prevent the car from moving. ◀

Frequent starting in quick succession

Avoid repeated futile attempts at starting the car and avoid starting the car frequently in quick succession. Otherwise, the fuel is not burned or is inadequately burned, and there is the danger of overheating and damaging the catalytic converter. ◀

Do not wait for the engine to warm-up while the vehicle remains stationary. Start driving right away, but at moderate engine speeds.

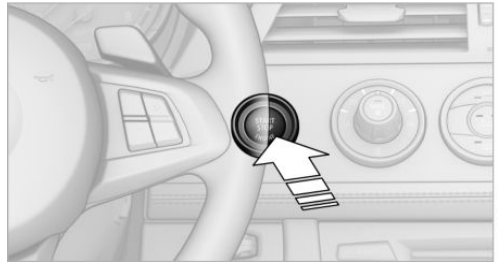

Manual transmission

Remote control in the ignition lock or, with Comfort Access, inside the vehicle, refer to page 37.

1. Depress the brake pedal.
2. Depress the clutch pedal.
3. Press the Start/Stop button.

The starter operates automatically for a certain time, and stops automatically as soon as the engine has started.

Sport automatic transmission

Remote control in the ignition lock or, with Comfort Access, inside the vehicle, refer to page 37.

1. Depress the brake pedal.
2. Press the Start/Stop button.

The starter operates automatically for a certain time, and stops automatically as soon as the engine has started.

Engine stop

 Take the remote control with you
Take the remote control with you when leaving the vehicle so that children, for example, cannot start the engine or release the parking brake. ◀

 Set the parking brake and further secure the vehicle as required

Set the parking brake firmly when parking; otherwise, the vehicle could roll. On steep upward and downward inclines, further secure the vehicle, for example, by turning the steering wheel in the direction of the curb. ◀

Manual transmission

1. With the vehicle at a standstill, press the Start/Stop button.
2. Shift into first gear or reverse.
3. Set the parking brake.
4. Remove the remote control from the ignition lock, refer to page 55.

Sport automatic transmission

1. With the vehicle at a standstill, press the Start/Stop button.
2. Set the parking brake.
3. Remove the remote control from the ignition lock, refer to page 55.

Automatic Engine Start/Stop Function

The concept

The Automatic Engine Start/Stop Function helps save fuel and lower emissions. The system automatically switches off the engine during a stop, e.g., in traffic congestion or at traffic lights. The ignition remains switched on. The engine starts again automatically when the clutch is pressed.

Automatic operation

The automatic engine Start/Stop function is operational after each engine start. It is activated whenever you drive forward faster than 3 mph/5 km/h.

Automatic engine stop

The engine is switched off automatically during a stop under the following conditions:

- ▷ Neutral gear is engaged and the clutch pedal is not depressed.
- ▷ The driver's safety belt is fastened or the driver's door is closed.

When the engine is switched off, the air volume of the air conditioner or automatic climate control is reduced.

Indicator lamp in the instrument cluster



The indicator lamp lights up when the Auto Start/Stop function is ready to start the engine automatically.



The indicator lamp lights up if the requirements for an automatic engine stop are not fulfilled.

Note

The engine is not switched off automatically in the following situations:

- ▷ External temperature too low.

- ▷ High external temperature and operation of the automatic climate control.
- ▷ The interior is not yet heated or cooled as much as desired.
- ▷ The engine is not yet at operating temperature.
- ▷ Sharp steering angle or the steering wheel is being turned.
- ▷ After driving in reverse.
- ▷ Fogging of the windows when the automatic climate control is switched on.
- ▷ Vehicle battery charge is very low.
- ▷ Hood is unlocked.
- ▷ Stop-and-go traffic.



The indicator lamp is lit.

Parking the vehicle during an automatic engine stop

The vehicle can be parked safely during an automatic engine stop, such as when you wish to leave the vehicle.

1. Press the Start/Stop button. The ignition is switched off. The Auto Start/Stop function is deactivated.
2. Set the parking brake.

Start the engine as usual using the Start/Stop button.

Automatic engine start

To drive away, the engine starts automatically as soon as the clutch pedal is depressed.

After the engine starts, accelerate as usual.

Safety mode

The engine does not start by itself after it is switched off automatically if any of the following conditions are fulfilled:

- ▷ The driver's safety belt is unfastened or the driver's door is open.
- ▷ Hood was unlocked.



The indicator lamp lights up. A message appears on the Control Display.

The engine can only be started via the Start/Stop button.

Note

Even if you do not wish to drive away, the stopped engine still starts automatically in the following situations:

- ▷ The interior has heated up strongly with the cooling function switched on.
- ▷ The steering wheel is turned.
- ▷ The vehicle begins to roll.
- ▷ Fogging of the windows when the automatic climate control is switched on.
- ▷ Vehicle battery charge is very low.
- ▷ The interior has cooled down strongly with the heating switched on.
- ▷ Low braking pressure, such as from depressing the brake pedal a number of times consecutively.

Activating/deactivating the system manually



Press the button.

- ▷ LED on the button lights up: the Auto Start/Stop function is deactivated.

The engine is started during an automatic engine stop.

The engine can only be stopped or started via the Start/Stop button.

- ▶ LED goes out: the Auto Start/Stop function is activated.

Automatic deactivation

In certain situations, the Auto Start/Stop function is deactivated automatically in the interest of safety, for example if the driver's absence is detected.

Malfunction



The automatic engine Start/Stop function no longer switches of the engine automatically. The indicator lamp lights up. A message appears on the Control Display. It is possible to continue driving. Have the system checked.

Parking brake

The concept

Your vehicle is equipped with an electromechanical parking brake that can be set and released by using a switch.

The parking brake is primarily used to prevent the vehicle from rolling when it is parked.

When the vehicle is stationary, the parking brake acts on the rear wheels via an electro-mechanical mechanism. When the vehicle is rolling or being driven, the parking brake acts on the disc brakes of the front and rear wheels via the hydraulic brake system.

Setting



Pull the switch. The parking brake is set.



The indicator lamp in the instrument cluster and the LED on the switch light up red. The parking brake is set.



Indicator light in Canadian models.

To set the parking brake, the remote control does not need to be in the ignition lock.

While driving

If exceptional circumstances should make it necessary to engage the parking brake while the vehicle is in motion, pull the switch for an extended period: the vehicle brakes forcefully while the switch is being pulled.



The indicator lamp in the instrument cluster lights up red, a sound is issued and the brake lights light up.



Indicator light in Canadian models.

When the vehicle is braked almost to a halt, approx. 2 mph/3 km/h, the parking brake remains set.

Releasing



Take the remote control with you

Take the remote control with you when leaving the vehicle so that children, for example, cannot start the engine or release the parking brake. ◀

The parking brake can only be released while the ignition is switched on or the engine is running.



Manual transmission

Press the switch of the parking brake. Depress the brake and clutch pedals while doing so.

Sport automatic transmission

Press the parking brake switch while the brake is depressed or transmission position P is engaged.

Indicator lights



The indicator lamp in the instrument cluster goes out.



Indicator light in Canadian models.

Malfunction

In the event of a failure or malfunction of the parking brake, secure the vehicle against rolling using a wheel chock, for example, if you leave the vehicle.

Turn signal, high beams, headlamp flasher

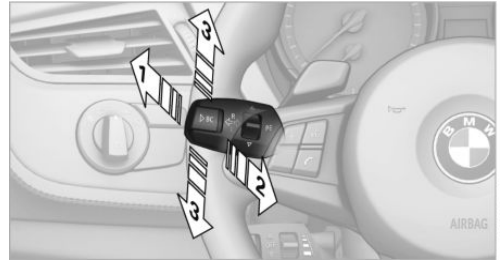

- 1 High beams
- 2 Headlamp flasher
- 3 Turn signal

Using turn signals

Press the lever beyond the resistance point.

To switch off manually, press the lever to the resistance point.

Unusually rapid flashing of the indicator lamp indicates that a turn signal bulb has failed.

Signaling a turn briefly

Press the lever to the resistance point and hold it there for as long as you want the turn signal to flash.

Triple turn signal activation

Press the lever to the resistance point. The turn signal flashes three times.

You can be set whether the turn signal should flash once or three times when activated.

1.  Press the button.
2. "Settings"

3. "Lighting"
4. "Triple turn signal"

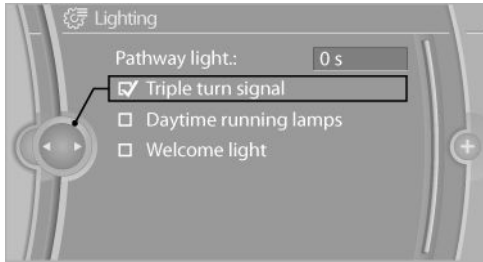

The setting is stored for the remote control currently in use.

Washer/wiper system

Notes

! Do not switch on the wipers if frozen
Do not switch on the wipers if they are frozen onto the windshield; otherwise, the wiper blades and the windshield wiper motor may be damaged. ◀

! Do not use the wipers on a dry windshield

Do not use the wipers on a dry windshield; otherwise, the wiper blades may wear more rapidly or become damaged. ◀

At a glance

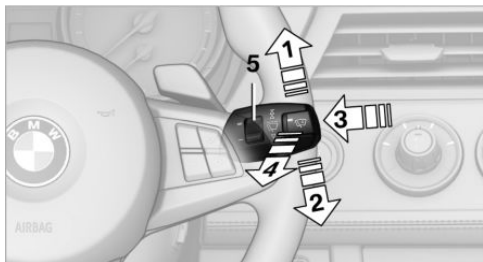

- 1 Switching on wipers
- 2 Switching off wipers or brief wipe

- 3 Activating/deactivating intermittent wipe or the rain sensor
- 4 Cleaning the windshield and headlamps
- 5 Setting speed for intermittent wipe or sensitivity of the rain sensor

Switching on wipers

Press the lever upward, arrow 1.

The lever automatically returns to its initial position when released.

Normal wiper speed

Press once.

The system switches to operation in the intermittent mode when the vehicle is stationary.

Fast wiper speed

Press twice or press beyond the resistance point.

The system switches to normal speed when the vehicle is stationary.

Intermittent wipe or rain sensor

If the car is not equipped with a rain sensor, the intermittent-wipe time is a preset.

If the car is equipped with a rain sensor, the time between wipes is controlled automatically and depends on the intensity of the rainfall.

The rain sensor is mounted on the windshield, directly in front of the interior rearview mirror.

Activating intermittent wipe or rain sensor

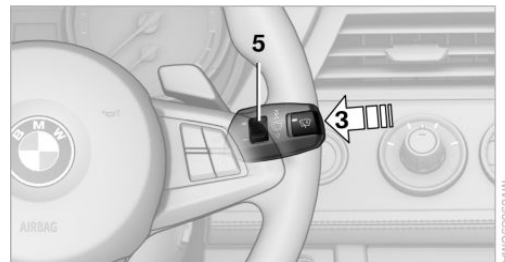

Press the button, arrow 3. The LED in the button lights up.

Setting speed for intermittent wipe or sensitivity of the rain sensor

Turn thumbwheel 5 up or down.

Deactivating intermittent wipe or rain sensor

Press the button again, arrow 3. The LED in the button goes out.

 Deactivate the rain sensor in car washes
Deactivate the rain sensor when passing through an automatic car wash; otherwise, damage could be caused by undesired wiper activation. ◀

Cleaning the windshield and headlamps

Pull the lever, arrow 4.

The system sprays washer fluid on the windshield and activates the wipers briefly.

When the vehicle lighting system is switched on, the headlamps are cleaned at regular and appropriate intervals.

 Do not use the washer system at freezing temperatures

Do not use the washers if there is any danger that the fluid will freeze on the windshield; otherwise, your vision could be obscured. For this reason, use antifreeze.

Avoid using the washer when the reservoir is empty; otherwise, you could damage the pump. ◀

Windshield washer nozzles

The windshield washer nozzles are heated automatically while the engine is running or the ignition is switched on.

Washer fluid

General information

 Antifreeze for washer fluid
Antifreeze is flammable and can cause injuries if used improperly.

Therefore, keep it away from sources of ignition.

Only keep it in the closed original container and inaccessible to children.

Follow the notes and instructions on the container.

United States: The washer fluid mixture ratio is regulated by the U.S. EPA and many individual states; do not exceed the allowable washer fluid dilution ratios limits that apply. Follow the usage instructions on the washer fluid container. Use BMW's Windshield Washer Concentrate or the equivalent. ◀

Washer fluid reservoir

 Adding washer fluid
Only add washer fluid when the engine is cool, and then close the cover completely to avoid contact between the washer fluid and hot engine parts.

Otherwise, there is the danger of fire and a risk to personal safety if the fluid is spilled. ◀

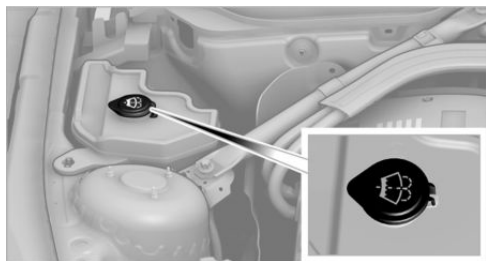

All washer nozzles are supplied from one reservoir.

The recommended minimum filling quantity is 0.2 US gal/1 liter.

Fill with a mixture of window washing concentrate and tap water; if needed, add antifreeze according to the manufacturer instructions.

Mix the washer fluid before adding to maintain the correct mixing ratio.

Do not fill in undiluted window washing concentrate and antifreeze and do not fill in pure water; this could damage the washer system.

Do not mix window washing concentrate from different manufacturers; this could cause the washer nozzles to clog.

Manual transmission

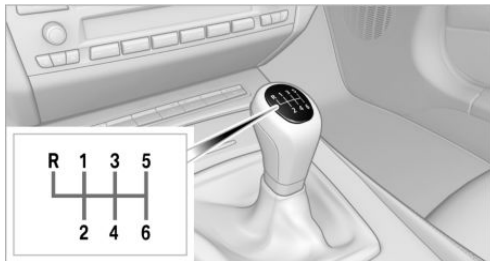

! Pay attention to the shift plane

When shifting into 5th or 6th gear, push the gearshift lever to the right; otherwise inadvertent shifting into the 3rd or 4th gear could lead to engine damage. ◀

Reverse gear

Select only when the vehicle is stationary. When the gearshift lever is pressed to the left, a slight resistance needs to be overcome.

Malfunction



The warning lamp lights up yellow. A message appears on the Control Display. In addition, a signal sounds.

The clutch temperature is too high.

8-gear Sport automatic transmission

Transmission positions

D Drive, automatic position

Position for normal vehicle operation. All forward gears are available.

Under normal operating conditions, fuel consumption is lowest when you are driving in position D.

Kickdown

Kickdown is used to achieve maximum driving performance. Press on the accelerator beyond the resistance point at the full throttle position.

R is Reverse

Select only when the vehicle is stationary.

N is Neutral

The vehicle can roll.

N remains engaged after the engine is switched off if the remote control remains in the ignition lock. This function can be used in an automatic car wash, refer to page 255, for example. P is automatically engaged after approx. 30 minutes.

P Park

The rear wheels are locked.

P is engaged automatically when the following conditions are met:

- ▷ The driver's door is opened while the engine is running, the safety belt is not fastened and neither the brake pedal nor the accelerator is activated.
- ▷ The engine is switched off unless N is engaged and the remote control is in the ignition lock.
- ▷ The remote control is removed from the ignition lock, refer to page 55.

Before leaving the vehicle, ensure that the transmission position P is engaged; otherwise, the vehicle may begin to roll.

Engaging transmission position

- ▷ Transmission position P can only be disengaged if the engine is running and the brake pedal is pressed.
- ▷ With the vehicle stationary, press on the brake pedal before shifting out of P or N; otherwise, the shift command will not be executed: shift lock.

 Press on the brake pedal until you start driving

To prevent the vehicle from creeping after you select a driving position, maintain pressure on the brake pedal until you are ready to start. ◀

Engaging transmission positions D, R, N

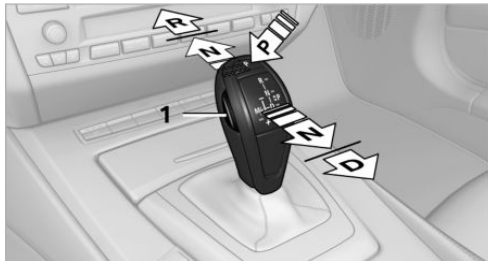

Briefly push the selector lever in the desired direction, beyond a resistance point if necessary. When shifting out of P or into R, simultaneously push the unlock button 1.

The engaged transmission position is displayed on the selector lever.

After releasing the selector lever, it returns to its center position.

Engaging transmission position P

Select only when the vehicle is stationary.



Press button P.

Sport program DS and M/S manual mode

Activating the Sport program DS



Push the selector lever to the left out of transmission position D.

The Sport program is activated and DS is displayed in the instrument cluster.

This position is recommended for a performance-oriented driving style.

Activating the M/S manual mode

1. Push the selector lever to the left out of transmission position D.
2. Push the selector lever forward or backward.

Manual mode becomes active and the gear is changed.

The engaged gear is displayed in the instrument cluster, e.g., M1.

When the maximum engine speed is reached, the transmission automatically shifts up when in M/S manual mode.

Shifting in manual mode

- To shift down: press the selector lever forward.
- To shift up: press the selector lever backward.

The gears are only shifted at a suitable engine and vehicle speed, e.g. a downshift is not carried out at excessively high engine speeds.

The selected gear is briefly displayed in the instrument cluster, followed by the current gear.

Avoid automatic upshifting in M/S manual mode

Gears are not shifted automatically, for instance at maximum engine speed, if one of the following conditions is met:

- DSC is deactivated.
- TRACTION is activated.
- SPORT+ is activated.

Dynamic Driving Control, refer to page 100

In addition, kickdown is disabled.

Ending the Sport program/manual mode

Push the selector lever to the right.

D is displayed in the instrument cluster.

Shifting gears using the shift paddles on the steering wheel

The shifting paddles make it possible to quickly change gears since both hands can remain on the steering wheel.

- If the shift paddles on the steering wheel are used to shift gears while in automatic mode D, the transmission temporarily switches to manual mode.
- If the shift paddles are not used and the vehicle is not accelerated for a certain time,

the system switches back into automatic mode if the selector lever is in transmission position D.



- Shift up: pull right shift paddle.
- Shift down: pull left shift paddle.

The vehicle only shifts up or down at appropriate engine and road speeds, e.g., it does not shift down if the engine speed is too high.

The selected gear is briefly displayed in the instrument cluster, followed by the current gear.

Displays in the instrument cluster

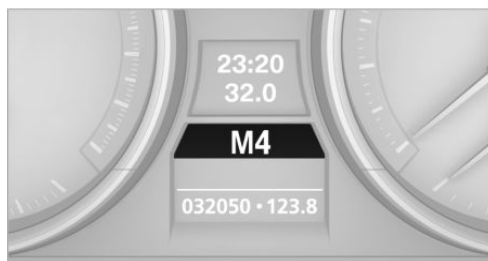

The transmission position is displayed and the engaged gear, such as M4, is displayed in manual mode.

7-gear Sport automatic transmission with dual clutch

The concept

This transmission is an automated manual transmission with two clutches and two gearbox components in which the gears are changed without loss of torque.

The transmission is operated using the selector lever and two shift paddles on the steering wheel.

Functions:

- ▷ Choice of manual or automatic operation: manual mode or Drive mode.
- ▷ Automatic downshifting and protection against selecting the wrong gear, even in manual mode.
- ▷ Acceleration assistant, Launch Control, refer to page 68.
- ▷ Automatic throttle blip.

System limits

This transmission is equipped with an overheating protection system that protects the clutches against extremely high loads.



The indicator lamp lights up yellow if the transmission becomes too warm. Avoid high engine loads and driving off frequently.

If the transmission overheats, the indicator lamp lights up red and power flow to the engine is interrupted. You can only continue driving after the transmission has cooled down.

Avoid driving off frequently with high acceleration and do not hold the vehicle on inclines by depressing the accelerator lightly; otherwise, the transmission may overheat.

Transmission positions

P R N D M/S + -

Displays in the instrument cluster

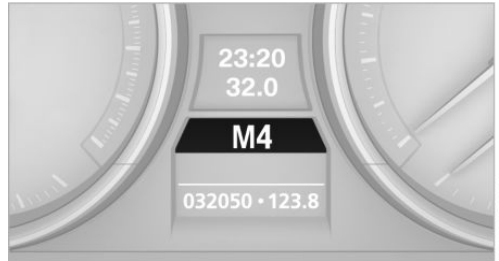

The gear position and the engaged gear, such as M4, are displayed.

Engaging transmission positions N, D, R

- ▷ Transmission position P can only be disengaged if the engine is running.
- ▷ Before moving the lever away from P or N with the vehicle stationary, depress the brake; otherwise, the transmission will not shift.



Press on the brake pedal until you start driving

To prevent the vehicle from creeping after you select a driving position, maintain pressure on the brake pedal until you are ready to start. ◀

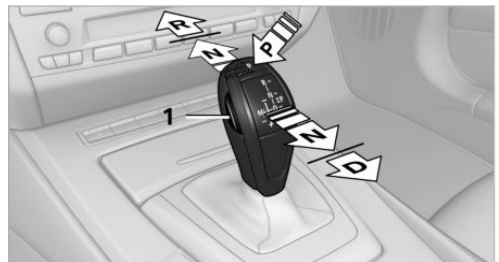

Briefly push the selector lever in the desired direction, beyond a resistance point if necessary. When shifting out of P or into R, press button 1 at the same time.

The engaged transmission position is also displayed on the selector lever.

When you release the selector lever, it returns to its center position.

N is Neutral

The vehicle can roll.

N remains engaged after the engine is switched off if the remote control remains in the ignition lock. This function can be used in an automatic car wash, refer to page 255, for example. P is automatically engaged after approx. 30 minutes.

D Drive mode

In Drive mode, all forward gears are shifted automatically.

R is Reverse

Select only when the vehicle is stationary.

P Park

The rear wheels are locked.

P is engaged automatically when the following conditions are met:

- ▶ The driver's door is opened while the engine is running, the safety belt is not fastened and neither the brake pedal nor the accelerator is activated.
- ▶ The engine is switched off unless N is engaged and the remote control is in the ignition lock.
- ▶ The remote control is removed from the ignition lock, refer to page 55.

Before leaving the vehicle, ensure that the transmission position P is engaged; otherwise, the vehicle may begin to roll.

Engaging transmission position P

Select only when the vehicle is stationary.



Press button P.

Kickdown

Kickdown is used to achieve maximum driving performance. Press the accelerator past the resistance point.

Sport program and manual mode M/S



Press the selector lever from gear position D to the left to activate the Sport program.

Sport program

This position is recommended for a performance-oriented driving style.

The gear position and the engaged gear are displayed in the instrument cluster, for instance S1.

Manual mode

When you press the selector lever forward or backward, or when you pull one of the shift paddles, manual mode is activated and the gear is changed.

The gear position and the engaged gear are displayed in the instrument cluster, for instance M1.

The transmission provides assistance in the following situations:

- ▷ Upshifts and downshifts are executed only when they will result in a feasible combination of engine and vehicle speed; thus, for example, a downshift that would cause the engine to overrev will not be executed by the system.
- ▷ When the vehicle stops, the transmission automatically shifts down to first gear.
- ▷ Shortly before the vehicle slows down to below the minimum speed of the gear currently engaged, the transmission automatically shifts down without requiring your intervention.

Shifting down rapidly: even in manual mode, you can skip several gears to achieve optimal acceleration. Do so by pressing the accelerator past the resistance point.

Changing to Drive mode

Push the selector lever to the right.

Shifting gears via the selector lever

In manual mode:

- ▷ To shift up, pull back the selector lever.
- ▷ To shift down, push it forward.

Shifting gears using the shift paddles on the steering wheel

The shift paddles allow you to shift gears without taking your hands off the steering wheel. You do not need to raise your foot from the accelerator when doing so.

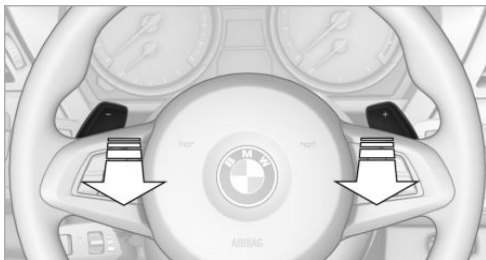

- ▷ Shift up: pull right shift paddle.
- ▷ Shift down: pull left shift paddle.

Gears can be shifted using the shift paddles in Drive mode or in manual mode.

Gear change in manual mode

When manual mode is active, refer to page 67, gears can be changed using the shift paddles or the selector lever.

Gear change in Drive mode

The shift paddles can be used to change gears in Drive mode as well.

Afterwards, if the shift paddles are not used for some time and vehicle acceleration is insufficient, the forward gears are changed again automatically.

Launch Control

Launch Control enables you to drive off with an optimal vehicle acceleration on a high grip road surface.



Do not use Launch Control too often

Do not use Launch Control too often, as the higher loads on the vehicle lead to premature component wear. ◀

Launch Control is available when the engine is at operating temperature, i.e., after driving continuously for at least 6 miles/10 km.

1. With the engine running, depress the brake pedal with your left foot.
2. Activate the SPORT+ program of the Dynamic Driving Control, refer to page 100.
3. With the vehicle stationary, activate manual mode and select first gear.
4. Press the accelerator all the way down. The engine speed when driving off is controlled. A flag symbol appears in the instrument cluster.

- The vehicle accelerates when you release the brake pedal. Keep the accelerator pressed all the way down.
- The transmission shifts up automatically as long as the accelerator is pressed all the way down.

Launch Control only becomes available again after a certain distance has been driven.

Launch Control can only be used after the break-in phase, refer to page 128.

To maintain driving stability, activate DSC whenever possible.

Manually releasing and engaging the transmission lock

If a power failure occurs, e.g., if the battery is discharged or disconnected, the transmission lock must be released manually, otherwise the rear wheels are blocked and the vehicle cannot be towed.

Release the transmission lock manually for towing only and set the parking brake beforehand to prevent the vehicle from rolling. After parking the vehicle, engage the transmission lock again manually, refer to page 70.

Manual release

- Unclip the sleeve of the selector lever.
- Pull the sleeve up over the selector lever until the sleeve is inside out.



- Unclip and raise cover frame.

- Insert an Allen wrench of the right size into the cap.

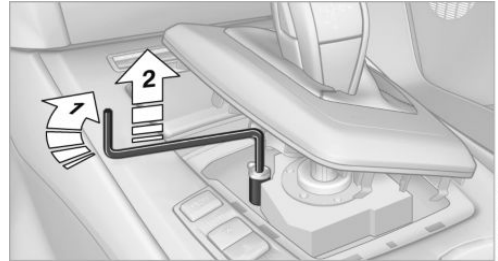

- Turn the cap with the Allen wrench, arrow 1, and remove it, arrow 2.
- Insert the Allen wrench into the opening, arrow 1.



Turn the Allen wrench in the correct direction

Do not turn the Allen wrench in the opposite direction as this may damage the mechanism. ◀

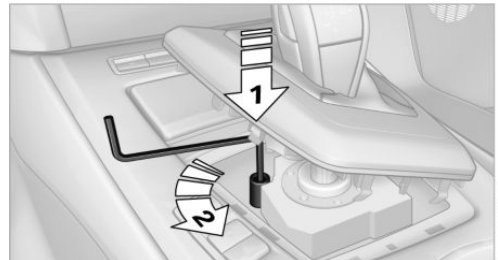

- Turn the Allen wrench as far as it will go, arrow 2. The transmission lock is released.
- Draw the Allen wrench out of the opening.



Locking the transmission lock again
After parking the vehicle, lock the transmission lock again to prevent the vehicle from rolling. ◀

Locking manually

1. Press the button, see arrow. The transmission lock is locked again.

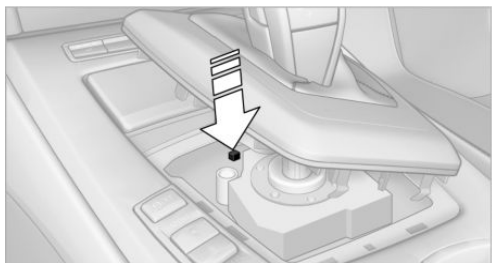

2. Clip the cover frame back into place.
3. Clip the sleeve of the selector lever back in place.
4. Set the parking brake.

Jump-starting, refer to page [250](#), towing, refer to page [251](#).

Displays

Vehicle equipment

This chapter describes all series equipment as well as country-specific and special equipment offered for this model series. Therefore, it also describes equipment that may not be found in your vehicle, for instance due to the selected special equipment or the country version. This also applies to safety-related functions and systems.

When using the features and systems described here, adhere to local regulations.

Odometer, external temperature display, clock

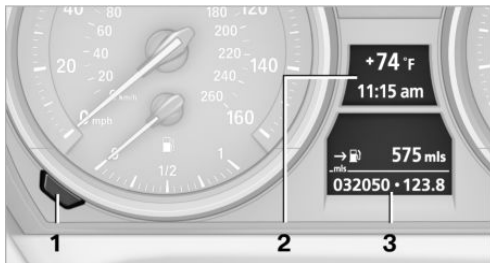

- 1 Knob in the instrument cluster
- 2 External temperature display and clock
- 3 Odometer and trip odometer

Knob in the instrument cluster

- ▶ To reset the trip odometer while the ignition is switched on.
- ▶ To display the time, external temperature and odometer briefly while the ignition is switched off.

Units of measure

To set the respective units of measure, miles or km for the odometer and °C or °F for the external temperature, refer to page 76.

The setting is stored for the remote control currently in use.

Time, external temperature display

Set the time, refer to page 76.

External temperature warning

If the display drops to 37 °F/3 °C, a signal sounds and a warning light lights up. There is the increased danger of ice.



Ice on roads

Even at temperatures above +37 °F/+3 °C, there can be a risk of ice on roads.

Therefore, drive carefully on bridges and shady roads, for example, to avoid the increased danger of an accident. ◀

Odometer and trip odometer

Resetting trip odometer:

With the ignition switched on, press button 1 in the instrument cluster.

When the vehicle is parked

If you still want to view the time, external temperature and odometer reading briefly after the remote control has been taken out of the ignition lock:

Press button 1 in the instrument cluster.

Tachometer



Never force the engine speed up into the red warning field, see arrow. In this range, the fuel supply is interrupted to protect the engine.

Coolant temperature

A warning lamp will come on if the coolant, and therefore the engine, becomes too hot. In addition, a message will appear on the Control Display.

Check the coolant level, refer to page [239](#).

Engine oil temperature



- ▶ Cold engine: the pointer is at the low temperature end. Drive at moderate engine and vehicle speeds.
- ▶ Normal operating temperature: the pointer is in the middle of the temperature display.
- ▶ Hot engine: the pointer is at the high temperature end. Switch off the engine immediately and allow it to cool down.

If the engine oil temperature is too high, a message appears on the Control Display.

Check the oil level, refer to page [236](#).

Fuel gauge



The vehicle inclination may cause the display to vary.

Notes on refueling, refer to page [222](#).

Range

After the reserve range is reached:

- ▶ A message is briefly displayed on the Control Display.

- The remaining range is shown on the computer.
- When a dynamic driving style is used, such as when corners are taken rapidly, engine functions are not ensured.

Below a range of approx. 30 miles/50 km, the message is displayed continuously.



Refuel promptly

At the latest, refuel at a range of 30 miles/50 km; otherwise, the engine function is not ensured and damage may occur. ◀

Computer

Displays in the instrument cluster

Calling up information

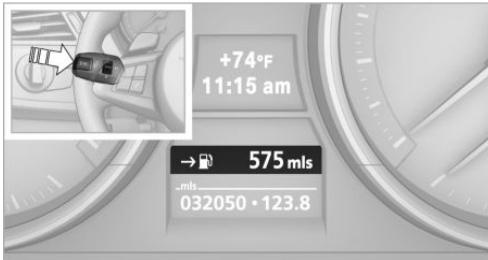

Press the button on the turn indicator lever. The following items of information are displayed in the order listed:

- Range.
- Average speed.
- Average fuel consumption.
- Current fuel consumption.
- No information.

To set the corresponding units of measure, units of measure, refer to page 76.

Range

Displays the estimated cruising range available with the remaining fuel. The range is calculated

based on your driving style over the last 18 miles/30 km and the current fuel supply.

Average speed

Periods in which the vehicle was parked and the engine was switched off manually are not included in the average speed calculations.

With the trip computer, refer to page 73, you can have the average speed displayed for an additional distance.

To reset the average speed: press the button on the turn indicator lever for approx. 2 seconds.

Average fuel consumption

The average fuel consumption is calculated for the time during which the engine is running.

The average consumption is computed based on the distance traveled since the last time the computer was reset.

With the trip computer, refer to page 73, you can have the average consumption displayed for an additional distance.

To reset the average consumption: press the button on the turn indicator lever for approx. 2 seconds.

Current fuel consumption

Displays the current fuel consumption. This allows you to see whether your current driving style is conducive to fuel economy with minimum exhaust emissions.

Displays on the Control Display

The computer can also be opened via iDrive.

1. "Vehicle Info"

2. "Onboard info" or "Trip computer"

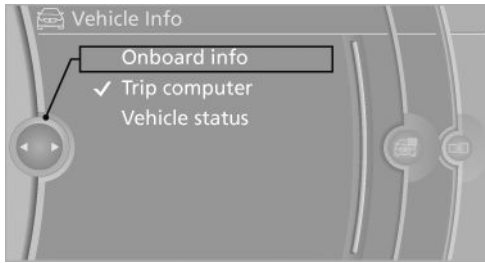

Displays on the "Onboard info":



- ▷ Range.
- ▷ Distance to destination.
- ▷ Estimated time of arrival if a destination was entered in the navigation system, refer to page 140.

Displays on the "Trip computer":

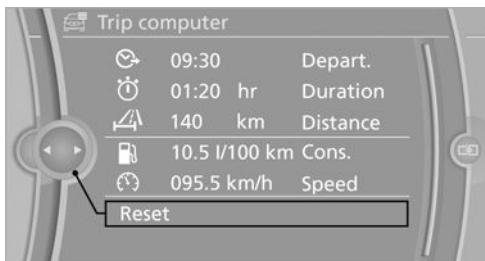

- ▷ Departure time.
- ▷ Trip duration.
- ▷ Trip distance.

Both displays show:

- ▷ Average speed.
- ▷ Average fuel consumption.

Resetting the fuel consumption and speed

You can reset the values for average speed and average consumption:

1. Select the respective menu item and press the controller.
2. Press the controller again to confirm your selection.

Resetting the trip computer

Resetting all values:

1. "Vehicle Info"
2. "Trip computer"
3. "Reset"

Settings and information

Operating concept

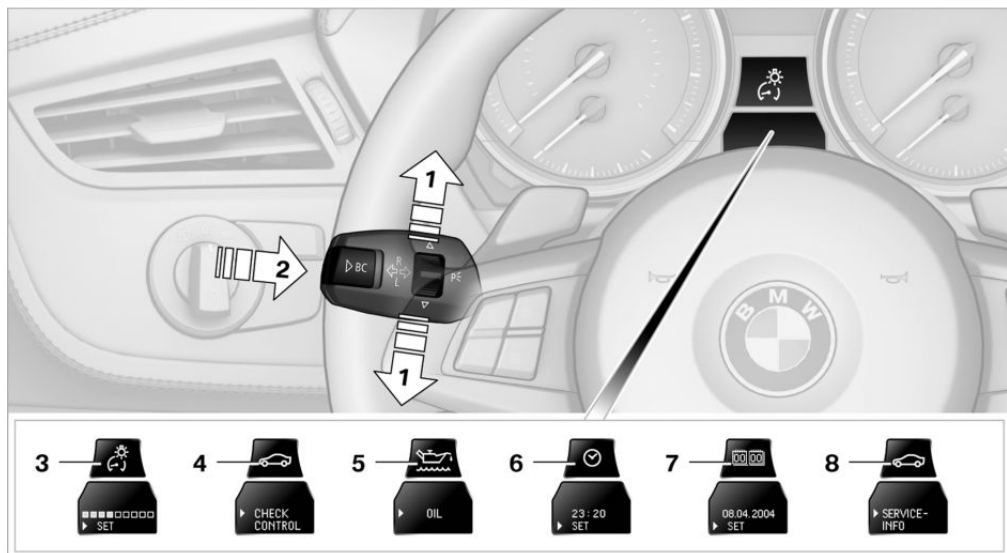

- 1 Button for:
 - ▶ Selecting the display
 - ▶ Setting values
- 2 Button for:
 - ▶ Confirming selected display or set values
- 3 With the lights switched on: dimming the instrument lighting [88](#)
- 4 Calling up Check Control [82](#)
- 5 Checking the engine oil level [236](#)
- 6 Setting the time [76](#)
- 7 Setting the date [77](#)
- 8 Viewing service requirement display [78](#)

Exiting displays

The external temperature reading and the time reappear when you press button 2 or if you make no entries within approx. 15 seconds. If required, complete the current setting first.

Units of measure

You can change the units for fuel consumption, route/distance, temperature and pressure.

1. "Settings"
2. "Language/Units"

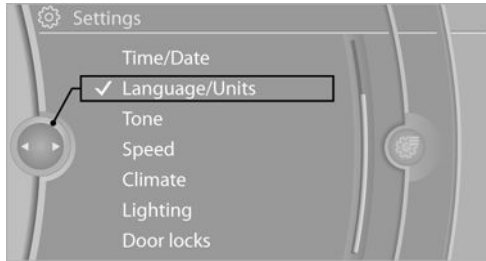

3. Select the desired menu item.
4. Select the desired unit.

The settings are stored for the remote control currently in use.

Clock

Setting the time

In the instrument cluster

To set the 12h/24h format, refer to Setting the time format below.

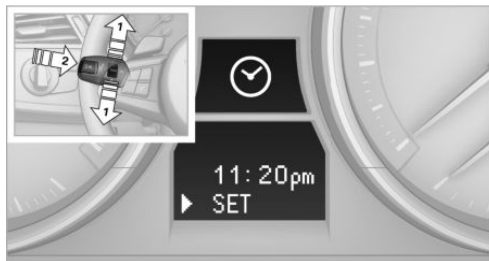

1. Press button 1 in the turn indicator lever up or down repeatedly until the appropriate symbol appears in the display, accompanied by the time and the word "SET".
2. Press button 2.

3. Use button 1 to set the hours.
4. Press button 2 to confirm the entry.
5. Use button 1 to set the minutes.
6. Press button 2 to confirm the entry.
7. Press button 2.

The system accepts the new time.

Via the iDrive

1.  Press the button.
The main menu is displayed.

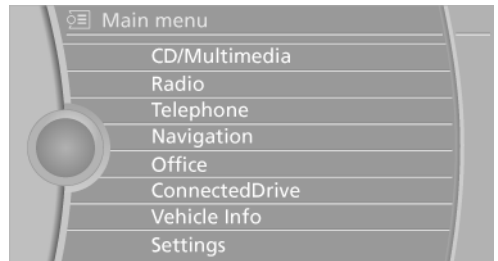

2. "Settings"

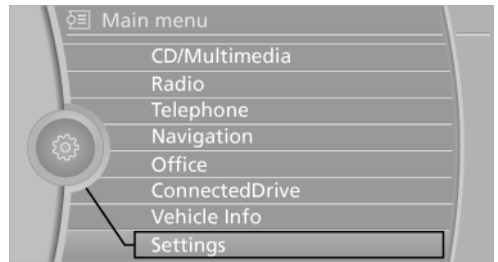

Setting the time zone

1. "Settings"
2. "Time/Date"
3. "Time zone:"
4. Select the desired time zone.

The time zone is stored.

Setting the time

1. "Settings"
2. "Time/Date"

3. "Time:"



4. Turn the controller until the desired hours are displayed, and then press the controller.
5. Turn the controller until the desired minutes are displayed, and then press the controller.

The time is stored.

Setting the time format

1. "Settings"
2. "Time/Date"
3. "Format:"
4. Select the desired format.

The time format is stored.

The settings are stored for the remote control currently in use, Personal Profile, refer to page 30.

Date

The settings are stored for the remote control currently in use, Personal Profile, refer to page 30.

Setting the date

In the instrument cluster

To set the dd/mm or mm/dd date format, refer to Setting the date format below.

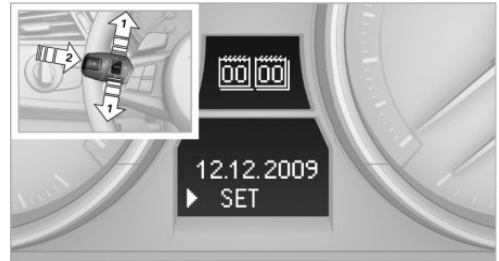

1. Push button 1 in the turn indicator lever up or down repeatedly until the appropriate symbol appears in the display, accompanied by the date and the word "SET".
 2. Press button 2.
 3. Use button 1 to set the day of the month.
 4. Press button 2 to confirm the entry.
 5. Set the month and the year in the same way.
 6. Press button 2.
- The system stores the new date.

Via the iDrive

1. "Settings"
2. "Time/Date"
3. "Date:"
4. Turn the controller until the desired day is displayed, and then press the controller.
5. Make the necessary settings for the month and year.

The date is stored.

Setting the date format

1. "Settings"
2. "Time/Date"

- "Format:"
- Select the desired format.



The date format is stored.

Settings on the Control Display

Language

Setting the language

To set the language on the Control Display:

- "Settings"
- "Language/Units"
- "Language:"

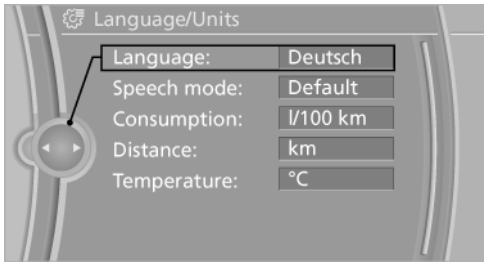

- Select the desired language.

The setting is stored for the remote control currently in use.

Setting the voice dialog

Voice dialog for the voice activation system, refer to page 26.

Brightness

Setting the brightness

To set the brightness of the Control Display:

- "Settings"
- "Control display"
- "Brightness"

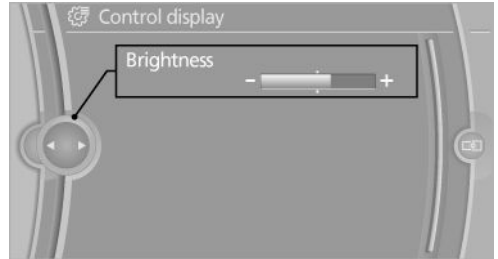

- Turn the controller until the desired brightness is set.
- Press the controller.

The setting is stored for the remote control currently in use.

Depending on the light conditions, the brightness control may not be clearly visible.

Service requirements

Display

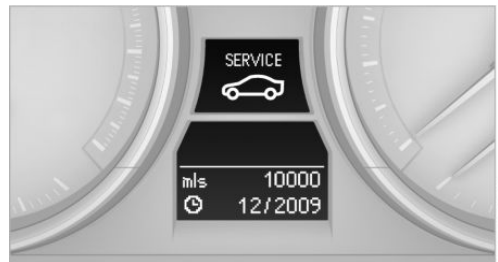

The remaining driving distance and the date of the next maintenance are displayed briefly after the ignition is switched on.

The current service requirements can be read out from the remote control by the service specialist.

Data regarding the maintenance status or legally mandated inspections of the vehicle are automatically transmitted to your service center before a service due date, Automatic Service Request, refer to page 215.

The remaining driving distance or the due date can be displayed individually for certain maintenance procedures.

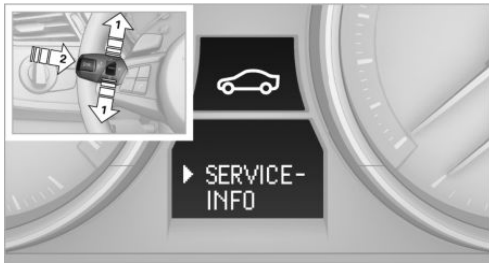

1. Switch on the ignition.
2. Press button 1 in the turn indicator lever up or down repeatedly until the appropriate symbol appears in the display, accompanied by the words "SERVICE INFO".
3. Press button 2.
4. Use button 1 to scroll through the individual service items.

Possible displays

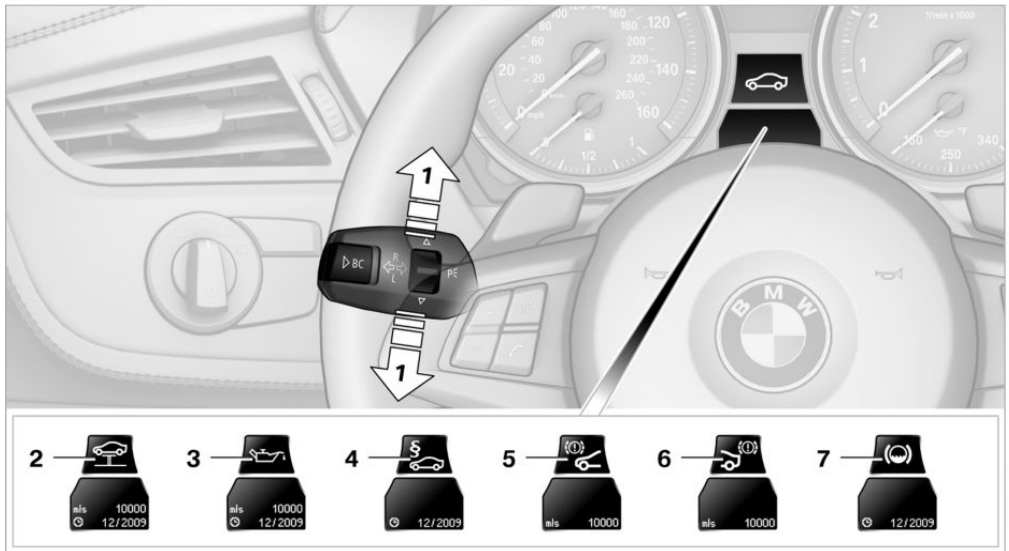

1 Button for selecting functions

2 Service requirements

3 Engine oil

4 Roadworthiness test

5 Front brake pads

6 Rear brake pads

7 Brake fluid

The sequence of displayed service items may vary. The data for the next service appointment is shown first.

More information

Detailed information on service requirements

More information on the scope of service required can be displayed on the Control Display.

1. "Vehicle Info"
2. "Vehicle status"

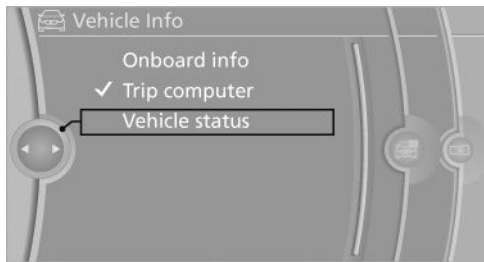

3. "Service required"

Required maintenance procedures and legally mandated inspections are displayed.



4. Select an entry to call up detailed information.

Symbols

Symbols	Description
	No service is currently required.
	The deadline for service or a legally mandated inspection is approaching.
	The service deadline has already passed.

Entering appointment dates

Enter the dates for the required inspections. Ensure that the vehicle date and time are set correctly on the Control Display.

1. "Vehicle Info"
2. "Vehicle status"
3. "Service required"



4. "§ Vehicle inspection"

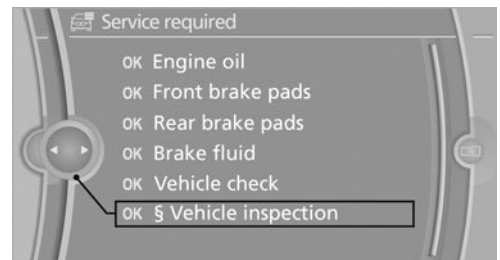

5. "Date:"

6. Create the settings.
7. Confirm.
The entered date is stored.

Automatic Service Request

Data regarding the maintenance status or legally mandated inspections of the vehicle are automatically transmitted to your service center before a service due date.

You can check when your service center was notified.

1. "Vehicle Info"
2. "Vehicle status"
3. Open "Options".
4. "Last Service Request"

Check Control

The concept

The Check Control monitors vehicle functions and alerts you to any malfunctions in the systems monitored.

Such Check Control messages involve indicator or warning lamps in the instrument cluster and, in some circumstances, an acoustic signal and text messages at the bottom of the Control Display.

Indicator/warning lamps



The indicator and warning lamps can light up in a variety of combinations and colors.

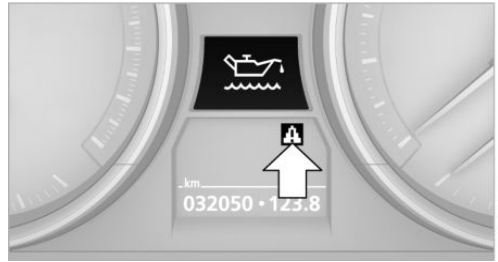

⚠ indicates that Check Control messages have been stored. You can view the Check Control messages whenever it is convenient for you.

Explanatory text messages



Text messages at the upper edge of the Control Display explain the meaning of the displayed indicator and warning lamps.

For most Check Control messages, you can view more information later, e.g., regarding the cause of a malfunction and how to respond; refer to the information provided below.

In urgent cases, this information will be shown as soon as the corresponding lamp comes on.

Symbols

The following functions can be selected within the supplementary text message, depending on the Check Control message.

- ▷  "Service request"
Contact the service partner.
- ▷  "Roadside Assistance"
Contact Roadside Assistance.

Hiding Check Control messages

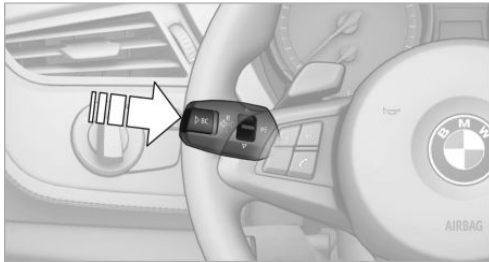

Press the button in the turn indicator lever. Some Check Control messages are displayed until the malfunctions have been rectified. They cannot be hidden. If several malfunctions occur at the same time, they are displayed in succession.

 They are marked with the symbol shown here.

Other messages are automatically hidden after approx. 20 seconds, but are kept in memory.

 They are marked with the symbol shown here.

Viewing stored Check Control messages

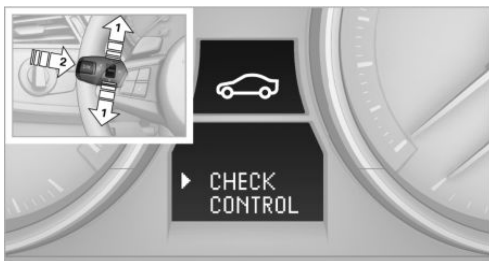

1. Press button 1 in the turn indicator lever up or down repeatedly until the appropriate symbol appears in the display, accompanied by the words "CHECK CONTROL".
2. Press button 2. If there is no Check Control message, this is indicated by "CHECK OK".

If a Check Control message has been stored, the corresponding lamp comes on. It is accompanied by a text message on the Control Display.

3. Press button 1 to check for other messages.
4. Press button 2.
The display again shows the external temperature and the time.

Displaying stored Check Control messages

1.  Press the button.
2. "Vehicle Info"
3. "Vehicle status"
4. "Check Control"

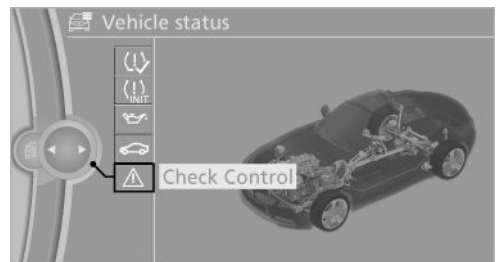

5. Select the text message.

Messages after trip completion

Special messages that were displayed during a trip are displayed again after the ignition is switched off.

Speed limit

You can enter a speed, and a Check Control message will indicate when you reach this speed. This enables you to receive warnings if you exceed a speed limit in an urban area, for example. You are only warned of reaching this

speed a second time if your vehicle speed falls below it again by at least 3 mph/5 km/h.

1. "Settings"
2. "Speed"
3. "Warning at:"

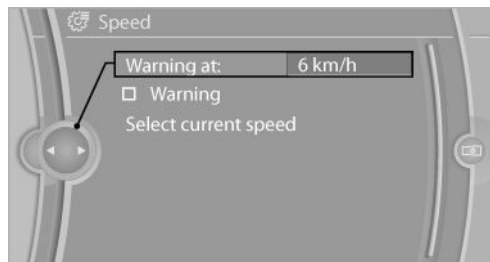

4. Turn the controller until the desired limit is displayed.
5. Press the controller.

The speed limit is stored.

Activating/deactivating the limit

1. "Settings"
2. "Speed"
3. "Warning"
4. Press the controller.

Applying your current speed as the limit

1. "Settings"
2. "Speed"
3. "Select current speed"
4. Press the controller.

The system adopts your current speed as the limit.

Lamps

Vehicle equipment

This chapter describes all series equipment as well as country-specific and special equipment offered for this model series. Therefore, it also describes equipment that may not be found in your vehicle, for instance due to the selected special equipment or the country version. This also applies to safety-related functions and systems.

When using the features and systems described here, adhere to local regulations.

At a glance

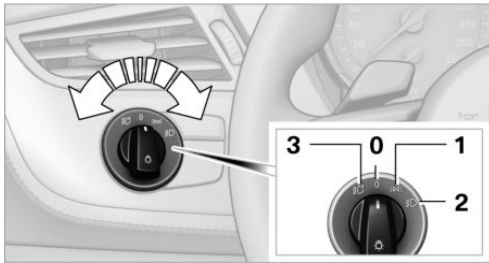

- 0 Lamps off
Daytime running lights
- 1 Parking lamps and daytime running lights
- 2 Low-beam headlamps and welcome lamps
- 3 Automatic headlamp control, daytime running lights, welcome lamps, High-beam Assistant, and Adaptive Light Control

When you open the driver's door with the ignition switched off, the exterior lighting is automatically switched off if the light switch is in position 0, 2, or 3.

Switch on the parking lamps if necessary, switch position 1.

Parking lamps/low beams, headlamp control

Parking lamps

Switch position  : the vehicle lamps light up on all sides, e.g., for parking.



Do not use the parking lamps for extended periods; otherwise, the battery may become discharged and it would then be impossible to start the engine.

When parking, it is preferable to switch on the one-sided roadside parking lamps, refer to page 87.

Low beams

Switch position  with the ignition switched on: the low beams light up.

Welcome lamps

When parking the vehicle, leave the switch in position  or  : the parking and interior lamps light up briefly when the vehicle is unlocked.

Activating/deactivating the welcome lamps

1. "Settings"
2. "Lighting"
3. "Welcome light"

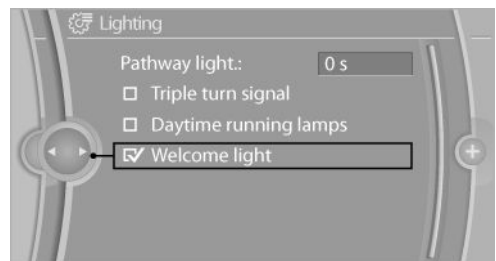

The setting is stored for the remote control currently in use.

Headlamp courtesy delay feature

The low beams stay lit for a short while after the ignition is switched off, if the lamps are switched off and the headlamp flasher is switched on.

Setting the duration

1. "Settings"
2. "Lighting"
3. "Pathway light.: s"

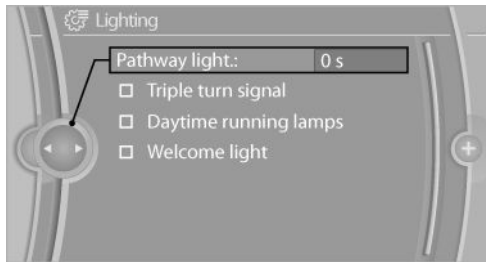

4. Set the duration.

The setting is stored for the remote control currently in use.

Automatic headlamp control

Switch position  : the low beams are switched on and off automatically, e.g., in tunnels, in twilight or if there is precipitation. The LED next to the symbol lights up.

A blue sky with the sun low on the horizon can cause the lights to be switched on.





Personal responsibility

The automatic headlamp control cannot serve as a substitute for your personal judgment in determining when the lamps should be switched on in response to ambient lighting conditions.

For example, the sensors are unable to detect fog or hazy weather. To avoid safety risks, you should always switch on the lamps manually under these conditions. ◀

Daytime running lights

The daytime running lights light up in position 0,  and . After the ignition is switched off, the parking lamps light up in position .

Activating/deactivating

In some countries, driving with daytime running lights is mandatory; for this reason, daytime running lights cannot be deactivated in these cases.

1. "Settings"
2. "Lighting"
3. "Daytime running lamps"

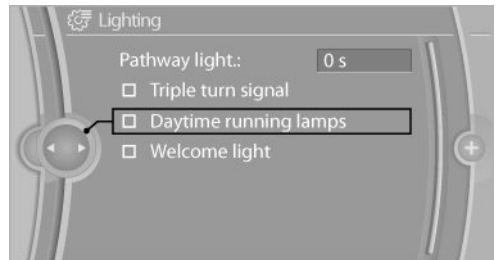

The setting is stored for the remote control currently in use.

Adaptive Light Control

The concept

Adaptive Light Control is a variable headlamp control system that enables dynamic illumination of the road surface.

Depending on the steering angle and other parameters, the light from the headlamp follows the course of the road.

Controls

Activating

Switch position  with the ignition switched on.

Auxiliary function:

To avoid blinding oncoming traffic, the Adaptive Light Control does not swivel to the driver's side when the vehicle is at a standstill.

Malfunction



The warning lamp lights up. A message appears on the Control Display. Adaptive Light Control is malfunctioning or has failed. Have the system checked as soon as possible.

High beams/roadside parking lamps

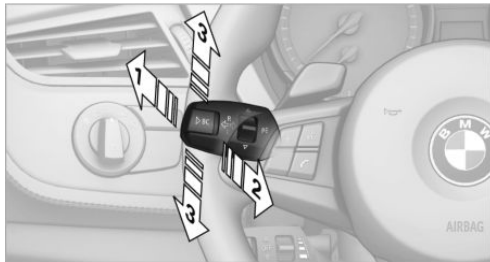

- 1 High beams
- 2 Headlamp flasher
- 3 Roadside parking lamps

Left and right roadside parking lamps

There is an additional option of switching on the lamps on the side of the car facing the road when parked.

Switching on

After parking the vehicle, press the lever up or down beyond the pressure point for a longer period, arrow 3.

The roadside parking lamps drain the battery. Therefore, do not leave them on for unduly long periods of time; otherwise, the battery might not have enough power to start the engine.

Switching off

Press the lever in the opposite direction to the pressure point, arrow 3.

High-beam Assistant

The concept

When the lights are switched on, this system automatically switches the high beams on and off. The procedure is controlled by a sensor on the front of the interior rearview mirror. The assistant ensures that the high beams are switched on whenever the traffic situation allows. The driver can intervene at any time and switch the high beams on and off as usual.

Activating the High-beam Assistant

1. Turn the light switch to .
2. With the low beams switched on, briefly push the turn indicator lever in the direction of the high beam.



The indicator lamp in the instrument cluster lights up.

When the lights are switched on, the high beams are switched on and off automatically.

The system responds to light from oncoming traffic and traffic driving ahead of you, and to adequate illumination, e.g., in towns and cities.

Switching the high beams on and off manually

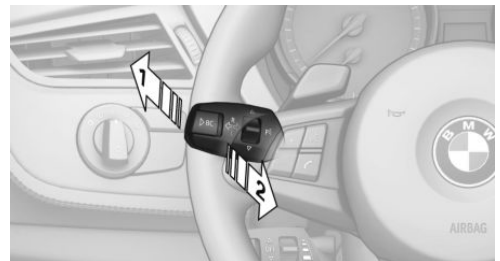

- ▷ High beams on, arrow 1.

- ▶ High beams off/headlamp flasher, arrow 2.

To reactivate the High-beam Assistant, briefly push the turn indicator lever toward the high beams.

Activating/deactivating via iDrive

1. "Settings"
2. "Lighting"
3. "High beam assistant"

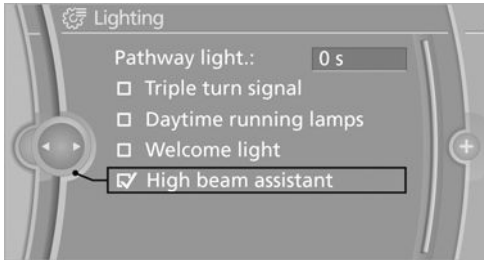

The setting is stored for the remote control currently in use.

System limits



Personal responsibility

The High-beam Assistant cannot serve as a substitute for the driver's personal judgment of when to use the high beams. Therefore, manually switch off the high beams in situations where this is required to avoid a safety risk. ◀

The system is not fully functional in situations such as the following, and driver intervention may be necessary:

- ▶ In very unfavorable weather conditions, such as fog or heavy precipitation.
- ▶ In detecting poorly-lit road users, such as pedestrians, cyclists, horseback riders and wagons; when driving close to train or ship traffic; and at animal crossings.
- ▶ In tight curves, on hilltops or in depressions, in cross traffic or half-observed on-coming traffic on freeways.

- ▶ In poorly-lit towns and cities and in the presence of highly reflective signs.
- ▶ At low speeds.
- ▶ When the windshield in front of the interior rearview mirror is fogged over, dirty or covered with stickers, etc.

Sensor view field

The view field of the sensor is located on the front of the interior rearview mirror.

Do not cover this area with stickers, etc.

Clean the view field, refer to page 258.

Instrument lighting

The parking lamps or low beams must be switched on to adjust the brightness.



1. Push button 1 up or down repeatedly until the appropriate symbol appears in the display, accompanied by the brightness setting and the word "SET".
2. Press button 2.



3. Push button 1 up or down to select the desired brightness level.
4. Press button 2.
The display again shows the outside temperature and the time.

Interior lamps

The interior lamps, footwell lamps, entry lamps, trunk lamp, and courtesy lamps are controlled automatically.

The LEDs for the courtesy lamps are set in the door handles and illuminate the ground in front of the doors.

To avoid draining the battery, all lamps inside the car are switched off about 8 minutes after the ignition is switched off, Start/Stop button, refer to page 55.

Switching interior lamps on/off manually

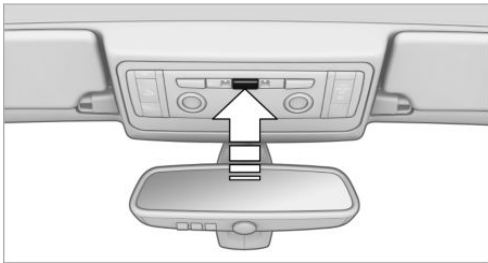

Interior lamps:

To switch on and off, press the button.

To switch off the interior lamps, footwell lamps, entry lamps, and courtesy lamps permanently, press the button for the front interior lamps for about 3 seconds.

Reading lamps

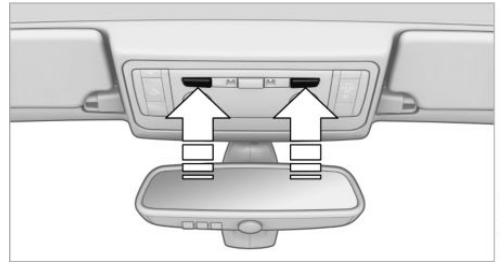

The reading lamps are located next to the interior lamp. To switch on and off, press the button.

Safety

Vehicle equipment

This chapter describes all series equipment as well as country-specific and special equipment offered for this model series. Therefore, it also describes equipment that may not be found in your vehicle, for instance due to the selected special equipment or the country version. This also applies to safety-related functions and systems.

When using the features and systems described here, adhere to local regulations.

Airbags

The following airbags are located under the marked covers:

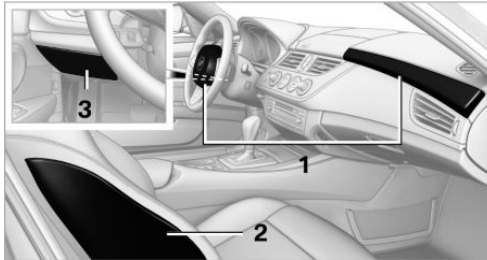

- 1 Front airbags
- 2 Side airbags in the seat backrests
- 3 Knee airbag

Front airbags

Front airbags help protect the driver and passenger by responding to frontal impacts in which safety belts alone cannot provide adequate restraint.

Side airbags

In a lateral impact, the side airbag protects the side of the body in the chest area.

Knee airbag

The knee airbag supports the legs in a frontal impact.

Protective action

Airbags are not triggered in every impact situation, e.g., in less severe accidents or rear-end collisions.

Even when all instructions are followed closely, injury from contact with the airbags cannot be ruled out in certain situations.

The ignition and inflation noise may lead to short-term and, in most cases, temporary hearing impairment in sensitive individuals.



Information on how to ensure the optimal protective effect of the airbags

- ▷ Keep at a distance from the airbags.
- ▷ Always grasp the steering wheel on the steering wheel rim, holding your hands at the 3 o'clock and 9 o'clock positions, to keep the danger of injury to your hands or arms as low as possible if the airbag is triggered.
- ▷ There should be no people, animals, or objects between an airbag and a person.
- ▷ Do not use the cover of the front airbag on the front passenger side as a storage area.
- ▷ Keep the dashboard and window on the front passenger side clear, i.e., do not cover with adhesive labels or coverings, and do not attach holders such as for navigation instruments and mobile phones.
- ▷ Make sure that the front passenger is sitting correctly, i.e., keeps his or her feet and legs in the footwell; otherwise, leg injuries can occur if the front airbag is triggered.

- ▶ Do not place slip covers, seat cushions or other objects on the front passenger seat that are not approved specifically for seats with integrated side airbags.
- ▶ Do not hang pieces of clothing, such as jackets, over the backrests.
- ▶ Make sure that passengers do not lean their heads against the side airbag; otherwise, serious injuries could result if the airbag suddenly deployed.
- ▶ Do not remove the airbag restraint system.
- ▶ Do not remove the steering wheel.
- ▶ Do not apply adhesive materials to the airbag cover panels, cover them or modify them in any way.
- ▶ Never modify either the individual components or the wiring in the airbag system. This also applies to the covers of the steering wheel, the dashboard and the seats. ◀

 In the case of a malfunction, deactivation and after triggering of the airbags

Do not touch the individual components immediately after the system has been triggered; otherwise, there is the danger of burns.

Only have the airbags checked, repaired or dismantled and the airbag generator scrapped by your service center or a workshop that has the necessary authorization for handling explosives.

Non-professional attempts to service the system could lead to failure in an emergency or undesired triggering of the airbag, either of which could result in injury. ◀

Warning notices and information about the airbags can also be found on the sun visors.

Automatic deactivation of the passenger airbags

The system determines whether the front passenger seat is occupied by measuring the resistance of the human body. The front and side airbags on the front passenger side are acti-

vated or deactivated accordingly by the system.

The indicator lamp above the interior rearview mirror shows the current status of the passenger airbags, deactivated or activated, refer to Status of passenger airbags below.



Passenger feet in the footwell

Make sure that the front passenger keeps his or her feet in the footwell; otherwise, the front passenger airbags may not function properly. ◀



Child restraint fixing system in the front passenger seat

Before transporting a child on the passenger seat, read the safety and operating instructions under Transporting children safely, refer to page 53. ◀

Malfunction of the automatic deactivation system

The front passenger airbags may be deactivated if adolescents and adults sit in certain positions; the indicator lamp for the front passenger airbags comes on. In this case, change the sitting position so that the front passenger airbags are activated and the indicator lamp goes out. If the desired airbag status cannot be achieved by changing the sitting position, do not transport the passenger in the vehicle.

To make sure that occupation of the seat cushion can be detected correctly:

- ▶ Do not attach seat covers, seat cushion padding, ball mats or other items to the passenger seat unless they are specifically recommended by BMW.
- ▶ Do not place any objects on the front passenger seat.
- ▶ Do not place objects under the seat that could press against the seat from below.

Status of passenger airbags



The indicator lamp for the front passenger airbags indicates the operating status of the front and side airbags on the front passenger side depending on the seat occupation. The indicator lamp shows whether the passenger airbags are activated or deactivated.

- ▷ The indicator lamp lights up when a child who is properly seated in a child restraint system intended for that purpose is detected on the seat or the seat is empty. The front and side airbags on the front passenger side are not activated. Most child seats are detected by the system, Especially the child seats required by NHTSA at the time that the vehicle was manufactured. After installing a child seat, make sure that the indicator lamp for the front passenger airbags lights up. This indicates that the child seat has been detected and the front passenger airbags are not activated.
- ▷ The indicator lamp does not light up when, for example, a person of sufficient size and in a correct sitting position is detected on the seat. The front and front passenger airbags on the front passenger side are activated.

Operational readiness of airbag system



When the ignition, refer to page 56, is switched on, the warning lamp comes on briefly to indicate that the entire airbag system and the belt tensioners are operational.

Airbag system malfunction

- ▷ The warning lamp does not light up when the ignition is switched on.
- ▷ Warning lamp remains permanently on.



Have the airbag system checked without delay if there is a malfunction

In the event of a malfunction in the airbag system, have it checked without delay; otherwise, there is the risk that the system will not function as intended even if a sufficiently severe accident occurs. ◀

Flat Tire Monitor FTM

The concept

The system detects a pressure loss in a tire on the basis of speed differences between the individual wheels during a trip.

In the event of pressure loss, the rolling circumference changes and, thus, the rotating speed of the affected wheel. This change is detected and is reported as a flat tire.

Functional requirements

The system must have been initialized when the tire inflation pressure was correct; other-

wise, reliable signaling of a flat tire is not ensured. Initialize the system after each correction of the tire inflation pressure and after every tire or wheel change.

System limits

 Sudden tire damage
Sudden serious tire damage caused by external influences cannot be indicated in advance. ◀

A natural, even pressure loss in all four tires cannot be detected.

The system could be delayed or malfunction in the following situations:

- ▶ When the system has not been initialized.
- ▶ When driving on a snowy or slippery road surface.
- ▶ Sporty driving style: slip in the drive wheels, high lateral acceleration.
- ▶ When driving with snow chains.

Status display

The current status of the Flat Tire Monitor can be displayed on the Control Display, e.g., whether or not the FTM is active.

1. "Vehicle Info"
2. "Vehicle status"
3. "Flat Tire Monitor"

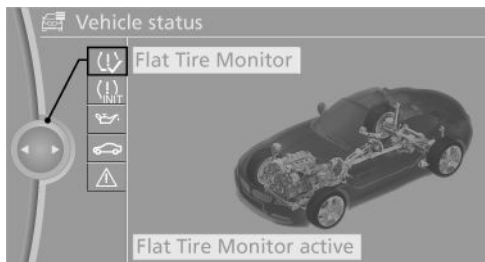

The status is displayed.

Initialization

The initialization process adopts the set inflation tire pressures as reference values for the detection of a flat tire. Initialization is started by confirming the inflation pressures.

Do not initialize the system when driving with snow chains.

1. "Vehicle Info"
2. "Vehicle status"
3. "Reset"

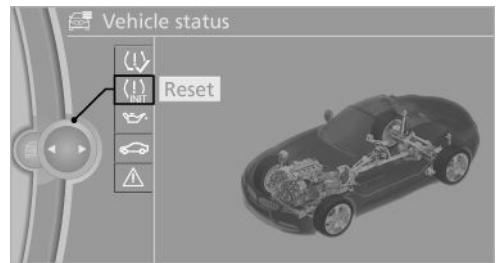

4. Start the engine - do not drive away.
5. Start the initialization with "Reset".
6. Drive away.

The initialization is completed while driving, which can be interrupted at any time.

The initialization automatically continues when driving resumes.

Indication of a flat tire

 The warning lamps come on in yellow and red. A message appears on the Control Display. In addition, a signal sounds.

There is a flat tire or a major loss in tire inflation pressure.

1. Reduce your speed and stop cautiously. Avoid sudden braking and steering maneuvers.
2. Check whether the vehicle is fitted with regular tires or run-flat tires.

Run-flat tires, refer to page 232, are labeled with a circular symbol containing the letters RSC marked on the tire sidewall.

 Do not continue driving without run-flat tires

Do not continue driving if the vehicle is not equipped with run-flat tires; continued driving may result in serious accidents. ◀

When a flat tire is indicated, DSC Dynamic Stability Control is switched on if necessary.

Actions in the event of a flat tire

Normal tires

1. Identify the damaged tire.

Do this by checking the air pressure in all four tires.

If the tire inflation pressure in all four tires is correct, the Flat Tire Monitor may not have been initialized. In this case, initialize the system.

If an identification is not possible, please contact the service center.

2. Rectify the flat tire.

Run-flat tires

You can continue driving with a damaged tire at speeds up to 50 mph/80 km/h.

Continued driving with a flat tire

If continuing to drive with a damaged tire:

1. Avoid sudden braking and steering maneuvers.
2. Do not exceed a speed of 50 mph/80 km/h.
3. Check the air pressure in all four tires at the next opportunity.

If the tire inflation pressure in all four tires is correct, the Flat Tire Monitor may not have been initialized. In this case, initialize the system.

Possible driving distance with complete loss of tire inflation pressure:

The possible driving distance after a loss of tire inflation pressure depends on the cargo load and the driving style and conditions.

For a vehicle containing an average load, the possible driving distance is approx. 50 miles/80 km.

When the vehicle is driven with a damaged tire, its handling characteristics change, e.g., reduced lane stability during braking, a longer braking distance, and altered self-steering properties. Adjust your driving style accordingly. Avoid abrupt steering maneuvers or driving over obstacles, e. g., curbs, potholes, etc.

Because the possible driving distance depends on how the vehicle is used during the trip, the actual distance may be smaller or greater depending on the driving speed, road conditions, external temperature, cargo load, etc.

 Continued driving with a flat tire

Drive moderately and do not exceed a speed of 50 mph/80 km/h.

A loss of tire inflation pressure results in a change in the handling characteristics, e.g., reduced lane stability during braking, a longer braking distance and altered self-steering properties. ◀

 Final tire failure

Vibrations or loud noises while driving can indicate the final failure of the tire. Reduce speed and stop; otherwise, pieces of the tire could come loose and cause an accident. Do not continue driving, and contact your service center. ◀

Tire Pressure Monitor TPM

The concept

The system monitors the tire pressure in the four mounted tires. The system issues a warning if there is a significant loss of pressure in

one or more tires. Sensors in the tire valves measure the tire pressure.

Notes



Tire damage caused by external influences

Sudden tire damage caused by external influences cannot be indicated in advance. ◀

To operate the system, also note the additional information and instructions contained under Tire inflation pressure, refer to page 226.

Functional requirement

The system must have been reset while the inflation pressure was correct; otherwise, reliable signaling of pressure loss is not ensured.

Reset the system after adjusting the tire inflation pressure and after changing a tire or wheel.

Always use wheels with TPM electronics to ensure that the system will operate properly.

Status display

1.  Press the button. The start menu opens.
2. "Vehicle Info"
3. "Vehicle status"
4. "TPM"
5. The status is displayed.

Status indicator on the Control Display

The tire and system status is indicated by the color of the tires.

TPM takes into account that tire pressures change while the vehicle is being driven.

All wheels are green

The system is active and issues warnings in case of deviations from the tire inflation pressures stored last.

"TPM active" appears on the Control Display.

One wheel is yellow

Flat tire or major drop in inflation pressure in the indicated tire. A message appears on the Control Display.

All wheels are yellow

- ▷ Flat tire or major drop in inflation pressure in several tires.
- ▷ The system was not reset after a wheel change and issues warnings in case of deviations from the tire inflation pressures stored last.
- ▷ A flat tire in one or more tires while the system is being reset.

A message appears on the Control Display.

The wheels are gray

The system cannot detect a flat tire.

Possible reasons for this:

- ▷ TPM is being reset.
- ▷ Disturbance by systems or devices with the same radio frequency.
- ▷ Malfunction.

Resetting the system

Reset the system after adjusting the tire inflation pressure and every time a tire or wheel is changed.

1.  Press the button. The start menu opens.
2. "Vehicle Info"
3. "Vehicle status"

4. "Reset"

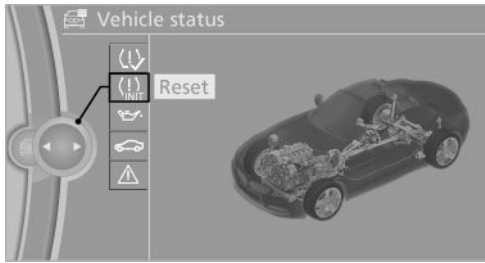



5. Start the engine, but do not start driving.
6. Start the system reset with "Reset".
7. Drive away. The tires are shown in gray and "Resetting TPM..." is displayed.

After a short trip at over 30 km/h, the set tire inflation pressures are adopted as target values. The system reset is completed as you drive, and can be interrupted at any time. When driving resumes, the reset is continued automatically. On the Control Display, the tires are shown in green and "TPM active" is displayed again.

If a flat tire is detected while the system is resetting and determining the inflation pressures, all tires on the Control Display are displayed in yellow. The message "Low tire!" is shown.

Low tire pressure message

 The warning lights come on in yellow and red. A message appears on the Control Display. In addition, a signal sounds.

- 
- ▷ There is a flat tire or a major loss in tire inflation pressure.
 - ▷ The system was not reset. The system therefore issues warnings in case of deviations from the tire inflation pressures stored last.
1. Reduce your speed and stop cautiously. Avoid sudden braking and steering maneuvers.

2. Check whether the vehicle is fitted with regular tires or run-flat tires.

Run-flat tires, refer to page 96, are labeled with a circular symbol containing the letters RSC marked on the tire sidewall.

 Do not continue driving without run-flat tires

Do not continue driving if the vehicle is not equipped with run-flat tires; continued driving may result in serious accidents. ◀

When a flat tire is indicated, DSC Dynamic Stability Control is switched on if necessary.

Actions in the event of a flat tire

Normal tires

1. Identify the damaged tire.

Do this by checking the air pressure in all four tires.

If the tire inflation pressure in all four tires is correct, the Tire Pressure Monitor may not have been reset. Reset the system.

If an identification is not possible, please contact the service center.

2. Rectify the flat tire.

The use of tire sealant can damage the TPM electronics. In this case, have the electronics checked at the next opportunity and have them replaced if necessary.

Run-flat tires

You can continue driving with a damaged tire at speeds up to 50 mph/80 km/h.

Continued driving with a flat tire

If continuing to drive with a damaged tire:

1. Avoid sudden braking and steering maneuvers.
2. Do not exceed a speed of 50 mph/80 km/h.
3. Check the air pressure in all four tires at the next opportunity.

If the tire inflation pressure in all four tires is correct, the Tire Pressure Monitor may not have been reset. Reset the system.

Possible driving distance with complete loss of tire inflation pressure:

The possible driving distance after a loss of tire inflation pressure depends on the cargo load and the driving style and conditions.

For a vehicle containing an average load, the possible driving distance is approx. 50 miles/80 km.

When the vehicle is driven with a damaged tire, its handling characteristics change, e.g., reduced lane stability during braking, a longer braking distance, and altered self-steering properties. Adjust your driving style accordingly. Avoid abrupt steering maneuvers or driving over obstacles, e. g., curbs, potholes, etc.

Because the possible driving distance depends on how the vehicle is used during the trip, the actual distance may be smaller or greater depending on the driving speed, road conditions, external temperature, cargo load, etc.

 Continued driving with a flat tire
Drive moderately and do not exceed a speed of 50 mph/80 km/h.

A loss of tire inflation pressure results in a change in the handling characteristics, e.g., reduced lane stability during braking, a longer braking distance and altered self-steering properties. ◀

 Final tire failure
Vibrations or loud noises while driving can indicate the final failure of the tire. Reduce speed and stop; otherwise, pieces of the tire could come loose and cause an accident. Do not continue driving, and contact your service center. ◀

Message when not reset



The warning light lights up yellow. A Check Control message is displayed. The system may not have been reset although a wheel was changed.

Check the tire inflation pressure and reset the system, refer to page 95.

System limits

The system does not function properly if it has not been reset, e.g., it may identify a tire as flat in spite of the fact that the tire is filled to the correct inflation pressure.

The tire pressure depends on the temperature of the tire. An increase in the tire temperature, e.g., while driving or due to sunlight, increases the tire inflation pressure. The tire pressure decreases when the tire temperature drops. In case of severe temperature drops, this behavior may lead to a warning on account of the defined warning limits.

Malfunction



The small warning light flashes in yellow and then lights up continuously; the larger warning light comes on in yellow. On the Control Display, the tires are shown in gray and a message appears. No flat tire can be detected.

Display in the following situations:

- ▶ A wheel without TPM electronics is fitted: have the service center check it if necessary.
- ▶ Malfunction: have the system checked by your service center.
- ▶ TPM could not be fully reset. Reset the system again.



The small warning light flashes in yellow and then lights up continuously; the larger warning light comes on in yellow. The tires are displayed in gray

on the Control Display. No flat tire can be detected.

Display in the following situations:

- ▶ Disturbance by systems or devices with the same radio frequency. After leaving the area of the disturbance, the system automatically becomes active again.

Declaration according to NHTSA/ FMVSS 138 Tire Pressure Monitoring Systems

Each tire, including the spare (if provided) should be checked monthly when cold and inflated to the inflation pressure recommended by the vehicle manufacturer on the vehicle placard or tire inflation pressure label (If your vehicle has tires of a different size than the size indicated on the vehicle placard or tire inflation pressure label, you should determine the proper tire inflation pressure for those tires.).

As an added safety feature, your vehicle has been equipped with a tire pressure monitoring system (TPMS) that illuminates a low tire pressure telltale when one or more of your tires is significantly under-inflated. Accordingly, when the low tire pressure telltale illuminates, you should stop and check your tires as soon as possible, and inflate them to the proper pressure. Driving on a significantly under-inflated tire causes the tire to overheat and can lead to tire failure. Under-inflation also reduces fuel efficiency and tire tread life, and may affect the vehicle's handling and stopping ability.

Please note that the TPMS is not a substitute for proper tire maintenance, and it is the driver's responsibility to maintain correct tire pressure, even if under-inflation has not reached the level to trigger illumination of the TPMS low tire pressure telltale.

Your vehicle has also been equipped with a TPMS malfunction indicator to indicate when the system is not operating properly. The TPMS malfunction indicator is combined with the low tire pressure telltale. When the system detects a malfunction, the telltale will flash for

approximately one minute and then remain continuously illuminated. This sequence will continue upon subsequent vehicle startups as long as the malfunction exists. When the malfunction indicator is illuminated, the system may not be able to detect or signal low tire pressure as intended. TPMS malfunctions may occur for a variety of reasons, including the installation of replacement or alternate tires or wheels on the vehicle that prevent the TPMS from functioning properly. Always check the TPMS malfunction telltale after replacing one or more tires or wheels on your vehicle to ensure that the replacement or alternate tires and wheels allow the TPMS to continue to function properly.

Brake force display

The concept

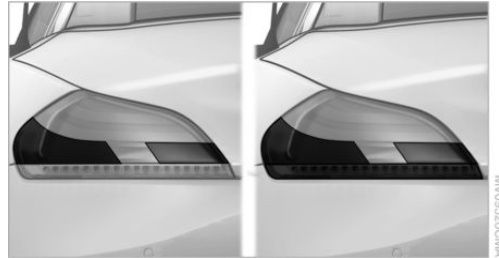

- ▶ During normal brake application, the brake lamps light up.
- ▶ During heavy brake application, the turn signals light up in addition.

The brake force display is not activated if the turn signal function is switched on.

Driving stability control systems

Vehicle equipment

This chapter describes all series equipment as well as country-specific and special equipment offered for this model series. Therefore, it also describes equipment that may not be found in your vehicle, for instance due to the selected special equipment or the country version. This also applies to safety-related functions and systems.

When using the features and systems described here, adhere to local regulations.

Antilock Brake System ABS

ABS prevents locking of the wheels during braking.

The vehicle remains steerable even during full brake applications, thus increasing active safety.

ABS is operational every time you start the engine.

Electronic brake-force distribution

The system controls the brake pressure in the rear wheels to ensure stable braking behavior.

Dynamic Brake Control DBC

When you apply the brakes rapidly, this system automatically produces the maximum braking force boost. It thus helps to achieve the shortest possible braking distance during full braking. This system utilizes all of the benefits provided by ABS.

Do not reduce the pressure on the brake pedal for the duration of the full braking.

Dynamic Stability Control DSC

The concept

DSC prevents traction loss in the driving wheels when driving away and accelerating.

DSC also recognizes unstable vehicle conditions, such as fishtailing or nose-diving. Subject to physical limits, DSC helps to keep the vehicle on a steady course by reducing engine speed and by applying brakes to the individual wheels.



Adjust your driving style to the situation

An appropriate driving style is always the responsibility of the driver.

The laws of physics cannot be repealed, even with DSC.

Therefore, do not reduce the additional safety margin by driving in a risky manner. ◀

Activating/deactivating DSC

DSC can be deactivated/activated via the DSC OFF program of the Dynamic Driving Control, refer to page 100.

For better control



The DSC indicator lamp flashes: DSC is controlling the drive forces and brake forces.

The DSC indicator lamp lights up: DSC has failed.

Dynamic Traction Control DTC

The concept

The DTC system and the TRACTION program are a variant of the DSC in which forward momentum is optimized.

The system ensures maximum forward momentum on special road conditions, e.g., unpolished snowy roads, but driving stability is limited.

It is therefore necessary to drive with appropriate caution.

You may find it useful to briefly activate DTC under the following special circumstances:

- ▶ When driving in slush or on uncleared, snow-covered roads.
- ▶ When rocking the vehicle or driving off in deep snow or on loose surfaces.
- ▶ When driving with snow chains.

Deactivating/activating Dynamic Traction Control DTC

The system and program can be deactivated/activated via Dynamic Driving Control, refer to page 101.

Dynamic Driving Control

The concept

Dynamic Driving Control can be used to adjust the driving dynamics of the vehicle. Several programs are available for this purpose; one program can be activated at a time using the Dynamic Driving Control buttons.

Operating the programs

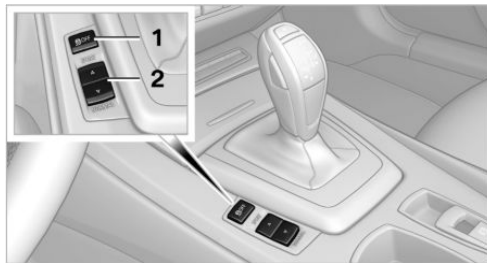

M10091191Q1MA

Press the button

Program



DSC OFF
TRACTION



SPORT+
SPORT
COMFORT

DSC OFF



M10091241Q1MA

Driving stability is limited during acceleration and when driving in bends.

To increase vehicle stability, activate DSC again as soon as possible.

Deactivating DSC: DSC OFF



Press the button for no longer than approx. 10 seconds until the indicator lamp for DSC OFF lights up in the instrument cluster and DSC OFF appears in the instrument cluster.

The DSC system is switched off.

Activating DSC



Press the button.

DSC OFF and the DSC OFF indicator lamp go out.

Indicator/warning lamps

When DSC is deactivated, DSC OFF is displayed in the instrument cluster.



The DSC OFF indicator lamp lights up: DSC is deactivated.

TRACTION

Maximum traction on loose road surfaces. Dynamic Traction Control DTC is switched on. Driving stability is limited during acceleration and when driving in bends.

Activating TRACTION



Press the button.

TRACTION is displayed in the instrument cluster.

The DSC OFF indicator lamp lights up in the instrument cluster.

Deactivating TRACTION



Press the button again.

TRACTION and the DSC OFF indicator lamp go out.

Indicator/warning lamps

When DTC is activated, TRACTION is displayed in the instrument cluster.



The DSC OFF indicator lamp lights up: Dynamic Traction Control DTC is activated.

SPORT+



Sporty driving with optimized chassis and suspension during limited driving stabilization.

Dynamic Traction Control is switched on.

The driver handles several of the stabilization tasks.

Activating SPORT+



Press the button repeatedly until SPORT+  is selected in the instrument cluster and the DSC OFF indicator lamp is displayed.

Indicator/warning lamps

SPORT+ is displayed in the instrument cluster.



The DSC OFF indicator lamp lights up: Dynamic Traction Control DTC is activated.

SPORT

Consistently sporty tuning of the suspension for greater driving agility with maximum driving stabilization.

Activating SPORT



Press the button repeatedly until SPORT is selected in the instrument cluster.

COMFORT

For a balanced tuning with maximum driving stabilization.

Activating COMFORT



Press the button repeatedly until COMFORT is selected in the instrument cluster.

Displays in the instrument cluster



The selected program is displayed in the instrument cluster.

Drive-off assistant

This system supports driving away on gradients. The parking brake is not required.

1. Hold the vehicle in place with the foot brake.
2. Release the foot brake and drive away without delay.

After the foot brake is released, the vehicle is held in place for approx. 2 seconds.

Depending on the vehicle load, the vehicle may roll back slightly.



Driving off without delay

After releasing the foot brake, start driving without delay, since the drive-off assistant will not hold the vehicle in place for more than approx. 2 seconds and the vehicle will begin rolling back. ◀

Servotronic

The concept

The Servotronic varies the steering force required to turn the wheels depending on the speed at which you are driving. Power steering provides strong support at low speeds, which means that little effort is needed to turn the wheels. Power steering support lessens as your speed increases.

The system works automatically.

Malfunction

Malfunctions are displayed via Check Control, refer to page [82](#).

Driving comfort

Vehicle equipment

This chapter describes all series equipment as well as country-specific and special equipment offered for this model series. Therefore, it also describes equipment that may not be found in your vehicle, for instance due to the selected special equipment or the country version. This also applies to safety-related functions and systems.

When using the features and systems described here, adhere to local regulations.

Cruise control

The concept

Cruise control is available for use at speeds of approx. 20 mph/30 km/h and higher. The car then stores and maintains the speed that you specify using the lever on the steering column. In order to maintain the specified speed, the system brakes the vehicle when the engine braking effect is insufficient on downhill gradients.



Do not use cruise control

Do not use the system if unfavorable conditions make it impossible to drive at a constant speed, for instance:

- ▶ On curvy roads.
- ▶ In heavy traffic.
- ▶ On slippery roads, in fog, snow or rain, or on a loose road surface.

Otherwise, you could lose control of the vehicle and cause an accident. ◀

Manual transmission

You can shift gears while cruise control is activated. An indicator lamp notifies you that you should shift gears when you drive for an ex-

tended period at very high or very low engine speeds, or the system is deactivated.

One lever for all functions

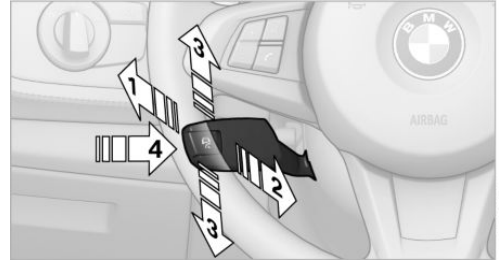

- 1 Storing and maintaining speed or accelerating
- 2 Storing and maintaining speed or decelerating
- 3 Deactivating cruise control
- 4 Resuming a speed stored beforehand

Maintaining current speed

Push the lever, arrow 1, or pull it briefly, arrow 2.

The car's current speed is stored and maintained. It is displayed on the speedometer and briefly in the instrument cluster.

On uphill gradients, it may prove impossible to maintain the set speed if current engine power output is insufficient. If the engine braking effect is insufficient on downhill slopes, the system will brake the vehicle slightly.

Increasing desired speed

Repeatedly press the lever to the resistance point or beyond, arrow 1, until the desired speed is reached.

- ▶ Each time the lever is pressed to the point of resistance, the desired speed increases by approx. 1 mph/1 km/h.

- ▷ Each time the lever is pressed beyond the resistance point, the desired speed is increased by up to 5 mph/10 km/h.

The system stores and maintains the speed.

Accelerating using the lever

Accelerating slightly:

Press the lever to the resistance point, arrow 1, and hold until the desired speed is reached.

Accelerating significantly:

Press the lever beyond the resistance point, arrow 1, and hold until the desired speed is reached.

The vehicle accelerates without pressure on the accelerator pedal. The system stores and maintains the speed.

Decreasing speed

Repeatedly pull the lever to the resistance point or beyond, arrow 2, until the desired speed is displayed.

- ▷ Each time the lever is pulled to the resistance point, the desired speed is decreased by approx. 1 mph/1 km/h.
- ▷ Each time the lever is pulled beyond the resistance point, the desired speed is reduced by up to 5 mph or 10 km/h until the minimum speed of 20 mph/30 km/h is achieved.

The system stores and maintains the speed.

Interrupting the system

Push the lever upwards or downwards, arrow 3.

The displays in the speedometer change color.

In addition, the system is automatically interrupted in the following situations:

- ▷ When the brakes are applied.
- ▷ In cars with manual transmission, when gears are shifted very slowly or if neutral is engaged.

- ▷ In cars with Sport automatic transmission, when transmission position N is engaged.
- ▷ When DTC is activated or DSC is deactivated.
- ▷ When DSC or ABS is intervening.

Cruise control is not deactivated by depressing the accelerator pedal. Once the accelerator pedal is released, the stored speed is achieved again and maintained.

Warning light



A message appears on the Control Display.

The warning light comes on, for example, when cruise control has been deactivated as a result of DSC intervention.

Deactivating the system

- ▷ Press the lever upward or downward twice, arrow 3.
- ▷ Switch off the ignition.

The stored speed is cleared.

Resuming a speed stored beforehand

Press the button, arrow 4. The last stored speed is resumed and maintained.

Displays in the instrument cluster

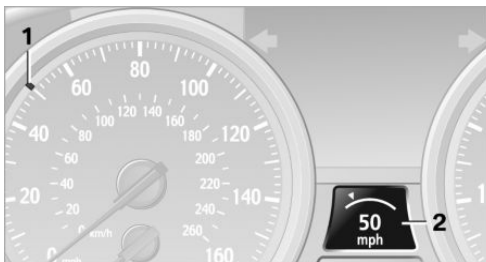

- 1 Stored speed
- 2 Selected speed is displayed briefly

If --- mph or --- km/h temporarily appears in the instrument cluster display, it is possible

that the system prerequisites for operation are currently not met.

Call up Check Control messages, refer to page 83.

Malfunction



The warning light comes on when the system has failed.

A message appears on the Control Display. More information, refer to page 82.

Park Distance Control PDC

The concept

PDC supports you when parking.

You are alerted that you are slowly approaching an object behind the vehicle and, if equipped accordingly, in front of the vehicle by:

- ▷ Signal tones.
- ▷ A visual display.

Measurement

Measurements are made by ultrasound sensors in the bumpers.

The range is approx. 6 ft/2 m.

An acoustic warning is first given:

- ▷ By the front sensors and two rear corner sensors at approx. 24 in/60 cm.
- ▷ By the rear middle sensors at approx. 5 ft/1.50 m.

System limits



Check the traffic situation as well

PDC cannot serve as a substitute for the driver's personal judgment of the traffic situation. Check the traffic situation around the vehicle with your own eyes. Otherwise, an accident could result from road users or objects located outside of the PDC detection range.

Loud noises from outside and inside the vehicle may prevent you from hearing the PDC's signal tone. ◀



Avoid driving quickly with PDC

Avoid approaching an object quickly.

Avoid driving away quickly while PDC is not yet active.

For technical reasons, the system may otherwise be too late in issuing a warning. ◀

Limits of ultrasonic measurement

The detection of objects can reach the physical limits of ultrasonic measurement, for instance:

- ▷ With tow bars and trailer hitches.
- ▷ With thin or wedge-shaped objects.
- ▷ With low objects.
- ▷ With objects with corners and sharp edges.

Low objects already displayed, e.g., curbs, can move into the blind area of the sensors before or after a continuous tone sounds.

High, protruding objects such as ledges may not be detected.

False warnings

PDC may issue a warning under the following conditions even though there is no obstacle within the detection range:

- ▷ In heavy rain.
- ▷ When sensors are very dirty or covered in ice.
- ▷ When sensors are covered in snow.
- ▷ On rough road surfaces.
- ▷ In large buildings with right angles and smooth walls, e.g., in underground garages.
- ▷ In heavy exhaust.
- ▷ Due to other ultrasound sources, e.g., sweeping machines, high pressure steam cleaners or neon lights.

Switching on automatically

Engage reverse gear with the engine running or the ignition switched on.

Switching off automatically when driving forward

The system switches off when a certain distance or speed is exceeded.

Switch on the system again if necessary.

Signal tones

When approaching an object, an intermittent tone is sounded that indicates the position of the object. For example, if an object is detected to the left rear of the vehicle, a signal tone sounds from the left rear speaker.

The shorter the distance to the object becomes, the shorter the intervals.

If the distance to a detected object is less than approx. 10 in/25 cm, a continuous tone is sounded.

If objects are located both in front of and behind the vehicle, an alternating continuous signal is sounded.

The intermittent tone is interrupted after approx. 3 seconds:

- ▶ If the vehicle stops in front of an object that is detected by only one of the corner sensors.
- ▶ If moving parallel to a wall.

The signal tone is switched off:

- ▶ When the vehicle moves away from an object by more than approx. 4 in/10 cm.
- ▶ When transmission position P is engaged.

Volume

You can set the volume of the PDC signal, refer to page 161.

The setting is stored for the remote control currently in use.

Visual warning

The approach of the vehicle to an object is shown on the Control Display. Objects that are farther away are displayed on the Control Display before a signal sounds. The display appears as soon as PDC is switched on.

Malfunction



The indicator lamp in the instrument cluster comes on. PDC has failed.

A message appears on the Control Display.

Have the system checked.

To ensure full operability:

- ▶ Keep the sensors clean and free of ice.
- ▶ When using high-pressure washers, do not spray the sensors for long periods and maintain a distance of at least 12 in/30 cm.

Climate

Vehicle equipment

This chapter describes all series equipment as well as country-specific and special equipment offered for this model series. Therefore, it also describes equipment that may not be found in your vehicle, for instance due to the selected

special equipment or the country version. This also applies to safety-related functions and systems.

When using the features and systems described here, adhere to local regulations.

Overview

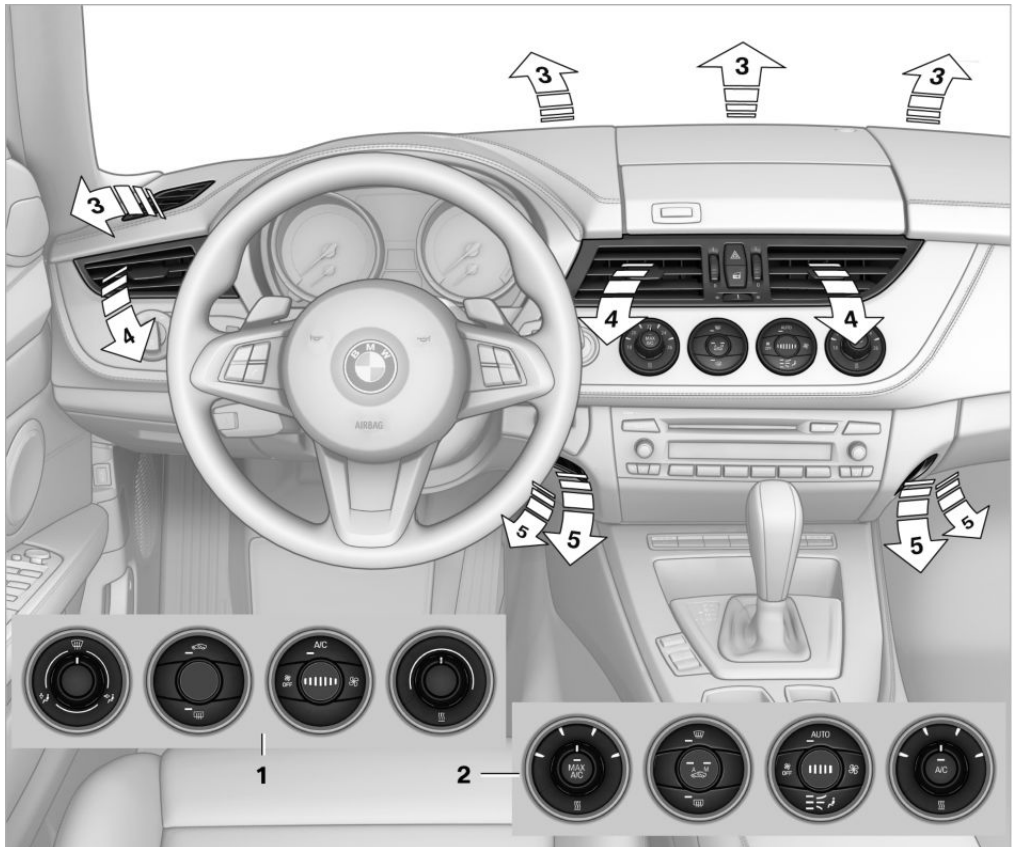

- 1 Equipment variant: air conditioner [108](#)
- 2 Equipment variant: automatic climate control [110](#)
- 3 Air vent: the airflow is directed toward the windshield and side windows

4 Air vent: air for the upper body area. The thumbwheels increase and decrease the

air supply continuously; the levers change the direction of the airflow.

5 Air vent: air for the knee area, footwell

Air conditioner

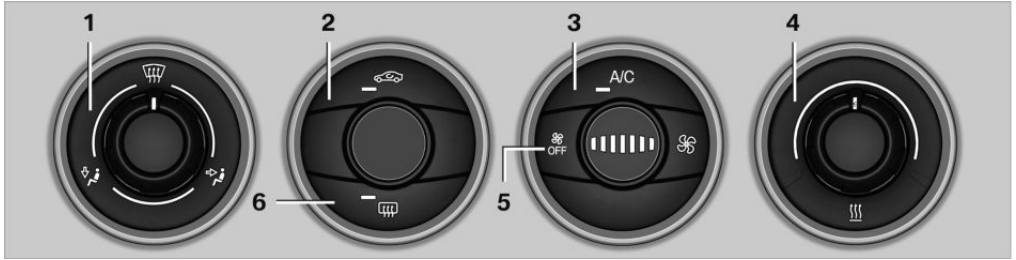

1 Vent settings

2 Recirculated air mode

3 Cooling function

4 Temperature

5 Air volume

6 Rear window defroster

Note

 Sufficient ventilation



When remaining in the vehicle for an extended period of time, ensure sufficient external ventilation. Do not continuously use recirculated-air mode; otherwise the air quality in the interior continuously worsens. ◀

tants, shut off the supply to the interior of the car temporarily. The system then recirculates the air currently within the vehicle.

The recirculated air mode can also be activated/deactivated, refer to page 12, via a button on the steering wheel.

Vent settings



Direct the flow of air to the windows , to the upper body area , or to the knee area and footwell . Intermediate positions are possible. In the 6 o'clock position, a small amount of air is also directed toward the windows to keep them from fogging over.

Air volume



Press the corresponding button. The higher the rate, the more effective the heating or cooling will be.

The air flow rate may be reduced or the blower may be switched off entirely to save on battery power.

Recirculated air mode



If the air outside the car has an unpleasant odor or contains pollu-



Switching the system on/off

Press and hold the left button or, with the blower at its lowest setting, press the left button. The

blower and air conditioner are completely switched off and the air supply is cut off. To switch on the air conditioner, set the desired air flow rate.

Switching cooling function on/off



The cooling function cools and dehumidifies the incoming air before reheating it as required, according to the temperature setting. This function is only available while the engine is running.

The cooling function helps to prevent condensation on the windows or to remove it quickly. Depending on the weather, the windshield may fog over briefly when the engine is started.

Rear window defroster



The defroster switches off automatically after a certain time or when the hardtop is opened.

Temperature



To increase the temperature, turn the rotary switch clockwise towards red. For a lower temperature, turn the rotary switch counterclockwise towards blue.

Defrosting windows and removing condensation

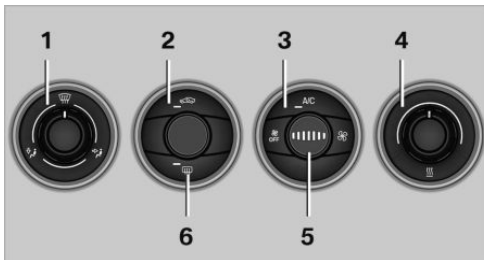

- 1 Air distribution 1 in position .
- 2 Deactivate recirculated air mode 2.

- 3 Switch on cooling function 3.
- 4 Temperature 4 to the right, red.
- 5 Set the air flow rate 5 to the maximum level.
- 6 Switch on the rear window defroster 6 to defrost the rear window .

Ventilation

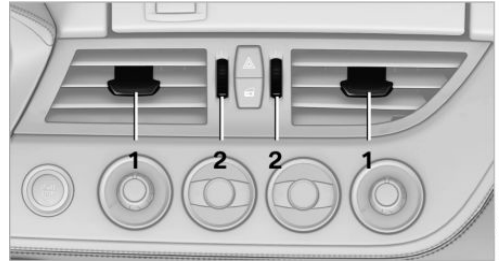

- 1 Use the lever to change the direction of the air flow
- 2 Use the thumbwheels to smoothly open and close the air vents

Ventilation for cooling

Adjust the vents to direct the flow of cool air in your direction, for instance if the interior has become too warm.

Draft-free ventilation

Adjust the vents to let the air flow past you.

Microfilter

The microfilter removes dust and pollen from the incoming air. The microfilter is changed by your service center during routine maintenance work.

Automatic climate control

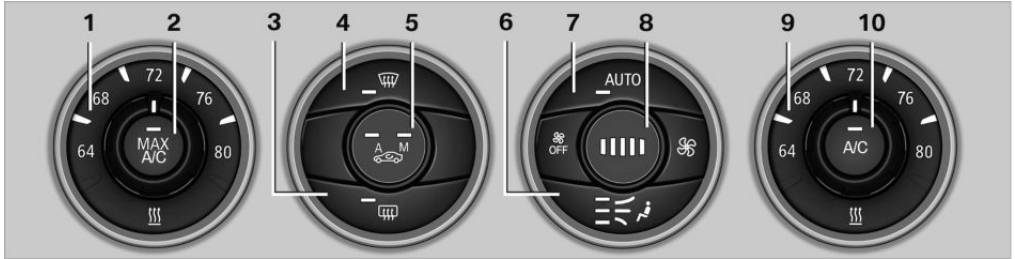

- 1 Temperature, left side of passenger compartment
- 2 Maximum cooling
- 3 Rear window defroster
- 4 Defrosting windows and removing condensation
- 5 Automatic recirculated air control/recirculated air mode
- 6 Manual air distribution
- 7 AUTO program
- 8 Air flow rate, manual, climate level
- 9 Temperature, right side of passenger compartment
- 10 Switching cooling function on/off manually

Note



Sufficient ventilation

When remaining in the vehicle for an extended period of time, ensure sufficient external ventilation. Do not continuously use recirculated-air mode; otherwise the air quality in the interior continuously worsens. ◀

Comfortable interior climate

For almost all conditions, the AUTO program 7 offers the optimum air distribution and air flow rate, refer to AUTO programs below. Select a comfortable interior temperature only.

The following sections contain more detailed information on the available setting options.

Most of these settings are stored for the remote control currently in use, Personal Profile settings, refer to page 31.

Air distribution, manual

Depending on the selected setting, the air is directed to the windshield, to the upper body area, to the knee area and into the footwell.

Adjusting air distribution manually



Press the button repeatedly until the air distribution is set as required. The corresponding LED lights up.

The manual air distribution is also switched on when the AUTO program is deactivated.

Temperature



Set the desired temperatures individually for the driver's and passenger sides.

The automatic climate control achieves this temperature as quickly as possible regardless of the season, using maximum cooling or heating power if necessary, and then maintains it.

To give the automatic climate control enough time to achieve the set temperature, do not switch between different temperature settings in quick succession.

Maximum heating power can be obtained with the highest setting, regardless of the external temperature.

The lowest setting effects continuous cooling.

Switching the cooling function on and off



The cooling function cools and dehumidifies the incoming air before reheating it as required, according to the temperature setting. This function is only available

while the engine is running.

The cooling function helps to prevent condensation on the windows or to remove it quickly.

Depending on the weather, the windshield may fog over briefly when the engine is started.

The cooling function is switched on automatically with the AUTO program.

Maximum cooling



The air is cooled as quickly as possible with the engine running.

The automatic climate control goes into recirculated air mode at the lowest temperature. Air flows at maximum rate from the vents for the upper body area. You should therefore open the vents for maximum cooling.

AUTO program

The AUTO program automatically adjusts the air distribution to the windshield and side windows, toward the upper body area, and into the footwell and knee area.

The air flow rate and air distribution, in addition to your temperature specifications, will be adapted to outside influences as a result of

seasonal changes, e.g., sunlight or window condensation.

The cooling function is switched on automatically with the AUTO program.

Switching on/off



Press the button.

Manual air distribution and air flow rate are activated when the AUTO program is deactivated.

AUTO program climate level

The climate levels can be used to vary the intensity when the AUTO program is switched on. For example, air flow is adjusted automatically to optimize climate control.



When the AUTO program is switched on, the climate level of the AUTO program can be selected

using the buttons for controlling the manual air flow rate.

The selected climate level is displayed by an LED.

Convertible program

When the hardtop is open, the convertible program is activated as well. In the convertible program, the automatic climate control is optimized for driving with the hardtop open. In addition, the air flow rate is increased as vehicle speed increases.

The effectiveness of the convertible program can be enhanced considerably by installing the wind deflector.

Adjusting air flow rate manually



Press the left side of the button to reduce air flow. Press the right side of the button to increase it.

The air volume may be reduced automatically to save battery power. The display remains the same.

Switching the system on/off

Press and hold the left button or, with the blower at its lowest setting, press the left button to switch off the automatic climate control completely. All displays are cleared except for the rear window defroster if it is switched on.

Press any button except the rear window defroster to reactivate the automatic climate control.

Residual heat

The heat stored in the engine is used to heat the interior.



This function can be switched on using the right-hand button under the following conditions:

- ▷ Up to 15 minutes after switching off the engine.
- ▷ When the engine is warm.
- ▷ With sufficient battery voltage.
- ▷ At an external temperature under 77 °F/25 °C.

The middle LED is lit when the function is on.

Automatic recirculated air mode/ recirculated air mode



Switch on the desired operating mode by pressing this button repeatedly:

- ▷ LED off: outside air flows in continuously.
- ▷ Left LED on, automatic recirculated air control: a sensor detects pollutants in the outside air. If necessary, the system blocks the supply of outside air and recirculates the inside air. As soon as the concentration of pollutants in the outside air has decreased sufficiently, the system automatically switches back to outside air supply.
- ▷ Right LED on, recirculated air mode: the supply of outside air into the vehicle is per-

manently blocked. The system then recirculates the air currently within the vehicle.

Defrosting and defogging windows



Quickly removes ice and condensation from the windshield and front side windows.

For this purpose, also switch on the cooling function.

Rear window defroster



The defroster switches off automatically after a certain time or when the hardtop is opened.

Ventilation

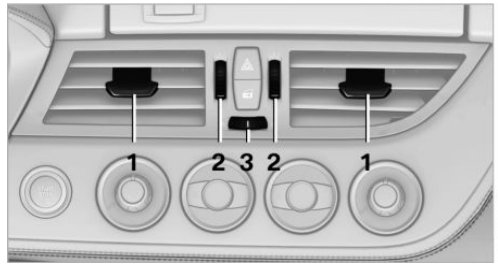

- 1 Use the lever to change the direction of the air flow
- 2 Use the thumbwheels to smoothly open and close the air vents
- 3 Thumbwheel for adjusting the temperature for the upper body area. The interior temperature setting for the driver and passenger does not change.

Ventilation for cooling

Adjust the vents to direct the flow of cool air in your direction, for instance if the interior has become too warm.

Draft-free ventilation

Adjust the vents to let the air flow past you.

Microfilter/activated-charcoal filter

The microfilter traps dust and pollen in the incoming air. The activated-charcoal filter provides additional protection by filtering gaseous pollutants from the outside air. Your service center replaces this combined filter during routine maintenance.

Interior equipment

Vehicle equipment

This chapter describes all series equipment as well as country-specific and special equipment offered for this model series. Therefore, it also describes equipment that may not be found in your vehicle, for instance due to the selected special equipment or the country version. This also applies to safety-related functions and systems.

When using the features and systems described here, adhere to local regulations.

Universal garage door opener

The concept

The universal garage door opener can be used to operate up to 3 functions in remote-controlled systems, such as garage door drives or lighting systems. The universal garage door opener replaces up to 3 different hand-held transmitters. To operate it, the buttons on the interior rearview mirror must be programmed for the desired functions. The hand-held transmitter for the system is needed for the programming procedure.

During programming

During programming and before activating a device using the Universal Garage Door Opener, ensure that there are no people, animals, or objects in the range of movement of the remote-controlled device; otherwise, there is a risk of injury or damage.

Also follow the safety instructions of the hand-held transmitter. ◀

Before selling the vehicle, delete the stored functions for security reasons.

Compatibility



If this symbol is printed on the packaging or in the operating instructions of the system being operated, the system is generally compatible with the universal garage door opener.

If you have any questions, please contact:

- ▶ Your service center.
- ▶ www.homelink.com on the Internet.

HomeLink is a registered trademark of the Gentex Corporation.

Controls on the interior rearview mirror



- 1 Buttons
- 2 LED
- 3 Hand-held transmitter, required for programming.

Programming

General information

1. Switch on the ignition.
2. Initial setup:

Press the right and left buttons on the interior rearview mirror simultaneously for approx. 20 seconds until the LED on the interior rearview mirror begins to flash. All programmed settings of the buttons on the interior rearview mirror are deleted.

3. Hold the hand-held transmitter of the system to be operated a distance of approx. 1 to 3 in/2.5 to 8 cm away from the buttons on the interior rearview mirror. The required distance depends on the particular hand-held transmitter.
4. Press the button of the desired function on the hand-held transmitter and the button being programmed on the interior rearview mirror simultaneously and hold. The LED on the interior rearview mirror flashes slowly at first.
5. When the LED flashes more rapidly, release both buttons. Rapid flashing indicates that the button on the interior rearview mirror has been programmed.

If the LED does not flash faster after 60 seconds, change the distance between the interior rearview mirror and the hand-held transmitter and repeat the step. Multiple trials at different distances may be necessary. Wait at least 15 seconds between trials.

Canada: if the programming procedure with the hand-held transmitter was interrupted, press and hold the button on the interior rearview mirror and press the button on the hand-held transmitter multiple times for 2 seconds each and release.

6. To program additional functions on other buttons, repeat steps 3 to 5.

The systems can be operated with the buttons on the interior rearview mirror.

Special characteristics of alternating-code radio systems

If the system cannot be operated after repeated programming, check whether the system to be operated uses an alternating-code system.

Read the operating instructions of the system or press and hold the programmed button on the interior rearview mirror. If the LED on the interior rearview mirror flashes rapidly at first

and then lights up continuously for 2 seconds, the system is equipped with an alternating-code system. This flashing LED pattern repeats itself for approx. 20 seconds.

In systems with an alternating-code system, the universal garage door opener and the system must be additionally synchronized.

Please obtain additional information on synchronization in the operating instructions of the system being set up.

The systems will be easier to synchronize with the aid of a second person.

Synchronization:

1. Park the vehicle within range of the remote-controlled system.
2. Program the corresponding button on the interior rearview mirror as described.
3. Identify and press the synchronization button on the system being set up. You have approx. 30 seconds for the next step.
4. Press and hold the button on the interior rearview mirror for approx. 3 seconds and then release it. Repeat this step up to three times if necessary to complete the synchronization procedure. When synchronization is completed, the programmed function is executed.

Reprogramming individual buttons

1. Switch on the ignition.
2. Hold the hand-held transmitter at a distance of approx. 1 to 3 in/2.5 to 8 cm from the memory buttons.

The required distance depends on the particular hand-held transmitter.

3. Press the memory button of the universal garage door opener.
4. If the LED flashes slowly after approx. 20 seconds, press the transmit button on the hand-held transmitter.
5. Release both buttons when the LED flashes rapidly.

If the LED does not flash rapidly after approx. 60 seconds, change the distance and repeat the step.

Canada: if the LED does not flash rapidly after approx. 60 seconds, change the distance and repeat the step. If programming was aborted by the hand-held transmitter, hold down the memory button and press and release the button on the hand-held transmitter several times for 2 seconds.

Controls



Prior to operation

Before operating a unit with the Universal Garage Door Opener, ensure that there are no people, animals, or objects in the range of movement of the system; otherwise, there is a risk of injury or damage.

Digital compass

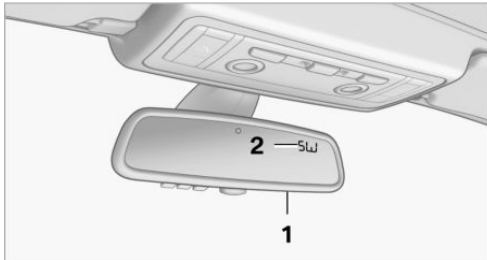

- 1 Adjustment button
- 2 Display

The display shows you the main or secondary compass direction in which you are driving.

Operating concept

You can call up a number of functions by pressing the adjustment button with a pointed

object such as a ball-point pen. The following adjustment options are displayed one after the other, depending on how long you keep the adjustment button pressed:

Also follow the safety instructions of the hand-held transmitter. ◀

The system, such as the garage door, can be operated using the button on the interior rearview mirror with the engine running or the ignition switched on. When you are within the reception range of the system, press and hold the button until the function is initiated. The LED on the interior rearview mirror lights up continuously while the radio signal is being transmitted.

Deleting stored functions

Press the right and left buttons on the interior rearview mirror simultaneously for approx. 20 seconds until the LED flashes rapidly. All stored functions are deleted. The functions cannot be deleted individually.

object such as a ball-point pen. The following adjustment options are displayed one after the other, depending on how long you keep the adjustment button pressed:

- ▷ Press briefly: switch the display on/off.
- ▷ 3 to 6 seconds: set the compass zone.
- ▷ 6 to 9 seconds: calibrate the compass.
- ▷ 9 to 12 seconds: set left-hand/right hand steering.
- ▷ 12 to 15 seconds: set the language.

Setting compass zones

Set the compass zone corresponding to your vehicle's geographic location so that the compass can function correctly; refer to the world map with compass zones.

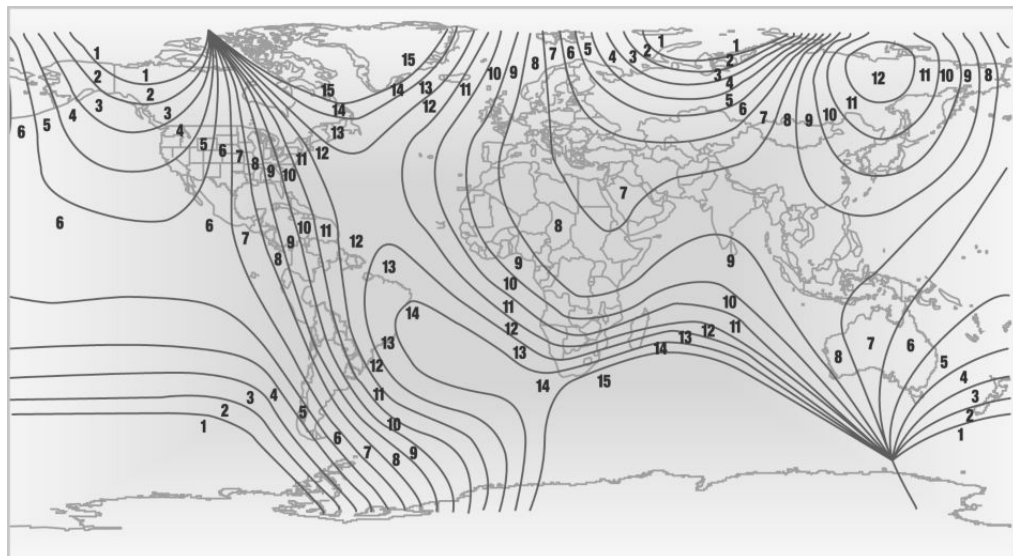

In order to set the compass zones, press and hold the adjustment button for 3-4 seconds. The number of the compass zone set is shown in the display.

To change the zone setting, briefly press the adjustment button repeatedly until the display shows the number of the compass zone corresponding to your current location.

The compass is operational again after approx. 10 seconds.

Calibrating the digital compass

The digital compass must be calibrated in the following situations:

- ▶ An incorrect compass direction is shown.
- ▶ The cardinal direction displayed does not change even if the direction of travel changes.
- ▶ Not all compass directions are shown.

Procedure

1. Make sure that there are no large metal objects or overhead power lines in the vicinity

of your vehicle and that you have enough space to drive in a circle.

2. Set the currently valid compass zone.
3. Ensure that the retractable hardtop is fully closed.
4. Press the adjustment button for 6-7 seconds to call up C. Then drive in at least one complete circle at a maximum speed of 4 mph/7 km/h. If the calibration was successful, the display C is replaced with the cardinal directions.
5. Open the retractable hardtop fully and repeat step 4.

Setting right-hand/left-hand steering

Your digital compass is factory-set to right-hand or left-hand steering, in accordance with your vehicle.

Setting the language

You can set the language of the display:

Press the adjustment button for 12-13 seconds. Briefly press the adjustment button

again to switch between English "E" and German "O".

The setting is automatically saved after approx. 10 seconds.

Ashtray

Opening



Press the ridge on the cover.

Emptying



Press the opened cover beyond the resistance point, refer to arrow. The ashtray can now be removed.

Lighter

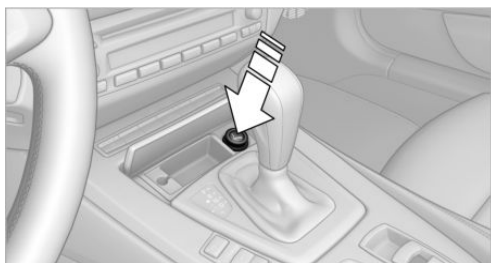

With the engine running or the ignition switched on, press in the cigarette lighter.

The lighter can be removed as soon as it pops back out.



Danger of burns

Only hold the hot lighter by its head; otherwise, there is the danger of getting burned.

Switch off the ignition and take the remote control with you when leaving the vehicle so that children cannot use the lighter and burn themselves. ◀



Replace the cover after use

Replace the lighter or socket cover after use; otherwise, objects that fall into the lighter socket or power socket could cause a short circuit. ◀

Connecting electrical devices

Note



Do not connect the charger to the socket

Do not connect the battery charger to the socket installed in the vehicle at the factory as this could damage the vehicle. ◀

Sockets

In your BMW, when the engine is running or the ignition is switched on, you can use electrical devices such as a hand lamp, car vacuum cleaner, etc., as long as one of the following sockets is available. The total load of all sockets must not exceed 140 Watt at 12 V. Avoid damaging the sockets by attempting to insert plugs of unsuitable shape or size.

Cigarette lighter socket

Access to socket: remove the lighter from the socket.

Under the center armrest

External audio device, refer to page 123.

In the passenger footwell

A socket is located on the left below the glove compartment.

Cargo area

Depending on your vehicle's equipment, the following storage spaces can be found in the cargo area:

- ▷ Rubber band for securing light objects
- ▷ Storage compartment.

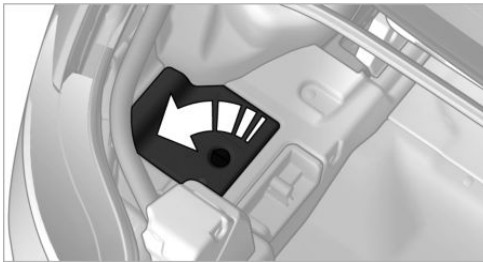

To open: turn the lock to the left, see arrow, and fold the cover up.

Enlarging the cargo area capacity

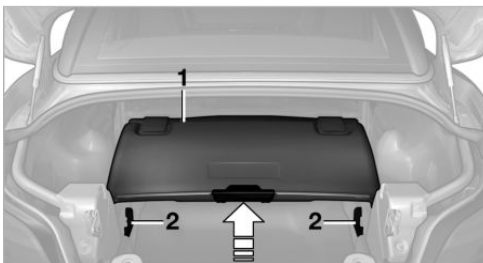

The cargo area capacity can be enlarged when the hardtop is closed:

To do so, press the cargo area partition 1 upward.

Before opening the hardtop, pull the cargo area partition 1 down until it engages in both guides 2.



Observe before opening and closing the hardtop

- ▷ Before moving the hardtop, ensure that there are no objects on or next to the cargo area partition; otherwise, parts of the hardtop may be damaged.
- ▷ Do not exceed the maximum loading height; refer to the sticker in the trunk showing a line indicating the maximum height.
- ▷ Do not use force to push down the cargo area partition. ◀

The retractable hardtop can only be opened if the cargo area partition is in its lowermost position and engaged on both sides.

Through-loading opening with integrated transport bag



Always secure skis

Always secure transported skis or similar objects with the ski support as they could otherwise endanger occupants during braking maneuvers and swerving. ◀

The transport bag lets you transport up to two pairs of standard skis safely and cleanly.

With the transport bag you can stow skis up to a length of 5.4 ft/1.70 m. When stowing skis with a length of 5.4 ft/1.70 m, the capacity of the transport bag is reduced as the bag narrows.

Loading

1. Fold the cover down.



M1009176C1AA

2. In the cargo area: press the handle up and fold the cover down.



M1009187C1AA

3. Undo the fastener and spread out the transport bag between the seats.
4. Insert the latch plate of the retaining strap into the belt buckle under the transport bag.

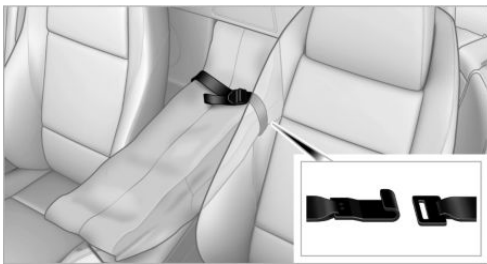

M1009186C1AA

5. Load the transport bag. The zipper eases access to the stored items.

Only place clean skis in the transport bag.
Wrap sharp edges to prevent damage.

Securing cargo



Securing the transport bag

Secure the transport bag by tightening the retaining strap; otherwise, the contents could present a source of danger to the passengers, for example during braking or evasive maneuvers. ◀

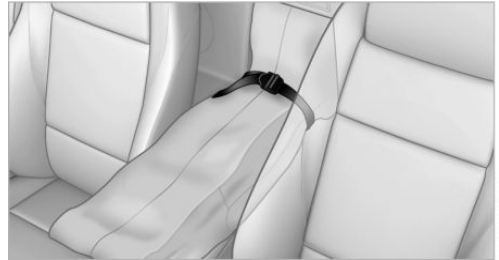

M1009093C1AA

After loading, secure the transport bag and its contents. Tighten the retaining strap on the tensioning buckle for this purpose.

To store the transport bag, perform the steps described for loading in reverse order.

Ski support



Always secure skis

Always secure transported skis or similar objects with the ski support as they could otherwise endanger occupants during braking maneuvers and swerving. ◀

1. Remove both covers 1 with the screwdriver.

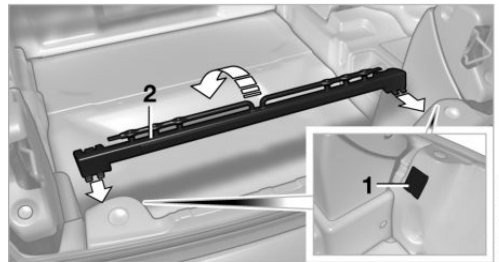

M1009393C1AA

2. Attach the ski support 2 and fold it down, see arrow.

3. Pull the fastener up and attach the rear of the ski.

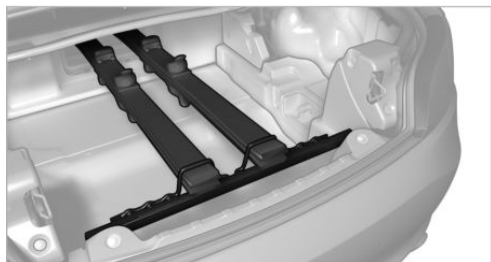

Prevent damage to the trunk lid

Before closing the trunk, ensure that the trunk lid cannot be damaged by the skis. ◀

Removing the transport bag

The transport bag can be completely removed, e.g., for faster drying or to allow you to use other inserts.



In the cargo area: press the handles up and fold the transport bag down fully.

More information on the various inserts available can be obtained from your service center.

Storage compartments

Vehicle equipment

This chapter describes all series equipment as well as country-specific and special equipment offered for this model series. Therefore, it also describes equipment that may not be found in your vehicle, for instance due to the selected special equipment or the country version. This also applies to safety-related functions and systems.

When using the features and systems described here, adhere to local regulations.

Glove compartment

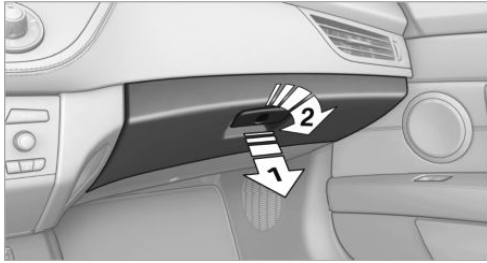

Opening

Pull the handle, arrow 1.

The light in the glove compartment switches on.

 Close the glove compartment again immediately

Close the glove compartment immediately after use while driving; otherwise, injury may occur during accidents. ◀

Closing

Fold up the cover.

Locking

Lock with a key, arrow 2.

If you hand out the remote control without the integrated key, refer to page 30, such as at a hotel, the glove compartment cannot be unlocked.

USB interface for data transfer

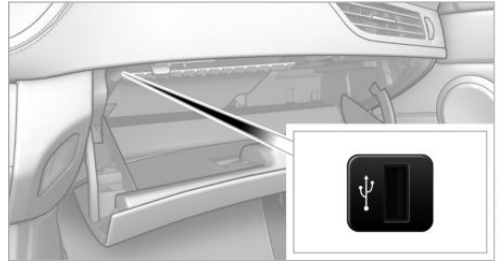

Port for importing and exporting data, such as music collections, refer to page 175, on USB devices.

Observe the following when connecting:

- ▶ Do not use force when plugging the connector into the USB interface.
- ▶ Do not connect devices such as fans or lamps to the USB interface.
- ▶ Do not connect a USB hard drive.
- ▶ Do not use the USB interface to recharge external devices.

Center armrest

Storage compartment

The center armrest contains either two cupholders, a compartment or the cover for the snap-in adapter, depending on the equipment version.

Details on this mobile phone cradle, refer to page 201.

Locking the storage compartment

When you lock the vehicle from the outside, the storage compartment in the center armrest is locked as well.

Opening

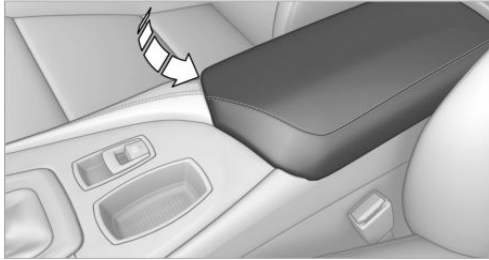

Fold the center armrest up, see arrow.

Connection for an external audio device

You can connect an external audio device such as a CD or MP3 player and play audio tracks over the car's loudspeaker system:

- ▷ AUX-IN port, refer to page 180.
- ▷ USB audio interface, refer to page 181.

Storage compartments inside the vehicle



No non-slip mats on the dashboard

Do not use non-slip materials, such as non-slip mats, on the dashboard, or it could be damaged by the substances in the materials. ◀

The following compartments are available, depending on how your vehicle is equipped:

In the doors

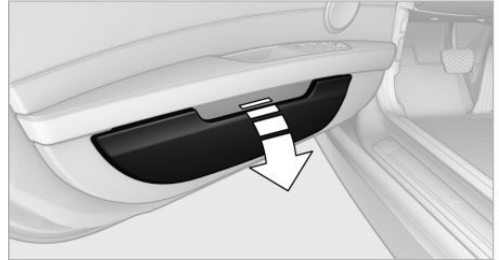

To open: fold open the cover.

In the center console

One open storage compartment or ashtray.

In the partition wall



To open: pull the handle.

The intermediate floor of the storage compartment can be removed and inserted at various heights.

Removing the storage compartment

The storage compartment can be removed completely to be able to use other inserts, for example.



In the cargo area:

Press the handles up and fold the storage compartment completely down.

More information on the various inserts available can be obtained from your service center.

Behind the seats

The rear storage shelf can be used to stow briefcases, for example.

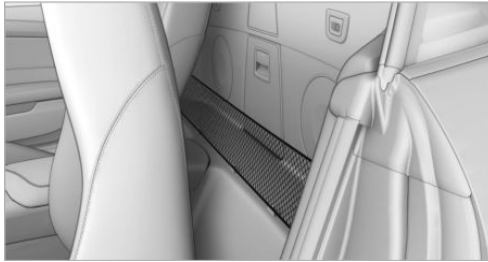

MAG09178CMA

 Observe when loading the rear storage shelf

- ▷ When loading the rear storage shelf, do not move both seats all the way forward while moving them to their uppermost position and leaning the backrests forward. Otherwise, the seats could hit and damage the seal on the windshield and the sun visor.
- ▷ Only transport light and small objects on the rear storage shelf; otherwise, braking maneuvers and swerving may lead to a safety hazard due to objects flying about the passenger compartment. Only transport heavy luggage in the trunk if it has been appropriately secured. ◀

Cupholders

 Shatter-proof containers and no hot drinks

Use light and shatter-proof containers and do not transport hot drinks. Otherwise, there is the increased danger of injury in an accident. ◀



Unsuitable containers

Do not forcefully push unsuitable containers into the cupholders. This may result in damage. ◀

In the center armrest

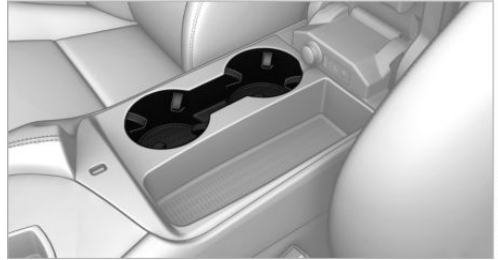

MAG09178CMA

The cupholders are located in the center armrest.

Attachable cupholder

Attaching to the center console



MAG09178CMA

Mount the cupholder onto the center console so that it snaps into place.

Storing in the glove compartment

Insert the cupholder into the holder in the glove compartment.



Driving tips

This section provides you with information useful in dealing with specific driving and operating conditions.

Things to remember when driving

Vehicle equipment

This chapter describes all series equipment as well as country-specific and special equipment offered for this model series. Therefore, it also describes equipment that may not be found in your vehicle, for instance due to the selected special equipment or the country version. This also applies to safety-related functions and systems.

When using the features and systems described here, adhere to local regulations.

Breaking-in period

General information

Moving parts need to be broken in to adjust to each other.

The following instructions will help achieve a long vehicle life and good economy.

Engine and differential

Always obey the official speed limits.

Up to 1,200 miles/2,000 km

Do not exceed the maximum engine and road speeds:

- ▷ 4,500 rpm and 100 mph/160 km/h.

Do not drive with full-throttle operation, and do not use the transmission's kickdown mode or Launch Control.

From 1,200 miles/2,000 km

The engine and vehicle speed can gradually be increased.

Tires

Due to technical factors associated with their manufacture, tires do not achieve their full

traction potential until after an initial breaking-in period.

Drive conservatively for the first 200 miles/300 km.

Brake system

Brakes require an initial break-in period of approx. 300 miles/500 km to achieve optimized contact and wear patterns between brake pads and discs. Drive cautiously during this break-in period.

Clutch

The clutch requires an initial break-in period of approx. 300 miles/500 km to function at an optimal level.

During this break-in period, engage the clutch gently.

Following part replacement

The same breaking in procedures should be observed if any of the components mentioned above have to be renewed in the course of the vehicle's operating life.

General driving notes

Ground clearance



Limited ground clearance

Note that the Z4 sDrive35 has limited ground clearance, for instance when driving into underground parking garages or over obstacles. Otherwise, the vehicle may be damaged. ◀

Closing the trunk lid

 Drive with the trunk lid closed
Only operate the vehicle with the trunk lid closed; otherwise, exhaust fumes could enter the passenger compartment. ◀

If the vehicle must be driven with the trunk lid open:

1. Close all windows.
2. Greatly increase the air flow rate of the air conditioner or automatic climate control.

Hot exhaust system

 Hot exhaust system
High temperatures are generated in the exhaust system.

Do not remove the heat shields installed and never apply undercoating to them. Make sure that flammable materials, e. g. hay, leaves, grass, etc. do not come in contact with the hot exhaust system during driving, while in idle position mode, or when parked. Such contact could lead to a fire, and with it the risk of serious personal injury as well as property damage.

Do not touch hot exhaust pipes; otherwise, there is the danger of getting burned. ◀

Mobile communication devices in the vehicle

 Mobile communication devices in the vehicle

It is not recommended to use mobile phones, such as mobile phones without a direct connection to an external aerial in the vehicle's passenger compartment. Otherwise, the vehicle electronics and mobile communication devices can interfere with each other. In addition, there is no assurance that the radiation generated during transmission will be discharged from the vehicle interior. ◀

Hydroplaning

On wet or slushy roads, a wedge of water can form between the tires and road surface.

This phenomenon is referred to as hydroplaning. It is characterized by a partial or complete loss of contact between the tires and the road surface, ultimately undermining your ability to steer and brake the vehicle.

 Hydroplaning
When driving on wet or slushy roads, reduce your speed to prevent hydroplaning. ◀

Driving through water

Drive through calm water only if it is not deeper than 9.8 inches/25 cm and at this height, no faster than walking speed, up to 6 mph/10 km/h.

 Adhere to water depth and speed limitations

Do not exceed this water depth and walking speed; otherwise, the vehicle's engine, the electrical systems and the transmission may be damaged. ◀

Braking safely

Your vehicle is equipped with ABS as a standard feature.

Applying the brakes fully is the most effective way of braking in situations when this is necessary.

The vehicle maintains steering responsiveness. You can still avoid any obstacles with a minimum of steering effort.

Pulsation of the brake pedal and sounds from the hydraulic circuits indicate that ABS is in its active mode.

Objects in the area around the pedals

 No objects in the area around the pedals
Keep floor mats, carpets, and any other objects out of the area of motion of the pedals; otherwise, the function of the pedals could be impeded while driving

Do not place additional floor mats over existing mats or other objects.

Only use floor mats that have been approved for the vehicle and can be properly fixed in place.

Ensure that the floor mats are securely fastened again when they are returned after being removed, such as for cleaning. ◀

Driving in wet conditions

When roads are wet or there is heavy rain, briefly exert gentle pressure on the brake pedal every few miles.

Ensure that this action does not endanger other road users.

The heat generated in this process helps dry the brake discs and pads.

In this way braking efficiency will be available when you need it.

Hills

Drive long or steep downhill gradients in the gear in which the least braking is required. Otherwise, the brake system may overheat, resulting in a reduction in the brake system efficiency.

You can increase the engine's braking effect by shifting down, going all the way to first gear, if necessary.

Downshifting in manual mode of the 8-gear Sport automatic transmission, refer to page 64.

Downshifting in manual mode of the 7-gear Sport automatic transmission with dual clutch, refer to page 67.



Avoid load on the brakes

Avoid placing excessive load on the brake system. Light but consistent brake pressure can lead to high temperatures, brake wear and possibly even brake failure. ◀



Do not drive in neutral

Never drive with the transmission in neutral, with the engine switched off or with the clutch depressed; otherwise, you will have neither the braking action of the engine or nor its power assistance when braking or steering. ◀

Brake disc corrosion

Corrosion on the brake discs and contamination on the brake pads are furthered by:

- ▷ Low mileage.
- ▷ Extended periods when the vehicle is not used at all.
- ▷ Infrequent use of the brakes.

Corrosion occurs when the minimum pressure that must be exerted by the pads during brake applications to clean the discs is not reached.

Should corrosion form on the brake discs, the brakes will tend to respond with a pulsating effect that generally cannot be corrected.

Condensation under the parked vehicle

When using the automatic climate control, condensation water develops that exits underneath the vehicle.

Therefore, traces of condensed water under the vehicle are normal.

Loading



Overloading the vehicle

To avoid exceeding the approved carrying capacity of the tires, never overload the vehicle. Overloading can lead to overheating and increases the rate at which damage develops

inside the tires. This could result in a sudden loss of tire inflation pressure. ◀

Secure heavy objects

Never transport unsecured heavy or hard objects in the passenger compartment, as they could be thrown around and pose a safety hazard to the vehicle's occupants during abrupt braking or evasive maneuvers. ◀

No fluids in the cargo area

Make sure that fluids do not leak into the cargo area; otherwise, the vehicle may be damaged. ◀

Determining the load limit



1. Locate the following statement on your vehicle's placard:
 - ▶ The combined weight of occupants and cargo should never exceed XXX kg or YYY lbs. Otherwise, damage to the vehicle and unstable driving situations may result.
2. Determine the combined weight of the driver and passengers that will be riding in your vehicle.
3. Subtract the combined weight of the driver and passengers from XXX kilograms or YYY pounds.
4. The resulting figure equals the available amount of cargo and luggage load capacity.

For example, if the YYY amount equals 1,400 lbs and there will be five 150 lbs passengers in your vehicle, the amount of

available cargo and luggage load capacity is 650 lbs: 1,400 lbs minus 750 lbs = 650 lbs.

5. Determine the combined weight of luggage and cargo being loaded on the vehicle. That weight may not safely exceed the available cargo and luggage load capacity calculated in Step 4.
6. If your vehicle will be towing a trailer, load from your trailer will be transferred to your vehicle. Consult the manual for transporting a trailer to determine how this may reduce the available cargo and luggage load capacity of your vehicle.

Load

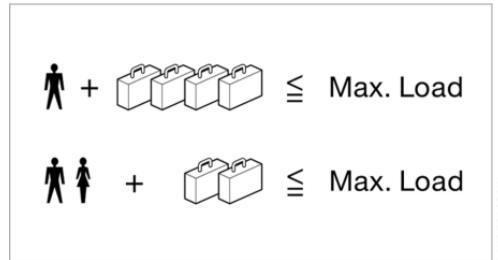

The maximum load is the sum of the weight of the occupants and the cargo.

The greater the weight of the occupants, the less cargo that can be transported.

Stowing cargo

Cargo area

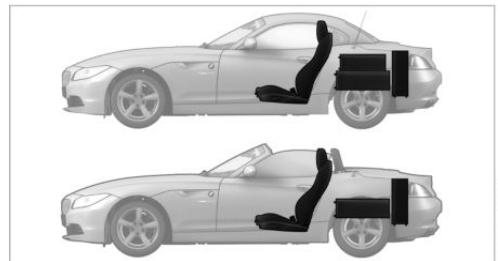

- ▶ Heavy cargo: stow as far forward and as low as possible, ideally directly behind the cargo area separating wall.
- ▶ Cover sharp edges and corners.



Loading with the hardtop open

Before opening the hardtop, fold down the cargo area partition and make sure the cargo area is loaded correctly; otherwise, parts of the hardtop could be damaged. ◀

Fold down the cargo area partition, refer to page 43.

Rear storage shelf



Loading the rear storage shelf

When loading the rear storage shelf, do not move both seats all the way forward while moving them to their uppermost position and leaning the backrests forward. Otherwise, the seats could hit and damage the seal on the windshield and the sun visor. ◀

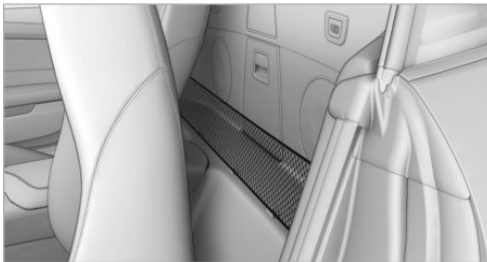

Light and small objects can be stored on the rear storage shelf.

Securing cargo

Cargo area

Use retaining straps, a luggage net or draw straps to secure small and lightweight items.

Rear storage shelf

You can obtain cargo straps from your service center. Four lashing eyes are provided behind the seats for attaching the cargo straps.

Adhere to the information included with the cargo straps.

Lashing eyes on the rear storage shelf

Top:

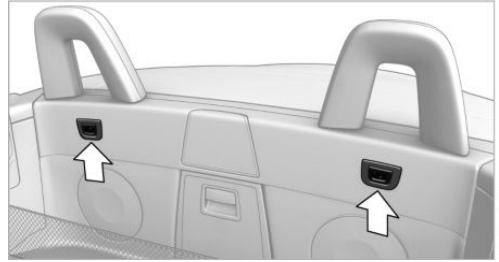

Bottom:



Saving fuel

General information

Your vehicle contains advanced technology for the reduction of fuel consumption and emissions.

Fuel consumption depends on a number of different factors.

The implementation of certain measures, driving style and regular maintenance, refer to page 241, can have an influence on fuel consumption and on the environmental impact.

Remove unnecessary cargo

Additional weight increases fuel consumption.

Remove attached parts following use

Remove auxiliary mirrors or rear-mounted luggage racks after use.

Attached parts on the vehicle impair the aerodynamics and increase the fuel consumption.

Close both windows

An open window causes higher air resistance and thus increases fuel consumption.

Tires

General information

Tires can have varying effects on fuel consumption; for example, fuel consumption can be influenced by the tire size.

Check the tire inflation pressure regularly

Check and, if necessary, correct the tire inflation pressure, refer to page 226, at least twice a month and before starting on a long trip.

Low tire inflation pressure increases rolling resistance and thus raises fuel consumption and tire wear.

Drive away without delay

Do not wait for the engine to warm-up while the vehicle remains stationary. Start driving right away, but at moderate engine speeds.

This is the fastest way for the cold engine to reach its operating temperature.

Look well ahead when driving

Avoid unnecessary acceleration and braking.

By maintaining a suitable distance to the vehicle driving ahead of you.

Driving smoothly and looking ahead reduces fuel consumption.

Avoid high engine speeds

Use 1st gear to get the vehicle in motion. Beginning with 2nd gear, accelerate rapidly.

When accelerating, shift up before reaching high engine speeds.

When you reach the desired speed, shift into the highest applicable gear and drive with the engine speed as low as possible and at a constant speed.

As a rule: driving at low engine speeds lowers fuel consumption and reduces wear.

Use coasting conditions

When approaching a red light, take your foot off the accelerator and coast to a halt in the highest applicable gear.

On a downhill slope, take your foot off the accelerator and coast in a suitable gear.

The flow of fuel is interrupted while coasting.

Switch off the engine during longer stops

Switch off the engine during longer stops, e.g., at traffic lights, railroad crossings or in traffic congestion.

Automatic Engine Start/Stop Function

The Automatic Engine Start/Stop Function automatically switches the engine off during a stop.

If the engine is stopped and then started again, fuel consumption and emissions drop compared to an engine that runs permanently. Stopping the engine even for just a few seconds can result in savings.

Use of this system can cause premature wear on certain vehicle components.

In addition, fuel consumption depends on other factors as well, such as driving style, road conditions, maintenance, and environmental factors.

Additional information on the Automatic Engine Start/Stop Function, refer to page 57.

Switch off any functions that are not currently needed

Functions such as the automatic climate control require a large amount of energy and consume additional fuel, especially in city and stop-and-go traffic.

Therefore, switch off these functions if they are not actually needed.

Have maintenance carried out

Have vehicles maintained regularly to achieve optimal vehicle economy and operating life.

Have the maintenance carried out by your service center.

Please also note the BMW Maintenance System, refer to page [241](#).



Navigation

This chapter contains various examples of how the navigation system can guide you reliably to your destination.

Navigation system

Vehicle equipment

This chapter describes all series equipment as well as country-specific and special equipment offered for this model series. Therefore, it also describes equipment that may not be found in your vehicle, for instance due to the selected special equipment or the country version. This also applies to safety-related functions and systems.

When using the features and systems described here, adhere to local regulations.

General information

The navigation system can determine the precise position of the vehicle, with the aid of satellites and vehicle sensors, and can reliably guide you to every entered destination.



Entries in stationary vehicle

Enter data only when the vehicle is stationary, and always give priority to the applicable traffic regulations in the event of any contradiction between traffic and road conditions and the instructions issued by the navigation system. Failure to take to this precaution can place you in violation of the law and put vehicle occupants and other road users in danger. ◀

Opening the navigation system

1.  Press the button on the controller.
2. "Navigation"



The navigation system can also be called up directly using the button on the controller.

Navigation data

Information on navigation data

1. "Navigation"
2. Open "Options".
3. "Navigation system version"
Information is displayed on the data version.

Updating the navigation data

General information

Navigation data are stored in the vehicle and can be updated.

Current navigation data and the authorization code are available from your service center.

- ▷ Depending on the data volume, a data update may take several hours.
- ▷ Update during the trip to preserve battery.
- ▷ During the update, only the basic functions of the navigation system are available.
- ▷ The status of the update can be viewed.
- ▷ After the updating process is complete, the system restarts.
- ▷ Remove the medium with the navigation data after the update.

Performing an update

1. Insert the navigation DVD into the DVD player with the labeled side facing up.
2. Follow the instructions on the Control Display.
3. Enter the authorization code of the navigation DVD.
4. Change the DVD if necessary.

After the trip is interrupted, follow the instructions on the Control Display.

Viewing the status

1. Open "Options".
2. "Navigation update"

Removing navigation DVD

1.  Press button 1.

The DVD emerges slightly from the drive.

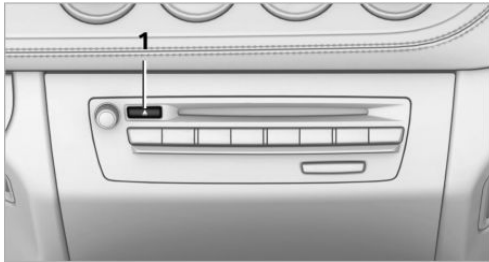

2. Remove the DVD.

Destination entry

Vehicle equipment

This chapter describes all series equipment as well as country-specific and special equipment offered for this model series. Therefore, it also describes equipment that may not be found in your vehicle, for instance due to the selected special equipment or the country version. This also applies to safety-related functions and systems.

When using the features and systems described here, adhere to local regulations.

At a glance

In entering your destination you can select from the following options:

- ▷ Enter the destination manually, see below.
- ▷ Select the destination from the address book, refer to page 142.
- ▷ Last destinations, refer to page 143.
- ▷ Special destinations, refer to page 143.
- ▷ Destination entry via map, refer to page 145.
- ▷ Using the home address as the destination, refer to page 143.
- ▷ Destination entry by voice, refer to page 146.
- ▷ Destination entry via the Concierge service, refer to page 145.

You can also store a navigation destination on the programmable memory buttons, refer to page 23.



Entries in stationary vehicle

Enter data only when the vehicle is stationary, and always give priority to the applicable traffic regulations in the event of any contradiction between traffic and road conditions and the instructions issued by the navigation

system. Failure to take to this precaution can place you in violation of the law and put vehicle occupants and other road users in danger. ◀

Manual destination entry

General information

The system supports you in entering street names and house numbers by automatically completing the entry and providing entry comparisons, refer to page 23.

Stored town/city and street names can be called up quickly.

- ▷ If the existing entries should not be changed, the entries for the state/province and town/city can be skipped.
- ▷ Destination guidance is started to the town/city center if no street is entered.

Entering a state/province

1.  Press the button.
2. "Navigation"
3. "Enter address"

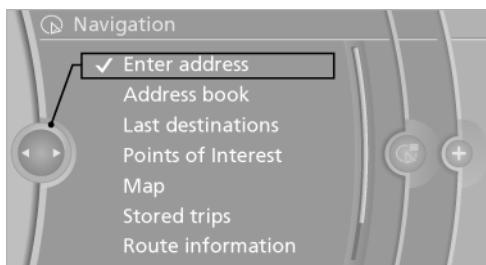

4. Select "State/Province" or the displayed state/province.

Entering a town/city

1. Select "Town/City/Postal Code" or the displayed town/city.

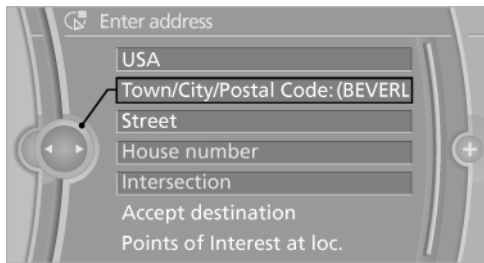

2. Select letters, if necessary.
The list is narrowed down further with each entry.
3. Move the controller to the right.
4. Select the name of the town/city from the list.

If there are several towns/cities with the same name:

1. Change to the list of town/city names.
2. Highlight the town/city.
3. Select the town/city.

Entering the postal code

1. Select "Town/City/Postal Code" or the displayed town/city.
2. 1@+ Select the symbol.
3. Select the numbers.
4. Change to the list of postal codes and towns/cities.
5. Highlight the entry.
6. Selecting an entry.

Entering a street and intersection

1. Select "Street" or the displayed street.
2. Enter a street and intersection in the same way as you would enter a town/city.

If there are several streets with the same name:

1. Change to the list of street names.
2. Highlight the street.
3. Select the street.

Alternative: enter the street address and house number

1. Select "Street" or the displayed street.
2. Enter the street as you would the town/city.
3. "House number"
4. Select the numbers.
5. Change to the list of house numbers.
6. Select a house number or range of house numbers.

Street does not exist in the destination city/town

The desired street does not exist in the specified city/town because it belongs to another part of the city/town.

1. "Navigation"
2. "Enter address"
3. Select "Street" or the displayed street.
4. Change to the list of street names.
5. Select "In" with the state/province currently displayed.

All streets of the selected state/province are offered. The associated town/city is displayed after the street name.

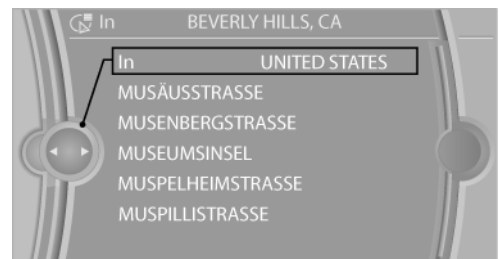

6. Select the letters.
7. Change to the list of street names.
8. Highlight the street.
9. Select the street.

Starting destination guidance after entering the destination

1. "Accept destination"
2. "Start guidance" or "Add as another destination"

Add, refer to page 147, a destination as a further destination.

Address book

Create contacts, refer to page 212.

Selecting a destination from the address book

1. "Navigation"
2. "Address book"

Contacts with addresses are displayed if these addresses have been checked as destinations in the contacts.

If the contacts with addresses from the mobile phone are not displayed, they first need to be checked as destinations, refer to page 213.

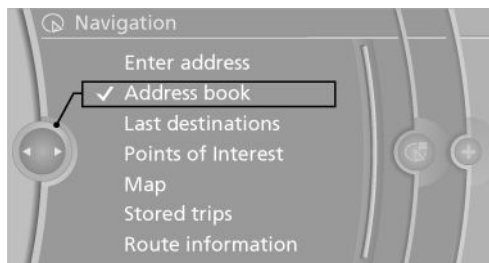

3. Select a contact in the list or, if desired, with "A-Z search".
4. "Business address" or "Home address"

Storing the destination in the address book

After entering the destination, store the destination in the address book.

1. "Navigation"
2. "Map"
3. "Guidance"
4. Open "Options".
5. "Store as new contact" or "Add to existing contact"

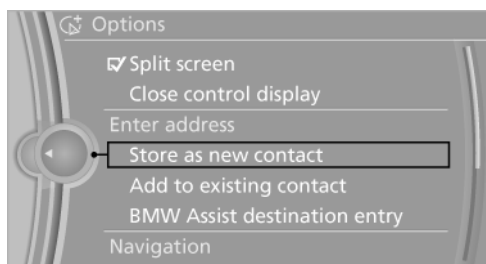

6. Select an existing contact, if available.
7. "Business address" or "Home address"
8. Enter "Last name" and, if necessary, "First name".
9. "Store in vehicle"

Storing the position

The current position can be stored in the address book.

1. "Navigation"
2. Open "Options".
3. "Store position as contact" or "Add position to contact"

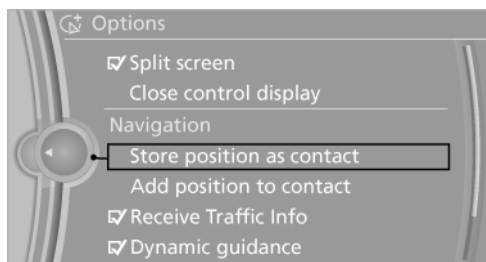

- Depending on the selection, choose an existing contact from the list. Select the type of address and enter the first and last name.
- "Store in vehicle"

Editing or deleting an address

- "Navigation"
- "Address book"
- Highlight the entry.
- Open "Options".
- "Edit in Contacts" or "Delete entry"

Using the home address as the destination

The home address must be stored. Specify the home address, refer to page 205.

- "Navigation"
- "Address book"
- "Home"

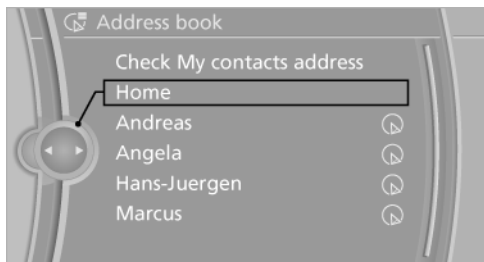

- "Start guidance"

Last destinations

At a glance

The destinations previously entered are stored automatically.

These destinations can be called up and used as a destination for destination guidance.

Calling up the last destination

- "Navigation"
- "Last destinations"

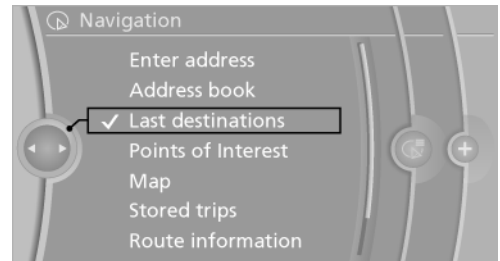

Starting destination guidance

- "Navigation"
- "Last destinations"
- Select the destination.
- "Start guidance"

Editing the destination

- "Navigation"
- "Last destinations"
- Highlight the destination.
- Open "Options".
- "Edit destination"

Deleting the last destinations

- "Navigation"
- "Last destinations"
- Highlight the destination.
- Open "Options".
- "Delete entry" or "Delete all last destinations"

Special destinations

General information

Even with the latest navigation data, information on specific special destinations may have

changed; for example, gas stations might not be in operation.

Opening the search for special destinations

Selection of special destinations, such as hotels or tourist attractions.

1. "Navigation"
2. "Points of Interest"
3. Select the search function.

Online Search

1. "Google™ Local Search"
2. Select a special destination.
3.  Select the symbol.
4. "Start guidance"

A-Z search

1. "A-Z search"
2. "Town/City"
3. Select or enter the town/city.
4. "Category"
5. Select the category.
6. "Category details"

For some special destinations, multiple category details can be selected. Move the controller to the left to leave the category details.

7. "Keyword"
8. Enter the keyword.

A list of the special destinations is displayed.

9. Select a special destination.
Details are displayed.

If multiple details are stored, you can leaf through the pages.

If a phone number is available, a connection can be established if necessary.

10.  Select the symbol.

11. "Start guidance" or "Add as another destination"

Add a destination as a further destination, refer to page 147.

"Start search": if a search term is not entered, the search is repeated with the previous search term.

Category search

1. "Category search"
2. "Town/City"
3. Select or enter the town/city.
4. "Category"
5. Select the category.
6. "Category details"

For some special destinations, multiple category details can be selected. Move the controller to the left to leave the category details.

7. "Start search"

A list of the special destinations is displayed.

8. Select a special destination.

Details are displayed.

If multiple details are stored, you can leaf through the pages.

If a phone number is available, a connection can be established if necessary.

9.  Select the symbol.

10. "Start guidance" or "Add as another destination"

Add a destination as a further destination, refer to page 147.

Display of special destinations

List of special destinations: special destinations are arranged by distance and appear with a directional arrow pointing to the special destination.

In the splitscreen, special destinations of the selected category are displayed in the map view as symbols. The display depends on the scale of the map and the category.

Destination entry via the Concierge service

A connection is established to the Concierge service, refer to page 215.

1. "Navigation"
2. "Enter address"
3. Open "Options".
4. "BMW Assist dest. entry"

Displaying special destinations in the map

To display symbols of the special destinations in the map view:

1. "Navigation"
2. "Map"
3. Open "Options".
4. "Display Points of Interest"
5. Select the setting.

Destination entry by map

Selecting the destination

1. "Navigation"
2. "Map"

The current position of the vehicle is displayed on the map.

3.  "Interactive map"

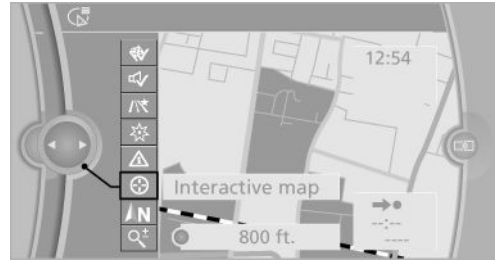

4. Select the destination with crosshairs.
 - ▷ To change the scale: turn the controller.
 - ▷ To shift the map: move the controller in the required direction.
 - ▷ To shift the map diagonally: move the controller in the required direction and turn it.

Specifying the street

If the system does not recognize the street, one of the following pieces of information is displayed:

- ▷ A street name in the vicinity.
- ▷ The county.
- ▷ The coordinates of the destination.

Additional functions

Additional functions are available on the interactive map after the controller is pressed.

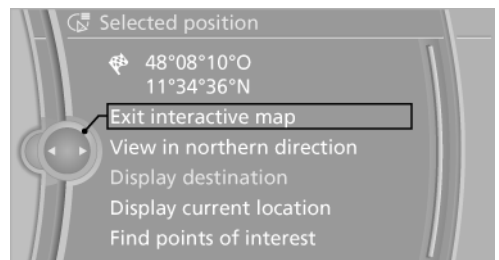

- ▷  Select the symbol. "Start guidance" or "Add as another destination"

Add a destination as a further destination, refer to page 147.

- ▷ "Exit interactive map": return to the map view.
- ▷ "View in northern direction" or "View in driving direction"
- ▷ "Display destination": the map section around the destination is displayed.
- ▷ "Display current location": the map section around your current location is displayed.
- ▷ "Find points of interest": the search for special destinations is started.

Destination entry by voice

General information

- ▷ Instructions for voice activation system, refer to page 25.
- ▷ When making a destination entry by voice, you can change between voice operation and iDrive.
- ▷ To have the available spoken instructions read out loud: ›Voice commands‹.

Saying the entries

- ▷ The town/city, street, and house number can be entered using a single command.
- ▷ Countries, towns and cities, streets, and intersections can be said as whole words or spelled in the language of the system, refer to page 78.
Example: to enter a town/city in a US states as a whole word, the language of the system must be English.
- ▷ Spell the entry if the spoken language and the language of the system differ.
- ▷ Say the letters smoothly, and avoid exaggerating the pronunciation and inserting lengthy pauses between the letters.

- ▷ The methods of entry depend on the navigation data in use and the country and language settings.

Entering the address in a command

1.  Press the button on the steering wheel.
2. ›Enter address‹
3. Wait for a request from the system.
4. Say the address in the suggested order.
5. Continue making the entry as prompted by the system.

If necessary, individually name the separate components of the address, e.g., the town/city.

Entering a town/city separately

The town/city can be said as a complete word.

With the destination entry menu displayed:

1.  Press the button on the steering wheel.
2. ›City‹ or ›Spell city‹
3. Wait for the system to prompt you for the town/city.

4. Say the name of the town/city, or name at least the first three letters.

Depending on the entry, up to 20 towns/cities may be suggested.

5. Select a location:
 - ▷ Select a recommended town/city: ›Yes‹.
 - ▷ Select a different town/city: ›New entry‹.
 - ▷ Select an entry: ›Entry ...‹, for instance, entry 2.
 - ▷ Spell an entry: ›Spell city‹.
6. Continue making the entry as prompted by the system.

If there are several towns/cities with the same name:

Towns/cities of the same name are grouped in a list and displayed as one location followed by an ellipsis.

1. Select an entry: ›Yes‹ or ›Entry ...‹, e. g., Entry 2.
2. Select the desired town/city.

Entering a street or intersection separately

Enter a street and intersection in the same way as you would enter a town/city.

Entering a house number separately

Depending on the data in the navigation system, house numbers up to number 2,000 can be entered.

1. ›House number‹
2. Say the house number.
Say each digit separately.
3. Continue making the entry as prompted by the system.

Starting destination guidance

›Start guidance‹

Planning a trip with intermediate destinations

New trip

A trip can be planned with several intermediate destinations.

1. "Navigation"
2. "Map"
3. Move the controller to the left if necessary.
4.  "Guidance"
5. "Enter new destination"

6. Select the type of destination entry.

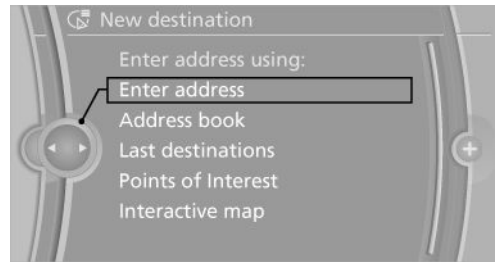

7. Enter the intermediate destination.
8. "Start guidance"

Entering intermediate destinations

A maximum of 30 intermediate destinations can be entered for a trip.

1. "Enter new destination"
2. Select the type of destination entry.
3. Enter the intermediate destination.
4. "Add as another destination"

The intermediate destination is entered in the destination list and is highlighted.

5. Turn the controller until the intermediate destination is located at the desired location in the list.
6. Press the controller.

Starting the trip

1. After all intermediate destinations are entered, highlight the first destination.

If the second destination, for example, is highlighted when destination guidance is started, the first destination is skipped.

2. "Start guidance"
 This symbol marks the active leg of the trip.

Storing a trip

Up to 30 trips can be stored in the trip list. If necessary, delete existing trips to be able to store new trips.

1. Open "Options".
2. "Store trip"
3. Enter a name for the trip.
4. "OK"

Selecting a stored trip

1. "Navigation"
2. "Stored trips"
3. Select a stored trip.
4. "Start guidance"

Changing the trip direction

Intermediate destinations are displayed in reverse order in the list.

1. "Map"
2.  "Guidance"
3. Open "Options".
4. "Reverse order of trip dest."

Intermediate destination options

1. "Map"
2.  "Guidance"
3. "Display all trip destinations"
4. Select an intermediate destination.
 - ▷ "Edit destination"
 - ▷ "Reposition dest. in the trip": move an intermediate destination to another position in the list.
 - ▷ "Delete dest. in the trip"
 - ▷ "Go to next dest. in the trip"

Some options are not available for certain trips.

Deleting a stored trip

1. "Navigation"
2. "Stored trips"

3. Highlight the desired trip.
4. Open "Options".
5. "Delete all trips" or "Delete trip"

Opening the last trip

1. "Navigation"
2. "Stored trips"
3. "Last trip"
4. "Start guidance"

Destination guidance

Vehicle equipment

This chapter describes all series equipment as well as country-specific and special equipment offered for this model series. Therefore, it also describes equipment that may not be found in your vehicle, for instance due to the selected special equipment or the country version. This also applies to safety-related functions and systems.

When using the features and systems described here, adhere to local regulations.

Starting destination guidance

1. "Navigation"
2. Make a destination entry, refer to page 140.
3. "Accept destination"
4. "Start guidance"

The route is shown on the Control Display. The distance to the destination/intermediate destination and the estimated time of arrival are displayed in the map view.

Terminating destination guidance

1. "Navigation"
2. "Map"
3.  "Guidance"
4. "Stop guidance"

Continuing destination guidance



If the destination was not reached during the last trip, destination guidance can be resumed. "Resume guidance"

Route criteria

General information

- ▷ The route calculated can be influenced by selecting certain criteria.
- ▷ The route criteria can be changed when the destination is entered and during destination guidance.
- ▷ Road types are part of the navigation data and are taken into consideration when planning a route, e.g., avoid highways.
- ▷ The recommended route may differ from the route you would take based on personal experience.
- ▷ The settings are stored for the remote control currently in use.
- ▷ Destination guidance with traffic bulletins, refer to page 155.

Changing the route criteria

1. "Navigation"
2. "Map"
3.  "Route preference"
4. Select the criterion:
 - ▷  "Fast route": time-optimized route, being a combination of the shortest possible route and the fastest roads.
 - ▷  "ECO PRO route" or "Efficient route": optimized combination of the fastest and shortest possible route.

- ▷  "Short route": short distance, irrespective of how fast or slow progress will be.
- ▷ "Alternative routes": if available, alternative routes are suggested during active destination guidance.
The individual suggestions are highlighted in color.

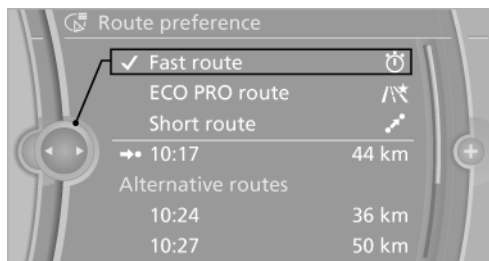

5. Specify additional criteria for the route, if necessary:
 - ▷ "Avoid highways": highways are avoided wherever possible.
 - ▷ "Avoid toll roads": toll roads are avoided wherever possible.
 - ▷ "Avoid ferries": ferries are avoided where possible.

Route

Different views of the route are available during destination guidance:

- ▷ Arrow view.
- ▷ List of route sections.
- ▷ Map view, refer to page 151.

Arrow view

The following information is displayed during destination guidance:

- ▷ Large arrow: indicates the current direction of travel.
- ▷ Street name of the road currently being driven on.

- ▷ Small arrow: indicates the next change in direction.
- ▷ Intersection view.
- ▷ Lane information.
- ▷ Traffic bulletins.
- ▷ Distance to the next change in direction.
- ▷ Street name at the next change in direction.

Lane information

On multi-lane roads, the recommended lanes are marked in the arrow view by a triangle.

- ▷ Solid triangle: best lane.
- ▷ Empty triangle: possible lane. However, another lane change may be needed shortly.

Displaying a list of route sections

When destination guidance is active, a list of the route sections can be displayed. The driving distance and traffic bulletins are displayed for each route section.

1. "Navigation"
2. "Route information"
3. Highlight a route section.

The route section is displayed on the split screen.

Bypassing a section of the route

Calculate a new route for a route section.

1. "Navigation"
2. "Route information"

3. "New route for"

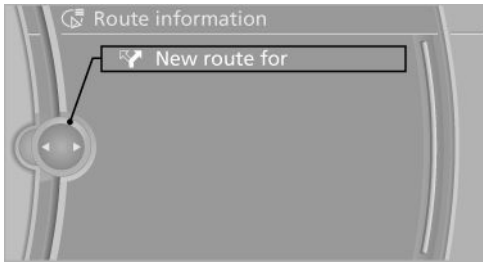

4. Turn the controller. Enter the number of kilometers within which you would like to return to the original route.
5. Press the controller.

Resuming the original route

If the route section should no longer be bypassed:

1. "Navigation"
2. "Route information"
3. "New route for:"
4. "Remove blocking"

Gas station recommendation

The remaining range is calculated and gas stations along the route are displayed if needed.

Even with the latest navigation data, information on individual special destinations may have changed; for example, gas stations might not be in operation.

1. "Navigation"
2. "Route information"
3. "Recommended refuel"
A list of the gas stations is displayed.

4. Highlight a gas station.
The position of the gas station is shown on the split screen.

5. Select the gas station.

6. Select the symbol.
7. "Start guidance": destination guidance to the selected gas station is started.
"Add as another destination": the gas station is added to the route.

Destination guidance through voice instructions

Switching spoken instructions on/off

The setting is stored for the remote control currently in use.

1. "Navigation"
2. "Map"
3. "Voice instructions"

Repeating a spoken instruction

1. "Navigation"
2. "Map"
3. Highlight the symbol.
4. Press the controller twice.

Volume of spoken instructions

Turn the volume knob while giving an spoken instruction until the desired volume is set.

The setting is stored for the remote control currently in use.

Saving the spoken instructions on the programmable memory buttons

The function for switching the spoken instructions on/off can be stored on a programmable memory button, refer to page 22, for quick access.

Map view

Selecting the map view

1. "Navigation"
2. "Map"

At a glance

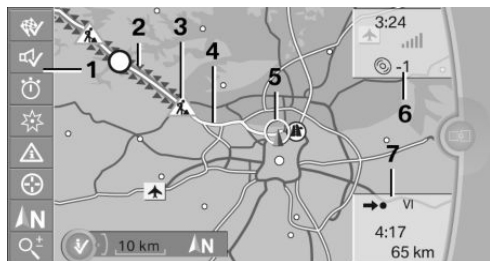

- 1 Function bar
- 2 Route section with traffic obstruction
- 3 Traffic sign for traffic obstruction
- 4 Planned route
- 5 Current location
- 6 Upper status field
- 7 Lower status field

Lines in the map

Streets and routes are displayed in different colors and styles depending on their classification. Dashed lines represent railways and ferry connections. Country borders are indicated by thin lines.

Traffic obstructions

Small triangles along the planned route indicate route sections with traffic obstructions, depending on the map scale. The direction of the triangles indicates the direction of the obstruction.

The traffic signs indicate the significance of the obstruction.

- ▷ Red traffic sign: the obstruction affects the planned route or direction.
- ▷ Grey traffic sign: the obstruction does not affect the planned route or direction.

Traffic bulletins, refer to page 153.

Planned route

After destination guidance is started, the planned route is displayed on the map.

Status fields

Show/hide: press the controller.

- ▷ Upper status field: time, telephone, and entertainment details.
- ▷ Lower status field: symbol for active destination guidance, status of traffic bulletins, time of arrival, and distance to destination.

Function bar

The following functions are available in the function bar:

Symbol	Function
	Start/end destination guidance.
	Switch spoken instructions on/off.
	Change the route criteria.
	Search for a special destination.
	Display traffic bulletins.
	Open the interactive map.
	Set the map view.
	Change the scale.

To change to the function bar, move the controller to the left.

Changing the map section

"Interactive map"

- ▷ To shift the map: move the controller in the required direction.
- ▷ To shift the map diagonally: move the controller in the required direction and turn it.

Changing the scale

1. Select the symbol.
2. To change the scale: turn the controller.

Automatically scaled map scale

In the map view facing north, turn the controller in any direction until the AUTO scale is displayed. The entire route between the current location and the destination is displayed on the map.

Settings for the map view

The settings are stored for the remote control currently in use.

1. "Navigation"
2. "Map"
3. Open "Options".
4. "Settings"
5. To set the map view:
 - ▷ "Day/night mode"

Select and create the necessary settings depending on the light conditions.

"Traffic conditions/gray map" active: the setting is disregarded.

- ▷ "Satellite images"

Depending on availability and resolution, satellite images are displayed at scales of approx. 1 mile to 600 miles/2 km to 1,000 km.
- ▷ "Perspective view in 3D"

Prominent areas that are contained in the navigation data are displayed on the map in 3D.
- ▷ "Traffic conditions/gray map"

The map is optimized for displaying traffic bulletins, refer to page [154](#).

Symbols for the special destinations are no longer displayed.

Map view for splitscreen

The map view can be selected for the split screen independently from the main screen:

1. Open "Options".
2. "Split screen"

3. Move the controller to the right repeatedly until the split screen is selected.
4. Select "Split screen content" or the scale.
5. Select the map view.
 - ▷ "Arrow display"
 - ▷ "Map facing north"
 - ▷ "Map direction of travel"
 - ▷ "Map view with perspective"
 - ▷ "Position"
 - ▷ "Exit ramp view": selected blind drive-ways are displayed three dimensionally.
 - ▷ "Traffic conditions/gray map"
6. To change the scale: select the split screen and turn the controller.

Traffic bulletins

At a glance

- ▷ Display the traffic bulletins from radio stations that broadcast the TI Traffic Information of a traffic information service. Information on traffic obstructions and hazards is updated continuously.

Certain BMW models equipped with navigation have the capability to display real-time traffic information. If your system has this capability the following additional terms and conditions apply:

An End-User shall no longer have the right to use the Traffic Data in the event that the End-User is in material breach of the terms and conditions contained herein.

A. Total Traffic Network, a division of Clear Channel Broadcasting, Inc. ("Total Traffic Network") holds the rights to the traffic incident data and RDS-TMC network through which it is delivered. You may not modify, copy, scan or use any other method to reproduce, duplicate, republish, transmit or distribute in any way any por-

tion of traffic incident data. You agree to indemnify, defend and hold harmless BMW of North America, LLC. ("BMW NA") and Total Traffic Network, Inrix, Inc (and their affiliates) against any and all claims, damages, costs or other expenses that arise directly or indirectly out of (a) your unauthorized use of the traffic incident data or the RDS-TMC network, (b) your violation of this directive and/or (c) any unauthorized or unlawful activities by you in connection herewith.

B. Total Traffic Network traffic data is informational only. User assumes all risk of use. Total Traffic Network, BMW NA, and their suppliers make no representations about content, traffic and road conditions, route usability, or speed.

C. The licensed material is provided to licensee "as is," and "where is". Total Traffic Network, including, but not limited to, any and all third party providers of any of the licensed material, expressly disclaims, to the fullest extent permitted by law, all warranties or representations with respect to the licensed material (including, without limitation, that the licensed material will be error-free, will operate without interruption or that the traffic data will be accurate), express, implied or statutory, including, without limitation, the implied warranties of merchantability, non-infringement fitness for a particular purpose, or those arising from a course of dealing or usage of trade.

D. Neither Total Traffic Network, Inrix, Inc. or BMW NA will be liable to you for any indirect, special, consequential, exemplary, or incidental damages (including, without limitation, lost revenues, anticipated revenues, or profits relating to the same) arising from any claim relating directly or indirectly to use of the traffic data, and even if Total Traffic Network, Inrix, Inc., or BMW NA are aware of the possibility of such damages. These limitations apply to all claims, including, without limitation, claims in con-

tract and tort (such as negligence, product liability and strict liability). Some states do not allow the exclusion or limitation of incidental or consequential damages, so those particular limitations may not apply to you.

- ▷ The traffic bulletins are indicated on the map by symbols.
- ▷ The traffic bulletins for the surrounding area are stored in a list.
 - ⚠ The symbol in the function bar of the map view turns red if there are traffic bulletins that affect the calculated route.

Switching the reception on/off

1. "Navigation"
2. Open "Options".
3. "Receive Traffic Info"

Opening the list of traffic bulletins

1. "Navigation"
2. "Map"
3. ⚠ "Traffic Info"

First, traffic bulletins for the calculated route are displayed.

The traffic bulletins are sorted by their distance from the current position of the vehicle.

4. Select a traffic bulletin.
 - 🔍 "More information": display additional information.
5. Scroll to the next or previous traffic bulletin if required.

Traffic bulletins on the map

"Traffic conditions/gray map" active:

The Control Display changes to a black and white display. This enables a better view of the traffic bulletins. The day/night mode is disre-

garded in this setting. Symbols and special destinations are not displayed.

1. "Navigation"
2. "Map"
3. Open "Options".
4. "Settings"
5. "Traffic conditions/gray map"

Symbols in the map view

Depending on the scale of the map and the location of the traffic obstruction along the route, the symbols for the traffic obstructions are displayed.

Additional information in the map view

Depending on the map scale, a traffic obstruction's length, direction, and impact are displayed in the map using triangles or gray bars along the calculated route.

- ▶ Red: traffic congestion
- ▶ Orange: stop-and-go traffic
- ▶ Yellow: heavy traffic
- ▶ Green: clear roads
- ▶ Gray: general traffic bulletins such as road construction

The displayed information depends on the particular traffic information service.

Filtering traffic bulletins

You can set which traffic bulletins appear on the map.

1. "Navigation"
2. "Map"
3. Open "Options".

4. "Traffic Info categories"
5. Select the desired category.

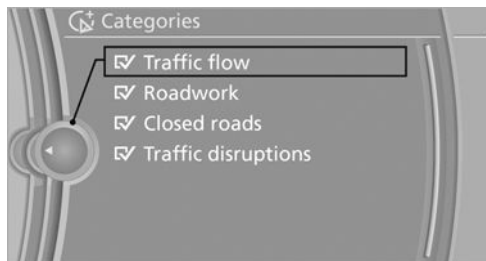

Traffic bulletins of the selected category are displayed on the map.

- ▶ Traffic bulletins that are relevant to the route are always shown.
- ▶ For your own safety, traffic bulletins that notify you of potentially dangerous situations, such as wrong-way drivers, cannot be hidden.

Destination guidance with traffic bulletins

General information

Detour suggestions from the navigation system can be manually accepted when using semi-dynamic destination guidance. When using dynamic destination guidance, they are automatically accepted for route guidance.

Semi-dynamic destination guidance

When traffic bulletin reception is switched on, semi-dynamic destination guidance is active.

The destination guidance system takes the available traffic bulletins into account. A message is displayed depending on the route, the traffic bulletins, and the possible detour routes. If possible, a detour is offered in case of traffic obstructions.

The upper part of the message shows:

- ▶ Symbol of the first traffic obstruction, possibly with the distance to the beginning of the obstruction.

- ▷ Total length of the traffic obstructions on the route.
- ▷ Time by which the trip is extended due to the traffic obstructions.

The lower part of the message shows:

- ▷ Detour recommendation with the distance to the beginning of the detour.
- ▷ Difference between the length of the new route compared to the original route.
- ▷ Time gained if the detour is taken compared to the original route with the traffic obstructions.



Both the original route, shown in white, and the detour are displayed on the split screen.

Accepting the detour

📍 "Detour"

In the event of special hazards, e. g., objects on the road, a message is displayed without a detour suggestion.

Detours can also be accepted if the traffic messages are called up in the list.

1. "Navigation"
2. "Map"
3.  "Traffic Info"
4. "Detour information"
5.  "Detour"

Dynamic destination guidance

The route is automatically changed in the event of traffic obstructions.

- ▷ The system does not point out traffic obstructions along the original route.
- ▷ Traffic bulletins continue to be displayed on the map.
- ▷ Depending on road type and the kind and extent of the traffic obstruction, the calculated route may lead through the traffic obstruction.
- ▷ Dangerous situations are displayed regardless of the setting.

Activating dynamic destination guidance

1. "Navigation"
2. Open "Options".
3. "Dynamic guidance"

What to do if...

Vehicle equipment

This chapter describes all series equipment as well as country-specific and special equipment offered for this model series. Therefore, it also describes equipment that may not be found in your vehicle, for instance due to the selected special equipment or the country version. This also applies to safety-related functions and systems.

When using the features and systems described here, adhere to local regulations.

The Control Display changes to a black and white display. This enables a better view of the traffic bulletins.

- ▷ Spoken instructions are no longer output during route guidance in front of intersections?

The area has not yet been fully recorded, or you have left the recommended route and the system requires a few seconds to calculate a new route suggestion.

What to do if...

- ▷ The current transmission position cannot be displayed?

The vehicle is located in an unrecognized region, is in a poor reception area, or the system is currently determining the position. Reception is usually best when you have an unobstructed view of the sky.

- ▷ The destination without street information is not used for route guidance?

When city has been input, no downtown can be determined. Input any street in the selected city and start destination guidance.

- ▷ The destination is not used for route guidance?

The destination data are not contained in the navigation data. Select a destination that is as close as possible to the original.

- ▷ Letters for destination input cannot be selected?

The stored data do not contain the data of the destination. Select a goal that is as close as possible to the original.

- ▷ Is the map displayed in shades of gray?

"Traffic conditions/gray map" active:



Entertainment

This chapter helps assure your enjoyment when receiving radio stations and playing CDs, DVDs, and tracks from the music collection.

Tone

Vehicle equipment

This chapter describes all series equipment as well as country-specific and special equipment offered for this model series. Therefore, it also describes equipment that may not be found in your vehicle, for instance due to the selected special equipment or the country version. This also applies to safety-related functions and systems.

When using the features and systems described here, adhere to local regulations.

General information

The sound settings are stored for the remote control currently in use.

Treble, bass, balance, and fader

- ▷ "Treble": treble adjustment.
- ▷ "Bass": depth adjustment.
- ▷ "Balance": left/right volume distribution.
- ▷ "Fader": front/rear volume distribution.

Setting treble, bass, balance, and fader

1. "CD/Multimedia", "Radio" or "Settings"
2. "Tone"



3. Select the desired tone settings.

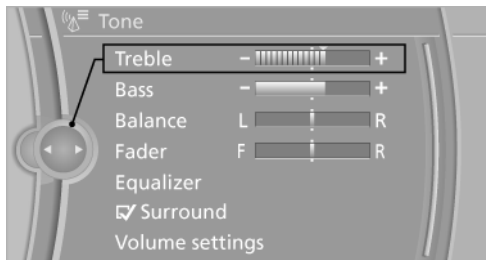

4. To adjust: turn the controller.
5. To store: press the controller.

Equalizer

Setting for individual audio frequency ranges.

Adjusting the equalizer

1. "CD/Multimedia", "Radio" or "Settings"
2. "Tone"
3. "Equalizer"
4. Select the desired setting.

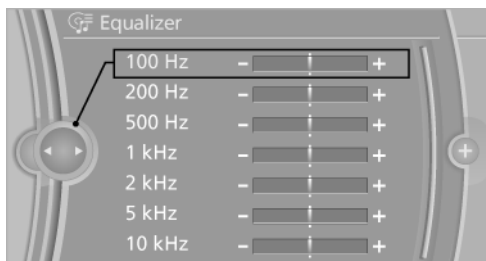

5. To adjust: turn the controller.
6. To store: press the controller.

Multi-channel playback, surround

Choose between stereo and multi-channel playback, surround.

Setting multi-channel playback, surround

1. "CD/Multimedia", "Radio" or "Settings"
2. "Tone"
3. "Surround"

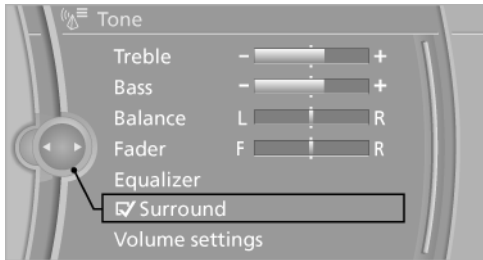

When surround is activated, multi-channel playback is simulated when a stereo audio track is played.

Volume

- ▶ "Speed volume": speed-dependent volume control.
- ▶ "PDC": volume of the PDC signal compared to the entertainment sound output.
- ▶ "Gong": volume of the signal, such as the safety belt reminder, compared to the entertainment sound output.
- ▶ "Microphone": volume of the microphone during a phone call.
- ▶ "Loudspeak.": volume of the loudspeakers during a phone call.

The following volumes are only stored for the respective paired telephone: "Microphone", "Loudspeak.".

Adjusting the volume

1. "CD/Multimedia", "Radio" or "Settings"
2. "Tone"
3. "Volume settings"
4. Select the desired volume setting.

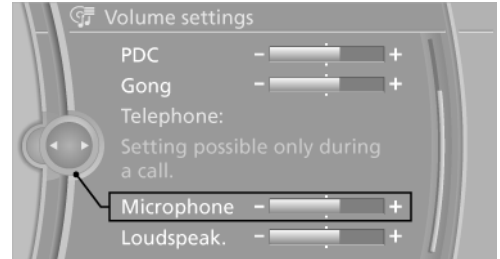

5. To adjust: turn the controller.
6. To store: press the controller.

Resetting the tone settings

All tone settings can be reset to the default setting.

1. "CD/Multimedia", "Radio" or "Settings"
2. "Tone"
3. "Reset"

Radio

Vehicle equipment

This chapter describes all series equipment as well as country-specific and special equipment offered for this model series. Therefore, it also describes equipment that may not be found in your vehicle, for instance due to the selected special equipment or the country version. This also applies to safety-related functions and systems.

When using the features and systems described here, adhere to local regulations.

Controls

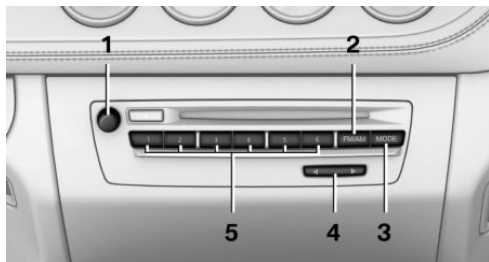

- 1 Volume, on/off
- 2 Change wave band
- 3 Change entertainment sources
- 4 Change station/track
- 5 Programmable memory buttons

Sound output

Switching on/off

When the ignition is switched off: press ON/OFF button on the radio.

Muting

When the ignition is switched on or the engine is running: press the ON/OFF button on the radio.

AM/FM station

Selecting a station

1. "Radio"
2. "FM" or "AM"
3. Select the desired station.

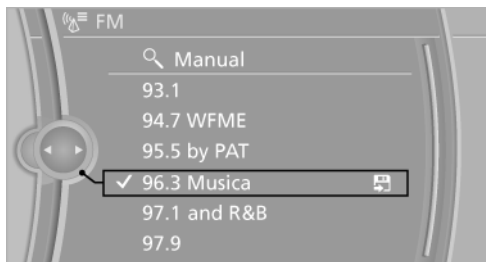

All saved stations are stored for the remote control currently in use.

Changing the station

Turn the controller and press it
or



Press the button

or

Press the buttons on the steering wheel, refer to page 12.

Storing a station

1. "Radio"
2. "FM" or "AM"

3. Highlight the desired station.

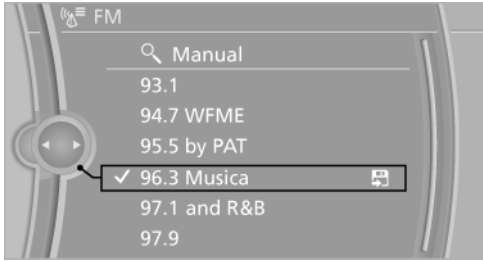

4. Press the controller for an extended period.
5. Select the desired memory location.

The stations are stored for the remote control currently in use.

The stations can also be stored on the programmable memory buttons, refer to page 22.

Selecting a station manually

Station selection via the frequency.

1. "Radio"
2. "FM" or "AM"
3. "Manual"
4. To select the frequency: turn the controller.

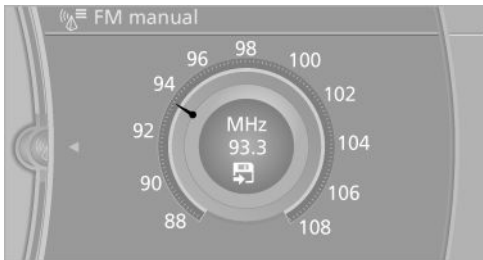

To store the station: press the controller for an extended period.

Renaming a station

An FM station with changing station names can be renamed.

1. "Radio"
2. "FM"

3. Select the desired station.
4. Open "Options".
5. "Rename to:"

If necessary, wait for the desired name to be displayed.

The selected station name is added to the list of current stations and stored stations.

RDS

RDS broadcasts additional information, such as the station name, in the FM wave band.

Switching the RDS on/off

1. "Radio"
2. "FM"
3. Open "Options".
4. "RDS"

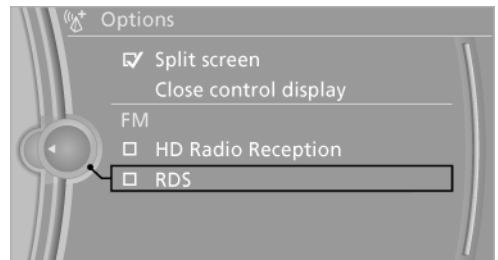

The setting is stored for the remote control currently in use.

HD Radio™ reception

Many stations broadcast both analog and digital signals.

License conditions

HD Radio Technology manufactured under license from iBiquity Digital Corporation. U.S. and Foreign Patents. HD Radio™ and the HD, HD Radio, and Arc logos are proprietary trademarks of iBiquity Digital Corp.

Activating/deactivating digital radio reception

1. "Radio"
2. "FM" or "AM"
3. Open "Options".
4. "HD Radio Reception"

The setting is stored for the remote control currently in use.

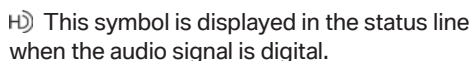
 This symbol is displayed in the status line when the audio signal is digital.

When tuning to a station with a digital signal, it may take several seconds for the station to be played back in digital quality.

Note on HD stations whose station name ends in ...HD or with ...HD1:

In areas in which the station is not continuously received in digital mode, the playback switches between analog and digital reception. In this case, switch off digital radio reception.

Note on HD multicast stations whose station name ends in ...HD2, ...HD3, ...:

In areas in which the station is not continuously received in digital mode, the audible signal may be interrupted for several seconds. This is reception related.

Displaying additional information

Some stations broadcast additional information on the current track, such as the name of the artist.

1. Select the desired station.
2. Open "Options".
3. "Station info"

Selecting a substation

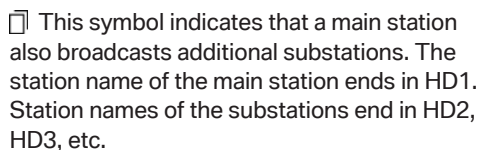
 This symbol indicates that a main station also broadcasts additional substations. The station name of the main station ends in HD1. Station names of the substations end in HD2, HD3, etc.

1. Select the desired station.

2. Press the controller.
3. Select the substation.







When reception is poor, the substation is muted.

Satellite radio

General information

The channels are offered in predefined packages. The packages must be enabled by telephone.

Navigation bar overview

Symbol	Function
	Change the list view.
	Select the category.
	Direct channel entry
	Timeshift
	Open the My Favorites category/open a favorite.
	Manage the favorites.
	Traffic Jump

The functions of the navigation bar symbols can also be stored on the programmable memory buttons, refer to page [23](#).

Managing a subscription

To be able to enable or unsubscribe from the channels, you must have reception. It is usually at its best when you have an unobstructed view of the sky. The channel name is displayed in the status line.

Enabling channels

The Unsubscribed Channels category contains all disabled channels.

1. "Radio"
2. "Satellite radio"
3.  "Category"



4. Select the Unsubscribed Channels category.
5. Select the desired channel.
The phone number and an electronic serial number, ESN, are displayed.
6. Select the phone number to have the channel enabled.



You can unsubscribe from the channels again via this phone number.

Unsubscribing from channels

1. "Radio"
2. "Satellite radio"
3. Open "Options".

4. "Manage subscription"

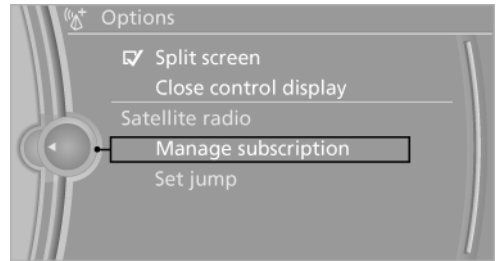

5. The phone number and an electronic serial number, ESN, are displayed.
6. Call Sirius to unsubscribe from the channels.

Selecting channels

You can only listen to enabled channels.

The selected channel is stored for the remote control currently in use.

Via the iDrive

1. "Radio"
2. "Satellite radio"
3. Select "All channels" or the desired category.
4. Select the desired channel.



Via the button on the radio

-  Press the button.
The next channel is selected.

Via direct channel entry

1. "Radio"
2. "Satellite radio"
3.  "Set channel"
4. Turn the controller until the desired channel is reached and press the controller.

Storing a channel

1. "Radio"
2. "Satellite radio"
3. If necessary, open "All channels" or the desired category.
4. Select the desired channel.
5. Press the controller again.
6. Press the controller again to confirm the highlighted channel.

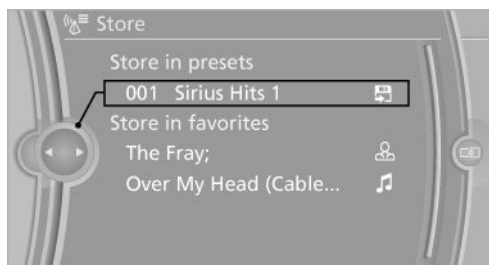



7. Select the desired memory location.
- The channels are stored for the remote control currently in use.

The channels can also be stored on the programmable memory buttons, refer to page 22.

Changing the list view

The list view changes every time the first symbol on the navigation bar is pressed.

Information on the channel is displayed.

Symbol	Meaning
	Channel name
	Artist
	Track

Selecting a category

1. "Radio"
2. "Satellite radio"
3.  "Category"
4. Select the desired category.

Timeshift

Approx. one hour of the program being broadcast on the channel currently being listened to is stored in a buffer. Prerequisite: the signal must be available.

The stored audio track can be played with a delay following the live broadcast. When the buffer is full, the older tracks are overwritten. The buffer is cleared when a new channel is selected.



Opening the timeshift function

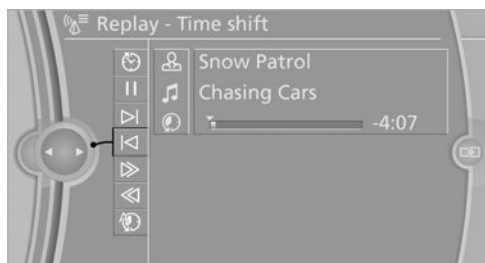



1. "Radio"
2. "Satellite radio"
3.  "Replay - Time shift"



- ▷ The red arrow shows the current playback position.
- ▷ The time difference to the live broadcast is displayed next to the buffer bar.
- ▷ For live transmissions "live".

Timeshift menu

Symbol	Function
	Go to the live broadcast
	Playback/pause

Symbol	Function
	Next track
	Previous track
	Fast forward
	Reverse
	Automatic timeshift deactivated/activated



Automatic timeshift

When the function is activated, audio playback is stopped automatically in the event of:

- ▶ Incoming and outgoing telephone calls.
- ▶ Activation of the voice activation system.
- ▶ Muting.

The audio playback then continues with a time delay.

To activate:

1. "Radio"
2. "Satellite radio"
3.  "Replay - Time shift"
4.  "Automatic time shift"

To deactivate:

-  "Automatic time shift"

Storing favorites

Up to 30 favorites can be stored in the favorites list. Available favorites are artist, track, game, league, and team.

Storing the artist, track, or game

It is only possible to store favorites that are currently being broadcast. The channel information must be available.

1. "Radio"
2. "Satellite radio"
3. If necessary, open "All channels" or the desired category.

4. Select the desired channel.
5. Press the controller again.
6. Select the artist, track, or game.

Storing the league or team

Leagues or teams can be added to the favorites from a selection list.

1. "Radio"
2. "Satellite radio"
3.  "Manage favorites"
4. "Add sports information"



5. Select the league.
6. Select "Add all teams" or the desired team.

Opening the favorites

If an activated favorite is played back, the following message appears for approx. 20 seconds "Favorite alert!".

 "Favorites"

Select the symbol while the message is shown.



The displayed favorite is played.

If there is no message, the system changes to the My Favorites category. All favorites currently being broadcast can be selected from a list.

Managing the favorites

Activating/deactivating the favorites

Favorites can be activated and deactivated globally and individually.

1. "Satellite radio"
2. ☆+ "Manage favorites"
3. Select "Activate alert" or the desired favorites.

The setting is stored for the remote control currently in use.

Deleting favorites

1. "Satellite radio"
2. ☆+ "Manage favorites"
3. Highlight the desired favorite.
4. Open "Options".
5. "Delete entry"

Traffic Jump

Traffic and weather information for a selected region is broadcast every few minutes.

Selecting a region

1. "Radio"
2. "Satellite radio"
3. Open "Options".
4. "Set jump"
5. Select the desired region.

The region is stored for the remote control currently in use.



Activating/deactivating the jump

1. "Radio"
2. "Satellite radio"
3. ↶ "Jump to:"

Information for the selected region is broadcast as soon as it is available.

A new panel opens.

Canceling the Traffic Jump: "Cancel".

Symbol	Meaning
	Information will be broadcast shortly.
	Information is currently being broadcast.

Select one of the symbols to deactivate Traffic Jump.

Automatic update

About twice a year, Sirius performs an update of the channel names and positions. The update takes place automatically and may take several minutes.

Notes

- ▷ Reception may not be available in some situations, such as under certain environmental or topographic conditions. The satellite radio has no influence on this.
- ▷ The signal may not be available in tunnels or underground garages; next to tall buildings; or near trees, mountains or other powerful sources of radio interference.

Stored stations

General information

It is possible to store up to 40 stations.

Calling up a station

1. "Radio"
2. "Presets"
3. Select the desired station.

Storing a station

The station currently selected is stored.

1. "Radio"
2. "Presets"
3. "Store station"



4. Select the desired memory location.

The list of stored stations is stored for the remote control currently in use.

The stations can also be stored on the programmable memory buttons, refer to page [22](#).

Deleting a station

1. "Radio"
2. "Presets"
3. Select the desired station.
4. Open "Options".
5. "Delete entry"

CD/multimedia

Vehicle equipment

This chapter describes all series equipment as well as country-specific and special equipment offered for this model series. Therefore, it also describes equipment that may not be found in your vehicle, for instance due to the selected special equipment or the country version. This also applies to safety-related functions and systems.

When using the features and systems described here, adhere to local regulations.

Controls

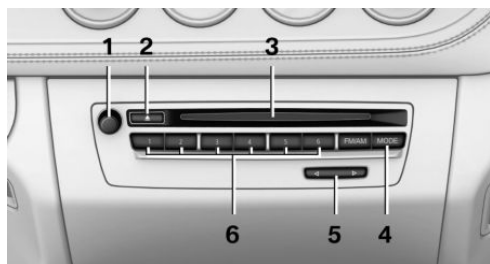

- 1 Volume, on/off
- 2 Eject CD/DVD
- 3 CD/DVD drive
- 4 Change the entertainment source
- 5 Change station/track
- 6 Programmable memory buttons

Sound output

Switching on/off

When the ignition is switched off: press ON/OFF button on the radio.

Muting

When the ignition is switched on or the engine is running: press the ON/OFF button on the radio.

CD/DVD

Playback

Loading the CD/DVD player

Insert the CD/DVD with the printed side up. Playback begins automatically.

Reading can take a few minutes with compressed audio files.

Starting playback

A CD/DVD is contained in the CD/DVD player.

1. "CD/Multimedia"
2. "CD/DVD"
3. Select the desired CD or DVD.

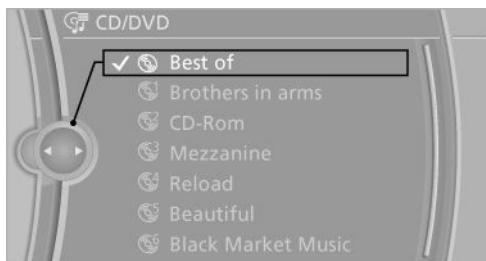

Symbol	Meaning
	CD/DVD player

Playable formats

- ▷ DVD: DVD-ROM, DVD-R, DVD+R, DVD-RW, DVD+RW, DVD-R DL, DVD+R DL, DVD audio (video part only), DVD video.

- ▷ CD: CD-ROM, CD-R, CD-RW, CD-DA.
- ▷ Compressed audio files: MP3, WMA, AAC, M4A.

Audio playback

Selecting the track using the button

 Press the button for the appropriate direction as often as necessary until the desired track is played back.

Selecting the track using the iDrive

Audio CDs

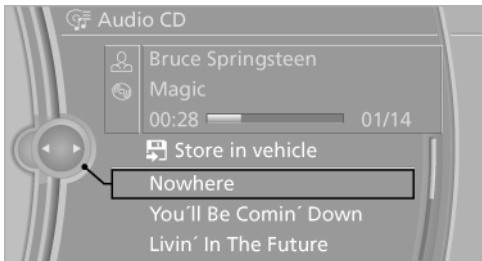

Select the desired track to begin playback.

CDs/DVDs with compressed audio files

Depending on the data, some letters and numbers of the CD/DVD may not be displayed correctly.

1. Select the directory if necessary.
To change to a higher level directory: move the controller to the left.

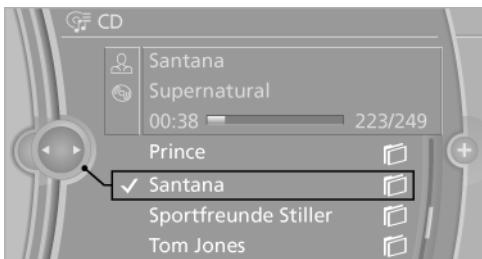

2. Select the desired track to begin playback.

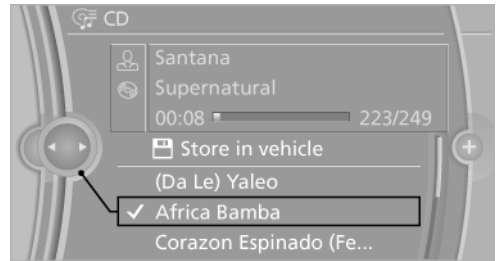

Displaying information on the track

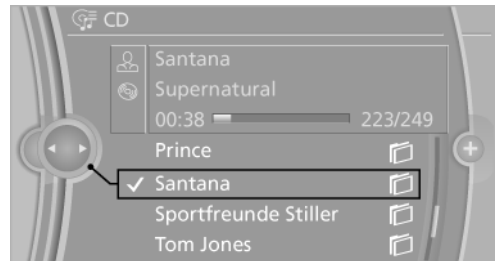

If information about a track has been stored, it is displayed automatically:

- ▷ Interpret.
- ▷ Album track.
- ▷ Number of tracks on the CD/DVD.
- ▷ File name of track.

Random playback

1. "CD/Multimedia"
2. "CD/DVD"
3. Select the desired CD or DVD.

4. Open "Options".
5. "Random"

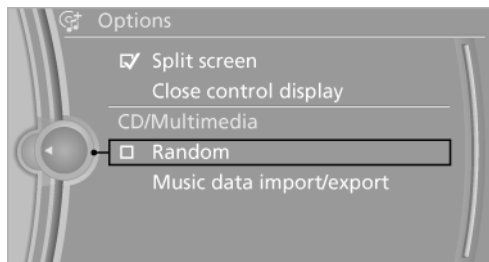

CDs/DVDs with compressed audio files: all tracks within the selected directory are played in random order.

Random mode is switched off when the audio source is changed and the ignition is switched off.

Fast forward/reverse



Press and hold the button.

Video playback

Country codes

Only DVDs with the code of the home region can be played back; also refer to the information on the DVD.

Code	Region
1	USA, Canada
2	Japan, Europe, Middle East, South Africa
3	Southeast Asia
4	Australia, Central and South America, New Zealand
5	Northwest Asia, North Africa
6	China
0	All regions

Playback

The video image is displayed on the Control Display up to a speed of approx. 2 mph/3 km/h; in some countries, it is only displayed while the parking brake is set or the automatic transmission is in position P.

DVD video

1. "CD/Multimedia"
2. "CD/DVD"
3. Select a DVD with video content.
4.  "DVD menu"

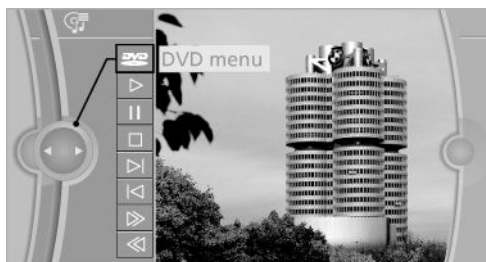









5. Start the DVD via the DVD menu.

Video menu

To open the video menu: turn the controller during playback.

Press the controller when "Back" is displayed.

Symbol	Function
	Open DVD menu
	Starting playback
	Pause
	Stop
	Next chapter
	Previous chapter
	Fast forward
	Reverse

In fast forward/reverse: the speed increases every time the controller is pressed. To stop, start playback.

DVD menu

1. If necessary, turn the controller to open the video menu.

2. **DVD** "DVD menu"

The DVD menu is displayed. The display depends on the contents of the DVD.

3. To select menu items: move the controller and press it.

To change to the video menu: turn the controller and press it.

DVD settings

For some DVDs, settings can only be made via the DVD menu; refer also to the information on the DVD.

Selecting the language

The languages that are available depend on the DVD.

1. Turn the controller during playback.

2. Open "Options".

3. "Audio/language"

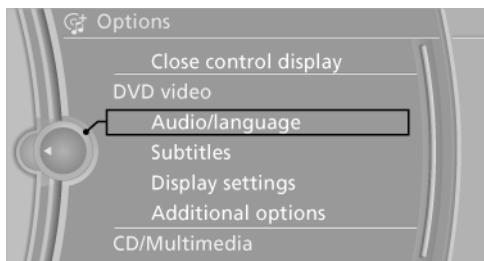

4. Select the desired language.

Selecting the subtitles

The subtitles that are available depend on the DVD.

1. Turn the controller during playback.

2. Open "Options".

3. "Subtitles"

4. Select the desired language or "Do not display subtitles".

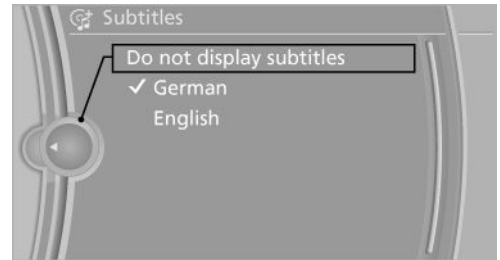

Setting the brightness, contrast and color

1. Turn the controller during playback.

2. Open "Options".

3. "Display settings"

4. "Brightness", "Contrast" or "Color"

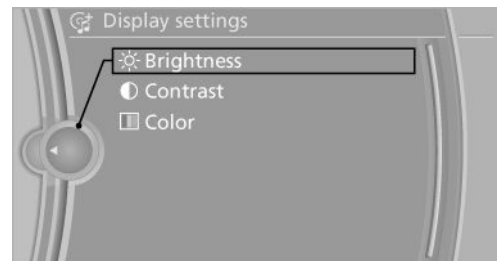

5. Turn the controller until the desired setting is reached and press the controller.

Selecting the zoom

Display the video image on the entire screen.

1. Turn the controller during playback.

2. Open "Options".

3. "Additional options"
4. "Zoom mode"

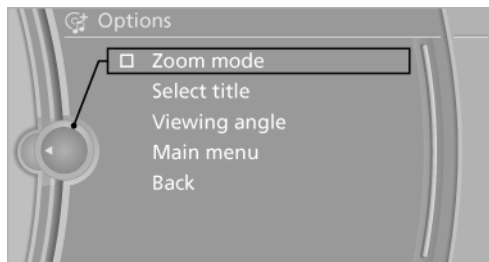

Selecting a track

DVD video:

1. Turn the controller when the DVD menu is displayed.
2. Open "Options".
3. "Additional options"
4. "Select title"
5. Select the desired track.

Selecting the camera angle

The availability of a different camera angle depends on the DVD and the current DVD track.

1. Turn the controller during playback.
2. Open "Options".
3. "Additional options"
4. "Viewing angle"
5. Select the desired camera angle.

Opening the main menu, back

These functions are not contained on every DVD. Therefore, they may not be available for use.

Notes

CD/DVD player

 Do not remove the cover
BMW CD/DVD players and changers are officially designated Class 1 laser products. Do not operate if the cover is damaged; otherwise, severe eye damage can result. ◀

CDs and DVDs

-  Use of CDs/DVDs
- ▶ Do not use self-recorded CDs/DVDs with labels applied, as these can become detached during playback due to heat buildup and can cause irreparable damage to the device.
 - ▶ Only use round CDs/DVDs with a standard diameter of 4.7 in/12 cm and do not play CDs/DVDs with an adapter, e.g., single CDs; otherwise, the CDs or the adapter may jam and no longer eject.
 - ▶ Do not use combined CDs/DVDs, e.g., DVD Plus, as the CDs/DVDs can jam and will no longer eject. ◀

General malfunctions

- ▶ CD/DVD players have been optimized for performance in vehicles. In some instances they may be more sensitive to faulty CDs/DVDs than stationary devices would be.
- ▶ If a CD/DVD cannot be played, first check whether it has been inserted correctly.

Humidity

High levels of humidity can lead to condensation on the CD/DVD or the laser's scan lens, and temporarily prevent playback.

Malfunctions involving individual CDs/DVDs

If malfunctions occur only with particular CDs/DVDs, this can be due to one of the following causes:

Self-recorded CDs/DVDs

- ▷ Possible reasons for malfunctions with self-recorded CDs/DVDs are inconsistent data creation or recording processes, or poor quality or old age of the blank CD/DVD.
- ▷ Only label CDs/DVDs on the upper side with a pen intended for this purpose.

Damage

- ▷ Avoid fingerprints, dust, scratches and moisture.
- ▷ Store CDs/DVDs in a sleeve.
- ▷ Do not subject CDs/DVDs to temperatures over 122 °F/50 °C, high humidity or direct sunlight.

CDs/DVDs with copy protection

CDs/DVDs are often provided with a copy protection feature by the manufacturer. This can mean that some CDs/DVDs cannot be played or can only be played to a limited extent.

MACROVISION

This product contains copyrighted technology that is based on multiple registered US patents and the intellectual property of the Macrovision Corporation and other manufacturers. The use of this copy protection must be approved by Macrovision. Media protected by this product - unless otherwise agreed with Macrovision - may only be used for private purposes. Copying of this technology is prohibited.

DTS Digital Surround™



Manufactured under license under U.S. Patent Numbers: 5,451,942; 5,956,674; 5,974,380; 5,978,762; 6,487,535 & and other patents granted and registered in the USA and worldwide. DTS and the logo are registered trademarks & DTS Digital Surround and the DTS logos are trademarks of DTS Inc. © DTS, Inc. All rights reserved.

Music collection

Storing music

General information

Music tracks from CDs/DVDs and USB devices can be stored in the music collection on a hard disc in the vehicle and played from there.

- ▷ Audio CD: tracks are converted into a compressed audio format. If available, information on the album, such as the artist, is stored as well.
- ▷ CD/DVD or USB device with compressed audio files: the entire content of the CD/DVD or the USB device is stored in the vehicle as an album. The WMA, MP3, M4A, and AAC formats are stored. Individual tracks and directories can be deleted later. Deleting a track and directory, refer to page 179.

Tracks with DRM copy protection can be stored but cannot be played back.



Backing up music data

Regularly back up the music data; otherwise, it could be lost if there is a fault on the hard disc. ◀



Music recognition technology and related data are provided by Gracenote®. Gracenote is the industry standard in music recognition technology and related content delivery. For more information, please visit www.gracenote.com.

CD and music-related data from Gracenote, Inc., copyright © 2000, Gracenote up to now. Gracenote-Software Copyright 2000, Gracenote up to now. This product and service may practice one or more of the following U.S. Patents: #5,987,525; #6,061,680; #6,154,773, #6,161,132, #6,230,192, #6,230,207, #6,240,459, #6,330,593, and other patents issued or pending. Some services supplied under license from Open Globe, Inc. for U.S. Patent: #6,304,523.

Storing from a CD/DVD

1. Insert a CD or DVD into the CD/DVD player.
2. "CD/Multimedia"
3. "CD/DVD"
4.  Select the symbol for the CD/DVD player.
5. "Store in vehicle"



The music collection is displayed and the first track of the CD/DVD is played back. During the storage process, the tracks are played in sequence.

Observe the following during the storage process:

Do not switch to the CD/DVD player and do not remove the CD/DVD from the CD/DVD player as this will interrupt the storage process. You can switch to the other audio sources without interrupting the storage process. Tracks from the current CD/DVD that have already been stored can be called up.

Interrupting storage

1. "CD/Multimedia"
2. "CD/DVD"

3. "Storing..."



4. "Cancel storing"

The storage process is interrupted and can be continued at any time.

Continuing the storage process

1. "CD/Multimedia"
2. "CD/DVD"
3.  Select the symbol for the CD/DVD player.
4. "Continue storing"

Storage of the CD/DVD continues at the beginning of the track at which storage was interrupted.

Album information

During storage, information such as the name of the artist is stored with the track, if this information is available in the vehicle database or on the CD.

To update the database, contact your service center.

Storing from a USB device

To store music, a suitable device must be connected to the USB interface in the glove compartment.

- ▶ Suitable devices: USB mass storage devices, such as USB flash drives or MP3 players with a USB interface.
- ▶ Unsuitable devices: USB hard drives, USB hubs, USB memory card readers with multiple inserts, Apple iPod/iPhone. Music from the Apple iPod/iPhone can be played

via the USB audio interface in the center armrest.

- ▶ File systems: standard file systems for USB devices are supported. The FAT 32 format is recommended.
1. Connect the USB device to the USB interface in the glove compartment, refer to page [122](#).
 2. "CD/Multimedia"
 3. "Music collection"
 4. Open "Options".
 5. "Music data import/export"
 6. "Import music (USB)"

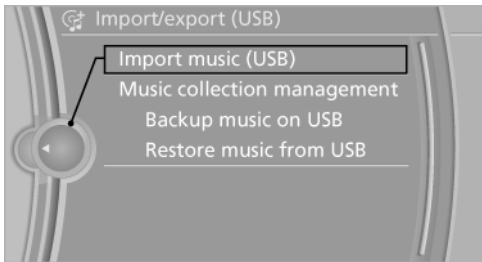

Playing music

Music search

All tracks for which additional information has been stored can be accessed by the music search. Tracks without additional information can be called up via the corresponding album, refer to page [178](#).

1. "CD/Multimedia"
2. "Music collection"

3. "Music search"



4. Select the desired category.



5. Select the desired entry.

- ▶ Select "A-Z search", refer to page [23](#), and input the desired entry.
- ▶ Select the desired entry from the list.

6. Select other categories if you wish.

The tracks found are listed in alphabetical order.

Not all categories need to be selected. For example, to search for all tracks by a certain artist, call up that artist only. All of the tracks by that artist are then displayed.

7. "Start play"

The list of tracks is repeated automatically.

Restarting the music search

"New search"

Music search by voice

Instructions for voice activation system, refer to page 25.

1.  Press the button on the steering wheel.
2. ›Music search:
3. Open the desired category, e. g., ›Select artist.
4. Say the desired entry in the list.
5. Select other categories if you wish.

To select a track directly: ›Title ...‹

Say the voice command and the name of the desired track in a single command.

Current playback

The list of tracks that was generated last by the music search, or the album that was selected last.

1. "CD/Multimedia"
2. "Music collection"
3. "Current playback"

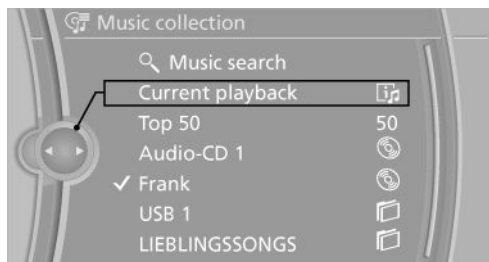

4. Select the desired track, if necessary.



Top 50

The 50 most frequently played tracks.

1. "CD/Multimedia"
2. "Music collection"
3. "Top 50"
4. Select the desired track, if necessary.

Albums

All stored albums, listed in order of their storage dates.

Symbol	Format
	Audio CD
	Compressed audio files

1. "CD/Multimedia"
2. "Music collection"
3. Select the desired album.

Depending on the album, the tracks or the subdirectories of the album are displayed. The first track is played automatically, if possible.

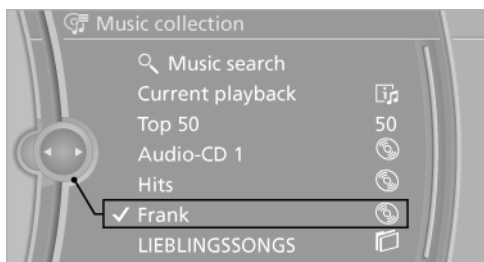

4. Change directories if needed to select tracks.

To go up a level in the directory: move the controller to the left.

Random playback

All tracks of the selection are played back in random order.

1. "CD/Multimedia"
2. "Music collection"

3. Open "Options".
4. "Random"



Managing music

Albums

Renaming an album

The name of the album, if available, is automatically entered when the album is stored. If the name is not available, it can be changed later if desired.

1. "CD/Multimedia"
2. "Music collection"
3. Highlight the desired album.
4. Open "Options".
5. "Rename album"



6. Select the letters individually.

Deleting an album

An album cannot be deleted while a track from that album is being played.

1. "CD/Multimedia"
2. "Music collection"
3. Highlight the desired album.
4. Open "Options".
5. "Delete album"

Deleting a track and directory

A track cannot be deleted while it is being played.

A directory cannot be deleted while a track from that directory is being played.

1. "CD/Multimedia"
2. "Music collection"
3. Highlight the directory or track.
4. Open "Options".
5. "Delete folder" or "Delete track"

Free memory capacity

Display the free memory capacity in the music collection.

1. "CD/Multimedia"
2. "Music collection"
3. Open "Options".
4. "Free memory"

Music collection

Backing up the music collection

The entire music collection can be stored on a USB device. Make sure there is enough free memory capacity on the USB device.

Depending on the number of tracks, backing up the music collection may take several

hours. Therefore, it is best to perform the backup during a long trip.

1. Starting the engine.
2. Connect the USB device to the USB interface in the glove compartment, refer to page 122.
3. "CD/Multimedia"
4. "Music collection"
5. Open "Options".
6. "Music data import/export"

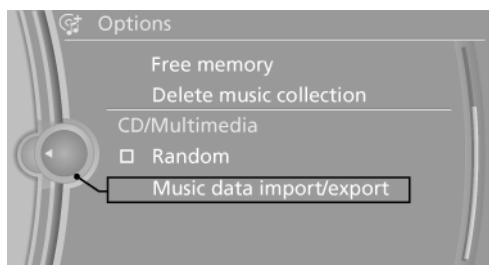

7. "Backup music on USB"

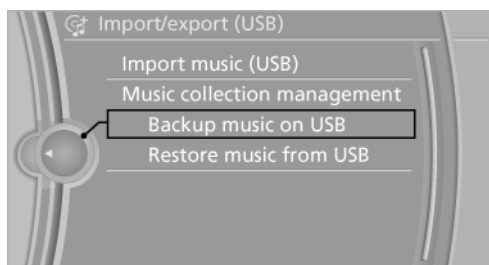

Storing the music collection in the vehicle

When storing from the USB device, the existing music collection in the vehicle is replaced.





1. "CD/Multimedia"
2. "Music collection"
3. Open "Options".
4. "Music data import/export"
5. "Restore music from USB"

Deleting the music collection

1. "CD/Multimedia"
2. "Music collection"
3. Open "Options".
4. "Delete music collection"

External devices

At a glance

Symbol	Meaning
	AUX-IN port
	USB audio interface
	Music interface for smartphones
	Bluetooth audio

AUX-IN port

At a glance

- ▷ For connecting audio devices, e.g., MP3 player. The sound is output on the vehicle loudspeakers.
- ▷ Recommendation: use medium tone and volume settings on the audio device. The tone depends on the quality of the audio files.

Connecting



The AUX-IN port is in the center armrest.

Connect the headphone connector or line-out connector of the device to the AUX-IN port.

Playback

1. Connect the audio device, switch it on and select a track on the audio device.
2. "CD/Multimedia"
3. If necessary, "External devices"
4.  "AUX front"

Sound is output on the vehicle loudspeakers.

Volume

The volume of the sound output is dependent on the audio device. If this volume differs markedly from the volume of the other audio sources, it is advisable to adjust the volumes.

Adjusting the volume

1. "CD/Multimedia"
2. If necessary, "External devices"
3.  "AUX front"
4. "Volume"

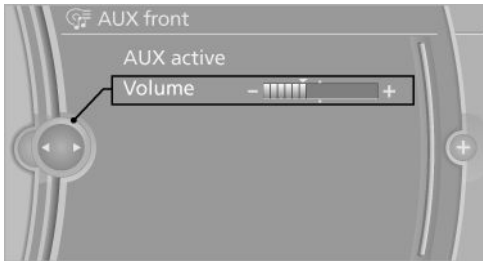

5. Turn the controller until the desired volume is set and press the controller.

USB audio interface/music interface for smartphones

At a glance

It is possible to connect external audio devices. They can be operated via iDrive. The sound is output on the vehicle loudspeakers.

Connectors for external devices

- ▷ Connection via USB audio interface: Apple iPod/iPhone, USB devices, e.g., MP3 players, USB flash drives, or mobile phones that are supported by the USB audio interface.
- ▷ Connection via snap-in adapter, refer to page 201, when equipped with the music interface for smartphones: Apple iPhone or mobile phones.

Playback is only possible if no audio device is connected to the analog AUX-IN port.

Due to the large number of different audio devices available on the market, it cannot be ensured that every audio device/mobile phone is operable on the vehicle.

Ask your service center about suitable audio devices/mobile phones.

Audio files

Standard audio files can be played back:

- ▷ MP3.
- ▷ WMA.
- ▷ WAV (PCM).
- ▷ AAC, M4A.
- ▷ Playback lists: M3U, WPL, PLS.

File system

Standard file systems for USB devices are supported. The FAT 32 format is recommended.

Connecting

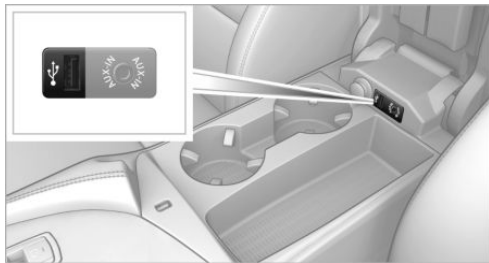

The USB audio interface is in the center armrest.

Connection of Apple iPod/iPhone via USB audio interface

Connect using a flexible adapter cable.

Connect the Apple iPod/iPhone to the USB interface.

The Apple iPod/iPhone menu structure is supported by the USB audio interface.

Connection of a USB device via the USB audio interface

Connect using a flexible adapter cable to protect the USB audio interface and the USB device against physical damage.

Connect the USB device to the USB interface.

After connecting for the first time

Information on all music tracks, e.g. artist or type of music, as well as playback lists are transmitted into the vehicle. This may take some time, depending on the USB device and the number of tracks.

During transmission, the tracks can be called up via the file directory.



Number of tracks

Information from up to four USB devices or for approx. 36,000 tracks can be stored in the vehicle. If a fifth device is connected or if more than 36,000 tracks are stored, information on existing tracks may be deleted.

Copy protection

Music tracks with integrated Digital Rights Management (DRM) cannot be played.

Playback

1. "CD/Multimedia"
2. "External devices"
3. Select the  or  symbol.



The playback starts with the first track.

The CD cover belonging to the track may appear on the Control Display after several seconds.



Track search

Selection is possible via:

- ▷ Playback lists.
- ▷ Information: type of music, artist, and, if available, composer, album, track.
- ▷ Additionally for USB devices: file directory, composer.

Tracks are displayed if they have been saved in the Latin alphabet.

Starting the track search

1. "CD/Multimedia"
2. "External devices"
3. Select the  or  symbol.
4.  "Search"
5. Select the desired category, e.g., "Genre" or "Artist".

All entries are displayed in a list.

- ▶ Open "A-Z search" and input the desired entry. When a letter is entered, the results are filtered using this letter as the first letter. If multiple letters are entered, all results that contain that sequence are displayed.
- ▶ Select the desired entry from the list.

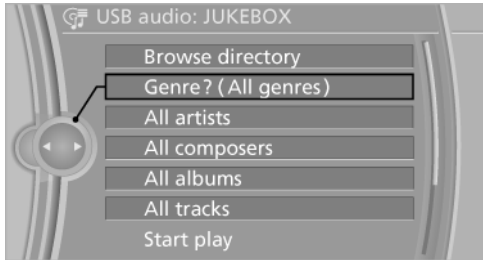

- 6. Select other categories if you wish.

Not all categories need to be selected. For example, if all of the tracks by a certain artist are to be displayed, call up that artist only. All of the tracks by that artist are then displayed.



- 7. "Start play"

Restarting a track search

"New search"



Playback lists

Calling up playback lists.

1. "CD/Multimedia"
2. "External devices"
3. Select the  or  symbol.
4.  "Playlists"

Current playback

List of tracks currently being played.

1. "CD/Multimedia"
2. "External devices"
3. Select the  or  symbol.
4.  "Current playback"

Random playback

The current list of tracks is played back in random order.

1. "CD/Multimedia"
2. "External devices"
3. Open "Options".
4. "Random"

Fast forward/reverse

 Press and hold the button.

Notes

Do not expose the audio device to extreme environmental conditions, such as very high temperatures; refer to the audio device operating instructions.

Depending on the configuration of the audio files, e.g., bit rates greater than 256 kbit/s, the files may not play back correctly in each case.

Information on connection

- ▶ The connected audio device is supplied with a max. power of 500 mA if supported by the device. Therefore, do not additionally connect the device to a socket in the vehicle; otherwise, playback may be compromised.
- ▶ Do not use force when plugging the connector into the USB interface.
- ▶ Do not connect devices such as fans or lamps to the USB audio interface.
- ▶ Do not connect USB hard drives.
- ▶ Do not use the USB audio interface to recharge external devices.

Bluetooth audio

At a glance

- ▶ Music files on external devices such as audio devices or mobile phones can be played back via Bluetooth.

Use of a mobile phone as an audio source, refer to page 194.

- ▷ Bluetooth® is a registered trademark of Bluetooth® SIG, Inc.
- ▷ The sound is output on the vehicle loudspeakers.
- ▷ The volume of the sound output is dependent on the device. If necessary, adjust the volume on the device.
- ▷ Up to four external devices can be paired with the vehicle.

Requirements

- ▷ The device is suitable. Information at www.bmwusa.com/bluetooth.
- ▷ The device is ready for operation.
- ▷ The ignition is switched on.
- ▷ Bluetooth is activated on the vehicle, refer to page 193, and on the device.
- ▷ Bluetooth presettings must be made on the device, such as for a connection without confirmation or visibility; refer to the device operating instructions.
- ▷ A number with at least four and a maximum of 16 digits is defined as the Bluetooth passkey. It is only required once for pairing.

Pairing and connecting

Pairing a device

To avoid becoming distracted and posing an unnecessary hazard both to your own vehicle's occupants and to other road users, only pair the device while the vehicle is stationary. ◀

1. "CD/Multimedia"
2. "Bluetooth® (audio)"
3. If necessary, "Bluetooth® audio"
4. "Add new phone"

The Bluetooth name of the vehicle is displayed.



5. Perform additional steps on the device, refer to the device operating instructions: for instance, search for or connect the Bluetooth device or a new device.
The Bluetooth name of the vehicle appears on the device display.
6. Select the Bluetooth name of the vehicle on the device display.
You are prompted by the iDrive or device to enter the same Bluetooth passkey.
7. Enter the passkey and confirm.

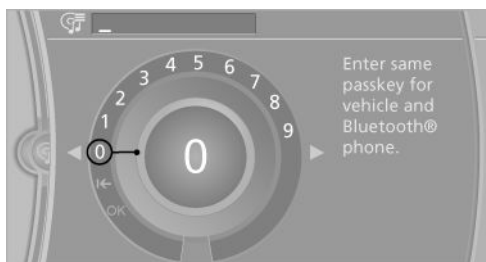

8. Select the desired functions with which the device is to be connected, for instance "Audio".
9. "OK"

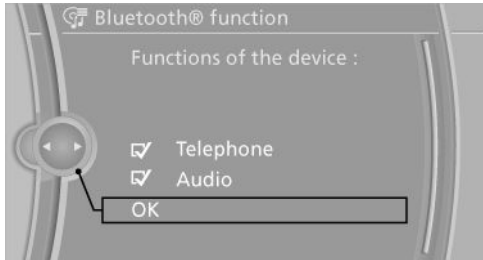

If pairing was successful, the device is displayed as connected.

White symbol  : the device is active as an audio source.

If pairing was unsuccessful: What to do if..., refer to page 186.

Connecting a specific device

A device that has already been paired can be connected as an active audio source.

Connecting is not possible when data is exchanged via a mobile phone connected via Bluetooth.

Requirements

If necessary, activate the audio connection of the desired device from the list of paired devices.

1. "CD/Multimedia"
2. "Bluetooth® (audio)"
3. If necessary, "Bluetooth® audio"
4. Select the desired device from the list of paired devices.
5. Open "Options".
6. "Configure phone"
7. Activate "Audio".
8. "OK"

Connecting the device

1. "CD/Multimedia"
2. "Bluetooth® (audio)"
3. If necessary, "Bluetooth® audio"
4. Select the desired device from the list of paired devices.



White symbol  : the device is active as an audio source.

Playback

General information

- ▶ The display of music track information depends on the device.
- ▶ Operation can take place on the device or iDrive.
- ▶ Playback is interrupted when data is exchanged via a mobile phone connected via Bluetooth.

Starting playback

1. Connect the device.
2. "CD/Multimedia"
3. "External devices"

4.  Select the symbol.

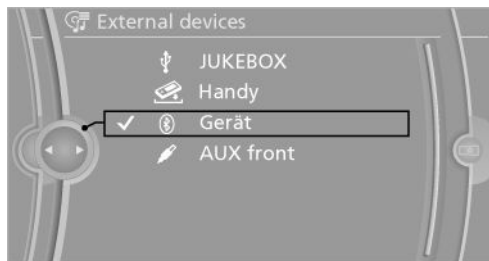

5. Select the desired track from the list, if necessary.

Playback menu

Depending on the particular device, some of the functions may not be available.

Symbol	Function
	Next track Fast forward: press and hold the symbol.
	Previous music track Reverse: press and hold the symbol.

Disconnecting the audio connection

1. "CD/Multimedia"
2. "Bluetooth® (audio)"
3. Highlight the desired device.
4. Open "Options".
5. "Configure phone"
6. "Audio"
7. "OK"

Unpairing a device

1. "CD/Multimedia"
2. "Bluetooth® (audio)"
3. If necessary, "Bluetooth® audio"
4. Highlight the device that is to be unpaired.

5. Open "Options".
6. "Remove phone from list"

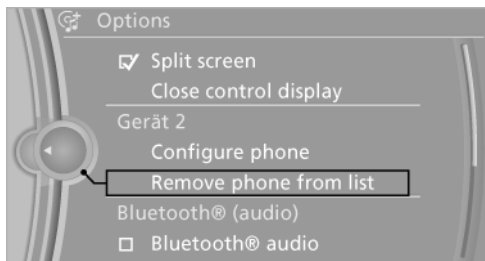

What to do if...

Information on suitable devices can be found at www.bmwusa.com/bluetooth.

Suitable mobile phones, refer to page 192.

The device is not supported by the vehicle.

- ▶ Perform a software update, refer to page 187, if needed.

The device could not be paired or connected.

- ▶ Do the Bluetooth passkeys on the device and the vehicle match? Enter the same passkey on the device and via iDrive.
- ▶ Did it take longer than 30 seconds to enter the passkey? Repeat the pairing procedure.
- ▶ Are too many Bluetooth devices connected to the device or vehicle? Delete connections with other devices if necessary.
- ▶ Is the mobile phone in power-save mode or does it have only a limited remaining battery life? Charge the mobile phone in the snap-in adapter or via a charging cable.
- ▶ Depending on the mobile phone, it is possible that only one device can be connected to the vehicle. Unpair the connected device from the vehicle and pair and connect only one device.
- ▶ The device no longer reacts? Switch the device off and on again.
- ▶ Repeat the pairing procedure.

Music cannot be played back.

- ▶ Start the program for playing back music data on the device and select a track on the device if necessary.
- ▶ Switch the radio on and off again.

Music files can only be played back softly.

- ▶ Adjust the volume settings on the device.

Playback is disturbed when buttons are pressed or by other messages on the device.

- ▶ Switch off the button tones and other signal tones on the device.

Playback is interrupted by a telephone call or traffic bulletin and is not resumed automatically.

- ▶ Switch the radio on and off again.

Playback is not possible if the mobile phone is connected via Bluetooth Audio while it is also connected via the USB interface or the snap-in adapter.

- ▶ Disconnect one of the two connections; for example, disconnect the audio connection, refer to page 186, and restart playback.

If all points in this list have been checked and the required function is still not available, please contact the hotline or service center.

Software Update

The vehicle supports various external devices depending on the current software version. With a software update, the vehicle can support new mobile phones or new external device, for example.

- ▶ USB.
Software updates and related current information is available at www.bmw.com/update.

Displaying the current version

The currently installed software is displayed.

1. "Settings"
2. "Software update"

3. "Show current version"

Select desired version to display additional information.

Updating software via USB

The software may only be updated when the vehicle is stationary.

1. Store the file for the software-update in the main director of a USB flash drive.
2. Insert the USB flash drive into the USB audio interface in the center armrest. An update via the USB interface in the glove compartment is not possible.
3. "Settings"
4. "Software update"
5. "Update software"

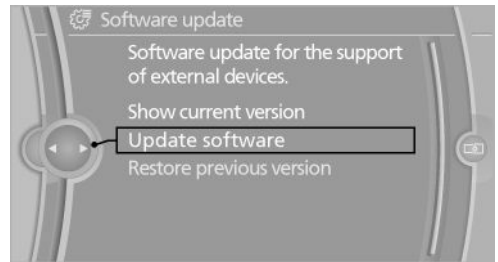

6. "Start update"
7. "OK"

All listed software updates are installed.

Restoring the previous version

The software version prior to the last software update can be restored.

The previous version can only be restored when the vehicle is stationary.

1. "Settings"
2. "Software update"
3. "Restore previous version"
4. "OK" Double-click.

All listed software updates are removed.

Note

While the software is being updated or a previous version is being restored, BMW Assist, Office functions, and the connected devices are temporarily unavailable. Wait several minutes for the functions to become available again.



Communications

All of the options available to you for mobile communication with family, friends, business partners, and service providers are described in this chapter.

Telephone

Vehicle equipment

This chapter describes all series equipment as well as country-specific and special equipment offered for this model series. Therefore, it also describes equipment that may not be found in your vehicle, for instance due to the selected special equipment or the country version. This also applies to safety-related functions and systems.

When using the features and systems described here, adhere to local regulations.

At a glance

The concept

Mobile phones or other external devices such as audio players can be connected to the vehicle via Bluetooth.

Bluetooth® is a registered trademark of Bluetooth® SIG, Inc.

After these devices are paired once, they are recognized automatically when the ignition is switched on as soon as they are in the vehicle and can then be operated via iDrive, the buttons on the steering wheel, and via voice activation.

Depending on their functionality, external devices can be used via the vehicle as a telephone or as an audio source. The telephone functions are described in the following. Operating the audio functions, refer to page 183.

Up to four external devices can be paired.

Certain functions may need to be enabled by the mobile phone provider or service provider.



Using the mobile phone while driving

Make entries only when traffic and road conditions allow. Do not hold the mobile phone in your hand while you are driving; use the hands-free system instead. If you do not ob-

serve this precaution, you can endanger the vehicle occupants and other road users. ◀

Snap-in adapter

The snap-in adapter is used to:

- ▶ Hold the mobile phone.
- ▶ Recharge the battery.
- ▶ Connect the mobile phone to an outside antenna of the vehicle.

This provides for better network reception and consistent sound quality.

Approved mobile phones

Details on which mobile phones and external devices with a Bluetooth interface are supported by the mobile phone preparation package can be obtained at www.bmwusa.com/bluetooth.

Displaying the vehicle identification number and software part number

The vehicle identification number and software part number are needed to determine which mobile phones are supported by the mobile phone preparation package. The software version of the mobile phone may also be required.

1. "Telephone"
2. Open "Options".
3. "Bluetooth® info"
4. "Display system information"

These approved mobile phones with a certain software version, support the vehicle functions described below.

Malfunctions may occur with other mobile phones or software versions.

Do not operate a mobile phone that is connected to the vehicle on the mobile phone keypad, as this may lead to a malfunction.

A software update, refer to page 187, can be performed if necessary.

Notes

At high temperatures, the charging function of the mobile phone may be limited and functions may not be executed.

When using the mobile phone via the vehicle, note the operating instructions of the mobile phone.

Pairing/unpairing the mobile phone

General information

The following functions are available:

- ▶ Use of a mobile phone as a telephone.
- ▶ Use of a mobile phone as an additional telephone.
- ▶ Use of a mobile phone as an audio source.
- ▶ Use of an audio device as an audio source, refer to page 183.

Requirements

- ▶ The mobile phone is suitable, refer to page 192.
- ▶ The mobile phone is ready for operation.
- ▶ Bluetooth is activated in the vehicle and on the mobile phone.
- ▶ Bluetooth presettings may need to be made on the mobile phone, e.g., for a connection without confirmation or visibility, refer to the mobile phone operating instructions.
- ▶ Deactivate Bluetooth audio if necessary.
- ▶ A number with at least four and a maximum of 16 digits was defined as the Bluetooth passkey. It is only required once for pairing.
- ▶ The ignition is switched on.

Activating/deactivating Bluetooth

Bluetooth is not permitted everywhere.

1. "Telephone"
2. Open "Options".
3. "Bluetooth®"

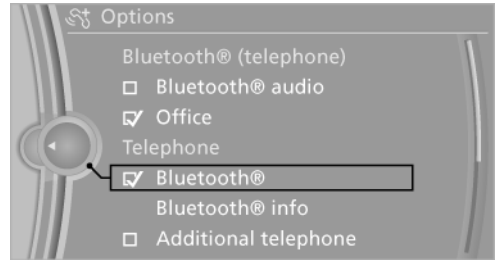

Additional functions

Activating/deactivating the additional functions

Activate the functions before pairing to be able to use them in the vehicle. Information on suitable mobile phones, refer to page 192, that support this function.

1. "Telephone"
2. "Bluetooth® (phone)"
3. Open "Options".
4. "Configure Bluetooth®"
5. Select the desired additional function.
 - ▶ "Additional telephone"
 - ▶ "Office"
 - ▶ "Bluetooth® audio"
6. "OK"

An additional function cannot be assigned to a telephone while it is deactivated.

Additional telephone

A mobile phone can be used as an additional telephone.

The additional telephone can be used to accept incoming calls, refer to page 196. While a call is active on the additional telephone, re-

ceived calls are displayed on the Control Display.

Audio source

A mobile phone can be used as an audio source.

Pairing and connecting a mobile phone



Pairing the mobile phone

To avoid becoming distracted and posing an unnecessary hazard both to your own vehicle's occupants and to other road users, only pair the mobile phone while the vehicle is stationary. ◀

1. "Telephone"
2. "Bluetooth® (phone)"
3. "Add new phone"

The Bluetooth name of the vehicle is displayed.

4. To perform additional steps on the mobile phone, refer to the mobile phone operating instructions: for instance, search for or connect the Bluetooth device or a new device.

The Bluetooth name of the vehicle appears on the mobile phone display.

5. Select the Bluetooth name of the vehicle on the mobile phone display.
6. You are prompted by the iDrive or mobile phone to enter the same Bluetooth passkey. Enter the passkey and confirm.

or

Compare the control number on the vehicle display with the control number on the mobile phone display. Confirm the control number on the mobile phone and in the vehicle.

"OK"

7. Select the functions for which the mobile phone is to be used.
8. "OK"

If the pairing was successful, the mobile phone appears at the top of the list of mobile phones.

The functions supported by the mobile phone and audio device are displayed as symbols when paired.

White symbol: the function is active.

Gray symbol: the function is inactive.

Symbol	Function
	Telephone.
	Additional telephone.
	Audio source.

Four mobile phones can be paired with the vehicle at once. Three mobile phones can be connected with the vehicle at once.

If pairing was unsuccessful: What to do if..., refer to page 195.

Following the initial pairing

- ▷ The mobile phone is detected/connected in the vehicle within a short period of time when the engine is running or the ignition is switched on.
- ▷ The phone book entries of the telephone stored on the SIM card or mobile phone are transmitted to the vehicle after detection, depending on the mobile phone.
- ▷ Four mobile phones can be paired.
- ▷ Specific settings may be necessary in some mobile phones, e.g., authorization or a secure connection; refer to the mobile phone operating instructions.

Connecting a particular mobile phone

1. "Telephone"
2. "Bluetooth® (phone)"
3. Select the mobile phone that is to be connected.

The functions assigned to the mobile phone before unpairing are assigned to the mobile

phone when it is reconnected. These functions are deactivated in a mobile phone that is already connected.

Configuring the mobile phone

Additional functions can be activated or deactivated for paired and connected mobile phones.

1. "Telephone"
2. "Bluetooth® (phone)"
3. Highlight the mobile phone to be configured.
4. Open "Options".
5. "Configure phone"
6. At least one function must be selected.
 - ▷ "Telephone"
 - ▷ "Additional telephone"
 - ▷ "Audio"
7. "OK"

If a function has already been assigned to another connected mobile phone, the function is deactivated in that mobile phone and the mobile phone is unpaired when the function is assigned to a new mobile phone.

Swapping the telephone and additional telephone

The function of the telephone and additional telephone can be swapped automatically.

1. "Telephone"
2. "Bluetooth® (phone)"
3. "Swap phone/addit. phone"

Unpairing the mobile phone

1. "Telephone"
2. "Bluetooth® (phone)"
3. Highlight the mobile phone that is to be unpaired.

4. Open "Options".
5. "Remove phone from list"

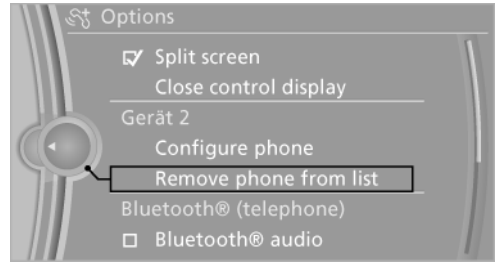

What to do if...

Information on suitable mobile phones, refer to page 192.

The mobile phone could not be paired or connected.

- ▷ Is Bluetooth activated in the vehicle and on the mobile phone? Activate Bluetooth in the vehicle and on the mobile phone.
- ▷ Do the Bluetooth passkeys on the mobile phone and the vehicle match? Enter the same passkey on the mobile phone and via iDrive.
- ▷ Did it take longer than 30 seconds to enter the passkey? Repeat the pairing procedure.
- ▷ Are too many Bluetooth devices connected to the mobile phone or vehicle? Delete connections with other devices if necessary.
- ▷ Is the audio connection activated? Deactivate the audio connection.
- ▷ Is the mobile phone in power-save mode or does it have only a limited remaining battery life? Charge the mobile phone in the snap-in adapter or via the charging cable.
- ▷ Depending on the mobile phone, it is possible that only one mobile phone can be connected to the vehicle. Unpair the connected mobile phone from the vehicle and pair and connect only one mobile phone.

The mobile phone no longer reacts.

- ▷ Switch the mobile phone off and on again.
- ▷ Is the ambient temperature too high or low? Do not expose the mobile phone to extreme environmental conditions.

The telephone functions are not available.

- ▷ Is the mobile phone paired as an additional telephone and is the additional telephone function deactivated? Activate the function.
- ▷ Is an outgoing call not possible? Connect the mobile phone as a telephone.

No phone book entries or only some phone book entries are displayed, or they are incomplete.

- ▷ Transmission of the phone book entries is not yet complete.
- ▷ It is possible that only the phone book entries of the mobile phone or the SIM card are transmitted.
- ▷ It may not be possible to display phone book entries with special characters.
- ▷ The number of phone book entries to be stored is too high.
- ▷ Is the data volume of the contact too large, e. g., due to stored information such as notes? Reduce the data volume of the contact.
- ▷ Is the mobile phone connected as an audio source or additional telephone? The mobile phone must be connected as a telephone.

The phone connection quality is poor.

- ▷ The strength of the Bluetooth signal on the mobile phone can be adjusted, depending on the mobile phone.
- ▷ Insert the mobile phone into the snap-in adapter or place it in the area of the center console.
- ▷ Adjust the volume of the microphone and loudspeakers separately.

If all points in this list have been checked and the required function is still not available, contact Customer Relations or the service center.

Controls

Adjusting the volume

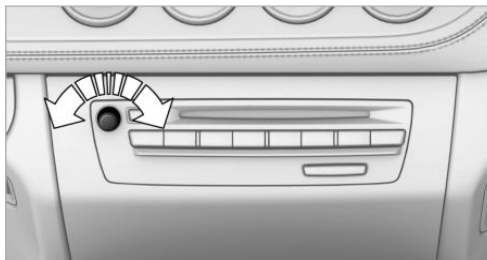

Turn the knob until the desired volume is selected. The setting is stored for the remote control currently in use.

The vehicle automatically adjusts the volume of the microphone on the telephone and the volume of the called party. Depending on the mobile phone, the volumes may need to be adjusted. The settings can only be created during a call and must be adjusted separately for each telephone. The settings are deleted when the telephone is unpaired.

1. "Settings"
2. "Tone"
3. "Volume settings"
4. Select the desired setting: "Microphone" or "Loudspeak."
5. To adjust: turn the controller.
6. To store: press the controller.

Incoming call

Receiving calls

If the number of the caller is stored in the phone book and is transmitted by the network,

the name of the contact is displayed. Otherwise, only the phone number is displayed.

If more than one phone number is assigned to a contact, only the name of the contact is displayed.

For calls on the additional telephone, the number is only displayed if it is transmitted by the network.

An incoming call to one of the telephones is automatically rejected if there is an active call on the other telephone.

Accepting a call



Press the button on the steering wheel.

or

"Accept"

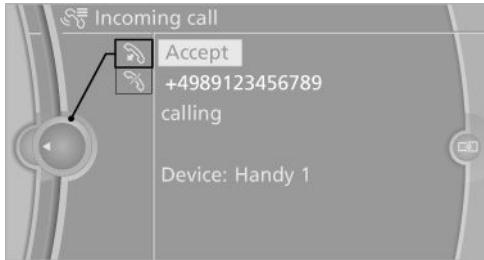

Rejecting a call

"Reject"

Ending a call



Press the button on the steering wheel.

or

1. "Telephone"

2. "End call"

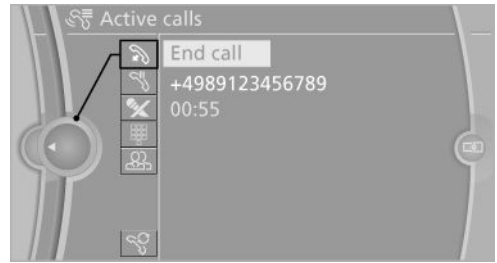

Entering a phone number

Dialing a number

1. "Telephone"
2. "Dial number"
3. Select the digits individually.
4. Select the symbol.



The phone number can also be entered by voice.

Calls with multiple parties

General information

You can switch between calls or connect two calls to a single conference call. These functions must be supported by the mobile phone and service provider.

Accepting a call while speaking to another party

This function might have to be activated by the service provider and the mobile phone must be adjusted accordingly.

If a second call comes in during an ongoing call, a call waiting signal is sounded.

 "Accept"

The call is accepted and the existing call is put on hold.

Establishing a second call

Establish an additional call during an active call.

1. "Telephone"
2. "Active calls"
3.  "Hold"

The existing call is put on hold.

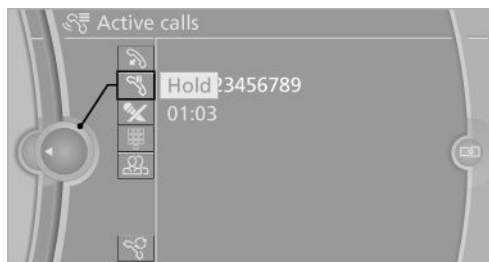

4. Dial the new phone number or select it from a list.

 "Return"

The call on hold is resumed.

Switching between two calls, hold call

The active call is displayed in color.

The call on hold is displayed in gray.

 "Swap calls"

The call on hold is resumed.

Establishing a conference call

Two calls can be connected to a single telephone conference call.

1. Establish two calls.
2.  "Conference call"

When terminating a conference call, both calls are ended. If one call is terminated by another party, the other call can be continued.

Switching the microphone to mute

When a call is active, the microphone can be muted.

1. "Telephone"
2. "Active calls"
3.  "Microphone mute"

A microphone that has been switched to mute is automatically reactivated:

- ▷ When a new connection is established.
- ▷ When switching between call parties.

DTMF suffix dialing

DTMF suffix dialing can be used for gaining access to network services or for controlling devices, e.g., to make a remote inquiry of an answering machine. The DTMF code is needed for this purpose.

1. "Telephone"
2. Select the contact from a list or "Dial number".
3.  "Keypad dialing"
4. Enter the DTMF code via iDrive.

Phone book

Displays



The phone book accesses the contacts and shows all contacts for which a phone number has been stored. The entries can be selected to make a call.

1. "Telephone"
2. "Phone book"

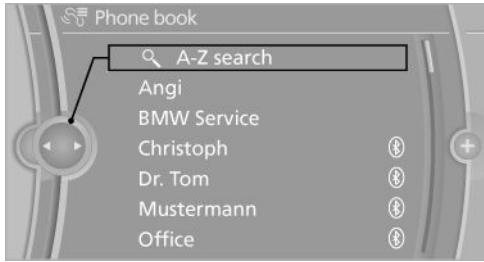
A symbol indicates the storage location of the contacts.



Calling a contact

Symbol	Meaning
	Contact with one stored phone number.
	Contact with more than one stored phone number.
	Call not possible; mobile phone without reception or network, or Service Request is active.

For contacts with one stored phone number: select the required contact. The connection is being established.

For contacts with more than one stored phone number: select the required contact and the phone number. The connection is being established.

Editing a contact

Changing the entries in "Contacts". When a contact is changed, the changes are not stored on the mobile phone. A copy of the entry is stored in the vehicle.

1. Highlight the contact.
2. Open "Options".
3. "Edit entry"

The contact can be edited.

Redialing

General information

The list of dialed numbers in the mobile phone is transmitted to the vehicle depending on the mobile phone. Possibly only those numbers are displayed that were dialed from the vehicle.

The 20 phone numbers dialed last are displayed. The sorting order of the phone numbers depends on the particular mobile phone.

Dialing a number via the instrument cluster

This is possible if a call is not currently active.

1.  Press the button on the steering wheel.
2. Select the desired phone number.
The connection is established.

Dialing the number via the iDrive

1. "Telephone"
2. "Redial"

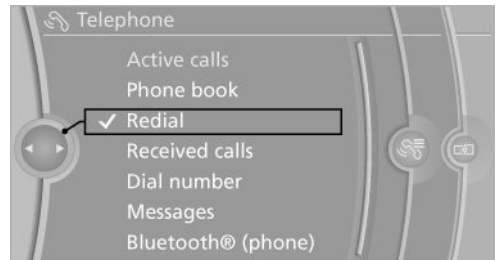

3. Select the desired entry and the phone number if necessary.
The connection is established.

Deleting a single entry or all entries

The deletion of entries depends on your particular mobile phone.

1. Highlight the entry.
2. Open "Options".
3. "Delete entry" or "Delete list"

Saving an entry in the contacts

1. Highlight the entry.
2. Open "Options".
3. "Store as new contact" or "Add to existing contact"
4. Select the contact if necessary.
5. Select the type of number: "Home", "Business", "Mobile" or "Other"
6. Complete the entries if necessary.
7. "Store contact"

Received calls

Displaying calls

The 20 calls that were last received are displayed.

1. "Telephone"
2. "Received calls"

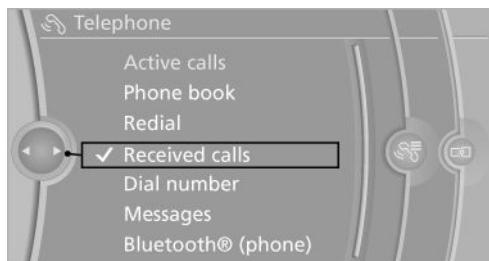

Calling a number from the list

Selecting an entry.

The connection is established.

Deleting a single entry or all entries

The deletion of entries depends on your particular mobile phone.

1. Highlight the entry.
2. Open "Options".
3. "Delete entry" or "Delete list"

Saving an entry in the contacts

1. Highlight the entry.
2. Open "Options".
3. "Store as new contact" or "Add to existing contact"
4. Select the contact if necessary.
5. Select the type of number: "Home", "Business", "Mobile" or "Other"
6. Complete the entries if necessary.
7. "Store contact"

Hands-free system

General information

Calls that are being made on the hands-free system can be continued on the mobile phone and vice versa.

From the mobile phone to the hands-free system

Calls that were begun outside of the Bluetooth range of the vehicle can be continued on the hands-free system with the ignition switched on.

Depending on the mobile phone, the system automatically switches to the hands-free system.

If the system does not switch over automatically, follow the instructions on the mobile phone display; refer also to the mobile phone operating instructions.

From the hands-free system to the mobile phone

Calls that are made on the hands-free system can in some cases be continued on the mobile phone; this depends on the mobile phone.

Follow the instructions on the mobile phone display; refer also to the mobile phone operating instructions.

Snap-in adapter

General information

More information on compatible snap-in adapters that support the functions of the mobile phone is available at the service center.

Notes

At high temperatures, the charging function of the mobile phone may be limited and functions may not be executed.

When using the mobile phone via the vehicle, note the operating instructions of the mobile phone.

Installation position

In the center armrest.

Inserting/removing the snap-in adapter

1. Press button 1 and remove the cover.

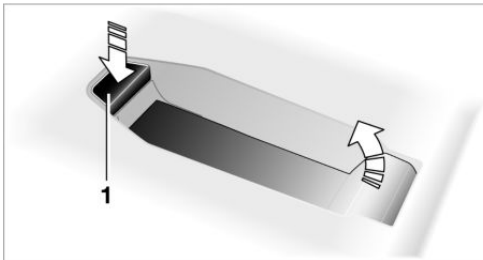

2. Insert the snap-in adapter at the front, arrow 1, and press down, arrow 2, until it engages.

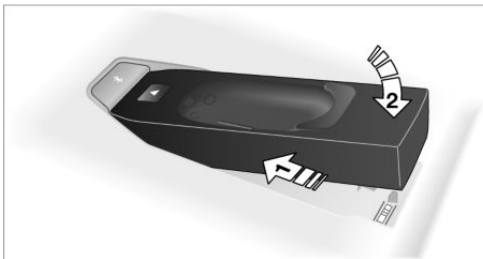

3. To remove the snap-in adapter: press button 1.

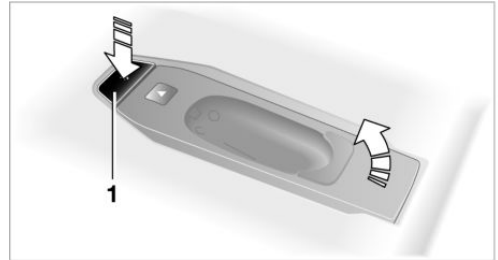

Inserting the mobile phone

1. Depending on the mobile phone, remove the protective cap from the antenna connector and from the USB connection of the mobile phone.
2. With the buttons facing up, slide the mobile phone up toward the electrical contacts and press it down until it engages.

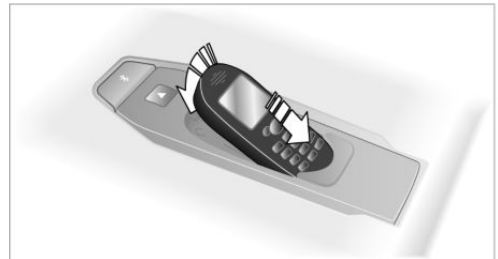

The battery is charged beginning with the radio ready state of the vehicle.

Removing the mobile phone

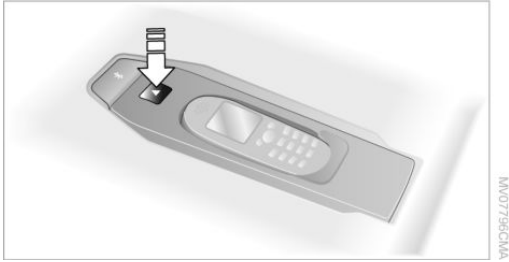

NN0798CMA

Press the button and remove the mobile phone.

Office

Vehicle equipment

This chapter describes all series equipment as well as country-specific and special equipment offered for this model series. Therefore, it also describes equipment that may not be found in your vehicle, for instance due to the selected special equipment or the country version. This also applies to safety-related functions and systems.

When using the features and systems described here, adhere to local regulations.

At a glance

General information

Contacts, appointments, tasks, notes, text messages, and e-mails from the mobile phone can be displayed on the Control Display if the mobile phone provides compatible support of these functions and the necessary Bluetooth standards.

Information about which mobile phones support the Office functions can be found at www.bmwusa.com/bluetooth. A limited number of compatible mobile phones is available for Office.

Contents are only displayed in full length when the vehicle is stationary.

The mobile phone has read-access only.



Do not use Office while driving

To avoid becoming distracted and posing an unnecessary hazard to your vehicle's occupants and to other road users, never attempt to use the controls or enter information unless traffic and road conditions allow this. ◀

Requirements

- ▶ A suitable mobile phone is paired with the vehicle and connected. In some mobile

phones, data access must be confirmed on the mobile phone.

- ▶ The time, time zone, and date, refer to page 76, are correctly set on the Control Display and on the mobile phone, for instance to correctly display appointments.
- ▶ Office is activated, refer to page 193.

Updating

Data are updated every time the mobile phone is connected to the vehicle. Appointment entries, tasks, notes and reminders can be updated separately.

1. "Office"
2. "Current office", "Calendar", "Tasks", "Notes" or "Reminders"
3. Open "Options".
4. "Update data"

Mobile phone data are transmitted again to the vehicle.

Office information

The number of unread messages and active tasks as well as the upcoming appointments are displayed.

1. "Office"
2. "Current office"
3. Select the desired entry to display details.

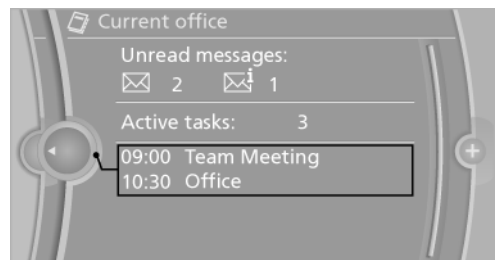

Contacts

Note

Equipment version with the mobile phone preparation package.

At a glance

Contacts can be created and edited. The contacts from the mobile phone are displayed as well if this function is supported by the mobile phone. The addresses can be adopted as destinations for navigation and the phone numbers can be dialed.

Displaying contacts

General information

1. "Office"
2. "Contacts"

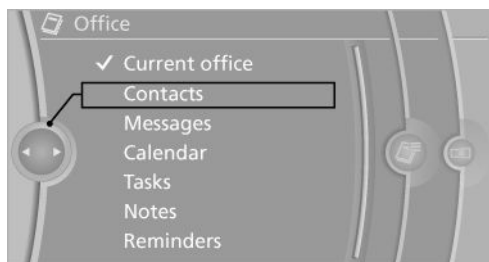

All contacts are listed in alphabetical order. Depending on the number of contacts, an A-Z search is offered, refer to page 23.

A symbol indicates the storage location of the contacts.

Symbol	Storage location
No symbol	In the vehicle; the address has not been checked as a destination.
	In the vehicle; the address has been checked as a destination.
	Mobile phone.

Dialing phone numbers

1. Select the desired contact.
2. Select the phone number.
The connection is established.

Editing a contact

1. Select the desired contact.
2. "Edit contact"

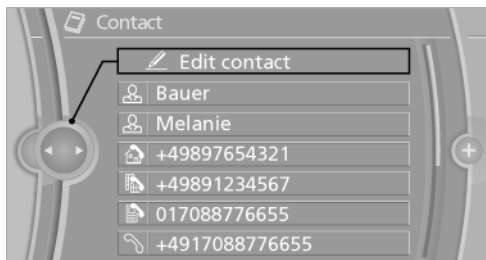

3. Change the entries.
4. "Store contact in vehicle"

When a contact is edited, the changes are not stored on the mobile phone. A copy of the entry is stored in the vehicle.

Selecting the contact as a navigation destination

1. Select the desired contact.
2. Select the address.

When contacts from the mobile phone are used, the address may need to be matched to the navigation data contained in the vehicle. In this case:

Correct the address.

3. "Start guidance" or "Add as another destination"

Checking the address as a destination

An address that is to be used for destination guidance must match the navigation data con-

tained in the vehicle. The address can be checked for this purpose.

1. Select the desired contact and highlight the address.
2. Open "Options".
3. "Check as destination"
4. Correct and store the address if necessary.

If the address is corrected and stored, a copy of it is stored in the vehicle. The address is not changed on the mobile phone.

New contact

General information

A contact can have up to 8 phone numbers, 2 addresses, 3 e-mail addresses and one Internet address.

1. "Office"
2. "Contacts"
3. Open "Options".
4. "New contact"

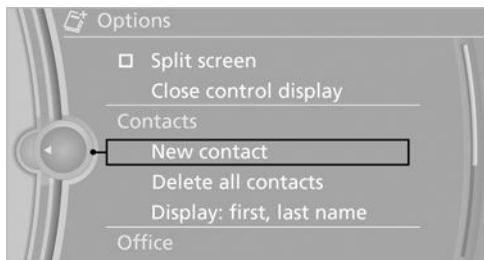







5. The entry fields are still filled with the previous entries: "Delete input fields"
6. Fill in the entry fields: select the symbol next to the entry field.
7. Enter the text and assign the contact type.
8. If the vehicle is equipped with a navigation system: enter the address. Only addresses contained in the navigation data in the vehicle can be entered. This ensures that destination guidance is possible for all addresses.

If necessary, "Accept address".

9. "Store contact in vehicle"

Contact types

Various contact types can be assigned to phone numbers and addresses.

Symbol	Meaning
	Home phone number.
	Business phone number.
	Mobile phone number.
	Other phone number.
	Home address.
	Business address.

Specifying the home address

A home address can be stored. It appears at the top of the contact list.

1. "Office"
2. "Contacts"
3. "Home"
4. Create a contact.
5. "Store contact in vehicle"

Selecting the sorting order of the names

Names can be displayed in a different order.

1. "Office"
2. "Contacts"
3. Open "Options".
4. "Display: last, first name" or "Display: first, last name"

Depending on how the contacts were stored on the mobile phone, the sorting order of the names may differ from the selected sorting order.

Show contact pictures

Pictures stored with the contacts are stored in the vehicle when the mobile phone is connected to the vehicle. The number of transmitted pictures depends on the mobile phone. The mobile phone must support this function.

1. "Office"
2. "Contacts"
3. Open "Options".
4. "Configure Bluetooth@"
5. "Show images"

Display of all contact pictures is activated or deactivated.

Deleting contacts

Only contacts that are stored in the vehicle are deleted. The contacts on the mobile phone cannot be deleted.

1. "Office"
2. "Contacts"
3. Highlight the contact.
4. Open "Options".
5. "Delete contact" or "Delete all contacts"
6. If necessary. "Yes"

Messages

General information

Whether or not text messages and e-mails from the mobile phone are displayed depends on whether transmission from the mobile phone to the vehicle is supported. Text messages and e-mails may not be supported by the service provider, or the function may need to be enabled separately. After the mobile phone is first paired, transmission may take several minutes. Messages are only displayed in full length when the vehicle is stationary. Messages from the additional telephone are not transmitted.

Displaying messages

1. "Office"
2. "Messages"

A symbol identifies the type of message.

Symbol	Message type
✉	Text messages.
✉	My Info
✉	Message from the Concierge service.
✉@	E-mail from mobile phone.

Filtering the message list

The message list can be filtered if more than one type of message exists.

1. "Filter:"

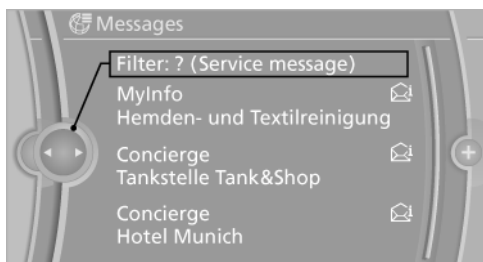

2. Select the type of message.
 - ▷ "All"
 - All messages are displayed.
 - ▷ "E-mail"
 - Only e-mails from the mobile phone are displayed.
 - ▷ "Service message"
 - Only messages from the BMW Assist Concierge service and My Info are displayed.
 - ▷ "Text message"
 - Only text messages from the mobile phone are displayed.

Deleting messages

Messages from the Concierge service and My Info can be deleted.

Delete a message:

1. "Office"
2. "Messages"
3. Select the desired message.
4. Open "Options".
5. "Delete message"

Delete all messages:

1. "Office"
2. "Messages"
3. Open "Options".
4. "Delete all messages" or "Delete service messages"

Text messages

Calling the sender of a text message

1. Select the desired message.
2.  Select the symbol.

Saving the sender in the contacts

1. Highlight the desired message.
2. Open "Options".
3. "Store as new contact" or "Add to existing contact"

Using contact data

Contact data from appointments, tasks, text messages, e-mails, and notes can be saved or selected, refer to page [210](#).



Reading the text message out loud

Read the text message out loud, refer to page [210](#).

My Info

Selecting additional functions

Additional functions are available when a message is selected.

Sym- bol	Function
	"Start guidance" or "Add as another destination"
	"Call" If the message contains a number, the connection is established.
	"Select phone number" If the message contains more than one number, select the desired number from the list. The connection is established.



Message from the Concierge service



Storing an address

1. Select the desired message.
2. Open "Options".
3. "Store contact in vehicle"

Selecting additional functions

Additional functions are available when a message is selected:

Sym- bol	Function
	"Start guidance" or "Add as another destination"
	"Call" If the message contains a number, the connection is established.

Sym- bol	Function
	"Select phone number" If the message contains more than one number, select the desired number from the list. The connection is established.
	"Further information" Display additional information.

E-mail

Displaying e-mails

1. "Office"
2. "Messages"
3. Select the desired e-mail.

Displaying e-mail contacts

If the sender and recipient of an e-mail are transmitted by the mobile phone, this information is displayed in the e-mail.

 "Sender/Recipient"

If the e-mail addresses are stored in the contacts, the contact is displayed. Select the contact to display details.

If the e-mail addresses are not stored in the contacts, only the e-mail address is displayed.

Using contact data

Contact data from appointments, tasks, text messages, e-mails, and notes can be saved or selected, refer to page 210.

Deactivating the full display

When an e-mail is opened in the vehicle, the e-mail is fully transmitted to the vehicle. This may result in charges.

1. "Office"
2. "Messages"

3. Open "Options".
4. "Fully download e-mails"

Only a part of the e-mail from the mobile phone is loaded into the vehicle.

Reading the e-mail out loud

Read the e-mail out loud, refer to page 210.

Calendar

Display the calendar

Appointments during the last 20 days and the next 50 days can be displayed.

1. "Office"
2. "Calendar"

The appointments on the current day are displayed.

Selecting the calendar day

1. Select the date.



2. Select the desired day or date.
 - ▷ "Next day"
 - ▷ "Date:"
 - ▷ "Previous day"
 - ▷ "Today"

Display the appointment

1. Select the desired appointment.
2. Scroll through the appointment if necessary:
 - ▷ Turn the controller.

- ▷  Select the symbol.

Using contact data

Contact data from appointments, tasks, text messages, e-mails, and notes can be saved or selected, refer to page 210.

Reading the appointment out loud

Read the appointment out loud, refer to page 210.

Tasks

Displaying the task list

Display tasks that are due within the next 90 days.

1. "Office"
2. "Tasks"

Sorting the task list

1. Select the header in the task list.

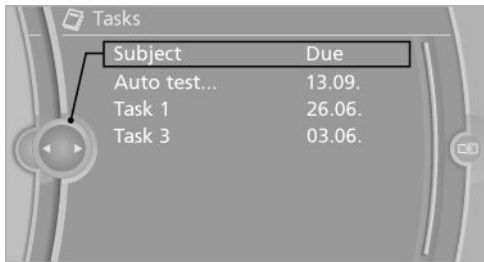

2. Select the sorting criterion:
 - ▷ "Priority (!)"
 - ▷ "Subject"
 - ▷ "Due date"

Displaying the task

1. Select the desired task.
2. Scroll in the task if necessary:
 - ▷ Turn the controller.
 - ▷  Select the symbol.

Using contact data

Contact data from appointments, tasks, text messages, e-mails, and notes can be saved or selected, refer to page 210.

Reading the task out loud

Read the task out loud, refer to page 210.

Notes

Displaying notes

1. "Office"
2. "Notes"
 - All notes are displayed.

Displaying the note

1. Select the desired note.

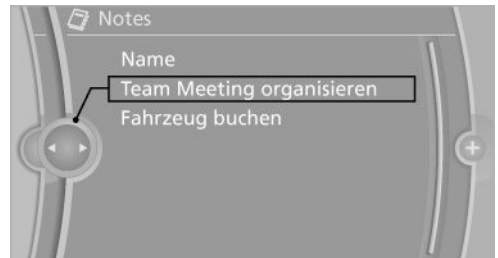

2. Scroll in the note if necessary:
 - ▷ Turn the controller.
 - ▷  Select the symbol.

Using contact data

Contact data from appointments, tasks, text messages, e-mails, and notes can be saved or selected, refer to page 210.

Reading the note out loud

Read the note out loud, refer to page 210.

Reminders

Displaying reminders

Reminders of pending appointments and tasks are displayed. After an appointment or after a task is due, the reminder is no longer displayed.

1. "Office"
2. "Reminders"
3. Select the desired reminder.

The corresponding appointment or the task are displayed.

Using contact data

At a glance

Contact data from appointments, tasks, text messages, emails, and notes can be stored or selected.

Displaying contact or selecting phone number

1.  "Use contact data"
2. Display the contact or select the phone number:
 - ▷ Select the contact to display contact details.
 - ▷ Select the phone number to establish a connection directly.

Storing contact data





1.  "Use contact data"
2. Highlight the phone number or e-mail address.
3. Open "Options".
4. "Add to existing contact" or "Store as new contact"

Reading out loud

Text messages, e-mails, appointment entries, tasks, and notes can be read out loud.

1. Select the desired message, appointment, task, or note.
2. ▷ Select the symbol.

The following options are available during reading:

- ▷  "Pause"
Interrupt reading. Select again to restart reading.
- ▷  "Back to beginning"
Start reading the message again from the beginning.
- ▷  Select the symbol.
Go back one paragraph.
- ▷  Select the symbol.
Skip a paragraph.
- ▷ To end reading, turn the controller to the left.

What to do if...

Information on suitable mobile phones, refer to page [192](#).

Appointments, tasks, notes, text messages, or e-mails from the mobile phone are not displayed.

- ▷ The mobile phone is not capable of the missing function or is not connected correctly.
- ▷ The Office function is deactivated.
- ▷ The mobile phone is connected as an additional phone.
- ▷ Appointments are older than 20 days or are more than 50 days in the future.
- ▷ The tasks have been marked as completed or have a due date that lies more than 90 days in the future.

- ▷ Depending on the number of stored appointments, task notes, and messages in the mobile phone, not all are displayed in the vehicle.

Not all appointments and tasks from the mobile phone are displayed at the right time?

- ▷ The time zone, time, or date is incorrectly set on the Control Display and mobile phone.

The e-mail attachment is not displayed.

- ▷ E-mails are transmitted without an attachment.

Entries are not displayed in full length.

- ▷ Text were already transmitted from the mobile phone in a shortened form.
- ▷ Synchronization between the mobile phone and vehicle may take several minutes.

The contact pictures are not being displayed?

- ▷ Up to 200 contact pictures can be stored in the vehicle.

The E-mail is displayed with a delay?

- ▷ Check the e-mail settings on the telephone and adjust if necessary.

If all points in this list have been checked and the required function is still not available, please contact the hotline or service center.

Contacts

Vehicle equipment

This chapter describes all series equipment as well as country-specific and special equipment offered for this model series. Therefore, it also describes equipment that may not be found in your vehicle, for instance due to the selected special equipment or the country version. This also applies to safety-related functions and systems.

When using the features and systems described here, adhere to local regulations.

Note

Equipment version without the mobile phone preparation package.

General information

Contacts can be created and edited. The contacts from the mobile phone are displayed as well if this function is supported by the mobile phone. The addresses can be adopted as destinations for navigation and the phone numbers can be dialed.

New contact

1. "Contacts"
2. "New contact"



3. The entry fields are still filled with the previous entries: "Delete input fields"
4. Fill in the entry fields: select the symbol next to the entry field.



5. Enter, refer to page 23, the text.

In vehicles equipped with a navigation system: it is only possible to enter addresses that are contained in the vehicle navigation data. This ensures that destination guidance is possible for all addresses.

6. If necessary, "Store"
7. "Store contact in vehicle"

Specifying the home address

A home address can be stored. It appears at the top of the contact list.

1. "Home"
2. Create a contact.
3. "Store contact in vehicle"

My contacts

General information

List of all contacts stored in the vehicle.

Displaying contacts

1. "Contacts"

2. "My contacts"

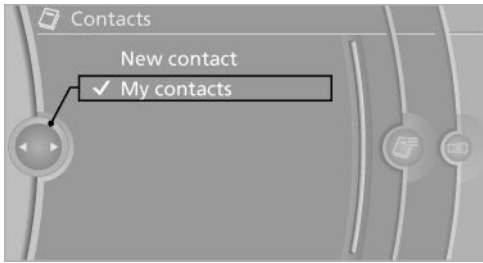

All contacts are listed in alphabetical order. Depending on the number of contacts, an A-Z search is offered, refer to page 23.

A symbol indicates the storage location of the contacts:

Symbol	Storage location
No symbol	In the vehicle; the address has not been checked as a destination.
	In the vehicle; the address has been checked as a destination.
	Mobile phone.

Dialing a phone number

1. Select the desired contact.
2. Select the phone number.
The connection is established.

Editing a contact

1. Select the desired contact.
2. "Edit contact"



3. Change the entries.

4. Move the controller to the left.
5. "Yes"

If a contact from the mobile phone is edited, the changes are not stored on the mobile phone. A copy of the entry is stored in the vehicle, and only this copy is displayed. Under certain circumstances, a contact entry with the same name is created.

Selecting the contact as a navigation destination

1. Select the desired contact.
2. Select the address.

When contacts from the mobile phone are used, the address may need to be matched to the navigation data contained in the vehicle. In this case:

Correct the address.

3. "Start guidance" or "Add as another destination"

Checking the address as a destination

An address that is to be used for destination guidance must match the navigation data contained in the vehicle. The address can be checked for this purpose.

1. Select the desired contact and highlight the address.
2. Open "Options".
3. "Check as destination"
4. Correct and store the address if necessary.

If the address is corrected and stored, a copy of it is stored in the vehicle. The address is not changed on the mobile phone.

Selecting the sorting order of the names

Names can be displayed in a different order.

1. "My contacts"
2. Open "Options".

3. "Display: last, first name" or "Display: first, last name"

Depending on how the contacts were stored on the mobile phone, the sorting order of the names may differ from the selected sorting order.

Deleting contacts

Only contacts that are stored in the vehicle are deleted. The contacts on the mobile phone cannot be deleted.

1. "My contacts"
2. Highlight the contact.
3. Open "Options".
4. "Delete contact" or "Delete all contacts"

ConnectedDrive

Vehicle equipment

This chapter describes all series equipment as well as country-specific and special equipment offered for this model series. Therefore, it also describes equipment that may not be found in your vehicle, for instance due to the selected special equipment or the country version. This also applies to safety-related functions and systems.

When using the features and systems described here, adhere to local regulations.

TeleService

General information

TeleService supports communication with your service center.

- ▶ Data on the vehicle's service requirements can be sent directly to the service center. In this way, the service center can plan its work in advance. This shortens the duration of the service appointment.
- ▶ In the event of a breakdown, data on the vehicle's condition can be sent directly to Roadside Assistance.
- ▶ The service varies by country.
- ▶ Connection costs may ensue.
- ▶ Services may be restricted abroad.

Requirements

Different variants of TeleService may be implemented in the vehicle. The following conditions must always be met:

- ▶ Wireless reception is available.
- ▶ The ignition is switched on.
- ▶ A current ConnectedDrive subscription or a vehicle equipped with intelligent Emergency Request.

Concierge service

General information

The Concierge service offers information on events, gas stations, and hotels, and provides phone numbers and addresses. Hotels can be booked directly using the Concierge service. The Concierge service is part of the optional Convenience Plan.

Starting the Concierge service

1. "BMW Assist" or "ConnectedDrive"
2. "Concierge"



3. "Start service"

A voice connection is established with the Concierge service. Phone numbers and addresses can be transmitted to the vehicle.

Messages

Information on messages, refer to page [206](#).

Roadside Assistance

At a glance

BMW Roadside Assistance can be contacted if assistance is needed in the event of a breakdown.

Roadside Assistance can also be contacted via a Check Control message, refer to page [82](#).

Starting Roadside Assistance without TeleService

1. "BMW Assist" or "ConnectedDrive"
2. "Roadside Assistance"

The Roadside Assistance number is displayed. If the mobile phone is paired, a connection is established to Roadside Assistance.



Starting Roadside Assistance with TeleService

General information

In vehicles equipped with TeleService, support is first offered by TeleService Diagnosis and then, if necessary, by TeleService Help.

1. "BMW Assist" or "ConnectedDrive"
2. "Roadside Assistance"
3. "Start service"

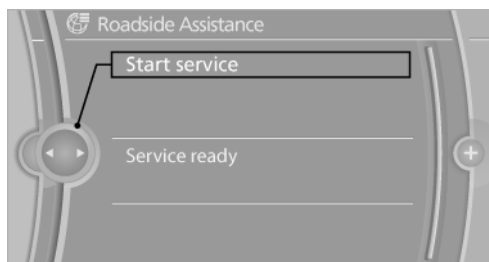

TeleService Diagnosis

TeleService Diagnosis enables the wireless transmission of detailed vehicle data that are important for vehicle diagnosis. These data are transmitted automatically.

After the data are transmitted, the voice connection to Roadside Assistance is re-established.

BMW Online

At a glance

A business search can be opened via BMW Online.

License conditions

This product contains NetFront Browser software of ACCESS Co., Ltd. Copyright © 2007 ACCESS Co., Ltd. All rights reserved.

NetFront is a trademark or registered trademark of ACCESS CO., LTD., in Japan and other countries.

This software is based in part on the work of the Independent JPEG Group.

Requirements

- ▷ Subscription to the optional Convenience Plan.
- ▷ The date setting, refer to page 77, on the Control Display is current.
- ▷ The vehicle is located within wireless network coverage.

Starting BMW Online

1. "BMW Assist" or "ConnectedDrive"
2. "BMW Online"



3. If necessary, "OK"

The BMW Online home page is displayed.

Operating BMW Online

To start a search:

- ▷ Turn the controller to highlight an element.
- ▷ Press the controller to display an element.

Opening the start page

1. Open "Options".
2. "Display start page"

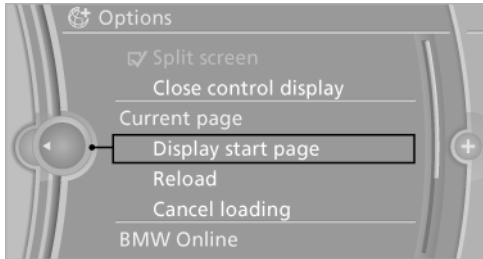

Loading a new page

1. Open "Options".
2. "Reload"

Cancel

1. Open "Options".
2. "Cancel loading"

Customer Relations

At a glance

Contact Customer Relations for information on all aspects of your vehicle.

Calling Customer Relations

Vehicle not equipped with TeleService

1. "BMW Assist" or "ConnectedDrive"
2. "Customer Relations"

The Customer Relations phone number is displayed. If the mobile phone is paired, a connection is established to Customer Relations.

Vehicle equipped with TeleService

1. "BMW Assist" or "ConnectedDrive"
2. "Customer Relations"
3. "Start service"

Service Request

At a glance

Sends information to your service partner to request the arrangement of a service appointment. The TeleService data is transmitted during a Service Request. If possible, your service partner will establish contact with you.

Starting a Service Request

1. "BMW Assist" or "ConnectedDrive"
2. "Service Request"
3. "Start service"



A Service Request can be started via a Check Control message, refer to page 82.

Automatic Service Request

The TeleService data necessary for servicing the vehicle are automatically sent to your service partner prior to the service deadline. If possible, the service partner will contact you and a service appointment can be arranged.

To check when your service partner was notified:

1. "Vehicle Info"
2. "Vehicle status"

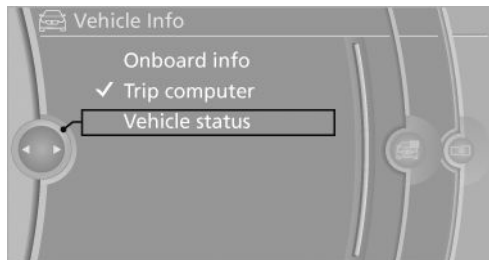

3. Open "Options".
4. "Last Service Request"

TeleService Report

Transmits technical data when needed from your vehicle to BMW at regular intervals; these are evaluated for the continued development of BMW products.

TeleService Report is activated in vehicles that meet certain technical conditions and that have a current ConnectedDrive subscription; it is free of charge.

Neither personal nor position data are transmitted.

To check when your service partner was notified:

1. "Vehicle Info"
2. "Vehicle status"
3. "Options"
4. "Last Teleservice Info"

Services status

Displaying available services

Display of all services available in the vehicle.

1. "BMW Assist" or "ConnectedDrive"
2. "Service Status"

3. "Available services"

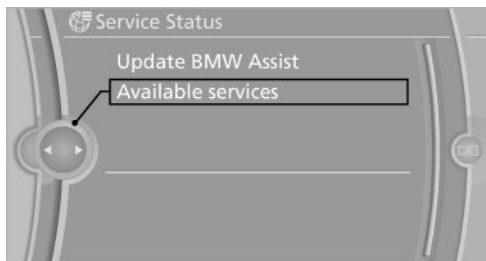

Updating BMW Assist

Manual update of TeleService.

1. "BMW Assist" or "ConnectedDrive"
2. "Service Status"
3. "Update BMW Assist"

Data transfer

During the updating of BMW services, display the status of the data transfer.

1. "BMW Assist" or "ConnectedDrive"
2. Open "Options".
3. "Data transfer"

Apps

At a glance

Certain software applications of a suitable mobile phone can be integrated in the vehicle.

These software applications are displayed on the Control Display.

They are operated via iDrive.

Requirements

- ▷ The mobile phone is suitable.
- ▷ The mobile phone operating system supports the software applications of Apps.
- ▷ Software applications are installed on the mobile phone and ready to use.

- ▷ Corresponding mobile wireless contract. Any additionally incurred costs are not a part of Apps.
- ▷ Use only BMW approved software applications; otherwise, it may result in malfunctions.

Information about suitable mobile phones, available software applications and their installation can be found at www.bmw.com/connectivity or at the service center.



Create the entries.

Make entries only when traffic and road conditions allow. Otherwise, the vehicle occupants and other road users may be put in danger because of the distraction from driving.

For reasons of safety, some software applications are usable only while the vehicle is stationary. ◀

Operating Apps

1. Connect the mobile phone via the snap-in adapter or via the USB audio interface.
2. "ConnectedDrive"
3. Select the desired software application.

Displaying status

Information about the currently available software applications can be displayed.

1. "ConnectedDrive"
2. "BMW apps"

Notes

- ▷ The ranges of Apps that can be displayed on the Control Display depend on the range of installed software applications on the mobile phone.
- ▷ The data transmission of the software applications from the mobile phone to the vehicle can last some time. Some software applications depend on the speed of the available Internet connection of the mobile phone.

- ▷ Some mobile phones cannot simultaneously use Apps and the Bluetooth hands-free system.

If necessary, restart the software application on the mobile phone after a phone conversation.

Remote Services

With Remote Services, a connection can be established between a mobile phone and the vehicle. This connection can be used, for example, to lock and unlock the vehicle.

Depending on the vehicle, additional functions may be available.

To be able to use the functions, the My BMW Remote app must be downloaded. Operation takes place via the app.

Alternatively, the functions can also be used via the ConnectedDrive Hotline.

The operating instructions for the My BMW Remote app can be found on the ConnectedDrive portal or at www.bmw.com.





Mobility

In order to always ensure your mobility, you will find important information on operating fluids, wheels and tires, maintenance and Roadside Assistance in the following.

Refueling

Vehicle equipment

This chapter describes all series equipment as well as country-specific and special equipment offered for this model series. Therefore, it also describes equipment that may not be found in your vehicle, for instance due to the selected special equipment or the country version. This also applies to safety-related functions and systems.

When using the features and systems described here, adhere to local regulations.

General information

 Refuel promptly

At the latest, refuel at a range of 30 miles/50 km; otherwise, the engine function is not ensured and damage may occur. ◀

Notes

 Switch off the engine before refueling

Always switch off the engine before refueling; otherwise, fuel cannot be added to the tank and a message will be displayed. ◀

 Observe when handling fuel

- ▷ Take all precautionary measures and observe all applicable regulations when handling fuel.
- ▷ Do not carry any spare fuel containers in your vehicle. They can develop a leak and cause an explosion or cause a fire in the event of an accident. ◀

Fuel filler flap

Opening

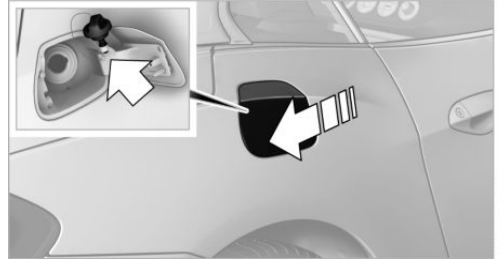

1. Briefly press the rear edge of the fuel filler flap.
2. Turn the fuel cap counterclockwise.
3. Place the fuel cap in the bracket attached to the fuel filler flap.

Closing

Fit the fuel cap and turn it clockwise until you clearly hear a click.

 Do not pinch the retaining strap
Do not pinch the retaining strap attached to the cap; otherwise, the cap cannot be closed properly and fuel vapors can escape. A message is displayed if the cap is loose or missing. ◀

Manually unlocking fuel filler flap

In the event of a malfunction, you can release the fuel filler flap manually:

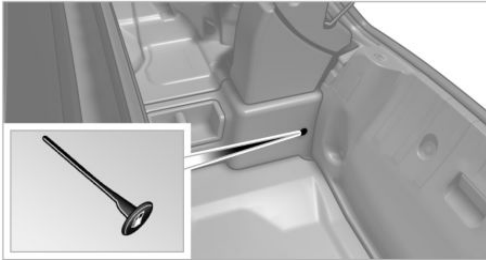

Pull the button with the fuel pump symbol in the cargo area. This releases the fuel filler flap.

Observe the following when refueling

 Do not overfill the fuel tank
Do not overfill the fuel tank; otherwise, escaping fuel may harm the environment or damage the vehicle. ◀

 Handling fuels
Obey safety regulations posted at the gas station. ◀

When refueling, insert the filler nozzle completely into the filler pipe. Avoid lifting the filler nozzle while filling the tank, as that would lead to:

- ▶ Premature pump shutoff.
- ▶ Reduced efficiency of the fuel-vapor recovery system.

The fuel tank is full when the filler nozzle clicks off the first time.

Fuel tank capacity

Approx. 14.5 gallons/55 liters.

Fuel

Vehicle equipment

This chapter describes all series equipment as well as country-specific and special equipment offered for this model series. Therefore, it also describes equipment that may not be found in your vehicle, for instance due to the selected special equipment or the country version. This also applies to safety-related functions and systems.

When using the features and systems described here, adhere to local regulations.

Fuel recommendation

For the best fuel economy, the gasoline should be sulfur-free or very low in sulfur content.

Do not use fuels that are labeled at the fuel pump as containing metals.

 Only refuel with lead-free gasoline without metal additives

Do not refuel with leaded gasoline or gasoline with metal additives, e. g., manganese or iron; otherwise, the catalytic converter and other components will be permanently damaged. ◀

Fuels with a maximum ethanol content of 10 %, i.e., E10, may be used for refueling.

The ethanol should fulfill the following quality standards:

US: ASTM 4806–xx

CAN: CGSB-3.511–xx

xx: always adhere to the currently applicable standard.

 Do not refuel with ethanol E85

Do not refuel with E85, i.e., fuel with an ethanol content of 85 %, or with Flex Fuel, as this would damage the engine and fuel supply system. ◀

The engine is knock controlled. Therefore, you can refuel with different recommended fuel grades.

Recommended fuel grade

BMW recommends AKI 91.

Minimum fuel grade

BMW recommends AKI 89.



Minimum fuel grade

Do not fill up with fuel below the specified minimum quality; otherwise, the engine may not run properly. ◀

If you use gasoline with this minimum AKI rating, the engine may produce knocking sounds when starting at high outside temperatures. This has no effect on the engine life.



Minimum fuel grade

The use of poor-quality fuels may result in harmful engine deposits or damage. Additionally, problems relating to drivability, starting and stalling, especially under certain environmental conditions such as high ambient temperature and high altitude, may occur.

If drivability problems are encountered, we recommend switching to a high quality gasoline brand and a higher octane grade — AKI number — for a few tank fills. To avoid harmful engine deposits, it is highly recommended to purchase gasoline from BP or Top Tier retailers.

Failure to comply with these recommendations may result in the need for unscheduled maintenance. ◀

BMW recommends BP fuels 

Wheels and tires

Vehicle equipment

This chapter describes all series equipment as well as country-specific and special equipment offered for this model series. Therefore, it also describes equipment that may not be found in your vehicle, for instance due to the selected special equipment or the country version. This also applies to safety-related functions and systems.

When using the features and systems described here, adhere to local regulations.

Tire inflation pressure

Information for your safety

It is not merely the tires' service life, but also driving comfort and, to a great extent, driving safety that depend on the condition of the tires and the maintenance of the specified tire pressure.

 Check the tire inflation pressure regularly

Regularly check the tire inflation pressure and correct it as needed: at least twice a month and before a long trip. If you fail to observe this precaution, you may be driving on tires with incorrect tire pressures, a condition that may not only compromise your vehicle's driving stability, but also lead to tire damage and the risk of an accident. ◀

Checking the pressure

Tires naturally lose pressure uniformly across all four tires.

Only check the tire inflation pressure when the tires are cold. This means after a maximum of 1.25 miles/2 km driving or when the vehicle has been parked for at least 2 hours. When the tires are warm, the tire inflation pressure is higher.

Tires warm up during driving and the tire inflation pressure increases as the temperature rises. The tire inflation pressure specifications apply to cold tires or tires at ambient temperature.

Only check the tire inflation pressure when the tires are cold. This means after a maximum of 1.25 miles/2 km driving or when the vehicle has been parked for at least 2 hours.

The values displayed by tire inflation stations may be up to 0.1 bar, 2 psi too low.

For the Flat Tire Monitor: after adjusting the tire inflation pressure to a new value, reinitialize the Flat Tire Monitor, refer to page 92.

For the Tire Pressure Monitor: after adjusting the tire inflation pressure to a new value, reset the Tire Pressure Monitor, refer to page 95.

Pressure specifications

The tables below provide all the correct inflation pressures for the specified tire sizes at ambient temperature.

The inflation pressures apply to the tire sizes approved and tire brands recommended by BMW; a list of these is available from your service center.

For correct identification of the right tire inflation pressures, observe the following:

- ▷ Tire sizes of your vehicle.
- ▷ Maximum allowable driving speed.

Tire inflation pressures for driving up to 100 mph or 160 km/h

For normal driving up to 100 mph/160 km/h, adjust pressures to the respective tire inflation pressures listed on the following pages in the column for traveling speeds up to 100 mph/160 km/h to achieve optimum driving comfort.

These tire inflation pressures can also be found on the driver's side door pillar when the driver's door is open.



MAGNETA

! Do not exceed the maximum permissible speed

The maximum permissible speed for these tire pressures is 100 mph/160 km/h Do not exceed

this speed; otherwise, tire damage and accidents could occur. ◀

Tire inflation pressures for driving above 100 mph or 160 km/h

! Adjust the tire inflation pressures
To drive at maximum speeds in excess of 100 mph/160 km/h, adjust pressures to the respective tire inflation pressures listed on the following pages in the column for traveling speeds including those exceeding 100 mph or 160 km/h. Otherwise, tire damage and accidents could occur. ◀

Observe all national and local maximum speed limits; otherwise, violations of the laws could occur.

Tire inflation pressures Z4 sDrive28i

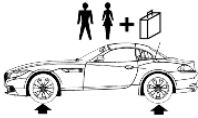
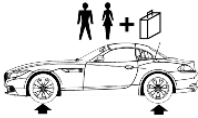
Tire size	Pressure specifications in bar/PSI			
	Traveling speeds of up to 100 mph/160 km/h		Traveling speeds including those exceeding 100 mph/160 km/h	
All pressure specifications in the table are indicated in bar/psi with cold tires. Cold = ambient temperature				
<div style="display: flex; justify-content: space-around; align-items: center;">   </div>				
Without Sport Package:				
225/45 R 17 91 V RSC	2.5/36	3.0/44	2.5/36	3.0/44
225/45 R 17 91 H M+S RSC				
225/45 R 17 94 V M+S XL RSC				
Front: 225/45 R 17 91 V RSC	2.5/36	-	2.5/36	-
Rear: 255/40 R 17 94 V RSC	-	2.7/39	-	2.7/39
Front: 225/40 R 18 88 W RSC	2.5/36	-	2.5/36	-
Rear: 255/35 R 18 90 W RSC	-	2.9/42	-	2.9/42
Front: 225/35 R 19 88 Y XL RSC	2.5/36	-	2.5/36	-
Rear: 255/30 R 19 91 Y XL RSC	-	2.9/42	-	2.9/42

Tire size	Pressure specifications in bar/PSI			
With Sport Package:				
225/45 R 17 91 W RSC	2.5/36	3.0/44	2.5/36	3.0/44
225/45 R 17 91 H M+S RSC				
225/45 R 17 94 V M+S XL RSC				
Front: 225/45 R 17 91 W RSC	2.5/36	-	2.5/36	-
Rear: 255/40 R 17 94 W RSC	-	2.7/39	-	2.7/39
Front: 225/40 R 18 88 W RSC	2.5/36	-	2.6/38	-
Rear: 255/35 R 18 90 W RSC	-	2.9/42	-	3.1/45
Front: 225/35 R 19 88 Y XL RSC	2.5/36	-	2.5/36	-
Rear: 255/30 R 19 91 Y XL RSC	-	2.9/42	-	3.0/44
More details on the permissible load and weights, refer to page 262 .				

Tire inflation pressures Z4 sDrive35i

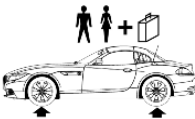
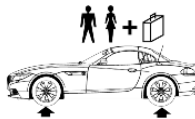
Tire size	Pressure specifications in bar/PSI			
	Traveling speeds of up to 100 mph/160 km/h		Traveling speeds including those exceeding 100 mph/160 km/h	
<p>All pressure specifications in the table are indicated in bar/psi with cold tires. Cold = ambient temperature</p> <div style="display: flex; justify-content: space-around; align-items: center;">   </div>				
Without Sport Package:				
225/45 R 17 91 H M+S RSC	2.5/36	3.0/44	2.5/36	3.0/44
225/45 R 17 94 V M+S XL RSC				
Front: 225/45 R 17 91 V RSC	2.5/36	-	2.5/36	-
Rear: 255/40 R 17 94 V RSC	-	2.7/39	-	2.7/39
Front: 225/40 R 18 88 W RSC	2.5/36	-	2.5/36	-
Rear: 255/35 R 18 90 W RSC	-	2.9/42	-	2.9/42
Front: 225/35 R 19 88 Y XL RSC	2.5/36	-	2.5/36	-
Rear: 255/30 R 19 91 Y XL RSC	-	2.9/42	-	2.9/42

Tire size	Pressure specifications in bar/PSI			
With Sport Package:				
225/45 R 17 91 H M+S RSC	2.5/36	3.0/44	2.5/36	3.0/44
225/45 R 17 94 V M+S XL RSC				
Front: 225/45 R 17 91 W RSC	2.5/36	-	2.5/36	-
Rear: 255/40 R 17 94 W RSC	-	2.7/39	-	2.8/41
Front: 225/40 R 18 88 W RSC	2.5/36	-	2.7/39	-
Rear: 255/35 R 18 90 W RSC	-	2.9/42	-	3.2/46
Front: 225/35 R 19 88 Y XL RSC	2.5/36	-	2.5/36	-
Rear: 255/30 R 19 91 Y XL RSC	-	2.9/42	-	3.0/44

More details on the permissible load and weights, refer to page [262](#).

Tire inflation pressures Z4 sDrive35is

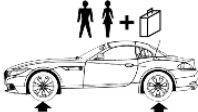
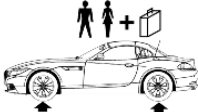
Tire size	Pressure specifications in bar/PSI			
	Traveling speeds of up to 100 mph/160 km/h		Traveling speeds including those exceeding 100 mph/160 km/h	
All pressure specifications in the table are indicated in bar/psi with cold tires. Cold = ambient temperature				
225/45 R 17 91 H M+S RSC	2.5/36	3.0/44	2.5/36	3.0/44
225/45 R 17 94 V M+S XL RSC				
Front: 225/40 R 18 88 W RSC	2.7/39	-	2.7/39	-
Rear: 255/35 R 18 90 W RSC	-	3.2/46	-	3.2/46
Front: 225/35 R 19 88 Y XL RSC	2.5/36	-	2.5/36	-
Rear: 255/30 R 19 91 Y XL RSC	-	3.0/44	-	3.0/44

More details on the permissible load and weights, refer to page [262](#).

Tire identification marks

Knowledge of the labeling on the side of the tire makes it easier to identify and choose the right tires.

Tire size

Example: 225/45 R 17 91 V

225: nominal width in mm

45: aspect ratio in %

R: radial tire code
 17: rim diameter in inches
 91: load rating, not for ZR tires
 V: speed rating, before the R on ZR tires

Speed letter

Q = up to 100 mph/160 km/h
 T = up to 118 mph/190 km/h
 H = up to 131 mph/210 km/h
 V = up to 150 mph/240 km/h
 W = up to 167 mph/270 km/h
 Y = up to 186 mph/300 km/h

Tire Identification Number

Tires with DOT codes meet the guidelines of the U.S. Department of Transportation.

DOT code:

DOT xxxx xxx 0313

xxxx: manufacturer code for the tire brand

xxx: tire size and tire design

0313: tire age

Tire age

The tire manufacturing date is contained in the tire identification mark: DOT ... 0313 means that the tire was manufactured in the week 3 of 2013.

BMW recommends that you replace all tires after 6 years at most, even if some tires may last for 10 years.

Uniform Tire Quality Grading

Quality grades can be found where applicable on the tire sidewall between tread shoulder and maximum section width. For example:

Treadwear 200 Traction AA

Temperature A

DOT Quality Grades

Treadwear

Traction AA A B C

Temperature A B C



All passenger car tires must conform to Federal Safety Requirements in addition to these grades. ◀

Treadwear

The treadwear grade is a comparative rating based on the wear rate of the tire when tested under controlled conditions on a specified government test course. For example, a tire graded 150 would wear one and one-half (1 1/2) times as well on the government course as a tire graded 100. The relative performance of tires depends upon the actual conditions of their use, however, and may depart significantly from the norm due to variations in driving habits, service practices and differences in road characteristics and climate.

Traction

The traction grades, from highest to lowest, are AA, A, B, and C.

Those grades represent the tire's ability to stop on wet pavement as measured under controlled conditions on specified government test surfaces of asphalt and concrete. A tire marked C may have poor traction performance.

The traction grade assigned to this tire is based on straight-ahead braking traction tests, and does not include acceleration, cornering, hydroplaning, or peak traction characteristics.

Temperature

The temperature grades are A, the highest, B, and C, representing the tire's resistance to the generation of heat and its ability to dissipate heat when tested under controlled conditions on a specified indoor laboratory test wheel. Sustained high temperature can cause the material of the tire to degenerate and reduce tire life, and excessive temperature can lead to sudden tire failure. The grade C corresponds to a level of performance which all passenger

car tires must meet under the Federal Motor Vehicle Safety Standard No. 109. Grades B and A represent higher levels of performance on the laboratory test wheel than the minimum required by law.

 Temperature grade for this tire

The temperature grade for this tire is established for a tire that is properly inflated and not overloaded. Excessive speed, underinflation, or excessive loading, either separately or in combination, can cause heat buildup and possible tire failure. ◀

RSC – Run-flat tires

The symbol identifying run-flat tires is a circle with the letters RSC on the sidewall, refer to page 232.

M+S

Winter and all-season tires.

These have better winter properties than summer tires.

XL

Designation for specially reinforced tires.

Tire tread

Summer tires

Do not drive with a tire tread depth of less than 0.12 in/3 mm.

There is an increased danger of hydroplaning if the tread depth is less than 0.12 in/3 mm.

Winter tires

Do not drive with a tire tread depth of less than 0.16 in/4 mm.

Below a tread depth of 0.16 in/4 mm, tires are less suitable for winter operation.

Minimum tread depth

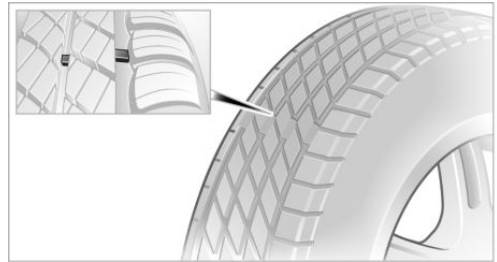

Wear indicators are distributed around the tire's circumference and have the legally required minimum height of 0.063 in/1.6 mm.

They are marked on the side of the tire with TWI, Tread Wear Indicator.

Tire damage

Driving over rough or damaged road surfaces, as well as debris, curbs and other obstacles can cause serious damage to wheels, tires and suspension parts. This is more likely to occur with low-profile tires, which provide less cushioning between the wheel and the road. Be careful to avoid road hazards and reduce your speed, especially if your vehicle is equipped with low-profile tires.

Inspect your tires often for damage, foreign objects lodged in the tread, and tread wear.

Indications of tire damage or other vehicle defects:

- ▷ Unusual vibrations during driving.
- ▷ Unusual handling such as a strong tendency to pull to the left or right.

 In case of tire damage

If there are indications of tire damage, reduce your speed immediately and have the wheels and tires checked right away; otherwise, there is the increased risk of an accident.

Drive carefully to the next service center or tire shop.

If necessary, have the vehicle towed. ◀

 Repair of tire damage

For safety reasons, the manufacturer of your vehicle recommends that you do not have damaged tires repaired; they should be replaced. Otherwise, damage can occur as a result. ◀

Run-flat tires

Label



RSC label on the tire sidewall.

The wheels are composed of special rims and tires that are self-supporting, to a limited degree.

The support of the sidewall allows the tire to remain drivable to a restricted degree in the event of a pressure loss.

Driving can continue with a damaged tire, refer to page 94.

Changing run-flat tires

For your own safety, only use run-flat tires. No spare tire is available in the case of a flat tire. Your service center will be glad to advise you.

Changing wheels and tires

Mounting

 Information on mounting tires

Have mounting and balancing performed only by a service center or tire specialist.

If this work is not carried out properly, there is the danger of subsequent damage and related safety hazards. ◀

Wheel and tire combination

Information on the correct wheel-tire combination and rim versions for your vehicle can be obtained from your service center.

Incorrect wheel and tire combinations impair the function of a variety of systems such as ABS or DSC.

To maintain good handling and vehicle response, use only tires with a single tread configuration from a single manufacturer.

Following tire damage, have the original wheel and tire combination remounted on the vehicle as soon as possible.

 Approved wheels and tires

The manufacturer of your vehicle recommends that you use only wheels and tires that have been approved for your particular vehicle model.

For example, despite having the same official size ratings, variations can lead to body contact and with it, the risk of severe accidents.

The manufacturer of your vehicle cannot evaluate non-approved wheels and tires to determine if they are suited for use, and therefore cannot ensure the operating safety of the vehicle if they are mounted. ◀

Recommended tire brands

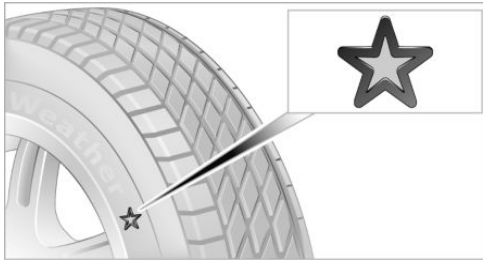

For each tire size, the manufacturer of your vehicle recommends certain tire brands. These can be identified by a star on the tire sidewall. With proper use, these tires meet the highest standards for safety and handling.

Retreaded tires

The manufacturer of your vehicle does not recommend the use of retreaded tires.



Retreaded tires

Possibly substantial variations in the design and age of the tire casing structures can limit service life and have a negative impact on road safety. ◀

Winter tires

The manufacturer of your vehicle recommends winter tires for winter roads or at temperatures below +45 °F/+7 °C.

Although so-called all-season M+S tires do provide better winter traction than summer tires, they do not provide the same level of performance as winter tires.

Maximum speed of winter tires

If the maximum speed of the vehicle is higher than the permissible speed for the winter tires, then display a corresponding sign in the field of vision. You can obtain this sign from the tire specialist or from your service center.



Maximum speed for winter tires

Do not exceed the maximum speed for the winter tires; otherwise, tire damage and accidents can occur. ◀

Run-flat tires

For your own safety, only use run-flat tires. No spare tire is available in the case of a flat tire. Your service center will be glad to advise you.

Rotating wheels between axles

The manufacturer of your vehicle advises against swapping wheels between the front and rear axles.

This can impair the handling characteristics.

Rotating the tires is not permissible when using different types of tires.

Storage

Store wheels and tires in a cool, dry place with as little exposure to light as possible.

Always protect tires against all contact with oil, grease and fuels.

Do not exceed the maximum tire inflation pressure indicated on the side wall of the tire.

Snow chains

Only certain fine-link snow chains have been tested by BMW, classified as safe for use and recommended. Consult your service center for more information.

Snow chains must be mounted in pairs and on the rear wheels only. Observe the manufacturer's instructions when mounting snow chains. Do not exceed a speed of 30 mph/50 km/h when using snow chains.

Do not initialize the Flat Tire Monitor if snow chains are mounted; otherwise, the instrument might issue an incorrect reading.

When driving with snow chains, it can be beneficial to temporarily activate DTC, refer to page [101](#).

Engine compartment

Vehicle equipment

This chapter describes all series equipment as well as country-specific and special equipment offered for this model series. Therefore, it also describes equipment that may not be found in your vehicle, for instance due to the selected

special equipment or the country version. This also applies to safety-related functions and systems.

When using the features and systems described here, adhere to local regulations.

Important features in the engine compartment

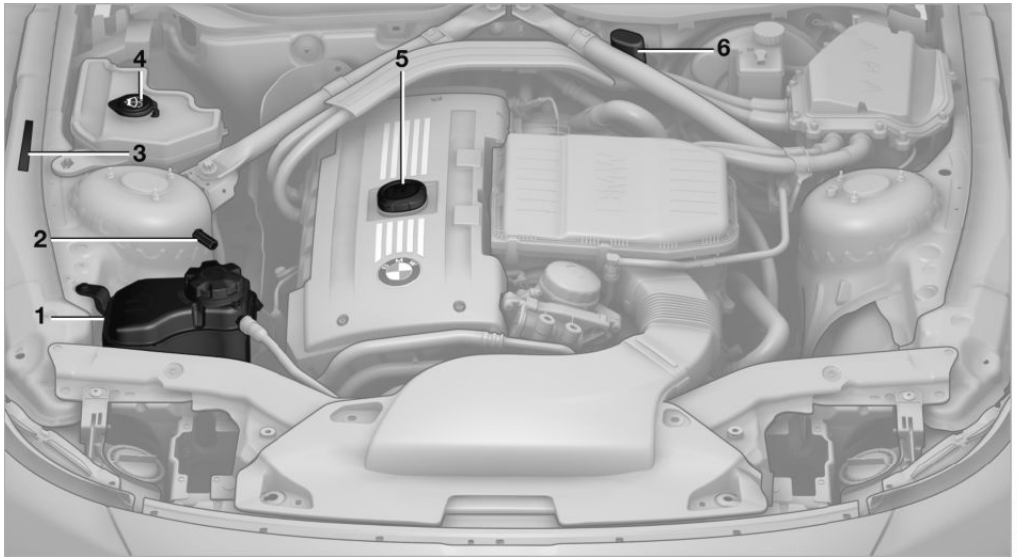

- | | | | | | |
|---|--|---------------------|---|--|---------------------|
| 1 | Coolant expansion tank | 239 | 5 | Engine oil filler neck | 238 |
| 2 | Starting aid terminal, negative terminal | 250 | 6 | Starting aid terminal, positive terminal | 250 |
| 3 | Vehicle identification number | | | | |
| 4 | Filler neck for washer fluid for the headlamp and window washer system | 62 | | | |

Hood

Opening the hood

 Working in the engine compartment
Never attempt to perform any service or repair operations on your vehicle without the necessary professional technical training.

If you are unfamiliar with the statutory guidelines, have any work on the vehicle performed only by a service center.

If this work is not carried out properly, there is the danger of subsequent damage and related safety hazards. ◀

 To avoid damage, make sure that the wiper arms are resting against the windshield before you open the engine compartment. Do not open the engine hood before the engine has cooled down; otherwise, injuries may result. ◀

1. Pull the lever.

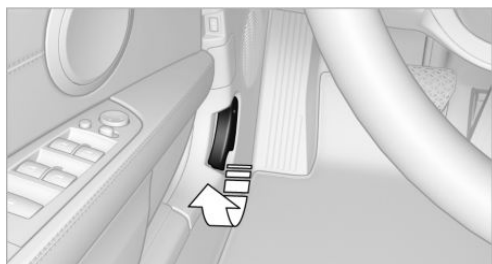

2. Push the release lever to the right and open the hood.



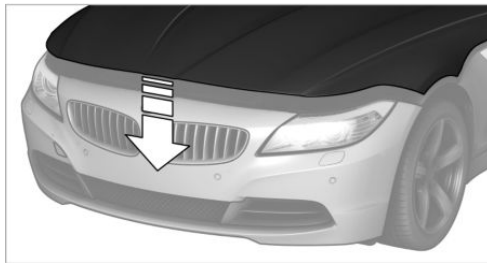

 Danger of injury when the hood is open
There is a danger of injury from protruding parts when the hood is open. ◀

Closing the hood



Close the hood from a height of approx. 16 in/40 cm with momentum. It must be clearly heard to engage.

 Hood open when driving
If you see any signs that the hood is not completely closed while driving, pull over immediately and close it securely. ◀

 Danger of pinching
Make sure that the closing path of the hood is clear; otherwise, injuries may result. ◀

Checking the oil level

General information

Engine oil consumption depends on the driving style and the conditions of use. A highly sporty driving style, for example, results in considerably higher engine oil consumption.

Therefore, regularly check the engine oil level after refueling.

The concept

The car is equipped with an electronic engine oil level check.

When the oil quantity reaches minimum level, a Check Control message is displayed.

Requirements

- ▶ The engine must be running and warm after the vehicle has been driven for at least 6.2 miles/10 km.
- ▶ The vehicle is stopped or being driven on a level roadway.

Display in the instrument cluster

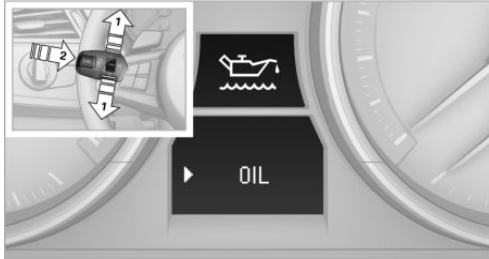

1. Press button 1 in the turn indicator lever up or down repeatedly until the appropriate symbol appears in the display, accompanied by the word "OIL".
2. Press button 2 in the turn indicator lever. The oil level is checked and the reading displayed.

Possible displays

-  Too much engine oil
Have the vehicle checked immediately; otherwise, surplus oil can lead to engine damage. ◀

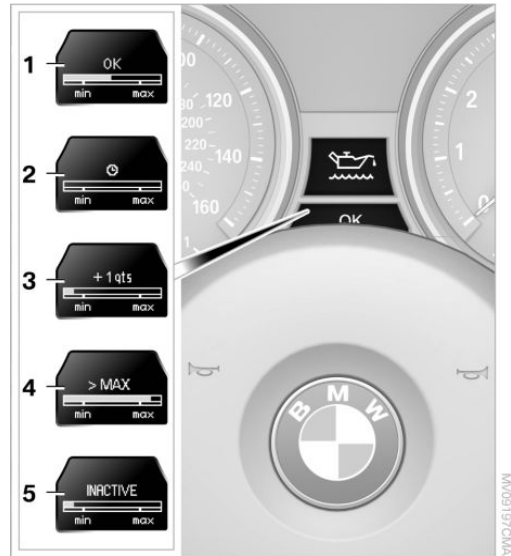

- 1 Oil level OK
- 2 Oil level is being checked. This can take about 3 minutes if the car is at a standstill on a level surface, or about 5 minutes while the car is on the move.
- 3 Oil level at minimum: add engine oil as soon as possible, but no more than 1 US quart/1 liter.
- 4 Oil level is too high.
- 5 The oil level sensor is defective. Do not add engine oil. It is possible to continue driving. Note the newly calculated remaining mileage until the next oil service. Have the system checked as soon as possible.

Display via iDrive

1. "Vehicle Info"

2. "Vehicle status"

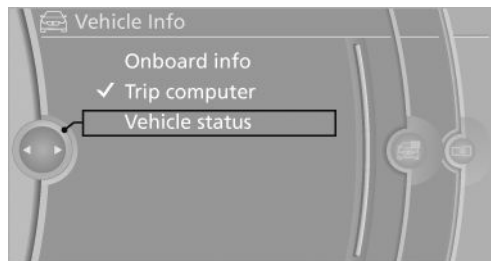

3. "Engine oil level"



Possible messages

- ▷ "Engine oil level OK"
- ▷ "Measurement not possible at this time."
- ▷ "Measuring engine oil level..."
 - Duration with the engine running: approx. 3 minutes.
 - Duration while driving: approx. 5 minutes.
 - If engine oil was added, it may take up to 30 minutes to obtain an oil level reading.
- ▷ "Engine oil level below minimum. Add 1 quart!"
 - Add a maximum of 1 US quart/1 liter of engine oil at the next opportunity, refer also to Adding engine oil below.
- ▷ "Engine oil level too high! Have this checked."
 -  Too much engine oil
 - Have the vehicle checked immediately; otherwise, surplus oil can lead to engine damage. ◀

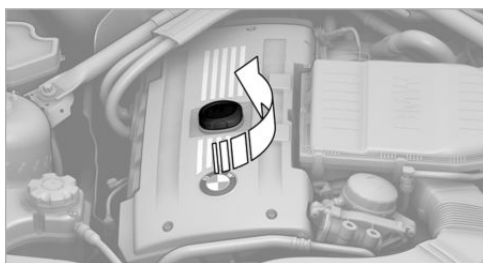

- ▷ "Measurement inactive. Have this checked." Do not add engine oil. It is possible to continue driving. Note the newly calculated remaining mileage until the next oil service, refer to page 78. Have the system checked as soon as possible.

Adding engine oil





Depending on the engine, the filler neck is located in the middle, as shown, or at the front corner in the engine cover.

Add a maximum quantity of 1 US quart/1 liter of oil only after a corresponding message appears on the Control Display.

-  Add oil promptly
 - Add oil within the next 125 miles/200 km; otherwise, engine damage could result. ◀
-  Protect children
 - Keep oil, grease, etc., out of reach of children and heed the warnings on the containers to prevent health risks. ◀

Oil types for refilling

Notes

-  No oil additives
 - Oil additives may lead to engine damage. ◀
-  Viscosity classes of engine oils
 - When selecting an engine oil, ensure that the engine oil belongs to one of the viscosity classes SAE 0W-40, SAE 0W-30, SAE 5W-40,

or SAE 5W-30, or malfunctions or engine damage may occur. ◀

The engine oil quality is critical for the life of the engine.

Some oil types are not available in all countries.

Approved oil types

Specification

BMW High Performance SAE 5W-30

BMW Longlife-01

BMW Longlife-01 FE

Further information on approved oil types can be obtained from the service center.

Alternative oil types

If the approved engine oils are not available, up to 1 US quart/liter of an oil with the following specification can be used:

Specification

API SM or a higher quality standard

Oil change

The manufacturer of your vehicle recommends having the engine oil changed by a service center.

Coolant

General information

 **Danger of burns from hot engine**
Do not open the cooling system while the engine is hot; otherwise, escaping coolant may cause burns. ◀

 **Suitable additives**

Only use suitable additives; otherwise, engine damage may occur. The additives are harmful to your health. ◀

Coolant consists of water and additives.

Not all commercially available additives are suitable for your vehicle. Ask your service center for suitable additives.

Checking the coolant level

1. Let the engine cool.
2. Turn the expansion tank cap counterclockwise slightly to allow any accumulated pressure to escape, then continue turning to open.

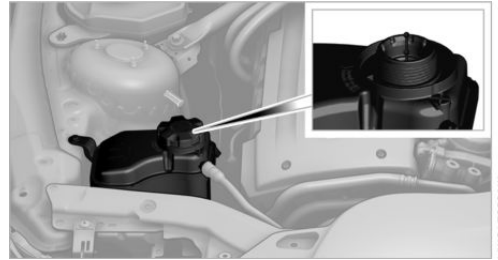

3. The filling level indicator 1 in the filler neck indicates the coolant level. The coolant level is correct if it is between the arrows, see the label on the reservoir 2.

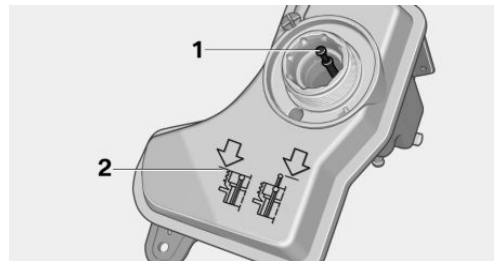

4. If the coolant is low, slowly add coolant up to the specified level; do not overfill.
5. Turn the cap until there is an audible click.
6. Have the cause of the coolant loss eliminated as soon as possible.

Disposal



Comply with the appropriate environmental protection regulations when disposing of coolant additives.

Maintenance

Vehicle equipment

This chapter describes all series equipment as well as country-specific and special equipment offered for this model series. Therefore, it also describes equipment that may not be found in your vehicle, for instance due to the selected special equipment or the country version. This also applies to safety-related functions and systems.

When using the features and systems described here, adhere to local regulations.

BMW Maintenance System



The maintenance system provides information on required maintenance measures and thus provides support in maintaining road safety and the operational reliability of the vehicle.

Condition Based Service CBS

Sensors and special algorithms take into account the driving conditions of your vehicle. Based on this, Condition Based Service determines the maintenance requirements.

The system makes it possible to adapt the amount of maintenance you need to your user profile.

Details on the service requirements, refer to page 78, can be displayed on the Control Display.

Service data in the remote control

Information on the required maintenance is continuously stored in the remote control. Your service center will read out this data and suggest the right array of service procedures for your vehicle.

Therefore, hand your service specialist the remote control that you used most recently.

Storage periods

Storage periods during which the vehicle battery was disconnected are not taken into account.

If this occurs, have a service center update the time-dependent maintenance procedures, such as checking brake fluid and, if necessary, changing the engine oil and the microfilter/activated-charcoal filter.

Service and Warranty Information Booklet for US models and Warranty and Service Guide Booklet for Canadian models

Please consult your Service and Warranty Information Booklet for US models and Warranty and Service Guide Booklet for Canadian models for additional information on service requirements.

Maintenance and repair should be performed by your service center. Make sure to have regular maintenance procedures recorded in the vehicle's Service and Warranty Information Booklet for US models, and in the Warranty and Service Guide Booklet for Canadian mod-

els. These entries are proof of regular maintenance.

Socket for OBD Onboard Diagnosis



Socket for Onboard Diagnosis

The socket for Onboard Diagnosis may only be used by the service center, by workshops that operate according to the specifications of the vehicle manufacturer with appropriately trained personnel, and by other authorized persons. Otherwise, its use may lead to vehicle malfunctions. ◀

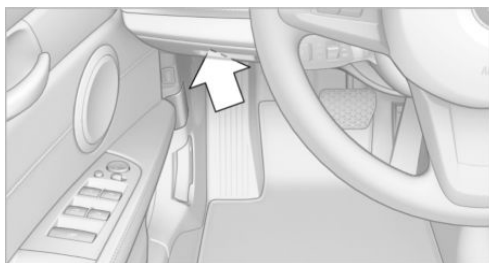

On the driver's side is an OBD socket for checking the primary components in the vehicle emissions.

Emissions



- ▷ The warning lamp lights up:

The emissions values are deteriorating. Have the vehicle checked as soon as possible.

- ▷ The warning lamp flashes under certain circumstances:

This indicates that there is excessive misfiring in the engine.

Reduce the vehicle speed and have the system checked immediately; otherwise, serious engine misfiring within a brief period can seriously damage emission control components, in particular the catalytic converter.



Display of the previously described malfunctions on Canadian models.

Fuel cap



The indicator lamp lights up.

If the fuel cap is not properly tightened, the OBD system may conclude that fuel vapor is escaping. If the cap is then tightened, the display should go out in a short time.

Replacing components

Vehicle equipment

This chapter describes all series equipment as well as country-specific and special equipment offered for this model series. Therefore, it also describes equipment that may not be found in your vehicle, for instance due to the selected special equipment or the country version. This also applies to safety-related functions and systems.

When using the features and systems described here, adhere to local regulations.

Tool kit

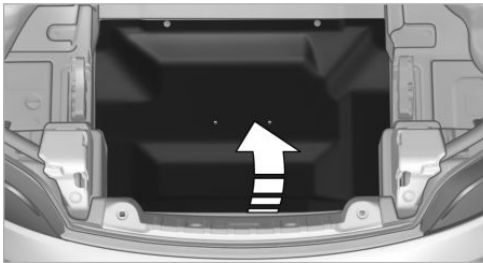

The onboard vehicle tool kit is stored in a pouch under the cargo floor panel.

Replacing the wiper blades

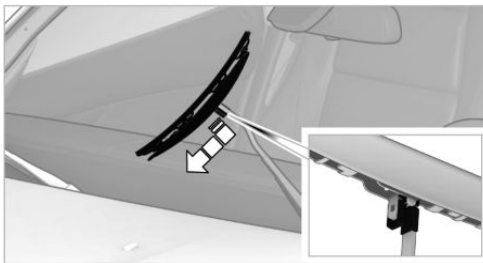

1. Fold up the wiper arm.
2. Fold the wiper blade upwards.

3. Press the hook.
4. Pull the wiper blade downward out of the holder and remove it toward the top left, see arrow.



Do not fold out the wiper arms

To avoid damage, make sure that the wiper arms are resting against the windshield before you open the engine compartment. ◀

Lamp and bulb replacement

General information

Lamps and bulbs make an essential contribution to vehicle safety.

The manufacturer of your vehicle recommends that you entrust corresponding procedures to your service center if you are unfamiliar with them or they are not described here.

You can obtain a selection of replacement bulbs at your service center.



Danger of burns

Only change bulbs when they are cool; otherwise, there is the danger of getting burned. ◀



Working on the lighting system

When working on the lighting system, you should always switch off the lights affected to prevent short circuits.

To avoid possible injury or equipment damage when replacing bulbs, observe any instructions provided by the bulb manufacturer. ◀



Do not touch the bulbs

Do not touch the glass of new bulbs with your bare hands, as even minute amounts of contamination will burn into the bulb's surface and reduce its service life.

Use a clean tissue, cloth or something similar, or hold the bulb by its base. ◀

Light-emitting diodes LED

Light-emitting diodes installed behind translucent lenses serve as the light source for many of the controls and displays in your vehicle.

These light-emitting diodes, which operate using a concept similar to that applied in conventional lasers, are officially designated as Class 1 light-emitting diodes.

 Do not remove the covers

Do not remove the covers, and never stare into the unfiltered light for several hours; otherwise, irritation of the retina could result. ◀

Headlight glass

Condensation can form on the inside of the external lights in cool or humid weather. When you drive with the lights switched on, the condensation evaporates after a short time. The headlight glasses do not need to be changed.

If the condensation in the headlights does not evaporate after trips with the lights switched on, and the amount of moisture in the headlights increases, for example if water droplets form, have them checked by your service center.

Headlight setting

Changing the bulbs and lights may influence the headlight settings. Have the headlight setting checked by a service center and corrected if necessary after changing bulbs or lights.

Xenon headlights

At a glance

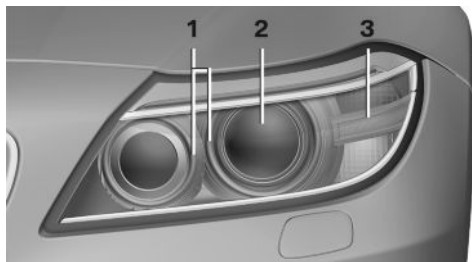

- 1 Parking lights / daytime running lights
- 2 Low beams/high beams/headlight flasher
- 3 Turn signal

Because of the long life of these bulbs, the likelihood of failure is very low. Switching the lights on and off frequently shortens their life.

 Do not perform work/bulb replacement on xenon headlamps

Have any work on the xenon lighting system, including bulb replacement, performed only by a service center.

Due to the high voltage present in the system, there is the danger of fatal injuries if work is carried out improperly. ◀

Adhere to the general instructions, refer to page 243.

With Xenon headlights, the following lights are designed with LED technology:

- ▶ Parking and roadside parking lights.
- ▶ Daytime running lights.

Contact your service center in the event of a malfunction.

Turn signals, front

PY24W bulb, 24 watt

1. Turn the wheel outwards.

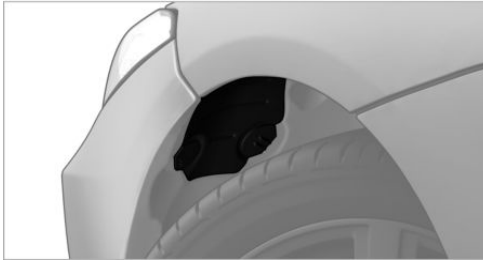

2. Turn both locks in the wheel house to the left and remove the cover.

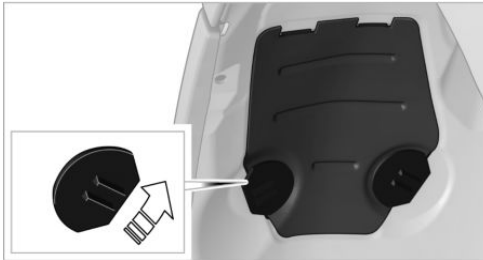

3. Turn the bulb holder to the left and remove it.
4. Turn the bulb to the right, see arrow, and remove it.

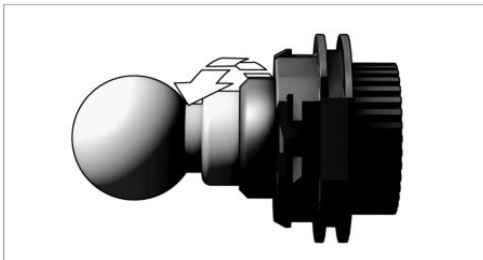

5. Change the bulb and screw it into the bulb holder toward the left.
6. Insert the bulb holder and turn it to the right.
7. Reattach the cover.

Tail lights

- ▶ Outer brake light, backup light: W16W bulb, 16 watt
- ▶ Inner brake light: H21W bulb, 21 watt

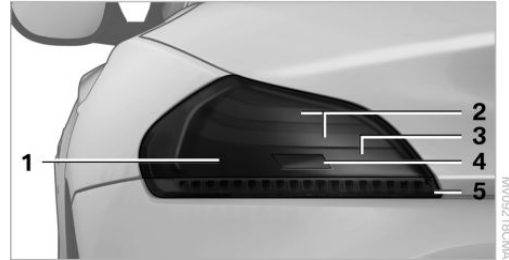

- 1 Outer brake light
- 2 Tail light, LED
- 3 Inner brake light
- 4 Backup light
- 5 Turn signal/dynamic brake light, LED

The lights of bulbs 2 and 5 use LED technology.

Follow the general instructions on lights and bulbs, refer to page 243.

Please contact your service center in the event of a malfunction.

Changing the backup light and inner brake light



Press the locking mechanism in the cargo area, see arrow, and remove the cover.

Inner brake light

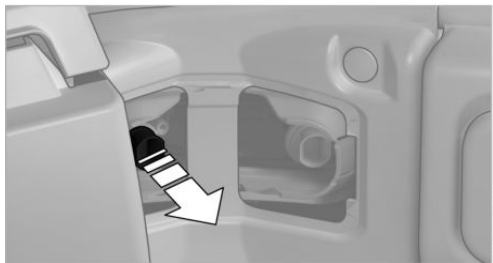

Pull out the bulb holder and replace the bulb.
Fasten the bulb holder and attach the cover.

Backup light

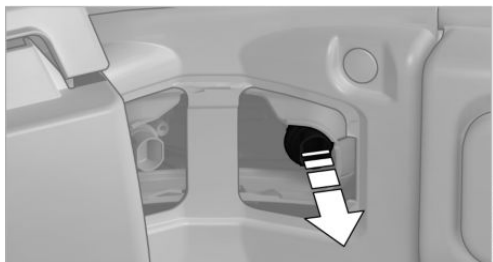

Pull out the bulb holder and replace the bulb.
Fasten the bulb holder and attach the cover.

Replacing the outer brake light

1. Remove the cover in the cargo area.

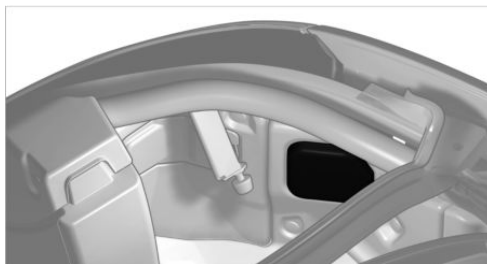

2. Pull out the bulb holder, see arrow, and change the bulb.

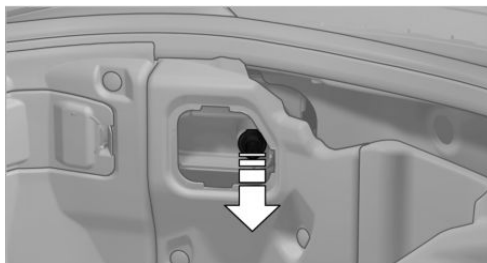

3. Attach the bulb holder.

4. Reattach the cover.

License plate light, tail light, center brake light and turn signal

These lights are made using LED technology.
Please contact your service center in the event of a malfunction.

Changing wheels

Notes

Your vehicle is equipped with run-flat tires, refer to page 232, as standard equipment.

They do not need to be replaced immediately in the event of a puncture.

When mounting new tires or changing from summer to winter tires or vice versa, use run-flat tires for your own safety.

No spare tire is available in the case of a flat tire.

The tools for changing wheels are available as accessories from your service center.

Jacking points for the vehicle jack

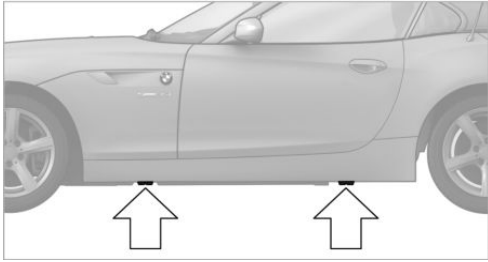

The jacking points for the vehicle jack are located in the positions shown.

Lug bolt lock

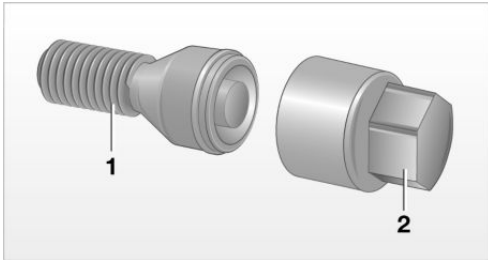

- 1 Lug bolt for adapter
- 2 Adapter, in onboard vehicle tool kit

Removing

1. Attach adapter 2 to the wheel lug.
2. Unscrew lug bolt 1.

Remove the adapter after screwing the lug bolt back on.

Vehicle battery

Maintenance

The battery is maintenance-free, i.e., the electrolyte will last for the life of the battery.

Your service center will be glad to advise you on questions regarding the battery.

Battery replacement



Use approved vehicle batteries.

Only use vehicle batteries that have been approved for your vehicle by the manufacturer; otherwise, the vehicle could be damaged and systems or functions may not be fully available. ◀

After a battery replacement, have the battery registered on the vehicle by your service center to ensure that all comfort functions are fully available.

Charging the battery

Note



Do not connect the charger to the socket

Do not connect the battery charger to the socket installed in the vehicle at the factory as this could damage the vehicle. ◀

Starting aid terminals

Only charge using the starting aid terminals, refer to page 250, in the engine compartment while the engine is switched off.

Power failure

After a temporary power loss, some equipment needs to be reinitialized.

Individual settings need to be reprogrammed:

- ▷ Seat and mirror memory: store the positions again, refer to page 49.
- ▷ Time: update, refer to page 76.
- ▷ Date: update, refer to page 77.

- ▷ Radio station: store again, refer to page 162.
- ▷ Navigation system: wait for the operability of the navigation.
- ▷ Interior rearview mirror with digital compass: recalibrate, refer to page 116.

Disposing of old batteries



Have old batteries disposed of by your service center or bring them to a recycling center.

Maintain the battery in an upright position for transport and storage. Secure the battery so that it does not tip over during transport.

Fuses

Notes



Replacing fuses

Never attempt to repair a blown fuse and do not replace a defective fuse with a substitute of another color or amperage rating; this could lead to a circuit overload, ultimately resulting in a fire in the vehicle. ◀

A pair of plastic tweezers is found on the current distributor.

See the inside of the cover for information on fuse assignment.

Below the glove compartment

1. Remove the screws 1 using the screwdriver from the onboard vehicle tool kit.
2. Remove cover 2, unwinding the cable to the footwell lamp if necessary.



3. Release the shiny fastener 3.

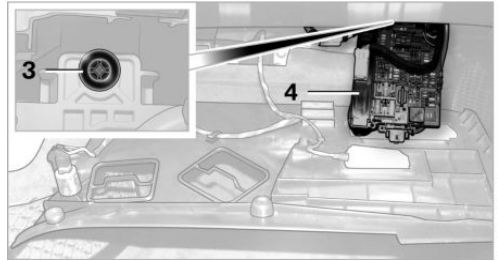

4. Fold the current distributor 4 downward and pull forward.

The cover is reinstalled in reverse order.

Breakdown assistance

Vehicle equipment

This chapter describes all series equipment as well as country-specific and special equipment offered for this model series. Therefore, it also describes equipment that may not be found in your vehicle, for instance due to the selected special equipment or the country version. This also applies to safety-related functions and systems.

When using the features and systems described here, adhere to local regulations.

Hazard warning system



The button for the hazard warning system is located on the center console.

Intelligent Emergency Request

Requirements

- ▶ Radio readiness is switched on.
- ▶ The Assist system is operable.
- ▶ The SIM card integrated in the vehicle is activated.
- ▶ ConnectedDrive subscription is available.

Only press the SOS button in an emergency.



Emergency Request not guaranteed

For technical reasons, the Emergency Request cannot be guaranteed under unfavorable conditions. ◀

Initiating an Emergency Request

1. Briefly press the cover flap to open.

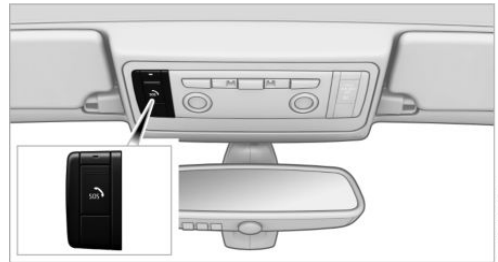

2. Press the SOS button until the LED in the button lights up.
 - ▶ The LED lights up: an Emergency Request was initiated.

If the situation allows, wait in your vehicle until the voice connection has been established.

- ▶ The LED flashes if the connection to the BMW Response Center has been established.

Once the BMW Response Center has received your Emergency Request, the BMW Response Center contacts you and takes further steps to help you.

Even if you are unable to respond, the BMW Response Center can take further steps to help you under certain circumstances.

For this purpose, data that are used to determine the necessary rescue measures, such as the current position of the vehicle if it can be established, are transmitted to the BMW Response Center.

- ▶ If the LED is flashing but the BMW Response Center cannot be heard on the hands-free system, the hands-free system may be malfunctioning. However, the BMW Response Center may still be able to hear you.

Initiating an Emergency Request automatically

Under certain conditions, an Emergency Request is automatically initiated immediately after a severe accident. Automatic Collision Notification is not affected by pressing the SOS button.

Warning triangle



The warning triangle is located in a holder in the trunk lid. Press the tabs to take it out.

First aid kit

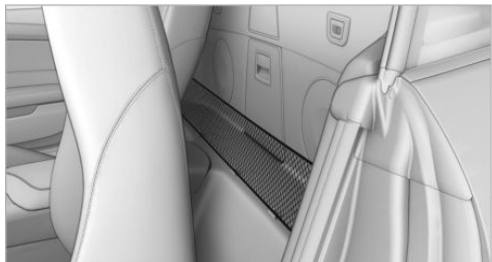

The first aid pouch is located on the lateral storage shelf behind the seats.

Some of the articles contained in the first aid pouch have a limited service life.

Check the expiration dates of the contents regularly and replace any items promptly.

Jump-starting

Notes

If the battery is discharged, an engine can be started using the battery of another vehicle and two jumper cables. Only use jumper cables with fully insulated clamp handles.

To prevent personal injury or damage to both vehicles, adhere strictly to the following procedure.



Do not touch live parts

To avoid the risk of potentially fatal injury, always avoid all contact with electrical components while the engine is running. ◀

Preparation

1. Check that the battery of the other vehicle has a voltage of 12 V. This information can be found on the battery.
2. Switch off the engine of the assisting vehicle.
3. Switch off any electronic systems/power consumers in both vehicles.



Bodywork contact between vehicles

Make sure that there is no contact between the bodywork of the two vehicles; otherwise, there is the danger of short circuits. ◀

Starting aid terminals



Connecting order

Connect the jumper cables in the correct order; otherwise, there is the danger of injury from sparking. ◀

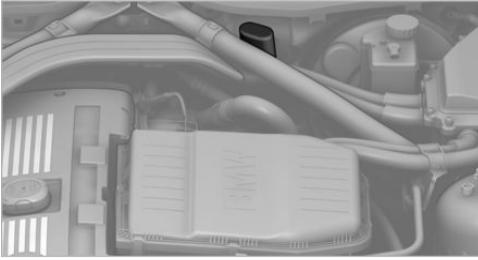

The so-called starting aid terminal in the engine compartment acts as the battery's positive terminal.

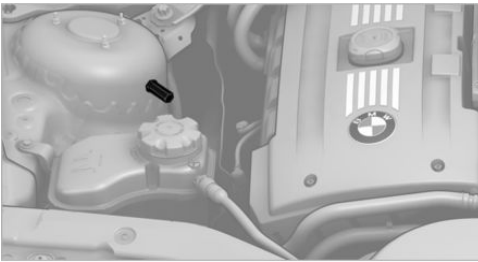

The body ground or a special nut acts as the negative terminal.

Connecting jumper cables

1. Pull off the cap of the BMW starting aid terminal.
2. Attach one terminal clamp of the positive jumper cable to the positive terminal of the battery, or to the corresponding starting aid terminal of the vehicle providing assistance.
3. Attach the other end of the cable to the positive terminal of the battery, or to the corresponding starting aid terminal of the vehicle to be started.
4. Attach one terminal clamp of the negative jumper cable to the negative terminal of the battery, or to the corresponding engine or body ground of the vehicle providing assistance.
5. Attach the other end of the cable to the negative terminal of the battery, or to the

corresponding engine or body ground of the vehicle to be started.

Starting the engine

Never use spray fluids to start the engine.

1. Start the engine of the assisting vehicle and let it run for several minutes at an increased idle speed.

If the vehicle being started has a diesel engine: let the engine of the assisting vehicle run for approx. 10 minutes.

2. Start the engine of the vehicle being started in the usual way.

If the first starting attempt is not successful, wait a few minutes before making another attempt in order to allow the discharged battery to recharge.

3. Let both engines run for several minutes.
4. Disconnect the jumper cables in the reverse order.

Check the battery and recharge if necessary.

Tow-starting and towing

Sport automatic transmission: transporting your vehicle

Note

Your vehicle is not permitted to be towed. Therefore, contact a service center in the event of a breakdown.



Observe in the event of a breakdown

Have the vehicle transported on a loading platform only, or damage may occur. ◀

Tow truck

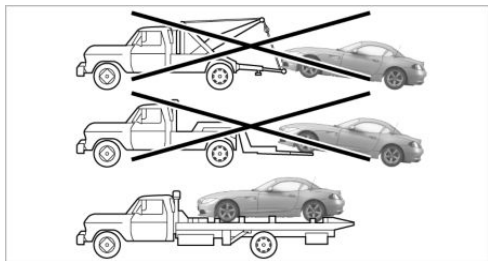

-  Do not lift the vehicle
- Do not lift the vehicle by the tow fitting or body and chassis parts; otherwise, damage may result. ◀

Use the tow fitting screwed in at the front for maneuvering the vehicle only.

7-gear Sport automatic transmission

Vehicles with a 7-gear Sport automatic transmission with a dual clutch can be towed for short distances if the following instructions are adhered to.

Manually release the transmission lock, refer to page 69.

-  Manually release the transmission lock
- Manually release the transmission lock, even if there is no malfunction involving the transmission. Otherwise, there is the danger that the transmission lock will be engaged automatically during towing. ◀

-  Adhere to the towing speed and distance
- Do not exceed a towing speed of 30 mph/50 km/h and a towing distance of 30 miles/50 km or damage to the transmission can occur. ◀

-  Blocked parking brake
- The parking brake cannot be released manually.

When the parking brake is blocked, do not tow the vehicle or else it may be damaged.

Contact your service center. ◀

-  Follow the towing instructions
- Follow all towing instructions, or vehicle damage or accidents may occur. ◀

- ▷ Make sure that the ignition is switched on; otherwise, the low beams, tail lights, turn signals, and windshield wipers may be unavailable.
- ▷ Do not tow the vehicle with the rear axle tilted, as the front wheels could turn.
- ▷ When the engine is stopped, there is no power assist. Consequently, more force needs to be applied when braking and steering.
- ▷ Larger steering wheel movements are required.
- ▷ The towing vehicle must not be lighter than the vehicle being towed; otherwise, it will not be possible to control the vehicle response.

-  Secure the vehicle against rolling off
- Apply the parking brake after towing and secure the vehicle against rolling off if necessary.

Have the operability of transmission position P checked by the service center. ◀

Manual transmission

Observe before towing your vehicle

Gearshift lever in neutral position.

Being towed

-  Blocked parking brake
- The parking brake cannot be released manually.

When the parking brake is blocked, do not tow the vehicle or else it may be damaged.

Contact your service center. ◀



Follow the towing instructions

Follow all towing instructions, or vehicle damage or accidents may occur. ◀

- ▶ Make sure that the ignition is switched on; otherwise, the low beams, tail lights, turn signals, and windshield wipers may be unavailable.
- ▶ Do not tow the vehicle with the rear axle tilted, as the front wheels could turn.
- ▶ When the engine is stopped, there is no power assist. Consequently, more force needs to be applied when braking and steering.
- ▶ Larger steering wheel movements are required.
- ▶ The towing vehicle must not be lighter than the vehicle being towed; otherwise, it will not be possible to control the vehicle response.

Tow truck

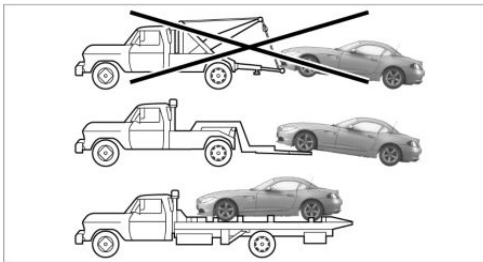

Have your vehicle transported with a tow truck with a so-called lift bar or on a flat bed.



Do not lift the vehicle

Do not lift the vehicle by the tow fitting or body and chassis parts; otherwise, damage may result. ◀

Towing other vehicles

General information



Light towing vehicle

The towing vehicle must not be lighter than the vehicle being towed; otherwise, it will not be possible to control the vehicle response. ◀



Attaching the tow bar/tow rope correctly

Attach the tow bar or tow rope to the tow fitting; connecting it to other vehicle parts may cause damage. ◀

- ▶ Switch on the hazard warning system, depending on local regulations.
- ▶ If the electrical system has failed, clearly identify the vehicle being towed by placing a sign or a warning triangle in the rear window.

Tow bar

The tow fittings used should be on the same side on both vehicles.

Should it prove impossible to avoid mounting the tow bar at an offset angle, please observe the following:

- ▶ Maneuvering capability is limited during cornering.
- ▶ The tow bar will generate lateral forces if it is secured with an offset.

Tow rope

When starting to tow the vehicle, make sure that the tow rope is taut.

To avoid jerking and the associated stresses on the vehicle components when towing, always use nylon ropes or nylon straps.



Attaching the tow rope correctly

Only secure the tow rope on the tow fitting; otherwise, damage can occur when it is secured on other parts of the vehicle. ◀

Tow fitting

The screw-in tow fitting should always be carried in the vehicle. It can be screwed in at the front or rear of the BMW.

It is stored in the onboard vehicle tool kit under the cargo floor panel, refer to page 243.



Tow fitting, information on use

- ▶ Use only the tow fitting provided with the vehicle and screw it all the way in.
- ▶ Use the tow fitting for towing on paved roads only.
- ▶ Avoid lateral loading of the tow fitting, e.g., do not lift the vehicle by the tow fitting.

Otherwise, damage to the tow fitting and the vehicle can occur. ◀

Screw thread

Front

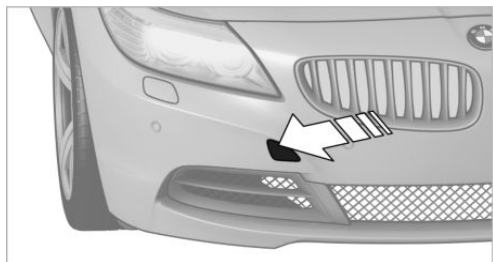

Release the cover panel in the bumper:

Press on the recess at the bottom left in the cover panel.

Rear



Release the cover panel in the bumper:

Press on the recess at the bottom center in the cover panel.

Tow-starting

Sport automatic transmission

Do not tow-start the vehicle.

Due to the Sport automatic transmission, the engine cannot be started by tow-starting.

Have the cause of the starting difficulties remedied.

Manual transmission

If possible, do not tow-start the vehicle but start the engine by jump-starting, refer to page 250, it. If the vehicle is equipped with a catalytic converter, only tow-start while the engine is cold.

1. Switch on the hazard warning system; .
2. Switch on the ignition, refer to page 55.
3. Shift into 3rd gear.
4. Have the vehicle tow-started with the clutch pressed and slowly release the clutch. After the engine starts, immediately depress the clutch completely again.
5. Stop at a suitable location, remove the tow bar or rope, and switch off the hazard warning system.
6. Have the vehicle checked.

Care

Vehicle equipment

This chapter describes all series equipment as well as country-specific and special equipment offered for this model series. Therefore, it also describes equipment that may not be found in your vehicle, for instance due to the selected special equipment or the country version. This also applies to safety-related functions and systems.

When using the features and systems described here, adhere to local regulations.

Car washes

Notes

 Steam jets or high-pressure washers
When using steam jets or high-pressure washers, hold them a sufficient distance away and use a maximum temperature of 140 °F/60 °C.

Holding them too close or using excessively high pressures or temperatures can cause damage or preliminary damage that may then lead to long-term damage.

Follow the operating instructions for the high-pressure washer. ◀

 Cleaning sensors/cameras with high-pressure washers

When using high-pressure washers, do not spray the seals of the retractable hardtop and the exterior sensors and cameras, for Park Distance Control, for instance, for extended periods of time and only from a distance of at least 12 in/30 cm. ◀

Regularly remove foreign bodies, such as leaves, from the area below the windshield when the hood is open.

Wash your vehicle frequently, particularly in winter.

Intense soiling and road salt can damage the vehicle.

Washing in automatic car washes

Give preference to cloth car washes or those that use soft brushes in order to avoid paint damage.

Notes

Note the following:

- ▷ Make sure that the wheels and tires are not damaged by the transport mechanisms.
- ▷ Fold in the exterior mirrors; otherwise, they may be damaged, depending on the width of the vehicle.
- ▷ Deactivate the rain sensor, refer to page 62, to avoid unintentional wiper activation.
- ▷ Unscrew the road antenna.

 Guide rails in car washes
Avoid car washes with guide rails higher than 4 in/10 cm; otherwise, the vehicle body could be damaged. ◀

Before driving into a car wash

The vehicle is able to roll if the following steps are taken.

Manual transmission

1. Shift to neutral.
2. Release the parking brake, refer to page 59.
3. Switch the engine off.
4. Leave the remote control in the ignition lock.

Sport automatic transmission

1. Insert the remote control into the ignition lock, even with Comfort Access.
2. Release the parking brake, refer to page 59.
3. Drive into the car wash.
4. Engage transmission position N.
5. Switch the engine off.
6. Leave the remote control in the ignition lock so that the vehicle can roll.

When starting the engine:

1. Depress the brake pedal.
2. Press the Start/Stop button.

Transmission position P is engaged automatically:

- ▷ Automatically after approx. 30 minutes.
- ▷ When the remote control is removed from the ignition lock.

Headlights

- ▷ Do not rub dry and do not use abrasive or caustic cleansers.
- ▷ Soak areas that have been soiled e.g. due to insects, with shampoo and wash off with water.
- ▷ Thaw ice with de-icing spray; do not use an ice scraper.

Retractable hardtop

When you open a wet hardtop, water drops may run into the cargo area. If necessary, remove items from the cargo area beforehand to avoid water stains or soiling.

After washing the vehicle

After washing the vehicle, apply the brakes briefly to dry them; otherwise, braking action can be reduced and corrosion of the brake discs can occur.

Fully remove any residue from the windows to prevent obstruction of view from streaking, wiping noises, and wiper wear.

Vehicle care

Car care products

BMW recommends using cleaning and care products from BMW, since these have been tested and approved.



Car care and cleaning products

Follow the instructions on the container.

When cleaning the interior, open the doors or windows.

Only use products intended for cleaning vehicles.

Cleansers can contain substances that are dangerous and harmful to your health. ◀

Vehicle paint

Regular care contributes to driving safety and value retention. Environmental influences in areas with high air pollution or natural contaminants, such as tree resin or pollen, can have an impact on the vehicle paint. Tailor the frequency and extent of your car care to these influences.

Immediately remove aggressive substances, such as spilled fuel, oil, grease, or bird droppings, to prevent damage to or discoloration of the paintwork.

Leather care

Remove dust from the leather often, using a cloth or vacuum cleaner.

Otherwise, particles of dust and road grime chafe in pores and folds, and lead to increased wear and premature degradation of the leather surface.

To guard against discoloration, such as from clothing, provide leather care roughly every two months.

Clean light-colored leather more frequently as dust and dirt are more noticeable.

Use leather care products; otherwise, dirt and grease will gradually break down the protective layer of the leather surface.

Suitable care products are available from the service center.

Upholstery material care

Vacuum regularly with a vacuum cleaner.

If they are very dirty, e.g., beverage stains, use a soft sponge or microfiber cloth with a suitable interior cleaner.

Clean the upholstery down to the seams using large sweeping motions. Avoid rubbing the material vigorously.



Damage from Velcro® fasteners

Open Velcro® fasteners on pants or other articles of clothing can damage the seat covers. Ensure that any Velcro® fasteners are closed. ◀

Caring for special components

Light-alloy wheels

When cleaning the wheels on the vehicle, only use a neutral wheel rim cleaner with a pH value of 5 to 9. Do not use abrasive cleaners or a steam jet hotter than 140 °F/60 °C; otherwise, damage may result. Adhere to the manufacturer instructions.

Aggressive, acidic, or alkaline cleaners may destroy the protective coating of neighboring components such as the brake disc.

Chrome surfaces

Carefully clean components such as the radiator grille or door handles with an ample supply of water, possibly with shampoo added, particularly when they have been exposed to road salt.

Rubber components

Aside from water, treat only with rubber cleansers.

When cleaning rubber seals, do not use any silicon-containing car care products in order to avoid damage or reduced noise damping.

Fine wood parts

Clean fine wood facing and fine wood components only with a moist rag. Then dry with a soft cloth.

Plastic components

These include:

- ▷ Imitation leather surfaces.
- ▷ Headliner.
- ▷ Lamp lenses.
- ▷ Instrument cluster cover.
- ▷ Matte black spray-coated components.
- ▷ Painted parts in the interior.

Clean with a microfiber cloth.

Moisten the cloth lightly with water if necessary.

Do not soak the headliner.



Do not use cleansers that contain alcohol or solvents

Do not use cleansers that contain alcohol or solvents, such as lacquer thinners, heavy-duty grease removers, fuel, or such; this could lead to surface damage. ◀

Safety belts

Dirty belt straps impede the reeling action and thus have a negative impact on safety.



No chemical cleaning

Do not clean chemically; this can destroy the webbing. ◀

Use only a mild soapy solution, with the safety belts clipped into their buckles.

Do not allow the reels to retract the safety belts until they are dry.

Carpets and floor mats

 No objects in the area around the pedals

Keep floor mats, carpets, and any other objects out of the area of motion of the pedals; otherwise, the function of the pedals could be impeded while driving

Do not place additional floor mats over existing mats or other objects.

Only use floor mats that have been approved for the vehicle and can be properly fixed in place.

Ensure that the floor mats are securely fastened again when they are returned after being removed, such as for cleaning. ◀

Floor mats can be removed from the passenger compartment for cleaning.

When returning the floor mats, secure them again to prevent slipping.

If the floor carpets are very dirty, clean with a microfiber cloth and water or a textile cleaner. To prevent matting of the carpet, rub back and forth in the direction of travel only.

 Cleaning the interior

When cleaning the interior, do not move both seats all the way forward while moving them to their uppermost position and leaning the backrests forward. Otherwise, the seats could hit and damage the seal on the windshield and the sun visor. ◀

Sensors/cameras

To clean the sensors or cameras of equipment such as the High-beam Assistant or Park Distance Control PDC, use a cloth moistened with a small amount of glass cleaner.

Displays/screens

Clean the displays with an anti-static microfiber cloth.



Cleaning displays

Do not use chemical or household cleansers.

Keep all fluids and moisture away from the unit.

Otherwise, they could affect or damage surfaces or electrical components.

Avoid pressing too hard when cleaning and do not use abrasive materials; otherwise, damage can result. ◀

Long-term vehicle storage

Your service center can advise you on what to consider when storing the vehicle for longer than three months.



Reference

This chapter contains technical data, short commands for the voice activation system, and an index that will quickly take you to the information you need.

Technical data

Vehicle equipment

This chapter describes all series equipment as well as country-specific and special equipment offered for this model series. Therefore, it also describes equipment that may not be found in your vehicle, for instance due to the selected

special equipment or the country version. This also applies to safety-related functions and systems.

When using the features and systems described here, adhere to local regulations.

Note

The technical data and specifications in the Owner's Manual serve as guidelines. Detailed values can be obtained from your registration

documents, from labels in your vehicle, or from the service center.

Dimensions

BMW Z4

Width with mirrors	inches/mm	76.8/1,951
Width without mirrors	inches/mm	70.5/1,790
Height	inches/mm	50.8/1,291
Height Z4 sDrive35is	inches/mm	50.6/1,284
Length	inches/mm	166.9/4,239
Length Z4 sDrive35is	inches/mm	167.1/4,244
Wheelbase	inches/mm	98.3/2,496
Smallest turning circle dia.	ft/m	35.1/10.7

Weights

		Z4 sDrive28i	Z4 sDrive35i	Z4 sDrive35is
Approved gross vehicle weight				
Manual transmission	lbs/kg	3,858/1,750	—	—

		Z4 sDrive28i	Z4 sDrive35i	Z4 sDrive35is
Automatic transmission	lbs/kg	3,924/1,780	4,178/1,895	4,178/1,895
Load	lbs/kg	562/255	562/255	562/255
Approved front axle load	lbs/kg	1,742/790	1,918/870	1,918/870
Approved rear axle load	lbs/kg	2,227/1,010	2,293/1,040	2,293/1,040
Cargo area capacity	cu ft/	10.9/	10.9/	10.9/
	liters	310	310	310

Capacities

			Notes
Fuel tank	US gal/liters	Approx. 14.5/55	Fuel recommendation, refer to page 224

Short commands of the voice activation system

Vehicle equipment

This chapter describes all series equipment as well as country-specific and special equipment offered for this model series. Therefore, it also describes equipment that may not be found in your vehicle, for instance due to the selected special equipment or the country version. This also applies to safety-related functions and systems.

When using the features and systems described here, adhere to local regulations.

Adjusting

Vehicle

Function	Command
Opens the main menu.	›Main menu‹
Open the options.	›Options‹
Open the settings.	›Settings‹
Settings on the Control Display.	›Control display‹
Open the time and date.	›Time and date‹
Open the language and units.	›Language and units‹
Open the speed limit.	›Speed‹
Open the light.	›Lighting‹
Open the door lock.	›Door locks‹

General information

Instructions for voice activation system, refer to page 25.

To have the available spoken instructions read out loud: ›Voice commands‹

The following short commands apply to vehicles equipped with a voice activation system. They have no function in vehicles in which only the mobile phone is operated using the voice.

Vehicle information

Computer

Function	Command
Open the computer.	›Onboard info‹
Open the trip computer.	›Trip computer‹

Vehicle

Function	Command
Open the vehicle information.	›Vehicle info‹
Open the vehicle status.	›Vehicle status‹

Navigation

General information

Function	Command
Navigation menu.	›Navigation‹
Open the destination entry.	›Enter address‹
Enter the address.	›Enter address‹
Enter the town/city.	›City‹
Enter the country.	›State‹
Enter the postal code.	›Postal Code‹
Open destination guidance.	›Guidance‹
Start destination guidance.	›Start guidance‹
Terminate destination guidance.	›Stop guidance‹
Open the home address.	›Home address‹
Open the route criteria.	›Route preference‹
Open the route.	›Route information‹
Switch on the spoken instruction.	›Switch on voice instructions‹

Function	Command
Repeat the spoken instruction.	›Repeat voice instructions‹
Switch off the spoken instruction.	›Switch off voice instructions‹
Display the address book.	›Address book‹
Display the most recent destinations.	›Last destinations‹
Open the traffic bulletins.	›Traffic Info‹
Special destinations.	›Points of interest‹

Map

Function	Command
Display the map.	›Map‹
Map facing north.	›Map facing north‹
Map facing the direction of travel.	›Map in direction of travel‹
Perspective map.	›Map perspective view‹
Automatic scaling of the map.	›Map with automatic scaling‹
Scale...feet.	›Map scale ... feet‹
Scale...meters.	›Map scale ... meters‹ e.g., map scale 100 meters
Scale...kilometers.	›Map scale ... kilometers‹ e.g., map scale 5 kilometers
Scale...miles.	›Map scale ... miles‹ e.g., map scale 5 miles

Split screen settings

Function	Command
Split screen.	›Switch on splitscreen‹
Switch off the split screen.	›Turn off split screen‹
Adjust the split screen.	›Split screen content‹
Split screen, map facing north.	›Split screen map facing north‹
Split screen, current position.	›Split screen current position‹

Function	Command
Split screen, facing the direction of travel.	›Split screen map in direction of travel‹
Split screen, perspective.	›Split screen perspective‹
Split screen, expanded intersection zoom.	›Splitscreen Exit ramp view‹
Split screen scale...feet.	›Split screen scale ... feet‹ e.g., split screen scale 100 feet
Split screen scale...meters.	›Split screen scale ... meters‹ e.g., split screen scale 100 meters
Split screen scale...kilometers.	›Split screen scale ... kilometers‹ e.g., split screen scale 5 kilometers
Split screen scale...miles.	›Split screen scale ... miles‹ e.g., split screen scale 5 miles
Split screen, highlight the traffic situation.	›Split screen, Traffic conditions‹
Split screen, computer.	›Split screen on board info‹
Split screen, trip computer.	›Splitscreen trip computer‹
Split screen, scale automatically.	›Split screen automatic scaling‹

Destination guidance with intermediate destinations

Function	Command
Enter a new destination.	›Enter address‹
Trip list.	›Stored trips‹

Radio

FM

Function	Command
Open a frequency.	›Frequency ... megahertz‹ e.g., 93.5 megahertz or frequency 93.5
Open the radio.	›Radio‹
Open the FM stations.	›F M‹

Function	Command
Open the manual search.	›Manual‹
Select a frequency range.	›Select frequency‹
Open a station.	›Select station‹

AM

Function	Command
Open a frequency.	›Frequency ... Kiloherzt‹ e.g., frequency 753 or 753 kilohertz
Open the AM stations.	›A M‹
Open the manual search.	›Manual‹

Satellite radio

Function	Command
Open the satellite radio.	›Satellite radio‹
Switch on the satellite radio.	›Satellite radio on‹
Select a satellite radio channel.	›Select satellite radio‹ e.g., satellite radio channel 2

Stored stations

Function	Command
Open the stored stations.	›Presets‹
Choose a stored station.	›Select preset‹
Select a stored station.	›Preset ...‹ e.g., stored station 2

CD/multimedia

CD/DVD drive

Function	Command
Select a track.	›Track ...‹ e.g., track 5 or ›C D track ...‹ e. g., CD track 5
Play back a CD.	›C D on‹
Select a CD.	›Select C D‹
Select a CD and track.	›C D ... track ...‹ e.g., CD 3 track 5
Open the CD and Multimedia menu.	›C D and multimedia‹
CD and DVD.	›C D‹
Select a DVD.	›D V D ...‹ e.g., DVD 3
Display the entertainment details on a split screen.	›Entertainment details‹

Music collection

Function	Command
Search for music, open a menu.	›Music search‹
Open the current playback.	›Current playback‹
Open the music collection.	›Music collection‹
Play back the music collection.	›Music collection on‹
Play back the most frequently played tracks.	›Top fifty‹

External devices

Function	Command
Open the external devices.	›External devices‹
Open the Bluetooth devices.	›Bluetooth‹

Tone

Function	Command
Open the tone settings.	›Tone‹

Telephone

Function	Command
Dial a phone number.	›Dial number‹
Open the Telephone menu.	›Telephone‹
Display the phone book.	›Phonebook‹
Redialing.	›Redial‹
Display received calls.	›Received calls‹
List of messages.	›Messages‹
Open the Bluetooth devices.	›Bluetooth‹

Office

Function	Command
Open the Office menu.	›Office‹
Display Office Today.	›Current office‹
Display the contacts.	›Contacts‹
Display the messages.	›Messages‹
Display the calendar.	›Calendar‹
Display the tasks.	›Tasks‹
Display the reminders.	›Reminders‹

Contacts

Function	Command
Select a name.	›Choose name‹
My contacts.	›My contacts‹
Open the contacts.	›Contacts‹
New contact.	›New contact‹

ConnectedDrive or BMW Assist

Function	Command
Open BMW Assist.	›B M W Assist‹
Open ConnectedDrive.	›Connected Drive‹
Open BMW Online.	›B M W Online‹

Everything from A to Z

Index

A

- ABS, Antilock Brake System **99**
- Acceleration assistant, Launch Control **68**
- Accident, refer to Emergency Request, initiating **249**
- Activated charcoal filter with automatic climate control **113**
- Adaptive brake light, refer to Brake force display **98**
- Adaptive Light Control **86**
- Additional telephone **192**
- Additives
 - Coolant **239**
- Additives, oil **238**
- After washing vehicle **256**
- Airbags **90**
- Airbags
 - Indicator/warning lamps **92**
- Air circulation, refer to Recirculated air mode **108, 112**
- Air conditioner **108**
- Air conditioning mode
 - Air conditioner **108**
 - Automatic climate control **110**
 - Ventilation **109, 112**
- Air distribution
 - Automatic **111**
 - Individual **108**
 - Manual **108**
- Air flow rate **108, 111**
- Airing, refer to Ventilation **109, 112**
- Air outlets, refer to Air vents **107**
- Air pressure, refer to Tire inflation pressure **226**
- Air supply
 - Air conditioner **108**
 - Automatic climate control **110**
 - Ventilation **109, 112**
- Air vents **107**
- Air vents
 - Refer to Ventilation **109, 112**
- Alarm system **39**
- Alarm system
 - Avoiding unintentional alarms **40**
 - Ending an alarm **39**
 - Interior motion sensor **40**
 - Tilt alarm sensor **40**
- All around the headliner **17**
- All-season tires, refer to Winter tires **233**
- Alternating-code hand-held transmitter **115**
- Alternative oil types **238**
- AM/FM station **162**
- Announcement, navigation, refer to Spoken instructions **151**
- Antifreeze
 - Coolant **239**
 - Washer fluid **62**
- Antilock Brake System, ABS **99**
- Anti-slip control, refer to DSC **99**
- Anti-theft protection **32**
- Anti-theft protection, lug bolts **247**
- Appointments **208**
- Approved axle loads, refer to Weights **262**
- Approved engine oils **238**
- Approved gross vehicle weight, refer to Weights **262**
- Armrest, refer to Center armrest **122**
- Arrival time, refer to Computer **73**
- Ashtray **118**
- Assistance systems, refer to Driving stability control systems **99**
- Assistance when driving off **102**
- Audio device, external **123**
- Audio playback **171**
- Audio playback, Bluetooth **183**
- Automatic air distribution **111**
- Automatic air flow rate **111**
- Automatic car wash **255**
- Automatic climate control **107, 110**
- Automatic climate control
 - Automatic air distribution **111**
- Automatic cruise control **103**
- Automatic Curb Monitor **50**
- Automatic Engine Start/Stop Function **57**
- Automatic headlamp control **86**
- Automatic recirculated air control **112**
- Automatic transmission
 - 7-gear with dual clutch **65**
 - 8-gear **63**
- AUTO program with automatic climate control **111**
- AUX-IN port **123, 180**
- Average fuel consumption **73**

Average fuel consumption
 – Setting the units **76**
 Average speed **73**
 Axle loads, refer to
 Weights **262**

B

Backrest curvature, refer to
 Lumbar support **47**
 Backrests, refer to Seat ad-
 justment **46**
 Backrest width adjust-
 ment **48**
 Backup lights
 – Bulb replacement **245, 246**
 Balance **160**
 Band-aids, refer to First aid
 kit **250**
 Bass **160**
 Battery
 – Disposal **39, 248**
 – Power failure **247**
 – Remote control **30**
 – Replacement in the remote
 control **39**
 – Replacement, vehicle bat-
 tery **247**
 – Vehicle **247**
 Before entering the car
 wash **255**
 Belts, refer to Safety belts **48**
 Belt tensioners, refer to
 Safety belts **48**
 Beverage holder, refer to Cu-
 pholder **124**
 Black and white map dis-
 play **154**
 Blower, refer to Air flow
 rate **108, 111**
 Bluetooth audio **183**
 Bluetooth connection, acti-
 vating/deactivating **193**
 BMW Apps **218**
 BMW EfficientDynamics, re-
 fer to Saving fuel **132**
 BMW Homepage **6**
 BMW Internet page **6**
 BMW Maintenance Sys-
 tem **241**
 BMW Online **216**
 Bottle holder, refer to Cu-
 pholder **124**
 Brake assistant, refer to Dy-
 namic Brake Control **99**
 Brake discs, breaking in **128**
 Brake force display **98**
 Brake force distribution, elec-
 tronic **99**
 Brake lamps
 – Brake force display **98**
 Brake lights
 – Bulb replacement **245, 246**
 Brake lights, adaptive **98**
 Brake pads, breaking in **128**
 Brakes
 – ABS **99**
 Braking
 – Notes **129**
 – Parking brake **59**
 Braking safely **129**
 Breakdown assistance, refer
 to Roadside Assistance **215**
 Breaking in **128**
 Brightness of Control Dis-
 play **78**
 Bulbs, replacing, refer to
 Lamps and bulbs **243**
 Button for starting the engine,
 refer to Start/Stop but-
 ton **55**
 Buttons on the steering
 wheel **12**
 Bypassing, see Starting
 aid **250**

C

Calendar **208**
 California Proposition 65
 Warning **7**
 Camera, care **258**
 Can holder, refer to Cu-
 pholder **124**

Capacities **263**
 Capacities
 – Cargo area, refer to
 Weights **262**
 – Fuel tank, refer to Filling ca-
 pacities **263**
 Car battery **247**
 Car care products **256**
 Care **255**
 Care, displays **258**
 Care, vehicle **256**
 Cargo **130**
 Cargo area **119**
 Cargo area
 – Capacity **262**
 – Comfort Access **38**
 – Lamp, refer to Interior
 lamps **89**
 – Opening from the inside **36**
 – Opening from the out-
 side **36**
 Cargo area capacity, enlarg-
 ing **119**
 Cargo, securing **120**
 Cargo straps, securing
 cargo **132**
 Car key, refer to Integrated
 key/remote control **30**
 Carpet, care **258**
 Car phone
 – Installation location, refer to
 Center armrest **122**
 Car phone, refer to Tele-
 phone **192**
 Car vacuum cleaner, connect-
 ing, refer to Connecting
 electrical devices **118**
 Car wash **255**
 Car wash
 – With Comfort Access **38**
 Catalytic converter, refer to
 Hot exhaust system **129**
 CBS Condition Based Serv-
 ice **241**
 CD/DVD **170**
 CD/DVD notes **174**
 CDs, storing **175**
 Cell phone **192**

- Center armrest [122](#)
 - Center brake light
 - Bulb replacement [246](#)
 - Center console, refer to Around the center console [16](#)
 - Central locking
 - Comfort Access [37](#)
 - From the inside [35](#)
 - Setting the unlocking characteristics [32](#)
 - Central locking system
 - From the outside [31](#)
 - Principle [31](#)
 - Central screen, refer to Control Display [18](#)
 - Changes, technical, refer to Safety [6](#)
 - Changing wheels/tires [232](#)
 - Chassis number, refer to Engine compartment [235](#)
 - Check Control [82](#)
 - Children, transporting safely [53](#)
 - Child restraint fixing system [53](#)
 - Child seats, refer to Transporting children safely [53](#)
 - Chrome parts, care [257](#)
 - Cigarette lighter, refer to Lighter [118](#)
 - Circulation of air, refer to Recirculated air mode [108](#), [112](#)
 - Cleaning, displays [258](#)
 - Cleaning your BMW, refer to Care [255](#)
 - Clock [71](#)
 - Clock
 - 12h/24h format [77](#)
 - Setting the time and date [76](#)
 - Closing
 - From the inside [35](#)
 - From the outside [32](#)
 - Cockpit [12](#)
 - Cold start, refer to Starting the engine [56](#)
 - Combination instrument, refer to Instrument cluster [14](#)
 - Combination switch
 - Refer to Washer/wiper system [61](#)
 - Combination switch, refer to Turn signal, high beams, headlamp flasher [60](#)
 - Comfort Access [37](#)
 - Comfort Access
 - Battery replacement [39](#)
 - In a car wash [38](#)
 - Comfort area, refer to Around the center console [16](#)
 - COMFORT program, Dynamic Driving Control [101](#)
 - Compartment for remote control, refer to Ignition lock [55](#)
 - Compartments, refer to Storage compartments [123](#)
 - Compass [116](#)
 - Computer [73](#)
 - Computer
 - Displays on the Control Display [73](#)
 - Concierge service [215](#)
 - Condensation under the vehicle [130](#)
 - Condition Based Service CBS [241](#)
 - Confirmation signals for locking/unlocking the vehicle [34](#)
 - Connecting, mobile phone, refer to Pairing the mobile phone [193](#)
 - Consumption, refer to Average fuel consumption [73](#)
 - Contacts [204](#), [212](#)
 - Control Display [18](#)
 - Control Display, care [258](#)
 - Control Display, settings [78](#)
 - Controller [19](#)
 - Controls and displays [12](#)
 - Control systems, driving stability [99](#)
 - Convenient loading [33](#)
 - Convenient opening and closing
 - Retractable hardtop [33](#)
 - Window [33](#)
 - Convertible top, refer to Retractable hardtop [42](#)
 - Coolant [239](#)
 - Coolant
 - Checking the level [239](#)
 - Temperature [72](#)
 - Cooling, maximum [111](#)
 - Cooling system, refer to Coolant [239](#)
 - Corrosion on brake discs [130](#)
 - Courtesy lamps, refer to Interior lamps [89](#)
 - Cradle for telephone or mobile phone
 - Refer to Snap-in adapter in center armrest storage compartment [122](#)
 - Cradle for telephone or mobile phone, refer to Snap-in adapter [201](#)
 - Cruise control [103](#)
 - Cruise control
 - Malfunction [105](#)
 - Cupholder [124](#)
 - Curb weight, refer to Weights [262](#)
 - Current location, storing [142](#)
- ## D
- Damage, tires [231](#)
 - Dashboard lighting, refer to Instrument lighting [88](#)
 - Dashboard, refer to Cockpit [12](#)
 - Data, technical
 - Dimensions [262](#)
 - Filling capacities [263](#)
 - Weights [262](#)
 - Date
 - Date format [77](#)
 - Setting [77](#)
 - Daytime running lights [86](#)

- DBC Dynamic Brake Control [99](#)
- DCC, refer to Cruise control [103](#)
- Defogging windows [109](#)
- Defroster
- Rear window [109](#), [112](#)
- Defrosting windows [109](#)
- Destination entry via the address book [142](#)
- Destination guidance [149](#)
- Destination guidance with intermediate destinations [147](#)
- Destination input, navigation [140](#)
- Digital clock [71](#)
- Digital compass [116](#)
- Digital radio [163](#)
- Dimensions [262](#)
- Dimming mirrors [51](#)
- Directional indicators, refer to
- Turn signals [60](#)
- Display lighting, refer to Instrument lighting [88](#)
- Display, refer to Control Display [18](#)
- Displays and controls [12](#)
- Displays, care [258](#)
- Displays, cleaning [258](#)
- Displays, refer to Instrument cluster [14](#)
- Disposal
- Coolant [239](#)
 - Remote control battery [39](#)
 - Vehicle battery [248](#)
- Distance control, refer to PDC [105](#)
- Divided screen view, split screen [22](#)
- Door key, refer to Remote control with integrated key [30](#)
- Door lock [35](#)
- Doors, manual operation [35](#)
- Doors, unlocking and locking
- Confirmation signals [34](#)
 - From the inside [35](#)
 - From the outside [32](#)
- DOT Quality Grades [230](#)
- Draft-free ventilation [109](#), [112](#)
- Drive-off assistant [102](#)
- Drive-off assistant, refer to DSC [99](#)
- Driving notes, breaking in [128](#)
- Driving notes, general [128](#)
- Driving stability control systems [99](#)
- Driving tips [128](#)
- DSC Dynamic Stability Control [99](#)
- DTC Dynamic Traction Control [100](#)
- DTMF suffix dialing [198](#)
- DVD/CD [170](#)
- DVDs, storing [175](#)
- DVD, video [172](#)
- Dynamic Brake Control DBC [99](#)
- Dynamic destination guidance [156](#)
- Dynamic Driving Control [100](#)
- Dynamic Stability Control DSC [99](#)
- Dynamic Traction Control DTC [100](#)
- ## E
- EBV electronic brake-force distribution [99](#)
- EfficientDynamics, refer to Saving fuel [132](#)
- Electrical fault
- 7-gear automatic transmission [69](#)
- Electrical malfunction
- Door lock [35](#)
 - Driver's door [35](#)
 - Fuel filler flap [222](#)
- Electric seat adjustment [47](#)
- Electronic brake-force distribution [99](#)
- Electronic engine oil level check [236](#)
- Electronic Stability Program ESP, refer to DSC [99](#)
- Emergency operation
- Fuel filler flap, unlocking manually [222](#)
- Emergency Request [249](#)
- Emergency unlocking
- Trunk lid, from the inside [37](#)
- Energy, saving
- Automatic Engine Start/Stop Function [57](#)
- Engine compartment [235](#)
- Engine coolant, refer to Coolant [239](#)
- Engine oil, adding [238](#)
- Engine oil additives [238](#)
- Engine oil, checking the level [236](#)
- Engine oil temperature [72](#)
- Engine oil types, alternative [238](#)
- Engine oil types, approved [238](#)
- Engine, overheating, refer to Coolant temperature [72](#)
- Engine start, Help [250](#)
- Engine, starting [56](#)
- Engine, starting
- Comfort Access [37](#)
 - Start/Stop button [55](#)
- Engine, stopping, Start/Stop button [55](#)
- Engine, switching off [57](#)
- Engine temperature [72](#)
- Entry comparison [23](#)
- Entry lamps, refer to Interior lamps [89](#)
- Equalizer [160](#)
- Equipment, interior [114](#)
- Error messages, refer to Check Control [82](#)

ESP Electronic Stability Program, refer to DSC [99](#)
Exchanging wheels/tires [232](#)
Exhaust system [129](#)
Exterior mirrors [50](#)
Exterior mirrors
– Automatic dimming [51](#)
– Automatic heating [51](#)
– Folding in and out [51](#)
– Setting [50](#)
External audio device [123](#)
External devices [180](#)
External start [250](#)
External temperature display [71](#)
External temperature display
– Changing the unit of measure [76](#)
– On computer [76](#)
External temperature warning [71](#)
Eyes for securing cargo [132](#)

F

Fader [160](#)
Failure messages, refer to
 Check Control [82](#)
Failure of an electrical accessory [248](#)
False alarm
– Avoiding unintentional alarms [40](#)
– Ending an alarm [39](#)
Fastening safety belts, refer to Safety belts [48](#)
Fasten safety belts reminder
– Refer to Safety belt reminder [49](#)
Filter
– Refer to Microfilter/activated-charcoal filter with automatic climate control [113](#)
– Refer to Microfilter for air conditioner [109](#)
Fine wood, care [257](#)
First aid kit [250](#)

Flashing when locking/unlocking [34](#)
Flat tire, Flat Tire Monitor FTM [92](#)
Flat Tire Monitor
– Snow chains [233](#)
Flat Tire Monitor FTM [92](#)
Flat tire, Tire Pressure Monitor TPM [94](#)
Flat tire, warning lamp [93](#)
Flat tire, wheel change [246](#)
Flooding [129](#)
Floor carpet, care [258](#)
Floor mats, care [258](#)
FM/AM station [162](#)
Foot brake [129](#)
Footwell lamps, refer to Interior lamps [89](#)
For your own safety [6](#)
Front airbags [90](#)
FTM Flat Tire Monitor [92](#)
Fuel
– Recommendation [224](#)
– Refer to Average fuel consumption [73](#)
Fuel, average consumption [73](#)
Fuel consumption display
– Average fuel consumption [73](#)
Fuel display [72](#)
Fuel filler flap [222](#)
Fuel filler flap
– Unlocking in case of an electrical malfunction [222](#)
Fuel gauge [72](#)
Fuel tank capacity, refer to Filling capacities [263](#)
Fuel tank contents, refer to Filling capacities [263](#)
Fuses [248](#)

G

Garage door opener, refer to Universal garage door opener [114](#)

Gasoline
– Fuel recommendation [224](#)
Gasoline display [72](#)
Gas station recommendation [151](#)
Gear display
– 7-gear automatic transmission [66](#)
– 8-gear automatic transmission [65](#)
General driving notes [128](#)
Glove compartment [122](#)
GPS navigation, refer to Navigation system [138](#)
Grilles, refer to Air vents [107](#)
Gross vehicle weight, refer to Weights [262](#)

H

Hand-held transmitter, alternating code [115](#)
Hands-free microphone [16](#)
Hardtop [42](#)
Hazard warning system [16](#)
HD Radio [163](#)
Head airbags [90](#)
Headlamp control, automatic [86](#)
Headlamp courtesy delay feature [86](#)
Headlamp flasher [60](#)
Headlamp flasher, indicator lamp [15](#)
Headlamps, care [256](#)
Headlamps, cleaning [62](#)
Headliner [17](#)
Heating [107](#)
Heating
– Mirrors [51](#)
– Rear window [109](#), [112](#)
– Seats [48](#)
Heavy cargo, stowing [131](#)
Height adjustment
– Seats [46](#)
– Steering wheel [52](#)

Height, refer to Dimensions [262](#)
High-beam Assistant [87](#)
High beams [60](#), [87](#)
High beams/low beams, refer to High-beam Assistant [87](#)
High beams, headlamp flasher [87](#)
High beams, indicator lamp [15](#)
High-pressure washers [255](#)
Hills [130](#)
Hill start assistant, refer to Drive-off assistant [102](#)
Holder for beverages [124](#)
Holder for remote control, refer to Ignition lock [55](#)
Homepage [6](#)
Hood [236](#)
Horn [12](#)
Hot exhaust system [129](#)
Hotline [217](#)
House number, entering for navigation [141](#)
Hydroplaning [129](#)

I

Ice warning, refer to External temperature warning [71](#)
Icy roads, refer to External temperature warning [71](#)
Identification marks
– Tires [229](#)
iDrive [18](#)
iDrive
– Changing the date and time [76](#)
– Changing the units of measure and display format [76](#)
Ignition [56](#)
Ignition
– Switched off [56](#)
– Switched on [56](#)
Ignition key position 1, refer to Radio ready state [56](#)

Ignition key position 2, refer to Ignition on [56](#)
Ignition key, refer to Remote control with integrated key [30](#)
Ignition lock [55](#)
Indication of a flat tire [93](#)
Indicator and warning lamps [15](#)
Indicator and warning lights, Tire Pressure Monitor TPM [96](#)
Individual air distribution [108](#)
Inflation pressure, refer to Tire inflation pressure [226](#)
Inflation pressure warning, tires [92](#)
Information on the navigation data [138](#)
Initializing
– Compass, refer to Calibrating [117](#)
– Flat Tire Monitor FTM [93](#)
Installation location
– Telephone [122](#)
Instrument cluster [14](#)
Instrument lighting [88](#)
Instrument panel, refer to Instrument cluster [14](#)
Instruments, refer to Cockpit [12](#)
Integrated key [30](#)
Interactive map [145](#)
Interior equipment [114](#)
Interior lamps [89](#)
Interior lamps
– Remote control [33](#)
Interior motion sensor [40](#)
Interior rearview mirror [51](#)
Interior rearview mirror
– Automatic dimming [51](#)
– Compass [116](#)
Interior temperature, setting, refer to Air conditioner [108](#)
Interior temperature, setting, refer to Automatic climate control [110](#)

Intermediate destinations [147](#)
Intermittent wipe [61](#)
Internet page [6](#)
Intersection, entering for navigation [141](#)
Interval display, service requirements [78](#)
iPod/iPhone [181](#)

J

Jacking points [247](#)
Joystick, refer to iDrive [18](#)

K

Keyless Go, refer to Comfort Access [37](#)
Keyless opening and closing, refer to Comfort Access [37](#)
Key Memory, refer to Personal Profile [30](#)
Key, refer to Integrated key/remote control [30](#)
Kickdown
– 7-gear automatic transmission [67](#)
– 8-gear automatic transmission [63](#)
Knee airbag [90](#)

L

Lamps and bulbs, bulb replacement [243](#)
Lamps, replacing, refer to Lamps and bulbs [243](#)
Language on Control Display [78](#)
Lap-and-shoulder belt, refer to Safety belts [48](#)
Lashing eyes, securing cargo [132](#)
Launch Control, acceleration assistant [68](#)
Leather, care [256](#)

LED, light-emitting diodes [244](#)

Length, refer to Dimensions [262](#)

Letters and numbers, entering [23](#)

License plate light, bulb replacement [246](#)

Light [85](#)

Light-alloy wheels, care [257](#)

Light control [86](#)

Light-emitting diodes
LED [244](#)

Lighter [118](#)

Lighter
– Connecting electrical devices [118](#)

Lighting
– Instruments [88](#)
– Lamps and bulbs [243](#)

Light switch [85](#)

Limit, refer to Speed limit [83](#)

Load [131](#)

Loading [130](#)

Lockable lug bolts, refer to
Lug bolt lock [247](#)

Lock buttons, doors, refer to
Locking [36](#)

Locking
– From the inside [36](#)
– From the outside [33](#)
– Setting the confirmation signals [34](#)
– Without remote control, refer to Comfort Access [37](#)

Locking the vehicle
– From the inside [35](#)
– From the outside [32](#)

Low beams [85](#)

Low beams, automatic, refer to High-beam Assistant [87](#)

Lower back support, refer to
Lumbar support [47](#)

Lug bolt lock [247](#)

Lumbar support [47](#)

M

M/S, automatic transmission
– 7-gear [67](#)
– 8-gear [64](#)

Maintenance [241](#)

Maintenance requirements [241](#)

Maintenance, service requirements [78](#)

Maintenance system,
BMW [241](#)

Malfunction
– Door lock [35](#)
– Fuel filler flap [222](#)
– Parking brake [60](#)

Malfunction warnings, refer to
Check Control [82](#)

Manual air distribution [108](#)

Manual mode
– 7-gear automatic transmission [67](#)
– 8-gear automatic transmission [64](#)

Manual operation
– Door lock [35](#)
– Driver's door [35](#)
– Fuel filler flap [222](#)
– Transmission lock [69](#)

Manual transmission [63](#)

Map, destination entry [145](#)

Map display in black and white [154](#)

Map in split screen [153](#)

Map view [151](#)

Marking on approved tires [233](#)

Marking, run-flat tires [232](#)

Master key, refer to Remote control with integrated key [30](#)

Maximum cooling [111](#)

Maximum speed, winter tires [233](#)

Medical kit, refer to First aid kit [250](#)

Memory, refer to Seat and mirror memory [49](#)

Menus, of iDrive, operating [18](#)

Menus, refer to iDrive operating concept [19](#)

Message list, traffic bulletins [153](#)

Messages [206](#)

Microfilter
– For air conditioner [109](#)
– With automatic climate control [113](#)

Minimum tread depth, tires [231](#)

Mirror
– Mirror memory, refer to Seat and mirror memory [49](#)

Mirrors [50](#)

Mirrors
– Automatic Curb Monitor [50](#)
– Exterior mirrors [50](#)
– Folding in, before driving into a car wash [51](#)
– Heating [51](#)
– Interior rearview mirror [51](#)

Mobile communication devices in the vehicle [129](#)

Mobile phone, installation location, refer to Center armrest [122](#)

Mobile phone, refer to Telephone [192](#)

Modifications, technical, refer to Safety [6](#)

Monitor, refer to Control Display [18](#)

MP3 player [180](#)

Multimedia [170](#)

Music collection [175](#)

Music search [177](#)

Music, storing [175](#)

N

Navigation [138](#)

Navigation data [138](#)

Navigation data, updating [138](#)

Navigation system
– Destination entry by voice [146](#)

Nets, refer to Storage compartments [123](#)

Neutral cleaner, care [257](#)

New wheels and tires [232](#)

Notes [6](#), [209](#)

Nozzles, refer to Air vents [107](#)

Nozzles, refer to Ventilation [109](#), [112](#)

O

OBD Onboard Diagnostics [242](#)

Odometer [71](#)

Office [203](#)

Oil additives [238](#)

Oil change interval, service requirements [78](#)

Oil consumption [236](#)

Oil level [236](#)

Oil, refer to Engine oil [236](#)

Oil types, alternative [238](#)

Oil types, approved [238](#)

Old batteries, disposal [248](#)

Onboard computer, refer to Computer [73](#)

Onboard Diagnostics
OBD [242](#)

Onboard monitor, refer to Control Display [18](#)

Onboard vehicle tool kit [243](#)

Opening and closing
– Comfort Access [37](#)
– From the inside [35](#)
– From the outside [32](#)
– Using the door lock [35](#)
– Using the remote control [32](#)

Operating principle, iDrive [18](#)

Outside-air mode
– Automatic climate control [112](#)

Outside air, refer to Recirculated air mode [108](#), [112](#)

Overheating of engine, refer to Coolant temperature [72](#)

P

Paint, vehicle [256](#)

Pairing, mobile phone [193](#)

Park Distance Control
PDC [105](#)

Parked vehicle, condensation [130](#)

Parking aid, refer to PDC [105](#)

Parking brake [59](#)

Parking brake, refer to Parking brake [59](#)

Parking lamps [85](#)

Passenger airbags, deactivating [91](#)

Passenger side mirror, tilting [50](#)

PDC Park Distance Control [105](#)

Personal information [203](#)

Personal Profile [30](#)

Pinch protection
– Windows [41](#)

Plastic, care [257](#)

Pollen
– Refer to Microfilter/activated-charcoal filter with automatic climate control [113](#)
– Refer to Microfilter for air conditioner [109](#)

Position, storing [142](#)

Postal code, entering in navigation [141](#)

Power failure [247](#)

Power windows, opening and closing [41](#)

Power windows, refer to Windows [40](#)

Pressure, tires [226](#)

Pressure warning, tires [92](#)

Pressure warning, tires
– Flat Tire Monitor [92](#)

Programmable memory buttons, iDrive [22](#)

Protective function, refer to Pinch protection
– Windows [41](#)

Push-and-turn switch, refer to Controller [19](#)

R

Radiator fluid, refer to Coolant [239](#)

Radio-operated key, refer to Remote control with integrated key [30](#)

Radio ready state [56](#)

Radio ready state
– Switched off [56](#)
– Switched on [56](#)

Radio setting, refer to Radio ready state [56](#)

Rain sensor [61](#)

Random [171](#)

Random playback [171](#)

Range [73](#)

RDS [163](#)

Reading lamps [89](#)

Reading out loud [210](#)

Rear lights
– Bulb replacement [245](#)

Rear lights, refer to Tail lights [245](#)

Rear lights, refer to Tail lights
– Bulb replacement [245](#), [246](#)

Rearview mirror, refer to Mirrors [50](#)

Rear window defroster [109](#), [112](#)

Recirculated air mode [108](#), [112](#)

Reclining seat, refer to Backrest [46](#)

Recommended tire brands [233](#)

Redialing [199](#)

Refueling [222](#)

- Remaining range, refer to Range [73](#)
- Reminders [210](#)
- Remote app [219](#)
- Remote control [30](#)
- Remote control
- Battery replacement [39](#)
 - Comfort Access [37](#)
 - Malfunction [34](#), [38](#)
 - Removing from the ignition lock [55](#)
 - Trunk lid [33](#)
- Remote control, universal [114](#)
- Remote inquiry [198](#)
- Remote Services [219](#)
- Replacement fuses, refer to Spare fuses [248](#)
- Replacement remote control [30](#)
- Replacing wheels/tires [232](#)
- Reporting safety defects [9](#)
- Reservoir for washer fluid [62](#)
- Restraining systems
- Refer to Safety belts [48](#)
- Restraint system
- For children [53](#)
- Retaining straps, securing cargo [132](#)
- Retractable hardtop
- Convenient opening and closing [33](#)
 - Opening and closing [42](#)
 - Remote control [33](#)
- Retreaded tires [233](#)
- Reverse gear
- 7-gear automatic transmission [67](#)
 - 8-gear automatic transmission [63](#)
 - Manual transmission [63](#)
- Rim cleaner, care [257](#)
- Road, avoiding [149](#)
- Road detour [149](#)
- Roadside Assistance [215](#)
- Roadside parking lamps [87](#)
- Roadworthiness test [78](#)
- Roof, refer to Retractable hardtop [42](#)
- Route [150](#)
- Route criteria, route [149](#)
- Route, displaying [150](#)
- Route section, bypassing [150](#)
- RSC Runflat System Component, refer to Run-flat tires [232](#)
- Rubber components, care [257](#)
- Run-flat tires [232](#)
- Run-flat tires
- Tire inflation pressure [226](#)
- Running lights, refer to Parking lamps/low beams [85](#)
- ## S
- Safety [6](#)
- Safety-belt height adjustment [49](#)
- Safety belts [48](#)
- Safety belts
- Damage [49](#)
 - Indicator/warning light [49](#)
 - Reminder [49](#)
- Safety belts, care [257](#)
- Safety systems
- Airbags [90](#)
 - Safety belts [48](#)
- Safety tires [232](#)
- Satellite radio [164](#)
- Saving fuel [132](#)
- Scale, changing during navigation [152](#)
- Screen, refer to Control Display [18](#)
- Search, refer to BMW Online [216](#)
- Seat adjustment, electric [47](#)
- Seat adjustment, mechanical [46](#)
- Seat and mirror memory [49](#)
- Seat and mirror memory, retrieving automatically [34](#)
- Seat Belt Reminder, refer to Safety belt reminder [49](#)
- Seat belts
- Refer to Safety belts [48](#)
- Seat heating [48](#)
- Seats [46](#)
- Seats
- Adjusting [46](#)
 - Adjusting electrically [47](#)
 - Heating [48](#)
 - Memory, refer to Seat and mirror memory [49](#)
 - Storing the setting, refer to Seat and mirror memory [49](#)
- Sensors, care [258](#)
- Service and warranty [7](#)
- Service requirements, CBS Condition Based Service [241](#)
- Service requirements, display [78](#)
- Services, remote [219](#)
- Servotronic [102](#)
- Settings and information [75](#)
- Settings, configuring, refer to Personal Profile [30](#)
- Settings, DVD [173](#)
- Settings on Control Display [78](#)
- Setting the clock, 12h/24h format [77](#)
- Shift paddles on steering wheel
- 7-gear automatic transmission [68](#)
 - 8-gear automatic transmission [65](#)
- Short commands, voice activation [264](#)
- Side airbags [90](#)
- Side windows, refer to Windows [40](#)
- Signal horn, refer to Horn [12](#)
- Sitting safely [46](#)
- Ski bag, refer to Through-loading opening with integrated transport bag [119](#)

- Slot for remote control [55](#)
 - Smokers' package, refer to Ashtray [118](#)
 - Snap-in adapter, mobile phone [201](#)
 - Snap-in adapter, refer to Center armrest storage compartment [122](#)
 - Snow chains [233](#)
 - Socket, OBD Onboard Diagnostics [242](#)
 - Socket, refer to Connecting electrical devices [118](#)
 - Software applications, iPhone [218](#)
 - Software part number [192](#)
 - Software update [187](#)
 - SOS, refer to Emergency Request, initiating [249](#)
 - Sound output [162](#), [170](#)
 - Spare fuses [248](#)
 - Special destinations, navigation [143](#)
 - Special equipment, series equipment [6](#)
 - Specified oil types [238](#)
 - Speed, average [73](#)
 - Speed limit [83](#)
 - Speedometer [14](#)
 - Split screen [22](#)
 - Split screen map settings [153](#)
 - Spoken instructions, navigation [151](#)
 - SPORT+ program, Dynamic Driving Control [101](#)
 - Sport program
 - 7-gear automatic transmission [67](#)
 - 8-gear automatic transmission [64](#)
 - SPORT program, Dynamic Driving Control [101](#)
 - Spray nozzles, refer to Cleaning the windshield and headlamps [62](#)
 - Stability control systems [99](#)
 - Start/Stop button [55](#)
 - Start/Stop button
 - Starting the engine [56](#)
 - Switching off the engine [57](#)
 - Starting aid [250](#)
 - Starting the engine [56](#)
 - State/province, selecting for navigation [140](#)
 - Stations, stored [168](#)
 - Station, storing [162](#)
 - Status information, iDrive [21](#)
 - Status of Owner's Manual [6](#)
 - Steam jets [255](#)
 - Steering wheel [52](#)
 - Steering wheel
 - Adjusting [52](#)
 - Buttons on the steering wheel [12](#)
 - Stopping
 - Engine [57](#)
 - Storage compartments [123](#)
 - Storage, tires [233](#)
 - Storing the seat position, refer to Seat and mirror memory [49](#)
 - Storing the vehicle [258](#)
 - Street, entering for navigation [141](#)
 - Summer tires, refer to Wheels and tires [226](#)
 - Summer tires, tread [231](#)
 - Suspension settings [100](#)
 - Switches, refer to Cockpit [12](#)
 - Switch for Dynamic Driving Control [100](#)
 - Switching off
 - Engine [57](#)
 - Vehicle [57](#)
 - Symbols [6](#)
- ## T
- Tachometer [72](#)
 - Tailgate, opening from the inside [36](#)
 - Tailgate, refer to Trunk lid [36](#)
 - Tail lights [245](#)
 - Tail lights
 - Bulb replacement [245](#), [246](#)
 - Tank display [72](#)
 - Tasks [209](#)
 - Technical changes, refer to Safety [6](#)
 - Technical data [262](#)
 - Telephone [192](#)
 - Telephone, adjusting the volume [196](#)
 - Telephone, installation location, refer to Center armrest [122](#)
 - TeleService [215](#)
 - Temperature, air conditioner [109](#)
 - Temperature, automatic climate control [110](#)
 - Temperature, changing the unit of measure [76](#)
 - Temperature, coolant [72](#)
 - Temperature display
 - External temperature [71](#)
 - External temperature warning [71](#)
 - Setting the unit [76](#)
 - Temperature, engine oil [72](#)
 - Text messages [206](#)
 - Theft alarm system, refer to Alarm system [39](#)
 - Thigh support adjustment [47](#)
 - Third brake light, refer to Center brake light [246](#)
 - Through-loading opening with integrated transport bag [119](#)
 - Tilt alarm sensor [40](#)
 - Tilting the passenger side mirror [50](#)
 - Time
 - Setting the time [76](#)
 - Setting the time zone [76](#)
 - Tire age [230](#)
 - Tire damage [231](#)
 - Tire identification marks [229](#)
 - Tire inflation pressure [226](#)

- Tire inflation pressure
 - Loss [95](#)
 - Tire pressure monitoring, refer to FTM [92](#)
 - Tire Pressure Monitor TPM [94](#)
 - Tire Pressure Monitor TPM
 - Resetting the system [95](#)
 - Warning light [96](#)
 - Tire Quality Grading [230](#)
 - Tires, changing [232](#)
 - Tires, flat tire [247](#)
 - Tire size [229](#)
 - Tires, pressure loss [96](#)
 - Tires, run-flat tires [232](#)
 - Tires, Tire Pressure Monitor TPM [94](#)
 - Tire tread [231](#)
 - Toll roads, route [149](#)
 - Tone [160](#)
 - Tool kit, refer to Onboard vehicle tool kit [243](#)
 - Tools, refer to Onboard vehicle tool kit [243](#)
 - Towing [251](#)
 - Town/city, navigation [141](#)
 - Tow-starting [251](#)
 - TPM Tire Pressure Monitor [94](#)
 - Traction control [100](#)
 - TRACTION program, Dynamic Driving Control [101](#)
 - Traffic bulletins, navigation [153](#)
 - Transmission
 - 7-gear automatic transmission with dual clutch [65](#)
 - 8-gear automatic transmission [63](#)
 - Manual transmission [63](#)
 - Unlocking transmission lock manually, for 7-gear automatic transmission [69](#)
 - Transmission lock, unlocking manually [69](#)
 - Transmission lock, unlocking manually, with 7-gear automatic transmission [69](#)
 - Transmission positions
 - 7-gear automatic transmission [66](#)
 - 8-gear automatic transmission [63](#)
 - Transporting children safely [53](#)
 - Tread depth, tires [231](#)
 - Tread, tires [231](#)
 - Treble, tone [160](#)
 - Trip-distance counter, refer to Trip odometer [71](#)
 - Triple turn signal activation [60](#)
 - Trip odometer [71](#)
 - Trips, planning [147](#)
 - Trunk lid [36](#)
 - Comfort Access [38](#)
 - Emergency unlocking [37](#)
 - Opening from the inside [36](#)
 - Opening from the outside [36](#)
 - Remote control [33](#)
 - Turning circle, refer to Dimensions [262](#)
 - Turn signal
 - Indicator/warning lamp [14](#)
 - Turn signals [60](#)
 - Turn signals
 - Bulb replacement, front [245](#)
 - Triple turn signal activation [60](#)
- ## U
- Uniform Tire Quality Grading/UTQG [230](#)
 - Unintentional alarms [40](#)
 - Units
 - Average fuel consumption [76](#)
 - Temperature [76](#)
 - Units of measure, changing on Control Display [76](#)
 - Universal remote control [114](#)
 - Unlocking
 - From the inside [36](#)
 - From the outside [32](#)
 - Hood [236](#)
 - Setting the unlocking characteristics [32](#)
 - Trunk lid [38](#)
 - Without remote control, refer to Comfort Access [37](#)
 - Updates made after the editorial deadline [6](#)
 - Update, software [187](#)
 - Upholstery care [257](#)
 - USB audio interface [181](#)
 - USB interface [122](#)
- ## V
- Vacuum cleaner, connecting, refer to Connecting electrical devices [118](#)
 - Vehicle
 - Battery replacement [247](#)
 - Breaking in [128](#)
 - Cargo [262](#)
 - Dimensions, refer to Dimensions [262](#)
 - Identification number [192](#)
 - Identification number, refer to Engine compartment [235](#)
 - Weight [262](#)
 - Vehicle battery [247](#)
 - Vehicle care [256](#)
 - Vehicle care, refer to Care [255](#)
 - Vehicle equipment [6](#)
 - Vehicle jack [247](#)
 - Vehicle paint [256](#)
 - Vehicle storage [258](#)
 - Vehicle, switching off [57](#)
 - Vehicle wash [255](#)
 - Ventilation [109](#), [112](#)
 - Ventilation
 - Draft-free [109](#), [112](#)
 - Refer to Climate control [107](#)
 - Vents, refer to Air vents [107](#)

Version of the navigation data [138](#)
Video playback [172](#)
Voice activation
– Navigation [146](#)
Voice activation, short commands [264](#)
Voice activation system [25](#)
Volume, setting [160](#)

W

Warning and indicator lamps [15](#)
Warning messages, refer to Check Control [82](#)
Warning signal volumes [161](#)
Warning triangle [250](#)
Washer/wiper system [61](#)
Washer fluid [62](#)
Washing, vehicle [255](#)
Waste tray, refer to Ash-tray [118](#)
Water on roads [129](#)
Wear indicator in tire [231](#)
Weights [262](#)
Welcome lamps [85](#)
Wheelbase, refer to Dimensions [262](#)
Wheel change [246](#)
Wheels and tires [226](#)
Wheels, changing [232](#)
Wheels, Flat Tire Monitor FTM [92](#)
Wheels, Tire Pressure Monitor TPM [94](#)
Width, refer to Dimensions [262](#)
Wind deflector [44](#)
Window, convenient opening and closing [33](#)
Windows [40](#)
Windows, defrosting and defogging
– Automatic climate control [112](#)

Windows, defrosting and removing condensation
– Air conditioner [109](#)
Windows, pinch protection [41](#)
Windshield
– Cleaning [62](#)
– Defrosting and defogging, air conditioner [109](#)
– Defrosting and defogging, automatic climate control [112](#)
Windshield, defrosting, refer to Defrosting windows [109](#)
Windshield wash [61](#)
Windshield wash
– Nozzles [62](#)
– Washer fluid [62](#)
Windshield washer fluid [62](#)
Windshield wiper blades, changing [243](#)
Windshield wiper, refer to Washer/wiper system [61](#)
Winter storage, care [258](#)
Winter tires, suitable tires [233](#)
Winter tires, tread [231](#)
Wiper blades, changing [243](#)
Wiper fluid [62](#)
Wood, care [257](#)
Wordmatch principle, navigation [23](#)
Working in the engine compartment [236](#)
Wrench/screwdriver, refer to Onboard vehicle tool kit [243](#)

X

Xenon headlights
– Bulb replacement [244](#)

Y

Your individual vehicle
– Settings, refer to Personal Profile [30](#)

More about BMW



The Ultimate
Driving Machine

bmwusa.com

01 40 2 957 403 ue



Online Edition for Part no. 01 40 2 957 403 - X/14