

# Contents

## A-Z

Owner's Manual  
for Vehicle



The Ultimate  
Driving Machine®



# THE BMW 5 SERIES SEDAN.

## OWNER'S MANUAL.

**BMW EfficientDynamics**  
Less emissions. More driving pleasure.



## 5 Series **Owner's Manual for Vehicle**

Thank you for choosing a BMW.

The more familiar you are with your vehicle, the better control you will have on the road. We therefore strongly suggest:

Read this Owner's Manual before starting off in your new BMW. Also use the Integrated Owner's Manual in your vehicle. It contains important information on vehicle operation that will help you make full use of the technical features available in your BMW. The manual also contains information designed to enhance operating reliability and road safety, and to contribute to maintaining the value of your BMW.

Any updates made after the editorial deadline for the printed or Integrated Owner's Manual are found in the appendix of the printed Quick Reference for the vehicle.

Supplementary information can be found in the additional brochures in the onboard literature.

We wish you a safe and enjoyable ride.

BMW AG

The Owner's Manual is available in many countries as an app.

Additional information on the Internet:

[www.bmw.com/bmw\\_drivers\\_guide](http://www.bmw.com/bmw_drivers_guide)

© 2015 Bayerische Motoren Werke  
Aktiengesellschaft  
Munich, Germany  
Reprinting, including excerpts, only with the written  
consent of BMW AG, Munich.  
US English II/15, 03 15 490  
Printed on environmentally friendly paper, bleached  
without chlorine, suitable for recycling.

## ADDENDUM TO OWNER'S MANUAL

We wanted to provide you with some updates and clarifications with respect to the printed BMW Owner's Manual. These updates and clarifications will supersede the materials contained in that document.

1. Where the terms “service center,” “the service center,” “your service center,” “service specialist,” or “service” are used in the Owner's Manual, we wanted to clarify that the terms refer to a BMW dealer's service center or another service center or repair shop that employs trained personnel that can perform maintenance and repair work on your vehicle in accordance with BMW specifications.
2. Where the text of the Owner's Manual contains an affirmative instruction to contact a “service center” or “your service center,” we wanted to clarify that BMW recommends that, if you are faced with one of the situations addressed by that text, you contact or seek the assistance of a BMW dealer's service center or another service center or repair shop that employs trained personnel that can perform maintenance and repair work on your vehicle in accordance with BMW specifications.

While BMW of North America LLC, at no cost to you, will pay for repairs required by the limited warranties provided with respect to your vehicle and for maintenance under the Maintenance Program during the applicable warranty and maintenance coverage periods, you are free to elect, both during those periods and thereafter, to have maintenance and repair work provided by other service centers or repair shops.

3. Where the Owner's Manual makes reference to parts and accessories having been approved by BMW, those references are intended to reflect that those parts and accessories are recommended by BMW of North America LLC. You may elect to use other parts and accessories, but, if you do,

we recommend that you make sure that any such parts and/or accessories are appropriate for use on your vehicle.

4. At page 7, under the warranty section's discussion of homologation, where it states that you “cannot lodge warranty claims for your vehicle there,” the text should read that you “may not be able to lodge warranty claims for your vehicle there.”
5. At page 7, under the “Parts and accessories” section, in the sixth sentence, the word “cannot” should read “does not.”
6. At page 58, in the “Check and replace safety belts” section, the text beginning, “This should only be done by your service center ...” should be disregarded and the following text should be read in lieu thereof: “BMW recommends having this work performed by a service center as it is important that this safety feature functions properly.”
7. At page 59, under the heading: “Active head restraint,” the paragraph beginning, “Only attach accessories ...” should be disregarded and the following text should be read in lieu thereof: “BMW recommends that you attach accessories approved by BMW to the seat or head restraint.”
8. At page 102, under the heading: “Special windshield,” the paragraph beginning, “Therefore, have the special windshield ...” should be disregarded and the following text should be read in lieu thereof: “BMW recommends that you have the special windshield replaced by the service center.”
9. At page 190 under the heading: “Objects within the range of movement of the pedals” and at page 254 under the heading: “Carpets and floor mats,” the paragraph that begins: “Only use floor mats ...” should be disregarded and the following language should be read in lieu thereof: “The manufacturer of your vehicle recommends that you use floor mats that have been identified

by it as appropriate for use in your vehicle and that can be properly fixed in place.”

10. At page 196, under the heading: “Have maintenance carried out,” the sentence beginning, “The maintenance should be carried out ...” should be disregarded and the following text should be read in lieu thereof: “BMW recommends that you have the maintenance carried out by your service center.”
11. At page 211, under the heading “Tire inflation specifications,” the sentence beginning, “Tire inflation pressure specifications apply to approved tire sizes ...” should be disregarded.
12. At page 223, under the heading: “Mounting,” the paragraph beginning, “Have mounting and balancing ...” should be disregarded and the following text should be read in lieu thereof: “BMW recommends that you have mounting and balancing performed by your service center or a tire mounting specialist.”
13. At page 223, under the heading: “Approved wheels and tires,” the term “Approved” should be disregarded and in lieu thereof, the term “Recommended” should be read in its place. In addition, the text of that section should be disregarded and the following text should be read in lieu thereof:  
The manufacturer of your vehicle strongly suggests that you use wheels and tires that have been recommended by the vehicle manufacturer for your vehicle type; otherwise, for example, despite having the same official size ratings, variations can lead to body contact and with it, the risk of severe accidents.  
The manufacturer of your vehicle does not evaluate non-recommended wheels and tires to determine if they are suitable for use on your vehicle.
14. At page 228, under the heading: “Snow Chains,” the text should be disregarded and

the following text should be read in lieu thereof:

Only certain types of fine-link snow chains have been tested by the manufacturer of your vehicle and are determined by the manufacturer of your vehicle to be road safe and are recommended by the manufacturer of your vehicle.

Information about recommended snow chains is available from a service center.

15. At page 229, under the heading “Hood,” the sentence beginning, “If you are unfamiliar” should be disregarded.
16. At page 233, under the heading: “Engine oil change,” the text should be disregarded and in lieu thereof should be read as follows:  
BMW recommends that you have the oil changed at your BMW dealer's service center or at another service center that has trained personnel that can perform the work in accordance with BMW specifications.
17. At page 236, under the heading: “Service and Warranty Information Booklet for US models and Warranty and Service Guide Booklet for Canadian models,” the second paragraph should be disregarded and the following text read in lieu thereof:  
The manufacturer of your vehicle recommends that you have maintenance and repair performed by your BMW dealer's service center or another service center or repair shop that employs trained personnel that can perform maintenance and repair work on your vehicle in accordance with BMW specifications. The manufacturer of your vehicle recommends that you maintain records of all maintenance and repair work performed on your vehicle.
18. At page 239 and page 240, where it reads: “Do not perform work/bulb replacement on xenon headlights,” that text should be disregarded and in lieu thereof the following text should be read: “Xenon headlight work or replacement can cause serious and fatal

injuries.” In the text that follows, where it reads: “[h]ave any work on the xenon lighting system ...,” the following words should be read as preceding that passage: “It is strongly suggested that you ...”

19. At page 243, under the “Battery replacement” section, the text should be disregarded and in lieu thereof the following text should be read:

#### Use of recommended vehicle batteries

The manufacturer of your vehicle recommends that you use vehicle batteries that it has tested and recommends for use in your vehicle; otherwise the vehicle could be damaged and systems or functions may not be fully available.

After a battery replacement, the manufacturer of your vehicle recommends that you have the battery registered on your vehicle by a service center to ensure that all comfort functions are fully available, and that any “check control” messages of these comfort functions are no longer displayed.





# Contents

The fastest way to find information on a particular topic or item is by using the index, refer to page 262.

6 Notes

## At a glance

14 Cockpit

18 iDrive

26 Voice activation system

29 Integrated Owner's Manual in the vehicle

## Controls

34 Opening and closing

53 Adjusting

65 Transporting children safely

69 Driving

84 Displays

103 Lights

108 Safety

135 Driving stability control systems

143 Driving comfort

165 Climate control

172 Interior equipment

181 Storage compartments

## Driving tips

188 Things to remember when driving

192 Loading

195 Saving fuel

## Mobility

204 Refueling

206 Fuel

211 Wheels and tires

229 Engine compartment

231 Engine oil

234 Coolant

236 Maintenance

238 Replacing components

245 Breakdown assistance

251 Care

## Reference

258 Technical data

262 Everything from A to Z

# Notes

## Using this Owner's Manual

### Orientation

The fastest way to find information on a particular topic is by using the index.

An initial overview of the vehicle is provided in the first chapter.

### Updates made after the editorial deadline

Any updates made after the editorial deadline for the Owner's Manuals are found in the appendix of the printed Quick Reference for the vehicle.

### User's manual for Navigation, Entertainment, Communication

The topics of Navigation, Entertainment, Communication and the short commands of the voice activation system are described in a separate user's manual, which is also included with the onboard literature.

## Additional sources of information

The service center will be happy to answer any other questions you may have.

Information on BMW, e.g., on technology, is available on the Internet: [www.bmwusa.com](http://www.bmwusa.com).

### BMW Driver's Guide App

The Owner's Manual is available in many countries as an app. Additional information on the Internet:

[www.bmw.com/bmw\\_drivers\\_guide](http://www.bmw.com/bmw_drivers_guide)

## Symbols

 Indicates precautions that must be followed precisely in order to avoid the possibility of personal injury and serious damage to the vehicle.

◀ Marks the end of a specific item of information.

 Refers to measures that can be taken to help protect the environment.

"..." Identifies display texts in vehicle used to select individual functions.

>...< Verbal instructions to use with the voice activation system.

»...« Identifies the answers generated by the voice activation system.

### Symbols on vehicle components

 Indicates that you should consult the relevant section of this Owner's Manual for information on a particular part or assembly.

## Vehicle features and options

This Owner's Manual describes all models and all standard, country-specific and optional equipment that is offered in the model series. Therefore, in this Owner's Manual, we also describe and illustrate features that are not available in your vehicle, e.g., because of the selected optional features or the country-specific version.

This also applies to safety-related functions and systems.

The respectively applicable country provisions must be observed when using the respective features and systems.

For any options and equipment not described in this Owner's Handbook, refer to the Supplementary Owner's Handbooks.

On right-hand drive vehicles, some controls are arranged differently from what is shown in the illustrations.

## Status of the Owner's Manual

### Basic information

The manufacturer of your vehicle pursues a policy of constant development that is conceived to ensure that our vehicles continue to embody the highest quality and safety standards. In rare cases, therefore, the features described in this Owner's Manual may differ from those in your vehicle.

### Updates made after the editorial deadline

Any updates made after the editorial deadline for the Owner's Manuals are found in the appendix of the printed Quick Reference for the vehicle.

## For your own safety

### Warranty

Your vehicle is technically configured for the operating conditions and registration requirements applying in the country of first delivery - homologation. If your vehicle is to be operated in a different country it might be necessary to adapt your vehicle to potentially differing operating conditions and permit requirements. If your vehicle does not comply with the homologation requirements in a certain country you cannot lodge warranty claims for your vehicle there. Further information can be obtained from your Service Centre.

### Maintenance and repairs

Advanced technology, e.g., the use of modern materials and high-performance electronics, requires suitable maintenance and repair work.

Therefore, have this work performed only by a BMW center or a workshop that works according to BMW repair procedures with appropriately trained personnel.

If work is not carried out properly, there is a danger of subsequent damage and related safety hazards.

### Parts and accessories

BMW recommends using parts and accessories approved by BMW for this purpose.

Your BMW center is the right contact for genuine BMW parts and accessories, other products approved by BMW and related qualified advice.

BMW has tested these products for safety and suitability in relation to BMW vehicles.

BMW can assume responsibility for them. However, we cannot assume any responsibility whatsoever for parts and accessories that have not been specifically approved by BMW.

BMW cannot evaluate whether each individual product from another manufacturer can be used with BMW vehicles without presenting a safety hazard. This guarantee does not apply when country-specific government approval has been granted. Testing of this kind may fail to embrace the entire range of potential operating conditions to which components might be exposed on BMW vehicles. Such products could conceivably fail to comply with BMW's own stringent quality standards.

### California Proposition 65 Warning

California laws require us to state the following warning:

Engine exhaust and a wide variety of automobile components and parts, including components found in the interior furnishings in a vehicle, contain or emit chemicals known to the State of California to cause cancer and birth defects and reproductive harm. In addition, certain fluids contained in vehicles and certain products of component wear contain or emit

chemicals known to the State of California to cause cancer and birth defects or other reproductive harm. Battery posts, terminals and related accessories contain lead and lead compounds. Wash your hands after handling. Used engine oil contains chemicals that have caused cancer in laboratory animals. Always protect your skin by washing thoroughly with soap and water.

## Service and warranty

We recommend that you read this publication thoroughly. Your vehicle is covered by the following warranties:

- ▷ New Vehicle Limited Warranty.
- ▷ Rust Perforation Limited Warranty.
- ▷ Federal Emissions System Defect Warranty.
- ▷ Federal Emissions Performance Warranty.
- ▷ California Emission Control System Limited Warranty.

Detailed information about these warranties is listed in the Service and Warranty Information Booklet for US models or in the Warranty and Service Guide Booklet for Canadian models.

Your vehicle has been specifically adapted and designed to meet the particular operating conditions and homologation requirements in your country and continental region in order to deliver the full driving pleasure while the vehicle is operated under those conditions. If you wish to operate your vehicle in another country or region, you may be required to adapt your vehicle to meet different prevailing operating conditions and homologation requirements. You should also be aware of any applicable warranty limitations or exclusions for such country or region. In such case, please contact Customer Relations for further information.

## Maintenance

Maintain the vehicle regularly to sustain the road safety, operational reliability and the New Vehicle Limited Warranty.

Specifications for required maintenance measures:

- ▷ BMW Maintenance system
- ▷ Service and Warranty Information Booklet for US models
- ▷ Warranty and Service Guide Booklet for Canadian models

If the vehicle is not maintained according to these specifications, this could result in serious damage to the vehicle. Such damage is not covered by the BMW New Vehicle Limited Warranty.

## Data memory

Many electronic components on your vehicle are equipped with data memories that temporarily or permanently store technical information about the condition of the vehicle, events and faults. This technical information generally records the state of a component, a module, a system or the environment:

- ▷ Operating mode of system components, fill levels for instance.
- ▷ Status messages for the vehicle and from its individual components, e.g., wheel rotation speed/vehicle speed, deceleration, transverse acceleration.
- ▷ Malfunctions and faults in important system components, e.g., lights and brakes.
- ▷ Responses by the vehicle to special situations such as airbag deployment or engaging the stability control system.
- ▷ Ambient conditions, such as temperature.

This data is purely technical in nature and is used to detect and correct faults and to optimize vehicle functions. Motion profiles over routes traveled cannot be created from this data. When service offerings are used, e.g., repair services, service processes, warranty claims, quality assurance, this technical information can be read out from the event and fault memories by the service personnel, in-

cluding the manufacturer, using special diagnostic tools. You can obtain further information there if you need it. After an error is corrected, the information in the fault memory is deleted or overwritten on a continuous basis.

With the vehicle in use there are situations where you can associate these technical data with individuals if combined with other information, e.g., an accident report, damage to the vehicle, eye witness accounts — possibly with the assistance of an expert.

Additional functions that are contractually agreed with the customer - such as vehicle emergency locating - you can transmit certain vehicle data from the vehicle.

## Event Data Recorder EDR

This vehicle is equipped with an event data recorder EDR. The main purpose of an EDR is to record, in certain crash or near crash-like situations, such as an air bag deployment or hitting a road obstacle, data that will assist in understanding how a vehicle's systems performed. The EDR is designed to record data related to vehicle dynamics and safety systems for a short period of time, typically 30 seconds or less.

The EDR in this vehicle is designed to record such data as:

- ▶ How various systems in your vehicle were operating.
- ▶ Whether or not the driver and passenger safety belts were fastened.
- ▶ How far, if at all, the driver was depressing the accelerator and/or brake pedal.
- ▶ How fast the vehicle was traveling.

These data can help provide a better understanding of the circumstances in which crashes and injuries occur.

EDR data are recorded by your vehicle only if a nontrivial crash situation occurs; no data are recorded by the EDR under normal driving

conditions and no personal data, e.g., name, gender, age, and crash location, are recorded. However, other parties, such as law enforcement, could combine the EDR data with the type of personally identifying data routinely acquired during a crash investigation.

To read data recorded by an EDR, special equipment is required, and access to the vehicle or the EDR is needed. In addition to the vehicle manufacturer, other parties, such as law enforcement, that have the special equipment, can read the information if they have access to the vehicle or the EDR.

## Vehicle identification number



The vehicle identification number can be found in the engine compartment.

The vehicle identification number can also be found behind the windshield.

## Reporting safety defects

### For US customers

The following only applies to vehicles owned and operated in the US.

If you believe that your vehicle has a defect which could cause a crash or could cause injury or death, you should immediately inform the National Highway Traffic Safety Administration NHTSA, in addition to notifying BMW of North America, LLC, P.O. Box 1227, West-

wood, New Jersey 07675-1227, Telephone 1-800-831-1117.

If NHTSA receives similar complaints, it may open an investigation, and if it finds that a safety defect exists in a group of vehicles, it may order a recall and remedy campaign.

However, NHTSA cannot become involved in individual problems between you, your dealer, or BMW of North America, LLC.

To contact NHTSA, you may call the Vehicle Safety Hotline toll-free at 1-888-327-4236 (TTY: 1-800-424-9153); go to <http://www.safercar.gov>; or write to: Administrator, NHTSA, 400 Seventh Street, SW., Washington, DC 20590. You can also obtain other information about motor vehicle safety from <http://www.safercar.gov>.

### **For Canadian customers**

Canadian customers who wish to report a safety-related defect to Transport Canada, Defect Investigations and Recalls, may call the toll-free hotline 1-800-333-0510. You can also obtain other information about motor vehicle safety from <http://www.tc.gc.ca/roadsafety>.







## At a glance

These overviews of buttons, switches and displays are intended to familiarize you with your vehicle. You will also become quickly acquainted with the available control concepts and options.

# Cockpit

## Vehicle features and options

This chapter describes all standard, country-specific and optional features offered with the series. It also describes features that are not necessarily available in your car, e. g., due to

the selected options or country versions. This also applies to safety-related functions and systems. The respectively applicable country provisions must be observed when using the respective features and systems.

## All around the steering wheel

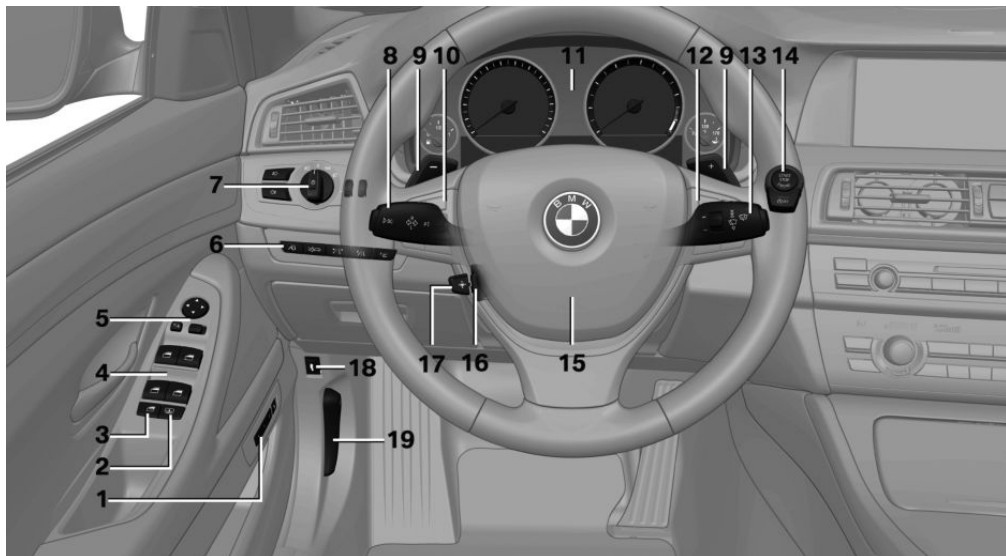

### 1 Seating comfort features



Seat, mirror, steering wheel memory [61](#)



Active seat [56](#)

### 2 Roller sunblinds [49](#)

### 3 Rear window safety switch [49](#)

### 4 Power windows [48](#)

### 5 Exterior mirror operation [62](#)

### 6 Driver assistance systems



Active Blind Spot Detection [131](#)



Intelligent Safety [117](#)



Lane departure warning [129](#)



Night Vision [126](#)



Head-up Display [101](#)

## 7 Lights



Front fog lights 106



Parking lights 103



Low beams 103



Automatic headlight control 104

Daytime running lights 104

Adaptive Light Control 104

High-beam Assistant 105



Instrument lighting 106

## 8 Steering column stalk, left



Turn signal 76



High beams, headlight flasher 76



High-beam Assistant 105



Roadside parking lights 104



On-board computer 97

## 9 Shift paddles 81

## 10 Steering wheel buttons, left



Store speed 150, 143



Resume speed 151, 146



Cruise control on/off, interrupting 143



Cruise control on/off, interrupting 150



Reduce distance 146



Increase distance 146

Cruise control rocker switch 151, 145

## 11 Instrument cluster 84

## 12 Steering wheel buttons, right



Entertainment source



Volume



Voice activation 26



Telephone, see user's manual for Navigation, Entertainment and Communication

Thumbwheel for selection lists 96

## 13 Steering column stalk, right



Wiper 77



Rain sensor 77



Clean the windshields and headlights 77



## 14 START STOP ENGINE



Auto Start/Stop function 71







## 15 Horn, total area

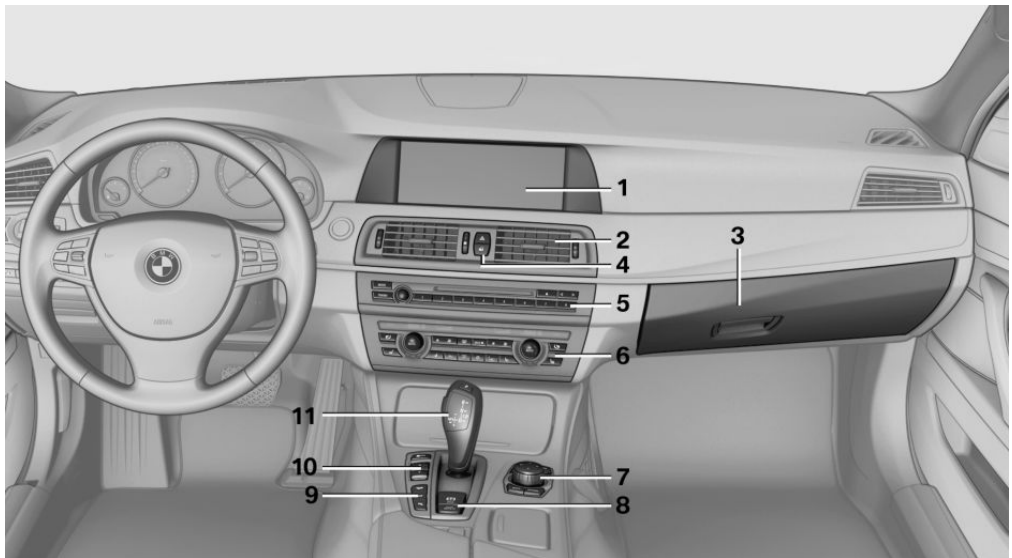

16  Steering wheel heating 64

- 17  Adjust the steering wheel [64](#)
- 18  Open the trunk lid [40](#)
- 19 Unlocking the hood

## All around the center console





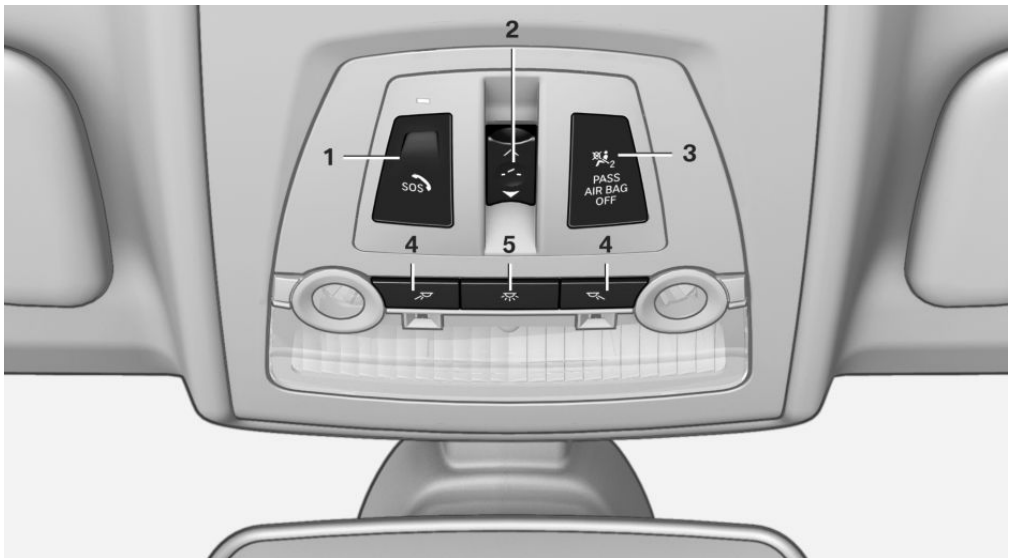

- 1 Control Display [18](#)
- 2 Glove compartment [181](#)
- 3 Ventilation [168](#)
- 4  Hazard warning system [245](#)
-  Central locking system [40](#)
- 5 Radio/CD/Multimedia, see user's manual for Navigation, Entertainment and Communication
- 6 Automatic climate control [165](#)
- 7 Controller with buttons [18](#)
- 8  Parking brake [73](#)
-  Auto Hold [74](#)
- 9  PDC Park Distance Control [152](#)  
Top View [158](#)  
Rearview camera [154](#)  
Parking assistant [160](#)  
Side View [157](#)
-  HDC Hill Descent Control [137](#)

- 10  Driving Dynamics Control [139](#)      11 Transmission selector lever
-  DSC Dynamic Stability Control [135](#)

## All around the roofliner



- 1  Intelligent Emergency Request [245](#)
- 2  Glass sunroof, powered [50](#)
- 3  Indicator lamp, front-seat passenger airbag [110](#)
- 4  Reading lights [107](#)
- 5  Interior lights [106](#)

# iDrive

## Vehicle features and options

This chapter describes all standard, country-specific and optional features offered with the series. It also describes features that are not necessarily available in your car, e. g., due to the selected options or country versions. This also applies to safety-related functions and systems. The respectively applicable country provisions must be observed when using the respective features and systems.

## The concept

The iDrive combines the functions of many switches. Thus, these functions can be operated from a central location.



Using the iDrive during a trip

To avoid becoming distracted and posing an unnecessary hazard to your vehicle's occupants and to other traffic, never attempt to use the controls or enter information unless traffic and road conditions allow it. ◀

## Control elements at a glance

### Control elements

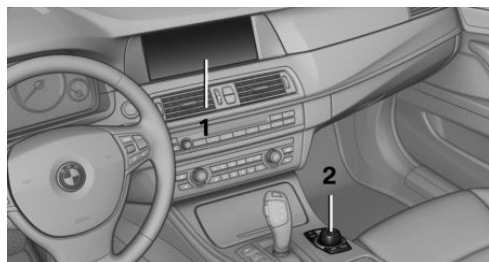

- 1 Control Display
- 2 Controller with buttons and, depending on the equipment version, with touchpad

## Control Display

### Hints

- ▶ To clean the Control Display, follow the care instructions.
- ▶ Do not place objects close to the Control Display; otherwise, the Control Display can be damaged.
- ▶ In the case of very high temperatures on the Control Display, e.g. due to intense solar radiation, the brightness may be reduced down to complete deactivation. Once the temperature is reduced, e.g. through shadow or climate control system, the normal functions are re-established.

### Switching on

1. Switch on the ignition.
2. Press the controller.

### Switch off

1.  Press button.
2. "Turn off control display"

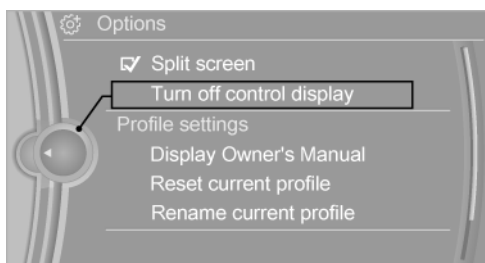

### Controller

The buttons can be used to open the menus directly. The controller can be used to select menu items and enter the settings.

Some iDrive functions can be operated using the touchpad on the controller.

## 1. Turn.

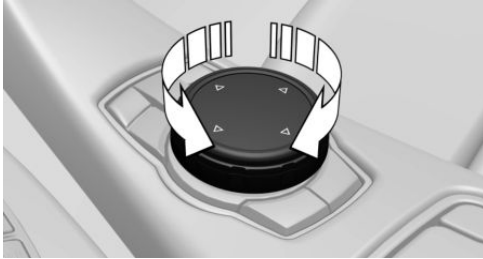

## 2. Press.



## 3. Move in four directions.

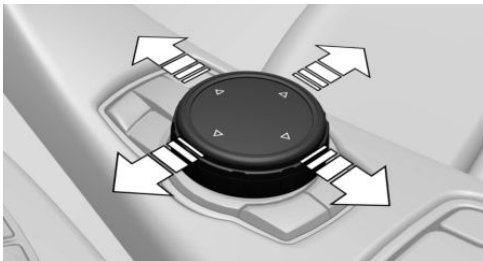

## Buttons on controller

Press button	Function
MENU	Open the main menu.
RADIO	Opens the Radio menu.
MEDIA	Opens the Multimedia menu.
NAV	Opens the Navigation menu.
TEL	Opens the phone menu.

Press button	Function
BACK	Displays the previous panel.
OPTION	Opens the Options menu.

## Operating concept

### Opening the main menu



Press button.

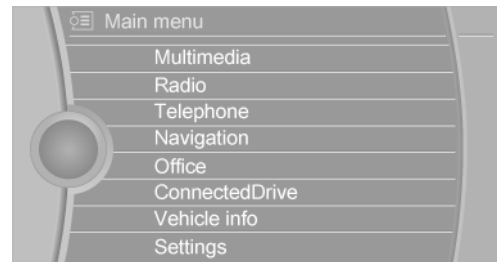

The main menu is displayed.

All iDrive functions can be called up via the main menu.

### Selecting menu items

Highlighted menu items can be selected.

1. Turn the controller until the desired menu item is highlighted.

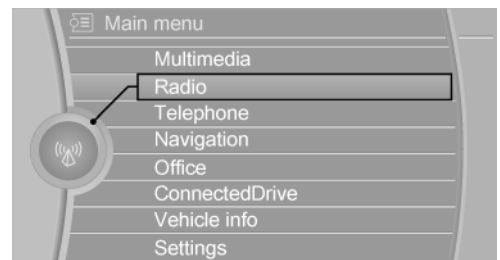

2. Press the controller.

## Menu items in the Owner's Manual

In the Owner's Manual, menu items that can be selected are set in quotation marks, e.g., "Settings".

## Changing between panels

After a menu item is selected, e.g., "Radio", a new panel is displayed. Panels can overlap.

- ▷ Move the controller to the left.
  - Closes current display and shows previous display.
  - Reopens previous display by pressing BACK button. In this case, the current panel is not closed.
- ▷ Move the controller to the right.
  - Opens new display on top of previous screen.

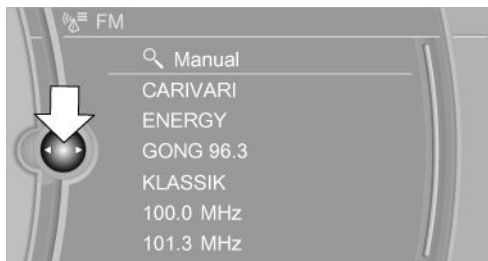

White arrows pointing to the left or right indicate that additional panels can be opened.

## Display of an opened menu

When selecting a menu, it generally opens with the panel that was last selected in that menu. To display the first panel of a menu:

- ▷ Move the controller to the left repeatedly until the first panel is displayed.
- ▷ Press the menu button on the controller twice.

## Opening the Options menu



Press button.

The "Options" menu is displayed.

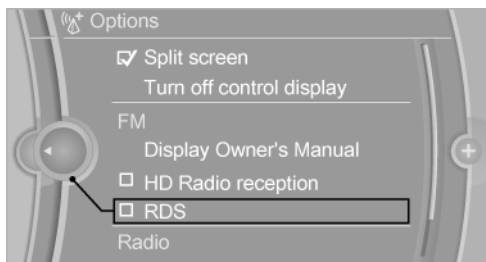

Additional options: move the controller to the right repeatedly until the "Options" menu is displayed.

## Options menu

The "Options" menu consists of various areas:

- ▷ Screen settings, e.g., "Split screen".
  - This area remains unchanged.
- ▷ Control options for the selected main menu, e.g., for "Radio".
- ▷ If applicable, further operating options for the selected menu, e.g., "Store station".

## Changing settings

1. Select a field.
2. Turn the controller until the desired setting is displayed.

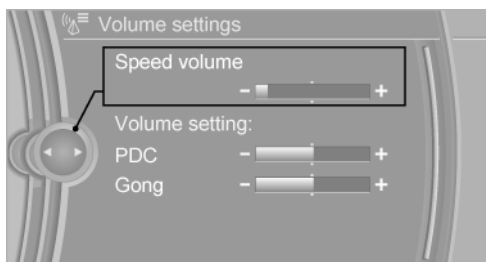

3. Press the controller.

## Activating/deactivating the functions

Several menu items are preceded by a check-box. It indicates whether the function is activated or deactivated. Selecting the menu item activates or deactivates the function.

Function is activated.



- Function is deactivated.

## Touchpad

Some iDrive functions can be operated using the touchpad on the controller:

### Selecting functions

1. "Settings"
2. "Touchpad"
3. Select the desired function.
  - ▷ "Speller": enter letters and numbers.
  - ▷ "Interactive map": viewing the interactive map.
  - ▷ "Browser": enter Internet addresses.
  - ▷ "Audio feedback": pronounces entered letters and numbers.

### Entering letters and numbers

Entering letters requires some practice at the beginning. When entering, pay attention to the following:

- ▷ For the input of upper/lower case letters and numbers, it may be necessary to reel via the controller to the corresponding Input mode, refer to page 24, e.g. when the spelling of upper and lower case letters is identical.
- ▷ Enter characters as they are displayed on the Control Display.
- ▷ Always enter associated characters, such as accents or periods so that the letter can be clearly recognized. Possible input depends on the set language. Where necessary, enter special characters via the controller.
- ▷ To delete a character, slide to the left on the touchpad.
- ▷ To enter a blank space, slide to the right in the center of the touchpad.
- ▷ To enter a hyphen, slide to the right in the upper area of the touchpad.

- ▷ To enter an underscore, swipe to the right in the lower area of the touchpad.

### Using interactive map and Internet

Via touch-pad move the interactive map in the navigation system and Internet sites.

Function	Controls
Move interactive map or Internet sites.	Swipe into respective direction.
Enlarge/shrink interactive map or Internet sites.	Drag in or out on the touchpad with fingers.
Display the menu or open a link in the Internet.	Tap once.

### Changing settings

You may change control display settings via touchpad. Swipe left or right accordingly.

## Example: setting the clock

### Setting the clock

On the Control Display:

1.  Press button. The main menu is displayed.
2. Turn the controller until "Settings" is highlighted, and then press the controller.

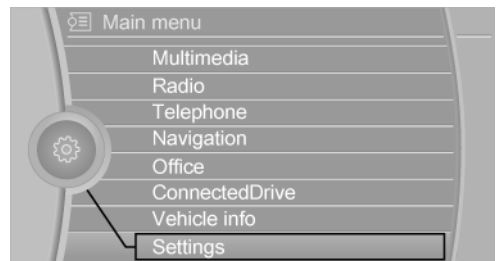

3. If necessary, move the controller to the left to display "Time/Date".

- Turn the controller until "Time/Date" is highlighted, and then press the controller.



- Turn the controller until "Time:" is highlighted, and then press the controller.



- Turn the controller to set the hours and press the controller.
- Turn the controller to set the minutes and press the controller.

## Status information

### Status field

The following information is displayed in the status field at the top right:

- ▷ Time.
- ▷ Current entertainment source.
- ▷ Sound output, on/off.
- ▷ Wireless network reception strength.
- ▷ Phone status.
- ▷ Traffic bulletin reception.

### Status field symbols

The symbols are grouped as follows.

### Radio symbols

Symbol	Meaning
	HD Radio station is being received.
	Satellite radio is switched on.

### Telephone symbols

Symbol	Meaning
	Incoming or outgoing call.
	Missed call.
	Wireless network reception strength. Symbol flashes: network search.
	Wireless network is not available.
	Bluetooth is switched on.
	Roaming is active.
	Text message was received.
	Check the SIM card.
	SIM card is blocked.
	SIM card is missing.
	Enter PIN.

### Entertainment symbols

Symbol	Meaning
	CD/DVD player.
	Music collection.
	Gracenote® database.
	AUX-IN port in the front or in the rear.
	USB audio interface.
	Mobile phone audio interface.

## Additional symbols

Symbol	Meaning
	Spoken instructions are turned off.

## Split screen

### General information

Additional information can be displayed on the right side of the split screen, e.g., information from the on-board computer.

In the divided screen view, the so-called split screen, this information remains visible even when you change to another menu.

### Switching the split screen on and off

On the Control Display:

-  Press button.
- "Split screen"

### Selecting the display

On the Control Display:

-  Press button.
- "Split screen"
- Move the controller until the split screen is selected.
- Press the controller or select "Split screen content".
- Select the desired menu item.

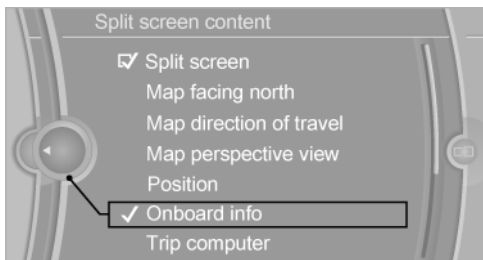



## Programmable memory buttons

### General information



The iDrive functions can be stored on the programmable memory buttons and called up directly, e.g., radio stations, navigation destinations, phone numbers and menu entries.

Settings are stored for the profile currently in use.

### Saving a function

- Highlight the function via the iDrive.
- ... Press and hold the desired button, until a signal sounds.

### Running a function

- ... Press button.  
The function will work immediately. This means, e.g., that the number is dialed when a phone number is selected.

### Displaying the button assignment

Touch buttons with bare fingers. Do not wear gloves or use objects.

The key assignment is displayed at top edge of screen.

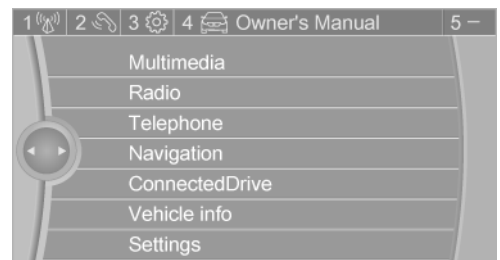

### Deleting the button assignments

- Press buttons 1 and 8 simultaneously for approx. five seconds.
- "OK"

## Deleting personal in the vehicle

### The concept

Depending on the usage, the vehicle saves personal data, such as stored radio stations. These personal data can be permanently deleted through iDrive.

### General information

Depending on the equipment package, the following data can be deleted:

- ▷ Personal Profile settings.
- ▷ Stored radio stations.
- ▷ Stored Favorites buttons.
- ▷ Travel and computer information.
- ▷ Music collection.
- ▷ Navigation, e.g. stored destinations.
- ▷ Phone book.
- ▷ Online data, e.g. Favorites, cookies.
- ▷ Voice notes.
- ▷ Login accounts.
- ▷ RemoteApp smartphone tethering.

Altogether, the deletion of the data can take up to 30 minutes.

### Functional requirement

Data can only be deleted while stationary.

### Deleting data

Heed and follow the instructions on the Control Display.



1. Switch on the ignition.
2. "Settings"
3. Open "Options".
4. "Delete personal data"
5. "Continue"
6. "OK"

## Entering letters and numbers

### General information

On the Control Display:

1. Turn the controller: select letters or numbers.
2. Select additional letters or numbers if needed.
3. "OK": confirm the entry.

Symbol	Function
	Press the controller: delete the letter or number.
	Press the controller for an extended period: delete all letters or numbers.

### Switching between cases, letters and numbers

Depending on the menu, you can reel between entering upper and lower case, letters and numbers:

Symbol	Function
<b>A<sup>B</sup>c</b>	Enter the letters.
1@+	Enter the numbers.
abc or ABC	Tip controller up.

### Without navigation system

@<sup>A</sup> A<sup>a</sup> a<sup>@</sup> Select the symbol.

### Entry comparison

Entering names and addresses: choice is narrowed down with every letter entered and letters may be added automatically.

Entries are continuously compared with data stored in the vehicle.

- ▷ Only those letters are offered during input for which data is available.

- ▶ Target search: names of locations may be entered in languages available through Control Display.

# Voice activation system

## Vehicle features and options

This chapter describes all standard, country-specific and optional features offered with the series. It also describes features that are not necessarily available in your car, e. g., due to the selected options or country versions. This also applies to safety-related functions and systems. The respectively applicable country provisions must be observed when using the respective features and systems.

## The concept

- ▷ Most functions displayed on the Control Display can be operated by voice commands via the voice activation system. The system supports you with announcements during input.
- ▷ Functions that can only be used when the vehicle is stationary cannot be used via the voice activation system.
- ▷ The system uses a special microphone on the driver's side.
- ▷ ›...‹ Verbal instructions in the Owner's Manual to use with the voice activation system.

## Requirements

Via the Control Display, set a language that is also supported by the voice activation system so that the spoken commands can be identified.

Set the language, refer to page 100.

## Using voice activation

### Activating the voice activation system

1.  Press button on the steering wheel.
2. Wait for the signal.
3. Say the command.

A command that is recognized by the voice activation system is announced and displayed in the instrument cluster.

 This symbol in the instrument cluster indicates that the voice activation system is active.

If no other commands are available, use function via iDrive.

### Terminating the voice activation system

 Briefly press the button on the steering wheel or ›Cancel‹.

## Possible commands

Most menu items on the Control Display can be voiced as commands.

The available commands depend on the menu that is currently displayed on the Control Display.

There are short commands for many functions.

You may select lists such as phone lists via voice activation. Read these lists out loud exactly as they show in the respective list.

### Having possible commands read aloud

You can have available commands read out loud for you: ›Voice commands‹

E. g. if the "Settings" menu is displayed, the commands for the settings are read out loud.

## Executing functions using short commands

Execute functions on the main menu via short commands. It almost doesn't matter which menu item is selected, e.g., ›Vehicle status‹.

List of short commands for the voice activation system, see Navigation, Entertainment, Communication Owner's Manual.

## Help dialog for the voice activation system

Calling up help dialog: ›Help‹

Additional commands for the help dialog:

- ▶ ›Help with examples‹: announces information about the current operating options and the most important commands for them.
- ▶ ›Help with voice activation‹: information about the principle of operation for the voice activation system is announced.

## One example: open the tone settings

### Via the main menu

The commands of the menu items are spoken just as they are selected via the controller.

1. Turn on the Entertainment sound output if needed.
2.  Press button on the steering wheel.
3. ›Radio‹
4. ›Tone‹

### Via short command

The desired tone settings can also be started via a short command.

1. Turn on the Entertainment sound output if needed.

2.  Press button on the steering wheel.
3. ›Tone‹

## Setting the voice dialog

Set system to standard dialog or use a short version.

The short version of the voice dialog plays back short messages in abbreviated form.

1. "Settings"
2. "Language/Units"
3. "Speech type:"
4. Select setting.

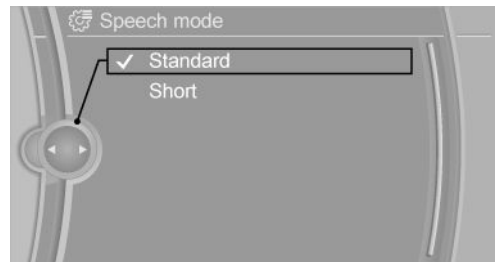

## Adjusting the volume

Turn the volume button while giving an instruction until the desired volume is set.

- ▶ The volume remains constant even if the volume of other audio sources is changed.
- ▶ The volume is stored for the profile currently in use.

## Hints on Emergency Requests

Do not use the voice activation system to initiate an Emergency Request. In stressful situations, the voice and vocal pitch can change.

This can unnecessarily delay the establishment of a phone connection.

Instead, use the SOS button, refer to page 245, close to the interior mirror.

## Environmental conditions

- ▷ Say the commands, numbers, and letters smoothly and with normal volume, emphasis, and speed.
- ▷ Always say commands in the language of the voice activation system.
- ▷ Keep the doors, windows, and glass sunroof closed to prevent noise interference.
- ▷ Avoid making other noise in the vehicle while speaking.



# Integrated Owner's Manual in the vehicle

## Vehicle features and options

This chapter describes all standard, country-specific and optional features offered with the series. It also describes features that are not necessarily available in your car, e. g., due to the selected options or country versions. This also applies to safety-related functions and systems. The respectively applicable country provisions must be observed when using the respective features and systems.

## Integrated Owner's Manual in the vehicle

The Integrated Owner's Manual can be displayed on the Control Display. It specifically describes features and functions found in the vehicle.

### Components of the Integrated Owner's Manual

The Integrated Owner's Manual consists of three parts, which offer various levels of information or possible access.

#### Quick Reference Guide

The Quick Reference Guide provides information how to operate the car, how to use basic vehicle functions or what to do in case of a breakdown. This information can also be displayed while driving.

#### Search by images

Image search provides information and descriptions. This is helpful when the terminology for a feature is not at hand.

#### Owner's Manual

Search for information and descriptions by entering terms selected from the index.

### Select components

1.  Press button.
2. Turn the controller: open "Vehicle info".
3. Press the controller.
4. Selecting desired range:
  - ▷ "Quick reference"
  - ▷ "Search by pictures"
  - ▷ "Owner's Manual"

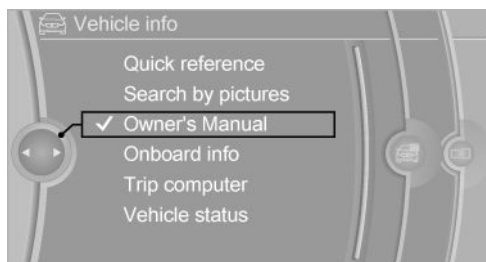

### Leafing through the Owner's Manual

#### Page by page with link access

Turn the controller until the next or previous page is displayed.

#### Page by page without link access

Scroll through the pages directly while skipping the links.

Highlight the symbol once. Now simply press the controller to browse from page to page.



Scroll back.



Scroll forward.

## Context help - Owner's Manual to the temporarily selected function

You may open the relevant information directly.

### Opening via the iDrive

To move directly from the application on the Control Display to the Options menu:

1.  Press button or move the controller to the right repeatedly until the "Options" menu is displayed.
2. "Display Owner's Manual"



### Opening when a Check Control message is displayed

Directly from the Check Control message on the Control Display:

"Display Owner's Manual"

### Changing between a function and the Owner's Manual

To reel from a function, e. g., radio, to the Owner's Manual on the Control Display and to alternate between the two displays:

1.  Press button or move the controller to the right repeatedly until the "Options" menu is displayed.
2. "Display Owner's Manual"
3. Select the desired page in the Owner's Manual.
4.  Press button again to return to last displayed function.
5.  Press button to return to the page of the Owner's Manual displayed last.

To alternate permanently between the last displayed function and the Owner's Manual repeat steps 4 & 5. Opens a new display every time.

## Programmable memory buttons

### General information

The Owner's Manual can be stored on the programmable memory buttons and called up directly.

### Storing

1. "Owner's Manual" Select via the iDrive.
2.  Press selected button for more than 2 seconds.

### Executing

-  Press button.  
The Owner's Manual is displayed immediately.





## Controls

This chapter is intended to provide you with information that will give you complete control of your vehicle. All features and accessories that are useful for driving and your safety, comfort and convenience are described here.

# Opening and closing

## Vehicle features and options

This chapter describes all standard, country-specific and optional features offered with the series. It also describes features that are not necessarily available in your car, e. g., due to the selected options or country versions. This also applies to safety-related functions and systems. The respectively applicable country provisions must be observed when using the respective features and systems.

## Remote control/key

### General information

The vehicle is supplied with two remote controls with integrated key.

Every remote control holds a replaceable battery.

You may set the key functions depending on the optional features and country-specific version. For Settings, refer to page 46.

The vehicle stores personal settings for every remote control. Personal Profile, refer to page 35.

The remote controls hold information on required maintenance. Service data in the remote control, refer to page 236

## Overview

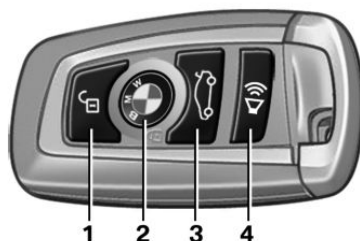

- 1 Unlocking
- 2 Locking
- 3 Opening the trunk lid
- 4 Press briefly: headlight courtesy delay feature  
Press and hold: Panic mode

## Integrated key

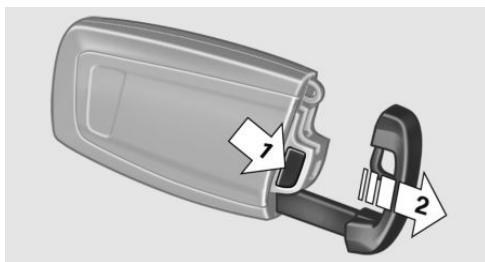

Press button, arrow 1, and remove the key, arrow 2.

The integrated key fits the following locks:

- ▷ Driver's door.
- ▷ Storage compartment in the front center armrest.

The storage compartment contains a switch for separately securing the trunk lid, refer to page 42.

## Replacing the battery

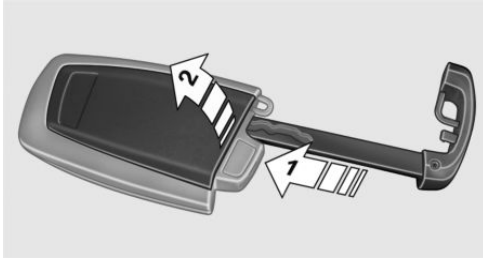

1. Remove integrated key from remote control.
2. Push in the catch with the key, arrow 1.
3. Remove the cover of the battery compartment, arrow 2.
4. Insert a battery of the same type with the positive side facing up.
5. Press the cover closed.



Take the used battery to a recycling center or to your service center.

## New remote controls

New remote controls are available from the service center.

## Loss of the remote controls

Lost remote controls can be disabled by your service center.

## Emergency detection of remote control

It is possible to switch on the ignition or start the engine in situations such as the following:

- ▷ Interference of radio transmission to remote control by external sources e.g., by radio masts.
- ▷ Empty battery in remote control.
- ▷ Interference from radio transmissions through mobile devices in close proximity to remote control.

- ▷ Interference of radio transmission by charger while charging items such as mobile devices in the vehicle.

A Check Control message is displayed if an attempt is made to switch on the ignition or start the engine.

## Starting the engine with emergency detection of the remote control

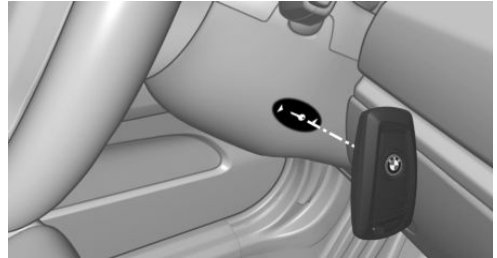

Steptronic transmission: if a corresponding Check Control message appears, hold the remote control, as shown, against the marked area on the steering column and press the Start/Stop button within 10 seconds while pressing the brake.

Manual transmission: if a corresponding Check Control message appears, hold the remote control, as shown, against the marked area on the steering column and press the Start/Stop button within 10 seconds while pressing the clutch pedal.

If the remote control is not recognized: slightly change the height position of the remote control and repeat the procedure.

## Personal Profile

### The concept

Personal Profile provides three profiles, using which personal vehicle settings can be stored. Every remote control has one of these profiles assigned.

If the vehicle is unlocked using a remote control, the assigned personal profile will be acti-

vated. All settings stored in the profile are automatically applied.

If several drivers use their own remote control, the vehicle will adjust the personal settings during unlocking. These settings are also re-stored, if the vehicle has been used in the meantime by a person with a different remote control.

Changes to the settings are automatically saved in the personal profile.

Three personal profiles and a guest profile can be created.

## Adjusting

The settings for the following systems and functions are saved in the active profile. The scope of storable settings is country- and equipment-dependable.

- ▷ Unlocking and locking.
- ▷ Lights.
- ▷ Climate control.
- ▷ Radio.
- ▷ Instrument cluster.
- ▷ Programmable memory buttons.
- ▷ Volumes, tone.
- ▷ Control Display.
- ▷ Navigation.
- ▷ Park Distance Control PDC.
- ▷ Rearview camera
- ▷ Side View.
- ▷ Head-up Display.
- ▷ Driving Dynamics Control.
- ▷ Driver's seat position, exterior mirror position, steering wheel position.
- ▷ Cruise control.
- ▷ Intelligent Safety.
- ▷ Active Blind Spot Detection.
- ▷ Night vision.

## Profile management

### Opening profiles

Regardless of the remote control in use a different profile may be activated.

1. "Settings"
2. "Profiles"
3. Select a profile.
  - ▷ All settings stored in the called-up profile are automatically applied.
  - ▷ The called-up profile is assigned to the remote control being used at the time.
  - ▷ If the profile is already assigned to a different remote control, this profile will apply to both remote controls. It cannot be differentiated anymore between the settings for the two remote controls.

### Renaming profiles

A personal name can be assigned to every profile to avoid confusion between the profiles.

1. "Settings"
2. "Profiles"
3. "Options"
4. "Rename current profile"

### Resetting profiles

The settings of the active profile are reset to their default values.

1. "Settings"
2. "Profiles"
3. "Options"
4. "Reset current profile"

### Exporting profiles

Most settings of the active profile can be exported.

This can be helpful for securing and retrieving personal settings, before delivering the vehicle to a workshop, e.g. Profiles can be taken to an-



other vehicle equipped with the Personal Profile function.

The following export options are available:

▷ Via BMW Online.

▷ Via the USB port to a USB device.

Popular file systems for USB devices are supported. FAT32 and exFAT are the recommended formats for profile export.

Other formats may not support the export.

1. "Settings"
2. "Profiles"
3. "Export profile"
4. BMW Online: "BMW Online"  
USB interface: "USB device"

### Importing profiles

Profiles exported via BMW Online can also be imported via BMW Online.

Profiles stored on a USB device can be imported via the USB interface.

Existing settings are overwritten with the imported profile.

1. "Settings"
2. "Profiles"
3. "Import profile"
4. BMW Online: "BMW Online"  
USB interface: "USB device"

### Using the guest profile

The guest profile is for individual settings that are saved in none of the three personal profiles.

This can be useful for drivers who are using the vehicle temporarily and do not have their own profile.

1. "Settings"
2. "Profiles"
3. "Guest"

The guest profile cannot be renamed. It is not assigned to the current remote control.

### Display profile list during start

The profile list can be displayed during each start to select the desired profile.

1. "Settings"
2. "Profiles"
3. "Options"
4. "Display user list at startup"

## Using the remote control

### Note



Take the remote control with you

People or animals left unattended in a parked vehicle can lock the doors from the inside. Always take the remote control with you when leaving the vehicle so that the vehicle can then be opened from the outside. ◀

### Unlocking



Press button on the remote control.

- ▷ All doors, the tailgate, and the fuel filler flap are being unlocked.
- ▷ Interior lamps and courtesy lamps are activated. This function is not available, if the interior lamps were switched off manually.
- ▷ The welcome lamps are switched on, if this function was activated.
- ▷ Exterior mirrors folded through convenient closing are folded open.

You can set how the vehicle is to be unlocked. For Settings, refer to page 46.

Anti-theft protection is switched off.

The alarm system, refer to page 47, is disarmed.

### Convenient opening



Press and hold this button on the remote control after unlocking.

The windows and the glass sunroof are opened, as long as the button on the remote control is pressed.

## Locking



Locking from the outside

Do not lock the vehicle from the outside with people inside the car, as the vehicle cannot be unlocked from inside without special knowledge. ◀

The driver's door must be closed.



Press button on the remote control.

All doors, the tailgate, and the fuel filler flap are being locked.

Anti-theft protection is switched on. It prevents the doors from being unlocked using the lock buttons or the door openers.

The alarm system, refer to page 47, is armed.

## Switching on interior lights and courtesy lights



Press button on the remote control with the vehicle locked.

This function is not available, if the interior lamps were switched off manually.

If the button is pressed again within 10 seconds after vehicle was locked, the interior motion sensor and tilt alarm sensor of the anti-theft warning system, refer to page 48, are turned off. After locking, wait 10 seconds before pressing the button again.

## Panic mode

You can trigger the alarm system if you find yourself in a dangerous situation.



Press button on the remote control for at least 3 seconds.

To reel off the alarm: press any button.

## Opening the trunk lid



Press button on the remote control for approx. 1 second.

The trunk lid opens, regardless of whether the vehicle was previously locked or unlocked.

During opening, the trunk lid pivots back and up. Ensure that adequate clearance is available before opening.

Depending on the features and the country version, it is also possible to have door unlocked. Create the settings, refer to page 46.

If the doors were not unlocked, the trunk lid is locked again as soon as it closes.



Do not place the remote control in the cargo area

Take the remote control with you and do not leave it in the cargo area; otherwise, the remote control is locked inside the vehicle when the trunk lid is closed. ◀

## Switching on the headlight courtesy delay feature



Briefly press the button on the remote control.

The duration can be set in the Control Display.

## Malfunction

Remote control detection by the vehicle can among others be malfunctioning under the following circumstances:

- ▷ The battery of the remote control is discharged. Replace the battery, refer to page 35.
- ▷ Interference of the radio connection from transmission towers or other equipment with high transmit power.
- ▷ Shielding of the remote control due to metal objects.
- ▷ Interference of the radio connection from mobile phones or other electronic devices in direct proximity.

Do not transport the remote control together with metal objects or electronic devices.

In the case of interference, the vehicle can also be unlocked and locked from the outside without remote control, refer to page 39.

### For US owners only

The transmitter and receiver units comply with part 15 of the FCC/Federal Communication Commission regulations. Operation is governed by the following:

FCC ID:

- ▶ LX8766S.
- ▶ LX8766E.
- ▶ LX8CAS.
- ▶ LX8CAS2.
- ▶ MYTCAS4.

Compliance statement:

This device complies with part 15 of the FCC Rules. Operation is subject to the following two conditions:

- ▶ This device may not cause harmful interference, and
- ▶ this device must accept any interference received, including interference that may cause undesired operation.

Any unauthorized modifications or changes to these devices could void the user's authority to operate this equipment.

## Without remote control

### From the outside



Locking from the outside

Do not lock the vehicle from the outside with people inside the car, as the vehicle cannot be unlocked from inside without special knowledge. ◀



Remove the key before pulling the door handle

Before pulling the outside door handle, remove the key to avoid damaging the paintwork and the key. ◀

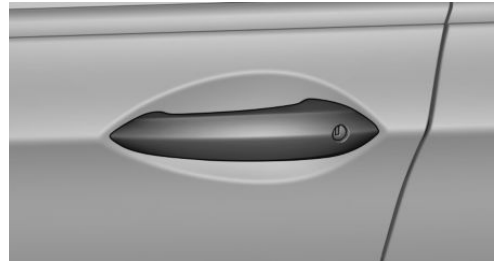

Unlock or lock the driver's door via the door lock using the integrated key, refer to page 34.

In some vehicle equipment versions, only the driver's door can be unlocked or locked via the door lock. In this case, the other doors must be unlocked or locked from the inside.

### Alarm system

With some country versions, the alarm system is not armed if the vehicle is locked with the integrated key.

In some country-specific versions, the alarm system is triggered when the vehicle is unlocked via the door lock.

In order to terminate this alarm, unlock vehicle with the remote control or switch on the ignition, if needed, through emergency detection of the remote control, refer to page 35.

## From the inside

### Unlocking and locking



Pressing the central locking system button locks or unlocks the vehicle with the front doors closed.

The vehicle is not secured against theft when locking.

The fuel filler flap remains unlocked.

In the event of a severe accident, the vehicle is automatically unlocked. The hazard warning system and interior lights come on.

### Unlocking and opening

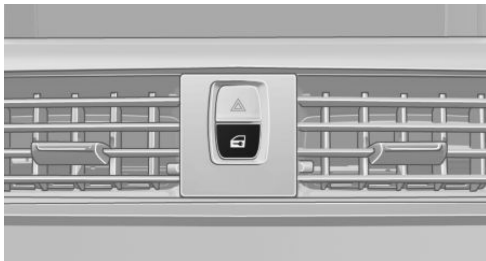

- ▷ Press the central locking system button to unlock the doors together, and then pull the door handle above the armrest.
- ▷ On the door to be opened, pull the door handle twice: the first time unlocks the door, the second time opens it. The other doors remain locked.

## Doors

### Automatic Soft Closing

To close the doors, push lightly. It is closed automatically.



Danger of jamming

Make sure that the closing path of the doors is clear; otherwise, injuries may result. ◀

## Trunk lid

### Opening

During opening, the trunk lid pivots back and up.

Ensure that adequate clearance is available before opening.

### Opening from the outside



- ▷ Press button on the trunk lid.
- ▷  Press button on the remote control for approx. 1 second.

As the case may be, the doors are also unlocked. Unlocking with the remote control, refer to page 38.

The trunk lid opens.

### Opening from the inside





With the vehicle is stationary, press the button in the driver's footwell.

The trunk lid opens.

## Locking and closing

### Hints

 Keep the closing path clear  
Make sure that the closing path of the trunk lid is clear; otherwise, injuries may result. ◀

 Do not place the remote control in the cargo area

Take the remote control with you and do not leave it in the cargo area; otherwise, the remote control is locked inside the vehicle when the trunk lid is closed. ◀

### Locking



Press the button on the inside of the trunk lid to lock the vehicle prior to closing.

The driver's door must be closed for this purpose.

### Closing





Recessed grips in the interior trim of the trunk lid make it easier to pull down the lid.

## Automatic tailgate operation

### Opening

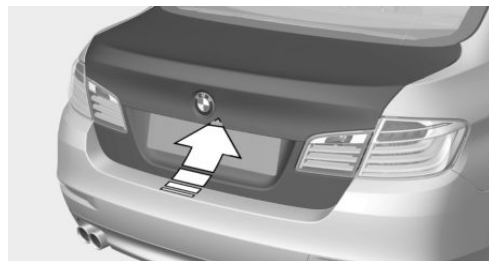
During opening, the trunk lid pivots back and up. Ensure that adequate clearance is available before opening.



- ▷ Press button on the exterior of the trunk lid.
- ▷  Press button on the remote control for approx. 1 second.

As the case may be, the doors are also unlocked. Opening with the remote control, refer to page 38.

- ▷  Push the button in the driver's footwell.

Pressing the button again stops the motion.

The opening procedure is likewise interrupted:

- ▷ When starting the engine.
- ▷ When the vehicle starts moving.
- ▷ By pressing the button in the driver's footwell.
- ▷ By pressing the button on the inside of the trunk lid.

 Provide edge protection

Sharp objects or those with edges can hit the rear window while driving and damage the heat conductors of the rear window. Provide edge protection. ◀

### Closing

Without Comfort Access:



- ▶ Press button on the inside of the trunk lid. The trunk lid closes automatically. Pressing the button again stops the motion.

With Comfort Access:

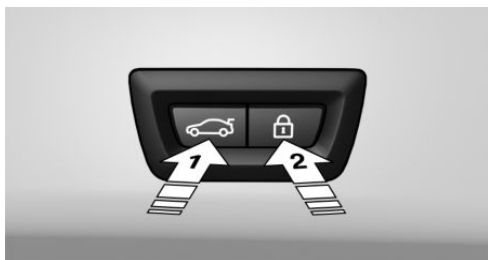

- ▶ Press button, arrow 1, on the inside of the trunk lid. Pressing the button again stops the motion.
- ▶ Press button, arrow 2. The vehicle will be locked after closing the tailgate. The driver's door must be closed for this purpose and the remote control must be outside of the vehicle in the area of the trunk lid. Pressing the button again stops the motion.

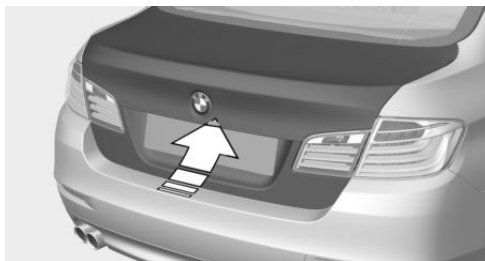

- ▶ Press button on the exterior of the trunk lid. Pressing the button again stops the motion.

The closing operation is interrupted:

- ▶ When starting the engine.
- ▶ The vehicle starts off with jerks.

 Keep the closing path clear  
Make sure that the closing path of the trunk lid is clear; otherwise, injuries may result. ◀

 Do not place the remote control in the cargo area

Take the remote control with you and do not leave it in the cargo area; otherwise, the remote control is locked inside the vehicle when the trunk lid is closed. ◀

### Manual operation

In the event of an electrical fault, manually operate the unlocked trunk lid slowly and smoothly.

To close it completely, push the trunk lid down lightly. It is closed automatically.

 Keep the closing path clear  
Make sure that the closing path is clear; otherwise, injuries may result. ◀

### Locking separately

The trunk lid can be locked separately using the switch in the center armrest. If the center

arm rest is locked, the trunk lid cannot be opened.



- ▷ Trunk lid secured, arrow 1.
- ▷ Trunk lid not secured, arrow 2.

Slide the switch into the arrow 1 position. This secures the trunk lid and disconnects it from the central locking system.

This is beneficial when the vehicle is parked using valet service. The infrared remote control can be handed out without the key.

## Emergency unlocking



Pull the handle inside the cargo area.  
The trunk lid unlocks.

## Comfort Access

### The concept

The vehicle can be accessed without activating the remote control.

All you need to do is to have the remote control with you, such as in your pants pocket.

The vehicle automatically detects the remote control when it is in close proximity or in the car's interior.

Comfort Access supports the following functions:

- ▷ Unlocking/locking of the vehicle.
- ▷ Convenient closing.

- ▷ Open the trunk lid individually.
- ▷ Open trunk lid with no-touch activation.
- ▷ Open/close trunk lid with no-touch activation.
- ▷ Start the engine.

## Functional requirements

- ▷ There are no external sources of interference nearby.
- ▷ To lock the vehicle, the remote control must be located outside of the vehicle.
- ▷ The next unlocking and locking cycle is not possible until after approx. 2 seconds.
- ▷ The engine can only be started if the remote control is in the vehicle.

## Unlocking

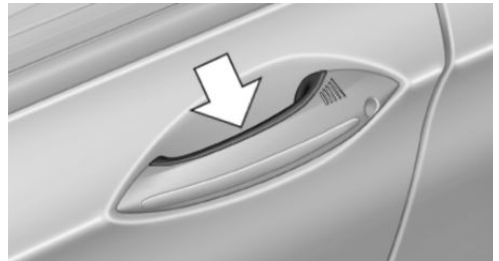

Grasp the handle of a vehicle door completely, arrow.

This corresponds with pressing the button on the remote control. 

## Locking

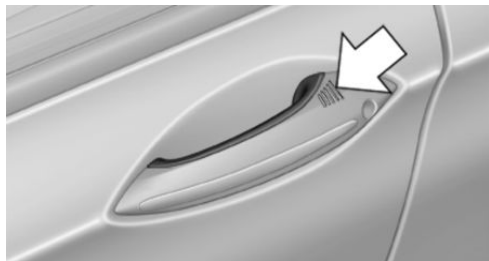

Touch the surface on the handle of a vehicle door, arrow, with your finger for approx. 1 second without grasping the door handle.

This corresponds with pressing the button on the remote control. 

To save battery power, ensure that the ignition and all electronic systems and/or power consumers are turned off before locking the vehicle.

## Convenient closing

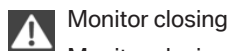

Monitor closing

Monitor closing to ensure that no one becomes trapped. ◀

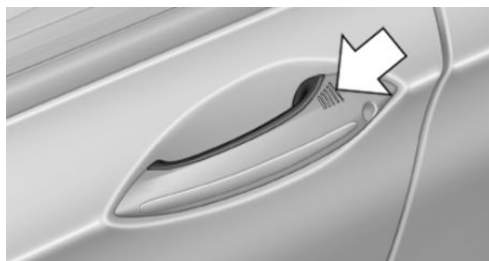

Touch the surface on the handle of a vehicle door, arrow, with your finger and hold it there without grasping the door handle.

This corresponds to pressing and holding  the remote control button.

In addition to locking, the windows and the glass sunroof close and the exterior mirrors fold in.

## Separately unlocking the trunk lid

Press button on the exterior of the trunk lid.

This corresponds to pressing  the remote control button.

The situation of the doors does not change.



Do not place the remote control in the cargo area

Take the remote control with you and do not leave it in the cargo area; otherwise, the remote control is locked inside the vehicle when the trunk lid is closed. ◀

## Opening and closing trunk lid with no-touch activation

The trunk lid can be opened with no-touch activation using the remote control you are carrying. With automatic tailgate operation, it can also be closed with no-touch activation. Two sensors detect a forward-directed foot motion in the center of the area at the rear of the car and the trunk lid opens and/or closes.

## Foot movement to be carried out



Do not touch vehicle

With the foot motion, make sure there is steady stance and do not touch the vehicle; otherwise, there is a danger of injury, e. g. from hot exhaust system parts. ◀

1. Place in the center behind the vehicle, about an arm's length from the vehicle rear.
2. Move a foot in the direction of travel as far under the vehicle as possible and immediately pull it back. With this movement, the



leg must pass through the ranges of both sensors.

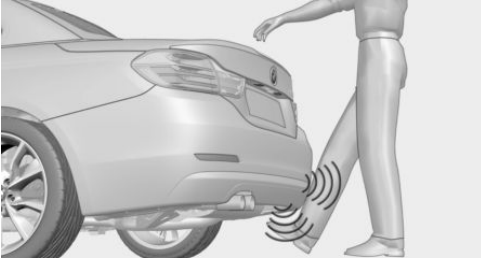

## Opening

Perform the foot movement described earlier. Before the opening, the hazard warning system flashes.

The trunk lid opens, regardless of whether it was previously locked or unlocked.

During opening, the trunk lid pivots back and up. Ensure that adequate clearance is available before opening.

### Preventing inadvertent opening

In situations where the trunk lid is not to be opened with no-touch activation, ensure that the remote control is located beyond the range of the sensor, at least 5 ft/1.50 m from the rear of the car.

Otherwise, the trunk lid may be opened inadvertently, for example by an unintentional or misinterpreted movement of the foot. ◀

## Closing

Tailgate closing with no-touch activation is only possible with automatic tailgate operation. Perform the foot movement described earlier.

The hazard warning system flashes on and an acoustic signal sounds before the trunk lid closes.

When closing, the trunk lid pivots back and down.

The closing of the trunk lid has no effect on the locking of the vehicle.

Another foot movement can interrupt the closing operation.

### Avoiding unintentional closing

In situations in which the opened trunk lid should not to be closed with no-touch activation, ensure that the remote control is located beyond the range of the sensor, at least 5 ft/1.50 m from the rear of the car.

Otherwise, the trunk lid may be closed inadvertently, for example by an unintentional or misinterpreted movement of the foot. ◀

### Keep the closing path clear

Make sure that the closing path of the trunk lid is clear; otherwise, injuries may result. ◀

### Do not place the remote control in the cargo area

Take the remote control with you and do not leave it in the cargo area; otherwise, the remote control is locked inside the vehicle when the trunk lid is closed. ◀

## Malfunction

Remote control detection by the vehicle can among others be malfunctioning under the following circumstances:

- ▶ The battery of the remote control is discharged. Replace the battery, refer to page 35.
- ▶ Interference of the radio connection from transmission towers or other equipment with high transmit power.
- ▶ Shielding of the remote control due to metal objects.
- ▶ Interference of the radio connection from mobile phones or other electronic devices in direct proximity.

Do not transport the remote control together with metal objects or electronic devices.

In the case of a malfunction, unlock and lock the vehicle using the buttons of the remote

control or using the integrated key, refer to page 39.

## Adjusting

### Unlocking

The settings are saved in the active profile, refer to page 35.

#### Doors

1. "Settings"
2. "Doors/key"
3.  Select the symbol.
4. Select the desired function:
  - ▷ "Driver's door only"  
Only the driver's door and the fuel filler flap are unlocked. Pressing again unlocks the entire vehicle.
  - ▷ "All doors"  
The entire vehicle is unlocked.

#### Trunk lid

Depending on optional features and country version, this setting is not offered in some cases.

1. "Settings"
2. "Doors/key"
3.  Select the symbol.
4. Select the desired function:
  - ▷ "Tailgate"  
The trunk lid is opened.
  - ▷ "Tailgate + door(s)"  
The trunk lid is opened and the doors are unlocked.

### Confirmation signals from the vehicle

The settings are saved in the active profile, refer to page 35.

1. "Settings"

2. "Doors/key"
3. Deactivate or activate the desired confirmation signals.
  - ▷ "Acoustic sig. lock/unlock"
  - ▷ "Flash when lock/unlock"

### Automatic locking

The settings are saved in the active profile, refer to page 35.

1. "Settings"
2. "Doors/key"
3. Select the desired function:
  - ▷ "Lock if no door is opened"  
The vehicle locks automatically after a short period of time if no door is opened.
  - ▷ "Lock after start driving"  
The vehicle locks automatically after you drive off.

### Retrieving the seat, mirror, and steering wheel settings

The driver's seat, exterior mirror, and steering wheel position adjusted last will be stored for the active profile.

When the vehicle is unlocked, these positions are automatically retrieved if this function was activated.



Pinch hazard when moving back the seat  
If this function is used, first make sure that the footwell behind the driver's seat is empty. Otherwise, people might get injured or objects damaged when the seat is moved back. ◀

The adjustment procedure is interrupted:

- ▷ When a seat position reel is pressed.
- ▷ When a button of the seat, mirror, and steering wheel memory is pressed briefly.

## Activating the setting

1. "Settings"
2. "Doors/key"
3. "Last seat position autom."

## Alarm system

### The concept

When the vehicle is locked, the vehicle alarm system responds to:

- ▷ Opening a door, the hood or the trunk lid.
- ▷ Movements in the interior.
- ▷ Changes in the vehicle tilt, e. g., during attempts at stealing a wheel or when towing the car.
- ▷ Disconnected battery voltage.

The alarm system briefly signals tampering:

- ▷ By sounding an acoustic alarm.
- ▷ By switching on the hazard warning system.
- ▷ By flashing the daytime running lights.

### Arming and disarming the alarm system

When you unlock or lock the vehicle, either with the remote control, Comfort Access or at the door lock the alarm system is disarmed or armed at the same time.

### Door lock and armed alarm system

Unlocking via the door lock will trigger the alarm on some country-specific versions.

### Trunk lid and armed alarm system

The trunk lid can be opened even when the alarm system is armed.

After the trunk lid is closed, it is locked and monitored again when the doors are locked. The hazard warning system flashes once.

## Panic mode

You can trigger the alarm system if you find yourself in a dangerous situation.



Press button on the remote control for at least 3 seconds.

To switch off the alarm: press any button.

## Indicator lamp on the interior rearview mirror

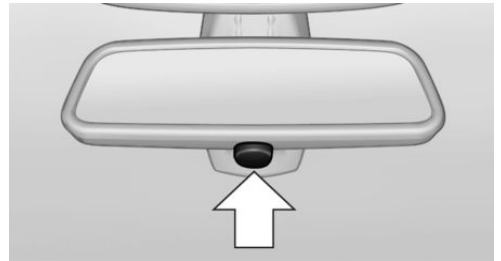

- ▷ The indicator lamp flashes briefly every 2 seconds:  
The system is armed.
- ▷ The indicator lamp flashes after locking:  
The doors, hood or trunk lid is not closed properly, but the rest of the vehicle is secured.  
After 10 seconds, the indicator lamp flashes continuously. Interior motion sensor and tilt alarm sensor are not active.  
When the still open access is closed, interior motion sensor and tilt alarm sensor will be switched on.
- ▷ The indicator lamp goes out after unlocking:  
The vehicle has not been tampered with.
- ▷ The indicator lamp flashes after unlocking until the engine ignition is switched on, but no longer than approx. 5 minutes:  
An alarm has been triggered.

## Tilt alarm sensor

The tilt of the vehicle is monitored.

The alarm system responds in situations such as attempts to steal a wheel or when the car is towed.

### Interior motion sensor

The windows and glass sunroof must be closed for the system to function properly.

### Avoiding unintentional alarms

The tilt alarm sensor and interior motion sensor can be switched off together, such as in the following situations:

- ▷ In automatic car washes.
- ▷ In duplex garages.
- ▷ During transport on trains carrying vehicles, at sea or on a trailer.
- ▷ With animals in the vehicle.

### Switching off the tilt alarm sensor and interior motion sensor

 Press the remote control button again within 10 seconds as soon as the vehicle is locked.

The indicator lamp lights up for approx. 2 seconds and then continues to flash.

The tilt alarm sensor and interior motion sensor are turned off, until the vehicle is locked again.

### Switching off the alarm

- ▷ Unlock vehicle with the remote control or switch on the ignition, if needed through emergency detection of remote control, refer to page 35.
- ▷ With Comfort Access: if you are carrying the remote control on your person, grasp the driver side or front passenger side door handle completely.

## Power windows

### Hint





Take the remote control with you

Take the remote control with you when leaving the vehicle so that children, e.g., cannot operate the power windows and injure themselves. ◀



### Opening

- ▷  Press the button to the resistance point.  
The window opens while the switch is held.
- ▷  Press the switch beyond the resistance point.  
The window opens automatically. Pressing the switch again stops the motion.

See also: Convenient opening, refer to page 37, via remote control.

### Closing



Keep the closing path clear

Monitor closing and make sure that the closing path of the window is clear; otherwise, injuries may result. ◀



- ▷ Pull the switch to the resistance point.  
The window closes while the switch is held.

- ▶  Pull the switch beyond the resistance point.

The window closes automatically. Pulling again stops the motion.

See also: closing by means of Comfort Access, refer to page 43.

## Pinch protection system

-  Danger of jamming even with pinch protection

Even with the pinch protection system, check that the window's closing path is clear; otherwise, the closing action may not stop in certain situations, e.g., if thin objects are present. ◀

-  No window accessories

Do not install any accessories in the window's range of movement; otherwise, the pinch protection system will be impaired. ◀

If closing force exceeds a specific margin as a window closes, closing is interrupted.

The window reopens slightly.

## Closing without the pinch protection system

-  Keep the closing path clear

Monitor closing and make sure that the closing path of the window is clear; otherwise, injuries may result. ◀

E.g. danger from the outside or ice might prevent window from closing properly - proceed as follows:

1. Pull the reel past the resistance point and hold it there.  
The pinch protection is limited and the window reopens slightly if the closing force exceeds a certain margin.
2. Pull the reel past the resistance point again within approx. 4 seconds and hold it there.  
The window closes without jam protection.

## Safety switch

### General information

The safety switch in the driver's door can be used to prevent children, e.g., from opening and closing the rear windows using the switches in the rear.

### Switching on and off



Press button.

The LED lights up if the safety function is switched on.



Safety switch for rear operation

Press the safety switch when transporting children in the rear; otherwise, injury may result if the windows are closed without supervision. ◀

## Roller sunblinds

### General information

If you are no longer able to move the roller sunblind for the rear window after having activated it a number of times in a row, the system is blocked for a limited time to prevent overheating. Let the system cool.

The roller sunblind for the rear window cannot be moved at low interior temperatures.

### Driver's door controls



## Roller sunblind for rear window



Press button.

## Roller sunblinds for the rear side windows

Pull out the roller sunblind at the loop and hook it onto the bracket.



Do not open the window while the roller sunblind is tilted

Do not open the window while the roller sunblind is tilted; otherwise, there is a risk of damage at high speeds that may result in personal injury. ◀

## Glass sunroof, powered

### General information

The glass sunroof and the sliding visor can be operated together or separately, using the same switch.

The glass sunroof is operational when the ignition is switched on.



Keep the closing path clear

Monitor closing and make sure that the closing path of the glass sunroof is clear; otherwise, injuries may result. ◀



Take the remote control with you

Take the remote control with you when leaving the vehicle so that children, e.g., cannot operate the glass sunroof and injure themselves. ◀



### Tilting the glass sunroof



Push switch briefly upward.

- ▶ The closed glass sunroof is tilted and the sliding visor opens slightly.
- ▶ The opened glass sunroof closes until it is in its tilted position. The sliding visor does not move.

### Opening/closing the glass sunroof and sliding visor separately

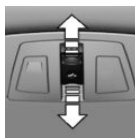

- ▶ Press the reel in the desired direction to the resistance point and hold it there.

The sliding visor opens, as long as the reel is held down. If the sliding visor is already fully open, the glass sunroof opens.

The glass sunroof closes as long as the reel is held down. If the glass sunroof is already closed or in the tilted position, the sliding visor closes.

- ▶ Press the reel in the desired direction past the resistance point.  
The sliding visor opens automatically. If the sliding visor is already fully open, the glass sunroof opens automatically.  
The glass sunroof closes automatically. If the glass sunroof is already closed or in the

tilted position, the sliding visor closes automatically.

Pressing the reel upward stops the motion.

## Opening/closing the glass sunroof and sliding visor together

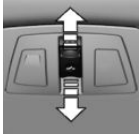

Briefly press the reel twice in succession in the desired direction past the resistance point.

The glass sunroof and sliding visor move together. Pressing the reel upward stops the motion.

- ▶ See also: Convenient opening, refer to page 37, via remote control.
- ▶ See also: closing by means of Comfort Access, refer to page 43.

## Comfort position

If the glass sunroof is not automatically completely opened, the comfort position has been attained. In this position the wind noises in the interior are the least.

If desired, continue the movement by pressing the reel.

## Pinch protection system

If the closing force when closing the glass sunroof exceeds a certain value, the closing movement is stopped, beginning at approximately the middle of the opening in the roof, or from the tilted position during closing.

The glass sunroof reopens slightly.

 **Danger of jamming even with pinch protection**

Despite the pinch protection system, check that the glass sunroof's closing path is clear; otherwise, the closing action may not be interrupted in certain extreme situations, such as when thin objects are present. ◀

## Closing from the open position without pinch protection

E. g. if there is an external danger, proceed as follows:

1. Press the reel forward beyond the resistance point and hold.
 

The pinch protection is limited and the glass sunroof reopens slightly if the closing force exceeds a certain margin.
2. Press the reel forward again beyond the resistance point and hold until the glass sunroof closes without jam protection. Make sure that the closing area is clear.

## Closing from the raised position without pinch protection

If there is an external danger, push the reel forward past the resistance point and hold it.

The glass sunroof closes without jam protection.

## Initializing after a power failure

After a power failure during the opening or closing process, the glass sunroof can only be operated to a limited extent.

## Initializing the system

The system can be initialized when the vehicle is stationary and the engine is running.

During the initialization, the glass sunroof closes without jam protection.

 **Keep the closing path clear**

Monitor closing and make sure that the closing path of the glass sunroof is clear; otherwise, injuries may result. ◀

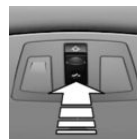

Press the reel up and hold it until the initialization is complete:

- ▶ Initialization begins within 15 seconds and is completed when the glass sunroof and sliding visor are completely closed.

- ▷ The glass sunroof closes without jam protection.



# Adjusting

## Vehicle features and options

This chapter describes all standard, country-specific and optional features offered with the series. It also describes features that are not necessarily available in your car, e. g., due to the selected options or country versions. This also applies to safety-related functions and systems. The respectively applicable country provisions must be observed when using the respective features and systems.

## Sitting safely

The ideal seating position can make a vital contribution to relaxed, fatigue-free driving.

The seating position plays an important role in an accident in combination with:

- Safety belts, refer to page 57.
- Head restraints, refer to page 58.
- Airbags, refer to page 108.

## Seats

### Hints

 Do not adjust the seat while driving  
Do not adjust the driver's seat while driving, or the seat could respond with unexpected movement and the ensuing loss of vehicle control could lead to an accident. ◀

 Do not incline the backrest too far to the rear

Do not incline the backrest too far to the rear while driving, or there is a risk of slipping under the safety belt in the event of an accident. This would eliminate the protection normally provided by the belt. ◀

 Keep the movement area unobstructed  
When changing the seat position, keep the seat's area of movement unobstructed; otherwise, people might get injured or objects damaged. ◀

## Semi-electrically adjustable seats

### At a glance

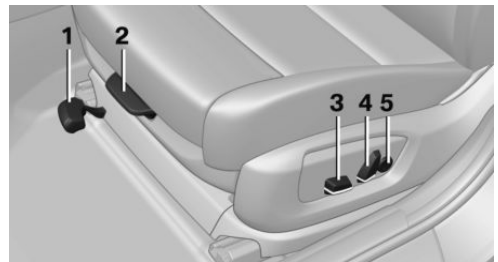

- 1 Forward/backward
- 2 Thigh support
- 3 Height, tilt
- 4 Backrest
- 5 Lumbar support

### Tilt

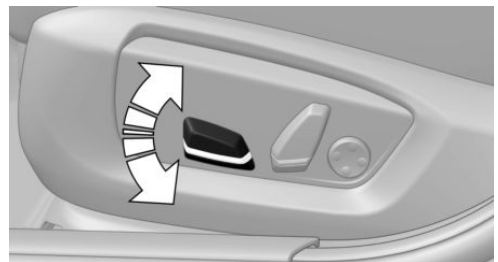

Move the control in the desired direction until the desired tilt is set.

## Forward/backward

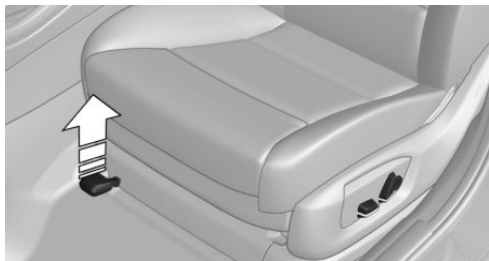

Pull the lever and slide the seat in the desired direction.

After releasing the control, move the seat forward or back slightly making sure it engages properly.

## Height

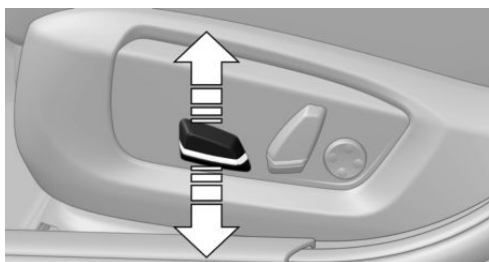

Move the button in the required direction.

## Backrest



Move the button in the required direction.

## Electrically adjustable seats

### Overview

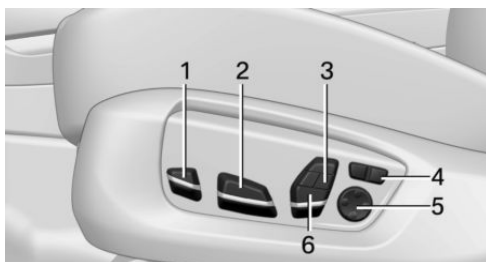

- 1 Thigh support
- 2 Forward/back, height, tilt
- 3 Shoulder support
- 4 Backrest width
- 5 Lumbar support
- 6 Backrest, head restraint

### General information

The seat setting for the driver's seat is stored for the profile currently in use. When the vehicle is unlocked via the remote control, the position is automatically retrieved if the Function, refer to page 46, is activated for this purpose.

### Adjustments in detail

1. Forward/back.

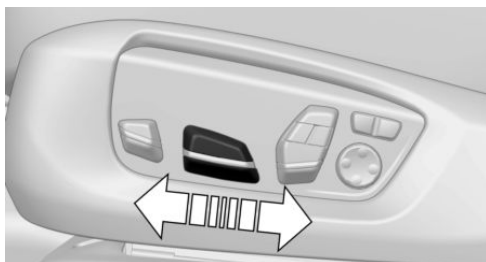

## 2. Height.

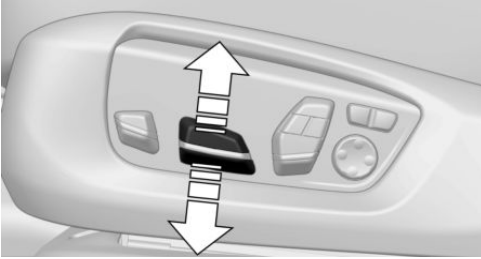

## 3. Seat tilt.

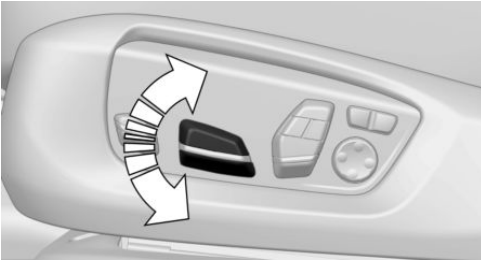

## 4. Backrest tilt.

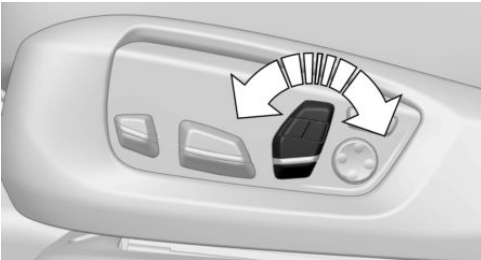

## 5. Thigh support.

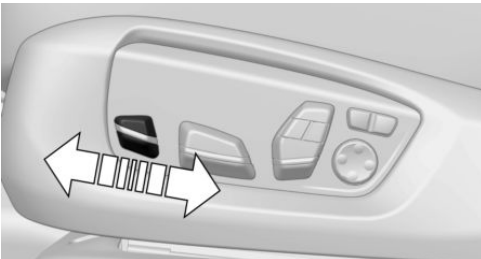

## Thigh support

## Multifunctional seat

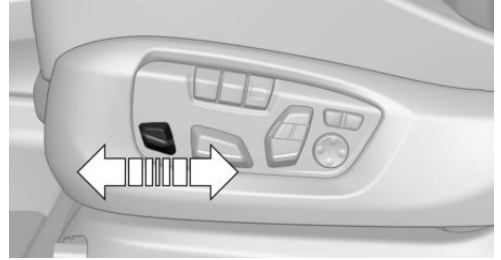

Adjust the position using the lever.

## Lumbar support

The curvature of the seat backrest can be adjusted in a way that it supports the lumbar region of the spine. The lower back and the spine are supported for upright posture.



- ▶ Press the front/rear section of the switch.  
The curvature is increased/decreased.
- ▶ Press the upper/lower section of the switch.  
The curvature is shifted up/down.

## Backrest width



Change the width of the backrest using the side wings to adjust the lateral support.

To make it easier to enter and exit the vehicle, the backrest width temporarily opens fully.

## Shoulder support

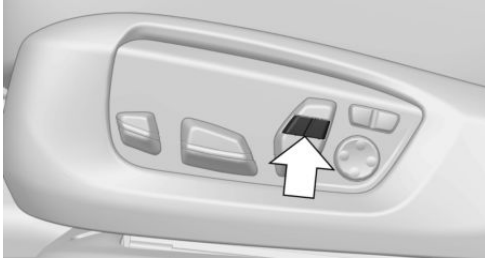

Also supports the back in the shoulder area:

- ▷ Results in a relaxed seating position.
- ▷ Reduces strain on the shoulder muscles.

## Active seat

Active adjustment of the seat cushion's contours reduces muscular tension and fatigue to help prevent lower back pain.



Press button. The LED lights up.

## Front seat heating



## Switching on



Press button once for each temperature level.

The maximum temperature is reached when three LEDs are lit.

If the journey is continued within approx. 15 minutes, the seat heating is activated automatically with the temperature selected last.

When ECO PRO, refer to page 196, is activated, the heater output is reduced.

## Switch off



Press button longer.

The LEDs go out.

## Temperature distribution

The heating action in the seat cushion and backrest can be distributed in different ways.

On the Control Display:

1. "Climate"
2. "Front seat heating"
3. Select the required seat.
4. Turn the controller to set the temperature distribution.

## Rear seat heating



## Switching on



Press button once for each temperature level.

The maximum temperature is reached when three LEDs are lit.

If the journey is continued within approx. 15 minutes, the seat heating is activated automatically with the temperature selected last.

When ECO PRO, refer to page 196, is activated, the heater output is reduced.

### Switch off



Press button longer.

The LEDs go out.

### Active seat ventilation, front

The seat cushion and backrest surfaces are cooled by means of integrated fans.

The ventilation cools the seat, e. g., if the vehicle interior is overheated or for continuous cooling at high temperatures.



### Switching on



Press button once for each ventilation level.

The highest level is active when three LEDs are lit.

After a short time, the system automatically moves down one level in order to prevent excessive cooling.

### Switch off



Press button longer.

The LEDs go out.

## Safety belts

### Seats with safety belt

The vehicle has five seats, each of which is equipped with a safety belt.

### General information

Always make sure that safety belts are being worn by all occupants before driving off.

For the occupants' safety the belt locking mechanism triggers early. Slowly guide the belt out of the holder when applying it.

Although airbags enhance safety by providing added protection, they are not a substitute for safety belts.

The upper shoulder strap's anchorage point will be correct for adult seat occupants of every build if the seat is correctly adjusted.

- ▷ The two outer safety belt buckles, integrated into the rear seat, are for passengers sitting on the left and right.
- ▷ The center rear safety belt buckle is solely intended for the center passenger.

### Hints



One person per safety belt

Never allow more than one person to wear a single safety belt. Never allow infants or small children to ride on a passenger's lap. ◀



Putting on the belt

Lay the belt, without twisting, snugly across the lap and shoulders, as close to the body as possible. Make sure that the belt lies low around the hips in the lap area and does not press on the abdomen. Otherwise, the belt can slip over the hips in a frontal impact and injure the abdomen.

The safety belt must not lie across the neck, rub on sharp edges, be routed over breakable objects, or be pinched. ◀



What reduces the restraining effect

Avoid wearing bulky clothing, and pull the shoulder belt periodically to readjust the tension. Make sure that the belt is not jammed; otherwise, the belt can be damaged and the restraining effect is reduced. ◀

## Buckling the belt

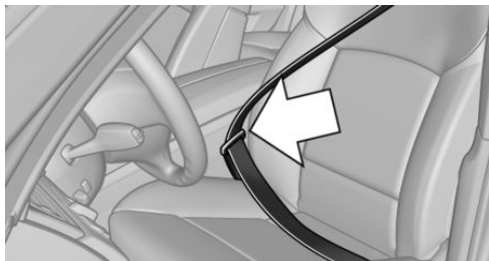

Make sure you hear the latch plate engage in the belt buckle.

## tensioning the safety belt automatically

When the belt is closed, it is automatically tightened once after the release.

## Unbuckling the belt

1. Hold the belt firmly.
2. Press the red button in the belt buckle.
3. Guide the belt back into its roll-up mechanism.

## Safety belt reminder for driver's and passenger's seat



The indicator lamp lights up and a signal sounds. Make sure that the safety belts are positioned correctly. The safety belt reminder is active at speeds above approx. 6 mph/10 km/h. It can also be activated if objects are placed on the front passenger seat.

## Safety mode

In critical situations, e.g., during full brake application, the front safety belts tighten automatically.

If the situation passes without an accident occurring, the belt tension relaxes.

If the belt tension does not loosen automatically, stop the vehicle and unbuckle the belt using the red button in the buckle. Fasten the belt before continuing on your trip.

## Damage to safety belts

Wear and tear after accidents or when damaged otherwise:

Have the safety belts, including the safety belt tensioners, replaced and have the belt anchors checked.



Check and replace safety belts

This should only be done by your service center; otherwise, this safety feature might not work properly. ◀

## Front head restraints

### Correctly adjusted head restraint

A correctly adjusted head restraint reduces the risk of injury to cervical vertebrae in the event of an accident.



Adjusting the head restraint

Adjust the head restraints of all occupied seats properly; otherwise, there is an increased risk of injury in an accident. ◀

### Height

Adjust the head restraint so that its center is approximately at ear level.

### Distance

Adjust the distance so that the head restraint is as close as possible to the back of the head.

## Active head restraint

In the event of a rear-end collision with a certain severity, the active head restraint automatically reduces the distance from the head.



Reduced protective function

- ▷ Do not use seat or head restraint covers.
- ▷ Do not hang objects, e.g., clothes hangers, on the head restraints.
- ▷ Only attach accessories approved by BMW to the seat or head restraint.

Otherwise, the protective function of the active head restraint will be impaired and the personal safety of the occupants will be endangered. ◀

Wear and tear after accidents or when damaged otherwise:

Have the active headrest checked and if needed replaced.

## Adjusting the height: manual head restraints

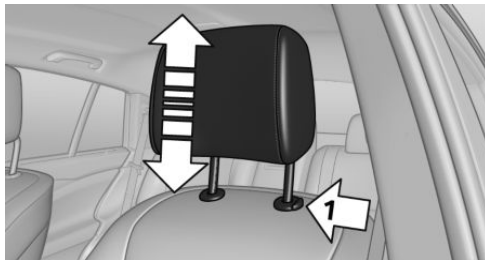

- ▷ To raise: push.
- ▷ To lower: press button, arrow 1, and push headrest down.

## Adjusting the height: electrical head restraints

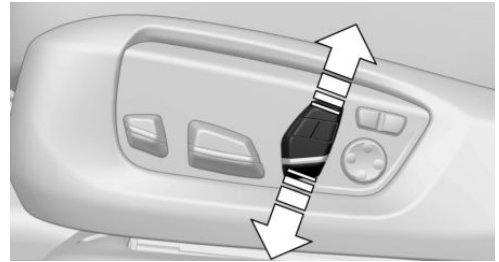

Adjusting electrically.

## Distance to the back of the head: manual head restraints

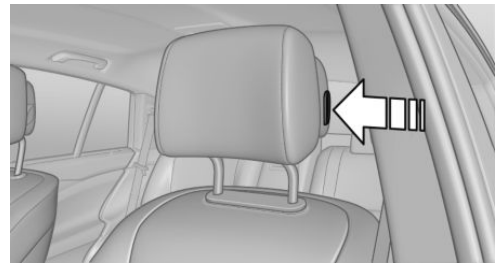

- ▷ Forward: by pulling.
- ▷ Back: press the button and push the head restraint toward the rear.

## Distance to the back of the head: electrical head restraints

The head restraint is automatically repositioned when the shoulder support is adjusted.

## Adjusting the side extensions

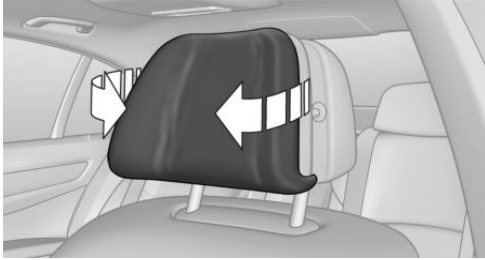

Fold forward for increased lateral support in the resting position.

## Removing

The head restraints cannot be removed.

## Rear head restraints

### Correctly adjusted head restraint

A correctly adjusted head restraint reduces the risk of injury to cervical vertebrae in the event of an accident.



Adjusting the head restraint

Adjust the head restraints of all occupied seats properly; otherwise, there is an increased risk of injury in an accident. ◀

### Height

Adjust the head restraint so that its center is approximately at ear level.

### Distance

Adjust the distance so that the head restraint is as close as possible to the back of the head.

## Adjusting the height

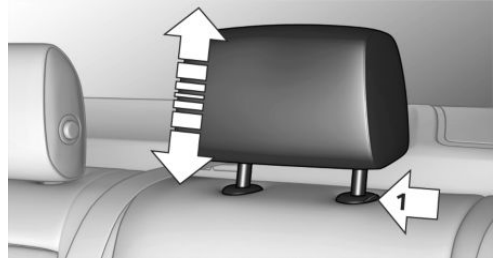

- ▷ To raise: push.
- ▷ To lower: press button, arrow 1, and push headrest down.

## Folding forward

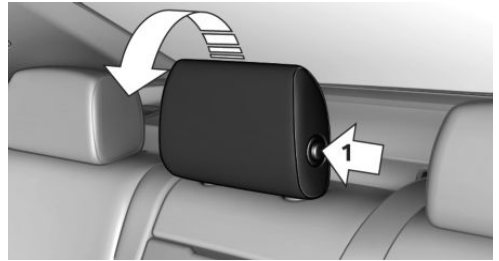

Press button, arrow 1, and fold the head restraint forward.

## Removing

Only remove the head restraint if no one will be sitting in the seat in question.

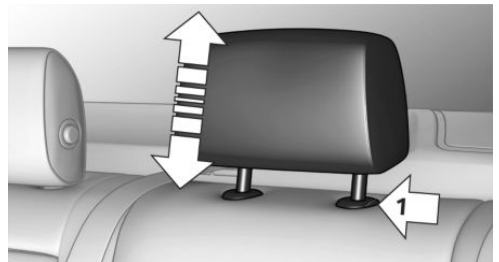

1. Raise the head restraint up against the resistance.



2. Press button, arrow 1, and pull the head restraint out completely.

 Before transporting passengers  
Reinstall the head restraint before transporting anyone in the seat; otherwise, the protective function of the head restraint is unavailable. ◀

## Seat, mirror, and steering wheel memory

### The concept

Two driver's seat and exterior mirror positions can be stored per profile, refer to page 35, and called up. Settings for the backrest width and lumbar support are not stored in memory.

### Hints

 Do not retrieve the memory while driving  
Do not retrieve the memory setting while driving, as an unexpected movement of the seat or steering wheel could result in an accident. ◀

 Keep the movement area unobstructed  
When changing the seat position, keep the seat's area of movement unobstructed; otherwise, people might get injured or objects damaged. ◀

### At a glance

#### Front



### Storing

1. Switch on the ignition.
2. Set the desired position.
3.  Press button. The LED in the button lights up.
4. Press selected button 1 or 2 while the LED is lit. The LED goes out.

If the SET button is pressed accidentally:

 Press button again.  
The LED goes out.

### Calling up settings

#### Comfort function

1. Open the driver's door.
  2. Switch off the ignition.
  3. Briefly press the desired button 1 or 2.
- The corresponding seat position is performed automatically.

The procedure stops when a reel for adjusting the seat or one of the buttons is pressed.

#### Safety mode

1. Close the driver's door or reel on the ignition.
2. Press and hold the desired button 1 or 2 until the adjustment procedure is completed.

### Calling up of a seat position deactivated

After a brief period, calling up stored seat positions is deactivated to save battery power.

To reactivate calling up of a seat position:

- ▷ Open or close the door or trunk lid.
- ▷ Press a button on the remote control.
- ▷ Press the Start/Stop button.

## Mirrors

### Exterior mirrors

#### General information

The mirror on the passenger side is more curved than the driver's side mirror.

Depending on the vehicle equipment, the mirror setting is stored for the profile currently in use. When the vehicle is unlocked via the remote control, the position is automatically retrieved if this function is active.

#### Note

 Estimating distances correctly  
Objects reflected in the mirror are closer than they appear. Do not estimate the distance to the traffic behind you based on what you see in the mirror, as this will increase your risk of an accident. ◀

#### At a glance



- 1 Adjusting 62
- 2 Left/right, Automatic Curb Monitor
- 3 Fold in and out 62

#### Selecting a mirror

 To change over to the other mirror:  
Slide the switch.

#### Adjusting electrically



The setting corresponds to the direction in which the button is pressed.

#### Saving positions

Seat, mirror, and steering wheel memory, refer to page 61.

#### Adjusting manually

In case of electrical malfunction press edges of mirror.

#### Automatic Curb Monitor

##### The concept

If reverse gear is engaged, the mirror glass on the front passenger side is tilted downward. This improves your view of the curb and other low-lying obstacles when parking, e.g.

##### Activating

1.  Slide the switch to the driver's side mirror position.
2. Engage selector lever position R.

##### Deactivating

Slide the switch to the passenger side mirror position.

##### Fold in and out

 Press button.

Possible at speeds up to approx. 15 mph/20 km/h.

E. g. this is advantageous

- ▷ In car washes.
- ▷ In narrow streets.
- ▷ For folding mirrors back out that were folded away manually.

Mirrors that were folded in are folded out automatically at a speed of approx. 25 mph/40 km/h.

 Fold in the mirror in a car wash

Before washing the car in an automatic car wash, fold in the exterior mirrors by hand or with the button; otherwise, the mirrors could be damaged, depending on the width of the vehicle. ◀

### Automatic heating

Both exterior mirrors are automatically heated whenever the engine is running.

### Automatic dimming feature

Both exterior mirrors are automatically dimmed. Photocells are used to control the Interior rearview mirror, refer to page 63.

### Interior rearview mirror, manually dimmable

#### Turn knob

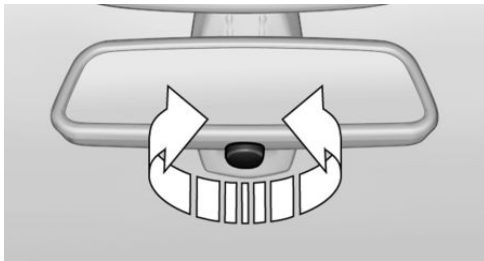

Turn the knob to reduce the blinding effect by the interior mirror.

### Interior rearview mirror, automatic dimming feature

#### The concept

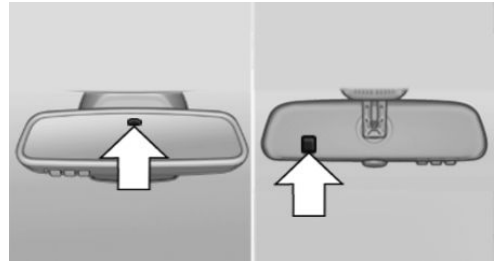

Photocells are used for control:

- ▷ In the mirror glass.
- ▷ On the back of the mirror.

#### Functional requirement

For proper operation:

- ▷ Keep the photocells clean.
- ▷ Do not cover the area between the inside rearview mirror and the windshield.

### Steering wheel

#### Note

 Do not adjust while driving  
Do not adjust the steering wheel while driving; otherwise, an unexpected movement could result in an accident. ◀

## Manual steering wheel adjustment

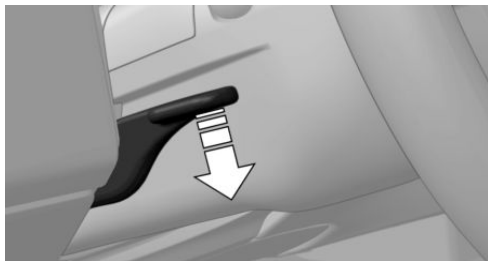

1. Fold the lever down.
2. Move the steering wheel to the preferred height and angle to suit your seating position.
3. Fold the lever back.

## Power steering wheel adjustment

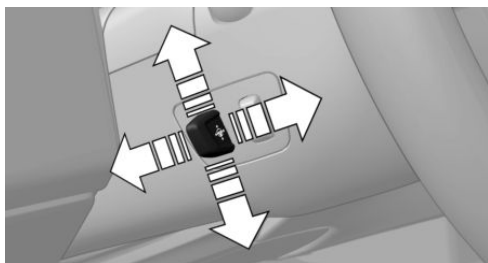

The steering wheel can be adjusted in four directions.

## Storing the position

Seat, mirror, and steering wheel memory, refer to page 61.

## Steering wheel heating



Press button.

- ▷ On: the LED lights up.
- ▷ Off: the LED goes out.

If the trip is resumed within approx. 15 min, steering wheel heating is automatically activated again.

# Transporting children safely

## Vehicle features and options

This chapter describes all standard, country-specific and optional features offered with the series. It also describes features that are not necessarily available in your car, e. g., due to

the selected options or country versions. This also applies to safety-related functions and systems. The respectively applicable country provisions must be observed when using the respective features and systems.

## The right place for children

### Note

 Children in the vehicle

Do not leave children unattended in the vehicle; otherwise, they could endanger themselves and other persons, e.g., by opening the doors. ◀

### Children should always be in the rear

Accident research shows that the safest place for children is in the back seat.

 Transporting children in the rear

Only transport children younger than 13 years of age or shorter than 5 ft/150 cm in the rear in child restraint systems provided in accordance with the age, weight and size of the child; otherwise, there is an increased risk of injury in an accident.

Children 13 years of age or older must wear a safety belt as soon as a suitable child restraint system can no longer be used due to their age, weight and size. ◀

### Children on the front passenger seat

Should it ever be necessary to use a child restraint system in the front passenger seat, make sure that the front, knee and side airbags on the front passenger side are deactivated. Automatic deactivation of front-seat passenger airbags, refer to page 110.

### Note

 Deactivating the front-seat passenger airbags

If a child restraint system is used in the front passenger seat, deactivate the front-seat passenger airbags; otherwise, there is an increased risk of injury to the child when the airbags are activated, even with a child restraint system. ◀

## Installing child restraint systems

### Hints

 Manufacturer's information for child restraint systems

To select, mount and use child restraint systems, observe the information provided by the system manufacturer; otherwise, the protective effect can be lost. ◀

 Ensuring the stability of the child seat

When installing child restraint systems, make sure that the child seat is securely fastened to the backrest of the seat. Angle and headrest of the backrest might need to be adjusted or possibly be removed. Make sure that all backrests are securely locked. Otherwise the stability of the child seat can be affected, and there is an increased risk of injury because

of unexpected movement of the seat backrest. ◀

## On the front passenger seat

### Deactivating airbags

 Deactivating the front-seat passenger airbags

If a child restraint system is used in the front passenger seat, deactivate the front-seat passenger airbags; otherwise, there is an increased risk of injury to the child when the airbags are activated, even with a child restraint system. ◀

After installing a child restraint system in the front passenger seat, make sure that the front, knee and side airbags on the front passenger side are deactivated.

Deactivate the front-seat passenger airbags automatically, refer to page 110.

### Seat position and height

Before installing a child restraint system, move the front passenger seat as far back as possible and bring it up to medium height to obtain the best possible position for the belt and to offer optimal protection in the event of an accident.

If the upper anchorage of the safety belt is located in front of the belt guide of the child seat, move the passenger seat carefully forward until the best possible belt guide position is reached.

## LATCH child restraint system

LATCH: Lower Anchors and Tether for Children.

## Child seat security



The rear safety belts and the front passenger safety belt can be permanently locked to fasten child restraint systems.

The front passenger safety belt can be permanently locked to fasten child restraint systems.

### Locking the safety belt

1. Pull out the strap completely.
2. Secure the child restraint system with the belt.
3. Allow the strap to be pulled in and pull it tight against the child restraint system. The safety belt is locked.

### Unlocking the safety belt

1. Unbuckle the belt buckle.
2. Remove the child restraint system.
3. Allow the strap to be pulled in completely.

### Note



Follow manufacturer's information for LATCH child restraint systems

To mount and use the LATCH child restraint systems, observe the operating and safety information from the system manufacturer; oth-

erwise, the level of protection may be reduced. ◀

### Mounts for the lower LATCH anchors

The lower anchors may be used to attach the CRS to the vehicle seat up to a combined child and CRS weight of 65 lb/30 kg when the child is restrained by the internal harnesses.

#### Note

 Properly engage the lower LATCH anchors

Make sure that the lower LATCH anchors have properly engaged and that the child restraint system is resting snugly against the backrest; otherwise, the degree of protection may be reduced. ◀

#### Position



The corresponding symbol shows the mounts for the lower LATCH anchors. Seats equipped with lower anchors are marked with a pair (2) of LATCH symbols. Use of inner lower anchors from standard outboard LATCH positions to

install a child restraint system in the center is not recommended. For the center position, use the vehicle seat belt instead.

### Before installing LATCH child restraint systems

Pull the belt away from the area of the child restraint system.

### Assembly of LATCH child restraint systems

1. Mount the child restraint system; refer to the user's manual of the system.
2. Ensure that both LATCH anchors are properly connected.

### Child restraint fixing system with a tether strap

#### Mounting points



The respective symbol shows the anchor for the upper retaining strap.

Seats with an upper Top Tether are marked with this symbol. It can be found on the rear seat backrest or the rear window shelf.

#### Note

 Mounting eyelets

Use the mounting eyes only for the upper retaining strap to secure child restraint systems; otherwise, the mounting eyes could be damaged. ◀

#### Retaining strap guide



Retaining strap

Make sure the upper retaining strap does not run over sharp edges and is not twisted as it passes to the top anchor. Otherwise, the strap will not properly secure the child restraint system in the event of an accident. ◀

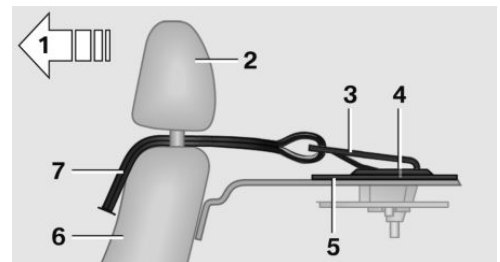

- 1 Direction of travel
- 2 Head restraint
- 3 Hook for upper retaining strap
- 4 Mounting point/eye
- 5 Rear window shelf
- 6 Seat backrest
- 7 Upper retaining strap

## Attaching the upper retaining strap to the mounting point

1. Remove the mounting point cover.
2. Raise the head restraint. Do not change the middle head restraint.
3. Guide the upper retaining strap between the supports of the head restraint.  
Guide it over the head restraint of the middle seat.
4. Attach the hook of the retaining strap to the mounting eye.
5. Tighten the retaining strap by pulling it down.
6. Lower and lock head restraints as needed.

## Locking the doors and windows

### Rear doors

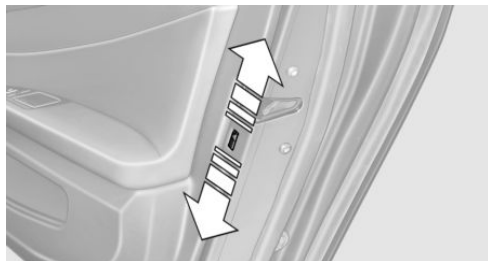

Push the locking lever on the rear doors down.

The door can now be opened from the outside only.

### Safety switch for the rear



Press button on the driver's door if children are being transported in the rear.

This locks various functions so that they cannot be operated from the rear: safety switch, refer to page [49](#).



# Driving

## Vehicle features and options

This chapter describes all standard, country-specific and optional features offered with the series. It also describes features that are not necessarily available in your car, e. g., due to the selected options or country versions. This also applies to safety-related functions and systems. The respectively applicable country provisions must be observed when using the respective features and systems.

## Start/Stop button

### The concept



Pressing the Start/Stop button switches the ignition on or off and starts the engine.

Steptronic transmission: The engine starts if the brakes are stepped on while pressing the Start/Stop button.

Manual transmission: The engine starts with the clutch pedal pressed when the Start/Stop button is pressed.

### Ignition on

Steptronic transmission: Press the Start/Stop button without stepping on the brake.

Manual transmission: Press the Start/Stop button without stepping on the clutch pedal.

All vehicle systems are ready for operation.

Most of the indicator and warning lights in the instrument cluster light up for a varied length of time.

To save battery power when the engine is off, switch off the ignition and any unnecessary electronic systems/power consumers.

### Ignition off

Steptronic transmission: Press the Start/Stop button again without stepping on the brake.

Manual transmission: Press the Start/Stop button again without stepping on the clutch pedal.

All indicator lights in the instrument cluster go out.

To save battery power when the engine is off, switch off the ignition and any unnecessary electronic systems/power consumers.



P when the ignition is switched off

P is engaged automatically when the ignition is switched off. When in an automatic car wash, e.g., ensure that the ignition is not switched off accidentally. ◀

The ignition automatically cuts off while the vehicle is stationary and the engine is stopped:

- ▶ When locking the vehicle, and when the low beams are activated.
- ▶ Shortly before the battery is discharged completely, so that the engine can still be started. This function is only available when the low beams are turned off.
- ▶ When opening or closing the driver door, if the driver's safety belt is unbuckled and the low beams are turned off.
- ▶ While the driver's safety belt is unbuckled with driver's door open and low beams off.

The low beams switch to parking lights after approx. 15 minutes of no use.

### Radio ready state

Activate radio-ready state:

- ▶ When the engine is running: press the Start/Stop button.

Some electronic systems/power consumers remain ready for operation.

The radio-ready state switches off automatically:

- ▷ After approx. 8 minutes.
- ▷ When the vehicle is locked using the central locking system.
- ▷ Shortly before the battery is discharged completely, so that the engine can still be started.

The radio-ready state remains active if, e.g., the ignition is automatically switched off for the following reasons:

- ▷ Opening or closing the driver's door.
- ▷ Unfastening of the driver's safety belt.
- ▷ When automatically switching from low beams to parking lights.

If the engine is switched off and the ignition is switched on, the system automatically switches to the radio-ready state if the lights are turned off or, if correspondingly equipped, the daytime running lights are activated.

## Starting the engine

### Hints



#### Enclosed areas

Do not let the engine run in enclosed areas, since breathing in exhaust fumes may lead to loss of consciousness and death. The exhaust gases contain carbon monoxide, an odorless and colorless but highly toxic gas. ◀



#### Unattended vehicle

Do not leave the vehicle unattended with the engine running; doing so poses a risk of danger.

Before leaving the vehicle with the engine running, set the parking brake and place the transmission in selector lever position P or N to prevent the vehicle from moving. ◀



#### Repeated starting in quick succession

Avoid trying to start the vehicle repeatedly and in quick succession. Otherwise, the fuel is not burned or is inadequately burned, posing a risk of overheating and damage to the catalytic converter. ◀

Do not wait for the engine to warm-up while the vehicle remains stationary. Start driving at moderate engine speeds.

### Diesel engine

If the engine is cold and temperatures are below approx. 32 °F/0 °C, the start process may be delayed somewhat due to automatic preheating.

A Check Control message is displayed.

### Steptronic transmission

#### Starting the engine

1. Depress the brake pedal.
2. Press the Start/Stop button.

The ignition is activated automatically for a certain time and is stopped as soon as the engine starts.

### Manual transmission

#### Starting the engine

1. Depress the brake pedal.
2. Press on the clutch pedal and shift to neutral.
3. Press the Start/Stop button.

The ignition is activated automatically for a certain time and is stopped as soon as the engine starts.

## Engine stop

### Hints



Take the remote control with you

Take the remote control with you when leaving the vehicle so that children, e.g., cannot start the engine. ◀



Apply parking brake and further secure the vehicle if needed.

Set the parking brake firmly when parking; otherwise, the vehicle could roll. On steep upward and downward inclines, further secure the vehicle, e.g., by turning the steering wheel in the direction of the curb. ◀

### Before driving into a car wash

So that the vehicle can roll into a car wash observe instructions for going into an automatic car wash, refer to page 251.

## Steptronic transmission

### Switching off the engine

1. Engage selector lever position P with the vehicle stopped.
2. Press the Start/Stop button.
  - The engine is switched off.
  - The radio-ready state is switched on.
3. Set the parking brake.

## Manual transmission

### Switching off the engine

1. With the vehicle at a standstill, press the Start/Stop button.
2. Shift into first gear or reverse.
3. Set the parking brake.

## Auto Start/Stop function

### The concept

The Auto Start/Stop function helps save fuel. The system switches off the engine during a stop, e.g., in traffic congestion or at traffic lights. The ignition remains switched on. The engine starts again automatically for driving off.

### Automatic mode

After every start of the engine using the Start/Stop button, the Auto Start/Stop function is in the last selected state, refer to page 73.

When the Auto Start/Stop function is active, it is available when the vehicle is traveling faster than about 3 mph, approx. 5 km/h.

### Engine stop

The engine is switched off automatically during a stop under the following conditions:

Steptronic transmission:

- ▷ The selector lever is in selector lever position D.
- ▷ The brake pedal remains pressed while the vehicle is stationary or the vehicle is held by Automatic Hold.
- ▷ The driver's safety belt is buckled or the driver's door is closed.

Manual transmission:

- ▷ Neutral is engaged and the clutch pedal is not pressed.
- ▷ The driver's safety belt is buckled or the driver's door is closed.

The air flow from the air conditioner is reduced when the engine is switched off.

### Displays in the instrument cluster



The display indicates that the Auto Start/Stop function is ready for an Automatic engine start.



The display indicates that the conditions for an automatic engine stop have not been met.

### Functional limitations

The engine is not switched off automatically in the following situations:

- ▷ External temperature too low.
- ▷ The external temperature is high and automatic climate control is running.
- ▷ The car's interior has not yet been heated or cooled to the required level.
- ▷ The engine is not yet at operating temperature.
- ▷ The wheels are at a sharp angle or the steering wheel is being turned.
- ▷ After driving in reverse.
- ▷ Fogging of the windows when the automatic climate control is switched on.
- ▷ Vehicle battery is heavily discharged.
- ▷ At higher elevations.
- ▷ The engine compartment lid is unlocked.
- ▷ HDC Hill Descent Control is activated.
- ▷ The parking assistant is activated.
- ▷ Stop-and-go traffic.
- ▷ The selector lever is in position N, M/S or R.
- ▷ Use of fuel with high ethanol content.

### Starting the engine

The engine starts automatically under the following conditions:

- ▷ Steptronic transmission:  
By releasing the brake pedal.  
When Automatic Hold is activated: press the accelerator pedal.
- ▷ Manual transmission:  
The clutch pedal is pressed.

After the engine starts, accelerate as usual.

### Safety mode

After the engine switches off automatically, it will not start again automatically if any one of the following conditions are met.

- ▷ The driver's safety belt is unbuckled and the driver's door is open.
- ▷ The hood was unlocked.

Some indicator lights light up for a varied length of time.

The engine can only be started via the Start/Stop button.

### Functional limitations

Even if driving off was not intended, the deactivated engine starts up automatically in the following situations:

- ▷ Excessive warming of the car's interior when the cooling function is switched on.
- ▷ The steering wheel is turned.
- ▷ Steptronic transmission: change from selector lever position D to R, N or M/S.
- ▷ Steptronic transmission: change from selector lever position P to N, D, R or M/S.
- ▷ The vehicle begins rolling.
- ▷ Fogging of the windows when the automatic climate control is switched on.
- ▷ Vehicle battery is heavily discharged.
- ▷ Excessive cooling of the car's interior when the heating is switched on.
- ▷ Low brake vacuum pressure; this can occur, e.g., if the brake pedal is depressed a number of times in succession.

## Activating/deactivating the system manually

### Using the button

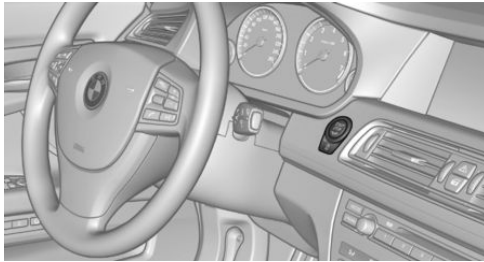

Press button.

- LED comes on: Auto Start/Stop function is deactivated.  
The engine is started during an automatic engine stop.  
The engine can only be stopped or started via the Start/Stop button.
- LED goes out: Auto Start/Stop function is activated.

### Switching off the vehicle during an automatic engine stop

During an automatic engine stop, the vehicle can be switched off permanently, e. g., when leaving it.

1. Press the Start/Stop button. The ignition is switched off. The Auto Start/Stop function is deactivated.  
Selector lever position P is engaged automatically.
2. Set the parking brake.  
Engine start as usual via Start/Stop button.

### Automatic deactivation

In certain situations, Auto Start/Stop function is deactivated automatically for safety reasons as if the driver were absent.

## Malfunction

The Auto Start/Stop function no longer switches off the engine automatically. A Check Control message is displayed. It is possible to continue driving. Have the system checked.

## Parking brake

### The concept

The parking brake is used to prevent the vehicle from rolling when it is parked.

### Overview



Parking brake

### Setting



Apply parking brake and further secure the vehicle if needed.

Set the parking brake firmly when parking; otherwise, the vehicle could roll. On steep upward and downward inclines, further secure the vehicle, e.g., by turning the steering wheel in the direction of the curb. ◀



Take the remote control with you

Take the remote control with you when leaving the vehicle so that children, e.g., cannot release the parking brake. ◀



Pull the reel.

The LED lights up.



The indicator lamp lights up red. The parking brake is set.

### While driving

Use as emergency brake while driving:

Pull the reel and hold it. The vehicle brakes hard while the reel is being pulled.



The indicator lamp lights up red, a signal sounds and the brake lights light up.

A Check Control message is displayed.

If the vehicle is slowed down down to a speed of approx. 2 mph/3 km/h the parking brake is set.

### Releasing

With the ignition switched on:



Manual transmission: Press the switch while the brake or clutch pedal is pressed.

Steptronic transmission: Press the switch while the brake is pressed or selector lever position P is set.

The LED and indicator lamp go out.

The parking brake is released.

### Automatic release in cars with Steptronic transmission



Inadvertent operation of the accelerator pedal

Make sure that the accelerator pedal is not operated unintentionally; otherwise, the vehicle is set in motion and there is a risk of an accident. ◀

For automatic release, step on the accelerator pedal.

The LED and indicator lamp go out.

The parking brake is automatically released when you step on the accelerator:

- ▷ Engine on.
- ▷ Drive mode engaged.
- ▷ Driver buckled in and doors closed.

### Automatic release in cars with manual transmission

Drive off as usual. The parking brake disengages when the clutch pedal is released.

The LED and indicator lamp go out.

Under the following conditions, the parking brake is automatically released:

- ▷ Engine on.
- ▷ Gear engaged.
- ▷ Driver buckled in and doors closed.
- ▷ Engine power is sufficient to drive off.



Inadvertent operation of the clutch pedal

Make sure that the clutch pedal is not operated unintentionally; otherwise, the vehicle is set in motion when the clutch is released, and there is a risk of an accident. ◀

### Automatic Hold

#### The concept

This system assists the driver by automatically setting and releasing the brake, such as when moving in stop-and-go traffic.

The vehicle is automatically held in place when it is stationary.

On inclines, the system prevents the vehicle from rolling backward when driving off.

### Overview



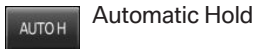

Automatic Hold

## Safety information



Secure the vehicle against rolling

Before leaving the vehicle with the engine running, engage position P of the Step-tronic transmission and ensure that the parking brake is set. Otherwise, the vehicle may begin to move. ◀

Under the following conditions, Automatic Hold is automatically deactivated and the parking brake is set:

- ▶ The engine is switched off.
- ▶ A door is opened and driver's safety belt is unbuckled while the vehicle is stationary.
- ▶ The moving vehicle is brought to a standstill using the parking brake.



The indicator lamp switches from green to red and the letters AUTO H go out.

## Activating

This function can be activated when the driver's door is closed, the safety belt is fastened and the engine is running.



Press button.

The LED and the letters AUTO H light up.



The indicator lamp lights up.

Automatic Hold is activated.

## Deactivating



Press button again.

The LED and the letters AUTO H go out.

Automatic Hold is deactivated.

If the vehicle is being held by Automatic Hold, press on the brake pedal to deactivate it.

When the parking brake is set manually, Automatic Hold is deactivated automatically.

## Driving

Automatic Hold is activated: the vehicle is automatically secured against rolling after braking to a standstill.



The indicator lamp lights up green.

Step on the accelerator pedal to drive off.

The brake is released automatically.

The indicator lamp goes out.



Before driving into a car wash

Before driving into the car wash, deactivate Automatic Hold; otherwise, the parking brake will be set when the vehicle is stationary and the vehicle will no longer be able to roll. ◀

## Parking

The parking brake is automatically set if the engine is switched off while the vehicle is being held by Automatic Hold.



The indicator lamp changes from green to red.

The parking brake is not set if the engine is switched off while the vehicle is coasting to a halt. Automatic Hold is deactivated.

Automatic Hold remains activated during the engine stop brought about by the Auto Start/Stop function.



Take the remote control with you

Take the remote control with you when leaving the vehicle so that children, e.g., cannot release the parking brake. ◀

## Malfunction

In the event of a failure or malfunction of the parking brake, secure the vehicle against rolling using a wheel chock, e.g., when leaving it.

## After a power failure

### Putting the parking brake into operation

1. Switch on the ignition.
2.  Press the reel while stepping on the brake pedal or selector lever position P is set.

It may take several seconds for the brake to be put into operation. Any sounds associated with this are normal.

 The indicator lamp in the instrument cluster goes out as soon as the parking brake is ready for operation.

## Turn signal, high beams, headlight flasher

### Turn signal

#### Hints

 Do not adjust the exterior mirrors while driving and when turn signals/hazard warning flashers are on, or else the additional turn signal lights in the exterior mirror are out of position and can't be seen. ◀

### Using turn signals

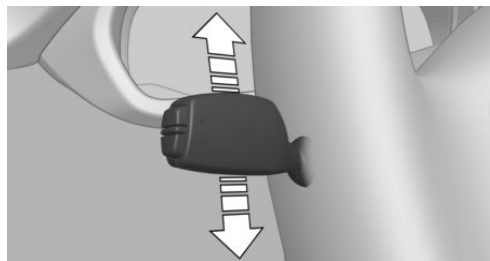

Press the lever beyond the resistance point.

To switch off manually, press the lever to the resistance point.

Unusually rapid flashing of the indicator lamp indicates that a turn signal bulb has failed.

### Triple turn signal activation

Press the lever to the resistance point.

The turn signal flashes three times.

The function can be activated or deactivated.

On the Control Display:

1. "Settings"
2. "Lighting"
3. "Triple turn signal"

Settings are stored for the profile currently in use.

### Signaling briefly

Press the lever to the resistance point and hold it there for as long as you want the turn signal to flash.

### High beams, headlight flasher

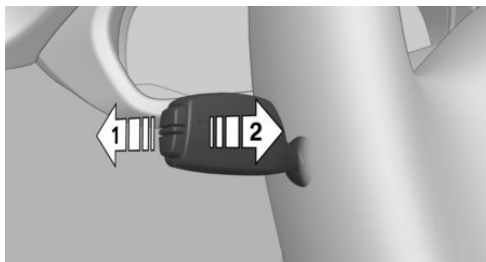

- ▷ High beams, arrow 1.
- ▷ Headlight flasher, arrow 2.



## Washer/wiper system

### Switching the wipers on/off and brief wipe

#### Hints

 Do not activate wipers if frozen to windshield

Do not switch on the wipers if they are frozen to the windshield; otherwise, the wiper blades and the wiper motor may be damaged. ◀

 Do not activate wipers on dry windshield  
Do not use the wipers if the windshield is dry, as this may damage the wiper blades or cause them to become worn more quickly. ◀

#### Switching on

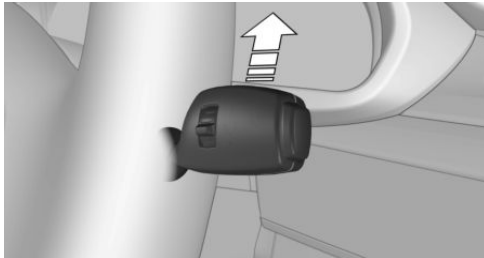

Push wiper lever up.

The lever automatically returns to its initial position when released.

- ▶ Normal wiper speed: push up once.  
The wipers switch to intermittent operation when the vehicle is stationary.
- ▶ Fast wiper speed: press up twice or press once beyond the resistance point.  
Wipers change to normal speed when vehicle comes to standstill.

### Switch off and brief wipe

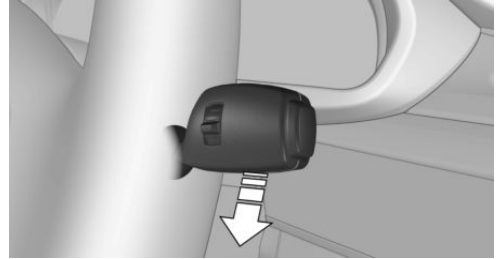

Push wiper lever down.

The lever automatically returns to its initial position when released.

- ▶ Single wipe: press down once.
- ▶ To switch off normal wipe: press down once.
- ▶ To switch off fast wipe: press down twice.

### Interval mode or rain sensor

#### The concept

The rain sensor automatically controls the time between wipes depending on the intensity of the rainfall. The sensor is located on the windshield, directly behind the interior rearview mirror.

### Activating/deactivating

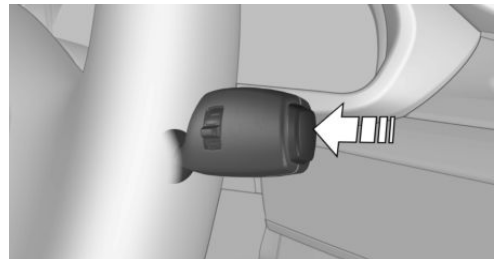

Press button on the wiper lever.

Wiping is started. If the vehicle is equipped with a rain sensor: LED in wiper lever lights up.

When wipers are frozen to windshield, wiper operation is deactivated.

During trip interruption with the rain sensor switched on: if the trip is resumed within approx. 15 minutes, the rain sensor is automatically activated again.

 Deactivate the rain sensor in car washes  
Deactivate the rain sensor when passing through an automatic car wash; otherwise, unintentional wiping can cause damages. ◀

### Setting the frequency or sensitivity of the rain sensor

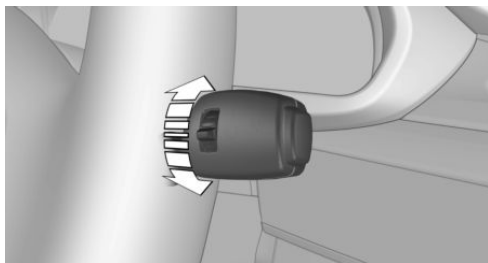

Turn the thumbwheel.

### Clean the windshield, headlights

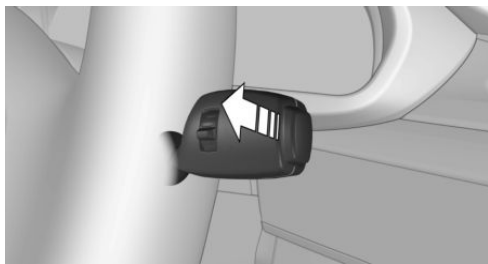

Pull the wiper lever towards you.

The system sprays washer fluid on the windshield and activates the wipers briefly.

In addition, the headlights are cleaned at regular intervals when the vehicle's lights are activated.

 Do not use the washer system at freezing temperatures

Do not use the washers if fluid could freeze onto the windshield which might impede your viewing field. Therefore use antifreeze fluid.

Avoid using the washer when the reservoir is empty; operation might damage pump. ◀

### Windshield washer nozzles

The windshield washer nozzles are automatically heated while the ignition is switched on.

### Fold-out position of the wipers

Fold wipers back when you want to change the blades or with pending low temperatures.

1. Switch the ignition on and off again.
2. With icy conditions make sure that blades are not frozen to the windshield.
3. Press the wiper lever up beyond the point of resistance and hold it for approx. 3 seconds, until the wiper remains in a nearly vertical position.

After the wipers are folded back down, the wiper system must be reactivated.

 Folding wipers back down  
Before switching the ignition on, fold the wipers back down to the windshield; otherwise, the wipers may become damaged when they are activated. ◀

1. Switch on the ignition.
2. Push wiper lever down. Wipers move to their resting position and are ready again for operation.

## Washer fluid

### Hints

 Antifreeze for washer fluid  
Antifreeze is flammable and can cause injury if it is used incorrectly.

Therefore, keep it away from possible sources of ignition.

Only keep it in the closed original container and inaccessible to children.

Follow the notes and instructions on the container.

United States: The washer fluid mixture ratio is regulated by the U.S. EPA and many individual states; do not exceed the allowable washer fluid dilution ratios limits that apply. Follow the usage instructions on the washer fluid container. Use BMW's Windshield Washer Concentrate or the equivalent. ◀



#### Adding washer fluid

Only add washer fluid when the engine is cool, and then close the cover completely to avoid contact between the washer fluid and hot engine parts.

Otherwise, there is a danger of fire and a risk to personal safety if the fluid is spilled. ◀

### Washer fluid reservoir

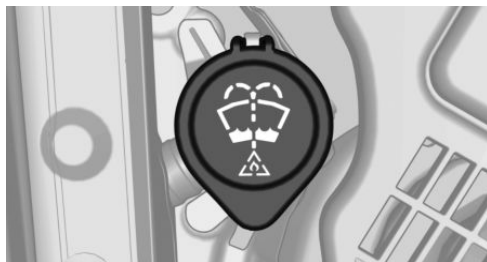

All washer nozzles are supplied from one reservoir.

Fill with a mixture of windshield washer concentrate and tap water and – if required – with a washer antifreeze, according to the manufacturer's recommendations.

Mix the washer fluid before adding to find the right mixture.

Do not add windshield washer concentrate and antifreeze undiluted and do not fill with pure water; this could damage the wiper system.

Do not mix window washer concentrates of different manufacturers because they can clog the windshield washer nozzles.

Recommended minimum fill quantity:  
0.2 US gal/1 liter.

## Manual transmission

### Shifting



Shifting into 5th or 6th gear

When shifting into 5th or 6th gear, push the gearshift lever to the right; otherwise, inadvertent shifting into 3rd or 4th gear could lead to engine damage. ◀

### Reverse gear

Select only when the vehicle is stationary.

To overcome the resistance push the selector lever dynamically to the left and engage the reverse gear.

## Steptronic transmission

### Selector lever positions

#### D Drive

Selector lever position for normal vehicle operation. All gears for forward travel are activated automatically.

#### R is Reverse

Select only when the vehicle is stationary.

#### N Neutral:

The vehicle may roll. Use in automatic car washes, e.g.

When the ignition is switched off, refer to page 69, selector lever position P is engaged automatically.

## P Park

Select only when the vehicle is stationary. The drive wheels are blocked.

P is engaged automatically:

- ▷ After the engine is switched off when the vehicle is in radio-ready state, refer to page 69, or when the ignition is switched off, refer to page 69, and when selector lever position R or D is set.
- ▷ With the ignition off, if selector lever position N is set.
- ▷ If the driver's safety belt is released, the driver's door is opened, and the brake pedal is not pressed while the vehicle is stationary and selector lever position D or R is set.

Before exiting the vehicle, make sure that selector lever position P is set. Otherwise, the vehicle may begin to move.

## Kickdown

Kickdown is used to achieve maximum driving performance. Step on the accelerator pedal beyond the resistance point at the full throttle position.

## Engaging selector lever positions

 Press on the brake pedal until you start driving

To prevent the vehicle from creeping after you select a gear, maintain pressure on the brake pedal until you are ready to start. ◀

- ▷ It is not possible to shift out of selector lever position P until the engine is running and the brake is applied.
- ▷ With the vehicle is stationary, press on the brake pedal before shifting out of P or N; otherwise, the shift command will not be executed: shift lock.

## Engaging D, R and N

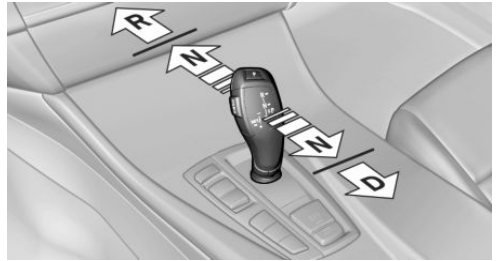

Briefly push the selector lever in the desired direction, beyond a resistance point if needed.

After releasing the selector lever, it returns to its center position.



Press unlock button, in order to:

- ▷ Engage R.
- ▷ Shift out of P.

## Engaging P



Press button P.

## Sport program and manual mode

### Activating the sport program



Press the selector lever to the left out of selector lever position D.

The engaged gear is displayed in the instrument cluster, e.g., S1.

The sport program of the transmission is activated.

### Activating the M/S manual mode

1. Press the selector lever to the left out of selector lever position D.
2. Push the selector lever forward or pull it backward.

Manual mode becomes active and the gear is changed.

The engaged gear is displayed in the instrument cluster, e.g., M1.

Once maximum engine speed is attained, M/S manual mode is automatically upshifted as needed.

### Switching to manual mode

- ▶ To shift down: press the selector lever forward.
- ▶ To shift up: pull the selector lever rearwards.

Gears will only be shifted at appropriate engine and road speeds, for example downshifting is not possible if the engine speed is too high.

The selected gear is briefly displayed in the instrument cluster, followed by the currently selected gear.

### Not M550d xDrive: Steptronic Sport transmission: prevent automatic upshifting in M/S manual mode

The Steptronic Sport transmission does not automatically upshift in M/S manual mode once the maximum speed is reached, if one of the following conditions is met:

- ▶ DSC deactivated.
- ▶ TRACTION activated.
- ▶ SPORT+ activated.

In addition, the kickdown is deactivated.

With the respective transmission version, the lowest possible gear can be selected by simultaneously operating the kickdown and the left shift paddle. However, this effect is not produced via the shift paddles when switching briefly from D to manual mode.

### Ending the sport program/manual mode

Push the selector lever to the right.

D is displayed in the instrument cluster.

### Shift paddles



The shift paddles on the steering wheel allow you to shift gears quickly while keeping both hands on the steering wheel.

- ▶ Shift up: briefly pull right shift paddle.
- ▶ Shift down: briefly pull left shift paddle.

- ▶ With the respective transmission version, the lowest possible gear can be selected by pulling and holding the left shift paddle.

Gears will only be shifted at appropriate engine and road speeds, for example downshifting is not possible if the engine speed is too high.

The selected gear is briefly displayed in the instrument cluster, followed by the current gear.

If the shift paddles on the steering wheel are used to shift gears in automatic mode, the transmission temporarily switches to manual mode.

If the selector lever is still in selector lever position D with the respective transmission version, it is possible to switch back into the automatic mode:

- ▶ Pull and hold right shift paddle.
- Or
- ▶ In addition to the briefly pulled right shift paddle, briefly pull the left shift paddle.

In the manual mode, after conservative driving for a certain amount of time or if there has been no acceleration or shifting of the shift paddles within a certain amount of time, the transmission switches back to automatic mode.

## Displays in the instrument cluster

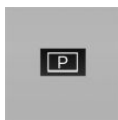

The selector lever position is displayed, e.g.: P.

## Electronic unlocking of the transmission lock

### General information

Electronically unlock the transmission lock to maneuver vehicle from the danger area.

Unlocking is possible, if the started can spin the engine.

## Engaging selector lever position N

1. Depress the brake pedal.
2. Press the Start/Stop button. The starter must audibly start.
3. Press and hold the selector lever into position N.  
A corresponding Check Control message is displayed.
4. Press the selector lever again into position N within approx. 6 seconds.  
Position N is displayed in the instrument cluster.
5. Release brake, as soon as the starter stops.
6. Maneuver the vehicle from the danger area and secure it against moving on its own.

## Steptronic Sport transmission: Launch Control

### The concept

Launch Control enables optimum acceleration on surfaces with good traction.

### Hints



Component wear

Do not use Launch Control too often; otherwise, this may result in premature wear of components due to the high stress placed on the vehicle. ◀

Do not use Launch Control during the break-in, refer to page 188, period.

To increase vehicle stability, activate DSC again as soon as possible.

An experienced driver may be able to achieve better acceleration values in DSC OFF mode.

### Requirements

Launch Control is available when the engine is warmed up, that is, after uninterrupted driving of at least 6 miles/10 km.

To start with Launch Control do not steer the steering wheel.

### Start with launch control

While the engine is running:

-  Press button or select Sport+ with the Driving Dynamics Control.  
TRACTION is displayed in the instrument cluster and the indicator lamp for DSC OFF lights up.
- Engage selector lever position S.
- With the left foot, forcefully press down on the brake.
- Press and hold down the accelerator pedal beyond the resistance point at the full throttle position.  
A flag symbol is displayed in the instrument cluster.
- The starting engine speed adjusts. Within 3 seconds, release the brake.

Before using Launch Control, allow the transmission to cool down for approx. 5 minutes.

Launch Control adjusts to the surrounding conditions, e.g., wet pavement, when used again.

# Displays

## Vehicle features and options

This chapter describes all standard, country-specific and optional features offered with the series. It also describes features that are not necessarily available in your car, e. g., due to

the selected options or country versions. This also applies to safety-related functions and systems. The respectively applicable country provisions must be observed when using the respective features and systems.

## Overview, instrument cluster

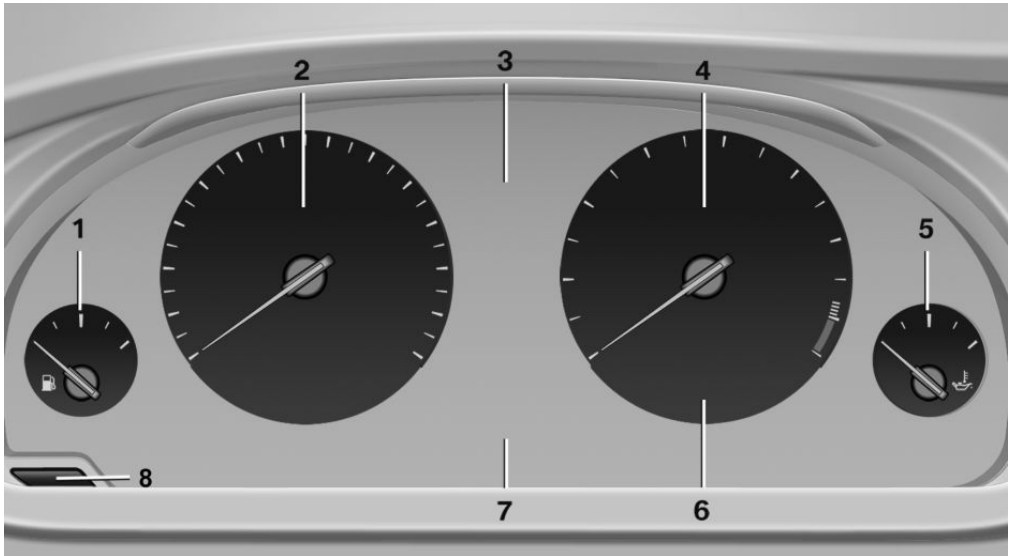

- |                                 |                                             |
|---------------------------------|---------------------------------------------|
| 1 Fuel gauge <a href="#">92</a> | 5 Engine oil temperature <a href="#">92</a> |
| 2 Speedometer                   | 6 Current fuel consumption                  |
| 3 Messages, e.g. Check Control  | 7 Electronic displays <a href="#">84</a>    |
| 4 Tachometer <a href="#">92</a> | 8 Reset miles <a href="#">92</a>            |

## Electronic displays

- ▷ Selection lists, refer to page [96](#).
- ▷ External temperature, refer to page [93](#).
- ▷ Auto Start/Stop function, refer to page [71](#).
- ▷ On-board computer, refer to page [97](#).
- ▷ Date, refer to page [93](#).
- ▷ Energy recovery, refer to page [94](#).
- ▷ Transmission display, refer to page [82](#).
- ▷ Miles/trip miles, refer to page [92](#).



- ▷ Messages, e.g. Check Control, refer to page [88](#).
- ▷ Current fuel consumption, refer to page [93](#).
- ▷ Navigation display, see User's manual for Navigation, Entertainment and Communication.
- ▷ Range, refer to page [93](#).
- ▷ Status, Driving Dynamics Control, refer to page [139](#).
- ▷ Service requirements, refer to page [94](#).
- ▷ Speed limit detection, refer to page [95](#).
- ▷ Time, refer to page [93](#).

## Multifunctional instrument display

### The concept

The instrument display is a variable display. In the event of a program change, the display rendition adapts to the respective program through the Driving Dynamics Control. The change of appearance can be deactivated on the Control Display.

Some of the displays in the instrument display may differ from the way they are shown in this Owner's Manual.

### At a glance

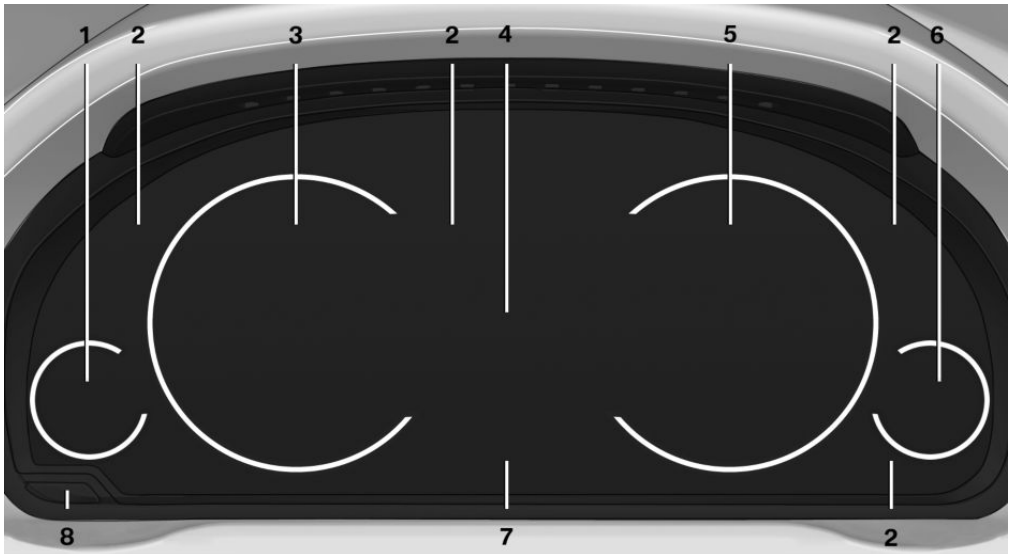

- |                                               |                                             |
|-----------------------------------------------|---------------------------------------------|
| 1 Fuel gauge <a href="#">92</a>               | 5 Tachometer <a href="#">92</a>             |
| 2 Indicator/warning lights <a href="#">88</a> | Selection lists <a href="#">96</a>          |
| 3 Speedometer                                 | ECO PRO displays <a href="#">196</a>        |
| 4 Variable displays                           | 6 Engine oil temperature <a href="#">92</a> |

7 Computer 97

8 Reset miles 92

### Switching the change of display on and off

You can set whether the instrument display automatically changes to the ECO PRO or SPORT in the display when you switch driving modes.

1. "Settings"
2. "Instrument cluster"
3. "ECO PRO Info"  
Or "Driving mode view"

On the Control Display:

1. "Settings"
2. "Instrument cluster"
3. "Magnifier function"

### With Professional Navigation System: switching zoom function on/off

You can program whether the current speed is to appear enlarged in the speedometer.

### ECO PRO displays

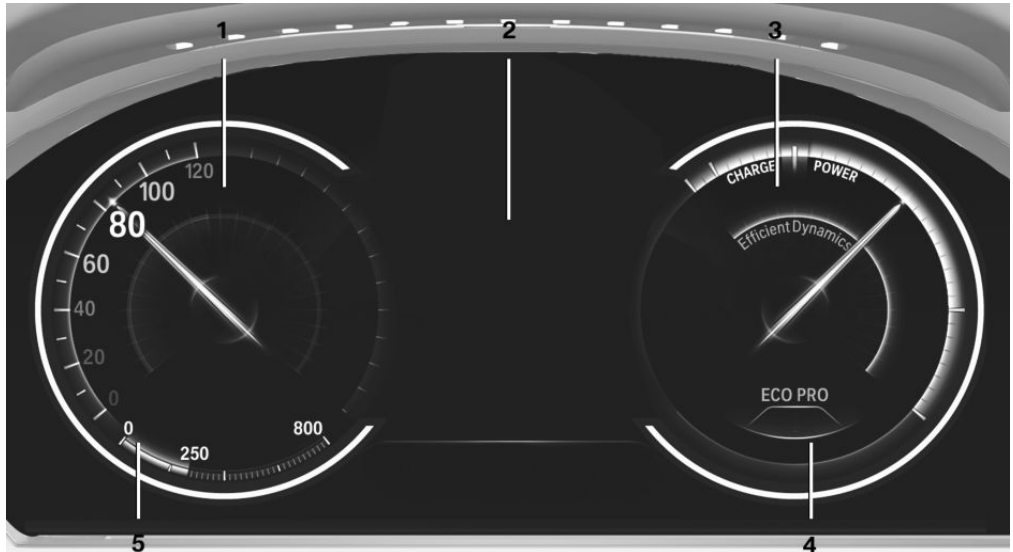

1 Speedometer

2 Variable displays: ECO PRO Tips, Deceleration assistant instructions, Driver assist system displays

- 3 Efficiency display 196
- 4 Transmission display

- 5 ▷ Blue: bonus range
- ▷ Gray: range

In the ECO PRO program the instrument display switches to the ECO PRO displays. These displays support a driving style that saves on

fuel consumption with more prominent representation of the efficiency display and various ECO PRO tips.

## Sport displays

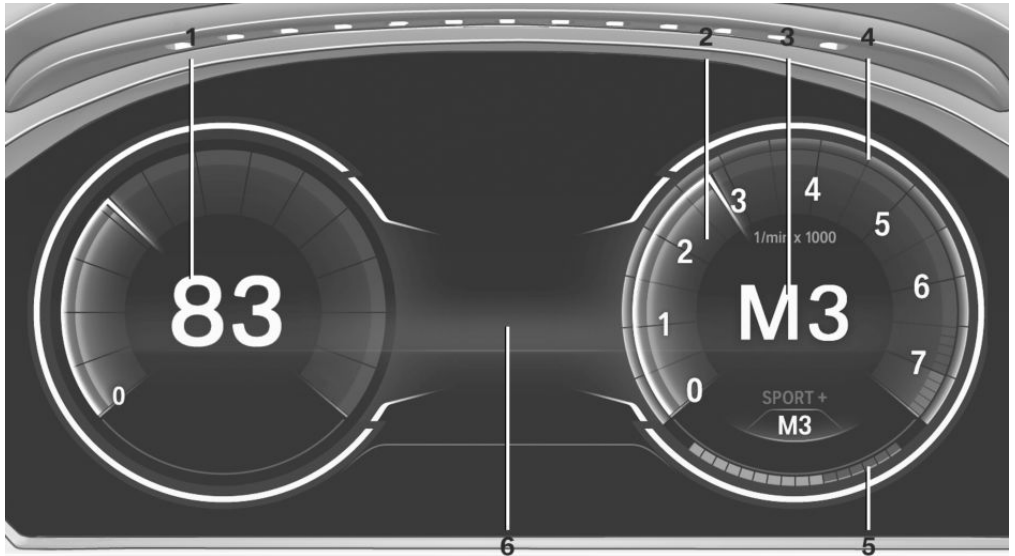

- 1 Speedometer
- 2 Tachometer 92
- 3 Transmission display 82

- 4 Shift lights, when respectively equipped
- 5 Performance display
- 6 Variable displays

In the Sport and Sport+ programs the instrument display switches to the sport displays. These displays support a sporty driving style with more prominent representation of the tachometer, the transmission displays, and the vehicle speed.

## Shift lights in the instrument display

### The concept

Shift lights indicate the optimum shift moment in the multifunction instrument display. Thus, with a sporty driving style, the best possible vehicle acceleration is achieved.

## General information

Steptronic Sport transmission: shift lights are shown, when the SPORT+ driving program is activated.

Manual transmission: shift lights are shown, when the SPORT or SPORT+ driving program is activated.

## Switching on shift lights

Steptronic Sport transmission:

1. Select SPORT+ using the Driving Dynamics Control.
2. Activate the M/S manual mode of the transmission.

Manual transmission:

1. Select SPORT or SPORT+ using the Driving Dynamics Control.
2. Deactivate DSC if needed.

## Display in the instrument display



- ▷ Current engine speed is displayed in the tachometer.
- ▷ Arrow 1: successive yellow illuminated fields indicate an increase in the speed.
- ▷ Arrow 2: successive orange illuminated fields indicate the upcoming shift moment.
- ▷ Arrow 3: fields are illuminated in red. Do not wait any further to shift.

When the maximum possible speed is reached, the entire display flashes. When the maximum speed is exceeded, the supply of fuel is interrupted in order to protect the engine. Speeds in this range must be avoided.

## Check Control

### The concept

The Check Control system monitors functions in the vehicle and notifies you of malfunctions in the monitored systems.

A Check Control message is displayed as a combination of indicator or warning lights and text messages in the instrument cluster and in the Head-up Display.

In addition, an acoustic signal may sound and a text message may appear on the Control Display.

### Indicator/warning lights

#### General information

The indicator and warning lights in the instrument cluster can light up in a variety of combinations and colors.

Several of the lights are checked for proper functioning and light up temporarily when the engine is started or the ignition is switched on.

### Red lights

#### Safety belt reminder



Flashing or illuminated: safety belt on the driver or passenger side is not buckled. The safety belt reminder can also be activated if objects are placed on the front passenger seat.

Make sure that the safety belts are positioned correctly.

#### Airbag system



Airbag system and belt tensioner are defective.

Have the vehicle checked by the service center immediately.

## Parking brake



The parking brake is set.

For additional information, refer to Release parking brake, refer to page 74.

## Brake system



Continue to drive moderately.

Have the vehicle checked by the service center immediately.



## Front-end collision warning



Illuminated: advance warning is issued, e.g., when there is the impending danger of a collision or the distance to the vehicle ahead is too small.

Increase distance.

Flashing: acute warning of the imminent danger of a collision when the vehicle approaches another vehicle at a relatively high differential speed.

Intervention by braking or make an evasive maneuver.

## Pedestrian warning



Symbol in the instrument cluster.



Symbol in the instrument display.

If a collision with a person detected in this way is imminent, the symbol lights up and a signal sounds.

## Orange lights

### Active Cruise Control



The number bars shows the selected distance from the vehicle driving ahead.

For additional information, refer to Active Cruise Control with Stop & Go function, ACC, refer to page 143.

### Vehicle detection, Active Cruise Control



Illuminated: vehicle driving ahead detected.

Flashing: the conditions are not adequate for operating the system.

The system was deactivated but applies the brakes until you actively resume control by pressing on the brake pedal or accelerator pedal.

## Yellow lights

### Anti-lock Braking System ABS



Avoid abrupt braking if possible. Braking force boost in some cases defective. Stop carefully. Take into account



longer brake travel. Have this checked by the service center immediately.

### DSC Dynamic Stability Control



Flashing: DSC controls the drive and braking forces. The vehicle is stabilized. Reduce speed and adapt driving profile to the driving circumstances.

Illuminated: DSC failed. Have the system checked by the service center.

For additional information, refer to Dynamic Stability Control DSC, refer to page 135.

### DSC Dynamic Stability Control is deactivated or DTC Dynamic Traction Control is activated



Dynamic Stability Control DSC is switched off or Dynamic Traction Control DTC is switched on.

For additional information, refer to Dynamic Stability Control, refer to page 135, and Dynamic Traction Control, refer to page 136.

### Flat Tire Monitor FTM



The Flat Tire Monitor signals a loss of tire inflation pressure in a tire.

Reduce your speed and stop cautiously. Avoid sudden braking and steering maneuvers.

For more information, see Flat Tire Monitor, refer to page 115.

### Tire Pressure Monitor TPM



Illuminated: the Tire Pressure Monitor signals a loss of tire inflation pressure in a tire.

Reduce your speed and stop cautiously. Avoid sudden braking and steering maneuvers.

Flashing and then continuously illuminated: no flat tire or loss of tire inflation pressure can be detected.

- ▷ Interference through systems or devices with the same radio frequency: after leaving the area of the interference, the system automatically becomes active again.
- ▷ TPM could not conclude the reset: perform the reset of the system again.
- ▷ A wheel without TPM electronics is fitted: have the service center check it if needed.
- ▷ Malfunction: have the system checked by your service center.

For more information, see Tire Pressure Monitor, refer to page 111.

### Steering system



Steering system in some cases defective.

Have the steering system checked by the service center.

### Engine functions



Have the vehicle checked by the service center.

For additional information, refer to On-board Diagnostics socket, refer to page 237.

### Lane departure warning



System is switched on and under certain circumstances warns if a detected lane is left without flashing beforehand.

For additional information, refer to Lane departure warning, refer to page 129.

### Green lights

#### Turn signal



Turn signal on.

Unusually rapid flashing of the indicator lamp indicates that a turn signal bulb has failed.

For additional information, refer to Turn signal, refer to page 76.

### Parking lights, headlight control



Parking lights or headlights are activated.

For additional information, refer to Parking lights/low beams, headlight control, refer to page 103.

### Front fog lights



Front fog lights are activated.

For additional information, refer to Front fog lights, refer to page 106.

### High-beam Assistant



High-beam Assistant is switched on.

High beams are activated and off automatically as a function of the traffic situation.

For additional information, refer to High-beam Assistant, refer to page 105.

### Cruise control



The system is switched on. It maintains the speed that was set using the control elements on the steering wheel.

### Automatic Hold



The vehicle is automatically held in place when it is stationary.

On inclines, the system prevents the vehicle from rolling backward when driving off.

For more information, see Automatic Hold, refer to page 74.

### Blue lights

#### High beams



High beams are activated.

For additional information, refer to High beams, refer to page 76.

### General lamps

#### Check Control



At least one Check Control message is displayed or is stored. The symbol is shown in the display of the instrument cluster.

### Text messages

Text messages in combination with a symbol in the instrument cluster explain a Check Control message and the meaning of the indicator and warning lights.

### Supplementary text messages

Additional information, such as on the cause of an error or the required action, can be called up via Check Control.

With urgent messages the added text will be automatically displayed on the Control Display.

### Symbols

Depending on the Check Control message, the following functions can be selected.

- ▷ "Owner's Manual"  
Display additional information about the Check Control message in the Integrated Owner's Manual.
- ▷ "Service request"  
Contact your service center.
- ▷ "Roadside Assistance"  
Contact Roadside Assistance.

### Hiding Check Control messages

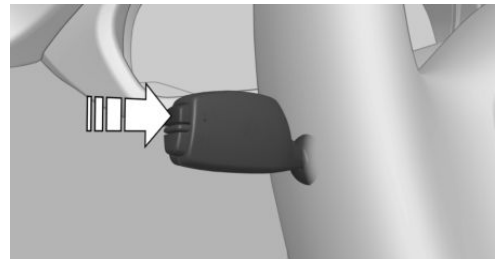

Press the onboard computer button on the turn signal lever.

- ▷ Some Check Control messages are displayed continuously and are not cleared until the malfunction is eliminated. If several malfunctions occur at once, the messages are displayed consecutively.

These messages can be faded for approx. 8 seconds. After this time, they are displayed again automatically.

- ▷ Other Check Control messages are faded automatically after approx. 20 seconds. They are stored and can be displayed again later.

## Displaying stored Check Control messages

On the Control Display:

1. "Vehicle info"
2. "Vehicle status"
3.  "Check Control"
4. Select the text message.

## Messages after trip completion

Special messages displayed while driving are displayed again after the ignition is switched off.

## Fuel gauge



Vehicle tilt position may cause the display to vary.

Depending on the equipment version, the arrow beside the fuel pump symbol shows which side of the vehicle the fuel filler flap is on.

Hints on refueling, refer to page 204.

## Tachometer

Always avoid engine speeds in the red warning field. In this range, the fuel supply is interrupted to protect the engine.

## Engine oil temperature



- ▷ Cold engine: the pointer is at the low temperature end. Drive at moderate engine and vehicle speeds.
- ▷ Normal operating temperature: the pointer is in the middle or in the left half of the temperature display.
- ▷ Hot engine: the pointer is at the high end of the temperature range. A Check Control message is also displayed.

## Coolant temperature

If the coolant along with the engine becomes too hot, a Check Control message is displayed.

Check the coolant level, refer to page 234.

## Odometer and trip odometer

### Display



- ▷ Odometer, arrow 1.
- ▷ Trip odometer, arrow 2.

### Show/reset kilometers



Press the knob.

- ▷ When the ignition is switched off, the time, the external temperature and the odometer are displayed.
- ▷ When the ignition is switched on, the trip odometer is reset.



## External temperature

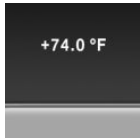

If the indicator drops to +37 °F/+3 °C or lower, a signal sounds.

A Check Control message is displayed.

There is an increased risk of ice on roads.



Ice on roads

Even at temperatures above +37 °F/+3 °C, roads might be icy.

Therefore, drive carefully on bridges and shaded roads, e.g., to avoid the increased risk of an accident. ◀

## Time

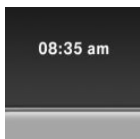

The time is displayed at the bottom of the instrument cluster.

Setting the time and time format, refer to page [99](#).

## Date

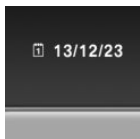

The date is displayed in the computer.

Setting the date and date format, refer to page [100](#).

## Range

### Display

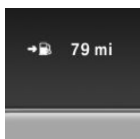

With a low remaining range:

- ▷ A Check Control message is displayed briefly.
- ▷ The remaining range is shown on the on-board computer.

- ▷ With a dynamic driving style - e.g., taking curves aggressively - engine operation might vary.

The Check Control message appears continuously below a range of approx. 30 miles/50 km.



Refuel promptly

Refuel no later than at a range of 30 miles/50 km or engine operation might fail and damage might occur. ◀

## Displaying the cruising range

Depending on your vehicle's optional features, the range can also be displayed as bar in the instrument cluster.

1. "Settings"
2. "Instrument cluster"
3. "Additional indicators"

## With navigation system: range with destination guidance active



If respective equipment is fitted and destination guidance is active, the remaining range is displayed when the destination is reached.

## Current fuel consumption

### Display



Depending on your vehicle's optional features, the current fuel consumption can be displayed in the instrument cluster. Check whether you are currently driving in an efficient and environmentally-friendly manner.

## Displaying the current fuel consumption

1. "Settings"

- "Instrument cluster"
- "Additional indicators"

The bar display for the current fuel consumption is displayed in the instrument cluster.

## Energy recovery

### Display

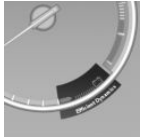

The kinetic energy of the vehicle is converted to electrical energy while coasting. The vehicle battery is partially charged and fuel consumption can be reduced.

## Service requirements

### The concept

After the ignition is turned on the instrument cluster briefly displays available driving distance or time to the next scheduled maintenance.

Your service specialist can read the current service requirements from your remote control.

### Display

Data regarding the service status or legally mandated vehicle inspections are automatically transmitted to your service center before a service due date.

### Detailed information on service requirements

More information on the scope of service required can be displayed on the Control Display.



On the Control Display:

- "Vehicle info"
- "Vehicle status"
-  "Service required"

Required maintenance procedures and legally mandated inspections are displayed.

- Select an entry to call up detailed information.

### Symbols

Symbols	Description
	No service is currently required.
	The deadline for scheduled maintenance or a legally mandated inspection is approaching.
	The service deadline has already passed.

### Entering appointment dates

Enter the dates for the required inspections.

Make sure that the vehicle's date and time are set correctly.

On the Control Display:

- "Vehicle info"
- "Vehicle status"
-  "Service required"
- "§ Vehicle inspection"
- "Date:"
- Adjust the settings.
- Confirm.

The entered date is stored.

### Automatic Service Request

Data regarding the service status or legally mandated vehicle inspections are automatically transmitted to your service center before a service due date.

You can check when your service center was notified.

On the Control Display:

1. "Vehicle info"
2. "Vehicle status"
3. Open "Options".
4. "Last Service Request"

## Gear shift indicator

### The concept





The system recommends the most fuel efficient gear for the current driving situation.

Depending on the vehicle's features and country version of the vehicle, the gear shift indicator is active in the manual mode of the Steptronic transmission and with manual transmission.



Suggestions to shift gear up or down are displayed in the instrument cluster.

On vehicles without a gear shift indicator, the engaged gear is displayed.

### Manual transmission: displaying

Symbol	Description
	Fuel efficient gear is set.
	Shift up to fuel efficient gear.
	Shift down to fuel efficient gear.
	Shift into neutral.

## Steptronic transmission: displays

Example	Description
	Fuel efficient gear is set.
	Shift into fuel efficient gear.

## Speed limit detection

### The concept

#### Speed limit detection

Speed limit detection uses a symbol in the shape of a traffic sign to display the currently detected speed limit. The camera in the area of the interior rearview mirror detects traffic signs at the edge of the road as well as variable overhead sign posts. Traffic signs with extra symbols for wet road conditions, etc. are also detected and compared with the vehicle's onboard data, such as for the rain sensor, and will be displayed depending on the situation. The system takes into account the information stored in the navigation system and also displays speed limits present on routes without signs.

### Hints



Personal judgment

The system cannot serve as a substitute for the driver's personal judgment of the traffic situation.

The system assists the driver and does not replace the human eye.◀

## At a glance

### Camera

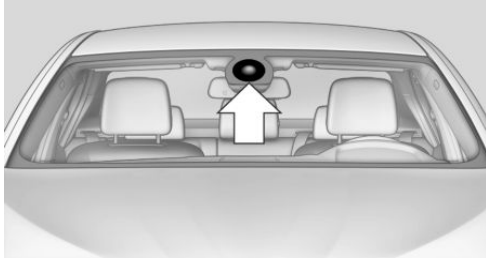

The camera is found near the interior rearview mirror.

Keep the windshield in the area behind the interior rearview mirror clean and clear.

### Switching on/off

On the Control Display:

1. "Settings"
2. "Instrument cluster"
3. "Speed limit information"

If speed limit detection is switched on, it can be displayed on the info display in the instrument cluster via the computer.

### Display

The following is displayed in the instrument cluster:

#### Speed limit detection

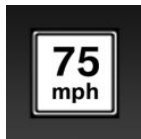

Current speed limit.



Speed limit detection is not available.

Speed limit detection can also be displayed in the Head-up Display.

### System limits

The system may not be fully functional and may provide incorrect information in the following situations:

- ▷ In heavy fog, rain or snowfall.
- ▷ When signs are concealed by objects.
- ▷ When driving very close to the vehicle in front of you.
- ▷ When driving toward bright lights.
- ▷ When the windshield behind the interior rearview mirror is fogged over, dirty or covered by a sticker, etc.
- ▷ In the event of incorrect detection by the camera.
- ▷ If the speed limits stored in the navigation system are incorrect.
- ▷ In areas not covered by the navigation system.
- ▷ When roads differ from the navigation, such as due to changes in road routing.
- ▷ When passing buses or trucks with a speed sticker.
- ▷ If the traffic signs are non-conforming.
- ▷ During calibration of the camera immediately after vehicle shipment.

## Selection lists in the instrument cluster

### The concept

Depending on your vehicle's optional features, the following can be displayed or operated using the buttons and the thumbwheel on the steering wheel as well as the displays in the instrument cluster and the Head-up Display:

- ▷ Current audio source.
- ▷ Redial phone feature.

- ▷ Turn on voice activation system.

## Display

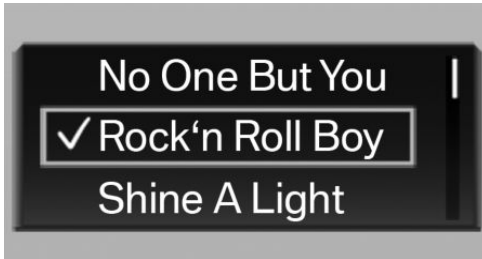

Depending on your vehicle's optional features, the list in the instrument cluster can differ from the illustration shown.

## Activating a list and adjusting the setting

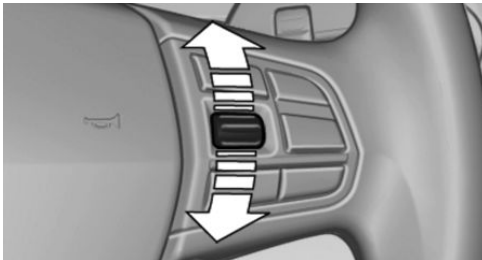

On the right side of the steering wheel, turn the thumbwheel to activate the corresponding list.

Using the thumbwheel, select the desired setting and confirm it by pushing the thumbwheel.

## On-board computer

### Indication in the info display

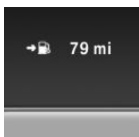

The information from the computer is shown in the info display in the instrument cluster.

## Calling up information on the info display

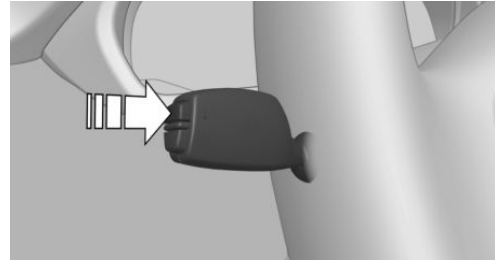

Press the onboard computer button on the turn signal lever.

Information is displayed in the info display of the instrument cluster.

## Information at a glance

Repeatedly pressing the button on the turn signal lever calls up the following information in the info display:

- ▷ Range.
- ▷ Average consumption, fuel.
- ▷ Average consumption, fuel.
- ▷ Miles and trip miles.

For a multi-functional instrument display.

- ▷ Average speed.
- ▷ Date.
- ▷ Speed limit detection.

Not for a multi-functional instrument display.

- ▷ Time of arrival.

When destination guidance is activated in the navigation system.

- ▷ Distance to destination.

When destination guidance is activated in the navigation system.

- ▷ ECO PRO bonus range.

## Adjusting the info display

Depending on the vehicle equipment version, you can select what information from the computer is to be displayed on the info display of the instrument cluster.

On the Control Display:

1. "Settings"
2. "Instrument cluster"
3. Select the desired displays.

## Information in detail

### Range

Displays the estimated cruising range available with the remaining fuel.

It is calculated based on your driving style over the last 20 miles/30 km.

If there is only enough fuel left for less than 45 miles/80 km, the color of the display changes.

### Average fuel consumption

The average fuel consumption is calculated for the period while the engine is running.

The average fuel consumption is calculated for the distance traveled since the last reset by the on-board computer.

### Average speed

Periods in which the vehicle is parked with the engine manually stopped are not included in the calculation of the average speed.

### Resetting average values

Press and hold the onboard computer button on the turn signal lever.

### Distance to destination

The distance remaining to the destination is displayed if a destination is entered in the navigation system before the trip is started.

The distance to the destination is adopted automatically.

### Time of arrival

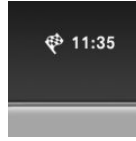

The estimated time of arrival is displayed if a destination is entered in the navigation system before the trip is started.

The time must be correctly set.

### Speed limit detection

Description of the speed limit detection, refer to page 95, function.

### Trip computer

The vehicle features two types of board computers.

- ▶ "Onboard info": the values can be reset as often as necessary.
- ▶ "Trip computer": the values provide an overview of the current trip.

### Resetting the trip computer

On the Control Display:

1. "Vehicle info"
2. "Trip computer"
3. "Reset": all values are reset.  
"Automatically reset": all values are reset approx. 4 hours after the vehicle came to a standstill.

### Display on the Control Display

Display the computer or trip computer on the Control Display.

1. "Vehicle info"
2. "Onboard info" or "Trip computer"

## Resetting the fuel consumption or speed

On the Control Display:

1. "Vehicle info"
2. "Onboard info"
3. "Consumpt." or "Speed"
4. "Yes"

## Sport displays

### The concept

On the Control Display, the current values for performance and torque can be displayed if the vehicle is appropriately equipped.

### Displaying sport displays on the Control Display

1. "Vehicle info"
2. "Sport displays"

## Speed warning

### The concept

Displays a speed, when reached, should cause a warning to be issued.

The warning is repeated if the vehicle speed drops below the set speed once by at least 3 mph/5 km/h.

### Displaying, setting or changing the speed warning

On the Control Display:

1. "Settings"
2. "Speed"
3. "Warning at:"
4. Turn the controller until the desired speed is displayed.
5. Press the controller.

Speed warning is stored.

## Activating/deactivating the speed warning

On the Control Display:

1. "Settings"
2. "Speed"
3. "Warning"
4. Press the controller.

## Setting your current speed as the speed warning

On the Control Display:

1. "Settings"
2. "Speed"
3. "Select current speed"
4. Press the controller.

The current vehicle speed is stored as the speed warning.

## Settings on the Control Display

### Time

#### Setting the time zone

1. "Settings"
2. "Time/Date"
3. "Time zone:"
4. Select the desired time zone.

The time zone is stored.

#### Setting the time

1. "Settings"
2. "Time/Date"
3. "Time:"
4. Turn the controller until the desired hours are displayed.
5. Press the controller.

6. Turn the controller until the desired minutes are displayed.
7. Press the controller.

The time is stored.

### Setting the time format

1. "Settings"
2. "Time/Date"
3. "Format:"
4. Select the desired format.

The time format is stored.

### Automatic time setting

Depending on your vehicle's optional features, the time, date and, if needed, the time zone are updated automatically.

1. "Settings"
2. "Time/Date"
3. "Auto time set"

## Date

### Setting the date

1. "Settings"
2. "Time/Date"
3. "Date:"
4. Turn the controller until the desired day is displayed.
5. Press the controller.
6. Make the necessary settings for the month and year.

The date is stored.

### Setting the date format

1. "Settings"
2. "Time/Date"
3. "Format:"
4. Select the desired format.

The date format is stored.

## Language

### Setting the language

To set the language on the Control Display:

1. "Settings"
2. "Language/Units"
3. "Language:"
4. Select the desired language.

Settings are stored for the profile currently in use.

### Setting the voice dialog

Voice dialog for the voice activation system, refer to page [27](#).

## Units of measure

### Setting the units of measure

To set the units for fuel consumption, route/distance and temperature:

1. "Settings"
2. "Language/Units"
3. Select the desired menu item.
4. Select the desired unit.

Settings are stored for the profile currently in use.

## Brightness

### Setting the brightness

To set the brightness of the Control Display:

1. "Settings"
2. "Control display"
3. "Brightness"
4. Turn the controller until the desired brightness is set.
5. Press the controller.

Settings are stored for the profile currently in use.



Depending on the light conditions, the brightness settings may not be clearly visible.

## Head-up Display

### The concept

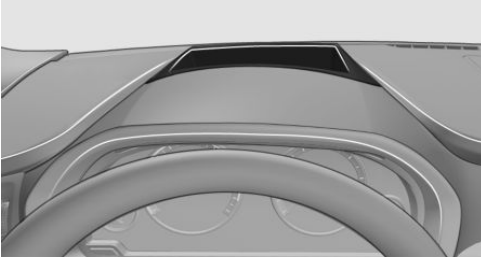

This system projects important information into the driver's field of vision, e.g., the speed. The driver can get information without averting his or her eyes from the road.

### Display visibility

The visibility of the displays in the Head-up Display is influenced by the following factors:

- ▶ Certain sitting positions.
- ▶ Objects on the cover of the Head-up Display.
- ▶ Sunglasses with certain polarization filters.
- ▶ Wet roads.
- ▶ Unfavorable light conditions.

If the image is distorted, check the basic settings.

### Switching on/off



Press button.

### Display

#### Overview

- ▶ Speed.
- ▶ Navigation system.
- ▶ Check Control messages.
- ▶ Selection list from the instrument cluster.
- ▶ Driver assistance systems.

Some of this information is only displayed briefly as needed.

### Selecting displays in the Head-up Display

On the Control Display:

1. "Settings"
2. "Head-Up Display"
3. "Displayed information"
4. Select the desired displays in the Head-up Display.

Settings are stored for the profile currently in use.

### Setting the brightness

The brightness is automatically adjusted to the ambient brightness.

The basic setting can be adjusted manually.

On the Control Display:

1. "Settings"
2. "Head-Up Display"
3. "Brightness"
4. Turn the controller.

When the low beams are activated, the brightness of the Head-up Display can be additionally influenced using the instrument lighting.

Settings are stored for the profile currently in use.

### Adjusting the height

On the Control Display:

1. "Settings"
2. "Head-Up Display"
3. "Height"
4. Turn the controller.

Settings are stored for the profile currently in use.

### Setting the rotation

On the Control Display:

1. "Settings"
2. "Head-Up Display"
3. "Rotation"
4. Turn the controller.

Settings are stored for the profile currently in use.

### Special windshield

The windshield is part of the system.

The shape of the windshield makes it possible to display a precise image.

A film in the windshield prevents double images from being displayed.

Therefore, have the special windshield replaced by a service center only.

# Lights

## Vehicle features and options

This chapter describes all standard, country-specific and optional features offered with the series. It also describes features that are not necessarily available in your car, e. g., due to the selected options or country versions. This also applies to safety-related functions and systems. The respectively applicable country provisions must be observed when using the respective features and systems.

## Overview



- 1 Rear fog lights
- 2 Front fog lights
- 3 Depending on the equipment: automatic headlight control, Adaptive Light Control, High-beam Assistant, Welcome lights, Daytime running lights
- 4 Lights off, daytime running lights
- 5 Parking lights, daytime running lights
- 6 Depending on the equipment: low beams, welcome lights, High-beam Assistant
- 7 Instrument lighting

## Parking lights/low beams, headlight control

### General information

Position of switch: 0, , 

If the driver door is opened with the ignition switched off, the exterior lighting is automatically switched off at these switch settings.

### Parking lights

Position of switch  : the vehicle's lights light up on all sides, e.g., for parking.



Do not use the parking lights for extended periods; otherwise, they might drain the battery and it would then be impossible to start the engine.

When parking, it is preferable to switch on the one-sided roadside parking lights, refer to page 104.

### Low beams

Position of switch  with the ignition switched on: the low beams light up.

### Welcome lights

When parking the vehicle, leave the switch in position  or  : the parking and interior lights light up briefly when the vehicle is unlocked.

### Activating/deactivating

On the Control Display:

1. "Settings"
2. "Lighting"
3. "Welcome lights"

Settings are stored for the profile currently in use.

## Headlight courtesy delay feature

The low beams stay lit for a short while after the radio-ready state is switched off if the lights are turned off and the headlight flasher is switched on.

### Setting the duration

On the Control Display:

1. "Settings"
2. "Lighting"
3. "Pathway lighting:"
4. Set length of time.

Settings are stored for the profile currently in use.

### Automatic headlight control

Position of switch  : the low beams are activated and off automatically, e.g., in tunnels, in twilight or if there is precipitation. The indicator lamp in the instrument cluster lights up.

When emerging from a tunnel during the day, the low beams are not switched off immediately but instead only after approx. 2 minutes.

A blue sky with the sun low on the horizon can cause the lights to be switched on.

The low beams always stay on when the fog lights are activated.







#### Personal responsibility

The automatic headlight control cannot serve as a substitute for your personal judgment in determining when to turn the lights on in response to ambient lighting conditions.

E. g. the sensors are unable to detect fog or hazy weather. To avoid safety risks under these conditions, you should always switch on the lights manually. ◀

### Daytime running lights

With the ignition switched on, the daytime running lights light up in position ,  or . After the ignition is switched off, the parking lights light up in position .

### Activating/deactivating

In some countries, daytime running lights are mandatory, so it may not be possible to deactivate the daytime running lights.

On the Control Display:

1. "Settings"
2. "Lighting"
3. "Daytime running lamps"

Settings are stored for the profile currently in use.

### Roadside parking lights

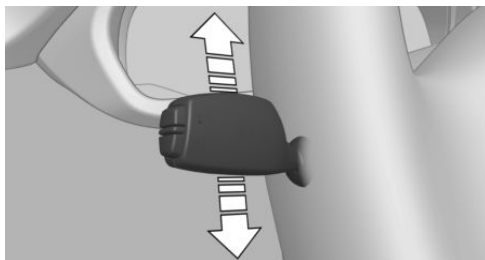

The vehicle can be illuminated on one side.

### Switching on

With the ignition switched off, press the lever either up or down past the resistance point for approx. 2 seconds.

### Switch off

Briefly press the lever to the resistance point in the opposite direction.

## Adaptive Light Control

### The concept

Adaptive Light Control is a variable headlight control system that enables dynamic illumination of the road surface.

Depending on the steering angle and other parameters, the light from the headlight follows the course of the road.

In tight curves, e.g., on mountainous roads or when turning, an additional, corner-illuminating lamp is switched on that lights up the inside of the curve when the vehicle is moving below a certain speed.

## Activating

Position of switch  with the ignition switched on.

To avoid blinding oncoming traffic, the Adaptive Light Control does not swivel to the driver's side when the vehicle is at a standstill.

The turning lights are automatically switched on depending on the steering angle or the use of turn signals.

When driving in reverse, the turning lights may be automatically switched on regardless of the steering angle.

## Self-leveling headlights

The self-leveling headlights compensate for acceleration and braking operations in order not to blind the oncoming traffic and to achieve optimum illumination of the roadway.

## Malfunction

A Check Control message is displayed.

Adaptive Light Control is malfunctioning or has failed. Have the system checked as soon as possible.

## High-beam Assistant

### The concept

When the low beams are activated, this system automatically switches the high beams on and off or suppresses the light in the areas that blind oncoming traffic. The procedure is controlled by a camera on the front of the interior rearview mirror. The assistant ensures that the high beams are activated whenever the traffic situation allows. The driver can intervene at

any time and switch the high beams non and off as usual.

## Note





Personal responsibility

The High-beam Assistant cannot serve as a substitute for the driver's personal judgment of when to use the high beams. Therefore, manually reel off the high beams in situations where required to avoid a safety risk. ◀

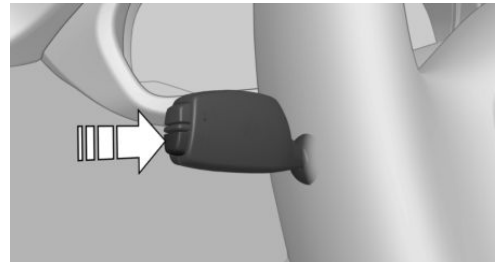
## Activating



1. Depending on the equipment, turn the light switch into position  or .
2. Press button on the turn signal lever, arrow.



The indicator lamp in the instrument cluster lights up.

When the low beams are on, the lights are automatically brightened or dimmed.

The system responds to light from oncoming traffic and traffic driving ahead of you, and to adequate illumination, e.g., in towns and cities.



The blue indicator lamp in the instrument cluster lights up when the system switches on the high beams. Depending on the version of the system in the vehicle, the high beams may not switch off for oncoming vehicles, but may only be dimmed in the areas that blind oncoming traffic. In this case, the blue indicator light will stay on.

## Switching the high beams on and off manually

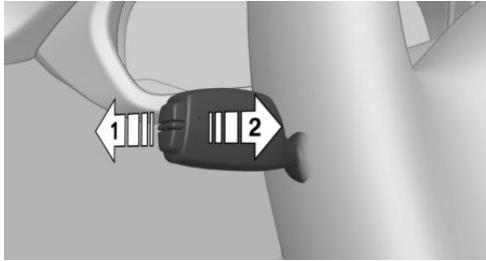

- ▷ High beams on, arrow 1.
- ▷ High beams off/headlight flasher, arrow 2.

The High-beam Assistant can be switched off when manually adjusting the light. To reactivate the High-beam Assistant, press the button on the turn signal lever.

### System limits

The system is not fully functional in situations such as the following, and driver intervention may be necessary:

- ▷ In very unfavorable weather conditions, such as fog or heavy precipitation.
- ▷ When detecting poorly-lit road users such as pedestrians, cyclists, horseback riders and wagons; when driving close to train or ship traffic; and at animal crossings.
- ▷ In tight curves, on hilltops or in depressions, in cross traffic or half-observed on-coming traffic on freeways.
- ▷ In poorly-lit towns and cities and in the presence of highly reflective signs.
- ▷ At low speeds.
- ▷ When the windshield behind the interior rearview mirror is fogged over, dirty or covered with stickers, etc.

## Fog lights

### Front fog lights

The parking lights or low beams must be switched on.



Press button. The green indicator lamp lights up.

If the automatic headlight control, refer to page 104, is activated, the low beams will come on automatically when you switch on the front fog lights.

When the high beams or headlight flasher are activated, the front fog lights are not switched on.

## Instrument lighting

### Adjusting



The parking lights or low beams must be switched on to adjust the brightness.

Adjust the brightness with the thumbwheel.

## Interior lights

### General information

The interior lights, footwell lights, access lights and courtesy lights are controlled automatically.

Thumb wheel for the instrument lighting controls brightness of some of these features.

## Overview

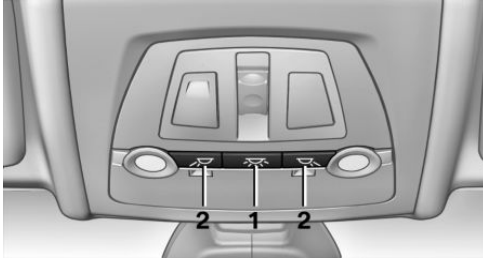

- 1 Interior lights
- 2 Reading lamp

## Switching the interior lights on and off



Press button.

To reel off permanently: press the button for approx. 3 seconds.

Switch back on: press button.

## Reading lights



Press button.

Reading lights are located at the front and rear next to the interior lights.

## Bang & Olufsen High End Surround Sound System

### Adjusting speaker lighting

Some speakers in the vehicle are illuminated. The lighting can be individually set.

1. "Settings"
2. "Lighting"
3. "B&O"
4. Select the desired lighting setting.
  - ▷ "Off": no lighting.
  - ▷ "Reduced": the speakers in the field of view are faded while driving.
  - ▷ "On": the speakers are always illuminated.

## Ambient light

Depending on the equipment, the lighting can be individually adjusted in the interior for some lights.

### Selecting color scheme

1. "Settings"
2. "Lighting"
3. "Ambient:"
4. Select desired setting.

With a color scheme selected and welcome lights activated they illuminate in the line's color when vehicle is unlocked.

### Setting the brightness

The brightness of the ambient light can be adjusted via the thumbwheel for the instrument lighting or on the Control Display.

1. "Settings"
2. "Lighting"
3. "Brightness:"
4. Adjust the brightness.

# Safety

## Vehicle features and options

This chapter describes all standard, country-specific and optional features offered with the series. It also describes features that are not necessarily available in your car, e. g., due to

the selected options or country versions. This also applies to safety-related functions and systems. The respectively applicable country provisions must be observed when using the respective features and systems.

## Airbags

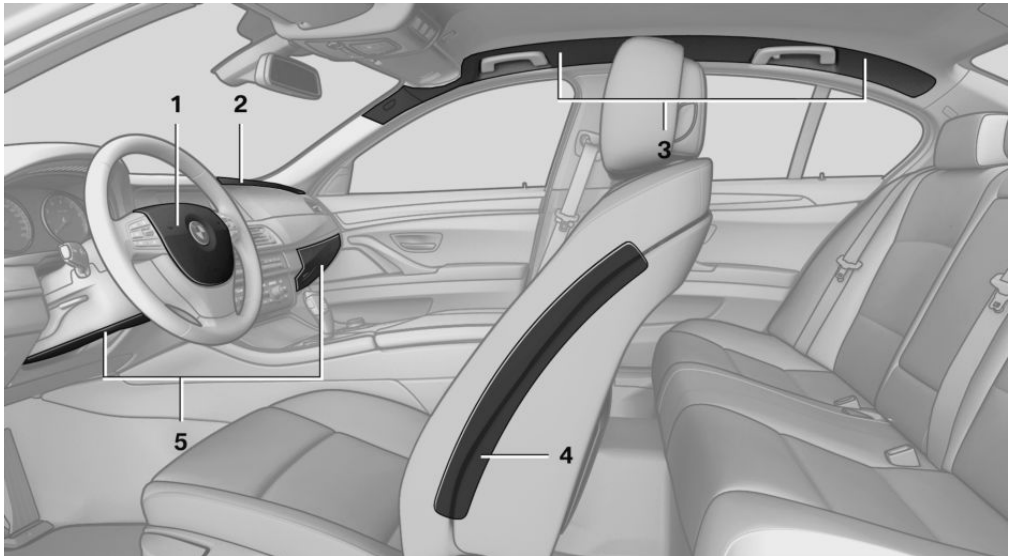

- |   |                               |   |              |
|---|-------------------------------|---|--------------|
| 1 | Front airbag, driver          | 4 | Side airbag  |
| 2 | Front airbag, front passenger | 5 | Knee airbags |
| 3 | Head airbag                   |   |              |

### Front airbags

Front airbags help protect the driver and front passenger by responding to frontal impacts in which safety belts alone would not provide adequate restraint.

### Side airbags

In a lateral impact, the side airbag supports the side of the body in the chest and lap area.

### Head airbags

In a lateral impact, the head airbag supports the head.



## Knee airbag

The knee airbag supports the legs in a frontal impact.

## Protective action

Airbags are not triggered in every impact situation, e.g., in less severe accidents or rear-end collisions.

 Information on how to ensure the optimal protective effect of the airbags

- ▷ Keep at a distance from the airbags.
- ▷ Always grasp the steering wheel on the steering wheel rim, holding your hands at the 3 o'clock and 9 o'clock positions, to keep the risk of injury to your hands or arms as low as possible when the airbag is triggered.
- ▷ There should be no person, animals, or objects between an airbag and a person.
- ▷ Do not use the cover of the front airbag on the front passenger side as a storage area.
- ▷ Dashboard and windshield on the front passenger side must stay clear - do not attach adhesive labels or coverings and do not attach brackets or cables, e. g., for GPS devices or mobile phones.
- ▷ Make sure that the front passenger is sitting correctly, i.e., keeps his or her feet and legs in the footwell; otherwise, leg injuries might occur when front airbag is activated.
- ▷ Do not place slip covers, seat cushions or other objects on the front passenger seat that are not approved specifically for seats with integrated side airbags.
- ▷ Do not hang pieces of clothing, such as jackets, over the backrests.
- ▷ Make sure that occupants keep their heads away from the side airbag and do not rest against the head airbag; otherwise, injuries might occur when airbag is activated.
- ▷ Do not remove the airbag system.
- ▷ Do not remove the steering wheel.

- ▷ Do not apply adhesive materials to the airbag cover panels, do not cover them or modify them in any way.
- ▷ Never modify either the individual components or the wiring in the airbag system. This also applies to steering wheel covers, the dashboard, the seats, the roof pillars and the sides of the roofliner. ◀

Even when you follow all instructions very closely, injury from contact with the airbags cannot be ruled out in certain situations.

The ignition and inflation noise may lead to short-term and, in most cases, temporary hearing impairment in sensitive individuals.

 Malfunction, deactivation and after deploying the airbags

Do not touch the individual components immediately after the system has been triggered; otherwise, you may risk burns.

Only have the airbags checked, repaired or dismantled and the airbag generator scrapped by the service center or an authorized repair shop for handling explosives.

Non-professional attempts to service the system could lead to failure in an emergency or unintentional activation of the airbag - both may lead to injury. ◀

Warnings and information on the airbags are also found on the sun visors.

## Functional readiness of the airbag system

 When the ignition is reel on, the warning lamp in the instrument cluster lights up briefly and thereby indicates the operational readiness of the entire airbag system and the belt tensioner.

## Airbag system malfunctioning

- ▷ Warning lamp does not come on when the ignition is turned on.
- ▷ The warning lamp lights up continuously.

 In case of a malfunction have airbag system checked immediately.

In case of a malfunction have airbag system checked immediately; otherwise, there is a risk that the system does not function as expected in case of a severe accident. ◀

### Automatic deactivation of the front-seat passenger airbags

The system reads if the front passenger seat is occupied by measuring the human body's resistance.

Front, knee and side airbag on the front passenger's side are either activated or deactivated.

 Leave feet in the footwell

Make sure that the front passenger keeps his or her feet in the footwell; otherwise, proper functioning of the front passenger airbag might not be assured. ◀

 Child restraint fixing system in the front passenger seat

Before transporting a child on the front passenger seat, refer to the safety notes and instructions for children on the front passenger seat, see Children. ◀

### Malfunction of the automatic deactivation system

When transporting older children and adults, the front-seat passenger airbags may be deactivated in certain sitting positions. In this case, the indicator lamp for the front-seat passenger airbags lights up.

In this case, change the sitting position so that the front-seat passenger airbags are activated and the indicator lamp goes out.

If it is not possible to activate the airbags, have the person sit in the rear.

To enable correct recognition of the occupied seat cushion

- ▶ Do not attach covers, cushions, ball mats or other items to the front passenger seat unless they are specifically recommended by your vehicle's manufacturer.
- ▶ Do not place any electronic devices on the passenger seat if a child restraint system is to be installed on it.
- ▶ Do not place objects under the seat that could press against the seat from below.
- ▶ No moisture in or on the seat.

### Indicator lamp for the front-seat passenger airbags



The indicator lamp for the front-seat passenger airbags indicates the operating state of the front-seat passenger airbags.

The lamp indicates whether the airbags are either activated or deactivated.



- ▶ The indicator lamp lights up when a child is properly seated in a child restraint fixing system or when the seat is empty. The airbags on the front passenger side are not activated.
- ▶ The indicator lamp does not light up when, e.g., a correctly seated person of sufficient size is detected on the seat. The airbags on the front passenger side are activated.

### Detected child seats

The system generally detects children seated in a child seat, particularly in child seats required by NHTSA when the vehicle was manu-

factured. After installing a child seat, make sure that the indicator lamp for the front-seat passenger airbags lights up. This indicates that the child seat has been detected and the front-seat passenger airbags are not activated.

### Strength of the driver's and front-seat passenger airbag

The explosive power that activates driver's/ front passenger's airbags very much depends on the positions of the driver's/front passenger's seat.

With a respective message appearing on Control Display calibrate the front seats to keep the accuracy of this function over the long-term.

### Calibrating the front seats

A corresponding message appears on the Control Display.

1. Press the reel and move the respective seat all the way forward.
2. Press the reel forward again. The seat still moves forward slightly.
3. Readjust the seat to the desired position.

The calibration procedure is completed when the message on the Control Display disappears.

If the message continues to be displayed, repeat the calibration.

If the message does not disappear after a repeat calibration, have the system checked as soon as possible.



Unobstructed area of movement

Ensure that the area of movement of the seats is unobstructed to avoid personal injury or damage to objects. ◀

## Tire Pressure Monitor TPM

### The concept

The system monitors tire inflation pressure in the four mounted tires. The system warns you if there is a significant loss of pressure in one or more tires. For this purpose, sensors in the tire valves measure the tire inflation pressure and tire temperature.

### Hints



Tire damage due to external factors

Sudden tire damage caused by external circumstances cannot be recognized in advance. ◀

With use of the system observe further information found under Tire inflation pressure, refer to page 211.

### Functional requirements

The system must have been reset with the correct tire inflation pressure; otherwise, reliable signaling of tire inflation pressure loss is not assured.

Reset the system after each adjustment of the tire inflation pressure and after every tire or wheel change.

Always use wheels with TPM electronics to ensure that the system will operate properly.

### Status display

The current status of the Tire Pressure Monitor TPM can be displayed on the Control Display, e.g., whether or not the TPM is active.

On the Control Display:

1. "Vehicle info"
2. "Vehicle status"
3.  "Tire Pressure Monitor (TPM)"

The status is displayed.

## Status control display

Tire and system status are indicated by the color of the wheels and a text message on the Control Display.

### All wheels green

System is active and will issue a warning relative to the tire inflation pressures stored during the last reset.

### One wheel is yellow

A flat tire or major drop in inflation pressure in the indicated tire.

### All wheels are yellow

A flat tire or major drop in inflation pressure in several tires.

### Wheels, gray

The system cannot detect a flat tire. Reasons for this may be:

- ▷ The system is being reset.
- ▷ Malfunction.

## Status information

The status control display additionally shows the current tire inflation pressures and, depending on the model, tire temperatures. It shows the actual values read; they may vary depending on driving style or weather conditions.

## Carry out reset

Reset the system after each adjustment of the tire inflation pressure and after every tire or wheel change.

On the Control Display and on the vehicle:

1. "Vehicle info"
2. "Vehicle status"
3.  "Perform reset"
4. Start the engine - do not drive off.

5. Reset tire inflation pressure: "Perform reset".
6. Drive away.

The tires are shown in gray and the status is displayed.

After driving faster than 19 mph/30 km/h for a short period, the set tire inflation pressures are accepted as reference values. The reset is completed automatically while driving.

After a successfully completed Reset, the wheels on the Control Display are shown in green and "Tire Pressure Monitor (TPM) active" is displayed.

You may interrupt this trip at any time. When you continue the reset resumes automatically.

## Low tire pressure message



The yellow warning lamp lights up. A Check Control message is displayed.

- ▷ There is a flat tire or a major loss in tire inflation pressure.
- ▷ No reset was performed for the system. The system therefore issues a warning based on the tire inflation pressures before the last reset.

1. Reduce your speed and stop cautiously. Avoid sudden braking and steering maneuvers.
2. Check whether the vehicle is fitted with regular tires or run-flat tires.

Run-flat tires, refer to page 224, are labeled with a circular symbol containing the letters RSC marked on the tire's sidewall.



Do not continue driving without run-flat tires

Do not continue driving if the vehicle is not equipped with run-flat tires; continued driving may result in serious accidents. ◀

A low tire inflation pressure might turn on DSC Dynamic Stability Control.

## Actions in the event of a flat tire

### Normal tires

#### 1. Identify the damaged tire.

Do this by checking the air pressure in all four tires.

The tire pressure gage of the Mobility System, refer to page 224, can possibly be used for this purpose.

If the tire inflation pressure in all four tires is shown to be correct, it is possible that the Tire Pressure Monitor did not perform a reset. Then perform the reset.

If an identification is not possible, please contact the service center.

#### 2. Fixing a flat tire, where applicable with the Mobility System.

Use of tire sealant, e.g., the Mobility System, may damage the TPM wheel electronics. In this case, have the electronics checked at the next opportunity and have them replaced if needed.

### Run-flat tires

#### Maximum speed

You may continue driving with a damaged tire at speeds up to 50 mph/80 km/h.

#### Continued driving with a flat tire

If continuing to drive with a damaged tire:

1. Avoid sudden braking and steering maneuvers.
2. Do not exceed a speed of 50 mph/80 km/h.
3. Check the air pressure in all four tires at the next opportunity.

If the tire inflation pressure in all four tires is shown to be correct, it is possible that the Tire Pressure Monitor did not perform a reset. In that case, carry out a reset.

Possible driving distance with complete loss of tire inflation pressure:

The possible driving distance after a loss of tire inflation pressure depends on cargo load, driving style and road conditions.

A vehicle with an average load has a possible driving range of approx. 50 miles/80 km.

A vehicle with a damaged tire reacts differently, e.g., it has reduced lane stability during braking, a longer braking distance and different self-steering properties. Adjust your driving style accordingly. Avoid abrupt steering maneuvers or driving over obstacles, e.g., curbs, potholes, etc.

Because the possible driving distance depends on how the vehicle is used during the trip, the actual distance may be shorter or longer depending on the driving speed, road conditions, external temperature, cargo load, etc.



#### Continued driving with a flat tire

Drive moderately and do not exceed a speed of 50 mph/80 km/h.

Your car handles differently when you lose tire inflation pressure, e.g., your lane stability is reduced when braking, braking distances are longer and the self-steering properties will change. ◀



#### Final tire failure

Vibrations or loud noises while driving can indicate the final failure of a tire. Reduce speed and stop; otherwise, pieces of the tire could come loose and cause an accident. Do not continue driving and contact your service center. ◀

### Required tire inflation pressure check message

A Check Control message is displayed in the following situations

- ▶ The system has detected a wheel change, but no reset was done.
- ▶ Inflation was not carried out according to specifications.

- ▶ The tire inflation pressure has fallen below the level of the last confirmation.

In this case:

- ▶ Check the tire pressure and correct as needed.
- ▶ Carry out a reset of the system after a tire change.

## System limits

The system does not function properly if a reset has not been carried out, e.g., a flat tire is reported though tire inflation pressures are correct.

The tire inflation pressure depends on the tire's temperature. Driving or exposure to the sun will increase the tire's temperature, thus increasing the tire inflation pressure. The tire inflation pressure is reduced when the tire temperature falls again. These circumstances may cause a warning when temperatures fall very sharply.

## Malfunction



The yellow warning lamp flashes and then lights up continuously. A Check Control message is displayed. No flat tire or loss of tire inflation pressure can be detected.

Display in the following situations:

- ▶ A wheel without TPM electronics is fitted: have the service center check it if needed.
- ▶ Malfunction: have the system checked by your service center.
- ▶ TPM was unable to complete the reset. Reset the system again.
- ▶ Interference through systems or devices with the same radio frequency: after leaving the area of the interference, the system automatically becomes active again.

## Declaration according to NHTSA/ FMVSS 138 Tire Pressure Monitoring System

Each tire, including the spare (if provided) should be checked monthly when cold and inflated to the inflation pressure recommended by the vehicle manufacturer on the vehicle placard or tire inflation pressure label. (If your vehicle has tires of a different size than the size indicated on the vehicle placard or tire inflation pressure label, you should determine the proper tire inflation pressure for those tires.) As an added safety feature, your vehicle has been equipped with a tire pressure monitoring system (TPMS) that illuminates a low tire pressure telltale when one or more of your tires is significantly under-inflated. Accordingly, when the low tire pressure telltale illuminates, you should stop and check your tires as soon as possible, and inflate them to the proper pressure. Driving on a significantly under-inflated tire causes the tire to overheat and can lead to tire failure. Under-inflation also reduces fuel efficiency and tire tread life, and may affect the vehicle's handling and stopping ability. Please note that the TPMS is not a substitute for proper tire maintenance, and it is the driver's responsibility to maintain correct tire pressure, even if under-inflation has not reached the level to trigger illumination of the TPMS low tire pressure telltale. Your vehicle has also been equipped with a TPMS malfunction indicator to indicate when the system is not operating properly. The TPMS malfunction indicator is combined with the low tire pressure telltale. When the system detects a malfunction, the telltale will flash for approximately one minute and then remain continuously illuminated. This sequence will continue upon subsequent vehicle start-ups as long as the malfunction exists. When the malfunction indicator is illuminated, the system may not be able to detect or signal low tire pressure as intended. TPMS malfunctions may occur for a variety of reasons, including the installation of replacement or alternate tires or wheels on the vehicle

that prevent the TPMS from functioning properly. Always check the TPMS malfunction tell-tale after replacing one or more tires or wheels on your vehicle to ensure that the replacement or alternate tires and wheels allow the TPMS to continue to function properly.

## FTM Flat Tire Monitor

### The concept

The system detects tire inflation pressure loss on the basis of rotation speed differences between the individual wheels while driving.

In the event of a tire inflation pressure loss, the diameter and therefore the rotational speed of the corresponding wheel changes. This will be detected and reported as a flat tire.

The system does not measure the actual inflation pressure in the tires.

### Functional requirements

The system must have been initialized when the tire inflation pressure was correct; otherwise, reliable flagging of a flat tire is not assured. Initialize the system after each correction of the tire inflation pressure and after every tire or wheel change.

### Status display

The current status of the Flat Tire Monitor can be displayed on the Control Display, e.g., whether or not the FTM is active.

On the Control Display:

1. "Vehicle info"
2. "Vehicle status"
3.  "Flat Tire Monitor (FTM)"

The status is displayed.

### Initialization

When initializing the once set inflation tire pressures serve as reference values in order to

detect a flat tire. Initialization is started by confirming the tire inflation pressures.

Do not initialize the system when driving with snow chains.

On the Control Display:

1. "Vehicle info"
2. "Vehicle status"
3.  "Perform reset"
4. Start the engine - do not drive off.
5. Start the initialization with "Perform reset".
6. Drive away.

The initialization is completed while driving, which can be interrupted at any time.

The initialization automatically continues when driving resumes.

### Indication of a flat tire



The yellow warning lamp lights up. A Check Control message is displayed.

There is a flat tire or a major loss in tire inflation pressure.

1. Reduce your speed and stop cautiously. Avoid sudden braking and steering maneuvers.
2. Check whether the vehicle is fitted with regular tires or run-flat tires.

Run-flat tires, refer to page 224, are labeled with a circular symbol containing the letters RSC marked on the tire's sidewall.



Do not continue driving without run-flat tires

Do not continue driving if the vehicle is not equipped with run-flat tires; continued driving may result in serious accidents. ◀

When a flat tire is indicated, DSC Dynamic Stability Control is switched on if needed.

## System limits



### Sudden tire damage

Sudden serious tire damage caused by external circumstances cannot be recognized in advance. ◀

A natural, even tire inflation pressure loss in all four tires will not be recognized. Therefore, check the tire inflation pressure regularly.

The system could be delayed or malfunction in the following situations:

- ▷ When the system has not been initialized.
- ▷ When driving on a snowy or slippery road surface.
- ▷ Sporty driving style: spinning traction wheels, high lateral acceleration (drifting).
- ▷ When driving with snow chains.

## Actions in the event of a flat tire

### Normal tires

1. Identify the damaged tire.

Do this by checking the air pressure in all four tires.

The tire pressure gage of the Mobility System, refer to page 224, can possibly be used for this purpose.

If the tire inflation pressure in all four tires is correct, the Flat Tire Monitor may not have been initialized. In this case, initialize the system.

If an identification is not possible, please contact the service center.

2. Fix the flat tire where applicable using the Mobility System, refer to page 224.

### Run-flat tires

#### Maximum speed

You may continue driving with a damaged tire at speeds up to 50 mph/80 km/h.

## Continued driving with a flat tire

If continuing to drive with a damaged tire:

1. Avoid sudden braking and steering maneuvers.
2. Do not exceed a speed of 50 mph/80 km/h.
3. Check the air pressure in all four tires at the next opportunity.

If the tire inflation pressure in all four tires is correct, the Flat Tire Monitor may not have been initialized. In this case, initialize the system.

Possible driving distance with complete loss of tire inflation pressure:

The possible driving distance after a loss of tire inflation pressure depends on cargo load, driving style and road conditions.

A vehicle with an average load has a possible driving range of approx. 50 miles/80 km.

A vehicle with a damaged tire reacts differently, e.g., it has reduced lane stability during braking, a longer braking distance and different self-steering properties. Adjust your driving style accordingly. Avoid abrupt steering maneuvers or driving over obstacles, e.g., curbs, potholes, etc.

Because the possible driving distance depends on how the vehicle is used during the trip, the actual distance may be shorter or longer depending on the driving speed, road conditions, external temperature, cargo load, etc.



### Continued driving with a flat tire

Drive moderately and do not exceed a speed of 50 mph/80 km/h.

Your car handles differently when you lose tire inflation pressure, e.g., your lane stability is reduced when braking, braking distances are longer and the self-steering properties will change. ◀



 **Final tire failure**  
 Vibrations or loud noises while driving can indicate the final failure of a tire. Reduce speed and stop; otherwise, pieces of the tire could come loose and cause an accident. Do not continue driving and contact your service center. ◀

## Intelligent Safety

### The concept

Intelligent Safety enables central operation of the driver assistance system.

Depending on how the vehicle is equipped, Intelligent Safety consists of one or more systems that can help prevent an imminent collision. These systems are active automatically every time the engine is started using the Start/Stop button:

- ▶ Front-end collision warning, refer to page 118.
- ▶ Pedestrian warning, refer to page 123.

### Hints

 **Personal responsibility**  
 The system does not serve as a substitute for the driver's personal judgment of the traffic situation.

Be aware of the traffic situation and the vehicle's surroundings at all times, otherwise accidents are still possible despite all warnings. ◀

 **Adapting your speed and driving style**  
 The displays and warnings of the system do not relieve the driver of the responsibility to adapt his or her driving speed and style to the traffic conditions. ◀

 **Be alert**  
 Due to system limitations, warnings may be not issued at all, or may be issued late or improperly. Therefore, always be alert and

ready to intervene; otherwise, there is the risk of an accident. ◀

 **Tow-starting and towing**  
 For tow-starting or towing, switch off the Intelligent Safety systems; otherwise malfunctions of the individual braking systems might lead to accidents. ◀

### At a glance

#### Button in the vehicle



 Intelligent Safety button

#### Camera

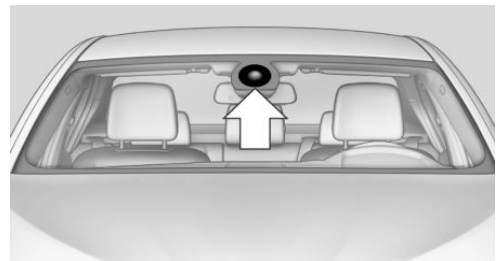

The camera is found near the interior rearview mirror.

Keep the windshield in the area behind the interior rearview mirror clean and clear.

#### Switching on/off

The Intelligent Safety systems are automatically active after every departure.



Press button: the systems are turned off. The LED goes out.

Press button: the systems are turned on. The LED lights up.

Settings can be made on the Control Display.

## Front-end collision warning

Depending on the equipment, the collision warning system consists of one of the two systems:

- ▷ Front-end collision warning with City Braking function, refer to page 118.
- ▷ Front-end collision warning with braking function, refer to page 120

## Front-end collision warning with City Braking function

### The concept

The system can help prevent accidents. If an accident cannot be prevented, the system will help reduce the collision speed.

The system sounds a warning before an imminent collision and actuates brakes independently if needed.

The automatic braking intervention is done with limited force and duration.

A camera in the area of the rearview mirror controls the system.

The front-end collision warning is available even if cruise control has been deactivated.

With the vehicle approaching another vehicle intentionally the collision warning is delayed avoiding false alarm.

### General information

The system warns at two levels of an imminent danger of collision at speeds from approx. 3 mph/5 km/h. Time of warnings may vary with the current driving situation.

Appropriate braking kicks in at speeds of up to 35 mph/60 km/h.

### Detection range

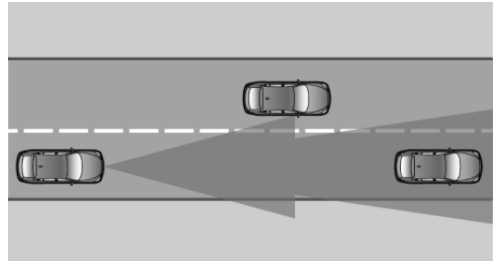

It responds to objects if they are detected by the system.

### Hints



Personal responsibility

The system does not serve as a substitute for the driver's personal judgment of the traffic situation.

Be aware of the traffic situation and the vehicle's surroundings at all times, otherwise accidents are still possible despite all warnings. ◀



Adapting your speed and driving style

The displays and warnings of the system do not relieve the driver of the responsibility to adapt his or her driving speed and style to the traffic conditions. ◀



Be alert

Due to system limitations, warnings may be not issued at all, or may be issued late or improperly. Therefore, always be alert and ready to intervene; otherwise, there is the risk of an accident. ◀



Tow-starting and towing

For tow-starting or towing, switch off the Intelligent Safety systems; otherwise malfunctions of the individual braking systems might lead to accidents. ◀

## At a glance

### Button in the vehicle



Intelligent Safety button

### Camera

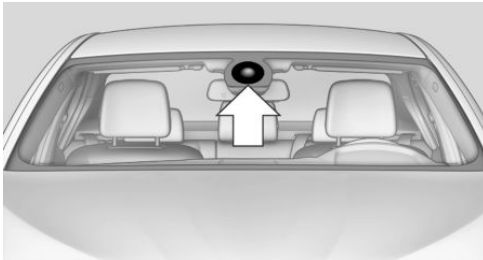

The camera is found near the interior rearview mirror.

Keep the windshield in the area behind the interior rearview mirror clean and clear.

### Switching on/off

#### Switching on automatically

The system is automatically active after every driving-off.

#### Switch off



Press button: the system is switched off. The LED goes out.

Re-press button: the system is switched on. The LED lights up.

### Setting the warning time

The warning time can be set via iDrive.

1. "Settings"
2. "Frontal Coll. Warning"
3. Activate the desired time on the Control Display.

The selected time is stored for the profile currently in use.

### Warning with braking function

#### Display

If a collision with a recognized vehicle is imminent a warning symbol appears in the instrument cluster and in the Head-Up Display.

Symbol	Measure
	The vehicle lights up red: prewarning. Brake and increase distance.
	The vehicle flashes red and an acoustic signal sounds: acute warning. You are requested to intervene by braking or make an evasive maneuver.



The vehicle lights up red: prewarning.  
Brake and increase distance.



The vehicle flashes red and an acoustic signal sounds: acute warning.

You are requested to intervene by braking or make an evasive maneuver.

#### Prewarning

This warning is issued, e.g., when there is the impending danger of a collision or the distance to the vehicle ahead is too small.

The driver must intervene actively when there is a prewarning.

#### Acute warning with braking function

Warning of the imminent danger of a collision when the vehicle approaches another object at a relatively high differential speed.

The driver must intervene actively when there is an acute warning. If necessary, the driver is assisted by a minor automatic braking intervention in a possible risk of collision.

Acute warnings can also be triggered without previous prewarning.

### Braking intervention

The warning prompts the driver himself/herself to react. During a warning, the maximum braking force is used. Premise for the brake booster is sufficiently quick and hard stepping on the brake pedal. The system can assist with some braking intervention if there is risk of a collision. At low speeds vehicles may thus come to a complete stop.

Manual transmission: During a braking intervention up to a complete stop, the engine may be shut down.

The braking intervention is executed only if DSC Dynamic Stability Control is switched on and Dynamic Traction Control DTC is activated.

The braking intervention can be interrupted by stepping on the accelerator pedal or by actively moving the steering wheel.

Object detection can be restricted. Limitations of the detection range and functional restrictions are to be considered.

### System limits

#### Detection range

The system's detection potential is limited.

Thus a warning might not be issued or be issued late.

E. g. the following situations may not be detected:

- ▶ Slow moving vehicles when you approach them at high speed.
- ▶ Vehicles that suddenly swerve in front of you, or sharply decelerating vehicles.
- ▶ Vehicles with an unusual rear appearance.
- ▶ Two-wheeled vehicles ahead of you.

### Functional limitations

The system may not be fully functional in the following situations:

- ▶ In heavy fog, rain, sprayed water or snow-fall.
- ▶ In tight curves.
- ▶ If the driving stability control systems are limited or deactivated, e.g., DSC OFF.
- ▶ If, depending on the vehicle equipment version, the field of view of the camera in the mirror or the radar sensor is dirty or obscured.
- ▶ Up to 10 seconds after the start of the engine, via the Start/Stop knob.
- ▶ During calibration of the camera immediately after vehicle shipment.
- ▶ If there is constant blinding effects because of oncoming light, e. g., from the sun low in the sky.

### Warning sensitivity

The more sensitive the warning settings are, e.g. the warning time, the more warnings are displayed. However, there may also be an excess of false warnings.

## Front-end collision warning with braking function

### The concept

The system can help prevent accidents. If an accident cannot be prevented, the system will help reduce the collision speed.

The system sounds a warning before an imminent collision and actuates brakes independently if needed.

The automatic braking intervention may be executed with maximum braking force and for a brief period only as necessary.

If the vehicle is equipped with Active Cruise Control with Stop & Go, the front-end collision

warning is controlled via the cruise control radar sensor in conjunction with a camera.

The front-end collision warning is available even if cruise control has been deactivated.

With the vehicle approaching another vehicle intentionally the collision warning is delayed avoiding false alarm.

## General information

The system issues a two-phase warning of a possible danger of collision with vehicles at speeds above approx. 3 mph/5 km/h. Time of warnings may vary with the current driving situation.

## Detection range

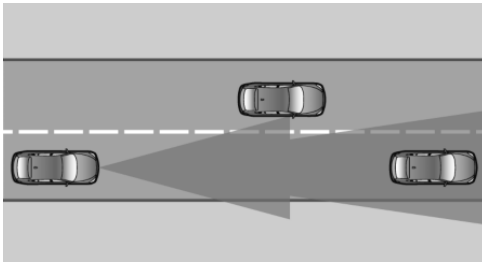

It responds to objects if they are detected by the system.

## Hints

### Personal responsibility

The system does not serve as a substitute for the driver's personal judgment of the traffic situation.

Be aware of the traffic situation and the vehicle's surroundings at all times, otherwise accidents are still possible despite all warnings. ◀

### Adapting your speed and driving style

The displays and warnings of the system do not relieve the driver of the responsibility to adapt his or her driving speed and style to the traffic conditions. ◀

### Be alert

Due to system limitations, warnings may be not issued at all, or may be issued late or improperly. Therefore, always be alert and ready to intervene; otherwise, there is the risk of an accident. ◀

### Tow-starting and towing

For tow-starting or towing, switch off the Intelligent Safety systems; otherwise malfunctions of the individual braking systems might lead to accidents. ◀

## At a glance

### Button in the vehicle



### Intelligent Safety button

## Radar sensor

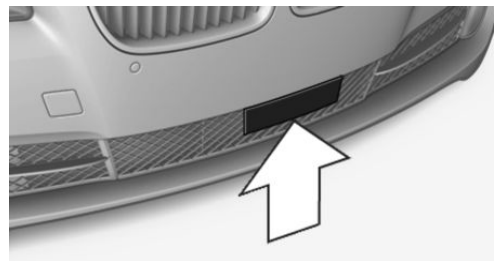

The radar sensor is located in the lower area of the front bumper.

Always keep radar sensor clean and unobstructed.

## Camera

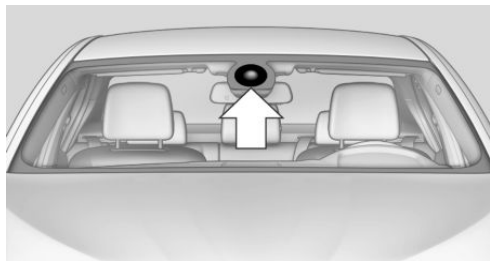

The camera is found near the interior rearview mirror.

Keep the windshield in the area behind the interior rearview mirror clean and clear.

## Switching on/off

### Switching on automatically

The system is automatically active after every driving-off.

### Switch off



Press button: the system is switched off. The LED goes out.

Re-press button: the system is switched on. The LED lights up.

## Setting the warning time

The warning time can be set via iDrive.

1. "Settings"
2. "Frontal Coll. Warning"
3. Activate the desired time on the Control Display.

The selected time is stored for the profile currently in use.

## Warning with braking function

### Display

If a collision with a recognized vehicle is imminent a warning symbol appears in the instrument cluster and in the Head-Up Display.

Symbol	Measure
	The vehicle lights up red: prewarning. Brake and increase distance.
	The vehicle flashes red and an acoustic signal sounds: acute warning. You are requested to intervene by braking or make an evasive maneuver.



### Prewarning

This warning is issued, e.g., when there is the impending danger of a collision or the distance to the vehicle ahead is too small.

The driver must intervene actively when there is a prewarning.

### Acute warning with braking function

Warning of the imminent danger of a collision when the vehicle approaches another object at a relatively high differential speed.

The driver must intervene actively when there is an acute warning. If necessary, the driver is assisted by an automatic braking intervention in a possible risk of collision.

Acute warnings can also be triggered without previous prewarning.

### Braking intervention

The warning prompts the driver himself/herself to react. During a warning, the maximum braking force is used. Premise for the brake booster is sufficiently quick and hard stepping on the brake pedal. The system can assist with automatic braking intervention if there is risk of

a collision. The intervention can bring the vehicle to a complete stop.

Manual transmission: During a braking intervention up to a complete stop, the engine may be shut down.

The braking intervention is executed only if DSC Dynamic Stability Control is switched on and Dynamic Traction Control DTC is activated.

Above approx. 130 mph/210 km/h the braking intervention occurs as a brief braking pressure. No automatic delay occurs.

The braking intervention can be interrupted by stepping on the accelerator pedal or by actively moving the steering wheel.

Object detection can be restricted. Limitations of the detection range and functional restrictions are to be considered.

## System limits

### Detection range

The system's detection potential is limited.

Thus a warning might not be issued or be issued late.

E. g. the following situations may not be detected:

- ▶ Slow moving vehicles when you approach them at high speed.
- ▶ Vehicles that suddenly swerve in front of you, or sharply decelerating vehicles.
- ▶ Vehicles with an unusual rear appearance.
- ▶ Two-wheeled vehicles ahead of you.

### Functional limitations

The system may not be fully functional in the following situations:

- ▶ In heavy fog, rain, sprayed water or snowfall.
- ▶ In tight curves.
- ▶ If the driving stability control systems are limited or deactivated, e.g., DSC OFF.

- ▶ If, depending on the vehicle equipment version, the field of view of the camera in the mirror or the radar sensor is dirty or obscured.
- ▶ Up to 10 seconds after the start of the engine, via the Start/Stop knob.
- ▶ During calibration of the camera immediately after vehicle shipment.
- ▶ If there is constant blinding effects because of oncoming light, e. g., from the sun low in the sky.

## Warning sensitivity

The more sensitive the warning settings are, e.g. the warning time, the more warnings are displayed. However, there may also be an excess of false warnings.

## Pedestrian warning

Depending on how the vehicle is equipped, the function warns of an imminent collision with pedestrians during daytime or nighttime.

The function is subdivided into the following systems:

- ▶ During daytime: Pedestrian warning with city braking function, refer to page [123](#)
- ▶ At night: Night vision, refer to page [126](#)

## Pedestrian warning with city braking function

### The concept

The system can help prevent accidents with pedestrians.

The system issues a warning in the city driving speed area if there is imminent danger of a collision with pedestrians and includes a braking function.

The camera in the area of the rearview mirror controls the system.

## General information

In daylight the system warns of possible collisions with pedestrians at speeds from about 6 mph/10 km/h to about 35 mph/60 km/h shortly before a collision the system supports you with a braking intervention.

Under those circumstances it reacts to people who are within the detection range of the system.

## Detection range

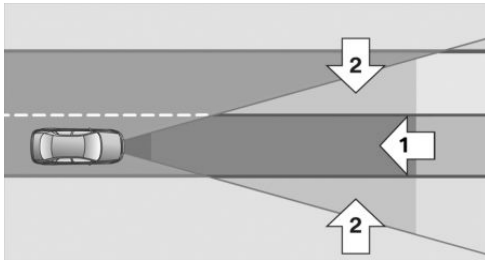

The detection area in front of the vehicle is divided into two areas.

- ▶ Central area, arrow 1, directly in front of the vehicle.
- ▶ Expanded area, arrow 2, to the right and left.

A collision is imminent if pedestrians are located within the central area. A warning is issued about pedestrians who are located within the extended area only if they are moving in the direction of the central area.

## Hints

### Personal responsibility

The system does not serve as a substitute for the driver's personal judgment of the traffic situation.

Be aware of the traffic situation and the vehicle's surroundings at all times, otherwise accidents are still possible despite all warnings. ◀



Adapting your speed and driving style

The displays and warnings of the system do not relieve the driver of the responsibility to adapt his or her driving speed and style to the traffic conditions. ◀



Be alert

Due to system limitations, warnings may be not issued at all, or may be issued late or improperly. Therefore, always be alert and ready to intervene; otherwise, there is the risk of an accident. ◀



Tow-starting and towing

For tow-starting or towing, switch off the Intelligent Safety systems; otherwise malfunctions of the individual braking systems might lead to accidents. ◀

## At a glance

### Button in the vehicle



Intelligent Safety button



## Camera

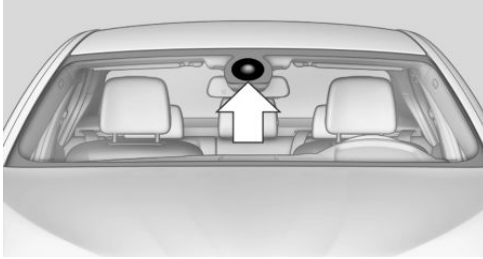

The camera is found near the interior rearview mirror.

Keep the windshield in the area behind the interior rearview mirror clean and clear.

## Switching on/off

### Switching on automatically

The system is automatically active after every driving-off.

### Switch off



Press button: the systems are turned off. The LED goes out.

Press button: the systems are turned on. The LED lights up.

## Warning with braking function

### Display

If a collision with a person detected in this way is imminent, a warning symbol appears on the instrument cluster and in the Head-up Display.



The red symbol is displayed and a signal sounds.



With instrument display: The red symbol is displayed and a signal sounds.

Intervene immediately by braking or make an evasive maneuver.

## Braking intervention

The warning prompts the driver himself/herself to react. During a warning, the maximum braking force is used. Premise for the brake booster is sufficiently quick and hard stepping on the brake pedal. The system can assist with some braking intervention if there is risk of a collision. At low speeds vehicles may thus come to a complete stop.

Manual transmission: During a braking intervention up to a complete stop, the engine may be shut down.

The braking intervention is executed only if DSC Dynamic Stability Control is switched on and Dynamic Traction Control DTC is activated.

The braking intervention can be interrupted by stepping on the accelerator pedal or by actively moving the steering wheel.

Object detection can be restricted. Limitations of the detection range and functional restrictions are to be considered.

## System limits

### Detection range

The detection potential of the camera is limited.

Thus a warning might not be issued or be issued late.

E. g. the following situations may not be detected:

- ▶ Partially covered pedestrians.
- ▶ Pedestrians that are not detected as such because of the viewing angle or contour.
- ▶ Pedestrians outside of the detection range.
- ▶ Pedestrians having a body size less than 32 in/80 cm.

### Functional limitations

The system may not be fully functional or may not be available in the following situations:

- ▷ In heavy fog, rain, sprayed water or snow-fall.
- ▷ In tight curves.
- ▷ If the driving stability control systems are deactivated, e.g. DSC OFF.
- ▷ If the camera viewing field or the front windshield are dirty or covered.
- ▷ Up to 10 seconds after the start of the engine, via the Start/Stop knob.
- ▷ During calibration of the camera immediately after vehicle shipment.
- ▷ If there is constant blinding effects because of oncoming light, e. g., from the sun low in the sky.
- ▷ When it is dark outside.

## Night Vision with Pedestrian and Animal Detection

### The concept

Night Vision with pedestrian and animal detection is a night vision system.

An infrared camera scans the area in front of the vehicle and issues a warning if it detects pedestrians and animals on the street. Warm objects that are similar in shape to human beings or animals are detected by the system. If necessary, the heat image can be displayed on the Control Display.

### Heat image



The image shows the heat radiated by objects in the field of view of the camera.

Warm objects have a light appearance and cold objects, a dark appearance.

The ability to detect an object depends on the temperature difference between the object and the background and on the level of heat radiation emitted by the object. Objects that are similar in temperature to the environment or that radiate very little heat are difficult to detect.

For safety reasons, when driving at speeds above approx. 3 mph/5 km/h and in low ambient light, the image is only displayed when the low beams are activated.

A still image is displayed at regular intervals for a fraction of a second.

### Pedestrian and animal detection



Object detection and warning only functions in darkness.

Warm objects that are similar in shape to human beings are detected by the system.

In addition, the system also detects animals above a certain minimum size, e.g., deer.

With heat image activated on the Control Display:

People detected by the system are displayed with a slight yellow hue.

Animals detected by the system are displayed in a darker yellow.

Under good ambient conditions, the object detection operates within the following distance ranges:

- ▷ Pedestrian detection: up to approx. 330 ft/100 m
- ▷ Detection of large animals: up to approx. 490 ft/150 m
- ▷ Detection of medium animals: up to approx. 230 ft/70 m

Environmental influences can limit the availability of object detection.

If the vehicle systems detect that the vehicle is located in a residential area, the animal detection is temporarily switched off.

## Hints



Personal responsibility

Night Vision cannot replace the driver's personal judgment of the visibility conditions and the traffic situation. The view ahead and the actual visibility conditions must always be the basis on which the vehicle speed is adjusted; otherwise, there is a risk to road safety. ◀

## Overview

### Buttons in the vehicle



Intelligent Safety button



Switch on/switch off heat image

## Camera

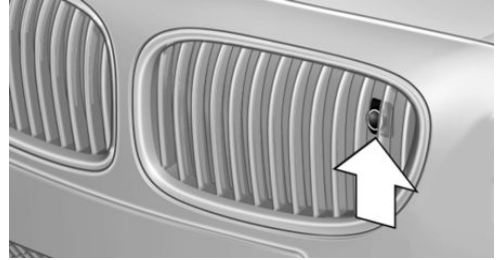

The camera is automatically heated when the external temperatures are low.

The camera lens is automatically cleaned together with the headlights.

## Switching on/off

### Switching on automatically

When it is dark outside, the system is automatically active after every driving-off.

### Switch off

The system is only switched off until the next time the engine is started with the Start/Stop button.



Press button.

The LED goes out.

### Switching on heat image additionally

The heat image from the Night Vision camera can also be displayed on the Control Display. This function has no effect on object detection.





Press button.

The image from the camera is displayed on the Control Display.

## Adjustments via the iDrive

With heat image switched on:

1. Press the controller.
2. Select brightness or contrast.
  - ▶  Select the symbol.
  - ▶  Select the symbol.
3. Turn the controller until the desired setting is selected.
4. Press the controller.

## Display

### Warning of people or animals in danger

If a collision with a person or an animal detected in this way is imminent, a warning symbol appears on the instrument cluster and in the Head-up Display.

Although both the shape and the heat radiation are analyzed, false warnings cannot be ruled out.

### Warning area in front of the vehicle

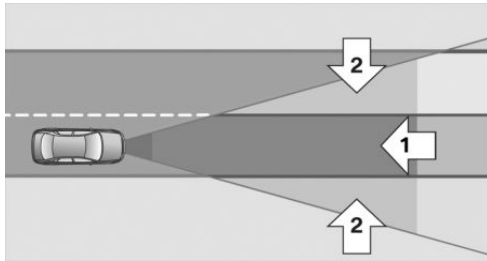

The warning area for the pedestrian warning consists of two parts:

- ▶ Central area, arrow 1, directly in front of the vehicle.
- ▶ Expanded area, arrow 2, to the right and left.

With animal warnings, no distinction is made between the central or expanded area.

The entire area moves along with the vehicle in the direction of the steering angle and changes

with the vehicle speed. As the vehicle speed increases, the area becomes longer and wider, e.g.

### Prewarning



The yellow symbol is displayed when a person is detected in the central area immediately in front of the vehicle.

The yellow symbol is displayed when a person in the extended area is moving from the right or left towards the central area.

The displayed symbol can vary with the people detected.

Intervene actively by braking or make an evasive maneuver.



When animals are detected, an animal symbol is displayed. The symbol also shows the side of the road on which

the animal was detected. Intervene actively by braking or make an evasive maneuver.

### Acute warning



The red symbol is displayed and a signal sounds.



With instrument display: The red symbol is displayed and a signal sounds.

When animals are detected, a red animal symbol is displayed with the signal tone.



Red symbol in the instrument cluster.



Red symbol in the instrument display.

Intervene immediately by braking or make an evasive maneuver.

## Display in the Head-up Display



The warning is displayed simultaneously in the Head-up Display and on the instrument cluster. The displayed symbol can vary with the people detected.

When animals are detected, an animal symbol is displayed.

## System limits

### Basic limits

System operation is limited in situations such as the following:

- ▶ On steep hills, in steep depressions or in tight curves.
- ▶ When the camera is dirty or the protective glass is damaged.
- ▶ In heavy fog, rain or snowfall.
- ▶ At very high external temperatures.

### Limits of pedestrian and animal detection

In some situations, it may occur that pedestrians are detected as animals or animals as pedestrians.

Small animals are not detected by the object detection function, even if they are clearly visible in the image.

Limited detection:

- ▶ People or animals who are fully or partially covered, especially when their heads are covered.
- ▶ People who are not in an upright position, e.g., lying down.
- ▶ Cyclists on unconventional bicycles (e.g., recumbent bicycles).
- ▶ After physical damage to the system, e.g., after an accident.

### No display on the rear screen

The image from Night Vision cannot be displayed on the rear screen.

## Lane departure warning

### The concept

Starting at a specific speed, this system alerts you when the vehicle on streets with lane markings is about to leave the lane. This speed, depending on the country version, is between 35 mph/55 km/h and 45 mph/70 km/h.

When switching on the system below this speed, a message is displayed in the instrument cluster.

The steering wheel begins vibrating gently in the event of warnings. The time of the warning may vary depending on the current driving situation.

The system does not provide a warning if the turn signal is set before leaving the lane.

### Hints



#### Personal responsibility

The system cannot serve as a substitute for the driver's personal judgment of the course of the road and the traffic situation.

In the event of a warning, do not jerk the steering wheel, as you may lose control of the vehicle. ◀

### At a glance

### Button in the vehicle



Lane departure warning

## Camera

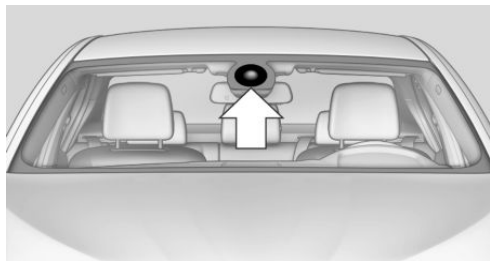

The camera is found near the interior rearview mirror.

Keep the windshield in the area behind the interior rearview mirror clean and clear.

### Switching on/off



Press button.

- ▷ On: the LED lights up.
- ▷ Off: the LED goes out.

Settings are stored for the profile currently in use.

### Display in the instrument cluster



- ▷ Lines: system is activated.
- ▷ Arrows: at least one lane marking was detected and warnings can be issued.

### Display in the instrument display



- ▷ Symbol orange: system is activated.
- ▷ Symbol green: at least one lane marking was detected and warnings can be issued.

### Issued warning

If you leave the lane and if a lane marking has been detected, the steering wheel begins vibrating.

If the turn signal is set before changing the lane, a warning is not issued.

### End of warning

The warning ends:

- ▷ Automatically after approx. 3 seconds.
- ▷ When returning to your own lane.
- ▷ When braking hard.
- ▷ When using the turn signal.

### System limits

The system may not be fully functional in the following situations:

- ▷ In heavy fog, rain or snowfall.
- ▷ In the event of missing, worn, poorly visible, merging, diverging, or multiple lane markings such as in construction areas.
- ▷ When lane markings are covered in snow, ice, dirt or water.
- ▷ In tight curves or on narrow lanes.
- ▷ When the lane markings are covered by objects.
- ▷ When driving very close to the vehicle in front of you.
- ▷ When driving toward bright lights.
- ▷ When the windshield in front of the interior rearview mirror is fogged over, dirty or covered with stickers, etc.
- ▷ During calibration of the camera immediately after vehicle shipment.

## Active Blind Spot Detection

### The concept

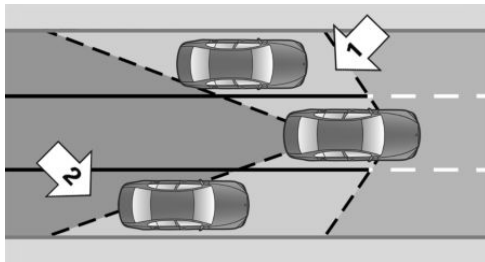

Two radar sensors below the rear bumper monitor the area behind and next to the vehicle at speeds above approx. 30 mph/50 km/h.

The system indicates whether there are vehicles in the blind spot, arrow 1, or approaching from behind on the adjacent lane, arrow 2.

The lamp in the exterior mirror housing is dimmed.

Before you change lanes after setting the turn signal, the system issues a warning in the situations described above.

The lamp in the exterior mirror housing flashes and the steering wheel vibrates.

### Hints

 Personal responsibility

The system does not serve as a substitute for the driver's personal judgment of the traffic situation.

Be aware of the traffic situation and the vehicle's surroundings at all times, otherwise accidents are still possible despite all warnings. ◀

### At a glance

#### Button in the vehicle



 Active Blind Spot Detection

#### Radar sensors



The radar sensors are located under the rear bumper.

#### Switching on/off

 Press button.

- ▷ On: the LED lights up.
- ▷ Off: the LED goes out.

Settings are stored for the profile currently in use.

## Display

### Lamp in the exterior mirror housing

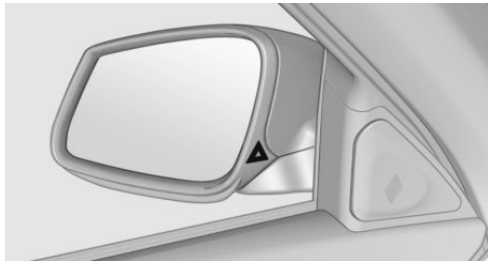

### Information stage

The dimmed lamp in the exterior mirror housing indicates when there are vehicles in the blind spot or approaching from behind.

### Warning

If the turn signal is set while a vehicle is in the critical zone, the steering wheel vibrates briefly and the lamp in the exterior mirror housing flashes brightly.

The warning stops when the turn signal is switched off, or the other vehicle leaves the critical zone.

### System limits

The system may not be fully functional in the following situations:

- ▷ When a vehicle is approaching at a speed much faster than your own.
- ▷ In heavy fog, rain or snowfall.
- ▷ In tight curves or on narrow lanes.
- ▷ If the bumper is dirty or iced up, or covered with stickers.

A Check Control message is displayed when the system is not fully functional.

### For US owners only

The transmitter and receiver units comply with part 15 of the FCC/Federal Communication

Commission regulations. Operation is governed by the following:

FCC ID:

- ▷ NBG009014A.

Compliance statement:

This device complies with part 15 of the FCC Rules. Operation is subject to the following two conditions:

- ▷ This device may not cause harmful interference, and
- ▷ this device must accept any interference received, including interference that may cause undesired operation.

Any unauthorized modifications or changes to these devices could void the user's authority to operate this equipment.

## Brake force display

### The concept



- ▷ During normal brake application, the outer brake lights light up.
- ▷ During heavy brake application, the inner brake lights light up in addition.

## Active Protection

### General information

The Active Protection safety package consists of systems that are independent of each other:

- ▷ Attentiveness assistant.



- ▷ PreCrash
- ▷ PostCrash

## Attentiveness assistant

### The concept

The system can detect increasing lack of alertness or fatigue of the driver during long, monotonous journeys, e.g., on highways. In this situation, it is recommended that the driver takes a break.

### Note



Personal responsibility

The system cannot act as a substitute for the personal assessment of one's physical state and may not detect an increasing lack of alertness or fatigue or may not detect it correctly. Therefore, make sure that the driver is rested and alert; otherwise, risks may be detected too late and an accident be caused as a result. ◀

### Function

The system is activated each time the engine is started and cannot be switched off.

After travel has begun, the system is trained about the driver, so that increasing lack of alertness or fatigue can be detected.

This procedure takes the following criteria into account:

- ▷ Personal driving style, e.g., steering behavior.
- ▷ Driving conditions, e.g., length of trip.

Starting at approximately 43 mph/70 km/h, the system is active and can display a recommendation to take a break.

### Break recommendation

If the driver becomes increasingly less alert or fatigued, a message is displayed in the Control Display with the recommendation to take a break.

A recommendation to take a break is displayed only once during an uninterrupted trip.

After a break, another recommendation to take a break cannot be displayed until after approximately 45 minutes.

### System limits

The function may be limited in the following situations, for instance, and will either output an incorrect warning or no warning at all:

- ▷ When the clock is set incorrectly.
- ▷ When the vehicle speed is mainly below about 43 mph/70 km/h.
- ▷ With a sporty driving style, such as during rapid acceleration or when cornering fast.
- ▷ In active driving situations, such as when changing lanes frequently.
- ▷ When the road surface is poor.
- ▷ In the event of strong side winds.

## PreCrash

### The concept

With this system critical driving situations that might result in an accident can be detected above a speed of approx. 20 mph/30 km/h. In these situations, preventive measures are automatically taken to minimize the risk of an accident as much as possible.

Critical driving situations may include:

- ▷ Emergency stop.
- ▷ Severe understeering.
- ▷ Severe oversteering.

If the vehicle includes the front-end collision warning or front-end collision warning with braking feature, impending collisions with vehicles driving ahead or stopped in front of you can also be detected within the system's range.

## Note



### Personal responsibility

The system cannot possibly serve as a substitute for the driver's personal judgment of the traffic situation. The system may not always detect critical situations reliably and in a timely manner. Adapt speed to traffic situation and drive alertly; otherwise, a risk to safety may result. ◀

## Function

After the safety belt is buckled, the front belts are automatically pretensioned once after the vehicle is driven is away.

In critical driving situations, the following individual functions become active as needed:

- ▷ The front belts are automatically pretensioned.
- ▷ Automatic closing of the windows.
- ▷ Automatic closing of the glass sunroof.
- ▷ For vehicles equipped with Comfort Seats: automatic positioning of the backrest for the front passenger seat.

After a critical driving situation without an accident, the front belts are loosened again. All other systems can be restored to the desired setting.

If the belt tension does not loosen automatically, stop the vehicle and unbuckle the belt using the red button in the buckle. Fasten the belt before continuing on your trip.

## PostCrash

In the event of an accident, the system can bring the car to a halt automatically without intervention by the driver in certain situations. This can reduce the risk of a further collision and the consequences thereof.

Depressing the brake pedal can cause the vehicle to brake harder. This interrupts automatic braking. Destepping on the gas pedal also interrupts automatic braking.

After coming to a halt, the brake is released automatically. Secure the vehicle against rolling.

# Driving stability control systems

## Vehicle features and options

This chapter describes all standard, country-specific and optional features offered with the series. It also describes features that are not necessarily available in your car, e. g., due to the selected options or country versions. This also applies to safety-related functions and systems. The respectively applicable country provisions must be observed when using the respective features and systems.

## Antilock Brake System ABS

ABS prevents locking of the wheels during braking.

The vehicle contains its steering power even during full brake applications, thus increasing active safety.

ABS is operational every time you start the engine.

## Brake assistant

When you apply the brakes rapidly, this system automatically produces the greatest possible braking force boost. It reduces the braking distance to a minimum during emergency stop. This system utilizes all of the benefits provided by ABS.

Do not reduce the pressure on the brake pedal for the duration of the emergency stop.

## Adaptive brake assistant

In combination with the Active Cruise Control, this system ensures that the brakes respond even more rapidly when braking in critical situations.

## Drive-off assistant

This system supports driving off on inclines. The parking brake is not required.

1. Hold the vehicle in place with the foot brake.
2. Release the foot brake and drive off without delay.

After the foot brake is released, the vehicle is held in place for approx. 2 seconds.

Depending on the vehicle load or when a trailer is used, the vehicle may roll back slightly.



Driving off without delay

After releasing the foot brake, start driving without delay, since the drive-off assistant will not hold the vehicle in place for more than approx. 2 seconds and the vehicle will begin to roll back. ◀

## DSC Dynamic Stability Control

### The concept

DSC prevents traction loss in the power wheels when driving off and accelerating.

DSC also recognizes unstable vehicle conditions such as fishtailing or nose-diving. Within the physical limits DSC helps to keep the vehicle on a steady course by reducing engine speed and by applying brakes to the individual wheels.

### Note



Adjust your driving style to the situation

An appropriate driving style is always the responsibility of the driver.

The laws of physics cannot be repealed, not even with DSC.

Therefore, do not reduce the additional safety margin by driving in a risky manner. ◀

 Do not deactivate DSC when driving with roof load

Do not deactivate Dynamic Stability Control DSC when driving with roof load, e.g. roof-mounted luggage rack.

Otherwise, driving safety is not given in driving-critical situation due to the elevated center of gravity. ◀

## Overview

### Button in the vehicle



 DSC OFF button

### Indicator/warning lights

 The indicator lamp flashes: DSC controls the drive and braking forces.

The indicator lamp lights up: DSC has failed.

### Deactivating DSC: DSC OFF

When DSC is deactivated, driving stability is reduced during acceleration and when driving in curves.

Stabilizing interventions by the Integral Active Steering system are only performed by the rear axle steering.

To increase vehicle stability, activate DSC again as soon as possible.

### Deactivating DSC

 Press and hold this button but not longer than approx. 10 seconds, until the indicator lamp for DSC OFF lights up in the instrument cluster and displays DSC OFF.

The DSC system is switched off.

The steering and, depending on the equipment, suspension are tuned for sporty driving.

### Activating DSC

 Press button.  
DSC OFF and the DSC OFF indicator lamp go out.

### Indicator/warning lights

When DSC is deactivated, DSC OFF is displayed in the instrument cluster.

 The indicator lamp lights up: DSC is deactivated.

## DTC Dynamic Traction Control

### The concept

The DTC system is a version of the DSC where forward momentum is optimized.

The system ensures maximum headway on special road conditions or loose road surfaces, e.g., unplowed snowy roads, but with somewhat limited driving stability.

Activating the Dynamic Traction Control DTC provides maximum traction. Driving stability is limited during acceleration and when driving in curves.

Therefore drive with appropriate caution.

You may find it useful to briefly activate DTC under the following special circumstances:

- ▶ When driving in slush or on uncleared, snow-covered roads.

- ▶ When freeing vehicle from deep snow or driving off from loose grounds.
- ▶ When driving with snow chains.

## Deactivating/activating DTC Dynamic Traction Control

### Activating DTC



Press button.

TRACTION is displayed in the instrument cluster and the indicator lamp for DSC OFF lights up.

### Deactivating DTC



Press button again.

TRACTION and the DSC OFF indicator lamp go out.

### Indicator/warning lights

If DTC is activated, TRACTION is displayed in the instrument cluster.



The indicator lamp lights up: DTC Dynamic Traction Control is activated.

## xDrive

xDrive is the all-wheel-drive system of your vehicle. Concerted action by the xDrive and DSC further optimize traction and driving dynamics. The xDrive all-wheel-drive system variably distributes the drive forces to the front and rear axles as demanded by the driving situation and road surface.

## HDC Hill Descent Control

### The concept

HDC is a downhill driving assistant that automatically controls vehicle speed on steep downhill gradients. Without applying the

brakes, the vehicle moves at slightly more than walking speed.

Hill Descent Control can be activated at speeds below approx. 22 mph/35 km/h. When driving downhill, the vehicle reduces its speed to approx. walking speed and then keeps its speed constant.

As long as there is active braking, the system is on standby. The system does not brake the vehicle during this time.

Only use HDC in low gears or in selector lever position D or R.

### Increasing or decreasing vehicle speed

Specify desired speed in the range from approx. 4 mph/6 km/h to approx. 15 mph/25 km/h using the rocker switch of the cruise control on the steering wheel. Vehicle speed can be changed by lightly accelerating.

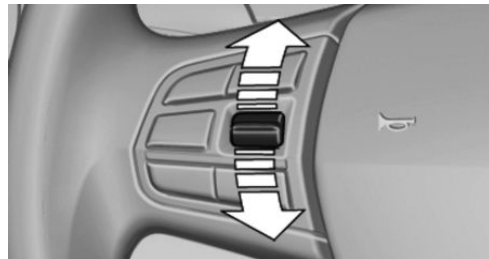

- ▶ Press the rocker switch up to the point of resistance: the speed increases gradually.
- ▶ Press up the rocker switch past the point of resistance: the speed increases while the rocker switch is pressed.
- ▶ Press the rocker switch down to the point of resistance: the speed decreases gradually.
- ▶ Press the rocker switch down past the point of resistance: when driving forward, the speed decreases to approx. 6 mph/10 km/h; when reversing, the speed decreases to approx. 4 mph/6 km/h.

## Activating HDC



 Press button; the LED above the button lights up.

## Deactivating HDC

 Press button again and the LED goes out. HDC is automatically deactivated above approx. 37 mph/60 km/h.

## Display in the instrument cluster



The selected speed is displayed in the speedometer.

- ▷ Green: the system is actively braking the vehicle.
- ▷ Orange: the system is on standby.

## Malfunction

A message is displayed in the instrument cluster. HDC is not available, e.g., due to elevated brake temperatures.

## Adaptive Drive

### The concept

Adaptive Drive includes the following systems:

- ▷ Dynamic Drive, refer to page 138.
- ▷ Dynamic Damping Control, refer to page 138.

The system increases driving stability and driving comfort.

## Dynamic Drive

### The concept

The system reduces the lateral inclination of the vehicle that occurs during rapid driving in curves or during quick evasive maneuvers.

Driving stability and driving comfort are increased under all driving conditions. The system utilizes active stabilizer bars on the front and rear axles that react immediately to all driving situations.

### Programs

The system offers two different programs.

Select the programs via the Driving Dynamics Control, refer to page 139.

### SPORT

Sporty tuning for greater driving agility.

### COMFORT

Comfort-oriented tuning for optimal comfort.

## Dynamic Damping Control

### The concept

This system reduces undesirable vehicle motion when using a dynamic driving style or traveling on uneven road surfaces.

The system enhances driving dynamics and comfort fitting road surface and driving style.

### Programs

The system offers several different programs.

Select the programs via the Driving Dynamics Control, refer to page 139.

### SPORT/SPORT+

Consistently sporty control of the shock absorbers for greater driving agility.

## COMFORT/ECO PRO

Balanced tuning.

## COMFORT+

Comfort-oriented tuning of the shock absorbers for optimal traveling comfort.

## Integral Active Steering

### The concept

Integral Active Steering is a combination of Active Steering and rear axle steering.

Active Steering varies the steering angle of the wheels in relation to the steering wheel movement as a function of the speed.

At speeds up to approx. 37 mph/60 km/h, e.g., in curves, the steering angle is increased, i.e., steering becomes more direct.

The rear axle steering acts to increase maneuverability by turning the rear wheels slightly in a direction opposite to the front wheels.

At higher speeds, the steering angle is increasingly reduced.

The rear wheels are turned to the same angle as the front wheels.

In critical situations, Integral Active Steering can specifically steer the front and rear wheels to stabilize the vehicle before the driver intervenes, e.g., when braking where road conditions differ on the left and right sides of the vehicle.

### Initializing

In rare cases, it may become necessary to initialize the Integral Active Steering.



The warning lamp lights up. A Check Control message is displayed.

1. With the engine running, turn the steering wheel all the way to the left and right several times in a uniform manner until the warning lamp disappears.

2. Have the system checked if the warning lamp does not go out after moving the steering wheel approx. 6 times or if the steering wheel is at an angle.

## Using snow chains

### Note

When snow chains are in use, refer to page 228, rear wheel steering is deactivated.

## Programs

The system offers several different programs. Select the programs via the Driving Dynamics Control, refer to page 139.

### SPORT

Consistently sporty tuning of the Integral Active Steering for greater driving agility.

### Malfunction

In the event of a malfunction, the steering wheel must be turned further, while the vehicle responds more sensitively to steering wheel movements in the higher speed range.

The stability-enhancing intervention may be deactivated.

Proceed cautiously and drive defensively.

Have the system checked.

## Driving Dynamics Control

### The concept

The Driving Dynamics Control can be used to adjust the driving dynamics of the vehicle. For this purpose various programs are available for selection that are activated via the two buttons of the Driving Dynamics Control and the DSC OFF-button.

## Overview

### Button in the vehicle



### Operating the programs

Press button

Program



DSC OFF  
TRACTION



SPORT+  
SPORT  
COMFORT  
COMFORT+  
ECO PRO

### Automatic program change

The system may automatically switch to COMFORT in the following situations:

- ▷ Failure of Integral Active Steering.
- ▷ Failure of Dynamic Damping Control.
- ▷ Failure of DSC Dynamic Stability Control.
- ▷ The vehicle has a flat tire.
- ▷ When activating cruise control in TRACTION or DSC OFF mode.

### DSC OFF

When DSC OFF, refer to page 136, is active, driving stability is limited during acceleration and when driving in curves.

## TRACTION

When TRACTION is active, the vehicle has maximum traction on loose road surfaces. DTC Dynamic Traction Control, refer to page 137, is activated. Driving stability is limited during acceleration and when driving in curves.

## SPORT+

Sporty driving with optimized suspension and adapted engine control with limited driving stabilization.

Dynamic Traction Control is switched on.

The driver handles several of the stabilization tasks.

### Activating SPORT+



Press button repeatedly until SPORT+ appears in the instrument cluster and the DSC OFF indicator lamp lights up.

### Automatic program change

When switching on the adjustable speed limit or activating cruise control, the program automatically switches to SPORT mode.

### Indicator/warning lights

SPORT+ is displayed in the instrument cluster.



The DSC OFF indicator lamp lights up: Dynamic Traction Control is activated.

## SPORT

Consistently sporty tuning of the suspension and engine control for greater driving agility with maximum driving stabilization.

The program can be configured to individual specifications.

The configuration is stored for the profile currently in use.



## Activating SPORT



Press button repeatedly until SPORT is displayed in the instrument cluster.

## Configuring SPORT

When the display is activated on the Control Display, refer to page 142, the SPORT driving mode can be set.

After the SPORT driving mode is activated, select "Configure SPORT" on the displayed panel and configure the program.

SPORT can also be configured before it is activated:

1. "Settings"
2. "SPORT mode" or: "Driving mode"
3. Configure driving mode.

This configuration is retrieved when the SPORT driving mode is activated.

## COMFORT

For a balanced tuning with maximum driving stabilization.

## Activating COMFORT



Press button repeatedly until COMFORT is displayed in the instrument cluster.

In certain situations, the system automatically changes to the NORMAL program, automatic program change, refer to page 140.

## COMFORT+

Comfort-oriented tuning of the shock absorbers and adapted engine control for optimal traveling comfort with maximum driving stabilization.

## COMFORT+ activation



Press button repeatedly until COMFORT+ is displayed in the instrument cluster.

## ECO PRO

ECO PRO, refer to page 196, provides consistent tuning to minimize fuel consumption for maximum range with maximum driving stabilization.

Comfort functions and the engine controller are adjusted.

The program can be configured to individual specifications.

## Activating ECO PRO



Press button repeatedly until ECO PRO is displayed in the instrument cluster.

## Configuring ECO PRO

1. Activate ECO PRO.
2. "Configure ECO PRO"

Make the desired settings.

## Configure driving mode

Settings can be made for the following driving modes in Driving mode:

- ▷ SPORT mode, refer to page 141.
- ▷ ECO PRO mode, refer to page 197.

## Displays in the instrument cluster

### Selected program



The instrument cluster displays the selected program.

### Program selection

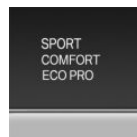

Pressing the button displays a list of the selectable programs. Depending on your vehicle's optional features, the list in the instrument cluster can differ from the illustration shown.

### Display on the Control Display

Program changes can be displayed briefly on the Control Display.

To do so, make the following settings:

1. "Settings"
2. "Driving mode"
3. "Driving mode info"

# Driving comfort

## Vehicle features and options

This chapter describes all standard, country-specific and optional features offered with the series. It also describes features that are not necessarily available in your car, e. g., due to the selected options or country versions. This also applies to safety-related functions and systems. The respectively applicable country provisions must be observed when using the respective features and systems.

## Active Cruise Control with Stop & Go function, ACC

### The concept

Use this system to select a desired speed that the vehicle will maintain automatically on clear roads.

To the extent possible, the system automatically adjusts the speed to a slower vehicle ahead of you.

The distance that the vehicle maintains to the vehicle ahead of you can be varied.

For safety reasons, it depends on the speed.

To maintain a certain distance, the system automatically reduces the speed, applies the brakes lightly, or accelerates again if the vehicle ahead begins moving faster.

If the vehicle ahead of you brakes to a halt, and then proceeds to drive again within a brief period, the system is able to detect this within the given system limits. Your own vehicle will brake automatically and then accelerate again.

If the vehicle ahead of you drives away again after a prolonged period, briefly press the accelerator pedal or press the appropriate button to reactivate the system. The vehicle will automatically accelerate.

As soon as the road is clear, the vehicle accelerates to the desired speed.

The speed is also maintained downhill, but may not be maintained uphill if engine power is insufficient.

### General information

Depending on the driving settings, the features of the cruise control can change in certain areas.

### Hints



#### Personal responsibility

Even an active system holds the driver responsible for his or her driving, particularly for staying in your lane, adjusting your speed, keeping your distance and for your driving style all in relation to traffic.

Technically the system has its limits, it cannot independently react to all traffic situations.

Monitor your driving, be on the alert, observe the vehicle surroundings and other traffic and react when needed, e.g. through braking, steering or make evasive maneuvers - risk of accident. ◀



#### Unfavorable weather conditions



In the event of unfavorable weather and light conditions, e. g. if there is rain, snowfall, slush, fog or glare, this may result in poorer recognition of vehicles as well as short-term interruptions for vehicles that are already detected. Drive attentively, and react to the current traffic situation. Intervene actively when necessary, e.g., by braking, steering or making an evasive maneuver, otherwise, there is the risk of an accident. ◀

 Before leaving the vehicle, secure it against moving on its own.

Before leaving the vehicle with the engine running: set the parking brake and ensure that the Steptronic transmission is in position P. Otherwise, the vehicle may begin to move. ◀

## At a glance

### Buttons on the steering wheel

Press button	Function
	Cruise control on/off, interrupt, refer to page 144
	Store/maintain speed, refer to page 145
	Resume speed, refer to page 146
	Reduce distance, refer to page 146
	Increase distance, refer to page 146
	rocker switch: Maintain, store, change speed, refer to page 145

Buttons are arranged according to vehicle's series, optional features and country specifications.

### Radar sensor

A radar sensor is located in the front bumper for detecting vehicles on the road ahead of the vehicle.

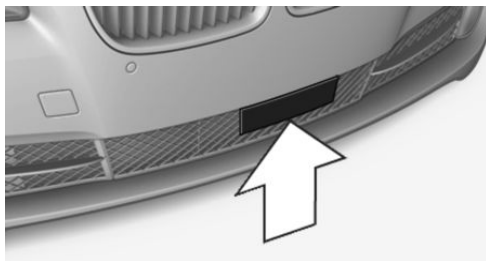

A dirty or covered sensor may prevent the detection of vehicles.

- ▶ If necessary, clean the radar sensor. Remove layers of snow and ice carefully.
- ▶ Do not cover the view field of the radar sensor.

### Camera

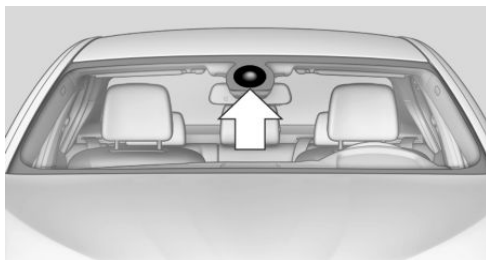

The camera is found near the interior rearview mirror.

Keep the windshield in the area behind the interior rearview mirror clean and clear.

A dirty or covered area in front of the interior mirror may hinder the detection of vehicles.

If necessary, clean the area in front of the interior mirror, e.g., carefully remove salt residue in the winter.

### Switching on/off and interrupting cruise control

#### Switching on



Press button on the steering wheel.

The indicator lights in the instrument cluster light up and the mark in the speedometer is set to the current speed.

Cruise control can be used.

## Switch off

 Deactivated or interrupted system

With deactivated or interrupted system use your brakes, steering and moves as usual to avoid the chance of an accident. ◀

To switch off the system while standing, step on brake pedal at the same time.

 Press button on the steering wheel.

- ▷ If active: press twice.
- ▷ If interrupted: press once.

The displays go out. The stored desired speed is deleted.

## Interrupting

 Press button on the steering wheel.

If interrupting the system while stationary, press on the brake pedal at the same time.

The system is automatically interrupted in the following situations:

- ▷ When the brakes are applied.
- ▷ When the clutch pedal is depressed.
- ▷ When selector lever position D is disengaged.
- ▷ When DTC Dynamic Traction Control is activated or DSC is deactivated.
- ▷ When DSC is actively controlling stability.
- ▷ When SPORT+ is activated with Driving Dynamics Control.
- ▷ If the safety belt and the driver's door are opened while the vehicle is standing still.
- ▷ If the system has not detected objects for an extended period, e.g., on a road with

very little traffic without curb or shoulder markings.

- ▷ If the detection range of the radar is disrupted, e.g., by dirt or heavy fog.

## Maintaining, storing, and changing the speed

### Hints

 Adjusting the desired speed

Modify desired speed to road conditions and be ready to brake at all times; otherwise, there is the risk of an accident. ◀

 Differences in speed

Large differences in speed relative to other vehicles cannot be compensated by the system such as in the following situations:

- ▷ When fast approaching a slowly moving vehicle.
- ▷ When another vehicle suddenly swerves into the wrong lane.
- ▷ When stationary objects are approached at high speed. ◀

## Maintaining/storing the speed

 Press button.  
Or:

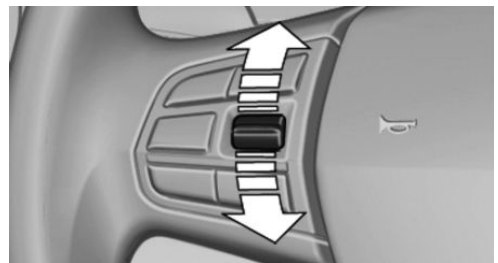

Press the rocker switch while the system is interrupted.

When the system is switched on, the current speed is maintained and stored as the desired speed.

This is displayed in the speedometer and briefly in the instrument cluster. Displays in the instrument cluster, refer to page 147.

When cruise control is maintained or stored, DSC Dynamic Stability Control will be turned on if needed.

### Changing the speed

Press the rocker switch up or down repeatedly until the desired speed is set.

If active, the displayed speed is stored and the vehicle reaches the stored speed when the road is clear.

- ▷ Each time the rocker switch is pressed to the point of resistance, the desired speed increases or decreases by approx. 1 mph/1 km/h.
- ▷ Each time the rocker switch is pressed past the point of resistance, the desired speed increases or decreases by a maximum of 5 mph/10 km/h.

Hold the rocker switch in position to repeat the action.

### Distance



Select a distance

Adjust the distance according to the traffic and weather conditions; otherwise, there is the risk of an accident. Maintain the prescribed safety distance. ◀

### Reduce distance



Press button repeatedly until the desired distance is set.

Instrument cluster will display selected distance, refer to page 147.

### Increase distance



Press button repeatedly until the desired distance is set.

Instrument cluster will display selected distance, refer to page 147.

### Calling up the desired speed and distance

#### While driving



Press button with the system switched on.

In the following cases, the stored speed value is deleted and cannot be called up again:

- ▷ When the system is switched off.
- ▷ When the ignition is switched off.

#### While standing

The system brought the vehicle to a complete standstill:

- ▷ Green marking in the speedometer:  
Your vehicle accelerates automatically as soon as the vehicle in the range of the radar sensor moves off.
- ▷ Speedometer markings turn orange: no automatic driving off.

To accelerate to the desired speed automatically, press the accelerator or press the RES or SET button.

Rolling bars in the distance display indicate that the the vehicle detected by the radar sensor has driven off.

Your vehicle was brought down to a halt through stepping on the brake pedal and it is standing behind another vehicle:

1.  Press button to call up a stored desired speed.
2. Release the brake pedal.
3. Step on the accelerator briefly, or press the RES rocker switch when the vehicle ahead of you drives away.

## Displays in the instrument cluster

### Desired speed



- ▶ The marking lights up green: the system is active.
- ▶ The marking lights up orange: the system has been interrupted.
- ▶ The marking does not light up: the system is switched off.



With instrument display: the symbol is displayed in the speedometer similarly to the mark for the desired speed.

### Brief status display



Selected desired speed.

If --- appears briefly on the display for Check Control messages, it is possible that the system requirements are currently not ready for operations.

### Distance to vehicle ahead of you

Shown is selected distance to the vehicle driving ahead of you.

#### Distance display



Distance 1



Distance 2



Distance 3



Distance 4

This value is set after the system is switched on.

#### Distance display



The system has been interrupted or distance control is temporarily suppressed because the accelerator pedal is being pressed; a vehicle was not detected.



Distance control is temporarily suppressed because the accelerator pedal is being pressed; a vehicle was detected.

Rolling bars: the detected vehicle has driven away.

ACC is no longer accelerating. To accelerate further, activate ACC by briefly stepping on the accelerator pedal, pressing the RES button or rocker switch.

### Indicator/warning lights



Personal responsibility

The indicator and warning lights do not relieve the driver of the responsibility to adapt his or her desired driving speed and style to the traffic conditions. ◀



The vehicle symbol lights up orange: A vehicle has been detected ahead of you.



The vehicle symbol flashes orange: The conditions are not adequate for the system to work.

The system was deactivated but applies the brakes until you actively resume control by pressing on the brake pedal or accelerator pedal.



The vehicle symbol flashes red and an acoustic signal sounds:

You are requested to intervene by braking or make an evasive maneuver.

## Displays in the Head-up Display

Some system information can also be displayed in the Head-up Display.

### Distance information



The symbol is displayed when the distance from the vehicle traveling ahead is too short.

- ▷ Active Cruise Control switched off.
- ▷ Display in the Head-up Display selected, refer to page 101.
- ▷ Distance too short.
- ▷ Speed greater than approx. 40 mph/70 km/h.

### System limits

#### Speed range

The system is best used on well-constructed roads.

The minimum speed that can be set is 20 mph/30 km/h. The maximum speed that can be set depends on the vehicle.

The system can also be activated when stationary.

Comply with the legal speed limit in every situation when using the system.

#### Detection range

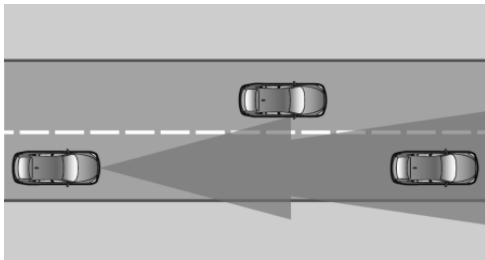

The detection capability of the system and the automatic braking capability are limited.

Two-wheeled vehicles for instance might not be detected.



Limited detection potential

Because of the limited possible detection, you should be alert at all times so that you can intervene if needed; otherwise, there is the risk of an accident. ◀

### Deceleration

The system does not decelerate for:

- ▷ Pedestrians or similar slow-moving road users.
- ▷ Red traffic lights.
- ▷ Cross traffic.
- ▷ Oncoming traffic.

### Swerving vehicles

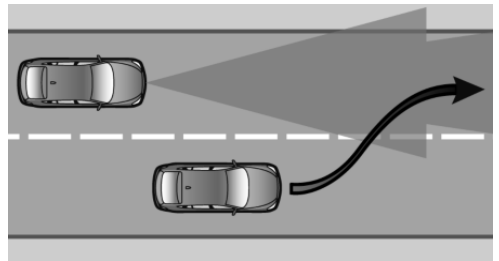

A vehicle driving in front of you is not detected until it is completely within the same lane as your vehicle.



Swerving vehicles

If a vehicle driving ahead of you suddenly swerves into your lane, the system may not be able to automatically restore the selected distance. This also applies to major speed differences to vehicles driving ahead of you, e.g., when rapidly approaching a truck. When a vehicle driving ahead of you is reliably detected, the system requests that the driver intervene by braking and carrying out evasive maneuvers, if needed. You must react yourself; otherwise, there is the risk of an accident. ◀



## Cornering

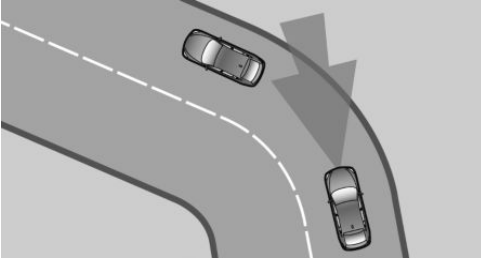

If the desired speed is too high for a curve, the speed is reduced slightly, although curves cannot be anticipated in advance. Therefore, drive into a curve at an appropriate speed.

In tight curves the system offers only restricted detection where a vehicle ahead of you might be detected late or not at all.

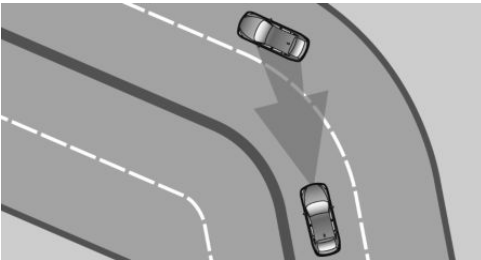

When you approach a curve the system may briefly report vehicles in the next lane due to the bend of the curve. If the system decelerates you may compensate it by briefly accelerating.

After releasing the gas pedal the system is re-activated and controls speed independently.

## Driving away

In some situations, the vehicle cannot drive off automatically; for example:

- ▶ On steep inclines.
- ▶ From behind bumps in the road.

In these cases, step on the accelerator pedal.

## Radar sensor

### For US owners only

The transmitter and receiver units comply with part 15 of the FCC/Federal Communication Commission regulations. Operation is governed by the following:

FCC ID:

- ▶ OAYARS3-A

Compliance statement:

This device complies with part 15 of the FCC Rules. Operation is subject to the following two conditions:

- ▶ This device may not cause harmful interference, and
- ▶ this device must accept any interference received, including interference that may cause undesired operation.

Any unauthorized modifications or changes to these devices could void the user's authority to operate this equipment.

### Malfunction

The system cannot be activated if the radar sensor is not aligned correctly. This may be caused by damage incurred during parking, e.g.

A Check Control message is displayed if the system fails.

The function for detecting and responding when approaching stationary vehicles may be limited in the following situations:

- ▶ During calibration of the camera immediately after vehicle shipment.
- ▶ If the camera is malfunctioning or dirty. A Check Control message is displayed.

## Cruise control

### The concept

The system maintains a preset speed via the buttons on the steering wheel. The system brakes on downhill gradients if engine braking is insufficient.

### General information

Depending on the driving settings, the features of the cruise control can change in certain areas.

### Hints





 Unfavorable conditions  
Do not use the system if unfavorable conditions make it impossible to drive at a constant speed, e.g.:

- ▷ On winding roads.
- ▷ In heavy traffic.
- ▷ On slippery roads, in fog, snow or rain, or on a loose road surface.

Otherwise, you could lose control of the vehicle and cause an accident. ◀

## Controls

### Overview

Press button	Function
	Cruise control on/off, interrupt, refer to page <a href="#">150</a>
	Store/maintain speed, refer to page <a href="#">151</a>
	Resume speed, refer to page <a href="#">151</a>
	rocker switch: Maintain, store, change speed, refer to page <a href="#">151</a>

Buttons are arranged according to vehicle's series, optional features and country specifications.

### Switching on



Press button on the steering wheel.

The marking in the speedometer is set to the current speed.

The cruise control can be used.

### Switch off



Deactivated or interrupted system

With deactivated or interrupted system use your brakes, steering and moves as usual to avoid the chance of an accident. ◀



Press button on the steering wheel.

- ▷ If active: press twice.
- ▷ If interrupted: press once.

The displays go out. The stored desired speed is deleted.

### Interrupting



When active, press the button.

The system is automatically interrupted if:

- ▷ The brakes are applied.
- ▷ The clutch pedal is depressed for a few seconds or released while a gear is not engaged.
- ▷ Selector lever position D is disengaged.
- ▷ DTC Dynamic Traction Control is activated or DSC is deactivated.
- ▷ DSC is actively controlling stability.
- ▷ HDC is activated.
- ▷ When SPORT+ is activated with Driving Dynamics Control.

## Maintaining, storing, and changing the speed

### Hints

-  Adjusting the desired speed  
Modify desired speed to road conditions and be ready to brake at all times; otherwise, there is the risk of an accident. ◀

### Maintaining/storing the speed

-  Press button.  
Or:

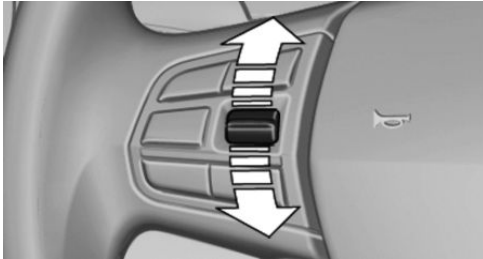

Press the rocker switch while the system is interrupted.

When the system is switched on, the current speed is maintained and stored as the desired speed.

This is displayed, refer to page 151, in the speedometer and briefly in the instrument cluster.

When cruise control is maintained or stored, DSC Dynamic Stability Control will be turned on if needed.

### Changing the speed

Press the rocker switch up or down repeatedly until the desired speed is set.

If active, the displayed speed is stored and the vehicle reaches the stored speed when the road is clear.

- ▷ Each time the rocker switch is pressed to the point of resistance, the desired speed

increases or decreases by approx. 1 mph/km/

- ▷ Each time the rocker switch is pressed past the point of resistance, the desired speed increases or decreases by a maximum of 5 mph/10 km/h.  
The maximum speed that can be set depends on the vehicle.
- ▷ Pressing the rocker switch to the resistance point and holding it accelerates or decelerates the vehicle without requiring pressure on the accelerator pedal.  
After the rocker switch is released, the vehicle maintains its final speed. Pressing the switch beyond the resistance point causes the vehicle to accelerate more rapidly.

### Resuming the desired speed

-  Press button.

The stored speed is reached and maintained.

## Displays in the instrument cluster

### Indicator lamp

-  Depending on how the vehicle is equipped, the indicator lamp in the instrument cluster indicates whether the system is switched on.

### Desired speed

-  ▷ The marking lights up green: the system is active.  
▷ The marking lights up orange: the system has been interrupted.
- ▷ The marking does not light up: the system is switched off.

-  With instrument display: the symbol is displayed in the speedometer similarly to the mark for the desired speed.

## Brief status display



Selected desired speed.

If --- appears briefly on the display for Check Control messages, it is possible that the system requirements are currently not ready for operations.

## Displays in the Head-up Display

Some system information can also be displayed in the Head-up Display.

## PDC Park Distance Control

### The concept

PDC is a support when parking. When you slowly approach an object in the rear - or also in the front of the vehicle if the feature is available - then the object is reported through:

- ▷ Signal tones.
- ▷ Visual display.

### General information

Ultrasound sensors in the bumpers measure the distances from objects.

The maneuvering range, depending on the obstacle and environmental conditions, is approx. 6 ft/2 m.

An acoustic warning is first given:

- ▷ By the front sensors and the two rear corner sensors at approx. 24 in/60 cm.
- ▷ By the rear middle sensors at approx. 5 ft/1.50 m.

To ensure full functionality:

- ▷ Do not cover sensors, e.g., with stickers, bicycle racks.
- ▷ Keep the sensors clean and free of ice.
- ▷ When using high-pressure washers, do not spray the sensors for long periods and maintain a distance of at least 12 in/30 cm.

## Hints



Personal responsibility

Even an active system does not relieve the driver from personal responsibility while driving.

Technically the system has its limits, it cannot independently react to all traffic situations.

Monitor your driving, be on the alert, observe the vehicle surroundings and other traffic and react when needed - risk of accident. ◀



Avoid driving fast with PDC

Avoid approaching an object too fast.

Avoid driving off fast while PDC is not yet active.

For technical reasons, the system may otherwise be too late in issuing a warning. ◀

## Overview

### With front PDC: button in vehicle



PDC Park Distance Control

### Switching on/off

#### Switching on automatically

With the engine running, engage lever in position P R.

The rearview camera also switches on.

## Automatic deactivation during forward travel

The system switches off when a certain driving distance or speed is exceeded.

Switch the system back on if needed.

## With front PDC: switching on/off manually



Press button.

- ▷ On: the LED lights up.
- ▷ Off: the LED goes out.

The rearview camera image is displayed when the reverse gear is engaged by pressing the button.

## Display

### Signal tones

When approaching an object, an intermittent sound indicates the position of the object. E. g. if an object is detected to the left rear of the vehicle, a signal tone sounds from the left rear speaker.

The shorter the distance to the object, the shorter the intervals.

If the distance to a detected object is less than approx. 10 in/25 cm, a continuous tone is sounded.

With front PDC: if objects are located both in front of and behind the vehicle, an alternating continuous signal is sounded.

An interval tone is interrupted with the appropriate equipment after about 3 seconds:

- ▷ If the vehicle stops in front of an object that is detected by only one of the corner sensors.
- ▷ If moving parallel to a wall.

The signal tone is switched off, when selector lever position P is engaged on vehicles with Steptronic transmission.

## Volume

The volume of the PDC signal tone can be adjusted similar to the sound and volume settings of the radio.

Settings are stored for the profile currently in use.

## Visual warning

The approach of the vehicle to an object can be shown on the Control Display. Objects that are farther away are already displayed on the Control Display before a signal sounds.

A display appears as soon as Park Distance Control (PDC) is activated.

The range of the sensors is represented in the colors green, yellow and red.

When the image of the rearview camera is displayed, the reel can be made to PDC:

 "Rear view camera"

## System limits

### Limits of ultrasonic measurement

Ultrasonic measuring might not function under the following circumstances:

- ▷ For small children and animals.
- ▷ For persons with certain clothing, e.g. coats.
- ▷ With external interference of the ultrasound, e.g. from passing vehicles or loud machines.
- ▷ When sensors are dirty, iced over, damaged or out of position.
- ▷ Under certain weather conditions such as high relative humidity, rain, snowfall, extreme heat or strong wind.
- ▷ With tow bars and trailer couplings of other vehicles.
- ▷ With thin or wedge-shaped objects.
- ▷ With moving objects.

- ▷ With elevated, protruding objects such as ledges or cargo.
- ▷ With objects with corners and sharp edges.
- ▷ With objects with a fine surface structure such as fences.
- ▷ For objects with porous surfaces.

Low objects already displayed, e.g., curbs, can move into the blind area of the sensors before or after a continuous tone sounds.

### False warnings

PDC may issue a warning under the following conditions even though there is no obstacle within the detection range:

- ▷ In heavy rain.
- ▷ When sensors are very dirty or covered with ice.
- ▷ When sensors are covered in snow.
- ▷ On rough road surfaces.
- ▷ On uneven surfaces, such as speed bumps.
- ▷ In large buildings with right angles and smooth walls, e.g., in underground garages.
- ▷ In automatic car washes.
- ▷ Through heavy pollution.
- ▷ Due to other ultrasound sources, e.g., sweeping machines, high pressure steam cleaners or neon lights.

### Malfunction

A Check Control message is displayed.

The range of the sensors is shown as a shaded area on the Control Display.

PDC has failed. Have the system checked.

To ensure full functionality:

- ▷ Keep the sensors clean and free of ice.
- ▷ dimmedDo not put any stickers on sensors.

- ▷ When using high-pressure washers, do not spray the sensors for long periods and maintain a distance of at least 12 in/30 cm.

## Surround View

### The concept

Surround View comprises various camera assistance systems that help the driver when parking, maneuvering, and at complex exits and intersections.

- ▷ Rearview camera, refer to page [154](#)
- ▷ Side View, refer to page [157](#).
- ▷ Top View, refer to page [158](#).

## Rearview camera

### The concept

The rearview camera provides assistance in parking and maneuvering backwards. The area behind the vehicle is shown on the Control Display.

### Hints



- Check the traffic situation as well
- Check the traffic situation around the vehicle with your own eyes. Otherwise, an accident could result from road users or objects that are not lidtured by the camera.◀

## At a glance

### Button in the vehicle



 Rearview camera

### Camera

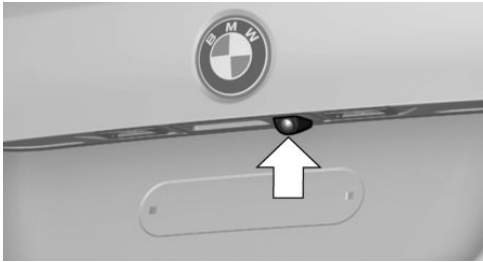

The camera lens is located in the handle of the tail gate. The image quality may be impaired by dirt.

Clean the camera lens, refer to page [254](#).

## Switching on/off

### Switching on automatically

With the engine running, engage lever in position P R.

### Automatic deactivation during forward travel

The system switches off when a certain driving distance or speed is exceeded.

Switch the system back on if needed.

## Switching on/off manually

 Press button.

- ▷ On: the LED lights up.
- ▷ Off: the LED goes out.

The PDC is shown on the Control Display.

The rearview camera image is displayed when the reverse gear is engaged by pressing the button.

## Switching the view via iDrive

With PDC activated or Top View switched on:

 "Rear view camera"

The rearview camera image is displayed.



## Display on the Control Display

### Functional requirement

- ▷ The rearview camera is switched on.
- ▷ The trunk lid is fully closed.

## Activating assistance functions

More than one assistance function can be active at the same time.

- ▷ Parking aid lines
  -  "Parking aid lines"  
Lanes and turning radius are indicated.
- ▷ Obstacle marking
  -  "Obstacle marking"  
Spatially-shaped markings are displayed.

## Pathway lines

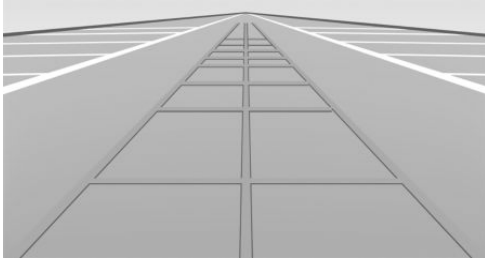

- ▷ Pathway lines can be superimposed on the image of the rearview camera.
- ▷ They help you to estimate how much space is needed when parking and maneuvering on level pavement.
- ▷ They are dependent on the current steering angle and are continuously adjusted to the steering wheel movements.

## Turning circle lines

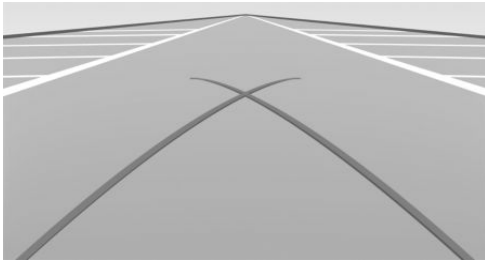

- ▷ Turning circle lines can only be superimposed on the rearview camera image together with pathway lines.
- ▷ They show the course of the smallest possible turning radius on a level road.
- ▷ Only one turning radius line is displayed after the steering wheel is turned past a certain angle.

## Obstacle marking

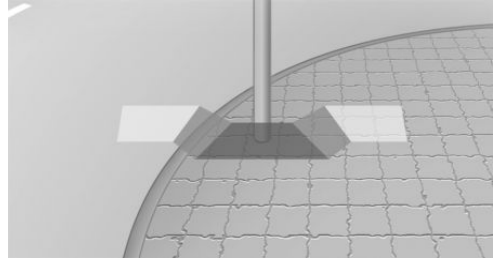

Obstacle markings can be faded into the image of the rearview camera.

Their colored margins match the markings of the PDC. This simplifies estimation of the distance to the object shown.

## Parking using pathway and turning radius lines

1. Position the vehicle so that the turning radius lines lead to within the limits of the parking space.

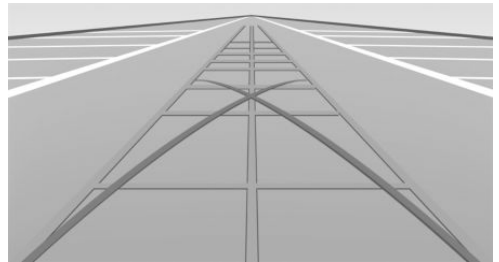

2. Turn the steering wheel to the point where the pathway line covers the corresponding turning radius line.

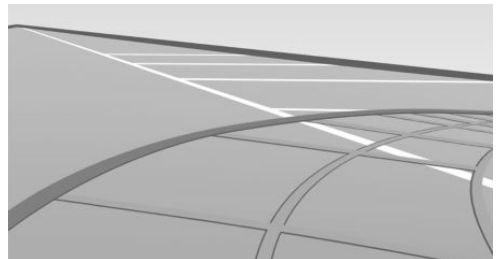



## Display settings

### Brightness

With the rearview camera switched on:

1. ☀ Select the symbol.
2. Turn the controller until the desired setting is reached, and press the controller.

### Contrast

With the rearview camera switched on:

1. ● Select the symbol.
2. Turn the controller until the desired setting is reached, and press the controller.

## System limits

### Detection of objects

Very low obstacles as well as high, protruding objects such as ledges may not be detected by the system.

Assistance functions also take into account data of the PDC.

Follow instructions in the PDC chapter, refer to page 152.

The objects displayed on the Control Display under certain circumstances are closer than they appear. Do not estimate the distance from the objects on the display.

## Side View

### The concept

Side View provides an early look at cross traffic at blind driveways and intersections. Road users concealed by obstacles to the left and right of the vehicle can only be detected relatively late from the driver's seat. To improve visibility, two cameras in the front of the vehicle record the traffic situation on each side.

## Hints

The images from both cameras are shown simultaneously on the Control Display.



Check the traffic situation as well

Check the traffic situation around the vehicle on blind driveways and intersections with your own eyes. Otherwise, an accident could result from road users or objects located outside the picture area of the Side View cameras. ◀

## At a glance

### Button in the vehicle



Side View

## Cameras

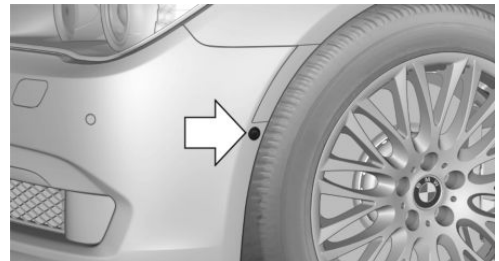

Two cameras integrated in the bumpers capture the image.

The two camera lenses are located on the sides of the bumper.

The image quality may be impaired by dirt. Clean the camera lenses, refer to page 254.

## Switching on/off

### Switching on/off manually



Press button.

### Automatic deactivation during forward travel

The system switches off when a certain driving distance or speed is exceeded.

Switch the system back on if needed.

### Display

The traffic area to the left and right is displayed on the Control Display.

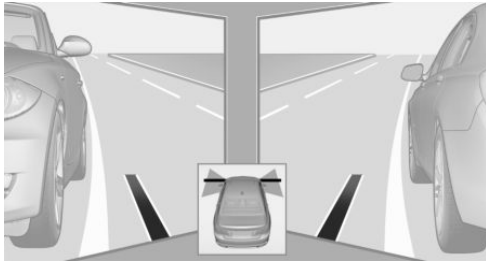

Guidelines at the bottom of the image show the position of the front of the vehicle.

### Brightness

With the Side View switched on:

1. ☀ "Brightness"
2. Turn the controller until the desired setting is reached, and press the controller.

### Contrast

With the Side View switched on:

1. ● "Contrast"
2. Turn the controller until the desired setting is reached, and press the controller.

## System limits

The cameras lidture a maximum range of 330 ft/100 m.

## Top View

### The concept

Top View provides assistance in parking and maneuvering. The area around the doors and the road area around the vehicle are shown on the Control Display for this purpose.

### General information

The image is lidture by two cameras integrated in the exterior mirrors and by the rearview camera.

The range is at least 7 ft/2 m to the side and rear.

In this way, obstacles up to the height of the exterior mirrors are detected early.

### Hints



Check the traffic situation as well

Check the traffic situation around the vehicle with your own eyes. Otherwise, an accident could result from road users or objects that are not lidture by the camera. ◀

## Overview

### Button in the vehicle



Top View

## Cameras

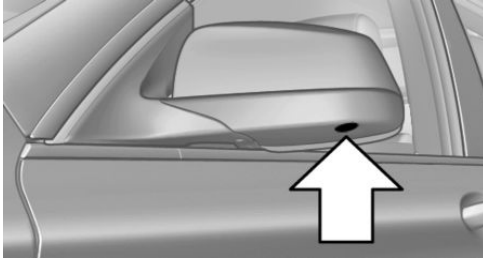

The lenses of the Top View camera are located at the bottom in the mirror housings. The image quality may be impaired by dirt.

Clean the camera lenses, refer to page 254.

## Switching on/off

### Switching on automatically

With the engine running, engage lever in position P R.

The rearview camera image is displayed. To switch to the Top View:

 "Rear view camera"

### Automatic deactivation during forward travel

The system switches off when a certain driving distance or speed is exceeded.

Switch the system back on if needed.

### Switching on/off manually



Press button.

- ▷ On: the LED lights up.
- ▷ Off: the LED goes out.

Top View is displayed.

The rearview camera image is displayed when the reverse gear is engaged by pressing the button.

## Display

### Visual warning

The approach of the vehicle to an object can be shown on the Control Display.

When the distance to an object is small, a red bar is shown in front of the vehicle, as it is in the PDC display.

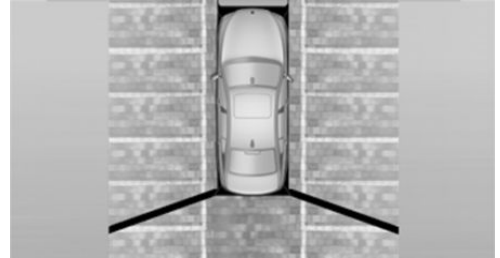

The display appears as soon as Top View is activated.

When the image of the rearview camera is displayed, it is possible to reel to top view:

 "Rear view camera"

### Brightness

With Top View switched on:

1.  Select the symbol.
2. Turn the controller until the desired setting is reached, and press the controller.

### Contrast

With Top View switched on:

1.  Select the symbol.
2. Turn the controller until the desired setting is reached, and press the controller.

### Displaying the turning radius and pathway lines

- ▷ The static, red turning radius line shows the space needed to the side of the vehicle when the steering wheel is turned all the way.

- ▶ The variable, green pathway line assists you in assessing the amount of space actually needed to the side of the vehicle.

The lane line depends on the engaged gear and the current steering angle. The track line is continuously adjusted for the steering wheel movement.

### "Parking aid lines"

Turning circle and pathway lines are displayed.

## System limits

Top View cannot be used in the following situations:

- ▶ With a door open.
- ▶ With the trunk lid open.
- ▶ With an exterior mirror folded in.
- ▶ In poor light.

A Check Control message is displayed in some of these situations.

## Parking assistant

### The concept

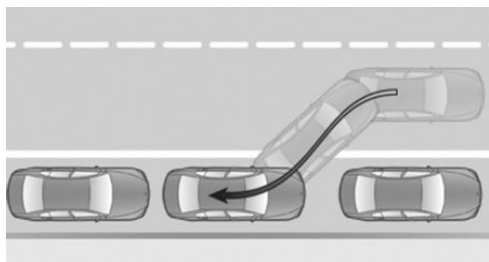

This system assists the driver in parking parallel to the road.

Ultrasound sensors measure parking spaces on both sides of the vehicle.

Manual transmission:

The parking assistant calculates the best possible parking line and takes control of steering during the parking procedure.

Steptronic transmission:

The parking assistant calculates the best possible parking line and during the parking procedure takes control of steering, the acceleration and braking and if needed changes the gears. Hold down the parking assistant button for the duration of the parking procedure. At the end of the parking procedure, the P selector lever position is set.

When parking, also take note of the visual and acoustic information and instructions issued by the PDC, the parking assistant and the rear-view camera and react accordingly.

A component of the parking assistant is the PDC Park Distance Control, refer to page 152.

### Hints



Personal responsibility

Even an active system does not relieve the driver from personal responsibility while driving.

Technically the system has its limits, it cannot independently react to all traffic situations.

Monitor your driving, be on the alert, observe the vehicle surroundings and other traffic and react when needed - risk of accident. ◀



Changes to the parking space

Changes to the parking space after it was measured are not taken into account by the system.

Therefore, always be alert and ready to intervene; otherwise, there is the risk of an accident. ◀



Transporting cargo

Cargo that extends beyond the perimeter of the vehicle is not taken into account by the system during the parking procedure.

Therefore, always be alert and ready to intervene; otherwise, there is the risk of an accident. ◀



### Curbs

The parking assistant may steer the vehicle over or onto curb if need be.

Therefore, always be alert and ready to intervene; otherwise, the wheels, tires, or the vehicle may become damaged. ◀

An engine that has been switched off by the Auto Start Stop function is restarted automatically when the parking assistant is activated.

## Requirements

### For measuring parking spaces

- ▷ Maximum speed while driving forward approx. 22 mph/35 km/h.
- ▷ Maximum distance to row of parked vehicles: 5 ft/1.5 m.

### Suitable parking space

- ▷ Gap between two objects with a minimum length of approx. 5 ft/1.5 m.
- ▷ Min. length of gap between two objects: your vehicle's length plus approx. 4 ft/1.2 m.
- ▷ Minimum depth: approx. 5 ft/1.5 m.

### Regarding the parking procedure

- ▷ Doors and trunk lid closed.
- ▷ Parking brake released.
- ▷ When parking in parking spaces on the driver's side, the corresponding turn signal must be set where applicable.

Steptronic transmission:

- ▷ Driver's safety belt fastened.

## Overview

### Button in the vehicle



Parking assistant

### Ultrasound sensors

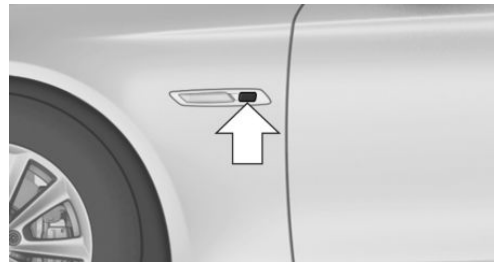

The ultrasound sensors for measuring parking spaces are located on the side of the vehicle.

To ensure full functionality:

- ▷ Keep the sensors clean and free of ice.
- ▷ When using high-pressure washers, do not spray the sensors for long periods and maintain a distance of at least 12 in/30 cm.
- ▷ Do not put stickers over sensors.

### Switching on/off

#### Switching on with the button



Press button.

The LED lights up.

The current status of the parking space search is indicated on the Control Display.

 Parking assistant is activated automatically.

### Switching on with the reverse gear

Shift into reverse.

The current status of the parking space search is indicated on the Control Display.

To activate:  "Parking Assistant"

### Switch off



The system can be deactivated as follows:

▷  Press button.

▷ Switch off the ignition.

### Display on the Control Display

#### System activated/deactivated

Symbol	Meaning
	Gray: the system is not available. White: the system is available but not activated.
	The system is activated.

### System status

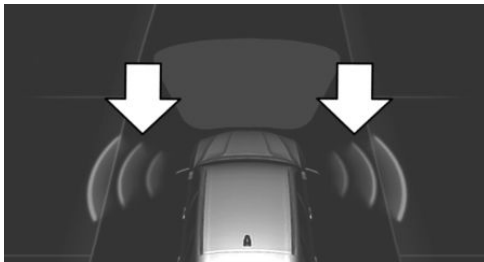

- ▷ Colored symbols, see arrows, on the side of the vehicle illustrated. Parking assistant is activated and search for parking space active.
- ▷ Control Display shows suitable parking spaces at the edge of the road next to the vehicle symbol. When the parking assistant

is active, suitable parking spaces are highlighted.

▷  The parking procedure is active. Steering control has been taken over by system.

- ▷ Parking space search is always active whenever the vehicle is moving forward slow and straight, even if the system is deactivated. When the system is deactivated, the displays on the Control Display are shown in gray.

### Parking using the parking assistant

 Check the traffic situation as well. Loud noises outside and inside the vehicle can drown out the parking assistant's and PDC's signals.

Check the traffic situation around the vehicle with your own eyes; otherwise, there is a danger of an accident. ◀

1. Switch on the parking assistant and activate it if needed.  
The status of the parking space search is indicated on the Control Display.
2. Follow the instructions on the Control Display.  
The best possible parking position will come after gear change on the stationary vehicle - wait for the automatic steering wheel move.  
The end of the parking procedure is indicated on the Control Display.
3. Adjust the parking position yourself if needed.

### Interrupting manually

The parking assistant can be interrupted at any time:

- ▷  "Parking Assistant" Select the symbol on the Control Display.

- ▷  Press button.

### Interrupting automatically

The system is interrupted automatically in the following situations:

- ▷ If the driver grasps the steering wheel or if he takes over steering.
- ▷ If a gear is selected that does not match the instruction on the Control Display.
- ▷ If the vehicle speed exceeds approx. 6 mph/10 km/h.
- ▷ Possible on snow-covered or slippery road surfaces.
- ▷ When there are obstacles that are hard to overcome, such as curbs.
- ▷ When there are obstacles that suddenly arise.
- ▷ If the Park Distance Control PDC displays clearances that are too small.
- ▷ If a maximum number of parking attempts or the time taken for parking is exceeded.
- ▷ If a turn signal has been actuated contrary to the desired side for parking.
- ▷ When switching to another function on the Control Display.

Steptronic transmission:

- ▷ When the button is released.
- ▷ If the trunk lid is open.
- ▷ If doors are open.
- ▷ When setting the parking brake.
- ▷ During acceleration.
- ▷ When braking.
- ▷ When unfastening the driver's safety belt.

A Check Control message is displayed.

### Resume

An interrupted parking procedure can be continued if needed.

Follow the instructions on the Control Display to do this.

### System limits

#### No parking assistance

The parking assistant does not offer assistance in the following situations:

- ▷ In tight curves.

#### Functional limitations

The system may not be fully functional in the following situations:

- ▷ On bumpy road surfaces such as gravel roads.
- ▷ On slippery ground.
- ▷ On steep uphill or downhill grades.
- ▷ With accumulations of leaves/snow in the parking space.

#### Limits of ultrasonic measurement

Ultrasonic measuring might not function under the following circumstances:

- ▷ For small children and animals.
- ▷ For persons with certain clothing, e.g. coats.
- ▷ With external interference of the ultrasound, e.g. from passing vehicles or loud machines.
- ▷ When sensors are dirty, iced over, damaged or out of position.
- ▷ Under certain weather conditions such as high relative humidity, rain, snowfall, extreme heat or strong wind.
- ▷ With tow bars and trailer couplings of other vehicles.
- ▷ With thin or wedge-shaped objects.
- ▷ With moving objects.
- ▷ With elevated, protruding objects such as ledges or cargo.
- ▷ With objects with corners and sharp edges.

- ▷ With objects with a fine surface structure such as fences.
- ▷ For objects with porous surfaces.

Low objects already displayed, e.g., curbs, can move into the blind area of the sensors before or after a continuous tone sounds.

The parking assistant may identify parking spaces that are not suitable for parking.

### **Malfunction**

A Check Control message is displayed.

The parking assistant failed. Have the system checked.



# Climate control

## Vehicle features and options

This chapter describes all standard, country-specific and optional features offered with the series. It also describes features that are not necessarily available in your car, e. g., due to

the selected options or country versions. This also applies to safety-related functions and systems. The respectively applicable country provisions must be observed when using the respective features and systems.

## Automatic climate control

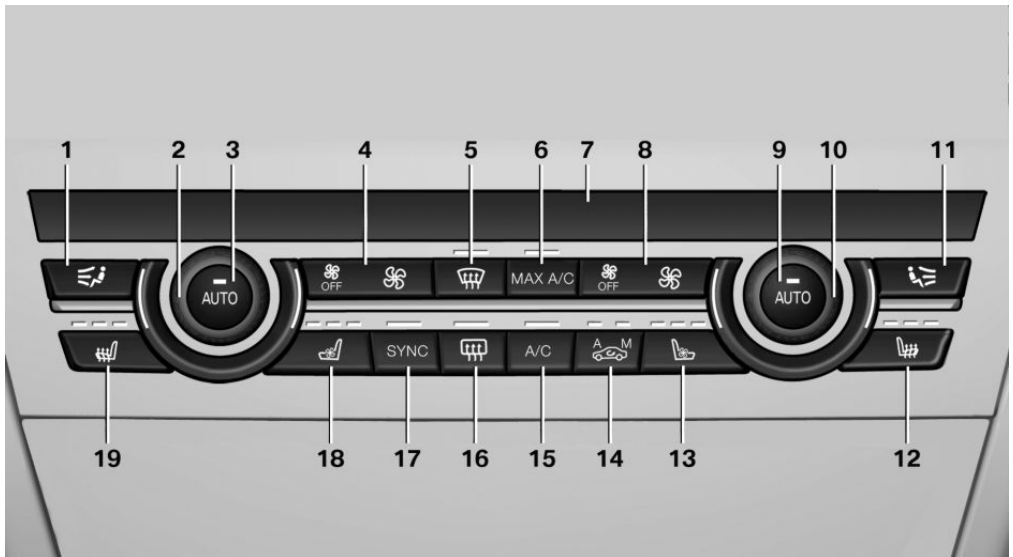

- |                                                 |                                                             |
|-------------------------------------------------|-------------------------------------------------------------|
| 1 Air distribution, left                        | 11 Air distribution, right                                  |
| 2 Temperature, left                             | 12 Seat heating, right <a href="#">56</a>                   |
| 3 AUTO program, left                            | 13 Active seat ventilation, right <a href="#">57</a>        |
| 4 Air flow, AUTO intensity, left, residual heat | 14 Automatic recirculated-air control/recirculated-air mode |
| 5 Remove ice and condensation                   | 15 Cooling function                                         |
| 6 Maximum cooling                               | 16 Rear window defroster                                    |
| 7 Display                                       | 17 SYNC program                                             |
| 8 Air flow, AUTO intensity, right               | 18 Active seat ventilation, left <a href="#">57</a>         |
| 9 AUTO program, right                           | 19 Seat heating, left <a href="#">56</a>                    |
| 10 Temperature, right                           |                                                             |

## Hints



### Sufficient ventilation

When remaining in the vehicle for an extended period of time, ensure sufficient external ventilation. Do not continuously use recirculated-air mode; otherwise the air quality in the interior continuously deteriorates and window condensation increases. ◀

## Climate control functions in detail

### Manual air distribution



Press button repeatedly to select a program:

- ▷ Upper body region.
- ▷ Upper body region and footwell.
- ▷ Footwell.
- ▷ Windows and footwell.
- ▷ Windows, upper body region, and footwell.
- ▷ Windows: driver's side only.
- ▷ Windows and upper body region.

If the windows are fogged over, press the AUTO button on the driver's side to utilize the condensation sensor.

## Temperature



Turn the ring to set the desired temperature.

The automatic climate control achieves this temperature as quickly as possible, if needed by using the maximum cooling or heating load, and then keeps it constant.

Do not rapidly switch between different temperature settings. Otherwise, the automatic climate control will not have sufficient time to adjust the set temperature.

## AUTO program



Press button.

Air flow, air distribution and temperature are controlled automatically.

Depending on the selected temperature, AUTO intensity program and outside influences, the air is directed to the windshield, side windows, upper body, and into the footwell.

The cooling function, refer to page 167, is switched on automatically with the AUTO program.

At the same time, a condensation sensor controls the program so as to prevent window condensation as much as possible.

### Intensity of the AUTO program

With the AUTO program activated, the automatic intensity control can be changed.



Press the left or right side of the button: decrease or increase the intensity.

The selected intensity is shown on the display of the automatic climate control.

### Air flow, manual

To manually adjust air flow turn off AUTO program first.



Press the left or right side of the button: decrease or increase air flow.

The selected air flow is shown on the display of the automatic climate control.

The air flow of the automatic climate control may be reduced automatically to save battery power.

### Defrosts windows and removes condensation



Press button.

Ice and condensation are quickly removed from the windshield and the front side windows.

For this purpose, point the side vents onto the side windows as needed.

Adjust air flow with the program active.

If the windows are fogged over, you can also switch on the cooling function or press the AUTO button to utilize the condensation sensor.

### Maximum cooling

 Press button.

The system is set to the lowest temperature, optimum air flow and air circulation mode.

Air flows out of the vents to the upper body region. The vents need to be open for this.

The function is available above an external temperature of approx. 32 °F/0 °C and with the engine running is indicated.

Adjust air flow with the program active.

### Automatic recirculated-air control/ recirculated-air mode

You may respond to unpleasant odors or pollutants in the immediate environment by temporarily suspending the supply of outside air. The system then recirculates the air currently within the vehicle.

 Press button repeatedly to select an operating mode:

- ▷ LEDs off: outside air flows in continuously.
- ▷ Left LED on, automatic recirculated-air control: a sensor detects pollutants in the outside air and shuts off automatically.
- ▷ Right LED on, recirculated-air mode: the supply of outside air into the vehicle is permanently blocked.

If the windows are fogged over, switch off the recirculated-air mode and press the AUTO

button on the driver's side to utilize the condensation sensor. Make sure that air can flow to the windshield.



#### Sufficient ventilation

When remaining in the vehicle for an extended period of time, ensure sufficient external ventilation. Do not continuously use recirculated-air mode; otherwise the air quality in the interior continuously deteriorates and window condensation increases.◀

### Cooling function

The car's interior can only be cooled with the engine running.



Press button.

The air will be cooled and dehumidified and, depending on the temperature setting, warmed again.

Depending on the weather, the windshield and side windows may fog up briefly when the engine is started.

The cooling function is switched on automatically with the AUTO program.

When using the automatic climate control, condensation water, refer to page 191, develops that exits underneath the vehicle.

### Rear window defroster



Press button.

The rear window defroster switches off automatically after a certain period of time.

### SYNC program



The current settings on the driver's side for temperature, air flow, air distribution, and AUTO program are transferred to the front passenger side and to the left and right rear.

The program is switched off if the settings on the front passenger side or in the rear are changed.

## Residual heat

The heat stored in the engine is used to heat the interior.

## Functional requirement

- ▷ Up to 15 minutes after switching off the engine.
- ▷ Warm engine.
- ▷ The battery is sufficiently charged.
- ▷ External temperature below 77 °F/25 °C.

The availability of the function is shown on the display of the automatic climate control.

## Switching on

1. Switch off the ignition.

2.  Press the right side of the button on the driver's side.

⏏ The symbol appears on the automatic climate Control Display.

The interior temperature, air volume and air distribution can be adjusted with the ignition switched on.

## Switch off

At the lowest fan speed, press the left side of the button on the driver's side.

⏏ The symbol on the display of the automatic climate control flashes.

## Switching the system on/off

### Switch off

- ▷ Complete system:

 Press and hold the left button on the driver's side until the control clicks off.

- ▷ On the front passenger side:

 Press and hold the left button on the front passenger side.

## Switching on

Press any button except:

- ▷ Rear window defroster.
- ▷ Left side of Air volume button.
- ▷ Seat heating.
- ▷ Seat ventilation.
- ▷ If necessary, SYNC program.

## Microfilter/activated-charcoal filter

The microfilter removes dust and pollen from the incoming air.

The activated-charcoal filter removes gaseous pollutants from the outside air that enters the vehicle.

This combined filter should be replaced during scheduled maintenance, refer to page 236, of your vehicle.

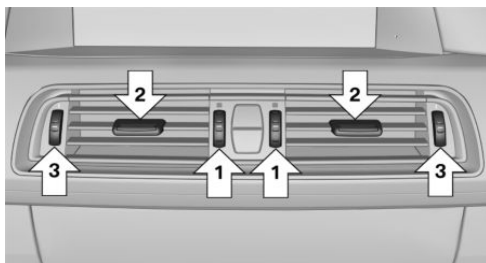

## Ventilation

### Front ventilation



- ▷ Thumbwheels to vary the temperature in the upper body region, arrow 1.
  - Toward blue: colder.
  - Toward red: warmer.
 The set interior temperature for the driver and passenger are not changed.
- ▷ Lever for changing the air flow direction, arrow 2.
- ▷ Thumbwheels for opening and closing the vents continuously, arrows 3.

## Ventilation levels

- ▶ Draft-free ventilation:  
Thumbwheel, arrow 3, in level  : the air current is fanned out.
- ▶ Maximum air flow:  
Thumbwheel, arrow 3, in level  : the air is partially fanned out and partially bundled. This maximizes the air supply.
- ▶ Direct ventilation:  
Thumbwheel, arrow 3, in level  : the air is bundled and can be directed to a specific point.

## Adjusting the ventilation

- ▶ Ventilation for cooling:  
Direct vent in your direction when vehicle's interior is too hot.
- ▶ Draft-free ventilation:  
Adjust the vent to let the air flow past you.

## Ventilation in rear, center

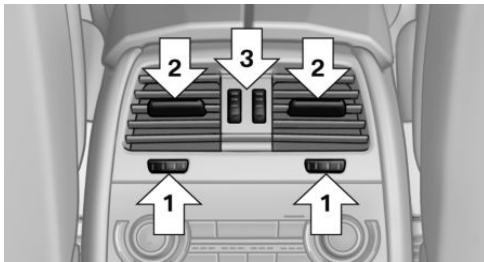

- ▶ Thumbwheels to vary the temperature, arrow 1.  
Toward blue: colder.  
Toward red: warmer.
- ▶ Lever for changing the air flow direction, arrow 2.
- ▶ Thumbwheels for continuous opening and closing of the vents, arrow 3.

## Ventilation, side

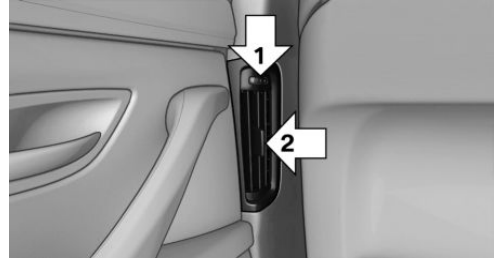

- ▶ Thumbwheel for continuous opening and closing of the vents, arrow 1.
- ▶ Lever for changing the air flow direction, arrow 2.

## Rear automatic climate control

### At a glance



- 1 Temperature
- 2 AUTO program
- 3 Vent settings
- 4 Air flow, AUTO intensity
- 5 Display
- 6 Maximum cooling
- 7 Seat heating [56](#)

### Switching the rear automatic climate control on/off

1. "Settings"
2. "Climate"

### 3. "Rear climate"

The rear automatic climate control is not operational if the automatic climate control is switched off or if the function for defrosting of the windows is active.

## AUTO program

 Press button. Air flow, air distribution, and temperature are controlled automatically:

Depending on the selected temperature, the AUTO intensity, and outside influences, the air is directed to the upper body and into the footwell.

The cooling function is switched on automatically with the AUTO program.

## Intensity of the AUTO program

With the AUTO program activated, the automatic intensity control can be changed:

 Press the left or right side of the button: decrease or increase the intensity.

The selected intensity is shown on the display of the automatic climate control.

## Temperature



Turn the ring to set the desired temperature.

The automatic climate control achieves this temperature as quickly as possible, if needed by using the maximum cooling or heating capacity, and then keeps it constant.

Do not rapidly switch between different temperature settings. The automatic climate control will not have sufficient time to adjust the set temperature.

## Manual air distribution

The air distribution can be adjusted to individual needs.



Press button repeatedly to select a program:

- ▷ Upper body region.
- ▷ Upper body region and footwell.
- ▷ Footwell.

## Air flow, manual

To manually adjust air flow turn off AUTO program first.



Press the left or right side of the button: decrease or increase air flow.

The selected air flow is shown on the display of the automatic climate control.

## Switching the system on/off

### Switch off



Press and hold the left button.

### Switching on

Press any button except:

- ▷ Left side of Air volume button.
- ▷ Seat heating.

## Maximum cooling



Press button.

The system is set to the lowest temperature, maximum air flow and air circulation mode.

Air flows out of the vents to the upper body region. The vents need to be open for this.

Air is cooled as quickly as possible:

- ▷ At an external temperature of approx. 32 °F/0 °C.
- ▷ When the engine is running.

## Parked-car ventilation

### The concept

The parked-car ventilation ventilates the vehicle interior and lowers its temperature, if needed.

Operation can be performed via iDrive.

### Functional requirements

#### Parked-car ventilation

- ▶ Using the preset reel-on time or when operated directly: any external temperature.

Open the vents to allow air to flow out.

#### Switching on/off directly

On the Control Display:

1. "Settings"
2. "Climate"
3. "Activate comf. ventilation"

☞ The symbol on the automatic climate control flashes if the system is switched on.

The system continues to run for some time after being switched off.

#### Preselecting the reel-on time

On the Control Display:

1. "Settings"
2. "Climate"
3. "Timer 1:" or "Timer 2:"
4. Set the desired time.

#### Activating the reel-on time

On the Control Display:

1. "Settings"
2. "Climate"
3. "Activate timer 1" or "Activate timer 2"

☞ The symbol on the automatic climate control lights up when the reel-on time is activated.

☞ The symbol on the automatic climate control flashes when the system has been switched on.

The system will only be switched on within the next 24 hours. After that, it needs to be reactivated.

# Interior equipment

## Vehicle features and options

This chapter describes all standard, country-specific and optional features offered with the series. It also describes features that are not necessarily available in your car, e. g., due to the selected options or country versions. This also applies to safety-related functions and systems. The respectively applicable country provisions must be observed when using the respective features and systems.

## Universal Integrated Remote Control

### The concept

The universal garage door opener can operate up to 3 functions of remote-controlled systems such as garage door drives or lighting systems. The universal garage door opener replaces up to 3 different hand-held transmitters. To operate the remote control, the buttons on the interior rearview mirror must be programmed with the desired functions. The hand-held transmitter for the particular system is required in order to program the remote control.

### During programming

During programming and before activating a device using the universal garage door opener, ensure that there are no people, animals or objects in the area of the remote-controlled device; otherwise, there is a risk of injury or damage.

Also follow the safety instructions of the hand-held transmitter. ◀

Before selling the vehicle, delete the stored functions for the sake of security.

## Compatibility



If this symbol is printed on the packaging or in the instructions of the system to be controlled, the system is generally compatible with the universal garage door opener.

If you have any questions, please contact:

- ▷ Your service center.
- ▷ [www.homelink.com](http://www.homelink.com) on the Internet.

HomeLink is a registered trademark of Gentex Corporation.

## Control elements on the interior rearview mirror

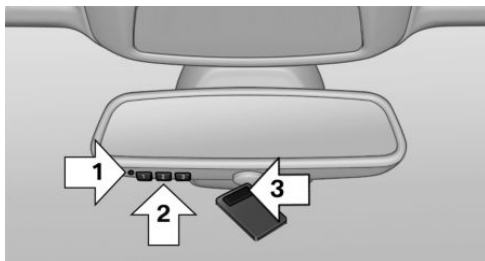

- ▷ LED, arrow 1.
- ▷ Buttons, arrow 2.
- ▷ The hand-held transmitter, arrow 3, is required for programming.

## Programming

### General information

1. Switch on the ignition.
2. Initial setup:

Press and hold the left and right button on the interior rearview mirror simultaneously for approximately 20 seconds until the LED on the interior rearview mirror flashes. This



erases all programming of the buttons on the interior rearview mirror.

3. Hold the hand-held transmitter for the system to be controlled approx. 1 to 3 in/2.5 to 8 cm away from the buttons of the interior rearview mirror. The required distance depends on the manual transmitter.
4. Simultaneously press and hold the button of the desired function on the hand-held transmitter and the button to be programmed on the interior rearview mirror. The LED on the interior rearview mirror will begin flashing slowly.
5. Release both buttons as soon as the LED flashes more rapidly. The LED flashing faster indicates that the button on the interior rearview mirror has been programmed. If the LED does not flash faster after at least 60 seconds, change the distance between the interior rearview mirror and the hand-held transmitter and repeat the step. Several more attempts at different distances may be necessary. Wait at least 15 seconds between attempts.

Canada: if programming with the hand-held transmitter was interrupted, hold down the interior rearview mirror button and repeatedly press and release the hand-held transmitter button for 2 seconds.

6. To program other functions on other buttons, repeat steps 3 to 5.

The systems can be controlled using the interior rearview mirror buttons.

### Special feature of the alternating-code wireless system

If you are unable to operate the system after repeated programming, please check if the system to be controlled features an alternating-code system.

Read the system's operating manual, or press the programmed button on the interior rearview mirror longer. If the LED on the interior

rearview mirror starts flashing rapidly and then stays lit constantly for 2 seconds, the system features an alternating-code system. Flashing and continuous illumination of the LED will repeat for approximately 20 seconds.

For systems with an alternating-code system, the universal garage door opener and the system also have to be synchronized.

Please read the operating manual to find out how to synchronize the system.

Synchronizing is easier with the aid of a second person.

To synchronize:

1. Park the vehicle within range of the remote-controlled system.
2. Program the relevant button on the interior rearview mirror as described.
3. Locate and press the synchronizing button on the system being programmed. You have approx. 30 seconds for the next step.
4. Hold down the programmed button on the interior rearview mirror for approximately 3 seconds and then release it. If necessary, repeat this step up to three times in order to finish synchronization. Once synchronization is complete, the programmed function will be carried out.

### Reprogramming individual buttons

1. Switch on the ignition.
2. Press and hold the interior rearview mirror button to be programmed.
3. As soon as the interior rearview mirror LED starts flashing slowly, hold the hand-held transmitter for the system to be controlled approx. 1 to 3 in/2.5 to 8 cm away from the buttons of the interior rearview mirror. The required distance depends on the manual transmitter.

4. Likewise, press and hold the button of the desired function on the hand-held transmitter.
5. Release both buttons as soon as the interior rearview mirror LED flashes more rapidly. The LED flashing faster indicates that the button on the interior rearview mirror has been programmed. The system can then be controlled by the button on the interior rearview mirror.

If the LED does not flash faster after at least 60 seconds, change the distance and repeat the step. Several more attempts at different distances may be necessary. Wait at least 15 seconds between attempts.

Canada: if programming with the hand-held transmitter was interrupted, hold down the interior rearview mirror button and repeatedly press and release the hand-held transmitter button for 2 seconds.

## Controls



Before operation

Before operating a system using the universal garage door opener, ensure that there are no people, animals, or objects within the range of movement of the remote-controlled system; otherwise, there is a risk of injury or damage.

Also follow the safety instructions of the hand-held transmitter. ◀

The system, such as the garage door, can be operated using the button on the interior rearview mirror while the engine is running or when the ignition is started. To do this, hold down the button within receiving range of the system until the function is activated. The interior rearview mirror LED stays lit while the wireless signal is being transmitted.

## Deleting stored functions

Press and hold the left and right button on the interior rearview mirror simultaneously for ap-

proximately 20 seconds until the LED flashes rapidly. All stored functions are deleted. The functions cannot be deleted individually.

## Sun visor

### Glare shield

Fold the sun visor down or up.

### Vanity mirror

A vanity mirror is located in the sun visor behind a cover. When the cover is opened, the mirror lighting switches on.

## Ashtray/cigarette lighter

### Manual transmission: Front

#### Opening

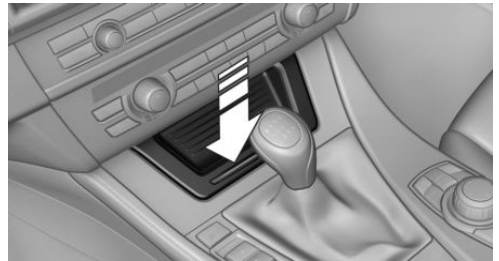

Press on the cover.

#### Emptying

Take out the insert.

#### Lighter



Push in the lighter.

The lighter can be removed as soon as it pops back out.



**Danger of burns**

Only hold the hot lighter by its knob; otherwise, there is a danger of getting burned.

Switch off the ignition and take the remote control with you when leaving the vehicle so that children cannot use the lighter and burn themselves. ◀



**Replace the cover after use**

Reinsert the lighter or socket cover after use, otherwise objects may get into the lighter socket or fixture and cause a short circuit. ◀

## Steptronic transmission: Front

### Opening

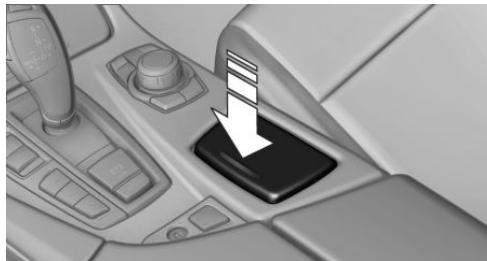

Press on the cover.

### Emptying

Take out the insert.

### Lighter



Press on the cover.



Push in the lighter.

The lighter can be removed as soon as it pops back out.



**Danger of burns**

Only hold the hot lighter by its knob; otherwise, there is a danger of getting burned.

Switch off the ignition and take the remote control with you when leaving the vehicle so that children cannot use the lighter and burn themselves. ◀



**Replace the cover after use**

Reinsert the lighter or socket cover after use, otherwise objects may get into the lighter socket or fixture and cause a short circuit. ◀

## Rear

### Opening

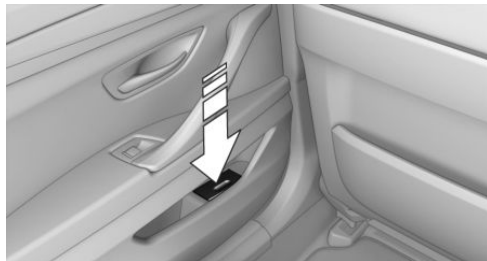

Press on the cover.

### Emptying

Take out the insert.

## Lighter



Push in the lighter.

The lighter can be removed as soon as it pops back out.



**Danger of burns**

Only hold the hot lighter by its knob; otherwise, there is a danger of getting burned.

Take the remote control with you when leaving the vehicle so that children cannot use the lighter and burn themselves. ◀



**Replace the cover after use**

Reinsert the lighter or socket cover after use, otherwise objects may get into the lighter socket or fixture and cause a short circuit. ◀

## Connecting electrical devices

### Hints



**Do not connect charging devices to the 12 volt socket in the vehicle**

Do not connect battery chargers to the factory-installed 12 volt sockets in the vehicle as this may damage the vehicle battery due to an increased power consumption. ◀



**Replace the cover after use**

Reinsert the lighter or socket cover after use, otherwise objects may get into the lighter socket or fixture and cause a short circuit. ◀

## Sockets

### General information

The lighter socket can be used as a socket for electrical equipment while the engine is running or when the ignition is switched on.

### Note

The total load of all sockets must not exceed 140 watts at 12 volts.

Do not damage the socket by using unsuitable connectors.

### Front center console: manual transmission

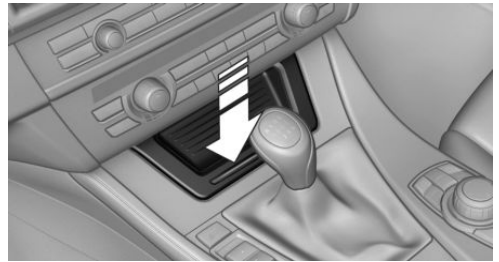

Press on the cover.

Remove the cover or cigarette lighter.

### Front center console: Steptronic transmission

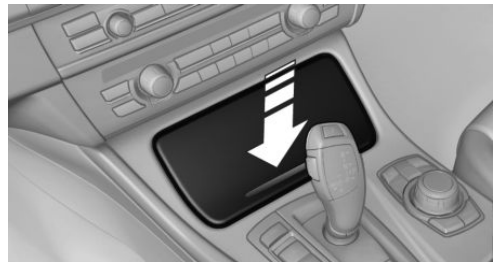

Press on the cover.

Remove the cover or cigarette lighter.

## Center armrest

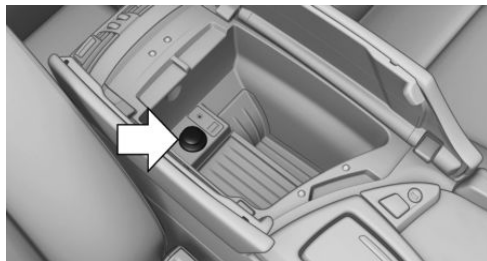

Remove the cover.

## Rear center console



Remove the cover or cigarette lighter.

## In the front passenger footwell



Socket is located below the glove compartment.

To access the socket: fold open the cover.

## In the cargo area

The socket is located in the cover of the loading lip.

To access the socket: fold open the cover.

## USB interface for data transfer

### The concept

Connection for importing and exporting data on USB devices, e.g.:

- ▷ Personal Profile settings, refer to page 35.
- ▷ Music collection, see user's manual for Navigation, Entertainment and Communication.

### Hints

Observe the following when connecting:

- ▷ Do not use force when plugging the connector into the USB interface.
- ▷ Do not connect devices such as fans or lights to the USB interface.
- ▷ Do not connect USB hard drives.
- ▷ Do not use the USB interface for recharging external devices.

## With navigation system Professional or TV: at a glance

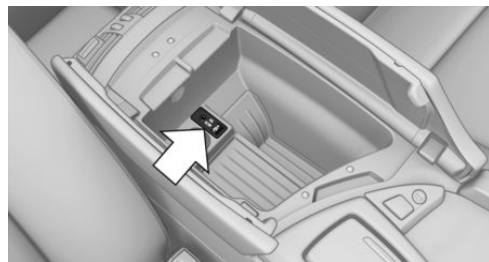

The USB interface is located in the center armrest.

## Through-loading system

### The concept

The cargo area can be enlarged by folding down the rear seat backrest.

The rear seat backrest is divided into two parts at a ratio of 60 to 40.

The sides can be folded down separately or together.

## Hints

### Danger of jamming

Before folding down the rear seat backrests, ensure that the area of movement of the backrests is clear. In particular, ensure that no one is located in or reaches into the area of movement of the rear seat backrests when the middle section is folded down. Otherwise, injury or damage may result. ◀

### Ensuring the stability of the child seat

When installing child restraint systems, make sure that the child seat is securely fastened to the backrest of the seat. Angle and headrest of the backrest might need to be adjusted or possibly be removed. Make sure that all backrests are securely locked. Otherwise the stability of the child seat can be affected, and there is an increased risk of injury because of unexpected movement of the seat backrest. ◀

## Opening

### Move the front seats to an upright position

Before folding down the rear backrests, ensure that the front seats are moved forward slightly

and are in an upright position. Otherwise, the head restraint and screen could be damaged. ◀

1. Unlock the belt lock of the center safety belt in the rear using the latch plate of another safety belt.
2. Insert the latch plate at the end of the belt into the specially designated fixture on the rear window shelf.

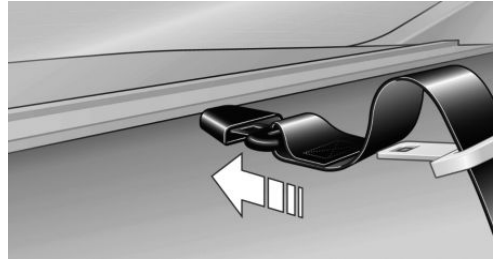

3. Push the corresponding head restraint down as far as it will go.
4. Pull the corresponding lever in the cargo area to release the rear seat backrest.

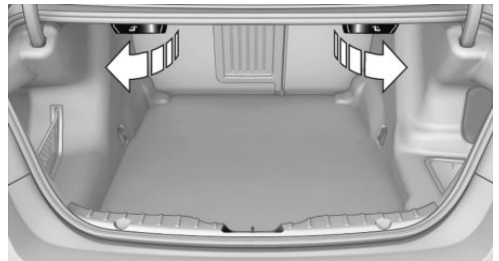

5. The unlocked rear seat backrest moves forward slightly.



6. Fold backrest forward.

## Closing

1. Return the rear seat backrest to the upright seating position and engage it.

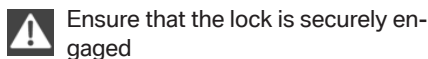

Make sure that the lock engages properly when folding back, otherwise transported cargo could enter the car's interior during braking or evasive maneuvers and endanger the vehicle's occupants. ◀

2. Release the belt tongue from the fixture on the rear window shelf.
3. Insert the belt tongue in the belt lock of the center safety belt. Make sure you hear the latch plate engage.

To secure cargo, refer to page 193, with nets or draw straps, the cargo area is fitted with lashing eyes.

## Ski bag

### Capacity

The ski bag can be used to transport up to four pairs of skis with a length of up to 6 ft/2.10 m or, depending on the binding, up to two snowboards with a length of up to 5 ft/1.60 m.

### Preparing and loading the ski bag

1. Fold open the center armrest on the inside.
2. Open the inside cover and cargo area by pressing the button.



3. Lay out the ski bag.

4. Load the ski bag. If necessary, wrap the sharp edges of the skis.
5. Insert the tongue plate into the belt buckle.



6. Tighten the retaining strap.



### Securing the ski bag

Secure the ski bag by tightening the retaining strap; otherwise, the contents could present a source of danger to the passengers, for example during braking or evasive maneuvers. ◀

### Removing the ski bag

The ski bag can be removed entirely, e.g., to dry quickly or to use other inserts.

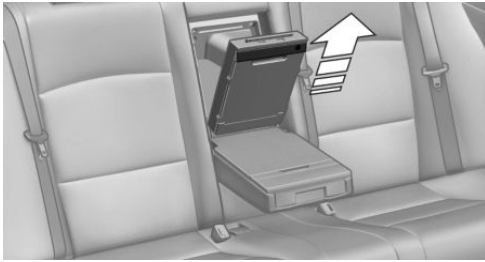

1. Pull the handle forward and lift the ski bag out.
2. Close the cover in the cargo area.

More information on the various inserts available can be obtained from your service center.





# Storage compartments

## Vehicle features and options

This chapter describes all standard, country-specific and optional features offered with the series. It also describes features that are not necessarily available in your car, e. g., due to the selected options or country versions. This also applies to safety-related functions and systems. The respectively applicable country provisions must be observed when using the respective features and systems.

## Hints

 No loose objects in the car's interior  
Do not stow any objects in the car's interior without securing them; otherwise, they may present a danger to occupants e.g., during braking and evasive maneuvers.◀

 Do not place anti-slip mats on the dashboard

Do not place anti-slip mats on the dashboard. The mat materials could damage the dashboard.◀

## Storage compartments

The following storage compartments are available in the vehicle interior:

- ▶ Glove compartment on the driver's and front passenger side, refer to page 181.
- ▶ Storage compartment on the center console: manual transmission.
- ▶ Storage compartment, refer to page 184, in the center console for remote control: Steptronic transmission.
- ▶ Storage compartment in the center armrest, refer to page 182, in the front and rear.

- ▶ Compartments in the doors.
- ▶ Pockets on the backrests of the front seats.
- ▶ Net in the front passenger footwell.

## Glove compartment

### Front passenger side

#### Note

 Close the glove compartment again immediately

Close the glove compartment immediately after use while driving; otherwise, injury may occur during accidents.◀

#### Opening



Pull the handle.

The light in the glove compartment switches on.

#### Closing

Fold cover closed.

## Driver's side

### Note

 Close the glove compartment again immediately

Close the glove compartment immediately after use while driving; otherwise, injury may occur during accidents. ◀

### Opening



Pull the handle.

### Closing

Fold cover closed.

## Center armrest

### Front

A storage compartment is located in the center armrest between the front seats.

### Opening

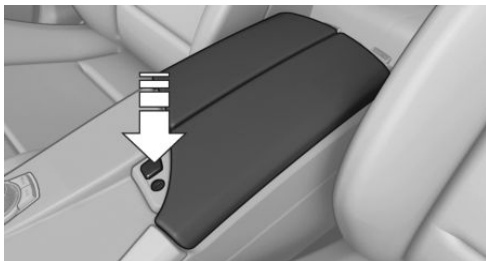

Press button.

## Locking the storage compartment

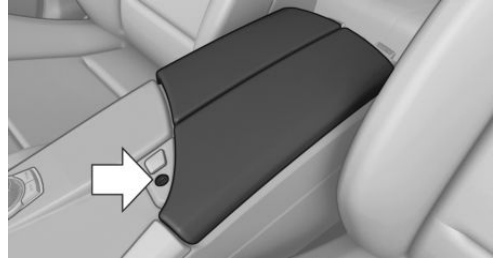

The storage compartment in the armrest can be locked with an integrated key to separately secure the trunk lid, refer to page 42, e.g.

After the storage compartment is locked, the remote control can be handed out without the integrated key, refer to page 34, for instance at a hotel.

This prevents access to the storage compartment and to the cargo area.

## Connection for an external audio device



An external audio device, e.g., an MP3 player, can be connected via the AUX-IN port or the USB audio interface in the center armrest.

### Rear

The center armrest contains a storage compartment.

## Folding down



Pull on the opener and fold the armrest forward.

## Opening



Pull on the handle and fold open the cover.

## Cupholders

### Hints



Shatter-proof containers and no hot drinks

Use light and shatter-proof containers and do not transport hot drinks. Otherwise, there is the increased danger of injury in an accident. ◀



Unsuitable containers

Do not forcefully push unsuitable containers into the cupholders. This may result in damage. ◀

## Manual transmission: Front

### On the center console

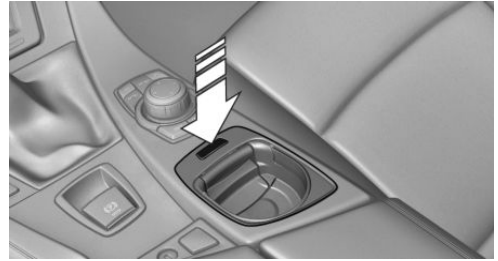

To open: press the button.

The insert folds out.

To use as a storage compartment, fold the insert back in.

## Steptronic transmission: Front



To open: press on the cover.

## Rear

In the front center armrest.

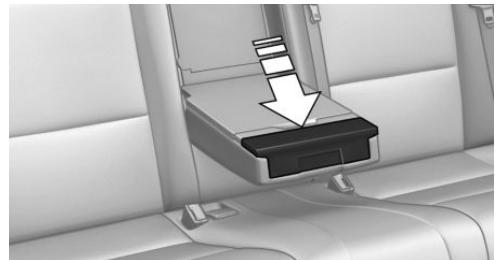

The cupholder can be adjusted for three different container sizes.

To open: press the button.

To reduce in size: fold closed to the desired position.

To close: fold all the way closed. The cupholder must be closed before it can be opened fully.

## Remote control storage compartment

### Opening



Press on the cover.

### Remote control storage compartment



Storage is possible in a vertical position in the center armrest.

## Clothes hooks

The clothes hooks are located next to the grab handles in the rear and on the door pillar in the rear.



Do not obstruct view

When suspending clothing from the hooks, ensure that it will not obstruct the driver's view. ◀



No heavy objects

Do not hang heavy objects from the hooks; otherwise, they may present a danger to passengers during braking and evasive maneuvers. ◀

## Storage compartments in the trunk

### Net

Smaller objects can be stored in the net on the side of the trunk.

To transport larger objects, it can be pushed down.

### Multi-function hook

A multi-function hook is available on the left trunk wall.



Lightweight objects only

Only hang lightweight objects, e.g. shopping bags, from the multifunction hooks. Otherwise, there is a danger of objects flying about during braking and evasive maneuvers.

Only transport heavy luggage in the trunk if it has been appropriately secured. ◀

## Storage under the cargo floor panel



Fold up the cargo floor panel.

## Storage compartment on the side

A storage compartment is located at the side of the trunk.

## Lashing eyes

To secure the cargo, refer to page [193](#), there are lashing eyes in the trunk.



## Driving tips

This chapter provides you with information useful in dealing with specific driving and operating modes.

# Things to remember when driving

## Vehicle features and options

This chapter describes all standard, country-specific and optional features offered with the series. It also describes features that are not necessarily available in your car, e. g., due to the selected options or country versions. This also applies to safety-related functions and systems. The respectively applicable country provisions must be observed when using the respective features and systems.

## Breaking-in period

### General information

Moving parts need time to adjust to one another (break-in time).

The following instructions will help accomplish a long vehicle life and good efficiency.

During break-in, do not use the Launch Control, refer to page 82.

### Engine, transmission, and axle drive

#### Up to 1,200 miles/2,000 km

Do not exceed the maximum engine and road speed:

- ▷ For gasoline engine 4,500 rpm and 100 mph/160 km/h.
- ▷ For diesel engine 3,500 rpm and 93 mph/150 km/h.

Avoid full load or kickdown under all circumstances.

#### From 1,200 miles/2,000 km

The engine and vehicle speed can gradually be increased.

## Tires

Tire traction is not optimal due to manufacturing circumstances when tires are brand-new; they achieve their full traction potential after a break-in time.

Drive conservatively for the first 200 miles/300 km.

## Brake system

Brakes require an initial break-in period of approx. 300 miles/500 km to achieve optimal performance between brake discs and brake pads. Drive moderately during this break-in period.

## Clutch

The function of the clutch reaches its optimal level only after a distance driven of approx. 300 miles/500 km. During this break-in period, engage the clutch gently.

## Following part replacement

The same break-in procedures should be observed if any of the components above-mentioned have to be renewed in the course of the vehicle's operating life.

## General driving notes

### Closing the trunk lid



Drive with the trunk lid closed

Only drive with the tailgate closed; otherwise, in the event of an accident or braking and evasive maneuvers, passengers and other traffic may be injured, and the vehicle may be damaged. In addition, exhaust fumes may enter the vehicle interior. ◀

If driving with the tailgate open cannot be avoided:



- ▶ Close all windows and the glass sunroof.
- ▶ Greatly increase the air flow from the vents.
- ▶ Drive moderately.

### Hot exhaust system



#### Hot exhaust system

High temperatures are generated in the exhaust system.

Do not remove the heat shields installed and never apply undercoating to them. Make sure that flammable materials, e. g. hay, leaves, grass, etc. do not come in contact with the hot exhaust system while driving, while in idle position mode, or when parked. Such contact could lead to a fire, resulting in an increased risk of serious personal injury as well as property damage.

Do not touch hot exhaust pipes; otherwise, there is a danger of getting burned. ◀

### Diesel particulate filter

The diesel particulate filter collects soot particles and burns them periodically at high temperatures.

During several minutes of cleaning the following may occur:

- ▶ Temporarily, the engine may run less smoothly.
- ▶ Noises and a slight amount of smoke coming from the exhaust until shortly after the engine is shut down.
- ▶ A somewhat higher engine speed is necessary to reach usual performance.

### Climate control windshield

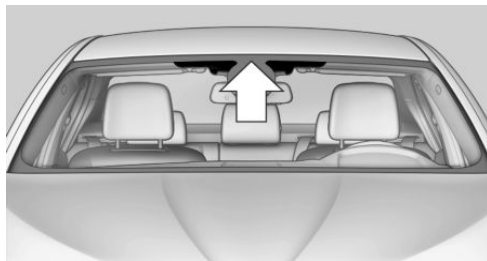

The marked area is not covered with heat reflective coating.

Use this area for garage door openers, devices for electronic toll collection, etc.

### Climate control laminated tinted safety glass

The vehicle glass provides full protection against the harmful effects of UV radiation on the skin.

### Mobile communication devices in the vehicle



#### Mobile communication devices in the vehicle

It is not recommended to use mobile phones, such as mobile phones, in the vehicle interior without a direct connection to an external aerial. Otherwise, the vehicle's electronics and mobile communication devices can interfere with each other. In addition, there is no assurance that the radiation generated during transmission will be conducted away from the vehicle interior. ◀

### Hydroplaning



#### Hydroplaning

When driving on wet or slushy roads, reduce your speed to prevent hydroplaning. ◀

On wet or slushy roads, a wedge of water can form between the tires and road surface.

This phenomenon is referred to as hydroplaning. It is characterized by a partial or complete loss of contact between the tires and the road surface, ultimately undermining your ability to steer and brake the vehicle.

### Driving through water



Observe water level and speed

Do not exceed the maximum water level and maximum speed; otherwise, the vehicle's engine, the electrical systems and the transmission may be damaged. ◀

Drive through calm water only and only if it is not deeper than 9.8 inches/25 cm and at this height, no faster than walking speed, up to 3 mph/5 km/h.

### Braking safely

Your vehicle is equipped with ABS as a standard feature.

Applying the brakes fully is the most effective way of braking in situations needed.

Steering is still responsive. You can still avoid any obstacles with a minimum of steering effort.

Pulsation of the brake pedal and sounds from the hydraulic circuits indicate that ABS is in its active mode.

In certain braking situations, the perforated brake discs can cause functional problems. However, this has no effect on the performance and operational reliability of the brake.

### Objects within the range of movement of the pedals



No objects in the area around the pedals

Keep floor mats, carpets, and any other objects out of the pedal area; otherwise, the function of the pedals could be impeded while driving and create the risk of an accident.

Do not place additional floor mats over existing mats or other objects.

Only use floor mats that have been approved for the vehicle and can be properly attached to floor.

Ensure that the floor mats are securely fastened again after they were removed for cleaning, e.g. ◀

### Driving in wet conditions

When roads are wet, salted, or in heavy rain, press brake pedal ever so gently every few miles.

Ensure that this action does not endanger other traffic.

The heat generated in this process helps dry the brake discs and pads.

In this way braking efficiency will be available when you need it.

### Hills



Avoid stressing the brakes

Avoid placing excessive stress on the brake system. Light but consistent brake pressure can lead to high temperatures, brakes wearing out and possibly even brake failure. ◀



Do not drive in neutral

Do not drive in neutral or with the engine stopped, as doing so disables engine braking. In addition, steering and brake assist are unavailable with the engine stopped. ◀

Drive long or steep downhill gradients in the gear that requires least braking efforts. Otherwise the brakes may overheat and reduce brake efficiency.

You can increase the engine's braking effect by shifting down, going all the way to first gear, if needed.

### Brake disc corrosion

Brake disc corrosion and contamination of the brake pads are favored by:

- ▶ Low mileage.

- Extended periods when the vehicle is not used at all.
- Infrequent use of the brakes.

Corrosion will built up when the maximum pressure applied to the brake pads during braking is not reached - thus discs don't get cleaned.

Corrosion buildup on the brake discs will cause a pulsating effect on the brakes in their response - generally that cannot be corrected.

### **Condensation under the parked vehicle**

When using the automatic climate control, condensation water develops collecting underneath the vehicle.

These traces of water under the vehicle are normal.

# Loading

## Vehicle features and options

This chapter describes all standard, country-specific and optional features offered with the series. It also describes features that are not necessarily available in your car, e. g., due to the selected options or country versions. This also applies to safety-related functions and systems. The respectively applicable country provisions must be observed when using the respective features and systems.

## Hints



### Overloading the vehicle

To avoid exceeding the approved capacity of the tires, never overload the vehicle. Overloading can lead to overheating and increases the rate at which damage develops inside the tires. This could result in a sudden loss of tire inflation pressure. ◀



### No fluids in the cargo area

Make sure that fluids do not leak into the cargo area; otherwise, the vehicle may be damaged. ◀



### Heavy and hard objects

Do not stow any heavy and hard objects in the car's interior without securing them; otherwise, they may present a danger to occupants, e.g., during braking and evasive maneuvers. ◀

vehicle and unstable driving situations may result.



2. Determine the combined weight of the driver and passengers that will be riding in your vehicle.
3. Subtract the combined weight of the driver and passengers from XXX kilograms or YYY pounds.
4. The resulting figure equals the available amount of cargo and luggage load capacity.

For example, if the YYY amount equals 1,000 lbs and there will be four 150 lbs passengers in your vehicle, the amount of available cargo and luggage load capacity is 400 lbs: 1,000 lbs minus 600 lbs = 400 lbs.

5. Determine the combined weight of luggage and cargo being loaded on the vehicle. That weight may not safely exceed the available cargo and luggage load capacity calculated in Step 4.

## Determining the load limit

1. Locate the following statement on your vehicle's placard:
  - ▶ The combined weight of occupants and cargo should never exceed XXX kg or YYY lbs. Otherwise, damage to the

## Load

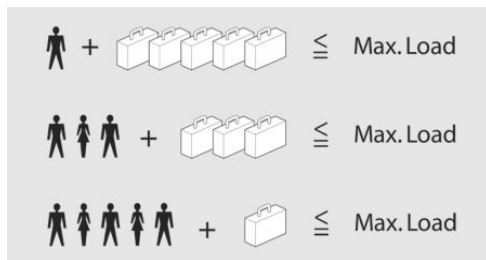

The maximum load is the sum of the weight of the occupants and the cargo.

The greater the weight of the occupants, the less cargo that can be transported.

## Stowing cargo

- ▷ Cover sharp edges and corners on the cargo.
- ▷ Heavy cargo: stow as far forward as possible, directly behind and at the bottom of the rear passenger seat backrests.
- ▷ Very heavy cargo: when the rear seat is not occupied, secure each of the outer safety belts in the opposite buckle.
- ▷ If necessary, fold down the rear backrests to stow cargo.
- ▷ Do not stack cargo above the top edge of the backrests.

## Securing cargo

### Lashing eyes in the trunk

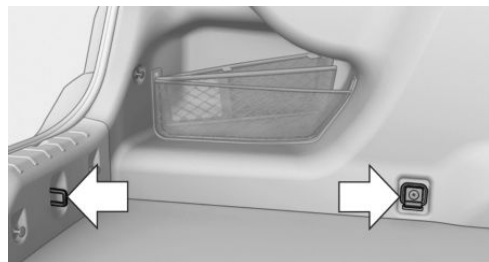

To secure the cargo there are four lashing eyes in the cargo area.

### Securing cargo



#### Securing cargo

Stow and secure the cargo as described; otherwise it may present a danger to the occupants, e.g., during braking and evasive maneuvers. ◀

- ▷ Smaller and lighter items: secure with retaining straps or with a cargo net or draw straps.
- ▷ Larger and heavy objects: secure with cargo straps.

Cargo straps, cargo netting, retaining straps or draw straps on the lashing eyes in the trunk.

## Roof-mounted luggage rack

### Note

Roof racks are available as special accessories.

### Securing

Follow the installation instructions of the roof rack.

## Roof drip rail with flaps



The anchorage points are located in the roof drip rail above the doors.

Fold the cover outward.

## Loading

Be sure that adequate clearance is maintained for tilting and opening the glass sunroof.

Because roof racks raise the vehicle's center of gravity when loaded, they have a major effect on vehicle handling and steering response.

Therefore, note the following when loading and driving:

- ▷ Do not exceed the approved roof/axle loads and the approved gross vehicle weight.
- ▷ Distribute the roof load uniformly.
- ▷ The roof load should not extend past the loading area.
- ▷ Always place the heaviest pieces on the bottom.
- ▷ Secure the roof luggage firmly, e.g., tie with ratchet straps.
- ▷ Do not let objects project into the opening path of the trunk lid.
- ▷ Drive cautiously and avoid sudden acceleration and braking maneuvers. Take corners gently.

# Saving fuel

## Vehicle features and options

This chapter describes all standard, country-specific and optional features offered with the series. It also describes features that are not necessarily available in your car, e. g., due to the selected options or country versions. This also applies to safety-related functions and systems. The respectively applicable country provisions must be observed when using the respective features and systems.

## General information

Your vehicle contains advanced technology for the reduction of fuel consumption and emissions.

Fuel consumption depends on a number of different factors.

Carrying out certain measures, such as a moderate driving style and regular maintenance, can influence fuel consumption and the environmental impact.

## Remove unnecessary cargo

Additional weight increases fuel consumption.

## Remove attached parts following use

Remove auxiliary mirrors, roof or rear luggage racks which are no longer required following use.

Attached parts on the vehicle impair the aerodynamics and increase the fuel consumption.

## Close the windows and glass sunroof

Driving with the glass sunroof and windows open results in increased air resistance and thereby reduces the range.

## Tires

### General information

Tires can affect fuel consumption in various ways, e.g., tire size may influence fuel consumption.

### Check the tire inflation pressure regularly

Check and, if needed, correct the tire inflation pressure at least twice a month and before starting on a long trip.

Low tire inflation pressure increases rolling resistance and thus raises fuel consumption and tire wear.

## Drive away immediately

Do not wait for the engine to warm-up while the vehicle remains stationary. Start driving right away, but at moderate engine speeds.

This is the quickest way of warming the cold engine up to operating temperature.

## Look well ahead when driving

Avoid unnecessary acceleration and braking.

By maintaining a suitable distance to the vehicle driving ahead of you.

Driving smoothly and proactively reduces fuel consumption.

## Avoid high engine speeds

As a rule: driving at low engine speeds lowers fuel consumption and reduces wear.

Use 1st gear to get the vehicle moving. Starting with the 2nd gear, accelerate rapidly. When accelerating, shift up before reaching high engine speeds.

When you reach the desired speed, shift into the highest applicable gear and drive with the engine speed as low as possible and at a constant speed.

If necessary, observe the gear shift indicator of the vehicle, refer to page [95](#).

## Use coasting

When approaching a red light, take your foot off the accelerator and let the vehicle coast to a halt.

For going downhill take your foot off the accelerator and let the vehicle roll.

The flow of fuel is interrupted while coasting.

## Switch off the engine during longer stops

Switch off the engine during longer stops, e.g., at traffic lights, railroad crossings or in traffic congestion.

### Auto Start/Stop function

The Auto Start/Stop function of your vehicle automatically switches off the engine during a stop.

If the engine is switched off and then restarted rather than leaving the engine running constantly, fuel consumption and emissions are reduced. Savings can begin within a few seconds of switching off the engine.

In addition, fuel consumption is also determined by other factors, such as driving style,

road conditions, maintenance or environmental factors.

## Switch off any functions that are not currently needed

Functions such as seat heating and the rear window defroster require a lot of energy and reduce the range, especially in city and stop-and-go traffic.

Reel off these functions if they are not needed.

The ECO PRO driving program supports the energy conserving use of comfort features. These functions are automatically deactivated partially or completely.

## Have maintenance carried out

Have vehicles maintained regularly to achieve optimal vehicle efficiency and operating life. The maintenance should be carried out by your service center.

Also note the BMW Maintenance System, refer to page [236](#).

## ECO PRO

### The concept

ECO PRO supports a driving style that saves on fuel consumption. For this purpose, the engine control and comfort features, e. g. the climate control output, are adjusted.

Under certain conditions the engine is automatically decoupled from the transmission in the D selector lever position. The vehicle continues traveling with the engine idling to reduce fuel consumption. Selector lever position D remains engaged.

In addition, context-sensitive instructions are displayed to assist with an optimized fuel consumption driving style.



The achieved extended range is displayed in the instrument cluster as bonus range.

## Overview

The system includes the following EfficientDynamics functions and displays:

- ▷ ECO PRO bonus range, refer to page 197.
- ▷ ECO PRO tips driving instruction, refer to page 198
- ▷ ECO PRO climate control, refer to page 197.
- ▷ ECO PRO coasting driving status, refer to page 199.

## Activate ECO PRO



Press button repeatedly until ECO PRO is displayed in the instrument cluster.

## Configuring ECO PRO

### Via the Driving Dynamics Control

1. Activate ECO PRO.
2. "Configure ECO PRO"
3. Configure the program.

### Via the iDrive

1. "Settings"
2. "ECO PRO mode"

Or

1. "Settings"
2. "Driving mode"
3. "Configure ECO PRO"

Configure the program.

## ECO PRO Tip

- ▷ "Tip at:":  
Adjust the ECO PRO speed.
- ▷ "ECO PRO speed warning":

The output is reduced once the set ECO PRO speed is reached.

## Coasting

Fuel-efficiency can be optimized by disengaging the engine and Coasting, refer to page 199, with the engine idling.

This function is only available in ECO PRO mode.

## ECO PRO climate control

"ECO PRO climate control"

Climate control is set to be fuel-efficient.

By making a slight change to the set temperature, or slowly adjusting the rate of heating or cooling of the car's interior, fuel consumption can be economized.

The mirror heating is made available when outside temperatures are very cold.

## ECO PRO potential

Shows potential savings with the current settings in percentages.

## Display in the instrument cluster

### Display in the instrument display

When ECO PRO mode is activated, the display switches to a special configuration.

Some of the displays may differ from the display in the instrument cluster.

Blue bar segments symbolize the gained bonus range in stages.

In addition, the bonus range is highlighted in blue in the total range display.

## ECO PRO bonus range

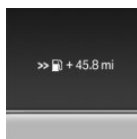

An adjusted driving style helps you extend your driving range.

This may be displayed as the bonus range in the instrument cluster.

The bonus range is shown in the range display.

The bonus range is automatically reset every time the vehicle is refueled.

## Efficiency display

Display in the instrument cluster

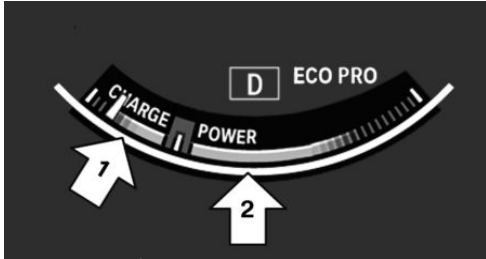

Display in the instrument display

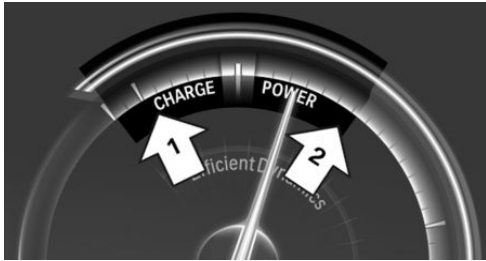

A mark in the efficiency display informs about the current driving style.

Mark in the area of arrow 1: display of the energy recovered by coasting or when braking.

Mark in the area of arrow 2: display when accelerating.

Your driving style's efficiency is shown by the bar's color:

- ▶ Blue display: efficient driving style as long as the mark moves within the blue range.
- ▶ Gray display: adjust driving style, e. g. by backing off the accelerator pedal.

The display switches to blue as soon as all conditions for fuel-efficiency-optimized driving are met.

## ECO PRO tip, driving tip



The arrow indicates that the driving style can be adjusted to be more fuel efficient by backing off the accelerator for instance.

## Note

The efficiency display and ECO PRO tips in the instrument cluster appear when the ECO PRO display is activated.

Activating driving style and ECO PRO tips:





1. "Settings"
2. "Instrument cluster"
3. "ECO PRO Info"

In the instrument display:

1. "Settings"
2. "Instrument cluster"
3. "Driving mode view"

## ECO PRO tip, symbols

An additional symbol and text instructions are displayed.

Symbol	Measure
	For efficient driving back off the accelerator or delay accelerating to allow time to assess road conditions.
	Reduce speed to the selected ECO PRO speed.
	Steptronic transmission: shift from M/S to D.
	Steptronic transmission/manual transmission: follow shifting instructions.
	Manual transmission: engage neutral for engine stop.

## Indications on the Control Display

### EfficientDynamics

Information on fuel consumption and technology can be displayed while driving.

1. "Vehicle info"
2. "EfficientDynamics"

### Displaying fuel consumption history

The average fuel consumption can be displayed within an adjustable time frame.

Vertical bars show consumption for the selected time frame.

Trip interruptions are represented below the bar on the time axis.

 "Consumption history"

### Adjusting fuel consumption history time frame

 Select the symbol.

### Resetting fuel consumption history

1. Open "Options".
2. "Reset consumption history"

### Displaying EfficientDynamics info

The current efficiency can be displayed.

 "EfficientDynamics info"

The following systems are displayed:

- ▷ Auto Start/Stop function.
- ▷ Energy recovery.
- ▷ Climate control output.
- ▷ Coasting.

### Display ECO PRO tips

 "ECO PRO Tips"

Settings are stored for the profile currently in use.

## Coasting

### The concept

The system helps to conserve fuel.

To do this, under certain conditions the engine is automatically decoupled from the transmission when selector lever position D is set. The vehicle continues traveling with the engine idling to reduce fuel consumption. Selector lever position D remains engaged.

This driving condition is referred to as coasting.

As soon as you step on the brake or accelerator pedal, the engine is automatically coupled again.

### Hints

Coasting is a component of the ECO PRO, refer to page 196, driving mode.

Coasting is automatically activated when ECO PRO mode is called via the Driving Dynamics Control.

The function is available in a certain speed range.

A proactively driving style helps the driver to use the function as often as possible and supports the fuel-conserving effect of coasting.

### Safety mode

The function is not available under one of the following conditions.

- ▷ DSC OFF or TRACTION activated.
- ▷ Driving in the dynamic limit range and on steep uphill or downhill grades.
- ▷ Battery charge status temporarily too low or vehicle electrical system drawing excessive current.
- ▷ Cruise control activated.

### Functional requirements

In ECO PRO mode, this function is available in a speed range from approximately 30 mph, ap-

prox. 50 km/h to 100 mph, approx. 160 km/h, if the following conditions are met:

- ▷ Accelerator pedal and brake pedal are not operated.
- ▷ The selector lever is in selector lever position D.
- ▷ Engine and transmission are at operating temperature.

The driving status Coast can be influenced with the shift paddles.

## Display

### Display in the instrument cluster

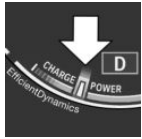

The mark in the efficiency display below the tachometer is backlit in blue and is located at the zero point. The tachometer approximately indicates idle

speed.

The coasting point indicator is illuminated at the zero point during coasting.

### Display in the instrument display

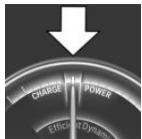

The mark in the efficiency display is backlit in blue and is located at the zero point.

The coasting point indicator is illuminated at the zero point during coasting.

### Indications on the Control Display

The Coasting driving condition is displayed in EfficientDynamics Info while this driving mode is active.

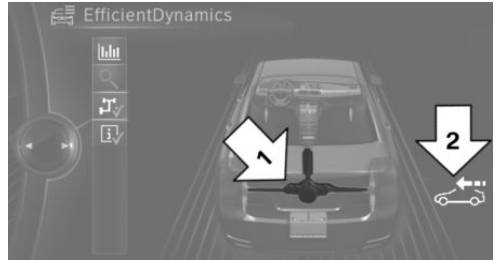

Color code blue, arrow 1, and symbol, arrow 2: driving condition Coasting.

### Displaying EfficientDynamics info

1. "Vehicle info"
2. "EfficientDynamics"
3.  "EfficientDynamics info"

### Deactivating the system manually

The function can be deactivated in the Config-ure ECO PRO, refer to page 197, menu, e.g., to use the braking effect of the engine when traveling downhill.

Settings are stored for the profile currently in use.







## Mobility

In order to always ensure your mobility, you will find important information on operating fluids, wheels and tires, maintenance and Roadside Assistance in the following.

# Refueling

## Vehicle features and options

This chapter describes all standard, country-specific and optional features offered with the series. It also describes features that are not necessarily available in your car, e. g., due to the selected options or country versions. This also applies to safety-related functions and systems. The respectively applicable country provisions must be observed when using the respective features and systems.

## Hints

Observe the fuel recommendation, refer to page 206, prior to refueling.

-  Refuel promptly
- Refuel no later than at a range of 30 miles/50 km or engine operation might fail and damage might occur. ◀

## Diesel engines

The filler neck is designed for refueling at diesel fuel pumps.

## Fuel lid

### Opening

1. Briefly press the rear edge of the fuel filler flap.



2. Turn the tank lid counterclockwise.

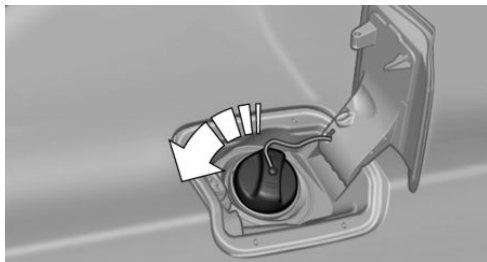

3. Place the tank lid in the bracket attached to the fuel filler flap.

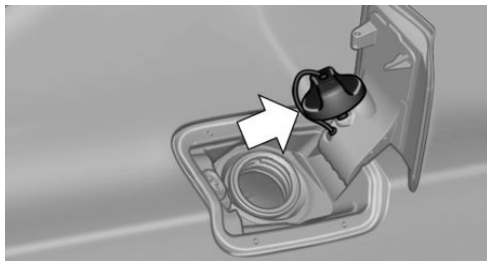

### Closing

1. Fit the lid and turn it clockwise until you clearly hear a click.
2. Close the fuel filler flap.

-  Do not pinch the retaining strap
- Do not pinch the retaining strap attached to the lid; otherwise, the lid cannot be closed properly and fuel vapors can escape. ◀

### Manually unlocking fuel filler flap

In the event of an electrical malfunction, e.g. The release is located in the trunk.



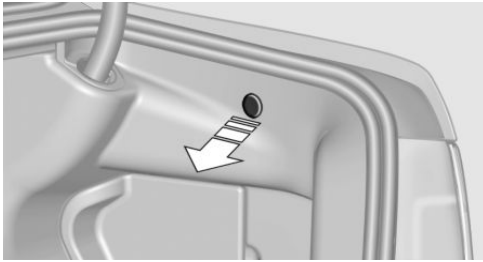

Pull the green knob with the fuel pump symbol. This releases the fuel filler flap.

## Observe the following when refueling

The fuel tank is full when the filler nozzle clicks off the first time.



Do not overfill the fuel tank

Do not overfill the fuel tank; otherwise fuel may eslide, causing harm to the environment and damaging the vehicle.◀



Handling fuels

Observe safety regulations posted at the gas station.◀

# Fuel

## Vehicle features and options

This chapter describes all standard, country-specific and optional features offered with the series. It also describes features that are not necessarily available in your car, e. g., due to the selected options or country versions. This also applies to safety-related functions and systems. The respectively applicable country provisions must be observed when using the respective features and systems.

## Fuel recommendation

### Note

 General fuel quality  
Even fuels that conform to the specifications can be of low quality. This may cause engine problems, for instance poor engine start-up behavior, poor handling and/or poor performance. Switch gas stations or use a brand name fuel with a higher octane rating. ◀

### Gasoline

For the best fuel efficiency, the gasoline should be sulfur-free or very low in sulfur content.

Fuels that are marked on the gas pump as containing metal must not be used.

 Refuel only with unleaded gasoline without metallic additives.

Do not refuel with any leaded gasoline or gasoline with metallic additives, e. g. manganese or iron, as this can cause permanent damage to the catalytic converter and other components. ◀

Fuels with a maximum ethanol content of 10 %, i. e., E10, may be used for refueling.

Ethanol should satisfy the following quality standards:

US: ASTM 4806–xx

CAN: CGSB-3.511–xx

xx: comply with the current standard in each case.

 Do not use a fuel with a higher percentage of ethanol

Do not use a fuel with a higher ethanol percentage than recommended or one with other types of alcohol, e.g. M5 to M100; otherwise this could damage the engine and fuel supply system. ◀

### Recommended fuel grade

BMW recommends AKI 91.

### Minimum fuel grade

BMW recommends AKI 89.

 Minimum fuel grade  
Do not use any gasoline below the minimum fuel grade as this may impair engine performance. ◀

If you use gasoline with this minimum AKI Rating, the engine may produce knocking sounds when starting at high outside temperatures. This has no effect on the engine life.

 Fuel quality  
The use of poor-quality fuels may result in harmful engine deposits or damage. Additionally, problems relating to drivability, starting and stalling, especially under certain environmental conditions such as high ambient temperature and high altitude, may occur.

If drivability problems are encountered, we recommend switching to a high quality gasoline brand and a higher octane grade — AKI number — for a few tank fills. To avoid harmful en-

gine deposits, it is highly recommended to purchase gasoline from Top Tier retailers. Failure to comply with these recommendations may result in the need for unscheduled maintenance. ◀

## Diesel

### Low-Sulfur Diesel

The engine of your BMW is designed for diesel with low sulfur content:

Ultra-Low Sulfur Diesel ASTM D 975-xx.

xx: comply with the current standard in each case.



Use only Ultra-Low Sulfur Diesel.

The fraction of biodiesel in the fuel must not exceed 5 %, referred to as B5. Do not use gasoline. If you do fill the tank with the wrong fuel, e.g., gasoline, do not start the engine as this may damage the engine. ◀

After adding the wrong fuel, contact your service center or Roadside Assistance.

If the fuel pump nozzle does not fit in the filler pipe of your BMW, please check to ensure that you are refueling at a diesel fuel pump that is equipped with a diesel fuel pump nozzle.

In the event the Ultra-Low Sulfur Diesel fuel cannot be fully inserted into the fuel filler neck, please contact BMW Roadside Assistance for instructions on how to add fuel.

For additional information regarding Roadside Assistance, refer to Owner's Manual for Navigation, Entertainment and Communication.

### Winter diesel

To ensure that the diesel engine remains operational in the winter, use winter diesel.

It is available at gas stations during winter months.

The fuel filter heating system, included as a standard feature, prevents disruption of the fuel supply while driving.



Do not add any diesel additives

Do not add additives, including gasoline; otherwise, engine damage may occur. ◀

## BMW Advanced Diesel

### The concept

BMW Advanced Diesel reduces nitrogen oxides in the diesel emissions by injecting diesel exhaust fluid reducing agent into the exhaust system. A chemical reaction takes place inside the catalytic converter that minimizes nitrogen oxides.

The vehicle has a tank that can be refilled.

To be able to start the engine as usual, there must be an adequate reducing agent.

Reducing agent is added by the service center.

### Warming up the system

In order to warm the engine up to its operating temperature after a cold start, the Steptronic transmission may subsequently shift up to the next higher gear.

### Displays in the instrument cluster

#### Reserve indication

This display in the instrument cluster provides information about the distance that can still be driven with the current reserve level.



- ▶ Lamp white: refill with reduction agent at the next opportunity.
- ▶ Lamp yellow: not enough reduction agent present. The remaining range is displayed in the instrument cluster. Immediately refill with reduction agent, refer to page 208.

## Diesel exhaust fluid on minimum

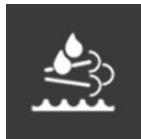

- ▷ The remaining range is displayed in the instrument cluster: refill with reduction agent. The engine will continue to run as long as it is not switched off and all other operating conditions are satisfied; sufficient fuel, e.g.



Engine does not start

Do not continue driving to the limit of the remaining travel distance. Otherwise, you will not be able to restart the engine after switching it off. In certain cases, this could cause safety to be impaired. ◀

## Filling with an incorrect fluid

A Check Control message is displayed when an incorrect fluid is added.

After adding the incorrect fluid, contact your service center.

## System defect

A Check Control message is displayed when there is a system defect.

## Have the diesel exhaust fluid replenished

The reducing agent is added by the service center within the context of regular maintenance.

It may be necessary to have the fluid replenished several times under particular circumstances, e.g., if the vehicle is driven in a particularly sporty style or if it is driven at high altitudes.

The reducing agent must be replenished as soon as the reserve display appears in the instrument cluster to avoid not being able to restart the engine.

## Diesel exhaust fluid at low temperatures

Due to its physical properties, it is possible that the reducing agent may also need to be replenished between regular maintenance appointments if it is exposed to temperatures under + 23 °F/- 5 °C. In this case, add reducing agent only immediately before driving off.

The need to replenish it is indicated by the Reserve display in the instrument cluster.

At temperatures below + 12 °F/- 11 °C, the filling level cannot be measured in some cases.

After adding reducing agent, the Reserve Display is displayed only until the fill level can be measured again.

## Replenishing Diesel exhaust fluid yourself in exceptional cases

You can replenish reducing agent yourself in exceptional cases, e.g., to get to the service center.



Avoid contact with Diesel exhaust fluid

Do not come into contact with the reducing agent. Otherwise, skin or eye irritations may result. ◀



Handling Diesel exhaust fluid

When working with reducing agent in closed spaces, ensure good ventilation. When the bottle or container is opened, acrid smelling fumes may eslide. ◀



Keeping Diesel exhaust fluid out of reach of children

Keep reducing agent out of reach of children. ◀



Avoid contact with surfaces

Avoid contact of reduction agent with surfaces of the vehicle; otherwise, damage could occur. ◀

## Suitable Diesel exhaust fluid

- ▷ Preferred: BMW Diesel Exhaust Fluid. With this bottle and its special adapter, Diesel

exhaust fluid can be replenished simply and safely.

- ▶ Alternative: NOx reduction agent AUS 32 Diesel exhaust fluid can be purchased at your service center.

### Refill quantity

When the Reserve display starts, add at least 3 bottles of reducing agent.

This corresponds to approx. 1.5 US gal/6 liters.

### Tank for reducing agent

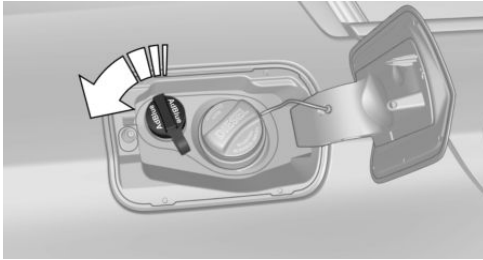

The tank for the reducing agent is located next to the fuel tank.

### Adding the reducing agent

Add the reducing agent when the ignition is switched on.

1. Open the fuel filler flap, refer to page 204.
2. Turn the tank lid counterclockwise and remove.
3. Place the bottle on it and turn it as far as it will go, see arrow.



4. Press the bottle down, see arrow.

The vehicle tank will be filled.

The tank is full when the fill level in the bottle no longer changes. It is not possible to overfill.



5. Pull back the bottle, see arrow, and unscrew it.



6. Replace the tank lid and turn it clockwise.
7. Close the fuel filler flap.

### After adding Diesel exhaust fluid

#### Note



**Incorrect fluids**

After filling with incorrect fluids, such as antifreeze for washer fluid, do not start the engine, otherwise there is risk of fire. ◀

Contact your service center.

### Disposing of bottles



You take your empty Diesel exhaust fluid bottles to your service center for disposal.

Do not dispose of empty bottles with household waste unless this is permitted by local regulations.

### Reserve indication



The Reserve display will still appear along with the remaining range after refilling.

Engine can be started.

After several minutes of driving, the Reserve indication goes out.

### Diesel exhaust fluid on minimum



After filling, the indication -- is still displayed.

Only after the display goes out can the engine -- be started.

1. Switch on the ignition.  
Display -- goes out after approx. 1 minute.
2. Engine can be started.

# Wheels and tires

## Vehicle features and options

This chapter describes all standard, country-specific and optional features offered with the series. It also describes features that are not necessarily available in your car, e. g., due to the selected options or country versions. This also applies to safety-related functions and systems. The respectively applicable country provisions must be observed when using the respective features and systems.

## Tire inflation pressure

### Safety information

The tire characteristics and tire inflation pressure influence the following:

- ▷ The service life of the tires.
- ▷ Road safety.
- ▷ Driving comfort.

### Checking the tire inflation pressure



Check the tire inflation pressure regularly

Regularly check the tire inflation pressure, and correct it as needed: at least twice a month and before a long trip. If you fail to observe this precaution, you may be driving on tires with incorrect tire pressures, a condition that may not only compromise your vehicle's driving stability, but also lead to tire damage and the risk of an accident. ◀

Tires have a natural, consistent loss of tire inflation pressure.

Tires heat up while driving, and the tire inflation pressure increases along with the tire's temperature. The tire inflation pressure specifications relate to cold tires or tires with the ambient temperature.

Only check the tire inflation pressure when the tires are cold. This means after driving no more than 1.25 miles/2 km or when the vehicle has been parked for at least 2 hours.

The displays of inflation devices may under-read by up to 1.45 psi/0.1 bar.

For Flat Tire Monitor: after correcting the tire inflation pressure, reinitialize the Flat Tire Monitor.

For Tire Pressure Monitor: after correcting the tire inflation pressure, reset the Tire Pressure Monitor.

### Tire inflation pressure specifications

The tire inflation pressure table, refer to page 212, contains all tire inflation pressure specifications for the specified tire sizes at the ambient temperature. Tire inflation pressure specifications apply to approved tire sizes and recommended tire brands. This information can be obtained from your service center.

To identify the correct tire inflation pressure, please note the following:

- ▷ Tire sizes of your vehicle.
- ▷ Maximum permitted driving speed.

### Tire inflation pressures up to 100 mph/160 km/h

For speeds of up to 100 mph/160 km/h and for optimum driving comfort, note the pressure values in the tire inflation pressure table, refer to page 212, and adjust as necessary.



These pressure values can also be found on the tire inflation pressure label on the driver's door pillar.

 **Maximum permissible speed**  
Do not exceed 100 mph/160 km/h; otherwise, tire damage and accidents may result. ◀

### Tire inflation pressure values up to 100 mph/160 km/h

#### 528i

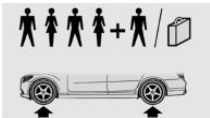
Tire size	Pressure specifications in bar/PSI	
Specifications in bar/PSI with cold tires		
225/55 R 17 97 V M +S A/S RSC	2.2 / 32	2.4 / 35
225/55 R 17 97 H M +S RSC		
245/45 R 18 100 V M+S XL A/S RSC	2.4 / 35	2.6 / 38
245/40 R 19 98 V M +S XL A/S RSC		
245/45 R 18 96 Y RSC		
245/45 R 18 100 V M+S XL RSC		

Tire size	Pressure specifications in bar/PSI	
Front: 245/45 R 18 96 Y RSC	2.4 / 35	-
Rear: 275/40 R 18 99 Y RSC	-	2.4 / 35
Front: 245/40 R 19 94 Y RSC	2.4 / 35	-
Rear: 275/35 R 19 96 Y RSC	-	2.6 / 38
Front: 245/35 R 20 95 Y XL RSC	2.4 / 35	-
Rear: 275/30 R 20 97 Y XL RSC	-	2.9 / 42
Emergency wheel: T 135/90 R 17 104 M	Speed up to a max. of 50 mph / 80 km/h	4.2 / 60

#### 535i, 535d

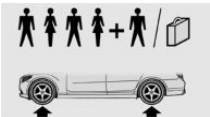
Tire size	Pressure specifications in bar/PSI	
Specifications in bar/PSI with cold tires		
245/45 R 18 100 V M+S XL A/S RSC	2.4 / 35	2.7 / 39
245/40 R 19 98 V M+S XL A/S RSC		
245/45 R 18 96 Y RSC		
225/55 R 17 97 H M+S RSC		
245/45 R 18 100 V M+S XL RSC		



Tire size	Pressure specifications in bar/PSI	
Front: 245/45 R 18 96 Y RSC	2.4 / 35	-
Rear: 275/40 R 18 99 Y RSC	-	2.4 / 35
Front: 245/40 R 19 94 Y RSC	2.4 / 35	-
Rear: 275/35 R 19 96 Y RSC	-	2.6 / 38
Front: 245/35 R 20 95 Y XL RSC	2.4 / 35	-
Rear: 275/30 R 20 97 Y XL RSC	-	2.9 / 42
Emergency wheel: T 135/90 R 17 104 M	Speed up to a max. of 50 mph / 80 km/h	
	4.2 / 60	

## 550i

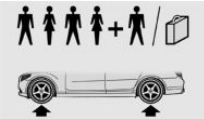
Tire size	Pressure specifications in bar/PSI	
Specifications in bar/PSI with cold tires		
245/45 R 18 100 V M+S XL A/S RSC	2.5 / 36	2.7 / 39
245/40 R 19 98 V M +S XL A/S RSC		
245/45 R 18 96 Y RSC		
245/45 R 18 100 V M+S XL RSC		
Front: 245/45 R 18 96 Y RSC	2.5 / 36	-
Rear: 275/40 R 18 99 Y RSC	-	2.5 / 36

Tire size	Pressure specifications in bar/PSI	
Front: 245/40 R 19 94 Y RSC	2.5 / 36	-
Rear: 275/35 R 19 96 Y RSC	-	2.6 / 38
Front: 245/35 R 20 95 Y XL RSC	2.6 / 38	-
Rear: 275/30 R 20 97 Y XL RSC	-	2.9 / 42

## 528i xDrive

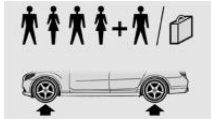
Tire size	Pressure specifications in bar/PSI	
Specifications in bar/PSI with cold tires		
225/55 R 17 97 V M +S A/S RSC	2.4 / 35	2.6 / 38
225/55 R 17 97 H M +S RSC		
245/45 R 18 100 V M+S XL A/S RSC		
245/40 R 19 98 V M +S XL A/S RSC		
245/45 R 18 96 Y RSC		
245/45 R 18 100 V M+S XL RSC		
Front: 245/45 R 18 96 Y RSC	2.4 / 35	-
Rear: 275/40 R 18 99 Y RSC	-	2.4 / 35
Front: 245/40 R 19 94 Y RSC	2.4 / 35	-
Rear: 275/35 R 19 96 Y RSC	-	2.6 / 38

Tire size	Pressure specifications in bar/PSI	
Front: 245/35 R 20 95 Y XL RSC	2.5 / 36	-
Rear: 275/30 R 20 97 Y XL RSC	-	3.0 / 44
Emergency wheel: T 135/90 R 17 104 M	Speed up to a max. of 50 mph / 80 km/h 4.2 / 60	

Tire size	Pressure specifications in bar/PSI	
Front: 245/35 R 20 95 Y XL RSC	2.5 / 36	-
Rear: 275/30 R 20 97 Y XL RSC	-	3.0 / 44
Emergency wheel: T 135/90 R 17 104 M	Speed up to a max. of 50 mph / 80 km/h 4.2 / 60	

### 535i xDrive, 535d xDrive

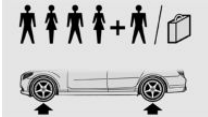
Tire size	Pressure specifications in bar/PSI	
Specifications in bar/PSI with cold tires		
245/45 R 18 100 V M+S XL A/S RSC	2.4 / 35	2.7 / 39
245/40 R 19 98 V M+S XL A/S RSC		
245/45 R 18 96 Y RSC		
225/55 R 17 97 H M+S RSC		
245/45 R 18 100 V M+S XL RSC		
Front: 245/45 R 18 96 Y RSC	2.4 / 35	-
Rear: 275/40 R 18 99 Y RSC	-	2.4 / 35
Front: 245/40 R 19 94 Y RSC	2.4 / 35	-
Rear: 275/35 R 19 96 Y RSC	-	2.6 / 38

### 550i xDrive

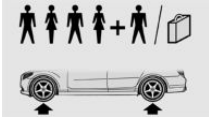
Tire size	Pressure specifications in bar/PSI	
Specifications in bar/PSI with cold tires		
245/45 R 18 100 V M+S XL A/S RSC	2.6 / 38	2.7 / 39
245/40 R 19 98 V M +S XL A/S RSC		
245/45 R 18 96 Y RSC		
245/45 R 18 100 V M+S XL RSC		
Front: 245/45 R 18 96 Y RSC	2.6 / 38	-
Rear: 275/40 R 18 99 Y RSC	-	2.6 / 38
Front: 245/40 R 19 94 Y RSC	2.6 / 38	-
Rear: 275/35 R 19 96 Y RSC	-	2.7 / 39
Front: 245/35 R 20 95 Y XL RSC	2.7 / 39	-
Rear: 275/30 R 20 97 Y XL RSC	-	3.1 / 45

## Tire inflation pressures at max. speeds above 100 mph/160 km/h



Speeds above 100 mph/160 km/h

In order to drive at maximum speeds in excess of 100 mph/160 km/h, please observe, and, if necessary, adjust tire pressures for speeds exceeding 100 mph/160 km/h from the relevant table on the following pages. Otherwise tire damage and accidents could occur. ◀

## Tire inflation pressure values over 100 mph/160 km/h

### 528i

Without high-speed tuning feature

Tire size	Pressure specifications in bar/PSI	
Specifications in bar/PSI with cold tires		
225/55 R 17 97 V M +S A/S RSC	2.2 / 32	2.6 / 38
225/55 R 17 97 H M+S RSC		
245/45 R 18 100 V M+S XL A/S RSC	2.4 / 35	2.9 / 42
245/40 R 19 98 V M +S XL A/S RSC		
245/45 R 18 96 Y RSC		
245/45 R 18 100 V M+S XL RSC		
Front: 245/45 R 18 96 Y RSC	2.4 / 35	-
Rear: 275/40 R 18 99 Y RSC	-	2.4 / 35

Tire size	Pressure specifications in bar/PSI	
Front: 245/40 R 19 94 Y RSC	2.4 / 35	-
Rear: 275/35 R 19 96 Y RSC	-	2.6 / 38
Front: 245/35 R 20 95 Y XL RSC	2.4 / 35	-
Rear: 275/30 R 20 97 Y XL RSC	-	2.9 / 42
Emergency wheel: T 135/90 R 17 104 M	Speed up to a max. of 50 mph / 80 km/h	4.2 / 60

With high-speed tuning feature

Tire size	Pressure specifications in bar/PSI	
Specifications in bar/PSI with cold tires		
225/55 R 17 97 V M +S A/S RSC	2.5 / 36	3.0 / 44
225/55 R 17 97 H M+S RSC		
245/45 R 18 100 V M+S XL A/S RSC	2.7 / 39	3.2 / 46
245/40 R 19 98 V M +S XL A/S RSC		
245/45 R 18 96 Y RSC		
245/45 R 18 100 V M+S XL RSC		
Front: 245/45 R 18 96 Y RSC	2.7 / 39	-
Rear: 275/40 R 18 99 Y RSC	-	2.7 / 39

Tire size	Pressure specifications in bar/PSI	
Front: 245/40 R 19 94 Y RSC	2.7 / 39	-
Rear: 275/35 R 19 96 Y RSC	-	3.0 / 44
Front: 245/35 R 20 95 Y XL RSC	2.7 / 39	-
Rear: 275/30 R 20 97 Y XL RSC	-	3.2 / 46
Emergency wheel: T 135/90 R 17 104 M	Speed up to a max. of 50 mph / 80 km/h	
	4.2 / 60	

Tire size	Pressure specifications in bar/PSI	
Front: 245/40 R 19 94 Y RSC	2.4 / 35	-
Rear: 275/35 R 19 96 Y RSC	-	2.6 / 38
Front: 245/35 R 20 95 Y XL RSC	2.4 / 35	-
Rear: 275/30 R 20 97 Y XL RSC	-	2.9 / 42
Emergency wheel: T 135/90 R 17 104 M	Speed up to a max. of 50 mph / 80 km/h	
	4.2 / 60	

### 535i, 535d

Without high-speed tuning feature

Tire size	Pressure specifications in bar/PSI	
Specifications in bar/PSI with cold tires		
245/45 R 18 100 V M+S XL A/S RSC	2.4 / 35	2.9 / 42
245/40 R 19 98 V M+S XL A/S RSC		
245/45 R 18 96 Y RSC		
225/55 R 17 97 H M+S RSC		
245/45 R 18 100 V M+S XL RSC		
Front: 245/45 R 18 96 Y RSC	2.4 / 35	-
Rear: 275/40 R 18 99 Y RSC	-	2.4 / 35

With high-speed tuning feature

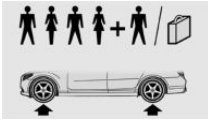
Tire size	Pressure specifications in bar/PSI	
Specifications in bar/PSI with cold tires		
245/45 R 18 100 V M+S XL A/S RSC	2.7 / 39	3.2 / 46
245/45 R 18 96 Y RSC		
225/55 R 17 97 H M+S RSC		
245/45 R 18 100 V M+S XL RSC		
245/40 R 19 98 V M+S XL A/S RSC	2.8 / 41	3.3 / 48
Front: 245/45 R 18 96 Y RSC	2.7 / 39	-
Rear: 275/40 R 18 99 Y RSC	-	2.7 / 39

Tire size	Pressure specifications in bar/PSI	
Front: 245/40 R 19 94 Y RSC	2.7 / 39	-
Rear: 275/35 R 19 96 Y RSC	-	3.0 / 44
Front: 245/35 R 20 95 Y XL RSC	2.7 / 39	-
Rear: 275/30 R 20 97 Y XL RSC	-	3.2 / 46
Emergency wheel: T 135/90 R 17 104 M	Speed up to a max. of 50 mph / 80 km/h 4.2 / 60	

## 550i

Without high-speed tuning feature

Tire size	Pressure specifications in bar/PSI	
Specifications in bar/PSI with cold tires		
245/45 R 18 100 V M+S XL A/S RSC	2.5 / 36	3.0 / 44
245/40 R 19 98 V M +S XL A/S RSC		
245/45 R 18 96 Y RSC		
245/45 R 18 100 V M+S XL RSC		
Front: 245/45 R 18 96 Y RSC	2.5 / 36	-
Rear: 275/40 R 18 99 Y RSC	-	2.5 / 36

Tire size	Pressure specifications in bar/PSI	
Front: 245/40 R 19 94 Y RSC	2.5 / 36	-
Rear: 275/35 R 19 96 Y RSC	-	2.6 / 38
Front: 245/35 R 20 95 Y XL RSC	2.6 / 38	-
Rear: 275/30 R 20 97 Y XL RSC	-	2.9 / 42

With high-speed tuning feature

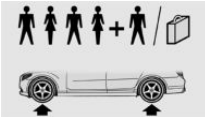
Tire size	Pressure specifications in bar/PSI	
Specifications in bar/PSI with cold tires		
245/45 R 18 100 V M+S XL A/S RSC	2.9 / 42	3.3 / 48
245/40 R 19 98 V M +S XL A/S RSC		
245/45 R 18 96 Y RSC		
245/45 R 18 100 V M+S XL RSC		
Front: 245/45 R 18 96 Y RSC	2.9 / 42	-
Rear: 275/40 R 18 99 Y RSC	-	2.9 / 42
Front: 245/40 R 19 94 Y RSC	2.9 / 42	-
Rear: 275/35 R 19 96 Y RSC	-	3.3 / 48
Front: 245/35 R 20 95 Y XL RSC	2.9 / 42	-
Rear: 275/30 R 20 97 Y XL RSC	-	3.3 / 48

### 528i xDrive

Without high-speed tuning feature

Tire size	Pressure specifications in bar/PSI	
Specifications in bar/PSI with cold tires		
225/55 R 17 97 V M +S A/S RSC	2.4 / 35	2.9 / 42
225/55 R 17 97 H M +S RSC		
245/45 R 18 100 V M+S XL A/S RSC		
245/40 R 19 98 V M +S XL A/S RSC		
245/45 R 18 96 Y RSC		
245/45 R 18 100 V M+S XL RSC		
Front: 245/45 R 18 96 Y RSC	2.4 / 35	-
Rear: 275/40 R 18 99 Y RSC	-	2.4 / 35
Front: 245/40 R 19 94 Y RSC	2.4 / 35	-
Rear: 275/35 R 19 96 Y RSC	-	2.6 / 38
Front: 245/35 R 20 95 Y XL RSC	2.5 / 36	-
Rear: 275/30 R 20 97 Y XL RSC	-	3.0 / 44
Emergency wheel: T 135/90 R 17 104 M	Speed up to a max. of 50 mph / 80 km/h	
	4.2 / 60	

With high-speed tuning feature

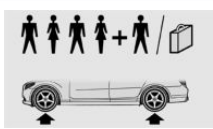
Tire size	Pressure specifications in bar/PSI	
Specifications in bar/PSI with cold tires		
225/55 R 17 97 V M +S A/S RSC	2.8 / 41	3.3 / 48
245/45 R 18 100 V M+S XL A/S RSC		
245/40 R 19 98 V M +S XL A/S RSC		
225/55 R 17 97 H M +S RSC		
245/45 R 18 96 Y RSC		
245/45 R 18 100 V M+S XL RSC		
Front: 245/45 R 18 96 Y RSC	2.8 / 41	-
Rear: 275/40 R 18 99 Y RSC	-	2.8 / 41
Front: 245/40 R 19 94 Y RSC	2.8 / 41	-
Rear: 275/35 R 19 96 Y RSC	-	3.0 / 44
Front: 245/35 R 20 95 Y XL RSC	2.9 / 42	-
Rear: 275/30 R 20 97 Y XL RSC	-	3.3 / 48
Emergency wheel: T 135/90 R 17 104 M	Speed up to a max. of 50 mph / 80 km/h	
	4.2 / 60	

### 535i xDrive, 535d xDrive

Without high-speed tuning feature

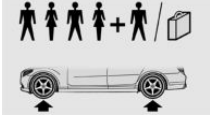
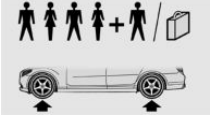
Tire size	Pressure specifications in bar/PSI		Tire size	Pressure specifications in bar/PSI	
Specifications in bar/PSI with cold tires			Specifications in bar/PSI with cold tires		
245/45 R 18 100 V M+S XL A/S RSC	2.5 / 36	2.9 / 42	245/45 R 18 100 V M+S XL A/S RSC	2.8 / 41	3.3 / 48
245/40 R 19 98 V M +S XL A/S RSC			245/40 R 19 98 V M +S XL A/S RSC		
245/45 R 18 96 Y RSC			245/45 R 18 96 Y RSC		
225/55 R 17 97 H M +S RSC			225/55 R 17 97 H M +S RSC		
245/45 R 18 100 V M+S XL RSC			245/45 R 18 100 V M+S XL RSC		
Front: 245/45 R 18 96 Y RSC	2.5 / 36	-	Front: 245/45 R 18 96 Y RSC	2.8 / 41	-
	-	2.5 / 36		-	2.8 / 41
Rear: 275/40 R 18 99 Y RSC			Rear: 275/40 R 18 99 Y RSC		
Front: 245/40 R 19 94 Y RSC	2.4 / 35	-	Front: 245/40 R 19 94 Y RSC	2.8 / 41	-
	-	2.6 / 38		-	3.0 / 44
Rear: 275/35 R 19 96 Y RSC			Rear: 275/35 R 19 96 Y RSC		
Front: 245/35 R 20 95 Y XL	2.5 / 36	-	Front: 245/35 R 20 95 Y XL RSC	2.9 / 42	-
	-	3.0 / 44		-	3.3 / 48
Rear: 275/30 R 20 97 Y XL			Rear: 275/30 R 20 97 Y XL RSC		
Emergency wheel: T 135/90 R 17 104 M	Speed up to a max. of 50 mph / 80 km/h		Emergency wheel: T 135/90 R 17 104 M	Speed up to a max. of 50 mph / 80 km/h	
	4.2 / 60			4.2 / 60	
With high-speed tuning feature					

### 550i xDrive

Without high-speed tuning feature

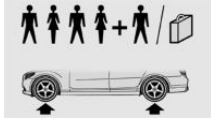
Tire size	Pressure specifications in bar/PSI	
Specifications in bar/PSI with cold tires		
245/45 R 18 100 V M+S XL A/S RSC	2.6 / 38	3.0 / 44
245/40 R 19 98 V M +S XL A/S RSC		
245/45 R 18 96 Y RSC		
245/45 R 18 100 V M+S XL RSC		
Front: 245/45 R 18 96 Y RSC	2.6 / 38	-
Rear: 275/40 R 18 99 Y RSC	-	2.6 / 38
Front: 245/40 R 19 94 Y RSC	2.6 / 38	-
Rear: 275/35 R 19 96 Y RSC	-	2.7 / 39
Front: 245/35 R 20 95 Y XL RSC	2.7 / 39	-
Rear: 275/30 R 20 97 Y XL RSC	-	3.1 / 45

With high-speed tuning feature

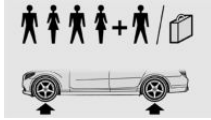
Tire size	Pressure specifications in bar/PSI	
Specifications in bar/PSI with cold tires		
245/45 R 18 100 V M+S XL A/S RSC	3.0 / 44	3.4 / 49
245/40 R 19 98 V M +S XL A/S RSC		
245/45 R 18 96 Y RSC		
245/45 R 18 100 V M+S XL RSC		
Front: 245/45 R 18 96 Y RSC	3.0 / 44	-
Rear: 275/40 R 18 99 Y RSC	-	3.0 / 44
Front: 245/40 R 19 94 Y RSC	3.0 / 44	-
Rear: 275/35 R 19 96 Y RSC	-	3.2 / 46
Front: 245/35 R 20 95 Y XL RSC	3.1 / 45	-
Rear: 275/30 R 20 97 Y XL RSC	-	3.4 / 49

## Tire identification marks

### Tire size

245/45 R 18 96 Y

245: nominal width in mm

45: aspect ratio in %

R: radial tire code

18: rim diameter in inches

96: load rating, not for ZR tires

Y: speed rating, before the R on ZR tires



## Speed letter

Q = up to 100 mph, 160 km/h

R = up to 106 mph, 170 km/h

S = up to 112 mph, 180 km/h

T = up to 118 mph, 190 km/h

H = up to 131 mph, 210 km/h

V = up to 150 mph, 240 km/h

W = up to 167 mph, 270 km/h

Y = up to 186 mph, 300 km/h

## Tire Identification Number

DOT code: DOT xxxx xxx 0115

xxxx: manufacturer code for the tire brand

xxx: tire size and tire design

0115: tire age

Tires with DOT codes meet the guidelines of the U.S. Department of Transportation.

## Tire age

DOT ... 0115: the tire was manufactured in the 1st week of 2015.

## Recommendation

Regardless of wear and tear, replace tires at least every 6 years.

## Uniform Tire Quality Grading

Quality grades can be found where applicable on the tire sidewall between tread shoulder and maximum section width.

For example: Treadwear 200; Traction AA; Temperature A

## DOT Quality Grades

Treadwear

Traction AA A B C

Temperature A B C

All passenger car tires must conform to Federal Safety Requirements in addition to these grades.

## Treadwear

The treadwear grade is a comparative rating based on the wear rate of the tire when tested under controlled conditions on a specified government test course. For example, a tire graded 150 would wear one and one-half, 1 g, times as well on the government course as a tire graded 100. The relative performance of tires depends upon the actual conditions of their use, however, and may depart significantly from the norm due to variations in driving habits, service practices and differences in road characteristics and climate.

## Traction

The traction grades, from highest to lowest, are AA, A, B, and C.

Those grades represent the tire's ability to stop on wet pavement as measured under controlled conditions on specified government test surfaces of asphalt and concrete. A tire marked C may have poor traction performance.

The traction grade assigned to this tire is based on straight-ahead braking traction tests, and does not include acceleration, cornering, hydroplaning, or peak traction characteristics.

## Temperature

The temperature grades are A, the highest, B, and C, representing the tire's resistance to the generation of heat and its ability to dissipate heat when tested under controlled conditions on a specified indoor laboratory test wheel. Sustained high temperature can cause the material of the tire to degenerate and reduce tire life, and excessive temperature can lead to sudden tire failure. The grade C corresponds to a level of performance which all passenger car tires must meet under the Federal Motor Vehicle Safety Standard No. 109. Grades Band A represent higher levels of performance on the laboratory test wheel than the minimum required by law.



Temperature grade for this tire

The temperature grade for this tire is established for a tire that is properly inflated and not overloaded. Excessive speed, underinflation, or excessive loading, either separately or in combination, can cause heat buildup and possible tire failure.

If necessary, have the vehicle towed. ◀

### RSC – Run-flat tires

Run-flat tires, refer to page 224, are labeled with a circular symbol containing the letters RSC marked on the sidewall.

### M+S

Winter and all-season tires with better cold weather performance than summer tires.

## Tire tread

### Summer tires

Do not drive with a tire tread depth of less than 0.12 in/3 mm.

There is an increased danger of hydroplaning if the tire tread depth is less than 0.12 in/3 mm.

### Winter tires

Do not drive with a tire tread depth of less than 0.16 in/4 mm.

Below a tread depth of 0.16 in/4 mm, tires are less suitable for winter operation.

## Minimum tread depth

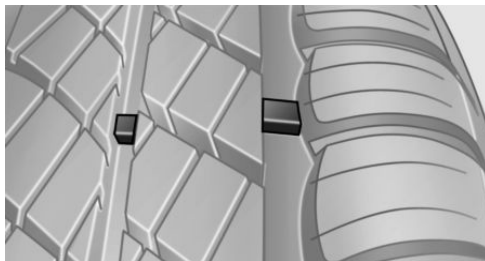

Wear indicators are distributed around the tire's circumference and have the legally required minimum height of 0.063 in/1.6 mm.

They are marked on the side of the tire with TWI, Tread Wear Indicator.

## Tire damage

### General information

Inspect your tires often for damage, foreign objects lodged in the tread, and tread wear.

### Hints

Driving over rough or damaged road surfaces, as well as debris, curbs and other obstacles can cause serious damage to wheels, tires and suspension parts. This is more likely to occur with low-profile tires, which provide less cushioning between the wheel and the road. Be careful to avoid road hazards and reduce your speed, especially if your vehicle is equipped with low-profile tires.

Indications of tire damage or other vehicle defects:

- ▷ Unusual vibrations while driving.
- ▷ Unusual handling such as a strong tendency to pull to the left or right.

Damage can, e. g., be caused by driving over curbs, road damage, or similar things.

**In case of tire damage**

If there are indications of tire damage, reduce your speed immediately and have the rims and tires checked right away; otherwise, there is the increased risk of an accident.

Drive carefully to the nearest service center. If necessary, have the vehicle towed or transported there. Otherwise, tire damage can become life threatening for vehicle occupants and also other traffic. ◀

**Repair of tire damage**

For safety reasons, the manufacturer of your vehicle recommends that you do not have damaged tires repaired; they should be replaced. Otherwise, damage can occur as a result. ◀

## Changing wheels and tires

### Mounting

**Information on mounting tires**

Have mounting and balancing performed only by a service center.

If work is not carried out properly, there is a danger of subsequent damage and related safety hazards. ◀

### Wheel and tire combination

You can ask the service center about the right wheel/tire combination and wheel rim versions for the vehicle.

Incorrect wheel and tire combinations impair the function of a variety of systems such as ABS or DSC.

To maintain good handling and vehicle response, use only tires with a single tread configuration from a single manufacturer.

Following tire damage, have the original wheel and tire combination remounted on the vehicle as soon as possible.

**Approved wheels and tires**

You should only use wheels and tires that have been approved by the vehicle manufacturer for your vehicle type; otherwise, e.g., despite having the same official size ratings, variations can lead to chassis contact and with it, the risk of severe accidents

The manufacturer of your vehicle cannot evaluate non-approved wheels and tires to determine if they are suited for use, and therefore cannot guarantee the operating safety of the vehicle. ◀

### Recommended tire brands



For each tire size, the manufacturer of your vehicle recommends certain tire brands. These can be identified by a star on the tire sidewall. With proper use, these tires meet the highest standards for safety and handling.

### New tires

Tire traction is not optimal due to manufacturing circumstances when tires are brand-new; they achieve their full traction potential after a break-in time.

Drive conservatively for the first 200 miles/300 km.

### Retreaded tires

The manufacturer of your vehicle does not recommend the use of retreaded tires.



### Retreaded tires

Possibly substantial variations in the design and age of the tire casing structures can limit service life and have a negative impact on road safety. ◀

## Winter tires

Winter tires are recommended for operating on winter roads.

Although so-called all-season M+S tires provide better winter traction than summer tires, they do not provide the same level of performance as winter tires.

### Maximum speed of winter tires

If the maximum speed of the vehicle is higher than the permissible speed for the winter tires, then a respective symbol is displayed in your field of vision. You can obtain this sign from the tire specialist or from your service center.



### Maximum speed for winter tires

Do not exceed the maximum speed for the respective winter tires; otherwise, tire damage and accidents can occur. ◀

## Run-flat tires

If you are already using run-flat tires, for your own safety you should replace them only with the same kind. No spare tire is available in the case of a flat tire. Your service center will be glad to advise you.

## Rotating wheels between axles

Different wear patterns can occur on the front and rear axles depending on individual driving conditions. The tires can be rotated between the axles to achieve even wear. Your service center will be glad to advise you. After rotating, check the tire pressure and correct if needed.

Rotating the tires is not permissible on vehicles with different tire sizes or rim sizes on the front and rear axles.

## Storage

Store wheels and tires in a cool, dry place with as little exposure to light as possible.

Always protect tires against all contact with oil, grease and fuels.

Do not exceed the maximum tire inflation pressure indicated on the side wall of the tire.

## Run-flat tires

### Label



RSC label on the tire sidewall.

The wheels consist of tires that are self-supporting, to a limited degree, and possibly special rims.

The support of the sidewall allows the tire to remain drivable to a restricted degree in the event of a tire inflation pressure loss.

Follow the instructions for continued driving with a flat tire.

### Changing run-flat tires

For your own safety, only use run-flat tires. No spare tire is available in the case of a flat tire. Your service center will be glad to advise you.

## Mobility System

### The concept

With the Mobility System, minor tire damage can be sealed quickly to enable continued travel. To accomplish this, sealant is pumped

into the tires, which seals the damage from the inside.

The compressor can be used to check the tire inflation pressure.

## Hints

- ▶ Follow the instructions on using the Mobility System found on the compressor and sealant container.
- ▶ Use of the Mobility System may be ineffective if the tire puncture measures approx. 1/8 in/4 mm or more.
- ▶ Contact the nearest service center if the tire cannot be made drivable.
- ▶ If possible, do not remove foreign bodies that have penetrated the tire.
- ▶ Pull the speed limit sticker off the sealant container and apply it to the steering wheel.
- ▶ The use of a sealant can damage the TPM wheel electronics. In this case, have the electronics checked at the next opportunity and have them replaced if needed.



### Enclosed areas

Do not let the engine run in enclosed areas, since breathing in exhaust fumes may lead to loss of consciousness and death. The exhaust gases contain carbon monoxide, an odorless and colorless but highly toxic gas. ◀

## Storage

The Mobility System is located under the cargo floor panel.

## Sealing container



- ▶ Sealing container, arrow 1.
- ▶ Filling hose, arrow 2.

Observe use-by date on the sealant container.

## Compressor

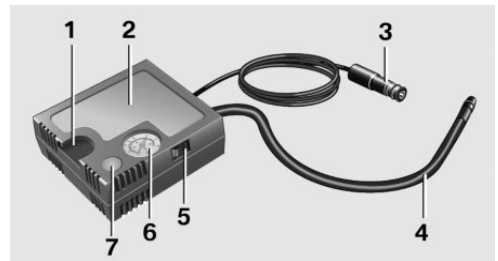

- 1 Holder for bottle
- 2 Compressor
- 3 Connector/cable for socket
- 4 Connection hose
- 5 On/off reel
- 6 Inflation pressure dial
- 7 Reduce inflation pressure

### Filling the tire with sealant

1. Shake the sealing container.



2. Pull the connection hose fully out of the compressor housing. Do not kink the hose.

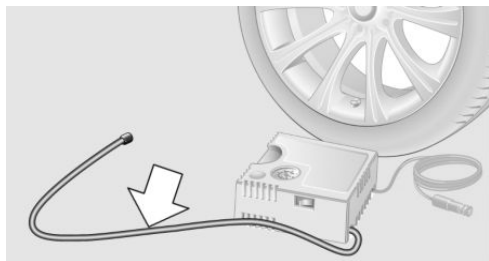

3. Screw the connection hose onto the connector of the sealant container.

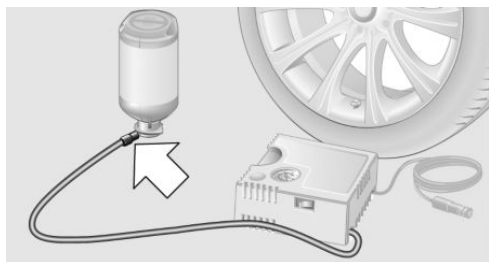

4. Insert the sealant container on the compressor housing in an upright position.

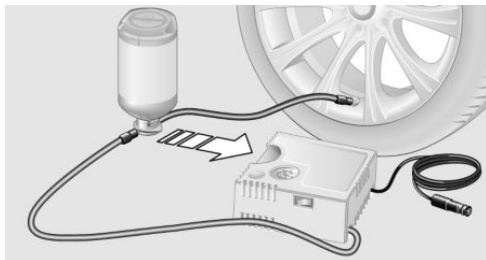

5. Screw the filling hose of the sealant container onto the tire valve of the defective wheel.

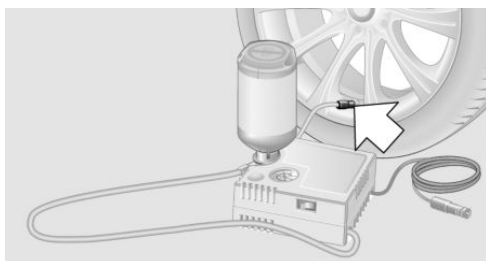

6. With the compressor switched off, insert the plug into the power socket inside the vehicle.

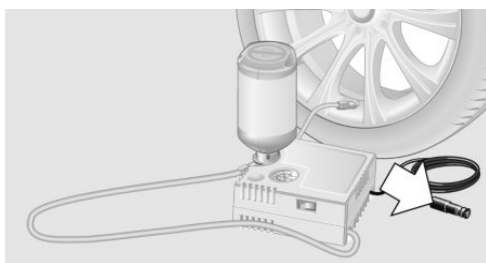

7. With the ignition turned on or the engine running, reel on the compressor.

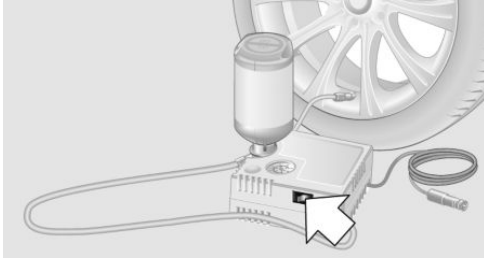

- ⚠** Switch off the compressor after 10 minutes

Do not allow the compressor to run longer than 10 minutes; otherwise, the device will overheat and may be damaged. ◀

Let the compressor run for approx. 3 to 8 minutes to fill the tire with sealant and achieve a tire inflation pressure of approx. 2.5 bar.

While the tire is being filled with sealant, the tire inflation pressure may sporadically reach approx. 5 bar. Do not reel off the compressor at this point.

If a tire inflation pressure of 2 bar is not reached:

1. Switch off the compressor.
2. Unscrew the filling hose from the wheel.
3. Drive 33 ft/10 m forward and back to distribute the sealant in the tire.
4. Inflate the tire again using the compressor.

If a tire inflation pressure of 2 bar cannot be reached, contact your service center.

### Stowing the Mobility System

1. Unscrew the filling hose of the sealant container from the wheel.
2. Unscrew the connection hose of the compressor from the sealant container.
3. Connect the filling hose of the sealant container previously connected to the tire valve with the available connector on the sealant container.

This prevents leftover sealant from escaping from the container.

4. Wrap the empty sealant container in suitable material to avoid dirtying the cargo area.
5. Stow the Mobility System back in the vehicle.

### Distributing the sealant

Immediately drive approx. 5 miles/10 km to ensure that the sealant is evenly distributed in the tire.

Do not exceed a speed of 50 mph/80 km/h.

If possible, do not drive at speeds less than 12 mph/20 km/h.

### To correct the tire inflation pressure

1. Stop at a suitable location.
2. Screw the connection hose of the compressor directly onto the tire valve stem.
3. Insert the connector into the power socket inside the vehicle.
4. Correct the tire inflation pressure to 2.5 bar.
  - ▶ Increase pressure: with the ignition turned on or the engine running, reel on the compressor.
  - ▶ To reduce the pressure: press the button on the compressor.

### Continuing the trip

Do not exceed the maximum permissible speed of 50 mph/80 km/h.

Reinitialize the Flat Tire Monitor.

Reinitialize the Tire Pressure Monitor.

Replace the defective tire and the sealant container of the Mobility System as soon as possible.

## Snow chains

### Fine-link snow chains

Only certain types of fine-link snow chains have been tested by the manufacturer of the vehicle, classified as road-safe and approved.

Information about the approved snow chains are available from the service center.

### Use

Use only in pairs on the rear wheels, equipped with the tires of the following size:

- ▷ 225/55 R 17.
- ▷ 245/45 R 18.
- ▷ 245/40 R 19.

Follow the snow chain manufacturer's instructions.

Make sure that the snow chains are always sufficiently tight. Retighten as needed according to the chain manufacturer's instructions.

Do not initialize the Flat Tire Monitor after mounting snow chains, as doing so may result in incorrect readings.

Do not initialize the Tire Pressure Monitor after mounting snow chains, as doing so may result in incorrect readings.

When driving with snow chains, briefly activate Dynamic Traction Control if needed.

### Maximum speed with snow chains

Do not exceed a speed of 30 mph/50 km/h when using snow chains.

### Snow chain detection

#### The concept

When using snow chains, settings should be made via the iDrive for the snow chains being applied.

The snow chain detection system supports you by automatically showing the detected state on the Control Display.

When snow chains are in use, the rear axle steering of the Integral Active Steering is deactivated automatically.

At speeds above the maximum permitted speed with snow chains of 30 mph/50 km/h, the rear axle steering is activated again automatically.

### Activating the status

1. "Settings"
2. "Tire chains"
3. "Tire chains installed"

### Automatic detection

If functioning properly:

- ▷ Snow chains are mounted. Settings are not activated  .

After you drive a short distance, a Check Control message is shown and the state is activated automatically.

Confirm the automatic activation.

- ▷ Snow chains are not mounted. Settings are activated  .

At speeds above 30 mph/50 km/h, a Check Control message is displayed. Deactivate the status manually.

If not functioning properly:

- ▷ Snow chains are mounted. Settings are not activated  .

A Check Control message is not displayed.

The automatic detection system is malfunctioning. Activate the status manually.

### Activating/deactivating rear axle steering

If the status indicating that snow chains are in use is activated, the rear axle steering is deactivated automatically.

At speeds above 30 mph/50 km/h, the rear axle steering is activated again, even though snow chains are in use.



# Engine compartment

## Vehicle features and options

This chapter describes all standard, country-specific and optional features offered with the series. It also describes features that are not necessarily available in your car, e. g., due to

the selected options or country versions. This also applies to safety-related functions and systems. The respectively applicable country provisions must be observed when using the respective features and systems.

## Important features in the engine compartment

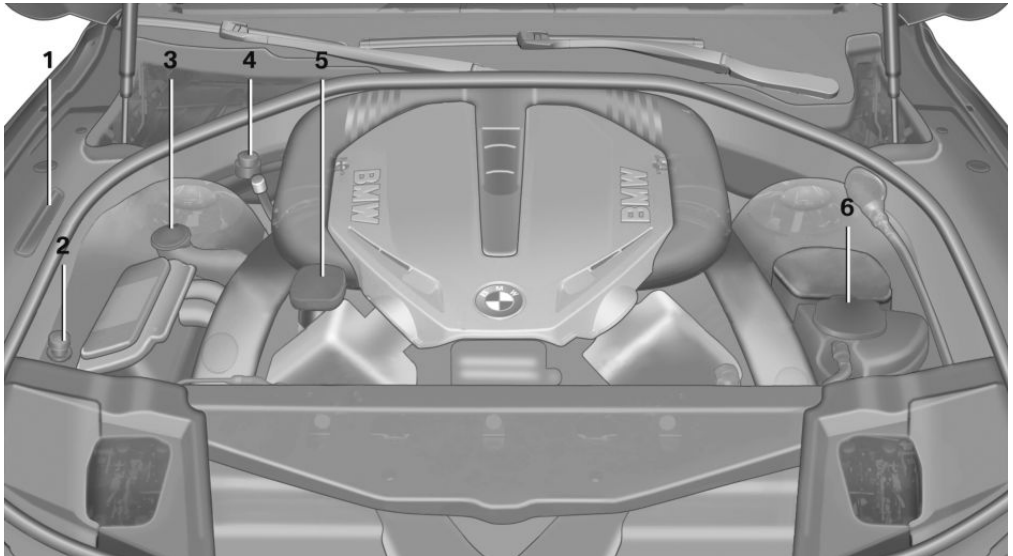

- |                                                                                                                          |                                                                                                       |
|--------------------------------------------------------------------------------------------------------------------------|-------------------------------------------------------------------------------------------------------|
| <p>1 Vehicle identification number</p> <p>2 Jump-starting, negative battery terminal</p> <p>3 Washer fluid reservoir</p> | <p>4 Jump-starting, positive battery terminal</p> <p>5 Oil filler neck</p> <p>6 Coolant reservoir</p> |
|--------------------------------------------------------------------------------------------------------------------------|-------------------------------------------------------------------------------------------------------|

## Hood

### Opening the hood



Working in the engine compartment

Never attempt to perform any service or repair operations on your vehicle without the necessary professional technical training.

If you are unfamiliar with the statutory guidelines, have any work on the vehicle performed only by a service center.

If work is not carried out properly, there is a danger of subsequent damage and related safety hazards. ◀

 Never reach into the engine compartment

Never reach into spaces or gaps in the engine compartment; otherwise, there is a risk of injury, e.g., from rotating or hot parts. ◀

 Danger of injury when the hood is open  
There is a danger of injury from protruding parts when the hood is open. ◀

1. Pull the lever.

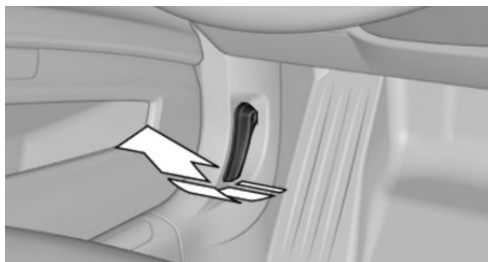

2. Press the release handle and open the hood.

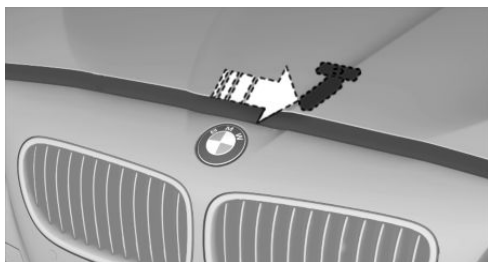

3. Be careful of protruding parts on the hood.



## Closing the hood

 Hood open when driving  
If you see any signs that the hood is not completely closed while driving, pull over immediately and close it securely. ◀

 Danger of jamming  
Make sure that the closing path of the hood is clear; otherwise, injuries may result. ◀



Let the hood drop from a height of approx. 16 in/40 cm and push down on it to lock it fully.

The hood must audibly engage on both sides.

# Engine oil

## Vehicle features and options

This chapter describes all standard, country-specific and optional features offered with the series. It also describes features that are not necessarily available in your car, e. g., due to the selected options or country versions. This also applies to safety-related functions and systems. The respectively applicable country provisions must be observed when using the respective features and systems.

## General information

The engine oil consumption is dependent on the driving style and driving conditions.

The engine oil consumption can increase in case of, for example:

- ▶ Sporty driving.
- ▶ Break-in the engine.
- ▶ Idling of the engine.
- ▶ Usage of non-approved engine oil grades.

Therefore, regularly check the engine oil level after refueling.

Depending on its engine, the vehicle is equipped with electronic oil measurement or oil measuring is done with a dipstick.

The electronic oil measurement has two measuring principles:

- ▶ Status display
- ▶ Detailed measurement

## Electronic oil measurement

### Status display

#### The concept

The engine oil level is monitored electronically while driving and shown on the Control Display.

If the engine oil level reaches the minimum level, a check control message is displayed.

#### Requirements

A current measured value is available after approx. 30 minutes of driving. During a shorter trip, the status of the last, sufficiently long trip is displayed.

With frequent short-distance trips, regularly perform a detailed measurement.

### Displaying the engine oil level

On the Control Display:

1. "Vehicle info"
2. "Vehicle status"
3.  "Engine oil level"

### Engine oil level display messages

Different messages appear on the display depending on the engine oil level. Pay attention to these messages.

If the engine oil level is too low, within the next 125 miles/200 km Add engine oil, refer to page 232.



Engine oil level too low

Add engine oil immediately; otherwise, an insufficient amount of engine oil could result in engine damage. ◀

Take care not to add too much engine oil.



Too much engine oil

Have the vehicle checked immediately; otherwise, surplus engine oil can lead to engine damage. ◀

## Detailed measurement

### The concept

In the detailed measurement the engine oil level is checked and displayed via a scale.

Gasoline engine:

If the engine oil level reaches the minimum level, a check control message is displayed.

Diesel engine:

If the engine oil level reaches the minimum level or an overfilling is detected, a check control message is displayed.

During the measurement, the idle speed is increased somewhat.

### General information

A detailed measurement is only possible with certain engines.

### Requirements

- ▷ Vehicle is on level road.
- ▷ Manual transmission: shift lever in neutral position, clutch and accelerator pedals not depressed.
- ▷ Steptronic transmission: selector lever in selector lever position N or P and accelerator pedal not depressed.
- ▷ Engine is running and is at operating temperature.

### Performing a detailed measurement

In order to perform a detailed measurement of the engine oil level:

1. "Vehicle info"
2. "Vehicle status"

3.  "Measure engine oil level"

4. "Start measurement"

The engine oil level is checked and displayed via a scale.

Time: approx. 1 minute.

## Adding engine oil

### General information

Switch off the ignition and safely park the vehicle before engine oil is added.

### Oil filler neck

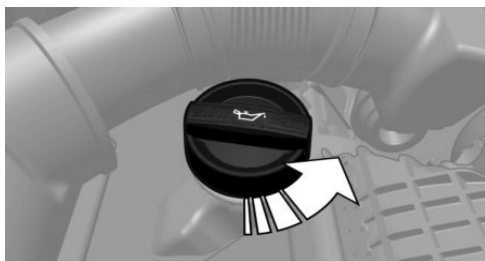

Only add engine oil when the message is displayed in the instrument cluster or when the engine oil level has almost dropped to the lower mark of the dipstick.

Add 1 US quart/liter.



Adding engine oil

Add oil within the next 125 miles/200 km; otherwise, this may cause engine damage. ◀



Do not add too much engine oil

When too much engine oil is added, immediately have the vehicle checked, otherwise, this may cause engine damage. ◀



Protect children

Keep oil, grease, etc., out of reach of children and observe the warnings on the containers to prevent health risks. ◀

## Engine oil types to add

### Hints



No oil additives

Oil additives may lead to engine damage. ◀



Viscosity grades for engine oils

When selecting an engine oil, ensure that the engine oil belongs to one of the viscosity grades SAE 0W-40, SAE 0W-30, SAE 5W-40, and SAE 5W-30 or malfunctions or engine damage may occur. ◀

The engine oil quality is critical for the life of the engine.

### Suitable engine oil types

You can add engine oils that meet the following oil rating standards:

#### Gasoline engine

BMW Longlife-01.

BMW Longlife-01 FE.

#### Diesel engine

BMW Longlife-04.

Further information regarding the oil specifications and viscosities of engine oils can be inquired with the service center.

### Alternative engine oil types

If an engine oil suitable for continuous use is not available, up to 1 US quart/liter of an engine oil with the following oil rating can be added:

#### Gasoline engine

API SM or superior oil rating.

#### Diesel engine

API CJ-4.

## Engine oil change:

The vehicle manufacturer recommends that you let the service center change the motor oil.

**BMW recommends  
Original BMW Engine Oil.**

# Coolant

## Vehicle features and options

This chapter describes all standard, country-specific and optional features offered with the series. It also describes features that are not necessarily available in your car, e. g., due to the selected options or country versions. This also applies to safety-related functions and systems. The respectively applicable country provisions must be observed when using the respective features and systems.

## Hints



**Danger of burns from hot engine**

Do not open the cooling system while the engine is hot; otherwise, escaping coolant may cause burns. ◀



**Suitable additives**

Only use suitable additives; otherwise, engine damage may occur. The additives are harmful to your health. ◀

Coolant consists of water and additives.

Not all commercially available additives are suitable for the vehicle. Information about the suitable additives are available from the service center.

## Coolant level

### General information

If there is no Min. and Max. mark in the filler neck of the coolant reservoir, have the coolant level checked if needed by your service center and add coolant as needed.

Depending on the engine installation, the coolant reservoir is located on the right side or the left side of the engine compartment.

## Checking

1. Let the engine cool.
2. Turn the lid of the coolant reservoir slightly counterclockwise to allow any excess pressure to dissipate, then open it.

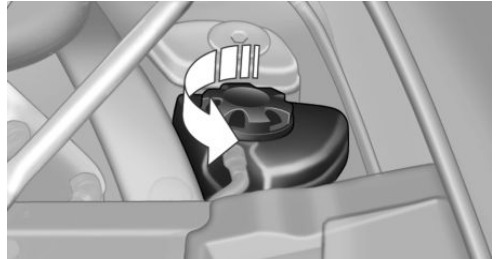

3. Open the coolant reservoir lid.
4. The coolant level is correct if it lies between the minimum and maximum marks in the filler neck.



## Adding

1. Let the engine cool.
2. Turn the lid of the coolant reservoir slightly counterclockwise to allow any excess pressure to dissipate, then open it.

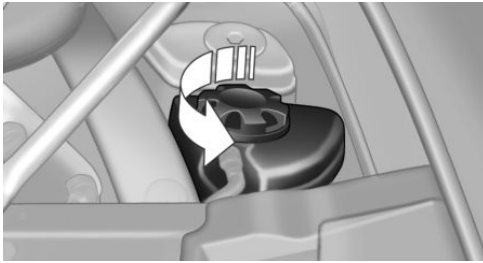

3. If the coolant is low, slowly add coolant up to the specified level; do not overfill.
4. Turn the lid until there is an audible click. The arrows on the coolant reservoir and the lid must point towards one another.
5. Have the cause of the coolant loss eliminated as soon as possible.

## Disposal



Comply with the relevant environmental protection regulations when disposing of coolant and coolant additives.

# Maintenance

## Vehicle features and options

This chapter describes all standard, country-specific and optional features offered with the series. It also describes features that are not necessarily available in your car, e. g., due to the selected options or country versions. This also applies to safety-related functions and systems. The respectively applicable country provisions must be observed when using the respective features and systems.

## BMW maintenance system

The maintenance system indicates required maintenance measures, and thereby provides support in maintaining road safety and the operational reliability of the vehicle.

In some cases scopes and intervals may vary according to the country-specific version. Replacement work, spare parts, fuels and lubricants and wear materials are calculated separately. Additional information is available from the service center.

## Condition Based Service CBS

Sensors and special algorithms take into account the driving conditions of your vehicle. Based on this, Condition Based Service recognizes the maintenance requirements.

The system makes it possible to adapt the amount of maintenance corresponding to your user profile.

Detailed information on service requirements, refer to page 94, can be displayed on the Control Display.

## Service data in the remote control

Information on the required maintenance is continuously stored in the remote control. Your service center will read out this data and suggest the right array of service procedures for your vehicle.

Therefore, hand your service specialist the remote control with which the vehicle was driven most recently.

## Storage periods

Storage periods during which the vehicle battery was disconnected are not taken into account.

If this occurs, have a service center update the time-dependent maintenance procedures, such as checking brake fluid and, if needed, changing the engine oil and the microfilter/activated-charcoal filter.

## Service and Warranty Information Booklet for US models and Warranty and Service Guide Booklet for Canadian models

Please consult your Service and Warranty Information Booklet for US models and Warranty and Service Guide Booklet for Canadian models for additional information on service requirements.

Maintenance and repair should be performed by your service center. Make sure to have regular maintenance procedures recorded in the vehicle's Service and Warranty Information Booklet for US models, and in the Warranty and Service Guide Booklet for Canadian models. These entries are proof of regular maintenance.



## Socket for OBD Onboard Diagnosis

### Note



#### Socket for Onboard Diagnosis

The socket for onboard diagnostics may only be used by the service center or a workshop that operates in accordance with the specifications of the vehicle manufacturer with correspondingly trained personnel and other authorized persons. Otherwise, use may result in operating problems for the vehicle. ◀

### Position

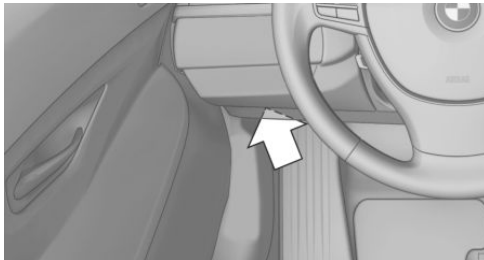

There is an OBD socket on the driver's side for checking the primary components in the vehicle's emissions.

### Emissions



- ▷ The warning lamp lights up:  
Emissions are deteriorating. Have the vehicle checked as soon as possible.

- ▷ The warning lamp flashes under certain circumstances:

This indicates that there is excessive misfiring in the engine.

Reduce the vehicle speed and have the system checked immediately; otherwise, serious engine misfiring within a brief period can seriously damage emission control components, in particular the catalytic converter.

# Replacing components

## Vehicle features and options

This chapter describes all standard, country-specific and optional features offered with the series. It also describes features that are not necessarily available in your car, e. g., due to the selected options or country versions. This also applies to safety-related functions and systems. The respectively applicable country provisions must be observed when using the respective features and systems.

## Onboard vehicle tool kit



The onboard vehicle tool kit is located in a fold-down cover in the trunk lid.

Unscrew the wing nut to open.

## Wiper blade replacement

### Hints

 Do not fold down the wipers without wiper blades

Do not fold down the wipers if wiper blades have not been installed; this may damage the windshield. ◀

## Replacing the wiper blades

1. To change the wiper blades, fold up, refer to page 78, the wiper arms.
2. Fold up the wipers.

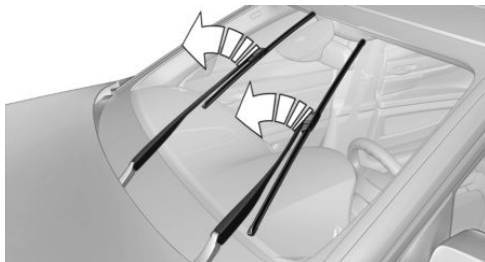

3. Position the wiper blade in a horizontal position.
4. Remove the wiper blade toward one side.

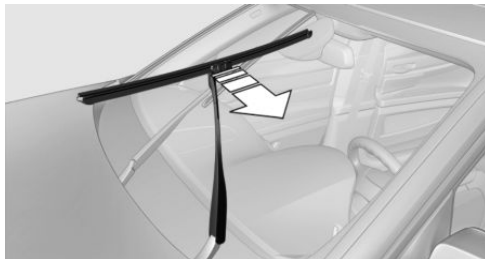

5. Insert the new wiper blade in reverse order of removal until it locks in place.
6. Fold down the wipers.

## Lamp and bulb replacement

### Hints

#### Lights and bulbs

Lights and bulbs make an essential contribution to vehicle safety.

The manufacturer of the vehicle recommends that you entrust corresponding procedures to

the service center if you are unfamiliar those or if they have not been described here.

You can obtain a selection of replacement bulbs at the service center.

**!** Danger of burns

Only change bulbs when they are cool; otherwise, there is a danger of getting burned. ◀

**!** Working on the lighting system

When working on the lighting system, you should always reel off the lights affected to prevent short circuits.

To avoid possible injury or equipment damage when replacing bulbs, observe any instructions provided by the bulb manufacturer. ◀

**!** Do not perform work/bulb replacement on xenon headlights

Have any work on the xenon lighting system, including bulb replacement, performed only by a service center. Due to the high voltage present in the system, there is a danger of fatal injuries if work is carried out improperly. ◀

**!** Do not touch the bulbs

Do not touch the glass of new bulbs with your bare hands, as even minute amounts of contamination will burn into the bulb's surface and reduce its service life.

Use a clean tissue, cloth or something similar, or hold the bulb by its base. ◀

### Light-emitting diodes (LEDs)

Some items of equipment use light-emitting diodes installed behind a cover as a light source.

These light-emitting diodes, which are related to conventional lasers, are officially designated as Class 1 light-emitting diodes.

**!** Do not remove the covers

Do not remove the covers, and never stare into the unfiltered light for several hours; otherwise, irritation of the retina could result. ◀

### Headlight glass

Condensation can form on the inside of the external lights in cool or humid weather. When driving with the light switched on, the condensation evaporates after a short time. The headlight glass does not need to be changed.

If the headlights do not dim despite driving with the light switched on, increasing humidity forms, e. g. water droplets in the light, have the service center check this.

### Headlight setting

The headlight adjustments can be affected by changing lights and bulbs. Have the headlights' settings checked and corrected by service after a replacement.

### Front lights, bulb replacement

#### Xenon headlights

#### At a glance

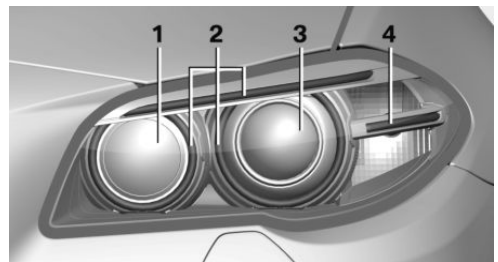

- 1 Corner-illuminating lights
- 2 Parking lamp, daytime running lights
- 3 Low beams/high beams
- 4 Turn signal

## Hints

Because of the long life of these bulbs, the likelihood of failure is very low. Switching the lights on and off frequently shortens their life.

If a bulb fails, reel on the front fog lights and continue the trip with great care. Comply with local regulations.

 Do not perform work/bulb replacement on xenon headlights

Have any work on the xenon lighting system, including bulb replacement, performed only by a service center. Due to the high voltage present in the system, there is a danger of fatal injuries if work is carried out improperly. ◀

For checking and adjusting headlamp aim, please contact your BMW center.

## Parking lights and roadside parking lamp

Follow general instructions, refer to page 238.

These lights feature LED technology.

Contact your service center in the event of a malfunction.

## Accessing the bulbs

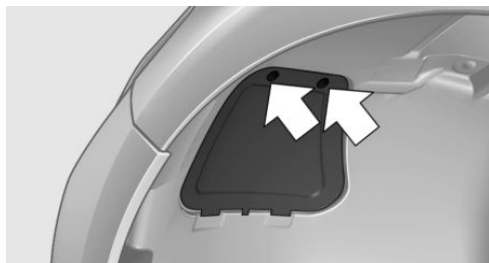

Remove the screws and fold down the lid.

## Turn signal

Follow general instructions, refer to page 238.

The illustration shows the left side of the engine compartment.

24-watt bulb, PY.

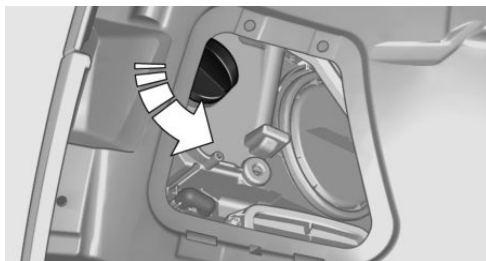

Unscrew the lid, remove it, and change the bulb.

## Corner-illuminating lights

Follow general instructions, refer to page 238.

The illustration shows the left side of the engine compartment.

55-watt bulb, H7.

1. Fold open the cover in the engine compartment.



2. Unscrew the lid and remove it.

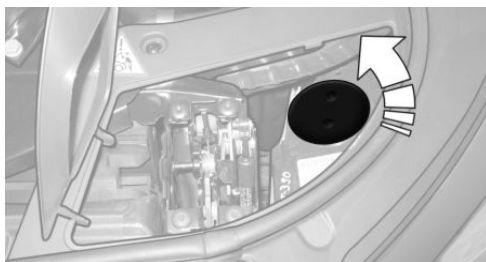

- Unscrew the bulb holder counterclockwise.



- Remove the bulb and replace it.
- Insert the new bulb and attach the cover in the reverse order.

## LED headlights

### At a glance

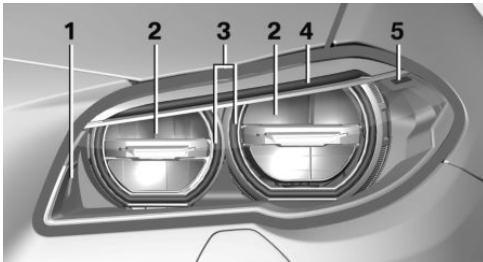

- Corner-illuminating lights
- Low beams/high beams
- Parking lamp, daytime running lights
- Turn signal
- Side marker lights

### Light-emitting diodes (LEDs)

With LED headlights, all front lights and side indicators are designed with LED technology.

If an LED fails, switch on the front fog lights and continue the trip with great care. Comply with local regulations.

Contact your service center in the event of a malfunction.

## LED front fog lights

These front fog lights are made using LED technology. Contact your service center in the event of a malfunction.

## Turn signal in exterior mirror

The turn signals in the exterior mirrors feature LED technology. Contact your service center in the event of a malfunction.

## Tail lights, bulb replacement

### At a glance

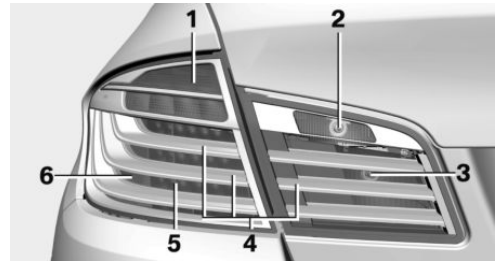

- Turn signal
- Reversing lamp
- Inside brake lamp
- Rear lamp
- Outside brake lamp
- Rear reflector

## Turn signal, outer brake, tail, and license plate lights

Follow general instructions, refer to page [238](#).

These lights feature LED technology.

Contact your service center in the event of a malfunction.

## Lights in the trunk lid

### Access to the lights

1. Remove the three screws using the screw driver from the onboard vehicle tool kit.

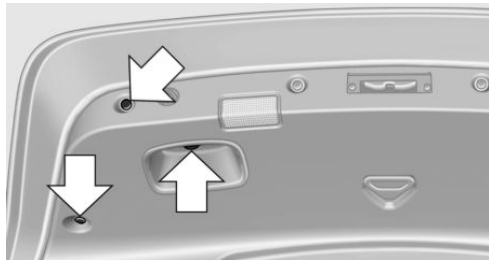

2. Fold away the cover.



### Inside brake lamp

Follow general instructions, refer to page 238.  
21-watt bulb, H21W.

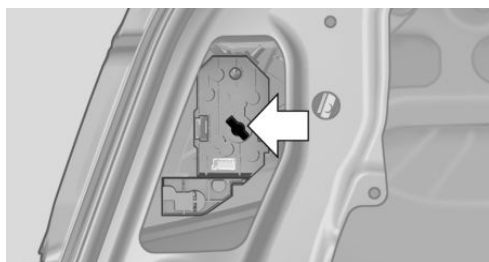

The illustration shows the position of the bulb in the installed bulb holder.

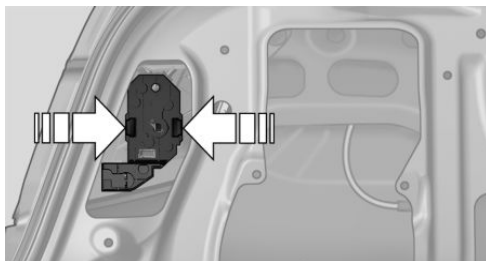

Squeeze the clips together and remove the bulb holder.

Press the bulb into the bulb holder, turn counterclockwise and remove.

### Reversing lamp

Follow general instructions, refer to page 238.  
16-watt bulb, W16W.

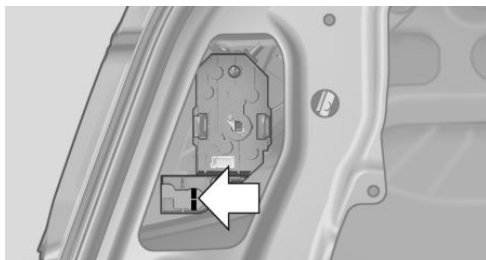

The illustration shows the position of the bulb in the installed bulb holder.

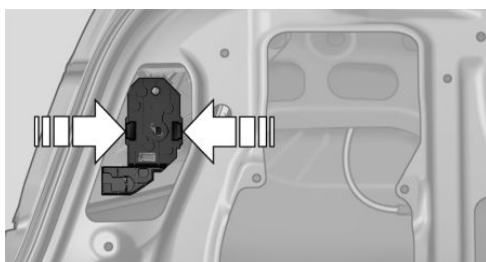

Squeeze the clips together and remove the bulb holder.

Pull out the bulb and replace it.

## Changing wheels

### Hints

When using run-flat tires or sealants, a tire does not need to be changed immediately in the event of pressure loss due to a flat tire.

Which is why no spare tire is available.

The tools for changing wheels are available as accessories from your service center.

### Jacking points for the vehicle jack

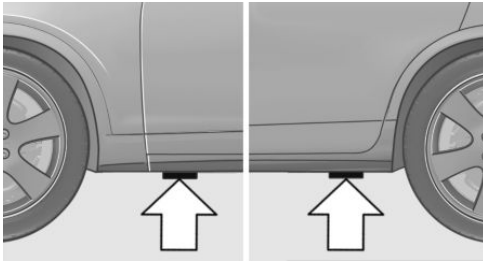

The jacking points for the vehicle jack are located at the positions shown.

## Vehicle battery

### Maintenance

The battery is maintenance-free.

The added amount of acid is sufficient for the service life of the battery.

Further information about the battery can be obtained from your service center.

### Battery replacement



Use approved vehicle batteries only

Only use vehicle batteries that have been approved for your vehicle by the manufacturer; otherwise, the vehicle could be damaged and systems or functions may not be fully available. ◀

After a battery replacement, have the battery registered on the vehicle by the service center

to ensure that all comfort features are fully available and that any Check Control messages of these comfort features are no longer displayed.

### Charging the battery

#### General information

Make sure that the battery is always sufficiently charged to guarantee that the battery remains usable for its full service life.

The battery may need to be charged in the following cases:

- ▷ When making frequent short-distance drives.
- ▷ If the vehicle is not used for prolonged periods, longer than a month.

#### Hints



Do not connect charging devices to the 12 volt socket in the vehicle

Do not connect battery chargers to the factory-installed 12 volt sockets in the vehicle as this may damage the vehicle battery due to an increased power consumption. ◀

### Starting aid terminals

In the vehicle, only charge the battery via the starting aid terminals, refer to page 247, in the engine compartment with the engine off.

### Power failure

After a temporary power loss, some equipment needs to be newly initialized or individual settings updated, e. g.:

- ▷ Seat, mirror, and steering wheel memory: store the positions again.
- ▷ Time: update.
- ▷ Date: update.
- ▷ Glass sunroof: initialize the system, refer to page 51.

## Disposing of old batteries



Have old batteries disposed of by your service center or bring them to a recycling center.

Maintain the battery in an upright position for transport and storage. Secure the battery so that it does not tip over during transport.

## Fuses

### Hints



Replacing fuses

Never attempt to repair a blown fuse and do not replace a defective fuse with a substitute of another color or amperage rating; this could lead to a circuit overload, ultimately resulting in a fire in the vehicle. ◀

Plastic tweezers and information on the fuse types and locations are stored in the fuse box in the trunk.

### In the glove compartment

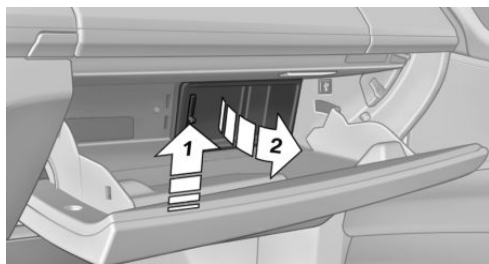

Push the handle up, arrow 1, and open the lid, arrow 2.

### In the trunk

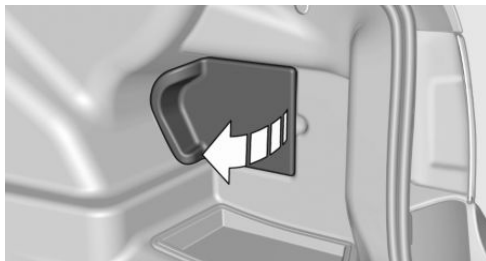

Open the cover on the right side trim, arrow.

Information on the fuse types and locations is found on a separate sheet.



# Breakdown assistance

## Vehicle features and options

This chapter describes all standard, country-specific and optional features offered with the series. It also describes features that are not necessarily available in your car, e. g., due to the selected options or country versions. This also applies to safety-related functions and systems. The respectively applicable country provisions must be observed when using the respective features and systems.

## Hazard warning flashers

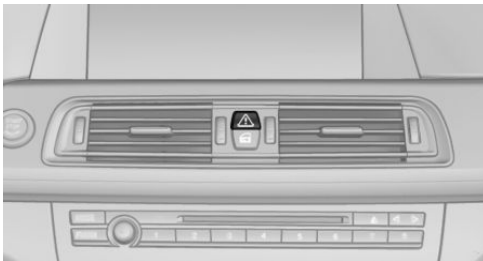

The button is located in the center console.

## Intelligent Emergency Request

### The concept

In case of an emergency, an Emergency Request can be made through this system.

### General information

Only press the SOS button in an emergency.

## Hints



Emergency Request not guaranteed

For technical reasons, the Emergency Request cannot be guaranteed under unfavorable conditions. ◀

## Overview



SOS button in the roofliner

## Requirements

- ▷ The SIM card integrated in the vehicle has been activated.
- ▷ The radio-ready state is switched on.
- ▷ The Assist system is functional.

## Initiating an Emergency Request

1. Press the cover briefly to open it.
  2. Press the SOS button until the LED at the button lights up green.
- ▷ The LED lights up green: an Emergency Request was initiated.

If a cancel prompt appears on the display, the Emergency Request can be aborted.

If the situation allows, wait in your vehicle until the voice connection has been established.

- ▷ The LED flashes green when a connection to the BMW Response Center has been established.

When the emergency request is received at the BMW Response Center, the BMW Response Center contacts you and takes further steps to help you.

Even if you are unable to respond, the BMW Response Center can take further steps to help you under certain circumstances.

For this, data are transmitted to the BMW Response Center which serve to determine the necessary rescue measures. E. g. the current position of the vehicle, if it can be established.

- ▶ If the LED is flashing green, but the BMW Response Center can no longer be heard via the speaker, you can nevertheless still be heard at the BMW Response Center.

### Initiating an Emergency Request automatically

Under certain conditions, an Emergency Request is automatically initiated immediately after a severe accident. Automatic Collision Notification is not affected by pressing the SOS button.

### Warning triangle



The warning triangle is located in the container on the inside of the trunk lid.

Unscrew the wing nut to open.

### First aid kit

#### Note

Some of the articles have a limited service life.

Check the expiration dates of the contents regularly and replace any expired items promptly.

#### Storage



The first aid kit is located in the container on the inside of the trunk lid.

Unscrew the wing nut to open.

### Jump-starting

#### General information

If the battery is discharged, the engine can be started using the battery of another vehicle and two jumper cables. Only use jumper cables with fully insulated clamp handles.

#### Hints



Do not touch live parts

To avoid the risk of potentially fatal injury, always avoid all contact with electrical components while the engine is running. ◀

To prevent personal injury or damage to both vehicles, adhere strictly to the following procedure.

## Preparation



Bodywork contact between vehicles

Make sure that there is no contact between the bodywork of the two vehicles; otherwise, there is a danger of short circuits. ◀

1. Check whether the battery of the other vehicle has a voltage of 12 volts. This information can be found on the battery.
2. Switch off the engine of the assisting vehicle.
3. Switch off any electronic systems/power consumers in both vehicles.

## Starting aid terminals



Connecting order

Connect the jumper cables in the correct order to prevent risk of injury from arcing. ◀

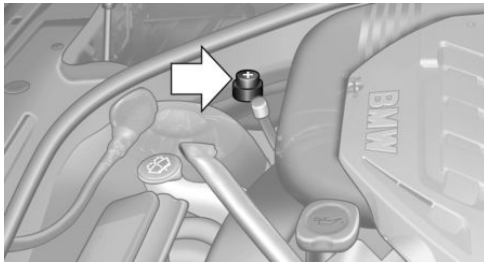

The so-called starting aid terminal in the engine compartment acts as the battery's positive terminal.

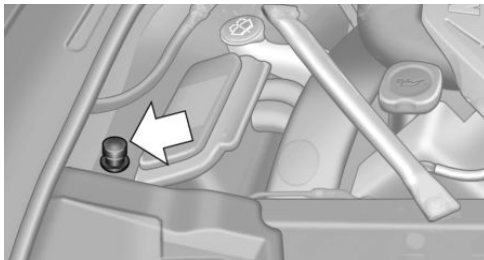

The body ground or a special nut acts as the battery negative terminal.

## Connecting the cables

1. Pull off the lid of the BMW starting aid terminal.
2. Attach one terminal clamp of the positive jumper cable to the positive terminal of the battery, or to the corresponding starting aid terminal of the vehicle providing assistance.
3. Attach the terminal clamp on the other end of the cable to the positive terminal of the battery, or to the corresponding starting aid terminal of the vehicle to be started.
4. Attach one terminal clamp of the negative jumper cable to the negative terminal of the battery, or to the corresponding engine or body ground of assisting vehicle.
5. Attach the second terminal clamp to the negative terminal of the battery, or to the corresponding engine or body ground of the vehicle to be started.

## Starting the engine

Never use spray fluids to start the engine.

1. Start the engine of the assisting vehicle and let it run for several minutes at an increased idle speed.  
If the vehicle to be started has a diesel engine: let the engine of the assisting vehicle run for approx. 10 minutes.
2. Start the engine of the vehicle that is to be started in the usual way.  
If the first starting attempt is not successful, wait a few minutes before making another attempt in order to allow the discharged battery to recharge.
3. Let both engines run for several minutes.
4. Disconnect the jumper cables in the reverse order.

Check the battery and recharge if needed.

## Tow-starting and towing

### Note

 Tow-starting and towing

For tow-starting or towing, switch off the Intelligent Safety systems; otherwise malfunctions of the individual braking systems might lead to accidents. ◀

### Steptronic transmission: transporting your vehicle

### Note

Your vehicle is not permitted to be towed. Therefore, contact a service center in the event of a breakdown.

 Do not have the vehicle towed

Have your vehicle transported on a loading platform only; otherwise, damage may occur. ◀

### Tow truck

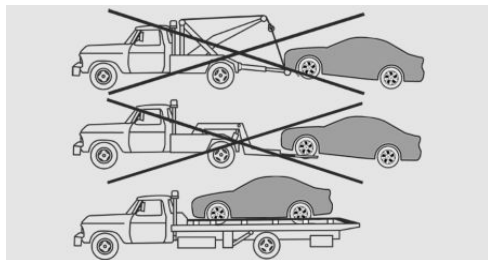

The vehicle should only be transported on a loading platform.

 Do not lift the vehicle

Do not lift the vehicle by the tow fitting or body and chassis parts; otherwise, damage may result. ◀

Use tow fitting located in the front only for positioning the vehicle.

## Manual transmission

### Observe before towing your vehicle

Gearshift lever in neutral position.

### Towing

 When the parking brake is blocked

The parking brake cannot be released manually.

Do not tow the vehicle with the parking brake blocked, or the vehicle can be damaged.

Contact your service center. ◀

 Follow the towing instructions

Follow all towing instructions; otherwise, vehicle damage or accidents may occur. ◀

- ▶ Make sure that the ignition is switched on; otherwise, the low beams, tail lights, turn signals, and wipers may be unavailable.
- ▶ Do not tow the vehicle with the rear axle tilted, as the front wheels could turn.
- ▶ When the engine is stopped, there is no power assist. Consequently, more force needs to be applied when braking and steering.
- ▶ Larger steering wheel movements are required.
- ▶ The towing vehicle must not be lighter than the vehicle being towed; otherwise, it will not be possible to control the vehicle's response.

## Tow truck

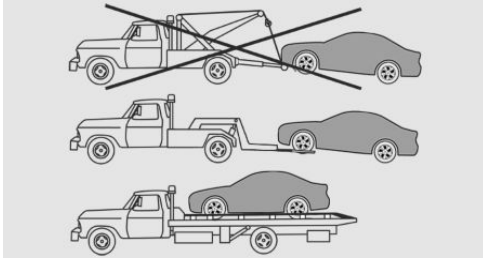



Have your vehicle transported with a tow truck with a so-called lift bar or on a flat bed.

-  Do not lift the vehicle
- Do not lift the vehicle by the tow fitting or body and chassis parts; otherwise, damage may result. ◀

## Towing other vehicles

### Hints

-  Light towing vehicle
- The towing vehicle must not be lighter than the vehicle being towed; otherwise, it will not be possible to control the vehicle's response. ◀
-  Attaching the tow bar/tow rope correctly
- Attach the tow bar or tow rope to the tow fitting; connecting it to other vehicle parts may cause damage. ◀
- ▶ Switch on the hazard warning system, depending on local regulations.
- ▶ If the electrical system has failed, clearly identify the vehicle being towed by placing a sign or a warning triangle in the rear window.

### Tow bar

The tow fittings used should be on the same side on both vehicles.

Should it prove impossible to avoid mounting the tow bar at an offset angle, please observe the following:

- ▶ Maneuvering capability is limited going around corners.
- ▶ The tow bar will generate lateral forces if it is secured with an offset.

### Tow rope

When starting to tow the vehicle, make sure that the tow rope is taut.

To avoid jerking and the associated stresses on the vehicle components when towing, always use nylon ropes or nylon straps.

### Tow fitting

The screw-in tow fitting should always be carried in the vehicle.

The tow fitting can be screwed in at the front or rear of the BMW.



The tow fitting is located in the container on the inside of the trunk lid.

-  Tow fitting, information on use
- ▶ Use only the tow fitting provided with the vehicle and screw it all the way in.
- ▶ Use the tow fitting for towing on paved roads only.
- ▶ Avoid lateral loading of the tow fitting, e.g., do not lift the vehicle by the tow fitting.

Otherwise, damage to the tow fitting and the vehicle can occur. ◀

## Screw thread for tow fitting



Push out the cover by pressing on the top edge.

## Tow-starting

### Steptronic transmission

Do not tow-start the vehicle.

Tow-starting the engine is not possible due to the transmission.

Have the cause of the starting problems fixed.

### Manual transmission

If possible, do not tow-start the vehicle but start the engine by jump-starting, refer to page 246. If the vehicle is equipped with a catalytic converter, only tow-start while the engine is cold.

1. Switch on the hazard warning system and comply with local regulations.
2. Ignition, refer to page 69, on.
3. Engage third gear.
4. Have the vehicle tow-started with the clutch pedal pressed and slowly release the pedal. After the engine starts, immediately press on the clutch pedal again.
5. Stop at a suitable location, remove the tow bar or rope, and switch off the hazard warning system.
6. Have the vehicle checked.

# Care

## Vehicle features and options

This chapter describes all standard, country-specific and optional features offered with the series. It also describes features that are not necessarily available in your car, e. g., due to the selected options or country versions. This also applies to safety-related functions and systems. The respectively applicable country provisions must be observed when using the respective features and systems.

## Car washes

### General information

Regularly remove foreign objects such as leaves in the area below the windshield when the hood is raised.

Wash your vehicle frequently, particularly in winter. Intense soiling and road salt can damage the vehicle.

### Hints

 Steam jets or high-pressure washers  
When using steam jets or high-pressure washers, hold them a sufficient distance away and use a maximum temperature of 140 °F/60 °C.

If the vehicle has a glass sunroof, ensure that a distance of at least 31.5 inches/80 cm is maintained. Holding them too close or using excessively high pressures or temperatures can cause damage or preliminary damage that may then lead to long-term damage.

Follow the user's manual for the high-pressure washer. ◀



Cleaning sensors/camera lenses with high-pressure washers

When using high-pressure washers, do not spray the sensors and camera lenses on the outside of the vehicle for long periods and maintain a distance of at least 12 in/30 cm. ◀

## Automatic car washes

### Hints

Note the following:

- ▷ Give preference to cloth car washes or those that use soft brushes in order to avoid paint damage.
- ▷ Make sure that the wheels and tires are not damaged by the transport mechanisms.
- ▷ Fold in the exterior mirrors; otherwise, they may be damaged, depending on the width of the vehicle.
- ▷ Deactivate the rain sensor, refer to page 77, to avoid unintentional wiper activation.
- ▷ In some cases, an unintentional alarm can be triggered by the interior motion sensor of the alarm system. Follow the instructions on avoiding an unintentional alarm, refer to page 48.



Guide rails in car washes

Avoid car washes with guide rails higher than 4 in/10 cm; otherwise, the vehicle body could be damaged. ◀

## Before driving into a car wash

In order to ensure that the vehicle can roll in a car wash, take the following steps:

Manual transmission:

1. Drive into the car wash.
2. Shift to neutral.

3. Switch the engine off.
4. Switch on the ignition.

Steptronic transmission:

1. Drive into the car wash.
2. Engage selector lever position N.
3. Deactivating Automatic Hold, refer to page 75.
4. Release the parking brake.
5. Switch the engine off.

In this way, the ignition remains switched on, and a Check-Control message is displayed.

 Do not turn off the ignition in the car wash

Do not turn off the ignition in the car wash; otherwise, selector lever position P is engaged and damages can result. ◀

The vehicle cannot be locked from the outside when in selector lever position N. A signal sounds when an attempt is made to lock the vehicle.

To start the engine with manual transmission:

1. Press on the clutch pedal.
2. Press the Start/Stop button.

To start the engine with Steptronic transmission:

1. Depress the brake pedal.
2. Press the Start/Stop button.

Pressing the Start/Stop button without stepping on the brake turns the ignition off.

### Selector lever position

Selector lever position P is engaged automatically:

- ▷ When the ignition is switched off.
- ▷ After approx. 15 minutes.

### Headlights

- ▷ Do not rub dry and do not use abrasive or acidic cleansers.
- ▷ Soak areas that have been dirtied e. g., from insects, with shampoo and wash off with water.
- ▷ Thaw ice with de-icing spray; do not use an ice scraper.

### After washing the vehicle

After washing the vehicle, apply the brakes briefly to dry them; otherwise, braking action can be reduced and corrosion of the brake discs can occur.

Completely remove all residues on the windows, to minimize loss of visibility due to smearing and to reduce wiper noises and wiper blade wear.

## Vehicle care

### Car care products

BMW recommends using care and cleaning products from BMW, since these have been tested and approved.

 Car care and cleaning products  
Follow the instructions on the container.

When cleaning the interior, open the doors or windows.

Only use products intended for cleaning vehicles.

Cleansers can contain substances that are dangerous and harmful to your health. ◀

### Vehicle paint

Regular care contributes to driving safety and value retention. Environmental influences in areas with elevated air pollution or natural contaminants, such as tree resin or pollen can affect the vehicle's paintwork. Tailor the frequency and extent of your car care to these influences.



Aggressive substances such as spilled fuel, oil, grease or bird droppings, must be removed immediately to prevent the finish from being altered or discolored.

Only use respectively approved cleaning and care products for vehicles with matte finish. Suitable care products for matte finishes are available from the service center.

### Leather care

Remove dust from the leather often, using a cloth or vacuum cleaner.

Otherwise, particles of dust and road grime chafe in pores and folds, and lead to increased wear and premature degradation of the leather surface.

To guard against discoloration, such as from clothing, provide leather care roughly every two months.

Clean light-colored leather more frequently because soiling on such surfaces is substantially more visible.

Use leather care products; otherwise, dirt and grease will gradually break down the protective layer of the leather surface.

Suitable care products are available from the service center.

### Upholstery material care

Vacuum regularly with a vacuum cleaner.

If upholstery is very dirty, e.g., with beverage stains, use a soft sponge or microfiber cloth with a suitable interior cleaner.

Clean the upholstery down to the seams using large sweeping motions. Avoid rubbing the material vigorously.



Damage from Velcro® fasteners

Open Velcro® fasteners on pants or other articles of clothing can damage the seat covers. Ensure that any Velcro® fasteners are closed. ◀

## Caring for special components

### Light-alloy wheels

When cleaning the vehicle, use only neutral wheel cleaners having a pH value from 5 to 9. Do not use abrasive cleaning agents or steam jets above 140 °F/60 °C. Follow the manufacturer's instructions.

Aggressive, acidic or alkaline cleaning agents can destroy the protective layer of adjacent components, such as the brake disk.

### Chrome surfaces

Carefully clean components such as the radiator grille or door handles with an ample supply of water, possibly with shampoo added, particularly when they have been exposed to road salt.

### Rubber components

Aside from water, treat only with rubber cleansers.

When cleaning rubber seals, do not use any silicon-containing car care products in order to avoid damage or noises.

### Fine wood parts

Clean fine wood facing and fine wood components only with a moist rag. Then dry with a soft cloth.

### Plastic components

These include:

- ▷ Imitation leather surfaces.
- ▷ Roofliner.
- ▷ Lamp lenses.
- ▷ Instrument cluster cover.
- ▷ Matt black spray-coated components.
- ▷ Painted parts in the interior.

Clean with a microfiber cloth.

Dampen cloth lightly with water.

Do not soak the roofliner.

 No cleansers that contain alcohol or solvents

Do not use cleansers that contain alcohol or solvents, such as lacquer thinners, heavy-duty grease removers, fuel, or such; this could lead to surface damage. ◀

### Safety belts

Dirty belt straps impede the reeling action and thus have a negative impact on safety.

 Chemical cleaning  
Do not clean chemically; this can destroy the webbing. ◀

Use only a mild soapy solution, with the safety belts clipped into their buckles.

Do not allow the reels to retract the safety belts until they are dry.

### Carpets and floor mats

 No objects in the area around the pedals  
Keep floor mats, carpets, and any other objects out of the pedal area; otherwise, the function of the pedals could be impeded while driving and create the risk of an accident.

Do not place additional floor mats over existing mats or other objects.

Only use floor mats that have been approved for the vehicle and can be properly attached to floor.

Ensure that the floor mats are securely fastened again after they were removed for cleaning, e.g. ◀

Floor mats can be removed from the car's interior for cleaning.

If the floor carpets are very dirty, clean with a microfiber cloth and water or a textile cleaner. To prevent matting of the carpet, rub back and forth in the direction of travel only.

### Sensor/camera lenses

To clean sensors and camera lenses, use a cloth moistened with a small amount of glass detergent.

### Displays/monitors

 Cleaning displays and screens  
Do not use any chemical or household cleaning agents; otherwise, surfaces can be affected. ◀

 Keeping out moisture  
Keep all fluids and moisture away from the unit; otherwise, electrical components can be damaged. ◀

 Avoid pressure  
Avoid pressing too hard when cleaning and do not use abrasive materials; otherwise, damage can result. ◀

Clean with a clean, antistatic microfiber cloth.

### Long-term

When the vehicle is shut down for longer than three months, special measures must be taken. Additional information is available from the service center.





## Reference

This chapter contains the technical data and an index that will quickly take you to the information you need.

# Technical data

## Vehicle features and options

This chapter describes all standard, country-specific and optional features offered with the series. It also describes features that are not necessarily available in your car, e. g., due to

the selected options or country versions. This also applies to safety-related functions and systems. The respectively applicable country provisions must be observed when using the respective features and systems.

## Note

The technical data and specifications in this Owner's Manual are used as guidance values. The vehicle-specific data can deviate from this, for example, due to the selected special equipment, country version or country-specific measurement method. Detailed values can be

found in the approval documents, on information signs on the vehicle or can be obtained from the service center.

The information in the vehicle documents always has priority.

## Dimensions

The dimensions can vary depending on the model version, equipment or country-specific measurement method.

The specified heights do not take into account attached parts, for example, a roof antenna,

roof racks or spoiler. The heights can deviate, for example, due to the selected special equipment, tires, load and chassis version.

### BMW 5 Series Sedan

Width with mirrors	inches/mm	82.8/2,102
Width without mirrors	inches/mm	73.2/1,860
Height	inches/mm	57.6/1,464
Length	inches/mm	193.4/4,913
Wheelbase	inches/mm	116.9/2,968
Smallest turning radius diam.	ft/m	39.4/12-39.7/12.1

## Weights

528i		
Approved gross vehicle weight	lbs/kg	4,971/2,255
Load	lbs/kg	948/430
Approved front axle load	lbs/kg	2,359/1,070
Approved rear axle load	lbs/kg	2,844/1,290
Approved roof load capacity	lbs/kg	220/100
Trunk capacity	cu ft/liters	18.4/520

535i		
Approved gross vehicle weight	lbs/kg	5,181/2,350
Load	lbs/kg	992/450
Approved front axle load	lbs/kg	2,491/1,130
Approved rear axle load	lbs/kg	2,910/1,320
Approved roof load capacity	lbs/kg	220/100
Cargo area capacity	cu ft/liters	18.4/520

550i		
Approved gross vehicle weight	lbs/kg	5,401/2,450
Load	lbs/kg	948/430
Approved front axle load	lbs/kg	2,712/1,230
Approved rear axle load	lbs/kg	2,932/1,330
Approved roof load capacity	lbs/kg	220/100
Cargo area capacity	cu ft/liters	18.4/520

535d		
Approved gross vehicle weight	lbs/kg	5,300/2,404
Load	lbs/kg	950/431

## 535d

Approved front axle load	lbs/kg	2,550/1,157
Approved rear axle load	lbs/kg	2,910/1,320
Approved roof load capacity	lbs/kg	220/100
Cargo area capacity	cu ft/liters	18.4/520

## 528i xDrive

Approved gross vehicle weight	lbs/kg	5,170/2,345
Load	lbs/kg	948/430
Approved front axle load	lbs/kg	2,447/1,110
Approved rear axle load	lbs/kg	2,888/1,310
Approved roof load capacity	lbs/kg	220/100
Cargo area capacity	cu ft/liters	18.4/520

## 535i xDrive

Approved gross vehicle weight	lbs/kg	5,379/2,440
Load	lbs/kg	992/450
Approved front axle load	lbs/kg	2,701/1,225
Approved rear axle load	lbs/kg	2,910/1,320
Approved roof load capacity	lbs/kg	220/100
Cargo area capacity	cu ft/liters	18.4/520

## 550i xDrive

Approved gross vehicle weight	lbs/kg	5,600/2,540
Load	lbs/kg	948/430
Approved front axle load	lbs/kg	2,800/1,270
Approved rear axle load	lbs/kg	2,954/1,340
Approved roof load capacity	lbs/kg	220/100
Cargo area capacity	cu ft/liters	18.4/520



**535d xDrive**

Approved gross vehicle weight	lbs/kg	5,390/2,445
Load	lbs/kg	950/431
Approved front axle load	lbs/kg	2,700/1,225
Approved rear axle load	lbs/kg	2,910/1,320
Approved roof load capacity	lbs/kg	220/100
Cargo area capacity	cu ft/liters	18.4/520

## Capacities

	US gal/liters	Notes
Fuel tank, approx.	18.5/70	Fuel quality, refer to page <a href="#">206</a>

# Everything from A to Z

## Index

### A

- ABS, Antilock Brake System **135**
- ACC, Active Cruise Control with Stop & Go **143**
- Acceleration Assistant, refer to Launch Control **82**
- Accessories and parts **7**
- Activated-charcoal filter **168**
- Active Blind Spot Detection **131**
- Active Cruise Control with Stop & Go, ACC **143**
- Active Protection **132**
- Active seat, front **56**
- Active seat ventilation, front **57**
- Active Steering, integral **139**
- Adaptive brake assistant **135**
- Adaptive brake lights, refer to Brake force display **132**
- Adaptive drive **138**
- Adaptive Light Control **104**
- Additives, oil **233**
- Adjustments, seats/head restraints **53**
- After washing vehicle **252**
- Airbags **108**
- Airbags, indicator/warning light **109**
- Air circulation, refer to Recirculated-air mode **167**
- Air, dehumidifying, refer to Cooling function **167**
- Air distribution, manual **166**
- Air flow, automatic climate control **166**
- Air outlets, see ventilation **168**
- Air pressure, tires **211**
- Alarm system **47**
- Alarm, unintentional **48**
- All around the center console **16**
- All around the roofliner **17**
- All around the steering wheel **14**
- All-season tires, refer to Winter tires **224**
- All-wheel-drive **137**
- Alternating-code hand-held transmitter **173**
- Alternative oil types **233**
- Ambient light **107**
- Animal detection, see Night Vision **126**
- Antifreeze, washer fluid **78**
- Antilock Brake System, ABS **135**
- Anti-slip control, refer to DSC **135**
- Approved axle load **259**
- Approved engine oils, see Suitable engine oil types **233**
- Armrest, refer to Center armrest **182**
- Arrival time **98**
- Ashtray **174**
- Ashtray, front **174, 175**
- Ashtray, rear **175**
- Assistance when driving off **135**
- Attentiveness assistant **133**
- AUTO H button **74**
- AUTO H button, refer to Automatic Hold **74**
- AUTO intensity **166**
- Automatic car wash **251**
- Automatic climate control **165**
- Automatic Cruise Control with Stop & Go **143**
- Automatic Curb Monitor **62**
- Automatic deactivation, front-seat passenger airbags **110**
- Automatic headlight control **104**
- Automatic Hold **74**
- Automatic locking **46**
- Automatic recirculated-air control **167**
- Automatic Soft Closing, doors **40**
- Automatic transmission, see Steptronic transmission **79**
- Automatic trunk lid **41**
- AUTO program, automatic climate control **166**
- AUTO program, intensity **166**
- Auto Start/Stop function **71**
- Average fuel consumption **98**
- Average speed **98**
- Axle loads, weights **259**

### B

- Backrest curvature, refer to Lumbar support **55**
- Backrest, width **55**
- Band-aids, refer to First aid kit **246**
- Bar for tow-starting/towing **249**
- Battery replacement, vehicle battery **243**
- Battery replacement, vehicle remote control **35**
- Battery, vehicle **243**
- Belts, safety belts **57**
- Beverage holder, cupholder **183**

- Blinds, sun protection [49](#)  
BMW Advanced Diesel [207](#)  
BMW Assist, see user's manual for Navigation, Entertainment and Communication  
BMW Driver's Guide App [6](#)  
BMW Homepage [6](#)  
BMW Internet page [6](#)  
BMW maintenance system [236](#)  
Bonus range, ECO PRO [197](#)  
Bottle holder, refer to Cupholder [183](#)  
Brake assistant [135](#)  
Brake assistant, adaptive [135](#)  
Brake discs, break-in [188](#)  
Brake force display [132](#)  
Brake lights, adaptive [132](#)  
Brake lights, brake force display [132](#)  
Brake lights, bulb replacement [241](#)  
Brake pads, break-in [188](#)  
Braking, hints [190](#)  
Breakdown assistance [245](#)  
Break-in [188](#)  
Brightness of Control Display [100](#)  
Bulb replacement [238](#)  
Bulb replacement, front [239](#)  
Bulb replacement, rear [241](#)  
Bulbs and lights [238](#)  
Button, RES [146](#)  
Button, Start/Stop [69](#)  
Bypassing, refer to Jumpstarting [246](#)
- C**
- California Proposition 65 Warning [7](#)  
Calling up mirror adjustment [46](#)  
Calling up seat adjustment [46](#)  
Calling up steering wheel adjustment [46](#)  
Camera lenses, care [254](#)  
Camera, rearview camera [155](#)  
Camera, Side View [157](#)  
Camera, Top View [159](#)  
Can holder, refer to Cupholder [183](#)  
Car battery [243](#)  
Car care products [252](#)  
Care, displays [254](#)  
Care, vehicle [252](#)  
Cargo [192](#)  
Cargo area, enlarging [177](#)  
Cargo area, storage compartments [184](#)  
Cargo, securing [193](#)  
Cargo straps, securing cargo [193](#)  
Car key, refer to Remote control [34](#)  
Carpet, care [254](#)  
Car wash [251](#)  
Catalytic converter, refer to Hot exhaust system [189](#)  
CBS Condition Based Service [236](#)  
CD/Multimedia, see user's manual for Navigation, Entertainment and Communication  
Center armrest [182](#)  
Center console [16](#)  
Central locking system [40](#)  
Central screen, refer to Control Display [18](#)  
Changes, technical, refer to Safety [7](#)  
Changing parts [238](#)  
Changing wheels [243](#)  
Changing wheels/tires [223](#)  
Chassis number, see vehicle identification number [9](#)  
Check Control [88](#)  
Checking the engine oil level electronically [231](#)  
Checking the oil level electronically [231](#)  
Children, seating position [65](#)  
Children, transporting safely [65](#)  
Child restraint fixing system [65](#)  
Child restraint fixing system LATCH [66](#)  
Child restraint fixing systems, mounting [65](#)  
Child safety locks [68](#)  
Child seat, mounting [65](#)  
Child seats [65](#)  
Chrome parts, care [253](#)  
Cigarette lighter [174](#)  
Cleaning displays [254](#)  
Climate control [165](#)  
Climate control laminated tinted safety glass [189](#)  
Climate control windshield [189](#)  
Clock [93](#)  
Closing/opening via door lock [39](#)  
Closing/opening with remote control [37](#)  
Closing the trunk lid with no-touch activation [44](#)  
Clothes hooks [184](#)  
Coasting [199](#)  
Coasting with engine decoupled, coasting [199](#)  
Coasting with idling engine [199](#)  
Cold starting, refer to Starting the engine [70](#)  
Combination reel, refer to Turn signals [76](#)  
Combination switch, refer to Wiper system [77](#)  
COMFORT+ program, Driving Dynamics Control [141](#)  
Comfort Access [43](#)

- COMFORT program, Driving Dynamics Control [141](#)
- Compressor [224](#)
- Computer, refer to On-board computer [97](#)
- Condensation on windows [166](#)
- Condensation under the vehicle [191](#)
- Condition Based Service CBS [236](#)
- Configure driving mode [141](#)
- Confirmation signal [46](#)
- ConnectedDrive, see user's manual for Navigation, Entertainment and Communication
- ConnectedDrive Services
- Continued driving with a flat tire [113](#), [116](#)
- Control Display [18](#)
- Control Display, settings [99](#)
- Controller [18](#)
- Control systems, driving stability [135](#)
- Convenient opening with the remote control [37](#)
- Coolant [234](#)
- Coolant level [234](#)
- Coolant temperature [92](#)
- Cooling function [167](#)
- Cooling, maximum [167](#)
- Cooling system [234](#)
- Cornering light [104](#)
- Corrosion on brake discs [190](#)
- Cosmetic mirror [174](#)
- Courtesy lamps during unlocking [37](#)
- Courtesy lamps with the vehicle locked [38](#)
- Cruise control [150](#)
- Cruise control, active with Stop & Go [143](#)
- Cruise Control, refer to Active Cruise Control [143](#)
- Cruising range [93](#)
- Cupholder [183](#)
- Current fuel consumption [93](#)
- ## D
- Damage, tires [222](#)
- Damping control, dynamic [138](#)
- Data, technical [258](#)
- Date [93](#)
- Daytime running lights [104](#)
- Defrosting, refer to Windows, defrosting [166](#)
- Dehumidifying, air [167](#)
- Deleting personal data [24](#)
- Deletion of personal data [24](#)
- Destination distance [98](#)
- Diesel exhaust fluid, at low temperatures [208](#)
- Diesel exhaust fluid, having refilled [208](#)
- Diesel exhaust fluid, on minimum [208](#)
- Diesel exhaust fluid, replenishing yourself [208](#)
- Diesel particulate filter [189](#)
- Digital clock [93](#)
- Dimensions [258](#)
- Dimmable exterior mirrors [63](#)
- Dimmable interior rearview mirror [63](#)
- Direction indicator, refer to Turn signals [76](#)
- Display, electronic, instrument cluster [84](#)
- Display in windshield [101](#)
- Display lighting, refer to Instrument lighting [106](#)
- Displays [85](#)
- Displays, cleaning [254](#)
- Disposal, coolant [235](#)
- Disposal, vehicle battery [244](#)
- Distance control, refer to PDC [152](#)
- Distance to destination [98](#)
- Divided screen view, split screen [23](#)
- Door lock [39](#)
- Door lock, refer to Remote control [34](#)
- Doors, Automatic Soft Closing [40](#)
- Downhill control [137](#)
- Drive-off assistant [135](#)
- Drive-off assistant, refer to DSC [135](#)
- Driver assistance, refer to Intelligent Safety [117](#)
- Driving Assistant, refer to Intelligent Safety [117](#)
- Driving Dynamics Control [139](#)
- Driving instructions, break-in [188](#)
- Driving mode [139](#)
- Driving notes, general [188](#)
- Driving stability control systems [135](#)
- Driving tips [188](#)
- DSC Dynamic Stability Control [135](#)
- DTC Dynamic Traction Control [136](#)
- Dynamic Damping Control [138](#)
- Dynamic Drive [138](#)
- Dynamic Stability Control DSC [135](#)
- Dynamic Traction Control DTC [136](#)
- ## E
- ECO PRO [196](#)
- ECO PRO, bonus range [197](#)
- ECO PRO display [196](#)
- ECO PRO displays [86](#)
- ECO PRO driving mode [196](#)
- ECO PRO mode [196](#)
- ECO PRO Tip - driving instruction [198](#)

EfficientDynamics 199  
Electronic displays, instrument cluster 84  
Electronic oil measurement 231  
Electronic Stability Program ESP, refer to DSC 135  
Emergency detection, remote control 35  
Emergency release, fuel filler flap 204  
Emergency Request 245  
Emergency start function, engine start 35  
Emergency unlocking, transmission lock 82  
Emergency unlocking, trunk lid 43  
Energy Control 93  
Energy recovery 94  
Engine, automatic Start/Stop function 71  
Engine, automatic switch-off 71  
Engine compartment 229  
Engine compartment, working in 229  
Engine coolant 234  
Engine idling when driving, coasting 199  
Engine oil 231  
Engine oil, adding 232  
Engine oil additives 233  
Engine oil change 233  
Engine oil filler neck 232  
Engine oil temperature 92  
Engine oil types, alternative 233  
Engine oil types, approved 233  
Engine start during malfunction 35  
Engine start, jump-starting 246  
Engine start, refer to Starting the engine 70

Engine stop 71  
Engine temperature 92  
Entering a car wash 251  
Equipment, interior 172  
Error displays, see Check Control 88  
ESP Electronic Stability Program, refer to DSC 135  
Exchanging wheels/tires 223  
Exhaust system 189  
Exterior mirror, automatic dimming feature 63  
Exterior mirrors 62  
External start 246  
External temperature display 93  
External temperature warning 93  
Eyes for securing cargo 193

## F

Failure message, see Check Control 88  
False alarm, refer to Unintentional alarm 48  
Fan, refer to Air flow 166  
Filler neck for engine oil 232  
Fine wood, care 253  
First aid kit 246  
Fitting for towing, see Tow fitting 249  
Flat tire, changing wheels 243  
Flat Tire Monitor FTM 115  
Flat tire, Tire Pressure Monitor TPM 111  
Flat tire, warning lamp 112, 115  
Flooding 190  
Floor carpet, care 254  
Floor mats, care 254  
Fold down the rear seat backrest, see Though-loading system 177  
Fold-out position, wiper 78

Foot brake 190  
Front airbags 108  
Front-end collision warning with braking function 120  
Front-end collision warning with City Braking function 118  
Front fog lights 106  
Front fog lights, bulb replacement 241  
Front lights 239  
front-seat passenger airbags, automatic deactivation 110  
Front-seat passenger airbags, indicator lamp 110  
FTM Flat Tire Monitor 115  
Fuel 206  
Fuel consumption, refer to Average fuel consumption 98  
Fuel filler flap 204  
Fuel gauge 92  
Fuel lid 204  
Fuel quality 206  
Fuel recommendation 206  
Fuel, tank capacity 261  
Fuse 244

## G

Garage door opener, refer to Universal Integrated Remote Control 172  
Gasoline 206  
Gear change, Steptronic transmission 80  
Gear shift indicator 95  
General driving notes 188  
Glare shield 174  
Glass sunroof, powered 50  
Glove compartment 181  
Gross vehicle weight, approved 259

**H**

Handbrake, refer to Parking brake [73](#)

Hand-held transmitter, alternating code [173](#)

Hazard warning flashers [245](#)

HDC Hill Descent Control [137](#)

Head airbags [108](#)

Headlight control, automatic [104](#)

Headlight courtesy delay feature [104](#)

Headlight courtesy delay feature via remote control [38](#)

Headlight flasher [76](#)

Headlight glass [239](#)

Headlights [239](#)

Headlights, care [252](#)

Headlight washer system [77](#)

Head restraints [53](#)

Head restraints, front [58](#)

Head restraints, rear [60](#)

Head-up Display [101](#)

Head-up Display, care [254](#)

Heavy cargo, stowing [193](#)

Height, vehicle [258](#)

High-beam Assistant [105](#)

High beams [76](#)

High beams/low beams, refer to High-beam Assistant [105](#)

Hill Descent Control  
HDC [137](#)

Hills [190](#)

Hill start assistant, refer to Drive-off assistant [135](#)

Hints [6](#)

Holder for beverages [183](#)

Homepage [6](#)

Hood [229](#)

Horn [14](#)

Hotel function, trunk lid [42](#)

Hot exhaust system [189](#)

HUD Head-up Display [101](#)

Hydroplaning [189](#)

**I**

Ice warning, see External temperature warning [93](#)

Icy roads, see External temperature warning [93](#)

Identification marks, tires [220](#)

Identification number, see vehicle identification number [9](#)

iDrive [18](#)

Ignition key, refer to Remote control [34](#)

Ignition off [69](#)

Ignition on [69](#)

Indication of a flat tire [112](#), [115](#)

Indicator and alarm lamps, see Check Control [88](#)

Indicator lamp, see Check Control [88](#)

Individual air distribution [166](#)

Individual settings, refer to Personal Profile [35](#)

Inflation pressure, tires [211](#)

Inflation pressure warning FTM, tires [115](#)

Info display, refer to On-Board computer [97](#)

Initialization, Integral Active Steering [139](#)

Initialize, Tire Pressure Monitor TPM [112](#)

Initializing, Flat Tire Monitor FTM [115](#)

Instrument cluster [84](#)

Instrument cluster, electronic displays [84](#)

Instrument display, multifunctional [85](#)

Instrument lighting [106](#)

Integral Active Steering [139](#)

Integrated key [34](#)

Integrated Owner's Manual in the vehicle [29](#)

Intelligent Emergency Request [245](#)

Intelligent Safety [117](#)

Intensity, AUTO program [166](#)

Interior equipment [172](#)

Interior lights [106](#)

Interior lights during unlocking [37](#)

Interior lights with the vehicle locked [38](#)

Interior motion sensor [48](#)

Interior rearview mirror, automatic dimming feature [63](#)

Interior rearview mirror, manually dimmable [63](#)

Internet page [6](#)

Interval display, service requirements [94](#)

Interval mode [77](#)

**J**

Jacking points for the vehicle jack [243](#)

Joystick, Steptronic transmission [80](#)

Jump-starting [246](#)

**K**

Key/remote control [34](#)

Keyless Go, refer to Comfort Access [43](#)

Key Memory, refer to Personal Profile [35](#)

Kickdown, Steptronic transmission [80](#)

Knee airbag [109](#)

**L**

Lamp replacement [238](#)

Lamp replacement, front [239](#)

Lamp replacement, rear [241](#)

Lane departure warning [129](#)

Lane margin, warning [129](#)  
Language on Control Display [100](#)  
Lashing eyes, securing cargo [193](#)  
LATCH child restraint system [66](#)  
Launch Control [82](#)  
Leather, care [253](#)  
LED front fog lights, bulb replacement [241](#)  
LED headlights, bulb replacement [241](#)  
LED light [241](#)  
LEDs, light-emitting diodes [239](#)  
Length, vehicle [258](#)  
Letters and numbers, entering [24](#)  
License plate lamp, bulb replacement [241](#)  
Light alloy wheels, care [253](#)  
Light control [104](#)  
Light-emitting diodes, LEDs [239](#)  
Lighter, front [174](#), [175](#)  
Lighter, rear [176](#)  
Lighting [103](#)  
Lighting, speaker [107](#)  
Lights [103](#)  
Lights and bulbs [238](#)  
Light switch [103](#)  
Load [193](#)  
Loading [192](#)  
Lock, door [39](#)  
Locking/unlocking via door lock [39](#)  
Locking/unlocking with remote control [37](#)  
Locking, automatic [46](#)  
Locking, settings [46](#)  
Locking via trunk lid [41](#)  
Lock, power window [49](#)  
Locks, doors, and windows [68](#)  
Low beams [103](#)

Low beams, automatic, refer to High-beam Assistant [105](#)  
Lower back support [55](#)  
Low-Sulfur Diesel [207](#)  
Luggage rack, see Roof-mounted luggage rack [193](#)  
Lumbar support [55](#)

## M

Maintenance [236](#)  
Maintenance requirements [236](#)  
Maintenance, service requirements [94](#)  
Maintenance system, BMW [236](#)  
Make-up mirror [174](#)  
Malfunction displays, see Check Control [88](#)  
Manual air distribution [166](#)  
Manual air flow [166](#)  
Manual brake, refer to Parking brake [73](#)  
Manual mode, Steptronic transmission [81](#)  
Manual operation, door lock [39](#)  
Manual operation, exterior mirrors [62](#)  
Manual operation, fuel filler flap [204](#)  
Manual operation, Park Distance Control PDC [153](#)  
Manual operation, rearview camera [155](#)  
Manual operation, Side View [158](#)  
Manual operation, Top View [159](#)  
Manual transmission [79](#)  
Marking on approved tires [223](#)  
Marking, run-flat tires [224](#)  
Massage seat, front [56](#)

Master key, refer to Remote control [34](#)  
Maximum cooling [167](#)  
Maximum speed, display [95](#)  
Maximum speed, winter tires [224](#)  
Measure, units of [100](#)  
Medical kit [246](#)  
Memory for seat, mirrors, steering wheel [61](#)  
Menu, EfficientDynamics [199](#)  
Menu in instrument cluster [96](#)  
Menus, operating, iDrive [18](#)  
Menus, refer to iDrive operating concept [19](#)  
Messages, see Check Control [88](#)  
Microfilter [168](#)  
Minimum tread, tires [222](#)  
Mirror [62](#)  
Mirror memory [61](#)  
Mobile communication devices in the vehicle [189](#)  
Mobility System [224](#)  
Modifications, technical, refer to Safety [7](#)  
Moisture in headlight [239](#)  
Monitor, refer to Control Display [18](#)  
Mounting of child restraint systems [65](#)  
Multifunctional instrument display [85](#)  
Multifunction steering wheel, buttons [14](#)

## N

Navigation, see user's manual for Navigation, Entertainment and Communication  
Neck restraints, front, refer to Head restraints [58](#)  
Neck restraints, rear, refer to Head restraints [60](#)

Neutral cleaner, see wheel cleaner [253](#)  
New wheels and tires [223](#)  
Night Vision [126](#)  
Night Vision device, see Night Vision [126](#)  
Nylon rope for tow-starting/towing [249](#)

## O

OBD Onboard Diagnosis [237](#)  
OBD, see OBD Onboard Diagnosis [237](#)  
Object detection, see Night Vision [126](#)  
Obstacle marking, rearview camera [156](#)  
Octane rating, refer to Recommended fuel grade [206](#)  
Odometer [92](#)  
Office, see user's manual for Navigation, Entertainment and Communication  
Oil [231](#)  
Oil, adding [232](#)  
Oil additives [233](#)  
Oil change [233](#)  
Oil change interval, service requirements [94](#)  
Oil filler neck [232](#)  
Oil types, alternative [233](#)  
Oil types, approved [233](#)  
Old batteries, disposal [244](#)  
On-board computer [97](#)  
Onboard monitor, refer to Control Display [18](#)  
Onboard vehicle tool kit [238](#)  
Opening/closing via door lock [39](#)  
Opening and closing [34](#)  
Opening and closing, without remote control [39](#)  
Opening and closing, with remote control [37](#)

Opening the trunk lid with no-touch activation [44](#)  
Operating concept, iDrive [18](#)  
Optional equipment, standard equipment [6](#)  
Outside air, refer to Automatic recirculated-air control [167](#)  
Overheating of engine, refer to Coolant temperature [92](#)

## P

Paint, vehicle [252](#)  
Parallel parking assistant [160](#)  
Park Distance Control PDC [152](#)  
Parked-car ventilation [171](#)  
Parked vehicle, condensation [191](#)  
Parking aid, refer to PDC [152](#)  
Parking assistant [160](#)  
Parking brake [73](#)  
Parking lights [103](#)  
Parking with Automatic Hold [74](#)  
Particulate filter [189](#)  
Parts and accessories [7](#)  
Passenger side mirror, tilting downward [62](#)  
Pathway lines, rearview camera [156](#)  
PDC Park Distance Control [152](#)  
Pedestrian detection, see Night Vision [126](#)  
Pedestrian warning with city braking function [123](#)  
Personal Profile [35](#)  
Personal Profile, exporting profiles [36](#)  
Pinch protection system, glass sunroof [51](#)  
Pinch protection system, windows [49](#)  
Plastic, care [253](#)

Power failure [243](#)  
Power sunroof, glass [50](#)  
Power windows [48](#)  
Pressure, tire air pressure [211](#)  
Pressure warning FTM, tires [115](#)  
Profile, refer to Personal Profile [35](#)  
Programmable memory buttons, iDrive [23](#)  
Protective function, glass sunroof [51](#)  
Protective function, windows [49](#)  
Push-and-turn switch, refer to Controller [18](#)

## R

Radiator fluid [234](#)  
Radio-operated key, refer to Remote control [34](#)  
Radio ready state [69](#)  
Radio, see user's manual for Navigation, Entertainment and Communication  
Rain sensor [77](#)  
Rear automatic climate control [169](#)  
Rear axle steering [139](#)  
Rear lights [241](#)  
Rear socket [177](#)  
Rearview camera [154](#)  
Rearview mirror [62](#)  
Rear window defroster [167](#)  
Recirculated-air mode [167](#)  
Recommended fuel grade [206](#)  
Recommended tire brands [223](#)  
Refueling [204](#)  
Remaining range [93](#)  
Remote control/key [34](#)  
Remote control, malfunction [38](#)



- Remote control, universal [172](#)
- Replacement fuse [244](#)
- Replacing parts [238](#)
- Replacing wheels/tires [223](#)
- Reporting safety defects [9](#)
- RES button [146](#)
- RES button, see Active Cruise Control, ACC [143](#)
- RES button, see Cruise control [150](#)
- Reserve warning, refer to Range [93](#)
- Reset, Tire Pressure Monitor TPM [112](#)
- Residual heat, automatic climate control [168](#)
- Retaining straps, securing cargo [193](#)
- Retreaded tires [223](#)
- Reversing lamp, bulb replacement [242](#)
- Roadside parking lights [104](#)
- Roller sunblinds [49](#)
- Roll stabilization, refer to Adaptive Drive [138](#)
- Roll stabilization, refer to Dynamic Drive [138](#)
- RON recommended fuel grade [206](#)
- Roofliner [17](#)
- Roof load capacity [259](#)
- Roof-mounted luggage rack [193](#)
- Rope for tow-starting/towing [249](#)
- RSC Run Flat System Component, refer to Run-flat tires [224](#)
- Rubber components, care [253](#)
- Run-flat tires [224](#)
- S**
- Safe braking [190](#)
- Safety [7](#)
- Safety belt reminder for driver's seat and front passenger seat [58](#)
- Safety belts [57](#)
- Safety belts, care [254](#)
- Safety Package, refer to Active Protection [132](#)
- Safety switch, windows [49](#)
- Safety systems, airbags [108](#)
- Saving fuel [195](#)
- Screen, refer to Control Display [18](#)
- Screwdriver, see Onboard vehicle tool kit [238](#)
- Screw thread, refer to Screw thread for tow fitting, screw thread for tow fitting [250](#)
- Sealant [224](#)
- Seat belts, refer to Safety belts [57](#)
- Seat heating, front [56](#)
- Seat heating, rear [56](#)
- Seating position for children [65](#)
- Seat, mirror, and steering wheel memory [61](#)
- Seats [53](#)
- Seat ventilation, front [57](#)
- Selection list in instrument cluster [96](#)
- Selector lever, Steptronic transmission [80](#)
- Sensors, care [254](#)
- Service and warranty [8](#)
- Service requirements, Condition Based Service CBS [236](#)
- Service requirements, display [94](#)
- Services, ConnectedDrive
- SET button, see Active Cruise Control, ACC [143](#)
- SET button, see Cruise control [150](#)
- Settings, locking/unlocking [46](#)
- Settings on Control Display [99](#)
- Settings, storing for seat, mirrors, steering wheel [61](#)
- Shift paddles on the steering wheel [81](#)
- Shift point indicator [87](#)
- Shoulder support [56](#)
- Side airbags [108](#)
- Side View [157](#)
- Signaling, horn [14](#)
- Signals when unlocking [46](#)
- Sitting safely [53](#)
- Size [258](#)
- Ski bag [179](#)
- Slide/tilt glass roof [50](#)
- Smallest turning radius [258](#)
- Smoker's package [174](#)
- Snow chains [228](#)
- Socket [176](#)
- Socket, OBD Onboard Diagnostics [237](#)
- Soot particulate filter [189](#)
- SOS button [245](#)
- Spare fuse [244](#)
- Speaker lighting [107](#)
- Specified engine oil types [233](#)
- Speed, average [98](#)
- Speed limit detection, onboard computer [98](#)
- Speed limiter, display [95](#)
- Speed Limit Information [95](#)
- Speed warning [99](#)
- Split screen [23](#)
- SPORT+ - program, Dynamic Driving Control [140](#)
- Sport displays, torque display, performance display [99](#)
- SPORT program, driving dynamics [140](#)
- Sport program, transmission [81](#)

- Stability control systems [135](#)
- Start/stop, automatic function [71](#)
- Start/Stop button [69](#)
- Start function during malfunction [35](#)
- Starting the engine [70](#)
- Status control display, tires [112](#)
- Status information, iDrive [22](#)
- Status of Owner's Manual [7](#)
- Steering, Integral Active Steering [139](#)
- Steering wheel, adjusting [63](#)
- Steering wheel heating [64](#)
- Steering wheel memory [61](#)
- Steptronic Sport transmission, refer to Steptronic transmission [79](#)
- Steptronic transmission [79](#)
- Stopping the engine [71](#)
- Storage compartment, remote control [184](#)
- Storage compartments [181](#)
- Storage compartments, locations [181](#)
- Storage, tires [224](#)
- Storing the vehicle [254](#)
- Suitable engine oils [233](#)
- Summer tires, tread [222](#)
- Sun visor [174](#)
- Supplementary text message [91](#)
- Surround View [154](#)
- Suspension settings [139](#)
- Switch for Dynamic Driving Control [139](#)
- Switch-on times, parked-car ventilation [171](#)
- Switch, refer to Cockpit [14](#)
- Symbols [6](#)
- Symbols in the status field [22](#)
- SYNC program, automatic climate control [167](#)
- ## T
- Tachometer [92](#)
- Tail and brake lights [241](#)
- Tail lights [241](#)
- Tail lights, bulb replacement [241](#)
- Technical changes, refer to Safety [7](#)
- Technical data [258](#)
- Telephone, see user's manual for Navigation, Entertainment and Communication
- Temperature, automatic climate control [166](#)
- Temperature display for external temperature [93](#)
- Temperature, engine oil [92](#)
- Terminal, starting aid [247](#)
- Text message, supplementary [91](#)
- Theft alarm system, refer to Alarm system [47](#)
- Thermal camera, see Night Vision [126](#)
- Thigh support [55](#)
- Through-loading system [177](#)
- Tilt alarm sensor [47](#)
- Time of arrival [98](#)
- Tire damage [222](#)
- Tire identification marks [220](#)
- Tire inflation pressure [211](#)
- Tire inflation pressure monitor, refer to FTM [115](#)
- Tire Pressure Monitor TPM [111](#)
- Tires, changing [223](#)
- Tire sealant [224](#)
- Tires, everything on wheels and tires [211](#)
- Tires, run-flat tires [224](#)
- Tire tread [222](#)
- Tone, see user's manual for Navigation, Entertainment and Communication
- Tool [238](#)
- Top View [158](#)
- Total vehicle weight [259](#)
- Touchpad [21](#)
- Tow fitting [249](#)
- Towing [248](#)
- Tow lug, see Tow fitting [249](#)
- Tow-starting [248](#)
- Tow truck [249](#)
- TPM Tire Pressure Monitor [111](#)
- Traction control [136](#)
- TRACTION, driving dynamics [136](#)
- Transmission lock, electronic unlocking [82](#)
- Transmission, manual transmission [79](#)
- Transmission, see Steptronic transmission [79](#)
- Transporting children safely [65](#)
- Tread, tires [222](#)
- Trip computer [98](#)
- Triple turn signal activation [76](#)
- Trip odometer [92](#)
- Truck for tow-starting/towing [249](#)
- Trunk lid, automatic [41](#)
- Trunk lid closing [41](#)
- Trunk lid, closing with no-touch activation [44](#)
- Trunk lid, emergency unlocking [43](#)
- Trunk lid, hotel function [42](#)
- Trunk lid opening [40](#)
- Trunk lid, opening with no-touch activation [44](#)
- Trunk lid via remote control [38](#)
- Turning circle [258](#)
- Turning circle lines, rearview camera [156](#)
- Turn signals, operation [76](#)
- Turn signals, rear, bulb replacement [241](#)

**U**

Unintentional alarm [48](#)  
Units of measure [100](#)  
Universal remote control [172](#)  
Unlock button, Steptronic transmission [80](#)  
Unlocking/locking via door lock [39](#)  
Unlocking/locking with remote control [37](#)  
Unlocking, settings [46](#)  
Updates made after the editorial deadline [7](#)  
Upholstery care [253](#)  
USB interface [177](#)

**V**

Vanity mirror [174](#)  
Variable steering, Integral Active Steering [139](#)  
Vehicle battery [243](#)  
Vehicle battery, replacing [243](#)  
Vehicle, break-in [188](#)  
Vehicle care [252](#)  
Vehicle features and options [6](#)  
Vehicle identification number [9](#)  
Vehicle jack [243](#)  
Vehicle paint [252](#)  
Vehicle storage [254](#)  
Vehicle wash [251](#)  
Ventilation [168](#)  
Ventilation, refer to Parked-car ventilation [171](#)  
Venting, see ventilation [168](#)  
Vent, see ventilation [168](#)  
VIN, see vehicle identification number [9](#)  
Voice activation system [26](#)

**W**

Warning and indicator lamps, see Check Control [88](#)  
Warning displays, see Check Control [88](#)  
Warning messages, see Check Control [88](#)  
Warning triangle [246](#)  
Warranty [7](#)  
Washer fluid [78](#)  
Washer nozzles, windshield [78](#)  
Washer system [77](#)  
Washing, vehicle [251](#)  
Water on roads [190](#)  
Weights [259](#)  
Welcome lamps during unlocking [37](#)  
Welcome lights [103](#)  
Wheel base, vehicle [258](#)  
Wheel cleaner [253](#)  
Wheels, changing [223](#)  
Wheels, everything on wheels and tires [211](#)  
Wheels, Flat Tire Monitor FTM [115](#)  
Wheels, Tire Pressure Monitor TPM [111](#)  
Width, vehicle [258](#)  
Window defroster, rear [167](#)  
Windows, powered [48](#)  
Windshield, climate control [189](#)  
Windshield washer fluid [78](#)  
Windshield washer nozzles [78](#)  
Windshield washer system [77](#)  
Windshield wiper [77](#)  
Winter diesel [207](#)  
Winter storage, care [254](#)  
Winter tires, suitable tires [224](#)  
Winter tires, tread [222](#)  
Wiper [77](#)

Wiper blades, replacing [238](#)  
Wiper fluid [78](#)  
Wiper, fold-out position [78](#)  
Wiper system [77](#)  
Wood, care [253](#)  
Word match concept, navigation [24](#)  
Wrench, see Onboard vehicle tool kit [238](#)

**X**

xDrive [137](#)  
Xenon headlights, bulb replacement [239](#)



More about BMW



The Ultimate  
Driving Machine®

[bmwusa.com](http://bmwusa.com)

01 40 2 954 312 ue

