

Owner's Manual
for Vehicle



The Ultimate
Driving Machine



Z4 3.0i Z4 3.0si

Owner's Manual for Vehicle

Congratulations, and thank you for choosing a BMW.

Thorough familiarity with your vehicle will provide you with enhanced control and security when you drive it. We therefore have this request:

Please take the time to read this Owner's Manual and familiarize yourself with the information that we have compiled for you before starting off in your new vehicle. It contains important data and instructions intended to assist you in gaining maximum use and satisfaction from your BMW's unique range of technical features. The manual also contains information on maintenance designed to enhance operating safety and contribute to maintaining the value of your BMW throughout an extended service life.

This manual is supplemented by a Service and Warranty Information Booklet for US models or a Warranty and Service Guide Booklet for Canadian models.

We wish you an enjoyable driving experience.

BMW AG

© 2007 Bayerische Motoren Werke
Aktiengesellschaft
Munich, Germany
Reprinting, including excerpts, only with the
written consent of BMW AG, Munich.
Order No. 01 41 0 014 500
US English VIII/07
Printed in Germany
Printed on environmentally friendly paper,
bleached without chlorine, suitable for recycling.

Contents

The fastest way to find information on special topics is by using the index starting on page [116](#).

Using this Owner's Manual

- 4 Notes
- 7 Reporting safety defects

At a glance

- 10 Cockpit

Controls

- 18 Opening and closing
- 30 Adjustments
- 36 Transporting children safely
- 40 Driving
- 48 Everything under control
- 51 Technology for driving comfort and safety
- 59 Lamps
- 62 Climate
- 68 Practical interior accessories

Driving tips

- 74 Things to remember when driving

Mobility

- 82 Refueling
- 84 Wheels and tires
- 91 Under the hood
- 96 Maintenance
- 98 Replacing components
- 103 Giving and receiving assistance

Reference

- 110 Technical data
- 116 Everything from A to Z

Notes

About this Owner's Manual

We have tried to make all the information in this Owner's Manual easy to find. The fastest way to find specific topics is to refer to the detailed index at the back of the manual. If you wish to gain an initial overview of your vehicle, you will find this in the first chapter.

Should you sell your BMW at some time in the future, please remember to pass the Owner's Manual on to the new owner. The manual represents an important component of the vehicle.

Additional sources of information

Should you have any other questions, your BMW center will be glad to advise you at any time.

Information on BMW, e.g. on technical aspects, can also be found on the Internet at www.bmwusa.com

Symbols used

 Indicates precautions that must be followed precisely in order to avoid the possibility of personal injury and serious damage to the vehicle.

 Indicates information that will assist you in gaining the optimum benefit from your vehicle and enable you to care more effectively for your vehicle.

 Refers to measures that can be taken to help protect the environment.

◀ Marks the end of a specific item of information.

* Indicates special equipment, country-specific equipment and optional extras, as well as equipment and functions not yet available at the time of printing.

 Vehicle Memory, Key Memory, refer to page 18. Identifies functions that can be specifically adapted for a particular key or vehicle. These adjustments can be performed by your BMW center.

Symbols on vehicle components

 Indicates that you should consult the relevant section of this Owner's Manual for information on a particular part or assembly.

Your individual vehicle

When you ordered your BMW, you chose various items of equipment. This Owner's Manual describes all models and equipment that BMW offers within the same group.

We hope you will understand that equipment and features are included which you might not have chosen for your vehicle. Any differences can easily be identified since all optional accessories and special equipment are marked with an asterisk *.

If your BMW features equipment not described in this Owner's Manual, please observe the enclosed supplementary Owner's Manuals.

Status at time of printing

BMW pursues a policy of continuous, ongoing development that is conceived to ensure that our vehicles continue to embody the highest quality and safety standards combined with advanced, state-of-the-art technology. In exceptional cases, the features described in this Owner's Manual could therefore differ from those on your vehicle.

For your own safety

Maintenance and repair



Advanced technology, e.g. the use of modern materials and powerful electronics, requires specially adapted maintenance and repair methods. You should therefore have the corresponding work on your vehicle performed only by your BMW center or at a workshop that works according to BMW repair procedures with correspondingly trained personnel. If this work is not carried out properly, there is a danger of subsequent damage and related safety hazards. ◀

California Proposition 65 warning

California laws require us to state the following warning:



Engine exhaust and a wide variety of automobile components and parts, including components found in the interior furnishings in a vehicle, contain or emit chemicals known to the State of California to cause cancer and birth defects and reproductive harm. In addition, certain fluids contained in vehicles and certain products of component wear contain or emit chemicals known to the State of CA to cause cancer and birth defects or other reproductive harm.

Battery posts, terminals and related accessories contain lead and lead compounds. Wash your hands after handling.

Used engine oil contains chemicals that have caused cancer in laboratory animals. Always protect your skin by washing thoroughly with soap and water. ◀

Parts and accessories



For your own safety, use genuine parts and accessories approved by BMW.

When you purchase accessories tested and approved by BMW and Original BMW Parts, you simultaneously acquire the assurance that they have been thoroughly tested by BMW to ensure optimum performance when installed on your vehicle.

BMW warrants these parts to be free from defects in material and workmanship.

BMW will not accept any liability for damage resulting from installation of parts and accessories not approved by BMW.

BMW cannot test every product made by other manufacturers to verify if it can be used on a BMW safely and without risk to either the vehicle, its operation, or its occupants.

Original BMW Parts, BMW Accessories and other products approved by BMW, together with professional advice on using these items, are available from all BMW centers.

Installation and operation of non-BMW approved accessories such as alarms, radios, amplifiers, radar detectors, wheels, suspension components, brake dust shields, telephones, including operation of any mobile phone from within the vehicle without using an externally mounted antenna, or transceiver equipment, for instance, CBs, walkie-talkie, ham radio or similar accessories, may cause extensive damage to the vehicle, compromise its safety, interfere with the vehicle's electrical system or affect the validity of the BMW Limited Warranty. See your BMW center for additional information. ◀



Maintenance, replacement or repair of the emission control devices and systems may be performed by any automotive repair establishment or individual using any certified automotive part. ◀

Service and warranty

We recommend that you read this publication thoroughly.

Your BMW is covered by the following warranties:

- ▷ New Vehicle Limited Warranty
- ▷ Rust Perforation Limited Warranty
- ▷ Federal Emissions System Defect Warranty
- ▷ Federal Emissions Performance Warranty
- ▷ California Emission Control System Limited Warranty

Detailed information about these warranties is listed in the Service and Warranty Information Booklet for US models or in the Warranty and Service Guide Booklet for Canadian models.

Reporting safety defects

For U.S. customers

The following only applies to vehicles owned and operated in the US.

If you believe that your vehicle has a defect which could cause a crash or could cause injury or death, you should immediately inform the National Highway Traffic Safety Administration NHTSA in addition to notifying BMW of North America, LLC, P.O. Box 1227, Westwood, New Jersey 07675-1227, Telephone 1-800-831-1117.

If NHTSA receives similar complaints, it may open an investigation, and if it finds that a safety defect exists in a group of vehicles, it may order a recall and remedy campaign. However, NHTSA cannot become involved in individual problems between you, your dealer, or BMW of North America, LLC.

To contact NHTSA, you may call the Vehicle Safety Hotline toll-free at 1-888-327-4236 (TTY: 1-800-424-9153); go to <http://www.safercar.gov>; or write to: Administrator, NHTSA, 400 Seventh Street, SW., Washington, DC 20590. You can also obtain other information about motor vehicle safety from <http://www.safercar.gov>

For Canadian customers

Canadian customers who wish to report a safety-related defect to Transport Canada, Defect Investigations and Recalls, may call 1-800-333-0510 toll free from anywhere in Canada or 1-613-993-9851 from the Ottawa region and from other countries, or contact Transport Canada by mail at: Transport Canada, ASFAD, Place de Ville, Tower C, 330 Sparks Street, Ottawa, ON, K1A 0N5. You can also obtain other information about motor vehicle safety from <http://www.tc.gc.ca>











At a glance

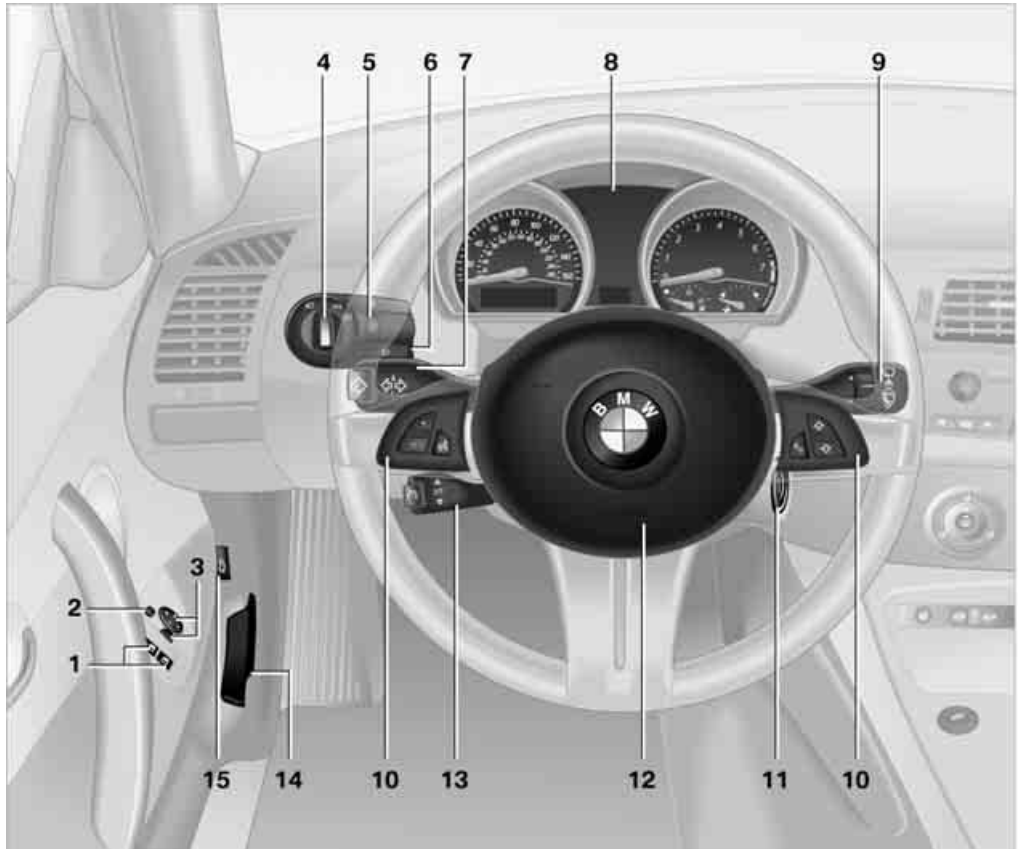

This overview of buttons, switches and displays is intended to familiarize you with your vehicle's operating environment. The section will also assist you in becoming acquainted with the control concepts and options available for operating the various systems.

Cockpit



Around the steering wheel: controls and displays



- | | | | | | | | |
|---|---|-------------------------------------|----|---|---|---------------------|----|
| 1 |  | Opening and closing windows | 25 | 5 |  | Instrument lighting | 60 |
| 2 | | Folding exterior mirrors in or out* | 34 | 6 |  | Fog lamps* | 60 |
| 3 | | Adjusting exterior mirrors | 34 | | | | |
| 4 |  | Parking lamps | 59 | | | | |
| |  | Low beams | 59 | | | | |
| |  | Automatic headlamp control* | 59 | | | | |

- 7  Turn signal indicators 44
-  High beams, headlamp flasher 60
-  Roadside parking lamps* 60
- BC** Computer* 50

8 Instrument cluster 12

- 9  Windshield wipers 45
-  Rain sensor* 45

10 Buttons* on the steering wheel

 Volume



-  ▷ Press: to accept and end a telephone call; to start dialing for selected telephone numbers
- ▷ Press longer: activate and deactivate voice entry*

 Fast forward/rewind

▷ Radio

 Press: next station stored

Press longer: station search

- ▷ CD
- Press: jump to next track
- Press longer: fast forward/rewind

- ▷ Telephone
- Scan register of names

R/T Display/hide telephone book. Display the entries one after another with the forward/backward buttons

11 Ignition lock 40

12 Horn: the entire surface

- 13  Cruise control* 46

14 Releasing the hood 91

- 15 Opening the luggage compartment lid/tailgate 21

Instrument cluster

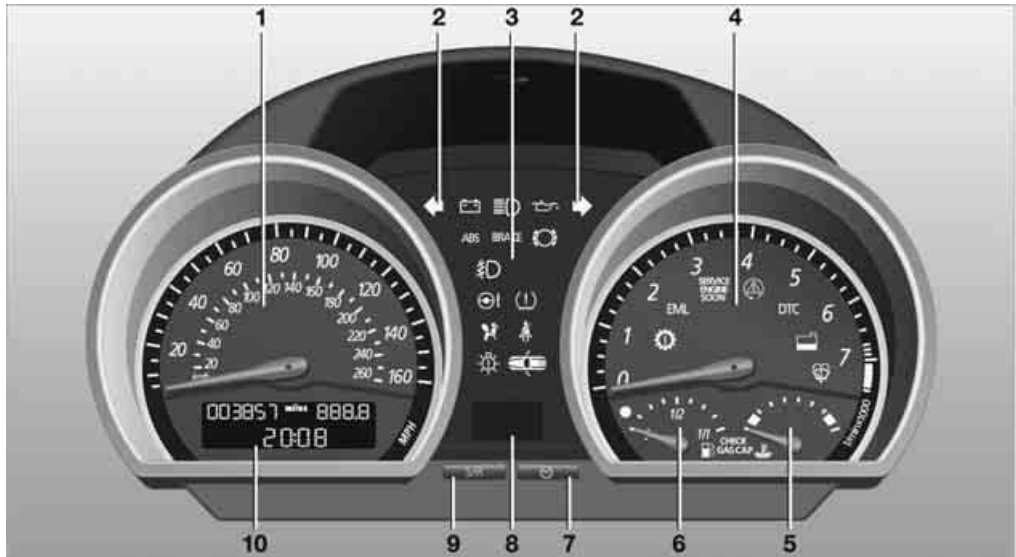

- 1 Speedometer
- 2 Indicator lamps for turn signals
- 3 Indicator and warning lamps [12](#)
- 4 Tachometer [48](#)
with indicator and warning lamps [12](#)
- 5 Engine coolant temperature gauge [49](#)
- 6 Fuel gauge [48](#)
- 7 Button for
 - ▷ Displaying the clock [49](#)
 - ▷ Service interval display [49](#)
 - ▷ Checking the oil level [93](#)
- 8 Position of automatic transmission* [42](#)
- 9 Button for
 - ▷ Resetting trip odometer [48](#)
 - ▷ Setting the clock [49](#)
- 10 Display for
 - ▷ Trip odometer/Odometer [48](#)
 - ▷ Clock [49](#)
 - ▷ Service interval [49](#)
 - ▷ Computer* [50](#)
 - ▷ Checking the oil level [93](#)

Indicator and warning lamps

Technology that monitors itself

Indicator and warning lamps that are identified by ● are tested for proper functioning whenever the key is turned. They each light up once for different periods of time.

If a malfunction occurs in one of the monitored systems, the corresponding lamp does not go out after the engine has started, or it lights up again while the vehicle is in motion. You can find more information about each system on the specified pages.



Turn signal indicators [44](#)



Battery charge current ● [102](#)



Headlamp flasher/High beams [44, 60](#)



Engine oil pressure/
Engine oil level ● [92](#)



Antilock Brake System ABS/Driving
stability control systems ● [51](#)



Antilock Brake System ABS/Driving stability control systems for Canadian models



Brake system ●
Parking brake released 95
Parking brake applied 41
With other warning lamps 52



Brake warning lamp for Canadian models



Brake pads ● 76



Fog lamps 60



Electric Power Steering ● 56



Flat Tire Monitor* ● 53
Tire Pressure Monitor* ● 54



Airbags ● 56



'Fasten safety belts' reminder 33



Defective bulb 59



Doors or luggage compartment lid/tailgate open



Automatic transmission ● 43



Engine electronics ●
Malfunction in the engine electronics. You can continue to drive with reduced engine output. Please have the system inspected by your BMW center.



Service engine soon ● 97



Service engine soon indicator lamp for Canadian models



Dynamic Stability Control DSC ● 51



Dynamic Traction Control DTC ● 51



Add coolant 94



Add washer fluid 46



Check gas cap ● 82













Colors

The indicator and warning lamps can light up in various colors and combinations.

- ▷ Red:
Stop the vehicle immediately or an important reminder
- ▷ Red and yellow:
Continue driving cautiously
- ▷ Yellow:
Have the system checked soon or for your information
- ▷ Green or blue:
For your information

Around the center console: controls and displays



- 1 Reading lamps* 61
- 2 Interior lamps 61
- 3 Air conditioning 62
or automatic climate control* 65
 -  Air distribution for air conditioning 63
 -  Air distribution for automatic climate control* 66
 - AUTO Automatic air distribution and flow rate* 66
 -  Cooling function* 63, 66
 -  AUC Automatic recirculated-air control* 67
 -  Recirculated-air mode 63, 67
 - MAX  Maximum cooling* 66
 -  Air flow rate 63, 66
 -  Defrosting windows* 66
 -  Rear window defroster 63, 67
- 4  Seat heating* 33
 -  Roadster: opening the convertible top* 27
 -  Roadster: closing the convertible top* 27
 - DTC Dynamic Traction Control DTC 51
 -  Flat Tire Monitor FTM* 53
Tire Pressure Monitor TPM* 54
- 5 Indicator/warning lamp passenger airbags 37
- 6 Central locking system 21
- 7 Hazard warning flashers
- 8 Dynamic Driving Control 44





Controls

This chapter is intended to provide you with information for complete control of your vehicle. All features and accessories that are useful for driving and your safety, comfort and convenience, are described here.

Opening and closing

The key set

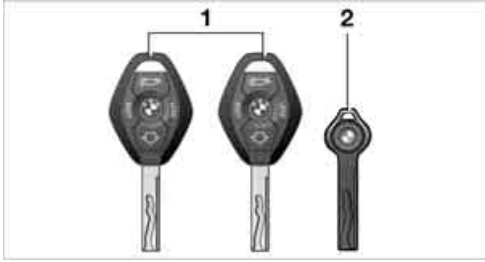

- 1 Master keys with remote control
- 2 Spare key

Master key with remote control

Each master key contains a rechargeable battery that is automatically recharged when it is in the ignition lock while the car is being driven. Use the master key at least twice a year in order to keep the batteries charged.

Depending on which master key is recognized when the vehicle is unlocked, different settings are called up and carried out in the vehicle, refer to Key Memory.

Spare key

For storage in a safe place, e.g. in your wallet. This key is not intended for constant use.

New keys

You can obtain new keys, whether as additional keys or replacement keys, at your BMW center.

Vehicle Memory, Key Memory

How the system functions

You can have your BMW center program a variety of functions on your BMW according to your individual requirements.

Vehicle Memory refers to vehicle-oriented settings and Key Memory refers to person-oriented settings.

You can have up to four different basic settings adjusted for four different persons. The only requirement is that each person uses his or her own master key with remote control.

When your vehicle is unlocked with the remote control, the vehicle recognizes the individual user by means of a data exchange with the key, and makes adjustments accordingly.

Colored decals were provided with the keys to help you distinguish between the different personal remote control keys.

What the system can do

You can learn about the entire array of features that Vehicle Memory and Key Memory offer you at your BMW center.



You will see this symbol throughout the Owner's Manual. It is to remind you at appropriate places of the settings that are available to you. ◀



Depending on how the memory functions are configured, the vehicle may be operated differently from what is described in the Owner's Manual. Should you decide to sell your BMW one day, please remember to have the memory functions returned to their original factory settings. ◀

Examples for Vehicle Memory

- ▷ Signal as acknowledgment when locking or unlocking your vehicle, refer to page 19, 20
- ▷ Automatic opening of windows, refer to page 25
- ▷ Acoustic warning when the key is still in the ignition switch after the driver's door has been opened, refer to page 41
- ▷ Activation/deactivation of triple turn signal, refer to page 44
- ▷ Activation/deactivation of daytime running lamps*, refer to page 59

- ▷ Activation/deactivation and duration of pathway lighting, refer to page 60
- ▷ Adjustment of sensitivity of automatic headlamp control*, refer to page 59
- ▷ Setting unit of measure for displaying the time and outside temperature in the instrument cluster, refer to page 50

Examples for Key Memory

- ▷ Automatic call-up* of the driver's seat position after unlocking, refer to page 33
- ▷ Locking of the vehicle after starting off, refer to page 21

Central locking system

The concept

The central locking system is ready for operation whenever the driver's door is closed.

The system simultaneously engages and releases the locks on the following:

- ▷ Doors
- ▷ Luggage compartment lid/tailgate
- ▷ Fuel filler door
- ▷ Storage compartment between the backrests
- ▷ Roadster: opened manual convertible top

Operating from outside

- ▷ Via the remote control
- ▷ Via the door lock

The anti-theft system is operated at the same time. It prevents the doors from being unlocked with the lock buttons or release handles. The remote control is also used to switch the interior lamps on and off. In addition, the alarm system* is armed or disarmed.

For further details of the alarm system*, refer to page 23.

Operating from inside

By means of the button for central locking, refer to page 21.

In the event of a sufficiently severe accident, the central locking system unlocks automatically. In addition, the hazard warning flashers and interior lamps come on.



Opening and closing: from outside

With the remote control



Persons or animals in the vehicle could lock the doors from the inside. You should therefore take the remote control with you when leaving the vehicle so that the car can be opened from the outside. ◀

Unlocking

1. Press the  button once.
The driver's door and fuel filler door are unlocked.
2. Press the  button again.
The entire vehicle is unlocked.

Convenience opening

Hold the  button down.

Coupe: the windows are opened.

Roadster: the windows and the fully automatic convertible top* are opened.

Locking

Press the  LOCK button.

The hazard warning flashers light up once.



If you wish, you can have this special feature activated/deactivated. ◀



Do not lock the vehicle from the outside if there is any person inside, because the vehicle cannot be unlocked from inside without special knowledge. ◀

Switching on interior lamps

With the vehicle locked:

Press the  LOCK button.

With this function, you can also search for your vehicle when parked in an underground garage, for instance.

Unlocking the luggage compartment lid/tailgate

Press the  button for approx. 1 second.

The luggage compartment lid/tailgate opens a short distance, regardless of whether it was locked or unlocked.

 A previously locked luggage compartment lid/tailgate is locked again after closing.

Before and after each trip, check that the luggage compartment lid/tailgate has not been inadvertently unlocked. ◀

Panic mode*

You can also trigger the alarm system* if you find yourself in a dangerous situation:

Press the  button for at least 3 seconds.

To switch off the alarm: press any button.

Malfunctions

The remote control may malfunction due to local radio waves. If this occurs, unlock and lock the car at the door lock or luggage compartment lid/tailgate lock with the key.

If the car can no longer be locked with a remote control, the battery in the remote control is discharged. Use this remote control key while driving for an extended period in order to recharge the battery, refer to page 18.

For US owners only

The transmitter and receiver units comply with part 15 of the FCC/Federal Communications Commission regulations. Operation is governed by the following:

FCC ID:

LX8EWS

LX8FZVS

LX8FZVE

Compliance statement:

This device complies with part 15 of the FCC Rules. Operation is subject to the following two conditions:

- ▷ This device may not cause harmful interference, and

- ▷ this device must accept any interference received, including interference that may cause undesired operation.

 Any unauthorized modifications or changes to these devices could void the user's authority to operate this equipment. ◀

At the door lock



1. Turn the key.
The driver's door and fuel filler door are unlocked.
2. Turn the key again.
The entire vehicle is unlocked.

When the vehicle is locked, the hazard warning flashers light up once.

 If you wish, you can have these special features activated/deactivated. ◀

 Do not lock the vehicle from the outside if there is any person inside, because the vehicle cannot be unlocked from inside without special knowledge. ◀

Convenience operation

You can also operate the windows and the Roadster's fully automatic convertible top* via the door lock.

Hold the key in the position for unlocking or locking.

 Watch the closing process to ensure that no one is trapped. Releasing the key stops the operation. ◀

Manual operation

If there is a malfunction, you can unlock or lock the driver's door by turning the key in the lock all the way to the left or right.

Opening and closing: from inside



This button serves to unlock or lock doors and the luggage compartment lid/tailgate when the doors are closed, but does not activate the anti-theft system. The fuel filler door remains unlocked.

If only the driver's door was unlocked from the outside and you press the button, then, with the driver's door still open, the luggage compartment lid/tailgate and the fuel filler door will unlock, too. If the driver's door is closed, it will be locked.



If you prefer, the central locking system is activated automatically as soon as you begin to drive. You can have the corresponding adjustment made for each key specifically. ◀

Unlocking and opening

- ▶ Either unlock the doors together using the button for the central locking system and then pull the door handle above the armrest or
- ▶ pull the release handle for each door twice: the initial pull unlocks the door, and the second one opens it.

Locking

- ▶ Either use the central locking button to lock both doors simultaneously, or
- ▶ press down the safety lock button of a door. To prevent you from being locked out, the open driver's door cannot be locked using the lock button.



Persons or animals in the vehicle could lock the doors from the inside. You should

therefore take the key with you when leaving the vehicle so that the car can be opened from the outside. ◀

Coupe: tailgate



The tailgate swings upward and towards the rear when it is opened. Make sure that it has enough clearance. ◀

Opening from inside the vehicle



If the tailgate has not been locked separately, you can open it with this button in the footwell on the driver's side when the vehicle is stationary.

Opening from the outside



Press the top half of the BMW emblem or press the  button on the remote control for approx. 1 second:
The tailgate will open.

Opening manually

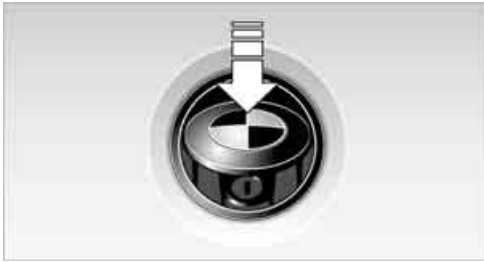

In the event of a malfunction you can open the tailgate manually. The tailgate lock is located underneath the BMW emblem. All keys, refer to page 18, fit the tailgate lock.

Turn the key all the way to the right: the tailgate will open.

 If you open the tailgate at the lock while the alarm system is activated, the alarm will be triggered. You should therefore unlock the vehicle first.

If the alarm was accidentally triggered: deactivate the alarm, refer to page 23. ◀

Closing



The handle recesses in the interior trim of the tailgate make it easier to pull down.

 Make sure that the closing path of the tailgate is clear, otherwise injuries may result. ◀

Roadster: luggage compartment lid

Opening from inside the vehicle



If the luggage compartment lid has not been locked separately, you can open it with this button in the footwell on the driver's side when the vehicle is stationary.

Opening from the outside

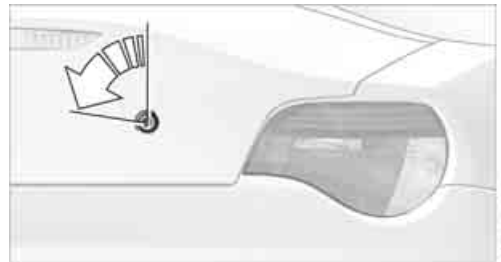

Turn the key all the way to the left or press the  button on the remote control for approx. 1 second. The luggage compartment lid will open a short distance. It can now be swung upwards.

Closing



The handle recess in the interior trim of the luggage compartment lid makes it easier to pull down.

 Make sure that the closing path of the luggage compartment lid is clear, otherwise injuries may result. ◀

Cargo bay

Emergency release



Pull the lever in the cargo bay. The luggage compartment lid/tailgate is unlocked.

Roadster: increasing cargo bay capacity

The cargo bay can be enlarged when the convertible top is closed.

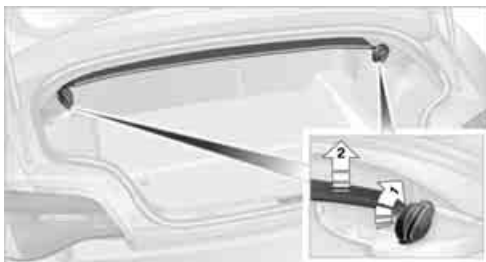

Turn the handles on both sides of the cargo bay outward beyond the resistance point at the same time, arrow 1.

The convertible top compartment panel swings up, arrow 2.

Before opening the convertible top:
Turn both handles inward.

The convertible top compartment panel is folded down.

 To avoid any damage when opening the convertible top, make sure that the convertible top compartment panel in the cargo bay has been folded down. ◀

Alarm system*

The concept

The vehicle alarm system responds:

- ▷ When a door, the hood or the luggage compartment lid/tailgate is opened
- ▷ When attempts are made to start the vehicle
- ▷ When there are movements in the vehicle interior: interior motion sensor, refer to page 24
- ▷ When the car's inclination changes, for instance if an attempt is made to jack it up and steal the wheels or to raise it prior to towing away: Tilt alarm sensor, refer to page 24
- ▷ When there is an interruption in the power supply from the battery

The alarm system signals unauthorized entry attempts for a short time by means of:

- ▷ An acoustic alarm
- ▷ Switching on the hazard warning flashers
- ▷ Flashing the high beams

Arming and disarming

When you lock or unlock the vehicle, either with the remote control or at the door lock, the alarm system is armed or disarmed at the same time.

The hazard warning flashers light up once when the alarm system has been properly armed.

 You can have different acknowledgment signals set to confirm arming and disarming. ◀

Even when the alarm system is armed, you can open the luggage compartment lid/tailgate using the  button on the remote control, refer to page 20. When you subsequently close the luggage compartment lid/tailgate, it is locked again and monitored.



Manual operation of the tailgate triggers the alarm. Refer to page 21. ◀

Switching off an alarm

- ▷ Unlock the car with the remote control, refer to page 19.
- ▷ Turn the master key in the ignition lock to position 1, refer to page 40.

Indicator lamp displays



- ▷ The indicator lamp beneath the interior mirror flashes continuously: The system is armed.
- ▷ The indicator lamp flashes immediately after the vehicle is locked: Doors, hood or luggage compartment lid/tailgate are not properly closed. Even if you do not close the alerted area, the system begins to monitor the remaining areas, and the indicator lamp flashes continuously after approx. 10 seconds. However, the interior motion sensor is not activated.
- ▷ If the indicator lamp goes out immediately after the vehicle is unlocked: Your vehicle has not been disturbed while you were away.
- ▷ If the indicator lamp flashes for 10 seconds immediately after the vehicle is unlocked: Your vehicle has been disturbed while you were away.

After an alarm has been triggered, the indicator lamp will flash continuously.

Tilt alarm sensor

The inclination of the vehicle is monitored. The alarm system reacts e.g. to attempts to steal a wheel or tow the vehicle.

Interior motion sensor*

Coupe

All windows must be closed in order for the interior motion sensor to function optimally.

Roadster

The system monitors the footwells and the seating areas of the driver and passenger. Even when the convertible top is open, the alarm system including the interior motion sensor is armed. Objects falling into the vehicle, e.g. leaves, can trigger unintentional alarms, refer to Avoiding unintentional alarms.

Avoiding unintentional alarms

The tilt alarm sensor and interior motion sensor can be deactivated at the same time. In this way you can avoid unintentional alarms, e.g. in the following situations:

- ▷ In duplex garages
- ▷ When transporting the vehicle on car-carrying trains, by ship or on a trailer
- ▷ When animals are to remain in the vehicle

Switching off tilt alarm sensor and interior motion sensor

- ▷ Press the  LOCK button on the remote control twice in a row.

The indicator lamp lights up briefly and then flashes continuously. The tilt alarm sensor and the interior motion sensor are deactivated until the vehicle is again unlocked and locked.

Windows



To prevent injuries, exercise care when closing the windows and keep them in your field of vision until they are shut.

Take the key with you when you leave the car, otherwise children could operate the windows and possibly injure themselves. ◀

Opening, closing

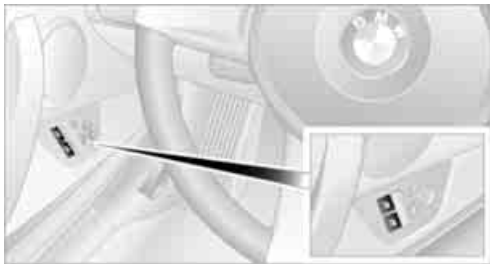

Ignition key in position 1 or higher:

- ▶ Press the switch downward to the resistance point.
The window continues to open as long as you press the switch.
- ▶ Press the switch beyond the resistance point.
The window opens automatically. Press the switch again to stop the opening movement.

You can close the window in the same manner by pulling the switch upward.



If you wish, you can have this special feature activated/deactivated. ◀

After switching off the ignition

You can still open or close the windows for approx. 1 minute, as long as no one opens any of the doors.

For convenience operation via the remote control or the door lock, refer to page 19 or 20, respectively.

Pinch protection system

If the closing force exceeds a certain value while a window is being raised, the system responds by stopping the window and then retracting it a short distance.



Despite the pinch protection system check and clear the window's travel path prior to closing it, otherwise the safety system might fail to detect certain kinds of obstructions, such as thin objects, and the window would continue closing.
Do not install any accessories within the win-

dows' range of movement; otherwise the pinch protection system could be impaired. ◀



The closing force can change as a result of extreme temperature fluctuations. The window then opens slightly after closing even if there is no obstacle within the window's travel path. If this occurs, override the pinch protection system. ◀

Pulling the switch beyond the resistance point and holding it there overrides and deactivates the pinch protection system.

After a power supply interruption

After a power supply interruption, for instance after disconnecting the battery, the pinch protection system must be reinitialized.



Roadster: when the convertible top has been stored in the convertible top compartment for an extended period of time, e.g. in the winter months because the hardtop was being used, it may also be necessary to reinitialize the pinch protection system. ◀

Ensure that the doors and the Roadster's convertible top are closed before initializing.

1. Open the window completely.
2. Press the switch 4 times within approx. 10 seconds.

Afterward, perform the following procedure twice for each window:

1. Close the window completely by pulling the switch.
2. After the window is closed, keep pulling the switch for approx. 2 seconds.
3. Open the window completely by pressing the switch.

Roadster: manual convertible top

The fabric top offers perfect protection against the weather and can be opened easily and quickly by one person alone.

Here are a few tips so that you get the most out of your BMW:

- ▷ It is advisable to close the convertible top when the vehicle is parked. When closed, the top not only guards the passenger compartment from unforeseeable damage from the weather, but also affords a degree of protection against theft. Valuables, however, should only be kept in the locked cargo bay, even when the convertible top is closed.
- ▷ When the convertible top is open, the central locking system also locks button **1** for the convertible top, refer to page 26. The convertible top cannot be operated. This provides better theft protection for valuables stored in the cargo bay.
- ▷ Never mount a roof-mounted luggage rack system on the convertible top.

⚠ Never keep a wet convertible top in the convertible top compartment for longer than one day, otherwise the moisture could cause damage. ◀

Opening

⚠ Operate the convertible top only when the vehicle is stationary.

To avoid any damage when opening the convertible top, make sure that the convertible top compartment panel in the cargo bay has been folded down, refer to page 23. ◀

1. Flip the handle out and turn it to the end stop.

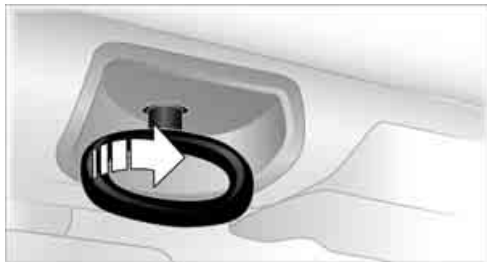

2. Fold the handle back in.

⚠ Do not guide the convertible top towards the rear with the handle folded out, otherwise the convertible top's headliner could be damaged. ◀

3. Open the convertible top and guide it toward the rear of the vehicle.



4. Gently swing the convertible top downward and press until it engages audibly.



Closing

1. Press button **1**.
The convertible top is released and moves up slightly.

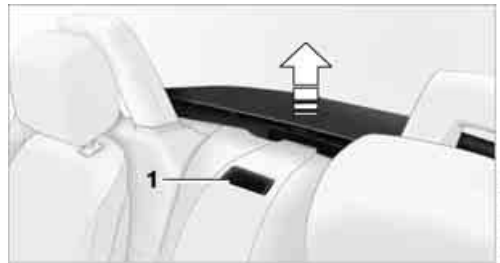

2. Using the handle, pull the convertible top forward onto the windshield frame.
3. Turn the handle until it engages audibly. The convertible top is locked.

▷ At higher speeds, a vacuum effect in the passenger compartment can cause the convertible top to begin fluttering. Increase the air flow from the air conditioning or automatic

climate control to prevent a partial vacuum in the vehicle. ◀

Roadster: fully automatic convertible top*

The fully automatic convertible top combines assured protection against the elements with simple and easy handling.

Here are a few tips so that you get the most out of your BMW:

- ▶ It is advisable to close the convertible top when the vehicle is parked. When closed, the top not only guards the passenger compartment from unforeseeable damage from the weather, but also affords a degree of protection against theft. Valuables, however, should only be kept in the locked cargo bay, even when the convertible top is closed.
- ▶ Never mount a roof-mounted luggage rack system on the convertible top.

 Do not operate the convertible top at temperatures below 14 °F / -10 °C, otherwise damage could result.

Never keep a wet convertible top in the convertible top compartment for longer than one day, otherwise the moisture could cause damage.

Do not lay objects on the convertible top, otherwise they could fall off when the convertible top is operated and cause damage or injuries.

Driving while the convertible top is not completely open or closed can cause vehicle damage or personal injury.

Do not reach into the convertible top mechanism during opening and closing. Keep children away from the convertible top's range of movement.

For safety reasons, whenever possible operate the convertible top when the vehicle is stationary. ◀

 If a convertible top operation has not yet been completed as you start to drive off, at a traffic light for example, you can continue the procedure at moderate speed:

To do so, press and hold the corresponding

button again.

At higher speeds, a vacuum effect in the passenger compartment can cause the convertible top to begin fluttering. Use the air conditioning or automatic climate control to increase the air flow rate and thus prevent a partial vacuum in the vehicle. ◀

Before opening and closing

- ▶ Read and comply with the preceding safety precautions.
- ▶ Make sure that the convertible top compartment panel in the cargo bay has been folded down; refer to page 23. Otherwise the convertible top cannot be opened.
- ▶ Ensure that the luggage compartment lid/ tailgate is closed.

Opening and closing

With the key in ignition position 1 or higher, refer to page 40, and while the vehicle is stationary:

 If at all possible, operate the convertible top only with the engine running. This saves unnecessary battery wear. Before closing the convertible top, remove any objects from the windshield frame that otherwise could prevent the convertible top from closing properly. ◀



1 Closing

2 Opening

 The side windows will move down slightly when you press the button for operating the convertible top.

After the opening or closing operation, the windows will move back up if you press the button for more than 2 seconds after the LED has gone

out. Every time you close the convertible top, keep the button pressed until the windows are completely closed; pinch protection will be suspended during this operation. ◀

 When the convertible top has been stored in the convertible top compartment for an extended period of time, e.g. in the winter months because the hardtop was being used, you may have to support the convertible top by hand when closing it for the first time. If the convertible top stops right before the closing phase is completed, press against the front part of the convertible top frame from the outside to help the closing process along. Keep pressing the button while doing so until the top starts moving on its own again. ◀

Indicator lamps

- ▷ The red LED in the button is lit while the convertible top is in motion. It goes out as soon as the opening or closing operation has been completed.
- ▷ If the red LED in the button flashes after the button has been released, then the opening or closing operation has not yet been completed. The movement can be continued in the desired direction by pressing this button.
- ▷ If the yellow LED in the button comes on when the button is pressed, the convertible top compartment panel in the cargo bay has been folded up. The convertible top cannot be moved.

Interruption

The automatic sequence will be interrupted immediately if you release the button that operates the top. The sequence can be continued in the desired direction by pressing this button.

 Do not close the side windows using the power window buttons before the closing procedure has been completed. Otherwise the side windows may not close properly against the rubber seal of the convertible top. ◀

Convenience operation

Remote control

Refer to page 19.

Driver's door

Refer to page 20.

To close manually in the event of a malfunction

1. Pull out the handle in the cargo bay as far as it will go.



2. Turn the handle 90° until it engages.
3. Grip the convertible top by its frame and guide it all the way to the windshield frame.



4. Pull out the cover panel that is in the center of the front convertible top frame.



5. Insert the Allen wrench into the hex slot. The Allen wrench is stored in a tool pouch, refer to page 98.

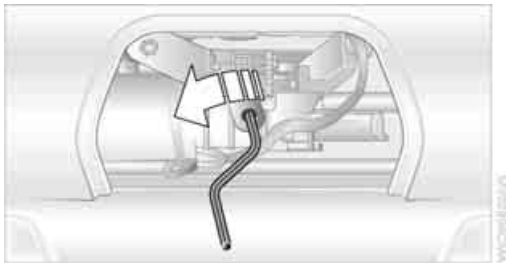

6. Pull the convertible top frame down as far as possible.
7. Keep turning the Allen wrench counter-clockwise until the convertible top frame has locked onto the windshield frame.

Adjustments

Safe seating position

For relaxed driving with as little fatigue as possible, you should select a seating position that reflects your personal requirements. In combination with the safety belts, the head restraints and the airbags, the seating position has a major influence on your safety in the event of an accident. To ensure that the vehicle's safety systems provide you with optimal protection, we request that you direct your careful attention to the following section.

For supplementary information on transporting children refer to page 36.

Airbags

 Always maintain an adequate distance between yourself and the airbags. Always grip the steering wheel on the rim, with your hands in the 3 o'clock and 9 o'clock positions, to minimize the risk of injury to the hands or arms in the event of the airbag being triggered off.

Never allow any objects, individuals or animals to obstruct the areas between passengers and airbags.

Never use the front airbag's cover as a storage tray or support for objects of any kind. Ensure that the passenger is correctly seated, e.g. does not prop feet or legs against the dashboard. Otherwise, leg injury could result if the knee airbag and front airbag suddenly deployed.

Make sure that the passenger does not lean his or her head against the side airbag, otherwise serious injuries could result if the airbags suddenly deployed. ◀

Even when all these guidelines are observed, the risk of injury as a result of contact with the airbags cannot entirely be ruled out in some situations. In sensitive individuals, the ignition and inflation noise may induce a mild hearing loss that is temporary in most cases.

For airbag locations and additional information on airbags, refer to page 56.

Head restraint

A correctly adjusted head restraint reduces the risk of neck injury in the event of an accident.

 Adjust the head restraint in such a way that its center is at approx. ear level. Otherwise, there is an increased risk of injury in the event of an accident. ◀

Head restraints, refer to page 32.

Safety belt

Make sure every occupant fastens his or her safety belt. As supplemental restraint devices, the airbags are designed to enhance the effectiveness of the safety belts, and not to replace them.

Your vehicle offers two sitting positions, each of which is equipped with a safety belt.

 Never allow more than one person to wear a single safety belt. Never allow infants or small children to ride in a passenger's lap. Make sure that the belt in the lap area sits low against the hips and does not press against the abdomen. The safety belt must never rest against the throat, rub against sharp edges, pass over hard or fragile objects or be pinched. Fasten the safety belt around your body snugly, making sure that it is pulled taut across your lap and shoulder and that it is not twisted; otherwise, the belt can slide over the hips in the event of a frontal collision and injure your abdomen. Avoid wearing bulky clothing and regularly pull the belt in the upper-body area taut, otherwise its restraining effect could be impaired. ◀

Safety belts, refer to page 33.

Seats

Before adjusting your seat, always observe the following precautions

 Never try to adjust your seat while driving. Otherwise, the seat could respond with unexpected movement, and the ensuing loss of

vehicle control could lead to an accident. On the passenger seat as well, do not incline the backrest too far to the rear while the vehicle is being driven, otherwise there is a danger in the event of an accident of sliding under the safety belt, eliminating the protection normally provided by the belt. ◀

Comply with the instructions on head restraint height on page 32 and on damaged safety belts on page 34.

Seat adjustment

 Comply with the preceding instructions in this chapter to ensure the best possible personal protection. ◀

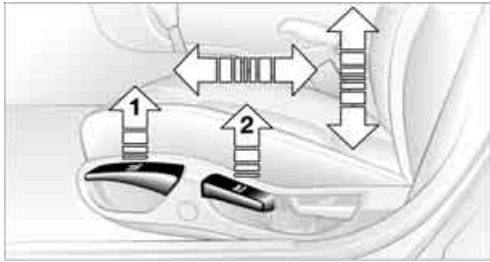

Backward/forward adjustment

Pull lever 1 and slide the seat to the desired position.

After releasing the lever, move the seat gently forward or back to make sure it engages properly.

Height

Pull lever 2 and apply your weight to the seat or lift it off, as necessary.

Backrest

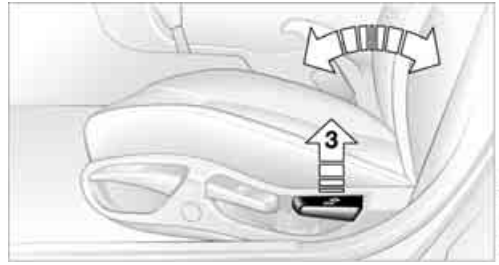

Pull lever 3 and apply your weight to the backrest or lift it off, as necessary.

Power seat adjustment*

 Read and comply with the adjustment instructions on page 30. Failure to do so can result in diminished personal safety. ◀



- 1 Tilt angle
- 2 Backward/forward adjustment
- 3 Height
- 4 Backrest

The head restraint is adjusted manually, refer to Head restraints on page 32.

M Sports seat*

On this seat, you can also adjust the thigh support and the tilt angle.



Tilting upward

Pull lever **1** repeatedly until the desired tilt has been reached.

Tilting downward

Press lever **2** repeatedly until the desired tilt has been reached.

Thigh support

Pull lever **3** and move the thigh support forward or back.

Head restraints

A correctly adjusted head restraint reduces the risk of neck injury in the event of an accident.

⚠ Adjust the head restraint in such a way that its center is at approx. ear level. Otherwise, there is an increased risk of injury in the event of an accident. Only remove the head restraint if no one is traveling in the passenger seat. Reinstall the head restraint before a person travels in the seat to provide the safety functions of the head restraint. ◀

Adjusting the height



▷ To move up: pull up.

▷ To move down: press button **1** and push the head restraint downward.

M Sports seat*

The head restraints are integrated in the backrests and cannot be adjusted in height.

Removal

1. Pull up all the way.
2. Press button **1** and pull out the head restraint completely.

M Sports seat*

The head restraints are integrated in the backrests and cannot be removed.

Seat memory*

You can store and recall three different driver's seat positions.

Storing

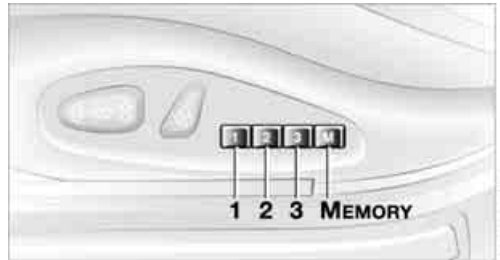

Ignition key in position 1 or higher

1. Adjust seat to desired position.
2. Press the **MEMORY** button. The LED in the button lights up.
3. Press memory button **1, 2 or 3**. The LED goes out.

Manual call-up

⚠ Do not select a memory position while the vehicle is moving. If you do, there is a risk of accident from an unexpected movement of the seat. ◀

Convenience function

1. Unlock and open the driver's door or turn the key to position 1, refer to page 40.
2. Press memory button **1**, **2** or **3** briefly.

Movement stops when one of the seat adjustment or memory buttons is operated during the adjustment process.



You can have this feature programmed so that after you use the remote control from your personalized key to unlock your door, your seat will move into your own preferred position. ◀

Safety function

1. Close the driver's door and turn the key to position 0 or 2.
2. Press the desired memory button **1**, **2** or **3** until the adjustment process is completed.

If you press the **MEMORY** button accidentally: Press the button again; the LED goes out.



Before activating the programmed adjustment feature, ensure that the space behind the driver's seat is empty and unobstructed. If you fail to do so, objects behind the seat could be damaged, should the seat move backward. ◀

Seat heating*



The seat cushion and backrest can be heated with the ignition key in position 2.

Press once for each temperature level. Three LEDs indicate the highest temperature.

To switch off:

Press button longer.

Safety belts



Comply with the instructions on page 30, or the occupants' personal safety will be diminished. ◀

Make sure every occupant fastens his or her safety belt. As supplemental restraint devices, the airbags are designed to enhance the effectiveness of the safety belts, and not to replace them.



To fasten

Make sure you hear the lock engage in the belt buckle.

The upper belt anchor is suitable for adults of any stature as long as the seat is adjusted properly, refer to page 31.

To unlock

1. Grasp the belt firmly.
2. Press the red button in the buckle.
3. Guide the belt back into its reel.

'Fasten safety belts' reminder



The indicator lamp flashes or lights up. A signal also sounds. Check whether the safety belt has been fastened correctly.

The 'Fasten safety belts' reminder is issued as long as the driver's safety belt has not been fastened. The 'Fasten safety belts' reminder is also activated at road speeds above approx. 5 mph/ 8 km/h if the passenger's safety belt is not fastened, if heavy objects are placed on the passenger seat, or if driver or passenger unfasten their safety belts.

Damaged safety belts

 When the belt system has absorbed an accident or has been damaged, have the system and its belt tensioners replaced and the belt anchors checked. Have this work done only by your BMW center or at a workshop that works according to BMW repair procedures with correspondingly trained personnel. Otherwise, it is not guaranteed that the safety devices will function properly. ◀

Mirrors

Exterior mirrors

 The passenger's mirror is more convex than the driver's mirror. The objects seen in the mirror are closer than they appear. Do not gauge your distance from traffic behind you on the basis of what you see in the mirror; otherwise there is an increased risk of an accident. ◀

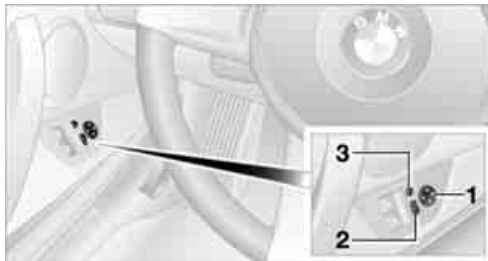

- 1 Adjustments
- 2 To switch from one mirror to the other
- 3 To fold the mirrors in or out*

Manual adjustment

The mirrors can also be adjusted manually: press on the edges of the lens.

Folding mirrors in or out*

The mirrors can be folded in or out up to a road speed of approx. 6 mph/10 km/h by pressing button **3**. This can be useful on narrow roads, for example, or to reset the mirrors to their correct positions after they were folded in.

Automatic heating*

Both exterior mirrors are automatically heated when the engine is running or the ignition is switched on.

Interior rearview mirror



Turn the knob to reduce glare from the headlights of cars behind you when driving at night.

Interior and exterior mirrors with automatic dimming feature*

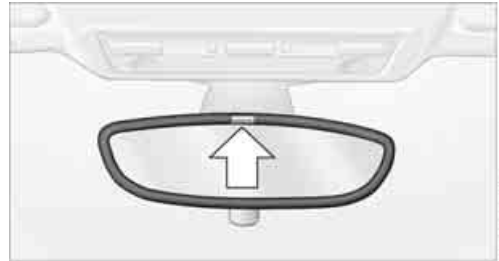

The automatic dimming feature of the interior and exterior mirrors* is controlled by two photo cells in the interior rearview mirror. In the Roadster, one is located in the top of the mirror frame, see arrow. In the Coupe, it is located at the bottom of the mirror frame. The other photo cell is on the back of the mirror.

In order to ensure that the system functions correctly, keep the photocells clean, do not cover the area between the interior rearview mirror and windshield, and do not affix adhesive labels or stickers of any kind to the windshield directly in front of the mirror.

Steering wheel

Adjustments

 Never attempt to adjust the steering wheel while driving the vehicle. It could respond with unexpected movement, posing a potential accident hazard. ◀

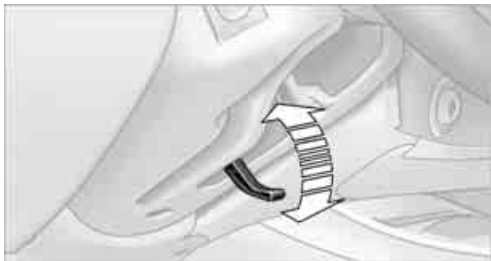

1. Fold the lever down.
2. Move the steering wheel to the preferred height and angle to suit your seated position.
3. Swing the lever back up.

Transporting children safely

The right place for children

⚠ Do not leave children unattended in the vehicle, otherwise they could endanger themselves and/or other persons by opening the doors, for example. ◀

Children on the passenger seat

⚠ Children under 13 years of age or under 5 ft/150 cm in height may only be transported in child-restraint systems suitable for their age, weight and size and if the passenger airbags are deactivated. Otherwise, there is an increased risk of injury in the event of an accident or should the airbags deploy. ◀

Children 13 years of age or older must be buckled in with a safety belt as soon as there no longer is any child-restraint system that is appropriate for their age, weight and size.

For a child, not an infant, certain precautions should be taken. Position the passenger seat as far back as possible and at the lowest level. This important precaution is intended to maximize the distance between the airbags and the child.

Deactivating/reactivating passenger airbags

⚠ The passenger airbags must be deactivated before using a rear-facing child-restraint system on the passenger seat, refer also to page 37 for explanation. BMW also recommends that the passenger airbags be deactivated if a child is transported in a front-facing child-restraint system, regardless of the age of the child. If you transport a child in the passenger seat, not an infant in a rear-facing seat, who is properly seated and seat-belted at all times, the potential benefits of airbags deploying in an accident generally outweigh the risks of the child being injured by the force of a deploying airbag. Therefore, you should deactivate the passenger airbags only if you find it difficult to ensure that the child will remain properly seated and

seat-belted at all times.

Always position the passenger seat as far back as possible and at the lowest level.

The above warning and recommendations are compatible with regulations established by the National Highway Traffic Safety Administration, NHTSA, permitting the deactivation of passenger airbags by means of an on-off switch for members of certain at-risk groups.

Specifically, the at-risk groups are:

- ▷ Infants in rear-facing infant seats
- ▷ Persons with certain medical conditions
- ▷ Children aged 12 and under in the passenger seat.

NHTSA provides this information via their website, www.nhtsa.dot.gov, or via their Auto Safety Hotline toll-free at 1-800-424-9393 or 366-0123 in Washington, D.C. area. ◀

Key switch for passenger airbags



The front, side and knee airbags for the passenger can be deactivated and reactivated using a key switch. It is located on the passenger side on the side of the dashboard.

The passenger airbags can only be deactivated and reactivated while the vehicle is at a standstill and the passenger door is open.

Deactivating

Use the key to turn the key switch to the OFF position.

The passenger airbags are deactivated in this position. The airbags for the driver remain active.

 Reactivate the passenger airbags as soon as a child-restraint system is no longer installed on the passenger seat; otherwise they may not deploy as intended in the event of an accident. ◀

Reactivating

Use the key to turn the key switch to the ON position.

The passenger airbags in the vehicle are reactivated and will be triggered in certain situations.

Operational status of the passenger airbags



- ▶ The indicator lamp remains lit when the passenger airbags are deactivated.
- ▶ The indicator lamp is not lit when the passenger airbags are activated.

 When the seat is empty, the passenger airbags are always deactivated. The indicator lamp is not lit. ◀

Installing child-restraint systems

 Before installing a child-restraint system on the passenger seat, make sure that the front and side airbags for the passenger are deactivated, otherwise there is an increased risk of injury if the airbags deploy. Observe the

child-restraint system manufacturer's instructions for selecting, installing and using child-restraint systems. Otherwise the protective effect may be diminished. ◀

Child seat security



The passenger's safety belt can be prevented from being pulled out in order to fasten child-restraint systems.

To lock the safety belt

1. Secure the child-restraint system with the belt.
2. Pull the belt strap all the way out.
3. Allow the belt strap to retract and pull it taut against the child-restraint system. The safety belt is locked.

To unlock the safety belt

1. Open the belt buckle.
2. Remove the child-restraint system.
3. Allow the safety belt strap to retract all the way.

Coupe: child-restraint system with tether strap

There is an anchor fitting in the cargo bay for child-restraint systems with a tether strap.

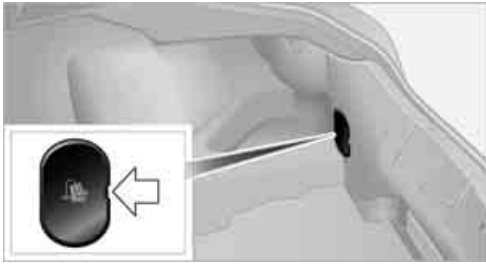

To gain access to this anchor fitting, lift the plastic plug with the help of a screwdriver, see arrow.

⚠ Use the tether strap anchor fittings only to fasten child-restraint systems in place; otherwise the anchor fittings could be damaged. ◀

Positioning the tether strap

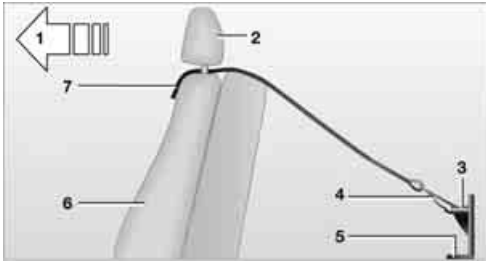

- 1 Forward driving direction
- 2 Head restraint
- 3 Child restraint anchor fitting
- 4 Attaching clip
- 5 Cargo bay floor
- 6 Seat backrest
- 7 Tether strap

If necessary, fold up the anchor fitting up before using.

1. Unhook the roller-blind cover, if necessary, and let it retract.
2. Push the head restraint upward.
3. Guide the tether strap through the head restraint support posts.
4. Push the head restraint into its lowest position.

5. Clip the tether strap onto the anchor fitting.

M Sports seat*: positioning the tether strap

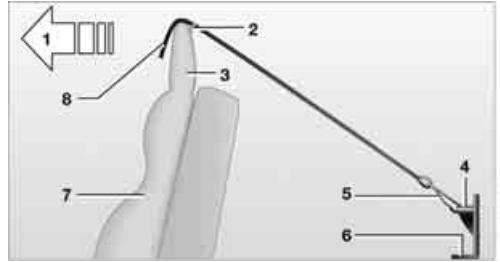

- 1 Forward driving direction
- 2 Support posts
- 3 Head restraint
- 4 Child restraint anchor fitting
- 5 Attaching clip
- 6 Cargo bay floor
- 7 Seat backrest
- 8 Tether strap

If necessary, fold up the anchor fitting up before using.

1. Unhook the roller-blind cover, if necessary, and let it retract.
2. Guide the tether strap through the head restraint support posts.
3. Clip the tether strap onto the anchor fitting.

LATCH child-restraint fixing system*

LATCH: Lower Anchor and Tethers for Children.

⚠ When installing a LATCH child seat, comply with the child seat manufacturer's operating and safety instructions. ◀

Anchor points

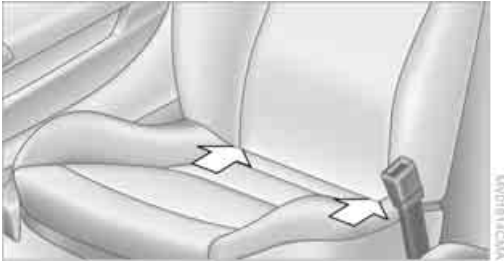

The anchor points for the LATCH child seat can be found at the locations marked by the arrows.

Carefully push the child seat brackets through the gap between the seat cushion and backrest cushion at the designated locations, see arrows.

Driving

Ignition lock

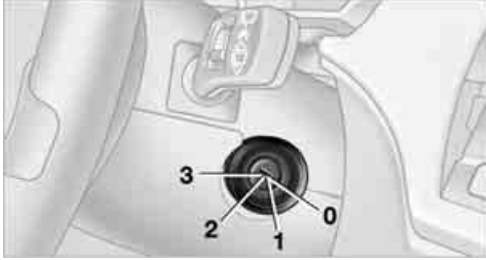

- 0** Steering locked
- 1** Steering unlocked
- 2** Ignition switched on
- 3** Starting the engine

Steering locked

This is the only position in which the ignition key can be inserted or removed.

After removing the key, turn the steering wheel slightly to the left or right until the lock engages.

Interlock with automatic transmission

The key can only be turned back to position **0** or removed if the selector lever is in position P: interlock.

Steering unlocked

You will find that it is often easier to turn the ignition key from position **0** to **1** if you move the steering wheel slightly to help disengage the detent.

Individual electrical equipment and accessories are available for use.

Ignition switched on

All systems are operational.

Starting the engine

Engine idle speed is controlled by the engine computer system. Increased speeds at start-up are normal and should decrease as the engine warms up. If engine speed does not decrease, service is required.

To prevent the battery from discharging, always deactivate electrical devices that are not in use. Switch the ignition off when the vehicle is not being driven.

 Do not leave the engine running in enclosed spaces. Otherwise, inhalation of the hazardous exhaust gases could lead to unconsciousness and death. The exhaust gases contain carbon monoxide, an odorless and colorless, but highly toxic gas. Do not leave the vehicle unattended with the engine running. An unattended vehicle with a running engine poses a safety hazard.

Before leaving the car with the engine running, place the transmission in idle or move the selector lever to position P and apply the parking brake to prevent the car from moving. ◀

When starting the engine, do not press the accelerator pedal.

Do not end the starting procedure too early, but do not continue it for more than 20 seconds. Release the key immediately when the engine starts.

Do not let the engine warm up in idling position. Instead, begin to drive at moderate engine speeds.

 Vehicles with manual transmission: Step on the clutch when starting the vehicle. A lockout prevents the engine from starting if the clutch is not depressed. ◀

Manual transmission

1. Apply the parking brake.
2. Depress the clutch and shift to idle position.
3. Start the engine.

Automatic transmission

1. Depress the brake.
2. Start the engine.

Special starting conditions

In the following situations, press the accelerator pedal halfway down when starting the engine:

- ▷ If the engine does not start on the first attempt, for instance when it is extremely hot or cold.
- ▷ If the engine is started at very low temperatures, below approx. +5 °F / -15 °C, at high altitudes above approx. 3,300 ft/1,000 m.

 Avoid frequent starting attempts in quick succession or repeated starting attempts during which the engine does not start. Otherwise, the fuel is not burned or inadequately burned; there is a danger of overheating and damaging the catalytic converter. ◀

Switching off the engine

 Do not remove the key while the vehicle is still moving. Otherwise, the steering lock would engage when the steering wheel is turned.

When you leave the vehicle, always remove the key and engage the steering lock.

Apply the parking brake when parking on steep gradients, otherwise the vehicle could start to roll. ◀

 You can have an acoustic signal set as a reminder that the key is still in the ignition switch after the driver's door has been opened. ◀

Manual transmission

1. Turn the key to position 1 or 0.
2. Engage first gear or reverse gear.
3. Apply the parking brake.



Automatic transmission

1. With the car at a standstill, move the selector lever to position P.
2. Turn the key to position 1 or 0.

Parking brake

The parking brake is designed primarily to prevent the vehicle from rolling when parked. It operates against the rear wheels.

Indicator lamp

-  The indicator lamp is lit, and when you drive off a signal sounds in addition.
-  The parking brake is still applied.

-  Indicator lamp for Canadian models.

Applying

The lever locks in position automatically.

Releasing

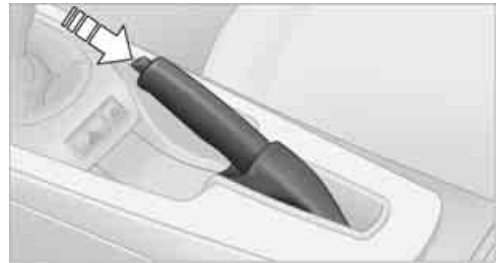

Pull slightly upwards, press the button and lower the lever.

 If, in exceptional circumstances, it should be necessary to engage the parking brake while the vehicle is in motion, do not pull it with excessive pressure. In doing so, continuously press the button of the parking brake lever. Otherwise, too violent an application of the parking brake can overbrake the rear axle and cause the rear of the car to swerve. ◀

 To prevent corrosion and one-sided braking action, occasionally apply the parking brake lightly when the vehicle is slowly coming to a stop if the traffic conditions are suitable. The brake lamps do not light up when the parking brake is applied. ◀

Manual transmission



⚠ When shifting into 5th or 6th gear, press the gearshift lever to the right. Otherwise, the engine could be damaged by accidentally engaging 3rd or 4th gear. ◀

Reverse

Select only when the vehicle is stationary. When the gearshift lever is pressed to the left, a slight resistance has to be overcome.

Automatic transmission with Steptronic*

In addition to operating the Steptronic as a fully automatic transmission, you can also shift gears manually with it, refer to page 43.

Vehicle parking

⚠ To prevent the vehicle from rolling, always select position P before leaving the vehicle with the engine running. ◀

Removing the key

To turn the key in the ignition lock back to position 0 or to remove it, first engage selector lever position P and switch off the engine: interlock.

Selector lever positions

P R N D M/S + -

Displays in the instrument cluster



P R N D SD M1 to M6

The selector lever position is displayed; in the manual mode, the gear currently engaged is shown.

Range selection

- ▷ With the ignition switched on or the engine running, the selector lever can be moved out of position P: interlock.
- ▷ Before moving the lever away from P or N with the vehicle stationary, first depress the brake; otherwise the selector lever will refuse to move: shiftlock.

⚠ To prevent the vehicle from creeping after you select a driving position, depress the brake until you are ready to start. ◀



A lock prevents you from inadvertently engaging selector lever positions R and P. To cancel the lock, press the button on the front of the selector lever, see arrow.

P Park

Select only when the vehicle is stationary. The transmission locks to prevent the rear wheels from turning.

R Reverse

Select only when the vehicle is stationary.

N Neutral, idle

You can select this in a car wash, for example. The vehicle can roll.

D Drive, automatic position

This position is designed for driving under all normal operating conditions. All forward gears are selected automatically.

Under normal operating conditions, fuel consumption is lowest when you are driving in position D.

Kickdown

Kick-down enables you to achieve maximum performance.

Press the accelerator pedal beyond the full-throttle resistance point.

Manual operation and Sport program M/S



Move the selector lever from position D to the left into the M/S range:

The Sport program is activated. This is indicated by the display SD in the instrument cluster. This position is recommended for a performance-oriented driving style.

The Sport program is enabled automatically when the Dynamic Driving Control system is activated, refer to page 44.

To use the automatic function again, move the selector lever to the right into position D.

Shifting gears using the selector lever

When you press the selector lever forwards or backwards, the manual mode is activated and Steptronic changes gear. The instrument cluster shows M1 through M6.

The transmission will only execute upshifts and downshifts that will result in an appropriate combination of vehicle speed and engine rpm. For instance, downshifts that would result in excessive engine speed will not be executed. The desired gear will appear briefly in the instrument cluster, followed by the actual gear.

Shifting gears via the shift paddles* on the steering wheel

The shift paddles allow you to shift gears quickly since your hands can remain on the steering wheel.

- ▷ When you use the shift paddles on the steering wheel to shift gears while in automatic mode, the transmission automatically switches to manual mode.
- ▷ If you do not use the shift paddles for a certain amount of time and do not accelerate, the transmission automatically switches back to automatic mode.
 - ▷ If the selector lever is in the M/S gear plane, manual mode remains active.
- ▷ To shift up, pull one of the shift paddles.
- ▷ To shift down, press one of the shift paddles.

The instrument cluster shows M1 through M6.

The transmission will only execute upshifts and downshifts that will result in an appropriate combination of vehicle speed and engine rpm. For instance, downshifts that would result in excessive engine speed will not be executed. The desired gear will appear briefly in the instrument cluster, followed by the actual gear.

Malfunction

Red warning lamp



The transmission is overheating. Reduce your speed immediately and pull over at a suitable location so that

the transmission can cool down again. You can continue your journey, but moderate your speed and exercise due caution. Have the system checked immediately.

Yellow warning lamp



The transmission system is malfunctioning. Avoid heavy loads.

All of the selector lever positions can continue to be engaged; in the forward drive positions, however, the vehicle will be operating in a restricted gear range only.

Have the system checked as soon as possible. Instructions on towing, tow-starting and jump-starting begin on page 104.

Dynamic Driving Control

At the touch of a button, Dynamic Driving Control enables you to drive your BMW in an even sportier style:

- ▶ The engine responds more spontaneously to any motion of the accelerator pedal.
- ▶ Power steering is adapted to further enhance contact with the road surface.
- ▶ Cruise control*: The stored speed is achieved more quickly when called up.

In addition with automatic transmission:

- ▶ The Sport program is activated.

To activate the system



Press the SPORT button while the key is in position 2. The LED in the button lights up.

To deactivate the system

Press the SPORT button again. The LED in the button goes out.

Turn signal indicators/ Headlamp flasher

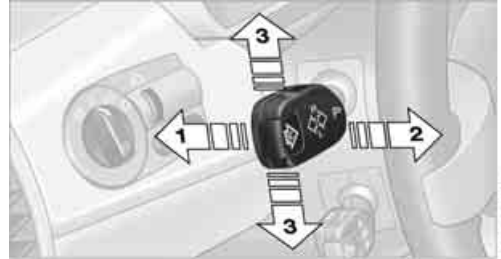

- 1 High beams
- 2 Headlamp flasher
- 3 Turn signal indicators



Unusually rapid flashing of the indicator lamp indicates that a turn signal indicator has failed. ◀

To signal briefly

Press the lever as far as the resistance point for as long as you wish to indicate a turn.

Triple turn signal activation

Press the lever as far as the resistance point. The turn signals flash three times.



If you wish, you can have this function activated. ◀

Washer/wiper system/ Rain sensor*



- 0 Wipers retracted
- 1 Intermittent or rain sensor mode
- 2 Normal wiper speed
- 3 Fast wiper speed
- 4 Brief wipe
- 5 Selecting speed for intermittent mode or setting sensitivity of the rain sensor

Intermittent mode

Not in vehicles with a rain sensor.

Rotary dial **5** is used to set the wipe interval to one of four levels.

In addition, the wipe interval is varied automatically depending on road speed.

Rain sensor*

On vehicles with a rain sensor, the wipe interval is automatically controlled according to rain intensity. The sensor is mounted on the windshield, directly in front of the interior rearview mirror.

 Deactivate the rain sensor before entering an automatic car wash. Failure to do so could result in damage caused by undesired wiper activation. ◀

Activating

With the ignition key in position 1 or higher, move the lever to position **1**.

In any case, the wipers will move once across the windshield.

You can leave the lever continuously in position **1**. Then, as long as the ignition key is in

position 1 or higher, you only need to activate the rain sensor.

To do so:

- ▷ Turn rotary dial **5** briefly or
- ▷ Clean the windshield, refer to Cleaning windshield and headlamps* below

Adjusting sensitivity

Turn the rotary wheel **5**.

Deactivating

Flip the lever to position **0**.

Normal wiper speed

When the vehicle is stopped the wipers automatically switch to intermittent wipe, except in vehicles with a rain sensor.

Fast wiper speed

When the vehicle is stopped the wipers operate at normal wiping speed, except in vehicles with a rain sensor.

Cleaning windshield and headlamps*



- 0 Wipers retracted
- 1 Cleaning windshield and headlamps*

 Do not use the washers if there is any danger that the fluid will freeze on the windshield, otherwise vision could be obscured. Antifreeze should therefore be added to the fluid, refer to Washer fluid on page 46.

Do not operate washing mechanisms when the washer fluid reservoir is empty, otherwise you will damage the washer pump. ◀

Cleaning windshield

The system sprays washer fluid against the windshield and activates the wipers for a brief period.

The windshield washer nozzles are automatically heated* when the engine is running or the ignition is on.

Cleaning headlamps*

When the vehicle lighting system is switched on, the headlamps are cleaned at regular and appropriate intervals.

Washer fluid

 Washer fluid antifreeze is flammable. For this reason, keep it away from sources of flame and store it only in its original container. Store it so that it is inaccessible to children. Comply with the instructions on the container. ◀

Washer fluid reservoir



Fill with water and, if required, with antifreeze according to its manufacturer's recommendations.

 Mix the water and antifreeze before filling the washer fluid reservoir to make sure the correct concentration is maintained. ◀

Capacity

Approx. 5.3 US quarts/5 liters.

Cruise control*

The concept

Cruise control is available at speeds of at least approx. 20 mph/30 km/h. The car stores and maintains the speed that you specify with the lever on the steering column.

 Do not use cruise control if conditions are unfavorable for driving at a constant speed, e.g. due to winding roads, dense traffic, or poor road conditions such as snow, rain, ice, loose surface, etc. Otherwise, you could lose control of the vehicle and cause an accident. ◀

One lever for all functions

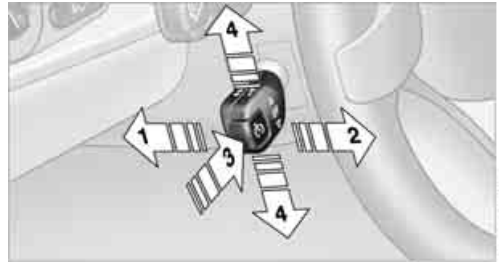

- 1 Storing and maintaining speed or accelerating
- 2 Storing and maintaining speed or decelerating
- 3 To recall the stored speed
- 4 Deactivating cruise control

To maintain current speed

Tap the lever, arrow **1**, or pull it briefly, arrow **2**. The car's current speed is stored and maintained. If, on downhill grades, the engine braking effect is not sufficient, the controlled speed can be exceeded. Speed can drop on uphill grades if the engine output is insufficient.

To increase speed

Tap the lever repeatedly, arrow **1**, until the desired speed is reached.

Every time you tap the lever, the speed increases by approx. 1 mph/1 km/h.

To accelerate using the lever

Press the lever, arrow **1**, until the desired speed is reached.

The vehicle accelerates without pressure on the accelerator pedal. The system stores and maintains the speed.

To decrease speed

Pull the lever repeatedly, arrow **2**, until the desired speed is reached.

Functions are the same as with increasing speed or accelerating, except the speed is decreased.

Deactivating cruise control

Tap the lever upwards or downwards, arrow **4**. In addition, the system is automatically deactivated:

- ▷ When you brake the vehicle
- ▷ When you engage the clutch or shift to idle in cars with manual transmission
- ▷ When you select the automatic transmission's neutral position N
- ▷ When you drive faster or slower than the set speed for a longer period of time, e.g. by pressing the accelerator pedal
- ▷ When the DSC comes on

You can recall the speed last stored.

To recall the stored speed

Briefly press the button, arrow **3**. The speed last stored is achieved again and maintained.

The stored speed is deleted as soon as the ignition is switched off.

Everything under control

Odometer



- 1 Odometer
- 2 Trip odometer
- 3 Resetting trip odometer
- 4 Outside temperature or computer displays*

Trip odometer

Resetting trip odometer:
While the ignition is switched on, press button **3** in the instrument cluster until the trip odometer is set to zero.

Outside temperature display, clock*

Setting the clock, refer to page 50.

Outside temperature warning

If the outside temperature drops to approx. 37 °F /+3 °C, the computer automatically switches to the outside temperature display. A signal also sounds and the display flashes for a short time. There is an increased risk of black ice.

 After an outside temperature warning has been issued, the computer switches back to its previous screen. You can have this activated/deactivated. ◀

 Black ice can also form at temperatures above 37 °F /+3 °C. You should therefore drive carefully on bridges and shaded roads, for example, otherwise there is an increased risk of an accident. ◀

When the vehicle is parked

If you still want to view the time and odometer reading briefly after the ignition has been switched off or the key has been removed:
Press button **3** in the instrument cluster.

Tachometer



Never allow the engine to operate with the needle in the red overspeed sector of the gauge.
To protect the engine, the fuel supply is interrupted when speed reaches this sector.

Fuel gauge



Fuel tank capacity: approx. 14.5 US gallons/ 55 liters. You can find information on refueling on page 82.

If the tilt of the vehicle varies for a longer period, when you are driving in mountainous areas, for example, the indicator may fluctuate slightly.

Reserve

Once the fuel level has fallen to the reserve zone of approx. 2.1 US gallons/8 liters, indicator lamp **1** lights up continuously.

 Do not drive until the fuel tank is empty and refill it well in advance. Otherwise the engine may not operate properly and damage could result. ◀

When you switch on the ignition, the indicator lamp comes on briefly to indicate an operational check.

Engine coolant temperature gauge



Blue

The engine is still cold. Drive at moderate engine and vehicle speeds.

Between the blue and red zones

Normal operating range. The needle may rise as far as the edge of the red sector during normal operation.

Red

When you switch on the ignition, warning lamp **1** comes on briefly to indicate an operational check.

Comes on while driving:

The engine has overheated. Stop and switch the engine off immediately and allow it to cool down.

For checking the coolant level, refer to page [94](#).

Service interval display



The remaining driving distance in miles/km until the next scheduled service is displayed briefly immediately after you start the engine or switch on the ignition.

The words OILSERVICE or INSPECTION indicate the type of service due next. The computer bases its calculations of the remaining driving distance on the preceding driving style.

A flashing message and a minus sign in front of the number mean that the service interval has already been exceeded by the number of miles/kilometers shown on the display. Please schedule an appointment with your BMW center or a workshop that works according to BMW repair procedures with correspondingly trained personnel.

 The extent of service work required can be read out from the remote control by your BMW Service Advisor. ◀

Clock

If you wish to have a permanent time display, you can have it appear in the car radio display, refer to the Owner's Manual for Radio.

You can set the time and the time display in the car radio as follows.

Setting the clock



1. Press button **2** for several seconds until the hours are displayed and the colon flashes.
2. Press button **1** repeatedly until the required hour is set.
3. Press button **2** to switch to the minutes display.
4. Press button **1** repeatedly until the required minutes are set.
5. Press button **2** to confirm the time.

The set time of day is transferred to the car radio display or appears in the instrument cluster display.

Computer*



To view the information on the instrument cluster display, press the onboard computer button BC in the turn signal lever.

Each time you tap the onboard computer button, the following information is shown in the specified order:

- ▷ Time
- ▷ Outside temperature
- ▷ Average fuel consumption
- ▷ Cruising range

▷ Average speed

With the ignition key in position 1 or higher, the respective last active setting is displayed.



If you wish, you can have all the following information displayed in another unit of measure. ◀

Setting the time format

You can have the clock displayed in 12h or 24h mode:

While the time display is active, press the onboard computer button BC in the turn signal lever until the display changes.

Changing unit of measure: °F/°C

While the outside temperature display is active, press the onboard computer button BC in the turn signal lever until the display changes.

Average fuel consumption

The average fuel consumption is calculated for the time for which the engine has been running.

To reset the average fuel consumption display: Press the onboard computer button BC in the turn signal lever for approx. 2 seconds.

Cruising range

The computer bases its calculations of the cruising range on the preceding driving style and on the amount of fuel remaining in the tank.



Be sure to refuel as soon as possible once your cruising range falls below 30 miles/ 50 km, otherwise engine functions are not ensured and damage can occur. ◀

Average speed

The average speed is calculated for the time for which the engine has been running.

To reset the average speed display: Press the onboard computer button BC in the turn signal lever for approx. 2 seconds.

Technology for driving comfort and safety

Driving stability control systems

Your BMW is equipped with a series of systems that help maintain driving stability even in adverse driving situations.

Antilock Brake System ABS

ABS keeps the wheels from locking during braking. Steering stability is maintained even during full brake applications. In this way, active safety is enhanced.

ABS is operational each time the engine is started. Braking safely, refer to page 76.

Electronic brake-force distribution

The system controls brake-force application at the rear wheels in order to obtain increased stability in the vehicle's braking response.

Dynamic Brake Control DBC

When you apply the brakes rapidly, this system automatically produces the maximum braking force boost and thus helps to achieve the shortest possible braking distance during full braking. At the same time, the benefits of the ABS are also exploited.

As long as you want full braking to continue, do not reduce pressure on the brake.

Dynamic Stability Control DSC

DSC prevents slip at the drive wheels while starting off and accelerating the vehicle. DSC also recognizes unstable vehicle conditions, such as fishtailing or nose-diving. In these cases, and subject to physical limits, DSC helps to keep the vehicle on a steady course by reducing engine speed and by applying brakes at individual wheels.

 The laws of physics cannot be repealed even with DSC. It will always be the driver's responsibility to drive in a manner that matches road conditions. Therefore, do not

limit the additional safety margin by practicing risky driving. ◀

Deactivating DSC



Press the button for at least 3 seconds; the indicator lamp for DSC lights up in the instrument cluster. Dynamic Traction Control DTC and DSC have been deactivated simultaneously. No more interventions to increase stability and forward momentum are carried out.

To enhance vehicle stability, reactivate DSC as soon as possible.

Activating DSC

Press the button again; the indicator lamp goes out in the instrument cluster.

Checking



The indicator lamp flashes:
DSC controls the drive forces and brake forces.

The indicator lamp is lit:
DSC has been deactivated completely.

Dynamic Traction Control DTC

DTC is a variant of the DSC in which forward momentum is optimized for special road conditions, e.g. snow-covered roads that have not yet been cleared. The system ensures maximum forward momentum, but driving stability is limited. Therefore, drive carefully in accordance with conditions.

In the following exceptional circumstances, it may be effective to activate the DTC for a short period:

- ▷ When driving on snow-covered grades, in slush or on uncleared, snow-covered roads
- ▷ When rocking the vehicle or starting off in deep snow or on loose surfaces
- ▷ When driving with snow chains

Activating DTC



Press the button briefly; the DTC indicator lamp lights up in the instrument cluster.

Checking



The indicator lamp flashes:
DTC controls the drive forces and brake forces.



The indicator lamp is lit:
DTC has been activated.

Deactivating DTC

Press the button again; the DTC indicator lamp in the instrument cluster goes out.

Malfunction in the driving stability control systems



The warning lamp for the brake system lights up in red, together with the yellow indicator lamps for ABS and DSC:



The driving stability control systems have failed.



Have the system checked as soon as possible.



Drive cautiously, think well ahead and avoid full brake applications, otherwise unstable driving conditions could result. ◀



Canadian models display these warning lamps.



The DSC warning lamp lights up together with the yellow warning lamp for the brake system:



DSC, including DTC and DBC, are malfunctioning.

The vehicle remains operational. Have the system checked as soon as possible.



Drive cautiously and think well ahead, otherwise unstable driving conditions could result. ◀



Canadian models display these warning lamps.



Drive-off assistant

The drive-off assistant enables you to drive off smoothly on uphill gradients. It is not necessary to use the parking brake for this.

1. Hold the car in place by depressing the brake.
2. Release the brake and drive off without delay.



The drive-off assistant holds the car in place for approx. 2 seconds after the brake is released. Depending on vehicle load, the car may roll backwards a little during this time span. Drive off without delay after releasing the brake. Otherwise, the drive-off assistant will no longer hold the car in place after approx. 2 seconds and the car will start to roll backwards. ◀

Malfunction

 The warning lamp for the brake system lights up in yellow. The drive-off assistant has failed. The car will not be held in place after the brake is released. Have the system checked as soon as possible.

Flat Tire Monitor FTM*

The concept

The Flat Tire Monitor monitors tire pressures while the car is being driven. The system reports any significant loss of pressure in one tire in relation to another.

In the event of tire pressure loss, the rolling radius of the tire changes, thereby affecting the rotational speed of the wheels. This change is detected, and a flat tire warning is issued to the driver.

System requirements

To ensure a reliable flat tire warning, the system must be initialized with the correct tire inflation pressures.

 The system must be reinitialized each time a tire inflation pressure has been corrected or a wheel or tire has been changed. ◀

System limitations

 The Flat Tire Monitor is unable to warn the driver of sudden, severe tire damage caused by external factors, nor can it identify the gradual loss of pressure that will inevitably occur in all four tires over a lengthy period of time. ◀

The system could issue a false warning or function in a delayed manner in the following situations:

- ▶ System was not initialized
- ▶ Driving on a snow-covered or slippery road surface
- ▶ Performance-oriented driving: slip at the drive wheels, high levels of lateral acceleration
- ▶ Driving with snow chains attached

Initializing the system

 The initialization is completed while you are driving, and can be interrupted at any time. Initialization is continued automatically when you continue driving. When driving with snow chains, do not initialize the system. ◀

1. Start the engine immediately before pulling away, but do not drive off yet.



2. Press the button until the yellow indicator lamp in the instrument cluster lights up for a few seconds.
3. Drive off.

Initialization is completed during the drive, without any feedback issued.

Flat tire warning

 The warning lamp in the instrument cluster lights up in red. A signal also sounds. There is a flat tire or a significant loss of tire pressure.

1. Cautiously reduce speed to 50 mph/80 km/h or lower. Avoid strong braking and steering maneuvers. Do not exceed a maximum speed of 50 mph/80 km/h.

 If the car is not equipped with Run-Flat Tires, refer to page 88, the standard equipment by design, do not continue driving. Otherwise a severe accident could result after a tire puncture. ◀

2. At the next opportunity, check the air pressure in all four tires.

 If the inflation pressure is correct in all four tires, it is possible that the Flat Tire Monitor was not initialized. In this case, initialize the system. ◀

3. In the event of complete tire pressure loss, 0 psi/0 kilopascal, you can estimate the possible distance for continued driving on the basis of the following guidelines:

- ▷ With a light load:
 - 1 person without luggage:
approx. 155 miles/250 km
- ▷ With a medium load:
 - 1 person, cargo bay full,
or
 - 2 persons without luggage:
approx. 90 miles/150 km
- ▷ With a full load:
 - 2 persons, cargo bay full:
approx. 30 miles/50 km

 Drive cautiously. Do not exceed a speed of 50 mph/80 km/h. Driving characteristics change if there is a loss of tire pressure. This includes reduced tracking stability in braking, extended braking distance and altered natural steering characteristics. If unusual vibration or loud noises occur during the journey, this may be an indication that the damaged tire has finally failed. Reduce your speed and pull over to the side of the road at the earliest opportunity. Otherwise, parts of the tire could come loose and cause an accident. Do not continue driving. Contact a BMW center. ◀

Tire Pressure Monitor TPM*

The concept

TPM monitors the tire inflation pressure in all four mounted tires. The system reports if inflation pressure has dropped significantly in one or more of the tires.

System requirements

To ensure a reliable flat tire warning, the system must have been reset while tire inflation pressures were correct.

Always use tires with TPM electronics to ensure that the system operates properly.

 The system must be reset each time a tire inflation pressure has been corrected or a wheel or tire has been changed. ◀

System limitations

 TPM cannot report sudden serious tire damage due to external causes. ◀

The system will not operate correctly if it was not reset, e.g. it may report a flat tire even if the tire inflation pressures are correct.

The system is inactive and cannot indicate a flat tire if a wheel without TPM electronics is mounted or if other systems or devices that use the same radio frequency temporarily interfere with the TPM system.

Resetting the system

 The system must be reset each time a tire inflation pressure has been corrected or a wheel or tire has been changed. ◀

1. Start the engine but do not drive off yet.



2. Press the button until the yellow warning lamp in the instrument cluster lights up for a few seconds.
3. Drive off.

After several minutes of driving, the current inflation pressures in the tires are adopted as the target values to be monitored. The resetting procedure is completed automatically without further notice during the trip, which can be interrupted at any time. Resetting is continued automatically when you continue driving.

Warning of low tire inflation pressure



The warning lamp lights up in yellow. A signal also sounds. There is a flat tire or a significant loss of tire pressure in one or more tires.

1. Cautiously reduce speed to 50 mph/80 km/h or lower. Avoid strong braking and steering maneuvers. Do not exceed a maximum speed of 50 mph/80 km/h.



If the car is not equipped with Run-Flat Tires, which is the standard equipment by design, refer to page 88, then do not continue driving. Doing so after a tire puncture may result in a severe accident. ◀

2. In the event of complete tire pressure loss, 0 psi/0 kilopascal, you can estimate how far you can continue driving on the basis of the following guidelines:

- ▷ With a light load:
 - 1 person without luggage: approx. 155 miles/250 km
- ▷ With a medium load:
 - 1 person, cargo bay full, or
 - 2 persons without luggage: approx. 90 miles/150 km
- ▷ With a full load:
 - 2 persons, cargo bay full: approx. 30 miles/50 km



Drive cautiously. Do not exceed a speed of 50 mph/80 km/h. Driving characteristics change if there is a loss of tire pressure. This includes reduced tracking stability in braking, extended braking distance and altered natural steering characteristics.

If unusual vibration or loud noises occur during the journey, this may be an indication that the damaged tire has finally failed. Reduce your speed and pull over to the side of the road at a suitable location at the earliest opportunity. Otherwise, parts of the tire could come loose and cause an accident. Do not continue driving. Contact a BMW center. ◀

Malfunction



The yellow warning lamp flashes and then lights up continuously. A flat tire cannot be detected.

This warning is displayed under the following circumstances:

- ▷ If there is a malfunction; have the system checked.
- ▷ If a wheel without TPM electronics is mounted.
- ▷ If other systems or devices that use the same radio frequency temporarily interfere with the TPM.

Declaration according to NHTSA/FMVSS 138 Tire Pressure Monitoring System

Each tire should be checked monthly when cold and inflated to the inflation pressure recommended by the vehicle manufacturer on the vehicle placard or tire inflation pressure label. If your vehicle has tires of a different size than the size indicated on the vehicle placard or tire inflation pressure label, you should determine the proper tire inflation pressure for those tires. As an added safety feature, your vehicle has been equipped with a tire pressure monitoring system, TPMS, that illuminates a low tire pressure telltale when one or more of your tires are significantly under-inflated. Accordingly, when the low tire pressure telltale illuminates, you should stop and check your tires as soon as possible, and inflate them to the proper pressure. Driving on a significantly underinflated tire causes the tire to overheat and can lead to tire failure. Under-inflation also reduces fuel efficiency and tire tread life, and may affect the vehicle's handling and stopping ability. Please note that the TPMS is not a substitute for proper tire maintenance, and it is the driver's responsibility to maintain correct tire pressure, even if under-inflation has not reached the level to trigger illumination of the TPMS low tire pressure telltale.

The TPMS malfunction indicator is combined with the low tire pressure telltale. When the system detects a malfunction, the telltale will flash for approximately one minute and then remain

continuously illuminated. This sequence will continue upon subsequent vehicle startups as long as the malfunction exists. When the malfunction indicator is illuminated, the system may not be able to detect or signal low tire pressure as intended. TPMS malfunctions may occur for a variety of reasons, including the installation of replacement or alternate tires or wheels on the vehicle that prevent the TPMS from functioning properly. Always check the TPMS malfunction telltale after replacing one or more tires or wheels on your vehicle to ensure that the replacement or alternate tires and wheels allow the TPMS to continue to function properly.

Electric Power Steering EPS

The concept

The electric power steering is a direct, sporting steering system. A special combination of electric motor and transmission helps you steer more easily. As your speed increases, steering power assistance is reduced.

Malfunction

 The indicator lamp stays lit:
The system is malfunctioning or defective.

Steering remains operational.
Have the system checked as soon as possible.

Brake Force Display



Left: normal braking.

Right: hard braking.

Airbags

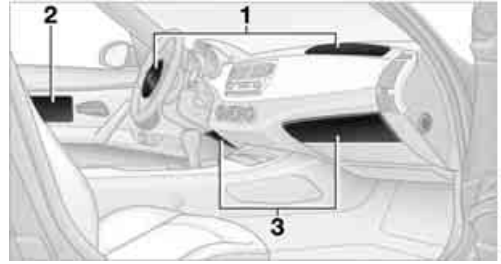

The following airbags are located under the marked covers:

- 1 Front airbags
- 2 Side airbags
- 3 Knee airbags

Protective action

 Comply with the instructions on page 30, or the occupants' personal safety will be diminished. ◀

The front airbags help protect the driver and passenger in the event of a frontal impact in which safety belts alone cannot provide sufficient protection. When needed, the side airbags help provide protection in the event of side impact. The relevant side airbag supports the side upper body area. The respective knee airbag protects the legs from hitting the cockpit.

The airbags will purposely not be activated by every collision, e.g. not by more minor accidents, or rear-end collisions.

 Do not apply adhesive materials to the cover panels of the airbags, cover them or modify them in any other way. Do not attempt to dismantle the airbag retention system. Do not modify the individual components of the system or its wiring in any way. This includes the padding in the steering wheel, the dashboard and the doors.

Do not attempt to remove or dismantle the steering wheel. Do not touch the individual components immediately after the system has been triggered, because there is a danger of burns.

In the event of malfunctions, deactivation, or

triggering of the airbag restraint system, have the testing, repair, removal, and disposal of airbag generators executed only by a BMW center or a workshop that works according to BMW repair procedures with correspondingly trained personnel and has the required explosives licenses. Unprofessional attempts to service the system could lead to failure in an emergency or undesired airbag activation, either of which could result in personal injury. ◀

Warning notices and information about the airbags can also be found on the sun visors.

Automatic deactivation of the passenger airbags

An analysis of the impression in the passenger seat cushion determines whether and how the seat is occupied. The front and side airbags for the passenger are activated or deactivated by the system accordingly.

▶ The indicator lamp in the center console shows the current status of the passenger airbags, deactivated or activated, refer to Status of passenger airbags below. ◀

⚠ Before transporting a child on the passenger seat, observe the safety and handling instructions under Transporting children safely, refer to page 36.

Adolescents and adults sitting in certain positions could inadvertently deactivate the front and side airbags on the passenger side; the indicator lamp for the passenger airbags comes on. In such cases, the passenger should change his or her sitting position so that the passenger airbags are activated and the indicator lamp goes out. If the passenger airbags cannot be restored to the desired status despite the passenger changing his or her seat position, use the key switch to activate or deactivate the passenger airbags, refer to page 36. Do not attach seat covers, seat cushion padding, ball mats or other items to the passenger seat unless they are specifically recommended by BMW. Do not place any items under the seat which could press against the seat from below. Otherwise a correct analysis of the seat cushion is not ensured. ◀

Status of passenger airbags



The indicator lamp for the passenger airbags shows the functional status of the passenger's front and side airbags in accordance with whether and how the passenger seat is occupied. The indicator lamp shows whether the passenger airbags are activated or deactivated.

- ▶ The indicator lamp comes on as intended when a child in an appropriate child-restraint system is detected on the seat. The front and side airbags for the passenger are not activated.
- ▶ The indicator lamp does not come on as long as a person of sufficient size and in a correct sitting position is detected on the seat. The front and side airbags for the passenger are activated.
- ▶ The indicator lamp does not come on if the seat is empty. However, the front and side airbags for the passenger are not activated.

Operational readiness of the airbag system



With the ignition key in position 1 or higher, the warning lamp comes on briefly to indicate that the entire airbag system and the belt tensioners are operational.

Airbag system malfunction

- ▷ Warning lamp does not come on with the ignition key in position 1 or higher
- ▷ Warning lamp remains permanently on

 In the event of a malfunction, have the airbag system checked immediately. Otherwise, there is a risk that the system may not respond in the expected manner to an impact within its normal response range. ◀

Lamps

Parking lamps/Low beams

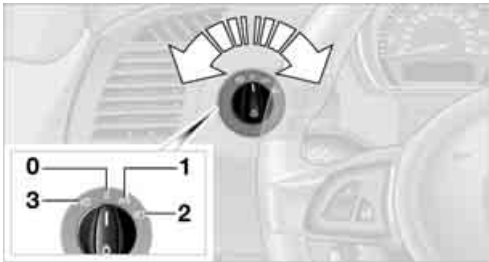

- 0 Lamps off and daytime running lamps*
- 1 Parking lamps and daytime running lamps*
- 2 Low beams
- 3 Automatic headlamp control* and daytime running lamps*

When you park the car, all its outside lamps are switched off automatically if the light switch is in position **0**, **2** or **3**.

If you want the parking lamps to be on, turn the switch to position **1**.

Parking lamps

In switch position **1**, the front, rear and side vehicle lighting is switched on. You can use the parking lamps to signal the position of the vehicle when it is parked. For the additional option of roadside parking lamps on one side of the vehicle only, refer to page **60**.

 The parking lamps will discharge the battery. Therefore, do not leave them on for unduly long periods of time, otherwise the battery might not have enough power to start the engine. ◀

Low beams

The low beams light up when the light switch is in position **2** and the ignition is on.

Defective bulb



The indicator lamp lights up:
At least one bulb of the vehicle's exterior lighting has failed.

For replacing bulbs refer to page **98**.

Automatic headlamp control*

When the switch is in position **3**, the low beams are switched on and off automatically depending on ambient light conditions, e.g. in a tunnel, in twilight, or if there is precipitation.

When driving into tunnels with bright overhead lights, there may be a delay before the headlamps come on.

The headlamps may also come on when the sun is sitting low on a blue sky.



The low beams remain switched on independent of the ambient lighting conditions when you switch on the fog lamps*. ◀

If desired, the light switch can remain in position **3**. The exterior lamps are automatically switched off after the vehicle is parked.



The automatic headlamp control cannot serve as a substitute for your personal judgment in determining when the lamps should be switched on in response to ambient lighting conditions. For example, the system cannot detect fog or hazy weather. To avoid safety risks, you should always switch on the lamps manually under these conditions. ◀



You can have the sensitivity of your vehicle's automatic headlamp control adjusted. ◀

Daytime running lamps*

If desired, the light switch can remain in the automatic headlamp control position. The exterior lamps are automatically switched off after the vehicle is parked.

In the Parking lamps position, the parking lamps come on after the ignition is switched off.

If necessary, switch on the parking lamps as described in the section about parking lamps.



You can have the daytime running lamps activated/deactivated on your vehicle. ◀

Pathway lighting

If you activate the headlamp flasher after parking the car, with the lights switched off, the low beams come on and remain on for a certain time.



You can have this function activated/deactivated as well as the duration of the pathway lighting set. ◀

LIGHTS ON warning

Whenever you open the driver's door after having turned the key to position 0, you will hear an acoustic signal for a few seconds to remind you that the lamps have not been switched off.

High beams/Roadside parking lamps

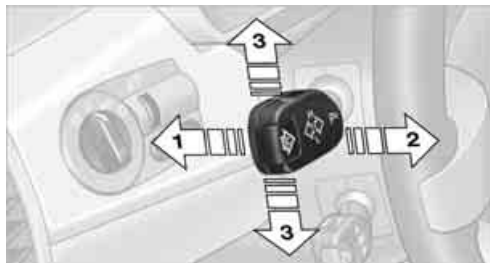

- 1 High beams
- 2 Headlamp flasher
- 3 Roadside parking lamps*

Roadside parking lamps, left or right*

When parking the vehicle, you have the option to switch on the lamps only on the side facing the road.

After parking the vehicle, press the lever up or down, arrow **3**, until it engages.



The roadside parking lamps discharge the battery. Therefore, do not leave them on for unduly long periods of time, otherwise

the battery might not have enough power to start the engine. ◀

Fog lamps*



Press the button to switch them on/off.

The parking lamps or low-beam headlamps must be switched on. A green indicator lamp comes on in the instrument cluster to indicate that the front fog lamps are on.



If the automatic headlamp control is activated, the low beams will come on automatically when you switch on the fog lamps. ◀

Instrument lighting

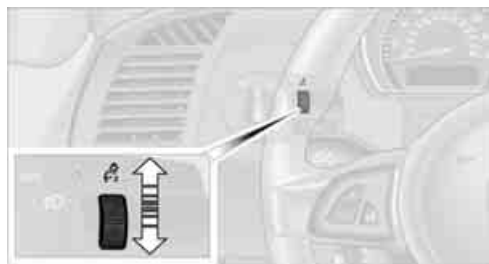

Turn the rotary dial to adjust brightness.

Interior lamps



The interior lamps operate automatically.

Switching interior lamps on/off manually

Press button **1** briefly.

If you want the interior lamps to remain off all the time, press the button for approx. 3 seconds.

Press the button briefly to revert to normal operation.

Reading lamps*

Switch each lamp on and off with the adjacent button **2**.

Climate

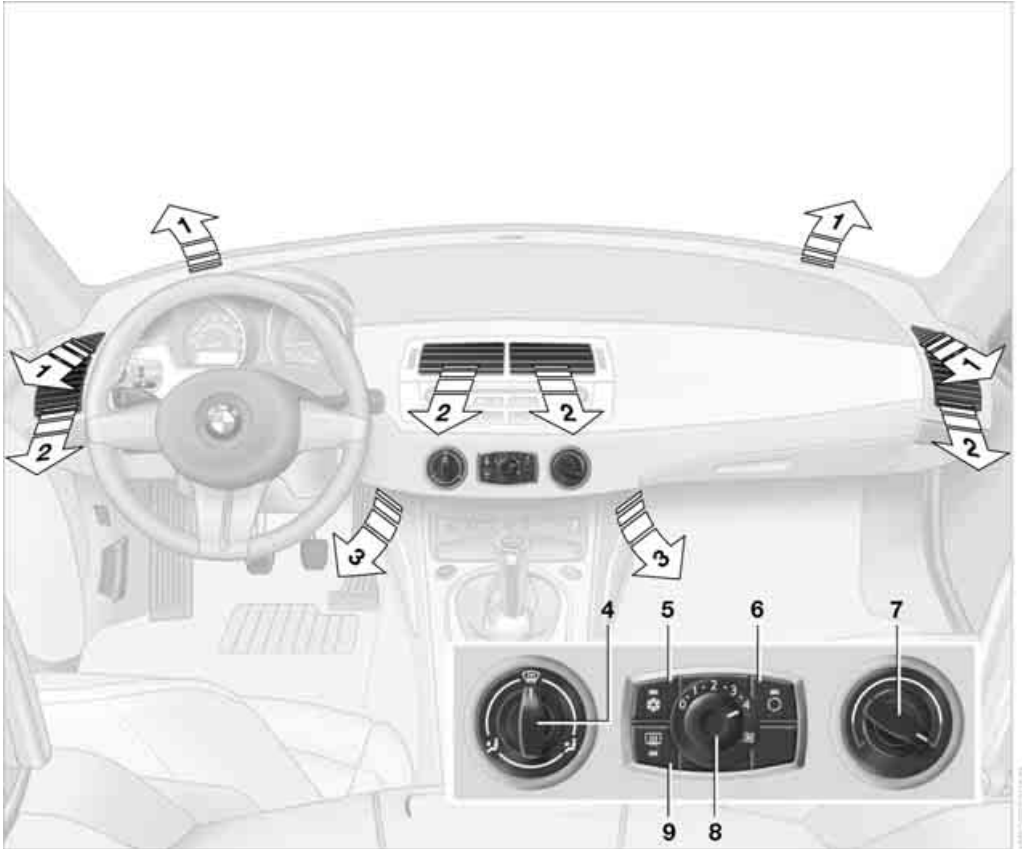

Air conditioning



- | | | | |
|---|--|---|-----------------------|
| 1 | Air flow toward the windshield and side windows | 6 | Recirculated-air mode |
| 2 | Air to the upper body area
Ventilation 63 | 7 | Temperature |
| 3 | Air to the footwell | 8 | Air flow rate |
| 4 | Air distribution | 9 | Rear window defroster |
| 5 | Cooling function* | | |

Air distribution



Direct the flow of air to the windows , to the upper body area  and to the footwell . Intermediate settings are possible.

Switching cooling function on/off



When the cooling function is on, the air is cooled, dehumidified, then reheated depending on the temperature setting.

Depending on the weather, the windshield may fog over briefly when the engine is started.

Recirculated-air mode



If the air outside the car has an unpleasant odor or contains pollutants, temporarily shut off the supply to the interior of the car. The system recirculates the air within the vehicle.

 If the windows fog over in the recirculated-air mode, you should switch it off and, if necessary, increase the air flow rate. The manually controlled recirculated-air mode should not be used continuously for lengthy periods, otherwise the quality of the air inside the car will gradually deteriorate. ◀

Temperature



For a higher temperature, turn the rotary switch clockwise towards red. For a lower temperature, turn the rotary switch counterclockwise towards blue.

Air flow rate



Adjust the air flow rate. The higher the rate, the more effective the heating or cooling will be.

Switching the system on/off

Set the air flow rate to 0. Blower and air conditioning are switched off and the air supply is cut off.

To switch on the heater or air conditioning, set any desired air flow rate.

Rear window defroster



The defroster switches off automatically after a certain time.

Defrosting windows and removing condensation



1. Air distribution **1** in position .
2. Set air flow rate **2** to position 4.
3. Temperature **3** to the right, red.
4. Switch on rear window defroster **4** to defrost the rear window.

Ventilation

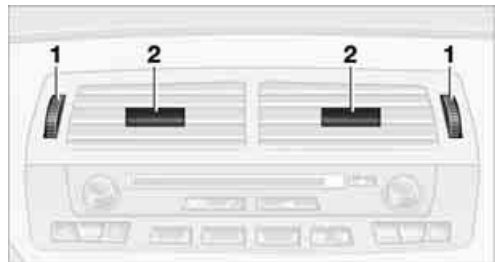

- 1 Knurled wheels to set any vent position from fully open to closed
- 2 Slide for adjusting air flow direction

Ventilation for cooling

Adjust the vent outlets to direct the flow of cool air toward you, for instance if it has become too hot in the car.

Draft-free ventilation

Set the vent outlets so that the air flows past you and not straight at you.

Microfilter

The microfilter removes dust and pollen from the incoming air. Your BMW center replaces this filter during regular maintenance. A substantial reduction in air flow indicates that the filter needs to be replaced earlier.

Automatic climate control*

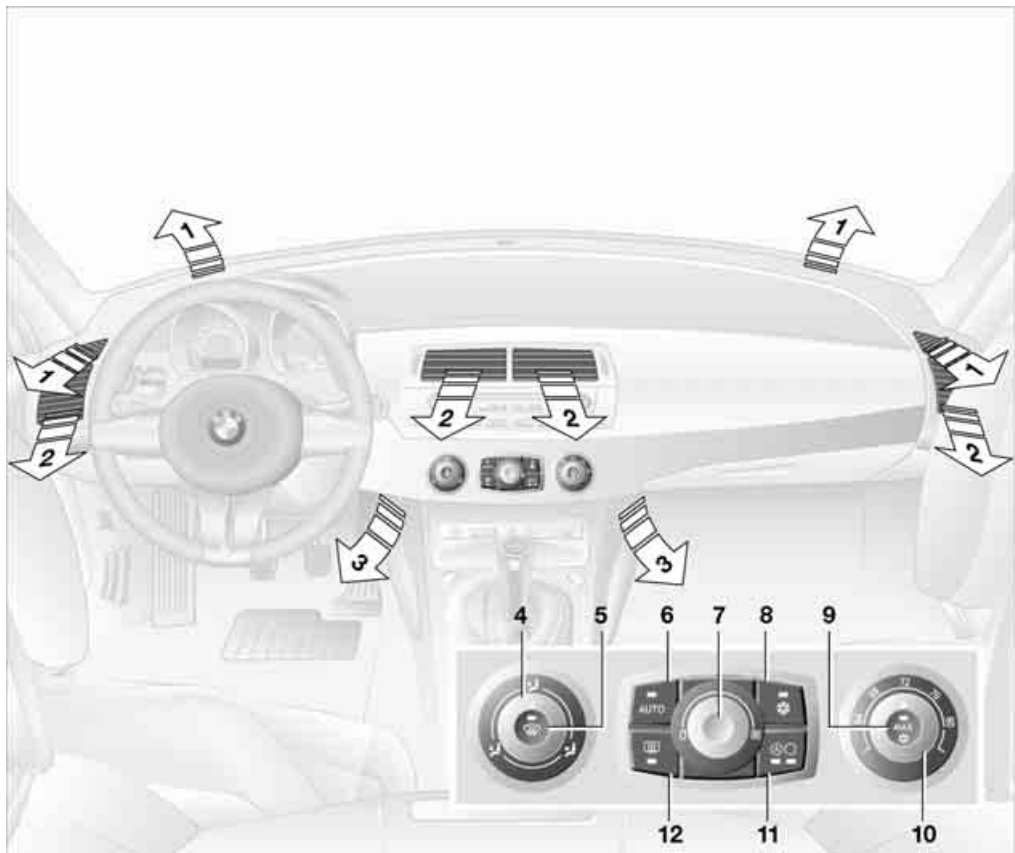



- | | | | |
|---|---|----|---|
| 1 | Air flow toward the windshield and side windows | 7 | Air flow rate, manual |
| 2 | Air to the upper body area Ventilation 67 | 8 | Cooling function |
| 3 | Air to the footwell | 9 | Maximum cooling |
| 4 | Air distribution, manual | 10 | Temperature |
| 5 | Defrosting windows and removing condensation | 11 | AUC Automatic recirculated-air control/ Recirculated-air mode |
| 6 | AUTO program | 12 | Rear window defroster |

Comfortable interior climate

AUTO program **6** offers the ideal air distribution and air flow rate for almost all conditions, refer to AUTO program below. In addition, you can select an interior temperature you find pleasant. The following sections inform you in detail about how to adjust the settings.

Air distribution, manual



Direct the flow of air to the windows , to the upper body area  and to the footwell . Intermediate settings are possible. The arrow lights up.

The automatic air supply remains unchanged. You can switch the automatic air distribution back on by pressing the AUTO button.

Defrosting windows and removing condensation



Quickly removes ice and condensation from the windshield and side windows.

AUTO program



The AUTO program adjusts the air distribution to the windshield and side windows, towards the upper body area and into the footwell for you. The air flow rate and your temperature specifications will be adapted to outside influences as a result of seasonal changes, e.g. sunlight or window condensation.

The cooling is switched on automatically with the AUTO program.

 The AUTO program functions only to a limited extent when the convertible top is open. ◀

Air flow rate, manual



Adjust the air flow rate. The arrow lights up.

The automatic air distribution remains unchanged. You can reactivate the automatic mode for the air flow rate with the AUTO button.

The higher the air flow rate, the more effective the air conditioning will be.

Switching the system on/off

Turn the rotary switch to 0. The automatic climate control is switched off and the air supply is cut off.

To switch on the automatic climate control, set any desired air flow rate.

Switching cooling function on/off



When the cooling function is on, the air is cooled, dehumidified, then reheated depending on the temperature setting.

Depending on the weather, the windshield may fog over briefly when the engine is started.

The cooling function is automatically switched on along with the AUTO program. The passenger compartment can only be cooled while the engine is running.

Maximum cooling



At outside temperatures above 32 °F / 0 °C and when the engine is running, you obtain a maximum cooling effect as soon as possible.

The automatic climate control switches to the lowest temperature and operates in recirculated-air mode. Air flows at maximum rate only from the vents for the upper body area. You should therefore open them for maximum cooling.

Temperature



Set the desired temperature.

The values on the dial are approximations of the respective temperature resulting in the passenger compartment.

The automatic climate control achieves this temperature as quickly as possible regardless of the season, using maximum cooling or heating power if necessary, and then maintains it.

 If you switch between different temperature settings in quick succession, the

automatic climate control does not have enough time to achieve the set temperature. ◀

AUC Automatic recirculated-air control/Recirculated-air mode



Switch on the desired operating mode by pressing this button repeatedly:

- ▷ LEDs off: outside air flows in continuously.
- ▷ Left-hand LED on, AUC mode: a sensor detects pollutants in the outside air. If necessary, the system blocks the supply of outside air and recirculates the inside air. As soon as the concentration of pollutants in the outside air has decreased sufficiently, the system automatically switches back to outside air supply.
- ▷ Right-hand LED on, recirculated-air mode: the inflow of outside air is shut off permanently. The system recirculates the air within the vehicle.

 If the windows fog over in the recirculated-air mode, you should switch it off and, if necessary, increase the air flow rate. The recirculated-air mode should not be used over an extended period of time, otherwise the air quality inside the car will deteriorate continuously. ◀

Rear window defroster



The defroster switches off automatically after a certain time.

Ventilation

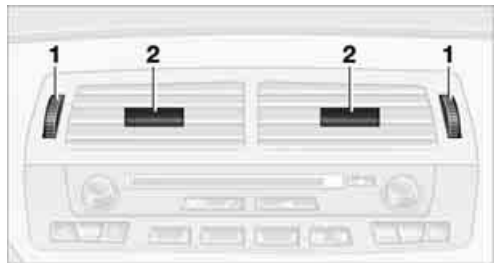

- 1 Knurled wheels to set any vent position from fully open to closed
- 2 Slide for adjusting air flow direction

Ventilation for cooling

Adjust the vent outlets to direct the flow of cool air toward you, for instance if it has become too hot in the car.

Draft-free ventilation

Set the vent outlets so that the air flows past you and not straight at you.

Microfilter/activated-charcoal filter

The microfilter removes dust and pollen from the incoming air. The activated-charcoal filter provides additional protection by filtering gaseous pollutants from the outside air. Your BMW center replaces this combined filter during regular maintenance. A substantial reduction in air flow indicates that the filter needs to be replaced earlier.

Practical interior accessories

Glove compartment

To open

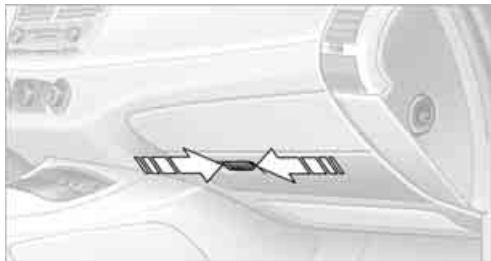

Press the two push buttons together.

To close

Swing the door up.

 To prevent injury in the event of an accident while the vehicle is being driven, close the glove compartment immediately after use. ◀

Connection for external audio device*

You can connect an external audio device such as a CD or MP3 player and play it over the vehicle loudspeakers. Volume and tone are set on the car radio, refer to the Owner's Manual for Radio/Onboard Computer.

Connecting the device

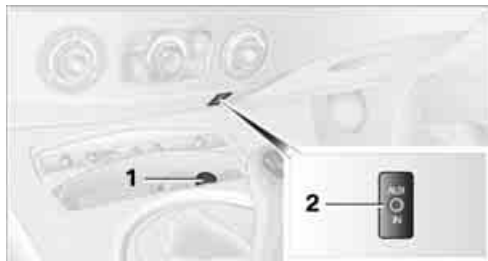

- 1 Power supply for your auxiliary device
- 2 Connection for audio playback:
Audio jack 3.5 mm

For playback on the vehicle loudspeakers, connect the device's headphone or line-out connection to jack **2**.

Storage compartments

Storage compartment between backrests

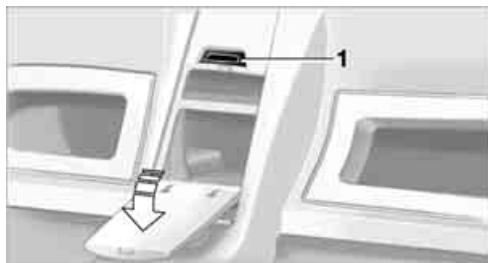

To open

1. Press button **1**.
2. Swing the cover down.

To close

Swing the cover up.

Locking/unlocking

The storage compartment between the backrests is automatically locked and unlocked with the central locking system.

Other compartments and nets*

Other compartments can be found on the doors, in the center console and behind the seats, depending on your vehicle's equipment.

Nets* are located on the passenger side of the center console and on the rear of the backrests.

Coupe: Eyeglasses compartment

To open

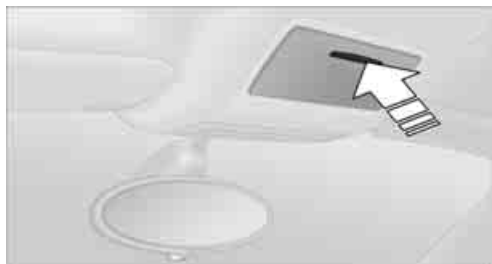

Press the strip on the eyeglasses compartment.

Cup holders

 Use light and shatterproof containers, otherwise there is an increased risk of injury in the event of an accident. Do not press unsuitable containers into the beverage holder with force as this may result in damage. ◀

A beverage holder is located on either side beneath the air outlets.

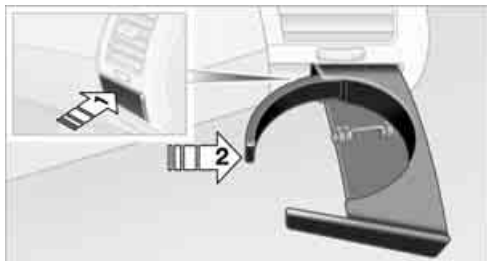

1. Press the trim piece beneath the air outlets; see arrow 1.
2. Place the beverage into the holder.
3. Adjust the holder to fit the size of the beverage container; see arrow 2.

Ashtray*

To empty



1. Open cover.
2. Pull out ashtray 1.

Cigarette lighter

Press in lighter 2. As soon as the lighter springs back out, it can be removed.

 Hold or touch the hot cigarette lighter by the knob only. Holding or touching it in other areas could result in burns.

The cigarette lighter remains operational even when the key has been removed. For this reason, children should never be left in the vehicle unattended. ◀

Connecting electrical appliances

In your BMW, you can use electrical devices such as a flashlight, car vacuum cleaner or a similar appliance up to approx. 200 watts at 12 volts.

Do not damage the socket by inserting plugs of a different shape or size.

 Do not keep electrical devices plugged in for extended periods when the engine is off, to protect the battery. ◀

Cigarette lighter socket

Pull the cigarette lighter out of the socket.

Coupe: roller-blind cover

The roller-blind cover is raised when the tailgate is opened.

 Do not place heavy or hard objects on the roller-blind cover. If you do, they can endanger the passengers, for example during braking or evasive maneuvers.

Do not let the roller-blind cover retract too quickly; otherwise it could be damaged. ◀

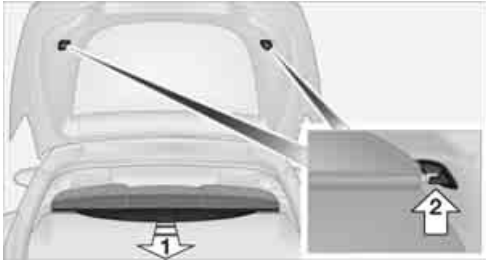

Pull out the roller-blind cover, arrow **1**, and clip it into the holders on the tailgate, arrow **2**.

Roadster: wind deflector*

With the convertible top open, the wind deflector keeps air movement in the passenger compartment to a minimum, thus providing you with a pleasant drive, even at higher speeds.

Installation



Insert the wind deflector in its proper orientation into the guides **1** provided on the rollover bars.

Refer to the labeling on the wind deflector to determine its proper orientation.

 The wind deflector must engage firmly, otherwise it could become detached at higher vehicle speeds. ◀

The wind deflector panels **2** in the rollover bars cannot be removed.

Removal



Slide both locks inward and remove the wind deflector.

Clothes hooks



Clothes hooks **1** are located on the wind deflector panels in the rollover bars.

! Do not hang heavy objects on the hooks. If you do, they could endanger the passengers, for example during braking or evasive maneuvers. ◀

Storage

For storage, e.g. to achieve a better view to the rear when the convertible top is closed, there are two brackets on the inside of the luggage compartment lid.



Insert the wind deflector into the brackets.

! Make sure that the wind deflector cannot be damaged by objects in the cargo bay. ◀

Mobile phone preparation package*

Hands-free microphone



In vehicles with a telephone preparation package, the cover for the hands-free microphone is located on the trim of the steering column.

For further information on the mobile phone, refer to the Owner's Manual for the telephone.



Driving tips

This section provides you with information useful in dealing with specific driving and operating conditions.

Things to remember when driving

Break-in procedures

Moving parts need to be given some time until they can interact smoothly with one another. To ensure that your vehicle provides maximum economy throughout a long service life, we request that you observe the following.

Always obey all official speed limits.

Engine and differential

Up to 1,200 miles/2,000 km

Drive at varying engine and road speeds, but do not exceed 4,500 rpm or 100 mph/160 km/h.

Refrain from using full throttle and avoid pressing the accelerator beyond the kickdown point.

After driving 1,200 miles/2,000 km

Engine and vehicle speeds can be gradually increased.

Tires

Due to technical factors associated with their manufacture, tires do not achieve their full traction potential until an initial break-in period has elapsed. Therefore, drive cautiously during the first 200 miles/300 km.

Brake system

Brakes require an initial break-in period of approx. 300 miles/500 km to achieve optimized contact and wear patterns between brake pads and rotors. Drive cautiously during this break-in period.

Clutch

The function of the clutch reaches its optimal level only after a distance driven of approx. 300 miles/500 km. Shift gears carefully during the break-in period.

After replacing components

The same break-in procedures should be observed if any of the components mentioned above have to be renewed in the course of the vehicle's operating life.

Saving fuel

The fuel consumption of your vehicle depends on several factors. You can lower fuel consumption and the environmental impact by taking certain measures, adjusting your driving style and having the vehicle serviced regularly.

Remove any unneeded cargo

Additional weight increases fuel consumption.

Remove any mounted parts after you have finished using them

Remove additional mirrors and the luggage rack when they are no longer in use. Mounted parts affect the vehicle's aerodynamics and increase fuel consumption.

Close both windows

Open windows cause higher air resistance and thus increase fuel consumption.

Check tire inflation pressure regularly

Check the tire inflation pressure at least twice a month and before embarking on a long journey, and correct it if necessary.

Low tire inflation pressure causes higher rolling resistance and thus increases fuel consumption and tire wear.

Set off immediately

Do not let the engine warm up while the car is still standing, but set off immediately at moderate engine speed. This is the fastest way for the cold engine to reach its operating temperature.

Drive defensively

Avoid unnecessary acceleration and braking maneuvers. To do so, keep an adequate distance to the forward vehicle. A defensive and smooth driving style keeps fuel consumption down.

Avoid high engine speeds

Only use first gear when setting off. In second and higher gears, accelerate without hesitation or pauses. When accelerating, shift up before reaching high engine speeds.

When you reach the desired speed, shift into the highest applicable gear and drive with the engine speed as low as possible and at a constant speed.

As a rule: driving at low engine speeds lowers fuel consumption and reduces wear.

Coasting

When approaching a red light, take your foot off the accelerator and coast to a stop in the highest applicable gear.

On a downhill slope, take your foot off the accelerator and coast in a suitable gear.

The fuel supply is interrupted when coasting.

Switch off the engine during lengthy stops

Switch off the engine when stopping for lengthy periods, e.g. at traffic lights, railroad crossings or in traffic congestions. You achieve fuel savings even if standing time is as short as approx. 4 seconds.

Switch off functions you do not need at the moment

Functions such as the air conditioner and the seat or rear window heating draw large amounts of power and consume additional fuel. Especially in city traffic and in stop and go driving they have a considerable impact. Therefore, switch these functions off when they are not really needed.

Have the vehicle serviced

Have the vehicle serviced regularly to achieve good economy and a long vehicle life. BMW recommends having the vehicle serviced at a BMW center. Also note the BMW service system, refer to page 96.

Driving notes

Close the luggage compartment lid/tailgate

 Operate the vehicle only when the luggage compartment lid/tailgate is closed. Otherwise, exhaust fumes could enter the interior of the vehicle. ◀

Should it be absolutely necessary drive with the luggage compartment lid/tailgate open:

1. Coupe: close both windows.
Roadster: close all windows if the convertible top is closed.
2. Greatly increase the air flow from the air conditioning or automatic climate control, refer to page 62 or 65.

Hot exhaust system

 In all vehicles, extremely high temperatures are generated in the exhaust system. Never remove the heat shields installed in this area, nor apply undercoating to their surfaces. When driving, standing at idle or parking the vehicle, take care to avoid contact between the hot exhaust system and flammable materials, e.g. hay, leaves, grass, etc. Such contact could lead to a fire, resulting in serious personal injury and property damage. Do not touch the hot exhaust pipes to avoid the risk of injury from burns. ◀

Hydroplaning

 When driving on wet or slushy roads, reduce vehicle speed. If you do not, a wedge of water may form between the tires and the road surface. This situation, known as hydroplaning, means that the tire can com-

pletely lose contact with the road surface, so that neither the car can be steered nor the brake be properly applied. ◀

The risk of hydroplaning increases with declining tread depth on the tires, refer also to Minimum tread depth on page 87.

Driving through water

 Drive through water on the road only if it is not deeper than 1 ft/30 cm, and then only at walking speed at the most. Otherwise, the vehicle's engine, the electrical systems and the transmission may be damaged. ◀

Moisture inside the vehicle

 Make sure that the passenger compartment does not become wet and that liquids are transported in closed containers. Otherwise, moisture could penetrate and damage electronic components inside the vehicle. ◀

Use the parking brake on inclines

 On inclines, keep the vehicle from rolling by using the parking brake rather than by slipping the clutch, which would lead to a high degree of clutch wear. ◀

Braking safely

Your BMW is equipped with ABS as a standard feature. Applying the brakes fully is the most effective way of braking in situations in which this is necessary. Since the vehicle maintains steering responsiveness, you can still avoid possible obstacles with a minimum of steering effort.

Pulsation at the brake pedal combines with sounds from the hydraulic circuits to indicate to the driver that ABS is in its active mode.

Wet roads

When roads are wet or there is heavy rain, briefly exert gentle pressure on the brake pedal every few miles. Watch traffic conditions to ensure that this maneuver does not endanger other road users. The resulting heat dries the brake rotors and brake pads. Immediate braking force is then available if necessary.

Inclines

 To prevent overheating and, as a result, diminished braking effectiveness, drive down long or steep downhill grades in the gear that requires the least braking. Otherwise, even light but consistent pedal pressure can lead to high temperatures, brake wear and possibly even brake failure. ◀

You can increase the engine's braking effect by shifting down, all the way to first gear if necessary. This strategy helps you avoid placing excessive loads on the brake system. Downshifting in manual mode of the automatic transmission, refer to page 43.

 Never drive with the clutch held down, with the transmission in idle or with the engine switched off; otherwise, engine braking action will not be present or there will be no power assistance to the brakes or steering. Never allow floor mats, carpets or any other objects to protrude into the area around the pedals, otherwise pedal function could be impaired. ◀

Corrosion on brake rotors

Limited vehicle use, extended periods with the vehicle parked or in storage, and operating conditions in which braking is restricted to gentle, low-pressure applications will all increase the tendency for corrosion to form on the rotors and contamination to accumulate on the brake pads. This occurs because the minimal pressure which must be exerted by the pads to clean the rotors by brake applications is not reached.

If the brake rotors are corroded, they will tend to respond to braking with a pulsating effect which even extended application will fail to cure.

Brake pads

 The warning lamp lights up. The brake pads have worn down to the minimum safe limit. Have the brake pads replaced as soon as possible.

When the vehicle is parked

Condensation forms while the air conditioning or automatic climate control is in operation, and then exits under the vehicle. Traces of condensed water on the ground underneath the vehicle are thus normal.

Before driving into a car wash

For general information about taking care of your BMW, refer to the Caring for your vehicle brochure.

Cargo loading

 Avoid overloading the vehicle so that the permissible carrying capacity of the tires is not exceeded. Otherwise, overheating and inner damage to the tires may result. The ultimate result can assume the form of a sudden air loss. ◀

 Make sure that no liquids are spilled or leak from their containers in the cargo bay, as this could result in damage to the vehicle. ◀

Determining the maximum load



1. Locate the following statement on your vehicle's placard*:

 The combined weight of occupants and cargo should never exceed XXX kg or YYY lbs. Otherwise, overloading can result in damage to the vehicle and unstable driving conditions. ◀

2. Determine the combined weight of the driver and passenger that will be riding in your vehicle.

3. Subtract the combined weight of the driver and passenger from XXX kilograms or YYY pounds.
4. The resulting figure equals the available amount of cargo and luggage load capacity. For example, if the YYY amount equals 551 lbs and there will be two 150 lbs occupants in your vehicle, the amount of available cargo and luggage load capacity is 251 lbs.
551 lbs minus 300 lbs = 251 lbs
5. Determine the combined weight of luggage and cargo being loaded on the vehicle. That weight may not safely exceed the available cargo and luggage load capacity calculated in step 4.

Load

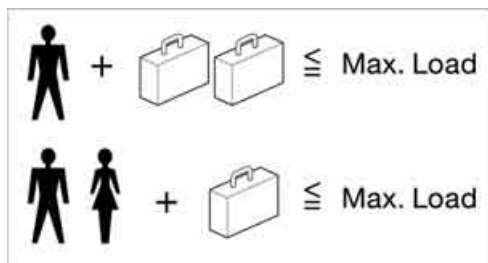

The permissible load is the sum of the occupants' weights and the weight of the cargo. The greater the weight of the occupants, the less cargo can be transported.

Stowing cargo

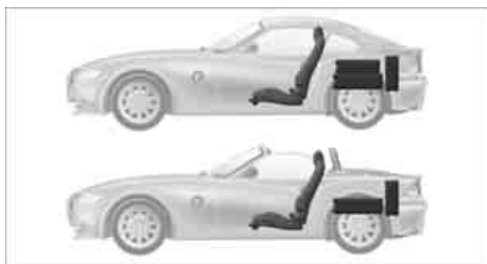

- ▷ Load heavy cargo as far forward as possible, directly behind the cargo bay partition, and as low as possible.
- ▷ Cover sharp edges and corners.

! To avoid damaging the rear of the backrests or the rear interior trim panel, do not stow heavy cargo or cargo with sharp edges and corners behind the seats.

In addition, large and bulky cargo stowed behind a seat may prevent the backrest from engaging properly. For this reason, check whether the backrest has engaged securely and move the seat forward, if necessary, refer to page 31.

Always position and secure the cargo as described above, so that it cannot endanger the car's occupants, for example if sudden braking or swerving is necessary.

Never exceed either the approved gross vehicle weight or either of the approved axle loads, refer to page 113, as excessive loads can pose a safety hazard, and may also place you in violation of traffic safety laws.

Heavy or hard objects should not be carried loose inside the car, since they could be thrown around, for example as a result of heavy braking, sudden swerves, etc., and endanger the occupants. ◀

Roadster: convertible top compartment

▷ With the convertible top closed you can expand the cargo bay, refer to page 23. It is best to always fold down the convertible top compartment panel as soon as you have removed your cargo from the cargo bay. This way, you can be sure that you can always operate the convertible top at any time.

When the convertible top is closed, fold the convertible top compartment panel up before stowing your cargo in the cargo bay, to avoid any damage to the convertible top compartment or your load.

Do not stow any items on the convertible top compartment panel, otherwise the convertible top could be damaged while it is opening. ◀

If you stow cargo behind the seats of your BMW:

- ▷ Only stow light objects such as clothing, etc.
- ▷ Do not pile objects higher than the top edge of the backrests.

Roadster: hardtop preparation*

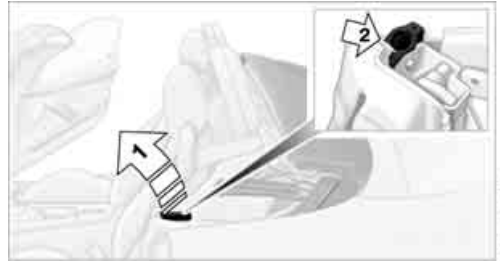

Pull covers off, see arrow 1.

The brackets for attaching the hardtop are located underneath the covers; see arrow 2.

▷ For instructions on how to install the hardtop, please read the accompanying assembly information.

The hardtop is available from your BMW center as an optional extra. ◀





Mobility

This section helps you maintain your car's mobility by supplying important information on vital topics including fuels and lubricants, wheels and tires, service, maintenance and breakdown assistance.

Refueling

⚠ Always switch off the engine before refueling. Otherwise the tank cannot be refilled. The Service Engine Soon warning lamp will come on. ◀

⚠ Take all precautionary measures and observe all applicable regulations when handling fuel. Do not carry any spare fuel containers in your vehicle. They can develop a leak and cause an explosion or cause a fire in the event of an accident. ◀

Gas cap

Opening

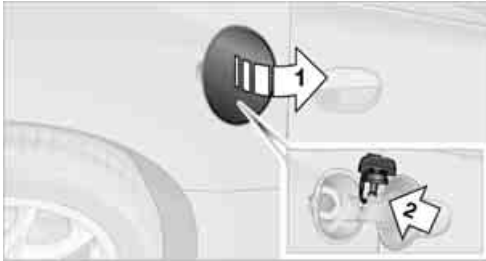

1. Open the fuel filler door, arrow 1.
2. Turn the gas cap counterclockwise.
3. Place the gas cap in the bracket attached to the fuel filler door, arrow 2.

Closing

Fit the gas cap and turn it clockwise until you clearly hear a click.

⚠ Do not jam the gas cap strap as this will allow fuel vapors to escape. ◀

⚠ The warning lamp* lights up briefly if the gas cap is loose or missing. Close the gas cap properly.

Manually releasing the fuel filler door

In the event of a malfunction you can unlock the fuel filler door manually.

1. Remove the cover for the right-hand rear lamps in the cargo bay by turning the lock, see arrow.



2. Pull the cargo bay trim panel slightly toward the interior. The green button with the fuel pump symbol becomes visible.

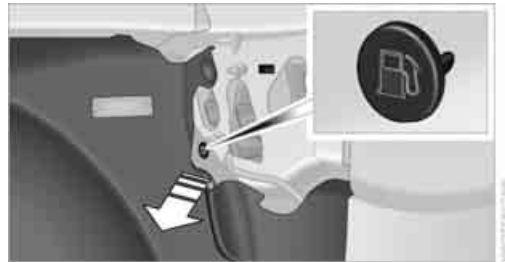

3. Undo the adhesive strip and pull off.
4. Pull the button. The fuel filler door is released.

▶ Pull on the button slowly and carefully; otherwise it could be torn off. ◀

Observe the following when refueling

⚠ When handling fuels, comply with all of the applicable safety precautions posted at the service station. ◀

When refueling, insert the filler nozzle completely into the filler pipe. Avoid lifting the filler nozzle while filling the tank, as it could otherwise lead to:

- ▷ Premature pump shutoff
- ▷ A reduced efficiency of the fuel-vapor recovery system.

The fuel tank is full when the filler nozzle shuts off the first time.

Fuel tank capacity

Approx. 14.5 US gallons/55 liters, including the reserve capacity of approx. 2.1 US gallons/8 liters.

 Do not drive until the fuel tank is empty. Otherwise, the engine may not operate properly and damage could result. ◀

Fuel specifications

 Do not fill the tank with leaded fuel, as this would cause permanent damage to the catalytic converter.

Do not fill the tank with E85, i.e. fuel that contains 85% ethanol, nor with Flex Fuel, as this would cause damage to the engine and fuel supply system. ◀

Required fuel

Super Premium Gasoline/AKI 91

This gasoline is highly recommended.

However, you may also use gasoline with less AKI. The minimum AKI Rating is 87.

If you use gasoline with this minimum AKI Rating, the engine may produce knocking sounds when starting at high outside temperatures. This has no effect on the engine life.

 Do not fill the tank with gasoline below the specified minimum grade; otherwise engine damage could result. ◀

Use high-quality brands

Field experience has indicated significant differences in fuel quality: volatility, composition, additives, etc., among gasolines offered for sale in the United States and Canada. Fuels containing up to and including 10% ethanol or other oxygenates with up to 2.8% oxygen by weight, that is, 15% MTBE or 3% methanol plus an equivalent amount of co-solvent, will not void the applicable warranties with respect to defects in materials or workmanship.

 The use of poor-quality fuels may result in drivability, starting and stalling problems especially under certain environmental conditions such as high ambient temperature and high altitude.

Should you encounter driveability problems which you suspect could be related to the fuel you are using, we recommend that you respond by switching to a recognized high-quality brand such as gasoline that is advertised as Top Tier Detergent Gasoline.

Failure to comply with these recommendations may also result in unscheduled maintenance. ◀

Wheels and tires

Tire inflation pressure

Information for your safety

It is not merely the tire's service life, but also driving safety and driving comfort that largely depend on the condition of the tires and the maintenance of the specified tire pressure.

 Check tire inflation pressures regularly and correct them if necessary: at least every two weeks and before every extended journey. If you fail to observe this precaution you may be driving on tires with incorrect tire pressures, a condition that can not only compromise your vehicle's driving stability, but also lead to tire damage and the risk of an accident. Do not drive with deflated, i.e. flat tires, except when using Run-Flat Tires. A flat tire will seriously impair your vehicle's handling and braking response. Attempts to drive on a flat tire can lead to loss of control over the vehicle. ◀

Checking pressure

Check the tire inflation pressures only when the tires are cold. This means after a maximum of 1.25 miles/2 km driving or when the vehicle has been parked for at least 2 hours. Warm tires have higher inflation pressures.

Inflation pressure specifications



The specified inflation pressures for your standard tires are provided on the placard on the B-pillar and are visible when the driver's door is open.

 After the tire inflation pressure is corrected, initialize the Flat Tire Monitor*, refer to page 53, or reset the Tire Pressure Monitor*, refer to page 54. ◀

The following tire inflation pressure tables show the inflation pressures for the specified tire sizes at ambient temperature.

 The inflation pressures in the table apply to BMW-approved tire sizes and recommended tire brands. Your BMW center will be glad to supply this information. ◀

To determine the correct tire inflation pressure for your tires, refer to the following tables.

Tire size

The inflation pressures in the table apply to BMW-approved tire sizes and recommended tire brands. Your BMW center will be glad to supply this information.

Z4 Roadster 3.0i

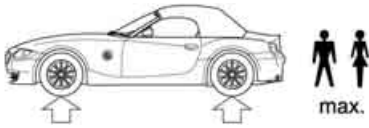
Tire size	Pressure specifications in psi/kPa	
All pressure specifications in the table are indicated in psi/kilopascal with cold tires, cold = ambient temperature		
		
225/50 R 16 92 V		
225/45 R 17 91 W		
205/55 R 16 91 H M+S	32/220	35/240
225/50 R 16 92 H M+S		
225/45 R 17 91 H/V M+S		
Front: 225/45 R 17 91W	32/220	–
Rear: 255/40 R 17 94 W	–	35/240
Front: 225/40 R 18 88 W	32/220	–
Rear: 255/35 R 18 90 W	–	35/240

You will find more information about permissible loads and weights on page [113](#).

Z4 Roadster 3.0si

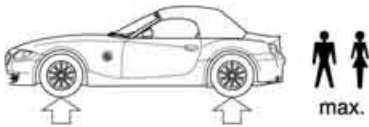
Tire size	Pressure specifications in psi/kPa	
All pressure specifications in the table are indicated in psi/kilopascal with cold tires, cold = ambient temperature		
		
225/45 R 17 91 W		
225/45 R 17 91 H/V M+S	33/230	38/260
Front: 225/45 R 17 91W	33/230	–
Rear: 255/40 R 17 94 W	–	38/260
Front: 225/40 R 18 88 W	33/230	–
Rear: 255/35 R 18 90 W	–	38/260

You will find more information about permissible loads and weights on page [113](#).

 All passenger car tires must conform to Federal Safety Requirements in addition to these grades. ◀

Tread wear

The tread wear grade is a comparative rating based on the wear rate of the tire when tested under controlled conditions on a specified government test course.

For example, a tire graded 150 would wear one and one-half, 1 ½, times as well on the government course as a tire graded 100. The relative performance of tires depends upon the actual conditions of their use, however, and may depart significantly from the norm due to variations in driving habits, service practices and differences in road characteristics and climate.

Traction

The traction grades, from highest to lowest, are AA, A, B and C.

Those grades represent the tire's ability to stop on wet pavement as measured under controlled conditions on specified government test surfaces of asphalt and concrete. A tire marked C may have poor traction performance.

 The traction grade assigned to this tire is based on straight-ahead braking traction tests, and does not include acceleration, cornering, hydroplaning, or peak traction characteristics. ◀

Temperature

The temperature grades are A, the highest, B and C, representing the tire's resistance to the generation of heat and its ability to dissipate heat when tested under controlled conditions on a specified indoor laboratory test wheel. Sustained high temperature can cause the material of the tire to degenerate and reduce tire life, and excessive temperature can lead to sudden tire failure. The grade C corresponds to a level of performance which all passenger car tires must meet under the Federal Motor Vehicle Safety Standard No. 109. Grades B and A represent higher levels of performance on the laboratory test wheel than the minimum required by law.

 The temperature grade for this tire is established for a tire that is properly inflated and not overloaded. Excessive speed, underinflation, or excessive loading, either separately or in combination, can cause heat buildup and possible tire failure. ◀

RSC: Run-Flat Tires

Run-Flat tires are labeled on the sidewall with a circular symbol containing the letters RSC. Refer to page 88.

M+S

Winter and all-season tires.

These have better winter performance properties than summer tires.

Tire condition

Inspect your tires frequently for tread wear, signs of damage and for foreign objects lodged in the tread. Check the tread depth.

Minimum tread depth

The tread depth should not drop below 1/8 in/ 3 mm, although, for example, European legislation only specifies a minimum tread depth of 1/16 in/1.6 mm. At tread depths below 1/8 in/ 3 mm there is an increased risk of high-speed hydroplaning, even when only small amounts of water are present on the road surface.

When winter tires wear down past a tread depth of 1/6 in/4 mm, they become perceptibly less suitable for winter conditions. In the interest of safety, new tires should be installed.

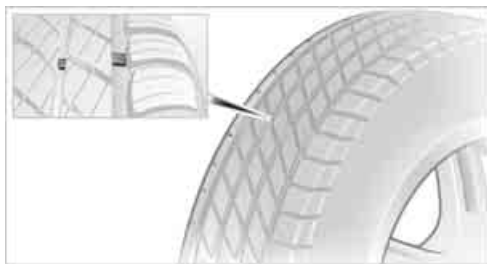

Wear indicators in the base of the tread groove are distributed around the tire's circumference;

the letters TWI, for Tread Wear Indicator, on the tire's sidewalls identify tires that incorporate these wear indicators. Once the tire tread has worn down to the wear indicators, the tire has worn to a depth of 1/16 in/1.6 mm.

Wheel/tire damage

 Due to low-profile tires, please note that wheels, tires and suspension parts are more susceptible to road hazards and consequential damages. ◀

Unusual vibrations encountered during normal vehicle operation can indicate tire failure or some other vehicle malfunction. This can, for example, be caused by driving over curbs. The same applies to any other abnormal road behavior, such as pulling severely to the right or left.

 In these cases, reduce speed immediately and have wheels and tires thoroughly checked. To do so, drive carefully to the nearest BMW center or tire shop that works according to BMW repair procedures with correspondingly trained personnel. If necessary, have the vehicle towed there. Tire damage can be extremely dangerous for vehicle occupants and other road users. ◀

Tire age

For various reasons, such as the development of brittleness, BMW recommends tire replacement after no more than 6 years, regardless of the actual wear of the tires.

The date on which the tire was manufactured is indicated by the code on the sidewall: DOT ... 5005 indicates that the tire was manufactured in week 50 of the year 2005.

Run-Flat Tires



The symbol identifying Run-Flat Tires is a circle with the letters RSC on the sidewall. Run-Flat Tires comprise a conditionally self-supporting tire and a special rim. The reinforcement in the sidewalls ensures that the tire can continue to be used subject to certain restrictions, even if depressurized.

To continue driving with a damaged tire:

- ▶ If the vehicle is equipped with the Flat Tire Monitor, refer to Flat tire warning on page 53.
- ▶ If the vehicle is equipped with the Tire Pressure Monitor, refer to Warning of low tire inflation pressure on page 54.

Wheel and tire replacement

 Have new wheels and tires installed only by your BMW center or tire shop that works according to BMW repair procedures with correspondingly trained personnel. Work that is improperly carried out could result in consequential damage and pose safety hazards. Make sure that the new wheels are balanced. ◀

Retreaded tires

 BMW advises against using retreaded tires, since driving safety may be impaired. The causes for this include potentially different tire casing structures and often wide variations in tire age, which can result in a limited service life. ◀

Correct wheels and tires

 BMW recommends using only wheels and tires that have been approved by BMW for your particular vehicle model, otherwise body contact and serious accidents can result despite the use of the same nominal size, e.g. due to manufacturing tolerances. If non-approved wheels and tires are used, BMW cannot evaluate their suitability, and therefore cannot be held liable for driving safety. ◀

You can inquire about the correct wheel/tire combination at your BMW center.

The correct combination of wheels and tires is also necessary to ensure reliable operation of various vehicle systems such as ABS and DSC.

To maintain good handling and vehicle response, only use tires of a single brand and tread configuration. After a tire has been damaged, for instance, mount the original wheel and tire combination again as soon as possible.

Wheels with electronics for the Tire Pressure Monitor TPM

When mounting new tires or changing from summer to winter tires or vice versa, only use wheels with TPMS electronics; otherwise the Tire Pressure Monitor would not be able to detect a flat tire, refer to page 54. Your BMW center will be glad to provide you with more information.

Recommended tire brands

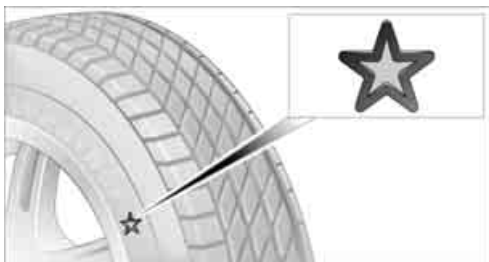

Certain makes of tire are recommended by BMW for each tire size. They are marked with a clearly visible BMW designation on the sidewall of the tire.

When properly used, these tires meet the highest standards in terms of safety and handling characteristics.

Run-Flat Tires

When mounting new tires or changing over from summer to winter tires and vice versa, mount Run-Flat Tires for your own safety. In the event of a flat, moreover, no spare wheel is available. Your BMW center will be glad to provide you with more information.

 For safety reasons, BMW recommends that damaged Run-Flat Tires be replaced rather than repaired. ◀

Special characteristics of winter tires

BMW recommends the use of winter tires for operation under winter road conditions. While all-season tires with M+S designation provide better winter traction than summer tires, they generally do not achieve the full performance of winter tires.

Pay attention to speed

 Always comply with the speed limit for the winter tires mounted on your car; failure to do so could result in tire damage and accidents. ◀

If the car is capable of speeds higher than that permitted for the winter tires, a label stating the maximum permitted speed for the mounted tires must be displayed in your field of view. Specialist tire dealers and your BMW center can supply these labels.

Storage

Store tires in a cool, dry place, protecting them against light whenever possible. Protect the tires from contact with oil, grease and fuel. Do not exceed the maximum tire inflation pressure indicated on the sidewall of the tire.

Swapping wheels between the axles

BMW advises against moving the front wheels to the rear wheel positions and vice versa, as this may impair vehicle handling characteristics.

Snow chains*

Only certain fine-link snow chains have been tested by BMW, classified as safe for use and recommended. Consult your BMW center for more information. Attach snow chains in pairs and only to the rear wheels.

Observe the manufacturer's instructions when mounting snow chains. Do not exceed a speed of 30 mph/50 km/h when using snow chains.

You are not permitted to mount snow chains to tires of the following sizes:

- ▷ 255/40 R 17
- ▷ 255/35 R 18

 Do not initialize the Flat Tire Monitor if snow chains are mounted*, as this may cause the instrument to issue an incorrect reading.

When driving with snow chains, you may find it helpful to activate DTC temporarily, refer to page [52](#). ◀

Under the hood

 Do not work on the car unless you possess the necessary technical knowledge. If you are unfamiliar with the statutory guidelines, have any work on the vehicle performed only by a BMW center or by a workshop that work according to BMW repair procedures with correspondingly trained personnel. If this work is not carried out properly, there is a danger of subsequent damage and related safety hazards. ◀

Hood

To release



Pull the lever located under the left-hand side of the instrument panel.

To open

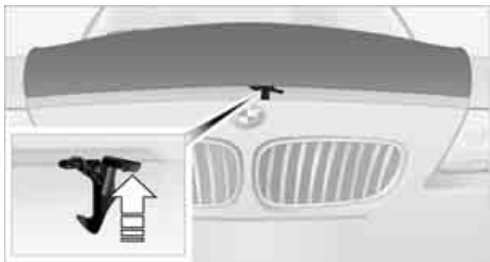

Press the release handle and open the hood.

To close

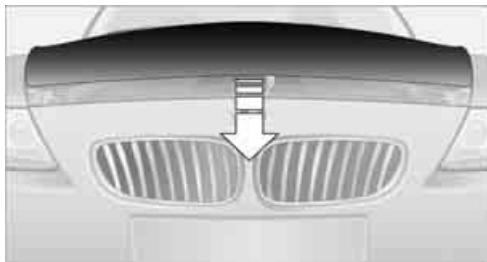

Close the hood from a height of approx. 16 in/ 40 cm with momentum. It must be clearly heard to engage.

 Make sure that the closing path of the hood is clear, otherwise injuries may result.

If you notice while driving that the hood is not completely closed, stop immediately and close it securely. ◀

Important parts in the engine compartment

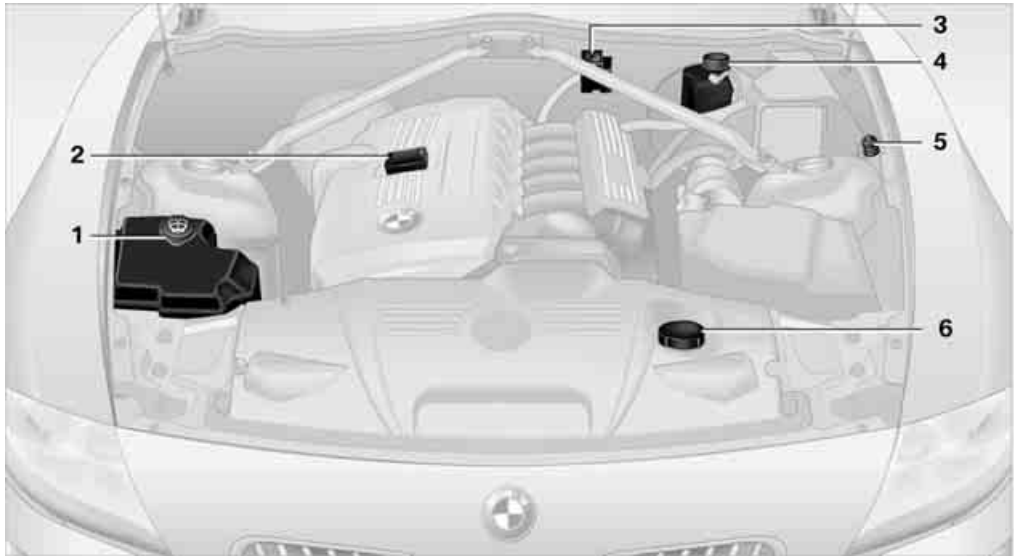



- 1 Washer fluid reservoir for headlamp cleaning system and window washer system, refer to page [46](#)
- 2 Filler neck for engine oil, refer to Adding engine oil
- 3 Jump-starting connection, refer to page [104](#)
- 4 Reservoir for brake fluid, refer to page [95](#)
- 5 Body ground, negative terminal, refer to page [105](#)
- 6 Expansion tank for coolant, refer to page [94](#)

Engine oil

Oil consumption is directly influenced by your driving style and vehicle operating conditions.



Warning lamp

Engine oil pressure

-  The warning lamp lights up in red:
 The engine oil pressure is too low.
 Stop the vehicle immediately and switch off the engine. Check the engine oil level and top up if necessary. If the oil level is correct, please contact your nearest BMW center or a workshop that works according to BMW repair procedures with correspondingly trained personnel.

-  Do not continue driving, otherwise the engine could sustain serious damage from inadequate lubrication. ◀

Engine oil level

-  The warning lamp lights up in yellow while you are driving. In addition, a signal sounds and "+1.0" appears in the instrument cluster, refer to page [93](#).
 The oil level is at the absolute minimum; refill as soon as possible. Do not drive more than 125 miles/200 km before refilling.
-  The warning lamp comes on in yellow after the engine is switched off. A signal also sounds.

Add engine oil at the earliest opportunity, e.g. when you stop to refuel.

- ▢ The warning lamp lights up in yellow within 30 seconds after the engine is started: the oil level sensor is defective. It is not possible to issue a current or accurate measurement. Have the system checked as soon as possible.

Checking the oil level

Your car is equipped with an electronic oil-level monitor.

For a precise measurement and display of the oil level, it is necessary that the engine be at operating temperature, i.e. after uninterrupted driving for at least approx. 6.5 miles/10 km. You can have the oil level displayed while you are driving, or while the vehicle is at a standstill on a level surface and the engine is running.

You can have the oil level reading displayed in the instrument cluster.



Press button **1**. The oil level is checked and displayed for approx. 15 seconds.

To exit the display sooner, press button **1** again.

Possible displays

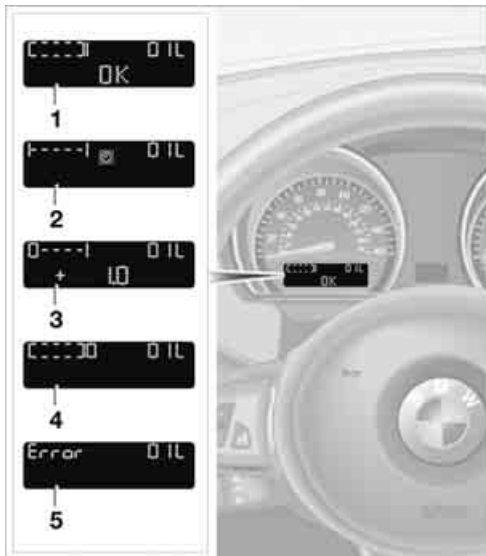



- 1 Oil level OK
- 2 Oil level is being checked.
This can take about 3 minutes if the car is at a standstill on a level surface, or about 5 minutes while the car is on the move.
- 3 Oil level down to minimum:
Add 1 US quart/1 liter of engine oil as soon as possible, refer also to Adding engine oil.
- 4 Oil level is too high.
 Have the vehicle checked immediately, as excessive oil can damage the engine. ◀
- 5 The oil level sensor is defective:
it is not possible to issue a current or accurate measurement.
Do not add engine oil. You can continue your journey. Have the system checked as soon as possible.

Adding engine oil



Do not add the maximum amount of 1 US quart/ 1 liter of engine oil until the warning lamp lights up in the instrument cluster, refer to page 92, or until the oil level monitor shows "+1.0".

 Add oil within the next 125 miles/200 km, otherwise the engine could be damaged. ◀

 Keep oils, greases, etc. out of the reach of children and comply with the warnings on the containers. Otherwise, health hazards may result. ◀

Oil change

Have your oil changed only by a BMW center or a workshop that works according to BMW requirements with the appropriately trained personnel.

Approved engine oils

The quality of the engine oil is extremely important for the function and life of an engine. BMW continuously approves specific oils after confirming their suitability for use in its vehicles with extensive testing.

Only use approved BMW High Performance Synthetic Oil.

If BMW High Performance Synthetic Oil is not available, you can add small quantities of other synthetic oils in between oil changes. Only use oils with the API SH specification or higher.

 Your BMW center will be glad to answer any questions regarding BMW High Performance Synthetic Oil or other approved synthetic oils. ◀

You can also call BMW of North America at 1-800-831-1117 or visit the website www.bmwusa.com to obtain this information.

 Do not use any oil additives, as they could cause engine damage under some circumstances. ◀

Viscosity classes

Viscosity is a measure of an oil's flow rating and is categorized in SAE classes.

Selecting the appropriate SAE class depends on the regional climatic conditions in which you normally drive your BMW.

 Approved oils belong to the 5W-40 and 5W-30 classes. ◀

These oils can be used for driving at all outside temperatures.

Coolant

Warning lamp

 The warning lamp lights up:
The coolant level is too low. Top up the coolant as soon as possible.

 Do not open the cooling system when the engine is hot. If you do, escaping coolant can cause burns. ◀

Coolant consists of water and coolant additives. Not all commercially available additives are suitable for your BMW. Your BMW center knows which additives are appropriate.

 Only use approved additives, otherwise the engine could be damaged. The additives are hazardous to health. ◀

 Comply with the appropriate environmental protection regulations when disposing of coolant additives. ◀

Checking the coolant level

1. The engine must be at ambient temperature.
2. Turn the cap of the expansion tank a little counterclockwise to allow any accumulated

pressure to escape, then continue turning to open.

3. The coolant level is correct if the upper end of the red float spindle is at least at the same level as the upper edge of the filler neck but no more than 3/4 in or 2 cm above it, i.e. up to the mark on the float spindle. Refer also to the diagram next to the filler neck.



4. If the coolant is low, slowly add coolant up to the specified level; do not overfill.
5. Twist the cap back on and tighten it firmly.
6. Have the cause for the coolant loss removed as soon as possible.

Brake system

Malfunction

Brake fluid

BRAKE The warning lamp lights up although the parking brake is not engaged.

The brake fluid level in the reservoir is too low. At the same time, you may notice that brake pedal travel is longer. Have the system checked as soon as possible.

⚠ If you continue driving, extended brake pedal travel may be necessary and braking distances may be significantly longer. Be sure to adapt your driving style accordingly. ◀

(!) Canadian models display this warning lamp.

Maintenance

BMW Maintenance System



The BMW Maintenance System helps maintain the road safety and operating reliability of your BMW.

Regular maintenance is not only necessary for the safety of your vehicle, but also plays a significant role in maintaining the resale value of your vehicle.

Service interval display

The BMW Maintenance System takes the vehicle's operating conditions into account for the service intervals:

From a maintenance point of view, 62,100 miles/100,000 km accumulated in short-distance urban driving are not the same as 62,100 miles/100,000 km accumulated at moderate cruising speeds in long-distance highway travel.

The BMW Maintenance System includes the Engine Oil Service and Inspections I and II.

Determining the maintenance intervals based on the actual loads on the vehicle covers every kind of operating situation. Minimal use drivers, who drive fewer than about 6,210 miles/10,000 km per year, should nevertheless have the oil changed at least every 2 years since engine oil deteriorates over time, regardless of use.

Service and Warranty Information Booklet for US models and Warranty and Service Guide Booklet for Canadian models

Please consult your Service and Warranty Information Booklet for US models and Warranty and Service Guide Booklet for Canadian models for additional information on service requirements.

▶ BMW recommends that you have service and repair operations performed at your BMW center.

Take the time to ensure that these service procedures are confirmed by entries in your vehicle's Service and Warranty Information Booklet for US models and Warranty and Service Guide Booklet for Canadian models. These entries verify that your vehicle has received the specified regular maintenance. ◀

Socket for On-Board Diagnosis OBD



Vehicle components that are relevant to the composition of exhaust emissions can be checked with a device via the OBD socket.

This socket is located on the driver's side to the left, on the bottom of the instrument panel underneath a cover.

Exhaust emission values



The warning lamp lights up: the exhaust emission values have worsened. Have the car checked as soon as possible.

The lamps flash under certain conditions. This indicates excessive misfiring of the engine. If this happens, you should reduce your speed and visit your nearest BMW center as soon as possible. Severe engine misfiring can quickly lead to serious damage of emissions-related components, especially the catalytic converter.



Canadian models display this warning lamp.



The warning lamp lights up if the gas cap is not properly tightened and the OBD system can assume that fuel vapor is escaping. If the gas cap is then tightened, the warning lamp should go out within a few days.

Event Data Recorders

Your vehicle may be equipped with one or several measuring or diagnostic modules or a device for recording or sending certain vehicle data or information. In addition, if you have signed a subscription contract for BMW Assist, certain vehicle data may be transmitted or recorded in order to facilitate the corresponding services.

Care

Important information on the care and maintenance of your BMW is contained in the Caring for your vehicle brochure.

Replacing components

Onboard tool kit

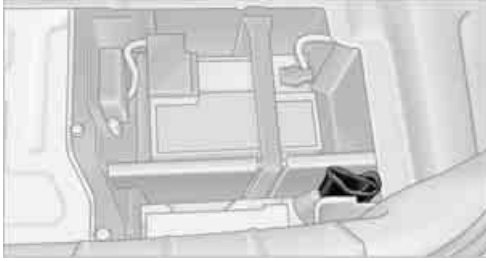

The onboard tool kit is stored in a tool pouch. It is located in the cargo bay beneath the floor panel.

Windshield wiper blades

1. Fold up the wiper arm.
2. Place the wiper blade in a position at right angles to the wiper arm.
3. Press the locking spring.



4. Fold in the wiper blade and unhook it in the direction of the windshield.
5. Pull the wiper blade past the wiper arm toward the top.
6. Insert the new wiper blade and press it on until it audibly engages.

Lamps and bulbs

Lamps and bulbs make an essential contribution to vehicle safety. They should, therefore,

be handled carefully. BMW recommends having your BMW center perform any work that you do not feel competent to perform yourself or that is not described here.

▶ Do not touch the glass portion of a new bulb with your bare hands since even small amounts of impurities burn into the surface and reduce the service life of the bulb. Use a clean cloth, paper napkin or a similar material, or hold the bulb by its metallic base. ◀

A replacement bulb set is available from your BMW center.

⚠ When working on electrical systems, always begin by switching off the corresponding consumers, otherwise short-circuits could result. To avoid possible injury or equipment damage when replacing bulbs, be sure to observe any instructions provided by the bulb manufacturer. ◀

For care and maintenance of the headlamps, please follow the instructions in the separate Caring for your vehicle brochure.

▶ If the routine for changing a particular bulb is not described here, please contact your BMW center or a workshop that works according to BMW repair procedures with correspondingly trained personnel. ◀

Light-emitting diodes LEDs

Control elements, display units and other interior equipment in your vehicle use a light-emitting diode behind a cover as a light source. These light-emitting diodes, which operate using a concept similar to that applied in conventional lasers, are officially designated as Class 1 light-emitting diodes.

⚠ Do not remove the covers, and do not look directly at the unfiltered light for several hours. Otherwise, your eyes could suffer irritation of the retina. ◀

Xenon lamps*

These bulbs have a very long service life and are unlikely to fail. If one of these bulbs should nevertheless fail, it is possible to continue driving with great caution using the fog lamps, provided traffic laws in your area do not prohibit this.

 Have work on the xenon lighting system performed only by your BMW center or a workshop that works according to BMW repair procedures with correspondingly trained personnel. Due to the high electrical voltages present, there is a risk of potentially fatal accidents if work is performed inappropriately. ◀

Parking lamps, roadside parking lamps

In the event of a malfunction, please contact your BMW center or a workshop that works according to BMW repair procedures with correspondingly trained personnel.

Halogen lamps

 For checking and adjusting headlamp aim, please contact your BMW center. ◀

Access through the wheel well

1. Turn the wheel outwards.



2. Open the flap in the wheel well. To do so, turn the fastener counterclockwise using a coin, for example.

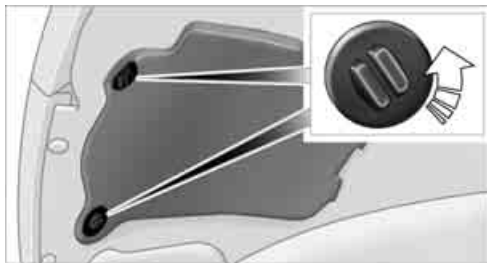

3. Open up the flap in the wheel well.

Headlamp cover

1. Pull the wire clamp past the catches, see arrows, and fold it down.

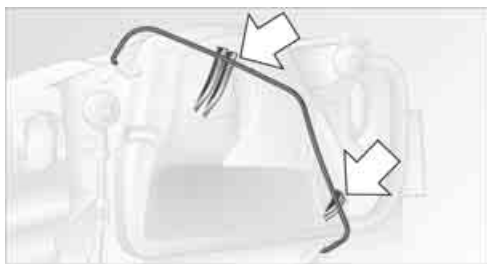

2. Flip the headlamp cover open and remove.

 Reinstall the headlamp cover carefully. If it is not on tight, the headlamp installation could be damaged. ◀

Reinstall the headlamp cover in reverse order.

Low beams and high beams

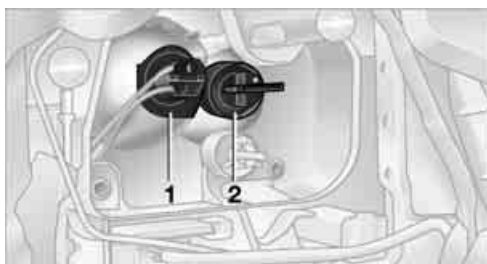

- 1 Low beams
- 2 High beams

55-watt bulb, H7

⚠ The H7 bulb is pressurized. Therefore, wear safety glasses and protective gloves. Otherwise there is a risk of injury if the bulb is damaged. ◀

1. Turn the bulb socket counterclockwise and take it out.
2. Remove and replace the bulb.
3. Insert bulb socket.

Side marker lamps, front

5-watt bulb, W5W

1. Take out bulb socket.

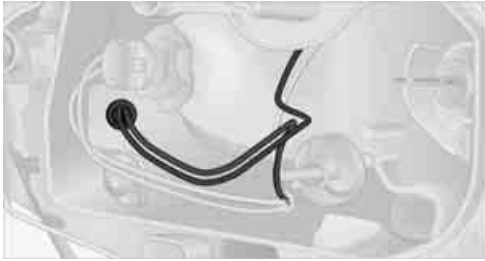

2. Remove and replace the bulb.
3. Insert bulb socket.

Front turn signal indicators

21-watt bulb, H21

1. Insert a Phillips-head screwdriver from the onboard tool kit into the appropriate opening, arrows 1.

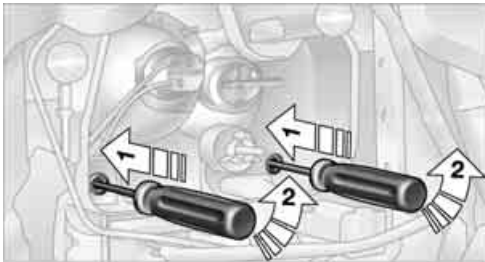

2. Turn the Phillips-head screwdriver to the left, arrows 2.

3. Use the Phillips-head screwdriver to take the bulb socket out.



4. Remove and replace the bulb.
5. Insert bulb socket.

Side turn signal indicators

5-watt bulb, WY5W

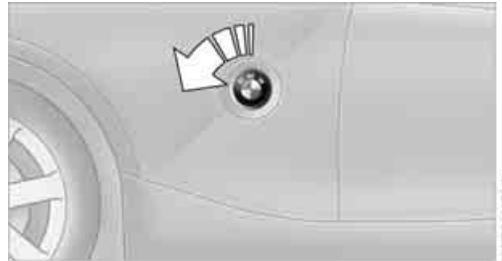

1. Turn the lamp to the left and remove.
2. Apply gentle pressure to the bulb socket while turning it to the left and remove it.
3. Remove and replace the bulb.
4. Insert bulb socket.
5. Insert the lamp.

Rear lamps

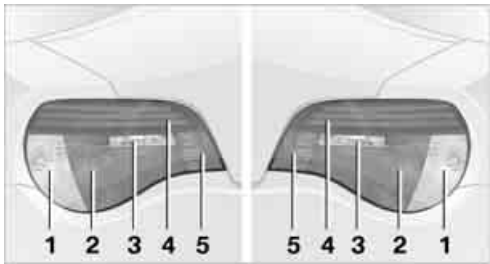

- 1 Turn signal indicators, 21 watts, PY21W Silver Vision
- 2 Brake lamp, 21 watts, P21W
- 3 Backup lamp, 16 watts, W16W
- 4 Tail lamp, LED
- 5 Brake lamp, 21 watts, H21W

In the event of a malfunction in lamp 4 or 5, please contact your BMW center or a workshop that works according to BMW repair procedures with correspondingly trained personnel.

Changing bulbs

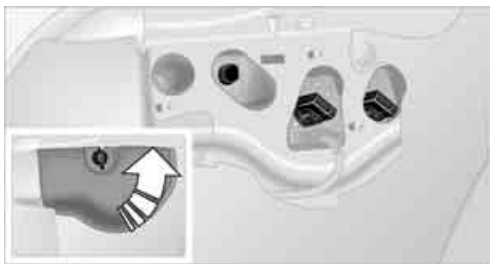

1. Remove the cover in the cargo bay by turning the lock, see arrow.
2. Apply gentle pressure to the bulb socket while turning it to the left and remove it.
3. Remove and replace the bulb.
4. Insert bulb socket.
5. Reattach the cover.

Side marker lamps, rear

To change the bulbs, please contact your BMW center or a workshop that works according to BMW repair procedures with correspondingly trained personnel.

Center high-mount brake lamp

This lamp uses LED technology for operation. In the event of a malfunction, please contact your BMW center or a workshop that works according to BMW repair procedures with correspondingly trained personnel.

License plate lamps

5-watt bulb, W5W

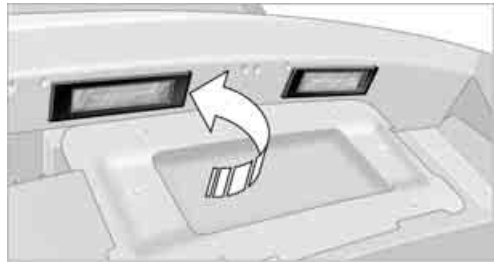

1. Push out the lamp with a screwdriver and remove it.
2. Change the bulb and reinsert the lamp.

Changing a wheel

Run-Flat Tires

Your BMW is equipped with Run-Flat Tires as standard. Therefore, no wheel has to be changed immediately in the event of a loss in inflation pressure.

Run-Flat Tires are labeled on the tire sidewall with a circular symbol containing the letters RSC. Also observe the information on page 88.

When mounting new tires or changing over from summer to winter tires and vice versa, mount Run-Flat Tires for your own safety. In the event of a flat, moreover, no spare wheel is available. Your BMW center will be glad to advise you. Refer also to Wheel and tire replacement, page 88.

 The tools for changing wheels are available as optional accessories from your BMW center. ◀

Jacking points

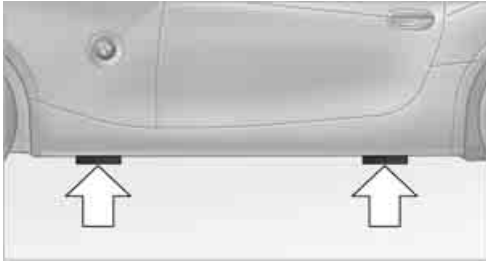

The jacking points are located at the positions indicated in the illustration.

Vehicle battery

Maintenance

The battery is completely maintenance-free. This means that the original electrolyte will normally last for the service life of the battery under moderate climatic conditions. Your BMW center will be happy to advise you if you have any questions concerning the battery.

Indicator lamp

 The indicator lamp lights up:
The battery is no longer being charged.
The alternator drive belt is defective or there is a malfunction in the charging circuit of the alternator. Have the system checked as soon as possible.

 If the drive belt is defective, pull over and switch off the engine immediately to prevent overheating and serious engine damage. If the onboard supply voltage drops to a very low level, increased steering effort may also be necessary. ◀

Charging the battery

Charge the battery in the vehicle only when the engine has been switched off. Connections, refer to Jump-starting on page 104.

Battery disposal

 After changing a battery, have the used battery disposed of by your BMW center

or bring it to a recycling point. Maintain the battery in an upright position for transport and storage. Secure the battery against tilting when transporting. ◀

Power loss

After a temporary power loss, the functioning of some equipment may be limited and require initialization. Individual settings are also lost and must be reset:

- ▷ Seat memory
The positions must be stored again, refer to page 32.
- ▷ Clock must be reset, refer to page 49.

Fuses

 Do not attempt to repair a burned fuse or replace it with a fuse having a different color or amperage rating. To do this could cause a fire in the vehicle as a result of circuit overload. ◀

You will find the fuses and information on their respective allocation behind the glove compartment.

1. Open the glove compartment.
2. Press the lock on the left, arrow 1.

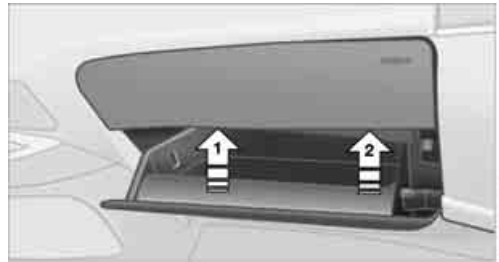

3. Press the lock on the right, arrow 2.
4. Swing the glove compartment down.

Spare fuses and plastic tweezers for grasping the fuses are found in the onboard tool kit; refer to page 98.

Giving and receiving assistance

Receiving assistance

If your vehicle has the necessary equipment, you can use buttons in the center console to contact Roadside Assistance or issue an emergency call.

Requirements for initiating an emergency call or contacting Roadside Assistance:

- ▶ The key must be in position 1 or higher.
- ▶ The car phone must be logged on to a mobile phone network.
- ▶ The emergency calling system must be operable.

Access to the buttons

The buttons are in the center console, under a cover flap in front of the parking brake.



- 1 Emergency call*
- 2 Roadside Assistance*

Initiating an emergency call*

1. Fold the cover flap upward to open it.
2. Press button 1 for at least 2 seconds.

The LED in the button lights up. As soon as a telephone connection to the BMW Assist Response Center has been established, the LED flashes.

If the circumstances allow this, remain in the vehicle until the connection has been established. You will then be able to provide a detailed description of the situation.

If BMW Assist has been activated for your vehicle and the current location of the vehicle can be determined, this location is transmitted to the BMW Assist Response Center.

If the LED is flashing but you cannot hear the emergency response center, you may still be heard by the emergency response center.

If certain requirements are met, an emergency call is automatically initiated immediately after a serious accident. This Automatic Collision Notification will not be hindered by pressing the button.



For technical reasons, the emergency calling services cannot be guaranteed for the most unfavorable conditions. ◀

Roadside Assistance

The BMW Group's Roadside Assistance service is there to assist you around the clock in the event of a breakdown, including on weekends and public holidays.

The phone numbers of the Roadside Assistance in your home country can be found in the Contact brochure.

Contacting Roadside Assistance*

1. Fold the cover flap upward to open it.
2. Press button 2 for at least 2 seconds.

The LED in the button lights up. As soon as a telephone connection to the Roadside Assistance has been established, the LED flashes.

Depending on the country you are in, your vehicle's current location will be transmitted if BMW Assist has been activated for your vehicle.

Warning triangle*



The warning triangle is stored in the rear trim panel of the cargo bay.

To take it out, pull the ends of the rubber bands upward and out of the fasteners.

First-aid kit*



The first-aid kit is located beneath the passenger seat.

Some of the articles in the first-aid kit have a limited period of use before expiration. For this reason, check the expiration dates of each of the items regularly, and replace any with passed dates.

To open

1. Pull the handle.
2. Swing the cover downward.

To close

Swing the cover back up until it engages.

Jump-starting

If the car's own battery is flat, your BMW's engine can be started by connecting two jumper cables to another vehicle's battery. You can also use the same method to help start another vehicle. Always use jumper cables with fully insulated handles on the terminal clamps.

 Do not touch any electrically live parts when the engine is running, or a fatal accident may occur. Contact with these components can cause fatal injury. Carefully observe the following instructions to avoid personal injury and/or damage to one or both vehicles. ◀

Preparations

1. Check whether the battery of the support vehicle has 12 volts and approximately the same capacitance in Ah. This information can be found on the battery.
2. Switch off the engine of the assisting vehicle.
3. Switch off all electrical accessories in both vehicles.

 There must not be any contact between the bodies of the two vehicles, otherwise there is a danger of shorting. ◀

Connecting jumper cables

 Connect the jumper cables in the correct order; otherwise, sparks at the battery terminals could pose an injury hazard. ◀

On your BMW, the so-called jump-starting connection in the engine compartment serves as the battery positive terminal, refer also to the engine compartment overview on page 92. The symbol + is embossed on the cover.

1. Open the cover of the BMW jump-starting connection. Do so by pulling the tab.

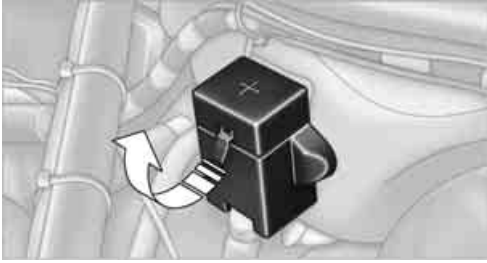

2. Attach one terminal clamp of the plus/+ jumper cable to the positive terminal of the battery or a jump-starting connection of the vehicle providing assistance.
3. Attach the second terminal clamp of the plus/+ jumper cable to the positive terminal of the battery or a jump-starting connection of the vehicle to be started.
4. Attach one terminal clamp of the minus/- jumper cable to the negative terminal of the battery or to an engine or body ground of the assisting vehicle. Your BMW is equipped with a special nut, refer also to the engine compartment overview on page 92.



5. Attach the second terminal clamp of the minus/- jumper cable to the negative terminal of the battery or to the engine or body ground of the vehicle to be started.

Starting the engine

1. Start the engine of the donor vehicle and allow it to run for a few minutes at slightly increased idle speed.
2. Start the engine of the other vehicle as usual. If the first start attempt is not successful, wait a few minutes before another attempt in order to allow the discharged battery to recharge.
3. Let the engines run for a few minutes.
4. Disconnect the jumper cables by reversing the above connecting sequence.

If necessary, have the battery checked and recharged.

 Never use spray starter fluids to start the engine. ◀

Tow-starting, towing away

Using the towing eyelet

The screw-in tow fitting must always be carried in the car. It can be attached at the front or rear of your BMW.

It is located in the onboard tool kit, refer to page 98.

 Only use the towing eyelet supplied with the vehicle, and screw it in firmly until it stops. Use the towing eyelet for towing on paved roads only. Avoid subjecting the towing eyelet to lateral loads, e.g. do not lift the vehicle using the towing eyelet. Otherwise the tow fitting and the vehicle could be damaged. ◀

Access to the threaded socket

Press out the cover with a screwdriver inserted in the recess at the top.



Being towed

! Make sure that the key is in position 1, because otherwise the steering lock could engage and the vehicle could no longer be steered. There is no power assist while the engine is off. Therefore, you will need to exert more force to brake and steer the vehicle. ◀

Turn on the hazard warning flashers, if required by national regulations. If the electrical system has failed, clearly identify the vehicle being towed, e.g. by placing a sign or a warning triangle in the rear window.

Manual transmission

Gearshift lever in idling position.

Automatic transmission

Selector lever in position N.

! Do not exceed a towing speed of 45 mph/ 70 km/h or a towing distance of 90 miles/ 150 km. Otherwise, the automatic transmission could be damaged. ◀

Towing methods

In some countries, it is not permitted to tow the vehicle with a tow bar or tow rope on public roads.

Familiarize yourself with the applicable towing regulations for the country in which you are driving.

With a tow bar

! The towing vehicle must not be lighter than the towed vehicle, otherwise it may be impossible to maintain control. ◀

The towing eyelets of both vehicles should be on the same side. Should it prove impossible to avoid mounting the tow bar at an angle, please observe the following:

- ▷ Clearance and maneuvering capability will be sharply limited during cornering.
- ▷ The tow bar will generate lateral forces if it is attached offset.

! Attach the tow bar to the tow fittings only, as attaching it to other parts of the vehicle could result in damage. ◀

With a tow rope

Before the towing vehicle starts to drive off, make sure that the tow rope is taut.

! Use nylon ropes or straps for towing because they prevent sudden jerking movements. Attach the tow rope to the tow fittings only, as attaching it to other parts of the vehicle could result in damage. ◀

With a tow truck

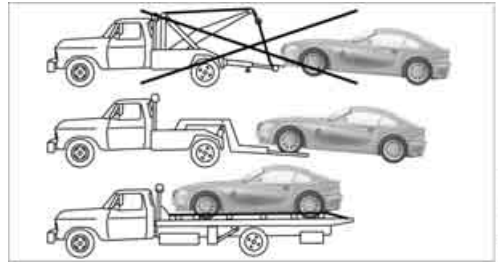

Have the BMW transported by a tow truck with a lift sling or a flat bed.

! Do not lift the vehicle by the towing eyelet, or by parts of the body or chassis. Otherwise damage could result. ◀

Tow-starting

▷ Do not tow-start vehicles with an automatic transmission. Vehicles with a catalytic converter should only be tow-started if the

engine is cold. It is recommended to start the engine using jumper cables, refer to page 104. ◀

1. Switch on hazard warning flashers, comply with local regulations.
2. Turn the key to position 2.
3. Shift into 3rd gear.
4. Have the vehicle tow-started with the clutch depressed and slowly release the clutch. After the engine starts, immediately depress the clutch again.
5. Stop at a suitable location, remove the tow bar or rope and switch off the hazard warning flashers.
6. Have the vehicle checked.



Reference

This chapter contains technical data and an index that will help you find information most quickly.

Technical data

Engine data

		Z4 3.0i	Z4 3.0si
Displacement	cu in/cm ³	182.8/2,996	182.8/2,996
Number of cylinders		6	6
Maximum power output	hp	215	255
at engine speed	rpm	6,250	6,600
Maximum torque	ft lbs/Nm	185/251	220/300
at engine speed	rpm	2,750	2,750

Roadster: dimensions

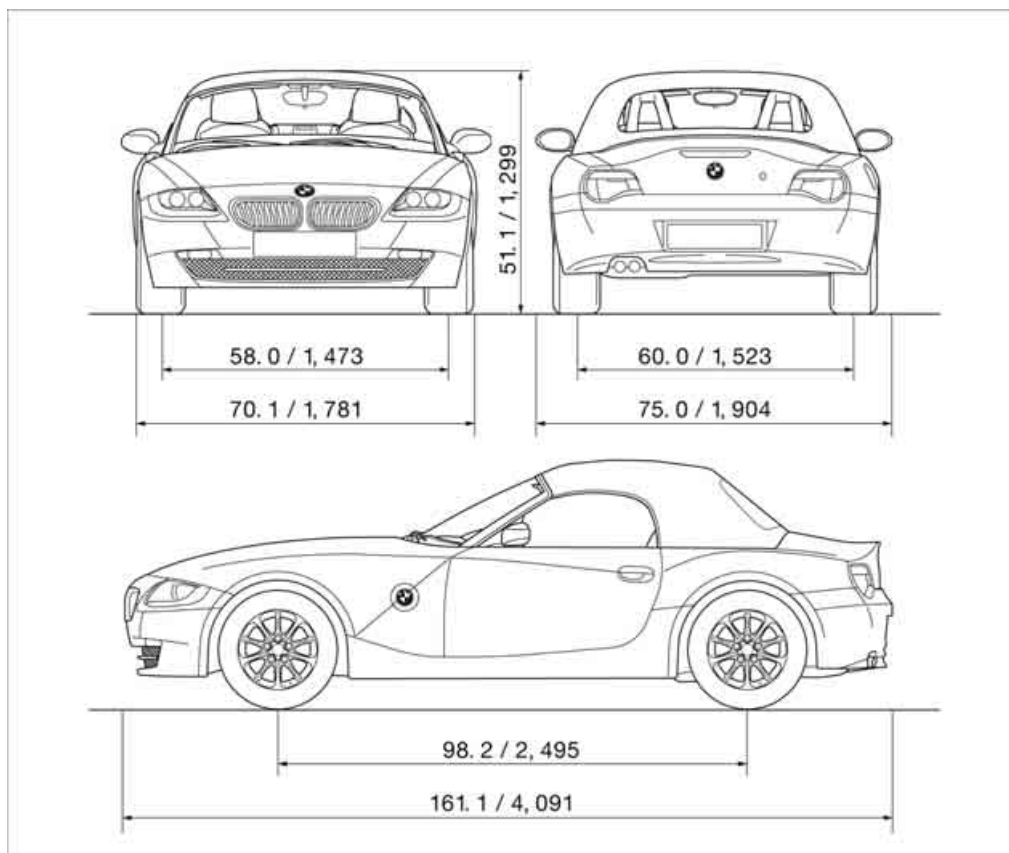

All measurements in inches/millimeters. Smallest turning circle dia. 32 ft 2 in/9.8 m.

Coupe: dimensions

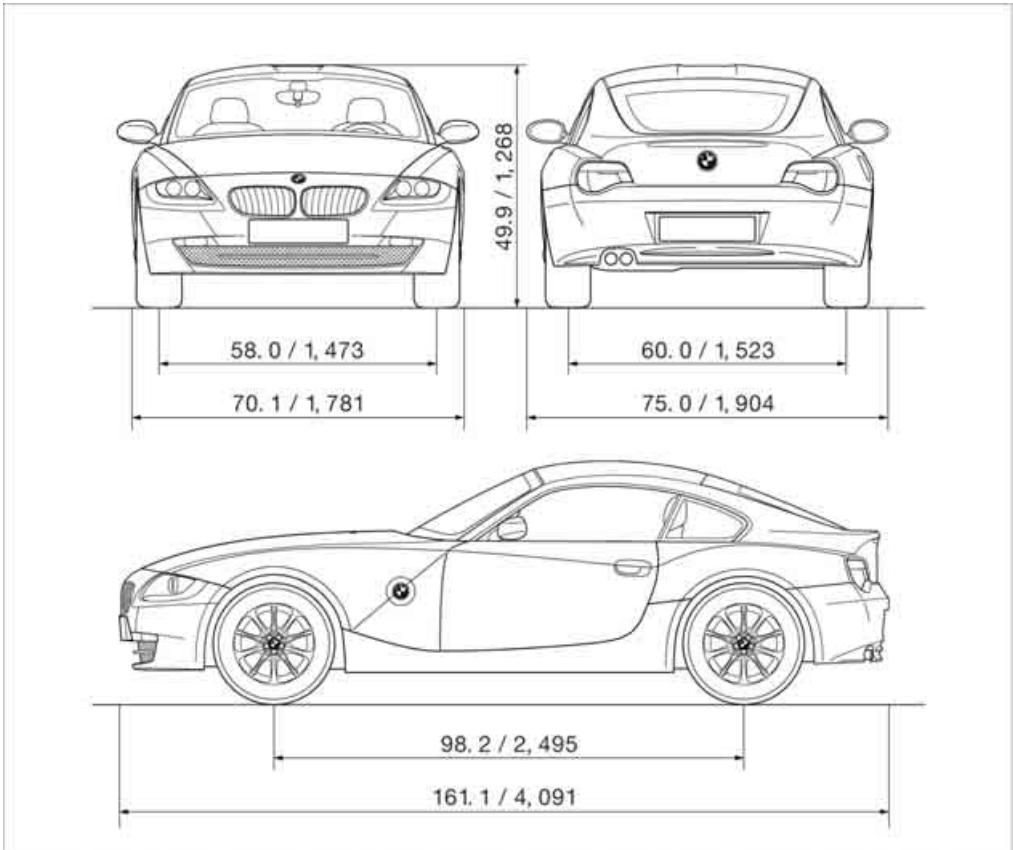

All measurements in inches/millimeters. Smallest turning circle dia. 32 ft 2 in/9.8 m.

Weights

Roadster		Z4 3.0i	Z4 3.0si
Curb weight			
▷ Manual transmission	lbs/kg	3,020/1,370	3,086/1,400
▷ Automatic transmission	lbs/kg	3,086/1,400	3,131/1,420
Approved gross vehicle weight			
▷ Manual transmission	lbs/kg	3,571/1,620	3,638/1,650
▷ Automatic transmission	lbs/kg	3,638/1,650	3,682/1,670
Load	lbs/kg	551/250	551/250
Approved front axle load	lbs/kg	1,720/780	1,742/790
Approved rear axle load	lbs/kg	1,940/880	1,962/890
Cargo bay capacity	cu ft/liters	8.5/240	8.5/240
With convertible top compartment folded up	cu ft/liters	9.2/260	9.2/260
Never exceed either the approved axle loads or the approved gross vehicle weight.			

Coupe			Z4 3.0si
Curb weight			
▷ Manual transmission	lbs/kg		3,108/1,410
▷ Automatic transmission	lbs/kg		3,156/1,430
Approved gross vehicle weight			
▷ Manual transmission	lbs/kg		3,726/1,690
▷ Automatic transmission	lbs/kg		3,770/1,710
Load	lbs/kg		617/280
Approved front axle load	lbs/kg		1,764/800
Approved rear axle load	lbs/kg		2,006/910
Cargo bay capacity	cu ft/liters		10.1-12.0/285-340
Never exceed either the approved axle loads or the approved gross vehicle weight.			

Capacities

			Notes
Fuel tank including reserve of	US gal/liters US gal/liters	approx. 14.5/55 approx. 2.1/8	Fuel specifications: page 83
Window washer system including headlamp washers	US quarts/liters	approx. 5.3/5.0	For details: page 46
Cooling system including heating circuit			For details: page 94
▷ Manual transmission	US quarts/liters	8.0/7.6	
▷ Automatic transmission	US quarts/liters	8.9/8.4	

Everything from A to Z

Index

A

- ABS Antilock Brake System **51**
 - indicator lamp **12**
- Accident, refer to Emergency call **103**
- Acknowledgment signal for locking/unlocking vehicle **19**
- Activated-charcoal filter for automatic climate control **67**
- Additives
 - coolant **94**
 - engine oil **94**
- Adjusting
 - seats **30**
- Adjusting the thigh support **32**
- Airbags **56**
 - deactivating **37**
 - indicator/warning lamp **13**
 - passenger airbags indicator lamp **37**
 - reactivation **37**
 - safe seating position **30**
- Airbag switch, refer to Key switch for passenger airbags **36**
- Air conditioning **62**
- Air-conditioning operation, refer to Cooling function **63, 66**
- Air distribution
 - air conditioning **63**
 - automatic **66**
 - automatic climate control **66**
 - individual **63, 66**
 - manual **66**
- Air flow rate
 - air conditioning **63**
 - automatic climate control **66**
- Airing out, refer to Ventilation **63, 67**
- Air outlets, refer to Ventilation **63, 67**
- Air pressure, refer to Tire inflation pressure **84**
- Air recirculation, refer to Recirculated-air mode **63, 67**
- AKI, refer to Fuel specifications **83**
- Alarm system **23**
 - avoiding unintentional alarms **24**
 - interior motion sensor **24**
 - switching off an alarm **24**
 - tilt alarm sensor **24**
- All-season tires, refer to Winter tires **87, 89**
- Ambient air, refer to Recirculated-air mode **63, 67**
- Ambient temperature display **48**
- Antenna, refer to the Caring for your vehicle brochure
- Antifreeze **46, 94**
 - coolant **94**
 - washer fluids **46**
- Antilock Brake System **ABS 51**
 - indicator/warning lamp **12**
 - indicator lamp **13**
- Anti-theft alarm system, refer to Alarm system **23**
- Anti-theft protection **19, 23**
- Approved engine oils **94**
- Artificial leather, refer to the Caring for your vehicle brochure
- Ashtray **69**
- Assistance systems, refer to Driving stability control systems **51**
- AUC Automatic recirculated-air control **67**
- Audio device, external **68**
- Automatic
 - air distribution **66**
 - air flow rate **66**
 - cruise control **46**
 - headlamp control **59**
 - luggage compartment lid operation **22**
 - recirculated-air control AUC **67**
 - tailgate operation **21**
- Automatic car wash, refer to the Caring for your vehicle brochure
- Automatic climate control **65**
- Automatic convertible top **27**
- Automatic lamps **59**
- Automatic transmission with Steptronic **42**
 - indicator lamp **13**
 - interlock **40, 42**
 - selector lever **43**
 - selector lever lock **42**
 - shiftlock **42**
 - shift paddles on steering wheel **43**
 - towing the vehicle **106**
 - tow-starting **106**
- AUTO program for automatic climate control **66**
- AUX-In jack **68**
- Average fuel consumption **50**
 - setting unit of measure **50**
- Average speed **50**
 - setting unit of measure **50**
- Avoiding unintentional alarms **24**
- Axle loads, refer to Weights **113**

B

Backrests, refer to Seat adjustment [31](#)
Backup lamps
– bulb replacement [101](#)
Bandages, refer to First-aid kit [104](#)
Bar, refer to Towing methods [106](#)
Battery [102](#)
– charging [102](#)
– disposal [102](#)
– indicator/warning lamp [12](#), [102](#)
– jump-starting [104](#)
– power supply interruption [102](#)
– remote control [18](#)
Being towed [106](#)
Belts, refer to Safety belts [33](#)
Belt tensioner, refer to Safety belts [33](#)
Beverage holders [69](#)
Blower, refer to Air flow rate [63](#), [66](#)
BMW Homepage [4](#)
BMW Maintenance System [96](#)
Bottle holders, refer to Beverage holders [69](#)
Brake assist, refer to Dynamic Brake Control DBC [51](#)
Brake fluid [95](#)
– indicator/warning lamp [13](#), [95](#)
– low level [95](#)
Brake Force Display [56](#)
Brake hydraulics, refer to Brake system [95](#)
Brake hydraulic system
– indicator/warning lamp [13](#)
Brake lamps
– brake force display [56](#)
– bulb replacement [101](#)
– indicator lamp, defective bulb [13](#)

Brake pads [76](#)
– break-in procedures [74](#)
– warning lamp [76](#)
Brake pad wear indicator
– brake pads [76](#)
– indicator/warning lamp [13](#)
Brake rotors [76](#)
– brakes [76](#)
– break-in procedures [74](#)
Brakes
– ABS [51](#)
– brake fluid [95](#)
– brake pads [76](#)
– braking safely [76](#)
– break-in procedures [74](#)
– indicator/warning lamps [13](#), [52](#)
– parking brake [41](#)
Brake system [95](#)
– brake fluid [95](#)
– brake pads [76](#)
– break-in procedures [74](#)
– disc brakes [76](#)
– indicator/warning lamp [13](#)
Breakdown service, refer to Roadside Assistance [103](#)
Breaking in the clutch [74](#)
Breaking in the differential, refer to Engine and differential [74](#)
Break-in procedures [74](#)
Bridging, refer to Jump-starting [104](#)
Bulb changing, refer to Lamps and bulbs [98](#)
Bulb replacement, refer to Lamps and bulbs [98](#)
Buttons on the steering wheel [11](#)

C

California Proposition 65 warning [5](#)
Can holders, refer to Beverage holders [69](#)
Capacity
– cargo bay, refer to Weights [113](#)
Car battery, refer to Vehicle battery [102](#)
Car care, refer to the Caring for your vehicle brochure
Care, refer to the Caring for your vehicle brochure
Care products, refer to the Caring for your vehicle brochure
Cargo bay [23](#)
– capacity [113](#)
– emergency release [23](#)
– floor panel [98](#)
– increasing capacity [23](#)
– opening and closing [21](#), [22](#)
– opening from inside the vehicle [21](#), [22](#)
– opening from the outside [21](#)
– roll-up cover [70](#)
Cargo loading
– stowing cargo [77](#)
– vehicle [77](#)
Car jack
– jacking points [102](#)
Car keys, refer to The key set [18](#)
Carpet care, refer to the Caring for your vehicle brochure
Car phone, refer to the separate Owner's Manual
Car radio, refer to the separate Owner's Manual
Car wash, refer to the Caring for your vehicle brochure
Catalytic converter, refer to Hot exhaust system [75](#)
CD changer, refer to Owner's Manual for Radio/Onboard Computer
CD operation, refer to Owner's Manual for Radio/Onboard Computer
Center console, refer to Around the center console [14](#)
Center high-mount brake lamp, bulb replacement [101](#)

- Central locking
 - from inside [21](#)
 - Central locking system [19](#)
 - Changes, technical, refer to
 - For your own safety [5](#)
 - Changing a wheel [101](#)
 - Run-Flat Tires [101](#)
 - Charge indicator lamp [12](#), [102](#)
 - Check gas cap, indicator lamp [13](#)
 - Child-restraint mounting system, LATCH [38](#)
 - Child-restraint systems [37](#)
 - Child seat, refer to Installing child-restraint systems [37](#)
 - Chrome parts, refer to the Caring for your vehicle brochure
 - Cigarette lighter [69](#)
 - Cleaning the rear window, refer to the Caring for your vehicle brochure
 - Cleaning the vehicle, refer to the Caring for your vehicle brochure
 - Cleaning the windows
 - automatically, refer to Rain sensor [45](#)
 - reservoir capacity [114](#)
 - spray nozzles [46](#)
 - washer/wiper system [45](#)
 - washer fluid [46](#)
 - washer fluid reservoir [46](#)
 - Clock [49](#)
 - 12h/24h mode [50](#)
 - onboard computer [50](#)
 - setting [50](#)
 - setting, refer also to Owner's Manual for Radio/Onboard Computer
 - Clothes hooks [71](#)
 - Cockpit [10](#)
 - Cold start, refer to Starting the engine [40](#)
 - Combination, wheel/tire [88](#)
 - Comfort area, refer to Around the center console [14](#)
 - Compact disc operation, refer to Owner's Manual for Radio/Onboard Computer
 - Computer [50](#)
 - button BC [50](#)
 - clock, 12h/24h mode [50](#)
 - refer to Owner's Manual for Onboard Computer
 - Computer, refer to the separate Owner's Manual
 - Condensation, refer to When the vehicle is parked [77](#)
 - Condensation, removing from windows
 - air conditioning [63](#)
 - automatic climate control [66](#)
 - Configuring settings, refer to Vehicle Memory, Key Memory [18](#)
 - Connecting vacuum cleaner, refer to Connecting electrical appliances [70](#)
 - Consumption, refer to Average fuel consumption [50](#)
 - Consumption display, refer to Fuel gauge [48](#)
 - Controls, refer to Cockpit [10](#)
 - Convenience operation
 - convertible top [20](#)
 - from outside [20](#)
 - windows [20](#)
 - Convertible top [25](#), [27](#)
 - care, refer to the Caring for your vehicle brochure
 - convenience operation [20](#)
 - electrical fault [28](#)
 - emergency closing [28](#)
 - fully automatic [27](#)
 - malfunction [28](#)
 - manual [25](#)
 - mechanical [25](#)
 - Convertible top compartment panel [23](#)
 - Coolant [94](#)
 - checking level [94](#)
 - indicator lamp [13](#)
 - thermometer [49](#)
 - Coolant temperature [49](#)
 - Coolant water, refer to Coolant [94](#)
 - Cooling
 - maximum [66](#)
 - refer to Switching cooling function on/off [63](#), [66](#)
 - Cooling fluid, refer to Coolant [94](#)
 - Cooling function
 - air conditioning [63](#)
 - automatic climate control [66](#)
 - Cooling system, refer to Capacities [114](#)
 - Cooling system, refer to Coolant [94](#)
 - Copyright [2](#)
 - Correct tires [89](#)
 - Cruise control [46](#)
 - Cruising range [50](#)
 - Cup holders, refer to Beverage holders [69](#)
 - Curb weight, refer to Weights [113](#)
 - Cylinders, refer to Engine data [110](#)
- ## D
- Dashboard, refer to Cockpit [10](#)
 - Dashboard lighting, refer to Instrument lighting [60](#)
 - Data, technical
 - capacities [114](#)
 - dimensions [111](#), [112](#)
 - engine [110](#)
 - measurements [111](#), [112](#)
 - weights [113](#)
 - Daytime running lamps [59](#)
 - DBC Dynamic Brake Control [51](#)
 - indicator/warning lamp [13](#)
 - Deadlocking, refer to Locking [19](#)
 - Defective bulb [59](#)
 - Defrosting, windows [63](#), [66](#)
 - Defrosting the windshield, refer to Defrosting windows [63](#), [66](#)

Defrosting windows and removing condensation
– air conditioning 63
– automatic climate control 66
Defrost position, refer to
 Defrosting windows 63, 66
Dehumidifying air, refer to
 Switching cooling function on/off 63, 66
Digital clock 49
Dimensions 111, 112
Dimming mirrors 34
Directional indicators, refer to
 Turn signal indicators 44
Disc brakes 76
Displacement, refer to Engine data 110
Display elements, refer to
 Instrument cluster 12
Display lighting, refer to
 Instrument lighting 60
Displays, refer to Instrument cluster 12
Displays and controls 10
Disposal
– coolant 94
– vehicle battery 102
Distance remaining, refer to
 Cruising range 50
Door keys, refer to The key set 18
Door lock 20
Doors, unlocking and locking
– acknowledgment signals 19, 20
– from inside 21
– from outside 19
DOT quality grades 86
Draft-free ventilation 63, 67
Drive-off assistance, refer to
 Dynamic Stability Control DSC 51
Drive-off assistant 52
Driving light, refer to Parking lamps/Low beams 59
Driving notes 74, 75
Driving off on uphill gradients, refer to Drive-off assistant 52

Driving stability control systems 51
Driving through water 76
Driving tips, refer to Driving notes 75
Dry air, refer to Switching cooling function on/off 63, 66
DSC Dynamic Stability Control 51
– indicator/warning lamp 51
– indicator lamp 13
DTC Dynamic Traction Control 51
– indicator/warning lamp 13, 52
Dynamic Brake Control DBC 51
– indicator/warning lamp 13
Dynamic Driving Control 44
Dynamic Stability Control DSC 51
– indicator/warning lamp 51
Dynamic Traction Control DTC 51
– indicator/warning lamp 52

E

EBV Electronic brake-force distribution 51
Electric
– seat adjustment 31
Electrical malfunction
– automatic transmission with Steptronic 43
– convertible top 28
– door lock 20
– fuel filler door 82
– luggage compartment lid 22
– tailgate 22
Electric Power Steering EPS 56
– indicator/warning lamp 13, 56
Electric power windows 24
Electronic
– brake-force distribution 51
– oil level check 93
Emergency call 103
– button 103
Emergency operation, refer to
 Opening manually
 – tailgate 22
Emergency release 23
Emergency services, refer to
 Roadside Assistance 103
Engine 40
– breaking in 74
– electronics 13
– indicator lamp 13
– overheated, refer to Coolant thermometer 49
– speed 48
– starting 40
– switching off 41
– temperature 49
Engine compartment 92
Engine coolant, refer to
 Coolant 94
Engine oil 92
– adding 94
– additives, refer to Approved engine oils 94
– approved engine oils 94
– BMW Maintenance System 96
– change intervals, refer to
 Service and Warranty Information Booklet for US models, Warranty and Service Guide Booklet for Canadian models
– change intervals, refer to
 Service interval display 49
– checking level 93
– indicator/warning lamp 12
– oil grades, refer also to
 Approved engine oils 94
– oil level 92
– pressure 92
Engine output, refer to Engine data 110
Engine starting, refer to
 Starting the engine 40
EPS Electric Power Steering 56

Equipment scope, refer to the Service and Warranty Information Booklet for US models, Warranty and Service Guide Booklet

ESP Electronic Stability Program, refer to DSC Dynamic Stability Control [51](#)

Event Data Recorders [97](#)

Exhaust system, refer to Hot exhaust system [75](#)

Exterior mirrors [34](#)

- adjusting [34](#)
- automatic dimming feature [34](#)
- automatic heating [34](#)
- folding in and out [34](#)

External audio device [68](#)

Eyeglasses compartment [69](#)

Eyes, tow-starting and towing away [105](#)

F

False alarm

- refer to Avoiding unintentional alarms [24](#)
- refer to Switching off an alarm [24](#)

Fasten safety belts, refer to Safety belts [33](#)

Filter

- refer to Microfilter [64](#)
- refer to Microfilter/activated-charcoal filter [67](#)

Fine wood, refer to the Caring for your vehicle brochure

First aid, refer to First-aid kit [104](#)

First-aid kit [104](#)

Flat tire

- Flat Tire Monitor [53](#)
- refer to Changing a wheel [101](#)
- refer to Tire condition [87](#)
- Run-Flat Tires [88](#)
- Tire Pressure Monitor [54](#)

Flat Tire Monitor FTM [53](#)

- flat tire warning [53](#)
- indicator/warning lamp [53](#)
- initializing the system [53](#)
- snow chains [90](#)
- system limits [53](#)

Floods, refer to Driving through water [76](#)

Floor covers, carpets, refer to the Caring for your vehicle brochure

Floor mats, refer to the Caring for your vehicle brochure

Fog lamps [60](#)

- indicator lamp [13](#)

Footbrake, refer to Braking safely [76](#)

For your own safety [5](#)

Front airbags [56](#)

FTM, refer to Flat Tire Monitor [53](#)

Fuel

- average consumption [50](#)
- capacity, refer to Capacities [114](#)
- display [48](#)
- quality [83](#)
- refer to Average fuel consumption [50](#)
- refer to Fuel specifications [83](#)
- tank capacity [83](#)

Fuel display, refer to Fuel gauge [48](#)

Fuel filler door, refer to Gas cap [82](#)

Fuel level

- refer to Fuel tank capacity [83](#)

Fuel tank capacity, refer to Capacities [114](#)

Fully automatic convertible top [27](#)

Fuses [102](#)

G

Gas cap [82](#)

Gasoline, refer to Fuel specifications [83](#)

Gasoline gauge, refer to Fuel gauge [48](#)

Gear indicator, automatic transmission with Steptronic [42](#)

Gear lever

- automatic transmission with Steptronic [42](#)
- manual transmission [42](#)

Gearshifts

- automatic transmission with Steptronic [42](#)
- manual transmission [42](#)

Glove compartment [68](#)

Gross weight, refer to Weights [113](#)

H

Halogen lamps

- replacing bulbs [99](#)

Handbrake, refer to Parking brake [41](#)

Hands-free microphone [71](#)

Hardtop, refer to the separate Owner's Manual

Hardtop preparation [78](#)

Hazard warning flashers [14](#)

Headlamp control, automatic [59](#)

Headlamp flasher [44](#)

- indicator lamp [12](#)

Headlamps

- bulb replacement [99](#)
- care, refer to the Caring for your vehicle brochure
- cleaning [45](#)
- cleaning system, washer fluid [46](#)
- cover [99](#)
- glass, care, refer to the Caring for your vehicle brochure
- washer reservoir, refer to Washer fluid reservoir [46](#)
- washer reservoir volume, refer to Capacities [114](#)

Head restraints **32**
– removing **32**
– safe seating position **30**
Heated
– mirrors **34**
– rear window **63, 67**
– seats **33**
Heating
– mirrors **34**
– rear window **63, 67**
– seats **33**
Heavy loads, refer to Cargo loading **77**
Height, refer to
 Dimensions **111, 112**
Height adjustment
– seats **31**
– steering wheel **35**
High beams **60**
– bulb replacement **99**
– headlamp flasher **44**
– indicator lamp **12**
High temperatures **75**
Holders for beverages **69**
Homepage of BMW **4**
Hood **91**
Horn **10**
Hot exhaust system **75**
Hydraulic Brake Assistant, refer to Dynamic Brake Control DBC **51**
Hydraulics, brake **95**
Hydroplaning **75**

I

Ice warning, refer to Outside temperature warning **48**
Identification mark
– Run-Flat Tires **88**
– tire coding **86**
– tires **88, 89**
Ignition, refer to Ignition switched on **40**
Ignition key positions, refer to Ignition lock **40**
Ignition keys, refer to The key set **18**
Ignition lock **40**

Imprint **2**
Inclines **76**
Indicator/warning lamp **12**
– airbags **57**
– alarm system **24**
– automatic transmission with Steptronic **43**
– brakes **13**
– coolant temperature **49**
– DSC **51**
– DTC **52**
– engine oil level **92**
– engine oil pressure **92**
– engine temperature **49**
– fasten safety belts **33**
– Flat Tire Monitor **53**
– passenger airbags **37**
– reserve **48**
– Tire Pressure Monitor **55**
Indicator and warning lamps, overview **12**
Individual vehicle
– equipment, refer to Your individual vehicle **5**
Inflation pressure, refer to Tire inflation pressure **84**
Inflation pressure monitoring, refer to
– Flat Tire Monitor **53**
– Tire Pressure Monitor **54**
Initializing
– after power supply interruption **102**
– Flat Tire Monitor FTM **53**
– windows **25**
Inspection **49**
Instrument cluster **12**
Instrument lighting **60**
Instrument panel, refer to Cockpit **10**
Instrument panel, refer to Instrument cluster **12**
Interior lamps **61**
– remote control **19**
Interior motion sensor **24**
Interior rearview mirror **34**
– automatic dimming feature **34**

Interior temperature adjusting **63, 66**
Interlock, refer to Steering locked **40, 42**
Intermittent
– operation of the wipers **45**
Interval
– display, service **49**

J

Jack **101**
Jacking points **102**
Jets, refer to Ventilation **63, 67**
Jump-starting **104**

K

Key Memory **18**
Keys **18**
Keys, refer to The key set **18**
Key switch for passenger airbags **36**
Kickdown **43**
Knee airbags **56**
Knock control **83**

L

Lamps **59**
Lamps and bulbs **98**
LATCH, child-restraint mounting system **38**
Leather care, refer to the Caring for your vehicle brochure
LEDs Light-emitting diodes **98**
Length, refer to Dimensions **111, 112**
License plate lamps, bulb replacement **101**
Light-alloy wheels, care, refer to the Caring for your vehicle brochure
Light-emitting diodes LEDs **98**

Lighter socket, refer to
 Cigarette lighter **69**

Lighting
 – instruments **60**
 – lamps and bulbs **98**
 – vehicle, refer to Lamps **59**

Lighting of the instruments,
 refer to Instrument
 lighting **60**

LIGHTS ON warning **60**

Light switch **59**

Loads, refer to Cargo
 loading **77**

Loads, securing **77**

Locking the doors
 – from inside **21**
 – from outside **19, 20**

Locking the vehicle
 – from inside **21**
 – from outside **19**

Longlife oils
 – approved engine oils **94**

Low beams **59**
 – automatic **59**
 – bulb replacement **99**
 – indicator lamp, defective
 bulb **13**

Luggage compartment, refer
 to Cargo bay **23**

Luggage compartment lid **22**
 – emergency release **23**
 – indicator lamp **13**
 – opening from inside the
 vehicle **22**
 – opening from the outside **22**
 – remote control **20**

M

M+S tires, refer to Winter
 tires **89**

Maintenance **96**
 – refer to Service Booklet
 – refer to Service interval
 display **49, 96**

Making telephone calls, refer
 to Owner's Manual for
 Telephone

Malfunction
 – automatic transmission with
 Steptronic **43**
 – convertible top **28**
 – door lock **20**
 – fuel filler door **82**
 – luggage compartment lid **22**
 – tailgate **22**

Malfunction of electrical
 accessory **102**

Manual
 – air distribution **66**
 – air flow rate **66**

Manual convertible top **25**

Manual mode, refer to
 Automatic transmission with
 Steptronic **43**

Manual operation
 – door lock **20**
 – driver's door **20**
 – fuel filler door **82**
 – luggage compartment lid **22**
 – power convertible top **28**
 – tailgate **22**
 – transmission lock, automatic
 transmission **42**

Manual transmission **42**

Manufacturer **5**

Master keys with remote
 control **18**

Maximum cooling **66**

Maximum speed
 – with winter tires **89**

Measurements, refer to
 Dimensions **111, 112**

Mechanical seat **31**

Memory
 – Seat memory **32**
 – Vehicle Memory, Key
 Memory **18**

Microfilter
 – air conditioning **64**
 – automatic climate control **67**

Microphone, refer to Mobile
 phone preparation
 package **71**

Minidisc operation, refer to
 Owner's Manual for Radio/
 Onboard Computer

Mirrors **34**
 – exterior mirrors **34**
 – heating **34**
 – interior rearview mirror **34**

Mobile communications in the
 vehicle, refer to the separate
 Owner's Manual

Mobile phone, refer to the
 separate Owner's Manual

Mobile phone preparation
 package **71**

Modifications, technical, refer
 to For your own safety **5**

M Sports seat **31**

Multifunctional steering
 wheel, refer to Buttons on
 the steering wheel **11**

Multifunction switch
 – refer to Turn signal
 indicators/headlamp
 flasher **44**
 – refer to Washer/wiper
 system **45**

N

Navigation system, refer to the
 separate Owner's Manual

Neck support, refer to Head
 restraints **32**

Nets **69**

New
 – keys **18**
 – tires **88**

Nylon rope, refer to Tow
 rope **106**

O

OBD socket, refer to Socket
 for On-Board Diagnosis
 OBD **96**

Octane numbers, refer to Fuel
 specifications **83**

Odometer **48**

Oil, refer to Engine oil **92**

Oil level **92**
 – checking **93**

Oil service **49**

Onboard computer, refer to
Computer [50](#)
Onboard tool kit [98](#)
On-call services, refer to
Roadside Assistance [103](#)
Opening
– from inside [21](#)
Opening and closing the
vehicle
– at the door lock [20](#)
– from inside [21](#)
– from outside [19](#)
– with the remote control [19](#)
Outlets, refer to
Ventilation [63, 67](#)
Outside temperature display
– changing units of
measure [50](#)
– in the onboard computer [50](#)
Outside temperature
warning [48](#)
Overheated engine, refer to
Coolant temperature [49](#)

P

Paintwork, refer to the Caring
for your vehicle brochure
Parking brake [41](#)
– indicator lamp [13, 41](#)
Parking lamps, refer to
Parking lamps/Low
beams [59](#)
Parking lamps/Low beams [59](#)
– bulb replacement [99](#)
Parking lock, refer to P
Parking [42](#)
Passenger airbags
– deactivation [37](#)
– reactivation [37](#)
Passenger-side mirror tilt
function [34](#)
Pathway lighting [60](#)
Permissible axle load, refer to
Weights [113](#)
Permissible gross weight,
refer to Weights [113](#)
Pinch protection system
– windows [25](#)

Placing the vehicle in storage,
refer to the Caring for your
vehicle brochure
Plastic, refer to the Caring for
your vehicle brochure
Pollen
– refer to Microfilter [64](#)
– refer to Microfilter/activated-
charcoal filter [67](#)
Power
– windows, refer to
Windows [24](#)
Power convertible top [27](#)
Power failure [102](#)
Power output, refer to Engine
data [110](#)
Power steering, electric [56](#)
Power windows
– initializing [25](#)
Pressure, tires [84](#)
Pressure monitoring, tires,
refer to
– Flat Tire Monitor [53](#)
– Tire Pressure Monitor
TPM [54](#)
Protective function, refer to
Pinch protection system [25](#)

R

Radio, refer to the separate
Owner's Manual
Radio navigation, refer to the
separate Owner's Manual
Radio remote control key,
refer to Master keys with
remote control [18](#)
Rain sensor [45](#)
Reading lamps [61](#)
Rear lamps
– bulb replacement [101](#)
– indicator lamp, defective
bulb [13](#)
Rearview mirror, refer to
Mirrors [34](#)
Rear window defroster
– air conditioning [63](#)
– automatic climate control [67](#)
Recirculated-air mode
– air conditioning [63](#)
– automatic climate control [67](#)
Recirculating the air, refer to
Recirculated-air
mode [63, 67](#)
Reclining seat, refer to
Seats [30](#)
Refueling [82](#)
Releasing
– hood [91](#)
Remaining distance, refer to
Cruising range [50](#)
Remote control [19](#)
– luggage compartment lid [20](#)
– malfunction [20](#)
– tailgate [20](#)
Repairs
– refer to Maintenance
system [96](#)
Replacement key, refer to
New keys [18](#)
Replacement of tires [88](#)
Replacing lamps, refer to
Lamps and bulbs [98](#)
Replacing tires, refer to Wheel
and tire replacement [88](#)
Reserve
– indicator lamp, refer to Fuel
gauge [48](#)
Restraint systems
– for children [37, 38](#)
– refer to Safety belts [33](#)
Reverse gear
– automatic transmission with
Steptronic [43](#)
– manual transmission [42](#)
Roadside Assistance [103](#)
Roadside parking lamps [60](#)
Rod antenna, refer to the
Caring for your vehicle
brochure
Roller-blind cover [70](#)
Rope, refer to Towing
methods [106](#)
RSC Runflat System
Component, refer to Run-
Flat Tires [88](#)

Rubber parts, refer to the
 Caring for your vehicle
 brochure
 Runflat System Component
 RSC, refer to Run-Flat
 Tires **88**
 Run-Flat Tires **88**
 – changing a tire **87, 89**
 – changing a wheel **101**
 – flat tire **53, 55**
 – Flat Tire Monitor **53**
 – tire inflation pressure **84**
 – Tire Pressure Monitor **54**
 – winter tires **89**
 Runflat Tyres, refer to Run-
 Flat Tires **88**

S

Safe seating position **30**
 – with airbags **30**
 – with head restraints **30**
 – with safety belts **30**
 Safety belts **33**
 – care, refer to the Caring for
 your vehicle brochure
 – damage **34**
 – indicator/warning lamp **33**
 – reminder **33**
 – safe seating position **30**
 Safety knobs, doors, refer to
 Locking the doors from
 inside **21**
 Safety systems
 – airbags **56**
 – Antilock Brake System
 ABS **51**
 – driving stability control
 systems **51**
 Safety tires, refer to Run-Flat
 Tires **88**
 Saving
 – fuel **74**
 Screw thread, tow fitting **106**
 Seat Belt Reminder, refer to
 'Fasten safety belts'
 reminder **33**
 Seat heating **33**
 Seat memory **32**

Seats **30**
 – adjusting mechanically **31**
 – adjusting the sports seat **31**
 – heating **33**
 – memory, refer to Seat
 memory **32**
 – power adjustment **31**
 – safe seating position **30**
 – saving positions, refer to
 Seat memory **32**
 Securing, locking the vehicle
 – from inside **21**
 – from outside **19**
 Selector lever **42**
 – automatic transmission with
 Steptronic **42**
 – lock, refer to Range
 selection, shiftlock **42**
 Selector lever positions
 – automatic transmission with
 Steptronic **42**
 Service, refer to Roadside
 Assistance **103**
 Service, refer to Service and
 Warranty Information
 Booklet for US models,
 Warranty and Service Guide
 Booklet for Canadian
 models **96**
 Service and warranty **6**
 Service interval display **49, 96**
 Sheet ice, refer to Outside
 temperature warning **48**
 Shifting gears
 – automatic transmission with
 Steptronic **42**
 – manual transmission **42**
 Shiftlock, refer to Range
 selection **42**
 Shift paddles on the steering
 wheel **43**
 Side airbags **56**
 Side marker lamps, front
 – bulb replacement **100**
 Side marker lamps, rear **101**
 Side turn signal indicators,
 bulb replacement **100**
 Side windows, refer to
 Windows **24**

Signal horn, refer to Horn **10**
 Slipstream deflector, refer to
 Wind deflector **70**
 Smokers' package, refer to
 Ashtray **69**
 Snow chains **90**
 Socket, On-Board Diagnosis
 OBD **96**
 Socket, refer to Connecting
 electrical appliances **70**
 SOS, refer to Emergency
 call **103**
 Spare
 – fuses **102**
 – key **18**
 – wheel, refer to Run-Flat
 Tires **89**
 Spare fuses, refer to
 Fuses **102**
 Special oils, refer to Approved
 engine oils **94**
 Special wash program, refer to
 the Caring for your vehicle
 brochure
 Specified engine oils, refer to
 Approved engine oils **94**
 Speed
 – Run-Flat Tires **53, 55**
 – winter tires **89**
 Speedometer **12**
 Sport program
 – automatic transmission with
 Steptronic **43**
 – Dynamic Driving Control **44**
 Sports seat **31**
 Spray nozzles, refer to
 Cleaning windshield **46**
 Stability control, refer to
 Driving stability control
 systems **51**
 Starting, refer to Starting the
 engine **40**
 Starting difficulties
 – jump-starting **104**
 – temperature **41**
 Starting with a flat battery,
 refer to Jump-starting **104**
 Status of this Owner's Manual
 at time of printing **5**

- Steering wheel **10**
 - adjusting **35**
 - buttons on steering wheel **11**
 - lock **40**
- Steptronic, refer to Sport program and Manual operation **43**
- Storage compartments **68**
 - eyeglasses compartment **69**
 - glove compartment **68**
- Storage nets **69**
- Storage space
 - refer to Cargo bay **23**
 - refer to Storage compartments **68**
- Storing seat position, refer to Seat memory **32**
- Stowage, refer to Storage compartments **68**
- Summer tires, refer to Wheels and tires **84**
- Supply reservoir, refer to Washer fluid reservoir **46**
- Switches, refer to Cockpit **10**
- Switch for passenger airbags **36**
- Switching cooling function on/off manually **63, 66**
- Symbols **4**

T

- Table of contents **3**
- Tachometer **48**
- Tailgate **21**
 - emergency operation **22**
 - indicator lamp **13**
 - opening from inside the vehicle **21**
 - opening from the outside **21**
 - opening manually **22**
 - remote control **20**
 - roller-blind cover **70**
- Tail lamps, refer to Rear lamps **101**

- Tail lights, refer to Rear lamps **101**
- Tank contents
 - refer to Capacities **114**
- Tank indicator, refer to Fuel gauge **48**
- Technical data **110**
- Technical modifications, refer to For your own safety **5**
- Telephone, refer to the separate Owner's Manual
- Telephone preparation package **71**
- Temperature
 - air conditioning **63**
 - automatic climate control **66**
 - coolant, refer to Coolant thermometer **49**
 - engine **49**
- Temperature display
 - outside temperature **48**
 - outside temperature warning **48**
 - setting unit of measure **50**
- Tempomat, refer to Cruise control **46**
- Third brake lamp, refer to Center high-mount brake lamp **101**
- Three-point safety belt, refer to Safety belts **33**
- Tilt alarm sensor **24**
- Tilt function, passenger-side mirror **34**
- Tire, flat **53, 55**
 - Flat Tire Monitor **53**
 - indicator/warning lamp **13**
 - Run-Flat Tires **88**
 - Tire Pressure Monitor **54**
- Tire inflation pressure **84**
 - checking **84**
 - loss **53, 54**
 - restoring **84**
- Tire pressure monitoring, refer to
 - Flat Tire Monitor **53**
 - Tire Pressure Monitor **54**

- Tire Pressure Monitor TPM **54**
 - indicator/warning lamp **55**
 - resetting the system **54**
 - system limits **54**
- Tire Quality Grading **86**
- Tire renewal **88**
- Tires
 - age **86, 88**
 - break-in procedures **74**
 - changing **88**
 - coding **86**
 - condition **87**
 - damage **88**
 - DOT quality grades **86**
 - flat **53, 55**
 - inflation pressure **84**
 - pressure monitoring, refer to Flat Tire Monitor **53**
 - replacement **88**
 - size **84**
 - storage **89**
 - temperature **87**
 - traction **87**
 - tread **87**
 - tread wear **87**
 - Uniform Tire Quality Grading **86**
 - wear indicators, refer to Minimum tread depth **87**
 - wheel and tire replacement **88**
 - winter tires **89**
 - with emergency features, refer to Run-Flat Tires **88**
- Tire storage **89**
- Tool kit, refer to Onboard tool kit **98**
- Torque, refer to Engine data **110**
- Tow bar **106**
- Tow fitting
 - screw thread **106**
- Towing eyelet **105**
- Towing the vehicle **105**
 - methods **106**
 - with automatic transmission **106**
- Tow rope **106**

Tow-starting [106](#)
 Tow truck [106](#)
 TPM Tire Pressure Monitor [54](#)
 Track width, refer to Dimensions [111](#), [112](#)
 Traction control, refer to Dynamic Stability Control DSC [51](#)
 Transmission
 – automatic transmission with Steptronic [42](#)
 – manual transmission [42](#)
 Transmission detent, refer to Range selection [42](#)
 Transmission malfunction, refer to Malfunction [43](#)
 Transporting children safely [36](#)
 Transport securing device, refer to Cargo loading [77](#)
 Tread depth, refer to Minimum tread depth [87](#)
 Trip distance recorder, refer to Trip odometer [48](#)
 Triple turn signal [44](#)
 Trip meter, refer to Trip odometer [48](#)
 Trip odometer [48](#)
 Turning circle, refer to Dimensions [111](#), [112](#)
 Turn signal indicators [44](#)
 – bulb replacement [100](#)
 – indicator lamp [12](#), [13](#)
 Turn signals
 – triple turn signal [44](#)
 TV function, refer to Owner's Manual for Onboard Computer
 Tying down loads, refer to Cargo loading [77](#)

U

Undercoating, refer to the Caring for your vehicle brochure
 Uniform Tire Quality Grading/UTQR [86](#)

Units
 – average consumption [50](#)
 – average speed [50](#)
 – temperature [50](#)
 – time [50](#)
 Units of measure
 – outside temperature display [50](#)
 – time format [50](#)
 Unlatching, refer to Unlocking [19](#)
 Unlocking
 – from inside [21](#)
 – from outside [19](#)
 – luggage compartment lid [20](#), [22](#)
 – tailgate [20](#), [21](#)
 Used batteries, refer to Battery disposal [102](#)

V

Vehicle
 – battery [102](#)
 – break-in period [74](#)
 – care, refer to the Caring for your vehicle brochure
 – cargo loading [77](#)
 – car wash, refer to the Caring for your vehicle brochure
 – dimensions, refer to Dimensions [111](#), [112](#)
 – engine [41](#)
 – leaving the vehicle [41](#)
 – parked [77](#)
 – placing in storage, refer to the Caring for your vehicle brochure
 – weight [113](#)
 Vehicle Memory [18](#)
 Ventilation [63](#), [67](#)
 – air conditioning [63](#)
 – automatic climate control [67](#)
 – draft-free [63](#), [67](#)
 Vents, refer to Ventilation [63](#), [67](#)
 Viscosity [94](#)

Volume
 – fuel tank, refer to Capacities [114](#)

W

Warning and indicator lamps [12](#)
 Warning triangle [104](#)
 Warranty, refer to Service and Warranty Information Booklet for US models, Warranty and Service Guide Booklet for Canadian models [96](#)
 Warranty and service [6](#)
 Washer/wiper system [45](#)
 Washer fluid reservoir [46](#)
 Washer fluids [46](#)
 Washer reservoir, refer to Washer fluid reservoir [46](#)
 Washing systems [46](#)
 Waste tray, refer to Ashtray [69](#)
 Water on roads, refer to Driving through water [76](#)
 Wear indicator in tires, refer to Minimum tread depth [87](#)
 Weights [113](#)
 Wheel/tire combination, refer to Correct wheels and tires [89](#)
 Wheelbase, refer to Dimensions [111](#), [112](#)
 Wheels and tires [84](#)
 Width, refer to Dimensions [111](#), [112](#)
 Wind deflector [70](#)
 Window defrosting, refer to Defrosting windows
 – automatic climate control [66](#)
 – heating and ventilation [63](#)
 Windows [24](#)
 – convenience operation [20](#)
 – opening/closing [25](#)
 – pinch protection system [25](#)
 – power supply interruption [25](#)

Windshield

- cleaning [45](#)
- defrosting and removing condensation [63](#), [66](#)

Windshield wipers

- blades, care, refer to the Caring for your vehicle brochure
- changing blades [98](#)
- refer to Washer/wiper system [45](#)

Winter tires [89](#)

- changing [101](#)
- condition [87](#)
- Run-Flat Tires [89](#)
- storage [89](#)

Wiper blades

- care, refer to the Caring for your vehicle brochure
- changing [98](#)

Wood decoration, refer to the

Caring for your vehicle brochure

Work in the engine compartment [91](#)

Wrench/screwdriver, refer to Onboard tool kit [98](#)

X

Xenon lamps

- replacing bulbs [99](#)

Refueling

So that you have important specifications available to you when you stop to refuel, we recommend that you fill out this table with the data that apply to your vehicle. Consult the index for individual specifications.

Fuel

Specifications

Please enter your preferred fuel here.

Engine oil

Preferred oil grade

Do not add engine oil until the corresponding warning lamp comes on in the instrument cluster or the oil level monitor shows "+1.0", refer to page [93](#).

Tire inflation pressures

	Summer tires Front	Rear	Winter tires Front	Rear
Up to 2 persons				
2 persons plus luggage				

More about BMW

bmwusa.com



The Ultimate
Driving Machine

01 41 0 014 500 ue

