

Owner's Manual
for Vehicle



The Ultimate
Driving Machine



X3 2.5i **Owner's Manual for Vehicle**

X3 3.0i

Congratulations, and thank you for choosing a BMW.

Thorough familiarity with your vehicle will provide you with enhanced control and security when you drive it. We therefore have this request:

Please take the time to read this Owner's Manual and familiarize yourself with the information that we have compiled for you before starting off in your new vehicle. It contains important data and instructions intended to assist you in gaining maximum use and satisfaction from your BMW's unique range of technical features. The manual also contains information on maintenance designed to enhance operating safety and contribute to maintaining the value of your BMW throughout an extended service life.

This manual is supplemented by a Service and Warranty Information Booklet for US models or a Warranty and Service Guide Booklet for Canadian models.

We wish you an enjoyable driving experience.

BMW AG

© 2006 Bayerische Motoren Werke
Aktiengesellschaft
Munich, Germany
Reprinting, including excerpts,
only with the written consent of
BMW AG, Munich.
Order No. 01 41 0 012 213
US English II/06
Printed in Germany
Printed on environmentally friendly paper,
bleached without chlorine, suitable for recycling.

Contents

The fastest way to find specific topics is to use the index, refer to page **118**.

Using this Owner's Manual

- 4 Notes
- 7 Reporting safety defects

At a glance

- 10 Cockpit

Controls

- 18 Opening and closing
- 26 Adjustments
- 33 Transporting children safely
- 36 Driving
- 43 Everything under control
- 47 Technology for comfort, convenience and safety
- 56 Lamps
- 59 Air conditioner
- 65 Practical interior accessories

Driving tips

- 76 Things to remember when driving

Mobility

- 84 Refueling
- 86 Wheels and tires
- 92 Under the hood
- 97 Maintenance
- 99 Replacing components
- 107 Giving and receiving assistance

Reference

- 114 Technical data
- 118 Everything from A to Z

Notes

Using this Owner's Manual

We have made every effort to ensure that you are easily able to find what you need in this Owner's Manual. The fastest way to find certain topics is by using the detailed index at the end. For a brief initial overview of your vehicle, please refer to the first chapter.

Should you sell your BMW some day, please remember to hand over the Owner's Manual as well; it is an important component of your vehicle.

Additional sources of information

If you have additional questions, your BMW Sports Activity Vehicle Center is always happy to advise you.

You can find information on BMW, e.g. technology, on the Internet at www.bmwusa.com.

Symbols used

 Indicates precautions that must be followed precisely in order to avoid the possibility of personal injury and serious damage to the vehicle.

 Indicates information that will assist you in gaining the optimum benefit from your vehicle and enable you to care more effectively for your vehicle.

 Refers to measures that can be taken to help protect the environment.

◀ Marks the end of a specific item of information.

* Indicates special equipment, country-specific equipment and optional extras, as well as equipment and functions not yet available at the time of printing.

 Vehicle Memory, Key Memory, refer to page 32. Identifies functions that can be specifically adapted for a particular key or vehicle. These adjustments can be performed by your BMW Sports Activity Vehicle Center.

Symbols on vehicle components

 Indicates that you should consult the relevant section of this Owner's Manual for information on a particular part or assembly.

The individual vehicle

In purchasing your BMW, you have decided in favor of a model with individualized equipment and features. This Owner's Manual describes all models and equipment that BMW offers within the same group.

We hope you will understand that equipment and features are included that you might not have chosen for your vehicle. Sections describing options and special equipment are marked by asterisks * to assist you in identifying possible differences between the descriptions in this manual and your own vehicle's equipment.

If equipment in your BMW is not described in this Owner's Manual, please refer to the accompanying Supplementary Owner's Manuals.

Editorial notice

BMW pursues a policy of continuous, ongoing development that is conceived to ensure that our vehicles continue to embody the highest quality and safety standards combined with advanced, state-of-the-art technology. In isolated cases it is possible that the features described in this Owner's Manual could differ from those on your vehicle.

For your own safety

Maintenance and repair

 Advanced technology, e.g. the use of modern materials and powerful electronics, requires specially adapted maintenance and repair methods. You should therefore have the corresponding work on your vehicle performed only by your BMW Sports Activity Vehicle Center or at a workshop that works according to BMW repair procedures with correspondingly trained personnel. If this work is not carried out properly, there is a danger of subsequent damage and related safety hazards. ◀

California Proposition 65 Warning

California law requires us to state the following warning:

 Engine exhaust and a wide variety of automobile components and parts, including components found in the interior furnishings in a vehicle, contain or emit chemicals known to the State of California to cause cancer and birth defects and reproductive harm. In addition, certain fluids contained in vehicles and certain products of component wear contain or emit chemicals known to the State of California to cause cancer and birth defects or other reproductive harm.

Battery posts, terminals and related accessories contain lead and lead compounds. Wash your hands after handling.

Used engine oil contains chemicals that have caused cancer in laboratory animals. Always protect your skin by washing thoroughly with soap and water. ◀

Parts and accessories

 For your own safety, use genuine parts and accessories approved by BMW.

When you purchase accessories tested and approved by BMW and Genuine BMW Parts, you simultaneously acquire the assurance that they have been thoroughly tested by BMW to ensure optimum performance when installed on your vehicle.

BMW warrants these parts to be free from defects in material and workmanship.

BMW will not accept any liability for damage resulting from installation of parts and accessories not approved by BMW.

BMW cannot test every product made by other manufacturers to verify if it can be used on a BMW safely and without risk to either the vehicle, its operation or its occupants.

Genuine BMW Parts, BMW Accessories and other products approved by BMW, together with professional advice on using these items, are available from all BMW Sports Activity Vehicle Centers.

Installation and operation of non-BMW approved accessories such as alarms, radios, amplifiers, radar detectors, wheels, suspension components, brake dust shields, telephones, including operation of any mobile phone from within the vehicle without using an externally mounted antenna, or transceiver equipment such as CBs, walkie-talkies, ham radios or similar accessories may cause extensive damage to the vehicle, compromise its safety, interfere with the vehicle's electrical system, or affect the validity of the BMW Limited Warranty. See your BMW Sports Activity Vehicle Center for additional information. ◀

 Maintenance, replacement, or repair of the emission control devices and systems may be performed by any automotive repair establishment or individual using any certified automotive part. ◀

Service and warranty

We recommend that you read this publication thoroughly.

Your BMW is covered by the following warranties:

- ▷ New Vehicle Limited Warranty
- ▷ Rust Perforation Limited Warranty
- ▷ Federal Emissions System Defect Warranty
- ▷ Federal Emissions Performance Warranty
- ▷ California Emission Control System Limited Warranty.

Detailed information about these warranties is listed in the Service and Warranty Information Booklet for US models or in the Warranty and Service Guide Booklet for Canadian models.

Reporting safety defects

For US customers

The following only applies to vehicles owned and operated in the US.

If you believe that your vehicle has a defect which could cause a crash or could cause injury or death, you should immediately inform the National Highway Traffic Safety Administration, NHTSA, in addition to notifying BMW of North America, LLC, P.O. Box 1227, Westwood, New Jersey 07675-1227, Telephone 1-800-831-1117.

If NHTSA receives similar complaints, it may open an investigation, and if it finds that a safety defect exists in a group of vehicles, it may order a recall and remedy campaign. However, NHTSA cannot become involved in individual problems between you, your dealer, or BMW of North America, LLC.

To contact NHTSA, you may call the Vehicle Safety Hotline toll-free at 1-800-327-4236 (TTY: 1-800-424-9153); go to <http://www.safercar.gov>; or write to: Administrator, NHTSA, 400 Seventh Street, SW., Washington, DC 20590. You can also obtain other information about motor vehicle safety from <http://www.safercar.gov>

For Canadian customers

Canadian customers who wish to report a safety-related defect to Transport Canada, Defect Investigations and Recalls, may telephone the toll free hotline 1-800-333-0510, or contact Transport Canada by mail at: Transport Canada, ASFAD, Place de Ville Tower C, 330 Sparks Street, Ottawa ON K1A 0N5.



A blue-tinted photograph of a group of people on a beach. In the foreground, the front of a dark-colored car is visible, including the hood and headlights. The background shows several people, some of whom appear to be playing beach volleyball. The overall scene is bright and sunny, with a clear sky.

At a glance

This overview of buttons, switches and displays is intended to serve as a source of orientation in your vehicle's operating environment.

The section will also assist you in becoming acquainted with the control concepts and options available for operating the various systems.

Cockpit

Controls

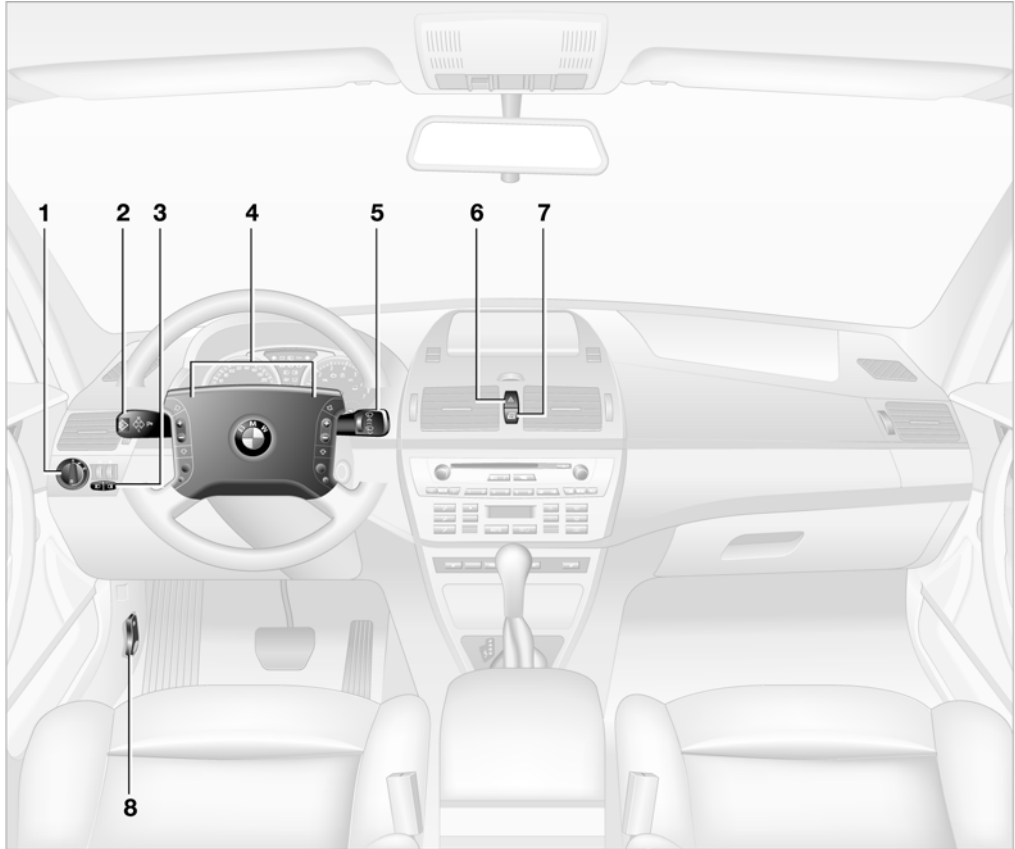

MVG2448CMA

- | | |
|--|---|
| 1 Parking lamps/low beams 56 | 4 Horn |
| 2 ▷ Turn signals 39 | 5 Washer/wiper system/rain sensor* 40 |
| ▷ Roadside parking lamps 57 | 6 Hazard warning flashers |
| ▷ High beams 57 | 7 Central locking system 18 |
| ▷ Headlamp flasher 39 | 8 Unlocking the hood 92 |
| ▷ Computer* 45 | |
| 3 Front fog lamps* 57 | |

Instrument cluster

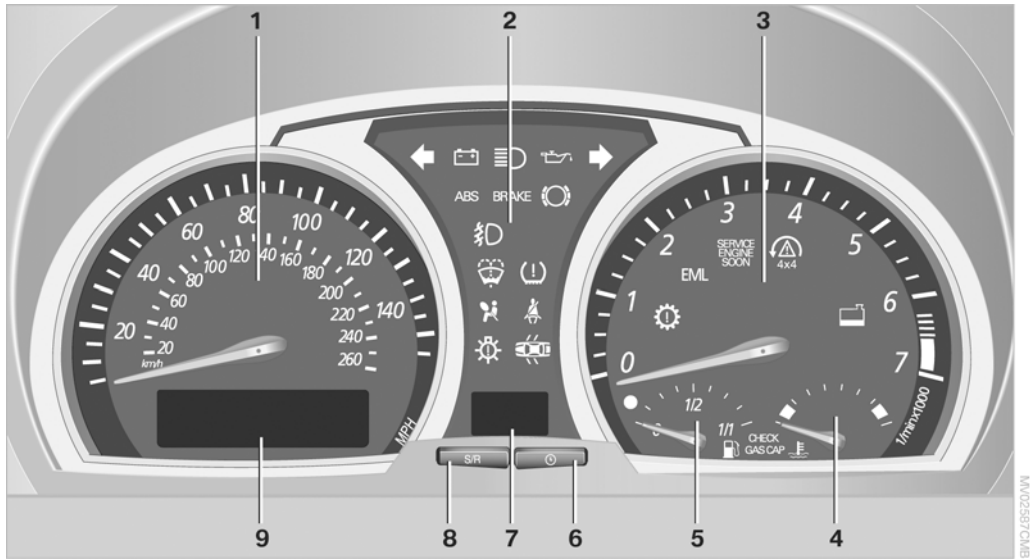

- 1 Speedometer
- 2 Indicator and warning lamps [12](#)
- 3 Tachometer [43](#)
Indicator and warning lamps [12](#)
- 4 Coolant temperature gauge [44](#)
- 5 Fuel gauge [43](#)
- 6 Button for
 - ▷ Displaying the time [44](#)
 - ▷ Service Interval Display [44](#)
- 7 Selector lever and program display for automatic transmission [38](#)
- 8 Button for
 - ▷ Resetting trip odometer [43](#)
 - ▷ Setting the time [44](#)
- 9 Display for
 - ▷ Trip odometer/odometer [43](#)
 - ▷ Time [44](#)
 - ▷ Service Interval [44](#)
 - ▷ Computer [45](#)

Indicator and warning lamps

Technology that monitors itself

Indicator and warning lamps that are identified with ● are checked for proper function each time you turn the ignition key. They each light up once for different periods of time.

When a malfunction occurs in a monitored system, the corresponding lamp will either fail to go out when the engine is started, or it will come on again during normal driving. Detailed information is provided on the specified pages.

 Battery charge current ● 105

 Headlamp flasher 39
High beams 57

 Engine oil ● 94

 Driving stability control systems/
ABS Antilock Brake System ● 48

 ABS Antilock Brake System/chassis
control system for Canadian models

 Brake system ●
With handbrake released 50, 96
With handbrake engaged 37
With other warning lamps 50

 Brake warning lamp for Canadian
models

 Brake pads ● 96

 Please fasten safety belt ● 29

 Airbags ● 53

 Front fog lamps 57

 Automatic transmission ● 38

 Turn signals 39

 DSC Dynamic Stability Control/
xDrive ● 48, 49

 Service Engine Soon ● 98

 Service Engine Soon warning lamp for
Canadian models.

 Check Gas Cap* ● 84

 Engine electronics ● 36

 Washer fluid low 41

 Coolant low 95

 Flat Tire Monitor* ● 50
Tire Pressure Monitor* ● 52

 Lamp defective 56

 Cruise control 41

 With ignition key in position 2, this
warning lamp indicates that a door
or the liftgate is open.

Colors

The indicator and warning lamps can light up in different colors and combinations.

The following section explains the significance of the individual colors as well as how you should respond when they appear.

- ▷ red:
Stop the vehicle immediately
or
an important reminder
- ▷ yellow:
Have the system inspected as soon as possible
or
for your information
- ▷ green:
For your information
- ▷ blue:
For your information

Buttons on steering wheel*

The buttons integrated into the steering wheel are provided so that you can operate a number of accessories quickly and without being distracted from traffic conditions. You may operate:

- ▷ Selected audio source functions
- ▷ Recirculated-air mode/steering wheel heater
- ▷ Cruise control
- ▷ Selected telephone functions
- ▷ Voice command system

 In order to operate a system, it must be switched on. ◀

Telephone*/voice command system*



Press briefly:
Accept incoming call, start dialing, terminate call.

Extended pressure:
Activate/deactivate voice command system

Telephone*/audio sources*

R/T

Display/hide phonebook. Display entries consecutively with buttons for fast forward/reverse

Fast forward/reverse



- ▷ Radio
Press briefly: next station
- ▷ CD
Press briefly: skip track
Extended pressure: fast forward/reverse
- ▷ Phone
Browse through list of names

Volume



On the sports steering wheel* and M sports steering wheel*, the +/- buttons for the volume are on the left side of the steering wheel.

Cruise control*



Cruise control: resuming



Cruise control: accelerating and storing + as well as decelerating and storing -

On the sports steering wheel* and M sports steering wheel*, the +/- buttons for the cruise control are on the right side of the steering wheel.

I/O

Cruise control: activating/interrupting/deactivating

Recirculated-air mode/steering wheel heater*

 Depending on the equipment, a button is provided for the recirculated-air mode or steering wheel heater. ◀



Recirculated-air mode: switching on/off



Steering wheel heater: switching on/off, refer to page [31](#).



A blurred, blue-tinted photograph of a car's interior, showing the dashboard, center console, and gear shift area. The image is out of focus, emphasizing the text overlay.

Controls

This chapter is intended to provide you with information for complete control of your vehicle. Its extensive array of features and accessories, both for driving and for your own safety, comfort and convenience, are described here.

Opening and closing

Key set

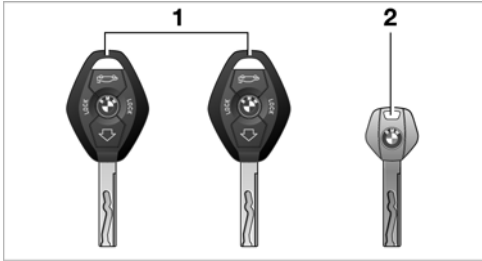

MAN02817CMA

1 Master keys with remote control

Every master key with remote control contains an extended-life battery as a power supply, which is charged automatically in the ignition lock as you drive. You should use each master key at least twice a year in order to maintain the charge condition. Depending on which master key is detected by the vehicle during unlocking, different settings in the vehicle are requested and executed, refer to Vehicle and Key Memory on page 32.

2 Spare key

For storage in a safe place, such as in your wallet.

This key does not fit in the lock of the glove compartment. This is an advantage, e.g. when valet parking. The key is not intended for constant use.

Replacement keys

You can get replacement keys or spare keys from your BMW Sports Activity Vehicle Center.

Central locking system

The concept

The central locking system is ready for operation whenever the driver's door is closed.

The system engages or releases the locks on the

- ▷ doors
- ▷ liftgate
- ▷ fuel filler door

Operating from outside

- ▷ via the remote control
- ▷ via the driver's door lock

The anti-theft system is automatically activated whenever you activate the central locking system from outside the vehicle. This prevents the doors from being unlocked via the lock buttons or door handles. The remote control also switches the interior lights on and off. The alarm system* is also armed or disarmed.

For additional details on the alarm system, refer to page 24.



You can set an acoustic signal to remind you if the ignition key is still in the ignition lock after you open the driver's door. ◀

Operating from inside

Via the central locking system button, refer to page 20.

When the system is locked from inside, the fuel filler door remains unlocked.

In the event of an accident of sufficient severity, the central locking system unlocks automatically. In addition, the hazard warning flashers and interior lamps switch on.



Opening and closing: from outside

Using the remote control

 Protect the remote control against unauthorized use by handing over only the spare key, for example when using hotel valet parking. ◀

 Because any persons or animals left unattended in a parked vehicle could lock the doors from the inside, you should always keep the remote control with you; this precaution ensures that you will remain able to unlock the vehicle from the outside at all times. ◀

Unlocking

1. Press the  button.
The driver's door and fuel filler door are unlocked.
2. Press the  button again.
All remaining doors and the liftgate are unlocked.

Convenience opening mode

Press and hold the  button. The windows and the panorama glass sunroof* are opened.

 If you wish, you can have this special feature activated/deactivated. ◀

Engaging locks

Press the  LOCK button.

 If you wish, the vehicle locks automatically if no door or lid is opened after unlocking. You can have your vehicle set to do this if you wish. ◀

As confirmation of the fact that the vehicle is properly locked, the hazard warning flashers light up.

 If you wish, you can have this special feature deactivated on vehicles without an alarm system. ◀

Switching off tilt alarm sensor* and interior motion sensor*

Press the  LOCK button again directly after locking.

For details, refer to page 25.

Switching on interior lamps

Press the  LOCK button if the vehicle is locked.

You can also use this function to locate your vehicle in parking garages etc.

Panic mode*

You can also trigger the alarm system in case of danger:

Press the  button for at least three seconds.

Deactivating alarm: press any button.

Unlocking liftgate

Press the  button.

The liftgate will open slightly, regardless of whether it was previously locked or unlocked.

 To avoid damage, make sure there is sufficient space when opening the liftgate. A previously locked liftgate is also locked again after closing.

Before and after a drive, make sure that the liftgate has not been inadvertently released. ◀

 If so desired, you can have the remote control system open the liftgate only when the vehicle is unlocked. You can have your vehicle set to do this if you wish. ◀

Malfunction

The remote control may malfunction due to local radio waves.

Should this occur, use the master key to unlock and relock the vehicle via the door lock.

If it is no longer possible to lock the vehicle using the remote control, its battery is discharged. Use this remote control during an extended drive; this will recharge the battery, refer to page 18.

For US owners only

The transmitter and receiver units comply with part 15 of the FCC/Federal Communications Commission regulations. Operation is governed by the following:

FCC ID:
LX8EWS
LX8FZVS
LX8FZVE

Compliance statement:

This device complies with part 15 of the FCC Rules. Operation is subject to the following two conditions:

- ▷ This device must not cause harmful interference, and
- ▷ this device must accept any interference received, including interference that may cause undesired operation.

 Any unauthorized modifications or changes to these devices could void the user's authority to operate this equipment. ◀

Using door lock

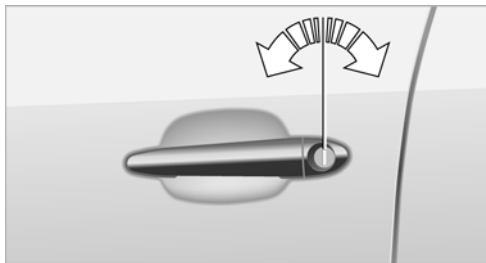

1. Turn key.
The driver's door and fuel filler door are unlocked.
2. Turn key again.
All remaining doors and the liftgate are unlocked.

As confirmation of the fact that the vehicle is properly locked, the hazard warning flashers light up.

 If you wish, you can have this special feature deactivated on vehicles without an alarm system. ◀

Convenience operation

You also have the option of using the door lock to operate the windows and the panorama glass sunroof*.

Hold the key in the positions for unlocking or locking.

 Watch during the closing process to be sure that no one is injured. Releasing the key stops the operation. ◀

Manual operation

If an electrical malfunction occurs, you can unlock or lock the driver's door with the key in the end positions of the door lock.

Opening and closing: from inside

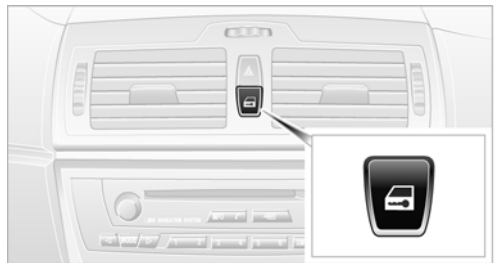

You can use this button to operate the central locking system when the front doors are closed. This button only unlocks or locks the doors and the liftgate. It does not activate the anti-theft system.

 If only the driver's door was unlocked from the outside and you press the button, with the driver's door still open, then the passenger-side door, the liftgate and the fuel filler door will also unlock.

If the driver's door is closed, it will be locked. ◀

 The central locking system locks automatically after you begin to drive. You can have your vehicle set to do this if you wish. ◀

Unlocking and opening doors

- ▷ Either unlock all of the doors by using the central locking system button and then pull on the door handle above the armrest or
- ▷ pull the door handle of each door twice: the first time unlocks the door, the second time opens it.

Engaging locks

- ▷ Either lock all doors via the central locking system button or
- ▷ press down the lock buttons of the doors. To prevent you from being locked out, the opened driver's door cannot be locked using the lock button.

 Because any persons or animals left unattended in a parked vehicle could lock the doors from the inside, you should always keep the vehicle key with you; this precaution ensures that you will remain able to unlock the vehicle from the outside at all times. ◀

 You can set an acoustic signal to remind you if the ignition key is still in the ignition lock after you open the driver's door. ◀

Liftgate

 To avoid damage, make sure there is sufficient space when opening the liftgate. ◀

Opening from outside

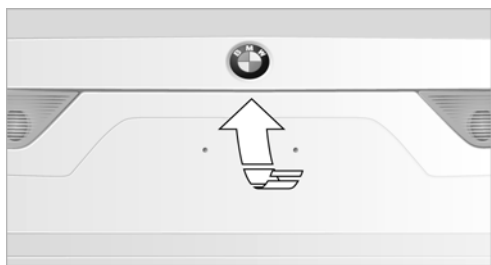

Press the button, refer to arrow, or the  button on the remote control. The liftgate opens slightly. It can be pivoted upward.

When the liftgate is open, the cargo area and interior are lit up.

Opening manually

In the event of an electrical malfunction:

1. Fold up the floor cover in the cargo area.
2. Release the jack from the bracket.
3. Press the lever behind the cover to the side, refer to arrow. The liftgate is released.

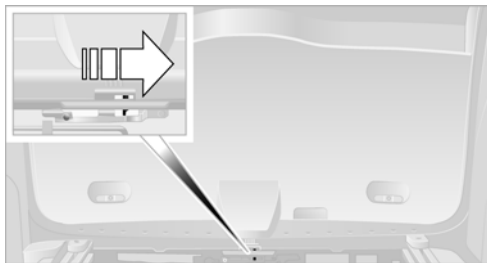

The liftgate is locked again as soon as it is closed.

Closing

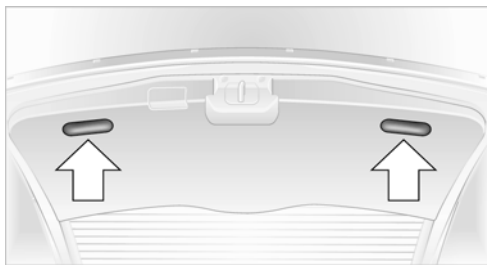

The handle recesses on the interior trim of the liftgate make it easier to pull down.

 Avoid injuries by making sure that the liftgate's closing region is clear and unobstructed. ◀

Windows

! Keep windows in your line of sight while closing. Failure to do so can result in bodily injury.

Always remove the key when leaving the vehicle; otherwise, children could operate the windows and injure themselves. ◀

Opening, closing



As of ignition key position 1:

- ▷ Press the switch to the resistance point: The window continues to open as long as you press the switch.
- ▷ Press the switch past the resistance point: The window opens automatically. Pressing again stops the opening motion.

You can close the windows in the same manner by pulling the switch.

In the back, separate switches are provided in the armrests.

For convenience operation using the remote control or the door lock, refer to pages 19, 20.

After switching off ignition

You can operate the windows for up to 1 minute as long as no door has been opened.

Pinch protection system

If the closing force rises beyond a predefined threshold during closing, the system will immediately stop moving the window prior to lowering it slightly.

! Despite the presence of the pinch protection system, inspect the window's travel path prior to closing it, as the safety system might fail to detect certain kinds of obstruc-

tions, such as very thin objects, and the window would continue closing.

You can disable the pinch protection system by pressing the switch past the resistance point and holding it.

Do not install any accessories in the movement range of the window as this could impair the function of the pinch protection system. ◀

Following interruptions in electrical power supply

After disconnecting the battery, the pinch protection system must be reinitialized. To do this, open and close the windows once and continue pull the switch for longer than 2 seconds after closing.

Safety switch



With the safety switch, you can prevent the rear windows from being opened or closed via the switches in the rear passenger area, by children, for example. The LED lights up when this safety function is activated.

! Press the safety switch when children ride in the rear; otherwise, unsupervised closing of the windows could lead to injuries. ◀

Panorama glass sunroof*

The panorama glass sunroof is ready for operation with the ignition key in position 2.

 Keep panorama glass sunroof in your line of sight while closing. Failure to do so can result in bodily injury.

Always remove the key when leaving the vehicle; otherwise, children could operate the sunroof and injure themselves. ◀

Raising, opening, closing

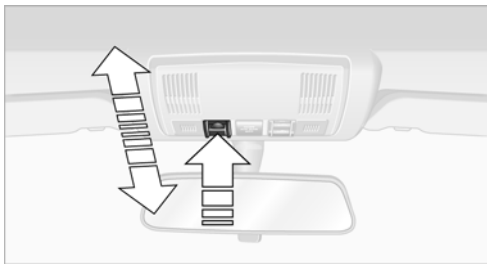

Press the switch or slide it in the desired direction up to the resistance point.

Release the switch to stop the motion.

The sliding visor is opened slightly when the panorama glass sunroof is raised.

The panorama glass sunroof can be opened or closed independently with the sliding visor open.

Ventilation setting

The panorama glass sunroof is raised and the sliding visor is opened slightly: briefly press the switch twice consecutively.

After switching off ignition

You can operate the panorama glass sunroof for approx. 1 minute as long as no door has been opened.

Automatic opening and closing

Briefly press the switch past the resistance point and then release it.

Briefly pressing the switch again stops the motion.

Opening and closing panorama glass sunroof and sliding visor together

Briefly press the switch past the resistance point twice consecutively.

Briefly pressing the switch again stops the motion.

Comfort position

Each time the panorama glass sunroof is completely opened or closed, it stops in the comfort position. If you wish, you can resume the motion by activating the switch.

In the comfort position, the wind noise in the interior is reduced.

Pinch protection system

If the panorama glass sunroof or sliding visor encounter resistance when closing from roughly one third of the roof opening or when closing from the raised position, the closing action is interrupted and the panorama glass sunroof and sliding visor reopen a little.

 Despite the presence of the pinch protection system, inspect the sunroof's travel path prior to closing it, as the safety system might fail to detect certain kinds of obstructions, such as very thin objects, and the sunroof would continue closing.

You can disable the pinch protection system by pressing the switch past the resistance point and holding it. ◀

Following interruptions in electrical power supply

After a power supply interruption, it may only be possible to raise the sunroof. The system must be initialized. BMW recommends having this work carried out by your BMW Sports Activity Vehicle Center.

Closing manually

In the event of an electrical malfunction, you can move the panorama glass sunroof manually.

1. Pull the cover firmly downward to remove.

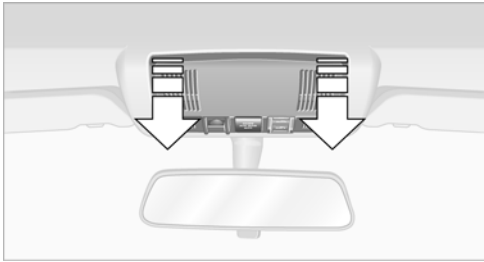

2. Insert the Allen wrench from the compartment beneath the cargo area floor, refer to page 103, into the proper opening and turn the panorama glass sunroof in the desired direction. The arrow in the illustration indicates the rotation direction for closing the sunroof.

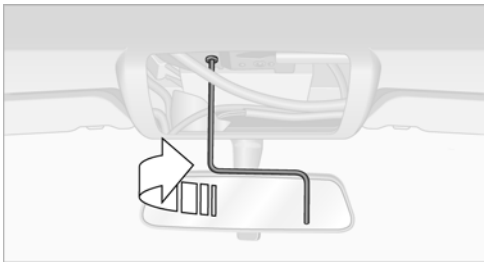

Alarm system*

The concept

The vehicle alarm system responds:

- ▷ When a door, the hood, or the liftgate is opened.
- ▷ To movements inside the vehicle: interior motion sensor, refer to description below.
- ▷ When the car's inclination changes, for instance if an attempt is made to jack it up and steal the wheels or to raise it prior to towing away.
- ▷ To interruptions in battery voltage.

The alarm system signals unauthorized manipulations for a short time by:

- ▷ Sounding an acoustic alarm
- ▷ Switching on the hazard warning flashers
- ▷ Flashing the high beams

Arming and disarming alarm system

When you lock or unlock the vehicle, either with the remote control or at the door lock, the alarm system is armed or disarmed at the same time.

If the alarm system has been properly armed, the hazard warning flashers light up once.

 You can have different acknowledgment signals set to confirm arming and disarming. ◀

You can open the liftgate even when the system is armed by using the  button of the remote control, refer to page 19. When the liftgate is closed, it is locked again and monitored.

Switching off alarm

- ▷ Unlock the vehicle using the remote control, refer to page 19.
- ▷ Turn the ignition key to position 1.

Indicator lamp displays



- ▷ The indicator lamp below the interior rearview mirror flashes continuously: the system is armed.
- ▷ The indicator lamp flashes after the vehicle is locked: doors, hood, or liftgate are not properly closed. Even if you do not close the alerted area, the system begins to monitor the remaining areas, and the indicator lamp flashes continuously after approx. 10 seconds. However, the interior motion sensor is not activated.
- ▷ The indicator lamp goes out after unlocking: no manipulation or attempted intrusions have been detected in the period since the system was armed.
- ▷ The indicator lamp flashes for 10 seconds after the vehicle is unlocked: an attempted entry has been detected in the period since the system was armed.

Following triggering of an alarm, the indicator lamp will flash continuously.

Tilt alarm sensor

The tilt of the vehicle is monitored. The alarm system reacts, e.g. in case of an attempted wheel theft or towing.

Interior motion sensor

In order for the interior motion sensor to function properly, the windows and panorama glass sunroof must be completely closed.

Avoiding unintentional alarms

The tilt alarm sensor and interior motion sensor may be switched off at the same time. This prevents unintentional alarms, e.g. in the following situations:

- ▷ In duplex garages
- ▷ When transporting on car-carrying trains
- ▷ When animals are to remain in the vehicle

Switching off tilt alarm sensor and interior motion sensor

Press the  LOCK button on the remote control again as soon as the vehicle is locked.

The indicator lamp lights up briefly and then flashes continuously. The tilt alarm sensor and the interior motion sensor are switched off until the next time the vehicle is unlocked and subsequently locked again.



If you wish, you can have the tilt alarm sensor and interior motion sensor permanently switched off. You can have this setting made at your BMW Sports Activity Vehicle Center. ◀

Adjustments

Sitting safely

The ideal sitting position can make a vital contribution to relaxed driving that is as fatigue-free as possible. Together with safety belts, head restraints, and airbags, sitting position plays an important role in an accident. Compliance with the following instructions is important; failure to do so could impair the protective function of the safety systems.

For additional information on transporting children safely, refer to page 33.

Airbags

 Always maintain an adequate distance between yourself and the airbags. Always hold the steering wheel by its rim with hands at the 9 o'clock and 3 o'clock positions, to minimize the risk of injuries to your hands and arms in the event of airbag deployment.

No one and nothing is to come between the airbags and the seat occupant.

Do not use the cover of the front airbag on the front passenger side as a storage area. Make sure that the passenger sits correctly, e.g. does not rest his feet or legs on the dashboard. Otherwise, a triggering of the front airbag could result in leg injuries. Make sure that passengers do not lean their heads against side or head airbags. Otherwise, a triggering of the airbag could result in injuries. ◀

Even if you adhere to all the instructions, injuries resulting from contact with airbags cannot be entirely ruled out, depending on the circumstances. The ignition and inflation noise may provoke a mild – usually temporary – hearing loss in extremely sensitive individuals.

For airbag locations and additional information on airbags, refer to page 53.

Head restraint

A correctly adjusted head restraint reduces the risk of damage to the cervical vertebrae in accidents.

 Adjust the head restraint so that its middle lies approximately at the height of your ears. Otherwise, there is an increased risk of injury in the event of an accident. ◀

Safety belts

Make sure the safety belts are worn in all occupied seats every time you drive. Although airbags enhance safety by providing added protection, they are not a substitute for safety belts.

Your vehicle has five seats that are each equipped with a safety belt.

 Never allow more than one person to wear a single safety belt. Infants and children must not ride on a lap. Make sure that the belt in the lap area sits low against the hips and does not press against the abdomen. The safety belt must never rest against the throat, rub against sharp edges, pass over hard or fragile objects or be pinched. Fasten the safety belt around your body snugly, making sure that it is pulled taut across your lap and shoulder and that it is not twisted; otherwise, the belt can slide over the hips in the event of a frontal collision and injure your abdomen. Avoid wearing clothing that prevents the belt from fitting properly and pull the shoulder belt upward periodically to readjust the tension across your lap in order to avoid a reduction in the restraining action of the safety belt. ◀

If the middle safety belt in the rear is used, then the wider backrest must be secured, refer to page 70, otherwise, the safety belt cannot exert any restraining action.

Safety belts, refer to page 29.

Seats

Note before adjusting

! Never try to adjust your seat while operating the vehicle. The seat could respond with unexpected movement, and the ensuing loss of vehicle control could lead to an accident. On the passenger seat as well, do not incline the backrest too far to the rear while the vehicle is being driven; otherwise, there is a danger in the event of an accident of sliding under the safety belt, eliminating the protection normally provided by the belt. ◀

Also follow the instructions regarding the height of head restraints on page 28 and regarding safety belt damage on page 30.

Adjusting manually

! To ensure that the safety systems continue to provide optimized protection, follow the adjustment instructions above. ◀

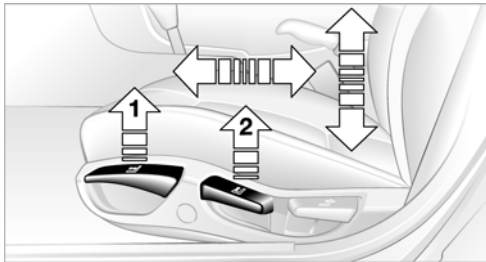

Longitudinal direction

Pull the lever **1** and slide the seat into the desired position.

After you release the lever, move the seat forward or backward slightly so that it engages fully.

Height

Pull the lever **2** and apply weight to or remove weight from the seat as needed.

Backrest

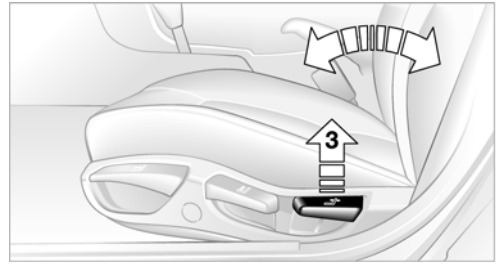

Pull the lever **3** and apply weight to or remove weight from the backrest as needed.

Adjusting electrically*

! To ensure that the safety systems continue to provide optimized protection, follow the adjustment instructions above. ◀

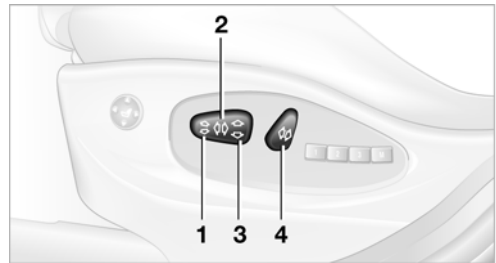

- 1 Tilt
- 2 Longitudinal direction
- 3 Height
- 4 Backrest

Manually adjusting head restraint, refer to Head restraints on page 28.

Adjusting lumbar support*



You can also adjust the contours of the backrest to obtain additional support in the lumbar region.

The upper hips and spinal column receive supplementary support to help you maintain a relaxed, upright sitting position.

- ▷ To increase or decrease curvature: press switch forward or back.
- ▷ To move curvature up or down: press switch up or down.

Sports seat*

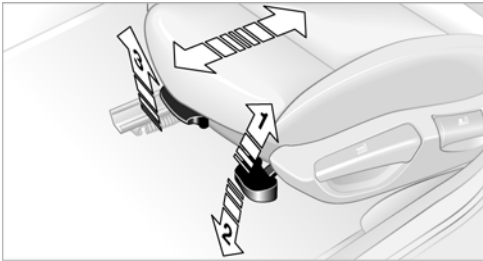

With this seat, you can also adjust the tilt and the thigh support:

Upward tilt

Pull the lever **1** repeatedly until you reach the desired tilt.

Downward tilt

Press the lever **2** repeatedly until you reach the desired tilt.

Thigh support

Pull the lever **3** and slide the thigh support in the longitudinal direction.

Head restraints

A correctly adjusted head restraint reduces the risk of damage to the cervical vertebrae in accidents.

- ⚠ Adjust the head restraint so that its middle lies approximately at the height of your ears. Otherwise, there is an increased risk of injury in the event of an accident. ◀

Adjusting height

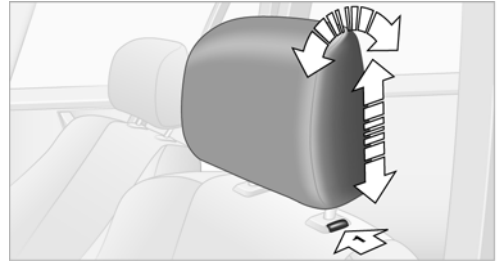

- ▷ To raise: pull upward.
- ▷ To lower: press button, arrow **1**, and slide head restraint downward.

Front head restraint tilt angle: adjust by tilting.

Removing front head restraint

1. Pull the head restraint upward to the stop.
2. Press button, arrow **1**, and pull head restraint all the way out.

Installing front head restraint

1. Press button, arrow **1**, and slide the head restraint into its sockets.
2. Adjust the head restraint.

Heated seats*



Press once for each temperature level. Highest preselected temperature when three LEDs are illuminated.

To switch off:

Press the button and hold it longer.

Seat and mirror memory*

You can store and select three different adjustment settings for the driver's seat and exterior mirrors.

The adjustment of the lumbar support is not stored in the memory.

Storing

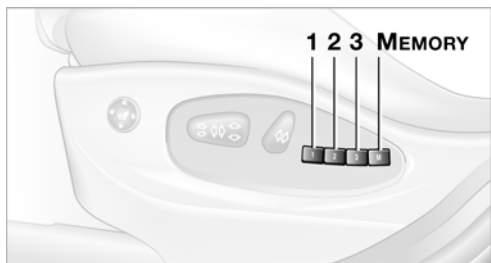

1. Turn the ignition key to position 1 or 2.
2. Set the desired seat and exterior mirror position.
3. Press the **MEMORY** button:
The LED in the button lights up.
4. Press the desired memory button **1**, **2** or **3**:
The LED goes out.

Requesting a stored setting

 Do not request a position from the memory while the vehicle is moving; otherwise, there is a risk of accident from unexpected seat movement. ◀

Convenience mode

1. Open the driver's door after unlocking or turn the ignition key to position 1.
2. Briefly press the desired memory button **1**, **2** or **3**.

The system immediately cancels the adjustment procedure when you press one of the seat adjustment buttons or use one of the memory buttons.

Safety feature

1. Close the driver's door and turn the ignition key to position 0 or 2.
2. Press the desired memory button **1**, **2** or **3** and maintain pressure until the adjustment process has been completed.

If you press the **MEMORY** button accidentally: Press the button again, the LED goes out.



You can have your vehicle programmed to automatically recall your own individual stored adjustment settings for the seat and exterior mirror position whenever you use your personal remote control to unlock the vehicle. ◀

 If you make use of this setting, be sure that the footwell behind the driver's seat is unobstructed before unlocking the vehicle. If you fail to do so, any persons, animals or objects behind the seat could be injured or damaged by a rearward movement of the seat. ◀

Safety belts

 To ensure that the safety systems continue to provide optimal protection, please follow the instructions on page 26. ◀

Make sure the safety belts are worn in all occupied seats every time you drive. Although air-bags enhance safety by providing added pro-

tection, they are not a substitute for safety belts.

In the rear, the middle belt buckle embossed with the word CENTER is intended exclusively for use by passengers riding in the center position.

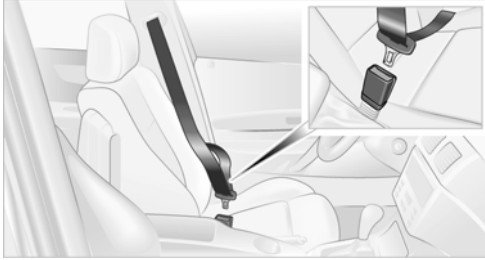

MAN0246CCMB

Fastening

Make sure you hear the latch plate engage in the belt buckle.

The upper shoulder strap's anchorage point will be in the correct position for seat occupants of every build if the seat is correctly adjusted, refer to page 26.

Releasing

1. Hold the belt firmly.
2. Press the red button in the buckle.
3. Guide the belt back into its reel.

Safety belt reminder for front seats



The indicator lamp flashes or lights up. In addition, a signal sounds. Please make sure that the safety belts are being worn correctly.

The safety belt reminder is activated if the safety belt on the driver's side has not yet been fastened.

At speeds greater than 5 mph/8 km/h, the safety belt reminder is also activated if the passenger side safety belt has not yet been fastened, if heavy objects are placed on the passenger's seat, or if the driver or front passenger's safety belt is released.

Damage to safety belts



When strained by an accident or when damaged: have the safety belt system, including the belt tensioners, replaced and have belt anchorage points inspected. Have this work done only by your BMW Sports Activity Vehicle Center or by a workshop that works according to BMW repair procedures with correspondingly trained personnel. Otherwise, there can be no guarantee that the safety devices will function properly. ◀

Mirrors

Exterior mirrors



The passenger side mirror is more curved than the driver's mirror. Objects in the mirrors are closer than they appear. Do not estimate the distance to following traffic based on the view in the mirrors; otherwise, there is an increased risk of accident. ◀



MAN02507CMA

- 1 Adjustments
- 2 Switching over to the other mirror or to the automatic parking function*

Storing the mirror positions, refer to Seat and mirror memory on page 29.

Manual adjustments

The mirrors can also be manually adjusted by pressing at the edges of the mirror glass.



To prevent the exterior mirrors on this vehicle from being damaged, always fold them in by hand before entering an automatic car wash. ◀

Automatic heating*

When the outside temperature falls below a specified temperature, both outside mirrors are automatically heated whenever the engine is running or the ignition is switched on.

Tilting down passenger's mirror, automatic parking function*

Activating

1. Select the driver's exterior mirror with switch 1.



2. When you shift into reverse or move the selector-lever into position R, the exterior mirror glass on the front passenger side tilts downward slightly. This allows the driver to see the area immediately adjacent to the vehicle – such as a curb – when parking, etc.



You can have the angle of downward tilt adjusted. ◀

Deactivating

Select the passenger side mirror with switch 1.

Interior rearview mirror



To reduce glare from vehicle headlights behind you when driving at night, turn the knob.

In vehicles without an alarm system: tilt the small lever forward.

Automatically dimming mirrors, refer to page 77.

Steering wheel

Adjustments



Do not adjust the steering wheel while the vehicle is moving. There is a risk of accident from unexpected movement. ◀

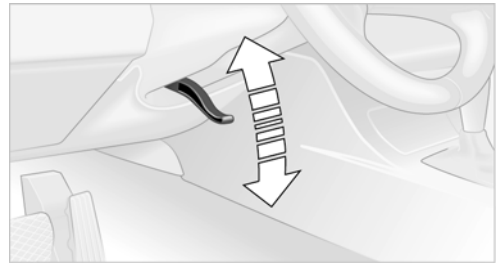

1. Fold the lever down.
2. Adapt the longitudinal position and height of the steering wheel to the seat position.
3. Fold the lever back up.

Steering wheel heater*

The button for steering wheel heater is located on the steering wheel, refer to page 13.



Steering wheel heater: switching on/off

The steering wheel heater operates as of ignition key position 2.

Press the button to activate or deactivate this system.

When the heater is switched on, the LED in the button lights up.

Vehicle Memory, Key Memory

How the system functions

You have probably frequently wished that you could configure individual functions of your vehicle to reflect your own personal requirements. In developing your vehicle, BMW has incorporated a number of options for personal adjustment. You can have these programmed at your BMW Sports Activity Vehicle Center.

There are vehicle-related and person-related adjustments: Vehicle Memory and Key Memory. You can configure up to four different basic adjustments for four different persons. The only requirement is that each person use his or her own master key with remote control.

When your vehicle is unlocked with the remote control, the vehicle recognizes the individual user by means of a data exchange with the key, and makes adjustments accordingly.

In order for you to distinguish between the master keys with remote control, color-coded decals are supplied together with the keys.

What the system can do

Ask your BMW Sports Activity Vehicle Center about the possibilities of Vehicle Memory and Key Memory.



You will see this symbol throughout the Owner's Manual. It is to remind you at appropriate places of the settings that are available to you. ◀



Following configuration of memory functions, vehicle operation may differ from the description in the Owner's Manual. Should you wish to sell your BMW some day, please remember to have the memory functions reset to the factory default settings. ◀

Examples of Vehicle Memory

- ▷ Different acknowledgment signals to confirm locking/unlocking of the vehicle, refer to page 19.
- ▷ Activating/deactivating function for pathway lighting, refer to page 56.
- ▷ Activating/deactivating daytime running lamps, refer to page 56.
- ▷ Active PDC Park Distance Control is acoustically indicated by a signal tone when you shift into reverse or move the selector lever into position R, refer to page 47.
- ▷ Different acknowledgment signals to confirm arming/disarming the alarm system, refer to page 24.
- ▷ After an outside temperature warning has been issued, the computer display returns to the previous setting, refer to page 45.
- ▷ Acoustic warning if the ignition key remains in the ignition lock after the driver's door has been opened, refer to page 18.

Examples of Key Memory functions

- ▷ Locking the vehicle after starting to drive, refer to page 20.
- ▷ Automatic adjustment of the driver's seat and exterior mirror position for each person when unlocking the vehicle, refer to page 29.
- ▷ Angle of downward tilt of passenger side mirror, refer to page 31.
- ▷ Setting units of measure for displays in the instrument cluster for time, outside temperature, distance driven and fuel consumption, refer to page 45.

Transporting children safely

The right place for children

! Do not leave children unattended in the vehicle; otherwise, they could endanger themselves and/or others, for example by opening the doors. ◀

Children always in the rear

Accident research has demonstrated that the safest place for children is in the rear seat.

! Children younger than 13 or smaller than 5 ft/150 cm should only ride in the rear, in child restraint systems provided in accordance with their age, weight, and height. Otherwise, there is an increased risk of injury in the event of an accident. ◀

Children older than 13 must be secured with a safety belt as soon as they have outgrown a suitable child restraint system due to their age, height, and weight.

All seats in your BMW, except for the driver's seat, correspond to the recommendations of the norm SAE J1819 for safely securing child restraint systems in motor vehicles.

Exception for the front passenger seat

! If it should be necessary to use a child restraint system on the front passenger seat, the front and side airbags must be deactivated. Otherwise, there is an increased risk of injury to the child if the airbag is triggered, even with a child restraint system. Your BMW Sports Activity Vehicle Center will be happy to advise you. ◀

For more information on automatic deactivation of the front passenger airbags, refer to page 54.

Installing child restraint systems

! Follow the child restraint system manufacturer's instructions for selection, installation and use of the child restraint system. Otherwise, the degree of protection can be reduced. ◀

On the passenger's seat

! Before installing a child restraint system in the passenger seat, make sure that the front and side airbag on the passenger seat have been deactivated. Otherwise, there is an increased risk of injury when the airbag is triggered. ◀

Child seat security



All rear seat safety belts and the safety belt for the front passenger can be locked to prevent their being pulled out in order to fasten child restraint systems.

Locking safety belt

1. Secure child restraint system with the belt.
2. Pull safety belt strap all the way out.
3. Allow safety belt to retract and pull it snugly against the child restraint system. The safety belt is locked.

Unlocking safety belt

1. Open safety belt buckle.
2. Remove child restraint system.
3. Allow safety belt strap to retract all the way.

Child restraint system with tether strap

⚠ Only use the tether strap attachment points to fasten child restraint systems; otherwise, the attachment points can be damaged. ◀

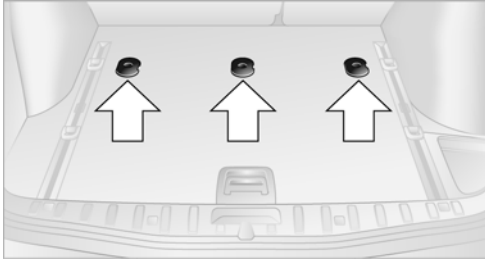

For child restraint systems with a tether strap, there are three additional attachment points, refer to arrows. To gain access to this anchor fitting, lift the plastic plug with the aid of a screwdriver.

Routing of tether strap

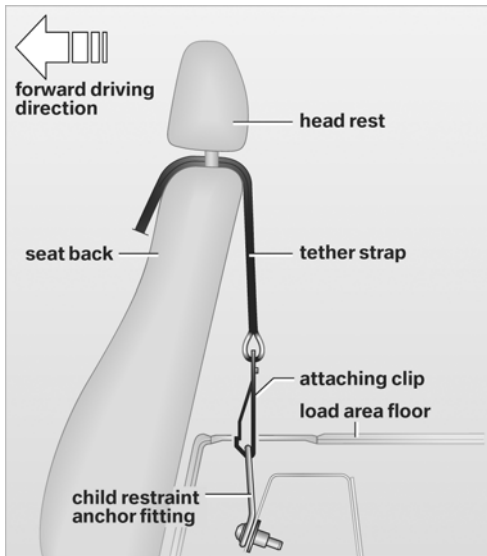

Outer seats:

1. Slide head restraints upward.
2. Guide fastening strap through the bracket of the head restraint.
3. Slide head restraint into the lowest position.
4. Hook fastening strap to attachment point.

Middle seat:

1. Fold center arm rest slightly forward.
2. Guide fastening strap through the opening.

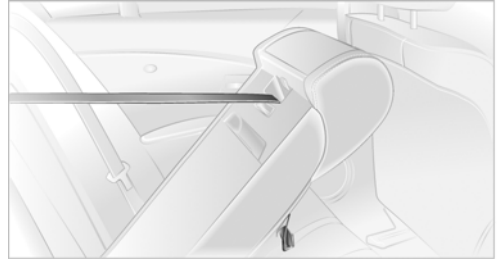

3. Fold center arm rest back.
4. Hook fastening strap to attachment point.

When using the cargo area cover:

Fastening strap must run between the rear backrest and the cargo area cover.

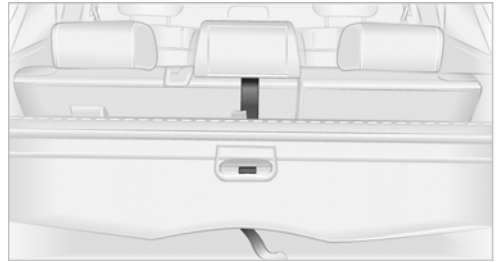

LATCH child-restraint fixing system*

LATCH: Lower Anchor and Tethers for Children.

⚠ To attach a LATCH child's seat, consult the instruction manual and safety notices from the manufacturer of the child's seat. ◀

Access to anchorage points



The picture shows the right rear seat as an example. The anchorage points for the LATCH child-restraint fixing system are located behind the cover caps.

Remove the cover caps toward the front.
Press into place to reinstall.

Before attachment of the LATCH child-restraint fixing system, remove the cover caps and pull the belt out of the region of the child-restraint fixing system.

For driving

 With rear side airbags, make sure that children do not lean out of the child's seat toward the door panel; otherwise, injuries can result if the side airbags are triggered. ◀

Child-safety lock of rear doors



Slide down the safety levers on the rear doors:
The door can now be opened from the outside only.

Safety switch for power windows

Press the safety switch for the power windows, refer to page 22, when children are in the rear of the vehicle.

Driving

Ignition lock

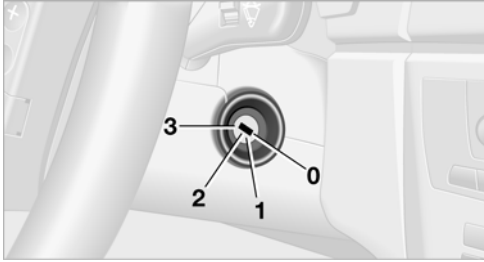

0 Steering locked

The key can be inserted or removed in this position only.

After removing the key, turn the steering wheel slightly to the left or right until you hear the lock engage.

Interlock

Automatic transmission:

To turn the key back to position 0 or to remove it, first place the selector lever in position P.

1 Steering unlocked

A slight steering wheel movement often makes it easier to turn the key from 0 to 1.

Some power accessories are ready for operation.

2 Ignition switched on

All vehicle systems are ready for operation.

3 Starting engine

Starting engine

 Do not run the engine in enclosed spaces; otherwise, inhalation of toxic exhaust gases can cause unconsciousness and death. The exhaust gases contain carbon monoxide, an odorless and colorless, but highly toxic gas. Do not leave the vehicle unattended with the

engine running, since an unattended vehicle with a running engine represents a safety hazard.

To prevent the vehicle from rolling, always shift into neutral or selector lever position P and engage the handbrake before leaving the vehicle with the engine running. ◀

Do not discontinue the starting procedure prematurely, but do not prolong it for more than 20 seconds. Release the ignition key immediately as soon as the engine starts.

When starting the engine, do not press the accelerator pedal.

Do not allow the motor to warm up while idling. Begin driving immediately with moderate engine speed.

Indicator lamps



The warning lamp lights up. Exhaust values are deteriorating. Have the vehicle checked as soon as possible.

Under certain conditions, the indicator will flash. This indicates a serious rate of engine misfire. When this occurs, you should reduce speed and consult the nearest BMW Sports Activity Vehicle Center as soon as possible. Severe engine misfire, even for only a short period of time, can seriously damage emission control components, especially the catalytic converter.



Display of the previously described malfunction on Canadian models.



The warning lamp lights up. Malfunction in the engine electronics. You can continue to drive with reduced engine output or speed. Have the system checked immediately.

Manual transmission

1. Apply the handbrake.
2. Depress the clutch pedal and shift into neutral.



If the clutch pedal is not depressed, the motor will not start. ◀

3. Start the engine.

Automatic transmission

1. Step on the brake.
2. Move selector lever into position P.
3. Start the engine.

Special starting conditions

In the following situations, press the accelerator pedal halfway down while starting:

- ▷ If the engine fails to start on the first attempt, for instance, if it is very hot or cold.
- ▷ When starting the engine at very low temperatures, below approx. +5 °F / -15 °C, at high altitudes over approx. 3,300 ft / 1,000 m.



Avoid frequent starting in quick succession or repeated start attempts in which the engine does not start. Otherwise, the fuel is not burned or inadequately burned and there is a danger of overheating and damaging the catalytic converter. ◀

Switching off engine



Do not remove the ignition key when the vehicle is rolling; otherwise, the steering wheel lock would engage during steering. When leaving the vehicle, remove the ignition key and lock the steering. When parking on downward inclines, engage the handbrake; otherwise, the vehicle could start to roll. ◀

Manual transmission

1. Apply the handbrake.
2. Turn the ignition key to position 1 or 0.
3. Shift into first gear or reverse.

Automatic transmission

1. With the vehicle at a stop, move the selector lever into position P.
2. Turn the ignition key to position 1 or 0.

3. Apply the handbrake.

Handbrake

The handbrake is primarily intended to prevent the vehicle from rolling while parked; it brakes the rear wheels.

Indicator lamp



The indicator lamp lights up; an acoustic signal also sounds when you begin to drive. The handbrake is still engaged.



Indicator lamp for Canadian models.

Engaging

The lever engages automatically.

Releasing



Pull up slightly on the lever, press the button and lower the lever.



If exceptional circumstances should make it necessary to engage the handbrake while the vehicle is in motion, do not pull it too strongly. In doing so, continuously press the button of the handbrake lever. Otherwise, strong application of the handbrake can lead to overbraking of the rear axle and to associated 'fishtailing' of the vehicle rear end. ◀



To prevent corrosion and one-sided braking action, occasionally engage the handbrake lightly when the vehicle is slowly coming to a stop if the traffic conditions are suitable. The brake lamps do not light up when the handbrake is applied. ◀

Manual transmission

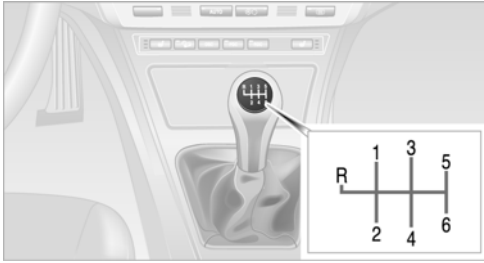

! When shifting into 5th or 6th gear, press the gearshift to the right. Otherwise, an inadvertent shift into 3rd or 4th gear could harm the engine. ◀

Reverse

Select only when the vehicle is stationary. Press the gearshift lever to the left to overcome the resistance.

Automatic transmission with Steptronic*

In addition to fully automatic operation, you can also manually shift with the Steptronic, refer to page 39.

Parking vehicle

! To prevent the vehicle from rolling, always select position P and engage the handbrake before leaving the vehicle with the engine running. ◀

Selector lever positions

P R N D M/S + -

Engine started

The engine can only be started in selector lever positions P: Park or N: Neutral.

Displays in the instrument cluster

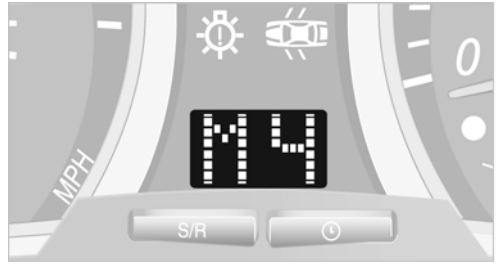

P R N D SD M1 M2 M3 M4 M5

The selector lever position is indicated, and in the manual mode the gear currently engaged.

Changing selector lever positions

- ▷ The selector lever can be moved out of the position P when the ignition is switched on or the engine is running: interlock.
- ▷ When the vehicle is stationary, step on the brake before shifting out of P or N; otherwise, the selector lever is locked: shiftlock.

! To prevent the vehicle from creeping after you select a drive position, maintain pressure on the brake pedal until you are ready to start driving. ◀



A lock prevents the selector lever from being inadvertently moved into positions R and P. To release the lock, press the button on the front of the selector lever handle, refer to arrow.

P Park

Select only when the vehicle is stationary. The transmission locks to prevent the rear wheels from turning.

R Reverse

Select only when the vehicle is stationary.

N Neutral

You can shift into neutral, for example, in automatic car washes. The vehicle can roll.

D Drive, automatic position

Under normal operating conditions, fuel consumption is the lowest when the vehicle is driven in position D.

Kick-down

The kick-down mode provides maximum acceleration.

Press the accelerator pedal past the increased resistance point at the full-throttle position.

Sport program and manual mode M/S

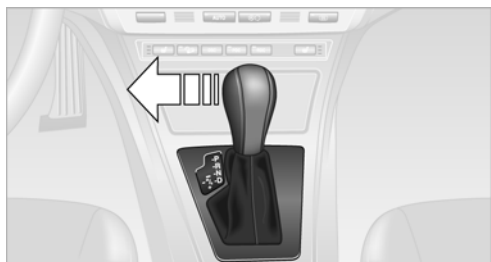

Move the selector lever from position D toward the left into the M/S shifting slot.

The Sport program is activated and SD appears in the instrument cluster. This position is recommended for a performance-oriented driving style.

When you push the selector lever forward or pull it back, this activates the manual mode and Steptronic changes gear. The instrument cluster shows M1 through M5.

Upshifts and downshifts are executed only when they will result in a plausible combination of engine and vehicle speed; as a result, for example, a downshift that would cause the engine to overrev will not be executed by the system. The gear selected will appear briefly in the instrument cluster followed by the current gear.

To use the automatic function again, move the selector lever to the right into position D.

Malfunction



The warning lamp lights up. A malfunction has occurred in the transmission system. Avoid heavy loads.

While it will still remain possible to move the selector lever to any desired position, the transmission will revert to its default mode with only a limited number of forward gears.

Have the system checked as soon as possible.

Instructions on towing, tow starting and jump starting begin on page 108.

Turn signals/headlamp flasher

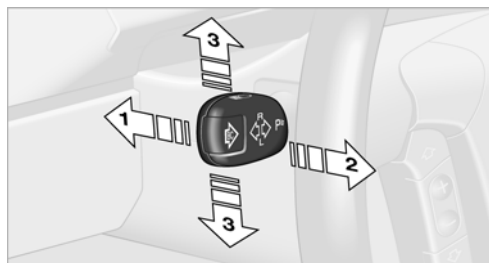

- 1 High beams
- 2 Headlamp flasher
- 3 Turn signals



Atypically rapid flashing of the indicator lamp indicates that a turn signal bulb has gone out. ◀

Signaling briefly

Press lever to resistance point and hold for as long as you wish to signal.

Touch signaling

Press lever to resistance point. The signal flashes three times.



If you wish, you can have this function activated. ◀

Washer/wiper system/ rain sensor*

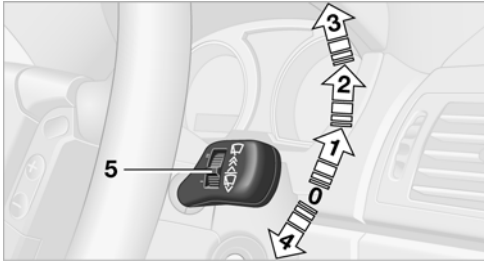

- 0 Wipers retracted
- 1 Intermittent or rain sensor operation
- 2 Normal wiper speed
- 3 Fast wipe
- 4 Brief wipe
- 5 Select interval time or set sensitivity of rain sensor

Fold-out position

The right wiper is partially concealed by the hood.

To move the wipers into a vertical position:

1. Switch on wipers in lever position **1**.
2. When the wipers are approximately vertical, move the ignition key to position **0**.

For changing the wiper blades, refer to page **99**.

 Fold the wipers back down onto the windshield before you turn the ignition key to position **1** or **2** again. If you do not, they could be damaged. ◀

Intermittent mode

Not on vehicles with rain sensor.

You can set the wipe interval to four stages with the knurled wheel **5**.

In addition, the wipe interval is varied automatically depending on road speed.

Rain sensor*

The rain sensor automatically controls wiper operation as a function of the rain intensity. The sensor is mounted on the windshield, directly in front of the interior rearview mirror.

 Deactivate the rain sensor when passing through an automatic car wash. Failure to do so could result in damage caused by undesired wiper activation. ◀

Activating

As of ignition key position **1** move the lever to position **1**. The wipers travel once across the windshield, regardless of the weather conditions.

You can leave the lever permanently in position **1** and then only need to activate the rain sensor as of ignition key position **1**. To do so:

- ▷ Briefly turn the knurled wheel **5** or
- ▷ Cleaning windshield **1**, refer to page **41**

Adjusting sensitivity

Turn the knurled wheel **5**.

Deactivating

Switch lever to position **0**.

Normal wiper speed

The system switches automatically to intermittent mode when the vehicle is not moving, not on vehicles with rain sensor.

Fast wipe

The wipers operate at normal speed when the vehicle is not moving, not on vehicles with rain sensor.

Cleaning windshield, rear window and headlamps*

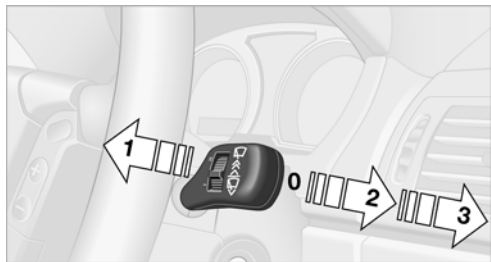

- 0 Wipers retracted
- 1 Cleaning windshield and headlamps
- 2 Rear window wiper intermittent mode
- 3 Cleaning rear window

 Do not activate the washer if there is any danger of the fluid freezing on the windshield. If you do so, your vision could be obscured. To avoid freezing, use a washer fluid antifreeze, refer to Washer fluid. Do not activate the washer when the washer fluid is empty as this will damage the washer pump. ◀

Cleaning windshield

The system sprays washer fluid against the windshield and activates the wipers for a brief period.

The washer jets are automatically heated whenever the engine is running or the ignition is switched on.

Cleaning headlamps*

When the vehicle lighting system is switched on, the headlamps are cleaned at regular and appropriate intervals.

Rear window wiper

Rear window wiper in intermittent mode. When reverse gear is engaged, the wiper operates continuously.

You can also program the interval:

- 1. Briefly move the wiper lever from position **0** to position **2**.
- 2. Wait for desired interval; maximum of 30 seconds.

- 3. Move the wiper lever from position **0** to position **2** again.

Washer fluid

 Washer fluid antifreeze is flammable. For this reason, keep it away from sources of flame and store it only in its original containers. Store it so that it is inaccessible to children. Always follow the instructions for use provided on the containers. ◀

Reservoir for washer fluid

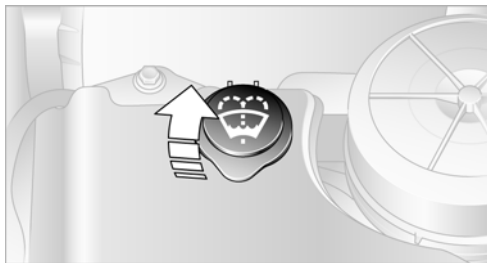

Fill with water and, if required, with an antifreeze additive according to manufacturer's recommendations.

 To maintain the mixing ratio, mix the washer fluid before adding it to the reservoir. ◀

Capacity

Approx. 3.2 US quarts/3 liters.

With headlamp washer system* approx. 6.9 quarts/6.5 liters.

Cruise control*

The vehicle maintains and stores the speed that you set as of a speed of approx. 20 mph/30 km/h.

You can use cruise control whenever the system is active while the engine is running.

On the sports steering wheel* and M sports steering wheel*, the +/- buttons for the cruise control are on the right side of the steering wheel.

 Do not use the cruise control under unfavorable conditions that do not permit a constant speed, e.g. when driving on winding roads or in heavy traffic or when negotiating poor road conditions such as snow, rain, ice, or a loose road surface. Otherwise, you could lose control of the vehicle and cause an accident. ◀

Indicator lamp



The indicator lamp lights up green: System ready for operation using the buttons on the steering wheel.

Activating system

I/O

As of ignition key position 2:
Press button on steering wheel; the indicator lamp in the instrument cluster comes on. You are able to use the cruise control.

Deactivating system

I/O

Press the button repeatedly until the indicator lamp in the instrument cluster goes out. The cruise control is also deactivated when the ignition key is turned to position 0. The speed stored in the memory is deleted in the process.

Maintaining speed, storing, and accelerating



Briefly press **+** button:
The system maintains and stores the current vehicle speed. Each additional touch of the button increases the speed by approx. 1 mph/ 1 km/h.

Press and hold **+** button:
The vehicle accelerates without pressure on the accelerator pedal. When you release the button, the system maintains and stores the current speed.

If the braking action of the engine is insufficient on a downhill stretch, the controlled speed can be exceeded. Speed can drop on uphill grades if the engine output is insufficient.

Decelerating



Briefly press **-** button:
Each press of the button decreases the vehicle's speed by roughly 1 mph/1 km/h, provided that you have already activated the cruise control.

Press and hold **-** button:
With the cruise control active, the system automatically reduces the fuel supply to slow the vehicle. When you release the button, the system maintains and stores the current speed.

Interrupting cruise control

I/O

When the system is activated, press button 1. The indicator lamp stays on. You can use the cruise control again whenever required by requesting the speed that was stored last.

In addition, the system is automatically interrupted in response to the following conditions:

- ▷ When you apply pressure to the brake pedal
- ▷ When you apply pressure to the clutch pedal or when you move the automatic transmission selector lever from D to N
- ▷ If you exceed or fall below the controlled speed for an extended period, by pressing the accelerator, for example
- ▷ When DSC is activated

Resuming stored speed



Press button:
The vehicle accelerates to and maintains the last speed stored.

Everything under control

Odometer



- 1 Odometer
- 2 Trip odometer

Odometer

You can activate the displays shown in the illustration in ignition key position 0 or with the ignition key removed by pressing the button in the instrument cluster.

Trip odometer

To reset to zero:

1. Ignition key in position 1.
2. Press and hold the button until the trip odometer is reset to zero.

Tachometer



Engine speeds in the red warning field must absolutely be avoided.

In this range, the fuel supply is interrupted to protect the engine.

Fuel gauge

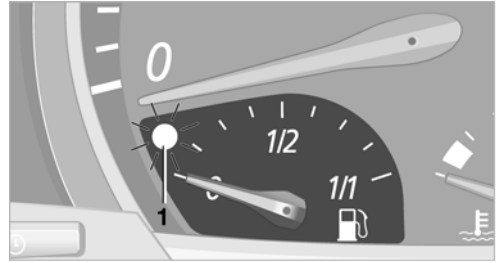

Fuel tank capacity: approx. 17.7 gallons/ 67 liters. Instructions for refueling can be found on page 84.

If the tilt of the vehicle varies, when you are driving in mountainous areas, for example, the indicator may fluctuate slightly.

Reserve

If the LED 1 starts to light up continuously, there are still approx. 2 gallons/8 liters of fuel left in the tank.

 Refuel well before the tank is empty. If you drive down to the last drop, engine functions are no longer assured and damage can occur. ◀

When you switch on the ignition, the LED comes on briefly to confirm that the system is operational.

Coolant temperature gauge

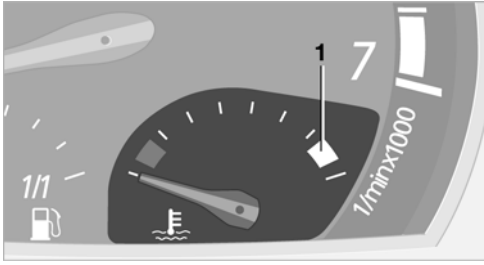

Blue

The engine is still cold. Drive at moderate engine and vehicle speeds.

Between blue and red fields

Normal operating range. It is permissible for the dial to drift up to the red field.

Red

Comes on while driving:
The engine is overheated. Switch off the engine immediately and allow it to cool down.
Checking coolant level, refer to page 95.

When you switch on the ignition, the warning lamp **1** comes on briefly to confirm that the system is operational.

Service Interval Display

Remaining distance until next service due

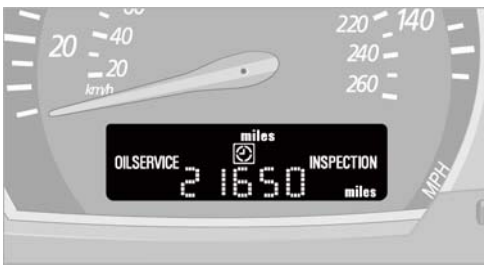

The displays shown in the illustration appear for a few seconds as of ignition key position 1 or after starting the engine.

Together with the message OIL SERVICE or INSPECTION, the next scheduled service and remaining distance to this service are displayed in miles/kilometers.

The remaining distance is determined on the basis of the past driving style.

A flashing display and a – sign before the numerical value mean that the service interval has been passed by the displayed number of miles/kilometers. Please make an appointment with your BMW Sports Activity Vehicle Center.

Clock

If you wish to have a continuous clock display, you can also have the time displayed in the display of the car radio, refer to Owner's Manual for Radio.

You can set the clock to also be displayed in the radio, as follows.

Setting time



As of ignition key position 1:

Hours

1. Hold button **2** pressed for a few seconds until the hours are displayed and the colon flashes.
2. Press button **1** repeatedly until the desired hour is set.

Minutes

3. Press button **2** to change to the minutes display.
4. Press button **1** repeatedly until the desired minutes are set.

5. Press button **2** to confirm the time.

The set time is transferred to the display of the radio or displayed in the instrument cluster.

Display mode

Ignition key in position 0 or removed:

Press button **1**.

The time and display of the miles/kilometers appear for a few seconds.

Computer*

Mode selection

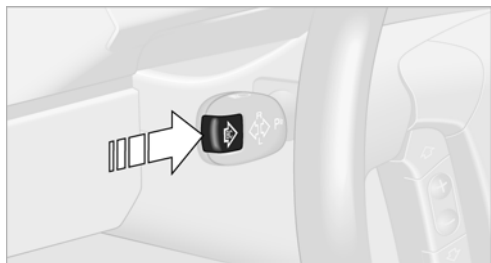

As of ignition key position 1, you can call up information from the computer using the computer button in the turn signal lever.

A new function appears each time you briefly press the computer button.

The following information is displayed in the sequence indicated:

- ▷ Time
- ▷ Outside temperature
- ▷ Average fuel consumption
- ▷ Cruising range
- ▷ Average speed

As of ignition key position 1, the last active setting is displayed.



If you wish, you can display the following functions in a different unit of measure. ◀

Outside temperature



Changing unit of measure °F / °C

During the display, hold down the button in the turn signal lever until the display changes.

Outside temperature warning

If the outside temperature falls below approx. +37.5 °F / +3 °C, the computer switches automatically to the outside temperature display. In addition, an acoustic signal sounds and the display flashes for a short time. There is an increased risk of icy conditions.



After an outside temperature warning has been issued, the display returns to the previous setting. You can have this activated/deactivated. ◀



Ice can also occur at temperatures greater than +37,5 °F / +3 °C. For this reason, drive carefully on bridges and shaded roadways, for example. Otherwise, there is an increased risk of accidents. ◀

Clock



12 or 24 hour mode

If your vehicle is equipped with a computer, you can have the time displayed in the 12 or 24 hour mode.

During the display, hold down the computer button in the turn signal lever until the display changes.

Average fuel consumption

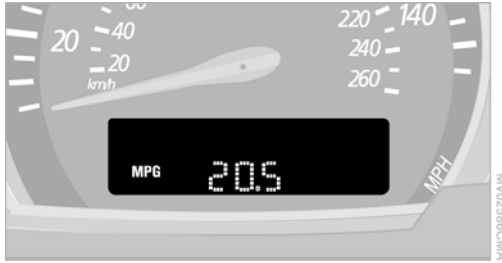

The average fuel consumption is calculated for the time during which the engine is running.

Reset average consumption:

Press the computer button in the turn indicator lever for approx. 2 seconds.

Cruising range

Displays the estimated cruising range available with the remaining fuel. The current fuel level is measured and the range is calculated taking into account the driving style over the last 20 miles/30 km.



Always refuel as soon as possible once your cruising range falls to below 30 miles/50 km; otherwise, engine functions are not ensured and damage can occur. ◀

Average speed

The calculation of the average speed does not take into account periods in which the vehicle is parked with the engine switched off.

Resetting average speed: press the computer button in the turn indicator lever for approx. 2 seconds.

Technology for comfort, convenience and safety

PDC Park Distance Control*

The concept

PDC provides extra safety and convenience during parking maneuvers. Audible signals indicate that you are approaching an object in front of or behind your vehicle. To measure the distance, there are four ultrasonic sensors in each bumper.

An acoustic signal begins to sound when the front sensors and the rear corner sensors are within approx. 2 ft/60 cm of an obstacle and when the rear middle sensors are within approx. 5 ft/1,50 m of an obstacle.



PDC is a parking aid that can indicate objects when they are approached slowly, as is usually the case when parking. Avoid approaching objects too fast; otherwise, the system may give warning of physical obstacles too late. ◀

If you are driving with a trailer, the rear sensors cannot take any meaningful measurements. Consequently, they do not switch on.

Automatic mode

In ignition key position 2, the system is automatically activated after approx. one second each time you shift into reverse or move the selector-lever into position R. Wait for this short time span before moving.



You can have a signal tone programmed into the system to verify that the PDC is active. ◀

Activating manual mode

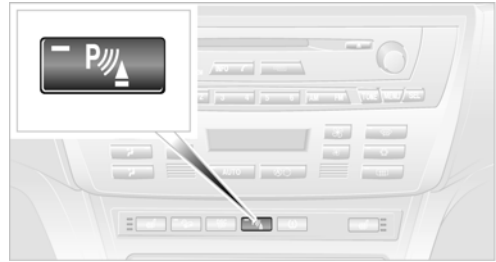

In ignition key position 2, press the button; the LED lights up.

Deactivating manual mode

Press the button again, the LED goes out.

The system is automatically deactivated once the vehicle travels approx. 160 ft/50 m or exceeds a speed of roughly 20 mph/30 km/h; the LED goes out. You can reactivate the system manually as needed.

Signal tones

An intermittent tone from a rear speaker signals the distance to an object behind the vehicle as you approach it.

An intermittent tone from a speaker beneath the dashboard signals the distance to an object in front of the vehicle as you approach it. As the distance between vehicle and object decreases, the intervals between the tones become shorter. The signal tone becomes continuous once the distance to the nearest object falls to below roughly 1 ft/30 cm.

An intermittent tone is interrupted after approx. 3 seconds:

- ▷ if you remain in front of an object that is only detected by one of the corner sensors
- ▷ if you are moving parallel to a wall

Malfunction

The LED in the button flashes and a short continuous tone sounds. PDC is malfunctioning. Switch off PDC. Have the system checked.

To prevent this problem, keep the sensors clean and free of ice or snow in order to ensure that they will continue to operate effectively. When using high-pressure washers, do not spray sensors for long periods and keep the sprayer at least 4 in/10 cm away from the sensors.

System limits

 Even with PDC, final responsibility for estimating the distance between the vehicle and any obstructions always remains with the driver. Even when sensors are involved, there is a blind spot in which objects cannot be detected. The system is also subject to the physical limits that apply to all forms of ultrasonic measurement, such as those encountered with tow bars and trailer couplings, or thin and wedge-shaped objects, etc. Low objects already displayed, e.g. a curb, can come into the blind spot of the sensors before a continuous tone sounds. The system may fail to detect higher obstacles such as ledges. Loud sources of sound, inside and outside the vehicle, could drown out the PDC signal tone. ◀

Driving stability control systems

Your BMW is equipped with an extended array of systems designed to enhance and maintain vehicle stability even under unfavorable driving conditions.

ABS Antilock Brake System

ABS prevents the wheels from locking during braking. Safe steering response is maintained even during full braking. This results in an increase in the active safety.

ABS is operational every time you start the engine. Safe braking, refer to page 78.

Electronic brake-force distribution

The system controls the brake pressure in the rear wheels to ensure a stable braking behavior.

DBC Dynamic Brake Control

When the brake pedal is depressed quickly, this system automatically generates a maximum braking force distribution and thus helps keep the braking distance to a minimum during full braking. This system exploits all of the benefits provided by ABS.

As long as you want full braking to continue, do not reduce pressure on the brake.

DSC Dynamic Stability Control

DSC prevents slip at the drive wheels when starting off and accelerating. DSC also detects unstable driving conditions, such as a fishtailing of the vehicle's rear end or the sliding of the vehicle on its front wheels. In these circumstances, DSC helps keep the vehicle on a safe path, within physical limits, by reducing engine output and by applying the brakes in individual wheels.

The DSC is operational every time you start the engine.

 The laws of physics cannot be repealed, even with DSC. An appropriate driving style always remains the responsibility of the driver. Do not reduce the additional safety margin again by taking unnecessary risks. ◀

Indicator lamp



The indicator lamp goes out shortly after the engine starts.

When the indicator lamp flashes: DSC is controlling the drive and braking forces.

When the indicator lamp stays lit: DSC has been switched off with the button.

Deactivating DSC



Press the button; the indicator lamp in the instrument cluster lights up continuously. DSC is now deactivated.

Stabilizing interventions of the chassis control system DSC are no longer available. However, the braking interventions that simulate the function of the differential lock continue to be active.

In the following exceptional circumstances, it may be useful to switch off DSC for a short period:

- ▶ When rocking the vehicle and starting off in deep snow or on loose road surfaces
- ▶ On sandy road surfaces
- ▶ On poor surfaces with deep ruts
- ▶ If the wheels spin on muddy surfaces
- ▶ When driving with snow chains

 As a result of the braking interventions, the brakes may be subjected to additional loads when the system is switched off. In order to limit the brake temperature, brief automatic suppression of the brake activation is possible. To maintain vehicle stability, always drive with the system switched on when possible. ◀

Reactivating DSC



Press the button again; the indicator lamp in the instrument cluster goes out. DSC is now activated.

xDrive

xDrive is the all-wheel drive system of your X3. The combined effects of xDrive and DSC further optimize the traction and dynamic driving characteristics. The all-wheel drive system xDrive variably distributes the drive torque to the front and rear axle depending on the driving situation and prevailing road conditions.

HDC Hill Descent Control

The concept

HDC is a system for hill descent assistance that reduces the speed on steep downward inclines and makes it even easier to control the driving characteristics of your BMW under these conditions. The vehicle moves at slightly more than walking speed without active intervention from the driver.

HDC is available for activation at vehicle speeds below approx. 20 mph/35 km/h. When driving down steep hills with a speed below approx. 20 mph/35 km/h, the vehicle reduces speed automatically down to slightly more than walking speed, approx. 5 mph/8 km/h, and then maintains this speed at a constant.

You can use the accelerator or brakes to vary this automatically controlled speed within a range extending from approx. 3 mph/5 km/h to 15 mph/25 km/h.

You can specify a target speed within the same range by using the +/- buttons of the cruise control on the steering wheel.

Activating system



Press the button; the LED lights up.
The LED flashes when the brakes are applied automatically.

Deactivating system

Press the button again; the LED goes out.
HDC is deactivated immediately above approx. 35 mph/60 km/h and after approx. 10 seconds when the ignition is switched off.

Using HDC

With manual transmission:
Use HDC in first gear and in reverse, because in the higher gears the engine's braking action diminishes.
With automatic transmission:
You can use HDC in every drive position.

Malfunction

If the LED in the button goes out in the HDC mode or fails to light up when the button is pressed:
HDC is temporarily not available, because the brake temperature is too high.

Malfunction in vehicle stability control systems

BRAKE The warning lamp lights up yellow. DBC Dynamic Brake Control is malfunctioning. Have the system checked as soon as possible.

(!) Display of the previously described malfunction on Canadian models.

(!) If one of the malfunctions described below occurs, proceed cautiously and defensively. When driving on poor roads, avoid using the full throttle or kick-down positions of the accelerator as well as heavy and panic braking. Otherwise, the drive train may be damaged or accidents can occur. ◀

BRAKE The red brake warning lamp lights up together with the warning lamps for ABS and DSC/xDrive. In addition, a warning signal sounds. ABS, DSC, HDC and xDrive have failed. It is then possible to exert driving force only via the rear axle. If the brake warning lamp lights up yellow in the described combination, the EBV Electronic brake-force distribution is still available. Have the system checked as soon as possible.

(!) Display of the previously described malfunction on Canadian models.



The warning lamp lights up continuously and a warning signal sounds: DSC or the xDrive all-wheel system has failed.

The stabilizing interventions of DSC or the all-wheel drive system xDrive are no longer available. It is then possible to exert driving force only via the rear axle. Have the system checked as soon as possible.

Flat Tire Monitor FTM*

The concept

The Flat Tire Monitor keeps track of the inflation pressures in the four mounted tires as you drive. The system triggers an alert whenever the inflation pressure in one tire drops significantly in relation to the pressure in another tire. When a loss of pressure occurs, the rolling radius changes and with it, the rotational speed

of the wheels. This change is detected and signaled as a flat tire.

Functional requirement

To ensure the reliable signaling of a flat tire, the system must be initialized at the correct tire inflation pressure.

 The initialization must be repeated after every correction of the tire inflation pressure, after every tire or wheel change, and after a trailer is hitched or unhitched. ◀

System limits

 The Flat Tire Monitor cannot predict sudden severe tire damage caused by outside factors and does not detect a natural, even pressure drop in all four tires. ◀

In the following situations, the system could be delayed or malfunction:

- ▶ When the system has not been initialized
- ▶ When driving on snow-covered or slippery road surfaces
- ▶ Sporty driving style: slip in the drive wheels, high lateral acceleration.
- ▶ When driving with snow chains

When driving with a compact wheel, the Flat Tire Monitor cannot operate.

Initializing system

 The system must be reinitialized after every correction of tire inflation pressure and after every tire or wheel change. Do not initialize the system when driving with snow chains or with a compact wheel. ◀

1. Start the engine just before driving, but do not begin to drive.
2. Press the button for at least 4 seconds, but not longer than 2 minutes. After the button is released, the indicator lamp in the instrument cluster lights up yellow for a few seconds.



3. Begin driving.
The initialization is completed during driving and can be interrupted at any time without requiring any input from you. The initialization automatically continues when driving resumes.

Indication of a flat tire

 The warning lamp lights up red. In addition, an acoustic signal sounds. There is a flat tire or extensive inflation pressure loss.

1. Reduce speed and stop the vehicle carefully. Avoid sudden braking and steering maneuvers.
2. Identify damaged tire.

 If identification is not possible, contact your BMW Sports Activity Vehicle Center. ◀

3. Replace the damaged wheel, refer to Changing a wheel on page 103.

Malfunction

 The warning lamp lights up yellow. The Flat Tire Monitor is malfunctioning or out of order. Have the system checked as soon as possible.

TPM Tire Pressure Monitor*

The concept

TPM controls the tire inflation pressure in the four mounted wheels. The system notifies you if the tire inflation pressure has fallen significantly in one or more tires.

Functional requirement

To ensure the reliable signaling of a flat tire, the system must be reset at the correct tire inflation pressure.

Always use wheels equipped with TPM electronics, including a metal valve; otherwise, there is no guarantee that the system will function properly.

▶ The system must be reset after every correction of tire inflation pressure and after every tire or wheel change. ◀

System limits

⚠ TPM cannot warn you of sudden, serious tire damage due to external factors. ◀

The system does not function properly if it has not been reset, e.g. it may identify a tire as flat in spite of the fact that the tire is filled to the correct inflation pressure.

The system is inactive and cannot indicate flat tires if a wheel not equipped with TPM electronics has been mounted, e.g. a compact wheel, or if TPM is experiencing temporary interference from other systems or devices that use the same frequency.

Resetting system

▶ The system must be reset after every correction of tire inflation pressure and after every tire or wheel change. ◀

1. Start engine, but do not begin to drive.
2. Press the button until the yellow warning lamp in the instrument cluster lights up for a few seconds.



3. Begin driving.

After a few minutes of driving, the tire inflation pressures in the tires are adopted as the desired values to be monitored. The resetting is completed during driving and can be interrupted at any time without requiring any input from you. The resetting automatically continues when driving resumes.

Low tire pressure message



The warning lamp lights up yellow. In addition, a signal sounds. You have a flat tire or a significant loss of tire pressure in one or more tires.

1. Reduce speed and stop the vehicle carefully. Avoid sudden braking and steering maneuvers.
2. Identify the damaged wheel or wheels.
 - ▶ If identification is not possible, contact your BMW Sports Activity Vehicle Center. ◀
3. Replace the damaged wheel, refer to Wheel changes on page 103.
4. Check tire inflation pressure and correct as needed.

The compact wheel is not equipped with the required TPM electronics and is not monitored when mounted.

When driving with the compact wheel, the system indicates a malfunction.

Have the damaged tire replaced by your BMW Sports Activity Vehicle Center or a workshop that is familiar with TPM and works in accordance with BMW repair procedures, using appropriately trained personnel.

Malfunction



The yellow warning lamp flashes and then lights up continuously. Flat tires cannot be detected.

Such a message is displayed in the following situations:

- ▷ In the event of a malfunction: Have the system checked
- ▷ When a wheel without TPM electronics is mounted, e.g. a compact wheel
- ▷ When TPM is experiencing temporary interference from other systems or devices that use the same frequency

Brake force display

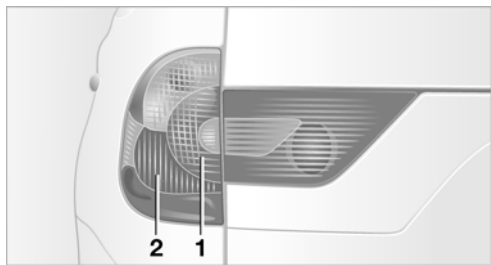

The brake lamps light up in two stages, depending on how heavily you apply the brakes.

- ▷ Normal braking: The brake lamps **1** and the center brake lamp light up.
- ▷ Powerful braking: The brake lamps **1** and **2** light up together with the center brake lamp.

Airbags

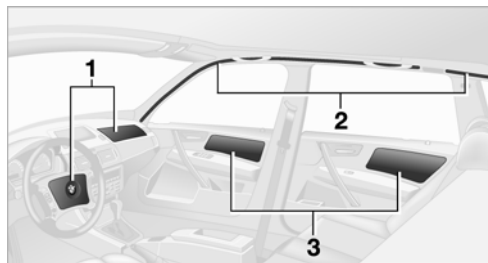

The following airbags are located beneath the marked covers:

- 1** Front airbags
- 2** Head airbags
- 3** Side airbags in front and rear*

Protective action



To ensure that the safety systems continue to provide optimal protection, please follow the instructions on page 26. ◀

The front airbags help protect the driver and front passenger by responding to frontal impacts in which safety belts alone cannot provide adequate restraint. When needed, the head and side airbags help provide protection in the event of side impact. The relevant side airbag supports the side upper body area. The respective head airbag supports the head.

The airbags will purposely not be activated by every collision, e.g. not by more minor accidents, or rear-end collisions.



Do not apply adhesive materials to the cover panels of the airbags, cover them or modify them in any other way.

Do not attempt to remove the airbag retention system from the vehicle. Do not modify the individual components of the system or its wiring in any way. This includes the padded covers in the center of the steering wheel, on the dashboard, the doors, and the roof pillars as well as the sides of the headliner. Do not attempt to remove or dismantle the steering wheel. Do not touch the individual components directly after the system has been triggered, because there is a danger of burns.

In the event of malfunctions, deactivation, or triggering of the airbag restraint system, have the testing, repair, removal, and disposal of airbag generators executed only by a BMW Sports Activity Vehicle Center or a workshop that works according to BMW repair procedures with correspondingly trained personnel and has the required explosives licenses. Unprofessional attempts to service the system could lead to failure in an emergency or undesired airbag activation, either of which could result in personal injury. ◀

Airbag warnings and information are also provided on the sun visors.

Automatic deactivation of front passenger airbags

By evaluating the pressure on the seat cushion of the front passenger seat, the system detects whether or not the seat is occupied. The front and side airbags for the passenger are activated or deactivated by the system accordingly.

 The indicator lamp located above the inside rearview mirror indicates whether the front passenger airbag system is currently deactivated or activated, refer to Status of passenger airbag in the section below. ◀

 Before transporting a child in the front passenger seat, follow the safety notices and instructions under Transporting children safely, refer to page 33.

When teenagers or adults assume certain sitting positions, the front and side airbags on the passenger side can deactivate; this causes the indicator lamp for the front passenger airbag to light up. If this happens, have them change their sitting position so that the passenger airbag is activated and the indicator lamp goes out. If the desired status cannot be achieved by changing their sitting position, then have the person ride in the back. Do not attach seat covers, seat cushion padding, ball mats or other items to the passenger seat unless they are specifically recommended by BMW. Do not place any items under the seat which could press against the seat from below. Otherwise, a correct analysis of the seat cushion is not ensured. ◀

Status of passenger airbags

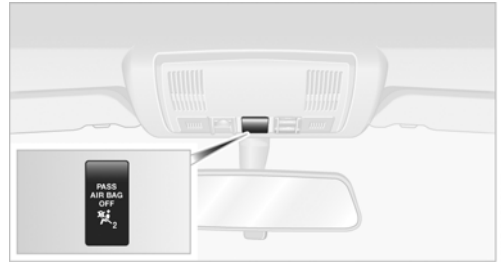

The indicator lamp for the passenger airbag indicates the operational readiness of the front and side airbag on the passenger side depending on whether or not the seat is occupied. The indicator lamp indicates whether the passenger airbags are activated or deactivated.

- ▷ The indicator lamp lights up when a child sitting as directed in a child restraint system designed for this is detected.
The front and side airbags on the passenger side are not activated.
- ▷ The indicator lamp does not come on as long as a person of sufficient size and in a correct sitting position is detected on the seat. The front and side airbags for the passenger are activated.
- ▷ The indicator lamp does not light up when the seat is empty.
However, the front and side airbags for the passenger are not activated.

Operational readiness of airbag system

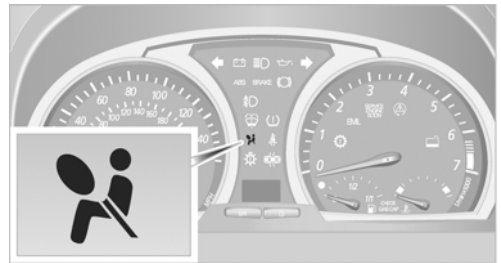

As of ignition key position 1, the warning lamp lights up briefly, thus indicating the operational readiness of the entire airbag system and the safety belt tensioners.

Airbag system malfunction

- ▷ Warning lamp does not come on with the ignition key in position 1 or higher.
- ▷ The warning lamp lights up continuously.



Have the airbag system checked immediately if a malfunction occurs; otherwise, there is a danger of the system failing to respond in the expected manner to an impact occurring within its normal response range. ◀

Lamps

Parking lamps/low beams



Parking lamps

 The front, rear and side vehicle lighting is switched on. You can use the parking lamps for parking. For the additional option of roadside parking lamps on one side of the vehicle only, refer to page 57.

 The parking lamps will discharge the battery. For this reason, avoid using them for extended periods; otherwise, it may no longer be possible to start the engine. ◀

Low beams

 When you switch off the ignition with the headlamps on, the headlamps go out and only the parking lamps remain on.

Defective lamps

 The indicator lamp lights up: At least one bulb of the exterior lighting on the vehicle is defective.

Replacing bulbs, refer to page 99.

Pathway lighting

When you activate the headlamp flasher after parking the vehicle and switching off the lamps, the low beams will come on for a brief period.

 You may also have this function deactivated if you wish. ◀

Lights on warning

If you turn the ignition key to position 0, an acoustic signal sounds when you open the driver's door for a few seconds to remind you that the lights have not yet been switched off.

Daytime running lamps*

If so desired, the light switch can remain in the low beam or automatic headlamp control position.

The exterior lamps are automatically switched off after the vehicle is parked.

You can switch on the parking lamps when needed using the standard procedure described under Parking lamps.

 You can have the daytime running lamps activated on your vehicle. ◀

Automatic headlamp control*

 When you set the switch to this position, the system activates and switches on and off the low beams in response to changes in ambient light conditions, for instance, in tunnels, at dawn and dusk, and in rain and snow.

When you enter a tunnel with bright ceiling lighting, this can delay the switching on of your low beams.

A blue sky with the sun low on the horizon can also cause the headlamps to come on.

 The low beams remain switched on regardless of the ambient light when you switch on the front fog lamps*.

When the daytime running lamps are activated as described in the section above, the low-beam headlamps are always switched on when the switch is in this position and the ignition is on. ◀

If so desired, the light switch can remain in the automatic headlamp control position. The exterior lamps are automatically switched off after the vehicle is parked.

 Automatic headlamp control cannot serve as a substitute for the driver's judgment in determining when the vehicle lamps should be switched on. For example, the system cannot detect fog or hazy weather. To avoid safety risks, you should always switch on the lamps manually under these conditions. ◀

 You can have the sensitivity of the headlamp control adjusted. ◀

Adaptive Head Light*

The concept

Adaptive Head Light is a variable headlamp control system that enables better illumination of the road surface. Depending on the steering angle and other assumptions, the light from the headlamp follows the course of the road.

Activating Adaptive Head Light

 In ignition position 2, turn the light switch into the automatic headlamp control position, refer to page 56.

The LED next to the symbol lights up.

In order not to blind oncoming traffic, the Adaptive Head Light is not active when driving in reverse and only points toward the passenger side when the vehicle is stationary.

Malfunction

The LED next to the symbol for automatic headlamp control flashes. Adaptive Head Light is malfunctioning or has failed. Have the system checked as soon as possible.

High beams/ roadside parking lamps

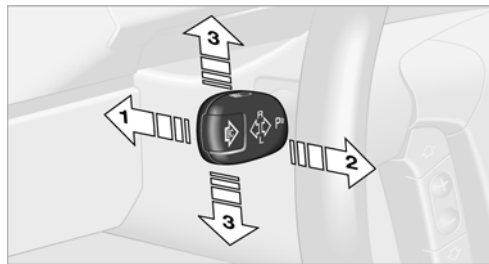

- 1 High beams
- 2 Headlamp flasher
- 3 Roadside parking lamps

Roadside parking lamps, left or right*

You also have the option of lighting up just one side of your vehicle when parking. When doing so, be sure to comply with national regulations.

After switching off the engine, press the lever past the resistance point in the corresponding direction **3**.

 The roadside parking lamps drain the battery. For this reason, avoid using them for extended periods; otherwise, it may no longer be possible to start the engine. ◀

Front fog lamps*



Briefly press the button once again to switch on/off.

 The parking lamps or low beams must be switched on for the fog lamps to operate. The green indicator lamp lights up when the fog lamps are on.

 If the automatic headlamp control is activated, the low beams will come on automatically when you switch on the fog lamps. ◀

Instrument lighting

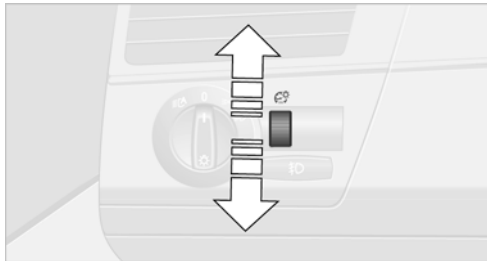

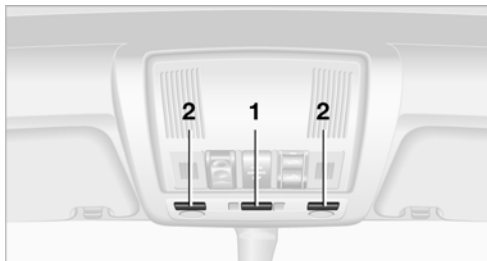

Turn the knurled wheel to adjust the illumination intensity.

Interior lamps



The interior lamps operate automatically.

 If you wish, the interior lamps are switched on after mechanical unlocking of the vehicle. You may have this function activated/deactivated if you wish. ◀

 If the interior lamps remain switched on after locking the vehicle, one of the doors or the liftgate may not be completely closed. ◀

Switching interior lamps on and off

Briefly press button **1**.

If you want the interior lamps to remain off all the time, press and hold the button for approx. 3 seconds.

Press the button briefly to revert to normal operation.

 You can have your interior lamps set to dim smoothly to the desired level when you switch them on or off. ◀

Front reading lamps*

Switch on and off with buttons **2**.

Rear reading lamps*

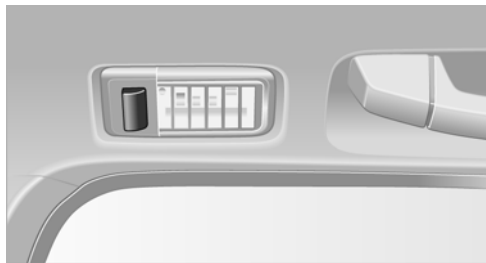

Switch on and off with the button.

 To avoid discharging the battery, all of the vehicle's interior lamps are automatically extinguished approx. 15 minutes after the ignition is switched off. ◀

Air conditioner

Air conditioner

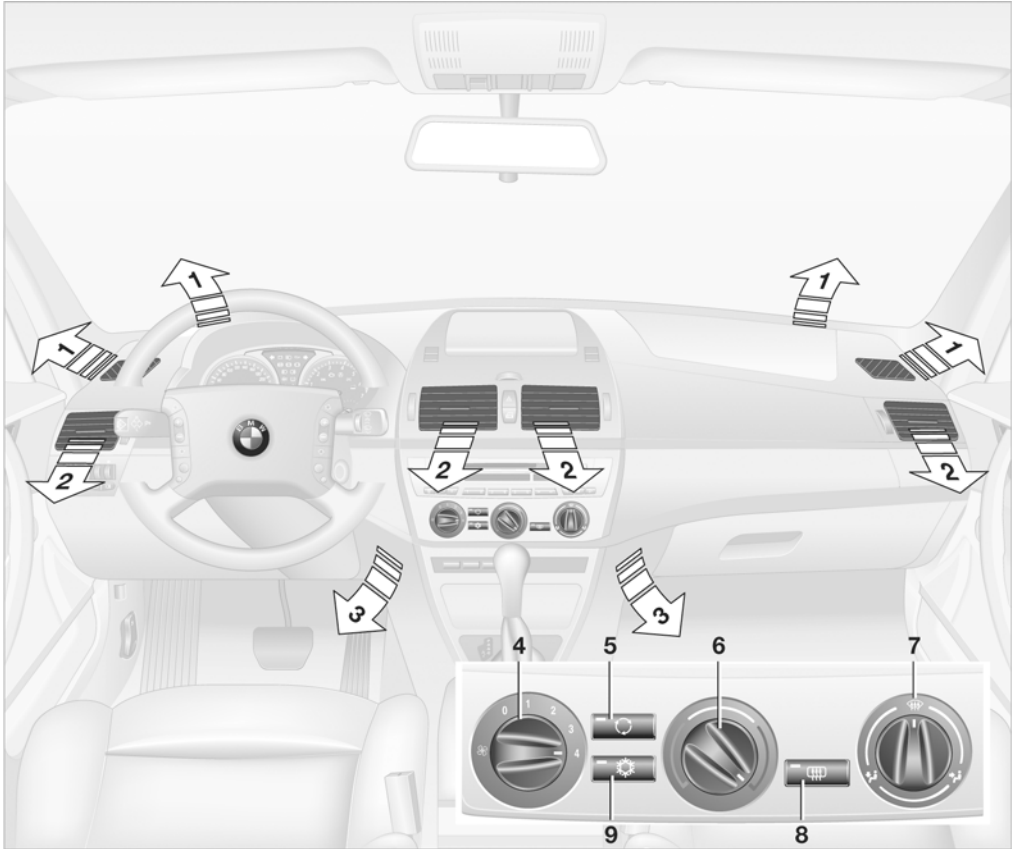

- | | | | | | |
|---|---|----|-----------------------|-----------------------|----|
| 1 | Airflow directed toward the windshield and side windows | 5 | Recirculated-air mode | 60 | |
| 2 | Airflow for the upper body | 61 | 6 | Temperature | 60 |
| 3 | Airflow to footwell | 61 | 7 | Air distribution | 60 |
| 4 | Air volume | 60 | 8 | Rear window defroster | 60 |
| | | | 9 | Cooling function | 60 |

Air volume



You can vary the air volume in steps 1 through 4. The heating or cooling output is more effective with a higher air volume.

Switching system on/off

Turn air volume rotary switch to 0. The blower and air conditioning system are completely switched off, the air flow is shut off.

To switch on the air conditioning system, set an arbitrary air volume.

Temperature





To increase the temperature, turn to the right, toward red.

For a lower temperature, turn the rotary switch counterclockwise toward blue.

Air distribution



You can direct air to flow onto the windows , toward the upper body  and into the footwell . Intermediate settings are possible.

Rear window defroster



The rear window heating switches off automatically after a certain amount of time.

Switching cooling function on/off



When the air conditioning is on, the air is cooled, dehumidified, and then reheated depending on the temperature setting.

Depending on the weather, the windshield may fog over briefly when the engine is started.

Recirculated-air mode





You can respond to unpleasant odors outside the vehicle by temporarily suspending the supply of outside air. The system then recirculates the air currently within the vehicle.

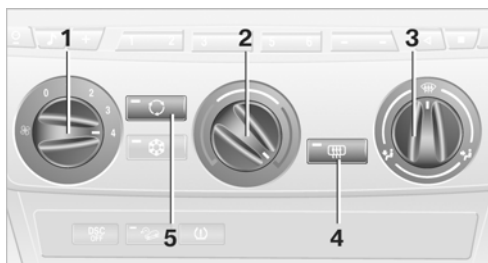

If condensation starts to form on the inside window surfaces during operation in the recirculated-air mode, you should switch it off and increase the air supply as needed. The recirculated-air mode should not be used over a sustained period of time; otherwise, the air quality inside the vehicle will steadily deteriorate. ◀

Defrosting windows and removing condensation



1. Air volume **1** at level 4.
2. Temperature **2** toward right, red.
3. Air distribution **3** in position .
4. Deactivate recirculated-air mode **5**.
5. Switch on the rear window heating **4** to defrost the rear window.

Ventilation

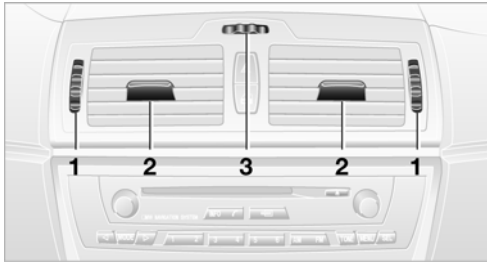

- 1 Knurled wheels for opening and closing the air vents through an infinitely variable range
- 2 Levers for changing airflow direction
- 3 Knurled wheel for more or less cool air from the air vents for the upper body region

Ventilation for cooling

Adjust the vents to direct the flow of cool air in your direction, for instance, if the interior has become too warm.

Draft-free ventilation

Set the vent outlets so that the air flows past you and is not directed straight at you.

Microfilter

The microfilter removes dust and pollen from the incoming outside air. It is replaced when maintenance is performed by your BMW Sports Activity Vehicle Center. A substantial reduction in air supply indicates that the filter should be replaced before normal maintenance.

Automatic climate control*



1M10248BCMA

- 1 Airflow directed toward the windshield and side windows
- 2 Airflow for the upper body 64
- 3 Airflow to footwell 64
- 4 Manually varying air distribution 63
- 5 Adjusting temperature 63
- 6 Temperature display 63, Air volume 63
- 7 Manually varying air volume 63
- 8 Defrosting windows and removing condensation 63
- 9 Rear window defroster 64
- 10 Switching cooling function on/off 63
- 11 Outside air/AUC Automatic recirculated-air control/recirculated-air mode 63
- 12 AUTO program 63

A congenial climate

For almost all conditions, the AUTO program 12 offers the optimal air distribution and air volume, refer to AUTO program below. You need only select an interior temperature that you find pleasant.

The following sections contain more detailed information on the available setting options.





 Your vehicle has been designed to automatically select your personal climate-control settings whenever you unlock the doors using your individually programmed remote control. ◀

AUTO program

 The AUTO program handles the adjustment of air distribution to the windshield and side windows, in the direction of the upper body, and in the footwell. It also adapts your instructions for the air volume and temperature to outside influences throughout the year, e.g. solar radiation or window condensation.



The cooling is switched on automatically along with the AUTO program.

Manually switching air distribution on/off

 You can direct air to flow onto the windows , toward the upper body  and into the footwell .

 You can reactivate the automatic air distribution mode by selecting the AUTO button.

Temperature

 Set the desired temperature.
 The automatic climate control assures that this temperature is reached as quickly as possible any time of year, using maximum cooling or heating capacity as needed, and then keeps this temperature constant.

 When you change between different temperature settings in rapid succession, the system does not have enough time to achieve the desired temperature. ◀

Manually adjusting air volume

 By pressing the lower button, you can reduce the air volume. You can increase it by pressing the upper button.

 You can reactivate the automatic air volume mode by pressing the AUTO button.

Switching system on/off

At the lowest fan speed, press the lower button to turn off the automatic climate control completely. All displays disappear.

Press any button to turn the automatic climate control back on again.

Defrosting windows and removing condensation

 This program quickly removes ice and condensation from the windshield and front door windows.

Switching cooling function on/off

 When the air conditioning is on, the air is cooled, dehumidified, and then reheated depending on the temperature setting. Depending on the weather, the windshield may fog over briefly when the engine is started.

The cooling function is automatically switched on along with the AUTO program. It is only possible to cool the passenger compartment with the engine running.

AUC Automatic Recirculated-air Control/recirculated air mode

 You can set the desired operating mode by pressing the button repeatedly:

- ▷ LEDs off: outside air continuously flows into the vehicle.

- ▶ Left LED on, AUC mode: a sensor detects pollutants in the outside air. The system suspends the supply of outside air as needed and recirculates the air currently within the vehicle. As soon as the concentration of pollutants in the outside air has decreased sufficiently, the system switches automatically back to supplying outside air.
- ▶ Right LED on, recirculated-air mode: the outside air supply into the vehicle is shut off continuously. The system then recirculates the air currently within the vehicle.

 If condensation starts to form on the inside window surfaces during operation in the recirculated-air mode, you should switch it off and increase the air supply as needed. The recirculated-air mode should not be used over a sustained period of time; otherwise, the air quality inside the vehicle will steadily deteriorate. ◀

Rear window defroster



The rear window heating switches off automatically after a certain amount of time.

Ventilation

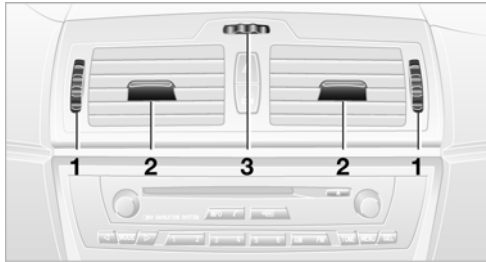

- 1 Knurled wheels for opening and closing the air vents through an infinitely variable range
- 2 Levers for changing airflow direction
- 3 Knurled wheel for more or less cool air from the air vents for the upper body region

Ventilation for cooling

Adjust the vents to direct the flow of cool air in your direction, for instance, if the interior has become too warm.

Draft-free ventilation

Set the vent outlets so that the air flows past you and is not directed straight at you.

Microfilter/activated-charcoal filter*

The microfilter removes dust and pollen from the incoming outside air. The activated-charcoal filter provides additional protection by filtering gaseous pollutants from the outside air. This combined filter is replaced when maintenance is performed by your BMW Sports Activity Vehicle Center. A substantial reduction in air supply indicates that the filter should be replaced before normal maintenance.

Practical interior accessories

Integrated universal remote control*

The concept

The integrated universal remote control replaces up to three different hand-held transmitters for various items of radio-controlled equipment such as door openers and house alarm systems. The integrated universal remote control recognizes and learns the transmitted signal of each of the original hand-held transmitters.

The signal of an original hand-held transmitter can be programmed on one of the three memory buttons **1**. Once this is done, each of the devices can be actuated with the appropriately programmed memory button **1**. The LED **2** indicates transmission of the signal.

Should you sell your vehicle one day, be sure to delete the stored programs beforehand for your security, refer to page 66.

 To prevent possible damage or injury, before programming or using the integrated universal remote control, always inspect the immediate area to make certain that no people, animals or objects are within the travel range of the device. Also, comply with the safety precautions of the original hand-held transmitter. ◀

Checking compatibility

 If you see this symbol on the packaging or in the manual supplied with the original hand-held transmitter, then it is safe to assume that the radio-controlled device is compatible with the integrated universal remote control.

 If you have additional questions, please ask at your BMW Sports Activity Vehicle Center or call: 1-800-355-3515. You can find also information on the Internet at: www.bmwusa.com or www.homelink.com.

HomeLink is a registered trademark of Johnson Controls, Inc. ◀

Programming

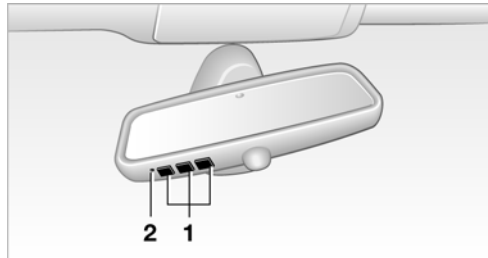

- 1 Memory buttons
- 2 LED

Fixed-code hand-held transmitters

1. Turn the ignition key to position 2.
2. For initial use:
Press both outer buttons **1** for approx. 20 seconds, maintaining pressure until the LED **2** starts to flash. All stored programs are deleted.
3. Hold the original hand-held transmitter at a distance of approx. 2 in/5 cm to 8 in/20 cm from the memory buttons **1**.

 The required distance between the hand-held transmitter and memory buttons **1** depends on the relevant system of the original hand-held transmitter used. ◀

4. Simultaneously press the transmit button on the original hand-held transmitter and the desired memory button **1** of the integrated universal remote control. Initially, the LED **2** flashes slowly. Release both buttons as soon as the LED **2** flashes rapidly. If the LED **2** does not flash rapidly after approx. 15 seconds, then change the distance.
5. To program other original hand-held transmitters, repeat steps 3 and 4.

The corresponding memory button **1** is now programmed with the signal of the original hand-held transmitter.

You can use the system when the engine is running or when the ignition is switched on.

▶ If the system cannot be operated after repeated programming, check whether the original hand-held transmitter uses an alternating-code system. To do so, either read the instructions of the original hand-held transmitter or press and hold down the programmed memory button **1** of the integrated universal remote control. If the LED **2** on the integrated universal remote control flashes rapidly for a short time then lights up for approx. 2 seconds, this indicates that the original hand-held transmitter uses an alternating-code system. In the case of an alternating-code system, program the memory buttons **1** as described in the section below on alternating-code transmitters. ◀

Alternating-code transmitters

Consult the operating instructions of the unit you wish to set when programming the universal remote control. You will find information there on the possibilities for synchronization. When programming hand-held transmitters that employ an alternating code, please follow these additional instructions:

▶ Programming will be easier with the aid of a second person. ◀

1. Park your vehicle within the range of the remote-controlled equipment.
2. Program the integrated universal remote control as described above in the section on Fixed-code hand-held transmitters.
3. Locate the button on the receiver of the equipment to be set, e.g. on its drive unit.
4. Press the button on the receiver of the device you want to set up. After step 4, you have approx. 30 seconds for step 5.
5. Press the programmed memory button **1** of the integrated universal remote control three times.

The corresponding memory button **1** is now programmed with the signal of the original hand-held transmitter.

▶ If you have questions, please contact your BMW Sports Activity Vehicle Center. ◀

Deleting stored programs

Press both outer buttons **1** for approx. 20 seconds, maintaining pressure until the LED **2** starts to flash: all stored programs are deleted. It is not possible to delete individual programs.

Cup holders

⚠ Do not place glass containers in the cup holders; otherwise, there is a danger of injury in the event of an accident. ◀

Front

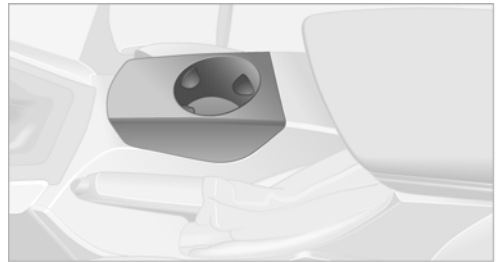

Depending on your optional equipment, the center console contains either one or two cup holders.

Passenger side*

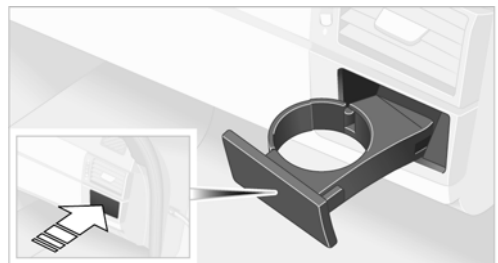

The cup holder for the front passenger is located beneath the air vent.

To open: briefly press the cover in the middle.

To close: press the cover in the middle and slide the cup holder in.

Rear

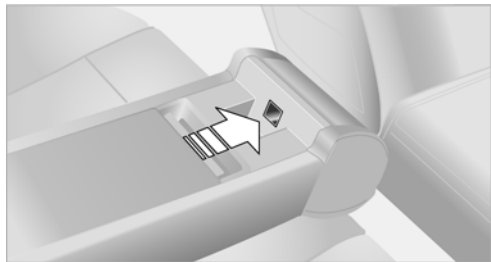

A cup holder is located in the center armrest at the rear:

Press the button to open.

Glove compartment

Opening

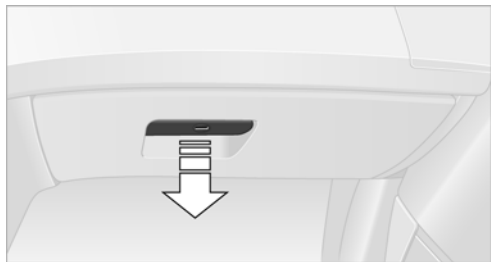

Pull the handle. The lamp inside the glove compartment comes on.

Closing

Fold the cover up.

 To prevent injury in the event of an accident while the vehicle is being driven, close the glove compartment immediately after use. ◀

Locking

Use one of the master keys. A master key is also required for unlocking.

 If you only hand over the spare key, e.g. for valet parking at a hotel, refer to page 18, then the glove compartment cannot be unlocked. ◀

Rechargeable flashlight

The flashlight is located on the left side of the glove compartment. It can remain plugged in continuously. Remove the flashlight from the socket whenever you need it.

 To avoid damage, be sure that the flashlight is switched off when it is inserted into its holder. ◀

Storage compartments

Armrest, front*



The armrest contains two storage compartments.

- ▷ Compartment for CDs:
Press button 1.
- ▷ Compartment for coins and miscellaneous items:
Press button 2.

Armrest, rear



The rear armrest contains a storage compartment:

To open, pull the cover upward.

Storage compartment in the instrument panel*



Opening

Press the button in the direction of the arrow.

Closing

Fold the cover down.

Storage package*

Your convenience is enhanced by:

- ▷ Armrest, front
- ▷ Sliding lashing eyes in cargo area, refer to page 73
- ▷ Floor cover in cargo area that can be used in two positions, refer to page 72
- ▷ Nets in cargo area, on rear side of front seat, and in passenger footwell

Clothes hooks

 When suspending clothing from the hooks ensure that it will not obstruct the driver's vision. Do not hang heavy objects on the hooks. If you do so, they could endanger passengers during braking or evasive maneuvers. ◀

Ashtray*



Emptying

Press the edge of the opened cover: the ashtray moves up and can be removed.

On vehicles with the non-smoker's equipment package, the insert is removed in the same way.

Lighter*

Press in the cigarette lighter 1.

The lighter can be removed as soon as it pops out.

 Hold or touch the hot cigarette lighter by the knob only. Holding or touching it in other areas could result in burns.

The cigarette lighter remains operational when the ignition key has been removed. For this reason, do not leave unsupervised children in the vehicle. ◀

Connecting electrical devices

You can use electrical devices such as flashlights, car vacuum cleaners, or the like with power ratings of up to approx. 200 W at 12 V if at least one of the following connection points is provided. Avoid damage to the socket caused by inserting plugs of the wrong shape or size.

Lighter socket

Remove cigarette lighter from its socket. With the non-smoker's equipment package the socket is covered with a removable cap.

Power socket in cargo area



Fold the cover upward.

Car phone preparation*

Hands-free system



In vehicles with car phone preparation*, the hands-free microphone is located on the headliner near the interior lamp.

For more information on the car phone, refer to the Owner's Manual for Telephone.

Ski bag*

The ski bag allows the safe and clean transport of up to four pairs of standard skis or up to two snowboards.

The ski bag allows you to stow skis up to a length of up to 6.8 ft/2.1 m. When skis of 6.8 ft/2.1 m in length are loaded, the ski bag will tend to narrow, reducing its overall capacity.

Loading

1. Fold down the center armrest, pull off the cover panel, press the button and disengage the door.

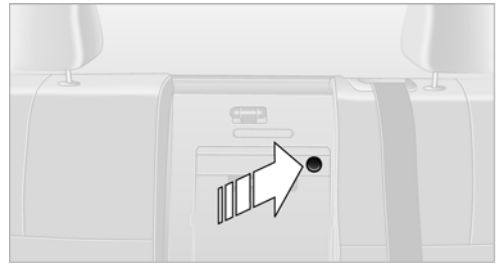

2. Press the button again; the door in the cargo area opens. If you press the button firmly the first time, this also opens the door in the cargo area.
3. Place the ski bag between the front seats and load. The zipper facilitates access to the stowed items.
4. Insert the latch plate of the ski bag retaining belt into the center safety belt buckle.

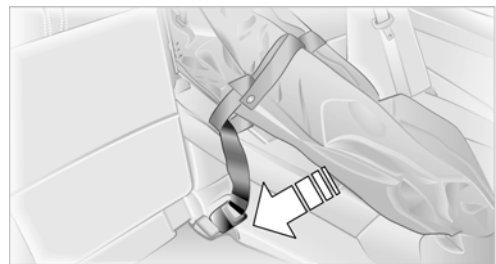

Make sure to load only clean skis into the ski bag. Wrap sharp edges so that no damage occurs.

Securing load

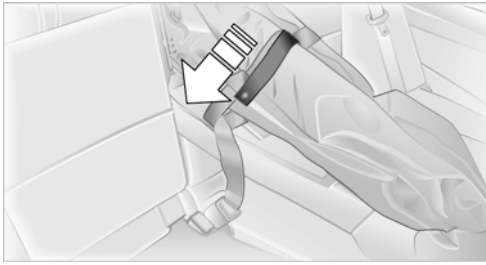

After loading, secure the ski bag and its contents. Tension the retaining strap on the tensioning buckle for this purpose.

! Always secure the ski bag in this way. If you fail to do so, it can endanger occupants during braking or evasive maneuvers. ◀

To store the ski bag, perform the above steps in reverse order.

Inserting ski bag

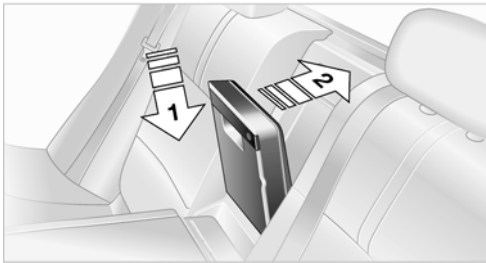

The ski bag is located in the cargo area under the floor cover.

1. Fold down the center armrest and pull off the cover.
2. Remove the tray behind the cover with a screwdriver by placing it against the indicated location in the center of the tray.
3. Position the ski bag on the lower edge of the opening, refer to arrow 1, then insert it, refer to arrow 2.

Removing ski bag



Pull the handle forward and remove the ski bag upward.

! Do not position cargo at the opening. If you do, it can endanger the passengers during braking or evasive maneuvers. ◀

Cargo area

When loading, follow the instructions on page 78.

Enlarging cargo area

The rear backrest is split. You can fold down both seats individually to enlarge the cargo area.



Reach into the opening and pull forward, refer to arrow.

▷ Before folding down the rear backrest, remove the cover caps for the LATCH child-restraint fixing system*. Otherwise, impressions can be left in the seat cushion. ◀

! When you fold back the backrest, be sure that the catch engages securely. This causes the red warning field in the recess to disappear. Otherwise, cargo can be thrown into the passenger compartment during braking or

evasive maneuvers, thus endangering the passengers. ◀

 To ensure that the safety belts continue to provide optimal protection, please follow the instructions on page 26. ◀

Ski bag*

To create a flat cargo surface, you can remove the ski bag and replace it with a tray before folding the rear backrest forward. The tray is inserted in the same way as inserting the ski bag, refer to Inserting ski bag. 70

Cargo area cover

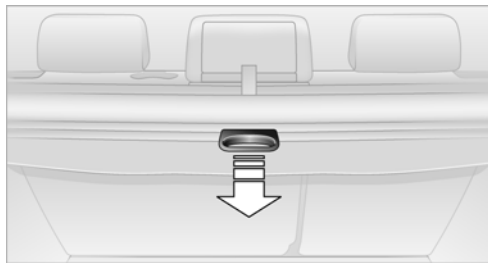

Pull the cargo area cover out by the handle and hook it into the rear holders.

You can carry light objects such as articles of clothing on the cargo area cover.

 Never place heavy, hard objects on the cover. If you do so, they could endanger passengers during braking or evasive maneuvers.

Do not allow the cover to snap back into place; this can damage it. ◀

Removal

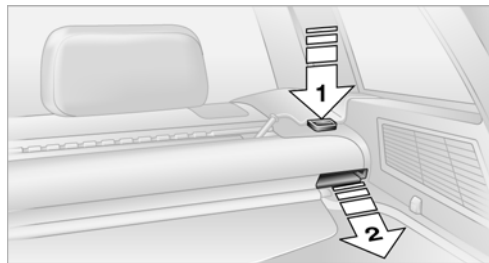

1. Press the side buttons, refer to arrow 1.
2. Pull the case toward the rear, refer to arrow 2.

Installation

Push the case forward into the two side holders until it locks into place.

Stowing* when rear seat back is folded down

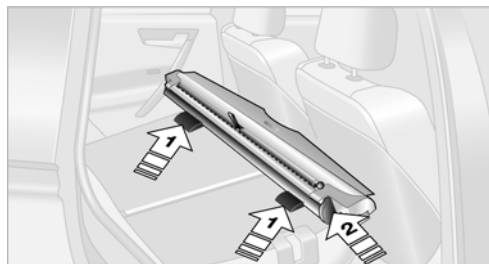

Holders for the case are mounted on the backs of the rear seat backs, refer to arrows 1.

Guide in the case from the right side until it locks into place, refer to arrow 2. As you do this, the cargo area cover must always point in the direction of travel and the loop of the partition net must point upward.

You can pull out the partition net and insert it into the holders in the roof area above.

Partition net*

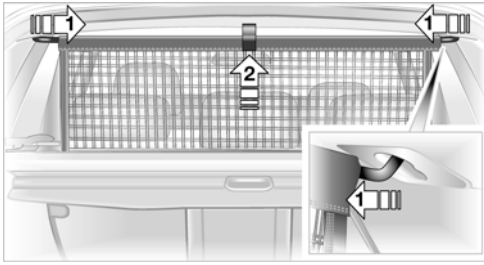

⚠ Do not allow the partition net to snap back into place; otherwise, there is a danger of injury and the partition net could be damaged. ◀

Hooking partition net into place

Pull the partition net out of the case by the strap. Press the ends of the bar toward each other, refer to arrows **1**, and insert into the brackets. Then press the bar all the way upward in the middle, refer to arrow **2**, so that it engages in the brackets.

Lowering partition net

Grasp bar on one side on the partition net, press upward and push the ends of the bar together, then release from the brackets.

Behind side trim panel

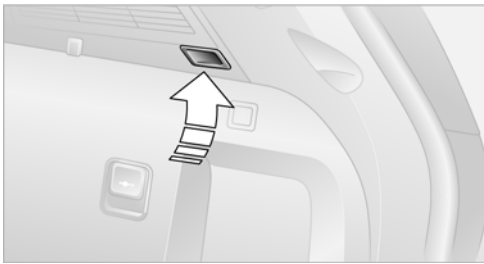

Press the button to open.

Floor cover

Opening

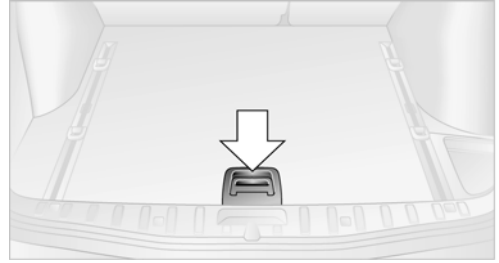

For access to the jack etc.

To open, raise the cover by the handle, refer to arrow.

If needed, you can remove or raise the floor cover.

Raising

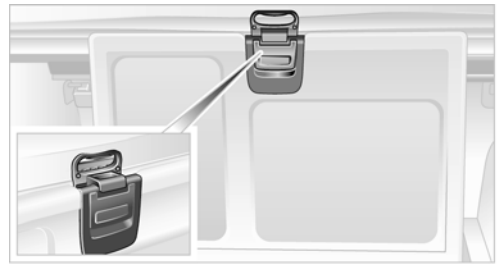

Swing up the floor cover and hook it onto the handle of the cargo area cover by its catch.

Lashing eyes, rail*



You can secure heavy-duty cargo straps to the lashing eyes on the cargo area floor.

The lashing eyes are located in the cargo area under the floor cover. They can be inserted into the openings in the rails. To slide the lashing eyes, press the button.



Read and follow instructions accompanying the heavy-duty cargo straps. ◀



Driving tips

This section is designed to provide you with extra support by supplying information useful in dealing with specific driving and operating conditions.

Things to remember when driving

Breaking-in

Moving parts should be allowed to adjust to one another. To ensure that your vehicle provides maximum economy throughout a long service life, we request that you observe the following instructions.

Engine and differential

Always obey all official speed limits.

For the first 1,200 miles/2,000 km

Drive at varying engine and driving speeds, but do not exceed 4,500 rpm or 100 mph/160 km/h in the process.

Refrain from using full throttle and avoid pressing the accelerator beyond the kick-down point.

After 1,200 miles/2000 km

Engine and road speed can be gradually increased.

Tires

Due to technical factors associated with their manufacture, tires do not achieve their full traction potential until after an initial break-in period. For this reason, drive with extra care during the initial 200 miles/300 km.

Obey your local and state maximum speed limits.

 When the vehicle is operated on wet or slushy roads, a wedge of water may form between the tire and the road surface. This phenomenon is referred to as hydroplaning and can lead to partial or complete loss of traction, vehicle control and braking effectiveness. Reduce your speed on wet roads. ◀

Brake system

Your vehicle must travel approx. 300 miles/500 km before the brake pads and rotors achieve the optimal pad-surface and wear

patterns required for trouble-free operation and long service life later on.

To break in the separate handbrake drums, apply the handbrake lightly when coasting to a stop – at a traffic signal, for instance; use caution to avoid posing a danger to other road users.

To avoid corrosion, repeat this procedure from time to time.

The brake lamps do not come on when the handbrake is applied.

 Vacuum for the brake system servo unit on your BMW is available only when the engine is running. When you move the vehicle with the engine off – e.g., by towing – substantially higher levels of pedal force will be required to brake the vehicle. ◀

Clutch

The function of the clutch reaches its optimal level only after a distance driven of approx. 300 miles/500 km. During this break-in period, engage the clutch gently.

Following component replacements

Follow the break-in sequence again if components addressed above must be replaced due to subsequent driving.

General driving notes

Close the liftgate

 Operate the vehicle only when the liftgate is completely closed; otherwise, exhaust fumes could enter the interior of the vehicle. ◀

If special circumstances should make it absolutely necessary to operate the vehicle with the liftgate open:

1. Close all windows and the panorama glass sunroof.
2. Greatly increase the air supply of the air conditioning system or automatic climate control, refer to page 60 or 63.

Hot exhaust system

 High temperatures occur in the exhaust system of every vehicle. Do not remove the heat shields installed adjacent to various sections of the exhaust system, and never apply undercoating to them. When driving, standing at idle, and parking, take care to avoid possible contact between the hot exhaust system and any highly flammable materials such as hay, leaves, grass, etc. Such contact could lead to a fire, resulting in serious personal injury and property damage. ◀

Mobile communications devices in vehicle

 BMW does not recommend using mobile communications devices, e.g. mobile phones, on the interior of the vehicle without a direct connection to an outside antenna. Otherwise, the vehicle electronics and mobile communications device can affect each other. In addition, there is no assurance that the radiation which results during transmission will be dissipated from the vehicle interior. ◀

Interior and exterior mirror, automatically dimming*



Two photocells are used to control the automatically dimming interior and exterior mirrors. One is integrated into the mirror glass, the other is located on the back of the mirror.

For trouble-free operation, keep the photocells clean and do not cover the area between the interior rearview mirror and the windshield. Do not attach any kind of sticker to the windshield in front of the mirror, either.

When the vehicle is parked

Condensation forms in the air conditioner system during operation, and then exits under the vehicle. Traces of condensed water under the vehicle are therefore normal.

Before driving into a car wash

Fold in the exterior mirrors, refer to page 30; otherwise, they could be damaged due to the width of the vehicle.

Deactivate the rain sensor; otherwise, damage could result from undesired wiper activation, refer to page 40.

Hydroplaning

 When driving on wet or slushy roads, reduce road speed. If you do not, a wedge of water can form between tires and road surface. This phenomenon is referred to as hydroplaning, and is characterized by a partial or complete loss of contact between tires and road surface, ultimately undermining your ability to steer and brake the vehicle. ◀

The danger of hydroplaning increases as tire tread depth decreases, also refer to Minimum tread depth on page 89.

Driving through water

 Do not drive through water on the road if it is deeper than 20 in/50 cm, and then only at walking speed. Otherwise, the vehicle's engine, the electrical system, and the transmission may be damaged. ◀

Using handbrake on inclines

 Do not hold the vehicle in place on slopes by slipping or riding the clutch, use the handbrake instead. Otherwise, greater clutch wear will result. ◀

Safe braking

Your BMW is equipped with ABS as standard equipment. In situations in which it is required, it is best to apply the brakes fully. Since the vehicle maintains steering responsiveness, you can nevertheless avoid possible obstacles with a minimum of steering effort.

Pulsation at the brake pedal combined with sounds from the hydraulic circuits indicates to the driver that ABS is in its active mode.

Wet roads

On wet roads or in heavy rain, briefly apply light pressure to the brake pedal every few miles. Watch traffic conditions to ensure that this maneuver does not endanger other road users. The heat that is generated by the brake applications helps to dry the brake pads and rotors. The full braking force will then be available when you need it.

Hills

 To prevent overheating and reduced efficiency of the brake system, drive long or steep downhill grades in the gear in which the least braking is required. Otherwise, even light but continuous pressure on the brake can lead to high temperatures, brake wear and possibly even brake failure. ◀

The braking action of the engine can be further intensified by downshifting, all the way down to first gear if need be. This strategy helps you avoid placing excessive loads on the brake system. Downshifting in manual mode of automatic transmission, refer to page 39. When descending hills slowly, use HDC Hill Descent Control, refer to page 49.

 Never drive with the clutch depressed, with the transmission in neutral, or with the engine switched off; otherwise, you will have neither the braking action of the engine or nor its power assistance to the brakes or steering.

Never allow floor mats, carpeting, or other articles to protrude into the area around the brake or accelerator pedals and obstruct their movement. ◀

Corrosion on brake rotors

When the vehicle is driven only occasionally, during extended periods when the vehicle is not used at all, and in operating conditions where brake applications are less frequent, there is an increased tendency for corrosion to form on rotors, while contaminants accumulate on the brake pads. This occurs because the minimal pressure which must be exerted by the pads during brake applications to clean the rotors is not reached.

Should corrosion form on the brake rotors, the brakes will tend to respond with a pulsating effect that even extended application will fail to cure.

Cargo loading

 To avoid loading the tires beyond their approved carrying capacity, never overload the vehicle. Overloading can lead to overheating and increases the rate at which damage develops inside the tires. The ultimate result can assume the form of a sudden blow-out. ◀

Determining load limit



1. Locate the following statement on your vehicle's placard*:

 The combined weight of occupants and cargo should never exceed XXX lbs. or YYY kg. Otherwise, the vehicle may be damaged and unstable driving conditions may result. ◀

2. Determine the combined weight of the driver and passengers that will be riding in your vehicle.

3. Subtract the combined weight of the driver and passengers from XXX lbs. or YYY kg.
4. The resulting figure equals the available amount of cargo and luggage load capacity. For example, if the XXX amount equals 990 lbs. and there will be five 150-lb. passengers in your vehicle, the amount of available cargo and luggage load capacity is 240 lbs.:
990 lbs. minus 750 lbs. = 240 lbs.
5. Determine the combined weight of luggage and cargo being loaded into and/or onto the vehicle. This combined weight may not safely exceed the available cargo and luggage load capacity calculated in step 4.
6. If your vehicle will be towing a trailer, part of the load from your trailer will be transferred to your vehicle. Consult the manual for transporting a trailer to determine how this may reduce the available cargo and luggage load capacity of your vehicle.

Load

The permitted load is the total of the weight of occupants and cargo/luggage. The greater the weight of occupants, the less cargo/luggage can be transported.

+ ≤ Max. Load
 + ≤ Max. Load
 + ≤ Max. Load

Stowing cargo

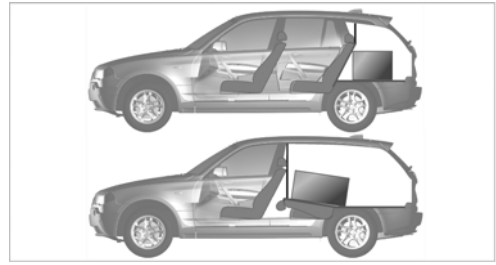

- ▷ To protect passengers, use the partition net, refer to page 72.
- ▷ Load heavy cargo as far forward and as low as possible, placing it directly behind the rear seat backrests.
- ▷ Cover sharp edges and corners.
- ▷ Do not stack cargo higher than the upper edge of the backrests.
- ▷ Items that could bump against the rear window while driving must be adequately covered.

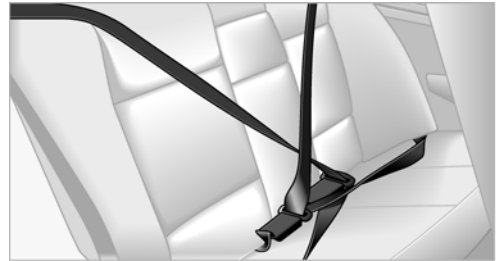

- ▷ For very heavy cargo when the rear seat is not occupied, secure each safety belt in the opposite buckle.

Securing cargo

- ▷ Use the luggage net* or draw straps to hold down small and lightweight luggage and cargo, refer to page 73.
- ▷ For larger and heavier pieces, heavy-duty cargo straps* are available from your BMW Sports Activity Vehicle Center. These heavy-duty cargo straps are attached using the lashing eyes in the cargo area, refer to page 73.

Please read the information provided with the heavy-duty cargo straps.



Always position and secure cargo as described above. If you do not, it can endanger the passengers during braking or evasive maneuvers.

Use only the lashing eyes, refer to page 73, to fasten the heavy-duty cargo straps; otherwise, the heavy-duty cargo straps could loosen or the vehicle could be damaged.

Never exceed either the approved gross vehicle weight or either of the approved axle loads, refer to page 116, as excessive loads can pose a safety hazard and may also place you in violation of road safety laws.

You should never transport heavy or hard objects unsecured in the passenger compartment, as they could be thrown about and pose a safety hazard to the vehicle's occupants during abrupt braking or evasive maneuvers. ◀

Roof-mounted luggage rack*

A special rack system is available as an optional accessory for your BMW. Please observe the information contained in the installation instructions.

Loading luggage rack

Because roof racks raise the vehicle's center of gravity when loaded, they have a major effect on its handling and steering response. You should therefore always remember not to exceed the approved roof load capacity, the approved gross vehicle weight, or the axle loads when loading the rack.

These specifications can be found under Weights on page 116.

Make sure that the load is evenly distributed, and that it does not extend outward beyond the limits of the loading surface. Always stow the heaviest pieces at the bottom. Be sure that adequate clearance is maintained for raising the glass sunroof and that objects do not project into the opening path of the liftgate.

Secure roof-mounted cargo correctly and securely to prevent it from shifting or falling off while you drive.

Drive smoothly. Avoid sudden acceleration and braking maneuvers. Take corners gently.

Driving on poor roads

Your X3 is at home on all paved and unpaved roads. It combines all-wheel drive with the advantages of a normal passenger car.



Driving on unpaved terrain can cause damage to the vehicle. ◀

When you are driving on poor roads, there are a few points which you should strictly observe – for your own safety and that of your passengers, as well as to protect the vehicle:

- ▷ Familiarize yourself with the vehicle before you begin driving. Do not take risks with the vehicle under any circumstances.
- ▷ Always adapt the driving speed to the road conditions. The more steep and uneven the roadway is, the lower the speed should be.
- ▷ You can operate your vehicle on uphill and downhill gradients with a maximum slope of 50%. If you wish to drive on uphill and downhill grades of this nature, make sure beforehand that the engine oil and coolant levels are near the MAX mark, refer to pages 94 and 95.
- ▷ When descending very steep hills, use HDC Hill Descent Control, refer to page 49. It is possible to start off on inclines of up to 32%.
The permitted side tilt is 32%.
- ▷ While driving, watch carefully for obstacles such as rocks or holes. Try to avoid these obstacles whenever possible.
- ▷ Avoid having the body make contact with the ground, e.g. on the crests of hills and bumpy roads. The ground clearance of the vehicle is a maximum of approx. 8.0 in/ 20 cm. Please be aware that the ground clearance can vary depending on the load and operating conditions of the vehicle.

- ▷ Do not drive in water that is deeper than 20 in/50 cm. If you must drive through water up to that depth, drive at a walking speed and do not stop.

After leaving the water, press on the foot-brake gently several times while driving at a low speed. The brake applications will help to dry the brakes, thus preventing a reduction in braking performance caused by the moisture.

For cleaning the handbrake, apply the lever slightly at approx. 25 mph/40 km/h and continue to drive for approx. 200 yards/ 200 meters, provided that traffic conditions allow you to do so.

Please bear the following points in mind after driving on poor roads, in order to preserve the road safety of your BMW:

- ▷ Clean the heavy dirt from the body.
- ▷ Clean mud, snow, ice and other materials from the wheels and tires. Check the tires for damage.





Mobility

This section helps you maintain your mobility by supplying important information on vital topics including fuels and lubricants, wheels and tires, service, maintenance and breakdown assistance.

Refueling

Fuel cap

Opening

 Always switch off the engine before refueling. Otherwise, no fuel can be dispensed into the tank and the Service Engine Soon lamp lights up. ◀

1. Open fuel filler door. To do so, briefly press it at the rear edge.

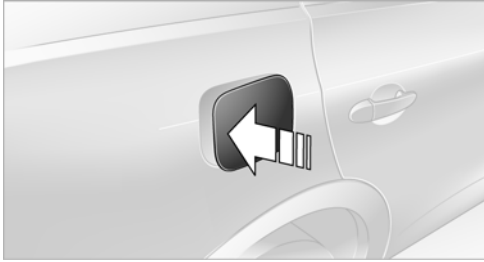

2. Turn fuel filler cap counterclockwise.
3. Put the fuel filler cap in the bracket attached to the fuel filler door.

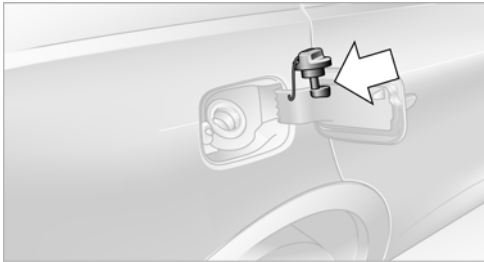

Closing

Replace the cap and turn it clockwise until you hear a clearly audible click.

Be careful not to crush the cap leash between the gas cap and the vehicle.

 The warning lamp* lights up. The fuel cap is not properly closed or is missing. Check whether the fuel cap is properly closed.

Manually releasing fuel filler door

In the event of an electrical malfunction in the system, you can release the fuel filler door manually:

1. Open the cover flap in the cargo area on the right-hand side panel, refer to page 72.
2. Pull the green button. The fuel filler flap is released.



 Always observe all applicable precautions and regulations when handling fuels. Never carry spare fuel containers in your vehicle. Whether empty or full, these containers can leak, cause an explosion, and lead to fire in the event of a collision. ◀

Observe the following when refueling

 When handling fuels, comply with all applicable safety precautions posted at the service station. ◀

When refueling, insert the filler nozzle completely into the filler pipe. Avoid lifting the filler nozzle while filling the tank; otherwise, this can result in:

- ▷ premature pump shutoff
- ▷ reduced efficiency in the fuel-vapor recovery system

The fuel tank is full when the filler nozzle clicks off the first time.

Fuel tank capacity

Approx. 17.7 gallons/67 liters, including the reserve capacity of approx. 2 gallons/8 liters.

 Never attempt to continue driving until the tank is completely empty; this can negatively affect engine function and can damage the vehicle. ◀

Fuel specifications

 Never use leaded gasoline. Otherwise, you will cause permanent damage to your catalytic converter. ◀

Required fuel

Super Premium Gasoline/AKI 91

This gasoline is highly recommended. However, you may also use gasoline with a lower AKI rating. The minimum AKI rating is 87. If you use gasoline with this minimum AKI rating, the engine may produce knocking sounds when starting at high outside temperatures. This has no effect on the engine life.

Use high-quality brands

Field experience has indicated significant differences in fuel quality: volatility, composition, additives, etc., among gasolines offered for sale in the United States and Canada. Fuels containing up to and including 10% ethanol or other oxygenates with up to 2,8% oxygen by weight, that is, 15% MTBE or 3% methanol plus an equivalent amount of co-solvent, will not void the applicable warranties with respect to defects in materials or workmanship.

 The use of poor-quality fuels may result in stalling, starting and drivability problems especially under certain environmental conditions such as high ambient temperature and high altitude.

Should you encounter drivability problems that you suspect could be related to the fuel you are using, we recommend that you respond by switching to a recognized high-quality brand such as gasoline that is advertised as Top Tier Detergent Gasoline.

Failure to comply with these recommendations may also result in unscheduled maintenance. ◀

Wheels and tires

Tire inflation pressure

Information for your safety

The condition of the tires and the maintenance of the specified tire pressure are crucial not only to the tire's service life, but also to driving comfort and most importantly, driving safety.

Checking pressure

Only check tire inflation pressure when the tires are cold. This means after a maximum of 1.25 miles/2 km driving or when the vehicle has been parked for at least 2 hours. When tires are warm, the tire inflation pressure increases.

 Check the tire inflation pressure regularly and correct it as needed, even on the compact wheel: at least twice a month and before starting long trips. If you fail to observe this precaution, you may be driving on tires with incorrect tire pressures, a condition that can not only compromise your vehicle's driving stability, but also lead to tire damage and the risk of an accident.

Do not drive with deflated, i.e. flat tires. A flat tire will seriously impair your vehicle's handling and braking response. Attempts to drive on a flat tire can lead to loss of control over the vehicle. ◀

 After correcting the tire inflation pressure, reinitialize the Flat Tire Monitor* or reset the Tire Pressure Monitor*, refer to pages 51, 52. ◀

Pressure specifications

The table on the next page provides all the correct inflation pressures for the specified tire sizes at ambient temperature.

 The inflation pressures in the table apply to BMW-approved tire sizes and recommended tire brands. Your BMW Sports Activity Vehicle Center will be glad to supply this information. ◀

For correct identification of the right tire inflation pressure for your tires, please note the following:

- ▷ Tire size for your vehicle
- ▷ Load status
- ▷ Maximum permissible driving speed

Tire inflation pressures for speeds up to 100 mph/160 km/h

For normal driving at speeds of up to 100 mph/160 km/h and to achieve an optimal driving comfort, take note of the tire inflation pressures listed on the following page in the column for speeds up to max. 100 mph/160 km/h and adjust your tire pressure as needed.

These tire inflation pressures are also listed on the door pillar and can be seen with the driver's door open.





 The maximum permissible speed for these tire inflation pressures is 100 mph/160 km/h. Do not exceed this speed; failure to heed this limit can lead to tire damage and accidents. ◀

Tire inflation pressures for speeds above 100 mph/160 km/h

 In order to drive at maximum speeds above 100 mph/160 km/h, take note of the tire inflation pressures listed in the column for speeds above 100 mph/160 km/h in the table on the following page and adjust your tire pressure as needed. Failure to do so can lead to tire damage and accidents. ◀

Observe all national and local maximum speed limits; failure to do so could put you in violation of the law.

X3 2.5i/3.0i

Tire size	Pressure specifications in psi/kPa					
	Traveling speeds of up to max. 100 mph/160 km/h		Traveling speeds including those above 100 mph/160 km/h			
All pressure specifications in the table are indicated in psi/kilopascal with cold tires. Cold = ambient temperature						
235/55 R 17 99 H M+S	29/200	32/220	29/200	32/220	32/220	38/260
215/60 R 17 96 H M+S	32/220	35/240	32/220	35/240	35/240	41/280
235/50 R 18 97 H M+S						
Front: 235/50 R 18 97 V	32/220	–	32/220	–	35/240	–
Rear: 255/45 R 18 99 V	–	32/220	–	32/220	–	38/260
Front: 235/45 R 19 95 W	32/220	–	32/220	–	35/240	–
Rear: 255/40 R 19 96W	–	35/240	–	35/240	–	41/280
Compact wheel: T 135/90 R 17 104 M	61/420	61/420	61/420	61/420	61/420	61/420

More details on the permissible load and weights can be found on page [116](#)

Tire identification marks

Knowledge of the labeling on the side of the tire makes it easier to identify and choose the right tires.

Tire size

e.g. 235/50 R 18 97 V

Nominal width in mm	_____				
Cross-sectional relationship in %	_____				
Radial tire code	_____				
Rim diameter in inches	_____				
Load rating, not for ZR tires	_____				
Speed rating, before R on ZR tires	_____				

Speed code letter

- Q = up to 105 mph/160 km/h
- T = up to 118 mph/190 km/h
- H = up to 131 mph/210 km/h
- V = up to 150 mph/240 km/h
- W = up to 167 mph/270 km/h
- Y = up to 186 mph/300 km/h

Tire Identification Number

Tires with DOT codes meet the guidelines of the U.S. Department of Transportation.

DOT code:

e.g. DOT xxxx xxx 0506

Manufacturer code for tire make	_____				
Tire size and tire design	_____				
Tire age	_____				

Tire age

The tire's date of manufacture is indicated on the sidewall:

DOT ... 0506 indicates that a tire was manufactured in week 5 of the year 2006.

BMW recommends that you replace all tires after 6 years at most, even if some tires may last for 10 years.

Uniform Tire Quality Grading

Quality grades can be found where applicable on the tire sidewall between tread shoulder and maximum section width.

For example:

Tread wear 200 Traction AA
Temperature A

DOT Quality Grades

Tread wear
Traction AA A B C
Temperature A B C



All passenger car tires must conform to Federal Safety Requirements in addition to these grades. ◀

Tread wear

The tread wear grade is a comparative rating based on the wear rate of the tire when tested under controlled conditions on a specified government test course.

For example, a tire graded 150 would wear one and one-half (1½) times as well on the government course as a tire graded 100. The relative performance of tires depends upon the actual conditions of their use, however, and may deviate significantly from the norm due to variations in driving habits and service practices as well as differences in road characteristics and climate.

Traction

The traction grades, from highest to lowest, are AA, A, B, and C.

These grades represent the tire's ability to stop on wet pavement as measured under controlled conditions on specified government test surfaces of asphalt and concrete. A tire marked C may have poor traction performance.



The traction grade assigned to this tire is based on straight-ahead braking traction tests, and does not include acceleration, cornering, hydroplaning, or peak traction characteristics. ◀

Temperature

The temperature grades are A, B, and C, A being highest, and represent the tire's resistance to the generation of heat and its ability to dissipate heat when tested under controlled conditions on a specified indoor laboratory test wheel. Sustained high temperature can cause the material of the tire to degenerate and reduce tire life, and excessive temperature can lead to sudden tire failure. The grade C corresponds to a level of performance that all passenger car tires must meet under the Federal Motor Vehicle Safety Standard No. 109. Grades B and A represent higher levels of performance on the laboratory test wheel than the minimum required by law.

 The temperature grade for this tire is established for a tire that is properly inflated and not overloaded. Excessive speed, underinflation, or excessive loading, either separately or in combination, can cause heat buildup and possible tire failure. ◀

M+S

Winter and all-season tires. These have better winter properties than summer tires.

Tire condition

Inspect your tires frequently for tread wear, signs of damage and for foreign objects lodged in the tread. Check the tread depth.

Minimum tread depth

The tread depth should not fall below 0.12 in/3 mm. At tread depths below 0.12 in/3 mm, there is an increased risk of high-speed hydroplaning, even when only small amounts of water are present on the road surface.

Winter tires display a noticeable loss in their ability to cope with cold-weather driving conditions once the tread wears to below 0.16 in/4 mm. To ensure continued safety you should always have such tires replaced.

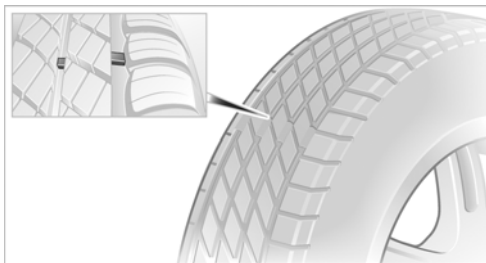

Wear indicators at the tread-groove base, refer to arrow, are distributed over the tire's circumference and are marked on the side of the tire with TWI – Tread Wear Indicator. If the tire tread has worn down to the wear indicators, then the legally permissible tread depth limit of 0.063 in/1.6 mm has been reached.

Wheel/tire damage

 Please note that low-profile tires, make wheels, tires and suspension parts more susceptible to road hazard and consequential damages. ◀

Unusual vibrations encountered during normal vehicle operation can indicate tire failure or some other vehicle defect. This can, for example, be caused by driving over curbs. The same applies to any other abnormal road behavior, such as pulling severely to the right or left.

 In these cases, reduce speed immediately and have wheels and tires checked immediately. Drive carefully to the nearest BMW Sports Activity Vehicle Center or tire specialist. Have the vehicle towed to one of these locations if necessary.

Tire damage can pose a potentially lethal safety hazard for the vehicle's occupants and other road users alike. ◀

New wheels and tires

 Have new wheels and tires installed only by your BMW Sports Activity Vehicle Center or a tire shop that works according to BMW repair procedures with correspondingly trained personnel. If this work is not carried out properly, there is a danger of subsequent dam-

age and related safety hazards. Make sure that the new wheels are balanced. ◀

Retreaded tires

! BMW does not recommend the use of retreaded tires; otherwise, driving safety may be reduced. The causes for this include the possibly different tire casing structures and the often wide variations in their age, which can result in a limited service life. ◀

The right wheels and tires

! BMW recommends that you use only wheel and tire combinations that BMW has tested and approved for your particular vehicle. Variations in factors such as manufacturing tolerances mean that even wheels and tires with identical official size ratings could actually have different dimensions than the approved units – these differences could lead to body contact and with it, the risk of severe accidents. If non-approved wheels and tires are used, BMW cannot evaluate their suitability, and therefore cannot be held liable for driving safety. ◀

You can ask your BMW Sports Activity Vehicle Center for the correct wheel-and-tire combination.

The correct wheel-and-tire combination affects various systems whose function would otherwise be impaired, e.g. ABS, DSC or xDrive.

To maintain good handling and vehicle response, use only tires of a single tread configuration from a single manufacturer. After a flat tire, always have the original wheel-and-tire combination remounted on the vehicle as soon as possible.

Wheels equipped with electronics for TPM Tire Pressure Monitor

When installing new tires or when changing from summer tires to winter tires or vice versa, only use wheels equipped with TPM electronics; otherwise, the Tire Pressure Monitor cannot detect a flat tire, refer to page 52. Your BMW Sports Activity Vehicle Center will be happy to advise you in this regard.

Recommended tire brands

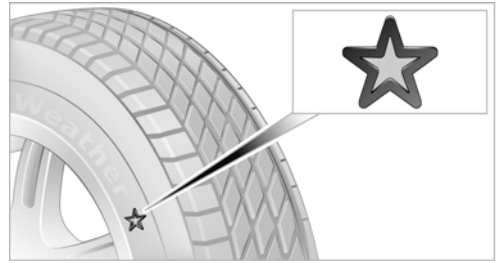

MAN02280CMA

BMW recommends particular tire brands for each tire size. You will recognize them by the clearly visible BMW identification on the tire sidewall.

With proper use, these tires meet the highest standards for safety and handling characteristics.

Special characteristics of winter tires

BMW recommends winter tires for use in cold winter driving conditions. Although all-season M+S tires do provide better winter traction than summer tires, they generally fail to provide the same levels of cold-weather performance as winter tires.

Observing speed ratings

! Never exceed the maximum speed for which the winter tires are rated. ◀

Storage

Store wheels or tires in a cool, dry place, protecting them from light whenever possible. Protect the tires from contact with oil, grease and fuel. Do not exceed the maximum tire inflation pressure indicated on the side wall of the tire.

Snow chains*

Only certain fine-link snow chains are tested, classified as road-safe, and recommended by BMW. You can obtain a list of these from your BMW Sports Activity Vehicle Center. It is only permissible to use them in pairs and on the rear wheels.

Follow the manufacturer's instructions when installing snow chains.

Do not exceed a vehicle speed of 30 mph/ 50 km/h with snow chains mounted.

It is not permissible to use snow chains on the following tire sizes:

- ▷ 255/45 R 18
- ▷ 255/40 R 19



Do not initialize the Flat Tire Monitor* with snow chains installed; otherwise, the instrument might issue an incorrect reading. When you are driving with snow chains, it can be beneficial to switch off DSC briefly, refer to page 49. ◀

Under the hood

⚠ Never attempt to perform any service or repair operations on your vehicle without the required professional technical training. If you are not familiar with the regulations to be observed, have work on your vehicle carried out only by your BMW Sports Activity Vehicle Center or at a workshop that works according to BMW repair procedures with appropriately trained personnel. If this work is not carried out properly, there is a danger of subsequent damage and related safety hazards. ◀

Hood

Unlocking

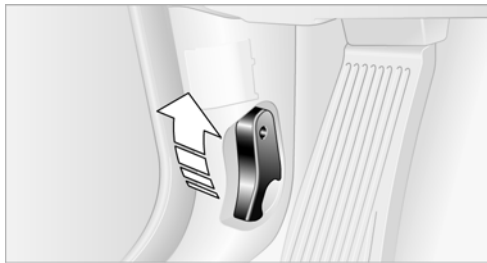

Pull the lever located under the left side of the instrument cluster.

Opening

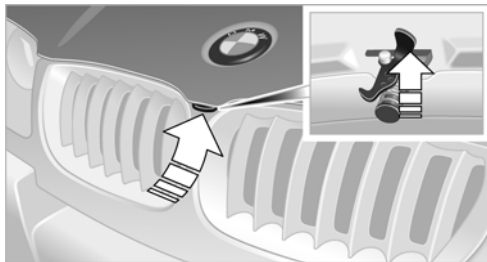

⚠ To avoid causing damage, make sure that wiper arms are resting against the windshield before opening the hood. ◀

Press the release handle and open the hood.

Closing

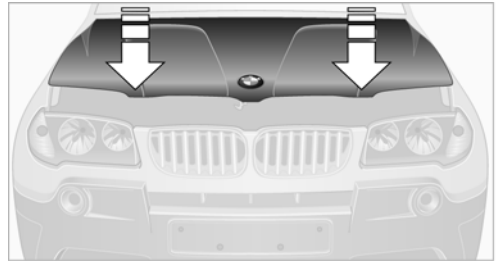

Close the hood with force by allowing it to fall from a height of approx. 1 ft/30 cm. It must engage audibly.

⚠ Avoid injuries by making sure that the hood's closing region is clear and unobstructed.

If you see any signs that the hood is not completely closed while driving your vehicle, you should stop at once and close it securely. ◀

Important components in the engine compartment

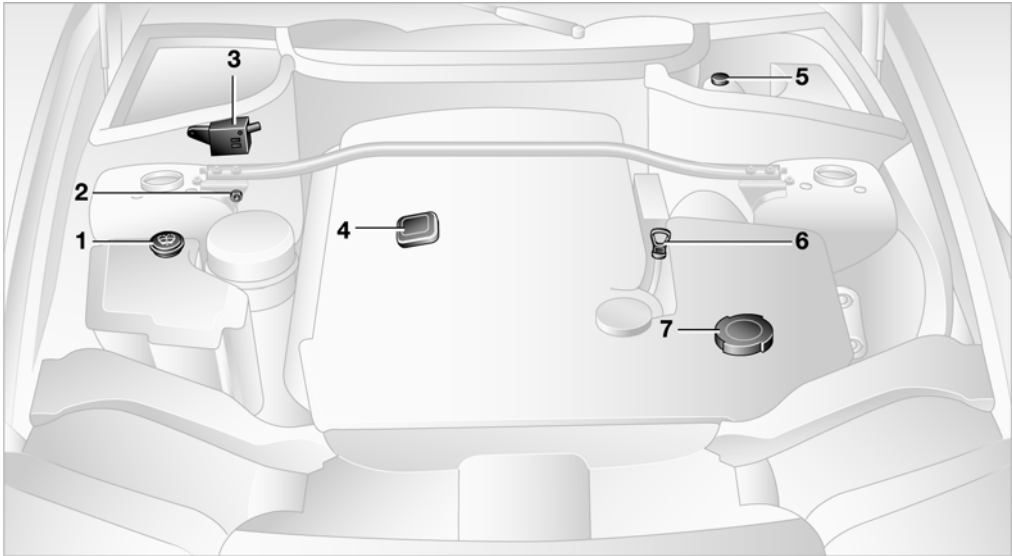

- | | | | |
|---|---|---|--|
| 1 | Reservoir for washer fluid for the headlamp and windshield washer system 41 | 4 | Engine oil filler neck 94 |
| 2 | Body ground: negative terminal 108 | 5 | Reservoir for brake fluid 96 |
| 3 | Jump starting terminal 108 | 6 | Dipstick for engine oil 94 |
| | | 7 | Coolant expansion tank 95 |

Engine oil

Engine oil consumption depends on driving style and operating conditions.

Warning lamp

Engine oil pressure



The warning lamp lights up red:
The engine oil pressure is too low.
Stop the vehicle immediately and

switch off the engine. Check the engine oil level and top off as needed. If the oil level is correct: have the system checked immediately.



Do not continue driving. The engine could be damaged because of inadequate lubrication. ◀

Engine oil level



The warning lamp lights up yellow during driving. In addition, an acoustic signal sounds.

The oil level is at the absolute minimum. Add engine oil as soon as possible. Until then, do not drive more than approx. 30 miles/50 km.



The warning lamp lights up yellow after the engine is switched off. In addition, an acoustic signal sounds.

Top off engine oil at the earliest opportunity, e.g. when refueling.

Engine oil sensor



The warning lamp lights up yellow within 30 seconds after starting the engine:

The oil level sensor is defective. Have it checked as soon as possible.

Checking oil level

1. With the engine at operating temperature, i.e. after at least 6 miles/10 km of uninterrupted driving, park the vehicle in a horizontal position.
2. Switch off engine.
3. After approx. 5 minutes, pull the dipstick out and wipe it off with a clean lint-free cloth, paper towel, or similar material.

4. Carefully push the dipstick all the way into the guide tube and pull it out again.
The oil should extend to between the two marks on the dipstick.

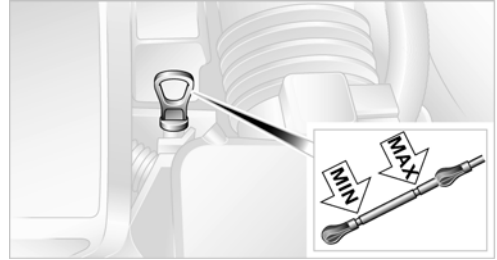

5. Push the oil dipstick into the dipstick tube as far as possible again.

The oil quantity between the two marks of the dipstick is approx. 1.1 US quarts/1 liter.



Do not fill beyond the upper mark on the dipstick. Excess oil can damage the engine. ◀

Adding engine oil



Do not add oil until the oil level has dropped to just above the lower marking on the dipstick, refer to page 94.



Add oil within the next 30 miles/50 km; otherwise, engine damage could result. ◀



Keep oil, grease, etc. out of reach of children and heed warnings on the containers. Otherwise, you could endanger your health. ◀

Oil change

Have the oil changed only by your BMW Sports Activity Vehicle Center or a workshop that

works according to BMW repair procedures with correspondingly trained personnel.

Approved engine oils

The quality of the engine oil selected has critical significance for the operation and service life of an engine. BMW continuously approves specific oils after confirming their suitability for use in its vehicles with extensive testing.

Only use approved BMW High Performance Synthetic Oil.

If you are unable to obtain BMW High Performance Synthetic Oil, you can add small amounts of another synthetic oil in between oil changes. Only use oils with the API SH specification or higher.

 Ask your BMW Sports Activity Vehicle Center for more details concerning BMW High Performance Synthetic Oil or other approved synthetic oils. ◀

You can also call BMW of North America at 1-800-831-1117 or visit website www.bmwusa.com to obtain this information.

 BMW engines are designed to operate without additives, and their use could even lead to damage in some cases. ◀

Viscosity classes

Viscosity is the oil flow rating as defined in SAE classes.

The selection of the correct SAE class depends on the climate conditions in the area where you typically drive your BMW.

 Approved oils belong to SAE classes 5W-40 and 5W-30. ◀

These oils can be used for driving in all ambient temperatures.

Coolant

Warning lamp

 The warning lamp lights up: coolant level is too low; top off at the next opportunity.

 Do not open the cooling system when the engine is hot. Escaping coolant can cause burns. ◀

Coolant consists of water and coolant additive. Not all commercially available additives are suitable for your BMW. Ask your BMW Sports Activity Vehicle Center for suitable additives.

 Only use suitable additives; otherwise, engine damage may result. The additives present a health hazard. ◀

 Always observe all applicable environmental laws and regulations when disposing of used coolant additives. ◀

Checking coolant level

1. The engine must be at ambient temperature.
2. Turn the cap of the expansion tank counterclockwise to allow any accumulated pressure to escape, then continue turning to open.
3. The coolant level is correct if the upper end of the red float bar is at least at the same height as the top edge of the filler neck, refer to arrow. The bar end may only protrude by a maximum of $\frac{3}{4}$ in/2 cm, i.e. up to the second mark on the float bar, refer also to drawing beside the filler neck.

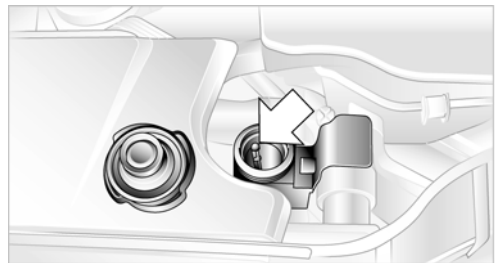

4. If the coolant is low, slowly add coolant up to the specified level – do not overfill.
5. Screw on the cap and tighten snugly.
6. Have the reason for the coolant loss corrected as soon as possible.

Brake system

Malfunction

Brake fluid

 The warning lamp lights up red despite the handbrake being released. Stop immediately.

The brake fluid in the reservoir has fallen to below the minimum level. At the same time, a considerably longer brake pedal travel may be noticeable. Have the system checked immediately.

 During continued driving, increased brake pedal travel may be necessary, and considerably longer braking distances may result. Please adapt your driving style accordingly. ◀

 Display of the previously described malfunction on Canadian models.

Brake pads

 The warning lamp lights up. The brake pads have reached their minimum pad thickness. Have brake pads replaced immediately.

 For your own safety, use only brake pads that BMW has approved for your particular vehicle model. As BMW cannot assess the suitability of other brake pads for use in your vehicle, we are unable to assume continued responsibility for the vehicle's operating safety if non-approved pads are installed. ◀

Maintenance

The BMW maintenance system

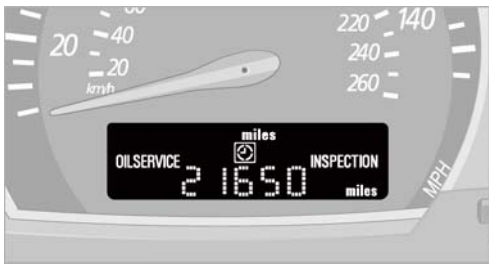

The BMW maintenance system supports the preservation of the road and operating safety of your BMW.

Regular maintenance is not only required for the safety of the vehicle, it also improves the resale value.

Service Interval Display

The BMW maintenance system takes the driving conditions of the vehicle into account when determining service intervals:

From the maintenance standpoint, 62,000 miles/100,000 km accumulated in short-distance urban driving are not the equivalent of the same distance covered at moderate speeds in long-distance highway travel.

The BMW maintenance system is divided into engine oil service and Inspections I and II.

Determining the maintenance intervals according to the actual loads on the vehicle covers practically every kind of operating situation. However, even those who drive only short distances, significantly less than 6,200 miles/10,000 km annually, should have the engine oil changed at least every 2 years since oil deteriorates over time, regardless of use.

 Brake fluid is hygroscopic: it absorbs moisture from the atmosphere over the course of time. To ensure that the brake system continues to provide safe and reliable performance, remember to have the brake fluid

changed at least every two years by a BMW Sports Activity Vehicle Center, also refer to the Service and Warranty Information Booklet for US models or the Warranty and Service Guide Booklet for Canadian models. ◀

Service and Warranty Information Booklet for US models and Warranty and Service Guide Booklet for Canadian models

Please consult your Service and Warranty Information Booklet for US models and Warranty and Service Guide Booklet for Canadian models for additional information on service requirements.



BMW recommends that you have service and repair operations performed at your BMW Sports Activity Vehicle Center.

Take the time to ensure that these service procedures are confirmed by entries in your vehicle's Service and Warranty Information Booklet for US models and Warranty and Service Guide Booklet for Canadian models. These entries verify that your vehicle has received the specified regular maintenance. ◀

Socket for OBD Onboard Diagnostics

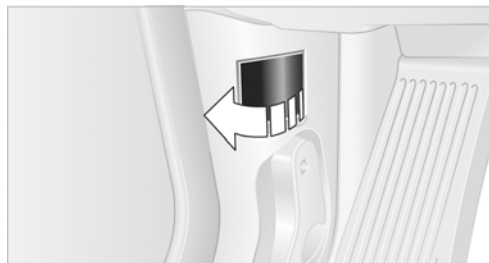

The chief components that make up the emissions content can be checked by a device that uses the OBD socket.

This socket is located under a cover on the left side of the driver's footwell, just under the dashboard.

Emissions values



The warning lamp lights up. Exhaust values are deteriorating. Have the vehicle checked as soon as possible.

Under certain conditions, the indicator will flash. This indicates a serious rate of engine misfire. When this occurs, you should reduce speed and consult the nearest BMW Sports Activity Vehicle Center as soon as possible. Severe engine misfire even for only a short period of time can seriously damage emission control components, especially the catalytic converter.



Display of the previously described malfunction on Canadian models.



When the fuel filler cap is not properly tightened, the OBD system can detect the vapor leak and the indicator lamp will light up. If the filler cap is subsequently tightened, the indicator lamp should go out within a few days.◀

Event data recorders

Your vehicle may be equipped with one or more sensing and diagnostic modules or a recording device capable of recording or transmitting certain vehicle data or information. In addition, if you have a Subscription Service Agreement for the BMW Assist system, certain vehicle information may be transmitted or recorded in order to provide such services.

Care

You can find useful information on caring for your BMW in the Caring for your vehicle brochure.

Replacing components

Onboard tool kit

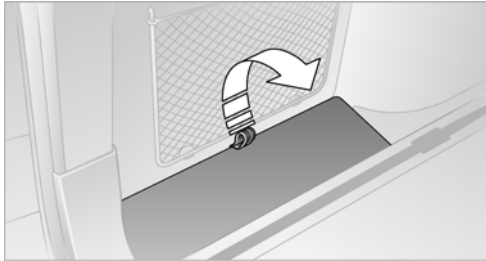

The onboard tool kit is located in a compartment on the left in the cargo area.

Wiper blades

Replacing front wiper blades

1. Move the wiper into the fold-out position, refer to page 40.
2. Lift the wiper arm and press the securing spring, refer to arrow.

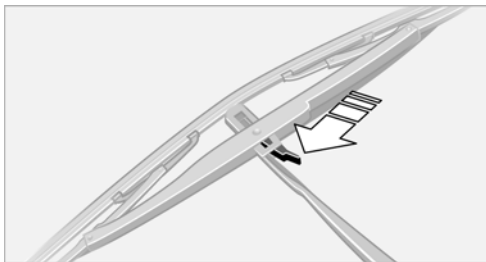

3. Pull the wiper blade off toward the wiper arm.
4. Insert the new blade and snap it into place.

! To prevent damage to the wipers, always fold them back down onto the windshield before you turn the ignition key to position 1 or 2 or open the hood. ◀

Replacing rear wiper blade

1. Lift the wiper arm.
2. Pull off the wiper blade, refer to arrow.



3. Insert a new wiper blade.

Lamps and bulbs

Lamps and bulbs make a significant contribution to road safety. Therefore, comply fully with the following instructions during bulb replacement. If you are not familiar with the specified procedures or they are not described here, BMW recommends having this work carried out at your BMW Sports Activity Vehicle Center.

▶ Never touch the glass of new bulbs with your bare fingers, as even minute amounts of contamination will burn into the bulb's surface and reduce its service life. Use a clean cloth, paper towel, or the like or grasp bulb by its base. ◀

A replacement bulb set is available from your BMW Sports Activity Vehicle Center.

! In all work on the electrical system, switch off the relevant component to prevent short circuits. To avoid possible injury or equipment damage when replacing bulbs, follow any instructions provided by the bulb manufacturer. ◀

When maintaining the headlamps, please follow the instructions in the separate Caring for your vehicle brochure.

 Please have your BMW Sports Activity Vehicle Center work on lamps whose replacement is not described here. ◀

Light-emitting diodes LEDs

Light-emitting diodes installed behind translucent lenses serve as the light source for many of the controls and displays in your vehicle. These light-emitting diodes are related to ordinary lasers.

 Do not remove the covers, and never stare into the unfiltered light for several hours, as irritation of the retina could result. ◀

Xenon lamps*

The service life of these bulbs is very long and the probability of failure is very low, provided that they are not switched on and off an unusual number of times. If one of these bulbs should nevertheless fail, it is possible to continue driving with great caution using the fog lamps, provided traffic laws in your area do not prohibit this.

 To avoid risk of potentially fatal injuries due to the extremely high voltages at which these units operate, service work should always be entrusted to qualified personnel. ◀

Parking and roadside parking lamps

In case of a malfunction, please contact your BMW Sports Activity Vehicle Center.

Halogen low beams

H7 bulb, 55 watts

 Always wear gloves and eye protection – the atmosphere within the bulb is pressurized. Failure to observe this precaution can lead to personal injury should the bulb be damaged. ◀

 For checking and adjusting headlamp aim, please contact your BMW Sports Activity Vehicle Center. ◀

Driver's side

1. Position the screwdriver from the onboard tool kit and pull off the lamp cover.

 Exercise caution when handling the screwdriver; otherwise, personal injury can occur or the vehicle can be damaged. ◀

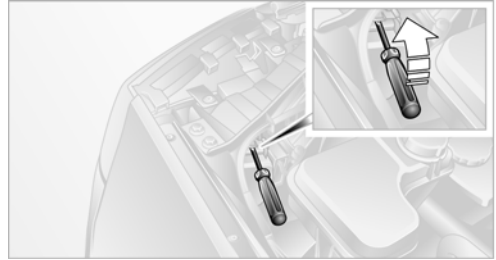

2. Press the bulb holder downward and remove.

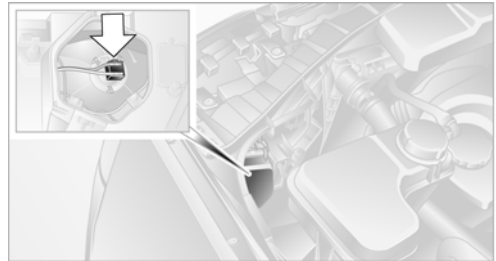

3. Remove the bulb, install a new bulb.

4. Place the bulb holder with the lower edge against the bracket and press it in until the lamp base locks into place.

Front passenger side



Before replacing the bulb, remove the reservoir for the windshield washing system from the

bracket. To do so, loosen the bolt, refer to arrow, and place the reservoir to one side.

! Bear in mind that the windshield washing system reservoir is heavy. If you do not, injuries or damage to the vehicle can occur. ◀

For bulb replacement procedure, refer to Driver's side.

Halogen high beams

H7 bulb, 55 watts

! Always wear gloves and eye protection – the atmosphere within the bulb is pressurized. Failure to observe this precaution can lead to personal injury should the bulb be damaged. ◀

▶ For checking and adjusting headlamp aim, please contact your BMW Sports Activity Vehicle Center. ◀

Driver's side

1. Open the clip and remove the lamp cover.

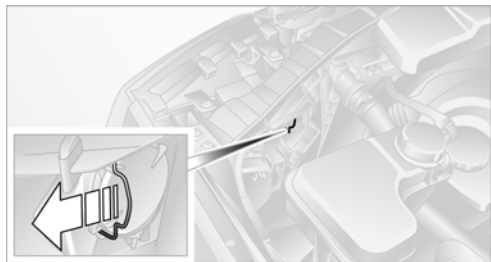

2. Press the bulb holder downward and remove, refer to Low beams.
3. Pull off the lamp base; plug in a new lamp base.
4. Place the lamp base with the lower edge against the bracket and press it in until the lamp base locks into place.

! Make sure that the cover does not fall into the engine compartment; otherwise, the vehicle can be damaged or other road users can be endangered. ◀

Front passenger side

Before replacing the bulb, remove the reservoir of the windshield washer system from the bracket, refer to Halogen low beams on page 100.

For bulb replacement procedure, refer to Driver's side.

Turn signal, front

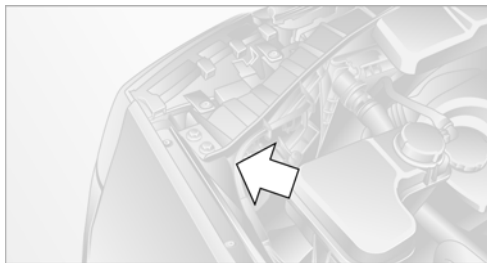

21 watt bulb

Access to the turn signal is at the edge of the lamp unit, refer to arrow.

! Make sure that the lamp base does not fall into the engine compartment; otherwise, the vehicle can be damaged or other road users can be endangered. ◀

1. Turn the lamp base and remove it.
2. Replace the bulb.
3. Insert the lamp base. If it does not snap into place immediately, turn the lamp base until it does.

Side-mounted turn signals

5 Watt bulb

1. Use finger pressure against the rear end of the lamp, refer to arrow, to press it forward for removal.

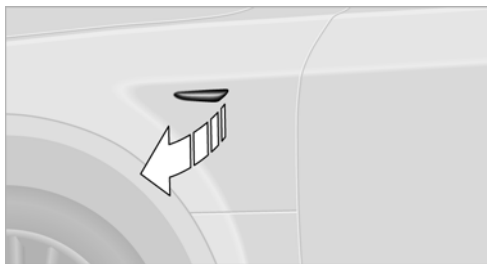

2. Apply gentle pressure to the bulb while turning it to the left and pull it out.
3. Install in the reverse order.

Front fog lamps

H11 bulb, 55 watts

! Always wear gloves and eye protection – the atmosphere within the bulb is pressurized. Failure to observe this precaution can lead to personal injury should the bulb be damaged. ◀

1. Pull the cover in front of the fog lamp forward.
2. Loosen the screws, refer to arrow, and pull out the headlamp.

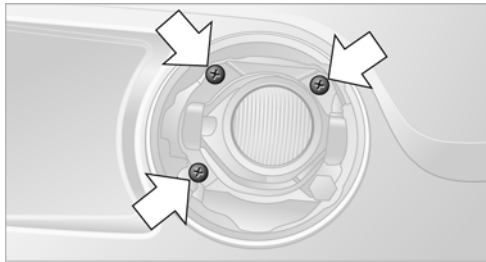

3. Turn the lamp base at the back of the headlamp to the left and remove it.
4. Replace the bulb.

Tail lamps

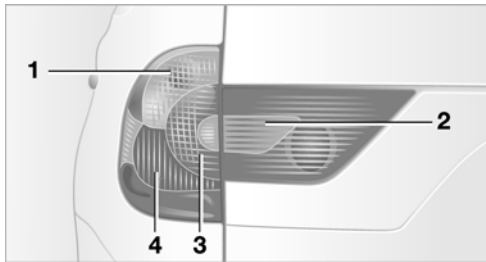

21 watt bulb

- 1 Turn signal
- 2 Backup lamp
- 3 Tail lamp/brake lamp
- 4 Tail lamp/brake lamp*

Replacing tail lamps

1. Open the flap in the side panel, refer to page 72.
2. To release the plug connection of the cable, press the spring, refer to arrow 1.
3. Lift the side panel somewhat.
4. To remove the back panel of the lamp, release the retainer, refer to arrow 2.



5. Apply gentle pressure to the bulb fitting while turning it to the left for removal and replacement.
6. Install in the reverse order.

Lamps in the liftgate

In case of a malfunction, please contact your BMW Sports Activity Vehicle Center.

License plate lamps

10 watt bulb

1. Press the lamp out to the side with a screwdriver.



2. Remove the lamp and replace the bulb.

Liftgate lamp

5 Watt bulb

1. Take out the bulb holder.

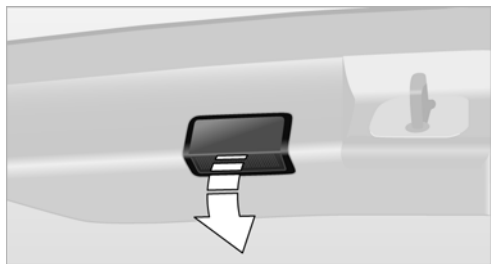

2. Replace the bulb.

Wheel changes

 Safety precautions to observe in the event of a flat tire and during all tire changes:

Park the vehicle as far as possible from passing traffic. Park on a firm, flat, surface. Switch on the hazard warning flashers.

Lock the steering wheel with the wheels pointing straight ahead. Engage the handbrake and shift into first gear or reverse, or move the selector lever to position P.

All passengers should be outside the vehicle and well away from your immediate working area, behind a guardrail, for instance.

If a warning triangle or portable hazard warning lamp is required, set it up on the roadside at an appropriate distance from the rear of the vehicle. Comply with all safety guidelines and regulations.

Change the wheel only on a level, firm surface which is not slippery. The vehicle or the jack could slip to the side if you attempt to raise the vehicle on a soft or slippery surface such as snow, ice, tile, etc.

Position the jack on a firm support surface.

Do not use a wooden block or similar object as a support base for the jack, as this would prevent it from extending to its full support height and reduce its load-carrying capacity.

To avoid serious or fatal injury: never lie under the vehicle, and never start the engine while it is supported by the jack. ◀

What you will need

Open liftgate and raise or remove floor cover, refer to page 72.

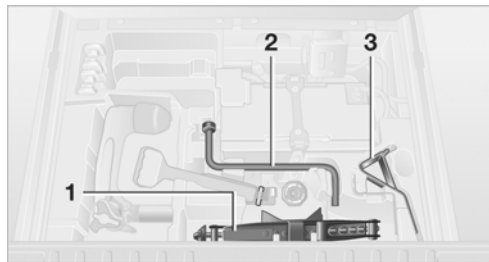

- 1 Vehicle jack
- 2 Lug wrench
- 3 Chocks, folding

In order to avoid rattling noises later, note the position of the tools when you remove them and return them to their original position when you are through using them.

Compact wheel

The compact wheel is located under the cargo area on the undercarriage of the vehicle.

Removing compact wheel

1. Unscrew bolt, refer to arrow 1.
2. Fold up lifting handle, refer to arrow 2.

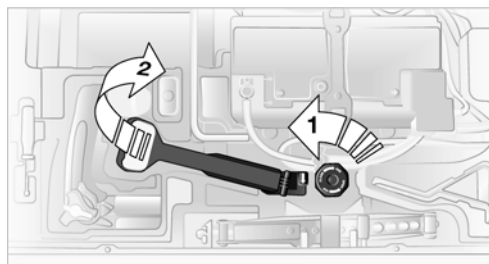

- Turn the handle to the left as far as possible, refer to arrow **3**.

 Turning the handle releases the compact wheel. Its weight of approx. 18 lbs./8 kg is then entirely supported by the handle. ◀

- Slowly lower the handle as far as possible, refer to arrow **4**.

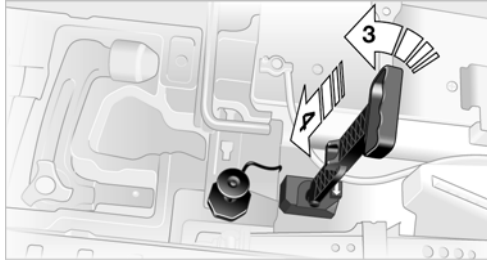

- Pull the compact wheel to the rear so that it is still securely resting in its compact wheel receptacle.
- If need be, turn the wheel in the compact wheel receptacle so that the attachment of the retaining strap to the rim points toward the rear.
- Rotate the clamp by 180°, refer to arrows **1**, and unhook the retaining strap from the clamp, refer to arrow **2**.

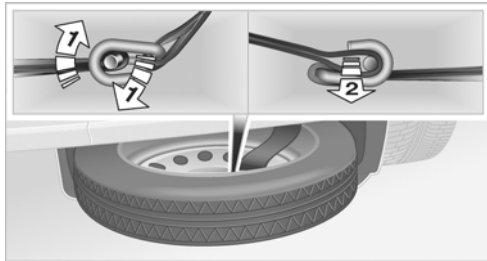

- Take out the compact wheel toward the back.
- Fasten the retaining strap to the compact wheel receptacle and resecure the compact wheel receptacle by reversing the above steps.

 The width of the defective wheel prevents it from fitting into the compact wheel

receptacle in place of the compact wheel itself. ◀

Inserting compact wheel

The compact wheel is reinserted in the reverse sequence of its removal.

 When attaching the retaining strap to the compact wheel, make sure the belt is threaded through 2 rim openings, with one unoccupied hole between them; otherwise, the compact wheel could come loose in an accident. ◀

Preparing wheel change

- Observe the safety precautions on page 103.
- Secure the vehicle to prevent it from rolling: place the wheel chock behind the front wheel on the side of the vehicle opposite the side being raised. If the vehicle is parked on a downward slope, place the wheel chock securely in front of the tire. If the wheel must be changed on a surface with a more severe slope, take additional precautions to secure the vehicle from rolling.
- Loosen the lug bolts by a ½ turn.

Jacking up vehicle

- Position the vehicle jack at the jacking point closest to the wheel so that the entire surface of the jack base perpendicularly contacts the ground under the jacking point.

 The vehicle jack is designed for changing wheels only. Do not attempt to raise another vehicle model with it or to raise any load of any kind. To do so could cause accidents and personal injury. ◀

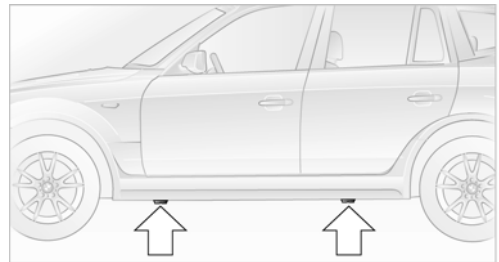

2. Guide the jack head into the rectangular recess of the jacking point when cranking up, refer to drawing inset.





3. Jack the vehicle up until the wheel you are changing is raised from the ground.

Mounting a wheel

1. Unscrew the lug bolts and remove the wheel.
2. Remove accumulations of mud or dirt from the mounting surfaces of the wheel and hub. Clean the lug bolts.
3. Position the new wheel or compact wheel. Secure the wheel by screwing at least two lug bolts into opposite bolt holes. When you mount wheels other than Genuine BMW light-alloy wheels, different lug bolts may also be required.
4. Screw in the remaining lug bolts. Tighten all the bolts securely in a diagonal pattern.
5. Lower the jack and remove it from beneath the vehicle.

After mounting

1. Tighten the lug bolts in a diagonal pattern.
 -  To ensure safety, always have the lug bolts checked with a calibrated torque wrench as soon as possible to ensure that they are tightened to the specified torque. The tightening torque is 101 lb ft/140 Nm. ◀
2. Stow the defective wheel in the cargo area.
3. Check and correct the tire inflation pressure at the earliest opportunity.
 -  Protect valve stems and valve stem seal caps from dirt and contamina-

tion. Dirt in valve stems is a frequent source of gradual air loss. ◀

4. Reinitialize the Flat Tire Monitor* or reset the Tire Pressure Monitor*, refer to pages 51, 52.
 -  Do not initialize the Flat Tire Monitor when driving with a compact wheel. ◀
5. Replace the damaged tire with a new one as soon as possible and have the new wheel balanced.

Driving with compact wheel

 Drive reservedly and do not exceed a speed of 50 mph/80 km/h. Do not deactivate DSC; otherwise, unstable driving conditions may result. ◀

Mounting the compact wheel can change the driving characteristics. For example, it can reduce tracking stability during braking, extend braking distances, and alter self-steering characteristics in the limit range. With winter tires, these characteristics are more pronounced.

 Only one compact wheel may be mounted. You should re-equip with wheels and tires of the original size as quickly as possible. ◀

Vehicle battery

Maintenance

The battery is 100% maintenance-free, i.e., the electrolyte will last for the life of the battery when the vehicle is operated in a temperate climate. Your BMW Sports Activity Vehicle Center will be happy to advise you on all questions concerning the battery.

Warning lamp

 The warning lamp lights up. The battery is no longer being charged. The alternator V-belt is defective or there is a malfunction in the charge current circuit of the alternator. Have the system checked immediately.

⚠ Do not continue driving if the V-belt is defective. The engine could be damaged due to overheating. Moreover, an increased amount of force is required for steering if there is a sharp drop in the onboard supply voltage. ◀

Charging battery

Charge the battery in the vehicle only when the engine has been switched off. For connections, refer to Jump starting on page 108.

Disposal

♻ Have old batteries disposed of following replacement at your BMW Sports Activity Vehicle Center or bring them to a collection point. Maintain the battery in an upright position for transport and storage. Always secure the battery to prevent it from tipping over during transport. ◀

Power failure

After a temporary power supply interruption, some equipment is subject to limited use and must be reinitialized. Individual settings are also lost and must be updated again:

- ▷ Panorama glass sunroof
It may be only possible to raise the sunroof. The system must be initialized, refer to page 23.
- ▷ Power windows
The pinch protection system must be reinitialized, refer to page 22.
- ▷ Seat and mirror memory
The positions must be stored again, refer to page 29.
- ▷ Time
Must be set again, refer to page 44.

Fuses

⚠ Never attempt to repair a blown fuse, and do not replace a defective fuse with a substitute of another color or amperage rating, as this could lead to a circuit overload, ultimately resulting in a fire in the vehicle. ◀

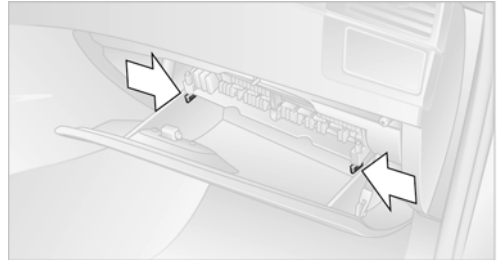

Open the glove compartment and turn the two quick-release fasteners to the left, refer to arrows.

Spare fuses, plastic tweezers, and information about fuse allocation are stored with the fuses.

Giving and receiving assistance

Receiving assistance

The Roadside Assistance of the BMW Group offers you assistance in the event of a breakdown around the clock, as well as on weekends and public holidays.

The phone numbers of the Roadside Assistance control center in your home country can be found in the BMW Dealer directory.

In the case of vehicles with the corresponding equipment, you can use buttons in the headliner to contact Roadside Assistance or initiate an emergency call.

When the emergency call is initiated, a telephone connection is established to the BMW Assist response center.

In vehicles with BMW Assist enabled, if the current position of your vehicle can be determined, it will be transmitted to the BMW Assist response center.

The conditions for initiating an emergency call or contacting Roadside Assistance:

- ▶ Ignition key in position 1 or higher
- ▶ The car phone is logged on to a mobile telephone network
- ▶ The emergency call system is operable

Access to buttons*

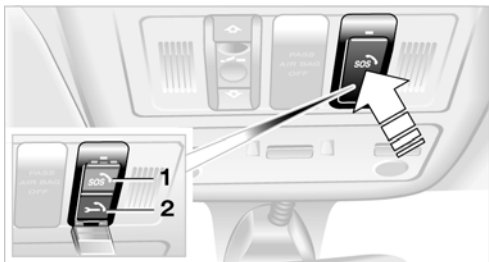

To open the cover:
Briefly press the cover, refer to arrow.

- 1 Emergency call
- 2 Roadside Assistance

Initiating an emergency call*

Press button **1** for at least 2 seconds.

The LED above the button lights up. As soon as a voice connection to the BMW Assist response center has been established, the LED flashes. If the LED flashes, but you are unable to hear the emergency response center, you can still be heard by the response center.

 For technical reasons, the emergency call cannot be guaranteed under the most unfavorable conditions. ◀

Under certain conditions, an emergency call is initiated automatically immediately after a severe accident. The automatic emergency call is not affected by the button being pressed.

Roadside Assistance*

Press button **2** for at least 2 seconds.

The LED above the button lights up. As soon as a voice connection to Roadside Assistance has been established, the LED flashes.

On a country-specific basis, with BMW Assist enabled, the current position of your vehicle is determined at the same time.

Warning triangle*

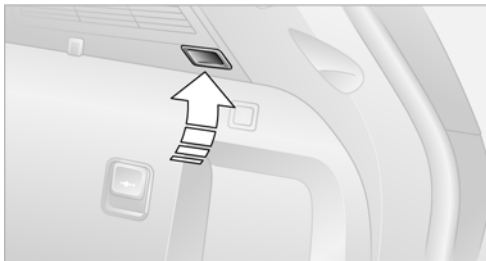

The warning triangle is stored behind the right side panel in the cargo area.

To open the side trim panel: press the button.

First-aid kit*

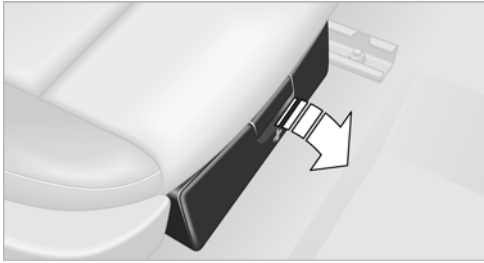

Beneath the front passenger's seat.

To open: pull the handle and fold the cover downward.

To close: fold the cover up.

Some of the articles in the first-aid kit may be used within a limited time only. Check the expiration dates of the contents regularly and replace the contents in a timely fashion as needed.

Jump starting

When your battery is discharged, you can use two jumper cables to start the engine of your BMW with power from the battery in another vehicle. You can also use the same method to help start another vehicle. Use only jumper cables with fully-insulated clamp handles.

! To avoid the risk of potentially fatal injury, always avoid all contact with electrical components while the engine is running. Carefully observe the following instructions to avoid personal injury and/or damage to one or both vehicles. ◀

Preparing

1. Check whether the battery of the other vehicle has a voltage of 12 Volts and approximately the same capacitance in Ah. This information can be found on the battery.
2. Switch off the engine of the vehicle providing assistance.
3. Switch off any electrical systems and components in both vehicles.

! Ensure that no contact exists between the bodywork on the two vehicles; otherwise, there is a danger of short circuits. ◀

Connecting jumper cables

! Connect the jumper cables in the correct order; failure to do so could generate sparks and cause injury. ◀

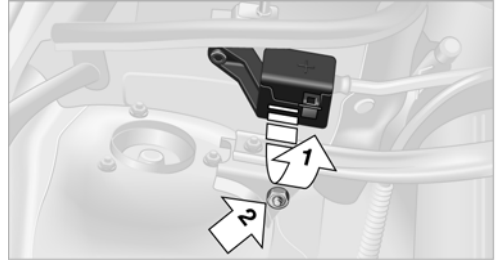

In your BMW, the so-called jump starting terminal in the engine compartment functions as the positive battery terminal, also refer to Engine compartment overview on page 93. The symbol + is embossed on the cover.

1. Open the cover of the BMW jump starting terminal, refer to arrow 1.
2. Connect one terminal clamp of the positive/+ jumper cable to the positive terminal of the battery or to a jump starting terminal of the vehicle providing starting assistance.
3. Connect the second terminal clamp of the positive/+ jumper cable to the positive terminal of the battery or to a jump starting terminal of the vehicle to be started.

Your BMW has a special nut that serves as the body ground or negative terminal, refer to arrow 2.

4. Connect one terminal clamp of the negative/- jumper cable to the negative terminal of the battery or to an engine or body ground of the vehicle providing assistance.
5. Connect the second terminal clamp of the negative/- jumper cable to the negative terminal of the battery or to the engine or body ground of the vehicle to be started.

Starting engine

1. Start the engine of the assisting vehicle and let it run at a slightly elevated idling speed for a few minutes.
2. Start the engine on the other vehicle in the usual way.
If the first start attempt is not successful, wait a few minutes before another attempt in order to allow the discharged battery to recharge.
3. Let the engines run for a few minutes.
4. Disconnect the jumper cables by reversing the connection sequence.

If need be, have the battery checked and recharged.

 Never use spray fluids to start the engine. ◀

Tow starting and towing

 Obey all applicable laws and guidelines for tow starting and towing. ◀

 Do not allow any passengers other than the driver to ride in a vehicle that is being towed. ◀

Using tow fitting

The threaded tow fitting is stored in the onboard tool kit, refer to page 99, and must always remain in the vehicle. It can be screwed in at the front or rear of the BMW.

 Only use the tow fitting that comes with the vehicle and screw it in as far as it will go. Use the tow fitting only for towing on roads. Avoid lateral loading of the tow fitting, e.g. do not lift the vehicle by the tow fitting. Otherwise, the tow fitting and the vehicle can be damaged. ◀

Access to screw thread

Press out the cover in the front or rear bumper at the notch at the bottom with a screwdriver.



Being towed

 Make sure that the ignition key is in position 1; otherwise, the steering lock will engage, making it impossible to steer the vehicle. There is no power assist with the engine switched off. It is therefore necessary to exert increased effort for braking and steering. ◀

Switch on the hazard warning flashers depending on the local regulations. If the electrical system fails, mark the vehicle to be towed, e.g. with a sign or warning triangle in the rear window.

 Do not exceed a towing speed of 30 mph/50 km/h and a towing distance of 95 miles/150 km; otherwise, the drive train may be damaged. ◀

Manual transmission

Gearshift lever in neutral.

Automatic transmission

Selector lever in position N.
Changing selector lever positions, refer to page 38.

Towing methods

In some countries, towing with tow bars or ropes on public roads is not permitted.

Familiarize yourself with the regulations on towing in the specific country.

With tow bar

⚠ The towing vehicle must not be lighter than the vehicle to be towed; otherwise, it will not be possible to safely control vehicle response. ◀

The tow fittings used should be on the same side on both vehicles. Should it prove impossible to avoid mounting the tow bar at an offset angle, please observe the following:

- ▷ Clearance and maneuvering capability will be strictly limited in corners.
- ▷ When mounted at an angle, the tow bar will exert lateral forces, tending to push the vehicle sideways.

⚠ Secure the tow bar to the tow fittings only. Otherwise, other vehicle parts could be damaged. ◀

With tow-rope

When starting off in the towing vehicle, make sure that the tow-rope is taut.

⚠ To avoid jerking and the associated stresses on vehicle components when towing, always use nylon ropes or nylon straps. Secure the tow rope to the tow fittings only. Otherwise, other vehicle parts could be damaged. ◀

With tow truck

⚠ Do not tow the X3 with only the front or rear axle raised; otherwise, the wheels could lock and the transfer case could be damaged. ◀

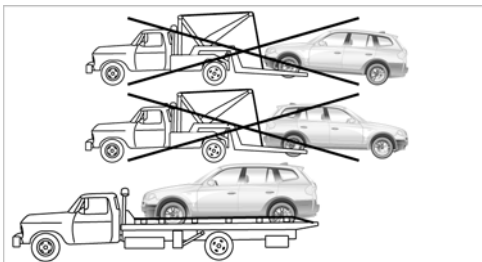

Have the X3 transported only on a flat bed.

⚠ To avoid damage, do not lift the vehicle from the tow fitting or body and suspension parts. ◀

Tow starting

If possible, do not tow start the vehicle; jump start the engine instead, refer to page 108. Vehicles equipped with catalytic converters should only be tow started when the engine is cold. It is not possible to tow start an engine equipped with an automatic transmission.

1. Switch on hazard warning flashers, comply with local regulations.
2. Switch on ignition, refer to page 36.
3. Shift into 3rd gear.
4. Have the vehicle tow-started with the clutch depressed and slowly release the clutch. After the engine starts, immediately depress the clutch again.
5. Stop at a suitable location, remove the tow bar or rope and switch off the hazard warning flashers.
6. Have the vehicle checked.

▶ Do not activate the HDC Hill Descent Control during tow starting, refer to page 49. ◀

Reference

This chapter contains the technical data and the index that will direct you as quickly as possible to the information sought.

Technical data

Engine specifications

		X3 2.5i	X3 3.0i
Displacement	cu in/cm ³	152.2/2,494	181.8/2,979
Number of cylinders		6	6
Maximum output	hp	184	225
at engine speed	rpm	6,000	5,900
Maximum torque	lb ft/Nm	175/237	214/290
at engine speed	rpm	3,500	3,500

An engine performance test is authorized only on an appropriate chassis dynamometer.

Dimensions

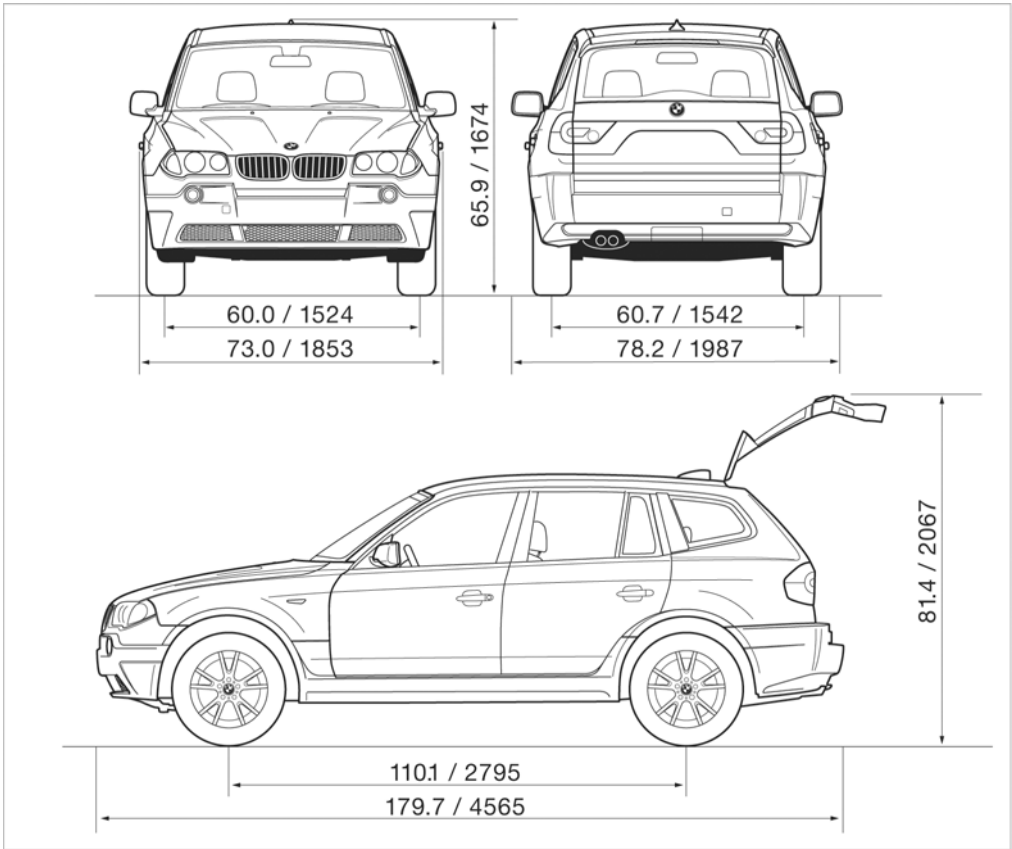

All dimensions in inches/millimeters. Smallest turning circle dia.: 38.4 ft/11.7 m.
Height with roof rack*: 66.0 in/1674 mm.

Weights

		X3 2.5i	X3 3.0i
Curb weight			
with manual transmission	lbs./kg	4,001/1,815	4,023/1,825
with automatic transmission	lbs./kg	4,045/1,835	4,067/1,845
Approved gross vehicle weight			
with manual transmission	lbs./kg	4,993/2,265	5,049/2,290
with automatic transmission	lbs./kg	5,049/2,290	5,104/2,315
Payload			
with manual transmission	lbs./kg	992/450	1,025/465
with automatic transmission	lbs./kg	1,003/455	1,036/470
Approved front axle load	lbs./kg	2,425/1,100	2,425/1,100
Approved rear axle load	lbs./kg	2,756/1,250	2,778/1,260
Approved roof load capacity	lbs./kg	165/75	165/75
Cargo area capacity	cu ft/l	71/2,011	71/2,011

Never exceed either the approved axle loads or the gross vehicle weight.

Capacities

			Notes
Fuel tank	gal./liters	approx. 17.7/67	Fuel specification: page 85
Reserve	gal./liters	approx. 2/8	
Windshield washer/ headlamp washer system	quarts/liters	approx. 3.2/3.0 approx. 6.9/6.5	For details: page 41
Engine oil and filter change	quarts/liters	approx. 6.6/6.2	For details: page 94

Everything from A to Z

Index

A

- ABS Antilock Brake System **48**
 - indicator lamp **12**
- Accessories, refer to For your own safety **6**
- Accident, refer to Receiving assistance **107**
- Acknowledgment signal for locking/unlocking vehicle **19, 20**
- Activated-charcoal filter **64**
- Adaptive Head Light **57**
- Adding engine oil **94**
- Adjusting seats **27**
 - electrically **27**
 - mechanically **27**
 - mechanically Sports seat **28**
- Airbags **53**
 - deactivating front passenger side **33, 54**
 - indicator lamp for front passenger airbags **54**
 - sitting safely **26**
 - warning lamp **54**
- Air circulation, refer to Recirculated-air mode **60, 63**
- Air conditioner **59**
- Air distribution
 - air conditioner **60**
 - automatic climate control **63**
- Airing, refer to Ventilation **61, 64**
- Air outlets, refer to Ventilation **61, 64**
- Air pressure, refer to Tire inflation pressure **86**
- Air vents, refer to Ventilation **61, 64**
- Air volume **60**
 - adjusting manually **63**
- AKI, refer to Fuel specifications **85**
- Alarm system **24**
 - avoiding unintentional alarms **25**
- All-season tires, refer to Special characteristics of winter tires **90**
- All wheel drive, refer to xDrive **49**
- Anchorage points **73**
- Antifreeze
 - coolant **95**
 - washer fluid **41**
- Antifreeze protection, coolant **95**
- Antilock Brake System
 - ABS **48**
 - indicator lamp **12**
- Anti-theft alarm system, refer to Alarm system **18, 24**
- Approved axle load, refer to Weights **116**
- Approved engine oils **95**
- Approved gross vehicle weight, refer to Weights **116**
- Armrest
 - front **67**
 - rear **68**
- Artificial leather, refer to Caring for your vehicle brochure
- Ashtray **68**
- AUC Automatic recirculated-air control **63**
- Automatic
 - air distribution **63**
 - air volume **63**
 - recirculated-air control AUC **63**
- Automatic car wash, refer to Caring for your vehicle brochure
- Automatic climate control **62**
- Automatic cruise control **41**
- Automatic curb monitor **31**
- Automatic deactivation of front passenger airbags **54**
- Automatic headlamp control **56**
- Automatic transmission with Steptronic **38**
 - indicator lamp **39**
 - interlock **36**
 - selector lever interlock **38**
 - shiftlock **38**
 - towing **109**
 - tow starting **110**
- AUTO program **63**
- Average fuel consumption **46**
 - setting units **45**
- Average speed **46**
 - setting units **45**
- Avoiding unintentional alarms **25**
- Axle loads, refer to Weights **116**

B

- Backrest, refer to Seats **27**
- Backrest contour, refer to Lumbar support **28**
- Backup lamps
 - bulb replacement **102**
 - refer to Tail lamps **102**
- Bandages, refer to First-aid kit **108**
- Bar, towing **110**
- Battery **105**
 - disposal **106**
 - indicator lamp **12**
 - jump starting **108**
 - power failure **106**
 - remote control **18**
 - warning lamp **105**

Belts, refer to Safety belts [29](#)
Beverage holder, refer to Cup holders [66](#)
Blower, refer to
– Air volume [60](#)
– Air volume, adjusting manually [63](#)
BMW maintenance system [97](#)
Bottle holder, refer to Cup holders [66](#)
Brake fluid [96](#)
– level [96](#)
– warning lamp [96](#)
Brake force display [53](#)
Brake lamps
– brake force display [53](#)
– indicator lamp, defective bulb [12](#), [56](#)
– replacing bulbs [102](#)
Brake light, refer to Brake lamps [102](#)
Brake pads [96](#)
– breaking-in [76](#)
– warning lamp [96](#)
Brake pedal, refer to Safe braking [78](#)
Brake rotors
– brake system [76](#)
– breaking-in [76](#)
Brakes [78](#), [96](#)
– ABS [48](#), [78](#)
– brake fluid [96](#)
– brake pads [96](#)
– breaking-in [76](#)
– handbrake [37](#)
– indicator/warning lamp [12](#)
Brake system [96](#)
– brake fluid [96](#)
– brake pads [96](#)
– breaking-in [76](#)
– disk brakes [78](#)
– warning lamp [96](#)
Brake wear warning
– refer to Brake pads [96](#)
– warning lamp [96](#)
Breakdown service, refer to Receiving assistance [107](#)
Breaking-in [76](#)

Bulb replacement, refer to Lamps and bulbs [99](#)
Buttons on steering wheel [13](#)

C

California law
– Event Data Recorders [98](#)
– Proposition 65 Warning [6](#)
Calling, refer to telephone Owner's Manual
Can holder, refer to Cup holders [66](#)
Capacities [116](#)
Capacity, cargo area [116](#)
Car care, refer to Caring for your vehicle brochure
Car-care products, refer to Caring for your vehicle brochure
Care, refer to Caring for your vehicle brochure
Cargo, securing [79](#)
Cargo area [21](#), [70](#)
– capacity [116](#)
– cover [71](#)
– emergency operation, refer to Opening manually [21](#)
– enlarging [70](#)
– floor cover [72](#)
– folding rear seat backrest [70](#)
– lashing eyes [73](#)
– lid, refer to Liftgate [21](#)
– opening from outside [21](#)
– opening with remote control [19](#)
– power socket [69](#)
Cargo loading [78](#)
– load [79](#)
– securing cargo [79](#)
– stowing cargo [79](#)
– vehicle [78](#)
Caring for artificial leather, refer to Caring for your vehicle brochure
Caring for carpet, refer to Caring for your vehicle brochure
Caring for leather, refer to Caring for your vehicle brochure
Caring for plastic, refer to Caring for your vehicle brochure
Caring for vehicle finish, refer to Caring for your vehicle brochure
Car keys, refer to Key set [18](#)
Car phone, refer to separate Owner's Manual
Car phone preparation [69](#)
Car radio, refer to Owner's Manual for Radio/Onboard Computer
Car wash [77](#)
– refer to Caring for your vehicle brochure
Cassette operation, refer to Owner's Manual for Radio/Onboard Computer
CD operation, refer to Owner's Manual for Radio/Onboard Computer
Cellphone, refer to separate Owner's Manual
Central locking system [18](#)
– interior [20](#)
Changes, technical, refer to For your own safety [6](#)
Changing a wheel [103](#)
Changing gears
– automatic transmission with Steptronic [39](#)
– manual transmission [38](#)
Changing wheels [89](#)
Charge-current indicator lamp [12](#), [105](#)
Charging battery [106](#)
Check Gas Cap, warning lamp [12](#), [84](#)
Checking oil level [94](#)
Child's seat, refer to Child restraint systems [33](#)
Child-restraint fixing system LATCH [34](#)

- Child restraint systems **33**
 - installing **33**
 - with tether strap **34**
 - Child-safety locks **35**
 - Child seat security **33**
 - Chock **103**
 - Chrome parts, care, refer to
 - Caring for your vehicle brochure
 - Cigarette lighter **68**
 - Circulation of air, refer to
 - Recirculated-air mode **60, 63**
 - Cleaning, vehicle, refer to
 - Caring for your vehicle brochure
 - Cleaning rear window **41**
 - Cleaning windows, reservoir **41**
 - Clock **44, 45**
 - 12 or 24 hour mode **45**
 - setting, also refer to Owner's Manual for Radio/Onboard Computer
 - setting time **44**
 - Closing
 - from inside **20**
 - from outside **19**
 - Clothes hooks **68**
 - Clutch **76**
 - breaking-in **76**
 - Cockpit **10**
 - Cold start, refer to Starting engine **36**
 - Combination of wheel/tire **90**
 - Compact wheel, wheel changes **103**
 - Compartments, refer to
 - Storage compartments **67**
 - Compartments in cargo area, refer to Behind side trim panel **72**
 - Computer **45**
 - also refer to Owner's Manual for Onboard Computer
 - functions **45**
 - Condensation, refer to When the vehicle is parked **77**
 - Connecting car vacuum cleaner, refer to Connecting electrical devices **69**
 - Connecting electrical devices **69**
 - Consumption, refer to
 - Average fuel consumption **46**
 - Consumption indicator, refer to Fuel gauge **43**
 - Controls, refer to Cockpit **10**
 - Convenience operation
 - from outside **20**
 - panorama glass sunroof **20**
 - windows **20**
 - Coolant **95**
 - level **95**
 - temperature gauge **44**
 - warning lamp **95**
 - Cooling, refer to
 - Temperature **60, 63**
 - Cruise control **41**
 - buttons on steering wheel **13**
 - indicator lamp **42**
 - Cruising range **46**
 - Cup holders **66**
 - Curb weight, refer to
 - Weights **116**
 - Cylinders, refer to Engine data **114**
- D**
- Dashboard lighting, refer to Instrument lighting **58**
 - Dashboard system, refer to Cockpit **10**
 - Data, technical **114**
 - dimensions **115**
 - engine **114**
 - filling capacities **116**
 - weights **116**
 - Daytime running lamps **56**
 - DBC Dynamic Brake Control **48**
 - warning lamp **50**
 - Deactivating front passenger airbags **33, 54**
 - Defective lamp **56**
 - Defects **7**
 - Defrosting windows **60, 63**
 - air conditioner **60**
 - automatic climate control **63**
 - Defrosting windows and removing condensation
 - air conditioner **60**
 - automatic climate control **63**
 - Defrost position, refer to
 - Defrosting windows **60, 63**
 - Digital clock **44**
 - Dimensions **115**
 - Dimming mirror **77**
 - Dipstick, engine oil **94**
 - Directional indicators, refer to
 - Turn signals **39**
 - Disk brakes **78**
 - Displacement, refer to Engine data **114**
 - Display illumination, refer to Instrument lighting **58**
 - Display lighting, refer to Instrument lighting **58**
 - Displays, refer to Instrument cluster **11**
 - Disposal, vehicle battery **106**
 - Disposal of the vehicle, refer to Caring for your vehicle brochure
 - Distance warning, refer to
 - PDC Park Distance Control **47**
 - Door keys **18**
 - Door lock **20**
 - Doors
 - locking and unlocking from inside **20**
 - locking and unlocking from outside **19**
 - manual operation **20**
 - unlocking and locking, acknowledgment signals **19, 20**
 - DOT Quality Grades **88**
 - Draft-free ventilation **61, 64**
 - Driving lamps, refer to Parking lamps/low beams **56**

Driving notes [76](#)
Driving on poor roads [80](#)
Driving stability control systems [48](#)
Driving through water [80](#)
Driving tips, refer to Driving instructions [76](#)
Drying air, refer to Switching cooling function on/off [60](#), [63](#)
DSC Dynamic Stability Control [48](#)
– indicator lamp [48](#)
DVD changer, refer to Owner's Manual for Radio/Onboard Computer
Dynamic Brake Control, refer to DBC Dynamic Brake Control [48](#)
Dynamic Brake Control DBC
– warning lamp [50](#)
Dynamic Stability Control DSC [48](#)
– indicator lamp [48](#)

E

Electrical malfunctions
– automatic transmission malfunction [39](#)
– door lock [20](#)
– driver's door [20](#)
– fuel filler door [84](#)
– liftgate [21](#)
– panorama glass sunroof [24](#)
Electronic brake-force distribution [48](#)
Electronic Stability Program, refer to DSC Dynamic Stability Control [48](#)
Emergency call [107](#)
Emergency operation, refer to Manual operation
– doors [20](#)
– driver's door [20](#)
– fuel filler door [84](#)
– liftgate [21](#)
– panorama glass sunroof [24](#)

Emergency Service, refer to Receiving assistance [107](#)
Engine
– breaking-in [76](#)
– data [114](#)
– indicator lamps [36](#)
– overheated, refer to Coolant thermometer [44](#)
– speed [43](#)
– starting [36](#)
– switching off [37](#)
Engine compartment [93](#)
Engine coolant [95](#)
Engine coolant temperature [44](#)
Engine oil [94](#)
– additives, refer to Approved engine oils [95](#)
– approved engine oils [95](#)
– indicator/warning lamp [94](#)
– required oil grades [95](#)
Engine oil grades [95](#)
Engine oil level [94](#)
– indicator/warning lamp [94](#)
Engine oil pressure [94](#)
– indicator/warning lamp [94](#)
Engine oil sensor [94](#)
– indicator/warning lamp [94](#)
Engine output, refer to Engine data [114](#)
Equipment range, refer to Service and Warranty Information Booklet for US models, Warranty and Service Guide Booklet for Canadian models
ESP Electronic Stability Program, refer to DSC Dynamic Stability Control [48](#)
Exhaust system [77](#)
Exterior mirrors [30](#)
– automatically dimming [77](#)
Eye, tow starting and towing [109](#)

F

Failure of electrical accessories [106](#)
False alarms, refer to Avoiding unintentional alarms [25](#)
Fastening safety belts, refer to Safety belts [29](#)
Filter, refer to
– Microfilter [61](#)
– Microfilter/activated charcoal filter [64](#)
First aid, refer to First-aid kit [108](#)
First-aid kit [108](#)
Flat tire [103](#)
– compact wheel [103](#)
– Flat Tire Monitor [50](#)
– refer to Tire inflation pressure [86](#)
– refer to Wheel changes [103](#)
– Tire Pressure Monitor [52](#)
Flat Tire Monitor [50](#)
– indicator lamp [51](#)
– initializing system [51](#)
– snow chains [91](#)
– system limits [51](#)
– warning errors [51](#)
Flooding, refer to Driving through water [77](#)
Floor cover [72](#)
Fog lamps, indicator lamp [57](#)
Folding rear seat back [70](#)
Four wheel drive, refer to xDrive [49](#)
Front airbags [53](#)
Front fog lamps [57](#)
– replacing bulbs [102](#)
Front passenger airbags, automatic deactivation [54](#)
Fuel [85](#)
– average consumption [46](#)
– capacity [116](#)
– gauge [43](#)
– quality [85](#)
Fuel cap [84](#)
Fuel display, refer to Fuel gauge [43](#)

Fuel filler door [84](#)
 – releasing in the event of electrical malfunction [84](#)
 Fuel gauge [43](#)
 Fuel tank contents, refer to Filling capacities [116](#)
 Full preparation package mobile phone, refer to separate Owner's Manual
 Fuses [106](#)

G

Garage-door opener, refer to Integrated universal remote control [65](#)
 Gasoline
 – refer to Average consumption [46](#)
 – refer to Fuel quality [85](#)
 – refer to Fuel specifications [85](#)
 Gasoline display, refer to Fuel gauge [43](#)
 Gear indicator with automatic transmission with Steptronic [38](#)
 Gearshift lever, manual transmission [38](#)
 General driving notes [76](#)
 Glove compartment [67](#)
 Grills, refer to Ventilation [61](#), [64](#)
 Gross vehicle weight, refer to Weights [116](#)
 Ground clearance [80](#)

H

Halogen lamps [100](#)
 Handbrake [37](#)
 – indicator lamp [37](#)
 Hands-free microphone, refer to Car phone preparation [69](#)
 Hazard warning flashers [10](#)
 HDC Hill Descent Control [49](#)
 Head airbags [53](#)
 Headlamp control, automatic [56](#)

Headlamp flasher [39](#)
 – indicator lamp [12](#)
 Headlamps [100](#)
 – care, refer to Caring for your vehicle brochure
 – replacing bulbs [99](#)
 Headlamp washer reservoir [41](#)
 – capacity, refer to Filling capacities [116](#)
 Headlamp washer system
 – headlamp washing [41](#)
 – washer fluid [41](#)
 Head Light, refer to Adaptive Head Light [57](#)
 Head restraints [28](#)
 – installing, front [28](#)
 – removing, front [28](#)
 – sitting safely [26](#)
 Heated mirrors [31](#)
 Heated rear window
 – air conditioner [60](#)
 – automatic climate control [64](#)
 Heated seats [29](#)
 Heated steering wheel [31](#)
 Heater
 – rear window [60](#), [64](#)
 – windshield washer jets [41](#)
 Heating
 – exterior mirror [31](#)
 – seats [29](#)
 – steering wheel [31](#)
 Heating and ventilation [59](#), [62](#)
 Heavy cargo, refer to Cargo loading [78](#)
 Height, refer to Dimensions [115](#)
 Height adjustment
 – seats [27](#)
 – steering wheel [31](#)
 High beams [57](#)
 – headlight flasher [57](#)
 – indicator lamp [12](#)
 – replacing bulbs [101](#)
 High Performance Synthetic Oil [95](#)
 Hill-climbing ability, refer to Driving on poor roads [80](#)

Hill descent assistance, refer to HDC Hill Descent Control [49](#)
 Hill Descent Control HDC [49](#)
 Hills [78](#)
 Holder for beverages [66](#)
 Hood [92](#)
 Horn [10](#)
 Hotel function [18](#)
 Hot exhaust system [77](#)
 Hydraulic Brake Assistant, refer to DBC Dynamic Brake Control [48](#)
 Hydroplaning [77](#)

I

Icy conditions, refer to Outside temperature warning [45](#)
 Ignition [36](#)
 Ignition key [18](#)
 Ignition key positions, refer to Ignition lock [36](#)
 Ignition lock [36](#)
 Indicator/warning lamp
 – airbags [54](#)
 – alarm system [25](#)
 – automatic transmission with Steptronic [39](#)
 – brakes [96](#)
 – coolant temperature [44](#)
 – DSC [48](#)
 – engine temperature [44](#)
 – Flat Tire Monitor [51](#)
 – fog lamps [57](#)
 – front passenger airbags [54](#)
 – overview [12](#)
 – reserve [43](#)
 – safety belt warning [30](#)
 – Tire Pressure Monitor [52](#)
 Indicator and warning lamps [12](#)
 Individual settings, refer to Vehicle Memory, Key Memory [32](#)
 Inflation pressure, refer to Tire inflation pressure [86](#)

Inflation pressure monitoring, refer to
– Flat Tire Monitor [50](#)
– Tire Pressure Monitor [52](#)
Initializing, refer to Power supply interruption [22, 23](#)
INSPECTION [44](#)
Instrument cluster [11](#)
Instrument lighting [58](#)
Instrument panel, refer to Cockpit [10](#)
Integrated universal remote control [65](#)
Interior lamps [58](#)
– remote control [19](#)
Interior motion sensor [25](#)
– switching off [19, 25](#)
Interior rearview mirror [31](#)
– automatic dimming feature [77](#)
Interlock [36](#)
Intermittent mode of the wipers [40](#)
Interval indicator, Service [44](#)

J

Jacking points [104](#)
Jump starting [108](#)

K

Key Memory [32](#)
Keys [18](#)
– key-specific settings, refer to Vehicle Memory, Key Memory [32](#)
Kick-down [39](#)

L

Labeling, tires [88](#)
Lamps and bulbs [99](#)
Lashing eyes, refer to Securing cargo [79](#)
LATCH child-restraint fixing system [34](#)

LEDs light-emitting diodes [100](#)
Length, refer to Dimensions [115](#)
License plate lamp, replacing bulbs [102](#)
Liftgate [21](#)
– closing [21](#)
– emergency operation [21](#)
– opening from outside [21](#)
– opening manually [21](#)
– remote control [19](#)
Liftgate lamp, replacing bulbs [103](#)
Lifting handle, compact wheel [103](#)
Light-alloy wheels, care, refer to Caring for your vehicle brochure
Light-emitting diodes LEDs [100](#)
Lighter [68](#)
Lighter socket [69](#)
Lighting of instruments [58](#)
Lights, refer to Parking lamps/low beams [56](#)
Lights on warning [56](#)
Light switch [56](#)
Load
– determining load limit [78](#)
– refer to Cargo loading [78](#)
Lock buttons, doors, refer to Locking [21](#)
Locking
– from inside [20](#)
– from outside [19](#)
Low beams [56](#)
– automatic [56](#)
– indicator lamp, defective bulb [56](#)
– replacing bulbs [100](#)
Lower back support, refer to Lumbar support [28](#)
Lug bolts [104](#)
– torque [105](#)

Luggage compartment [21](#)
– capacity [116](#)
– cover, refer to Cargo area cover [71](#)
– floor cover [72](#)
– increasing volume [70](#)
– opening/closing, refer to Liftgate [21](#)
– opening from outside [21](#)
– opening with remote control [19](#)
Luggage compartment, refer to Cargo area [70](#)
Luggage compartment cover, refer to Cargo area cover [71](#)
Luggage compartment lid
– emergency operation, refer to Opening manually [21](#)
– opening with remote control, refer to Unlocking liftgate [19](#)
Luggage compartment lid, refer to Liftgate [21](#)
Luggage compartment net, refer to Partition net [72](#)
Luggage rack, refer to Roof-mounted luggage rack [80](#)
Lug wrench [103](#)
Lumbar support [28](#)

M

Maintenance [97](#)
– refer to Service Interval Display [44](#)
Maintenance system [97](#)
Malfunctions
– automatic transmission [39](#)
– door lock [20](#)
– fuel filler door [84](#)
– liftgate [21](#)
– panorama glass sunroof [24](#)
Manual air distribution [60, 63](#)
Manual operation
– door lock [20](#)
– driver's door [20](#)
– fuel filler door [84](#)
– liftgate [21](#)
– panorama glass sunroof [24](#)
Manual transmission [38](#)

Master key [18](#)
 – with remote control [18](#)
 Maximum speed, with winter tires [90](#)
 Mechanical seats [27](#)
 Memory, refer to
 – Seat and mirror memory [29](#)
 – Vehicle Memory, Key Memory [32](#)
 Microfilter
 – air conditioner [61](#)
 – automatic climate control [64](#)
 Microphone, refer to Car phone preparation [69](#)
 Microphone for telephone [69](#)
 Mirrors [30](#)
 – automatic curb monitor [31](#)
 – mirror heating [31](#)
 – mirror memory, refer to Seat and mirror memory [29](#)
 Mobile communications devices in vehicle [77](#)
 Mobile phone, refer to separate Owner's Manual
 Monitoring tire pressure, refer to Flat Tire Monitor [50](#)
 Monitoring tire pressure, refer to Tire Pressure Monitor [52](#)
 Multi-function steering wheel, refer to Buttons on steering wheel [13](#)
 Multifunction switch
 – turn signals/headlamp flasher [39](#)
 – washer/wiper system [40](#)

N

Navigation system, refer to separate Owner's Manual
 Neck support, refer to Head restraints [28](#)
 Nets [68](#)
 Nonsmoker's equipment package [68](#), [69](#)
 Nozzles, refer to Ventilation [61](#), [64](#)
 Nylon rope, refer to Tow starting and towing [109](#)

O

OBD socket [97](#)
 Octane rating, refer to Fuel quality [85](#)
 Odometer [43](#)
 Oil
 – additives, refer to Approved engine oils [95](#)
 – approved engine oils [95](#)
 – capacity [116](#)
 – consumption, refer to Checking engine oil level [94](#)
 – dipstick [94](#)
 – level [94](#)
 – refilling, refer to Adding engine oil [94](#)
 Oil change interval, refer to Service Interval Display [44](#)
 Oil grades [95](#)
 Oil level [94](#)
 – warning lamp [94](#)
 Oil pressure [94](#)
 – warning lamp [94](#)
 Oil sensor [94](#)
 – warning lamp [94](#)
 OILSERVICE [44](#)
 Old batteries, refer to Disposal [106](#)
 Onboard Diagnostics OBD interface socket [97](#)
 On-board monitor, refer to separate Owner's Manual
 Onboard tool kit [99](#)
 Opening and closing
 – from inside [20](#)
 – from outside [19](#)
 – using the door lock [20](#)
 – using the remote control [19](#)
 Output, refer to Engine data [114](#)
 Outside air
 – air conditioner [60](#)
 – automatic climate control [63](#)
 Outside temperature display
 – changing unit of measure [45](#)
 – on computer [45](#)
 Overheating of engine, refer to Coolant thermometer [44](#)

P

Panic mode [19](#)
 Panorama glass sunroof [23](#)
 – automatic opening and closing [23](#)
 – closing with electrical malfunction [24](#)
 – comfort operation [20](#)
 – comfort position [23](#)
 – initializing [23](#)
 – power failure [23](#)
 – remote control [19](#)
 Parcel shelf, refer to Cargo area cover [71](#)
 Park Distance Control PDC [47](#)
 Parking aid, refer to PDC Park Distance Control [47](#)
 Parking assistant, refer to PDC Park Distance Control [47](#)
 Parking brake, refer to Handbrake [37](#)
 Parking lamps [56](#)
 Parking lamps/low beams [56](#)
 Partition net [72](#)
 Parts and accessories, refer to For your own safety [6](#)
 Passenger airbags, status [54](#)
 Passenger-side mirror tilt function [31](#)
 Pathway lighting [56](#)
 PDC Park Distance Control [47](#)
 Pinch protection system [22](#), [23](#)
 – panorama glass sunroof [23](#)
 – power windows [22](#)
 Plastic, refer to Caring for your vehicle brochure
 Pollen, refer to
 – Microfilter [61](#)
 – Microfilter/activated charcoal filter [64](#)
 Power failure
 – battery [106](#)
 – panorama glass sunroof [23](#)
 – windows [22](#)
 Power seat adjustment [27](#)

Power socket in cargo area [69](#)
Power windows [22](#)
– initializing [22](#)
– safety switch [22](#)
Precious wood, refer to Caring for your vehicle brochure
Pressure, tires [86](#)
Pressure monitoring, tires [50](#), [52](#)
Programming settings, refer to Vehicle Memory, Key Memory [32](#)
Puncture, Flat Tire Monitor [50](#)

R

Radiator, refer to Coolant [95](#)
Radio, refer to Owner's Manual for Radio/Onboard Computer
Radio-control key, refer to Master key with remote control [18](#)
Radio navigation, refer to separate Owner's Manual
Rain sensor [40](#)
Range, setting units [45](#)
Reading lamps
– front [58](#)
– rear [58](#)
Rear armrest, refer to Armrest, rear [68](#)
Rear backrests, folding [70](#)
Rear lamps, refer to Tail lamps [102](#)
Rear reflector, refer to Tail lamps [102](#)
Rear seat back, folding [70](#)
Rearview mirrors, exterior [30](#)
Rear window defroster
– air conditioner [60](#)
– automatic climate control [64](#)
Rear window safety switch [22](#)
Rear window wiper [41](#)
– wiper blade replacement [99](#)
Rechargeable flashlight [67](#)

Recirculated-air mode
– air conditioner [60](#)
– automatic climate control [63](#)
Refueling [84](#)
Remaining distance, refer to Cruising range [46](#)
Remaining distance for Service [44](#)
Remote control [19](#)
– garage-door opener [65](#)
– liftgate [19](#)
– malfunction [19](#)
Removing condensation, windows
– air conditioner [60](#)
– automatic climate control [63](#)
Replacement fuses [106](#)
Replacement keys [18](#)
Replacing bulbs, refer to Lamps and bulbs [99](#)
Replacing tires
– new wheels and tires [89](#)
– wheel changes [103](#)
Replacing windshield wiper [99](#)
Report an accident, refer to Initiating an emergency call [107](#)
Reporting safety defects [7](#)
Required oil grades, refer to Approved engine oils [95](#)
Reserve indicator lamp, refer to Fuel gauge [43](#)
Restraint systems
– for children [33](#)
– refer to Safety belts [29](#)
Reverse gear
– automatic transmission with Steptronic [39](#)
– manual transmission [38](#)
Roadside Assistance, refer to Receiving assistance [107](#)
Roadside parking lamps [57](#)
Roller cover for cargo area, refer to Cargo area cover [71](#)
Roll-up cover, refer to Cargo area cover [71](#)

Roof load capacity, refer to Weights [116](#)
Roof-mounted luggage rack [80](#)
Rope, refer to Tow starting and towing [109](#)
Rotating coin holder, refer to Storage compartments [67](#)
Run-flat indicator, refer to – Flat Tire Monitor [50](#)

S

Safety belts [29](#)
– safe seating position [26](#)
– warning lamp [30](#)
Safety belt tensioners, refer to Safety belts [29](#)
Safety defects, reporting [7](#)
Safety feature
– panorama glass sunroof [23](#)
– window [22](#)
Safety systems, refer to
– ABS Antilock Brake System [48](#)
– Airbags [53](#)
– DSC Dynamic Stability Control [48](#)
– xDrive [49](#)
Screw thread for tow fitting [109](#)
Seat heating [29](#)
Seat memory, refer to Seat and mirror memory [29](#)
Seats
– adjusting electrically [27](#)
– adjusting sports seat [28](#)
– heating [29](#)
– memory, refer to Seat and mirror memory [29](#)
– sitting safely [26](#)
– storing the setting [29](#)
Securing cargo, refer to Cargo loading [78](#)
Selector lever
– automatic transmission [38](#)
– automatic transmission with Steptronic [38](#)

Selector lever interlock, refer to Shiftlock **38**

Selector-lever positions, automatic transmission **38**

Service, refer to Receiving assistance **107**

Service and warranty **7**

Service Engine Soon **36, 98**

Service Interval Display **44, 97**

Setting interior temperature **60, 63**

Shifting gears with automatic transmission with Steptronic **39**

Shiftlock **38**

Side airbags **53**

Side tilt, permissible **80**

Side turn signals, bulb replacement **101**

Signal horn, refer to Horn **10**

Sitting safely **26**

- with airbags **26**
- with head restraint **26**
- with safety belt **26**

Ski bag **69**

Smokers' package, refer to Ashtray **68**

Snow chains **91**

Socket, refer to Cigarette lighter socket **69**

Soft drink can holder, refer to Cup holders **66**

SOS, refer to Initiating an emergency call **107**

Spare fuses **106**

Spare key **18**

Spare wheel, refer to Compact wheel **103**

Speed

- with compact wheel **105**
- with winter tires **90**

Speedometer **11**

- refer to Instrument cluster **11**

Split rear backrest, refer to Enlarging cargo area **70**

Sport program, automatic transmission with Steptronic **39**

Sports seat **28**

Stability control, refer to Driving stability control systems **48**

Starting, refer to Starting engine **36**

Starting difficulties

- at very low temperatures **37**
- jump starting **108**

Starting engine **36**

Status of passenger airbags **54**

Status of this Owner's Manual at time of printing **5**

Steering lock **36**

Steering wheel **10, 13**

- adjustment **31**
- buttons on steering wheel **13**
- heater **31**
- lock **36**

Steering wheel with buttons **13**

Steptronic **38**

Storage compartments **67**

Storage package **68**

Storage package nets **68**

Storage space, refer to Cargo area **70**

Storing desired speed, refer to Cruise control **41**

Storing seat position, refer to Seat and mirror memory **29**

Storing tires **90**

Straps, refer to Cargo loading **78**

Sunroof, refer to Panorama glass sunroof **23**

Supply reservoirs, washer systems **41**

Switches, refer to Cockpit **10**

Switching cooling function on/off **60, 63**

Switching off engine **37**

Symbols **4**

T

Tachometer **43**

Tail lamps **102**

- indicator lamp, defective bulb **56**
- replacing bulbs **102**

Tank capacity **116**

Technical data **114**

Technical modifications **6**

Telephone, refer to separate Owner's Manual

Temperature

- air conditioner **60**
- automatic climate control **63**

Temperature, tires **89**

Temperature display

- outside temperature **45**
- outside temperature warning **45**
- setting units **45**

Temperature gauge **44**

Temperature of coolant, refer to Coolant thermometer **44**

Temperature warning **45**

Tempomat, refer to Cruise control **41**

The individual vehicle **5**

The right wheels and tires **90**

High support adjustment **28**

Three point safety belts **29**

Tightening torque of lug bolts, refer to After mounting **105**

Tilt alarm sensor

- remote control **19**
- switching off **19, 25**

Tilt function, passenger-side mirror **31**

Tire inflation pressure monitoring, refer to Tire Pressure Monitor **52**

Tire inflation pressures **86**

- restoring **86**

Tire Pressure Monitor **52**

- malfunction warnings **52**
- resetting system **52**
- system limitations **52**
- warning lamp **52**

Tire replacement **89**
Tires
– age **88**
– breaking-in **76**
– changing **89**
– changing, refer to Wheel changes **103**
– coding **88**
– condition **89**
– damage **89**
– DOT Quality Grades **88**
– flat **103**
– inflation pressure **86**
– inflation pressure table **87**
– size, refer to The right wheels and tires **90**
– storage **90**
– temperature **89**
– traction **88**
– tread **89**
– tread wear **88**
– Uniform Tire Quality Grading **88**
– wear indicators, refer to Minimum tread depth **89**
– winter tires **90**
Tools, refer to Onboard tool kit **99**
Torque
– engine **114**
– lug bolts **105**
Touch signaling **39**
Tow bar **110**
Tow fitting **109**
Towing **109**
– with automatic transmission **109**
Towing eye **109**
Towing the vehicle **109**
Tow rope **110**
Tow sockets for tow fitting **109**
Tow starting **109**
TPM Tire Pressure Monitor **52**
Track width, refer to Dimensions **115**
Traction **88**

Traction aid, refer to DSC **48**
Traction control, refer to DSC Dynamic Stability Control **48**
Transmission
– automatic transmission with Steptronic **38**
– manual transmission **38**
Transmission locking mechanism, refer to P Park **38**
Transmission malfunction, refer to Malfunction **39**
Transporting children safely **33**
Transport securing device, refer to Securing cargo **79**
Traveling on poor roads **80**
Tread depth, refer to Minimum tread depth **89**
Tread wear **88**
Tread wear indicator in tires, refer to Minimum tread depth **89**
Trip-distance counter, refer to Trip odometer **43**
Trip odometer **43**
Trunk, refer to Cargo area **70**
Trunk lid, refer to Liftgate **21**
Turning circle, refer to Dimensions **115**
Turn signals **39**
– indicator lamp **12**
– replacing bulbs **101**
– side, replacing bulbs **101**

U

Units **45**
– outside temperature **45**
Universal garage-door opener, refer to Integrated universal remote control **65**
Universal remote control **65**
Unlocking
– from inside **20**
– from outside **19**
– hood **92**

Upholstery care, refer to Caring for your vehicle brochure

V

Valve screw caps, refer to After mounting **105**
Vehicle
– battery **105**
– breaking-in **76**
– care, refer to Caring for your vehicle brochure
– cargo loading **78**
– dimensions **115**
– disposal, refer to Caring for your vehicle brochure
– locking from inside **20**
– locking from outside **19**
– parking **37**
– washing, refer to Caring for your vehicle brochure
– weights **116**
Vehicle battery **105**
Vehicle jack **103**
– jacking points **104**
Vehicle Memory **32**
Ventilation **61, 64**
– draft-free **61, 64**
Viscosity **95**
Voice control, refer to separate Owner's Manual

W

Warning and indicator lamps **12**
Warning triangle **107**
Warranty, refer to Service and Warranty Information Booklet for US models, Warranty and Service Guide Booklet for Canadian models **97**
Warranty and service **7**
Washer fluid **41**
Washer fluid reservoir, capacity, refer to Filling capacities **116**

- Washer reservoir, refer to
 - Reservoir for washer fluid [41](#)
- Waste tray, refer to Ashtray [68](#)
- Weights [116](#)
- Wheel/tire combination [90](#)
- Wheelbase, refer to
 - Dimensions [115](#)
- Wheel bolt, wrench [103](#)
- Wheel changes, compact wheel [103](#)
- Wheels and tires [90](#)
- Width, refer to
 - Dimensions [115](#)
- Windows [22](#)
 - convenience operation [20](#)
 - safety switch [22](#)
- Windshield
 - cleaning [41](#)
 - defrosting, refer to
 - Defrosting windows [60](#), [63](#)
- Windshield washer reservoir [41](#)
 - capacity, refer to Filling capacities [116](#)
- Windshield washer system
 - washer/wiper system [40](#)
 - washer fluid [41](#)
- Windshield wiper blade replacement [99](#)
- Windshield wipers, refer to
 - Washer/wiper system [40](#)
- Winter tires [90](#)
 - changing [103](#)
 - condition [89](#)
 - storage [90](#)
- Wiper blade replacement [99](#)
- Wiper system [40](#)
- Working in the engine compartment [92](#)
- Wrench/screwdriver, refer to
 - Onboard tool kit [99](#)

X

- xDrive [49](#)
- Xenon headlamp [100](#)
 - replacing bulbs [100](#)

Refueling

To ensure that you always have all the essential data on hand when refueling, we recommend that you fill in the following tables with the specifications and information that apply to your vehicle. Consult the index for individual specifications.

Fuel

Designation

Please enter your preferred fuel here.

Engine oil

Quality

The oil quantity between the two marks on the dipstick is approx. 1.1 US quarts/1 liter.

Tire inflation pressures

	Summer tires Front	Rear	Winter tires Front	Rear
Up to 4 persons				
5 persons or 4 plus luggage				

More about BMW

bmwusa.com



The Ultimate
Driving Machine

01 41 0 012 213 ue



