



*2017*

# Envision Owner's Manual



[buick.com](http://buick.com) (U.S.)  
[buick.gm.ca](http://buick.gm.ca) (Canada)

---

# Contents

Introduction .....	2
In Brief .....	5
Keys, Doors, and Windows .....	26
Seats and Restraints .....	50
Storage .....	99
Instruments and Controls .....	105
Lighting .....	157
Infotainment System .....	165
Climate Controls .....	166
Driving and Operating .....	172
Vehicle Care .....	234
Service and Maintenance .....	309
Technical Data .....	321
Customer Information .....	324
Reporting Safety Defects .....	334
OnStar .....	337
Index .....	347

# Introduction



The names, logos, emblems, slogans, vehicle model names, and vehicle body designs appearing in this manual including, but not limited to, GM, the GM logo, BUICK, the BUICK Emblem, and Envision are trademarks and/or service marks of General Motors LLC, its subsidiaries, affiliates, or licensors.

For vehicles first sold in Canada, substitute the name "General Motors of Canada Company" for Buick Motor Division wherever it appears in this manual.

This manual describes features that may or may not be on the vehicle because of optional equipment that was not purchased on the vehicle, model variants, country specifications, features/applications that may not be available in your region, or changes subsequent to the printing of this owner manual.

Refer to the purchase documentation relating to your specific vehicle to confirm the features.

Keep this manual in the vehicle for quick reference.

### Canadian Vehicle Owners

A French language manual can be obtained from your dealer, at [www.helminc.com](http://www.helminc.com), or from:

#### Propriétaires Canadiens

On peut obtenir un exemplaire de ce guide en français auprès du concessionnaire ou à l'adresse suivante:

Helm, Incorporated  
Attention: Customer Service  
47911 Halyard Drive  
Plymouth, MI 48170  
USA

### Using this Manual

To quickly locate information about the vehicle, use the Index in the back of the manual. It is an alphabetical list of what is in the manual and the page number where it can be found.

### About Driving the Vehicle

As with other vehicles of this type, failure to operate this vehicle correctly may result in loss of control or an accident. Be sure to read the driving guidelines in this manual in the section called "Driving and Operating" and specifically *Driver Behavior* ⇨ 173, *Driving Environment* ⇨ 173, and *Vehicle Design* ⇨ 173.

## Danger, Warning, and Caution

Warning messages found on vehicle labels and in this manual describe hazards and what to do to avoid or reduce them.

### Danger

Danger indicates a hazard with a high level of risk which will result in serious injury or death.

### Warning

Warning indicates a hazard that could result in injury or death.

### Caution

Caution indicates a hazard that could result in property or vehicle damage.





A circle with a slash through it is a safety symbol which means “Do Not,” “Do not do this,” or “Do not let this happen.”

## Symbols

The vehicle has components and labels that use symbols instead of text. Symbols are shown along with the text describing the operation or information relating to a specific component, control, message, gauge, or indicator.

















 : Shown when the owner manual has additional instructions or information.

 : Shown when the service manual has additional instructions or information.

 : Shown when there is more information on another page — “see page.”

## Vehicle Symbol Chart

Here are some additional symbols that may be found on the vehicle and what they mean. For more information on the symbol, refer to the Index.

-  : Airbag Readiness Light
-  : Air Conditioning
-  : Antilock Brake System (ABS)
-  : Brake System Warning Light
-  : Charging System
-  : Cruise Control
-  : Do Not Puncture
-  : Do Not Service
-  : Engine Coolant Temperature
-  : Exterior Lamps
-  : Flame/Fire Prohibited
-  : Fog Lamps
-  : Fuel Gauge
-  : Fuses
-  : Headlamp High/Low-Beam Changer
-  : LATCH System Child Restraints

## 4 Introduction

---

 : Malfunction Indicator Lamp

 : Oil Pressure

 : OnStar<sup>®</sup>

 : Power

 : Remote Vehicle Start

 : Safety Belt Reminders

 : Steering Wheel Controls

 : Tire Pressure Monitor

 : Traction Control/StabiliTrak<sup>®</sup>

 : Under Pressure

 : Windshield Washer Fluid

## In Brief

### Instrument Panel

Instrument Panel Overview ..... 6

### Initial Drive Information

Initial Drive Information ..... 8

Remote Keyless Entry (RKE)  
System ..... 8

Remote Vehicle Start ..... 9

Door Locks ..... 9

Liftgate ..... 9

Windows ..... 10

Seat Adjustment ..... 10

Memory Features ..... 11

Heated and Ventilated Seats ... 12

Head Restraint Adjustment .... 12

Safety Belts ..... 12

Passenger Sensing System ... 13

Mirror Adjustment ..... 13

Steering Wheel Adjustment .... 14

Interior Lighting ..... 14

Exterior Lighting ..... 15

Windshield Wiper/Washer ..... 16

Climate Controls ..... 17

Transmission ..... 18

### Vehicle Features

Infotainment System ..... 18

Steering Wheel Controls ..... 18

Cruise Control ..... 18

Driver Information

Center (DIC) ..... 19

Forward Collision Alert (FCA)

System ..... 19

Forward Automatic

Braking (FAB) ..... 19

Lane Keep Assist (LKA) ..... 20

Lane Change Alert (LCA) ..... 20

Surround Vision ..... 20

Rear Vision Camera (RVC) .... 20

Rear Cross Traffic Alert (RCTA)

System ..... 20

Parking Assist ..... 21

Automatic Parking

Assist (APA) ..... 21

Power Outlets ..... 21

Universal Remote System .... 21

Sunroof ..... 22

### Performance and Maintenance

Traction Control/Electronic

Stability Control ..... 23

Tire Pressure Monitor ..... 23

Fuel (2.5L Engine) ..... 24

Fuel (2.0L Engine) ..... 24

E85 or FlexFuel ..... 24

Engine Oil Life System ..... 24

Driving for Better Fuel

Economy ..... 25

Roadside Assistance  
Program ..... 25

## Instrument Panel

### Instrument Panel Overview

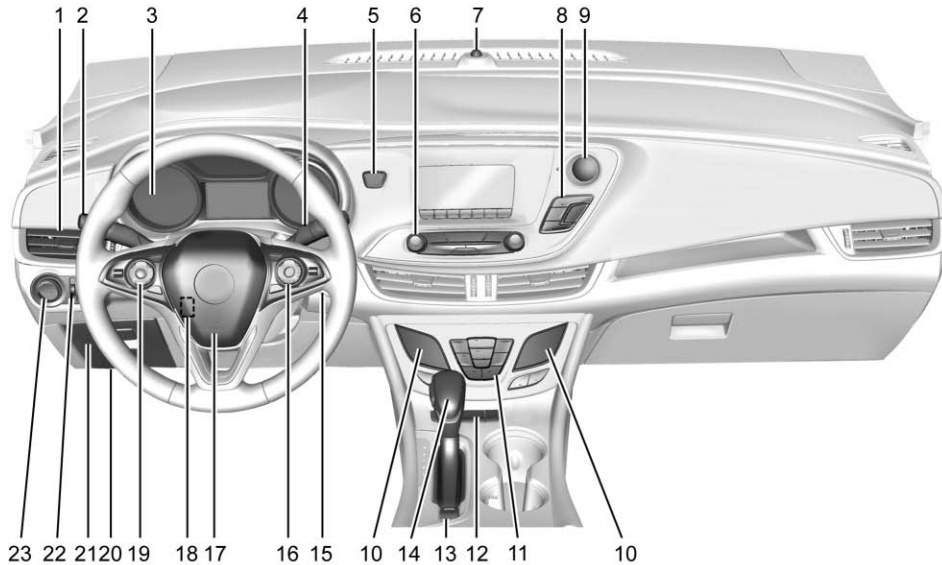

1. *Air Vents* ⇨ 170.
2. *Turn Signal Lever. See Turn and Lane-Change Signals* ⇨ 161.
3. *Instrument Cluster* ⇨ 113.  
Driver Information Center Display. See *Driver Information Center (DIC) (Base Level)* ⇨ 130 or *Driver Information Center (DIC) (Uplevel)* ⇨ 132.
4. *Windshield Wiper/Washer* ⇨ 107.  
*Rear Window Wiper/Washer* ⇨ 109.
5. *Hazard Warning Flashers* ⇨ 161.
6. *Infotainment* ⇨ 165.
7. *Light Sensor. See Automatic Headlamp System* ⇨ 159.
8. *Lane Keep Assist (LKA)* ⇨ 221 (If Equipped).  
*Assistance Systems for Parking or Backing* ⇨ 210 (If Equipped).
9. *Clock* ⇨ 110.
10. *Heated and Ventilated Front Seats* ⇨ 56 (If Equipped).
11. *Dual Automatic Climate Control System* ⇨ 166.
12. *Traction Control/Electronic Stability Control* ⇨ 198.
13. *Electric Parking Brake* ⇨ 196.
14. *Shift Lever. See Automatic Transmission* ⇨ 192.
15. *ENGINE START/STOP Button. See Ignition Positions* ⇨ 184.
16. *Steering Wheel Controls* ⇨ 106 (If Equipped).  
Driver Information Center (DIC) Buttons. See *Driver Information Center (DIC) (Base Level)* ⇨ 130 or *Driver Information Center (DIC) (Uplevel)* ⇨ 132.
17. *Horn* ⇨ 107.
18. *Steering Wheel Adjustment* ⇨ 106.
19. *Cruise Control* ⇨ 200.  
*Adaptive Cruise Control* ⇨ 202 (If Equipped).
20. *Heated Steering Wheel* ⇨ 106 (If Equipped).  
*Forward Collision Alert (FCA) System* ⇨ 215 (If Equipped).
20. *Data Link Connector (DLC) (Out of View). See Malfunction Indicator Lamp (Check Engine Light)* ⇨ 121.
21. *Front Storage* ⇨ 99.
22. *Instrument Panel Illumination Control* ⇨ 162.  
*Head-Up Display (HUD)* ⇨ 135 (If Equipped) (Out of View).
23. *Exterior Lamp Controls* ⇨ 157.  
*Fog Lamps* ⇨ 161 (If Equipped).



## Initial Drive Information

This section provides a brief overview about some of the important features that may or may not be on your specific vehicle.

For more detailed information, refer to each of the features which can be found later in this owner manual.

## Remote Keyless Entry (RKE) System

The Remote Keyless Entry (RKE) transmitter may work up to 60 m (197 ft) away from the vehicle.



Press this button to remove the key. The key can be used to open the driver door.





 : Press to unlock the driver door or all doors.



For vehicles with the manual liftgate, press  twice within five seconds to unlock the liftgate.

 : Press to lock all doors.

Lock and unlock feedback can be personalized.

 : If equipped, press twice quickly to open or close the liftgate. Press and release once to stop the liftgate from moving.

 : Press and release to initiate vehicle locator. Press and hold for at least three seconds to sound the panic alarm. Press  again to cancel the panic alarm.



 : Press and release  and then immediately press and hold  for at least four seconds to start the engine from outside the vehicle using the RKE transmitter.

See *Keys* ⇨ 26 and *Remote Keyless Entry (RKE) System Operation* ⇨ 27.

## Remote Vehicle Start

If equipped, the engine can be started from outside of the vehicle.

### Starting the Vehicle

1. Press and release  on the RKE transmitter.
2. Immediately press and hold  for at least four seconds or until the turn signal lamps flash.

Start the vehicle normally after entering.

When the vehicle starts, the parking lamps will turn on.

Remote start can be extended.

### Canceling a Remote Start

To cancel a remote start, do one of the following:

- Press and hold  until the parking lamps turn off.
- Turn on the hazard warning flashers.
- Turn the vehicle on and then off.

See *Remote Vehicle Start* ⇨ 33.

## Door Locks

See *Door Locks* ⇨ 34.

### Keyless Access





If equipped with Keyless Access, the RKE transmitter must be within 1 m (3 ft) of the door being opened. Press the button on the door handle to open. The liftgate is also unlocked when the RKE transmitter is within range of the liftgate handle. Press the touch pad underneath the handle and lift.

See “Keyless Access Operation” in *Remote Keyless Entry (RKE) System Operation* ⇨ 27.

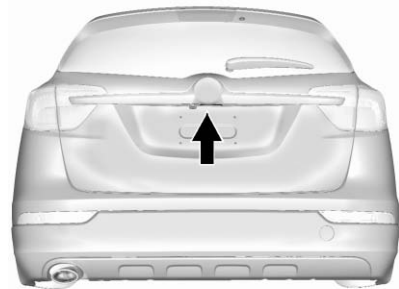
## Liftgate





To open the liftgate, press  on the power door lock switch or press  on the Remote Keyless Entry (RKE) transmitter twice to unlock all doors. Press the touch pad on the underside of the liftgate handle and lift up. See *Remote Keyless Entry (RKE) System Operation* ⇨ 27.

Use the pull cup to lower and close the liftgate. Do not press the touch pad while closing the liftgate. This will cause the liftgate to be unlatched.

## Power Liftgate Operation

If equipped with a power liftgate, the switch is on the driver door. The vehicle must be in P (Park).

Choose the power liftgate mode by selecting MAX or 3/4. Press  on the driver door. The driver door must be unlocked. On the RKE transmitter press  twice quickly until the liftgate starts moving.

Press any liftgate button while the liftgate is moving to stop it. Pressing again reverses the direction.

To close, press  on the bottom of the liftgate next to the pull cup.

To disable the power liftgate function, select OFF on the liftgate switch. See *Liftgate* ⇨ 37.

## Windows

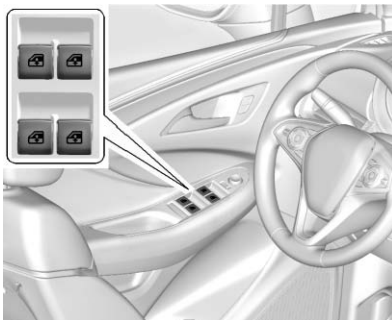

Press or pull the switch to open or close the window.

See *Power Windows* ⇨ 46

## Seat Adjustment

### Power Seat



To adjust a power seat:

- Move the seat forward or rearward by sliding the control forward or rearward.
- Raise or lower the front part of the seat cushion by moving the front of the control up or down.
- Raise or lower the entire seat by moving the rear of the control up or down.

See *Power Seat Adjustment* ⇨ 53.

## Lumbar Support

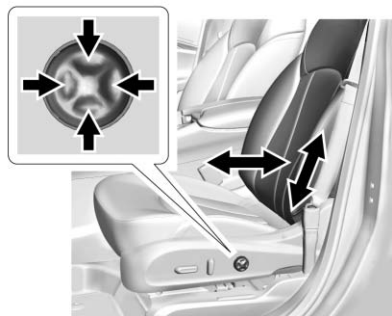

To adjust the lumbar support, if equipped:

- Press the front or rear of the switch to increase or decrease lumbar support.
- Press the top or bottom of the switch to raise or lower the lumbar support.
- Release the switch when the level of support is reached.

See *Lumbar Adjustment* ⇨ 53.

## Reclining Seatbacks

### Power Reclining Seatbacks

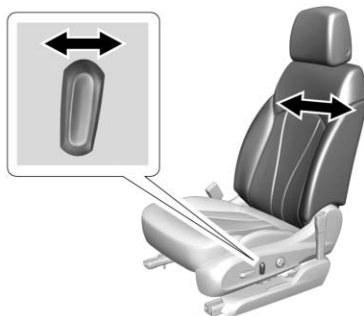

To adjust a power seatback:

- Tilt the top of the control rearward to recline.
- Tilt the top of the control forward to raise.

See *Reclining Seatbacks* ⇨ 54.

## Memory Features

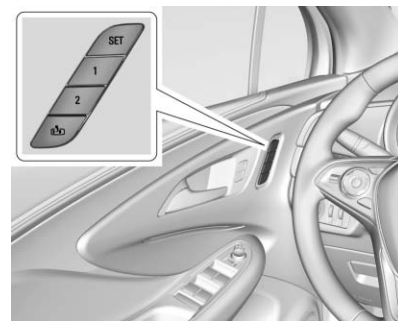

If equipped, the 1, 2, SET, and EXIT (Exit) buttons on the driver door are used to manually store and recall memory settings for the driver seat and outside mirrors.



Automatic Memory Recall and/or Easy Exit Recall features may be enabled in the vehicle personalization menus to automatically recall positions stored to the 1, 2, and EXIT buttons.

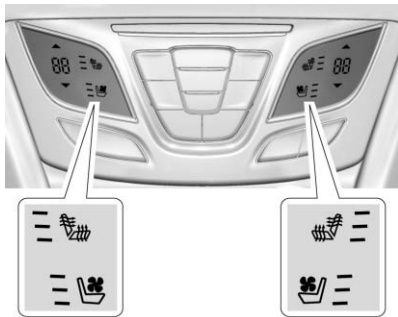

See *Memory Seats* ⇨ 54 and *Vehicle Personalization* ⇨ 147.

## Heated and Ventilated Seats



If equipped, the buttons are near the climate controls. To operate, the engine must be running.

Press  or  to heat the driver or passenger seat cushion and seatback.

If equipped, press  or  to ventilate the driver or passenger seat.

Three lights next to the button indicate the temperature setting.

See *Heated and Ventilated Front Seats* ⇨ 56.

## Head Restraint Adjustment

Do not drive until the head restraints for all occupants are installed and adjusted properly.

To achieve a comfortable seating position, change the seatback recline angle as little as necessary while keeping the seat and the head restraint height in the proper position.

See *Head Restraints* ⇨ 51 and *Reclining Seatbacks* ⇨ 54.

## Safety Belts

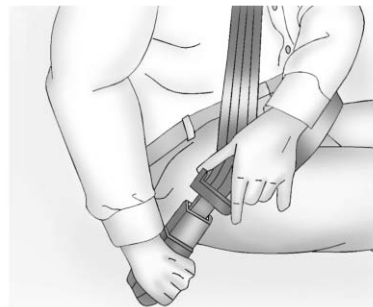

Refer to the following sections for important information on how to use safety belts properly:

- *Safety Belts* ⇨ 60.
- *How to Wear Safety Belts Properly* ⇨ 61.
- *Lap-Shoulder Belt* ⇨ 62.
- *Lower Anchors and Tethers for Children (LATCH System)* ⇨ 86.

## Passenger Sensing System



### United States



### Canada and Mexico

The passenger sensing system will turn off the front outboard passenger frontal airbag and knee airbag under certain conditions. No other airbag is affected by the passenger sensing system. See *Passenger Sensing System* ⇨ 73.

The passenger airbag status indicator lights on the overhead console are visible when the vehicle is started. See *Passenger Airbag Status Indicator* ⇨ 120.

## Mirror Adjustment

### Interior Mirrors

Adjust the rearview mirror for a clear view of the area behind your vehicle.

### Automatic Dimming Rearview Mirror

Automatic dimming reduces the glare of headlamps from behind. The dimming feature comes on when the vehicle is started.

## Exterior Mirrors

### Power Mirrors

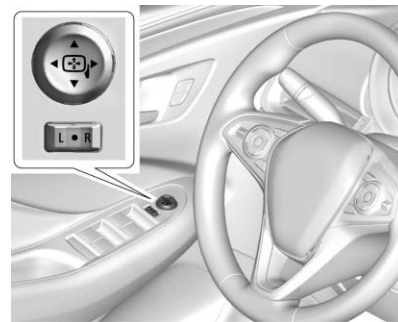

To adjust the mirrors:

1. Move the selector switch to L (Left) or R (Right) to choose the driver or passenger mirror.
2. Press the arrows on the control pad to move each mirror to the desired position.
3. Return the selector switch to the center position.

See *Power Mirrors* ⇨ 44.

### Manual Folding Mirrors

The outside mirrors fold inward to prevent damage when going through an automatic car wash. To fold, push the mirror toward the vehicle. Push outward to return to the original position.

### Heated Mirrors

If equipped, press  REAR to heat the outside mirrors.

See “Rear Window Defogger” under *Dual Automatic Climate Control System* ⇨ 166.

### Steering Wheel Adjustment

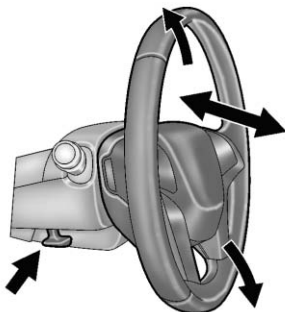

To adjust the steering wheel:

1. Pull the lever down.
2. Move the steering wheel up or down.
3. Pull or push the steering wheel closer or away from you.
4. Pull the lever up to lock the steering wheel in place.

Do not adjust the steering wheel while driving.

### Interior Lighting

#### Dome Lamp

The dome lamp is in the overhead console.



To change the dome lamp settings, press the following:

 : Turns the lamp off, even when a door is open.

 : The lamp comes on when a door is opened.

 : Turns the lamp on.

## Reading Lamps

There are reading lamps on the overhead console and over the rear passenger doors. These lamps come on when any door is opened.



**Front Reading Lamps**

The reading lamps in the overhead console are operated by touch. Touch the lamp for dim light, touch again for bright light, and touch again to turn the light off.

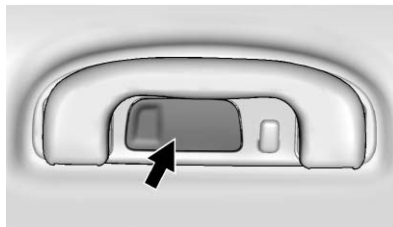

**Rear Reading Lamps**

Press the lamp lens to turn the rear passenger reading lamps on or off.

For more information on interior lighting, see *Instrument Panel Illumination Control* ⇨ 162.

## Exterior Lighting

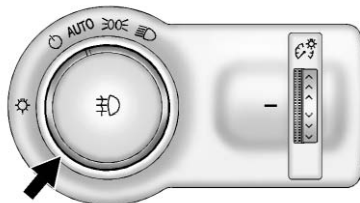

The exterior lamp control is on the instrument panel on the outboard side of the steering wheel.

Turn the control to the following positions:

☐ : Turns off the exterior lamps. The knob returns to the AUTO position after it is released. Turn to ☐ again to reactivate the AUTO mode.

**AUTO** : Automatically turns the exterior lamps on and off, depending on outside lighting.

☐☐ : Turns on the parking lamps including all lamps, except the headlamps.

☐☐☐ : Turns on the headlamps together with the parking lamps and instrument panel lights.

See:

- *Exterior Lamp Controls* ⇨ 157.
- *Fog Lamps* ⇨ 161.



## Windshield Wiper/Washer



Windshield Wiper with Rainsense (AUTO Shown)



Windshield Wiper with Intermittent Wipes (INT Shown)

With the ignition in ACC/ACCESSORY or ON/RUN/START, move the windshield wiper lever to select the wiper speed.

**HI** : Use for fast wipes.

**LO** : Use for slow wipes.

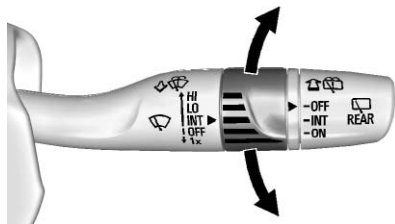

**INT** : Use for intermittent wipes. To adjust wipe frequency, turn the band up for more frequent wipes or down for less frequent wipes. If the vehicle has Rainsense™, see the following Rainsense information.

**OFF** : Use to turn the wipers off.

**1x** : For a single wipe, briefly move the wiper lever down. For several wipes, hold the wiper lever down.

### Windshield Washer

Pull the windshield wiper lever toward you to spray windshield washer fluid and activate the wipers.

### Rainsense™

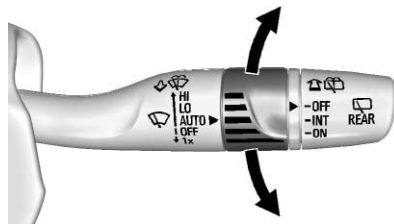

For vehicles with Rainsense:

**AUTO** : Move the windshield wiper lever to AUTO. Turn the band on the wiper lever to adjust the sensitivity.

- Turn the band up for more sensitivity to moisture.
- Turn the band down for less sensitivity to moisture.
- Move the windshield wiper lever out of the AUTO position to deactivate Rainsense.

### Rear Window Wiper/Washer

Turn the end of the windshield wiper lever to operate the rear window wiper/washer.

**OFF** : Turns the system off.

**INT** : Intermittent wipes.

**ON** : Slow wipes.

 : Push the windshield wiper lever forward to spray washer fluid on the rear window.

See *Windshield Wiper/Washer* ⇨ 107 and *Rear Window Wiper/Washer* ⇨ 109.

## Climate Controls

The heating, cooling, and ventilation for the vehicle can be controlled with this system.

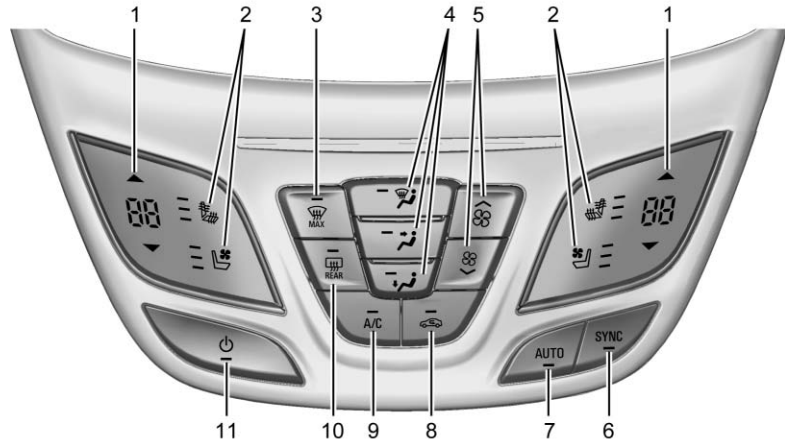

- |  |                                    |
|--|------------------------------------|
| 1. Driver and Passenger Temperature Controls   | 5. Fan Control                     |
| 2. Heated and Cooled Front Seats (If Equipped) | 6. SYNC (Synchronized Temperature) |
| 3. Defrost                                     | 7. AUTO (Automatic Operation)      |
| 4. Air Delivery Mode Controls                  | 8. Recirculation                   |
|  | 9. A/C (Air Conditioning)          |

10. Rear Window Defogger

11. Power

See *Dual Automatic Climate Control System* ⇨ 166 and *Rear Climate Control System* ⇨ 169 (if equipped).

## Transmission

### Electronic Range Select (ERS) Mode

ERS or manual mode allows for the selection of the range of gear positions. Use this mode when driving downhill to limit the top gear and vehicle speed.

To use this feature:

1. Move the shift lever to L (Low).
2. Press the plus/minus button on the shift lever to increase or decrease the gear range available.

See *Manual Mode* ⇨ 194.

## Vehicle Features

### Infotainment System

See the infotainment manual for information on the radio, audio players, phone, navigation system, and voice or speech recognition. It also includes information on settings.

### Steering Wheel Controls

The infotainment system can be operated by using the steering wheel controls. See "Steering Wheel Controls" in the infotainment manual.

## Cruise Control

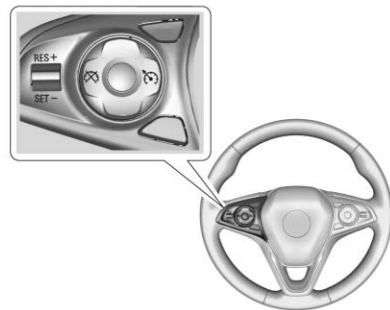

 : Press to turn cruise control on or off. A white indicator comes on in the instrument cluster when the cruise is turned on.

**RES+** : If there is a set speed in memory, press briefly to resume that speed or press and hold to accelerate. If cruise control is already active, use to increase vehicle speed.

**SET-** : Press the control down briefly to set the speed and activate cruise control. If cruise control is already active, use to decrease vehicle speed.

 : Press to disengage cruise control without erasing the set speed from memory.

See *Cruise Control* ⇨ 200 or *Adaptive Cruise Control* ⇨ 202, if equipped.

## Driver Information Center (DIC)

The DIC display is in the instrument cluster. It shows the status of many vehicle systems.

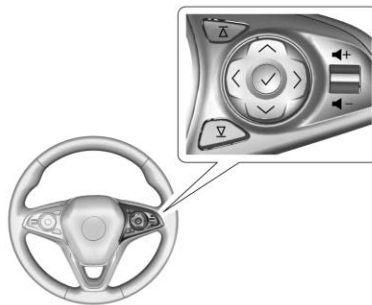

**▲ or ▼** : Press to move up or down in a list.

**< or >** : Press **<** to open application menus on the left. Press **>** to open interaction menus on the right.

**✓** : Press to open a menu or select a menu item. Press and hold to reset values on certain screens.

See *Driver Information Center (DIC) (Base Level)* ⇨ 130 or *Driver Information Center (DIC) (Uplevel)* ⇨ 132.

## Forward Collision Alert (FCA) System

If equipped, FCA may help avoid or reduce the harm caused by front-end crashes. FCA provides a green indicator, , when a vehicle is detected ahead. This indicator displays amber if you follow a vehicle much too closely. When approaching a vehicle ahead too quickly, FCA provides a flashing red alert on the windshield and rapidly beeps or pulses the driver seat.

See *Forward Collision Alert (FCA) System* ⇨ 215.

## Forward Automatic Braking (FAB)

If the vehicle has Adaptive Cruise Control (ACC), it also has FAB, which includes Intelligent Brake Assist (IBA). When the system detects a vehicle ahead in your path that is traveling in the same direction that you may be about to crash into, it can provide a boost to braking or automatically brake the

vehicle. This can help avoid or lessen the severity of crashes when driving in a forward gear.

See *Forward Automatic Braking (FAB)* ⇨ 217.

## **Lane Keep Assist (LKA)**

If equipped, LKA may help avoid crashes due to unintentional lane departures. It may assist by gently turning the steering wheel if the vehicle approaches a detected lane marking without using a turn signal in that direction. It may also provide a Lane Departure Warning (LDW) alert as the lane marking is crossed. The system will not assist or alert if it detects that you are actively steering. Override LKA by turning the steering wheel. LKA uses a camera to detect lane markings between 60 km/h (37 mph) and 180 km/h (112 mph).

See *Lane Departure Warning (LDW)* ⇨ 220 and *Lane Keep Assist (LKA)* ⇨ 221.

## **Lane Change Alert (LCA)**

If equipped, the LCA system is a lane-changing aid that assists drivers with avoiding lane change crashes that occur with moving vehicles in the side blind zone (or spot) areas or with vehicles rapidly approaching these areas from behind. The LCA warning display will light up in the corresponding outside side mirror and will flash if the turn signal is on. The Side Blind Zone Alert (SBZA) system is included as part of the LCA system.

See *Side Blind Zone Alert (SBZA)* ⇨ 218 and *Lane Change Alert (LCA)* ⇨ 219.

## **Surround Vision**

If equipped, views around the vehicle display in the infotainment display to aid with parking and low-speed maneuvers.

See “Surround Vision” under *Assistance Systems for Parking or Backing* ⇨ 210.

## **Front Vision Camera**

If equipped, a view of the area in front of the vehicle displays on the infotainment display to aid with parking and low-speed maneuvers.

See “Front Vision Camera” under *Assistance Systems for Parking or Backing* ⇨ 210.

## **Rear Vision Camera (RVC)**

If equipped, RVC displays a view of the area behind the vehicle on the infotainment display when the vehicle is shifted into R (Reverse) to aid with parking and low-speed backing maneuvers.

See *Assistance Systems for Parking or Backing* ⇨ 210.

## **Rear Cross Traffic Alert (RCTA) System**

If equipped, the RCTA system uses a triangle with an arrow displayed on the infotainment display to warn of traffic behind your vehicle that may cross your vehicle's path while

in R (Reverse). In addition, beeps will sound, or the driver seat will pulse.

See *Assistance Systems for Parking or Backing* ⇨ 210.

## Parking Assist

If equipped, Rear Parking Assist (RPA) uses sensors on the rear bumper to assist with parking and avoiding objects while in R (Reverse). It operates at speeds less than 8 km/h (5 mph). RPA may display a warning triangle on the Rear Vision Camera screen and a graphic on the instrument cluster to provide the object distance. In addition, multiple beeps or seat pulses may occur if very close to an object.

The vehicle may also have the Front Parking Assist system.

See *Assistance Systems for Parking or Backing* ⇨ 210.

## Automatic Parking Assist (APA)

If equipped, the APA system helps to search for and maneuver the vehicle into parallel or perpendicular parking spots using automatic steering, DIC displays, and beeps. When the vehicle speed is below 30 km/h (18 mph), press  to enable the system.

See “Automatic Parking Assist (APA)” under *Assistance Systems for Parking or Backing* ⇨ 210.

## Power Outlets

The vehicle has four 12-volt accessory power outlets, which can be used to plug in electrical equipment, such as a cell phone or MP3 player.

There are power outlets:

- On the center floor console.
- Inside the center floor console.
- On the rear of the center floor console.
- In the rear cargo area.

To use the outlet, remove the cover.

See *Power Outlets* ⇨ 111.

## Universal Remote System



This system provides a way to replace up to three remote control transmitters used to activate devices such as garage door openers, security systems, and home automation devices.

Read the instructions completely before attempting to program the Universal Remote system. Because of the steps involved, it may be

helpful to have another person available to assist with programming the Universal Remote system.

See *Universal Remote System* ⇨ 154.

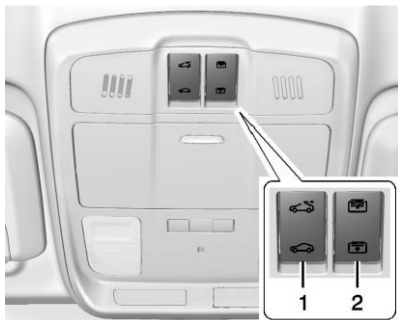

## Sunroof







1. Sunroof Switch
2. Sunshade Switch



If equipped, the sunroof only operates when the ignition is in ACC/ACCESSORY or ON/RUN, or when Retained Accessory Power (RAP) is active. See *Retained Accessory Power (RAP)* ⇨ 189.

**Vent** : From the closed position, press  (1) to vent the sunroof.

**Open/Close (Manual Mode)** : To open the sunroof, press and hold  (1) until the sunroof reaches the desired position. Press and hold  (1) to close it.

**Express-Open/Express-Close** : To express-open the sunroof, fully press and release  (1). Press the switch again to stop it. To express-close the sunroof, fully press and release  (1). Press the switch again to stop it.

**Sunshade** : To open the sunshade, press and hold  (2) until the sunshade reaches the desired position. Press  (2) to close the sunshade,

To express-open the sunshade, fully press and release  (2). To express-close the sunshade, fully press and release  (2) . Press the switch again to stop it.

When the sunroof is opened, an air deflector will automatically raise. The air deflector will retract when the sunroof is closed.

If an object is in the path of the sunroof while it is closing, the automatic reversal system will detect the object and stop the sunroof.





See *Sunroof* ⇨ 48.







## Performance and Maintenance

### Traction Control/ Electronic Stability Control

The Traction Control System (TCS) limits wheel spin. The system is on when the vehicle is started.

The StabiliTrak system assists with directional control of the vehicle in difficult driving conditions. The system is on when the vehicle is started.

- To turn off TCS, press and release  on the center console. The traction off light  illuminates in the instrument cluster.
- Press and release  again to turn TCS back on. The traction off light  in the instrument cluster will turn off.

- To turn off both TCS and StabiliTrak, press and hold  until the traction off light  and StabiliTrak OFF light  illuminate in the instrument cluster.
- Press and release  again to turn on both systems. The traction off light  and StabiliTrak OFF light  in the instrument cluster will turn off.

See *Traction Control/Electronic Stability Control* ⇨ 198.

### Tire Pressure Monitor

This vehicle may have a Tire Pressure Monitor System (TPMS).



The low tire pressure warning light alerts to a significant loss in pressure of one of the vehicle's

tires. If the warning light comes on, stop as soon as possible and inflate the tires to the recommended pressure shown on the Tire and Loading Information label. See *Vehicle Load Limits* ⇨ 180. The warning light will remain on until the tire pressure is corrected.

The low tire pressure warning light may come on in cool weather when the vehicle is first started, and then turn off as the vehicle is driven. This may be an early indicator that the tire pressures are getting low and the tires need to be inflated to the proper pressure.

The TPMS does not replace normal monthly tire maintenance. Maintain the correct tire pressures.

See *Tire Pressure Monitor System* ⇨ 274.



## Fuel (2.5L Engine)



### Regular Fuel

Use only unleaded gasoline rated 87 octane or higher in your vehicle. Do not use gasoline with an octane rating lower as it may result in vehicle damage and lower fuel economy. See *Fuel* ⇨ 222.

## Fuel (2.0L Engine)



### Premium Recommended Fuel

Use premium 93 octane unleaded gasoline in your vehicle. Unleaded gasoline with an octane rating as

low as 87 may be used, but it will reduce performance and fuel economy. See *Fuel* ⇨ 222.

## E85 or FlexFuel



### No E85 or FlexFuel

Gasoline-ethanol fuel blends greater than E15 (15% ethanol by volume), such as E85, cannot be used in this vehicle.

## Engine Oil Life System

The engine oil life system calculates engine oil life based on vehicle use and displays the CHANGE ENGINE OIL SOON message when it is time to change the engine oil and filter. The oil life system should be reset to 100% only following an oil change.

## Resetting the Oil Life System

- Using the DIC controls on the right side of the steering wheel, display REMAINING OIL LIFE on the DIC. See *Driver Information Center (DIC) (Base Level)* ⇨ 130 or *Driver Information Center (DIC) (Uplevel)* ⇨ 132. When remaining oil life is low, the CHANGE ENGINE OIL SOON message will appear on the display. See *Engine Oil Messages* ⇨ 141.
- Press ✓ on the DIC controls and hold down for a few seconds to clear the CHANGE ENGINE OIL SOON message and reset the oil life at 100%.

Be careful not to reset the oil life display accidentally at any time other than after the oil is changed. It cannot be reset accurately until the next oil change.

See *Engine Oil Life System* ⇨ 243.

## Driving for Better Fuel Economy

Driving habits can affect fuel mileage. Here are some driving tips to get the best fuel economy possible.

- Avoid fast starts and accelerate smoothly.
- Brake gradually and avoid abrupt stops.
- Avoid idling the engine for long periods of time.
- When road and weather conditions are appropriate, use cruise control.
- Always follow posted speed limits or drive more slowly when conditions require.
- Keep vehicle tires properly inflated.
- Combine several trips into a single trip.
- Replace the vehicle's tires with the same TPC Spec number molded into the tire's sidewall near the size.

- Follow recommended scheduled maintenance.

## Roadside Assistance Program

U.S.: 1-800-252-1112

TTY Users (U.S. Only):  
1-888-889-2438

Canada: 1-800-268-6800

New Buick owners are automatically enrolled in the Roadside Assistance Program.

See *Roadside Assistance Program* ⇨ 328.

## Keys, Doors, and Windows

### Keys and Locks

Keys .....	26
Remote Keyless Entry (RKE) System .....	27
Remote Keyless Entry (RKE) System Operation .....	27
Remote Vehicle Start .....	33
Door Locks .....	34
Power Door Locks .....	35
Delayed Locking .....	35
Automatic Door Locks .....	36
Lockout Protection .....	36
Safety Locks .....	36

### Doors

Liftgate .....	37
----------------	----

### Vehicle Security

Vehicle Security .....	42
Vehicle Alarm System .....	42
Immobilizer .....	43
Immobilizer Operation .....	43

### Exterior Mirrors

Convex Mirrors .....	44
Power Mirrors .....	44

Folding Mirrors .....	45
Heated Mirrors .....	45
Automatic Dimming Mirror .....	45
Reverse Tilt Mirrors .....	45

### Interior Mirrors

Interior Rearview Mirrors .....	45
Automatic Dimming Rearview Mirror .....	45

### Windows

Windows .....	46
Power Windows .....	46
Sun Visors .....	48

### Roof

Sunroof .....	48
---------------	----

## Keys and Locks

### Keys



#### Warning

Leaving children in a vehicle with a Remote Keyless Entry (RKE) transmitter is dangerous and children or others could be seriously injured or killed. They could operate the power windows or other controls or make the vehicle move. The windows will function with the RKE transmitter in the vehicle, and children or others could be caught in the path of a closing window. Do not leave children in a vehicle with an RKE transmitter.



The key that is part of the Remote Keyless Entry (RKE) transmitter can be used to open the driver door.



Press the button on the RKE transmitter to remove the key.

If it becomes difficult to turn the key, inspect the key blade for debris. Periodically clean with a brush or pick.

See your dealer if a new key is needed.

If locked out of the vehicle, see *Roadside Assistance Program* ⇨ 328.

With an active OnStar subscription, an OnStar Advisor may remotely unlock the vehicle. See *OnStar Overview* ⇨ 337.

## Remote Keyless Entry (RKE) System

See *Radio Frequency Statement* ⇨ 334.

If there is a decrease in the Remote Keyless Entry (RKE) operating range:

- Check the distance. The transmitter may be too far from the vehicle.

- Check the location. Other vehicles or objects may be blocking the signal.
- Check the transmitter's battery. See "Battery Replacement" later in this section.
- If the transmitter is still not working correctly, see your dealer or a qualified technician for service.



## Remote Keyless Entry (RKE) System Operation

The RKE transmitter may work up to 60 m (197 ft) away from the vehicle.

Other conditions can affect the performance of the transmitter. See *Remote Keyless Entry (RKE) System* ⇨ 27.





The following may be available:

 : Press to lock all doors. The turn signal indicators may flash and/or the horn may sound to indicate locking. See *Vehicle Personalization* ⇨ 147. If a passenger door is open when  is pressed, all doors lock.

If the driver door is open when  is pressed, all doors lock except the driver door. These settings can be modified. See *Vehicle Personalization* ⇨ 147.



Pressing  may also arm the alarm system. See *Vehicle Alarm System* ⇨ 42.



 : Press to unlock the driver door or all doors. See *Vehicle Personalization* ⇨ 147. The turn signal indicators may flash to indicate unlocking has occurred. See *Vehicle Personalization* ⇨ 147.

Pressing  may also disarm the alarm system. See *Vehicle Alarm System* ⇨ 42.

For vehicles with the manual liftgate, press  twice within five seconds to unlock the liftgate.

 : If equipped, press twice quickly to open or close the liftgate. Press and release once to stop the liftgate from moving.

 : Press and release one time to initiate vehicle locator. The exterior lamps flash and the horn chirps three times. Press and hold  for at least three seconds to sound the panic alarm. The horn sounds and the turn signals flash until  is pressed again or the vehicle is started.

 : Press and release  and then immediately press and hold  for at least four seconds to start the engine from outside the vehicle using the RKE transmitter.

### Keyless Access Operation

The Keyless Access system lets you lock and unlock the doors and access the liftgate without removing the RKE transmitter from your pocket, purse, briefcase, etc. The RKE transmitter should be within 1 m (3 ft) of the door or liftgate being opened. If equipped, there will be buttons on the outside front door handles.

Keyless Access can be programmed to unlock all doors on the first lock/unlock press from the driver door. See *Vehicle Personalization* ⇨ 147.

### Keyless Unlocking/Locking from the Driver Door

When the doors are locked and the RKE transmitter is within 1 m (3 ft) of the driver door handle, pressing the lock/unlock button on the driver door handle will unlock the driver

door. If the lock/unlock button is pressed again within five seconds, all passenger doors will unlock. Pull the door handle to unlatch the door.



**Driver Side Shown, Passenger Side Similar**

Pressing the lock/unlock button will cause all doors to lock if any of the following occur:

- It has been more than five seconds since the first lock/unlock button press.
- Two lock/unlock button presses were used to unlock all doors.
- Any vehicle door has opened and all doors are now closed.

### **Keyless Unlocking/Locking from the Passenger Doors**

When the doors are locked and the RKE transmitter is within 1 m (3 ft) of the passenger door handle, pressing the lock/unlock button on the passenger door handle will unlock all doors.

Pressing the lock/unlock button will cause all doors to lock if any of the following occur:

- The lock/unlock button was used to unlock all doors.
- Any vehicle door has opened and all doors are now closed.



### **Passive Locking**

If equipped with Keyless Access, the vehicle will lock several seconds after all doors are closed if the vehicle is off and at least one transmitter has been removed or none remain in the vehicle.

If other electronic devices interfere with the RKE transmitter signal, the vehicle may not detect the RKE transmitter inside the vehicle. If passive locking is enabled, the

doors may lock with the RKE transmitter inside the vehicle. Do not leave the RKE transmitter in an unattended vehicle.

### **Temporary Disable of the Passive Locking Feature**

Temporarily disable passive locking by pressing and holding  on the interior door switch with a door open for at least four seconds, or until three chimes are heard. Passive locking will then remain disabled until  on the interior door is pressed, or until the vehicle is turned on.

To customize the doors to automatically lock when exiting the vehicle, see *Vehicle Personalization* ⇨ 147.

### **Remote Left In Vehicle Alert**

When the vehicle is turned off and a remote is left in the vehicle, the horn will chirp three times after all doors are closed. To turn on or off see *Vehicle Personalization* ⇨ 147.

### Keyless Liftgate Opening

When the doors are locked, press the touch pad to open the liftgate if the RKE transmitter is within 1 m (3 ft).

### Programming Transmitters to the Vehicle

Only RKE transmitters programmed to the vehicle will work. If a transmitter is lost or stolen, a replacement can be purchased and programmed through your dealer. The vehicle can be reprogrammed so that lost or stolen transmitters no longer work. Any remaining transmitters will need to be reprogrammed. Each vehicle can have up to eight transmitters matched to it.

### Programming with Two Recognized Transmitters

A new transmitter can be programmed to the vehicle when there are two recognized transmitters. To program, the vehicle must be off and all of the

transmitters, both currently recognized and new, must be with you.

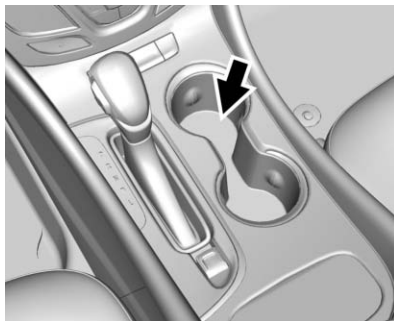

1. Place the two recognized transmitters in the front cupholder.
2. Insert the vehicle key of the new transmitter into the key lock cylinder on the outside of the driver door and turn the key to the unlock position five times within 10 seconds.

The Driver Information Center (DIC) displays READY FOR REMOTE #2, 3, 4 or 5.

3. Place the new transmitter in the front cupholder
4. Press ENGINE START/STOP. When the transmitter is learned, the DIC will show that it is ready to program the next transmitter.
5. Remove the transmitter from the transmitter pocket and press .

To program additional transmitters, repeat Steps 3–5.

When all additional transmitters are programmed, press and hold ENGINE START/STOP for 12 seconds to exit programming mode.

### Programming without Two Recognized Transmitters

If two currently recognized transmitters are not available, follow this procedure to program up to eight transmitters. This feature is not available in Canada. This procedure will take approximately 30 minutes to complete. The vehicle

must be off and all of the transmitters to be programmed must be with you.

1. Insert the vehicle key of the transmitter into the key lock cylinder on the outside of the driver door and turn the key to the unlock position five times within 10 seconds.

The Driver Information Center (DIC) displays REMOTE LEARN PENDING, PLEASE WAIT.

2. Wait for 10 minutes until the DIC displays PRESS ENGINE START BUTTON TO LEARN and then press ENGINE START/STOP.

The DIC displays will again show REMOTE LEARN PENDING, PLEASE WAIT.

3. Repeat Step 2 two additional times. After the third time, all previously known transmitters will no longer work with the vehicle. Remaining transmitters can be relearned during the next steps.

The DIC display should now show READY FOR REMOTE # 1.

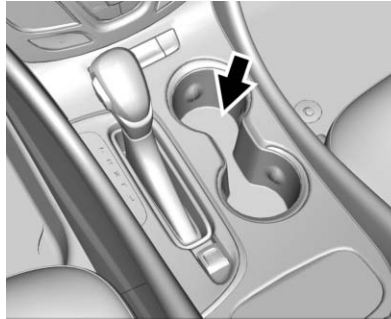

4. Place the new transmitter in the front cupholder.
5. Press ENGINE START/STOP. When the transmitter is learned, the DIC will show that it is ready to program the next transmitter.
6. Remove the transmitter from the cupholder and press .

To program additional transmitters, repeat Steps 4–6.

When all additional transmitters are programmed, press and hold ENGINE START/STOP for 12 seconds to exit programming mode.

### Starting the Vehicle with a Low Transmitter Battery

If the transmitter battery is weak or if there is interference with the signal, the DIC may display NO REMOTE DETECTED or NO REMOTE KEY WAS DETECTED PLACE KEY IN TRANSMITTER POCKET THEN START YOUR VEHICLE. See *Key and Lock Messages* ⇨ 142.



To start the vehicle:

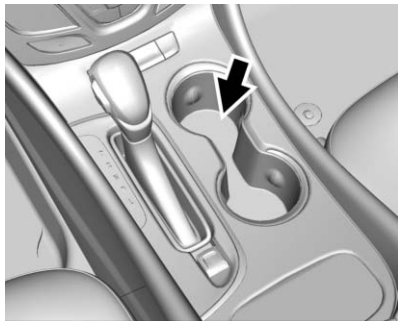

1. Place the transmitter in the front cupholder.
2. With the vehicle in P (Park) or N (Neutral), press the brake pedal and ENGINE START/STOP.

Replace the transmitter battery as soon as possible.

### Battery Replacement

Replace the battery if the REPLACE BATTERY IN REMOTE KEY message displays in the DIC. See *Key and Lock Messages* ⇨ 142.

### Caution

When replacing the battery, do not touch any of the circuitry on the transmitter. Static from your body could damage the transmitter.

The battery is not rechargeable. To replace the battery:



1. Press the button on the transmitter to access the key.



2. Separate the two halves of the transmitter using a flat tool inserted into the bottom of the transmitter.



3. Remove the battery by pushing on the battery and sliding it toward the bottom of the transmitter.
4. Insert the new battery, positive side facing the back cover. Push the battery down until it is held in place. Replace with a CR2032 or equivalent battery.
5. Snap the battery cover back on to the transmitter.

## Remote Vehicle Start

If equipped with the remote start feature, the climate control system will come on when the vehicle is started remotely depending on the outside temperature.

The rear defog and heated and cooled seats, if equipped, may also come on. See *Heated and Ventilated Front Seats* ⇨ 56 and *Vehicle Personalization* ⇨ 147.

Laws in some communities may restrict the use of remote starters. Check local regulations for any requirements on remote starting of vehicles.

Do not use remote start if the vehicle is low on fuel.

The vehicle cannot be remote started if:

- The transmitter is in the vehicle.
- The hood is not closed.
- There is an emission control system malfunction and the malfunction indicator lamp is on.

The engine will turn off during a remote vehicle start if:

- The coolant temperature gets too high.
- The oil pressure gets low.

The RKE transmitter range may be reduced while the vehicle is running.

Other conditions can affect the performance of the transmitter. See *Remote Keyless Entry (RKE) System* ⇨ 27 or *Vehicle Personalization* ⇨ 147.

### Starting the Engine Using Remote Start

1. Press and release .

2. Immediately press and hold  until the turn signal lamps flash or for at least four seconds.

When the vehicle starts, the parking lamps will turn on. The doors will be locked and the climate control system may come on.

The engine will continue to run for 10 minutes. After 30 seconds, repeat Steps 1 and 2 if a 10-minute time extension is desired.

Place the ignition in ON/RUN/START to operate the vehicle.

### Extending Engine Run Time

The engine run time can be extended by 10 minutes, for a total of 20 minutes, if during the first 10 minutes Steps 1 and 2 are repeated while the engine is still running. An extension can be requested, 30 seconds after starting.

A maximum of two remote starts, or a single start with an extension, is allowed between ignition cycles.

The vehicle's ignition must be turned on and then back off to use remote start again.

### Canceling a Remote Start

To cancel a remote start, do one of the following:

- Press and hold  until the parking lamps turn off.
- Turn on the hazard warning flashers.
- Turn the ignition on and then off.

### Door Locks

#### Warning

Unlocked doors can be dangerous.

- Passengers, especially children, can easily open the doors and fall out of a moving vehicle. When a door is locked, the handle will not open it. The chance of being thrown out of the vehicle in a crash is



(Continued)

#### Warning (Continued)



increased if the doors are not locked. So, all passengers should wear safety belts properly and the doors should be locked whenever the vehicle is driven.

- Young children who get into unlocked vehicles may be unable to get out. A child can be overcome by extreme heat and can suffer permanent injuries or even death from heat stroke. Always lock the vehicle whenever leaving it.
- Outsiders can easily enter through an unlocked door when you slow down or stop the vehicle. Locking the doors can help prevent this from happening.

To lock or unlock the doors from outside the vehicle:

- Press  or  on the Remote Keyless Entry (RKE) transmitter.
- Use the key in the driver door.

To lock or unlock the doors from inside the vehicle:

- Press  or  on the power door lock switch.
- Pushing down the manual lock knob on the driver door will lock all doors. Pushing down the manual lock knob on a passenger door will lock only that door.
- Pulling an interior door handle will unlock the door. Pulling the door handle again unlatches it.

#### Keyless Access

If equipped, the RKE transmitter must be within 1 m (3 ft) of the door being opened. Press the button on the door handle to open. See "Keyless Access Operation" in *Remote Keyless Entry (RKE) System Operation* ⇨ 27.

## Key Cylinder Access

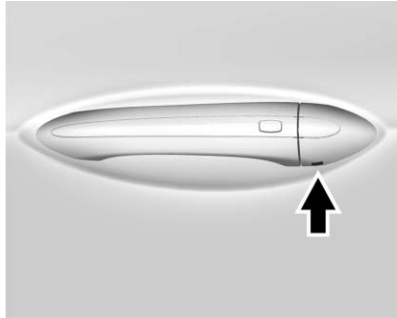



To access the key cylinder:

1. Pull the door handle to the open position.
2. Insert the key into the slot on the bottom of the cap and pry outward.
3. Move the cap rearward and remove.

Replace the cap by snapping on the tabs.

## Power Door Locks

Press  or  on the Remote Keyless Entry (RKE) transmitter. See *Remote Keyless Entry (RKE) System Operation* ⇨ 27.

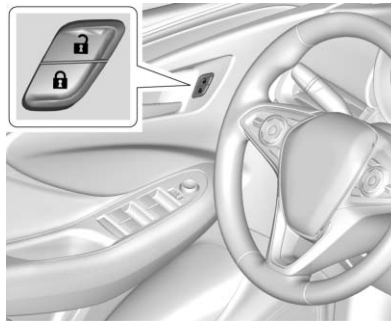

 : Press to lock the doors.

 : Press to unlock the doors.



## Delayed Locking

This feature delays the actual locking of the doors until five seconds after all doors are closed.

Delayed locking can only be turned on when the Unlocked Door Anti Lock Out feature has been turned off.

When  is pressed on the power door lock switch with the door open, a chime will sound three times indicating that delayed locking is active.

The doors will then lock automatically five seconds after all doors are closed. If a door is reopened before five seconds have elapsed, the five-second timer will reset once all the doors are closed again.

Press  on the door lock switch again, or press  on the RKE transmitter, to override this feature and lock the doors immediately.

Delayed locking can be programmed through the Driver Information Center (DIC). See *Vehicle Personalization* ⇨ 147.

## Automatic Door Locks

The doors will lock automatically when all doors are closed, the ignition is on, and the vehicle is shifted out of P (Park).

To unlock the doors:

- Press  on the power door lock switch.
- Shift the transmission into P (Park).

Automatic door locking cannot be disabled. Automatic door unlocking can be programmed. See *Vehicle Personalization* ⇨ 147.

## Lockout Protection

If the vehicle is in ACC/ACCESSORY or ON/RUN/START and the power door lock switch is pressed with the driver door open, all the doors will lock and only the driver door will unlock.

If the vehicle is off and locking is requested while a door is open, when all doors are closed the vehicle will check for RKE transmitters inside. If an RKE

transmitter is detected and the number of RKE transmitters inside has not reduced, the driver door will unlock and the horn will chirp three times.

Lockout Protection can be manually overridden with the driver door open by pressing and holding  on the power door lock switch.



## Unlocked Door Anti Lockout



If Unlocked Door Anti Lockout is turned on and the vehicle is off, the driver door is open, and locking is requested, all the doors will lock and only the driver door will unlock. The Unlocked Door Anti Lockout feature can be turned on or off using the vehicle personalization menus. See *Vehicle Personalization* ⇨ 147.

## Safety Locks



The rear door safety locks prevent passengers from opening the rear doors from inside the vehicle.

Press   to activate the rear door safety locks. The indicator light comes on when activated.

Press   again to deactivate the safety locks.

If an inside rear door handle is being pulled at the same time a safety lock is deactivated, only that door will remain locked and the indicator light may flash. Release

the handle, then press the safety lock twice to deactivate the safety locks.

The rear window lockout is also enabled. See *Power Windows* ⇨ 46.

## Doors

### Liftgate

#### Warning

Exhaust gases can enter the vehicle if it is driven with the liftgate or trunk/hatch open, or with any objects that pass through the seal between the body and the trunk/hatch or liftgate. Engine exhaust contains carbon monoxide (CO) which cannot be seen or smelled. It can cause unconsciousness and even death.

If the vehicle must be driven with the liftgate or trunk/hatch open:

- Close all of the windows.
- Fully open the air outlets on or under the instrument panel.
- Adjust the climate control system to a setting that brings in only outside air

(Continued)

#### Warning (Continued)

and set the fan speed to the highest setting. See “Climate Control Systems” in the Index.

- If the vehicle is equipped with a power liftgate, disable the power liftgate function.



See *Engine Exhaust* ⇨ 191.

#### Caution

To avoid damage to the liftgate or liftgate glass, make sure the area above and behind the liftgate is clear before opening it.

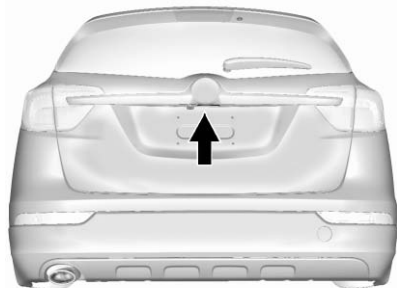
## Manual Liftgate



To open the liftgate, press  on the power door lock switch or press  on the RKE transmitter twice to unlock all doors. Press the touch pad on the underside of the liftgate handle and lift up.

Use the pull cup to lower and close the liftgate. Do not press the touch pad while closing the liftgate. This will cause the liftgate to be unlatched.

If equipped with Keyless Access, the liftgate can be opened when locked if the RKE transmitter is

within 1 m (3 ft) of the touch pad. See *Remote Keyless Entry (RKE) System Operation* ⇨ 27.

The liftgate has an electric latch. If the battery is disconnected or has low voltage, the liftgate will not open. The liftgate will resume operation when the battery is reconnected and charged.

## Power Liftgate Operation

### Warning

You or others could be injured if caught in the path of the power liftgate. Make sure there is no one in the way of the liftgate as it is opening and closing.

### Caution

Driving with an open and unsecured liftgate may result in damage to the power liftgate components.





If equipped with a power liftgate, the switch is on the driver door. The vehicle must be in P (Park).

The modes are:

- MAX: Opens to maximum height.
- 3/4: Opens to a reduced height that can be set from 3/4 to fully open. Use to prevent the liftgate from opening into overhead obstructions such as a garage door or roof-mounted cargo. The liftgate can be manually opened all the way.
- OFF: Opens manually only.

To power open or close the liftgate, select MAX or 3/4 mode.

- Press  twice quickly on the RKE transmitter until the liftgate moves.
- Press  on the driver door.
- Press the touch pad on the outside liftgate handle after unlocking all doors. If equipped with Keyless Access, the RKE transmitter must be within 1 m (3 ft).

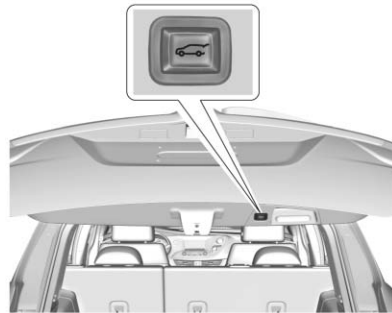

- Press  on the bottom of the liftgate next to the pull cup to close.

Press any liftgate button or the touch pad while the liftgate is moving to stop it. Pressing again restarts the operation in the reverse direction. The touch pad on the liftgate handle cannot be used to close the liftgate.

**Caution**

Manually forcing the liftgate to open or close during a power cycle can damage the vehicle. Allow the power cycle to complete.

The power liftgate may be temporarily disabled under extreme low temperatures, or after repeated power cycling over a short period of time. If this occurs, the liftgate can still be operated manually.

If the vehicle is shifted out of P (Park) while the power function is in progress, the liftgate will continue to completion. If the vehicle is accelerated before the liftgate has completed moving, the liftgate may stop or reverse direction. Check for

DIC messages and make sure the liftgate is closed and latched before driving.

**Falling Liftgate Detection**

The power liftgate will automatically close if the support strut has lost pressure. See your dealer for service before using the power liftgate.

**Obstacle Detection Features**

If the liftgate encounters an obstacle during a power open or close cycle, a warning chime will sound and the liftgate will automatically reverse direction and move a short distance away from the obstacle. After removing the obstruction, the power liftgate operation can be used again. If the liftgate encounters multiple obstacles on the same power cycle, the power function will deactivate. After removing the obstructions, manually close the liftgate which will allow normal power operation functions to resume.



If the vehicle is locked while the liftgate is closing, and an obstacle is encountered that prevents the liftgate from completely closing, the horn will sound as an alert that the liftgate did not close.

Pinch sensors are on the side edges of the liftgate. If an object is caught between the liftgate and the vehicle and presses against this sensor, the liftgate will reverse direction and open fully. The liftgate will remain open until it is activated again or closed manually.

### Setting the 3/4 Mode

To change the position the liftgate stops at when opening:

1. Select MAX or 3/4 mode and power open the liftgate.
2. Stop the liftgate movement at the desired height by pressing any liftgate switch. Manually adjust the liftgate position if needed.

3. Press and hold  next to the pull cup on the outside of the liftgate until the turn signals flash and a beep sounds. This indicates the setting has been recorded.

The liftgate cannot be set below a minimum programmable height. If there is no light flash or sound, then the height adjustment may be too low.

### Manual Operation

Select OFF to manually operate the liftgate. See “Manual Liftgate” at the beginning of this section.

#### Caution

Attempting to move the liftgate too quickly and with excessive force may result in damage to the vehicle.

Operate the liftgate manually with a smooth motion and moderate speed. The system includes a feature which limits the manual closing speed to protect the components.

### Hands-Free Operation

If equipped, the liftgate may be operated with a kicking motion under the rear bumper.

The liftgate will not operate if the RKE transmitter is not within 1 m (3 ft).

The hands-free feature will not work while the liftgate is moving. To stop the liftgate while in motion use one of the liftgate switches.

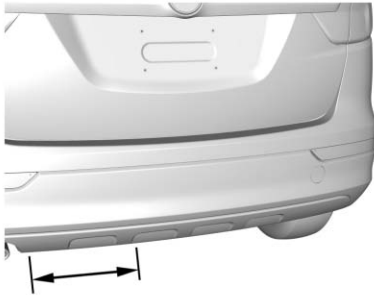

**Length of Kick Zone**

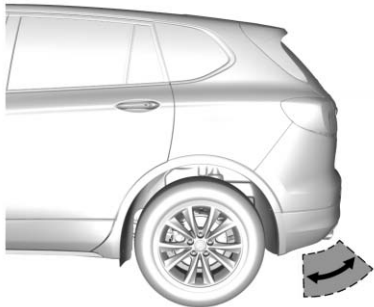

To operate, kick your foot straight up in one swift motion under the left corner of the rear bumper, then pull it back.

### Caution

Splashing water may cause the liftgate to open. Keep the RKE transmitter away from the rear bumper detection area or turn the liftgate mode to OFF when cleaning or working near the rear bumper to avoid accidental opening.

- Do not sweep your foot side to side.
- Do not keep your foot under the bumper; the liftgate will not activate.
- Do not touch the liftgate until it has stopped moving.
- This feature may temporarily be disabled under some conditions. If the liftgate does not respond to the kick, open or close the liftgate by another method or start the vehicle. The feature will be re-enabled.

When closing the liftgate using this feature, there will be a short delay. The rear lights will flash and a chime will sound. Step away from the liftgate before it starts moving.

## Vehicle Security

This vehicle has theft-deterrent features; however, they do not make the vehicle impossible to steal.

## Vehicle Alarm System

This vehicle has an anti-theft alarm system.

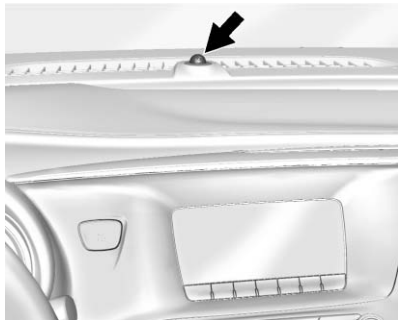

The indicator light, on the instrument panel near the windshield, indicates the status of the system:



**Off** : Alarm system is disarmed.

**On Solid** : Vehicle is secured during the delay to arm the system.

**Fast Flash** : Vehicle is unsecured. A door, the hood, or the liftgate is open.

**Slow Flash** : Alarm system is armed.

### Arming the Alarm System

1. Turn off the vehicle.
2. Lock the vehicle in one of three ways:
  - Use the RKE transmitter.
  - Use the Keyless Access system.
  - With a door open, press the inside .
3. After 30 seconds the alarm system will arm, and the indicator light will begin to slowly flash indicating the alarm system is operating. Pressing  on the RKE transmitter a second time will bypass the 30-second delay and immediately arm the alarm system.

The vehicle alarm system will not arm if the doors are locked with the key.

If the driver door is opened without first unlocking with the RKE transmitter, the horn will chirp and the lights will flash to indicate pre-alarm. If the vehicle is not started, or the door is not unlocked by pressing  on the RKE transmitter during the 10-second pre-alarm, the alarm will be activated.

The alarm will also be activated if a door, the hood, or the liftgate is opened without first disarming the system. When the alarm is activated, the turn signals will flash and the horn will sound for about 30 seconds. The alarm system will then re-arm to monitor for the next unauthorized event.

### Disarming the Alarm System

To disarm the alarm system or turn off the alarm if it has been activated:

- Press  on the RKE transmitter.

- Unlock the vehicle using the Keyless Access system.
- Start the vehicle.

To avoid setting off the alarm by accident:

- Lock the vehicle after all occupants have exited.
- Always unlock the vehicle with the RKE transmitter, or use the Keyless Access system.

Unlocking the driver door with the key will not disarm the system or turn off the alarm.

### How to Detect a Tamper Condition

If  is pressed on the RKE transmitter and the horn chirps and the lights flash three times, an alarm occurred previously while the alarm system was armed.

If the alarm has been activated, a message will appear on the DIC. See *Security Messages* ⇨ 145.

## Immobilizer

See *Radio Frequency Statement* ⇨ 334.

### Immobilizer Operation

This vehicle has a passive theft-deterrent system.

The system does not have to be manually armed or disarmed.

The vehicle is automatically immobilized when the transmitter leaves the vehicle.

The immobilization system is disarmed when the ignition button is pushed in and a valid transmitter is found in the vehicle.



The security light in the instrument cluster comes on when there is a problem with arming or disarming the theft-deterrent system.

The system has one or more transmitters matched to an immobilizer control unit in your vehicle. Only a correctly matched transmitter will start the vehicle. If the transmitter is ever damaged, you may not be able to start your vehicle.

When trying to start the vehicle, the security light comes on briefly when the ignition is turned on.

If the engine does not start and the security light stays on, there is a problem with the system. Turn the vehicle off and try again.

If the RKE transmitter appears to be undamaged, try another transmitter. Or, you may try placing the transmitter in the transmitter pocket in the front cupholder. See “Starting the Vehicle with a Low Transmitter Battery” under *Remote Keyless Entry (RKE) System Operation* ⇨ 27.

If the engine does not start with the other transmitter or when the transmitter is in the pocket in the front cupholder, your vehicle needs service. See your dealer who can

service the theft-deterrent system and have a new transmitter programmed to the vehicle.

Do not leave the transmitter or device that disarms or deactivates the theft-deterrent system in the vehicle.

## Exterior Mirrors

### Convex Mirrors

#### Warning

A convex mirror can make things, like other vehicles, look farther away than they really are. If you cut too sharply into the right lane, you could hit a vehicle on the right. Check the inside mirror or glance over your shoulder before changing lanes.

The passenger side mirror is convex shaped. A convex mirror's surface is curved so more can be seen from the driver seat.

## Power Mirrors

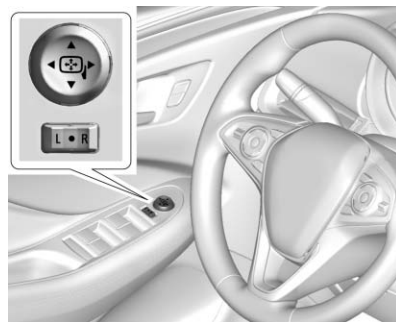

To adjust the mirrors:

1. Move the selector switch to the L (Left) or R (Right) to choose the driver or passenger mirror.
2. Press the arrows on the control pad to move each mirror to the desired position.
3. Return the selector switch to the center position.

## Turn Signal Indicator

The vehicle may also have a turn signal indicator on the mirror. An arrow on the mirror flashes in the direction of the turn or lane change.

## Folding Mirrors

### Manual Folding Mirrors

The mirrors can be folded inward toward the vehicle to prevent damage when going through an automatic car wash. Push the mirror outward to return it to the original position.

## Heated Mirrors

If equipped with heated mirrors:



**REAR** : The rear window defogger also heats the outside mirrors.

See *Dual Automatic Climate Control System* ⇨ 166.

## Automatic Dimming Mirror

If equipped, the vehicle has an automatic dimming outside mirror(s). The mirror(s) will adjust for the glare of headlamps behind you.

## Reverse Tilt Mirrors

If equipped with memory seats, the passenger and/or driver mirror tilts to a preselected position when the vehicle is in R (Reverse). This allows the curb to be seen when parallel parking.

The mirror(s) return to the original position when:

- The vehicle is shifted out of R (Reverse), or remains in R (Reverse) for about 30 seconds.
- The ignition is turned off.
- The vehicle is driven in R (Reverse) above a set speed.

To turn this feature on or off, see *Vehicle Personalization* ⇨ 147.

## Interior Mirrors

### Interior Rearview Mirrors

Adjust the rearview mirror for a clear view of the area behind the vehicle.

Do not spray glass cleaner directly on the mirror. Use a soft towel dampened with water.

### Automatic Dimming Rearview Mirror

The rearview mirror automatically dims to reduce the glare of the headlamps from behind. This feature comes on when the vehicle is started.

## Windows

### Warning

Never leave a child, a helpless adult, or a pet alone in a vehicle, especially with the windows closed in warm or hot weather. They can be overcome by the extreme heat and suffer permanent injuries or even death from heat stroke.



The vehicle aerodynamics are designed to improve fuel economy performance. This may result in a

pulsing sound when either rear window is down and the front windows are up. To reduce the sound, open either a front window or the sunroof, if equipped.

## Power Windows

### Warning

Children could be seriously injured or killed if caught in the path of a closing window. Never leave keys in a vehicle with children. When there are children in the rear seat, use the window lockout button to prevent operation of the windows. See *Keys* ⇨ 26.

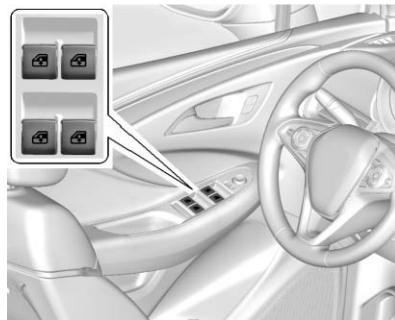

The windows work when the vehicle is in ON/RUN, ACC/ACCESSORY, or Retained Accessory Power (RAP). See *Retained Accessory Power (RAP)* ⇨ 189.





Press or pull the switch to open or close the window.

The windows will be temporarily disabled if the window switches are used repeatedly within a short time.

### Window Lockout

This feature stops the rear door passenger window switches from working.



- Press   to engage the rear window lockout feature. An indicator light will illuminate when the feature is on.
- Press   again to disengage.

This also disables the rear power door locks. See *Safety Locks* ⇨ 36.

### Window Express Movement

Express-down/up allows the windows to be opened or closed without holding the window switch. Press the window switch fully down or pull it up, and quickly release it to engage. Briefly press or pull the same switch to stop window movement.

### Express Window Obstacle Detection

The express-up feature will reverse window movement if it comes in contact with an object. Extreme cold or ice could cause the window to auto-reverse. The window will operate as normal after the object or condition is removed.

### Obstacle Detection Override

#### Warning

If express override is activated, the window will not reverse automatically. You or others could be injured and the window could be damaged. Before you use express override, make sure that all people and obstructions are clear of the window path.

The window can be closed by holding the window switch in the up position if conditions prevent it from express closing.

### Programming the Power Windows

Programming may be necessary if the vehicle's battery has been disconnected or discharged. If the window is unable to express-up, program the window:

1. Close all doors.
2. Place the ignition in ACC/ACCESSORY or ON/RUN.
3. Partially open the window to be programmed, then close it and continue to pull the switch briefly after the window has fully closed.
4. Press the power window switch until the window is fully open and briefly hold.



## Sun Visors

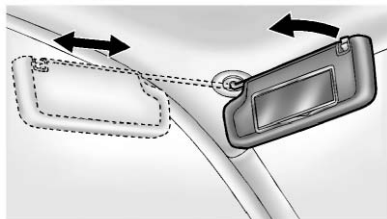

Pull the sun visor down to block glare. Detach the sun visor from the center mount to pivot to the side window or, if equipped, extend along the rod.

## Roof

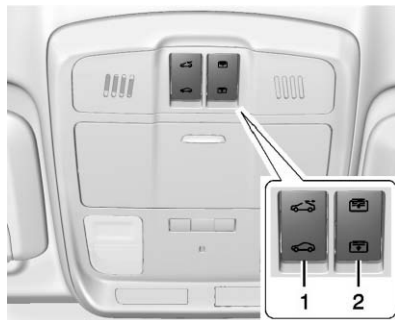

### Sunroof





1. Sunroof Switch
2. Sunshade Switch

If equipped, the sunroof only operates when the ignition is in ACC/ACCESSORY or ON/RUN, or when Retained Accessory Power (RAP) is active. See *Retained Accessory Power (RAP)* ⇨ 189.



### Sunroof Switch

**Express-Open/Express-Close :** To express-open the sunroof, fully press and release  (1). Press the switch again to stop it. To express-close the sunroof, fully press and release  (1). Press the switch again to stop it.

**Open/Close (Manual Mode) :** To open the sunroof, press and hold  (1) until the sunroof reaches the desired position. Press and hold  (1) to close it.

**Vent :** From the closed position, press  (1) to vent the sunroof.

### Sunshade Switch

**Express-open/Express-close :** To express-open the sunshade, fully press and release  (2). To express-close the sunshade, fully press and release  (2). Press the switch again to stop it.

**Open/Close :** To open the sunshade, press and hold  (2) until the sunshade reaches the desired position.

When the sunroof is opened, an air deflector will automatically raise. The air deflector will retract when the sunroof is closed.

### Automatic Reversal System

The sunroof/sunshade is equipped with an automatic reversal system that is only active when the sunroof/sunshade is being operated in express-close. If an object is in the path of the sunroof/sunshade while it is express-closing, the reversal system will detect the object and stop.

In the event of closing difficulties like frost or other conditions, it is possible to override the reversal system. To override the reversal system, close in manual mode. To stop the movement, release the switch.



Dirt and debris may collect on the sunroof seal or in the track. This could cause an issue with sunroof operation or noise. It could also plug the water drainage system. Periodically open the sunroof and remove any obstacles or loose debris. Wipe the sunroof seal and roof sealing area using a clean cloth, mild soap, and water. Do not remove grease from the sunroof.

If water is seen dripping into the water drainage system, this is normal.

# Seats and Restraints

## Head Restraints

Head Restraints ..... 51

## Front Seats

Power Seat Adjustment ..... 53

Lumbar Adjustment ..... 53

Thigh Support Adjustment ..... 53

Reclining Seatbacks ..... 54

Memory Seats ..... 54

Heated and Ventilated Front Seats ..... 56

## Rear Seats

Rear Seats ..... 57

Rear Seat Armrest ..... 59

Heated Rear Seats ..... 59

## Safety Belts

Safety Belts ..... 60

How to Wear Safety Belts

Properly ..... 61

Lap-Shoulder Belt ..... 62

Safety Belt Use During

Pregnancy ..... 65

Safety Belt Extender ..... 65

Safety System Check ..... 65

Safety Belt Care ..... 65

Replacing Safety Belt System

Parts after a Crash ..... 66

## Airbag System

Airbag System ..... 67

Where Are the Airbags? ..... 68

When Should an Airbag

Inflate? ..... 70

What Makes an Airbag

Inflate? ..... 71

How Does an Airbag

Restrain? ..... 71

What Will You See after an

Airbag Inflates? ..... 72

Passenger Sensing System ... 73

Servicing the Airbag-Equipped

Vehicle ..... 77

Adding Equipment to the

Airbag-Equipped Vehicle .... 78

Airbag System Check ..... 78

Replacing Airbag System Parts

after a Crash ..... 79

## Child Restraints

Older Children ..... 79

Infants and Young Children .... 81

Child Restraint Systems ..... 83

Where to Put the Restraint .... 85

Lower Anchors and Tethers for

Children (LATCH System) .... 86

Replacing LATCH System Parts

After a Crash ..... 93

Securing Child Restraints (With

the Safety Belt in the

Rear Seat) ..... 93

Securing Child Restraints (With

the Safety Belt in the

Front Seat) ..... 95

## Head Restraints

### Front Seats

The vehicle's front seats have adjustable head restraints in the outboard seating positions.

**⚠ Warning**

With head restraints that are not installed and adjusted properly, there is a greater chance that occupants will suffer a neck/spinal injury in a crash. Do not drive until the head restraints for all occupants are installed and adjusted properly.



Adjust the head restraint so that the top of the restraint is at the same height as the top of the occupant's head. This position reduces the chance of a neck injury in a crash.

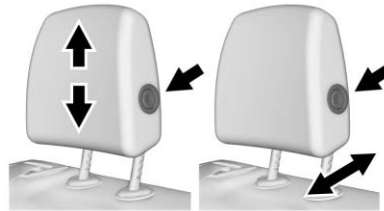

To raise or lower the head restraint, press the button located on the side of the head restraint, and pull up or

push the head restraint down, and release the button. Pull and push on the head restraint after the button is released to make sure that it is locked in place.

To adjust the head restraint forward and rearward, press the button located on the side facing of the head restraint and move it forward or rearward until the desired locking position is reached. Try to move the head restraint after the button is released to make sure that it is locked in place.

The front seat outboard head restraints are not removable.

### Rear Seats

The vehicle's rear seats have adjustable head restraints in the outboard seating positions.

The height of the head restraint can be adjusted. Pull the head restraint up to raise it. Try to move the head restraint to make sure that it is locked in place.

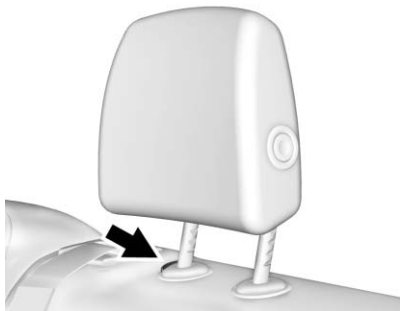

To lower the head restraint, press the button located on the top of the seatback and push the head restraint down. Try to move the head restraint after the button is released to make sure it is locked in place.

Always adjust the head restraint so that the top of the restraint is at the same height as the top of the occupant's head.

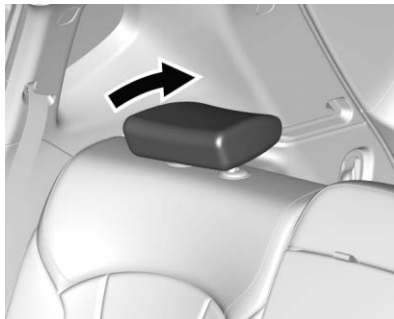

The rear outboard head restraints are designed to be folded. The head restraint can be folded backward to allow for better visibility when the rear seat is unoccupied. To fold the head restraint, press the button on the side of the head restraint.

When an occupant is in the seat, always return the head restraint to the upright position. Pull the head restraint up and push it backward until it locks into place. Push and pull on the head restraint to make sure that it is locked.

If you are installing a child restraint in the rear seat, see "Securing a Child Restraint Designed for the LATCH System" under *Lower Anchors and Tethers for Children (LATCH System)* ⇨ 86.

## Front Seats

### Power Seat Adjustment

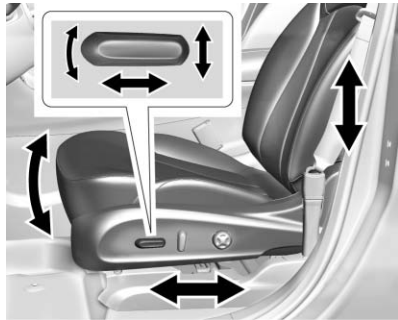

To adjust a power seat:

- Move the seat forward or rearward by sliding the control forward or rearward.
- Raise or lower the front part of the seat cushion by moving the front of the control up or down.
- Raise or lower the entire seat by moving the rear of the control up or down.

To adjust the seatback, see *Reclining Seatbacks* ⇨ 54.

To adjust the lumbar support, see *Lumbar Adjustment* ⇨ 53.

### Lumbar Adjustment

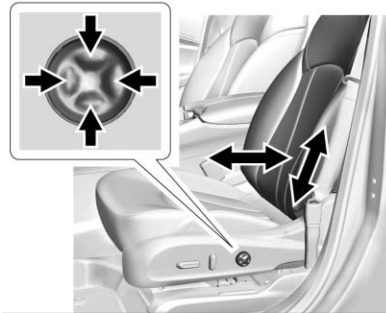

To adjust the lumbar support, if equipped:

- Press the front or rear of the switch to increase or decrease lumbar support.
- Press the top or bottom of the switch to raise or lower the lumbar support.

- Release the switch when the level of support is reached.

### Thigh Support Adjustment

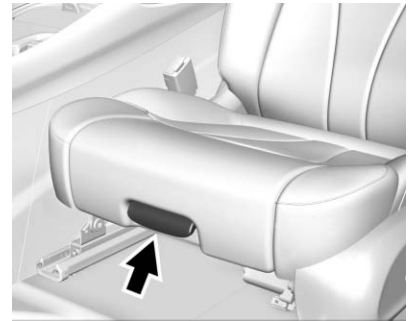

If equipped, adjust the manual leg extension by pulling up on the lever, and then pulling or pushing on the support to lengthen or shorten it. Release the lever to lock it in place.

## Reclining Seatbacks

### Warning

Sitting in a reclined position when the vehicle is in motion can be dangerous. Even when buckled up, the safety belts cannot do their job.

The shoulder belt will not be against your body. Instead, it will be in front of you. In a crash, you could go into it, receiving neck or other injuries.

The lap belt could go up over your abdomen. The belt forces would be there, not at your pelvic bones. This could cause serious internal injuries.

For proper protection when the vehicle is in motion, have the seatback upright. Then sit well back in the seat and wear the safety belt properly.



Do not have a seatback reclined if the vehicle is moving.

### Power Reclining Seatbacks

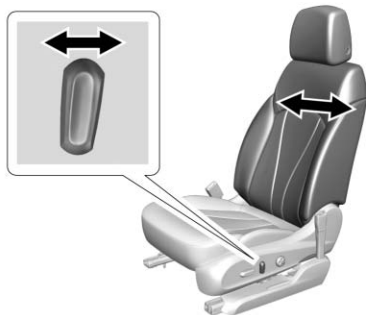

To adjust a power seatback:

- Tilt the top of the control rearward to recline.
- Tilt the top of the control forward to raise.

## Memory Seats

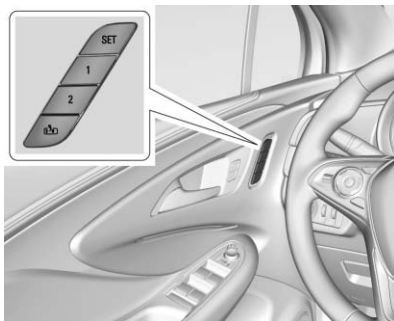



If equipped, the 1, 2, SET, and  (Exit) buttons on the driver door are used to manually store and recall memory settings for the driver seat and outside mirrors.

### Storing Memory Positions

To store positions to the 1 and 2 buttons:

1. Place the ignition in ON/RUN or ACC/ACCESSORY.
2. Adjust the driver seat and outside mirrors.
3. Press and release SET. A beep will sound.
4. Immediately press and hold 1 until two beeps sound.
5. Repeat Steps 1–4 for a second driver using 2.

To store positions to the  (Exit) button and easy exit features, repeat Steps 1–4 using  to store your positions for getting out of the vehicle.

### Manually Recalling Memory Positions

Press and hold 1, 2, or  (Exit) to manually recall the previously stored memory positions. Releasing

1, 2, or  before the stored positions are reached stops the recall.

### Automatically Recalling Memory Positions (Auto Memory Recall)

When the Auto (Automatic) Memory Recall feature is enabled in the vehicle personalization menu, the current driver's previously stored 1 or 2 positions are recalled by placing the ignition in ON/RUN or ACC/ACCESSORY.

See "Auto Memory Recall" under "Comfort and Convenience" in *Vehicle Personalization* ⇨ 147.

To stop recall movement, press one of the memory, power mirror, or power seat controls.

RKE transmitters are not labeled with a number. If your memory seat position is saved to 1 or 2 but this position is not automatically recalling, then store your positions to the other button or switch RKE transmitters with the other driver.

### Easy Exit Recall

When the Easy Exit Recall feature is enabled in the vehicle personalization menu, the positions previously stored to the  (Exit) button are automatically recalled when getting out of the vehicle.

See *Vehicle Personalization* ⇨ 147.

### Obstructions

If something has blocked the driver seat while recalling a memory position, the recall may stop. Remove the obstruction. Then do one of the following:

- If manually or automatically recalling the memory position, press and hold the appropriate manual control for the memory item that is not recalling for two seconds. Try recalling again by pressing the appropriate memory button.
- If recalling the exit position, press and hold the appropriate manual control for the exit feature not recalling for two seconds. Then try recalling the exit position again.



If the memory position is still not recalling, see your dealer for service.



## Heated and Ventilated Front Seats

### Warning

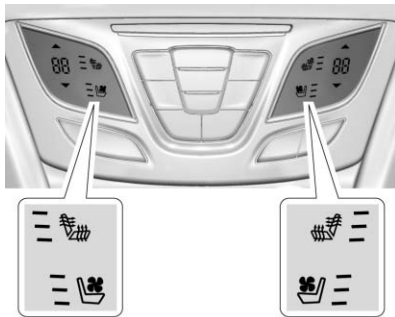

If you cannot feel temperature change or pain to the skin, the seat heater may cause burns. To reduce the risk of burns, people with such a condition should use care when using the seat heater, especially for long periods of time. Do not place anything on the seat that insulates against heat, such as a blanket, cushion, cover, or similar item. This may cause the seat heater to overheat. An overheated seat heater may cause a burn or may damage the seat.



If equipped, the buttons are near the climate controls. To operate, the engine must be running.

Press  or  to heat the driver or passenger seat cushion and seatback.

The passenger seat may take longer to heat up.

Press  or  to ventilate the driver or passenger seat.

Press the button once for the highest setting. With each press of the button, the heated and ventilated seat will change to the next lower setting, and then the off

setting. Three lights indicate the highest setting, and one light indicates the lowest.

If the heated seats are on high, the level may automatically be lowered after approximately 30 minutes.

### Remote Start Auto Heated and Ventilated Seats

The heated and ventilated seats can be programmed to turn on automatically during a remote vehicle start when conditions allow. The heated seat function can be programmed to come on when ENGINE START/STOP is pressed under certain conditions. See *Vehicle Personalization* ⇨ 147. Press the heated or ventilated seat button to use the heated or ventilated seats after the vehicle is started.

The heated and ventilated seat button lights will not turn on during a remote start.

The temperature of an unoccupied seat may be reduced.

To program the heated and ventilated seat features, see *Vehicle Personalization* ⇨ 147.

## Rear Seats

### Rear Seat Adjustment

The second row seats slide forward for more room.

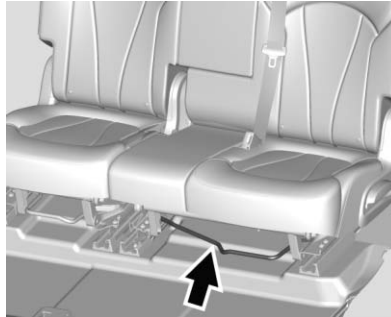

To adjust the seat position, lift the lever below the seat cushion and slide the seat forward or backward.

### Split Folding Seatbacks

Either side of the rear seatback can be folded down for more cargo space.

### Manually Folding the Seatbacks

#### Caution

Folding a rear seat with the safety belts still fastened may cause damage to the seat or the safety belts. Always unbuckle the safety belts and return them to their normal stowed position before folding a rear seat.

### Sliding Seatback

To fold a sliding seatback:

1. Place the front seatbacks in the upright position. See *Reclining Seatbacks* ⇨ 54.
2. Fold the rear seat head restraints. See *Head Restraints* ⇨ 51.



3. Pull on the lever on the side of the seatback to unlock it and fold the seatback forward.
4. Verify the seat is locked in the folded position by pushing down on the seatback.
5. Repeat the steps for the other seatback, if desired.

### Automatically Folding the Seatbacks

If equipped, to automatically fold the seatback:

1. Place the front seatbacks in the upright position. See *Reclining Seatbacks* ⇨ 54.

2. Fold the rear seat head restraints. See *Head Restraints* ⇨ 51.



3. Pull the lever to activate the automatic folding feature.
4. Verify the seat is locked in the folded position by pushing down on the seatback.

Keep the seatback in the upright, locked position when not in use.

### Raising the Seatbacks

#### Warning

If either seatback is not locked, it could move forward in a sudden stop or crash. That could cause injury to the person sitting there. Always push and pull on the seatbacks to be sure they are locked.

#### Warning

A safety belt that is improperly routed, not properly attached, or twisted will not provide the protection needed in a crash. The person wearing the belt could be seriously injured. After raising the rear seatback, always check to be sure that the safety belts are properly routed and attached, and are not twisted.

To raise the sliding seatback:

1. Pull on the lever on the side of the seat cushion to release the seatback from its locked position.
2. Push the seatback rearward until it locks in the upright position.
3. Make sure the rear safety belts are in the belt guide and are not twisted or caught between the seat cushion and the seatback.

## Rear Seat Armrest

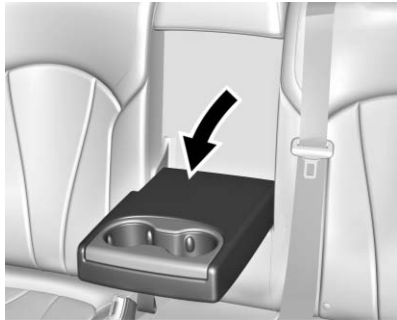

If equipped, the rear seat has an armrest in the center of the seatback. Lower the armrest to access the cupholders.

To fold, lift the armrest up and push it rearward until it is flush with the seatback.



## Heated Rear Seats

### WARNING

If you cannot feel temperature change or pain to the skin, the seat heater may cause burns. See the Warning under *Heated and Ventilated Front Seats* ⇨ 56.



If equipped, the buttons are on the rear of the center console.

With the ignition in ON/RUN/START, press  or  to heat the left or right outboard seat cushion. An indicator on the climate control display appears when this feature is on.

Press the button once for the highest setting. With each press of the button, the heated seat changes to the next lower setting, and then the off setting. Three lights indicate the highest setting, and one light indicates the lowest.

## Safety Belts

This section describes how to use safety belts properly, and some things not to do.

### Warning

Do not let anyone ride where a safety belt cannot be worn properly. In a crash, if you or your passenger(s) are not wearing safety belts, injuries can be much worse than if you are wearing safety belts. You can be seriously injured or killed by hitting things inside the vehicle harder or by being ejected from the vehicle. In addition, anyone who is not buckled up can strike other passengers in the vehicle.

It is extremely dangerous to ride in a cargo area, inside or outside of a vehicle. In a collision, passengers riding in these areas are more likely to be seriously injured or killed. Do not allow

(Continued)

### Warning (Continued)

passengers to ride in any area of the vehicle that is not equipped with seats and safety belts.

Always wear a safety belt, and check that all passenger(s) are restrained properly too.

This vehicle has indicators as a reminder to buckle the safety belts. See *Safety Belt Reminders* ⇨ 119.

### Why Safety Belts Work

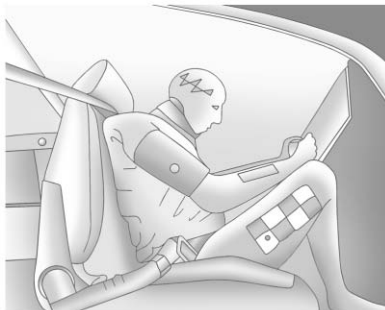

When riding in a vehicle, you travel as fast as the vehicle does. If the vehicle stops suddenly, you keep going until something stops you. It could be the windshield, the instrument panel, or the safety belts!

When you wear a safety belt, you and the vehicle slow down together. There is more time to stop because you stop over a longer distance and, when worn properly, your strongest bones take the forces from the safety belts. That is why wearing safety belts makes such good sense.

### Questions and Answers About Safety Belts

**Q:** Will I be trapped in the vehicle after a crash if I am wearing a safety belt?

**A:** You *could* be — whether you are wearing a safety belt or not. Your chance of being conscious during and after a crash, so you *can* unbuckle and get out, is *much* greater if you are belted.

**Q: If my vehicle has airbags, why should I have to wear safety belts?**

**A:** Airbags are supplemental systems only. They work *with* safety belts — not instead of them. Whether or not an airbag is provided, all occupants still have to buckle up to get the most protection.

Also, in nearly all states and in all Canadian provinces, the law requires wearing safety belts.

## How to Wear Safety Belts Properly

This section is only for people of adult size.

There are special things to know about safety belts and children, and there are different rules for smaller children and infants. If a child will be riding in the vehicle, see *Older Children* ⇨ 79 or *Infants and Young Children* ⇨ 81. Follow those rules for everyone's protection.

It is very important for all occupants to buckle up. Statistics show that unbelted people are hurt more often in crashes than those who are wearing safety belts.

There are important things to know about wearing a safety belt properly.

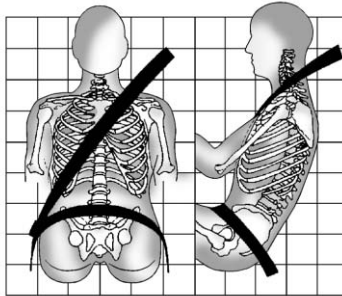

- Sit up straight and always keep your feet on the floor in front of you.
- Always use the correct buckle for your seating position.
- Wear the lap part of the belt low and snug on the hips, just touching the thighs. In a crash, this applies force to the strong

pelvic bones and you would be less likely to slide under the lap belt. If you slid under it, the belt would apply force on your abdomen. This could cause serious or even fatal injuries.

- Wear the shoulder belt over the shoulder and across the chest. These parts of the body are best able to take belt restraining forces. The shoulder belt locks if there is a sudden stop or crash.

### Warning

You can be seriously injured, or even killed, by not wearing your safety belt properly.

- Never allow the lap or shoulder belt to become loose or twisted.
- Never wear the shoulder belt under both arms or behind your back.
- Never route the lap or shoulder belt over an armrest.

## Lap-Shoulder Belt

All seating positions in the vehicle have a lap-shoulder belt.

The following instructions explain how to wear a lap-shoulder belt properly.

1. Adjust the seat, if the seat is adjustable, so you can sit up straight. To see how, see "Seats" in the Index.

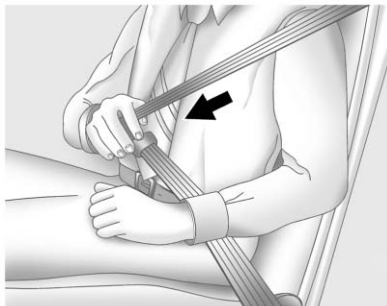

2. Pick up the latch plate and pull the belt across you. Do not let it get twisted.

The lap-shoulder belt may lock if you pull the belt across you very quickly. If this happens, let the belt go back slightly to unlock it. Then pull the belt across you more slowly.

If the shoulder portion of a passenger belt is pulled out all the way, the child restraint locking feature may be engaged. If this happens, let the belt go back all the way and start again.

Engaging the child restraint locking feature in the front outboard seating position may affect the passenger sensing system. See *Passenger Sensing System* ⇨ 73.

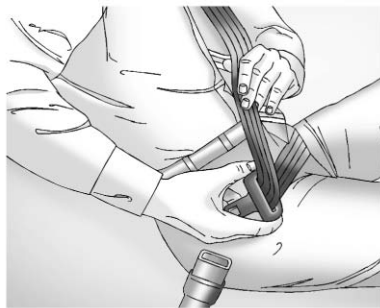

If the webbing locks in the latch plate before it reaches the buckle, tilt the latch plate flat to unlock.

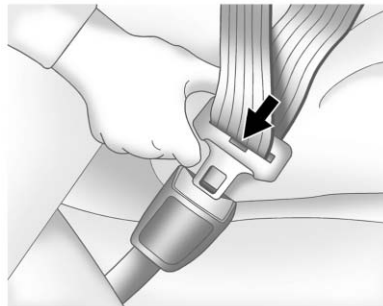

3. Push the latch plate into the buckle until it clicks.

Pull up on the latch plate to make sure it is secure. If the belt is not long enough, see *Safety Belt Extender* ⇨ 65.

Position the release button on the buckle so that the safety belt could be quickly unbuckled if necessary.

4. If equipped with a shoulder belt height adjuster, move it to the height that is right for you. See “Shoulder Belt Height Adjuster” later in this section for instructions on use and important safety information.

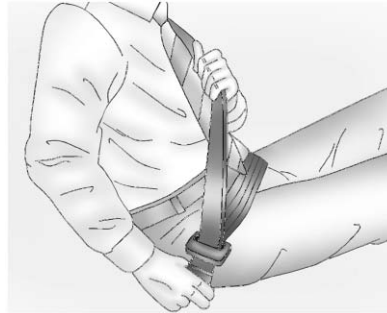

5. To make the lap part tight, pull up on the shoulder belt.

It may be necessary to pull stitching on the safety belt through the latch plate to fully tighten the lap belt on smaller occupants.

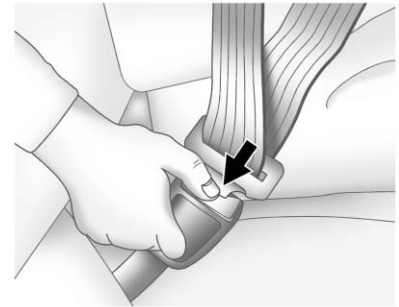

To unlatch the belt, push the button on the buckle. The belt should return to its stowed position. Slide the latch plate up the safety belt webbing when the safety belt is not in use. The latch plate should rest on the stitching on the safety belt, near the guide loop on the side wall.

Always stow the safety belt slowly. If the safety belt webbing returns quickly to the stowed position, the retractor may lock and cannot be pulled out. If this happens, pull the safety belt straight out firmly to unlock the webbing, and then release it. If the webbing is still locked in the retractor, see your dealer.



Before a door is closed, be sure the safety belt is out of the way. If a door is slammed against a safety belt, damage can occur to both the safety belt and the vehicle.

### Shoulder Belt Height Adjuster

The vehicle has a shoulder belt height adjuster for the driver and front outboard passenger seating positions.

Adjust the height so the shoulder portion of the belt is on the shoulder and not falling off of it. The belt should be close to, but not contacting, the neck. Improper shoulder belt height adjustment could reduce the effectiveness of the safety belt in a crash. See *How to Wear Safety Belts Properly* ⇨ 61.



Move the height adjuster up to the desired position by pushing up on the height adjuster.

Press the release button to lower the height adjuster. After the height adjuster is set to the desired position, try to move it down without pressing the release button to make sure it has locked into position.

### Safety Belt Pretensioners

This vehicle has safety belt pretensioners for the front outboard occupants. Although the safety belt pretensioners cannot be seen, they are part of the safety belt assembly. They can help tighten the safety

belts during the early stages of a moderate to severe frontal, near frontal, or rear crash if the threshold conditions for pretensioner activation are met. Safety belt pretensioners can also help tighten the safety belts in a side crash or a rollover event.

Pretensioners work only once. If the pretensioners activate in a crash, the pretensioners and probably other parts of the vehicle's safety belt system will need to be replaced. See *Replacing Safety Belt System Parts after a Crash* ⇨ 66.

Do not sit on the outboard safety belt while entering or exiting the vehicle or at any time while sitting in the seat. Sitting on the safety belt can damage the webbing and hardware.

### Rear Safety Belt Comfort Guides

Rear safety belt comfort guides may provide added safety belt comfort for older children who have outgrown booster seats and for some adults. When installed on a

shoulder belt, the comfort guide positions the belt away from the neck and head.

Comfort guides are available through your dealer for the rear outboard seating positions. Instructions are included with the guide.

## Safety Belt Use During Pregnancy

Safety belts work for everyone, including pregnant women. Like all occupants, they are more likely to be seriously injured if they do not wear safety belts.



A pregnant woman should wear a lap-shoulder belt, and the lap portion should be worn as low as possible, below the rounding, throughout the pregnancy.

The best way to protect the fetus is to protect the mother. When a safety belt is worn properly, it is more likely that the fetus will not be hurt in a crash. For pregnant women, as for anyone, the key to making safety belts effective is wearing them properly.

## Safety Belt Extender

If the vehicle's safety belt will fasten around you, you should use it.

But if a safety belt is not long enough, your dealer will order you an extender. When you go in to order it, take the heaviest coat you will wear, so the extender will be long enough for you. To help avoid personal injury, do not let someone else use it, and use it only for the seat it is made to fit. The extender has been designed for adults. Never use it for securing child restraints. To wear it, attach it to the regular

safety belt. For more information, see the instruction sheet that comes with the extender.

## Safety System Check

Check that the safety belt reminder, safety belts, buckles, latch plates, and retractors, are all working properly. Look for any other loose or damaged safety belt system parts that might keep a safety belt system from performing properly. See your dealer to have it repaired. Torn or frayed safety belts may not protect you in a crash. They can rip apart under impact forces. If a belt is torn or frayed, have it replaced immediately.

Make sure the safety belt reminder light is working. See *Safety Belt Reminders* ⇨ 119.

Keep safety belts clean and dry. See *Safety Belt Care* ⇨ 65.

## Safety Belt Care

Keep belts clean and dry.

 **Warning**

Do not bleach or dye safety belt webbing. It may severely weaken the webbing. In a crash, they might not be able to provide adequate protection. Clean and rinse safety belt webbing only with mild soap and lukewarm water. Allow the webbing to dry.

Safety belts should be properly cared for and maintained.

Safety belt hardware should be kept dry and free of dust or debris. As necessary exterior hard surfaces and safety belt webbing may be lightly cleaned with mild soap and water. Ensure there is not excessive dust or debris in the mechanism. If dust or debris exists in the system please see the dealer. Parts may need to be replaced to ensure proper functionality of the system.

## Replacing Safety Belt System Parts after a Crash

 **Warning**

A crash can damage the safety belt system in the vehicle. A damaged safety belt system may not properly protect the person using it, resulting in serious injury or even death in a crash. To help make sure the safety belt systems are working properly after a crash, have them inspected and any necessary replacements made as soon as possible.

After a minor crash, replacement of safety belts may not be necessary. But the safety belt assemblies that were used during any crash may have been stressed or damaged. See your dealer to have the safety belt assemblies inspected or replaced.

New parts and repairs may be necessary even if the safety belt system was not being used at the time of the crash.

Have the safety belt pretensioners checked if the vehicle has been in a crash, or if the airbag readiness light stays on after you start the vehicle or while you are driving. See *Airbag Readiness Light* ⇨ 119.

## Airbag System

The vehicle has the following airbags:

- A frontal airbag for the driver.
- A frontal airbag for the front outboard passenger.
- A knee airbag for the driver.
- A knee airbag for the front outboard passenger.
- A seat-mounted side impact airbag for the driver.
- A seat-mounted side impact airbag for the front outboard passenger.
- Seat-mounted side impact airbags for the second row outboard passengers.
- A roof-rail airbag for the driver and the passenger seated directly behind the driver.
- A roof-rail airbag for the front outboard passenger and the passenger seated directly behind the front outboard passenger.

All vehicle airbags have the word AIRBAG on the trim or on a label near the deployment opening.

For frontal airbags, the word AIRBAG is on the center of the steering wheel for the driver and on the instrument panel for the front outboard passenger.

For knee airbags, the word AIRBAG is on the lower part of the instrument panel.

For seat-mounted side impact airbags, the word AIRBAG is on the side of the seatback closest to the door.

For roof-rail airbags, the word AIRBAG is on the ceiling or trim.

Airbags are designed to supplement the protection provided by safety belts. Even though today's airbags are also designed to help reduce the risk of injury from the force of an inflating bag, all airbags must inflate very quickly to do their job.

Here are the most important things to know about the airbag system:

### Warning

You can be severely injured or killed in a crash if you are not wearing your safety belt, even with airbags. Airbags are designed to work with safety belts, not replace them. Also, airbags are not designed to inflate in every crash. In some crashes safety belts are the only restraint. See *When Should an Airbag Inflate?* ⇨ 70.

Wearing your safety belt during a crash helps reduce your chance of hitting things inside the vehicle or being ejected from it. Airbags are “supplemental restraints” to the safety belts. Everyone in the vehicle should wear a safety belt properly, whether or not there is an airbag for that person.

**Warning**

Because airbags inflate with great force and faster than the blink of an eye, anyone who is up against, or very close to any airbag when it inflates can be seriously injured or killed. Do not sit unnecessarily close to any airbag, as you would be if sitting on the edge of the seat or leaning forward. Safety belts help keep you in position before and during a crash. Always wear a safety belt, even with airbags. The driver should sit as far back as possible while still maintaining control of the vehicle. The safety belts and the front outboard passenger airbags are most effective when you are sitting well back and upright in the seat with both feet on the floor.

Occupants should not lean on or sleep against the door or side windows in seating positions with seat-mounted side impact airbags and/or roof-rail airbags.

**Warning**

Children who are up against, or very close to, any airbag when it inflates can be seriously injured or killed. Always secure children properly in the vehicle. To read how, see *Older Children* ⇨ 79 or *Infants and Young Children* ⇨ 81.

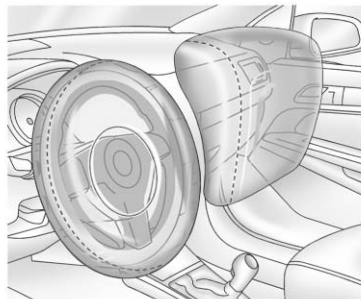

There is an airbag readiness light on the instrument cluster, which shows the airbag symbol. The system checks the airbag electrical system for malfunctions. The light tells you if there is an electrical problem. See *Airbag Readiness Light* ⇨ 119 for more information.

**Where Are the Airbags?**

The driver frontal airbag is in the center of the steering wheel.

The front outboard passenger frontal airbag is in the passenger side instrument panel.

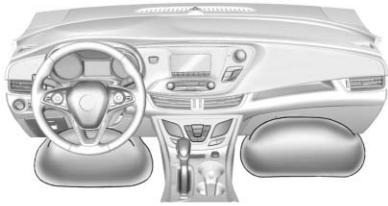

The driver knee airbag is below the steering column. The front outboard passenger knee airbag is below the glove box.



**Driver Side Shown, Passenger Side Similar**

The seat-mounted side impact airbags for the driver and front outboard passenger are in the side of the seatbacks closest to the door.



**Driver Side Shown, Passenger Side Similar**

The roof-rail airbags for the driver, front outboard passenger, and second row outboard passengers are in the ceiling above the side windows.

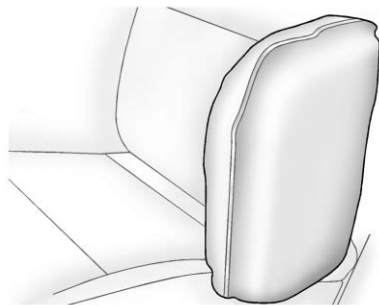

**Rear Seat Driver Side Shown,  
Passenger Side Similar**

The second row seat-mounted side impact airbags are in the sides of the seatback closest to the door.

### **Warning**

If something is between an occupant and an airbag, the airbag might not inflate properly or it might force the object into that person causing severe injury or even death. The path of an inflating airbag must be kept clear. Do not put anything

(Continued)

### **Warning (Continued)**

between an occupant and an airbag, and do not attach or put anything on the steering wheel hub or on or near any other airbag covering.

Do not use seat accessories that block the inflation path of a seat-mounted side impact airbag.

Never secure anything to the roof of a vehicle with roof-rail airbags by routing a rope or tie-down through any door or window opening. If you do, the path of an inflating roof-rail airbag will be blocked.

### **When Should an Airbag Inflate?**

This vehicle is equipped with airbags. See *Airbag System* ⇨ 67. Airbags are designed to inflate if the impact exceeds the specific airbag system's deployment threshold. Deployment thresholds are used to predict how severe a crash is likely

to be in time for the airbags to inflate and help restrain the occupants. The vehicle has electronic sensors that help the airbag system determine the severity of the impact. Deployment thresholds can vary with specific vehicle design.

Frontal airbags are designed to inflate in moderate to severe frontal or near frontal crashes to help reduce the potential for severe injuries, mainly to the driver's or front outboard passenger's head and chest.

Whether the frontal airbags will or should inflate is not based primarily on how fast the vehicle is traveling. It depends on what is hit, the direction of the impact, and how quickly the vehicle slows down.

Frontal airbags may inflate at different crash speeds depending on whether the vehicle hits an object straight on or at an angle, and whether the object is fixed or moving, rigid or deformable, narrow or wide.

Frontal airbags are not intended to inflate during vehicle rollovers, rear impacts, or many side impacts.

In addition, the vehicle has advanced technology frontal airbags. Advanced technology frontal airbags adjust the restraint according to crash severity or occupant interaction.

The vehicle also has a seat position sensor that enables the sensing system to monitor the position of the front outboard passenger seat. The passenger seat position sensor and the passenger safety belt buckle provide information that is used to adjust the deployment of the front outboard passenger frontal airbag.

Knee airbags are designed to inflate in moderate to severe frontal or near frontal impacts. Knee airbags are not designed to inflate during vehicle rollovers, in rear impacts, or in many side impacts.

The passenger seat position sensor and the passenger safety belt buckle also provide information that

is used to determine if the passenger knee airbag should inflate.

Seat-mounted side impact airbags are designed to inflate in moderate to severe side crashes depending on the location of the impact. Seat-mounted side impact airbags are not designed to inflate in frontal impacts, near frontal impacts, rollovers, or rear impacts.

A seat-mounted side impact airbag is designed to inflate on the side of the vehicle that is struck.

Roof-rail airbags are designed to inflate in moderate to severe side crashes depending on the location of the impact. In addition, these roof-rail airbags are designed to inflate during a rollover or in a severe frontal impact. Roof-rail airbags are not designed to inflate in rear impacts. Both roof-rail airbags will inflate when either side of the vehicle is struck, if the sensing system predicts that the vehicle is about to roll over on its side, or in a severe frontal impact.

In any particular crash, no one can say whether an airbag should have inflated simply because of the vehicle damage or the repair costs.

## What Makes an Airbag Inflate?

In a deployment event, the sensing system sends an electrical signal triggering a release of gas from the inflator. Gas from the inflator fills the airbag causing the bag to break out of the cover. The inflator, the airbag, and related hardware are all part of the airbag module.

For airbag locations, see *Where Are the Airbags?* ⇨ 68.

## How Does an Airbag Restrain?

In moderate to severe frontal or near frontal collisions, even belted occupants can contact the steering wheel or the instrument panel. In moderate to severe side collisions, even belted occupants can contact the inside of the vehicle.



Airbags supplement the protection provided by safety belts by distributing the force of the impact more evenly over the occupant's body.

Rollover capable roof-rail airbags are designed to help contain the head and chest of occupants in the outboard seating positions in the first and second rows. The rollover capable roof-rail airbags are designed to help reduce the risk of full or partial ejection in rollover events, although no system can prevent all such ejections.

But airbags would not help in many types of collisions, primarily because the occupant's motion is not toward those airbags. See *When Should an Airbag Inflate?* ⇨ 70.

Airbags should never be regarded as anything more than a supplement to safety belts.

### What Will You See after an Airbag Inflates?

After the frontal, knee, and seat-mounted side impact airbags inflate, they quickly deflate, so quickly that some people may not even realize an airbag inflated. Roof-rail airbags may still be at least partially inflated for some time after they inflate. Some components of the airbag module may be hot for several minutes. For location of the airbags, see *Where Are the Airbags?* ⇨ 68.

The parts of the airbag that come into contact with you may be warm, but not too hot to touch. There may be some smoke and dust coming from the vents in the deflated airbags. Airbag inflation does not prevent the driver from seeing out of the windshield or being able to steer the vehicle, nor does it prevent people from leaving the vehicle.

### Warning

When an airbag inflates, there may be dust in the air. This dust could cause breathing problems for people with a history of asthma or other breathing trouble. To avoid this, everyone in the vehicle should get out as soon as it is safe to do so. If you have breathing problems but cannot get out of the vehicle after an airbag inflates, then get fresh air by opening a window or a door. If you experience breathing problems following an airbag deployment, you should seek medical attention.

The vehicle has a feature that may automatically unlock the doors, turn on the interior lamps and hazard warning flashers, and shut off the fuel system after the airbags inflate. The feature may also activate, without airbag inflation, after an event that exceeds a predetermined threshold. You can lock the doors, turn off the interior lamps, and turn

off the hazard warning flashers by using the controls for those features.

### Warning

A crash severe enough to inflate the airbags may have also damaged important functions in the vehicle, such as the fuel system, brake and steering systems, etc. Even if the vehicle appears to be drivable after a moderate crash, there may be concealed damage that could make it difficult to safely operate the vehicle.

Use caution if you should attempt to restart the engine after a crash has occurred.

In many crashes severe enough to inflate the airbag, windshields are broken by vehicle deformation. Additional windshield breakage may also occur from the front outboard passenger airbag.

- Airbags are designed to inflate only once. After an airbag inflates, you will need some new parts for the airbag system. If you do not get them, the airbag system will not be there to help protect you in another crash. A new system will include airbag modules and possibly other parts. The service manual for the vehicle covers the need to replace other parts.
- The vehicle has a crash sensing and diagnostic module which records information after a crash. See *Vehicle Data Recording and Privacy* ⇨ 335 and *Event Data Recorders* ⇨ 335.
- Let only qualified technicians work on the airbag systems. Improper service can mean that an airbag system will not work properly. See your dealer for service.

## Passenger Sensing System

The vehicle has a passenger sensing system for the front outboard passenger position. The passenger airbag status indicator will light on the overhead console when the vehicle is started.



### United States



### Canada and Mexico

The words ON and OFF, or the symbol for on and off, will be visible during the system check. When the system check is complete, either the word ON or OFF, or the symbol for

on and off will be visible. See *Passenger Airbag Status Indicator* ⇨ 120.

The passenger sensing system turns off the front outboard passenger frontal airbag and knee airbag, under certain conditions. No other airbag is affected by the passenger sensing system.

The passenger sensing system works with sensors that are part of the front outboard passenger seat and safety belt. The sensors are designed to detect the presence of a properly seated occupant and determine if the front outboard passenger frontal airbag and knee airbag should be allowed to inflate or not.

According to accident statistics, children are safer when properly secured in a rear seat in a correct child restraint for their weight and size.

Whenever possible, children aged 12 and under should be secured in a rear seating position.

Never put a rear-facing child seat in the front. This is because the risk to the rear-facing child is so great, if the airbag inflates.

### **Warning**

A child in a rear-facing child restraint can be seriously injured or killed if the passenger frontal airbag inflates. This is because the back of the rear-facing child restraint would be very close to the inflating airbag. A child in a forward-facing child restraint can be seriously injured or killed if the passenger frontal airbag inflates and the passenger seat is in a forward position.

Even if the passenger sensing system has turned off the front outboard passenger airbag(s), no system is fail-safe. No one can guarantee that an airbag will not deploy under some unusual circumstance, even though the airbag(s) are off.

(Continued)

### **Warning (Continued)**

Never put a rear-facing child restraint in the front seat, even if the airbag is off. If securing a forward-facing child restraint in the front outboard passenger seat, always move the seat as far back as it will go. It is better to secure child restraints in the rear seat. Consider using another vehicle to transport the child when a rear seat is not available.

The passenger sensing system is designed to turn off the front outboard passenger frontal airbag and knee airbag if:

- The front outboard passenger seat is unoccupied.
- The system determines that an infant is present in a child restraint.
- A front outboard passenger takes his/her weight off of the seat for a period of time.

- There is a critical problem with the airbag system or the passenger sensing system.

When the passenger sensing system has turned off the front outboard passenger frontal airbag and knee airbag, the off indicator will light and stay lit as a reminder that the airbags are off. See *Passenger Airbag Status Indicator* ⇨ 120.

The passenger sensing system is designed to turn on the front outboard passenger frontal airbag and knee airbag anytime the system senses that a person of adult size is sitting properly in the front outboard passenger seat.

When the passenger sensing system has allowed the airbags to be enabled, the on indicator will light and stay lit as a reminder that the airbags are active.

For some children, including children in child restraints, and for very small adults, the passenger sensing system may or may not turn off the front outboard passenger frontal airbag and knee airbag,

depending upon the person's seating posture and body build. Everyone in the vehicle who has outgrown child restraints should wear a safety belt properly — whether or not there is an airbag for that person.

### Warning

If the airbag readiness light ever comes on and stays on, it means that something may be wrong with the airbag system. To help avoid injury to yourself or others, have the vehicle serviced right away. See *Airbag Readiness Light* ⇨ 119 for more information, including important safety information.

### If the On Indicator Is Lit for a Child Restraint

The passenger sensing system is designed to turn off the front outboard passenger frontal airbag and knee airbag if the system determines that an infant is present

in a child restraint. If a child restraint has been installed and the on indicator is lit:

1. Turn the vehicle off.
2. Remove the child restraint from the vehicle.
3. Remove any additional items from the seat such as blankets, cushions, seat covers, seat heaters, or seat massagers.
4. Reinstall the child restraint following the directions provided by the child restraint manufacturer and refer to *Securing Child Restraints (With the Safety Belt in the Rear Seat)* ⇨ 93 or *Securing Child Restraints (With the Safety Belt in the Front Seat)* ⇨ 95.

Make sure the safety belt retractor is locked by pulling the shoulder belt all the way out of the retractor when installing the child restraint, even if the child restraint is equipped with a safety belt lock-off. When the retractor

lock is set, the belt can be tightened but not pulled out of the retractor.

5. If, after reinstalling the child restraint and restarting the vehicle, the on indicator is still lit, turn the vehicle off. Then slightly recline the vehicle seatback and adjust the seat cushion, if adjustable, to make sure that the vehicle seatback is not pushing the child restraint into the seat cushion.

Also make sure the child restraint is not trapped under the vehicle head restraint. If this happens, adjust the head restraint. See *Head Restraints* ⇨ 51.

6. Restart the vehicle.

The passenger sensing system may or may not turn off the airbags for a child in a child restraint depending upon the child's size. It is better to secure the child restraint in a rear seat. Never put a

rear-facing child restraint in the front seat, even if the on indicator is not lit.

### **If the Off Indicator Is Lit for an Adult-Sized Occupant**



If a person of adult size is sitting in the front outboard passenger seat, but the off indicator is lit, it could be because that person is not sitting properly in the seat or that the child restraint locking feature is engaged. Use the following steps to allow the system to detect that person and enable the front outboard passenger frontal airbag and knee airbag:

1. Turn the vehicle off.

2. Remove any additional material from the seat, such as blankets, cushions, seat covers, seat heaters, or seat massagers.
3. Place the seatback in the fully upright position.
4. Have the person sit upright in the seat, centered on the seat cushion, with legs comfortably extended.
5. If the shoulder portion of the belt is pulled out all the way, the child restraint locking feature will be engaged. This may unintentionally cause the passenger sensing system to turn the airbags off for some adult-sized occupants. If this happens, unbuckle the belt, let the belt go back all the way, and then buckle the belt again without pulling the belt out all the way.
6. Restart the vehicle and have the person remain in this position for two to three minutes after the on indicator is lit.

 **Warning**

If the front outboard passenger airbag is turned off for an adult-sized occupant, the airbag will not be able to inflate and help protect that person in a crash, resulting in an increased risk of serious injury or even death. An adult-sized occupant should not ride in the front outboard passenger seat, if the passenger airbag off indicator is lit.

**Additional Factors Affecting System Operation**

Safety belts help keep the passenger in position on the seat during vehicle maneuvers and braking, which helps the passenger sensing system maintain the passenger airbag status. See “Safety Belts” and “Child Restraints” in the Index for additional information about the importance of proper restraint use.

A thick layer of additional material, such as a blanket or cushion, or aftermarket equipment such as seat covers, seat heaters, and seat massagers can affect how well the passenger sensing system operates. We recommend that you not use seat covers or other aftermarket equipment except when approved by GM for your specific vehicle. See *Adding Equipment to the Airbag-Equipped Vehicle* ⇨ 78 for more information about modifications that can affect how the system operates.

The on indicator may be lit if an object, such as a briefcase, handbag, grocery bag, laptop, or other electronic device, is put on an unoccupied seat. If this is not desired, remove the object from the seat.

 **Warning**

Stowing of articles under the passenger seat or between the passenger seat cushion and

(Continued)

**Warning (Continued)**

seatback may interfere with the proper operation of the passenger sensing system.

**Servicing the Airbag-Equipped Vehicle**

Airbags affect how the vehicle should be serviced. There are parts of the airbag system in several places around the vehicle. Your dealer and the service manual have information about servicing the vehicle and the airbag system. To purchase a service manual, see *Service Publications Ordering Information* ⇨ 333.

 **Warning**

For up to 10 seconds after the vehicle is turned off and the battery is disconnected, an airbag can still inflate during improper service. You can be injured if you

(Continued)

**Warning (Continued)**

are close to an airbag when it inflates. Avoid yellow connectors. They are probably part of the airbag system. Be sure to follow proper service procedures, and make sure the person performing work for you is qualified to do so.

**Adding Equipment to the Airbag-Equipped Vehicle**

Adding accessories that change the vehicle's frame, bumper system, height, front end, or side sheet metal, may keep the airbag system from working properly. The operation of the airbag system can also be affected by changing any parts of the front seats, safety belts, airbag sensing and diagnostic module, steering wheel, instrument panel, any of the airbag modules, ceiling or pillar garnish trim, overhead console, front sensors, side impact sensors, or airbag wiring.

Your dealer and the service manual have information about the location of the airbag sensors, sensing and diagnostic module, and airbag wiring.

In addition, the vehicle has a passenger sensing system for the front outboard passenger position, which includes sensors that are part of the passenger seat. The passenger sensing system may not operate properly if the original seat trim is replaced with non-GM covers, upholstery, or trim; or with GM covers, upholstery, or trim designed for a different vehicle. Any object, such as an aftermarket seat heater or a comfort-enhancing pad or device, installed under or on top of the seat fabric, could also interfere with the operation of the passenger sensing system. This could either prevent proper deployment of the passenger airbag(s) or prevent the passenger sensing system from properly turning off the passenger airbag(s). See *Passenger Sensing System* ⇨ 73.

If the vehicle has rollover roof-rail airbags, see *Different Size Tires and Wheels* ⇨ 282 for additional important information.

If you have to modify your vehicle because you have a disability and you have questions about whether the modifications will affect the vehicle's airbag system, or if you have questions about whether the airbag system will be affected if the vehicle is modified for any other reason, call Customer Assistance. See *Customer Assistance Offices* ⇨ 326.

**Airbag System Check**

The airbag system does not need regularly scheduled maintenance or replacement. Make sure the airbag readiness light is working. See *Airbag Readiness Light* ⇨ 119.

**Caution**

If an airbag covering is damaged, opened, or broken, the airbag may not work properly. Do not

(Continued)

**Caution (Continued)**

open or break the airbag coverings. If there are any opened or broken airbag coverings, have the airbag covering and/or airbag module replaced. For the location of the airbags, see *Where Are the Airbags?* ⇨ 68. See your dealer for service.

**Replacing Airbag System Parts after a Crash****⚠ Warning**

A crash can damage the airbag systems in the vehicle. A damaged airbag system may not properly protect you and your passenger(s) in a crash, resulting in serious injury or even death. To help make sure the airbag systems are working properly after a crash, have them

(Continued)

**Warning (Continued)**

inspected and any necessary replacements made as soon as possible.

If an airbag inflates, you will need to replace airbag system parts. See your dealer for service.

If the airbag readiness light stays on after the vehicle is started or comes on when you are driving, the airbag system may not work properly. Have the vehicle serviced right away. See *Airbag Readiness Light* ⇨ 119.

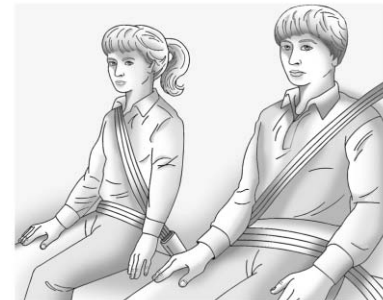
**Child Restraints****Older Children**

Older children who have outgrown booster seats should wear the vehicle's safety belts.

The manufacturer instructions that come with the booster seat state the weight and height limitations for that booster. Use a booster seat with a lap-shoulder belt until the child passes the fit test below:



- Sit all the way back on the seat. Do the knees bend at the seat edge? If yes, continue. If no, return to the booster seat.
- Buckle the lap-shoulder belt. Does the shoulder belt rest on the shoulder? If yes, continue. If no, try using the rear safety belt comfort guide, if available. See “Rear Safety Belt Comfort Guides” under *Lap-Shoulder Belt* ⇨ 62. If a comfort guide is not available, or if the shoulder belt still does not rest on the shoulder, then return to the booster seat.
- Does the lap belt fit low and snug on the hips, touching the thighs? If yes, continue. If no, return to the booster seat.
- Can proper safety belt fit be maintained for the length of the trip? If yes, continue. If no, return to the booster seat.

**Q: What is the proper way to wear safety belts?**

**A:** An older child should wear a lap-shoulder belt and get the additional restraint a shoulder belt can provide. The shoulder belt should not cross the face or neck. The lap belt should fit snugly below the hips, just touching the top of the thighs. This applies belt force to the child's pelvic bones in a crash. It should never be worn over the abdomen, which could cause severe or even fatal internal injuries in a crash.

Also see “Rear Safety Belt Comfort Guides” under *Lap-Shoulder Belt* ⇨ 62.

According to accident statistics, children are safer when properly restrained in a rear seating position.

In a crash, children who are not buckled up can strike other people who are buckled up, or can be thrown out of the vehicle. Older children need to use safety belts properly.

**Warning**

Never allow more than one child to wear the same safety belt. The safety belt cannot properly spread the impact forces. In a crash, they can be crushed together and seriously injured. A safety belt must be used by only one person at a time.

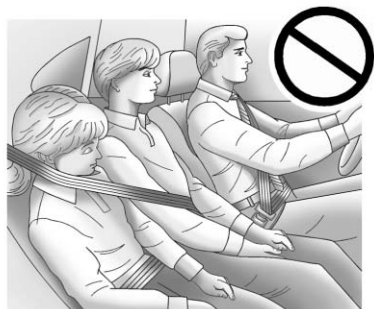

**⚠ Warning**

Never allow a child to wear the safety belt with the shoulder belt behind their back. A child can be seriously injured by not wearing the lap-shoulder belt properly. In a crash, the child would not be restrained by the shoulder belt. The child could move too far forward increasing the chance of head and neck injury. The child might also slide under the lap belt. The belt force would then be applied right on the abdomen. That could cause serious or fatal injuries. The shoulder belt should go over the shoulder and across the chest.

**Infants and Young Children**

Everyone in a vehicle needs protection! This includes infants and all other children. Neither the distance traveled nor the age and size of the traveler changes the need, for everyone, to use safety restraints. In fact, the law in every state in the United States and in every Canadian province says children up to some age must be restrained while in a vehicle.

**⚠ Warning**

Children can be seriously injured or strangled if a shoulder belt is wrapped around their neck. The shoulder belt can tighten but cannot be loosened if it is locked. The shoulder belt locks when it is pulled all the way out of the retractor. It unlocks when the shoulder belt is allowed to go all the way back into the retractor, but it cannot do this if it is wrapped around a child's neck. If the shoulder belt is locked and tightened around a child's neck, the only way to loosen the belt is to cut it.

Never leave children unattended in a vehicle and never allow children to play with the safety belts.

Every time infants and young children ride in vehicles, they should have the protection provided by appropriate child restraints. Neither

the vehicle's safety belt system nor its airbag system is designed for them.

Children who are not restrained properly can strike other people, or can be thrown out of the vehicle.

### Warning

Never hold an infant or a child while riding in a vehicle. Due to crash forces, an infant or a child will become so heavy it is not possible to hold it during a crash. For example, in a crash at only 40 km/h (25 mph), a 5.5 kg (12 lb) infant will suddenly become a 110 kg (240 lb) force on a person's arms. An infant or child should be secured in an appropriate restraint.



### Warning

Children who are up against, or very close to, any airbag when it inflates can be seriously injured or killed. Never put a rear-facing child restraint in the front outboard seat. Secure a rear-facing child restraint in a rear seat. It is also better to secure a forward-facing child restraint in a rear seat. If you must secure a forward-facing child restraint in the front outboard seat, always move the front passenger seat as far back as it will go.



Child restraints are devices used to restrain, seat, or position children in the vehicle and are sometimes called child seats or car seats.

### **There are three basic types of child restraints:**

- Forward-facing child restraints
- Rearward-facing child restraints
- Belt-positioning booster seats

The proper child restraint for your child depends on their size, weight, and age, and also on whether the child restraint is compatible with the vehicle in which it will be used.

For each type of child restraint, there are many different models available. When purchasing a child restraint, be sure it is designed to be used in a motor vehicle. If it is, the restraint will have a label saying that it meets federal motor vehicle safety standards. The restraint manufacturer's instructions that come with the restraint state the weight and height limitations for a particular child restraint. In addition, there are many kinds of restraints available for children with special needs.

### **Warning**

To reduce the risk of neck and head injury in a crash, infants and toddlers should be secured in a rear-facing child restraint until age two, or until they reach the maximum height and weight limits of their child restraint.

### **Warning**

A young child's hip bones are still so small that the vehicle's regular safety belt may not remain low on the hip bones, as it should. Instead, it may settle up around the child's abdomen. In a crash, the belt would apply force on a body area that is unprotected by any bony structure. This alone could cause serious or fatal injuries. To reduce the risk of serious or fatal injuries during a crash, young children should always be secured in appropriate child restraints.

## Child Restraint Systems

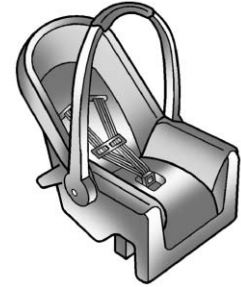

### **Rear-Facing Infant Seat**

A rear-facing child restraint provides restraint with the seating surface against the back of the infant.

The harness system holds the infant in place and, in a crash, acts to keep the infant positioned in the restraint.



### Forward-Facing Child Seat

A forward-facing child restraint provides restraint for the child's body with the harness.

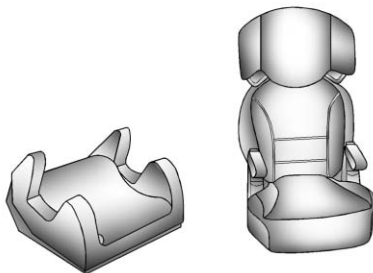

### Booster Seats

A belt-positioning booster seat is used for children who have outgrown their forward-facing child restraint. Boosters are designed to improve the fit of the vehicle's safety belt system until the child is large enough for the vehicle safety belts to fit properly without a booster seat. See the safety belt fit test in *Older Children* ⇨ 79.

## Securing an Add-On Child Restraint in the Vehicle

### Warning

A child can be seriously injured or killed in a crash if the child restraint is not properly secured in the vehicle. Secure the child restraint properly in the vehicle using the vehicle's safety belt or LATCH system, following the instructions that came with that child restraint and the instructions in this manual.

To help reduce the chance of injury, the child restraint must be secured in the vehicle. Child restraint systems must be secured in vehicle seats by lap belts or the lap belt portion of a lap-shoulder belt, or by the LATCH system. See *Lower Anchors and Tethers for Children (LATCH System)* ⇨ 86 for more information. Children can be endangered in a crash if the child restraint is not properly secured in the vehicle.

When securing an add-on child restraint, refer to the instructions that come with the restraint which may be on the restraint itself or in a booklet, or both, and to this manual. The child restraint instructions are important, so if they are not available, obtain a replacement copy from the manufacturer.

Keep in mind that an unsecured child restraint can move around in a collision or sudden stop and injure people in the vehicle. Be sure to properly secure any child restraint in the vehicle — even when no child is in it.

In some areas of the United States and Canada, Certified Child Passenger Safety Technicians (CPSTs) are available to inspect and demonstrate how to correctly use and install child restraints. In the U.S., refer to the National Highway Traffic Safety Administration (NHTSA) website to locate the nearest child safety seat inspection station. For CPST availability in Canada, check with Transport Canada or the Provincial Ministry of Transportation office.

## Securing the Child Within the Child Restraint

### Warning

A child can be seriously injured or killed in a crash if the child is not properly secured in the child restraint. Secure the child properly following the instructions that came with that child restraint.

## Where to Put the Restraint

According to accident statistics, children and infants are safer when properly restrained in an appropriate child restraint secured in a rear seating position.

Whenever possible, children aged 12 and under should be secured in a rear seating position.

Never put a rear-facing child restraint in the front. This is because the risk to the rear-facing child is so great if the airbag deploys.

### Warning

A child in a rear-facing child restraint can be seriously injured or killed if the front passenger airbag inflates. This is because the back of the rear-facing child restraint would be very close to the inflating airbag. A child in a forward-facing child restraint can be seriously injured or killed if the front passenger airbag inflates and the passenger seat is in a forward position.

Even if the passenger sensing system has turned off the front passenger frontal airbag, no system is fail-safe. No one can guarantee that an airbag will not deploy under some unusual circumstance, even though it is turned off.

Secure rear-facing child restraints in a rear seat, even if the airbag is off. If you secure a forward-facing child restraint in

(Continued)

**Warning (Continued)**

the front seat, always move the front passenger seat as far back as it will go. It is better to secure the child restraint in a rear seat.

See *Passenger Sensing System*  
⇨ 73 for additional information.

When securing a child restraint in a rear seating position, study the instructions that came with the child restraint to make sure it is compatible with this vehicle.

Child restraints and booster seats vary considerably in size, and some may fit in certain seating positions better than others.

Depending on where you place the child restraint and the size of the child restraint, you may not be able to access adjacent safety belts or LATCH anchors for additional passengers or child restraints. Adjacent seating positions should not be used if the child restraint prevents access to or interferes with the routing of the safety belt.

Wherever a child restraint is installed, be sure to follow the instructions that came with the child restraint system and secure the child restraint system properly.

Keep in mind that an unsecured child restraint can move around in a collision or sudden stop and injure people in the vehicle. Be sure to properly secure any child restraint in the vehicle — even when no child is in it.

**Lower Anchors and Tethers for Children (LATCH System)**

The LATCH system secures a child restraint during driving or in a crash. LATCH attachments on the child restraint are used to attach the child restraint to the anchors in the vehicle. The LATCH system is designed to make installation of a child restraint easier.

In order to use the LATCH system in your vehicle, you need a child restraint that has LATCH attachments. LATCH-compatible

rear-facing and forward-facing child seats can be properly installed using either the LATCH anchors or the vehicle's safety belts. Do not use both the safety belts and the LATCH anchorage system to secure a rear-facing or forward-facing child seat.

Booster seats use the vehicle's safety belts to secure the child in the booster seat. If the manufacturer recommends that the booster seat be secured with the LATCH system, this can be done as long as the booster seat can be positioned properly and there is no interference with the proper positioning of the lap-shoulder belt on the child.

Make sure to follow the instructions that came with the child restraint, and also the instructions in this manual.

When installing a child restraint with a top tether, you must also use either the lower anchors or the safety belts to properly secure the child restraint. A child restraint must never be installed using only the top tether.

The LATCH anchorage system can be used until the combined weight of the child plus the child restraint is 29.5 kg (65 lbs). Use the safety belt alone instead of the LATCH anchorage system once the combined weight is more than 29.5 kg (65 lbs).

See *Securing Child Restraints (With the Safety Belt in the Rear Seat)* ⇨ 93 or *Securing Child Restraints (With the Safety Belt in the Front Seat)* ⇨ 95.

Child restraints built after March 2014 will be labeled with the specific child weight up to which the LATCH system can be used to install the restraint.

The following explains how to attach a child restraint with these attachments in the vehicle.

Not all vehicle seating positions or child restraints have lower anchors and attachments or top tether anchors and attachments. In this case, the safety belt must be used (with top tether where available) to

secure the child restraint. See *Securing Child Restraints (With the Safety Belt in the Rear Seat)* ⇨ 93 or *Securing Child Restraints (With the Safety Belt in the Front Seat)* ⇨ 95.

### Lower Anchors

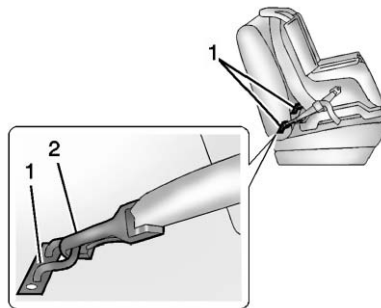

Lower anchors (1) are metal bars built into the vehicle. There are two lower anchors for each LATCH seating position that will accommodate a child restraint with lower attachments (2).

### Top Tether Anchor

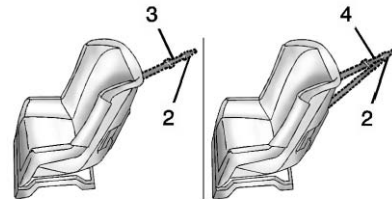

A top tether (3, 4) anchors the top of the child restraint to the vehicle. A top tether anchor is built into the vehicle. The top tether attachment hook (2) on the child restraint connects to the top tether anchor in the vehicle in order to reduce the forward movement and rotation of the child restraint during driving or in a crash.

Your child restraint may have a single tether (3) or a dual tether (4). Either will have a single attachment hook (2) to secure the top tether to the anchor.



Some child restraints that have a top tether are designed for use with or without the top tether being attached. Others require the top tether always to be attached.

In Canada, the law requires that forward-facing child restraints have a top tether, and that the tether be attached. Be sure to read and follow the instructions for your child restraint.

### Lower Anchor and Top Tether Anchor Locations

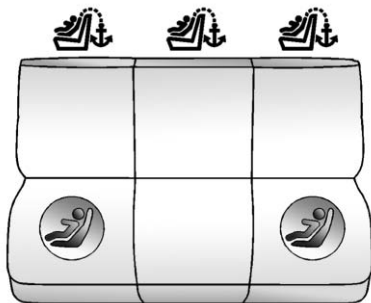

Rear Seat

 : Seating positions with two lower anchors.



To assist in locating the lower anchors, each seating position with lower anchors has two labels, near the crease between the seatback and the seat cushion.

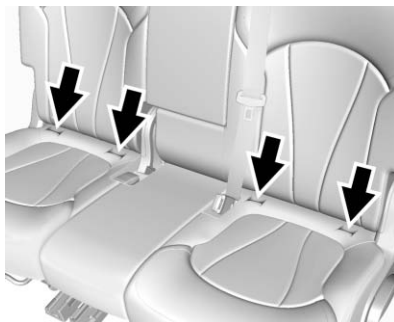

The lower anchors are behind the horizontal openings in the seat cushion trim located below the anchor label.

 : Seating positions with top tether anchors.



To assist in locating the top tether anchors, the top tether anchor symbol is near the top tether anchors.

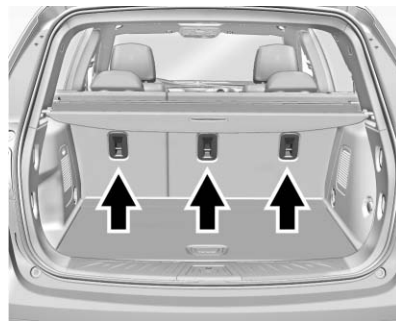

Top Tether Anchors

The top tether anchors for each rear seating position are on the back of the rear seatback. The rear

compartment storage panel/cover might need to be adjusted to access the anchors. Be sure to use an anchor on the same side of the vehicle as the seating position where the child restraint will be placed.

Do not secure a child restraint in a position without a top tether anchor if a national or local law requires that the top tether be attached, or if the instructions that come with the child restraint say that the top tether must be attached.

According to accident statistics, children and infants are safer when properly restrained in a child restraint system or infant restraint system secured in a rear seating position. See *Where to Put the Restraint* ⇨ 85 for additional information.

### Securing a Child Restraint with the LATCH System

#### Warning

If a LATCH-type child restraint is not attached to anchors, the child restraint will not be able to protect the child correctly. In a crash, the child could be seriously injured or killed. Install a LATCH-type child restraint properly using the anchors, or use the vehicle's safety belts to secure the restraint, following the instructions that came with the child restraint and the instructions in this manual.

#### Warning

To reduce the risk of serious or fatal injuries during a crash, do not attach more than one child restraint to a single anchor. Attaching more than one child

(Continued)

#### Warning (Continued)

restraint to a single anchor could cause the anchor or attachment to come loose or even break during a crash. A child or others could be injured.

#### Warning

Children can be seriously injured or strangled if a shoulder belt is wrapped around their neck. The shoulder belt can tighten but cannot be loosened if it is locked. The shoulder belt locks when it is pulled all the way out of the retractor. It unlocks when the shoulder belt is allowed to go all the way back into the retractor, but it cannot do this if it is wrapped around a child's neck. If the shoulder belt is locked and tightened around a child's neck, the only way to loosen the belt is to cut it.

(Continued)

**Warning (Continued)**

Buckle any unused safety belts behind the child restraint so children cannot reach them. Pull the shoulder belt all the way out of the retractor to set the lock, and tighten the belt behind the child restraint after the child restraint has been installed.

**Caution**

Do not let the LATCH attachments rub against the vehicle's safety belts. This may damage these parts. If necessary, move buckled safety belts to avoid rubbing the LATCH attachments.

Do not fold the rear seatback when the seat is occupied. Do not fold the empty rear seat with a safety belt buckled. This could damage the safety belt or the

(Continued)

**Caution (Continued)**

seat. Unbuckle and return the safety belt to its stowed position, before folding the seat.

If you need to secure more than one child restraint in the rear seat, see *Where to Put the Restraint* ⇨ 85.

1. Attach and tighten the lower attachments to the lower anchors. If the child restraint does not have lower attachments or the desired seating position does not have lower anchors, secure the child restraint with the top tether and the safety belts. Refer to the child restraint manufacturer instructions and the instructions in this manual.
  - 1.1. Find the lower anchors for the desired seating position.
  - 1.2. Put the child restraint on the seat.
2. If the child restraint manufacturer recommends that the top tether be attached, adjust the top tether to its full length and attach it to the anchor, if equipped. Refer to the child restraint instructions and the following steps:
  - 2.1. Find the top tether anchor.
  - 2.2. If you have an adjustable head restraint, raise the head restraint.
- 1.3. Attach and tighten the lower attachments on the child restraint to the lower anchors.

If the head restraint interferes with the proper installation of the child restraint, the head restraint may be removed. See "Head Restraint Removal and Reinstallation" at the end of this section.

- 2.3. Route, attach, and tighten the top tether according to your child restraint instructions and the following instructions:

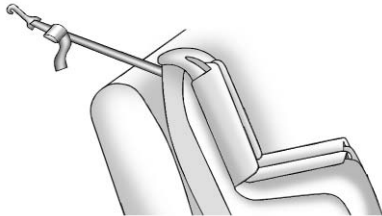

If the position you are using does not have a headrest or head restraint and you are using a single tether, route the tether over the seatback.

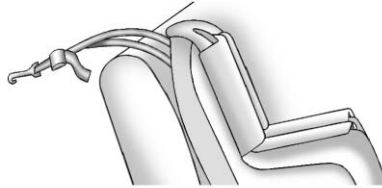

If the position you are using does not have a headrest or head restraint and you are using a dual tether, route the tether over the seatback.

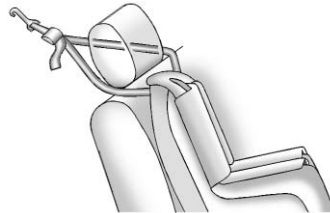

If the position you are using has an adjustable headrest or head restraint and you are using a dual tether, raise the headrest

or head restraint and route the tether under the headrest or head restraint and around the headrest or head restraint posts.

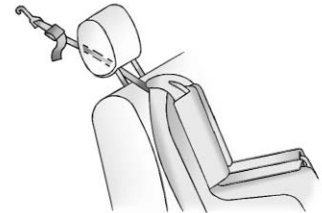

If the position being used has an adjustable headrest or head restraint and a single tether is being used, route the tether between the headrest or head restraint posts.

3. Before placing a child in the child restraint, make sure it is securely held in place. To check, grasp the child restraint at the LATCH path and attempt to move it side to side and back and forth. There should

be no more than 2.5 cm (1 in) of movement, for proper installation.

### Head Restraint Removal and Reinstallation

The second row outboard head restraints can be removed if they interfere with the proper installation of the child restraint.

To remove the head restraint:

1. Partially fold the seatback forward. See *Rear Seats* ⇨ 57 for additional information.

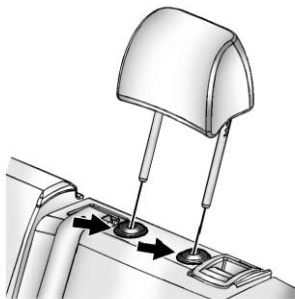

2. Press both buttons on the head restraint posts at the same time, and pull up on the head restraint.
3. Store the head restraint in the cargo area of the vehicle.
4. When the child restraint is removed, reinstall the head restraint before the seating position is used.

#### **Warning**

With head restraints that are not installed and adjusted properly, there is a greater chance that occupants will suffer a neck/spinal injury in a crash. Do not drive until the head restraints for all occupants are installed and adjusted properly.

To reinstall the head restraint:

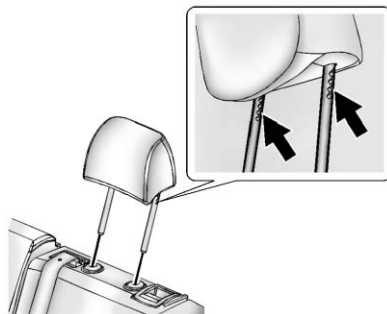

1. Insert the head restraint posts into the holes in the top of the seatback. The notches on the posts must face the driver side of the vehicle.
2. Push the head restraint down.
3. Try to move the head restraint to make sure that it is locked in place.

## Replacing LATCH System Parts After a Crash

### Warning

A crash can damage the LATCH system in the vehicle. A damaged LATCH system may not properly secure the child restraint, resulting in serious injury or even death in a crash. To help make sure the LATCH system is working properly after a crash, see your dealer to have the system inspected and any necessary replacements made as soon as possible.

If the vehicle has the LATCH system and it was being used during a crash, new LATCH system parts may be needed.

New parts and repairs may be necessary even if the LATCH system was not being used at the time of the crash.

## Securing Child Restraints (With the Safety Belt in the Rear Seat)

When securing a child restraint in a rear seating position, study the instructions that came with the child restraint to make sure it is compatible with this vehicle.

If the child restraint has the LATCH system, see *Lower Anchors and Tethers for Children (LATCH System)* ⇨ 86 for how and where to install the child restraint using LATCH. If a child restraint is secured in the vehicle using a safety belt and it uses a top tether, see *Lower Anchors and Tethers for Children (LATCH System)* ⇨ 86 for top tether anchor locations.

Do not secure a child seat in a position without a top tether anchor if a national or local law requires that the top tether be anchored, or if the instructions that come with the child restraint say that the top strap must be anchored.

If the child restraint or vehicle seat position does not have the LATCH system, you will be using the safety belt to secure the child restraint. Be sure to follow the instructions that came with the child restraint.

If more than one child restraint needs to be installed in the rear seat, be sure to read *Where to Put the Restraint* ⇨ 85.

1. Put the child restraint on the seat.
2. Pick up the latch plate, and run the lap and shoulder portions of the vehicle's safety belt through or around the restraint. The child restraint instructions will show you how.

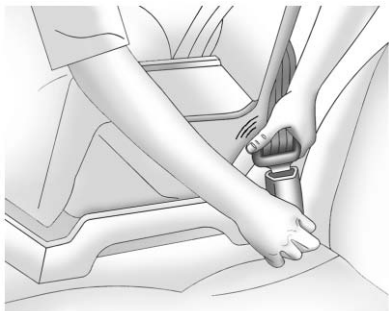

3. Push the latch plate into the buckle until it clicks.

Position the release button on the buckle, away from the child restraint system, so that the safety belt could be quickly unbuckled if necessary.



4. Pull the shoulder belt all the way out of the retractor to set the lock. When the retractor lock is set, the belt can be tightened but not pulled out of the retractor.

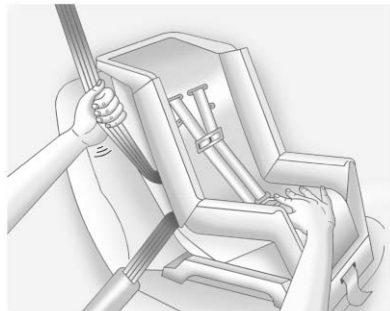

5. To tighten the belt, push down on the child restraint, pull the shoulder portion of the belt to tighten the lap portion of the belt, and feed the shoulder belt back into the retractor. When installing a forward-facing child restraint, it may be helpful to use your knee to push down on the child restraint as you tighten the belt.

Try to pull the belt out of the retractor to make sure the retractor is locked. If the retractor is not locked, repeat Steps 4 and 5.

6. If the child restraint has a top tether, follow the child restraint manufacturer's instructions regarding the use of the top tether. See *Lower Anchors and Tethers for Children (LATCH System)* ⇨ 86.
7. Before placing a child in the child restraint, make sure it is securely held in place. To check, grasp the child restraint at the safety belt path and attempt to move it side to side and back and forth. When the child restraint is properly installed, there should be no more than 2.5 cm (1 in) of movement.

To remove the child restraint, unbuckle the vehicle safety belt and let it return to the stowed position. If the top tether is attached to a top tether anchor, disconnect it.

## Securing Child Restraints (With the Safety Belt in the Front Seat)

This vehicle has airbags. A rear seat is a safer place to secure a forward-facing child restraint. See *Where to Put the Restraint* ⇨ 85.

In addition, the vehicle has a passenger sensing system which is designed to turn off the front outboard passenger frontal airbag and knee airbag under certain conditions. See *Passenger Sensing System* ⇨ 73 and *Passenger Airbag Status Indicator* ⇨ 120 for more information, including important safety information.

Never put a rear-facing child seat in the front. This is because the risk to the rear-facing child is so great if the airbag deploys.

### Warning

A child in a rear-facing child restraint can be seriously injured or killed if the front outboard passenger frontal airbag inflates. This is because the back of the rear-facing child restraint would be very close to the inflating airbag. A child in a forward-facing child restraint can be seriously injured or killed if the front outboard passenger frontal airbag inflates and the passenger seat is in a forward position.

Even if the passenger sensing system has turned off the front outboard passenger airbag(s), no system is fail-safe. No one can guarantee that an airbag will not deploy under some unusual circumstance, even though the airbag(s) are off.

Secure rear-facing child restraints in a rear seat, even if the airbag(s) are off. If you secure a

(Continued)



**Warning (Continued)**

forward-facing child restraint in the front outboard passenger seat, always move the seat as far back as it will go. It is better to secure the child restraint in a rear seat.

See *Passenger Sensing System* ⇨ 73 for additional information.

If the child restraint uses a top tether, see *Lower Anchors and Tethers for Children (LATCH System)* ⇨ 86 for top tether anchor locations.

Do not secure a child seat in a position without a top tether anchor if a national or local law requires that the top tether be anchored, or if the instructions that come with the child restraint say that the top strap must be anchored.

In Canada, the law requires that forward-facing child restraints have a top tether, and that the tether be attached.

When using the lap-shoulder belt to secure the child restraint in this position, follow the instructions that came with the child restraint and the following instructions:

1. Move the seat as far back as it will go before securing the forward-facing child restraint. Move the seat upward or the seatback to an upright position, if needed, to get a tight installation of the child restraint.

When the passenger sensing system has turned off the front outboard passenger frontal airbag and knee airbag, the off indicator on the passenger airbag status indicator should light and stay lit when you start the vehicle. See *Passenger Airbag Status Indicator* ⇨ 120.

2. Put the child restraint on the seat.
3. Pick up the latch plate, and run the lap and shoulder portions of the vehicle's safety belt

through or around the restraint. The child restraint instructions will show you how.

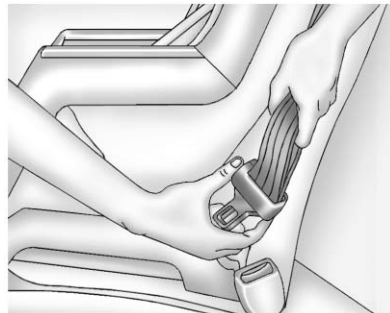

Tilt the latch plate to adjust the belt if needed.

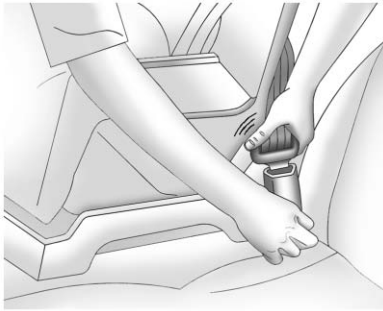

4. Push the latch plate into the buckle until it clicks.

Position the release button on the buckle, away from the child restraint system, so that the safety belt could be quickly unbuckled if necessary.



5. Pull the shoulder belt all the way out of the retractor to set the lock. When the retractor lock is set, the belt can be tightened but not pulled out of the retractor.

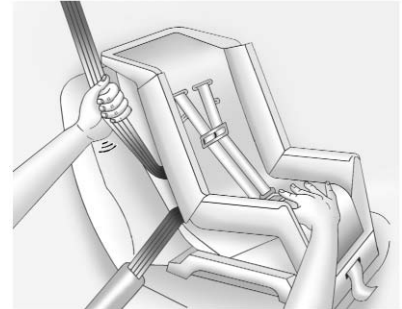

6. To tighten the belt, push down on the child restraint, pull the shoulder portion of the belt to tighten the lap portion of the belt, and feed the shoulder belt back into the retractor. When installing a forward-facing child restraint, it may be helpful to use your knee to push down on the child restraint as you tighten the belt.

Try to pull the belt out of the retractor to make sure the retractor is locked. If the retractor is not locked, repeat Steps 5 and 6.

7. Before placing a child in the child restraint, make sure it is securely held in place. To check, grasp the child restraint at the safety belt path and attempt to move it side to side and back and forth. When the child restraint is properly installed, there should be no more than 2.5 cm (1 in) of movement.

If the airbags are off, the off indicator in the passenger airbag status indicator will come on and stay on when the vehicle is started.

If a child restraint has been installed and the on indicator is lit, see “If the On Indicator Is Lit for a Child Restraint” under *Passenger Sensing System* ⇨ 73.

To remove the child restraint, unbuckle the vehicle's safety belt and let it return to the stowed position.

## Storage

### Storage Compartments

Storage Compartments .....	99
Glove Box .....	99
Cupholders .....	99
Front Storage .....	99
Sunglasses Storage .....	99
Rear Storage .....	100
Center Console Storage .....	100

### Additional Storage Features

Cargo Cover .....	101
Cargo Tie-Downs .....	102
Cargo Management System .....	102
Convenience Net .....	103

### Roof Rack System

Roof Rack System .....	103
------------------------	-----

## Storage Compartments

### Warning

Do not store heavy or sharp objects in storage compartments. In a crash, these objects may cause the cover to open and could result in injury.

### Glove Box

Open the glove box by lifting up on the lever.

### Cupholders

Two cupholders are in the center console. Cupholders may be located in the second row seat armrest. To access, pull the armrest down.

## Front Storage

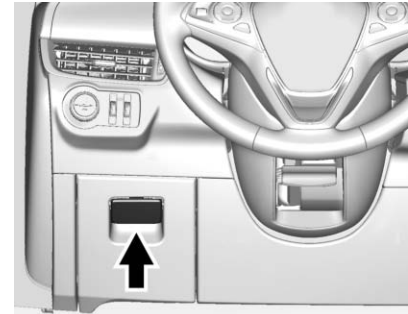

There is storage next to the steering wheel. Lift the handle to access.

### Sunglasses Storage

If equipped, sunglasses storage is on the overhead console. Press the fixed button on the cover and release to access.

## Rear Storage

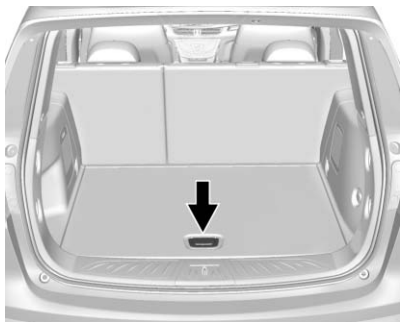

There is storage in the floor of the rear cargo area. Lift the handle to access. There is a removable divider to help organize.



Use the hook underneath to hold open the cargo floor cover.



## Center Console Storage

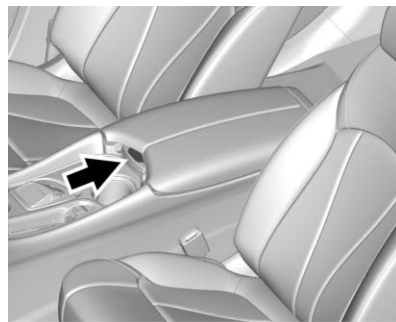

Press the button to access the storage in the center console. If equipped there is an auxiliary jack, an SD card reader, and a single or dual USB port inside.

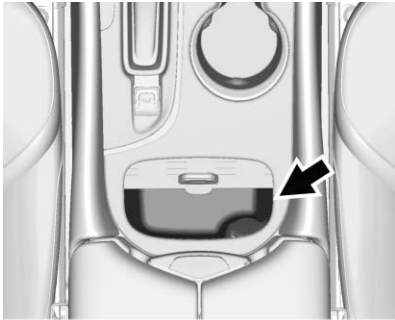

There is a small covered bin directly in front of the center console. Use the handle to open the covered bin. There is a power outlet inside.

## Additional Storage Features

### Cargo Cover

#### Warning

An unsecured cargo cover could strike people in a sudden stop or turn, or in a crash. Store the cargo cover securely or remove it from the vehicle.

#### Warning

Do not place objects on the cargo cover. Sudden stops or turns can cause objects to be thrown in the vehicle. You or others could be injured.



If equipped, use the cargo cover to cover items in the rear of the vehicle.

To remove the cover from the vehicle, pull both ends toward each other. To reinstall, place each end of the cover in the holes behind the rear seat.

## Cargo Tie-Downs

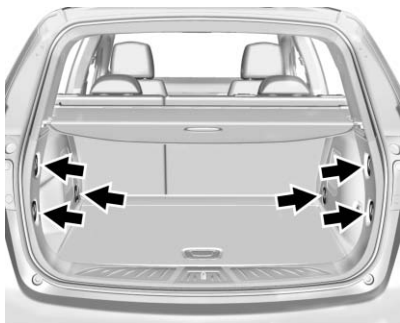

The vehicle may be equipped with six cargo tie-downs in the rear compartment.

## Cargo Management System

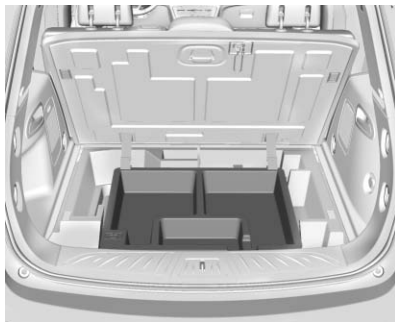

The cargo management system is used to store items in the cargo area under the load cover.

## Cargo Management System Removal



1. There are no attachments securing the cargo management system. Lift up on both sides to remove the cargo management system.



2. The spare tire is now accessible.
3. Store the cargo management system outside of the vehicle.

## Convenience Net

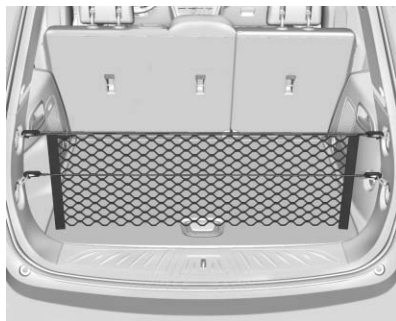

This vehicle may have a convenience net in the rear of the vehicle. Attach it to the cargo tie-downs for storing small loads.

Do not use the net to store heavy loads.

## Roof Rack System

### Warning

If something is carried on top of the vehicle that is longer or wider than the roof rack — like paneling, plywood, or a mattress — the wind can catch it while the vehicle is being driven. The item being carried could be violently torn off, and this could cause a collision and damage the vehicle. Never carry something longer or wider than the roof rack on top of the vehicle unless using a GM certified accessory carrier.

If equipped, the roof rack can be used to load items. For roof racks that do not have crossrails included, GM certified crossrails can be purchased as an accessory. See your dealer.



**Caution**

Loading cargo on the roof rack that weighs more than 100 kg (220 lb) or hangs over the rear or sides of the vehicle may damage the vehicle. Load cargo so that it rests evenly between the crossrails, making sure to fasten cargo securely.

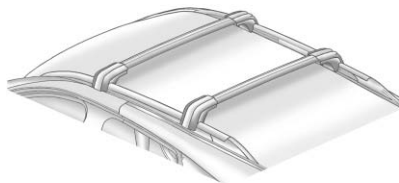

To prevent damage or loss of cargo when driving, check to make sure crossrails and cargo are securely fastened. Loading cargo on the roof rack will make the vehicle's center

of gravity higher. Avoid high speeds, sudden starts, sharp turns, sudden braking, or abrupt maneuvers; otherwise it may result in loss of control. If driving for a long distance, on rough roads, or at high speeds, occasionally stop the vehicle to make sure the cargo remains in its place. Do not exceed the maximum vehicle capacity when loading the vehicle. For more information on vehicle capacity and loading, see *Vehicle Load Limits* ⇨ 180.

# Instruments and Controls

## Controls

Steering Wheel Adjustment ...	106
Steering Wheel Controls .....	106
Heated Steering Wheel .....	106
Horn .....	107
Windshield Wiper/Washer ....	107
Rear Window Wiper/ Washer .....	109
Headlamp Washer .....	110
Compass .....	110
Clock .....	110
Power Outlets .....	111

## Warning Lights, Gauges, and Indicators

Warning Lights, Gauges, and Indicators .....	112
Instrument Cluster .....	113
Speedometer .....	116
Odometer .....	116
Trip Odometer .....	116
Tachometer .....	116
Fuel Gauge .....	117
Engine Coolant Temperature Gauge .....	118
Safety Belt Reminders .....	119

Airbag Readiness Light .....	119
Passenger Airbag Status Indicator .....	120
Charging System Light .....	121
Malfunction Indicator Lamp (Check Engine Light) .....	121
Brake System Warning Light .....	123
Electric Parking Brake Light .....	123
Service Electric Parking Brake Light .....	124
Antilock Brake System (ABS) Warning Light .....	124
Lane Keep Assist (LKA) Light .....	124
Vehicle Ahead Indicator .....	125
Traction Off Light .....	125
StabiliTrak <sup>®</sup> OFF Light .....	125
Traction Control System (TCS)/ StabiliTrak <sup>®</sup> Light .....	126
Engine Coolant Temperature Warning Light .....	126
Tire Pressure Light .....	126
Engine Oil Pressure Light ....	127
Low Fuel Warning Light .....	127
Security Light .....	128
High-Beam On Light .....	128
Adaptive Forward Lighting (AFL) Light .....	128
Front Fog Lamp Light .....	129

Lamps On Reminder .....	129
Cruise Control Light .....	129
Door Ajar Light .....	129

## Information Displays

Driver Information Center (DIC) (Base Level) .....	130
Driver Information Center (DIC) (Uplevel) .....	132
Head-Up Display (HUD) .....	135

## Vehicle Messages

Vehicle Messages .....	138
Battery Voltage and Charging Messages .....	138
Brake System Messages .....	139
Compass Messages .....	139
Cruise Control Messages .....	139
Door Ajar Messages .....	140
Engine Cooling System Messages .....	141
Engine Oil Messages .....	141
Engine Power Messages .....	142
Fuel System Messages .....	142
Key and Lock Messages .....	142
Object Detection System Messages .....	142
Ride Control System Messages .....	144
Airbag System Messages ....	145
Security Messages .....	145

Steering System	
Messages .....	145
Tire Messages .....	146
Transmission Messages .....	146
Washer Fluid Messages .....	147
Window Messages .....	147

### Vehicle Personalization

Vehicle Personalization .....	147
-------------------------------	-----

### Universal Remote System

Universal Remote System ....	154
Universal Remote System	
Programming .....	154
Universal Remote System	
Operation .....	156

## Controls

### Steering Wheel Adjustment

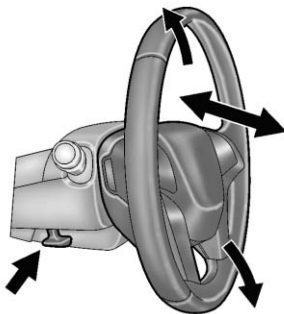

To adjust the steering wheel:

1. Pull the lever down.
2. Move the steering wheel up or down.
3. Pull or push the steering wheel closer or away from you.
4. Pull the lever up to lock the steering wheel in place.

Do not adjust the steering wheel while driving.

## Steering Wheel Controls

The infotainment system can be operated by using the steering wheel controls. See "Steering Wheel Controls" in the infotainment manual.

### Heated Steering Wheel



 : If equipped with a heated steering wheel, press to turn on or off. A light near the button displays when the feature is turned on.

The steering wheel takes about three minutes to start heating.

## Horn

Press  on the steering wheel pad to sound the horn.

## Windshield Wiper/Washer



Windshield Wiper with Rainsense  
(AUTO Shown)



Windshield Wiper with Intermittent  
Wipes (INT Shown)

With the ignition in ACC/ACCESSORY or ON/RUN/START, move the windshield wiper lever to select the wiper speed.

**HI** : Use for fast wipes.

**LO** : Use for slow wipes.

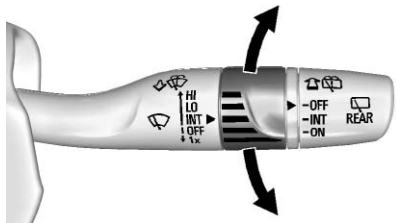

**INT** : Use for intermittent wipes or Rainsense™, if equipped and enabled. To adjust wipe frequency, turn the band up for more frequent wipes or down for less frequent wipes. If Rainsense™ is enabled, see “Rainsense” later in this section.

**OFF** : Use to turn the wipers off.

**1x** : For a single wipe, briefly move the wiper lever down. For several wipes, hold the wiper lever down.

Clear snow and ice from the wiper blades before using them. If frozen to the windshield, carefully loosen or thaw them. Damaged blades should be replaced. See *Wiper Blade Replacement* ⇨ 257.

Heavy snow or ice can overload the wiper motor.

### Wipe Parking

If the ignition is changed to LOCK/OFF while the wipers are on LO, HI, or INT, they will immediately stop.

If the windshield wiper lever is then moved to OFF before the driver door is opened or within 10 minutes, the wipers will restart and move to the base of the windshield.

If the ignition is changed to LOCK/OFF while the wipers are performing wiper due to windshield washing or Rainsense, the wipers continue to run until they reach the base of the windshield.

### Rainsense™

If equipped with Rainsense, a sensor located near the top center of the windshield detects the amount of water on the windshield and automatically controls the frequency of the windshield wiper.

When Rainsense is enabled, the normal intermittent control operates as a sensitivity control.

Keep this area of the windshield clear of debris to allow for best system performance.

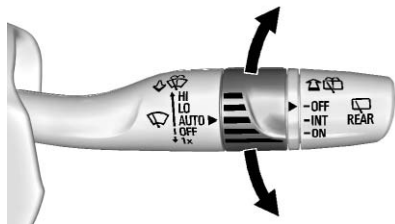

**AUTO** : Move the windshield wiper lever to AUTO. Turn the band on the wiper lever to adjust the sensitivity.

- Turn the band up for more sensitivity to moisture.
- Turn the band down for less sensitivity to moisture.
- Move the windshield wiper lever out of the AUTO position to deactivate Rainsense.

To enable or disable this feature, see “Rainsense Wipers” under *Vehicle Personalization* ⇨ 147.

### Wiper Arm Assembly Protection

When using an automatic car wash, move the windshield wiper lever to OFF. This disables the automatic Rainsense windshield wipers and/or manual windshield wipers.

With Rainsense, if the transmission is in N (Neutral) and the vehicle speed is very slow, the wipers will automatically stop at the base of the windshield.

The wiper operations return to normal when the transmission is no longer in N (Neutral) or the vehicle speed has increased.

### Windshield Washer

Pull the windshield wiper lever toward you to spray windshield washer fluid and activate the wipers. The wipers will continue until the lever is released or the maximum wash time is reached. When the windshield wiper lever is released, additional wipes may occur depending on how long the windshield washer had been

activated. See *Washer Fluid* ⇨ 252 for information on filling the windshield washer fluid reservoir.

### Warning

In freezing weather, do not use the washer until the windshield is warmed. Otherwise the washer fluid can form ice on the windshield, blocking your vision.

## Rear Window Wiper/Washer

The ignition must be in the ACC/ACCESSORY or ON/RUN position to operate the rear window wiper/washer.



### Rear Wiper with Rainsense Shown, without Rainsense Similar

Turn the end of the windshield wiper lever to operate the rear window wiper/washer.

**OFF** : Turns the system off.

**INT** : Intermittent wipes.

**ON** : Slow wipes.

 : Push the windshield wiper lever forward to spray washer fluid on the rear window. The lever automatically returns to its original position when released.

### Warning

In freezing weather, do not use the washer until the windshield is warmed. Otherwise the washer fluid can form ice on the windshield, blocking your vision.

## Reverse Gear Wipes

If the rear wiper control is off, the rear wiper will automatically operate continuously when the shift lever is in R (Reverse), and the front windshield wiper is performing low or high speed wipes. If the rear wiper control is off, the shift lever is in R (Reverse), and the front windshield wiper is performing interval wipes, then the rear wiper automatically performs interval wipes.

This feature can be turned on or off. See *Vehicle Personalization* ⇨ 147.

The windshield washer reservoir is used for the windshield and rear window. Check the fluid level if either washer is not working. See *Washer Fluid* ⇨ 252.

## Headlamp Washer

If equipped with headlamp washers, they are located to the side of the headlamps.

The headlamps must be on in order to use the headlamp washers. If the headlamps are not on, only the windshield will be washed.

Pull the wiper lever toward you and hold briefly to activate. The headlamp washers will spray once, pause, and spray again. The headlamp washers will spray again after five windshield wash cycles.

To refill the windshield washer fluid, see *Washer Fluid* ⇨ 252.

## Compass

The vehicle may have a compass display on the Driver Information Center (DIC). The compass receives its heading and other information from the Global Positioning System (GPS) antenna, StabiliTrak®, and vehicle speed information.

The compass system is designed to operate for a certain number of miles or degrees of turn before needing a signal from the GPS satellites. When the compass display shows CAL, drive the vehicle for a short distance in an open area where it can receive a GPS signal. The compass system will automatically determine when a GPS signal is restored and provide a heading again. See *Compass Messages* ⇨ 139 for the messages that may be displayed for the compass.

## Clock

### Setting the Digital Clock

The infotainment system controls are used to access the time and date settings through the menu system. See “Using the System” in the infotainment manual.

To set the time:

1. Touch SETTINGS from the Home Page, then touch Time and Date.

2. Touch Set Time and touch  $\wedge$  or  $\vee$  to increase or decrease hours, minutes, and AM or PM. Touch 12–24 Hr for 12 or 24 hour clock.
3. Touch  $\blacktriangleleft$  to go back to the previous menu.

Auto Set requires an OnStar subscription.

If auto timing is set, the time displayed on the clock may not update immediately when driving into a new time zone.

To set the date:

1. Touch SETTINGS from the Home Page, then touch Time and Date.
2. Touch Set Date and touch  $\wedge$  or  $\vee$  to increase or decrease month, day, or year.
3. Touch  $\blacktriangleleft$  to go back to the previous menu.

To set the clock display:

1. Touch SETTINGS and touch Time and Date.

2. Touch Clock Display and touch OFF or ON to turn the clock display off or on.
3. Touch  to go back to the previous menu.

### Setting the Analog Clock

The clock on the center stack is not connected to any other vehicle system. To adjust the time:

1. Press and hold the button next to the clock to quickly advance the time.
2. Press and release the button to increase the time by one-minute intervals.

### Power Outlets

The vehicle has four 12-volt accessory power outlets, which can be used to plug in electrical equipment, such as a cell phone or MP3 player.

There are power outlets:

- On the center floor console.
- Inside the center floor console.

- On the rear of the center floor console.
- In the rear cargo area.

To use the outlet, remove the cover.

#### Caution

Leaving electrical equipment plugged in for an extended period of time while the vehicle is off will drain the battery. Always unplug electrical equipment when not in use and do not plug in equipment that exceeds the maximum 20 amp rating.

#### Warning

Power is always supplied to the rear cargo power outlet. Do not leave electrical equipment plugged in when the vehicle is not in use because the vehicle could catch fire and cause injury or death.

Certain accessory plugs may not be compatible with the accessory power outlet and could overload vehicle and adapter fuses. If a problem is experienced, see your dealer.

When adding electrical equipment, be sure to follow the proper installation instructions included with the equipment. See *Add-On Electrical Equipment* ⇨ 233.

#### Caution

Hanging heavy equipment from the power outlet can cause damage not covered by the vehicle warranty. The power outlets are designed for accessory power plugs only, such as cell phone charge cords.

### Power Outlet 110/120 Volt Alternating Current

If equipped, this power outlet can be used to plug in electrical equipment that uses a maximum limit of 400 watts.





The power outlet is on the rear of the center console.

An indicator light on the outlet turns on to show it is in use. The light comes on when the ignition is in ON/RUN and equipment requiring less than 400 watts is plugged into the outlet, and no system fault is detected.

The indicator light does not come on when the ignition is in LOCK/OFF or if the equipment is not fully seated into the outlet.

If equipment is connected using more than 400 watts or a system fault is detected, a protection circuit shuts off the power supply and the

indicator light turns off. To reset the circuit, unplug the item and plug it back in or turn the Retained Accessory Power (RAP) off and then back on. See *Retained Accessory Power (RAP)* ⇨ 189. The power restarts when equipment using 400 watts or less is plugged into the outlet and a system fault is not detected.

The power outlet is not designed for the following and may not work properly if they are plugged in:

- Equipment with high initial peak wattage, such as compressor-driven refrigerators and electric power tools.
- Other equipment requiring an extremely stable power supply, such as microcomputer-controlled electric blankets and touch sensor lamps.
- Medical equipment.

## Warning Lights, Gauges, and Indicators

Warning lights and gauges can signal that something is wrong before it becomes serious enough to cause an expensive repair or replacement. Paying attention to the warning lights and gauges could prevent injury.

Some warning lights come on briefly when the engine is started to indicate they are working. When one of the warning lights comes on and stays on while driving, or when one of the gauges shows there may be a problem, check the section that explains what to do. Waiting to do repairs can be costly and even dangerous.

## Instrument Cluster

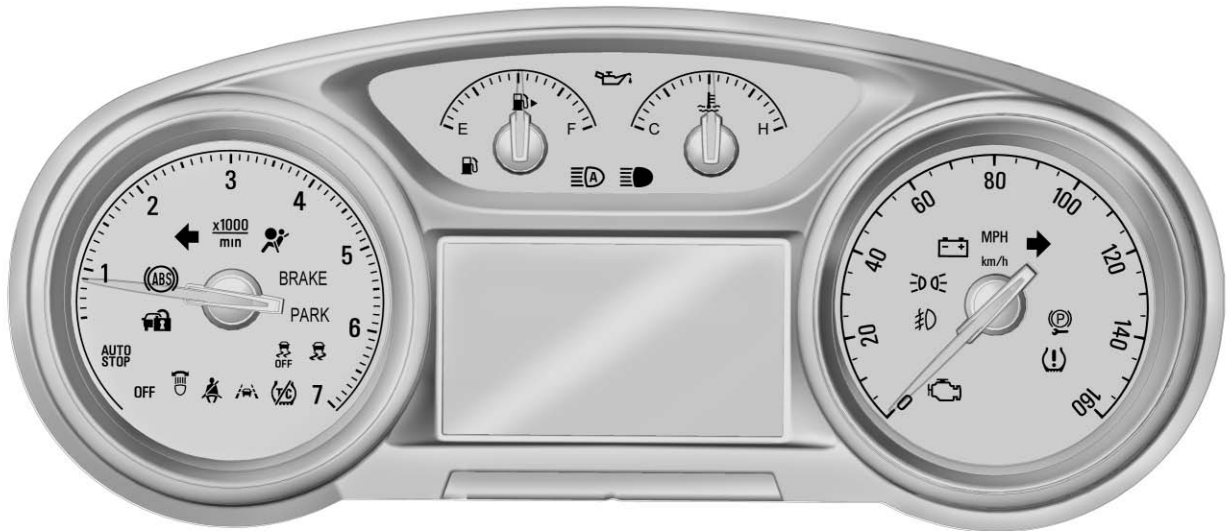

Base Level English Shown, Metric Similar

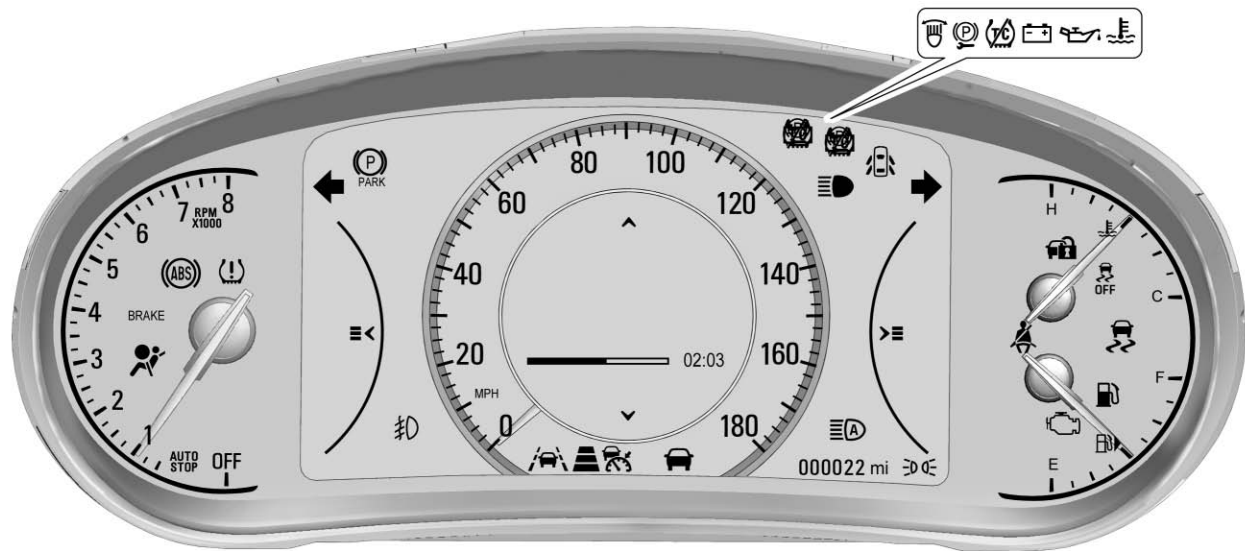

Uplevel English Shown, Metric Similar

## Cluster Menu

There is an interactive display area in the center of the instrument cluster.

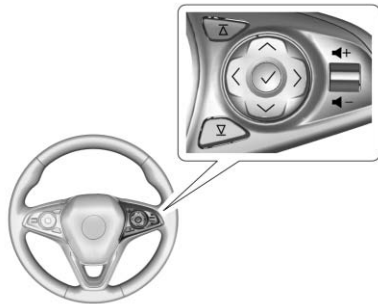

Use the right steering wheel control to open and scroll through the different items and displays.

Press  $\leftarrow$  to access the cluster applications. Use  $\wedge$  or  $\vee$  to scroll through the list of available applications. Not all applications will be available on all vehicles.

- **Info App.** This is where you can view the selected Driver Information Center (DIC)

displays. See *Driver Information Center (DIC) (Base Level)*  $\diamond$  130 or *Driver Information Center (DIC) (Uplevel)*  $\diamond$  132.

- Audio
- Phone
- Navigation
- Settings

### Audio

Press  $\checkmark$  to select the Audio app, then press  $\rightarrow$  to enter the Audio menu. In the Audio menu, browse for music, select from the favorites, or change the audio source.

### Phone

Press  $\checkmark$  to select the Phone app, then press  $\rightarrow$  to enter the Phone menu. In the Phone menu, if there is no active phone call, view recent calls, scroll through contacts, or select from the favorites. If there is an active call, mute or unmute the phone or switch to handset or handsfree operation.

## Navigation

Press  $\checkmark$  to select the Navigation app, then press  $\rightarrow$  to enter the Navigation menu. If there is no active route, you can resume the last route and turn the voice prompts on/off. If there is an active route, press  $\checkmark$  to cancel route guidance or turn the voice prompts on/off.

### Settings

Press  $\checkmark$  to select the Settings app. Use  $\wedge$  or  $\vee$  to scroll through items in the Settings menu.

**Units :** Press  $\rightarrow$  while Units is displayed to enter the Units menu. Choose US or Metric units by pressing  $\checkmark$  while the desired item is highlighted.

**Info Pages :** Press  $\rightarrow$  while Info Pages is displayed to enter the Info Pages menu and select the items to

be displayed in the Info App. See *Driver Information Center (DIC) (Base Level)* ⇨ 130 or *Driver Information Center (DIC) (Uplevel)* ⇨ 132.

**Speed Warning** : The Speed Warning display allows the driver to set a speed that they do not want to exceed. To set the Speed Warning, press > when Speed Warning is displayed. Press ^ or v to adjust the value. Press ✓ to set the speed. Once the speed is set, this feature can be turned off by pressing ✓ while viewing this page. If the selected speed limit is exceeded, a pop-up warning is displayed with a chime.

**Software Information (Uplevel Cluster)** : Displays the open source software information.

## Speedometer

The speedometer shows the vehicle's speed in either kilometers per hour (km/h) or miles per hour (mph).

## Odometer

The odometer shows how far the vehicle has been driven, in either kilometers or miles.

## Trip Odometer

The trip odometer shows how far the vehicle has been driven since the trip odometer was last reset.

The trip odometer is accessed and reset through the Driver Information Center (DIC). See *Driver Information Center (DIC) (Base Level)* ⇨ 130 or *Driver Information Center (DIC) (Uplevel)* ⇨ 132.

## Tachometer

The tachometer displays the engine speed in revolutions per minute (rpm).

For vehicles with the Stop/Start system, when the ignition is in ON/RUN, the tachometer indicates the vehicle status. When pointing to AUTO STOP, the engine is off but the vehicle is on and can move. The

engine could auto start at any time. When the indicator points to OFF, the vehicle is off.

When the engine is on, the tachometer will indicate the engine's revolutions per minute (rpm). The tachometer may vary by several hundred rpm's, during Auto Stop mode, when the engine is shutting off and restarting.

A slight bump may be felt when the transmission is determining the most fuel efficient operating range.

### Caution

If the engine is operated with the rpm's in the warning area at the high end of the tachometer, the vehicle could be damaged, and the damage would not be covered by the vehicle warranty. Do not operate the engine with the rpm's in the warning area.

## Fuel Gauge

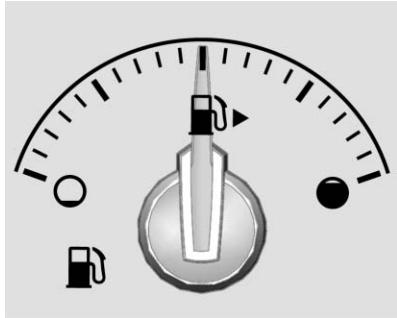

Base Level Metric

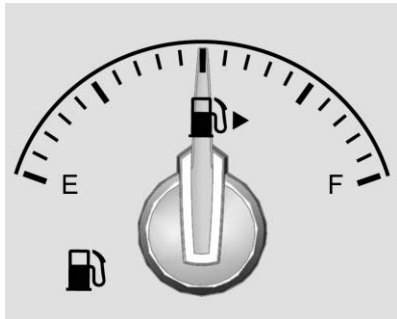

Base Level English

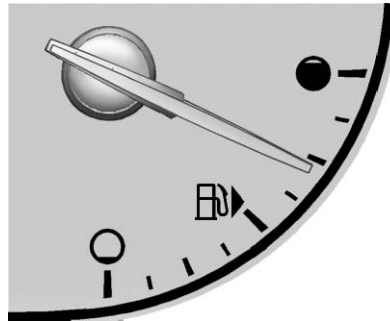

Uplevel Metric

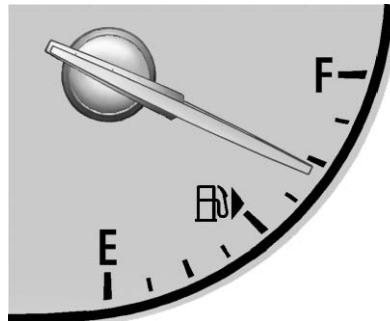

Uplevel English

When the ignition is on, the fuel gauge shows about how much fuel is left in the tank.

An arrow on the fuel gauge indicates the side of the vehicle the fuel door is on.

When the vehicle's fuel level becomes low, a message appears in the Driver Information Center (DIC) and a single chime sounds. See *Fuel System Messages* ⇨ 142.

Here are four things that some owners ask about. None of these show a problem with the fuel gauge:

- At the service station, the fuel pump shuts off before the gauge reads full.
- It takes a little more or less fuel to fill up than the gauge indicated. For example, the gauge may have indicated the tank was half full, but it actually took a little more or less than half the tank's capacity to fill the tank.
- The gauge moves a little while turning a corner or speeding up.

- The gauge takes a few seconds to stabilize after the ignition is turned on, and will go back to empty when the ignition is turned off.

## Engine Coolant Temperature Gauge

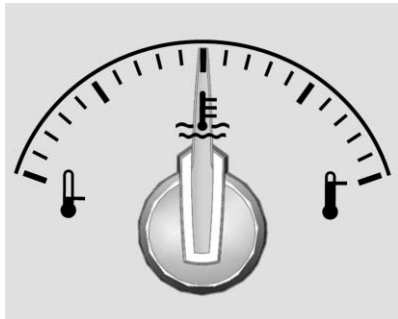

Base Level Metric

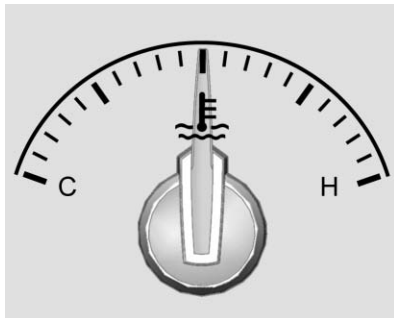

Base Level English

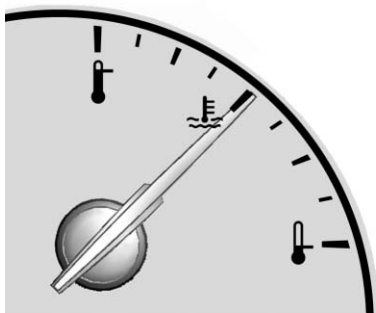

Uplevel Metric

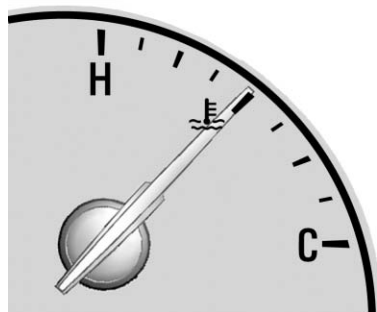

Uplevel English

This gauge shows the engine coolant temperature.

If the indicator needle moves to the hot side of the gauge toward the shaded area, the engine is too hot.

If the vehicle has been operated under normal driving conditions, pull off the road, stop the vehicle, and turn off the engine as soon as possible.

## Safety Belt Reminders

### Driver Safety Belt Reminder Light

There is a driver safety belt reminder light on the instrument cluster.



When the vehicle is started, this light flashes and a chime may come on to remind the driver to fasten their safety belt. Then the light stays on solid until the belt is buckled. This cycle may continue several times if the driver remains or becomes unbuckled while the vehicle is moving.

If the driver safety belt is buckled, neither the light nor the chime comes on.

### Passenger Safety Belt Reminder Light

The vehicle may also have a passenger safety belt reminder light.



When the vehicle is started, this light flashes and a chime may come on to remind passengers to fasten their safety belt. Then the light stays on solid until the belt is buckled.

This cycle continues several times if the front passenger remains or becomes unbuckled while the vehicle is moving.

If the front passenger safety belt is buckled, neither the chime nor the light comes on.

The front passenger safety belt reminder light and chime may turn on if an object is put on the seat such as a briefcase, handbag, grocery bag, laptop, or other

electronic device. To turn off the reminder light and/or chime, remove the object from the seat or buckle the safety belt.

### Airbag Readiness Light

This light shows if there is an electrical problem with the airbag system. The system check includes the airbag sensor(s), the passenger sensing system, the pretensioners, the airbag modules, the wiring, and the crash sensing and diagnostic module. For more information on the airbag system, see *Airbag System* ⇨ 67.



The airbag readiness light comes on for several seconds when the vehicle is started. If the light does not come on then, have it fixed immediately.



**Warning**

If the airbag readiness light stays on after the vehicle is started or comes on while driving, it means the airbag system might not be working properly. The airbags in the vehicle might not inflate in a crash, or they could even inflate without a crash. To help avoid injury, have the vehicle serviced right away.

If there is a problem with the airbag system, a Driver Information Center (DIC) message may also come on. See *Airbag System Messages* ⇨ 145.

**Passenger Airbag Status Indicator**

The vehicle has a passenger sensing system. See *Passenger Sensing System* ⇨ 73 for important safety information. The overhead console has a passenger airbag status indicator.

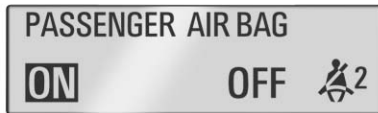
**United States****Canada and Mexico**

When the vehicle is started, the passenger airbag status indicator will light ON and OFF, or the symbol for on and off for several seconds as a system check. Then, after several more seconds, the status indicator will light either ON or OFF, or the on or off symbol to let you know the status of the front outboard passenger frontal airbag and knee airbag.

If the word ON or the on symbol is lit on the passenger airbag status indicator, it means that the front

outboard passenger frontal airbag and knee airbag are allowed to inflate.

If the word OFF or the off symbol is lit on the airbag status indicator, it means that the passenger sensing system has turned off the front outboard passenger frontal airbag and knee airbag.

If, after several seconds, both status indicator lights remain on, or if there are no lights at all, there may be a problem with the lights or the passenger sensing system. See your dealer for service.

**Warning**

If the airbag readiness light ever comes on and stays on, it means that something may be wrong with the airbag system. To help avoid injury to yourself or others, have the vehicle serviced right away. See *Airbag Readiness Light* ⇨ 119 for more information, including important safety information.

## Charging System Light

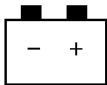

The charging system light comes on briefly when the ignition is turned on, but the engine is not running, as a check to show the light is working. The light turns off when the engine is started. If it does not, have the vehicle serviced by your dealer.

If the light stays on, or comes on while driving, there could be a problem with the electrical charging system. Have it checked by your dealer. Driving while this light is on could drain the battery.

If a short distance must be driven with the light on, be sure to turn off all accessories, such as the radio and air conditioner.

## Malfunction Indicator Lamp (Check Engine Light)

This light is part of the vehicle's emission control on-board diagnostic system. If this light is on while the engine is running, a malfunction has been detected and the vehicle may require service. The light should come on to show that it is working when the ignition is in Service Only Mode. See *Ignition Positions* ⇨ 184.



Malfunctions are often indicated by the system before any problem is noticeable. Being aware of the light and seeking service promptly when it comes on may prevent damage.

### Caution

If the vehicle is driven continually with this light on, the emission control system may not work as well, the fuel economy may be lower, and the vehicle may not run smoothly. This could lead to costly repairs that might not be covered by the vehicle warranty.

### Caution

Modifications to the engine, transmission, exhaust, intake, or fuel system, or the use of replacement tires that do not meet the original tire specifications, can cause this light to come on. This could lead to costly repairs not covered by the vehicle warranty. This could also affect the vehicle's ability to pass an Emissions Inspection/Maintenance test. See *Accessories and Modifications* ⇨ 236.

**If the light is flashing :** A malfunction has been detected that could damage the emission control system and increase vehicle emissions. Diagnosis and service may be required.

To help prevent damage, reduce vehicle speed and avoid hard accelerations and uphill grades. If towing a trailer, reduce the amount of cargo being hauled as soon as possible.

If the light continues to flash, find a safe place to park. Turn the vehicle off and wait at least 10 seconds before restarting the engine. If the light is still flashing, follow the previous guidelines and see your dealer for service as soon as possible.

**If the light is on steady :** A malfunction has been detected. Diagnosis and service may be required.

Check the following:

- If fuel has been added to the vehicle using the capless funnel adapter, make sure that it has

been removed. See “Filling the Tank with a Portable Gas Can” under *Filling the Tank* ⇨ 224. The diagnostic system can detect if the adapter has been left installed in the vehicle, allowing fuel to evaporate into the atmosphere. A few driving trips with the adapter removed may turn off the light.

- Poor fuel quality can cause inefficient engine operation and poor driveability, which may go away once the engine is warmed up. If this occurs, change the fuel brand. It may require at least one full tank of the proper fuel to turn the light off. See *Fuel* ⇨ 222.

If the light remains on, see your dealer.

### Emissions Inspection and Maintenance Programs

If the vehicle requires an Emissions Inspection/Maintenance test, the test equipment will likely connect to the vehicle's Data Link Connector (DLC).

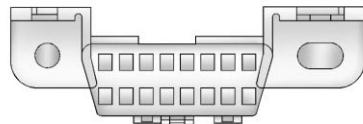

The DLC is under the instrument panel to the left of the steering wheel. Connecting devices that are not used to perform an Emissions Inspection/Maintenance test or to service the vehicle may affect vehicle operation. See *Add-On Electrical Equipment* ⇨ 233. See your dealer if assistance is needed.

The vehicle may not pass inspection if:

- The light is on when the engine is running.
- The light does not come on when the ignition is in Service Only Mode.
- Critical emission control systems have not been completely diagnosed. If this happens, the vehicle would not be ready for

inspection and might require several days of routine driving before the system is ready for inspection. This can happen if the 12-volt battery has recently been replaced or run down, or if the vehicle has been recently serviced.

See your dealer if the vehicle will not pass or cannot be made ready for the test.

## Brake System Warning Light

The vehicle brake system consists of two hydraulic circuits. If one circuit is not working, the remaining circuit can still work to stop the vehicle. For normal braking performance, both circuits need to be working.

If the warning light comes on, there is a brake problem. Have the brake system inspected right away.



**BRAKE**

**Metric**

**English**

This light should come on briefly when the engine is started. If it does not come on then, have it fixed so it will be ready to warn you if there is a problem.

If the light comes on and stays on, there is a brake problem.

### **Warning**

The brake system might not be working properly if the brake system warning light is on. Driving with the brake system warning light on can lead to a crash. If the light is still on after the vehicle has been pulled off the road and carefully stopped, have the vehicle towed for service.

## Electric Parking Brake Light



**PARK**

**Metric**

**English Base Level**



### **English Uplevel**

The Electric Parking Brake (EPB) status light comes on when the parking brake is applied. If the light continues flashing after the EPB is released, or while driving, there is a problem with the EPB system. A message may also display on the Driver Information Center (DIC). See *Brake System Messages* ⇨ 139.

If the light does not come on, or remains flashing, see your dealer.

## Service Electric Parking Brake Light



If this light comes on and stays on, there is a problem with a system on the vehicle that is causing the parking brake system to work at a reduced level. The vehicle can still be driven, but should be taken to a dealer as soon as possible. See *Electric Parking Brake* ⇨ 196. If a message displays in the Driver Information Center (DIC), see *Brake System Messages* ⇨ 139.

## Antilock Brake System (ABS) Warning Light



The ABS light comes on briefly when the engine is started.

If the light does not come on, have it fixed so it will be ready to warn if there is a problem.

If the ABS light stays on, turn the ignition off. If the light comes on while driving, stop as soon as it is safely possible and turn the ignition off. A chime may also sound when the light comes on steady. Then start the engine again to reset the system. If the ABS light stays on, or comes on again while driving, the vehicle needs service. If the regular brake system warning light is not on, the vehicle still has brakes, but not antilock brakes. If the regular brake system warning light is also on, the vehicle does not have

antilock brakes and there is a problem with the regular brakes. See *Brake System Warning Light* ⇨ 123.

See *Brake System Messages* ⇨ 139 for all brake-related DIC messages.

## Lane Keep Assist (LKA) Light



For some vehicles, this light comes on briefly while starting the vehicle. If it does not come on, have the vehicle serviced.

For vehicles with the uplevel cluster, this light may not come on when starting the vehicle.

This light is green if LKA is available to assist.

LKA may assist by gently turning the steering wheel if the vehicle approaches a detected lane marking

without using the turn signal in that direction. The LKA light will turn amber.

This light is amber and flashes as a Lane Departure Warning (LDW) alert, to indicate that the lane marking has been crossed.

See *Lane Keep Assist (LKA)* ⇨ 221.

## Vehicle Ahead Indicator



If equipped, this indicator will display green when a vehicle is detected ahead and amber when you are following a vehicle ahead much too closely.

See *Forward Collision Alert (FCA) System* ⇨ 215.

## Traction Off Light



This light comes on briefly while starting the engine. If it does not, have the vehicle serviced by your dealer. If the system is working normally, the indicator light then turns off.

The traction off light comes on when the Traction Control System (TCS) has been turned off by pressing and releasing the TCS/StabiliTrak button.

This light and the StabiliTrak OFF light come on when StabiliTrak is turned off.

If the TCS is off, wheel spin is not limited. Adjust driving accordingly.

See *Traction Control/Electronic Stability Control* ⇨ 198.

## StabiliTrak® OFF Light



This light comes on briefly while starting the engine. If it does not, have the vehicle serviced by your dealer.

This light comes on when the StabiliTrak system is turned off. If StabiliTrak is off, the Traction Control System (TCS) is also off.

If StabiliTrak and TCS are off, the system does not assist in controlling the vehicle. Turn on the TCS and the StabiliTrak systems, and the warning light turns off.

See *Traction Control/Electronic Stability Control* ⇨ 198.

## Traction Control System (TCS)/StabiliTrak® Light



This light comes on briefly when the engine is started.

If the light does not come on, have the vehicle serviced by your dealer. If the system is working normally, the indicator light turns off.

If the light is on and not flashing, the TCS and potentially the StabiliTrak system have been disabled. A Driver Information Center (DIC) message may display. Check the DIC messages to determine which feature(s) is no longer functioning and whether the vehicle requires service. See *Ride Control System Messages* ⇨ 144.

If the light is on and flashing, the TCS and/or the StabiliTrak system is actively working.

See *Traction Control/Electronic Stability Control* ⇨ 198.

## Engine Coolant Temperature Warning Light



This light comes on briefly while starting the vehicle.

If it does not, have the vehicle serviced by your dealer. If the system is working normally the indicator light goes off.

### Caution

The engine coolant temperature warning light indicates that the vehicle has overheated. Driving with this light on can damage the

(Continued)

### Caution (Continued)

engine and it may not be covered by the vehicle warranty. See *Engine Overheating* ⇨ 250.

The engine coolant temperature warning light comes on when the engine has overheated.

If this happens, pull over and turn off the engine as soon as possible. See *Engine Overheating* ⇨ 250.

## Tire Pressure Light



For vehicles with the Tire Pressure Monitor System (TPMS), this light comes on briefly when the engine is started. It provides information about tire pressures and the TPMS.

**When the Light Is On Steady**

This indicates that one or more of the tires are significantly underinflated.

A Driver Information Center (DIC) tire pressure message may also display. See *Tire Messages* ⇨ 146. Stop as soon as possible, and inflate the tires to the pressure value shown on the Tire and Loading Information label. See *Tire Pressure* ⇨ 273.

**When the Light Flashes First and Then Is On Steady**

If the light flashes for about a minute and then stays on, there may be a problem with the TPMS. If the problem is not corrected, the light will come on at every ignition cycle. See *Tire Pressure Monitor Operation* ⇨ 275.

**Engine Oil Pressure Light****Caution**

Lack of proper engine oil maintenance can damage the engine. Driving with the engine oil low can also damage the engine. The repairs would not be covered by the vehicle warranty. Check the oil level as soon as possible. Add oil if required, but if the oil level is within the operating range and the oil pressure is still low, have the vehicle serviced. Always follow the maintenance schedule for changing engine oil.



This light should come on briefly as the engine is started. If it does not come on, have the vehicle serviced by your dealer.

If the light comes on and stays on, it means that oil is not flowing through the engine properly. The vehicle could be low on oil and might have some other system problem. See your dealer.

**Low Fuel Warning Light**

This light is near the fuel gauge and comes on briefly when the ignition is turned on as a check to show it is working.

It also comes on when the fuel tank is low on fuel. The light turns off when fuel is added. If it does not, have the vehicle serviced.



## Security Light



The security light should come on briefly as the engine is started. If it does not come on, have the vehicle serviced by your dealer. If the system is working normally, the indicator light turns off.

If the light stays on and the engine does not start, there could be a problem with the theft-deterrent system. See *Immobilizer Operation* ⇨ 43.

## High-Beam On Light



This light comes on when the high-beam headlamps are in use.

See *Headlamp High/Low-Beam Changer* ⇨ 159.

## IntelliBeam® Light



This light comes on when the IntelliBeam system, if equipped, is enabled.

See *Exterior Lamp Controls* ⇨ 157.

## Adaptive Forward Lighting (AFL) Light



This light should come on briefly as the vehicle is started. If it does not come on, have the vehicle serviced by your dealer. For vehicles with an uplevel cluster, this light is in the display area and may not come on when the ignition is turned on.

This light comes on solid when there is a problem with the AFL system. It flashes when the system is switching between lighting modes. See *Adaptive Forward Lighting (AFL)* ⇨ 160.

If the battery has recently been run down or replaced, the Adaptive Forward Lighting (AFL) light or STEERING ASSIST IS REDUCED DIC message may remain on. This is normal and there is no loss of power steering or AFL performance. If the light or DIC message continues to display after normal driving, take the vehicle to your dealer for service. See *Steering System Messages* ⇨ 145.

## Front Fog Lamp Light



If equipped, this light comes on when the fog lamps are on.

The light goes out when the fog lamps are turned off. See *Fog Lamps* ⇨ 161.

## Lamps On Reminder



For vehicles with the lamps on reminder light, it comes on when the lights are in use.

## Cruise Control Light



The cruise control light is white when the cruise control is on and ready, and turns green when the cruise control is set and active.

See *Cruise Control* ⇨ 200.

## Adaptive Cruise Control Light



This light is white when the Adaptive Cruise Control (ACC, if equipped) is on and ready, and turns green when the ACC is set and active. See *Adaptive Cruise Control* ⇨ 202.

## Door Ajar Light

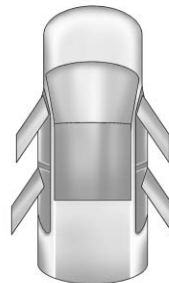

For vehicles equipped with this light, it comes on when a door is open or not securely latched. Before driving, check that all doors are properly closed. See *Door Ajar Messages* ⇨ 140 for more information.

## Information Displays

### Driver Information Center (DIC) (Base Level)

The DIC displays are shown in the center of the instrument cluster in the Info App. See *Instrument Cluster* ⇨ 113. The Info App is only available when the vehicle is in ON/RUN. The displays show the status of many vehicle systems. The controls for the DIC are on the right steering wheel control.

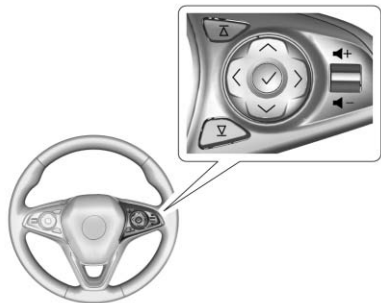

∧ or ∨ : Press to move up or down in a list.

< or > : Press < to open application menus on the left. Press > to open interaction menus on the right.

✓ : Press to open a menu or select a menu item. Press and hold to reset values on certain screens.

#### DIC Info Page Options

The info pages on the DIC can be turned on or off through the Settings app.

1. Press < to access the cluster applications.
2. Press ∧ or ∨ to scroll to the Settings application.
3. Press ✓ to select the Settings app, then press > to enter the Settings menu.
4. Scroll to Info Pages and press >.
5. Select Edit List.
6. Press ∧ or ∨ to move through the list of possible information displays.

7. Press ✓ while an item is highlighted to select or deselect that item. When an item is selected, a checkmark will appear next to it.

#### DIC Info Pages

The following is the list of all possible DIC info page displays. Some may not be available for your particular vehicle. Some items may not be turned on by default but can be turned on through the Settings app. See “DIC Info Page Options” earlier in this section.

**Current Speed** : Displays the vehicle speed in kilometers per hour (km/h) or miles per hour (mph).

**Trip A and Average Fuel Economy or Trip B and Average Fuel Economy** : The Trip display shows the current distance traveled, in kilometers (km) or miles (mi), since the trip odometer was last reset. The trip odometer can be reset by pressing and holding ✓ while this display is active.

The Average Fuel Economy display shows the approximate average liters per 100 kilometers (L/100 km) or miles per gallon (mpg). This number is calculated based on the number of L/100 km (mpg) recorded since the last time this menu item was reset. This number reflects only the approximate average fuel economy that the vehicle has right now, and will change as driving conditions change. The Average Fuel Economy can be reset by pressing and holding ✓ while this display is active.

**Fuel Range and Instantaneous Fuel Economy** : Displays the approximate distance the vehicle can be driven without refueling. LOW will be displayed when the vehicle is low on fuel. The fuel range estimate is based on an average of the vehicle's fuel economy over recent driving history and the amount of fuel remaining in the fuel tank.

Also displays the current fuel economy in liters per 100 kilometers (L/100 km) or miles

per gallon (mpg). This number reflects only the approximate fuel economy that the vehicle has right now and changes frequently as driving conditions change.

**Average Speed** : Displays the average speed of the vehicle in kilometers per hour (km/h) or miles per hour (mph). This average is calculated based on the various vehicle speeds recorded since the last reset of this value. The average speed can be reset by pressing and holding ✓ while this display is active.

**Timer** : To start the timer, press ✓ while this display is active. The display will show the amount of time that has passed since the timer was last reset. To stop the timer, press ✓ briefly while this display is active and the timer is running. To reset the timer to zero, press and hold ✓ while this display is active.

**Oil Life** : Displays an estimate of the oil's remaining useful life. If REMAINING OIL LIFE 99% is displayed, that means 99% of the current oil life remains.

When the remaining oil life is low, the CHANGE ENGINE OIL SOON message will appear on the display. See *Engine Oil Messages* ⇨ 141. The oil should be changed as soon as possible. See *Engine Oil* ⇨ 241. In addition to the engine oil life system monitoring the oil life, additional maintenance is recommended in the Maintenance Schedule. See *Maintenance Schedule* ⇨ 310.

The Oil Life display must be reset after each oil change. It will not reset itself. Do not reset the Oil Life display accidentally at any time other than when the oil has just been changed. It cannot be reset accurately until the next oil change. To reset the engine oil life system, press and hold ✓ for several seconds while the Oil Life display is active. See *Engine Oil Life System* ⇨ 243.

**Coolant Temperature** : Displays the coolant temperature in degrees Celsius (°C) or degrees Fahrenheit (°F).

**Tire Pressure** : Displays the approximate pressures of all four tires. Tire pressure is displayed in kilopascal (kPa) or pounds per square inch (psi). If the pressure is low, the value for that tire is shown in amber. See *Tire Pressure Monitor System* ⇨ 274 and *Tire Pressure Monitor Operation* ⇨ 275.

**Battery Voltage** : Displays the current battery voltage. The battery voltage can fluctuate while viewing this information on the DIC. This is normal.

### **Follow Distance Indicator/Gap**

**Setting** : The current follow time to the vehicle ahead is displayed as a time value on this page when ACC is not engaged. When ACC has been engaged, the Follow Distance Indicator page switches to the Gap Setting page. This page shows the current gap setting along with the vehicle ahead indicator.

**Best Average Fuel Economy** : The right hand side displays the best average fuel economy (AFE) that is achieved for a selected distance. The left hand side displays a running average of fuel economy for the most recently traveled selected distance. The center bar graph displays the instantaneous fuel economy. Quickly press the ✓ button to display a page for selecting one of the distance options. Move the up/down arrow to choose the selection, and ✓ to change the setting. When viewing best AFE, a several second press and hold of ✓ will reset the best value. The best value will show “- - -” until the selected distance has been traveled. The display provides feedback on how current driving behavior in the bar graph affects the running average in the left display and how well recent driving compares to the best that has been achieved.

**Speed Signs** : Displays sign information, which comes from a roadway database in the onboard navigation.

## **Driver Information Center (DIC) (Uplevel)**

The DIC displays are shown in the center of the instrument cluster in the Info App. See *Instrument Cluster* ⇨ 113. The Info App is only available when the vehicle is in ON/RUN. The displays show the status of many vehicle systems. The controls for the DIC are on the right steering wheel control.

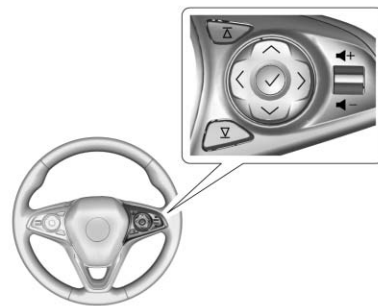

▲ or ▼ : Press to move up or down in a list.

< or > : Press < to open application menus on the left. Press > to open interaction menus on the right.

✓ : Press to open a menu or select a menu item. Press and hold to reset values on certain screens.

### DIC Info Page Options

The info pages on the DIC can be turned on or off through the Settings app.

1. Press < to access the cluster applications.
2. Press ▲ or ▼ to scroll to the Settings application.
3. Press ✓ to select the Settings app, then press > to enter the Settings menu.
4. Scroll to Info Pages and press >.

5. Press ▲ or ▼ to move through the list of possible information displays.

6. Press ✓ while an item is highlighted to select or deselect that item.

### DIC Info Pages

The following is the list of all possible DIC info page displays. Some may not be available for your particular vehicle. Some items may not be turned on by default but can be turned on through the Settings app. See “DIC Info Page Options” earlier in this section.

#### Trip A or Trip B with Average Fuel Economy and Average Speed :

The Trip display shows the current distance traveled, in kilometers (km) or miles (mi), since the trip odometer was last reset. The trip odometer can be reset by pressing and holding ✓ while this display is active.

The Average Fuel Economy display shows the approximate average liters per 100 kilometers (L/100 km)

or miles per gallon (mpg). This number is calculated based on the number of L/100 km (mpg) recorded since the last time this menu item was reset. This number reflects only the approximate average fuel economy that the vehicle has right now, and will change as driving conditions change. The Average Fuel Economy can be reset by pressing and holding ✓ while this display is active.

The Average Speed display shows the average speed of the vehicle in kilometers per hour (km/h) or miles per hour (mph). This average is calculated based on the various vehicle speeds recorded since the last reset of this value. The average speed can be reset by pressing and holding ✓ while this display is active.

#### Fuel Range and Instantaneous Fuel Economy :

Displays the approximate distance the vehicle can be driven without refueling. LOW will be displayed when the vehicle is low on fuel. The fuel range estimate is based on an

average of the vehicle's fuel economy over recent driving history and the amount of fuel remaining in the fuel tank.

Displays the current fuel economy in liters per 100 kilometers (L/100 km) or miles per gallon (mpg). This number reflects only the approximate fuel economy that the vehicle has right now and changes frequently as driving conditions change.

**Oil Life** : Displays an estimate of the oil's remaining useful life. If REMAINING OIL LIFE 99% is displayed, that means 99% of the current oil life remains.

When the remaining oil life is low, the CHANGE ENGINE OIL SOON message will appear on the display. See *Engine Oil Messages* ⇨ 141. The oil should be changed as soon as possible. See *Engine Oil* ⇨ 241. In addition to the engine oil life system monitoring the oil life, additional maintenance is recommended in the Maintenance Schedule. See *Maintenance Schedule* ⇨ 310.

The Oil Life display must be reset after each oil change. It will not reset itself. Do not reset the Oil Life display accidentally at any time other than when the oil has just been changed. It cannot be reset accurately until the next oil change. To reset the engine oil life system, press and hold ✓ for several seconds while the Oil Life display is active. See *Engine Oil Life System* ⇨ 243.

**Tire Pressure** : Displays the approximate pressures of all four tires. Tire pressure is displayed in kilopascal (kPa) or pounds per square inch (psi). If the pressure is low, the value for that tire is shown in amber. See *Tire Pressure Monitor System* ⇨ 274 and *Tire Pressure Monitor Operation* ⇨ 275.

**Fuel Economy** : The right hand side displays the best average fuel economy (AFE) that is achieved for a selected distance. The left hand side displays a running average of fuel economy for the most recently traveled selected distance. The center bar graph displays the

instantaneous fuel economy.

Quickly press the ✓ button to display a page for selecting one of the distance options. Move the up/down arrow to choose the selection, and ✓ to change the setting. When viewing best AFE, a several second press and hold of ✓ will reset the best value. The best value will show “- - -” until the selected distance has been traveled. The display provides feedback on how current driving behavior in the bar graph affects the running average in the left display and how well recent driving compares to the best that has been achieved.

**Speed Limit** : Displays sign information, which comes from a roadway database in the onboard navigation.

**Follow Distance Indicator/Gap Setting** : The current follow time to the vehicle ahead is displayed as a time value on this page when ACC is not engaged. When ACC has been engaged, the Follow Distance Indicator page switches to the Gap

Setting page. This page shows the current gap setting along with the vehicle ahead indicator.

**ECO Index** : The bar graph on the left hand side provides feedback on the efficiency of current driving behavior. The graph shows a percentage value that is based on current fuel consumption compared to what is expected from the vehicle with good and bad driving habits. Each box represents 10%, with all boxes filled being 100%. More economical driving will result in being in the ECO box. Instantaneous Fuel Economy is also shown on the right hand side. This display cannot be reset.

**Blank Page** : This page shows no information.

## Head-Up Display (HUD)

### Warning

If the HUD image is too bright or too high in your field of view, it may take you more time to see

(Continued)

### Warning (Continued)

things you need to see when it is dark outside. Be sure to keep the HUD image dim and placed low in your field of view.

If equipped with HUD, some information concerning the operation of the vehicle is projected onto the windshield. The image is projected through the HUD lens on top of the instrument panel. The information appears as an image focused out toward the front of the vehicle.

### Caution

If you try to use the HUD image as a parking aid, you may misjudge the distance and damage your vehicle. Do not use the HUD image as a parking aid.

The HUD information can be displayed in various languages in some vehicles. The speedometer

reading and other numerical values can be displayed in either English or metric units.

The language selection is changed through the radio and the units of measurement is changed through the instrument cluster. See *Vehicle Personalization* ⇨ 147 and “Cluster Menu” under *Instrument Cluster* ⇨ 113.

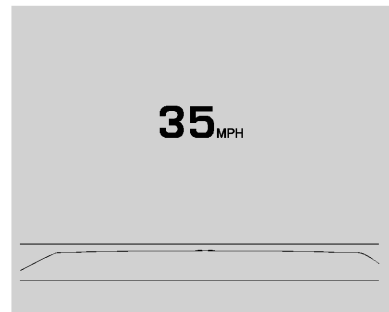

### HUD Display on the Vehicle Windshield

The HUD may display some of the following vehicle information and vehicle messages or alerts:

- Speed



- Tachometer
- Audio
- Phone
- Navigation
- Collision Alert
- Cruise Control
- Lane Departure
- Low Fuel

Some vehicle messages or alerts displayed in the HUD may be cleared by using the steering wheel controls. See *Vehicle Messages* ⇨ 138.



The HUD control is to the left of the steering wheel.

To adjust the HUD image:

1. Adjust the driver seat.
2. Start the engine.
3. Use the following settings to adjust the HUD.

**HUD** : Press down or lift up to center the HUD image. The HUD image can only be adjusted up and down, not side to side.

**INFO** : Press to select the display view. Each press will change the display view.

**±☀** : Lift up and hold to brighten the display. Press down and hold to dim the display. Hold down to turn the display off.

The HUD image will automatically dim and brighten to compensate for outside lighting. The HUD brightness control can also be adjusted as needed.

The HUD image can temporarily light up depending on the angle and position of the sunlight on the HUD display. This is normal.

Polarized sunglasses could make the HUD image harder to see.

### HUD Views

There are four views in the HUD. Some vehicle information and vehicle messages or alerts may be displayed in any view.



**Metric**



**English**

**Speed View** : This display gives the speedometer reading (in English or metric units), speed limit, Adaptive Cruise Control speed, Lane Departure Warning, and vehicle ahead indicator. Some information only appears on vehicles that have these features, and when they are active.



### Metric



### English

**Audio/Phone View** : This displays the speed view along with audio/ phone information. The current radio station, media type, and incoming calls will be displayed.

All HUD views may briefly display audio information when the driver uses the steering wheel controls to adjust the audio settings appearing in the instrument cluster.

Incoming phone calls appearing in the instrument cluster may also display in any HUD view.



### Metric



### English

**Navigation View** : This display includes the information in the speed view along with Turn-by-Turn Navigation information in some vehicles. The compass heading is displayed when navigation routing is not active.

Navigation Turn-by-Turn Alerts shown in the instrument cluster may also be displayed in any HUD view.

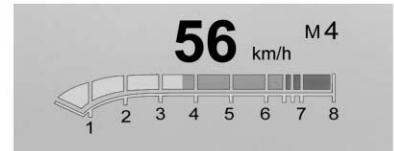

### Metric

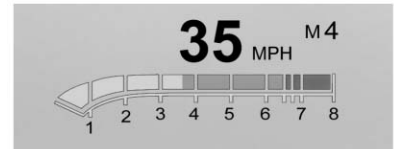

### English

**Performance View** : This displays the speedometer reading, rpm reading, transmission positions, and gear shift indicator.

### Care of the HUD

Clean the inside of the windshield to remove any dirt or film that could reduce the sharpness or clarity of the HUD image.

Clean the HUD lens with a soft cloth sprayed with glass cleaner. Wipe the lens gently, then dry it.

## HUD Troubleshooting

Check that:

- Nothing is covering the HUD lens.
- HUD brightness setting is not too dim or too bright.
- HUD is adjusted to the proper height.
- Polarized sunglasses are not worn.
- Windshield and HUD lens are clean.

If the HUD image is not correct, contact your dealer.

The windshield is part of the HUD system. If the windshield needs replacing, see *Windshield Replacement* ⇨ 258.

## Vehicle Messages

Messages displayed on the DIC indicate the status of the vehicle or some action that may be needed to correct a condition. Multiple messages may appear one after another.

The messages that do not require immediate action can be acknowledged and cleared by pressing ✓.

The messages that require immediate action cannot be cleared until that action is performed.

All messages should be taken seriously; clearing the message does not correct the problem.

The following are the possible messages and some information about them.

## Battery Voltage and Charging Messages

### BATTERY SAVER ACTIVE

This message displays when the vehicle has detected that the battery voltage is dropping beyond a reasonable point. The battery saver system starts reducing features of the vehicle that may be noticed. At the point that features are disabled, this message displays. Turn off unnecessary accessories to allow the battery to recharge.

### LOW BATTERY

This message is displayed when the battery voltage is low. See *Battery - North America* ⇨ 254.

### SERVICE BATTERY CHARGING SYSTEM

This message is displayed when there is a fault in the battery charging system. Take the vehicle to your dealer for service.

## TRANSPORT MODE ON

This message is displayed when the vehicle is in transport mode. Some features can be disabled while in this mode, including Remote Keyless Entry (RKE), remote start, and the vehicle alarm system. Take the vehicle to your dealer for service to turn transport mode off.

## Brake System Messages

### BRAKE FLUID LOW

This message displays when the brake fluid level is low. See *Brake Fluid* ⇨ 253.

### RELEASE PARKING BRAKE

This message displays if the Electric Parking Brake is on while the vehicle is in motion. Release it before attempting to drive. See *Electric Parking Brake* ⇨ 196.

### SERVICE BRAKE ASSIST

This message displays when there is a problem with the brake boost system. When this message displays, the brake pedal may be

harder to push and the stopping distance may be longer. See your dealer for service.

### SERVICE PARKING BRAKE

This message displays when there is a problem with the Electric Parking Brake. See your dealer for service.

### STEP ON BRAKE TO RELEASE PARK BRAKE

This message displays when attempting to release the Electric Parking Brake without the brake pedal applied. See *Electric Parking Brake* ⇨ 196.

## Compass Messages

Dashes may be displayed if the vehicle temporarily loses communication with the Global Positioning System (GPS).

## Cruise Control Messages

### ADAPTIVE CRUISE DISENGAGING

This message displays when the Adaptive Cruise Control (ACC) is disengaging.

This may occur when:

- The radar is not clean. Keep the radar sensors free of mud, dirt, snow, ice, and slush. Clean the entire front and/or rear of the vehicle. For cleaning instructions, see *Exterior Care* ⇨ 299.
- Heavy rain or snow is interfering with the radar object detection or camera performance.
- Stability Control or Traction Control has activated or been disabled.
- There is no traffic or other objects to detect.
- There is a fault in the system.

### **ADAPTIVE CRUISE SET TO XXX**

This message displays when the Adaptive Cruise Control (ACC) speed is set. See *Adaptive Cruise Control* ⇨ 202.

### **ADAPTIVE CRUISE TEMPORARILY UNAVAILABLE**

This message displays when attempting to activate Adaptive Cruise Control (ACC) when it is temporarily unavailable. The ACC system does not need service.

This can occur under the following conditions:

- The radar is not clean. Keep the radar sensors free of mud, dirt, snow, ice, and slush. Clean the entire front and/or rear of the vehicle. For cleaning instructions, see *Exterior Care* ⇨ 299.
- Heavy rain or snow is interfering with the radar object detection or camera performance.

### **CRUISE SET TO XXX**

This message displays when the cruise control speed is set. See *Cruise Control* ⇨ 200.

### **NO CRUISE BRAKING GAS PEDAL APPLIED**

This message displays when Adaptive Cruise Control (ACC) is active and the driver is pressing the gas pedal. When this occurs, ACC will not brake. See *Adaptive Cruise Control* ⇨ 202.

### **SERVICE ADAPTIVE CRUISE CONTROL**

This message displays when the Adaptive Cruise Control (ACC) needs service. Take the vehicle to your dealer.

### **SHIFT TO PARK BEFORE EXITING**

This message may display if Adaptive Cruise Control (ACC) is engaged holding the vehicle at a stop, and the driver attempts to exit the vehicle. Put the vehicle in P (Park) before exiting.

## **Door Ajar Messages**

### **DOOR OPEN**

This message displays and a chime may sound if a door is not fully closed. Stop and turn off the vehicle, check the door for obstructions, and close the door again. Check to see if the message still appears on the DIC.

### **HOOD OPEN**

This message displays and a chime may sound if the hood is not fully closed. Stop and turn off the vehicle, check the hood for obstructions, and close the hood again. Check to see if the message still appears on the DIC.

### **REAR ACCESS OPEN**

This message will display when the liftgate is open. Close the liftgate completely.

## Engine Cooling System Messages

### A/C OFF DUE TO HIGH ENGINE TEMP

This message displays when the engine coolant becomes hotter than the normal operating temperature. To avoid added strain on a hot engine, the air conditioning compressor automatically turns off. When the coolant temperature returns to normal, the air conditioning compressor turns back on. The vehicle can continue to be driven.

If this message continues to appear, have the system repaired by your dealer as soon as possible to avoid damage to the engine.

### ENGINE OVERHEATED — IDLE ENGINE

This message displays when the engine coolant temperature is too hot. Stop and allow the vehicle to idle until it cools down.

### ENGINE OVERHEATED — STOP ENGINE

This message displays and a continuous chime sounds if the engine cooling system reaches unsafe temperatures for operation. Stop and turn off the vehicle as soon as it is safe to do so to avoid severe damage. This message clears when the engine has cooled to a safe operating temperature.

### HIGH COOLANT TEMPERATURE

This message displays if the coolant temperature is hot. See *Engine Overheating* ⇨ 250.

## Engine Oil Messages

### CHANGE ENGINE OIL SOON

This message displays when the engine oil needs to be changed. When you change the engine oil, be

sure to reset the oil life system. See *Engine Oil Life System* ⇨ 243, *Driver Information Center (DIC) (Base Level)* ⇨ 130 or *Driver Information Center (DIC) (Uplevel)* ⇨ 132, *Engine Oil* ⇨ 241, and *Maintenance Schedule* ⇨ 310.

### ENGINE OIL HOT, IDLE ENGINE

This message displays when the engine oil temperature is too hot. Stop and allow the vehicle to idle until it cools down.

### ENGINE OIL LOW — ADD OIL

On some vehicles, this message displays when the engine oil level may be too low. Check the oil level before filling to the recommended level. If the oil is not low and this message remains on, take the vehicle to your dealer for service. See *Engine Oil* ⇨ 241.

### OIL PRESSURE LOW — STOP ENGINE

This message displays if low oil pressure levels occur. Stop the vehicle as soon as safely possible

and do not operate it until the cause of the low oil pressure has been corrected. Check the oil as soon as possible and have the vehicle serviced by your dealer.

## **Engine Power Messages**

### **ENGINE POWER IS REDUCED**

This message displays when the vehicle's engine power is reduced. Reduced engine power can affect the vehicle's ability to accelerate. If this message is on, but there is no reduction in performance, proceed to your destination. The performance may be reduced the next time the vehicle is driven. The vehicle may be driven at a reduced speed while this message is on, but maximum acceleration and speed may be reduced. Anytime this message stays on, or displays repeatedly, the vehicle should be taken to your dealer for service as soon as possible.

## **Fuel System Messages**

### **FUEL LEVEL LOW**

This message displays when the vehicle is low on fuel. Refuel as soon as possible.

## **Key and Lock Messages**

### **NO REMOTE DETECTED**

This message displays when the RKE transmitter battery is weak on vehicles with Keyless Access. See "Starting the Vehicle with a Low Transmitter Battery" under *Remote Keyless Entry (RKE) System Operation* ⇨ 27.

### **NO REMOTE KEY WAS DETECTED PLACE KEY IN TRANSMITTER POCKET THEN START YOUR VEHICLE**

This message displays when trying to start the vehicle if an RKE transmitter is not detected. The transmitter battery may be weak. See "Starting the Vehicle with a Low

Transmitter Battery" under *Remote Keyless Entry (RKE) System Operation* ⇨ 27.

### **REPLACE BATTERY IN REMOTE KEY**

This message displays when the battery in the RKE transmitter needs to be replaced. See "Battery Replacement" under *Remote Keyless Entry (RKE) System Operation* ⇨ 27.

## **Object Detection System Messages**

### **FORWARD COLLISION SYSTEM OFF**

This message displays when Forward Automatic Braking (FAB) has been turned off. See *Forward Automatic Braking (FAB)* ⇨ 217.

### **FORWARD COLLISION SYSTEM REDUCED**

This message displays when Forward Automatic Braking (FAB) has been set to the Alert setting.

This setting disables most FAB functions. See *Forward Automatic Braking (FAB)* ⇨ 217.

### **FORWARD COLLISION SYSTEM UNAVAILABLE**

This message displays when Forward Automatic Braking (FAB) has been unavailable for some time. FAB does not need service.

This can occur under the following conditions:

- The front of the vehicle or windshield is not clean. Keep these areas clean and free of mud, dirt, snow, ice, and slush. For cleaning instructions, see *Exterior Care* ⇨ 299.
- Heavy rain or snow is interfering with the object detection performance.

This message may also be displayed if there is a problem with the StabiliTrak system.

### **FORWARD COLLISION ALERT OFF**

This message displays when the Forward Collision Alert has been turned off.

### **FRONT CAMERA BLOCKED CLEAN WINDSHIELD**

This message displays when the camera is blocked. Cleaning the outside of the windshield behind the rearview mirror may correct the issue. The Lane Keep Assist (LKA) and the Lane Departure Warning (LDW) system will not operate. Adaptive Cruise Control (ACC), Forward Collision Alert (FCA), and Forward Automatic Braking (FAB) may not work or may not work as well.

### **LANE CHANGE ALERT OFF**

This message indicates that the driver has turned the Side Blind Zone Alert (SBZA) and Lane Change Alert (LCA) systems off.

### **LANE KEEPING ASSIST UNAVAILABLE**

This message displays when the Lane Keep Assist (LKA) and Lane Departure Warning (LDW) system is temporarily unavailable. The LKA system does not need service.

This message could be due to the camera being blocked. Cleaning the outside of the windshield behind the rearview mirror may correct the issue.

### **PARK ASSIST OFF**

This message displays when the Parking Assist system has been turned off or when there is a temporary condition causing the system to be disabled.

### **SERVICE FORWARD COLLISION SYSTEM**

If this message displays, take the vehicle to your dealer to repair the system. Adaptive Cruise Control (ACC), Forward Collision Alert (FCA), and/or Forward Automatic



Braking (FAB) may not work. Do not use these systems until the vehicle has been repaired.

### **SERVICE DRIVER ASSIST SYSTEM**

If this message displays, take the vehicle to your dealer to repair the system.

Adaptive Cruise Control (ACC), Forward Collision Alert (FCA), Forward Automatic Braking (FAB), Assistance Systems for Parking or Backing, and/or Lane Keep Assist (LKA) may not work. Do not use these systems until the vehicle has been repaired.

### **SERVICE FRONT CAMERA**

If this message remains on after continued driving, take the vehicle to your dealer for service. Do not use the Lane Keep Assist (LKA), Lane Departure Warning (LDW), and Forward Collision Alert (FCA) features.

### **SERVICE PARK ASSIST**

This message displays if there is a problem with the Parking Assist system. Do not use this system to help you park. See your dealer for service.

### **SERVICE SIDE DETECTION SYSTEM**

If this message remains on after continued driving, the vehicle needs service. Side Blind Zone Alert (SBZA), Lane Change Alert (LCA), and Rear Cross Traffic Alert (RCTA) features will not work. Take the vehicle to your dealer.

### **SIDE DETECTION SYSTEM UNAVAILABLE**

This message indicates that Side Blind Zone Alert (SBZA), Lane Change Alert (LCA), and Rear Cross Traffic Alert (RCTA) are disabled either because the sensor is blocked and cannot detect vehicles in the blind zone, or the vehicle is passing through an open area, such as the desert, where there is insufficient data for operation. This message may also

activate during heavy rain or due to road spray. The vehicle does not need service. For cleaning, see "Washing the Vehicle" under *Exterior Care* ⇨ 299.

### **TAKE STEERING**

If LKA does not detect active driver steering, an alert and chime may be provided. Move the steering wheel to dismiss. See *Lane Keep Assist (LKA)* ⇨ 221.

## **Ride Control System Messages**

### **AWD OFF**

This message displays when the All-Wheel Drive (AWD) System is temporarily disabled. The system may disable due to spare tire installation or a driving condition that could result in system damage. The system does not require service when this message is displayed. The AWD system will resume normal operation when driving conditions permit. See *All-Wheel Drive* ⇨ 195.

**SERVICE AWD**

This message displays when there is a problem with the All-Wheel Drive (AWD) System. See your dealer for service.

**SERVICE TRACTION CONTROL**

This message displays when there is a problem with the Traction Control System (TCS). When this message is displayed, the system will not limit wheel spin. Adjust your driving accordingly. See your dealer for service.

**SERVICE STABILITRAK**

This message displays if there is a problem with the StabiliTrak system. If this message appears, try to reset the system. Stop; turn off the engine for at least 15 seconds; then start the engine again. If this message still comes on, it means there is a problem. See your dealer for service. The vehicle is safe to drive; however, you do not have the benefit of StabiliTrak, so reduce your speed and drive accordingly.

**STABILITRAK INITIALIZING**

This message may come on if the StabiliTrak system has not fully initialized because of road conditions or the incorrect tire size. When the StabiliTrak system is fully initialized, the message will turn off. See *Traction Control/Electronic Stability Control* ⇨ 198. If this message continues to be displayed for multiple ignition cycles and on different road surfaces, see your dealer for service.

**Airbag System Messages****SERVICE AIRBAG**

This message displays if there is a problem with the airbag system. See your dealer for service.

**Security Messages****THEFT ATTEMPTED**

This message displays if the vehicle detects a tamper condition.

**Steering System Messages****STEERING ASSIST IS REDUCED**

This message may display if a problem occurs with the electric power steering system. If this message appears, steering effort may be slightly higher than normal. The vehicle is still safe to drive. Use caution while in reduced assist mode. If this message is persistent or appears repeatedly, take the vehicle to your dealer for service. See *Steering* ⇨ 175.

If the battery has recently been run down or replaced, the Adaptive Forward Lighting (AFL) light or STEERING ASSIST IS REDUCED message may remain on. This is normal and there is no loss of power steering or AFL performance. If the light or DIC message continues to display after normal driving, take the vehicle to your dealer for service. See *Adaptive Forward Lighting (AFL) Light* ⇨ 128.

**SERVICE POWER STEERING**

This message displays when there is a problem with electric power steering. If this message displays and a reduction in steering performance or loss of power steering assistance is noticed, see your dealer. See *Steering* ⇨ 175.

**Tire Messages****SERVICE TIRE MONITOR SYSTEM**

This message displays if there is a problem with the Tire Pressure Monitor System (TPMS). See *Tire Pressure Monitor Operation* ⇨ 275.

**TIRE LEARNING ACTIVE**

This message displays when the system is learning new tires. See *Tire Pressure Monitor Operation* ⇨ 275.

**TIRE PRESSURE LOW ADD AIR TO TIRE**

On vehicles with the Tire Pressure Monitor System (TPMS), this message displays when the pressure in one or more of the vehicle's tires is low.

The low tire pressure warning light will also come on. See *Tire Pressure Light* ⇨ 126.

If a tire pressure message displays, inflate the tires until the tire pressure is equal to the values shown on the Tire and Loading Information label. See *Tires* ⇨ 266, *Vehicle Load Limits* ⇨ 180, and *Tire Pressure* ⇨ 273.

More than one tire pressure message can be received at a time. The DIC also shows the tire pressure values. See *Driver Information Center (DIC) (Base Level)* ⇨ 130 or *Driver Information Center (DIC) (Uplevel)* ⇨ 132.

**Transmission Messages****APPLY AND HOLD BRAKE**

This message displays along with a temperature graph when the transmission clutch overheat temperature is reached.

**INCREASE SPEED OR APPLY BRAKE**

This message displays along with a temperature graph when the transmission clutch temperature is close to reaching an overheated condition.

**PLEASE WAIT**

This message displays along with a temperature graph when the vehicle is stopped and shows the actual clutch temperature and its cooled down target temperature. This may take several minutes.

**READY TO DRIVE AWAY**

This message displays along with a temperature graph when the clutch cool down temperature is reached and the vehicle can be driven.

## SERVICE TRANSMISSION

This message displays if there is a problem with the transmission. See your dealer.

## SHIFT TO PARK

This message displays when the transmission needs to be shifted to P (Park). This may appear when attempting to remove the transmitter from the vehicle if the vehicle is not in P (Park).

## TRANSMISSION HOT — IDLE ENGINE

This message displays and a chime sounds if the transmission fluid in the vehicle gets hot. Driving with the transmission fluid temperature high can cause damage to the vehicle. Stop the vehicle and let it idle to allow the transmission to cool. This message clears when the fluid temperature reaches a safe level.

## Washer Fluid Messages

### WASHER FLUID LOW ADD FLUID

This message may display when the washer fluid level is low. Fill the windshield washer reservoir as soon as possible. See *Engine Compartment Overview* ⇨ 238 for the location of the windshield washer reservoir. Also, see *Washer Fluid* ⇨ 252.

## Window Messages

### OPEN, THEN CLOSE DRIVER/PASSENGER WINDOW

This message is displayed when the window needs to be reprogrammed. If the vehicle's battery has been discharged or disconnected, you may need to program each front window for the express-up feature to work. See *Power Windows* ⇨ 46.

## Vehicle Personalization

The audio system controls are used to access the personalization menus for customizing vehicle features. See "Using the System" in the infotainment manual.

The following are all possible personalization features. Depending on the vehicle, some may not be available.

To access the personalization menus:

1. Select **SETTINGS** on the Home page of the infotainment system display.
2. Select the desired feature to display a list of available options.
3. Select the desired option.
4. Select the desired option setting.
5. Press ◀ **BACK** to return to the previous menu.

**Personalization Menus**

The following list of features may be available:

- Time
- Language (Language)
- Valet Mode
- Teen Driver
- Radio
- Vehicle
- Bluetooth
- Apple CarPlay
- Android Auto
- Voice
- Display
- Rear Camera
- Return to Factory Settings
- Software Information

Each menu is detailed in the following information.

**Time**

Manually set the time and date. See *Clock* ⇨ 110.

**Language**

Select Language, then select from the available language(s).

**Valet Mode**

To turn Valet Mode on and off, see “Valet Mode” under “Settings” in the infotainment manual.

**Teen Driver**

See “Teen Driver” under “Settings” in the infotainment manual.

**Radio**

To manage the radio features, see “Radio” under “Settings” in the infotainment manual.

**Vehicle**

Select and the following may display:

- Climate and Air Quality
- Collision/Detection Systems
- Comfort and Convenience
- Lighting
- Power Door Locks
- Remote Lock, Unlock, Start

**Climate and Air Quality**

Select and the following may display:

- Auto Fan Speed
- Auto Defog
- Auto Rear Defog

**Auto Fan Speed**

This feature will set the maximum auto fan speed.

Select Low, Medium, or High.

**Auto Defog**

When set to On, the front defog will automatically react to temperature and humidity conditions that may cause fogging.

Select Off or On.

**Auto Rear Defog**

If equipped, this allows the Auto Rear Defog to be turned on or off. This feature will automatically turn on the rear window defogger when it is cold outside.

Select Off or On.

### Collision/Detection Systems

Select and the following may display:

- Alert Type
- Auto Collision Preparation or Forward Collision System
- Go Notifier
- Rear Cross Traffic Alert
- Lane Change Alert

#### Alert Type

This feature will set crash alerts to beeps or seat vibrations. This setting affects all crash alerts including Forward Collision, Lane Departure Warning, Adaptive Cruise Control, and Parking Assist alerts.

Select Beeps or Safety Alert Seat.

#### Auto Collision Preparation or Forward Collision System

This feature will turn on or off the Forward Collision Alert (FCA) and Forward Automatic Braking (FAB). The Off setting disables all FCA and FAB functions. With the Alert and Brake setting, both FCA and FAB

are available. The Alert setting disables FAB. See *Forward Automatic Braking (FAB)* ⇨ 217.

Select Off, Alert and Brake, or Alert.

#### Go Notifier

This feature will give a reminder that Adaptive Cruise Control provides when it has brought the vehicle to a complete stop behind another stopping vehicle, and then that vehicle drives on.

Select Off or On.

#### Rear Cross Traffic Alert

This allows the feature to be turned on or off.

Select Off or On.

#### Lane Change Alert

This allows the feature to be turned on or off.

Select Off or On.

#### Comfort and Convenience

Select and the following may display:

- Auto Memory Recall

- Easy Exit Options
- Chime Volume
- Reverse Tilt Mirror
- Auto Wipe in Reverse Gear
- Rainsense Wipers

#### Auto Memory Recall

This feature automatically recalls the current driver's previously stored 1 or 2 button positions when entering the vehicle. See *Memory Seats* ⇨ 54.

Select Off or On.

#### Easy Exit Options

This feature automatically recalls the current driver's previously stored exit button position when exiting the vehicle. See *Memory Seats* ⇨ 54.

Select Off or On.

#### Chime Volume

This allows the selection of the chime volume level.

Press + or - to adjust the volume.

**Reverse Tilt Mirror**

When on, the driver, passenger, or both driver and passenger mirrors will tilt downward when the vehicle is shifted to R (Reverse). See *Reverse Tilt Mirrors* ⇨ 45.

Select Off, On-Driver and Passenger, On-Driver, or On-Passenger.

**Auto Wipe in Reverse Gear**

This allows this feature to be turned on or off. When on and the front wipers are on, the rear window wiper will turn on automatically when the vehicle is shifted into R (Reverse).

Select Off or On.

**Rainsense Wipers**

This allows the Rainsense Wipers feature to be disabled or enabled.

Select On or Off.

**Lighting**

Select and the following may display:

- Vehicle Locator Lights

- Exit Lighting

**Vehicle Locator Lights**

This feature will flash the exterior lamps when  on the Remote Keyless Entry (RKE) transmitter is pressed to locate the vehicle.

Select Off or On.

**Exit Lighting**

This allows the selection of how long the exterior lamps stay on when leaving the vehicle when it is dark outside.

Select Off, 30 Seconds, 60 Seconds, or 120 Seconds.

**Power Door Locks**

Select and the following may display:

- Unlocked Door Anti Lock Out
- Auto Door Unlock
- Delayed Door Lock

**Unlocked Door Anti Lock Out**

When on, this feature will keep the driver door from locking when the door is open. If Off is selected, the Delayed Door Lock menu will be available.

Select Off or On.

**Auto Door Unlock**

This allows selection of which of the doors will automatically unlock when the vehicle is shifted into P (Park).

Select Off, All Doors, or Driver Door.

**Delayed Door Lock**

When on, this feature will delay the locking of the doors. To override the delay, press the power door lock switch on the door.

Select Off or On.

**Remote Lock, Unlock, Start**

Select and the following may display:

- Remote Unlock Light Feedback
- Remote Lock Feedback
- Remote Door Unlock

- Remote Start Auto Cool Seats
- Remote Start Auto Heat Seats
- Auto Heated Seats
- Passive Door Unlock
- Passive Door Lock
- Remote Left in Vehicle Alert

### Remote Unlock Light Feedback

When on, the exterior lamps will flash when unlocking the vehicle with the RKE transmitter.

Select Off or Flash Lights.

### Remote Lock Feedback

This allows selection of what type of feedback is given when locking the vehicle with the RKE transmitter.

Select Off, Lights and Horn, Lights Only, or Horn Only.

### Remote Door Unlock

This allows selection of which doors will unlock when pressing  on the RKE transmitter.

Select All Doors or Driver Door.

### Remote Start Auto Cool Seats

If equipped and turned on, this feature will turn the ventilated seats on when using remote start on warm days.

Select Off, On-Driver and Passenger, or On-Driver.

### Remote Start Auto Heat Seats

If equipped and turned on, this feature will turn the heated seats on when using remote start on cold days.

Select Off or On.

### Auto Heated Seats

This feature will enable the heated seats to turn on after pressing ENGINE START/STOP when it is cold outside.

Select Off or On.

### Passive Door Unlock

This allows selection of which doors will unlock when using the button on the driver door to unlock the vehicle.

Select All Doors or Driver Door Only.

### Passive Door Lock

This feature can be turned on or off, or can be used to select feedback. See *Remote Keyless Entry (RKE) System Operation* ⇨ 27.

Select Off, On with Horn Chirp, or On.

### Remote Left in Vehicle Alert

This feature sounds an alert when the RKE transmitter is left in the vehicle.

Select Off or On.

### Bluetooth

Select and the following may display:

- Pair New Device
- Device Management
- Ringtones
- Voice Mail Numbers
- Text Message Alerts

### Pair New Device

Select to pair a new device. See “Pairing” under “Bluetooth” in the infotainment manual.



**Device Management**

Select to connect to a different phone source, disconnect a phone, or delete a phone.

**Ringtones**

Press to change the ring tone for the specific phone. The phone does not need to be connected to change the ring tone.

**Voice Mail Numbers**

This feature displays the voice mail number for all connected phones. To change the voice mail number, select EDIT or press the EDIT button. Type a new number, then select SAVE or press the SAVE button.

**Text Message Alerts**

This feature allows text messages to be received. See “Text Messaging” under “Phone” in the infotainment manual.

Select Off or On.

**Apple CarPlay™**

Select and the following may display:

- Apple CarPlay
- Manage Apple CarPlay Devices

**Apple CarPlay**

This feature allows Apple devices to be connected to the infotainment system through a USB port. See “Apple CarPlay and Android Auto” in the infotainment manual.

Select Off or On.

**Manage Apple CarPlay Devices**

Select to manage Apple devices. Apple CarPlay must be on for this feature to be accessed. See “Apple CarPlay and Android Auto” in the infotainment manual.

**Android Auto™**

Select and the following may display:

- Android Auto
- Manage Android Auto Devices

**Android Auto**

This feature allows Android devices to be connected to the infotainment system through a USB port. See “Apple CarPlay and Android Auto” in the infotainment manual.

Select Off or On.

**Manage Android Auto Devices**

Select to manage Android devices. Android Auto must be on for this feature to be accessed. See “Apple CarPlay and Android Auto” in the infotainment manual.

**Voice**

See “Voice” under “Settings” in the infotainment manual.

**Display**

Select and the following may display:

- Theme
- Calibrate Touchscreen
- Turn Display Off

**Theme**

Select to change the color, font, and art of the display.

Select Contemporary, Mainstreet, Edge, or Velocity.

**Calibrate Touchscreen**

Select to calibrate the touchscreen, then follow the prompts.

**Turn Display Off**

Select to turn the display off. Press anywhere on the display area or any faceplate button to turn the display on.

**Rear Camera**

Select and the following may display:

- Guidance Lines
- Rear Park Assist Symbols

**Guidance Lines**

Select to turn Off or On. See *Assistance Systems for Parking or Backing* ⇨ 210.

**Rear Park Assist Symbols**

Select to turn Off or On. See *Assistance Systems for Parking or Backing* ⇨ 210.

**Return to Factory Settings**

Select and the following may display:

- Restore Vehicle Settings
- Clear All Private Data
- Restore Radio Settings

**Restore Vehicle Settings**

This allows vehicle settings to be restored.

Select Cancel or Restore.

**Clear All Private Data**

This allows all private information to be cleared from the vehicle.

Select Cancel or Delete.

**Restore Radio Settings**

This allows radio settings to be restored.

Select Cancel or Restore.

**Software Information**

Select to view the infotainment system current software information.

## Universal Remote System

See *Radio Frequency Statement* ⇨ 334.

### Universal Remote System Programming



If equipped, these buttons are in the overhead console.

This system can replace up to three remote control transmitters used to activate devices such as garage door openers, security systems, and home automation devices. These

instructions refer to a garage door opener, but can be used for other devices.

Do not use the Universal Remote system with any garage door opener that does not have the stop and reverse feature. This includes any garage door opener model manufactured before April 1, 1982.

Read these instructions completely before programming the Universal Remote system. It may help to have another person assist with the programming process.

Keep the original hand-held transmitter for use in other vehicles as well as for future programming. Erase the programming when vehicle ownership is terminated. See “Erasing Universal Remote System Buttons” later in this section.

To program a garage door opener, park outside directly in line with and facing the garage door opener receiver. Clear all people and objects near the garage door.

Make sure the hand-held transmitter has a new battery for quick and accurate transmission of the radio-frequency signal.

### Programming the Universal Remote System

For questions or help programming the Universal Remote system, call 1-800-355-3515 or see [www.homelink.com](http://www.homelink.com).

Programming involves time-sensitive actions, and may time out causing the procedure to be repeated.

To program up to three devices:

1. Hold the end of the hand-held transmitter about 3 to 8 cm (1 to 3 in) away from the Universal Remote system buttons with the indicator light in view. The hand-held transmitter was supplied by the manufacturer of the garage door opener receiver.
2. At the same time, press and hold both the hand-held transmitter button and one of the three Universal Remote

system buttons to be used to operate the garage door. Do not release either button until the indicator light changes from a slow to a rapid flash. Then release both buttons.

Some garage door openers may require substitution of Step 2 with the procedure under “Radio Signals for Canada and Some Gate Operators” later in this section.

3. Press and hold the newly programmed Universal Remote system button for five seconds while watching the indicator light and garage door activation.
  - If the indicator light stays on continuously or the garage door moves when the button is pressed, then programming is complete. There is no need to complete Steps 4–6.
  - If the indicator light does not come on or the garage door does not move, a second button press may

be required. For a second time, press and hold the newly programmed button for five seconds. If the light stays on or the garage door moves, programming is complete.

- If the indicator light blinks rapidly for two seconds, then changes to a solid light and the garage door does not move, continue with programming Steps 4–6.

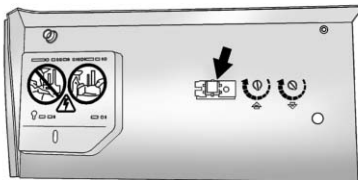

#### Learn or Smart Button

4. After completing Steps 1–3, locate the Learn or Smart button inside the garage on the garage door opener receiver.

The name and color of the button may vary by manufacturer.

5. Press and release the Learn or Smart button. Step 6 must be completed within 30 seconds of pressing this button.
6. Inside the vehicle, press and hold the newly programmed Universal Remote system button for two seconds and then release it. If the garage door does not move or the lamp on the garage door opener receiver does not flash, press and hold the same button a second time for two seconds, then release it. Again, if the door does not move or the garage door lamp does not flash, press and hold the same button a third time for two seconds, then release it.

The Universal Remote system should now activate the garage door.

Repeat the process for programming the two remaining buttons.

### **Radio Signals for Canada and Some Gate Operators**

For questions or programming help call 1-800-355-3515 or see [www.homelink.com](http://www.homelink.com).

Canadian radio-frequency laws and some U.S. gate operators require transmitter signals to time out or quit after several seconds of transmission. This may not be long enough for the Universal Remote system to pick up the signal during programming.

If the programming did not work, replace Step 2 under "Programming the Universal Remote System" with the following:

Press and hold the Universal Remote system button while pressing and releasing the hand-held transmitter button every two seconds until the signal has been successfully accepted by the Universal Remote system. The Universal Remote system indicator light will flash slowly at first and then rapidly. Proceed with Step 3 under "Programming the Universal Remote System" to complete.

### **Universal Remote System Operation**

#### **Using the Universal Remote System**

Press and hold the appropriate Universal Remote system button for at least one-half second. The indicator light will come on while the signal is being transmitted.

#### **Erasing Universal Remote System Buttons**

Erase all programmed buttons when vehicle ownership is terminated.

To erase:

1. Press and hold the two outside buttons until the indicator light begins to flash. This should take about 10 seconds.
2. Release both buttons.

### **Reprogramming a Single Universal Remote System Button**

To reprogram any of the system buttons:

1. Press and hold any one of the buttons. Do not release the button.
2. The indicator light will begin to flash after 20 seconds. Without releasing the button, proceed with Step 1 under "Programming the Universal Remote System."

## Lighting

### Exterior Lighting

Exterior Lamp Controls .....	157
Exterior Lamps Off Reminder .....	159
Headlamp High/Low-Beam Changer .....	159
Flash-to-Pass .....	159
Daytime Running Lamps (DRL) .....	159
Automatic Headlamp System .....	159
Adaptive Forward Lighting (AFL) .....	160
Headlamp Leveling Control ...	160
Hazard Warning Flashers .....	161
Turn and Lane-Change Signals .....	161
Fog Lamps .....	161

### Interior Lighting

Instrument Panel Illumination Control .....	162
Courtesy Lamps .....	162
Dome Lamps .....	162
Reading Lamps .....	163

### Lighting Features

Entry Lighting .....	163
----------------------	-----

Exit Lighting .....	164
Battery Power Protection .....	164
Exterior Lighting Battery Saver .....	164

## Exterior Lighting

### Exterior Lamp Controls

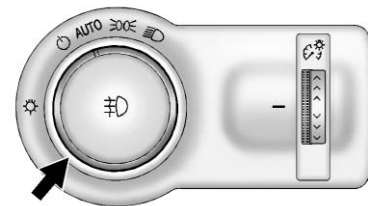



The exterior lamp control is on the instrument panel on the outboard side of the steering wheel.

Turn the control to the following positions:

**OFF** : Turns off the exterior lamps. The knob returns to the **AUTO** position after it is released. Turn to **DOE** again to reactivate the **AUTO** mode.

**AUTO** : Automatically turns the exterior lamps on and off, depending on outside lighting.

 : Turns on the parking lamps, including all lamps, except the headlamps.

 : Turns on the headlamps together with the parking lamps and instrument panel lights.

### Intellibeam® System

If equipped, this system turns the vehicle's high-beam headlamps on and off according to surrounding traffic conditions.

The system turns the high-beam headlamps on when it is dark enough and there is no other traffic present.

This light  comes on in the instrument cluster when the Intellibeam system is enabled.

### Turning On and Enabling Intellibeam

To enable the Intellibeam system, with the turn signal lever in the neutral position, turn the exterior lamp control to AUTO. The blue high-beam on light appears on the instrument cluster when the high beams are on.

### Driving with Intellibeam

The system only activates the high beams when driving over 40 km/h (25 mph).

There is a sensor near the top center of the windshield that automatically controls the system. Keep this area of the windshield clear of debris to allow for best system performance.

The high-beam headlamps remain on, under the automatic control, until one of the following situations occurs:

- The system detects an approaching vehicle's headlamps.
- The system detects a preceding vehicle's taillamps.
- The outside light is bright enough that high-beam headlamps are not required.
- The vehicle's speed drops below 20 km/h (12 mph).
- The Intellibeam system is disabled by the high/low-beam changer or the flash-to-pass

feature. If this happens, the high/low-beam changer must be activated two times within two seconds to reactivate the Intellibeam system. The instrument cluster light will come on to indicate the Intellibeam system is reactivated. See *Headlamp High/Low-Beam Changer* ⇨ 159 and *Flash-to-Pass* ⇨ 159.

The high beams may not turn off automatically if the system cannot detect another vehicle's lamps because of any of the following:

- The other vehicle's lamps are missing, damaged, obstructed from view, or otherwise undetected.
- The other vehicle's lamps are covered with dirt, snow, and/or road spray.
- The other vehicle's lamps cannot be detected due to dense exhaust, smoke, fog, snow, road spray, mist, or other airborne obstructions.

- The vehicle's windshield is dirty, cracked, or obstructed by something that blocks the view of the light sensor.
- The vehicle is loaded such that the front end points upward, causing the light sensor to aim high and not detect headlamps and taillamps.
- Driving on winding or hilly roads.

The automatic high-beam headlamps may need to be disabled if any of the above conditions exist.

## Exterior Lamps Off Reminder

A warning chime sounds if the driver door is opened while the ignition is off and the exterior lamps are on.

## Headlamp High/Low-Beam Changer

 : Push the turn signal lever away from you and release, to turn the high beams on. To return to low beams, push the lever again or pull it toward you and release.



This indicator light turns on in the instrument cluster when the high-beam headlamps are on.

## Flash-to-Pass

To flash the high beams, pull the turn signal lever toward you, and release.

## Daytime Running Lamps (DRL)

DRL can make it easier for others to see the front of the vehicle during the day. Fully functional DRL are required on all vehicles first sold in Canada.

The DRL system comes on when the following conditions are met:

- The ignition is on.
- The exterior lamp control is in AUTO.

- The transmission is not in P (Park).
- The light sensor determines it is daytime.

When the DRL system is on, only the DRL are on. The taillamps, sidemarker lamps, instrument panel lights, and other lamps will not be on.

When it begins to get dark, the automatic headlamp system switches from DRL to the headlamps.

To turn off the DRL, turn the exterior lamp control to the off position and then release. For vehicles first sold in Canada, off will only work when the vehicle is in P (Park).

## Automatic Headlamp System

When the exterior lamp control is set to AUTO and it is dark enough outside, the headlamps come on automatically.



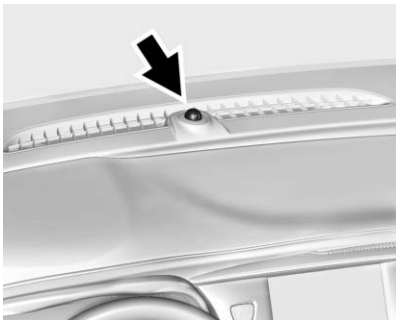



There is a light sensor on top of the instrument panel. Do not cover the sensor; otherwise the headlamps will come on when they are not needed.

The system may also turn on the headlamps when driving through a parking garage or tunnel.

When it is bright enough outside, the headlamps will turn off or may change to Daytime Running Lamps (DRL).

The automatic headlamp system turns off when the exterior lamp control is turned to  or the ignition is off.

### Lights On with Wipers

If the windshield wipers are activated in daylight with the engine on, and the exterior lamp control is in AUTO, the headlamps, parking lamps, and other exterior lamps come on. The transition time for the lamps coming on varies based on wiper speed. When the wipers are not operating, these lamps turn off. Move the exterior lamp control to  or  to disable this feature.

### Adaptive Forward Lighting (AFL)

If equipped with the AFL System, the headlamps pivot horizontally to provide greater road illumination while turning.

To enable AFL, set the exterior lamp control to the AUTO position. Moving the control out of AUTO will deactivate the system. AFL will operate when the vehicle speed is greater than 3 km/h (2 mph). AFL will not operate when the transmission is in R (Reverse). AFL is not immediately operable after

starting the vehicle; driving a short distance is required to calibrate the AFL. See *Exterior Lamp Controls* ⇨ 157.

### Headlamp Leveling Control

#### Automatic Headlamp Leveling

If equipped, the level of the headlamps is adjusted automatically based on the vehicle load.

Headlamp aiming is important to safe driving. If the headlamps require aiming or the automatic headlamp leveling system is malfunctioning, see your dealer for service.

## Hazard Warning Flashers

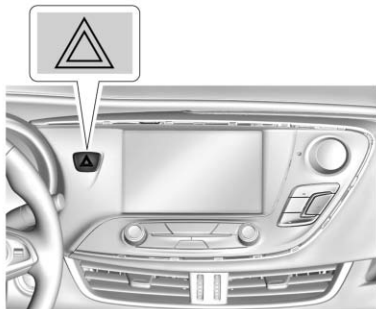

 : Press this button to make the front and rear turn signal lamps flash on and off. Press again to turn the flashers off.

The hazard warning flashers turn on automatically if the airbags deploy.

## Turn and Lane-Change Signals

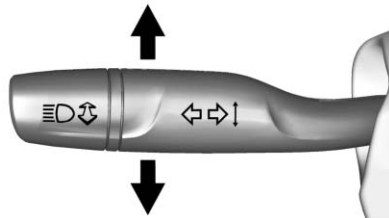

Move the lever all the way up or down to signal a turn.

An arrow on the instrument cluster flashes in the direction of the turn or lane change.

Raise or lower the lever until the arrow starts to flash to signal a lane change. Hold it there until the lane change is completed. If the lever is briefly pressed and released, the turn signal flashes three times.

The turn and lane-change signal can be turned off manually by moving the lever back to its original position.

If after signaling a turn or lane change, the arrow flashes rapidly or does not come on, a signal bulb may be burned out.

Replace any burned out bulbs. If a bulb is not burned out, check the fuse. See *Fuses and Circuit Breakers* ⇨ 261.

## Fog Lamps

The ignition and the parking lamps or headlamps must be on for the front fog lamps to work.

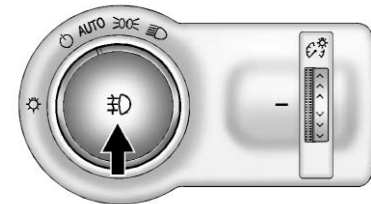

 : If equipped, press to turn on or off. An indicator light on the instrument cluster comes on when the fog lamps are on.

Some localities have laws that require the headlamps to be on along with the fog lamps.

## Interior Lighting

### Instrument Panel Illumination Control

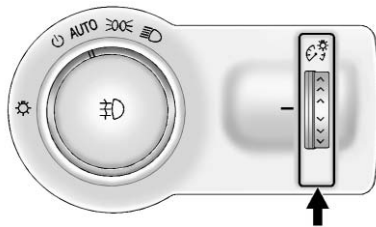

The brightness of the instrument panel lighting and steering wheel controls can be adjusted.

 : Move and hold the thumbwheel up or down to brighten or dim the lights.

### Courtesy Lamps

The courtesy lamps come on when any door is opened and the dome lamp is in the  position.

## Dome Lamps

The dome lamp is in the overhead console.



To change the dome lamp settings, press:

 : Turns the lamp off, even when a door is open.

 : The lamp comes on when a door is opened.

 : Turns the lamp on.

## Reading Lamps

There are reading lamps on the overhead console and over the rear passenger doors. These lamps come on when any door is opened.



**Front Reading Lamps**

The reading lamps in the overhead console are operated by touch. Touch the lamp for dim light, touch again for bright light, and touch again to turn the light off.

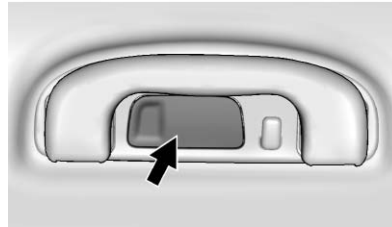



**Rear Reading Lamps**

Press the lamp lens to turn the rear passenger reading lamps on or off.

## Lighting Features

### Entry Lighting

Some exterior lamps and most of the interior lights turn on briefly at night, or in areas of limited lighting when  is pressed on the Remote Keyless Entry (RKE) transmitter. See *Remote Keyless Entry (RKE) System Operation* ⇨ 27. When the driver door is opened, all control lights, Driver Information Center (DIC) lights, and door pocket lights turn on. After about 30 seconds the exterior lamps turn off, then the remaining interior lights dim to off. Entry lighting can be disabled manually by changing the ignition out of the OFF position, or by pressing  on the RKE transmitter.

This feature can be changed. See “Vehicle Locator Lights” under *Vehicle Personalization* ⇨ 147.

## Exit Lighting

Some exterior lamps and interior lights come on at night, or in areas with limited lighting, when the driver door is opened after the ignition is turned off. The dome lamp comes on after the ignition is changed to the OFF position. The exterior lamps and dome lamp remain on for a set amount of time, then automatically turn off.

The exterior lamps turn off immediately by turning the exterior lamp control off.



This feature can be changed. See *Vehicle Personalization* ⇨ 147.

## Battery Power Protection

The battery saver feature is designed to protect the vehicle's battery.

If some interior lamps are left on and the ignition is turned off, the battery rundown protection system automatically turns the lamp off after some time.

## Exterior Lighting Battery Saver

The exterior lamps turn off about 10 minutes after the ignition is turned off, if the parking lamps or headlamps have been manually left on. This protects against draining the battery. To restart the 10-minute timer, turn the exterior lamp control to the  position and then back to the  or  position.

To keep the lamps on for more than 10 minutes, the ignition must be in the ACC/ACCESSORY or ON/RUN/START position.

# Infotainment System

## Introduction

Infotainment ..... 165

## Introduction

### Infotainment

See the infotainment manual for information on the radio, audio players, phone, navigation system, and voice or speech recognition. It also includes information on settings.

## Climate Controls

### Climate Control Systems

Dual Automatic Climate Control System .....	166
Rear Climate Control System .....	169

### Air Vents

Air Vents .....	170
-----------------	-----

### Maintenance

Passenger Compartment Air Filter .....	171
--	-----

## Climate Control Systems

### Dual Automatic Climate Control System

The heating, cooling, and ventilation for the vehicle can be controlled with this system.

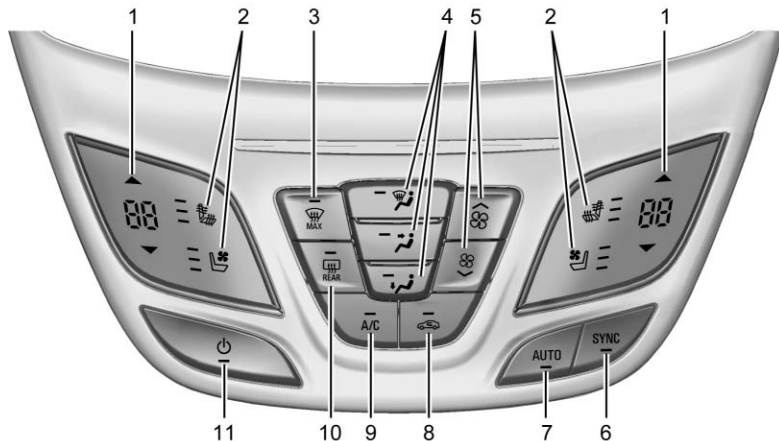

1. Driver and Passenger Temperature Controls
2. Heated and Cooled Front Seats (If Equipped)

3. Defrost
4. Air Delivery Mode Controls
5. Fan Control

6. SYNC (Synchronized Temperature)
7. AUTO (Automatic Operation)
8. Recirculation
9. A/C (Air Conditioning)
10. Rear Window Defogger
11. Power

### Automatic Operation

The system automatically controls the fan speed, air delivery, air conditioning, and recirculation in order to heat or cool the vehicle to the desired temperature:

When AUTO is lit, all four functions operate automatically. Each function can also be manually set and the selected setting is displayed. Functions not manually set will continue to be automatically controlled, even if the AUTO indicator is not lit.

For automatic operation:

1. Press AUTO.

2. Set the temperature. Allow the system time to stabilize. Adjust the temperature as needed for best comfort.



To improve fuel efficiency and to cool the vehicle faster, recirculation may be automatically selected in warm weather. The recirculation light will not come on. Press  to select recirculation; press it again to select outside air.

**▲ / ▼** : The temperature can be adjusted separately for the driver and the passenger. Press to increase or decrease the temperature.

**SYNC** : Press to link the passenger and rear climate temperature settings to the driver setting. The SYNC indicator light will turn on. When the passenger or rear climate settings are adjusted, the SYNC indicator light turns off.



### Manual Operation

 : Press to turn the fan off or on.

**▲  or  ▼** : Press to increase or decrease the fan speed. The fan speed setting appears on the main

display. Pressing either button cancels automatic fan control and the fan is controlled manually. Press AUTO to return to automatic operation.

### Air Delivery Mode Controls :

Press , , or  to change the direction of the airflow. The indicator light in the button will turn on. Any combination of the three buttons can be selected. The indicator light in the button will turn on. The current mode appears in the display screen. Pressing any of the three buttons cancels automatic air delivery control and the direction of the airflow is controlled manually. Press AUTO to return to automatic operation.

To change the current mode, select one or more of the following:

 : Clears the windows of fog or moisture. Air is directed to the windshield.

 : Air is directed to the instrument panel outlets.

 : Air is directed to the floor outlets.



 **MAX** : Air is directed to the windshield and the fan runs at a higher speed. Fog or frost is cleared from the windshield more quickly. When the button is pressed again, the system returns to the previous mode setting.

For best results, clear all snow and ice from the windshield before defrosting.

**A/C** : Press to turn the air conditioning system on or off. If the climate control system is turned off or the outside temperature falls below freezing, the air conditioner will not run.

Pressing this button cancels automatic air conditioning and turns off the air conditioner. Press AUTO to return to automatic operation and the air conditioner runs automatically as needed. When the indicator light is on, the air conditioner runs automatically to cool the air inside the vehicle or to dry the air needed to defog the windshield faster.

 : Press to turn on recirculation. An indicator light comes on. Air is recirculated to quickly cool the inside of the vehicle or to reduce the entry of outside air and odors.

**Auto Defog** : The climate control system may have a sensor to automatically detect high humidity inside the vehicle. When high humidity is detected, the climate control system may adjust to outside air supply and turn on the air conditioner. The fan speed may slightly increase to help prevent fogging. If the climate control system does not detect possible window fogging, it returns to normal operation.

To turn Auto Defog off or on, see “Climate and Air Quality” under *Vehicle Personalization* ⇨ 147.

### Rear Window Defogger

 **REAR** : Press to turn the rear window defogger on or off. An indicator light on the button comes on to show that the rear window defogger is on.

The defogger can be turned off by turning the ignition to ACC/ACCESSORY or LOCK/OFF.

The rear window defogger can be set to automatic operation. See “Climate and Air Quality” under *Vehicle Personalization* ⇨ 147. When auto rear defog is selected, the rear window defogger turns on automatically when the interior temperature is cold and the outside temperature is about 7 °C (44 °F) and below. The auto rear defogger turns off automatically.

If the vehicle is equipped with heated outside rearview mirrors, they turn on when the rear window defogger button is on and help to clear fog or frost from the surface of the mirror. See *Heated Mirrors* ⇨ 45.





### Caution



Do not try to clear frost or other material from the inside of the front windshield and rear window with a razor blade or anything else that is sharp. This may

(Continued)

**Caution (Continued)**

damage the rear window defogger grid and affect the radio's ability to pick up stations clearly. The repairs would not be covered by the vehicle warranty.

 or  : Press  or  to heat the driver or passenger seat.

Press  or , if equipped, to ventilate the driver or passenger seat. See *Heated and Ventilated Front Seats* ⇨ 56.

**Sensor**

The solar sensor on top of the instrument panel near the windshield, monitors the solar heat.

The climate control system uses the sensor information to adjust the temperature, fan speed, recirculation, and air delivery mode for best comfort.

Do not cover the sensor; otherwise the automatic climate control system may not work properly.

**Rear Climate Control System**

If equipped, the rear climate control system is on the rear of the center console storage. The rear climate settings can be adjusted with this system.

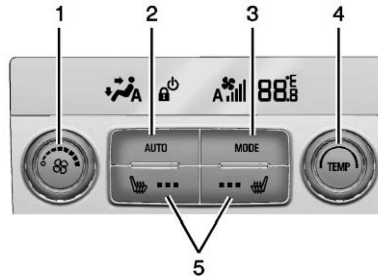

1. Fan Control
2. AUTO (Automatic Operation)
3. MODE (Air Delivery Mode Control)
4. TEMP (Temperature Control)
5. Heated Rear Seats

**Automatic Operation**

**AUTO** : Press AUTO to control the inside temperature, air delivery, and fan speed. A is indicated in the display when automatic operation is active. If any of the climate control settings are manually adjusted, this cancels full automatic operation.

The display only indicates climate control functions when the system is in rear independent mode.

**Manual Operation**





 : Turn clockwise or counterclockwise to increase or decrease the fan speed. Turn completely counterclockwise to turn the fan/power off.

**TEMP** : Turn clockwise or counterclockwise to increase or decrease the airflow temperature into the passenger area. If the SYNC button is pressed on the front climate controls, the rear climate temperature is linked to the driver temperature setting.

**MODE** : Press to change the direction of the airflow in the vehicle. Repeatedly press the button until

the desired mode appears on the display. Multiple presses will cycle through the delivery selections.

If the air delivery mode is directing all the air to the floor, the rear fan speed indicator will change when the knob is turned, but the airflow amount will not. This is normal operation for the system.

 or  : If equipped, press  or  to heat the left or right outboard seat cushion. See *Heated Rear Seats* ⇨ 59.

## Air Vents

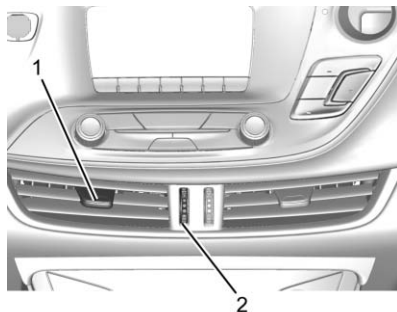

1. Slider Knob
2. Thumbwheel

Use the slider knobs (1) on the air vents to change the direction of the airflow.

Use the thumbwheels (2) near the air vents to control the amount of airflow or to shut off the airflow.

## Operation Tips

- Keep all outlets open whenever possible for best system performance.
- Keep the path under all seats clear of objects to help circulate the air inside the vehicle more effectively.
- Use of non-GM approved hood deflectors can adversely affect the performance of the system.

## Maintenance

### Passenger Compartment Air Filter

The filter removes dust, pollen, and other airborne irritants from outside air that is pulled into the vehicle.

The filter should be replaced as part of routine scheduled maintenance; see *Maintenance Schedule* ⇨ 310. To find out what type of filter to use, see *Maintenance Replacement Parts* ⇨ 319.

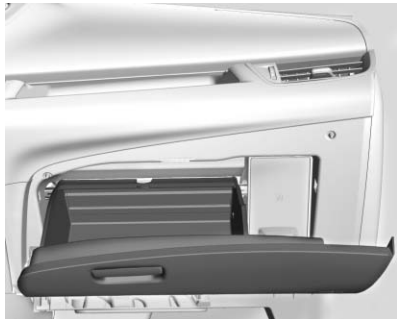

1. Open the glove box.

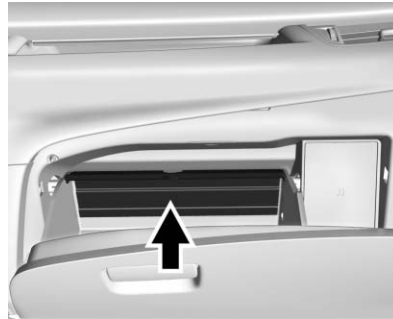

2. Remove the glove box rear wall.
3. Disconnect the glove box door damper string from the glove box door assembly. A pen or pencil may be inserted through the end of the damper string to prevent the string from slipping inside the housing assembly.
4. Squeeze both sides of the glove box bin inward to lower beyond the stops.

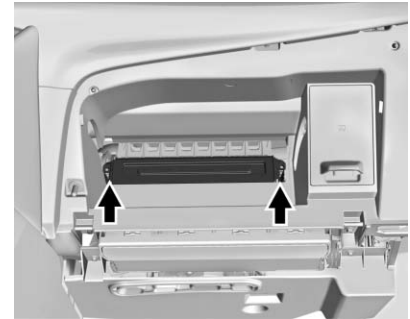

5. Release the latches on either side of the service door. Open the service door and remove the old filter.
6. Install the new air filter.
7. Close the service door completely.
8. Reverse the steps to reinstall the glove box.

See your dealer if additional assistance is needed.

# Driving and Operating

## Driving Information

Driver Behavior .....	173
Driving Environment .....	173
Vehicle Design .....	173
Distracted Driving .....	174
Defensive Driving .....	174
Drunk Driving .....	175
Control of a Vehicle .....	175
Braking .....	175
Steering .....	175
Off-Road Recovery .....	176
Loss of Control .....	176
Driving on Wet Roads .....	177
Hill and Mountain Roads .....	178
Winter Driving .....	178
If the Vehicle Is Stuck .....	179
Vehicle Load Limits .....	180

## Starting and Operating

New Vehicle Break-In .....	184
Ignition Positions .....	184
Starting the Engine .....	186
Engine Heater .....	187
Retained Accessory Power (RAP) .....	189
Shifting Into Park .....	189

Shifting out of Park .....	190
Parking over Things That Burn .....	190
Extended Parking .....	190

## Engine Exhaust

Engine Exhaust .....	191
Running the Vehicle While Parked .....	191

## Automatic Transmission

Automatic Transmission .....	192
Manual Mode .....	194

## Drive Systems

All-Wheel Drive .....	195
-----------------------	-----

## Brakes

Antilock Brake System (ABS) .....	195
Electric Parking Brake .....	196
Brake Assist .....	197
Hill Start Assist (HSA) .....	197

## Ride Control Systems

Traction Control/Electronic Stability Control .....	198
--	-----

## Cruise Control

Cruise Control .....	200
Adaptive Cruise Control .....	202

## Driver Assistance Systems

Driver Assistance Systems ...	209
Assistance Systems for Parking or Backing .....	210
Assistance Systems for Driving .....	214
Forward Collision Alert (FCA) System .....	215
Forward Automatic Braking (FAB) .....	217
Side Blind Zone Alert (SBZA) .....	218
Lane Change Alert (LCA) .....	219
Lane Departure Warning (LDW) .....	220
Lane Keep Assist (LKA) .....	221

## Fuel

Fuel .....	222
California Fuel Requirements .....	223
Fuels in Foreign Countries ...	224
Fuel Additives .....	224
Filling the Tank .....	224
Filling a Portable Fuel Container .....	225

## Trailer Towing

General Towing Information .....	226
-------------------------------------	-----

Driving Characteristics and Towing Tips .....	226
Trailer Towing .....	229
Towing Equipment .....	232

### **Conversions and Add-Ons**

Add-On Electrical Equipment .....	233
-----------------------------------	-----

## **Driving Information**

### **Driver Behavior**

Driving is an important responsibility. Driver behavior, the driving environment, and the vehicle's design all affect how well a vehicle performs.

Being aware of these factors can help in understanding how the vehicle handles and what can be done to avoid many types of crashes, including a rollover crash.

Most serious injuries and fatalities to unbelted occupants can be reduced or prevented by the use of safety belts. In a rollover crash, an unbelted person is significantly more likely to die than a person wearing a safety belt. In addition, avoiding excessive speed, sudden or abrupt turns, and drunken or aggressive driving can help make trips safer and avoid the possibility of a crash.

## **Driving Environment**

Be prepared for driving in inclement weather, at night, or during other times where visibility or traction may be limited, such as on curves, slippery roads, or hilly terrain. Unfamiliar surroundings can also have hidden hazards.

Learn more about driving in different conditions and off-road driving in this section.

### **Vehicle Design**

Utility vehicles have a significantly higher rollover rate than other types of vehicles. This is because they have a higher ground clearance and a narrower track or shorter wheelbase than passenger cars, which makes them more capable for off-road driving. While these design characteristics provide the driver with a better view of the road, these vehicles do have a higher center of gravity than other types of vehicles. A utility vehicle does not handle the same as a vehicle with a lower center of gravity, like a car, in similar situations.

Safe driver behavior and understanding of the environment can help avoid a rollover crash in any type of vehicle, including utility vehicles.

## **Distracted Driving**

Distraction comes in many forms and can take your focus from the task of driving. Exercise good judgment and do not let other activities divert your attention away from the road. Many local governments have enacted laws regarding driver distraction. Become familiar with the local laws in your area.

To avoid distracted driving, keep your eyes on the road, keep your hands on the steering wheel, and focus your attention on driving.

- It is against the law to use a phone held in your hand while driving. Use a hands-free method to place or receive necessary phone calls.
- Watch the road. Do not read, take notes, or look up information on phones or other electronic devices.
- Designate a front seat passenger to handle potential distractions.
- Become familiar with vehicle features before driving, such as programming favorite radio stations and adjusting climate control and seat settings. Program all trip information into any navigation device prior to driving.
- Wait until the vehicle is parked to retrieve items that have fallen to the floor.
- Stop or park the vehicle to tend to children.
- Keep pets in an appropriate carrier or restraint.
- Avoid stressful conversations while driving, whether with a passenger or on a cell phone.

### **Warning**

Taking your eyes off the road too long or too often could cause a crash resulting in injury or death. Focus your attention on driving.

Refer to the infotainment section for more information on using that system, including pairing and using a cell phone.

## **Defensive Driving**

Defensive driving means “always expect the unexpected.” The first step in driving defensively is to wear the safety belt. See *Safety Belts* ⇨ 60.

- Assume that other road users (pedestrians, bicyclists, and other drivers) are going to be careless and make mistakes. Anticipate what they might do and be ready.
- Allow enough following distance between you and the driver in front of you.

- Focus on the task of driving.

## Drunk Driving

Death and injury associated with drinking and driving is a global tragedy.

### Warning

Drinking and then driving is very dangerous. Your reflexes, perceptions, attentiveness, and judgment can be affected by even a small amount of alcohol. You can have a serious — or even fatal — collision if you drive after drinking.

Do not drink and drive or ride with a driver who has been drinking. Ride home in a cab; or if you are with a group, designate a driver who will not drink.

## Control of a Vehicle

Braking, steering, and accelerating are important factors in helping to control a vehicle while driving.

## Braking

Braking action involves perception time and reaction time. Deciding to push the brake pedal is perception time. Actually doing it is reaction time.

Average driver reaction time is about three-quarters of a second. In that time, a vehicle moving at 100 km/h (60 mph) travels 20 m (66 ft), which could be a lot of distance in an emergency.

Helpful braking tips to keep in mind include:

- Keep enough distance between you and the vehicle in front of you.
- Avoid needless heavy braking.
- Keep pace with traffic.

If the engine ever stops while the vehicle is being driven, brake normally but do not pump the brakes. Doing so could make the pedal harder to push down. If the engine stops, there will be some power brake assist but it will be used when the brake is applied.

Once the power assist is used up, it can take longer to stop and the brake pedal will be harder to push.

## Steering

### Electric Power Steering

The vehicle has electric power steering. It does not have power steering fluid. Regular maintenance is not required.

If power steering assist is lost due to a system malfunction, the vehicle can be steered, but may require increased effort. See your dealer if there is a problem.

If the steering wheel is turned until it reaches the end of its travel and is held against that position for an extended period of time, power steering assist may be reduced.

If the steering assist is used for an extended period of time, power assist may be reduced.

Normal use of the power steering assist should return when the system cools down.



See your dealer if there is a problem.

### Curve Tips

- Take curves at a reasonable speed.
- Reduce speed before entering a curve.
- Maintain a reasonable steady speed through the curve.
- Wait until the vehicle is out of the curve before accelerating gently into the straightaway.

### Steering in Emergencies

- There are some situations when steering around a problem may be more effective than braking.
- Holding both sides of the steering wheel allows you to turn 180 degrees without removing a hand.
- The Antilock Brake System (ABS) allows steering while braking.

### Off-Road Recovery

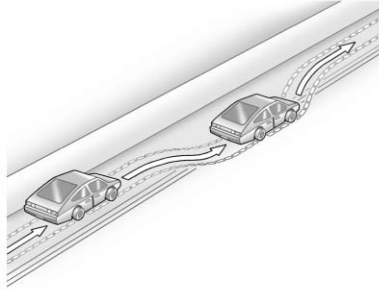

The vehicle's right wheels can drop off the edge of a road onto the shoulder while driving. Follow these tips:

1. Ease off the accelerator and then, if there is nothing in the way, steer the vehicle so that it straddles the edge of the pavement.
2. Turn the steering wheel about one-eighth of a turn, until the right front tire contacts the pavement edge.

3. Turn the steering wheel to go straight down the roadway.

### Loss of Control

#### Skidding

There are three types of skids that correspond to the vehicle's three control systems:

- Braking Skid — wheels are not rolling.
- Steering or Cornering Skid — too much speed or steering in a curve causes tires to slip and lose cornering force.
- Acceleration Skid — too much throttle causes the driving wheels to spin.

Defensive drivers avoid most skids by taking reasonable care suited to existing conditions, and by not overdriving those conditions. But skids are always possible.

If the vehicle starts to slide, follow these suggestions:

- Ease your foot off the accelerator pedal and steer the way you want the vehicle to go.

The vehicle may straighten out. Be ready for a second skid if it occurs.

- Slow down and adjust your driving according to weather conditions. Stopping distance can be longer and vehicle control can be affected when traction is reduced by water, snow, ice, gravel, or other material on the road. Learn to recognize warning clues — such as enough water, ice, or packed snow on the road to make a mirrored surface — and slow down when you have any doubt.
- Try to avoid sudden steering, acceleration, or braking, including reducing vehicle speed by shifting to a lower gear. Any sudden changes could cause the tires to slide.

Remember: Antilock brakes help avoid only the braking skid.

## Driving on Wet Roads

Rain and wet roads can reduce vehicle traction and affect your ability to stop and accelerate.

Always drive slower in these types of driving conditions and avoid driving through large puddles and deep-standing or flowing water.

### Warning

Wet brakes can cause crashes. They might not work as well in a quick stop and could cause pulling to one side. You could lose control of the vehicle.

After driving through a large puddle of water or a car/vehicle wash, lightly apply the brake pedal until the brakes work normally.

Flowing or rushing water creates strong forces. Driving through flowing water could cause the vehicle to be carried away. If this happens, you and other vehicle occupants could drown. Do not ignore police warnings and be very cautious about trying to drive through flowing water.

## Hydroplaning

Hydroplaning is dangerous. Water can build up under the vehicle's tires so they actually ride on the water. This can happen if the road is wet enough and you are going fast enough. When the vehicle is hydroplaning, it has little or no contact with the road.

There is no hard and fast rule about hydroplaning. The best advice is to slow down when the road is wet.

## Other Rainy Weather Tips

Besides slowing down, other wet weather driving tips include:

- Allow extra following distance.
- Pass with caution.
- Keep windshield wiping equipment in good shape.
- Keep the windshield washer fluid reservoir filled.
- Have good tires with proper tread depth. See *Tires* ⇨ 266.
- Turn off cruise control.

## Hill and Mountain Roads

Driving on steep hills or through mountains is different than driving on flat or rolling terrain. Tips include:

- Keep the vehicle serviced and in good shape.
- Check all fluid levels and brakes, tires, cooling system, and transmission.
- Shift to a lower gear when going down steep or long hills.

### **Warning**

Using the brakes to slow the vehicle on a long downhill slope can cause brake overheating, can reduce brake performance, and could result in a loss of braking. Shift the transmission to a lower gear to let the engine assist the brakes on a steep downhill slope.

### **Warning**

Coasting downhill in N (Neutral) or with the ignition off is dangerous. This can cause overheating of the brakes and loss of steering. Always have the engine running and the vehicle in gear.

- Drive at speeds that keep the vehicle in its own lane. Do not swing wide or cross the center line.
- Be alert on top of hills; something could be in your lane (e.g., stalled car, accident).
- Pay attention to special road signs (e.g., falling rocks area, winding roads, long grades, passing or no-passing zones) and take appropriate action.

## Winter Driving

### Driving on Snow or Ice

Snow or ice between the tires and the road creates less traction or grip, so drive carefully. Wet ice can occur at about 0 °C (32 °F) when freezing rain begins to fall. Avoid driving on wet ice or in freezing rain until roads can be treated.

### For Slippery Road Driving:

- Accelerate gently. Accelerating too quickly causes the wheels to spin and makes the surface under the tires slick.
- Turn on Traction Control. See *Traction Control/Electronic Stability Control* ⇨ 198.
- Antilock Brake System (ABS) improves vehicle stability during hard stops, but the brakes should be applied sooner than when on dry pavement. See *Antilock Brake System (ABS)* ⇨ 195.
- Allow greater following distance and watch for slippery spots. Icy patches can occur on otherwise

clear roads in shaded areas. The surface of a curve or an overpass can remain icy when the surrounding roads are clear. Avoid sudden steering maneuvers and braking while on ice.

- Turn off cruise control.

### Blizzard Conditions

Stop the vehicle in a safe place and signal for help. Stay with the vehicle unless there is help nearby. If possible, use Roadside Assistance. See *Roadside Assistance Program* ⇨ 328. To get help and keep everyone in the vehicle safe:

- Turn on the hazard warning flashers.
- Tie a red cloth to an outside mirror.

### Warning

Snow can trap engine exhaust under the vehicle. This may cause exhaust gases to get inside. Engine exhaust contains carbon monoxide (CO), which cannot be seen or smelled. It can cause unconsciousness and even death.

If the vehicle is stuck in snow:

- Clear snow from the base of the vehicle, especially any blocking the exhaust pipe.
- Open a window about 5 cm (2 in) on the vehicle side that is away from the wind, to bring in fresh air.
- Fully open the air outlets on or under the instrument panel.
- Adjust the climate control system to circulate the air inside the vehicle and set

(Continued)

### Warning (Continued)

the fan speed to the highest setting. See “Climate Control Systems.”

For more information about CO, see *Engine Exhaust* ⇨ 191.

To save fuel, run the engine for short periods to warm the vehicle and then shut the engine off and partially close the window. Moving about to keep warm also helps.

If it takes time for help to arrive, when running the engine, push the accelerator pedal slightly so the engine runs faster than the idle speed. This keeps the battery charged to restart the vehicle and to signal for help with the headlamps. Do this as little as possible, to save fuel.

### If the Vehicle Is Stuck

Slowly and cautiously spin the wheels to free the vehicle when stuck in sand, mud, ice, or snow.

If stuck too severely for the traction system to free the vehicle, turn the traction system off and use the rocking method. See *Traction Control/Electronic Stability Control* ⇨ 198.

 **Warning**

If the vehicle's tires spin at high speed, they can explode, and you or others could be injured. The vehicle can overheat, causing an engine compartment fire or other damage. Spin the wheels as little as possible and avoid going above 56 km/h (35 mph).

**Rocking the Vehicle to Get it Out**

Turn the steering wheel left and right to clear the area around the front wheels. Turn off any traction system. Shift back and forth between R (Reverse) and a low forward gear, spinning the wheels as little as possible. To prevent transmission wear, wait until the wheels stop spinning before shifting

gears. Release the accelerator pedal while shifting, and press lightly on the accelerator pedal when the transmission is in gear. Slowly spinning the wheels in the forward and reverse directions causes a rocking motion that could free the vehicle. If that does not get the vehicle out after a few tries, it might need to be towed out. If the vehicle does need to be towed out, see *Towing the Vehicle* ⇨ 295.

**Vehicle Load Limits**

It is very important to know how much weight the vehicle can carry. This weight is called the vehicle capacity weight and includes the weight of all occupants, cargo, and all nonfactory-installed options. Two labels on the vehicle may show how much weight it may properly carry, the Tire and Loading Information label and the Certification/Tire label.

 **Warning**

Do not load the vehicle any heavier than the Gross Vehicle Weight Rating (GVWR), or either the maximum front or rear Gross Axle Weight Rating (GAWR). This can cause systems to break and change the way the vehicle handles. This could cause loss of control and a crash. Overloading can also reduce stopping distance, damage the tires, and shorten the life of the vehicle.

## Tire and Loading Information Label

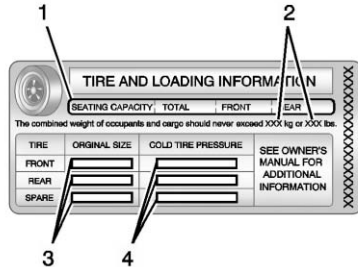

### Example Label

A vehicle-specific Tire and Loading Information label is attached to the center pillar (B-pillar). The tire and loading information label shows the number of occupant seating positions (1), and the maximum vehicle capacity weight (2) in kilograms and pounds.

The Tire and Loading Information label also shows the size of the original equipment tires (3) and the recommended

cold tire inflation pressures (4). For more information on tires and inflation see *Tires* ⇨ 266 and *Tire Pressure* ⇨ 273.

There is also important loading information on the vehicle Certification/Tire label. It may show the Gross Vehicle Weight Rating (GVWR) and the Gross Axle Weight Rating (GAWR) for the front and rear axle. See "Certification/Tire Label" later in this section.

### "Steps for Determining Correct Load Limit—

1. Locate the statement "The combined weight of occupants and cargo should never exceed XXX kg or XXX lbs." on your vehicle's placard.
2. Determine the combined weight of the driver and passengers that will be riding in your vehicle.
3. Subtract the combined weight of the driver and passengers from XXX kg or XXX lbs.
4. The resulting figure equals the available amount of cargo and luggage load capacity. For example, if the "XXX" amount equals 1400 lbs. and there will be five 150 lb passengers in your vehicle, the amount of available cargo and luggage load capacity is 650 lbs. (1400-750 (5 x 150) = 650 lbs.)
5. Determine the combined weight of luggage and cargo being loaded on the vehicle. That weight may not safely exceed the available cargo and luggage load capacity calculated in Step 4.
6. If your vehicle will be towing a trailer, load from your trailer will be transferred to

your vehicle. Consult this manual to determine how this reduces the available cargo and luggage load capacity of your vehicle."

See *Trailer Towing* ⇨ 229 for important information on towing a trailer, towing safety rules and trailering tips.

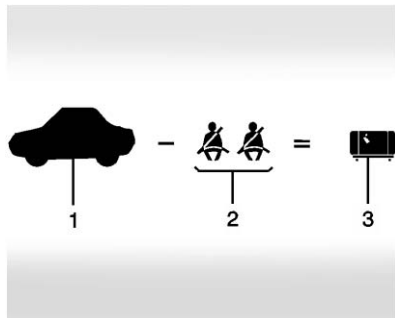

**Example 1**

1. Vehicle Capacity Weight for Example 1 = 453 kg (1,000 lbs).

2. Subtract Occupant Weight @ 68 kg (150 lbs) × 2 = 136 kg (300 lbs).
3. Available Occupant and Cargo Weight = 317 kg (700 lbs).

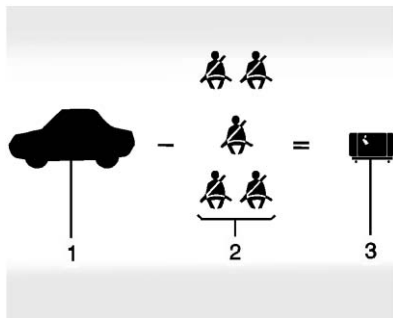

**Example 2**

1. Vehicle Capacity Weight for Example 2 = 453 kg (1,000 lbs).
2. Subtract Occupant Weight @ 68 kg (150 lbs) × 5 = 340 kg (750 lbs).
3. Available Cargo Weight = 113 kg (250 lbs).

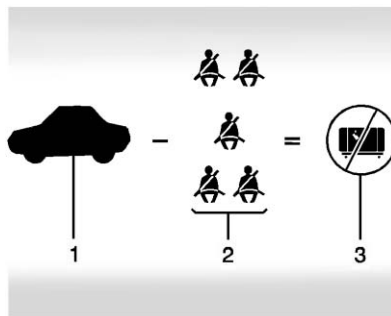

**Example 3**

1. Vehicle Capacity Weight for Example 3 = 453 kg (1,000 lbs).
2. Subtract Occupant Weight @ 91 kg (200 lbs) × 5 = 453 kg (1,000 lbs).
3. Available Cargo Weight = 0 kg (0 lbs).

Refer to the vehicle's tire and loading information label for specific information about the vehicle's capacity weight and seating positions. The combined

weight of the driver, passengers, and cargo should never exceed the vehicle's capacity weight.

### Certification/Tire Label

### Label Example

A vehicle-specific Certification/Tire label is attached to the center pillar (B-pillar).

The label may show the size of the vehicle's original tires and the inflation pressures needed to obtain the gross weight capacity of the vehicle. The label shows the gross weight capacity of the vehicle. This is called the Gross

Vehicle Weight Rating (GVWR). The GVWR includes the weight of the vehicle, all occupants, fuel, and cargo.

The Certification/Tire label may also show the maximum weights for the front and rear axles, called the Gross Axle Weight Rating (GAWR). To find out the actual loads on the front and rear axles, weigh the vehicle at a weigh station. Your dealer can help with this. Be sure to spread the load equally on both sides of the centerline.

### Caution

Overloading the vehicle may cause damage. Repairs would not be covered by the vehicle warranty. Do not overload the vehicle.

### Warning

Things inside the vehicle can strike and injure people in a sudden stop or turn, or in a crash.

- Put things in the cargo area of the vehicle. In the cargo area, put them as far forward as possible. Try to spread the weight evenly.
- Never stack heavier things, like suitcases, inside the vehicle so that some of them are above the tops of the seats.
- Do not leave an unsecured child restraint in the vehicle.
- Secure loose items in the vehicle.
- Do not leave a seat folded down unless needed.



## Starting and Operating

### New Vehicle Break-In

#### Caution

The vehicle does not need an elaborate break-in. But it will perform better in the long run if you follow these guidelines:

- Do not drive at any one constant speed, fast or slow, for the first 805 km (500 mi). Do not make full-throttle starts. Avoid downshifting to brake or slow the vehicle.
- Avoid making hard stops for the first 322 km (200 mi) or so. During this time the new brake linings are not yet broken in. Hard stops with new linings can mean premature wear and earlier replacement. Follow this

(Continued)

#### Caution (Continued)

breaking-in guideline every time you get new brake linings.

Following break-in, engine speed and load can be gradually increased.

### Ignition Positions

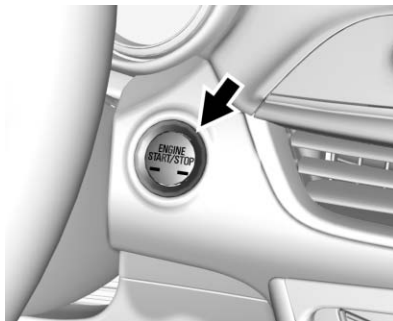

The vehicle has an electronic keyless ignition with pushbutton start.

The Remote Keyless Entry (RKE) transmitter must be in the vehicle for the system to operate. If the pushbutton start is not working, the vehicle may be near a strong radio antenna signal causing interference to the Keyless Access system. See *Remote Keyless Entry (RKE) System Operation* ⇨ 27.

To shift out of P (Park), the vehicle must be in ON/RUN and the brake pedal must be applied.

**Stopping the Engine/LOCK/OFF (No Indicator Lights)** : When the vehicle is stopped, press ENGINE START/STOP once to turn the engine off.

If the vehicle is in P (Park), the ignition will turn off, and Retained Accessory Power (RAP) will remain active. See *Retained Accessory Power (RAP)* ⇨ 189.

If the vehicle is not in P (Park), the ignition will return to ACC/ACCESSORY and display the message SHIFT TO PARK in the Driver Information Center (DIC). See *Transmission Messages* ⇨ 146.

When the vehicle is shifted into P (Park), the ignition system will switch to OFF.

The vehicle may have an electric steering column lock. The lock is activated when the vehicle is switched to OFF and either front door is opened. A sound may be heard as the lock actuates or releases. The steering column lock may not release with the wheels turned off center. If this happens, the vehicle may not start. Move the steering wheel from left to right while attempting to start the vehicle. If this does not work, the vehicle needs service.

Do not turn the engine off when the vehicle is moving. This will cause a loss of power assist in the brake and steering systems and disable the airbags.

If the vehicle must be shut off in an emergency:

1. Brake using a firm and steady pressure. Do not pump the brakes repeatedly. This may deplete power assist, requiring increased brake pedal force.

2. Shift the vehicle to N (Neutral). This can be done while the vehicle is moving. After shifting to N (Neutral), firmly apply the brakes and steer the vehicle to a safe location.
3. Come to a complete stop, shift to P (Park), and turn the ignition to OFF. On vehicles with an automatic transmission, the shift lever must be in P (Park) to turn the ignition switch to the OFF position.
4. Set the parking brake. See *Electric Parking Brake* ⇨ 196.

### Warning

Turning off the vehicle while moving may cause loss of power assist in the brake and steering systems and disable the airbags. While driving, only shut the vehicle off in an emergency.

If the vehicle cannot be pulled over and must be shut off while driving, press and hold ENGINE START/STOP for longer than two seconds, or press twice in five seconds.

**ACC/ACCESSORY (Amber Indicator Light)** : This mode allows you to use some electrical accessories when the engine is off.

With the ignition off, pressing the button one time without the brake pedal applied will place the ignition system in ACC/ACCESSORY.

The ignition will switch from ACC/ACCESSORY to OFF after five minutes to prevent battery rundown.

**ON/RUN/START (Green Indicator Light)** : This mode is for driving and starting. With the ignition off and the brake pedal applied, pressing the button once will place the ignition system in ON/RUN/START. Once engine cranking begins, release the button. Engine cranking will continue until the engine starts. See *Starting the Engine* ⇨ 186. The ignition will then remain in ON/RUN.

**Service Only Mode**

This power mode is available for service and diagnostics, and to verify the proper operation of the malfunction indicator lamp as may be required for emission inspection purposes. With the vehicle off and the brake pedal not applied, pressing and holding the button for more than five seconds will place the vehicle in Service Only Mode. The instruments and audio systems will operate as they do in ON/RUN, but the vehicle will not be able to be driven. The engine will not start in Service Only Mode. Press the button again to turn the vehicle off.

**Starting the Engine**

Move the shift lever to P (Park) or N (Neutral). To restart the engine when the vehicle is already moving, use N (Neutral) only.

**Caution**

Do not try to shift to P (Park) if the vehicle is moving. If you do, you could damage the transmission. Shift to P (Park) only when the vehicle is stopped.

**Caution**

If you add electrical parts or accessories, you could change the way the engine operates. Any resulting damage would not be covered by the vehicle warranty. See *Add-On Electrical Equipment* ⇨ 233.

**Starting Procedure**

1. With the Keyless Access system, the RKE transmitter must be in the vehicle. Press ENGINE START/STOP with the brake pedal applied. When the engine begins cranking, let go of the button.

The idle speed will go down as the engine gets warm. Do not race the engine immediately after starting it.

**Caution**

Cranking the engine for long periods of time, by returning the ignition to the START position immediately after cranking has ended, can overheat and damage the cranking motor, and drain the battery. Wait at least 15 seconds between each try, to let the cranking motor cool down.

2. If the engine does not start after five to 10 seconds, especially in very cold weather (below  $-18^{\circ}\text{C}$  or  $0^{\circ}\text{F}$ ), it could be flooded with too much gasoline. Try pushing the accelerator pedal all the way to the floor and holding it there as you hold ENGINE START/STOP for up to a maximum of 15 seconds. Wait at least 15 seconds between each try, to allow the cranking motor to

cool down. When the engine starts, let go of the button and the accelerator. If the vehicle starts briefly but then stops again, do the same thing. This clears the extra gasoline from the engine. Do not race the engine immediately after starting it. Operate the engine and transmission gently until the oil warms up and lubricates all moving parts.

## Stop/Start System

### Warning

Exiting the vehicle without first shifting into P (Park) may cause the vehicle to move. You or others may be injured. Because the vehicle has the auto engine stop/start feature, the vehicle's engine might seem to be shut off; however, once the brake pedal is released, the engine will start up again.

(Continued)

### Warning (Continued)

Shift to P (Park) and turn the ignition to LOCK/OFF, before exiting the vehicle.

The vehicle has a fuel saving stop/start system to shut off the engine to help conserve fuel.

### Auto Engine Stop/Start

When the brakes are applied and the vehicle is at a complete stop, the engine may turn off. When stopped, the tachometer displays AUTO STOP. See *Tachometer* ⇨ 116. When the brake pedal is released or the accelerator pedal is pushed, the engine will restart.

Auto Stop may be deactivated if:

- A minimum vehicle speed is not reached.
- The engine or transmission is not at the required operating temperature.

- The outside temperature is not in the required operating range, typically between  $-10^{\circ}\text{C}$  ( $14^{\circ}\text{F}$ ) and  $50^{\circ}\text{C}$  ( $122^{\circ}\text{F}$ ).
- The shift lever is in any gear other than D (Drive).
- The battery charge is low.
- The interior comfort level has not reached the required level for the climate control system or defog settings.
- The Auto Stop time is greater than two minutes.

## Engine Heater

The vehicle may have an engine heater. The engine heater can help in cold weather conditions at or below  $-18^{\circ}\text{C}$  ( $0^{\circ}\text{F}$ ) for easier starting and better fuel economy during engine warm-up. Plug in the heater at least four hours before starting the vehicle. An internal thermostat in the plug end of the cord will prevent engine heater operation at temperatures above  $-18^{\circ}\text{C}$  ( $0^{\circ}\text{F}$ ).

**To Use The Engine Heater**

1. Turn off the engine.

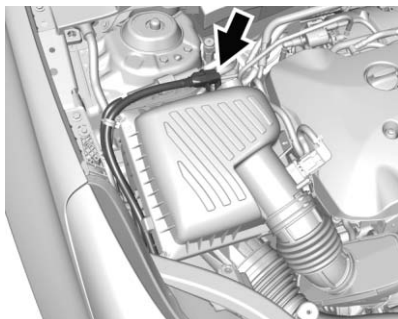

3. Open the hood and unwrap the electrical cord. The cord is in the driver side of the engine compartment, near the battery. It is shipped from the factory with a tie holding it in place. Use care in removing the tie so that the cord is not damaged.

Check the heater cord for damage. If it is damaged, do not use it. See your dealer for a replacement. Inspect the cord for damage yearly.

4. Plug it into a normal, grounded 110-volt AC outlet.

**⚠ Warning**

Improper use of the heater cord or an extension cord can damage the cord and may result in overheating and fire.

- Plug the cord into a three-prong electrical utility receptacle that is protected by a ground fault detection function. An ungrounded outlet could cause an electric shock.
- Use a weatherproof, heavy-duty, 15 amp-rated extension cord if needed. Failure to use the recommended extension cord in good operating condition, or using a damaged heater or extension cord, could make

(Continued)

**Warning (Continued)**

it overheat and cause a fire, property damage, electric shock, and injury.

- Do not operate the vehicle with the heater cord permanently attached to the vehicle. Possible heater cord and thermostat damage could occur.
  - While in use, do not let the heater cord touch vehicle parts or sharp edges. Never close the hood on the heater cord.
  - Before starting the vehicle, unplug the cord, reattach the cover to the plug, and securely fasten the cord. Keep the cord away from any moving parts.
5. Before starting the engine, be sure to unplug and store the cord as it was before to keep it

away from moving engine parts. If you do not it could be damaged.

The length of time the heater should remain plugged in depends on several factors. Ask a dealer in the area where you will be parking the vehicle for the best advice on this.

## Retained Accessory Power (RAP)

These vehicle accessories can be used for up to 10 minutes after the engine is turned off:

- Audio system
- Power windows
- Sunroof (if equipped)

Power to the audio system will continue to operate for up to 10 minutes or until the driver door is opened.

Power to the power windows and sunroof will continue to operate for up to 10 minutes or until any door is opened.

All these features will work when the vehicle is in ON/RUN or ACC/ACCESSORY.

## Shifting Into Park

To shift into P (Park):

1. Hold the brake pedal down and set the parking brake.

See *Electric Parking Brake* ⇨ 196.

2. Move the shift lever into P (Park) by holding in the button on the back of the shift lever and pushing the lever all the way toward the front of the vehicle.
3. Turn the ignition to LOCK/OFF.
4. Take the Remote Keyless Entry (RKE) transmitter with you.

## Leaving the Vehicle with the Engine Running

### Warning

It can be dangerous to leave the vehicle with the engine running. It could overheat and catch fire.

It is dangerous to get out of the vehicle if the shift lever is not fully in P (Park) with the parking brake firmly set. The vehicle can roll.

Do not leave the vehicle when the engine is running. If you have left the engine running, the vehicle can move suddenly. You or others could be injured. To be sure the vehicle will not move, even when you are on fairly level ground, always set the parking brake and move the shift lever to P (Park). See *Shifting Into Park* ⇨ 189.

If you have to leave the vehicle with the engine running, the vehicle must be in P (Park) and the parking brake set. After shifting into P (Park), try to move the shift lever without first

pressing the button on the shift lever. If you can, the shift lever was not fully locked into P (Park).

### **Torque Lock**

Torque lock is when the weight of the vehicle puts too much force on the parking pawl in the transmission. This happens when parking on a hill and shifting the transmission into P (Park) is not done properly and then it is difficult to shift out of P (Park). To prevent torque lock, set the parking brake and then shift into P (Park). To find out how, see "Shifting Into Park" listed previously.

If torque lock does occur, the vehicle may need to be pushed uphill by another vehicle to relieve the parking pawl pressure, so you can shift out of P (Park).

### **Shifting out of Park**

To shift out of P (Park):

1. Apply the brake pedal.
2. Turn the ignition to ON/RUN.
3. Press the shift lever button.

4. Move the shift lever.

If you still are unable to shift out of P (Park):

1. Fully release the shift lever button.
2. Hold the brake pedal down and press the shift lever button again.
3. Move the shift lever.

If you still cannot move the shift lever from P (Park), see your dealer for service.

### **Parking over Things That Burn**



Things that can burn could touch hot exhaust parts under the vehicle and ignite. Do not park over papers, leaves, dry grass, or other things that can burn.

### **Extended Parking**

It is better not to park with the vehicle running. If the vehicle is left while running, follow the proper steps to be sure the vehicle will not move and there is adequate ventilation. See *Shifting Into Park* ⇨ 189 and *Engine Exhaust* ⇨ 191.

If the vehicle is left in P (Park) while running and the Remote Keyless Entry (RKE) transmitter is outside the vehicle, the vehicle will turn off after one hour.

If the vehicle is left in P (Park) while running and the RKE transmitter is inside, the vehicle will run for two hours. At the end of the second hour, the vehicle will turn off.

The timer will reset if the vehicle is taken out of P (Park) while it is running.

## Engine Exhaust

### Warning

Engine exhaust contains carbon monoxide (CO), which cannot be seen or smelled. Exposure to CO can cause unconsciousness and even death.

Exhaust may enter the vehicle if:

- The vehicle idles in areas with poor ventilation (parking garages, tunnels, deep snow that may block underbody airflow or tail pipes).
- The exhaust smells or sounds strange or different.
- The exhaust system leaks due to corrosion or damage.
- The vehicle exhaust system has been modified, damaged, or improperly repaired.

(Continued)

### Warning (Continued)

- There are holes or openings in the vehicle body from damage or aftermarket modifications that are not completely sealed.

If unusual fumes are detected or if it is suspected that exhaust is coming into the vehicle:

- Drive it only with the windows completely down.
- Have the vehicle repaired immediately.

Never park the vehicle with the engine running in an enclosed area such as a garage or a building that has no fresh air ventilation.

## Running the Vehicle While Parked

It is better not to park with the engine running.

If the vehicle is left with the engine running, follow the proper steps to be sure the vehicle will not move. See *Shifting Into Park* ⇨ 189 and *Engine Exhaust* ⇨ 191.



## Automatic Transmission



**P** : This position locks the front wheels. Use P (Park) when starting the engine because the vehicle cannot move easily.

### Warning

It is dangerous to get out of the vehicle if the shift lever is not fully in P (Park) with the parking brake firmly set. The vehicle can roll.

(Continued)

### Warning (Continued)

Do not leave the vehicle when the engine is running. If you have left the engine running, the vehicle can move suddenly. You or others could be injured. To be sure the vehicle will not move, even when you are on fairly level ground, always set the parking brake and move the shift lever to P (Park). See *Shifting Into Park* ⇨ 189.

The vehicle has an automatic transmission shift lock control system. You must fully apply the regular brake first and then press the shift lever button before shifting from P (Park) when the ignition is in ON/RUN. If you cannot shift out of P (Park), ease pressure on the shift lever, then push the shift lever all the way into P (Park) as you maintain brake application. Then press the shift lever button and move the shift lever into another gear. See *Shifting out of Park* ⇨ 190.

**R** : Use this gear to back up.

### Caution

Shifting to R (Reverse) while the vehicle is moving forward could damage the transmission. The repairs would not be covered by the vehicle warranty. Shift to R (Reverse) only after the vehicle is stopped.

To rock the vehicle back and forth to get out of snow, ice, or sand without damaging the transmission, see *If the Vehicle Is Stuck* ⇨ 179.

**N** : In this position the engine and transmission do not connect. Use N (Neutral) to restart a vehicle that is already moving.

### Warning

Shifting into a drive gear while the engine is running at high speed is dangerous. Unless your foot is firmly on the brake pedal, the vehicle could move very rapidly. You could lose control and hit

(Continued)

**Warning (Continued)**

people or objects. Do not shift into a drive gear while the engine is running at high speed.

**Caution**

Shifting out of P (Park) or N (Neutral) with the engine running at high speed may damage the transmission. The repairs would not be covered by the vehicle warranty. Be sure the engine is not running at high speed when shifting the vehicle.

**D** : This position is for normal driving. It provides the best fuel economy. If you need more power for passing, and you are:

- Going less than 56 km/h (35 mph), push the accelerator pedal about halfway down.
- Going about 56 km/h (35 mph) or more, push the accelerator all the way down.

**Caution**

If the vehicle does not shift gears, the transmission could be damaged. Have the vehicle serviced right away.

**Caution**

Spinning the tires or holding the vehicle in one place on a hill using only the accelerator pedal may damage the transmission. The repair will not be covered by the vehicle warranty. If you are stuck, do not spin the tires. When stopping on a hill, use the brakes to hold the vehicle in place.

**L** : This position provides access to gear ranges, which offer more engine braking but lower fuel economy than D (Drive). This can be used on very steep hills, or in deep snow or mud. See *Manual Mode* ⇨ 194.

**Operating Modes**

The transmission may operate in a lower gear than normal to improve vehicle performance. The engine speed may be higher and there may be an increase in noise during the following conditions:

- When climbing a grade.
- When driving downhill.
- When driving in hot temperatures or at high altitude.

## Manual Mode

### Electronic Range Select (ERS) Mode

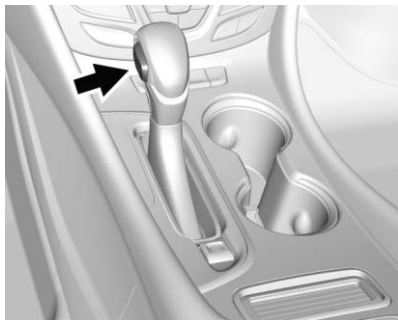

ERS or manual mode allows for the selection of the range of gear positions. Use this mode when driving downhill or to limit the top gear and vehicle speed. The shift position indicator within the Driver Information Center (DIC) will display a number next to the L indicating the highest available gear under manual mode and the driving conditions when manual mode was selected.

To use this feature:

1. Move the shift lever to L (Low).
2. Press the plus/minus button on the shift lever to increase or decrease the gear range available.

When shifting to L (Low), the transmission will shift to a preset lower gear range. For this preset range, the highest gear available is displayed next to the L in the DIC. See *Driver Information Center (DIC) (Base Level)* ⇨ 130 or *Driver Information Center (DIC) (Uplevel)* ⇨ 132. All gears below that number are available to use. For example, when 4 (Fourth) is shown next to the L, 1 (First) through 4 (Fourth) gears are shifted automatically. To shift to 5 (Fifth) gear or higher, press the + (Plus) button or shift into D (Drive).

L (Low) will prevent shifting to a lower gear range if the engine speed is too high. If vehicle speed is not reduced within the time allowed, the lower gear range shift will not be completed. Slow the vehicle, then press the - (Minus) button to the desired lower gear range.

While using the ERS, cruise control can be used.

## Drive Systems

### All-Wheel Drive

Vehicles with this feature transfer engine power, as required, to all four wheels. It is fully automatic, and adjusts itself as needed for road conditions.

When using a compact spare tire on an AWD vehicle, the system automatically detects the compact spare and reduces AWD performance to protect the system. An AWD message may be displayed. To restore full AWD operation and prevent excessive wear on the system, replace the compact spare with a full-size tire as soon as possible. See *Compact Spare Tire* ⇨ 291.

## Brakes

### Antilock Brake System (ABS)

This vehicle has an Antilock Brake System (ABS), an advanced electronic braking system that helps prevent a braking skid.

When the vehicle begins to drive away, ABS checks itself. A momentary motor or clicking noise may be heard while this test is going on, and it may even be noticed that the brake pedal moves a little. This is normal.



If there is a problem with ABS, this warning light stays on. See *Antilock Brake System (ABS) Warning Light* ⇨ 124.

If driving safely on a wet road and it becomes necessary to slam on the brakes and continue braking to avoid a sudden obstacle, a computer senses the wheels are slowing down. If one of the wheels is about to stop rolling, the computer will separately work the brakes at each wheel.

ABS can change the brake pressure to each wheel, as required, faster than any driver could. This can help you steer around the obstacle while braking hard.

As the brakes are applied, the computer keeps receiving updates on wheel speed and controls braking pressure accordingly.

Remember: ABS does not change the time needed to get a foot up to the brake pedal or always decrease stopping distance. If you get too close to the vehicle in front of you, there will not be enough time to apply the brakes if that vehicle suddenly slows or stops. Always leave enough room up ahead to stop, even with ABS.

## Using ABS

Do not pump the brakes. Just hold the brake pedal down firmly and let ABS work. You may hear the ABS pump or motor operating and feel the brake pedal pulsate. This is normal.

## Braking in Emergencies

ABS allows you to steer and brake at the same time. In many emergencies, steering can help more than even the very best braking.

## Electric Parking Brake

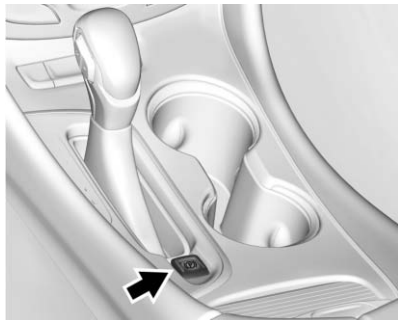

The Electric Parking Brake (EPB) switch is on the center console. The EPB can always be activated, even if the ignition is off. To prevent draining the battery, avoid repeated cycles of the EPB when the engine is not running.

The system has a red parking brake status light and an amber parking brake warning light. See *Electric Parking Brake Light* ⇨ 123 and *Service Electric Parking Brake Light* ⇨ 124. There are also parking brake-related Driver Information Center (DIC) messages. See *Brake System Messages* ⇨ 139. In case of insufficient electrical power, the EPB cannot be applied or released.

Before leaving the vehicle, check the red parking brake status light to ensure that the parking brake is applied.

### EPB Apply

To apply the EPB:

1. Be sure the vehicle is at a complete stop.
2. Lift up the EPB switch momentarily.

The red parking brake status light will flash and then stay on once the EPB is fully applied. If the red parking brake status light flashes continuously, then the EPB is only partially applied or there is a problem with the EPB. A DIC message will display. Release the EPB and try to apply it again. If the light does not come on, or keeps flashing, have the vehicle serviced. Do not drive the vehicle if the red parking brake status light is flashing. See your dealer. See *Electric Parking Brake Light* ⇨ 123.

If the amber parking brake warning light is on, lift up on the EPB switch and hold it up. Continue to hold the switch until the red parking brake status light remains on. If the amber parking brake warning light is on, see your dealer.

If the EPB is applied while the vehicle is moving, the vehicle will decelerate as long as the switch is held up. If the switch is held up until the vehicle comes to a stop, the EPB will remain applied.

The vehicle may automatically apply the EPB in some situations when the vehicle is not moving. This is normal, and is done to periodically check the correct operation of the EPB system.

If the EPB fails to apply, the rear wheels should be blocked to prevent vehicle movement.

### EPB Release

To release the EPB:

1. Place the ignition in the ACC/ACCESSORY or ON/RUN position.
2. Apply and hold the brake pedal.
3. Push down momentarily on the EPB switch.

The EPB is released when the red parking brake status light is off.

If the amber parking brake warning light is on, release the EPB by pushing down on the EPB switch and holding it down. Continue to hold the switch until the red parking

brake status light is off. If either light stays on after release is attempted, see your dealer.

### Caution

Driving with the parking brake on can overheat the brake system and cause premature wear or damage to brake system parts. Make sure that the parking brake is fully released and the brake warning light is off before driving.

### Automatic EPB Release

The EPB will automatically release if the vehicle is running, placed into gear, and an attempt is made to drive away. Avoid rapid acceleration when the EPB is applied, to preserve brake lining life.

### Brake Assist

The Brake Assist feature is designed to assist the driver in stopping or decreasing vehicle speed in emergency driving conditions. This feature uses the

stability system hydraulic brake control module to supplement the power brake system under conditions where the driver has quickly and forcefully applied the brake pedal in an attempt to quickly stop or slow down the vehicle. The stability system hydraulic brake control module increases brake pressure at each corner of the vehicle until the ABS activates. Minor brake pedal pulsation or pedal movement during this time is normal and the driver should continue to apply the brake pedal as the driving situation dictates. The Brake Assist feature will automatically disengage when the brake pedal is released or brake pedal pressure is quickly decreased.

### Hill Start Assist (HSA)

Hill Start Assist (HSA) will activate when the vehicle is stopped on a moderate to steep grade to help prevent it from rolling in the unintended direction.

After the brake pedal has been released and before the accelerator pedal has been pressed, HSA uses braking pressure to hold the vehicle stationary.

If HSA is holding the vehicle, a DIC message displays.

The vehicle will roll if in a drive gear and facing downhill, or in R (Reverse) and facing uphill.

Once HSA is active it will hold the vehicle, unless the driver door is opened or the driver's safety belt is unbuckled prior to releasing the brake pedal.

## **Ride Control Systems**

### **Traction Control/ Electronic Stability Control**

#### **System Operation**

The vehicle has a Traction Control System (TCS) and StabiliTrak<sup>®</sup>, an electronic stability control system.

These systems help limit wheel slip and assist the driver in maintaining control, especially on slippery road conditions.

TCS activates if it senses that any of the drive wheels are spinning or beginning to lose traction. When this happens, TCS applies the brakes to the spinning wheels and reduces engine power to limit wheel spin.

StabiliTrak activates when the vehicle senses a difference between the intended path and the direction the vehicle is actually traveling. StabiliTrak selectively applies braking pressure to any one of the

vehicle wheel brakes to assist the driver in keeping the vehicle on the intended path.

If cruise control is being used and TCS or StabiliTrak begins to limit wheel spin, cruise control will disengage. Cruise control may be turned back on when road conditions allow.



Both systems come on automatically when the vehicle is started and begins to move. The systems may be heard or felt while they are operating or while performing diagnostic checks. This is normal and does not mean there is a problem with the vehicle.

It is recommended to leave both systems on for normal driving conditions, but it may be necessary to turn TCS off if the vehicle gets stuck in sand, mud, ice, or snow. See *If the Vehicle Is Stuck* ⇨ 179 and "Turning the Systems Off and On" later in this section.



The indicator light for both systems is in the instrument cluster. This light will:

- Flash when TCS is limiting wheel spin.
- Flash when StabiliTrak is activated.
- Turn on and stay on when either system is not working.

If either system fails to turn on or to activate,  comes on and stays on to indicate that the system is inactive and is not assisting the driver in maintaining control. A message also displays in the Driver Information Center (DIC). See *Ride Control System Messages*  144. The vehicle is safe to drive, but driving should be adjusted accordingly.

If  comes on and stays on:

1. Stop the vehicle.
2. Turn the engine off and wait 15 seconds.
3. Start the engine.

Drive the vehicle. If  comes on and stays on, the vehicle may need more time to diagnose the problem. If the condition persists, see your dealer.

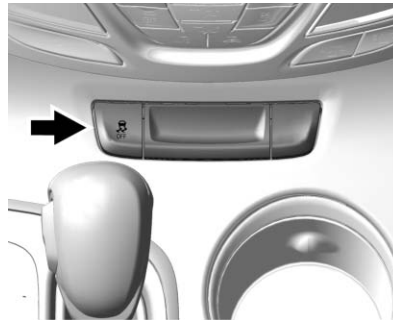

### Turning the Systems Off and On





The button for TCS and StabiliTrak is on the center console.



### Caution

Do not repeatedly brake or accelerate heavily when TCS is off. The vehicle driveline could be damaged.



To turn off only TCS, press and release . The traction off light  illuminates in the instrument cluster.

To turn TCS on again, press and release . The traction off light  in the instrument cluster will turn off.

If TCS is limiting wheel spin when  is pressed, the system will not turn off until the wheels stop spinning.

To turn off both TCS and StabiliTrak, press and hold  until the traction off light  and StabiliTrak OFF light  illuminate and stay on in the instrument cluster.



To turn TCS and StabiliTrak on again, press and release . The traction off light  and StabiliTrak OFF light  in the instrument cluster turn off.

Adding accessories can affect the vehicle performance. See *Accessories and Modifications* ⇨ 236.

## Cruise Control

With cruise control the vehicle can maintain a speed of about 40 km/h (25 mph) or more without keeping your foot on the accelerator. Cruise control does not work at speeds below 40 km/h (25 mph).

### **Warning**

Cruise control can be dangerous where you cannot drive safely at a steady speed. Do not use cruise control on winding roads or in heavy traffic.

Cruise control can be dangerous on slippery roads. On such roads, fast changes in tire traction can cause excessive wheel slip, and you could lose control. Do not use cruise control on slippery roads.

With the Traction Control System (TCS), the system may begin to limit wheel spin while you are using cruise control. If this happens, the cruise control will

automatically disengage. See *Traction Control/Electronic Stability Control* ⇨ 198. If a collision alert occurs when cruise control is activated, cruise control is disengaged. See *Forward Collision Alert (FCA) System* ⇨ 215. When road conditions allow you to safely use it again, cruise control can be turned back on.

If the brakes are applied, cruise control disengages.

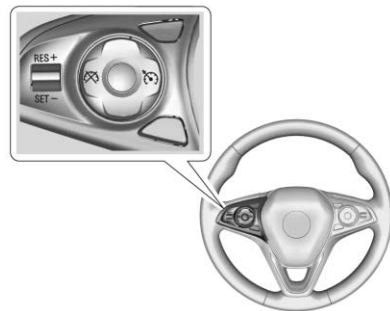



 : Press to turn cruise control on or off. A white indicator comes on in the instrument cluster when cruise control is turned on.

**RES+** : If there is a set speed in memory, press briefly to resume to that speed or press and hold to accelerate. If cruise control is already active, use to increase vehicle speed.

**SET-** : Press the control down briefly to set the speed and activate cruise control. If cruise control is already active, use to decrease vehicle speed.

 : Press to disengage cruise control without erasing the set speed from memory.

### Setting Cruise Control

If the  button is on when not in use, SET- or RES+ could get pressed and go into cruise when not desired. Keep the  button off when cruise is not being used.

1. Press  to turn the cruise system on.
2. Get to the desired speed.
3. Press and release SET- . The desired set speed briefly appears in the instrument cluster.

4. Remove your foot from the accelerator pedal.

The cruise control indicator on the instrument cluster turns green after cruise control has been set to the desired speed. See *Instrument Cluster* ⇨ 113.

### Resuming a Set Speed

If the cruise control is set at a desired speed and then the brakes are applied or  is pressed, the cruise control is disengaged without erasing the set speed from memory.

Once the vehicle reaches about 40 km/h (25 mph) or more, press RES+ up briefly. The vehicle returns to the previous set speed.

### Increasing Speed While Using Cruise Control

If the cruise control system is already activated:

- Press and hold RES+ up until the vehicle accelerates to the desired speed, then release it.

- To increase vehicle speed in small increments, press RES+ up briefly. For each press, the vehicle goes about 1.6 km/h (1 mph) faster.

### Reducing Speed While Using Cruise Control

If the cruise control system is already activated:

- Press and hold SET- down until the desired lower speed is reached, then release it.
- To decrease the vehicle speed in small increments, press SET- down briefly. For each press, the vehicle goes about 1.6 km/h (1 mph) slower.

### Passing Another Vehicle While Using Cruise Control

Use the accelerator pedal to increase the vehicle speed. When you take your foot off the pedal, the vehicle will slow down to the previously set cruise speed. While pressing the accelerator pedal or shortly following the release to



override cruise control, briefly pressing SET- will result in cruise set to the current vehicle speed.

### Using Cruise Control on Hills

How well the cruise control will work on hills depends upon the vehicle speed, load, and the steepness of the hills. When going up steep hills, you might have to step on the accelerator pedal to maintain your speed. When going downhill, you might have to brake or shift to a lower gear to keep your speed down. If the brake pedal is applied, cruise control will disengage.

### Ending Cruise Control

There are four ways to end cruise control:

- Step lightly on the brake pedal.
- Press .
- Shift the transmission to N (Neutral).
- To turn off cruise control, press .

### Erasing Speed Memory

The cruise control set speed is erased from memory if  is pressed or if the ignition is turned off.

### Adaptive Cruise Control

If equipped with Adaptive Cruise Control (ACC), it allows you to select the cruise control set speed and following gap. Read this entire section before using this system. The following gap is the following time between your vehicle and a vehicle detected directly ahead in your path moving in the same direction. If no vehicle is detected in your path, ACC works like regular cruise control. ACC uses camera and radar sensors. See *Radio Frequency Statement* ⇨ 334.

If a vehicle is detected in your path, ACC can apply acceleration or limited, moderate braking to maintain the selected following gap. To disengage ACC, apply the brake. If ACC is controlling your vehicle speed when the Traction Control System (TCS) or StabiliTrak system activates, the ACC may

automatically disengage. See *Traction Control/Electronic Stability Control* ⇨ 198. When road conditions allow ACC to be safely used, the ACC can be turned back on.

ACC will not engage if the TCS or StabiliTrak system is disabled.

### Warning

ACC has limited braking ability and may not have time to slow the vehicle down enough to avoid a collision with another vehicle you are following. This can occur when vehicles suddenly slow or stop ahead, or enter your lane. Also see “Alerting the Driver” in this section. Complete attention is always required while driving and you should be ready to take action and apply the brakes. See *Defensive Driving* ⇨ 174.

### Warning

ACC will not detect or brake for children, pedestrians, animals, or other objects.

Do not use ACC when:

- On winding and hilly roads or when the sensors are blocked by snow, ice, or dirt. The system may not detect a vehicle ahead. Keep the entire front of the vehicle clean.
- Visibility is low, such as in fog, rain, or snow conditions. ACC performance is limited under these conditions.
- On slippery roads where fast changes in tire traction can cause excessive wheel slip.

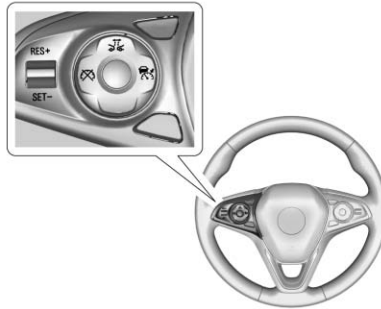

 : Press to turn the system on or off. A white cruise control indicator comes on in the instrument cluster.

**RES+** : Press the control up briefly to resume the previous set speed. If ACC is already active, use to increase vehicle speed.

**SET-** : Press the control down briefly to set the speed and activate ACC. If ACC is already active, use to decrease vehicle speed.

 : Press to disengage ACC without erasing the set speed from memory.

 : Press to select a following gap time (or distance) setting for ACC of Far, Medium, or Near.

### Setting Adaptive Cruise Control

If cruise control is on when not in use, the cruise on/off control could get pressed and cruise control could become active when not desired. Keep the cruise control off when cruise is not being used.

Select the set speed desired for cruise. This is the vehicle speed when no vehicle is detected in its path.

ACC will not set at a speed less than 24 km/h (15 mph), although it can be resumed when driving at lower speeds.

To set ACC:

1. Press .
2. Get up to the desired speed.
3. Press and release SET- .
4. Remove your foot from the accelerator.

After ACC is set, it may immediately apply the brakes if a vehicle ahead is detected closer than the selected following gap.



The ACC indicator displays in the instrument cluster and Head-Up display (HUD), if equipped. When the ACC is active, the indicator turns green.

Be mindful of speed limits, surrounding traffic speeds, and weather conditions when selecting the set speed.

### Resuming a Set Speed

If the ACC is set at a desired speed and then the brakes are applied, the ACC is disengaged without erasing the set speed from memory.

To begin using ACC again, press RES+ up briefly. The vehicle returns to the previous set speed.

### Increasing Speed While ACC is at a Set Speed

If ACC is already activated, do one of the following:

- Use the accelerator to get to the higher speed. Press SET- down. Release the control and the accelerator pedal. The vehicle will now cruise at the higher speed.

When the accelerator pedal is pressed, ACC will not brake because it is overridden. A warning message will appear on the Driver Information Center (DIC) and HUD, if equipped. See *Cruise Control Messages* ↻ 139.

- Press and hold RES+ up until the desired set speed appears on the display, then release it.
- To increase vehicle speed in small increments, press RES+ up briefly. For each press, the vehicle goes 1 km/h (1 mph) faster.

When it is determined that there is no vehicle ahead inside the selected following gap, then the vehicle speed will increase to the set speed.

### Reducing Speed While ACC is at a Set Speed

If ACC is already activated, do one of the following:

- Use the brake to get to the desired lower speed. Press SET- down and release the accelerator pedal. The vehicle will now cruise at the lower speed.
- Press and hold SET- down until the desired lower speed is reached, then release it.
- To decrease the vehicle speed in smaller increments, press SET- down briefly. For each press, the vehicle goes about 1 km/h (1 mph) slower.

### Selecting the Follow Distance

When a slower moving vehicle is detected ahead within the selected following gap, ACC will adjust the

vehicle's speed and attempt to maintain the follow distance gap selected.

Press  on the steering wheel to adjust the following gap. When pressed, the current gap setting displays briefly on the instrument cluster and HUD, if equipped. Subsequent presses cycle the gap button through three settings: Far, Medium, or Near. The gap setting will be maintained until it is changed.

Since each gap setting corresponds to a following time (Far, Medium, or Near), the following distance will vary based on vehicle speed. The faster the vehicle speed, the further back your vehicle will follow a vehicle detected ahead. Consider traffic and weather conditions when selecting the following gap. The range of selectable gaps may not be appropriate for all drivers and driving conditions.

Changing the gap setting automatically changes the alert timing sensitivity (Far, Medium,

or Near) for the Forward Collision Alert (FCA) feature. See *Forward Collision Alert (FCA) System* ⇨ 215.

### Alerting the Driver

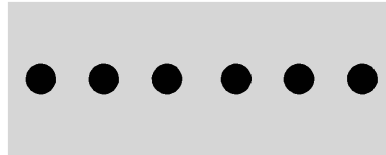

Without Head-Up Display

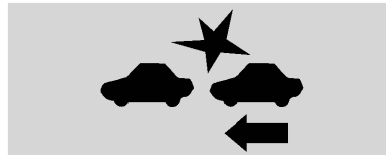

With Head-Up Display

If ACC is engaged, driver action may be required when ACC cannot apply sufficient braking because of approaching a vehicle too rapidly.

When this condition occurs, six red lights or the collision alert symbol on the windshield, and either eight beeps will sound from the front,

or both sides of the Safety Alert Seat will pulse five times. See "Collision/Detection Systems" under *Vehicle Personalization* ⇨ 147.

See *Defensive Driving* ⇨ 174.

### Approaching and Following a Vehicle



The vehicle ahead indicator is in the instrument cluster and HUD, if equipped.

The vehicle ahead indicator only displays when a vehicle is detected in your vehicle's path moving in the same direction.

If this symbol is not displaying, ACC will not respond to or brake for vehicles ahead.

ACC automatically slows the vehicle down and adjusts vehicle speed to follow the vehicle in front at the selected follow gap. The vehicle

speed increases or decreases to follow the vehicle in front of you, but will not exceed the set speed. It may apply limited braking, if necessary. When braking is active, the brake lamps will come on. The automatic braking may feel or sound different than if the brakes were applied manually. This is normal.

### **Stationary or Very Slow-Moving Objects**

#### **Warning**

ACC may not detect and react to stopped or slow-moving vehicles ahead of you. For example, the system may not brake for a vehicle it has never detected moving. This can occur in stop-and-go traffic or when a vehicle suddenly appears due to a vehicle ahead changing lanes. Your vehicle may not stop and could cause a crash. Use caution when using ACC. Your complete attention is always required while

(Continued)

#### **Warning (Continued)**

driving and you should be ready to take action and apply the brakes.

### **ACC Automatically Disengages**

ACC may automatically disengage and the driver will need to manually apply the brakes to slow the vehicle when:

- The sensors are blocked.
- The Traction Control System (TCS) or electronic stability control system has activated or been disabled.
- No traffic or other objects are being detected.
- There is a fault in the system.

A message will appear on the DIC indicating that ACC is disengaging.

The ACC active indicator will not be displayed when ACC is no longer active.

### **Notification to Resume ACC**

ACC will maintain a follow gap behind a detected vehicle and slow your vehicle to a stop behind that vehicle.

If the stopped vehicle ahead has driven away and ACC has not resumed, the vehicle ahead indicator will flash as a reminder to check traffic before proceeding. In addition, three beeps will sound. See “Go Notifier” in “Collision/ Detection Systems” under *Vehicle Personalization* ⇨ 147.

When the vehicle ahead drives away, press RES+ or the accelerator pedal to resume ACC. If stopped for more than two minutes or if the driver door is opened and the driver safety belt is unbuckled, the ACC automatically applies the Electric Parking Brake (EPB) to hold the vehicle. The EPB status light will turn on. See *Electric Parking Brake* ⇨ 196. To release the EPB, press the accelerator pedal.

A DIC warning message may display indicating to shift to P (Park) before exiting the vehicle. See *Cruise Control Messages* ⇨ 139.

### Warning

If ACC has stopped the vehicle, and if ACC is disengaged, turned off, or canceled, the vehicle will no longer be held at a stop. The vehicle can move. When ACC is holding the vehicle at a stop, always be prepared to manually apply the brakes.

### Warning

Leaving the vehicle without placing it in P (Park) can be dangerous. Do not leave the vehicle while it is being held at a stop by ACC. Always place the vehicle in P (Park) and turn off the ignition before leaving the vehicle.

## ACC Override

If using the accelerator pedal while ACC is active, a warning message in the DIC and in the HUD, if equipped, will indicate that automatic braking will not occur. See *Cruise Control Messages* ⇨ 139. ACC will resume operation when the accelerator pedal is not being pressed.

### Warning

The ACC will not automatically apply the brakes if your foot is resting on the accelerator pedal. You could crash into a vehicle ahead of you.

## Curves in the Road

### Warning

On curves, ACC may not detect a vehicle ahead in your lane. You could be startled if the vehicle accelerates up to the set speed,  
(Continued)

## Warning (Continued)

especially when following a vehicle exiting or entering exit ramps. You could lose control of the vehicle or crash. Do not use ACC while driving on an entrance or exit ramp. Always be ready to use the brakes if necessary.

### Warning

On curves, ACC may respond to a vehicle in another lane, or may not have time to react to a vehicle in your lane. You could crash into a vehicle ahead of you, or lose control of your vehicle. Give extra attention in curves and be ready to use the brakes if necessary. Select an appropriate speed while driving in curves.

ACC may operate differently in a sharp curve. It may reduce the vehicle speed if the curve is too sharp.



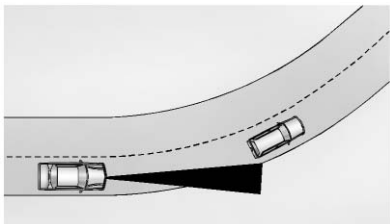

When following a vehicle and entering a curve, ACC may not detect the vehicle ahead and accelerate to the set speed. When this happens the vehicle ahead indicator will not appear.

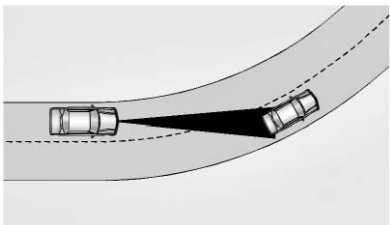

ACC may detect a vehicle that is not in your lane and apply the brakes.

ACC may occasionally provide an alert and/or braking that is considered unnecessary. It could respond to vehicles in different lanes, signs, guardrails, and other stationary objects when entering or exiting a curve. This is normal operation. The vehicle does not need service.

### Other Vehicle Lane Changes

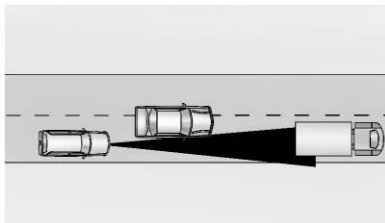

ACC will not detect a vehicle ahead until it is completely in the lane. The brake may need to be manually applied.

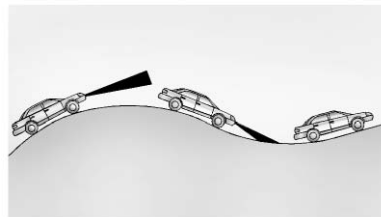

### Do Not Use ACC on Hills and When Towing a Trailer



Do not use ACC when driving on steep hills or when towing a trailer. ACC will not detect a vehicle in the lane while driving on steep hills. The driver will often need to take over acceleration and braking on steep hills, especially when towing a trailer. If the brakes are applied, the ACC disengages.

### Ending ACC

There are three ways to disengage ACC:

- Step lightly on the brake pedal.
- Press .
- Press .

### Erasing Speed Memory

The cruise control set speed is erased from memory if  is pressed or if the ignition is turned off.

### Cleaning the Sensing System

The camera sensor on the windshield ahead of the rearview mirror and the radar sensors on the front of the vehicle can become blocked by snow, ice, dirt, or mud. These areas need to be cleaned for ACC to operate properly.

For cleaning instructions, see “Washing the Vehicle” under *Exterior Care* ⇨ 299.

System operation may also be limited under snow, heavy rain, or road spray conditions.

## Driver Assistance Systems

This vehicle may have features that work together to help avoid crashes or reduce crash damage while driving, backing, and parking. Read this entire section before using these systems.

### Warning

Do not rely on the Driver Assistance Systems. These systems do not replace the need for paying attention and driving safely. You may not hear or feel alerts or warnings provided by these systems. Failure to use proper care when driving may result in injury, death, or vehicle damage. See *Defensive Driving* ⇨ 174.

Under many conditions, these systems will not:

(Continued)

### Warning (Continued)

- Detect children, pedestrians, bicyclists, or animals.
- Detect vehicles or objects outside the area monitored by the system.
- Work at all driving speeds.
- Warn you or provide you with enough time to avoid a crash.
- Work under poor visibility or bad weather conditions.
- Work if the detection sensor is not cleaned or is covered by ice, snow, mud, or dirt.
- Work if the detection sensor is covered up, such as with a sticker, magnet, or metal plate.
- Work if the area surrounding the detection sensor is damaged or not properly repaired.

(Continued)

**Warning (Continued)**

Complete attention is always required while driving, and you should be ready to take action and apply the brakes and/or steer the vehicle to avoid crashes.

**Audible or Safety Alert Seat**

Some driver assistance features alert the driver of obstacles by beeping. To change the volume of the warning chime, see “Comfort and Convenience” under *Vehicle Personalization* ⇨ 147.

If equipped with the Safety Alert Seat, the driver seat cushion may provide a vibrating pulse alert instead of beeping. To change this, see “Collision/Detection Systems” under *Vehicle Personalization* ⇨ 147.

**Assistance Systems for Parking or Backing**

If equipped, the Rear Vision Camera (RVC), Rear Parking Assist (RPA), Front Parking Assist (FPA), Surround Vision, Front Vision Camera, Rear Cross Traffic Alert (RCTA), and Automatic Parking Assist (APA) may help the driver park or avoid objects. Always check around the vehicle when parking or backing.

**Rear Vision Camera (RVC)**

When the vehicle is shifted into R (Reverse), the RVC displays an image of the area behind the vehicle in the infotainment display. The previous screen displays when the vehicle is shifted out of R (Reverse) after a short delay. To return to the previous screen sooner, press a button on the infotainment system, shift into P (Park), or reach a vehicle speed of 8 km/h (5 mph).

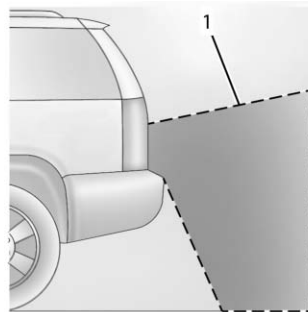

1. View Displayed by the Camera

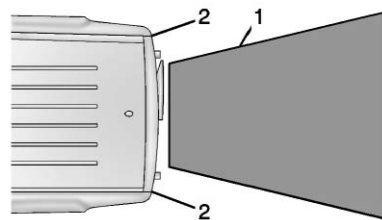

1. View Displayed by the Camera  
2. Corners of the Rear Bumper

Displayed images may be farther or closer than they appear. The area displayed is limited and objects that are close to either corner of the bumper or under the bumper do not display.

A warning triangle may appear on the infotainment display to show that it has detected an object. This triangle changes from amber to red and increases in size the closer the object.

### Surround Vision

If equipped, Surround Vision displays an image of the area surrounding the vehicle, along with the front or rear camera views in the center stack. The front camera is in the grille or near the front emblem, the side cameras are on the bottom of the outside rearview mirrors, and the rear camera is above the license plate.

**Warning**

The Surround Vision cameras have blind spots and will not display all objects near the corners of the vehicle. Folding side mirrors that are out of position will not display surround view correctly. Always check around the vehicle when parking or backing.



1. Views Displayed by the Surround Vision Cameras
2. Area Not Shown

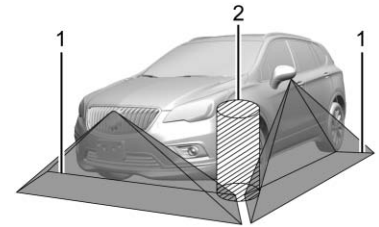

1. Views Displayed by the Surround Vision Cameras
2. Area Not Shown

### Front Vision Camera

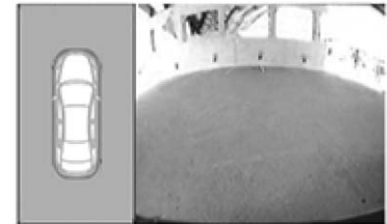

If equipped, a view of the area in front of the vehicle displays in the center stack. The front view shows after shifting from R (Reverse) to D (Drive) and when the vehicle is moving forward slower than 8 km/h

(5 mph), or when the Parking Assist system detects an object within 30 cm (12 in).

### Warning

The camera(s) do not display children, pedestrians, bicyclists, crossing traffic, animals, or any other object outside of the cameras' field of view, below the bumper, or under the vehicle. Shown distances may be different from actual distances. Do not drive or park the vehicle using only these camera(s). Always check behind and around the vehicle before driving. Failure to use proper care may result in injury, death, or vehicle damage.

### Parking Assist

With RPA, and if equipped with FPA, as the vehicle moves at speeds of less than 8 km/h (5 mph) the sensors on the bumpers may detect objects up to 1.8 m (6 ft) behind and 1.2 m (4 ft) in front of the vehicle within a zone 25 cm (10 in) high off

the ground and below bumper level. These detection distances may be shorter during warmer or humid weather. Blocked sensors will not detect objects and can also cause false detections. Keep the sensors clean of mud, dirt, snow, ice, and slush; and clean sensors after a car wash in freezing temperatures.

### Warning

The Parking Assist system does not detect children, pedestrians, bicyclists, animals, or objects located below the bumper or that are too close or too far from the vehicle. It is not available at speeds greater than 8 km/h (5 mph). To prevent injury, death, or vehicle damage, even with Parking Assist, always check the area around the vehicle and check all mirrors before moving forward or backing.



The instrument cluster may have a parking assist display with bars that show “distance to object” and object location information for RPA, and on some vehicles, FPA. As the object gets closer, more bars light up and the bars change color from yellow to amber to red.

When an object is first detected in the rear, one beep will be heard from the rear, or both sides of the Safety Alert Seat will pulse two times. When an object is very close (<0.6 m (2 ft) in the vehicle rear, or <0.3 m (1 ft) in the vehicle front), five beeps will sound from the front or rear depending on object location, or both sides of the Safety

Alert Seat will pulse five times. Beeps for FPA are higher pitched than for RPA.

### Rear Cross Traffic Alert (RCTA)

If equipped, when the vehicle is shifted into R (Reverse), RCTA displays a red warning triangle with a left or right pointing arrow on the infotainment display to warn of traffic coming from the left or right. This system detects objects coming from up to 20 m (65 ft) from the left or right side of the vehicle. When an object is detected, either three beeps sound from the left or right, or three Safety Alert Seat pulses occur on the left or right side, depending on the direction of the detected vehicle.

### Turning the Features On or Off

The  button on the center stack is used to turn on or off the Front and Rear Parking Assist and the Rear Cross Traffic Alert (RCTA). The indicator light in the button comes on when the features are on and turns off when the features have been disabled.

RCTA can also be turned off through vehicle personalization. See “Collision/Detection Systems” under *Vehicle Personalization* ⇨ 147.

To turn the RPA symbols or guidance lines on or off, see “Rear Camera” under *Vehicle Personalization* ⇨ 147.

### Automatic Parking Assist (APA)

If equipped, APA searches for and steers the vehicle into parallel and perpendicular parking spots. When using APA, you must still shift gears, and control the brakes and accelerator. A display and audible beeps help to guide parking maneuvers.

#### Warning

APA does not apply the brakes. APA may not detect objects in the parking space, objects that are soft or narrow, objects high off the ground such as flatbed trucks, or objects below ground level

(Continued)

#### Warning (Continued)

such as large potholes. Always verify that the parking space is appropriate for parking a vehicle. APA does not respond to changes in the parking space, such as movement of an adjacent vehicle, or a person or object entering the parking space. APA does not detect or avoid traffic that is behind or alongside of the vehicle. Always be prepared to stop the vehicle during the parking maneuver.

Press  on the center stack to enable the system to search for a parking space that is large enough and within 1.5 m (5 ft) of the vehicle. The vehicle speed must be below 30 km/h (18 mph). The system cannot:

- Detect whether it is a legal parking space.

- Park exactly lined up with the vehicle next to it if the spot is approached at an angle or if the parking space is angled.
- Park exactly centered in a spot that is marked too large.
- Always detect short curbs.

If the vehicle is equipped with perpendicular parking mode, press and hold **P**  during the search process to switch the APA parking mode between perpendicular and parallel parking.

APA searches for parking spaces to the right of the vehicle. To search for a parking space to the left, turn on the left turn signal.

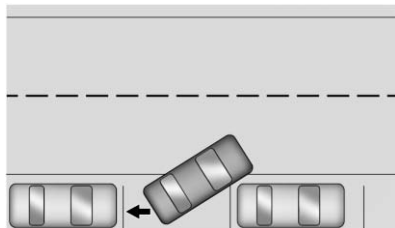

APA will instruct the vehicle to stop once a large enough space is found. Follow the displayed instructions. When instructed to drive in reverse, shift to R (Reverse) to engage automatic steering. The steering wheel will briefly vibrate as a reminder to remove hands from the steering wheel. Check surroundings and continue braking or accelerating as needed, and be prepared to stop to avoid vehicles, pedestrians, or objects.

If the vehicle exceeds 10 km/h (6 mph), APA is automatically disengaged and automatic steering will turn off. A progress arrow displays the status of the parking maneuver. Depending on the space size, additional maneuvers may be required, and there will be additional instructions. When changing gears, allow the automatic steering to complete before continuing the parking maneuver. Upon successful completion of a maneuver, APA will beep and display a PARKING COMPLETE message. Place the vehicle in P (Park).

APA may automatically disengage if:

- The steering wheel is used by the driver.
- The maximum allowed speed is exceeded.
- There is a failure with the APA system.
- Electronic stability control or antilock brakes are activated.
- A high priority vehicle message is displayed in the DIC.

To cancel APA, press **P**  again.

### When the System Does Not Seem to Work Properly

The APA system may require a short period of driving along curves to calibrate.

### Assistance Systems for Driving

If equipped, when driving the vehicle in a forward gear, Forward Collision Alert (FCA), Lane Departure Warning (LDW), Lane Keep Assist (LKA), Side Blind Zone Alert (SBZA), Lane Change Alert

(LCA), and/or Forward Automatic Braking (FAB) can help to avoid a crash or reduce crash damage.

## Forward Collision Alert (FCA) System

If equipped, the FCA system may help to avoid or reduce the harm caused by front-end crashes. When approaching a vehicle ahead too quickly, FCA provides a red flashing alert on the windshield and rapidly beeps or pulses the driver seat. FCA also lights an amber visual alert if following another vehicle much too closely.

FCA detects vehicles within a distance of approximately 60 m (197 ft) and operates at speeds above 40 km/h (25 mph). If the vehicle has Adaptive Cruise Control (ACC), it can detect vehicles to distances of approximately 110 m (360 ft) and operates at all speeds. See *Adaptive Cruise Control* ⇨ 202.

### Warning

FCA is a warning system and does not apply the brakes. When approaching a slower-moving or stopped vehicle ahead too rapidly, or when following a vehicle too closely, FCA may not provide a warning with enough time to help avoid a crash. It also may not provide any warning at all. FCA does not warn of pedestrians, animals, signs, guardrails, bridges, construction barrels, or other objects. Be ready to take action and apply the brakes. See *Defensive Driving* ⇨ 174.

FCA can be disabled with the FCA steering wheel control, or if your vehicle is equipped with Adaptive Cruise Control (ACC), through vehicle personalization. See the “Auto Collision Preparation” portion of “Collision/Detection Systems” under *Vehicle Personalization* ⇨ 147.

## Detecting the Vehicle Ahead



FCA warnings will not occur unless the FCA system detects a vehicle ahead. When a vehicle is detected, the vehicle ahead indicator will display green. Vehicles may not be detected on curves, highway exit ramps, or hills, due to poor visibility; or if a vehicle ahead is partially blocked by pedestrians or other objects. FCA will not detect another vehicle ahead until it is completely in the driving lane.

### Warning

FCA does not provide a warning to help avoid a crash, unless it detects a vehicle. FCA may not detect a vehicle ahead if the FCA sensor is blocked by dirt, snow,

(Continued)



**Warning (Continued)**

or ice, or if the windshield is damaged. It may also not detect a vehicle on winding or hilly roads, or in conditions that can limit visibility such as fog, rain, or snow, or if the headlamps or windshield are not cleaned or in proper condition. Keep the windshield, headlamps, and FCA sensors clean and in good repair.

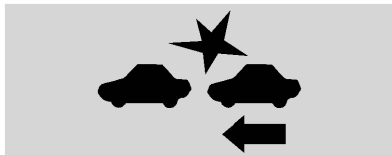
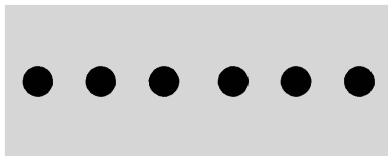
**Collision Alert****With Head-Up Display****Without Head-Up Display**



When your vehicle approaches another detected vehicle too rapidly, the red FCA display will flash on the windshield. Also, eight rapid high-pitched beeps will sound from the front, or both sides of the Safety Alert Seat will pulse five times.

When this Collision Alert occurs, the brake system may prepare for driver braking to occur more rapidly which can cause a brief, mild deceleration. Continue to apply the brake pedal as needed. Cruise control may be disengaged when the Collision Alert occurs.

**Tailgating Alert**

The vehicle ahead indicator will display amber when you are following a detected vehicle ahead much too closely.

**Selecting the Alert Timing**

The Collision Alert control is on the steering wheel. Press  or  to set the FCA timing to Far, Medium, or Near, or on some vehicles, Off. The first button press shows the current setting on the Driver Information Center (DIC). Additional button presses will change this setting. The chosen setting will remain until it is changed and will affect the timing of both the Collision Alert and the Tailgating Alert features. The timing of both alerts will vary based on vehicle speed. The faster the vehicle speed, the farther away the alert will occur.

Consider traffic and weather conditions when selecting the alert timing. The range of selectable alert timings may not be appropriate for all drivers and driving conditions.

If your vehicle is equipped with Adaptive Cruise Control (ACC), changing the FCA timing setting automatically changes the following gap setting (Far, Medium, or Near).

### Following Distance Indication

The distance to a moving vehicle that you are following is shown in seconds on the Driver Information Center (DIC). See *Driver Information Center (DIC) (Base Level)* ⇨ 130 or *Driver Information Center (DIC) (Uplevel)* ⇨ 132. The minimum following time is 0.5 seconds away. If there is no vehicle detected ahead, or the vehicle ahead is out of sensor range, dashes will be displayed.

### Unnecessary Alerts

FCA may provide unnecessary alerts to turning vehicles, vehicles in other lanes, objects that are not

vehicles, or shadows. These alerts are normal operation and the vehicle does not need service.

### Cleaning the System

If the FCA system does not seem to operate properly, cleaning the outside of the windshield in front of the rearview mirror, and cleaning the front of the vehicle where radar sensors are located, may correct the issue.

### Forward Automatic Braking (FAB)

If the vehicle has Adaptive Cruise Control (ACC), it also has FAB, which includes Intelligent Brake Assist (IBA). When the system detects a vehicle ahead in your path that is traveling in the same direction that you may be about to crash into, it can provide a boost to braking or automatically brake the vehicle. This can help avoid or lessen the severity of crashes when driving in a forward gear. Depending on the situation, the vehicle may automatically brake moderately or

hard. This forward automatic braking can only occur if a vehicle is detected. This is shown by the FCA vehicle ahead indicator being lit. See *Forward Collision Alert (FCA) System* ⇨ 215.

The system works when driving in a forward gear above 4 km/h (2 mph). It can detect vehicles up to approximately 60 m (197 ft).

#### Warning

FAB is an emergency crash preparation feature and is not designed to avoid crashes. Do not rely on FAB to brake the vehicle. FAB will not brake outside of its operating speed range and only responds to detected vehicles.

FAB may not:

- Detect a vehicle ahead on winding or hilly roads.

(Continued)

**Warning (Continued)**

- Detect all vehicles, especially vehicles with a trailer, tractors, muddy vehicles, etc.
- Detect a vehicle when weather limits visibility, such as in fog, rain, or snow.
- Detect a vehicle ahead if it is partially blocked by pedestrians or other objects.

Complete attention is always required while driving, and you should be ready to take action and apply the brakes and/or steer the vehicle to avoid crashes.

FAB may slow the vehicle to a complete stop to try to avoid a potential crash. If this happens, FAB may engage the Electric Parking Brake (EPB) to hold the vehicle at a stop. Release the EPB or firmly press the accelerator pedal.

 **Warning**

FAB may automatically brake the vehicle suddenly in situations where it is unexpected and undesired. It could respond to a turning vehicle ahead, guardrails, signs, and other non-moving objects. To override FAB, firmly press the accelerator pedal, if it is safe to do so.

**Intelligent Brake Assist (IBA)**

IBA may activate when the brake pedal is applied quickly by providing a boost to braking based on the speed of approach and distance to a vehicle ahead.

Minor brake pedal pulsations or pedal movement during this time is normal and the brake pedal should continue to be applied as needed. IBA will automatically disengage only when the brake pedal is released.

 **Warning**

IBA may increase vehicle braking in situations when it may not be necessary. You could block the flow of traffic. If this occurs, take your foot off the brake pedal and then apply the brakes as needed.

FAB and IBA can be disabled through vehicle personalization. See “Collision/Detection Systems” under *Vehicle Personalization* ⇨ 147.

**Side Blind Zone Alert (SBZA)**

If equipped, the SBZA system is a lane-changing aid that assists drivers with avoiding crashes that occur with moving vehicles in the side blind zone (or spot) areas. When the vehicle is in a forward gear, the left or right side mirror display will light up if a moving vehicle is detected in that blind zone. If the turn signal is activated and a vehicle is also detected on the same side, the display will flash

as an extra warning not to change lanes. Since this system is part of the Lane Change Alert (LCA) system, read the entire LCA section before using this feature.

## Lane Change Alert (LCA)

If equipped, the LCA system is a lane-changing aid that assists drivers with avoiding lane change crashes that occur with moving vehicles in the side blind zone (or spot) areas or with vehicles rapidly approaching these areas from behind. The LCA warning display will light up in the corresponding outside side mirror and will flash if the turn signal is on.

### Warning

LCA does not alert the driver to vehicles outside of the system detection zones, pedestrians, bicyclists, or animals. It may not provide alerts when changing lanes under all driving conditions. Failure to use proper care when  
(Continued)

### Warning (Continued)

changing lanes may result in injury, death, or vehicle damage. Before making a lane change, always check mirrors, glance over your shoulder, and use the turn signals.

### LCA Detection Zones

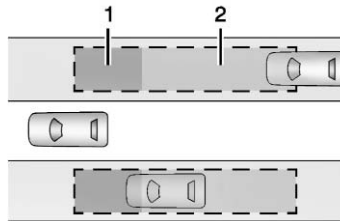

1. SBZA Detection Zone
2. LCA Detection Zone

The LCA sensor covers a zone of approximately one lane over from both sides of the vehicle, or 3.5 m (11 ft). The height of the zone is approximately between 0.5 m (1.5 ft) and 2 m (6 ft) off the ground. The

Side Blind Zone Alert (SBZA) warning area starts at approximately the middle of the vehicle and goes back 5 m (16 ft). Drivers are also warned of vehicles rapidly approaching from up to 25 m (82 ft) behind the vehicle.

### How the System Works

The LCA symbol lights up in the side mirrors when the system detects a moving vehicle in the next lane over that is in the side blind zone or rapidly approaching that zone from behind. A lit LCA symbol indicates it may be unsafe to change lanes. Before making a lane change, check the LCA display, check mirrors, glance over your shoulder, and use the turn signals.



**Left Side Mirror Display**      **Right Side Mirror Display**

When the vehicle is started, both outside mirror LCA displays will briefly come on to indicate the system is operating. When the vehicle is in a forward gear, the left or right side mirror display will light up if a moving vehicle is detected in the next lane over in that blind zone or rapidly approaching that zone. If the turn signal is activated in the same direction as a detected vehicle, this display will flash as an extra warning not to change lanes.

LCA can be disabled through vehicle personalization. See "Collision/Detection Systems" under *Vehicle Personalization* ⇨ 147. If LCA is disabled by the driver, the LCA mirror displays will not light up.

### **When the System Does Not Seem to Work Properly**

The LCA system requires some driving for the system to calibrate to maximum performance. This calibration may occur more quickly if the vehicle is driving on a straight highway road with traffic and roadside objects (e.g., guardrails, barriers). During a trip, the LCA

system is not operational until the vehicle first reaches a speed of 24 km/h (15 mph).

LCA displays may not come on when passing a vehicle quickly or for a stopped vehicle. LCA may alert to objects attached to the vehicle, such as a bicycle or object extending out to either side of the vehicle. Attached objects may also interfere with the detection of vehicles. This is normal system operation; the vehicle does not need service.

LCA may not always alert the driver to vehicles in the next lane over, especially in wet conditions or when driving on sharp curves. The system does not need to be serviced. The system may light up due to guardrails, signs, trees, shrubs, and other non-moving objects. This is normal system operation; the vehicle does not need service.

LCA may not operate when the LCA sensors in the left or right corners of the rear bumper are covered with mud, dirt, snow, ice, or slush, or in heavy rainstorms. For cleaning

instructions, see "Washing the Vehicle" under *Exterior Care* ⇨ 299. If the DIC still displays the system unavailable message after cleaning both sides of the vehicle toward the rear corners of the vehicle, see your dealer.

If the LCA displays do not light up when moving vehicles are in the side blind zone or rapidly approaching this zone and the system is clean, the system may need service. Take the vehicle to your dealer.

When LCA is disabled for any reason other than the driver turning it off, the Lane Change Alert On option will not be available on the personalization menu.

### **Radio Frequency Information**

See *Radio Frequency Statement* ⇨ 334.

### **Lane Departure Warning (LDW)**

If equipped, LDW may help avoid crashes due to unintentional lane departures. It may provide a

warning if the vehicle is crossing a detected lane marking without using a turn signal in the lane departure direction. Since this system is part of the Lane Keep Assist (LKA) system, read the entire LKA section before using this feature.

## Lane Keep Assist (LKA)

If equipped, LKA may help avoid crashes due to unintentional lane departures. It may assist by gently turning the steering wheel if the vehicle approaches a detected lane marking without using a turn signal in that direction. It may also provide a Lane Departure Warning (LDW) system alert as the lane marking is crossed. The LKA system will not assist or provide an LDW alert if it detects that you are actively steering. Override LKA by turning the steering wheel. LKA uses a camera to detect lane markings between 60 km/h (37 mph) and 180 km/h (112 mph).

### Warning

The LKA system does not continuously steer the vehicle. It may not keep the vehicle in the lane or give a Lane Departure Warning (LDW) alert, even if a lane marking is detected.

The LKA and LDW systems may not:

- Provide an alert or enough steering assist to avoid a lane departure or crash.
- Detect lane markings under poor weather or visibility conditions. This can occur if the windshield or headlamps are blocked by dirt, snow, or ice, if they are not in proper condition, or if the sun shines directly into the camera.
- Detect road edges.
- Detect lanes on winding or hilly roads.

(Continued)

### Warning (Continued)

If LKA only detects lane markings on one side of the road, it will only assist or provide an LDW alert when approaching the lane on the side where it has detected a lane marking. Even with LKA and LDW, you must steer the vehicle. Always keep your attention on the road and maintain proper vehicle position within the lane, or vehicle damage, injury, or death could occur. Always keep the windshield, headlamps, and camera sensors clean and in good repair. Do not use LKA in bad weather conditions.



### Warning

Using LKA while towing a trailer or on slippery roads could cause loss of control of the vehicle and a crash. Turn the system off.

### How the System Works

The LKA camera sensor is on the windshield ahead of the rearview mirror.

To turn LKA on and off, press  on the center stack.

When on,  is green if LKA is available to assist and provide LDW alerts. It may assist by gently turning the steering wheel and display  as amber if the vehicle approaches a detected lane marking without using a turn signal in that direction. It may also provide an LDW alert by flashing  amber as the lane marking is crossed. Additionally, there will be three beeps, or the driver seat will pulse three times, on the right or left, depending on the lane departure direction.

The LKA system does not continuously steer the vehicle. If LKA does not detect active driver steering, an alert and chime may be provided. Move the steering wheel to dismiss.

### When the System Does Not Seem to Work Properly

The system performance may be affected by:

- Close vehicles ahead.
- Sudden lighting changes, such as when driving through tunnels.
- Banked roads.
- Roads with poor lane markings, such as two-lane roads.

If the LKA system is not functioning properly when lane markings are clearly visible, cleaning the windshield may help.

LKA assistance and/or LDW alerts may occur due to tar marks, shadows, cracks in the road, temporary or construction lane markings, or other road imperfections. This is normal system operation; the vehicle does not need service. Turn LKA off if these conditions continue.

### Fuel

GM recommends the use of TOP TIER<sup>®</sup> detergent gasoline to keep the engine cleaner and reduce engine deposits. See [www.topTiergas.com](http://www.topTiergas.com) for a list of TOP TIER Detergent Gasoline marketers and applicable countries.



Do not use any fuel labeled E85 or FlexFuel. Do not use gasoline with ethanol levels greater than 15% by volume.

For the 2.5L L4 engine, use regular unleaded gasoline meeting ASTM specification D4814 with a posted octane rating of 87 or higher. Do not

use gasoline with a posted octane rating of less than 87, as this may cause engine knock and will lower fuel economy.

For the 2.0L L4 Turbo engine, premium unleaded gasoline meeting ASTM specification D4814 with a posted octane rating of 93 is highly recommended for best performance and fuel economy. Unleaded gasoline with an octane rated as low as 87 can be used. Using unleaded gasoline rated below 93 octane, however, will lead to reduced acceleration and fuel economy. If knocking occurs, use a gasoline rated at 93 octane as soon as possible, otherwise, the engine could be damaged. If heavy knocking is heard when using gasoline with a 93 octane rating, the engine needs service.

### Prohibited Fuels

#### Caution

Do not use fuels with any of the following conditions; doing so may damage the vehicle and void its warranty:

- For vehicles which are not FlexFuel, fuel labeled greater than 15% ethanol by volume, such as mid-level ethanol blends (16 – 50% ethanol), E85, or FlexFuel.
- Fuel with any amount of methanol, methylal, and aniline. These fuels can corrode metal fuel system parts or damage plastic and rubber parts.
- Fuel containing metals such as methylcyclopentadienyl manganese tricarbonyl (MMT), which can damage the emissions control system and spark plugs.

(Continued)

#### Caution (Continued)

- Fuel with a posted octane rating of less than the recommended fuel. Using this fuel will lower fuel economy and performance, and may decrease the life of the emissions catalyst.

### California Fuel Requirements

If the vehicle is certified to meet California Emissions Standards, it is designed to operate on fuels that meet California specifications. See the underhood emission control label. If this fuel is not available in states adopting California Emissions Standards, the vehicle will operate satisfactorily on fuels meeting federal specifications, but emission control system performance may be affected. The malfunction indicator lamp could turn on and the vehicle may not pass a smog-check test. See *Malfunction Indicator Lamp (Check Engine Light)* ⇨ 121. If this



occurs, return to your authorized dealer for diagnosis. If it is determined that the condition is caused by the type of fuel used, repairs may not be covered by the vehicle warranty.

## Fuels in Foreign Countries

The U.S., Canada, and Mexico post fuel octane ratings in anti-knock index (AKI). For fuel not to use in a foreign country, see "Prohibited Fuels" in *Fuel* ⇨ 222.

## Fuel Additives

To keep fuel systems clean, TOP TIER Detergent Gasoline is recommended. See *Fuel* ⇨ 222.

If TOP TIER Detergent Gasoline is not available, one bottle of GM Fuel System Treatment Cleaner added to the fuel tank at every engine oil change, can help. GM Fuel System Treatment Cleaner is the only gasoline additive recommended by General Motors. It is available at your dealer.

## Filling the Tank

### **Warning**

Fuel vapors and fuel fires burn violently and can cause injury or death.

- To help avoid injuries to you and others, read and follow all the instructions on the fuel pump island.
- Turn off the engine when refueling.
- Keep sparks, flames, and smoking materials away from fuel.
- Do not leave the fuel pump unattended.
- Do not use a cell phone while refueling.
- Do not reenter the vehicle while pumping fuel.
- Keep children away from the fuel pump and never let children pump fuel.

(Continued)

### **Warning (Continued)**

- Fuel can spray out if the refueling nozzle is inserted too quickly. This spray can happen if the tank is nearly full, and is more likely in hot weather. Insert the refueling nozzle slowly and wait for any hiss noise to stop prior to beginning to flow fuel.

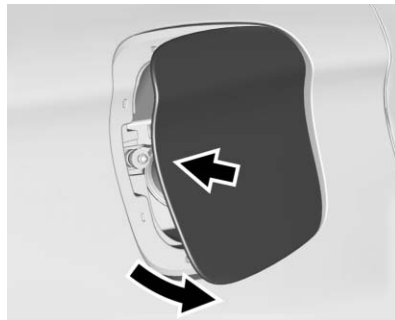

To open the fuel door, push and release the rearward center edge of the door.

The vehicle has a capless refueling system and does not have a fuel cap. The filling nozzle must be fully inserted and latched prior to starting fuel flow.

### Warning

Overfilling the fuel tank by more than three clicks of a standard fill nozzle may cause:

- Vehicle performance issues, including engine stalling and damage to the fuel system.
- Fuel spills.
- Potential fuel fires.

Be careful not to spill fuel. Wait a few seconds after you have finished pumping before removing the nozzle. Clean fuel from painted surfaces as soon as possible. See *Exterior Care* ⇨ 299.

### Warning

If a fire starts while you are refueling, do not remove the nozzle. Shut off the flow of fuel by shutting off the pump or by notifying the station attendant. Leave the area immediately.

### Filling the Tank with a Portable Gas Can

If the vehicle runs out of fuel and must be filled from a portable gas can:



1. Locate the capless funnel adapter from inside the vehicle.

2. Insert and latch the funnel into the capless fuel system.

### Warning

Attempting to refuel without using the funnel adapter may cause fuel spillage and damage the capless fuel system. This could cause a fire and you or others could be badly burned and the vehicle could be damaged.

3. Remove and clean the funnel adapter and return to the storage location.

### Filling a Portable Fuel Container

### Warning

Filling a portable fuel container while it is in the vehicle can cause fuel vapors that can ignite either by static electricity or other

(Continued)

**Warning (Continued)**

means. You or others could be badly burned and the vehicle could be damaged. Always:

- Use approved fuel containers.
- Remove the container from the vehicle, trunk, or pickup bed before filling.
- Place the container on the ground.
- Place the nozzle inside the fill opening of the container before dispensing fuel, and keep it in contact with the fill opening until filling is complete.
- Fill the container no more than 95% full to allow for expansion.
- Do not smoke, light matches, or use lighters while pumping fuel.
- Avoid using cell phones or other electronic devices.

**Trailer Towing****General Towing Information**

Only use towing equipment that has been designed for the vehicle. Contact your dealer or trailering dealer for assistance with preparing the vehicle for towing a trailer. Read the entire section before towing a trailer.

For towing a disabled vehicle, see *Towing the Vehicle* ⇨ 295. For towing the vehicle behind another vehicle such as a motor home, see *Recreational Vehicle Towing* ⇨ 297.

**Driving Characteristics and Towing Tips****Driving with a Trailer**

When towing a trailer:

- Become familiar with the state and local laws that apply specifically to trailer towing.

- Do not tow a trailer during the first 800 km (500 mi), to prevent damage to the engine, axle, or other parts.
- Then, during the first 800 km (500 mi) of trailer towing, do not drive over 80 km/h (50 mph) and do not make starts at full throttle.
- The vehicle can tow in D (Drive) but manual mode is recommended. See *Manual Mode* ⇨ 194. Use a lower gear if the transmission shifts too often.
- Turn off Parking Assist when towing.
- Turn off Lane Keep Assist (LKA) when towing. See *Lane Keep Assist (LKA)* ⇨ 221.

 **Warning**

When towing a trailer, exhaust gases may collect at the rear of the vehicle and enter if the liftgate, trunk/hatch, or rear-most window is open.

(Continued)

**Warning (Continued)**

When towing a trailer:

- Do not drive with the liftgate, trunk/hatch, or rear-most window open.
- Fully open the air outlets on or under the instrument panel.
- Also adjust the climate control system to a setting that brings in only outside air. See “Climate Control Systems” in the Index.

For information about carbon monoxide, see *Engine Exhaust* ⇨ 191.

Towing a trailer requires a certain amount of experience. The combination you are driving is longer and not as responsive as the vehicle itself. Get acquainted with the handling and braking of the rig before setting out for the open road.

Before starting, check all trailer hitch parts and attachments, safety chains, electrical connectors, lamps, tires, and mirrors. If the trailer has electric brakes, start the combination moving and then apply the trailer brake controller by hand to be sure the brakes work.

During the trip, check occasionally to be sure that the load is secure and the lamps and any trailer brakes still work.

**Towing with a Stability Control System**

When towing, the sound of the stability control system might be heard. The system is reacting to the vehicle movement caused by the trailer, which mainly occurs during cornering. This is normal when towing heavier trailers.

**Following Distance**

Stay at least twice as far behind the vehicle ahead as you would when driving the vehicle without a trailer. This can help to avoid situations that require heavy braking and sudden turns.

**Passing**

More passing distance is needed when towing a trailer. Because the rig is longer, it is necessary to go farther beyond the passed vehicle before returning to the lane.

**Backing Up**

Hold the bottom of the steering wheel with one hand. To move the trailer to the left, move your hand to the left. To move the trailer to the right, move your hand to the right. Always back up slowly and, if possible, have someone guide you.

**Making Turns****Caution**

Making very sharp turns while trailering could cause the trailer to come in contact with the vehicle. The vehicle could be damaged. Avoid making very sharp turns while trailering.

When turning with a trailer, make wider turns than normal so the trailer will not strike soft shoulders, curbs, road signs, trees, or other objects. Use the turn signal well in advance and avoid jerky or sudden maneuvers.

### **Turn Signals When Towing a Trailer**

The turn signal indicators on the instrument cluster flash whenever signaling a turn or lane change. Properly hooked up, the trailer lamps also flash, telling other drivers the vehicle is turning, changing lanes, or stopping.

When towing a trailer, the arrows on the instrument cluster flash for turns even if the bulbs on the trailer are burned out. Check occasionally to be sure the trailer bulbs are still working.

### **Driving on Grades**

Reduce speed and shift to a lower gear before starting down a long or steep downgrade. If the transmission is not shifted down, the brakes might have to be used so much that they would get hot and no longer work well.

The vehicle can tow in D (Drive). Use a lower gear if the transmission shifts too often.

When towing at high altitude on steep uphill grades, engine coolant boils at a lower temperature than at normal altitudes. If the engine is turned off immediately after towing at high altitude on steep uphill grades, the vehicle could show signs similar to engine overheating. To avoid this, let the engine run while parked, preferably on level ground, with the transmission in P (Park) for a few minutes before turning the engine off. If the overheat warning comes on, see *Engine Overheating* ⇨ 250.

### **Parking on Hills**



Parking the vehicle on a hill with the trailer attached can be dangerous. If something goes wrong, the rig could start to move. People can be injured, and both the vehicle and the trailer can be damaged. When possible, always park the rig on a flat surface.

If parking the rig on a hill:

1. Press the brake pedal, but do not shift into P (Park) yet. Turn the wheels into the curb if facing downhill or into traffic if facing uphill.
2. Have someone place chocks under the trailer wheels.
3. When the wheel chocks are in place, release the brake pedal until the chocks absorb the load.

4. Reapply the brake pedal. Then apply the parking brake and shift into P (Park).
5. Release the brake pedal.

### Leaving After Parking on a Hill

1. Apply and hold the brake pedal while you:
  - 1.1. Start the engine.
  - 1.2. Shift into a gear.
  - 1.3. Release the parking brake.
2. Let up on the brake pedal.
3. Drive slowly until the trailer is clear of the chocks.
4. Stop and have someone pick up and store the chocks.

### Maintenance When Trailer Towing

The vehicle needs service more often when pulling a trailer. See the *Maintenance Schedule* ⇨ 310. Things that are especially important in trailer operation are automatic transmission fluid, engine oil, axle

lubricant, belts, cooling system, and brake system. Inspect these before and during the trip.

Check periodically to see that all hitch nuts and bolts are tight.

### Engine Cooling When Trailer Towing

The cooling system may temporarily overheat during severe operating conditions. See *Engine Overheating* ⇨ 250.

### Trailer Towing

Do not tow a trailer during break-in. See *New Vehicle Break-In* ⇨ 184.

#### Warning

The driver can lose control when pulling a trailer if the correct equipment is not used or the vehicle is not driven properly. For example, if the trailer is too heavy, the brakes may not work well — or even at all. The driver and passengers could be

(Continued)

#### Warning (Continued)

seriously injured. The vehicle may also be damaged; the resulting repairs would not be covered by the vehicle warranty. Pull a trailer only if all the steps in this section have been followed. Ask your dealer for advice and information about towing a trailer with the vehicle.

#### Caution

Pulling a trailer improperly can damage the vehicle and result in costly repairs not covered by the vehicle warranty. To pull a trailer correctly, follow the advice in this section and see your dealer for important information about towing a trailer with the vehicle.

To identify the trailering capacity of the vehicle, read the information in “Weight of the Trailer” following.

Trailering is different than just driving the vehicle by itself.

Trailering means changes in handling, acceleration, braking, durability, and fuel economy.

Successful, safe trailering takes correct equipment, and it has to be used properly.

The following information has many time-tested, important trailering tips and safety rules. Many of these are important for your safety and that of your passengers. So please read this section carefully before pulling a trailer.

### **Weight of the Trailer**

How heavy can a trailer safely be?

Speed, altitude, road grades, outside temperature, special equipment, and the amount of tongue weight the vehicle can carry must be considered. See "Weight of the Trailer Tongue" following.

Maximum trailer weight is calculated assuming only the driver is in the tow vehicle and it has all the required trailering equipment. The weight of additional optional

equipment, passengers, and cargo in the tow vehicle must be subtracted from the maximum trailer weight.

Use the following chart to determine how much the vehicle can weigh, based upon the vehicle model and options.

Vehicle	Max. Trailer Wt.	*GCWR
AWD – 2.0L L4 Engine	680 kg (1,500 lb)	2 750 kg (6,060 lb)
2WD – 2.5L L4 Engine	680 kg (1,500 lb)	2 600 kg (5,730 lb)
AWD – 2.5L L4 Engine	680 kg (1,500 lb)	2 700 kg (5,950 lb)

\*The Gross Combination Weight Rating (GCWR) is the total allowable weight of the completely loaded vehicle and trailer including any passengers, cargo, equipment, and conversion. The GCWR for the vehicle should not be exceeded.

Ask your dealer for our trailering information or advice.

### Weight of the Trailer Tongue

The tongue load (1) of any trailer is very important because it is also part of the vehicle weight. The Gross Vehicle Weight (GVW) includes the curb weight of the vehicle, any cargo carried in it, and the people who will be riding in the vehicle as well as trailer tongue weight. Vehicle options, equipment, passengers, and cargo in the vehicle reduce the amount of tongue weight the vehicle can carry, which will also reduce the trailer weight the vehicle can tow.

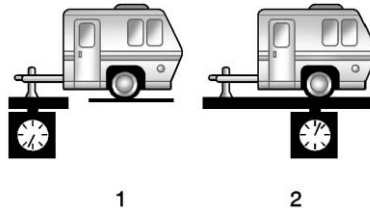

Do not exceed the maximum allowable tongue weight of 91 kg (200 lb) for the vehicle. Choose the shortest hitch extension that will position the hitch ball closest to the

vehicle. This will help reduce the effect of trailer tongue weight on the rear axle.

Trailer rating may be limited by the vehicle's ability to carry tongue weight. Tongue weight cannot cause the vehicle to exceed the GVWR (Gross Vehicle Weight Rating) or the RGAWR (Rear Gross Axle Weight Rating). See "Total Weight on the Vehicle's Tires" following.

After loading the trailer, weigh the trailer and then the tongue, separately, to see if the weights are proper. If they are not, adjustments might be made by moving some items around in the trailer.



If a cargo carrier is used in the trailer hitch receiver, choose a carrier that positions the load as close to the vehicle as possible. Make sure the total weight, including the carrier, is no more than half of the maximum allowable tongue weight for the vehicle or 91 kg (200 lb), whichever is less.

### **Total Weight on the Vehicle's Tires**

Inflate the vehicle's tires to the upper limit for cold tires. These numbers can be found on the Certification label or see *Vehicle Load Limits* ⇨ 180. Do not go over the GVW limit for the vehicle, or the GAWR, including the weight of the trailer tongue. If using a weight distributing hitch, do not go over the rear axle limit before applying the weight distribution spring bars.

## **Towing Equipment**

### **Hitches**

It is important to have the correct hitch equipment. Crosswinds, large trucks going by, and rough roads are a few reasons why the right hitch is needed.

- The rear bumper on the vehicle is not intended for hitches. Do not attach rental hitches or other bumper-type hitches to it. Use only a frame-mounted hitch that does not attach to the bumper.
- Will any holes be made in the body of the vehicle when the trailer hitch is installed? If there are, then be sure to seal the holes when the hitch is removed. If the holes are not sealed, dirt, water, and deadly carbon monoxide (CO) from the exhaust may get into the vehicle. See *Engine Exhaust* ⇨ 191.

### **Safety Chains**

Always attach chains between the vehicle and the trailer. Cross the safety chains under the tongue of

the trailer to help prevent the tongue from contacting the road if it becomes separated from the hitch. Always leave just enough slack so the rig can turn. Never allow safety chains to drag on the ground.

### **Trailer Brakes**

A loaded trailer that weighs more than 450 kg (1,000 lb) needs to have its own brake system that is adequate for the weight of the trailer. Be sure to read and follow the instructions for the trailer brakes so they are installed, adjusted, and maintained properly.

Because the vehicle has antilock brakes, do not try to tap into the vehicle's hydraulic brake system. If you do, both brake systems will not work well, or at all.

## Conversions and Add-Ons

### Add-On Electrical Equipment

#### Warning

The Data Link Connector (DLC) is used for vehicle service and Emission Inspection/Maintenance testing. See *Malfunction Indicator Lamp (Check Engine Light)* ⇨ 121. A device connected to the DLC — such as an aftermarket fleet or driver-behavior tracking device — may interfere with vehicle systems. This could affect vehicle operation and cause a crash. Such devices may also access information stored in the vehicle's systems.

#### Caution

Some electrical equipment can damage the vehicle or cause components to not work and would not be covered by the vehicle warranty. Always check with your dealer before adding electrical equipment.

Add-on equipment can drain the vehicle's 12-volt battery, even if the vehicle is not operating.

The vehicle has an airbag system. Before attempting to add anything electrical to the vehicle, see *Servicing the Airbag-Equipped Vehicle* ⇨ 77 and *Adding Equipment to the Airbag-Equipped Vehicle* ⇨ 78.

## Vehicle Care

### General Information

General Information .....	235
California Proposition 65 Warning .....	235
California Perchlorate Materials Requirements .....	235
Accessories and Modifications .....	236

### Vehicle Checks

Doing Your Own Service Work .....	236
Hood .....	237
Engine Compartment Overview .....	238
Engine Oil .....	241
Engine Oil Life System .....	243
Automatic Transmission Fluid .....	244
Engine Air Cleaner/Filter .....	245
Cooling System .....	246
Engine Coolant .....	248
Engine Overheating .....	250
Washer Fluid .....	252
Brakes .....	252
Brake Fluid .....	253
Battery - North America .....	254
All-Wheel Drive .....	255

Starter Switch Check .....	256
Automatic Transmission Shift Lock Control Function Check .....	256
Park Brake and P (Park) Mechanism Check .....	256
Wiper Blade Replacement .....	257
Windshield Replacement .....	258

### Headlamp Aiming

Headlamp Aiming .....	258
-----------------------	-----

### Bulb Replacement

Bulb Replacement .....	259
Halogen Bulbs .....	259
High Intensity Discharge (HID) Lighting .....	259
License Plate Lamp .....	259
Replacement Bulbs .....	260

### Electrical System

Electrical System Overload .....	260
Fuses and Circuit Breakers .....	261
Engine Compartment Fuse Block .....	261
Instrument Panel Fuse Block .....	264
Rear Compartment Fuse Block .....	265

### Wheels and Tires

Tires .....	266
-------------	-----

All-Season Tires .....	267
Winter Tires .....	267
Summer Tires .....	268
Tire Sidewall Labeling .....	268
Tire Designations .....	270
Tire Terminology and Definitions .....	271
Tire Pressure .....	273
Tire Pressure Monitor System .....	274
Tire Pressure Monitor Operation .....	275
Tire Inspection .....	278
Tire Rotation .....	279
When It Is Time for New Tires .....	280
Buying New Tires .....	280
Different Size Tires and Wheels .....	282
Uniform Tire Quality Grading .....	282
Wheel Alignment and Tire Balance .....	284
Wheel Replacement .....	284
Tire Chains .....	285
If a Tire Goes Flat .....	285
Tire Changing .....	287
Compact Spare Tire .....	291

**Jump Starting**

Jump Starting - North America ..... 292

**Towing the Vehicle**

Towing the Vehicle ..... 295  
 Recreational Vehicle Towing ..... 297

**Appearance Care**

Exterior Care ..... 299  
 Interior Care ..... 304  
 Floor Mats ..... 307

**General Information**

For service and parts needs, visit your dealer. You will receive genuine GM parts and GM-trained and supported service people.

Genuine GM parts have one of these marks:



**California Proposition 65 Warning**

**WARNING:** Most motor vehicles, including this one, as well as many of its service parts and fluids, contain and/or emit chemicals known to the State of California to

cause cancer and birth defects or other reproductive harm. Engine exhaust, many parts and systems, many fluids, and some component wear by-products contain and/or emit these chemicals.

See *Battery - North America* ⇨ 254 and *Jump Starting - North America* ⇨ 292.

**California Perchlorate Materials Requirements**

Certain types of automotive applications, such as airbag initiators, safety belt pretensioners, and lithium batteries contained in Remote Keyless Entry transmitters, may contain perchlorate materials. Special handling may be necessary. For additional information, see [www.dtsc.ca.gov/hazardouswaste/perchlorate](http://www.dtsc.ca.gov/hazardouswaste/perchlorate).

## Accessories and Modifications

Adding non-dealer accessories or making modifications to the vehicle can affect vehicle performance and safety, including such things as airbags, braking, stability, ride and handling, emissions systems, aerodynamics, durability, and electronic systems like antilock brakes, traction control, and stability control. These accessories or modifications could even cause malfunction or damage not covered by the vehicle warranty.

Damage to suspension components caused by modifying vehicle height outside of factory settings will not be covered by the vehicle warranty.

Damage to vehicle components resulting from modifications or the installation or use of non-GM certified parts, including control module or software modifications, is not covered under the terms of the vehicle warranty and may affect remaining warranty coverage for affected parts.

GM Accessories are designed to complement and function with other systems on the vehicle. See your dealer to accessorize the vehicle using genuine GM Accessories installed by a dealer technician.

Also, see *Adding Equipment to the Airbag-Equipped Vehicle* ⇨ 78.

## Vehicle Checks

### Doing Your Own Service Work



It can be dangerous to work on your vehicle if you do not have the proper knowledge, service manual, tools, or parts. Always follow owner's manual procedures and consult the service manual for your vehicle before doing any service work.

If doing some of your own service work, use the proper service manual. It tells you much more about how to service the vehicle than this manual can. To order the proper service manual, see *Service Publications Ordering Information* ⇨ 333.

This vehicle has an airbag system. Before attempting to do your own service work, see *Servicing the Airbag-Equipped Vehicle* ⇨ 77.

Keep a record with all parts receipts and list the mileage and the date of any service work performed. See *Maintenance Records* ⇨ 320.

### Caution

Even small amounts of contamination can cause damage to vehicle systems. Do not allow contaminants to contact the fluids, reservoir caps, or dipsticks.

## Hood

To open the hood:



1. Pull the hood release handle with this symbol until the hood is ajar. The release handle is located to the left of the steering column below the instrument panel.

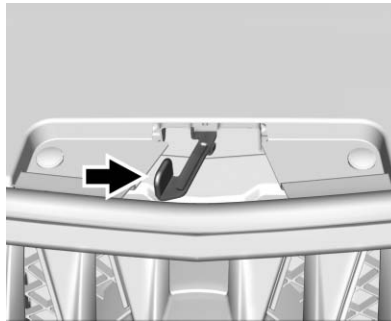

2. Go to the front of the vehicle to find the secondary release handle. The handle is under the front edge of the hood near the center. Push the handle to the right and at the same time raise the hood.

To close the hood:

1. Before closing the hood, be sure all the filler caps are on properly.
2. Lower the hood and push down to close. Check to make sure the hood is closed and repeat the process if necessary.

## Engine Compartment Overview

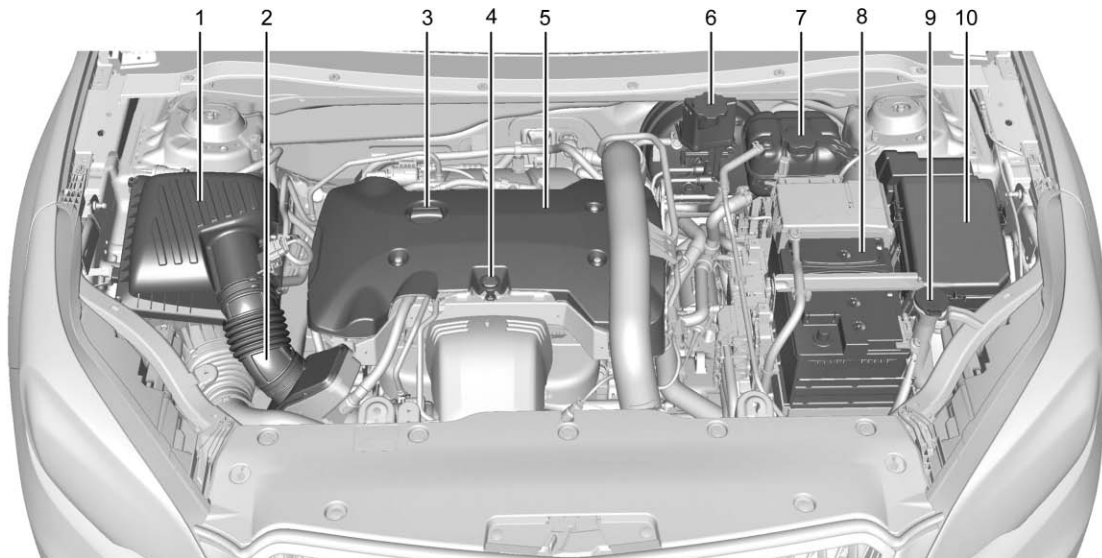

**2.0L L4 Engine**

1. *Engine Air Cleaner/Filter* ⇨ 245.
2. Engine Duct.
3. Engine Oil Fill Cap. See *Engine Oil* ⇨ 241.
4. Engine Oil Dipstick. See *Engine Oil* ⇨ 241.
5. Engine Cover.
6. Brake Fluid Reservoir. See *Brake Fluid* ⇨ 253.
7. Engine Coolant Surge Tank and Pressure Cap. See *Engine Coolant* ⇨ 248.
8. *Battery - North America* ⇨ 254.
9. Windshield Washer Fluid Reservoir. See *Washer Fluid* ⇨ 252.
10. *Engine Compartment Fuse Block* ⇨ 261.



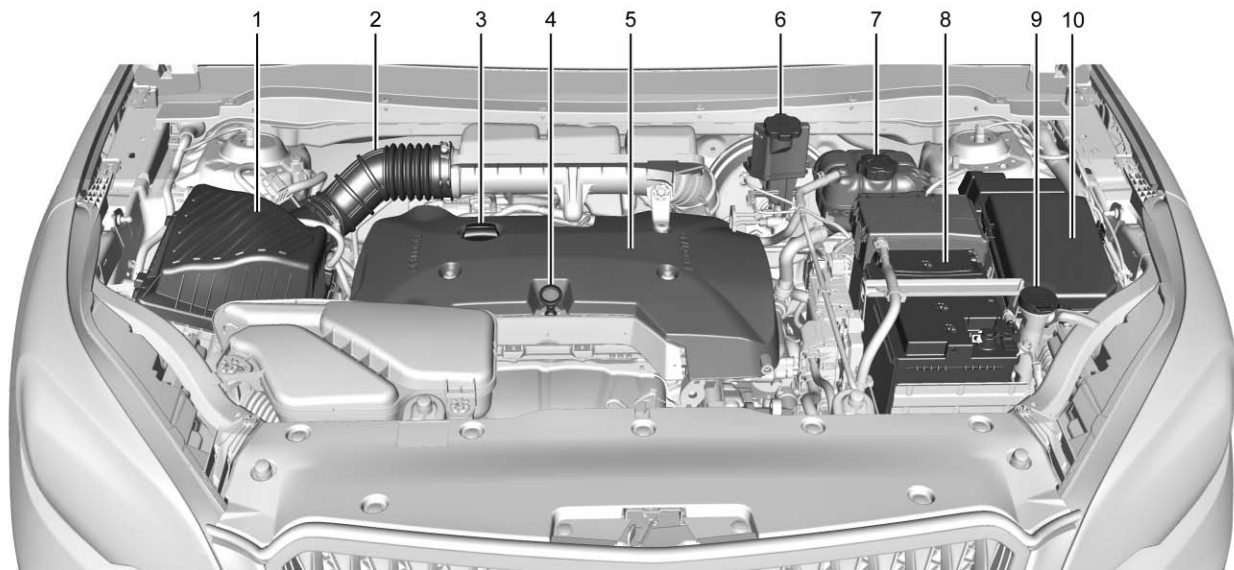

**2.5L L4 Engine**

1. *Engine Air Cleaner/Filter* ⇨ 245.
2. Engine Duct.
3. Engine Oil Fill Cap. See *Engine Oil* ⇨ 241.
4. Engine Oil Dipstick. See *Engine Oil* ⇨ 241.
5. Engine Cover.
6. Brake Fluid Reservoir. See *Brake Fluid* ⇨ 253.
7. Engine Coolant Surge Tank and Pressure Cap. See *Engine Coolant* ⇨ 248.
8. *Battery - North America* ⇨ 254.
9. Windshield Washer Fluid Reservoir. See *Washer Fluid* ⇨ 252.
10. *Engine Compartment Fuse Block* ⇨ 261.

## Engine Oil

To ensure proper engine performance and long life, careful attention must be paid to engine oil.

Following these simple, but important steps will help protect your investment:

- Use engine oil approved to the proper specification and of the proper viscosity grade. See “Selecting the Right Engine Oil” in this section.
- Check the engine oil level regularly and maintain the proper oil level. See “Checking Engine Oil” and “When to Add Engine Oil” in this section.
- Change the engine oil at the appropriate time. See *Engine Oil Life System* ⇨ 243.
- Always dispose of engine oil properly. See “What to Do with Used Oil” in this section.

### Checking Engine Oil

Check the engine oil level regularly, every 650 km (400 mi), especially prior to a long trip. The engine oil dipstick handle is a loop. See *Engine Compartment Overview* ⇨ 238 for the location.

### Warning

The engine oil dipstick handle may be hot; it could burn you. Use a towel or glove to touch the dipstick handle.

If a low oil Driver Information Center (DIC) message displays, check the oil level.

#### Follow these guidelines:

- To get an accurate reading, park the vehicle on level ground. Check the engine oil level after the engine has been off for at least two hours. Checking the engine oil level on steep grades or too soon after engine shutdown can result in incorrect readings. Accuracy improves when checking a cold engine prior to starting. Remove the dipstick and check the level.
- If unable to wait two hours, the engine must be off for at least 15 minutes if the engine is warm, or at least 30 minutes if the engine is not warm. Pull out

the dipstick, wipe it with a clean paper towel or cloth, then push it back in all the way. Remove it again, keeping the tip down, and check the level.

### When to Add Engine Oil



If the oil is below the cross-hatched area at the tip of the dipstick and the engine has been off for at least 15 minutes, add 1 L (1 qt) of the recommended oil and then recheck the level. See “Selecting the Right Engine Oil” later in this section for an explanation of what kind of oil to use. For engine oil crankcase capacity, see *Capacities and Specifications* ⇨ 322.

### Caution

Do not add too much oil. Oil levels above or below the acceptable operating range shown on the dipstick are harmful to the engine. If you find that you have an oil level above the operating range, i.e., the engine has so much oil that the oil level gets above the cross-hatched area that shows the proper operating range, the engine could be damaged. You should drain out the excess oil or limit driving of the vehicle and seek a service professional to remove the excess amount of oil.

See *Engine Compartment Overview* ⇨ 238 for the location of the engine oil fill cap.

Add enough oil to put the level somewhere in the proper operating range. Push the dipstick all the way back in when through.

### Selecting the Right Engine Oil

Selecting the right engine oil depends on both the proper oil specification and viscosity grade. See *Recommended Fluids and Lubricants* ⇨ 318.

#### Specification

Ask for and use engine oils that meet the dexos1™ specification.

Engine oils that have been approved by GM as meeting the dexos1 specification are marked with the dexos1 approved logo. See [www.gmdexos.com](http://www.gmdexos.com).



### Caution

Failure to use the recommended engine oil or equivalent can result in engine damage not covered by the vehicle warranty.

## Viscosity Grade

Use SAE 5W-30 viscosity grade engine oil.

**Cold Temperature Operation:** In an area of extreme cold, where the temperature falls below  $-29^{\circ}\text{C}$  ( $-20^{\circ}\text{F}$ ), an SAE 0W-30 oil may be used. An oil of this viscosity grade will provide easier cold starting for the engine at extremely low temperatures.

When selecting an oil of the appropriate viscosity grade, it is recommended to select an oil of the correct specification. See "Specification" earlier in this section.

## Engine Oil Additives/Engine Oil Flushes

Do not add anything to the oil. The recommended oils meeting the dexos1™ specification are all that is needed for good performance and engine protection.

Engine oil system flushes are not recommended and could cause engine damage not covered by the vehicle warranty.

## What to Do with Used Oil

Used engine oil contains certain elements that can be unhealthy for your skin and could even cause cancer. Do not let used oil stay on your skin for very long. Clean your skin and nails with soap and water, or a good hand cleaner. Wash or properly dispose of clothing or rags containing used engine oil. See the manufacturer's warnings about the use and disposal of oil products.

Used oil can be a threat to the environment. If you change your own oil, be sure to drain all the oil from the filter before disposal. Never dispose of oil by putting it in the trash or pouring it on the ground, into sewers, or into streams or bodies of water. Recycle it by taking it to a place that collects used oil.

## Engine Oil Life System

### When to Change Engine Oil

This vehicle has a computer system that indicates when to change the engine oil and filter. This is based on a combination of factors which

include engine revolutions, engine temperature, and miles driven. Based on driving conditions, the mileage at which an oil change is indicated can vary considerably. For the oil life system to work properly, the system must be reset every time the oil is changed.

When the system has calculated that oil life has been diminished, it indicates that an oil change is necessary. A CHANGE ENGINE OIL SOON message comes on. See *Engine Oil Messages* ⇨ 141.

Change the oil as soon as possible within the next 1 000 km (600 mi). It is possible that, if driving under the best conditions, the oil life system may indicate that an oil change is not necessary for up to a year. The engine oil and filter must be changed at least once a year and at this time the system must be reset. Your dealer has trained service people who will perform this work and reset the system. It is also important to check the oil regularly over the course of an oil drain interval and keep it at the proper level.

If the system is ever reset accidentally, the oil must be changed at 5 000 km (3,000 mi) since the last oil change. Remember to reset the oil life system whenever the oil is changed.

### How to Reset the Engine Oil Life System

Reset the system whenever the engine oil is changed so that the system can calculate the next engine oil change. To reset the system:

1. Using the DIC controls on the right side of the steering wheel, display REMAINING OIL LIFE on the DIC. See *Driver Information Center (DIC) (Base Level)* ⇨ 130 or *Driver Information Center (DIC) (Uplevel)* ⇨ 132. When remaining oil life is low, the CHANGE ENGINE OIL SOON message will appear on the display. See *Engine Oil Messages* ⇨ 141.

2. Press ✓ on the DIC controls and hold down for a few seconds to clear the CHANGE ENGINE OIL SOON message and reset the oil life at 100%.

Be careful not to reset the oil life display accidentally at any time other than after the oil is changed. It cannot be reset accurately until the next oil change.

The system is reset when the CHANGE ENGINE OIL SOON message is off.

If the CHANGE ENGINE OIL SOON message comes back on when the vehicle is started, the engine oil life system has not been reset. Repeat the procedure.

### Automatic Transmission Fluid

It is not necessary to check the transmission fluid level. A transmission fluid leak is the only reason for fluid loss. If a leak

occurs, take the vehicle to your dealer and have it repaired as soon as possible.

Change the fluid at the intervals listed in *Maintenance Schedule* ⇨ 310, and be sure to use the transmission fluid listed in *Recommended Fluids and Lubricants* ⇨ 318.

#### Caution

Use of the incorrect automatic transmission fluid may damage the vehicle, and the damage may not be covered by the vehicle warranty. Always use the automatic transmission fluid listed in *Recommended Fluids and Lubricants* ⇨ 318.

There is a special procedure for checking and changing the transmission fluid. Because this procedure is difficult, this should be done by your dealer.

## Engine Air Cleaner/Filter

The engine air cleaner/filter is in the engine compartment on the passenger side of the vehicle. See *Engine Compartment Overview* ⇨ 238 for more information on location.

### When to Inspect the Engine Air Cleaner/Filter

For intervals on changing and inspecting the engine air cleaner/filter, see *Maintenance Schedule* ⇨ 310.

### How to Inspect the Engine Air Cleaner/Filter

Do not start the engine or have the engine running with the engine air cleaner/filter housing open. Before removing the engine air cleaner/filter housing and nearby components are free of dirt and debris. Remove the engine air cleaner/filter. Lightly tap and shake the engine air cleaner/filter (away from the vehicle), to release loose dust and dirt. Inspect the engine air

cleaner/filter for damage, and replace if damaged. Do not clean the engine air cleaner/filter or components with water or compressed air.

To inspect or replace the air cleaner/filter:

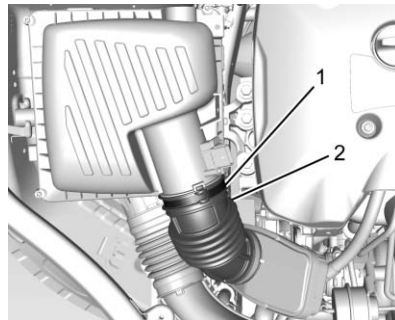

**2.0L L4 Engine**

1. Air Duct Clamp Screw
2. Air Duct

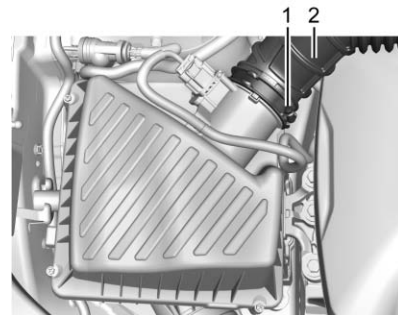

**2.5L L4 Engine**

1. Air Duct Clamp Screw
  2. Air Duct
1. Loosen the air duct clamp screw (1) and slide the air duct (2) from the air cleaner/filter cover.

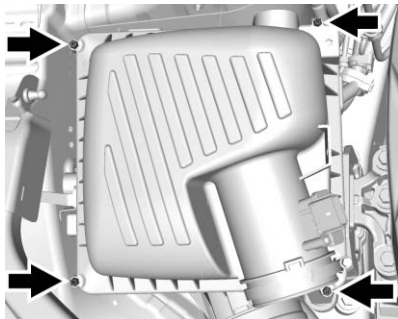

2.0L L4 Engine

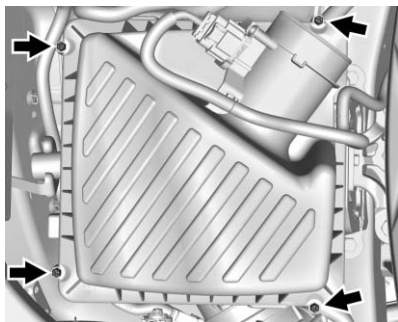

2.5L L4 Engine

- Remove the four screws and remove the air cleaner/filter cover, keeping the electrical connector connected.
- Inspect or replace the engine air cleaner/filter.

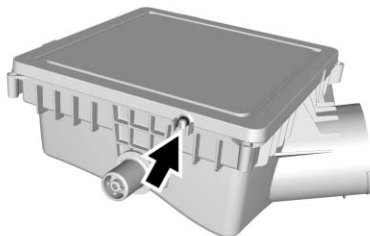

- Verify that the tab on the filter lines up with the slot in the air cleaner/filter assembly.
- Replace the cover and secure it with the four screws.
- Slide the air duct onto the assembly and tighten the air duct clamp screw.

See *Maintenance Schedule* ⇨ 310 for replacement intervals.

### **Warning**

Operating the engine with the air cleaner/filter off can cause you or others to be burned. The air cleaner not only cleans the air; it helps to stop flames if the engine backfires. Use caution when working on the engine and do not drive with the air cleaner/filter off.

### **Caution**

If the air cleaner/filter is off, dirt can easily get into the engine, which could damage it. Always have the air cleaner/filter in place when you are driving.

## **Cooling System**

The cooling system allows the engine to maintain the correct working temperature.

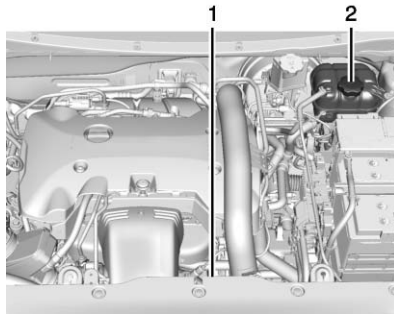

**2.0L L4 Engine**

1. Engine Cooling Fan (Out of View)
2. Engine Coolant Surge Tank and Pressure Cap

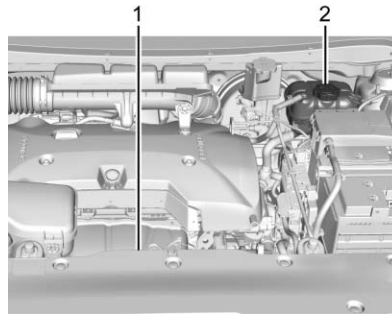

**2.5L L4 Engine**

1. Engine Cooling Fan (Out of View)
2. Engine Coolant Surge Tank and Pressure Cap

**Warning**

An electric engine cooling fan under the hood can start up even when the engine is not running and can cause injury. Keep hands, clothing, and tools away from any underhood electric fan.

**Warning**

Heater and radiator hoses, and other engine parts, can be very hot. Do not touch them. If you do, you can be burned.

Do not run the engine if there is a leak. If you run the engine, it could lose all coolant. That could cause an engine fire, and you could be burned. Get any leak fixed before you drive the vehicle.

**Caution**

Using coolant other than DEX-COOL® can cause premature engine, heater core, or radiator corrosion. In addition, the engine coolant could require changing sooner. Any repairs would not be covered by the vehicle warranty. Always use DEX-COOL (silicate-free) coolant in the vehicle.



## Engine Coolant

The cooling system in the vehicle is filled with DEX-COOL engine coolant. This coolant is designed to remain in the vehicle for 5 years or 240 000 km (150,000 mi), whichever occurs first.

The following explains the cooling system and how to check and add coolant when it is low. If there is a problem with engine overheating, see *Engine Overheating* ⇨ 250.

### What to Use

#### Warning

Adding only plain water or some other liquid to the cooling system can be dangerous. Plain water and other liquids, can boil before the proper coolant mixture will. The coolant warning system is set for the proper coolant mixture. With plain water or the wrong mixture, the engine could get too hot but you would not get the

(Continued)

#### Warning (Continued)

overheat warning. The engine could catch fire and you or others could be burned. Use a 50/50 mixture of clean, drinkable water and DEX-COOL coolant.

Use a 50/50 mixture of clean drinkable water and DEX-COOL coolant. This mixture:

- Gives freezing protection down to  $-37^{\circ}\text{C}$  ( $-34^{\circ}\text{F}$ ), outside temperature.
- Gives boiling protection up to  $129^{\circ}\text{C}$  ( $265^{\circ}\text{F}$ ), engine temperature.
- Protects against rust and corrosion.
- Will not damage aluminum parts.
- Helps keep the proper engine temperature.

#### Caution

If improper coolant mixture, inhibitors, or additives are used in the vehicle cooling system, the engine could overheat and be damaged. Too much water in the mixture can freeze and crack engine cooling parts. The repairs would not be covered by the vehicle warranty. Use only the proper mixture of engine coolant for the cooling system. See *Recommended Fluids and Lubricants* ⇨ 318.

Never dispose of engine coolant by putting it in the trash, pouring it on the ground, or pouring it into sewers, streams, or bodies of water. Have the coolant changed by an authorized service center, familiar with legal requirements regarding used coolant disposal. This will help protect the environment and your health.

## Checking Coolant

The vehicle must be on a level surface when checking the coolant level.

It is normal to see coolant moving in the upper coolant hose return line when the engine is running.

Check to see if coolant is visible in the coolant surge tank. If the coolant inside the coolant surge tank is boiling, do not do anything else until it cools down.

If coolant is visible but the coolant level is not at or above the mark pointed to, add a 50/50 mixture of clean, drinkable water and DEX-COOL coolant.

Be sure the cooling system is cool before this is done.

If no coolant is visible in the coolant surge tank, add coolant as follows:

## How to Add Coolant to the Coolant Surge Tank

### Caution

This vehicle has a specific coolant fill procedure. Failure to follow this procedure could cause the engine to overheat and be severely damaged.

If no problem is found, check to see if coolant is visible in the coolant surge tank. If coolant is visible but the coolant level is not at the indicated level mark, add a 50/50 mixture of clean, drinkable water and DEX-COOL coolant at the coolant surge tank, but be sure the cooling system, including the coolant surge tank pressure cap, is cool before you do it.

### Warning

Steam and scalding liquids from a hot cooling system can blow out and burn you badly. Never turn

(Continued)

### Warning (Continued)

the cap when the cooling system, including the surge tank pressure cap, is hot. Wait for the cooling system and surge tank pressure cap to cool.

### Caution

In cold weather, water can freeze and crack the engine, radiator, heater core, and other parts. Use the recommended coolant and the proper coolant mixture.

### Warning

You can be burned if you spill coolant on hot engine parts. Coolant contains ethylene glycol and it will burn if the engine parts are hot enough. Do not spill coolant on a hot engine.



1. Remove the coolant surge tank pressure cap when the cooling system, including the coolant surge tank pressure cap and upper radiator hose, is no longer hot.

Turn the pressure cap slowly counterclockwise about one-quarter of a turn. If you hear a hiss, wait for that to stop. This will allow any pressure still left to be vented out the discharge hose.

2. Keep turning the pressure cap slowly and remove it.

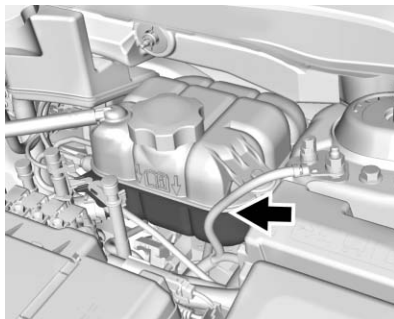

3. Fill the coolant surge tank with the proper DEX-COOL coolant mixture to the indicated level mark.
4. With the coolant surge tank pressure cap off, start the engine and let it run until you can feel the upper radiator hose getting hot. Watch out for the engine cooling fans.

By this time, the coolant level inside the coolant surge tank may be lower. If the level is lower, add more of the proper DEX-COOL coolant mixture to

the coolant surge tank until the level reaches the indicated level mark.

5. Replace the pressure cap tightly.

Check the level in the coolant surge tank when the cooling system has cooled down. If the coolant is not at the proper level, repeat Steps 1–3 and reinstall the pressure cap. If the coolant still is not at the proper level when the system cools down again, see your dealer.

### Caution

If the pressure cap is not tightly installed, coolant loss and possible engine damage may occur. Be sure the cap is properly and tightly secured.

## Engine Overheating

The vehicle has an engine coolant temperature gauge to warn of the engine overheating. See *Engine Coolant Temperature Gauge* ⇨ 118.

If the decision is made not to lift the hood when this warning appears, get service help right away.

If the decision is made to lift the hood, make sure the vehicle is parked on a level surface.

Then check to see if the engine cooling fans are running. If the engine is overheating, the fans should be running. If it is not, do not continue to run the engine. Have the vehicle serviced.

### Caution

Running the engine without coolant may cause damage or a fire. Vehicle damage would not be covered by the vehicle warranty.

### If Steam Is Coming from the Engine Compartment

#### Warning

Steam from an overheated engine can burn you badly, even if you just open the hood. Stay away from the engine if you see or hear steam coming from it. Just turn it off and get everyone away from the vehicle until it cools down. Wait until there is no sign of steam or coolant before you open the hood.

If you keep driving when the engine is overheated, the liquids in it can catch fire. You or others could be badly burned. Stop the engine if it overheats, and get out of the vehicle until the engine is cool.

### If No Steam Is Coming from the Engine Compartment

If an engine overheat warning is displayed but no steam can be seen or heard, the problem may not be

too serious. Sometimes the engine can get a little too hot when the vehicle:

- Climbs a long hill on a hot day.
- Stops after high-speed driving.
- Idles for long periods in traffic.

If the overheat warning is displayed with no sign of steam:

1. Turn the air conditioning off.
2. Turn the heater on to the highest temperature and to the highest fan speed. Open the windows as necessary.
3. When it is safe to do so, pull off the road, shift to P (Park) or N (Neutral), and let the engine idle.

If the engine coolant temperature gauge is no longer in the overheat zone, the vehicle can be driven. Continue to drive the vehicle slowly for about 10 minutes. Keep a safe vehicle distance from the vehicle in front. If the warning does not come back on, continue to drive normally and have the cooling system checked for proper fill and function.

If the warning continues, pull over, stop, and park the vehicle right away.

If there is no sign of steam, idle the engine for three minutes while parked. If the warning is still displayed, turn off the engine until it cools down.

## Washer Fluid

### What to Use

When the vehicle needs windshield washer fluid, be sure to read the manufacturer's instructions before use. If operating the vehicle in an area where the temperature may fall below freezing, use a fluid that has sufficient protection against freezing.

### Adding Washer Fluid



Open the cap with the washer symbol on it. Add washer fluid until the tank is full. See *Engine Compartment Overview* ⇨ 238 for reservoir location.

### Caution

- Do not use washer fluid that contains any type of water repellent coating. This can cause the wiper blades to chatter or skip.
- Do not use engine coolant (antifreeze) in the windshield washer. It can damage the windshield washer system and paint.
- Do not mix water with ready-to-use washer fluid. Water can cause the solution to freeze and damage the washer fluid tank and other parts of the washer system.

(Continued)

### Caution (Continued)

- When using concentrated washer fluid, follow the manufacturer instructions for adding water.
- Fill the washer fluid tank only three-quarters full when it is very cold. This allows for fluid expansion if freezing occurs, which could damage the tank if it is completely full.

## Brakes

Disc brake pads have built-in wear indicators that make a high-pitched warning sound when the brake pads are worn and new pads are needed. The sound can come and go or can be heard all the time when the vehicle is moving, except when applying the brake pedal firmly.

### **Warning**

The brake wear warning sound means that soon the brakes will not work well. That could lead to a crash. When the brake wear warning sound is heard, have the vehicle serviced.

### **Caution**

Continuing to drive with worn-out brake pads could result in costly brake repair.

Some driving conditions or climates can cause a brake squeal when the brakes are first applied or lightly applied. This does not mean something is wrong with the brakes.

Properly torqued wheel nuts are necessary to help prevent brake pulsation. When tires are rotated, inspect brake pads for wear and evenly tighten wheel nuts in the

proper sequence to torque specifications. See *Capacities and Specifications* ⇨ 322.

Brake pads should be replaced as complete sets.

### **Brake Pedal Travel**

See your dealer if the brake pedal does not return to normal height, or if there is a rapid increase in pedal travel. This could be a sign that brake service may be required.

### **Replacing Brake System Parts**

Always replace brake system parts with new, approved replacement parts. If this is not done, the brakes may not work properly. The braking performance expected can change in many other ways if the wrong replacement brake parts are installed or if parts are improperly installed.

## **Brake Fluid**

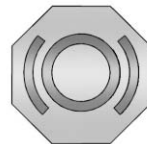

The brake master cylinder reservoir is filled with GM approved DOT 4 brake fluid as indicated on the reservoir cap. See *Engine Compartment Overview* ⇨ 238 for the location of the reservoir.

### **Checking Brake Fluid**

With the vehicle in P (Park) on a level surface, the brake fluid level should be between the minimum and maximum marks on the brake fluid reservoir.

There are only two reasons why the brake fluid level in the reservoir may go down:

- Normal brake lining wear. When new linings are installed, the fluid level goes back up.

- A fluid leak in the brake hydraulic system. Have the brake hydraulic system fixed. With a leak, the brakes will not work well.

Always clean the brake fluid reservoir cap and the area around the cap before removing it.

Do not top off the brake fluid. Adding fluid does not correct a leak. If fluid is added when the linings are worn, there will be too much fluid when new brake linings are installed. Add or remove fluid, as necessary, only when work is done on the brake hydraulic system.

### Warning

If too much brake fluid is added, it can spill on the engine and burn, if the engine is hot enough. You or others could be burned, and the vehicle could be damaged. Add brake fluid only when work is done on the brake hydraulic system.

When the brake fluid falls to a low level, the brake warning light comes on. See *Brake System Warning Light* ⇨ 123.

Brake fluid absorbs water over time which degrades the effectiveness of the brake fluid. Replace brake fluid at the specified intervals to prevent increased stopping distance. See *Maintenance Schedule* ⇨ 310.

### What to Add

Use only GM approved DOT 4 brake fluid from a clean, sealed container. See *Recommended Fluids and Lubricants* ⇨ 318.

### Warning

The wrong or contaminated brake fluid could result in damage to the brake system. This could result in the loss of braking leading to a possible injury. Always use the proper GM approved brake fluid.

### Caution

If brake fluid is spilled on the vehicle's painted surfaces, the paint finish can be damaged. Immediately wash off any painted surface.

## Battery - North America

The original equipment battery is maintenance free. Do not remove the cap and do not add fluid.

Refer to the replacement number shown on the original battery label when a new battery is needed. See *Engine Compartment Overview* ⇨ 238 for battery location.

The vehicle has an Absorbed Glass Mat (AGM) 12-volt battery. Installation of a standard 12-volt battery will result in reduced 12-volt battery life.

When using a 12-volt battery charger on the 12-volt AGM battery, some chargers have an AGM battery setting on the charger. If available, use the AGM setting on

the charger, to limit charge voltage to 14.8 volts. Follow the charger manufacturer's instructions.



**Warning**

Do not use a match or flame near a vehicle's battery. If you need more light, use a flashlight.

Do not smoke near a vehicle's battery.

When working around a vehicle's battery, shield your eyes with protective glasses.

(Continued)

**Warning (Continued)**

Keep children away from vehicle batteries.

**Warning**

**WARNING:** Battery posts, terminals, and related accessories contain lead and lead compounds, chemicals known to the State of California to cause cancer and birth defects or other reproductive harm. Batteries also contain other chemicals known to the State of California to cause cancer. **WASH HANDS AFTER HANDLING.**

See *California Proposition 65 Warning* ⇨ 235.

**Vehicle Storage**

**Warning**

Batteries have acid that can burn you and gas that can explode. You can be badly hurt if you are not careful. See *Jump Starting - North America* ⇨ 292 for tips on working around a battery without getting hurt.

**Infrequent Usage:** Remove the black, negative (-) cable from the battery to keep the battery from running down.

**Extended Storage:** Remove the black, negative (-) cable from the battery or use a battery trickle charger.

**All-Wheel Drive**

**Transfer Case**

Under normal driving conditions, transfer case fluid does not require maintenance unless there is a fluid



leak or unusual noise. If required, have the transfer case serviced by your dealer.

## Starter Switch Check

### Warning

When you are doing this inspection, the vehicle could move suddenly. If the vehicle moves, you or others could be injured.

1. Before starting this check, be sure there is enough room around the vehicle.
2. Apply both the parking brake and the regular brake.

Do not use the accelerator pedal, and be ready to turn off the engine immediately if it starts.

3. Try to start the engine in each gear. The vehicle should start only in P (Park) or N (Neutral).

If the vehicle starts in any other position, contact your dealer for service.

## Automatic Transmission Shift Lock Control Function Check

### Warning

When you are doing this inspection, the vehicle could move suddenly. If the vehicle moves, you or others could be injured.

1. Before starting this check, be sure there is enough room around the vehicle. It should be parked on a level surface.
2. Apply the parking brake. Be ready to apply the regular brake immediately if the vehicle begins to move.
3. With the engine off, turn the ignition on, but do not start the engine. Without applying the regular brake, try to move the

shift lever out of P (Park) with normal effort. If the shift lever moves out of P (Park), contact your dealer for service.

## Park Brake and P (Park) Mechanism Check

### Warning

When you are doing this check, the vehicle could begin to move. You or others could be injured and property could be damaged. Make sure there is room in front of the vehicle in case it begins to roll. Be ready to apply the regular brake at once should the vehicle begin to move.

Park on a fairly steep hill, with the vehicle facing downhill. Keeping your foot on the regular brake, set the parking brake.

- To check the parking brake's holding ability: With the engine running and the transmission in N (Neutral), slowly remove foot

pressure from the regular brake pedal. Do this until the vehicle is held by the parking brake only.

- To check the P (Park) mechanism's holding ability: With the engine running, shift to P (Park). Then release the parking brake followed by the regular brake.

Contact your dealer if service is required.

## Wiper Blade Replacement

Windshield wiper blades should be inspected for wear and cracking. See *Maintenance Schedule* ⇨ 310.

Replacement blades come in different types and are removed in different ways. For proper type and length, see *Maintenance Replacement Parts* ⇨ 319.

### Caution

Allowing the wiper arm to touch the windshield when no wiper blade is installed could damage  
(Continued)

### Caution (Continued)

the windshield. Any damage that occurs would not be covered by the vehicle warranty. Do not allow the wiper arm to touch the windshield.

## Front Wiper Blade Replacement

To replace the front wiper blades:

1. Pull the windshield wiper assembly away from the windshield.

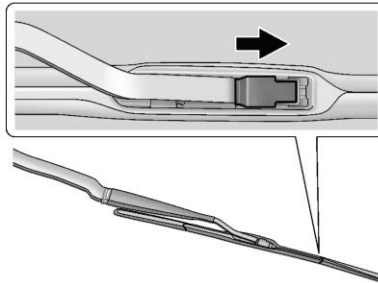

2. Lift up on the latch in the middle of the wiper blade where the wiper arm attaches.
3. With the latch open, pull the wiper blade down toward the windshield far enough to release it from the J-hooked end of the wiper arm.
4. Remove the wiper blade.
5. Reverse Steps 1–3 for wiper blade replacement.

### Caution

Damage may occur if the wiper blades are not in contact with the windshield before turning on the wiper system.

## Rear Wiper Blade Replacement

The rear wiper blade and wiper arm have a cover for protection. The rear wiper blade can be replaced while the cover is on.

1. Lift the wiper arm away from the windshield.

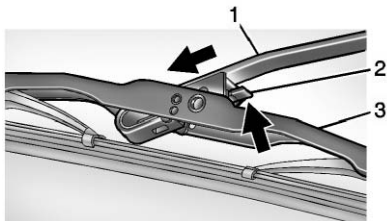

2. Push the release lever (2) to disengage the hook and push the wiper arm (1) out of the blade assembly (3).
3. Push the new blade assembly securely on the wiper arm until the release lever clicks into place.

If removal of the cover is necessary:



1. Slide a plastic tool under the cover and push upward to unsnap.

2. Slide the cover toward the wiper blade tip to unhook it from the blade assembly.
3. Remove the cover.
4. To reinstall the cover, ensure that the cover hook slides into the slot in the blade assembly.
5. Snap the cover down to secure.

## Windshield Replacement

The vehicle is equipped with an acoustic windshield. If the windshield needs to be replaced be sure to get an acoustic windshield so you will continue to have the benefits an acoustic windshield can provide.

If the vehicle is equipped with a Head-Up display (HUD) system and the windshield need to be replaced, get one that is designed for HUD or the HUD image may look out of focus.

## Headlamp Aiming

Headlamp aim has been preset and should need no further adjustment.

If the vehicle is damaged in a crash, the headlamp aim may be affected. If adjustment to the headlamps is necessary, see your dealer.

## Bulb Replacement

For the proper type of replacement bulbs, see *Replacement Bulbs* ⇨ 260.

For any bulb-changing procedure not listed in this section, contact your dealer.

## Halogen Bulbs

### Warning

Halogen bulbs have pressurized gas inside and can burst if you drop or scratch the bulb. You or others could be injured. Be sure to read and follow the instructions on the bulb package.

## High Intensity Discharge (HID) Lighting

### Warning

The High Intensity Discharge (HID) lighting system operates at a very high voltage. If you try to service any of the system components, you could be seriously injured. Have your dealer or a qualified technician service them.

After an HID headlamp bulb has been replaced, the beam might be a slightly different shade than it was originally. This is normal.

## License Plate Lamp

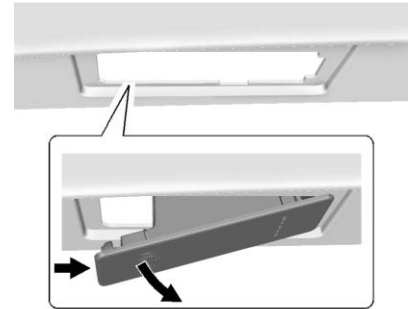

Lamp Assembly

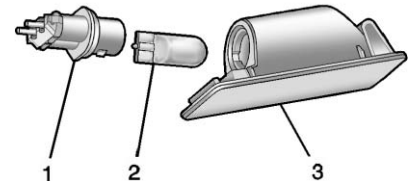

Bulb Assembly

To replace one of these bulbs:

1. Push the left end of the lamp assembly toward the right.
2. Turn the lamp assembly down to remove it.
3. Turn the bulb socket (1) counterclockwise to remove it from the lamp assembly (3).
4. Pull the bulb (2) straight out of the bulb socket (1).
5. Push the replacement bulb straight into the bulb socket and turn the bulb socket clockwise to install it into the lamp assembly.
6. Turn the lamp assembly into the lamp assembly opening engaging the clip side first.
7. Push on the lamp side opposite the clip until the lamp assembly snaps into place.

## Replacement Bulbs

Exterior Lamp	Bulb Number
License Plate Lamp	5W5 LL

For replacement bulbs not listed here, contact your dealer.

## Electrical System

### Electrical System Overload

The vehicle has fuses and circuit breakers to protect against an electrical system overload.

When the current electrical load is too heavy, the circuit breaker opens and closes, protecting the circuit until the current load returns to normal or the problem is fixed. This greatly reduces the chance of circuit overload and fire caused by electrical problems.

Replace a bad fuse with a new one of the identical size and rating.

If there is a problem on the road and a fuse needs to be replaced, the same amperage fuse can be borrowed. Choose some feature of the vehicle that is not needed to use and replace it as soon as possible.

### Headlamp Wiring

An electrical overload may cause the lamps to go on and off, or in some cases to remain off. Have the

headlamp wiring checked right away if the lamps go on and off or remain off.

## Windshield Wipers

If the wiper motor overheats due to heavy snow or ice, the windshield wipers will stop until the motor cools and will then restart.

Although the circuit is protected from electrical overload, overload due to heavy snow or ice may cause wiper linkage damage. Always clear ice and heavy snow from the windshield before using the windshield wipers.

If the overload is caused by an electrical problem and not snow or ice, be sure to get it fixed.

## Fuses and Circuit Breakers

The wiring circuits in the vehicle are protected from short circuits by a combination of fuses and circuit breakers. This greatly reduces the chance of damage caused by electrical problems.

To check a fuse, look at the silver-colored band inside the fuse. If the band is broken or melted, replace the fuse. Be sure to replace a bad fuse with a new one of the identical size and rating.

Fuses of the same amperage can be temporarily borrowed from another fuse location, if a fuse goes out. Replace the fuse as soon as possible.

To identify and check fuses, circuit breakers, and relays, see *Engine Compartment Fuse Block* ⇨ 261, *Instrument Panel Fuse Block* ⇨ 264, and *Rear Compartment Fuse Block* ⇨ 265.

## Engine Compartment Fuse Block

To remove the fuse block cover, squeeze the clips on the cover and lift it straight up. See *Engine Compartment Overview* ⇨ 238.

### Caution

Spilling liquid on any electrical component on the vehicle may damage it. Always keep the covers on any electrical component.

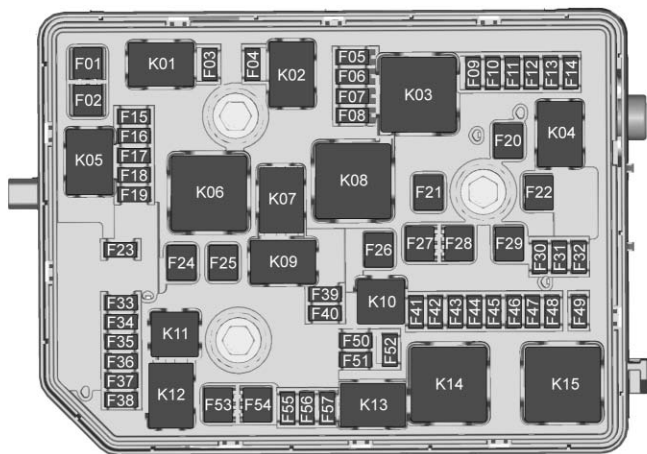

The vehicle may not be equipped with all of the fuses, relays, and features shown.

Fuse	Usage
F01	Starter 1
F02	Starter 2
F03	Non walk
F04	Engine control module

Fuse	Usage
F05	Flex fuel
F06	-/Transmission control module
F07	-
F08	Engine control module
F09	A/C

Fuse	Usage
F10	Canister vent solenoid
F11	Fuel pump
F12	Heated seats
F13	Engine coolant pump
F14	-
F15	O2 sensor
F16	Ignition coils – odd
F17	Ignition coils – even
F18	-
F19	-
F20	DC DC/Transmission
F21	Liftgate
F22	ABS
F23	Washer pump
F24	Headlamp washer
F25	-
F26	Transmission oil pump
F27	ABS

<b>Fuse</b>	<b>Usage</b>
F28	–
F29	Rear window defogger
F30	Mirror defogger
F31	–
F32	Various low current functions/Circuit 39 splice
F33	–
F34	Horn
F35	–
F36	Right high-beam headlamp
F37	Left high-beam headlamp
F38	Automatic headlamp leveling
F39	Front fog lamps
F40	Transmission oil pump
F41	Passenger seat ventilation
F42	Headlamp position

<b>Fuse</b>	<b>Usage</b>
F43	–
F44	Interior rearview mirror
F45	–
F46	Driver seat ventilation
F47	Electric steering column lock
F48	Rear wiper
F49	–
F50	–
F51	Right daytime running lamp
F52	Engine control module/ Transmission control module
F53	–
F54	–
F55	Front wiper
F56	–
F57	Left daytime running lamp

<b>Fuse</b>	<b>Usage</b>
K01	Start/Stop
K02	A/C clutch
K03	Engine control module
K04	Wiper
K05	Start solenoid
K06	–
K07	–
K08	Transmission oil pump
K09	Wiper speed
K10	Starter
K11	Headlamp washers
K12	High-beam headlamps
K13	Daytime running lamps
K14	Run/Crank
K15	Rear window/Mirror defogger



## Instrument Panel Fuse Block



The instrument panel fuse block is in the glove box. To access the fuses, open the fuse panel door from the passenger side by pulling it out.

To reinstall the door, insert the tabs on the top of the door into the console first, then push the door back into its original location.

The vehicle may not be equipped with all of the fuses, relays, and features shown.

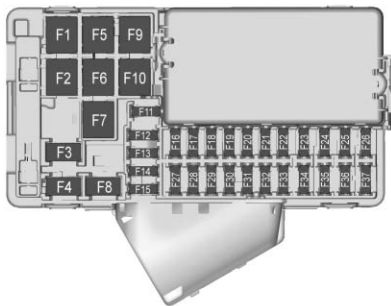

### Fuses Usage

F1	–
F2	Front HVAC blower
F3	Power seat
F4	Lighter (China only)
F5	–
F6	Front power windows
F7	–
F8	Accessory power outlet
F9	Body control module 8

Fuses	Usage
F10	Rear power windows
F11	–
F12	Sunroof
F13	Front heated seats
F14	Exterior rearview mirror
F15	Body control module 3
F16	–
F17	Body control module 6
F18	Body control module 7
F19	Data link connector
F20	SDM
F21	HVAC
F22	Liftgate release
F23	Passive entry/ Passive start
F24	OCC sensor
F25	Steering wheel controls

Fuses	Usage
F26	Ignition
F27	Body control module 4
F28	Transmission control module
F29	Body control module 2
F30	USB
F31	Rear HVAC blower
F32	Body control module 1
F33	Universal remote system
F34	Parking assist
F35	OnStar
F36	Display
F37	Radio

### Rear Compartment Fuse Block

The rear compartment fuse block is behind a cover on the left side of the rear compartment. To access the fuses, remove the cover.

The vehicle may not be equipped with all of the fuses, relays, and features shown.

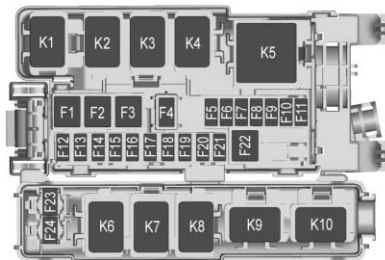

Fuses	Usage
F1	–
F2	DC AC
F3	–

Fuses	Usage
F4	Passenger power seat
F5	Memory seat module
F6	–
F7	Amplifier
F8	Rear accessory power outlet
F9	Rear heated seat
F10	Logistics relay
F11	Rear HVAC
F12	Power liftgate HF sensor
F13	Parking/Trailer lamps
F14	Side blind zone alert
F15	Left parking lamp
F16	Right parking lamp
F17	Body control module 6
F18	Heated steering wheel

Fuses	Usage
F19	AWD
F20	Lumbar seat
F21	Rear heated seat
F22	Rear drive control module
F23	Trailer left turn signal lamp
F24	Trailer right turn signal lamp
K1	Parking lamps
K2	–
K3	Ignition
K4	Logistics
K5	DC AC
K6	–
K7	Parking assist
K8	Right turn
K9	Left turn
K10	–

## Wheels and Tires

### Tires

Every new GM vehicle has high-quality tires made by a leading tire manufacturer. See the warranty manual for information regarding the tire warranty and where to get service. For additional information refer to the tire manufacturer.

#### Warning

- Poorly maintained and improperly used tires are dangerous.
- Overloading the tires can cause overheating as a result of too much flexing. There could be a blowout and a serious crash. See *Vehicle Load Limits* ⇨ 180.

(Continued)

#### Warning (Continued)

- Underinflated tires pose the same danger as overloaded tires. The resulting crash could cause serious injury. Check all tires frequently to maintain the recommended pressure. Tire pressure should be checked when the tires are cold.
- Overinflated tires are more likely to be cut, punctured, or broken by a sudden impact — such as when hitting a pothole. Keep tires at the recommended pressure.
- Worn or old tires can cause a crash. If the tread is badly worn, replace them.

(Continued)

**Warning (Continued)**

- Replace any tires that have been damaged by impacts with potholes, curbs, etc.
- Improperly repaired tires can cause a crash. Only the dealer or an authorized tire service center should repair, replace, dismount, and mount the tires.
- Do not spin the tires in excess of 56 km/h (35 mph) on slippery surfaces such as snow, mud, ice, etc. Excessive spinning may cause the tires to explode.

**All-Season Tires**

This vehicle may come with all-season tires. These tires are designed to provide good overall performance on most road surfaces

and weather conditions. Original equipment tires designed to GM's specific tire performance criteria have a TPC specification code molded onto the sidewall. Original equipment all-season tires can be identified by the last two characters of this TPC code, which will be "MS."

Consider installing winter tires on the vehicle if frequent driving on snow or ice-covered roads is expected. All-season tires provide adequate performance for most winter driving conditions, but they may not offer the same level of traction or performance as winter tires on snow or ice-covered roads. See *Winter Tires* ⇨ 267.

**Winter Tires**

This vehicle was not originally equipped with winter tires. Winter tires are designed for increased traction on snow and ice-covered roads. Consider installing winter tires on the vehicle if frequent driving on ice or snow covered roads is expected. See your dealer

for details regarding winter tire availability and proper tire selection. Also, see *Buying New Tires* ⇨ 280.

With winter tires, there may be decreased dry road traction, increased road noise, and shorter tread life. After changing to winter tires, be alert for changes in vehicle handling and braking.

If using winter tires:

- Use tires of the same brand and tread type on all four wheel positions.
- Use only radial ply tires of the same size, load range, and speed rating as the original equipment tires.

Winter tires with the same speed rating as the original equipment tires may not be available for H, V, W, Y, and ZR speed rated tires. If winter tires with a lower speed rating are chosen, never exceed the tire's maximum speed capability.

## Summer Tires

This vehicle may come with high performance summer tires. These tires have a special tread and compound that are optimized for maximum dry and wet road performance. This special tread and compound will have decreased performance in cold climates, and on ice and snow. It is recommended that winter tires be installed on the vehicle if frequent driving at temperatures below approximately 5 °C (40 °F) or on ice or snow covered roads is expected. See *Winter Tires* ⇨ 267.

### Caution

High performance summer tires have rubber compounds that lose flexibility and may develop surface cracks in the tread area at temperatures below -7 °C (20 °F). Always store high performance summer tires indoors and at temperatures above -7 °C (20 °F) when not in

(Continued)

### Caution (Continued)

use. If the tires have been subjected to -7 °C (20 °F) or less, let them warm up in a heated space to at least 5 °C (40 °F) for 24 hours or more before being installed or driving a vehicle on which they are installed. Do not apply heat or blow heated air directly on the tires. Always inspect tires before use. See *Tire Inspection* ⇨ 278.

## Tire Sidewall Labeling

Useful information about a tire is molded into its sidewall. The examples show a typical passenger vehicle tire and a compact spare tire sidewall.

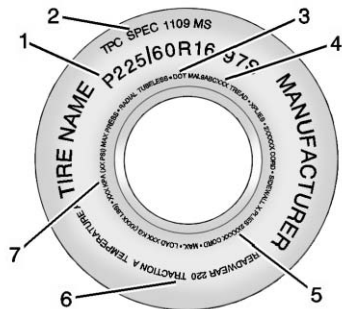

### Passenger (P-Metric) Tire Example

**(1) Tire Size :** The tire size is a combination of letters and numbers used to define a particular tire's width, height, aspect ratio, construction type, and service description. See the "Tire Size" illustration later in this section.

**(2) TPC Spec (Tire Performance Criteria Specification) :** Original equipment tires designed to GM's specific tire performance criteria have a TPC specification code molded onto the sidewall.

GM's TPC specifications meet or exceed all federal safety guidelines.

**(3) DOT (Department of Transportation)** : The Department of Transportation (DOT) code indicates that the tire is in compliance with the U.S. Department of Transportation Motor Vehicle Safety Standards.

#### **DOT Tire Date of**

**Manufacture** : The last four digits of the TIN indicate the tire manufactured date. The first two digits represent the week (01–52) and the last two digits, the year. For example, the third week of the year 2010 would have a four-digit DOT date of 0310.

**(4) Tire Identification Number (TIN)** : The letters and numbers following the DOT (Department of Transportation) code are the Tire Identification Number (TIN). The TIN shows the

manufacturer and plant code, tire size, and date the tire was manufactured. The TIN is molded onto both sides of the tire, although only one side may have the date of manufacture.

**(5) Tire Ply Material** : The type of cord and number of plies in the sidewall and under the tread.

**(6) Uniform Tire Quality Grading (UTQG)** : Tire manufacturers are required to grade tires based on three performance factors: treadwear, traction, and temperature resistance. For more information see *Uniform Tire Quality Grading* ⇨ 282.

**(7) Maximum Cold Inflation Load Limit** : Maximum load that can be carried and the maximum pressure needed to support that load.

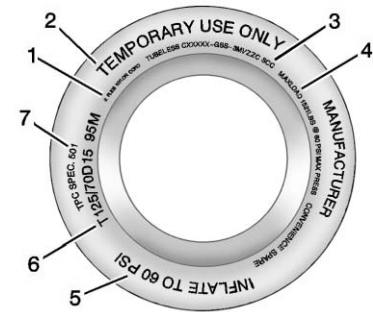

#### **Compact Spare Tire Example**

**(1) Tire Ply Material** : The type of cord and number of plies in the sidewall and under the tread.

**(2) Temporary Use Only** : The compact spare tire or temporary use tire should not be driven at speeds over 80 km/h (50 mph). The compact spare tire is for emergency use when a regular road tire has lost air and gone flat. If the vehicle has a compact spare tire, see *Compact Spare Tire* ⇨ 291 and *If a Tire Goes Flat* ⇨ 285.

**(3) Tire Identification Number (TIN)** : The letters and numbers following the DOT (Department of Transportation) code are the Tire Identification Number (TIN). The TIN shows the manufacturer and plant code, tire size, and date the tire was manufactured. The TIN is molded onto both sides of the tire, although only one side may have the date of manufacture.

**(4) Maximum Cold Inflation Load Limit** : Maximum load that can be carried and the maximum pressure needed to support that load.

**(5) Tire Inflation** : The temporary use tire or compact spare tire should be inflated to 420 kPa (60 psi). For more information on tire pressure and inflation see *Tire Pressure* ⇨ 273.

**(6) Tire Size** : A combination of letters and numbers define a tire's width, height, aspect ratio,

construction type, and service description. The letter T as the first character in the tire size means the tire is for temporary use only.

**(7) TPC Spec (Tire Performance Criteria Specification)** : Original equipment tires designed to GM's specific tire performance criteria have a TPC specification code molded onto the sidewall. GM's TPC specifications meet or exceed all federal safety guidelines.

## Tire Designations

### Tire Size

The following is an example of a typical passenger vehicle tire size.

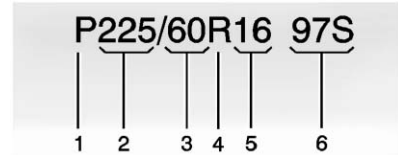

**(1) Passenger (P-Metric) Tire** : The United States version of a metric tire sizing system. The letter P as the first character in the tire size means a passenger vehicle tire engineered to standards set by the U.S. Tire and Rim Association.

**(2) Tire Width** : The three-digit number indicates the tire section width in millimeters from sidewall to sidewall.

**(3) Aspect Ratio** : A two-digit number that indicates the tire height-to-width measurements. For example, if the tire size aspect ratio is 60, as shown in item 3 of the illustration, it would mean that the tire's sidewall is 60 percent as high as it is wide.

**(4) Construction Code :** A letter code is used to indicate the type of ply construction in the tire. The letter R means radial ply construction; the letter D means diagonal or bias ply construction; and the letter B means belted-bias ply construction.

**(5) Rim Diameter :** Diameter of the wheel in inches.

**(6) Service Description :** These characters represent the load index and speed rating of the tire. The load index represents the load carrying capacity a tire is certified to carry. The speed rating is the maximum speed a tire is certified to carry a load.

## Tire Terminology and Definitions

**Air Pressure :** The amount of air inside the tire pressing outward on each square inch of

the tire. Air pressure is expressed in kPa (kilopascal) or psi (pounds per square inch).

**Accessory Weight :** The combined weight of optional accessories. Some examples of optional accessories are automatic transmission, power windows, power seats, and air conditioning.

**Aspect Ratio :** The relationship of a tire's height to its width.

**Belt :** A rubber coated layer of cords between the plies and the tread. Cords may be made from steel or other reinforcing materials.

**Bead :** The tire bead contains steel wires wrapped by steel cords that hold the tire onto the rim.

**Bias Ply Tire :** A pneumatic tire in which the plies are laid at alternate angles less than 90 degrees to the centerline of the tread.

**Cold Tire Pressure :** The amount of air pressure in a tire, measured in kPa (kilopascal) or psi (pounds per square inch) before a tire has built up heat from driving. See *Tire Pressure* ⇨ 273.

**Curb Weight :** The weight of a motor vehicle with standard and optional equipment including the maximum capacity of fuel, oil, and coolant, but without passengers and cargo.

**DOT Markings :** A code molded into the sidewall of a tire signifying that the tire is in compliance with the U.S. Department of Transportation (DOT) Motor Vehicle Safety Standards. The DOT code includes the Tire Identification Number (TIN), an alphanumeric designator which can also identify the tire manufacturer, production plant, brand, and date of production.



**GVWR** : Gross Vehicle Weight Rating. See *Vehicle Load Limits* ⇨ 180.

**GAWR FRT** : Gross Axle Weight Rating for the front axle. See *Vehicle Load Limits* ⇨ 180.

**GAWR RR** : Gross Axle Weight Rating for the rear axle. See *Vehicle Load Limits* ⇨ 180.

**Intended Outboard Sidewall** : The side of an asymmetrical tire that must always face outward when mounted on a vehicle.

**Kilopascal (kPa)** : The metric unit for air pressure.

**Light Truck (LT-Metric) Tire** : A tire used on light duty trucks and some multipurpose passenger vehicles.

**Load Index** : An assigned number ranging from 1 to 279 that corresponds to the load carrying capacity of a tire.

**Maximum Inflation Pressure** : The maximum air pressure to which a cold tire can be inflated. The maximum air pressure is molded onto the sidewall.

**Maximum Load Rating** : The load rating for a tire at the maximum permissible inflation pressure for that tire.

**Maximum Loaded Vehicle Weight** : The sum of curb weight, accessory weight, vehicle capacity weight, and production options weight.

**Normal Occupant Weight** : The number of occupants a vehicle is designed to seat multiplied by 68 kg (150 lb). See *Vehicle Load Limits* ⇨ 180.

**Occupant Distribution** : Designated seating positions.

**Outward Facing Sidewall** : The side of an asymmetrical tire that has a particular side that faces outward when mounted on a vehicle. The side of the tire that

contains a whitewall, bears white lettering, or bears manufacturer, brand, and/or model name molding that is higher or deeper than the same moldings on the other sidewall of the tire.

**Passenger (P-Metric) Tire** : A tire used on passenger cars and some light duty trucks and multipurpose vehicles.

**Recommended Inflation Pressure** : Vehicle manufacturer's recommended tire inflation pressure as shown on the tire placard. See *Tire Pressure* ⇨ 273 and *Vehicle Load Limits* ⇨ 180.

**Radial Ply Tire** : A pneumatic tire in which the ply cords that extend to the beads are laid at 90 degrees to the centerline of the tread.

**Rim** : A metal support for a tire and upon which the tire beads are seated.

**Sidewall** : The portion of a tire between the tread and the bead.

**Speed Rating** : An alphanumeric code assigned to a tire indicating the maximum speed at which a tire can operate.

**Traction** : The friction between the tire and the road surface. The amount of grip provided.

**Tread** : The portion of a tire that comes into contact with the road.

**Treadwear Indicators** : Narrow bands, sometimes called wear bars, that show across the tread of a tire when only 1.6 mm (1/16 in) of tread remains. See *When It Is Time for New Tires* ⇨ 280.

**UTQGS (Uniform Tire Quality Grading Standards)** : A tire information system that provides consumers with ratings for a tire's traction, temperature, and treadwear. Ratings are

determined by tire manufacturers using government testing procedures. The ratings are molded into the sidewall of the tire. See *Uniform Tire Quality Grading* ⇨ 282.

**Vehicle Capacity Weight** : The number of designated seating positions multiplied by 68 kg (150 lb) plus the rated cargo load. See *Vehicle Load Limits* ⇨ 180.

**Vehicle Maximum Load on the Tire** : Load on an individual tire due to curb weight, accessory weight, occupant weight, and cargo weight.

**Vehicle Placard** : A label permanently attached to a vehicle showing the vehicle capacity weight and the original equipment tire size and recommended inflation pressure. See "Tire and Loading Information Label" under *Vehicle Load Limits* ⇨ 180.

## Tire Pressure

Tires need the correct amount of air pressure to operate effectively.

### Caution

Neither tire underinflation nor overinflation is good. Underinflated tires, or tires that do not have enough air, can result in:

- Tire overloading and overheating which could lead to a blowout.
- Premature or irregular wear.
- Poor handling.
- Reduced fuel economy.

Overinflated tires, or tires that have too much air, can result in:

- Unusual wear.

(Continued)

**Caution (Continued)**

- Poor handling.
- Rough ride.
- Needless damage from road hazards.

The Tire and Loading Information label on the vehicle indicates the original equipment tires and the correct cold tire inflation pressures. The recommended pressure is the minimum air pressure needed to support the vehicle's maximum load carrying capacity. See *Vehicle Load Limits* ⇨ 180.

How the vehicle is loaded affects vehicle handling and ride comfort. Never load the vehicle with more weight than it was designed to carry.

**When to Check**

Check the tires once a month or more. Do not forget the compact spare, if the vehicle has one. The cold compact spare tire pressure should be at 420 kPa (60 psi). See *Compact Spare Tire* ⇨ 291.

**How to Check**

Use a good quality pocket-type gauge to check tire pressure. Proper tire inflation cannot be determined by looking at the tire. Check the tire inflation pressure when the tires are cold, meaning the vehicle has not been driven for at least three hours or no more than 1.6 km (1 mi).

Remove the valve cap from the tire valve stem. Press the tire gauge firmly onto the valve to get a pressure measurement. If the cold tire inflation pressure matches the recommended pressure on the Tire and Loading Information label, no

further adjustment is necessary. If the inflation pressure is low, add air until the recommended pressure is reached. If the inflation pressure is high, press on the metal stem in the center of the tire valve to release air.

Recheck the tire pressure with the tire gauge.

Put the valve caps back on the valve stems to keep out dirt and moisture and prevent leaks. Use only valve caps designed for the vehicle by GM. TPMS sensors could be damaged and would not be covered by the vehicle warranty.

**Tire Pressure Monitor System**

The Tire Pressure Monitor System (TPMS) uses radio and sensor technology to check tire pressure levels. The TPMS sensors monitor the air pressure in your tires and transmit tire pressure readings to a receiver located in the vehicle.

Each tire, including the spare (if provided), should be checked monthly when cold and inflated to the inflation pressure recommended by the vehicle manufacturer on the vehicle placard or tire inflation pressure label. (If your vehicle has tires of a different size than the size indicated on the vehicle placard or tire inflation pressure label, you should determine the proper tire inflation pressure for those tires.)

As an added safety feature, your vehicle has been equipped with a tire pressure monitoring system (TPMS) that illuminates a low tire pressure telltale when one or more of your tires is significantly under-inflated.

Accordingly, when the low tire pressure telltale illuminates, you should stop and check your tires as soon as possible, and inflate them to the proper pressure. Driving on a significantly under-inflated tire causes the tire to overheat and can lead to tire failure. Under-inflation also reduces fuel efficiency and tire

tread life, and may affect the vehicle's handling and stopping ability.

Please note that the TPMS is not a substitute for proper tire maintenance, and it is the driver's responsibility to maintain correct tire pressure, even if under-inflation has not reached the level to trigger illumination of the TPMS low tire pressure telltale.

Your vehicle has also been equipped with a TPMS malfunction indicator to indicate when the system is not operating properly. The TPMS malfunction indicator is combined with the low tire pressure telltale. When the system detects a malfunction, the telltale will flash for approximately one minute and then remain continuously illuminated. This sequence will continue upon subsequent vehicle start-ups as long as the malfunction exists.

When the malfunction indicator is illuminated, the system may not be able to detect or signal low tire pressure as intended. TPMS malfunctions may occur for a variety

of reasons, including the installation of replacement or alternate tires or wheels on the vehicle that prevent the TPMS from functioning properly. Always check the TPMS malfunction telltale after replacing one or more tires or wheels on your vehicle to ensure that the replacement or alternate tires and wheels allow the TPMS to continue to function properly.

See *Tire Pressure Monitor Operation* ⇨ 275.

See *Radio Frequency Statement* ⇨ 334.

## **Tire Pressure Monitor Operation**

This vehicle may have a Tire Pressure Monitor System (TPMS). The TPMS is designed to warn the driver when a low tire pressure condition exists. TPMS sensors are mounted onto each tire and wheel assembly, excluding the spare tire and wheel assembly. The TPMS sensors monitor the air pressure in

the tires and transmits the tire pressure readings to a receiver located in the vehicle.



When a low tire pressure condition is detected, the TPMS illuminates the low tire pressure warning light located on the instrument cluster. If the warning light comes on, stop as soon as possible and inflate the tires to the recommended pressure shown on the Tire and Loading Information label. See *Vehicle Load Limits* ⇨ 180.

A message to check the pressure in a specific tire displays in the Driver Information Center (DIC). The low tire pressure warning light and the DIC warning message come on at each ignition cycle until the tires are inflated to the correct inflation pressure. Using the DIC, tire pressure levels can be viewed. For additional information and details

about the DIC operation and displays see *Driver Information Center (DIC) (Base Level)* ⇨ 130 or *Driver Information Center (DIC) (Uplevel)* ⇨ 132.

The low tire pressure warning light may come on in cool weather when the vehicle is first started, and then turn off as the vehicle is driven. This could be an early indicator that the air pressure is getting low and needs to be inflated to the proper pressure.

A Tire and Loading Information label, attached to your vehicle, shows the size of the original equipment tires and the correct inflation pressure for the tires when they are cold. See *Vehicle Load Limits* ⇨ 180, for an example of the Tire and Loading Information label and its location. Also see *Tire Pressure* ⇨ 273.

The TPMS can warn about a low tire pressure condition but it does not replace normal tire maintenance. See *Tire Inspection* ⇨ 278, *Tire Rotation* ⇨ 279 and *Tires* ⇨ 266.

### Caution

Tire sealant materials are not all the same. A non-approved tire sealant could damage the TPMS sensors. TPMS sensor damage caused by using an incorrect tire sealant is not covered by the vehicle warranty. Always use only the GM approved tire sealant available through your dealer or included in the vehicle.

### TPMS Malfunction Light and Message

The TPMS will not function properly if one or more of the TPMS sensors are missing or inoperable. When the system detects a malfunction, the low tire warning light flashes for about one minute and then stays on for the remainder of the ignition cycle. A DIC warning message also displays. The malfunction light and DIC warning message come on at each ignition cycle until the problem

is corrected. Some of the conditions that can cause these to come on are:

- One of the road tires has been replaced with the spare tire. The spare tire does not have a TPMS sensor. The malfunction light and DIC message should go off after the road tire is replaced and the sensor matching process is performed successfully. See "TPMS Sensor Matching Process" later in this section.
- The TPMS sensor matching process was not done or not completed successfully after rotating the tires. The malfunction light and the DIC message should go off after successfully completing the sensor matching process. See "TPMS Sensor Matching Process" later in this section.
- One or more TPMS sensors are missing or damaged. The malfunction light and the DIC message should go off when the TPMS sensors are installed and

the sensor matching process is performed successfully. See your dealer for service.

- Replacement tires or wheels do not match the original equipment tires or wheels. Tires and wheels other than those recommended could prevent the TPMS from functioning properly. See *Buying New Tires* ⇨ 280.
- Operating electronic devices or being near facilities using radio wave frequencies similar to the TPMS could cause the TPMS sensors to malfunction.

If the TPMS is not functioning properly it cannot detect or signal a low tire condition. See your dealer for service if the TPMS malfunction light and DIC message comes on and stays on.

### **TPMS Sensor Matching Process**

Each TPMS sensor has a unique identification code. The identification code needs to be matched to a new tire/wheel position after rotating the vehicle's tires or replacing one or

more of the TPMS sensors. The TPMS sensor matching process should also be performed after replacing a spare tire with a road tire containing the TPMS sensor. The malfunction light and the DIC message should go off at the next ignition cycle. The sensors are matched to the tire/wheel positions, using a TPMS relearn tool, in the following order: driver side front tire, passenger side front tire, passenger side rear tire, and driver side rear. See your dealer for service or to purchase a relearn tool. A TPMS relearn tool can also be purchased. See Tire Pressure Monitor Sensor Activation Tool at [www.gmtoolsandequipment.com](http://www.gmtoolsandequipment.com) or call 1-800-GM TOOLS (1-800-468-6657).

There are two minutes to match the first tire/wheel position, and five minutes overall to match all four tire/wheel positions. If it takes longer, the matching process stops and must be restarted.

The TPMS sensor matching process is:

1. Set the parking brake.
2. Turn the ignition to ON/RUN with the engine off or place the vehicle power mode in ON/RUN/START. See *Ignition Positions* ⇨ 184.
3. Make sure the Tire Pressure info page option is turned on. The info pages on the DIC can be turned on and off through the Settings menu. See *Driver Information Center (DIC) (Base Level)* ⇨ 130 or *Driver Information Center (DIC) (Uplevel)* ⇨ 132.
4. Use the DIC controls on the right side of the steering wheel to scroll to the Tire Pressure screen under the DIC info page.
5. Press and hold ✓ in the center of the DIC controls.

The horn sounds twice to signal the receiver is in relearn mode and the TIRE LEARNING ACTIVE message displays on the DIC screen.

6. Start with the driver side front tire.
7. Place the relearn tool against the tire sidewall, near the valve stem. Then press the button to activate the TPMS sensor. A horn chirp confirms that the sensor identification code has been matched to this tire and wheel position.
8. Proceed to the passenger side front tire, and repeat the procedure in Step 7.
9. Proceed to the passenger side rear tire, and repeat the procedure in Step 7.
10. Proceed to the driver side rear tire, and repeat the procedure in Step 7. The horn sounds two times to indicate the sensor identification code has been matched to the driver side rear tire, and the TPMS sensor

matching process is no longer active. The TIRE LEARNING ACTIVE message on the DIC display screen goes off.

11. Turn the ignition to LOCK/OFF or press STOP to turn the ignition off.
12. Set all four tires to the recommended air pressure level as indicated on the Tire and Loading Information label.

## Tire Inspection

We recommend that the tires, including the spare tire, if the vehicle has one, be inspected for signs of wear or damage at least once a month.

Replace the tire if:

- The indicators at three or more places around the tire can be seen.
- There is cord or fabric showing through the tire's rubber.

- The tread or sidewall is cracked, cut, or snagged deep enough to show cord or fabric.
- The tire has a bump, bulge, or split.
- The tire has a puncture, cut, or other damage that cannot be repaired well because of the size or location of the damage.

## Tire Rotation

Tires should be rotated every 12 000 km (7,500 mi). See *Maintenance Schedule* ⇨ 310.

Tires are rotated to achieve a more uniform wear for all tires. The first rotation is the most important.

Anytime unusual wear is noticed, rotate the tires as soon as possible, check for proper tire inflation pressure, and check for damaged tires or wheels. If the unusual wear continues after the

rotation, check the wheel alignment. See *When It Is Time for New Tires* ⇨ 280 and *Wheel Replacement* ⇨ 284.

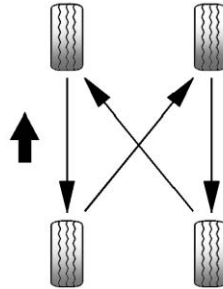

Use this rotation pattern when rotating the tires.

Do not include the compact spare tire in the tire rotation.

Adjust the front and rear tires to the recommended inflation pressure on the Tire and Loading Information label after the tires have been rotated. See *Tire Pressure* ⇨ 273 and *Vehicle Load Limits* ⇨ 180.

Reset the Tire Pressure Monitor System. See *Tire Pressure Monitor Operation* ⇨ 275.

Check that all wheel nuts are properly tightened. See “Wheel Nut Torque” under *Capacities and Specifications* ⇨ 322.

### Warning

Rust or dirt on a wheel, or on the parts to which it is fastened, can make wheel nuts become loose after time. The wheel could come off and cause an accident. When changing a wheel, remove any rust or dirt from places where the wheel attaches to the vehicle. In an emergency, a cloth or a paper towel can be used; however, use a scraper or wire brush later to remove all rust or dirt.

Lightly coat the center of the wheel hub with wheel bearing grease after a wheel change or tire rotation to prevent corrosion or rust build-up. Do not get



grease on the flat wheel mounting surface or on the wheel nuts or bolts.

## When It Is Time for New Tires

Factors such as maintenance, temperatures, driving speeds, vehicle loading, and road conditions affect the wear rate of the tires.

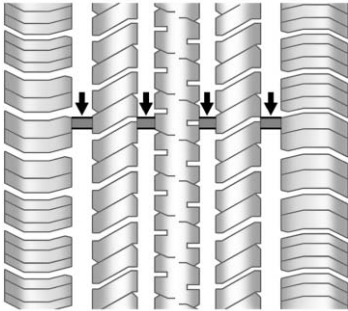

Treadwear indicators are one way to tell when it is time for new tires.

Treadwear indicators appear when the tires have only 1.6 mm (1/16 in)

or less of tread remaining. See *Tire Inspection* ⇨ 278 and *Tire Rotation* ⇨ 279.

The rubber in tires ages over time. This also applies to the spare tire, if the vehicle has one, even if it is never used. Multiple factors including temperatures, loading conditions, and inflation pressure maintenance affect how fast aging takes place. GM recommends that tires, including the spare if equipped, be replaced after six years, regardless of tread wear. The tire manufacture date is the last four digits of the DOT Tire Identification Number (TIN) which is molded into one side of the tire sidewall. The first two digits represent the week (01–52) and the last two digits, the year. For example, the third week of the year 2010 would have a four-digit DOT date of 0310.

## Vehicle Storage

Tires age when stored normally mounted on a parked vehicle. Park a vehicle that will be stored for at least a month in a cool, dry, clean area away from direct sunlight to

slow aging. This area should be free of grease, gasoline, or other substances that can deteriorate rubber.

Parking for an extended period can cause flat spots on the tires that may result in vibrations while driving. When storing a vehicle for at least a month, remove the tires or raise the vehicle to reduce the weight from the tires.

## Buying New Tires

GM has developed and matched specific tires for the vehicle. The original equipment tires installed were designed to meet General Motors Tire Performance Criteria Specification (TPC Spec) system rating. When replacement tires are needed, GM strongly recommends buying tires with the same TPC Spec rating.

GM's exclusive TPC Spec system considers over a dozen critical specifications that impact the overall performance of the

vehicle, including brake system performance, ride and handling, traction control, and tire pressure monitoring performance. GM's TPC Spec number is molded onto the tire's sidewall near the tire size. If the tires have an all-season tread design, the TPC Spec number will be followed by MS for mud and snow. See *Tire Sidewall Labeling* ⇨ 268.

GM recommends replacing worn tires in complete sets of four. Uniform tread depth on all tires will help to maintain the performance of the vehicle. Braking and handling performance may be adversely affected if all the tires are not replaced at the same time. If proper rotation and maintenance have been done, all four tires should wear out at about the same time. See *Tire Rotation* ⇨ 279. However, if it is

necessary to replace only one axle set of worn tires, place the new tires on the rear axle.

Winter tires with the same speed rating as the original equipment tires may not be available for H, V, W, Y and ZR speed rated tires. Never exceed the winter tires' maximum speed capability when using winter tires with a lower speed rating.

 **Warning**

Tires could explode during improper service. Attempting to mount or dismount a tire could cause injury or death. Only your dealer or authorized tire service center should mount or dismount the tires.

 **Warning**

Mixing tires of different sizes, brands, or types may cause loss of control of the vehicle, resulting in a crash or other vehicle damage. Use the correct size, brand, and type of tires on all wheels.

 **Warning**

Using bias-ply tires on the vehicle may cause the wheel rim flanges to develop cracks after many miles of driving. A tire and/or wheel could fail suddenly and cause a crash. Use only radial-ply tires with the wheels on the vehicle.

If the vehicle tires must be replaced with a tire that does not have a TPC Spec number, make sure they are the same size,

load range, speed rating, and construction (radial) as the original tires.

Vehicles that have a tire pressure monitoring system could give an inaccurate low-pressure warning if non-TPC Spec rated tires are installed. See *Tire Pressure Monitor System* ⇨ 274.

The Tire and Loading Information label indicates the original equipment tires on the vehicle. See *Vehicle Load Limits* ⇨ 180.

## Different Size Tires and Wheels

If wheels or tires are installed that are a different size than the original equipment wheels and tires, vehicle performance, including its braking, ride and handling characteristics, stability, and resistance to rollover may be affected. If the vehicle has electronic systems such as antilock brakes, rollover airbags, traction

control, electronic stability control, or All-Wheel Drive, the performance of these systems can also be affected.

### Warning

If different sized wheels are used, there may not be an acceptable level of performance and safety if tires not recommended for those wheels are selected. This increases the chance of a crash and serious injury. Only use GM specific wheel and tire systems developed for the vehicle, and have them properly installed by a GM certified technician.

See *Buying New Tires* ⇨ 280 and *Accessories and Modifications* ⇨ 236.

## Uniform Tire Quality Grading

The following information relates to the system developed by the United States National Highway

Traffic Safety Administration (NHTSA), which grades tires by treadwear, traction, and temperature performance. This applies only to vehicles sold in the United States. The grades are molded on the sidewalls of most passenger car tires. The Uniform Tire Quality Grading (UTQG) system does not apply to deep tread, winter tires, compact spare tires, tires with nominal rim diameters of 10 to 12 inches (25 to 30 cm), or to some limited-production tires.

While the tires available on General Motors passenger cars and light trucks may vary with respect to these grades, they must also conform to federal safety requirements and additional General Motors Tire Performance Criteria (TPC) standards.

Quality grades can be found where applicable on the tire sidewall between tread shoulder and maximum section width. For example:

**Treadwear 200 Traction AA  
Temperature A**

All Passenger Car Tires Must Conform to Federal Safety Requirements In Addition To These Grades.

**Treadwear**

The treadwear grade is a comparative rating based on the wear rate of the tire when tested under controlled conditions on a specified government test course. For example, a tire graded 150 would wear one and one-half (1½) times as well on the government course as a tire graded 100. The relative performance of tires depends upon the actual conditions of their use, however, and may depart significantly from the

norm due to variations in driving habits, service practices and differences in road characteristics and climate.

**Traction**

The traction grades, from highest to lowest, are AA, A, B, and C. Those grades represent the tire's ability to stop on wet pavement as measured under controlled conditions on specified government test surfaces of asphalt and concrete. A tire marked C may have poor traction performance. Warning: The traction grade assigned to this tire is based on straight-ahead braking traction tests, and does not include acceleration, cornering, hydroplaning, or peak traction characteristics.

**Temperature**

The temperature grades are A (the highest), B, and C, representing the tire's resistance

to the generation of heat and its ability to dissipate heat when tested under controlled conditions on a specified indoor laboratory test wheel. Sustained high temperature can cause the material of the tire to degenerate and reduce tire life, and excessive temperature can lead to sudden tire failure. The grade C corresponds to a level of performance which all passenger car tires must meet under the Federal Motor Safety Standard No. 109. Grades B and A represent higher levels of performance on the laboratory test wheel than the minimum required by law. Warning: The temperature grade for this tire is established for a tire that is properly inflated and not overloaded. Excessive speed, underinflation, or excessive loading, either separately or in combination, can cause heat buildup and possible tire failure.

## Wheel Alignment and Tire Balance

The tires and wheels were aligned and balanced at the factory to provide the longest tire life and best overall performance. Adjustments to wheel alignment and tire balancing are not necessary on a regular basis. Consider an alignment check if there is unusual tire wear or the vehicle is significantly pulling to one side or the other. Some slight pull to the left or right, depending on the crown of the road and/or other road surface variations such as troughs or ruts, is normal. If the vehicle is vibrating when driving on a smooth road, the tires and wheels may need to be rebalanced. See your dealer for proper diagnosis.

## Wheel Replacement

Replace any wheel that is bent, cracked, or badly rusted or corroded. If wheel nuts keep coming loose, the wheel, wheel bolts, and wheel nuts should be replaced. If the wheel leaks air, replace it.

Some aluminum wheels can be repaired. See your dealer if any of these conditions exist.

Your dealer will know the kind of wheel that is needed.

Each new wheel should have the same load-carrying capacity, diameter, width, offset, and be mounted the same way as the one it replaces.

Replace wheels, wheel bolts, wheel nuts, or Tire Pressure Monitor System (TPMS) sensors with new GM original equipment parts.

### Warning

Using the wrong replacement wheels, wheel bolts, or wheel nuts can be dangerous. It could affect the braking and handling of the vehicle. Tires can lose air, and cause loss of control, causing a crash. Always use the correct wheel, wheel bolts, and wheel nuts for replacement.

### Caution

The wrong wheel can also cause problems with bearing life, brake cooling, speedometer or odometer calibration, headlamp aim, bumper height, vehicle ground clearance, and tire or tire chain clearance to the body and chassis.

## Used Replacement Wheels

### Warning

Replacing a wheel with a used one is dangerous. How it has been used or how far it has been driven may be unknown. It could fail suddenly and cause a crash. When replacing wheels, use a new GM original equipment wheel.

## Tire Chains

### Warning

Do not use tire chains. There is not enough clearance. Tire chains used on a vehicle without the proper amount of clearance can cause damage to the brakes, suspension, or other vehicle parts. The area damaged by the tire chains could cause loss of control and a crash.

Use another type of traction device only if its manufacturer recommends it for the vehicle's tire size combination and road conditions. Follow that manufacturer's instructions. To avoid vehicle damage, drive slow and readjust or remove the traction device if it contacts the vehicle. Do not spin the wheels. If traction devices are used, install them on the front tires.

## If a Tire Goes Flat

It is unusual for a tire to blow out while driving, especially if the tires are maintained properly. See *Tires* ⇨ 266. If air goes out of a tire, it is much more likely to leak out slowly. But if there ever is a blowout, here are a few tips about what to expect and what to do:

If a front tire fails, the flat tire creates a drag that pulls the vehicle toward that side. Take your foot off the accelerator pedal and grip the steering wheel firmly. Steer to maintain lane position, and then gently brake to a stop, well off the road, if possible.

A rear blowout, particularly on a curve, acts much like a skid and may require the same correction as used in a skid. Stop pressing the accelerator pedal and steer to straighten the vehicle. It may be very bumpy and noisy. Gently brake to a stop, well off the road, if possible.

### Warning

Driving on a flat tire will cause permanent damage to the tire. Re-inflating a tire after it has been driven on while severely underinflated or flat may cause a blowout and a serious crash. Never attempt to re-inflate a tire that has been driven on while severely underinflated or flat. Have your dealer or an authorized tire service center repair or replace the flat tire as soon as possible.

### Warning

Lifting a vehicle and getting under it to do maintenance or repairs is dangerous without the appropriate safety equipment and training. If a jack is provided with the vehicle, it is designed only for changing a flat tire. If it is used for anything else, you or others could

(Continued)

**Warning (Continued)**

be badly injured or killed if the vehicle slips off the jack. If a jack is provided with the vehicle, only use it for changing a flat tire.

If a tire goes flat, avoid further tire and wheel damage by driving slowly to a level place, well off the road, if possible. Turn on the hazard warning flashers. See *Hazard Warning Flashers* ⇨ 161.

**Warning**

Changing a tire can be dangerous. The vehicle can slip off the jack and roll over or fall causing injury or death. Find a level place to change the tire. To help prevent the vehicle from moving:

1. Set the parking brake firmly.

(Continued)

**Warning (Continued)**

2. Put an automatic transmission in P (Park) or a manual transmission in 1 (First) or R (Reverse).
3. Turn off the engine and do not restart while the vehicle is raised.
4. Do not allow passengers to remain in the vehicle.
5. Place wheel blocks, if equipped, on both sides of the tire at the opposite corner of the tire being changed.

When the vehicle has a flat tire (2), use the following example as a guide to assist in the placement of the wheel blocks (1), if equipped.

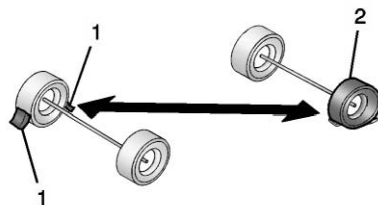

1. Wheel Block (If Equipped)
2. Flat Tire

The following information explains how to repair or change a tire.

## Tire Changing

### Removing the Spare Tire and Tools

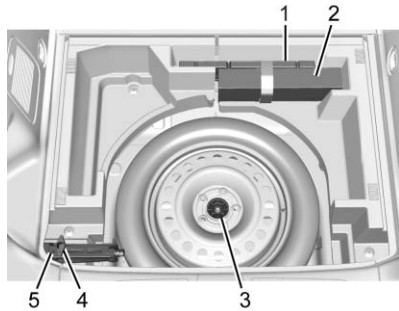

1. Warning Triangle (If Equipped)
2. Wheel Wrench, Tow Hook, and Spent Road Wheel Strap (In Bag)
3. Retainer Nut
4. Jack Retainer Nut
5. Jack

To access the spare tire and tools:

1. Open the liftgate. See *Liftgate* ⇨ 37.

2. Lift the load floor. Use the hook from the load floor to hold it open.
3. Remove the cargo management system. See *Cargo Management System* ⇨ 102.
4. Turn the jack retainer nut (4) counterclockwise to remove the jack (5).
5. Remove the wheel wrench (2) from the bag.
6. Place the tools next to the tire being changed.
7. Turn the retainer nut (3) counterclockwise to remove the spare tire.
8. Place the spare tire next to the tire being changed.

### Removing the Flat Tire and Installing the Spare Tire

1. Do a safety check before proceeding. See *If a Tire Goes Flat* ⇨ 285 for more information.

2. For vehicles with a wheel cover or center cap, pull the cover or center cap away from the wheel to remove it. Store the wheel cover in the cargo area until you have the flat tire repaired or replaced.

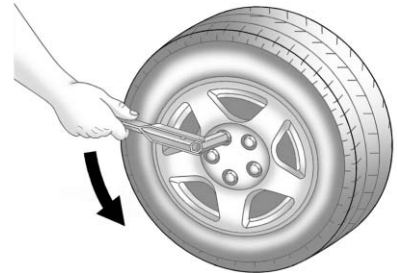

3. Turn the wheel wrench counterclockwise to loosen all the wheel nuts, but do not remove them yet.



**Caution**

Make sure that the jack lift head is in the correct position or you may damage your vehicle. The repairs would not be covered by your warranty.

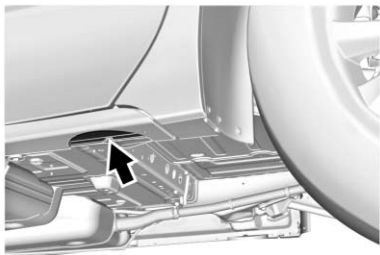
**Rear Shown, Front Similar**

4. Position the jack lift head at the jack location nearest the flat tire.

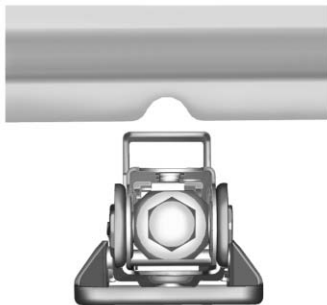

Locate the notch on the sheet metal weld flange. Place the center of the jack lift head on the center of the sheet metal notch.

The jack must not be used in any other position.

**Warning**

Getting under a vehicle when it is lifted on a jack is dangerous. If the vehicle slips off the jack, you could be badly injured or killed. Never get under a vehicle when it is supported only by a jack.

**Warning**

Raising the vehicle with the jack improperly positioned can damage the vehicle and even make the vehicle fall. To help avoid personal injury and vehicle damage, be sure to fit the jack lift head into the proper location before raising the vehicle.

**Warning**

Lifting a vehicle and getting under it to do maintenance or repairs is dangerous without the appropriate safety equipment and training. If a jack is provided with the vehicle, it is designed only for changing a flat tire. If it is used for anything else, you or others could be badly injured or killed if the vehicle slips off the jack. If a jack is provided with the vehicle, only use it for changing a flat tire.

- Attach the jack lift assist tool to the jack by fitting both ends of the jack and tool over one another.

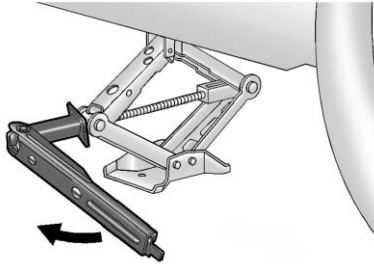

- Raise the vehicle by turning the jack handle clockwise. Raise the vehicle far enough off the ground so there is enough room for the road tire to clear the ground.

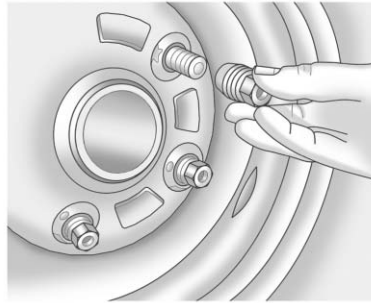

- Remove all of the wheel nuts.
- Remove the flat tire.

**Warning**

Rust or dirt on a wheel, or on the parts to which it is fastened, can make wheel nuts become loose after time. The wheel could come off and cause an accident. When changing a wheel, remove any rust or dirt from places where the wheel attaches to the vehicle. In an emergency, a cloth or a paper

(Continued)

**Warning (Continued)**

towel can be used; however, use a scraper or wire brush later to remove all rust or dirt.

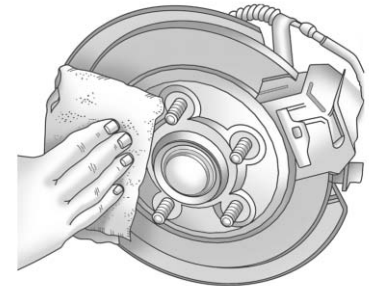

- Remove any rust or dirt from the wheel bolts, mounting surfaces, and spare wheel.
- Place the compact spare tire on the wheel-mounting surface.

**Warning**

Never use oil or grease on bolts or nuts because the nuts might come loose. The vehicle's wheel could fall off, causing a crash.

11. Reinstall the wheel nuts. Tighten each nut by hand until the wheel is held against the hub.
12. Lower the vehicle by turning the jack handle counterclockwise.

**Warning**

Wheel nuts that are improperly or incorrectly tightened can cause the wheels to become loose or come off. The wheel nuts should be tightened with a torque wrench to the proper torque specification after replacing. Follow the torque specification supplied by the aftermarket manufacturer when using accessory locking wheel

(Continued)

**Warning (Continued)**

nuts. See *Capacities and Specifications* ⇨ 322 for original equipment wheel nut torque specifications.

**Caution**

Improperly tightened wheel nuts can lead to brake pulsation and rotor damage. To avoid expensive brake repairs, evenly tighten the wheel nuts in the proper sequence and to the proper torque specification. See *Capacities and Specifications* ⇨ 322 for the wheel nut torque specification.

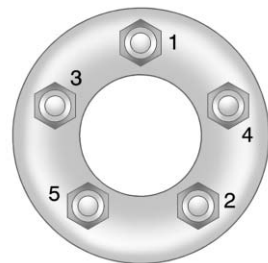

13. Tighten the wheel nuts firmly in a crisscross sequence, as shown.
14. Lower the jack all the way and remove the jack from under the vehicle.
15. Tighten the wheel nuts firmly with the wheel wrench.

When reinstalling the wheel cover or center cap on the full-size tire, tighten all five plastic caps hand snug with the aid of the wheel wrench and tighten them with the wheel wrench an additional one-quarter of a turn.

**Caution**

Wheel covers will not fit on the vehicle's compact spare. If you try to put a wheel cover on the compact spare, the cover or the spare could be damaged.

**Storing a Flat or Spare Tire and Tools****Warning**

Storing a jack, a tire, or other equipment in the passenger compartment of the vehicle could cause injury. In a sudden stop or collision, loose equipment could strike someone. Store all these in the proper place.

To store the flat tire:

1. Return the jack and tools to their original storage location.
2. Lower the load floor and snap the hook to the bottom of it.

3. Place the flat tire, lying flat, in the rear storage compartment.
4. Attach one end of the strap to a cargo tie-down in the rear of the vehicle.

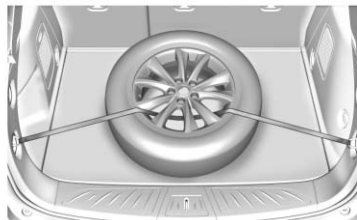

5. Route the strap through the wheel, as shown.
6. Attach the other end of the strap to the other cargo tie-down in the rear of the vehicle.
7. Tighten the strap.

The compact spare is for temporary use only. Replace the compact spare tire with a full-size tire as soon as you can.

**Compact Spare Tire****Warning**

Driving with more than one compact spare tire at a time could result in loss of braking and handling. This could lead to a crash and you or others could be injured. Use only one compact spare tire at a time.

If this vehicle has a compact spare tire, it was fully inflated when new; however, it can lose air over time. Check the inflation pressure regularly. It should be 420 kPa (60 psi).

Stop as soon as possible and check that the spare tire is correctly inflated after being installed on the vehicle. The compact spare tire is designed for temporary use only. The vehicle will perform differently with the spare tire installed and it is recommended that the vehicle speed be limited to 80 km/h (50 mph). To conserve the tread of the spare tire, have the standard tire

repaired or replaced as soon as convenient and return the spare tire to the storage area.

When using a compact spare tire, the AWD (if equipped), ABS, and Traction Control systems may engage until the spare tire is recognized by the vehicle, especially on slippery roads. Adjust driving to reduce possible wheel slip.

### Caution

When the compact spare is installed, do not take the vehicle through an automatic car wash with guide rails. The compact spare can get caught on the rails which can damage the tire, wheel, and other parts of the vehicle.

Do not use the compact spare on other vehicles.

Do not mix the compact spare tire or wheel with other wheels or tires. They will not fit. Keep the spare tire and its wheel together.

### Caution

Tire chains will not fit the compact spare. Using them can damage the vehicle and the chains. Do not use tire chains on the compact spare.

## Jump Starting

### Jump Starting - North America

For more information about the vehicle battery, see *Battery - North America* ⇨ 254.

If the battery has run down, try to use another vehicle and some jumper cables to start your vehicle. Be sure to use the following steps to do it safely.

### Warning

**WARNING:** Battery posts, terminals, and related accessories contain lead and lead compounds, chemicals known to the State of California to cause cancer and birth defects or other reproductive harm. Batteries also contain other chemicals known to the State of California to cause cancer. **WASH HANDS AFTER HANDLING.**

(Continued)

**Warning (Continued)**

See *California Proposition 65 Warning* ⇨ 235.

**Warning**

Batteries can hurt you. They can be dangerous because:

- They contain acid that can burn you.
- They contain gas that can explode or ignite.
- They contain enough electricity to burn you.

If you do not follow these steps exactly, some or all of these things can hurt you.

**Caution**

Ignoring these steps could result in costly damage to the vehicle that would not be covered by the vehicle warranty. Trying to start the vehicle by pushing or pulling it will not work, and it could damage the vehicle.

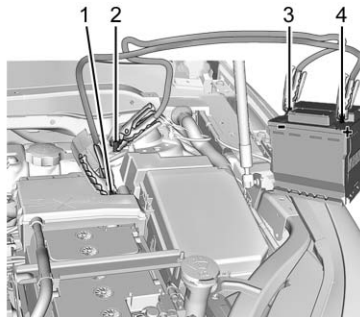

**2.0L L4 Engine Shown, 2.5L L4 Engine Similar**

1. Discharged Battery Positive (+) Terminal

2. Discharged Battery Negative (-) Grounding Point
3. Good Battery Negative (-) Terminal
4. Good Battery Positive (+) Terminal

The jump start negative grounding point (2) for the discharged battery is on the shock tower on the driver side.

The jump start positive terminal on the discharged battery (1) is located on the battery on the driver side of the vehicle.

The jump start positive terminal (4) and negative terminal (3) are on the battery of the vehicle providing the jump start.

The positive jump start connection for the discharged battery is under a cover. Open the cover to expose the terminal.

1. Check the other vehicle. It must have a 12-volt battery with a negative ground system.

**Caution**

If the other vehicle does not have a 12-volt system with a negative ground, both vehicles can be damaged. Only use a vehicle that has a 12-volt system with a negative ground for jump starting.

2. Position the two vehicles so that they are not touching.
3. Set the parking brake firmly and put the shift lever in P (Park) with an automatic transmission, or Neutral with a manual transmission.

**Caution**

If any accessories are left on or plugged in during the jump starting procedure, they could be damaged. The repairs would not be covered by the vehicle warranty. Whenever possible, turn off or unplug all accessories on either vehicle when jump starting.

4. Turn the ignition to LOCK/OFF. Turn off all lights and accessories in both vehicles, except the hazard warning flashers if needed.

 **Warning**

An electric fan can start up even when the engine is not running and can injure you. Keep hands, clothing, and tools away from any underhood electric fan.

 **Warning**

Using a match near a battery can cause battery gas to explode. People have been hurt doing this, and some have been blinded. Use a flashlight if you need more light.

Battery fluid contains acid that can burn you. Do not get it on you. If you accidentally get it in

(Continued)

**Warning (Continued)**

your eyes or on your skin, flush the place with water and get medical help immediately.

 **Warning**

Fans or other moving engine parts can injure you badly. Keep your hands away from moving parts once the engine is running.

5. Connect one end of the red positive (+) cable to the positive (+) terminal on the discharged battery.
6. Connect the other end of the red positive (+) cable to the positive (+) terminal of the good battery.
7. Connect one end of the black negative (-) cable to the negative (-) terminal of the good battery.

8. Connect the other end of the black negative (-) cable to the negative (-) grounding point for the discharged battery.
9. Start the engine in the vehicle with the good battery and run the engine at idle speed for at least four minutes.
10. Try to start the vehicle that had the dead battery. If it will not start after a few tries, it probably needs service.

### Caution

If the jumper cables are connected or removed in the wrong order, electrical shorting may occur and damage the vehicle. The repairs would not be covered by the vehicle warranty. Always connect and remove the jumper cables in the correct order, making sure that the cables do not touch each other or other metal.

### Jumper Cable Removal

Reverse the sequence exactly when removing the jumper cables.

After starting the disabled vehicle and removing the jumper cables, allow it to idle for several minutes.

## Towing the Vehicle

### Caution

Incorrectly towing a disabled vehicle may cause damage. The damage would not be covered by the vehicle warranty.

Do not use a wheel lift tow truck to tow the vehicle. Only use a flatbed car carrier.

Do not lash or hook to suspension components. Use the proper straps around the tires to secure the vehicle.

Use the tow eye for towing a disabled vehicle or loading it onto a flatbed car carrier. The tow eye should not be used to recover a vehicle from an off-road situation.



**Caution**

Improper use of the tow eye can cause vehicle damage. Use caution and low speeds to prevent damage to the vehicle.

Consult your dealer or a professional towing service if the disabled vehicle must be towed.

**Front Tow Eye**



Carefully open the cover by using the small notch that conceals the front tow eye socket.



Install the tow eye into the socket by turning it clockwise until it stops in a horizontal position.

When the tow eye is removed, reinstall the cover with the notch in the original position.

**Rear Tow Eye**

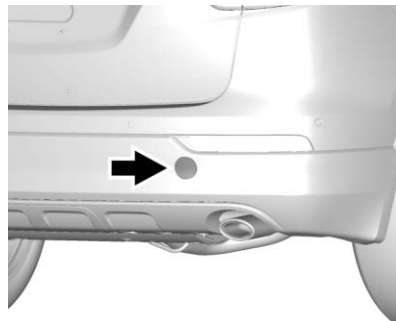

Carefully open the cover by using the small notch that conceals the rear tow eye socket.



Install the tow eye into the socket by turning it clockwise until it stops in a horizontal position.

When the tow eye is removed, reinstall the cover with the notch in the original position.

To tow the vehicle behind another vehicle for recreational purposes, such as behind a motor home, see “Recreational Vehicle Towing” following.

## Recreational Vehicle Towing

Recreational vehicle towing means towing the vehicle behind another vehicle, such as behind a motor home. The two most common types of recreational vehicle towing are known as dinghy towing and dolly towing. Dinghy towing is towing the vehicle with all four wheels on the ground. Dolly towing is towing the vehicle with two wheels on the ground and two wheels up on a device known as a dolly.

Here are some important things to consider before recreational vehicle towing:

- What is the towing capacity of the towing vehicle? Be sure to read the tow vehicle manufacturer's recommendations.
- What is the distance that will be traveled? Some vehicles have restrictions on how far and how long they can tow.

- Is the proper towing equipment going to be used? See your dealer or trailering professional for additional advice and equipment recommendations.
- Is the vehicle ready to be towed? Just as preparing the vehicle for a long trip, make sure the vehicle is prepared to be towed.

### Caution

Use of a shield mounted in front of the vehicle grille could restrict airflow and cause damage to the transmission. The repairs would not be covered by the vehicle warranty. If using a shield, only use one that attaches to the towing vehicle.

## Dinghy Towing

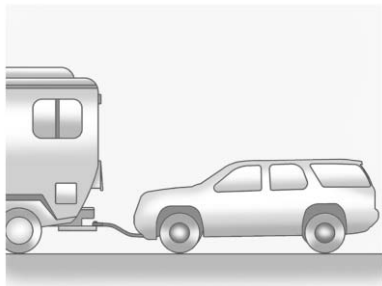

To dinghy tow the vehicle from the front with all four wheels on the ground:

1. Position the vehicle to tow and then secure it to the towing vehicle.
2. Turn the ignition on, and shift the transmission to N (Neutral).
3. With the transmission in N (Neutral), turn the ignition off.
4. To prevent the battery from draining while the vehicle is being towed, remove fuses 29 and 32 (Body Control

Module) from the instrument panel fuse block. See *Instrument Panel Fuse Block* ⇨ 264. Remember to reinstall the fuses once the destination has been reached.

## Dolly Towing (All-Wheel-Drive Vehicles)

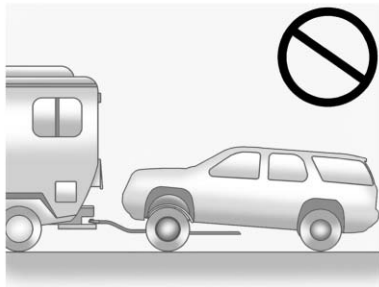

All-wheel-drive vehicles must not be towed with two wheels on the ground. To properly tow these vehicles, they should be placed on a platform trailer with all four wheels off of the ground.

## Dolly Towing (Front-Wheel-Drive Vehicles Only)

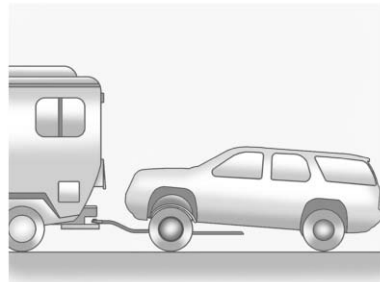

To tow a front-wheel-drive vehicle from the front with two wheels on the ground:

1. Put the front wheels on a dolly.
2. Move the shift lever to P (Park).
3. Set the parking brake.
4. Clamp the steering wheel in a straight-ahead position with a clamping device designed for towing.

5. Turn the vehicle off.
6. Secure the vehicle to the dolly.
7. Release the parking brake.

### Towing the Vehicle from the Rear

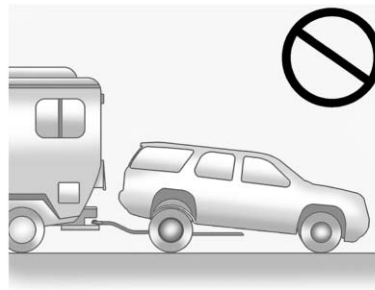
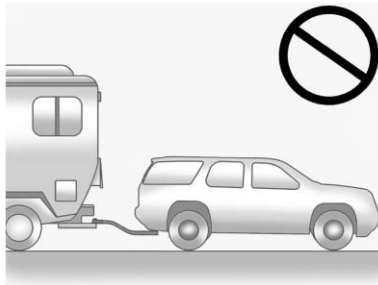

#### Caution

Towing the vehicle from the rear could damage it. Also, repairs would not be covered by the vehicle warranty. Never have the vehicle towed from the rear.

Do not tow the vehicle from the rear.

## Appearance Care

### Exterior Care

#### Locks

Locks are lubricated at the factory. Use a de-icing agent only when absolutely necessary, and have the locks greased after using. See *Recommended Fluids and Lubricants* ⇨ 318.

#### Washing the Vehicle

To preserve the vehicle's finish, wash it often and out of direct sunlight.

#### Caution

Do not use petroleum-based, acidic, or abrasive cleaning agents as they can damage the vehicle's paint, metal, or plastic parts. If damage occurs, it would not be covered by the vehicle warranty. Approved cleaning products can be obtained from

(Continued)

**Caution (Continued)**

your dealer. Follow all manufacturer directions regarding correct product usage, necessary safety precautions, and appropriate disposal of any vehicle care product.

**Caution**

Avoid using high-pressure washes closer than 30 cm (12 in) to the surface of the vehicle. Use of power washers exceeding 8,274 kPa (1,200 psi) can result in damage or removal of paint and decals.

**Caution**

Do not power wash any component under the hood that has this  symbol.

(Continued)

**Caution (Continued)**

This could cause damage that would not be covered by the vehicle warranty.

If using an automatic car wash, follow the car wash instructions. The windshield wiper and rear window wiper, if equipped, must be off. Remove any accessories that may be damaged or interfere with the car wash equipment.

Rinse the vehicle well, before washing and after, to remove all cleaning agents completely. If they are allowed to dry on the surface, they could stain.

Dry the finish with a soft, clean chamois or an all-cotton towel to avoid surface scratches and water spotting.

**Finish Care**

Application of aftermarket clearcoat sealant/wax materials is not recommended. If painted surfaces are damaged, see your dealer to

have the damage assessed and repaired. Foreign materials such as calcium chloride and other salts, ice melting agents, road oil and tar, tree sap, bird droppings, chemicals from industrial chimneys, etc., can damage the vehicle's finish if they remain on painted surfaces. Wash the vehicle as soon as possible. If necessary, use non-abrasive cleaners that are marked safe for painted surfaces to remove foreign matter.

Occasional hand waxing or mild polishing should be done to remove residue from the paint finish. See your dealer for approved cleaning products.

Do not apply waxes or polishes to uncoated plastic, vinyl, rubber, decals, simulated wood, or flat paint as damage can occur.

**Caution**

Machine compounding or aggressive polishing on a basecoat/clearcoat paint finish

(Continued)

**Caution (Continued)**

may damage it. Use only non-abrasive waxes and polishes that are made for a basecoat/clearcoat paint finish on the vehicle.

To keep the paint finish looking new, keep the vehicle garaged or covered whenever possible.

**Protecting Exterior Bright Metal Moldings**

**Caution**

Failure to clean and protect the bright metal moldings can result in a hazy white finish or pitting. This damage would not be covered by the vehicle warranty.

The bright metal moldings on the vehicle are aluminum or stainless steel. To prevent damage always follow these cleaning instructions:

- Be sure the molding is cool to the touch before applying any cleaning solution.
- Use a cleaning solution approved for aluminum or stainless steel. Some cleaners are highly acidic or contain alkaline substances and can damage the moldings.
- Always dilute a concentrated cleaner according to the manufacturer's instructions.
- Do not use chrome cleaners.
- Do not use cleaners that are not intended for automotive use.
- Use a nonabrasive wax on the vehicle after washing to protect and extend the molding finish.

**Cleaning Exterior Lamps/ Lenses, Emblems, Decals, and Stripes**

Use only lukewarm or cold water, a soft cloth, and a car washing soap to clean exterior lamps, lenses, emblems, decals, and stripes.

Follow instructions under "Washing the Vehicle" previously in this section.

Lamp covers are made of plastic, and some have a UV protective coating. Do not clean or wipe them when dry.

Do not use any of the following on lamp covers:

- Abrasive or caustic agents.
- Washer fluids and other cleaning agents in higher concentrations than suggested by the manufacturer.
- Solvents, alcohols, fuels, or other harsh cleaners.
- Ice scrapers or other hard items.
- Aftermarket appearance caps or covers while the lamps are illuminated, due to excessive heat generated.

**Caution**

Failure to clean lamps properly can cause damage to the lamp cover that would not be covered by the vehicle warranty.

**Caution**

Using wax on low gloss black finish stripes can increase the gloss level and create a non-uniform finish. Clean low gloss stripes with soap and water only.

**Air Intakes**

Clear debris from the air intakes, between the hood and windshield, when washing the vehicle.

**Shutter System**

The vehicle may have a shutter system designed to help increase fuel economy. Keep the shutter system clean for proper operation.

**Windshield and Wiper Blades**

Clean the outside of the windshield with glass cleaner.

Clean rubber blades using a lint-free cloth or paper towel soaked with windshield washer fluid or a mild detergent. Wash the windshield thoroughly when cleaning the blades. Bugs, road grime, sap, and

a buildup of vehicle wash/wax treatments may cause wiper streaking.

Replace the wiper blades if they are worn or damaged. Damage can be caused by extreme dusty conditions, sand, salt, heat, sun, snow, and ice.

**Weatherstrips**

Apply Dielectric silicone grease on weatherstrips to make them last longer, seal better, and not stick or squeak. Lubricate weatherstrips at least once a year. Hot, dry climates may require more frequent application. Black marks from rubber material on painted surfaces can be removed by rubbing with a clean cloth. See *Recommended Fluids and Lubricants* ⇨ 318.

**Tires**

Use a stiff brush with tire cleaner to clean the tires.

**Caution**

Using petroleum-based tire dressing products on the vehicle may damage the paint finish and/or tires. When applying a tire dressing, always wipe off any overspray from all painted surfaces on the vehicle.

**Wheels and Trim — Aluminum or Chrome**

Use a soft, clean cloth with mild soap and water to clean the wheels. After rinsing thoroughly with clean water, dry with a soft, clean towel. A wax may then be applied.

**Caution**

Chrome wheels and other chrome trim may be damaged if the vehicle is not washed after driving on roads that have been sprayed with magnesium, calcium, or sodium chloride. These

(Continued)

**Caution (Continued)**

chlorides are used on roads for conditions such as ice and dust. Always wash the chrome with soap and water after exposure.

**Caution**

To avoid surface damage, do not use strong soaps, chemicals, abrasive polishes, cleaners, brushes, or cleaners that contain acid on aluminum or chrome-plated wheels. Use only approved cleaners. Also, never drive a vehicle with aluminum or chrome-plated wheels through an automatic car wash that uses silicone carbide tire cleaning brushes. Damage could occur and the repairs would not be covered by the vehicle warranty.

**Brake System**

Visually inspect brake lines and hoses for proper hook-up, binding, leaks, cracks, chafing, etc. Inspect disc brake pads for wear and rotors for surface condition. Inspect drum brake linings/shoes for wear or cracks. Inspect all other brake parts.

**Steering, Suspension, and Chassis Components**

Visually inspect steering, suspension, and chassis components for damaged, loose, or missing parts or signs of wear at least once a year.

Inspect power steering for proper attachment, connections, binding, leaks, cracks, chafing, etc.

Visually check constant velocity joint boots and axle seals for leaks.

**Body Component Lubrication**

Lubricate all key lock cylinders, hood hinges, liftgate hinges, and the steel fuel door hinge, unless the components are plastic. Applying silicone grease on weatherstrips



with a clean cloth will make them last longer, seal better, and not stick or squeak.

### **Underbody Maintenance**

At least twice a year, spring and fall, use plain water to flush any corrosive materials from the underbody. Take care to thoroughly clean any areas where mud and other debris can collect.

Do not directly power wash the transfer case and/or front/rear axle output seals. High pressure water can overcome the seals and contaminate the fluid. Contaminated fluid will decrease the life of the transfer case and/or axles and should be replaced.

### **Sheet Metal Damage**

If the vehicle is damaged and requires sheet metal repair or replacement, make sure the body repair shop applies anti-corrosion material to parts repaired or replaced to restore corrosion protection.

Original manufacturer replacement parts will provide the corrosion protection while maintaining the vehicle warranty.

### **Finish Damage**

Quickly repair minor chips and scratches with touch-up materials available from your dealer to avoid corrosion. Larger areas of finish damage can be corrected in your dealer's body and paint shop.

### **Chemical Paint Spotting**

Airborne pollutants can fall upon and attack painted vehicle surfaces causing blotchy, ring-shaped discolorations, and small, irregular dark spots etched into the paint surface. See "Finish Care" previously in this section.

### **Interior Care**

To prevent dirt particle abrasions, regularly clean the vehicle's interior. Immediately remove any soils. Newspapers or dark garments can transfer color to the vehicle's interior.

Use a soft bristle brush to remove dust from knobs and crevices on the instrument cluster. Using a mild soap solution, immediately remove hand lotions, sunscreen, and insect repellent from all interior surfaces or permanent damage may result.

Use cleaners specifically designed for the surfaces being cleaned to prevent permanent damage. Apply all cleaners directly to the cleaning cloth. Do not spray cleaners on any switches or controls. Remove cleaners quickly.

Before using cleaners, read and follow all safety instructions on the label. While cleaning the interior, open the doors and windows to get proper ventilation.

To prevent damage, do not clean the interior using the following cleaners or techniques:

- Never use a razor or any other sharp object to remove soil from any interior surface.
- Never use a brush with stiff bristles.

- Never rub any surface aggressively or with too much pressure.
- Do not use laundry detergents or dishwashing soaps with degreasers. For liquid cleaners, use approximately 20 drops per 3.8 L (1 gal) of water. A concentrated soap solution will create streaks and attract dirt. Do not use solutions that contain strong or caustic soap.
- Do not heavily saturate the upholstery when cleaning.
- Do not use solvents or cleaners containing solvents.

### Interior Glass

To clean, use a terry cloth fabric dampened with water. Wipe droplets left behind with a clean dry cloth. If necessary, use a commercial glass cleaner after cleaning with plain water.

### Caution

To prevent scratching, never use abrasive cleaners on automotive glass. Abrasive cleaners or aggressive cleaning may damage the rear window defogger.

Cleaning the windshield with water during the first three to six months of ownership will reduce tendency to fog.

### Speaker Covers

Vacuum around a speaker cover gently, so that the speaker will not be damaged. Clean spots with water and mild soap.

### Coated Moldings

Coated moldings should be cleaned.

- When lightly soiled, wipe with a sponge or soft, lint-free cloth dampened with water.
- When heavily soiled, use warm soapy water.

### Fabric/Carpet/Suede

Start by vacuuming the surface using a soft brush attachment. If a rotating vacuum brush attachment is being used, only use it on the floor carpet. Before cleaning, gently remove as much of the soil as possible:

- Gently blot liquids with a paper towel. Continue blotting until no more soil can be removed.
- For solid soils, remove as much as possible prior to vacuuming.

To clean:

1. Saturate a clean, lint-free colorfast cloth with water. Microfiber cloth is recommended to prevent lint transfer to the fabric or carpet.
2. Remove excess moisture by gently wringing until water does not drip from the cleaning cloth.
3. Start on the outside edge of the soil and gently rub toward the center. Fold the cleaning cloth

to a clean area frequently to prevent forcing the soil in to the fabric.

4. Continue gently rubbing the soiled area until there is no longer any color transfer from the soil to the cleaning cloth.
5. If the soil is not completely removed, use a mild soap solution followed only by plain water.

If the soil is not completely removed, it may be necessary to use a commercial upholstery cleaner or spot lifter. Test a small hidden area for colorfastness before using a commercial upholstery cleaner or spot lifter. If ring formation occurs, clean the entire fabric or carpet.

After cleaning, use a paper towel to blot excess moisture.

### **Cleaning High Gloss Surfaces and Vehicle Information and Radio Displays**

Use a microfiber cloth on high gloss surfaces or vehicle displays. First, use a soft bristle brush to remove

dirt that can scratch the surface. Then gently clean by rubbing with a microfiber cloth. Never use window cleaners or solvents. Periodically hand wash the microfiber cloth separately, using mild soap. Do not use bleach or fabric softener. Rinse thoroughly and air dry before next use.

#### **Caution**

Do not attach a device with a suction cup to the display. This may cause damage and would not be covered by the vehicle warranty.

### **Instrument Panel, Leather, Vinyl, Other Plastic Surfaces, Low Gloss Paint Surfaces, and Natural Open Pore Wood Surfaces**

Use a soft microfiber cloth dampened with water to remove dust and loose dirt. For a more thorough cleaning, use a soft microfiber cloth dampened with a mild soap solution.

#### **Caution**

Soaking or saturating leather, especially perforated leather, as well as other interior surfaces, may cause permanent damage. Wipe excess moisture from these surfaces after cleaning and allow them to dry naturally. Never use heat, steam, or spot removers. Do not use cleaners that contain silicone or wax-based products. Cleaners containing these solvents can permanently change the appearance and feel of leather or soft trim, and are not recommended.

Do not use cleaners that increase gloss, especially on the instrument panel. Reflected glare can decrease visibility through the windshield under certain conditions.

**Caution**

Use of air fresheners may cause permanent damage to plastics and painted surfaces. If an air freshener comes in contact with any plastic or painted surface in the vehicle, blot immediately and clean with a soft cloth dampened with a mild soap solution. Damage caused by air fresheners would not be covered by the vehicle warranty.

**Cargo Cover and Convenience Net**

Wash with warm water and mild detergent. Do not use chlorine bleach. Rinse with cold water, and then dry completely.

**Care of Safety Belts**

Keep belts clean and dry.

 **Warning**

Do not bleach or dye safety belt webbing. It may severely weaken the webbing. In a crash, they might not be able to provide adequate protection. Clean and rinse safety belt webbing only with mild soap and lukewarm water. Allow the webbing to dry.

**Floor Mats** **Warning**

If a floor mat is the wrong size or is not properly installed, it can interfere with the pedals. Interference with the pedals can cause unintended acceleration and/or increased stopping distance which can cause a crash and injury. Make sure the floor mat does not interfere with the pedals.

Use the following guidelines for proper floor mat usage.

- The original equipment floor mats were designed for your vehicle. If the floor mats need replacing, it is recommended that GM certified floor mats be purchased. Non-GM floor mats may not fit properly and may interfere with the accelerator or brake pedal. Always check that the floor mats do not interfere with the pedals.
- Do not use a floor mat if the vehicle is not equipped with a floor mat retainer on the driver side floor.
- Use the floor mat with the correct side up. Do not turn it over.
- Do not place anything on top of the driver side floor mat.
- Use only a single floor mat on the driver side.
- Do not place one floor mat on top of another.

## Removing and Replacing the Floor Mat

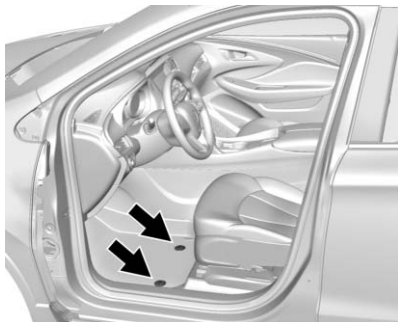

The driver side floor mat is held in place by two retainers.

1. Pull up on the rear of the floor mat to unlock each retainer and remove.
2. Reinstall by lining up the floor mat retainer openings over the carpet retainers and snap into position.
3. Make sure the floor mat is properly secured in place. Verify the floor mat does not interfere with the pedals.

# Service and Maintenance

**General Information**  
 General Information ..... 309

**Maintenance Schedule**  
 Maintenance Schedule ..... 310

**Special Application Services**  
 Special Application  
 Services ..... 315

**Additional Maintenance and Care**  
 Additional Maintenance  
 and Care ..... 315

**Recommended Fluids, Lubricants, and Parts**  
 Recommended Fluids and  
 Lubricants ..... 318  
 Maintenance Replacement  
 Parts ..... 319

**Maintenance Records**  
 Maintenance Records ..... 320

## General Information

Your vehicle is an important investment. This section describes the required maintenance for the vehicle. Follow this schedule to help protect against major repair expenses resulting from neglect or inadequate maintenance. It may also help to maintain the value of the vehicle if it is sold. It is the responsibility of the owner to have all required maintenance performed.

Your dealer has trained technicians who can perform required maintenance using genuine replacement parts. They have up-to-date tools and equipment for fast and accurate diagnostics. Many dealers have extended evening and Saturday hours, courtesy transportation, and online scheduling to assist with service needs.

Your dealer recognizes the importance of providing competitively priced maintenance and repair services. With trained technicians, the dealer is the place for routine maintenance such as oil

changes and tire rotations and additional maintenance items like tires, brakes, batteries, and wiper blades.

### Caution

Damage caused by improper maintenance can lead to costly repairs and may not be covered by the vehicle warranty. Maintenance intervals, checks, inspections, recommended fluids, and lubricants are important to keep the vehicle in good working condition.

The Tire Rotation and Required Services are the responsibility of the vehicle owner. It is recommended to have your dealer perform these services every 12 000 km/7,500 mi. Proper vehicle maintenance helps to keep the vehicle in good working condition, improves fuel economy, and reduces vehicle emissions.

Because of the way people use vehicles, maintenance needs vary. There may need to be more

frequent checks and services. The Additional Required Services - Normal are for vehicles that:

- Carry passengers and cargo within recommended limits on the Tire and Loading Information label. See *Vehicle Load Limits* ⇨ 180.
- Are driven on reasonable road surfaces within legal driving limits.
- Use the recommended fuel. See *Fuel* ⇨ 222.

Refer to the information in the Maintenance Schedule Additional Required Services - Normal chart.

The Additional Required Services - Severe are for vehicles that are:

- Mainly driven in heavy city traffic in hot weather.
- Mainly driven in hilly or mountainous terrain.
- Frequently towing a trailer.
- Used for high speed or competitive driving.

- Used for taxi, police, or delivery service.

Refer to the information in the Maintenance Schedule Additional Required Services - Severe chart.

 **Warning**

Performing maintenance work can be dangerous and can cause serious injury. Perform maintenance work only if the required information, proper tools, and equipment are available. If they are not, see your dealer to have a trained technician do the work. See *Doing Your Own Service Work* ⇨ 236.

## Maintenance Schedule

### Owner Checks and Services

#### At Each Fuel Stop

- Check the engine oil level. See *Engine Oil* ⇨ 241.

#### Once a Month

- Check the tire inflation pressures. See *Tire Pressure* ⇨ 273.
- Inspect the tires for wear. See *Tire Inspection* ⇨ 278.
- Check the windshield washer fluid level. See *Washer Fluid* ⇨ 252.

### Engine Oil Change

When the CHANGE ENGINE OIL SOON message displays, have the engine oil and filter changed within the next 1 000 km/600 mi. If driven under the best conditions, the engine oil life system may not indicate the need for vehicle service for up to a year. The engine oil and filter must be changed at least once

a year and the oil life system must be reset. Your trained dealer technician can perform this work. If the engine oil life system is reset accidentally, service the vehicle within 5 000 km/3,000 mi since the last service. Reset the oil life system when the oil is changed. See *Engine Oil Life System* ⇨ 243.

### **Tire Rotation and Required Services Every 12 000 km/7,500 mi**

Rotate the tires, if recommended for the vehicle, and perform the following services. See *Tire Rotation* ⇨ 279.

- Check engine oil level and oil life percentage. If needed, change engine oil and filter, and reset oil life system. See *Engine Oil* ⇨ 241 and *Engine Oil Life System* ⇨ 243.
- Check engine coolant level. See *Engine Coolant* ⇨ 248.
- Check windshield washer fluid level. See *Washer Fluid* ⇨ 252.
- Visually inspect windshield wiper blades for wear, cracking, or contamination. See *Exterior Care* ⇨ 299. Replace worn or damaged wiper blades. See *Wiper Blade Replacement* ⇨ 257.
- Check tire inflation pressures. See *Tire Pressure* ⇨ 273.
- Inspect tire wear. See *Tire Inspection* ⇨ 278.
- Visually check for fluid leaks.
- Inspect engine air cleaner filter. See *Engine Air Cleaner/Filter* ⇨ 245.
- Inspect brake system. See *Exterior Care* ⇨ 299.
- Visually inspect steering, suspension, and chassis components for damaged, loose, or missing parts or signs of wear. See *Exterior Care* ⇨ 299.
- Check restraint system components. See *Safety System Check* ⇨ 65.
- Visually inspect fuel system for damage or leaks.
- Visually inspect exhaust system and nearby heat shields for loose or damaged parts.
- Lubricate body components. See *Exterior Care* ⇨ 299.
- Check starter switch. See *Starter Switch Check* ⇨ 256.
- Check automatic transmission shift lock control function. See *Automatic Transmission Shift Lock Control Function Check* ⇨ 256.
- Check parking brake and automatic transmission park mechanism. See *Park Brake and P (Park) Mechanism Check* ⇨ 256.
- Check accelerator pedal for damage, high effort, or binding. Replace if needed.
- Visually inspect gas strut for signs of wear, cracks, or other damage. Check the hold open ability of the strut. See your dealer if service is required.
- Inspect sunroof track and seal, if equipped. See *Sunroof* ⇨ 48.



Maintenance Schedule Additional Required Services - Normal	12 000 km/7,500 mi	24 000 km/15,000 mi	36 000 km/22,500 mi	48 000 km/30,000 mi	60 000 km/37,500 mi	72 000 km/45,000 mi	84 000 km/52,500 mi	96 000 km/60,000 mi	108 000 km/67,500 mi	120 000 km/75,000 mi	132 000 km/82,500 mi	144 000 km/90,000 mi	156 000 km/97,500 mi	168 000 km/105,000 mi	180 000 km/112,500 mi	192 000 km/120,000 mi	204 000 km/127,500 mi	216 000 km/135,000 mi	228 000 km/142,500 mi	240 000 km/150,000 mi
	Rotate tires and perform Required Services. Check engine oil level and oil life percentage. Change engine oil and filter, if needed.	✓	✓	✓	✓	✓	✓	✓	✓	✓	✓	✓	✓	✓	✓	✓	✓	✓	✓	✓
Replace passenger compartment air filter. (1)			✓			✓			✓			✓			✓			✓		
Inspect evaporative control system. (2)						✓						✓						✓		
Replace engine air cleaner filter. (3)						✓						✓						✓		
2.5L Engine Only: Replace spark plugs. Inspect spark plug wires.													✓							
2.0L Turbo Engine Only: Replace spark plugs. Inspect spark plug wires.								✓								✓				
Drain and fill engine cooling system. (4)																				✓
Visually inspect accessory drive belts. (5)																				✓
Replace brake fluid. (6)																				

### Footnotes — Maintenance Schedule Additional Required Services - Normal

(1) Or every two years, whichever comes first. More frequent passenger compartment air filter

replacement may be needed if driving in areas with heavy traffic, poor air quality, high dust levels, or environmental allergens. Passenger compartment air filter replacement may also be needed if there is reduced airflow, window

fogging, or odors. Your GM dealer can help determine when to replace the filter.

(2) Visually check all fuel and vapor lines and hoses for proper attachment, connection, routing, and condition.

**(3)** Or every four years, whichever comes first. If driving in dusty conditions, inspect the filter at each oil change or more often as needed.

**(4)** Or every five years, whichever comes first. See *Cooling System* ⇨ 246.

**(5)** Or every 10 years, whichever comes first. Inspect for fraying, excessive cracking, or damage; replace, if needed.

**(6)** Replace brake fluid every three years. See *Brake Fluid* ⇨ 253.

Maintenance Schedule Additional Required Services - Severe	12 000 km/7,500 mi	24 000 km/15,000 mi	36 000 km/22,500 mi	48 000 km/30,000 mi	60 000 km/37,500 mi	72 000 km/45,000 mi	84 000 km/52,500 mi	96 000 km/60,000 mi	108 000 km/67,500 mi	120 000 km/75,000 mi	132 000 km/82,500 mi	144 000 km/90,000 mi	156 000 km/97,500 mi	168 000 km/105,000 mi	180 000 km/112,500 mi	192 000 km/120,000 mi	204 000 km/127,500 mi	216 000 km/135,000 mi	228 000 km/142,500 mi	240 000 km/150,000 mi
	Rotate tires and perform Required Services. Check engine oil level and oil life percentage. Change engine oil and filter, if needed.	✓	✓	✓	✓	✓	✓	✓	✓	✓	✓	✓	✓	✓	✓	✓	✓	✓	✓	✓
Replace passenger compartment air filter. (1)			✓		✓				✓			✓			✓			✓		
Inspect evaporative control system. (2)					✓							✓						✓		
Replace engine air cleaner filter. (3)					✓							✓						✓		
Change automatic transmission fluid.					✓							✓						✓		
2.5L Engine Only: Replace spark plugs. Inspect spark plug wires.													✓							
2.0L Turbo Engine Only: Replace spark plugs. Inspect spark plug wires.								✓								✓				
Drain and fill engine cooling system. (4)																				✓
Visually inspect accessory drive belts. (5)																				✓
Replace brake fluid. (6)																				

**Footnotes — Maintenance Schedule Additional Required Services - Severe**

(1) Or every two years, whichever comes first. More frequent passenger compartment air filter replacement may be needed if

driving in areas with heavy traffic, poor air quality, high dust levels, or environmental allergens. Passenger compartment air filter replacement may also be needed if there is reduced airflow, window

fogging, or odors. Your GM dealer can help determine when to replace the filter.

(2) Visually check all fuel and vapor lines and hoses for proper attachment, connection, routing, and condition.

(3) Or every four years, whichever comes first. If driving in dusty conditions, inspect the filter at each oil change or more often as needed.

(4) Or every five years, whichever comes first. See *Cooling System* ⇨ 246.

(5) Or every 10 years, whichever comes first. Inspect for fraying, excessive cracking, or damage; replace, if needed.

(6) Replace brake fluid every three years. See *Brake Fluid* ⇨ 253.

## Special Application Services

- Severe Commercial Use Vehicles Only: Lubricate chassis components every oil change.
- Have underbody flushing service performed. See "Underbody Maintenance" in *Exterior Care* ⇨ 299.

## Additional Maintenance and Care

Your vehicle is an important investment and caring for it properly may help to avoid future costly repairs. To maintain vehicle performance, additional maintenance services may be required.

It is recommended that your dealer perform these services — their trained dealer technicians know your vehicle best. Your dealer can also perform a thorough assessment with a multi-point inspection to recommend when your vehicle may need attention.

The following list is intended to explain the services and conditions to look for that may indicate services are required.

### Battery

The 12-volt battery supplies power to start the engine and operate any additional electrical accessories.

- To avoid break-down or failure to start the vehicle, maintain a battery with full cranking power.
- Trained dealer technicians have the diagnostic equipment to test the battery and ensure that the connections and cables are corrosion-free.

**Belts**

- Belts may need replacing if they squeak or show signs of cracking or splitting.
- Trained dealer technicians have access to tools and equipment to inspect the belts and recommend adjustment or replacement when necessary.

**Brakes**

Brakes stop the vehicle and are crucial to safe driving.

- Signs of brake wear may include chirping, grinding, or squealing noises, or difficulty stopping.

- Trained dealer technicians have access to tools and equipment to inspect the brakes and recommend quality parts engineered for the vehicle.

**Fluids**

Proper fluid levels and approved fluids protect the vehicle's systems and components. See *Recommended Fluids and Lubricants* ⇨ 318 for GM approved fluids.

- Engine oil and windshield washer fluid levels should be checked at every fuel fill.
- Instrument cluster lights may come on to indicate that fluids may be low and need to be filled.

**Hoses**

Hoses transport fluids and should be regularly inspected to ensure that there are no cracks or leaks. With a multi-point inspection, your dealer can inspect the hoses and advise if replacement is needed.

**Lamps**

Properly working headlamps, taillamps, and brake lamps are important to see and be seen on the road.

- Signs that the headlamps need attention include dimming, failure to light, cracking, or damage. The brake lamps need to be checked periodically to ensure that they light when braking.
- With a multi-point inspection, your dealer can check the lamps and note any concerns.

**Shocks and Struts**

Shocks and struts help aid in control for a smoother ride.

- Signs of wear may include steering wheel vibration, bounce/sway while braking, longer stopping distance, or uneven tire wear.
- As part of the multi-point inspection, trained dealer technicians can visually inspect the shocks and struts for signs

of leaking, blown seals, or damage, and can advise when service is needed.

### Tires

Tires need to be properly inflated, rotated, and balanced. Maintaining the tires can save money and fuel, and can reduce the risk of tire failure.

- Signs that the tires need to be replaced include three or more visible treadwear indicators; cord or fabric showing through the rubber; cracks or cuts in the tread or sidewall; or a bulge or split in the tire.
- Trained dealer technicians can inspect and recommend the right tires. Your dealer can also provide tire/wheel balancing services to ensure smooth vehicle operation at all speeds. Your dealer sells and services name brand tires.

### Vehicle Care

To help keep the vehicle looking like new, vehicle care products are available from your dealer. For information on how to clean and protect the vehicle's interior and exterior, see *Interior Care* ⇨ 304 and *Exterior Care* ⇨ 299.

### Wheel Alignment

Wheel alignment is critical for ensuring that the tires deliver optimal wear and performance.

- Signs that the alignment may need to be adjusted include pulling, improper vehicle handling, or unusual tire wear.
- Your dealer has the required equipment to ensure proper wheel alignment.

### Windshield

For safety, appearance, and the best viewing, keep the windshield clean and clear.

- Signs of damage include scratches, cracks, and chips.

- Trained dealer technicians can inspect the windshield and recommend proper replacement if needed.

### Wiper Blades

Wiper blades need to be cleaned and kept in good condition to provide a clear view.

- Signs of wear include streaking, skipping across the windshield, and worn or split rubber.
- Trained dealer technicians can check the wiper blades and replace them when needed.

## Recommended Fluids, Lubricants, and Parts

### Recommended Fluids and Lubricants

Usage	Fluid/Lubricant
Engine Oil	Engine oil meeting the dexos1™ specification of the proper SAE viscosity grade. ACDelco dexos1 Synthetic Blend is recommended. See <i>Engine Oil</i> ⇨ 241.
Engine Coolant	50/50 mixture of clean, drinkable water and use only DEX-COOL® Coolant. See <i>Engine Coolant</i> ⇨ 248.
Hydraulic Brake System	DOT 4 Hydraulic Brake Fluid (GM Part No. 19299570, in Canada 19299571).
Windshield Washer	Automotive windshield washer fluid that meets regional freeze protection requirements.
Automatic Transmission	DEXRON®-VI Automatic Transmission Fluid.
Hood Latch Assembly, Secondary Latch, Pivots, Spring Anchor, and Release Pawl	Lubriplate Lubricant Aerosol (GM Part No. 89021668, in Canada 89021674) or lubricant meeting requirements of NLGI #2, Category LB or GC-LB.
Key Lock Cylinders, Hood and Door Hinges	Multi-Purpose Lubricant, Superlube (GM Part No. 12346241, in Canada 10953474).
Weatherstrip Conditioning	Weatherstrip Lubricant (GM Part No. 3634770, in Canada 10953518) or Dielectric Silicone Grease (GM Part No. 12345579, in Canada 10953481).

## Maintenance Replacement Parts

Replacement parts identified below by name, part number, or specification can be obtained from your dealer.

Part	GM Part Number	ACDelco Part Number
Engine Air Cleaner/Filter	22971580	A3201C
Engine Oil Filter	12640445	PF64
Passenger Compartment Air Filter	13508023	CF185
Spark Plugs		
2.0L L4 Engine	12647827	41-125
2.5L L4 Engine	12627160	41-115
Wiper Blades		
Driver Side – 60.0 cm (23.6 in)	13227404	—
Passenger Side – 45.0 cm (17.7 in)	25882578	—
Rear – 30.0 cm (11.8 in)	23398639	—





## Technical Data

### Vehicle Identification

Vehicle Identification Number (VIN) .....	321
Service Parts Identification Label .....	321

### Vehicle Data

Capacities and Specifications .....	322
Engine Drive Belt Routing ....	323

## Vehicle Identification

### Vehicle Identification Number (VIN)



This legal identifier is in the front corner of the instrument panel, on the driver side of the vehicle. It can be seen through the windshield from outside. The Vehicle Identification Number (VIN) also appears on the Vehicle Certification and Service Parts labels and certificates of title and registration.

### Engine Identification

The eighth character in the VIN is the engine code. This code identifies the vehicle's engine, specifications, and replacement parts. See "Engine Specifications" under *Capacities and Specifications* ⇨ 322 for the vehicle's engine code.

## Service Parts Identification Label

If equipped, this label on the driver side B pillar has the following information:

- Vehicle Identification Number (VIN).
- Model designation.
- Paint information.
- Production options and special equipment.

Do not remove this label from the vehicle.

## Vehicle Data

### Capacities and Specifications

The following approximate capacities are given in metric and English conversions. See *Recommended Fluids and Lubricants* ⇨ 318 for more information.

Application	Capacities	
	Metric	English
Air Conditioning Refrigerant	For the air conditioning system refrigerant type and charge amount, see the refrigerant label under the hood. See your dealer for more information.	
Cooling System		
2.0L L4 Engine	7.75 L	8.1 qt
2.5L L4 Engine	6.6 L	7.0 L
Engine Oil with Filter		
2.0L L4 Engine	5.7 L	6.0 qt
2.5L L4 Engine	4.7 L	5.0 qt
Fuel Tank	65.5 L	17.3 gal
Wheel Nut Torque	140 N•m	100 lb ft
All capacities are approximate. When adding, be sure to fill to the approximate level, as recommended in this manual. Recheck fluid level after filling.		

**Engine Specifications**

Engine	VIN Code	Transmission	Spark Plug Gap
2.0L L4 Engine	X	Automatic	0.75–0.90 mm (0.030–0.035 in)
2.5L L4 Engine	A	Automatic	0.95–1.10 mm (0.037–0.043 in)

**Engine Drive Belt Routing**

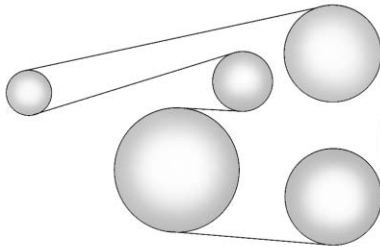

**2.0L and 2.5L Engines**

## Customer Information

### Customer Information

Customer Satisfaction Procedure .....	324
Customer Assistance Offices .....	326
Customer Assistance for Text Telephone (TTY) Users ....	326
Online Owner Center .....	327
GM Mobility Reimbursement Program .....	327
Roadside Assistance Program .....	328
Scheduling Service Appointments .....	329
Courtesy Transportation Program .....	330
Collision Damage Repair ....	331
Service Publications Ordering Information .....	333
Radio Frequency Statement .....	334

### Reporting Safety Defects

Reporting Safety Defects to the United States Government .....	334
--	-----

Reporting Safety Defects to the Canadian Government .....	334
Reporting Safety Defects to General Motors .....	335

### Vehicle Data Recording and Privacy

Vehicle Data Recording and Privacy .....	335
Event Data Recorders .....	335
OnStar® .....	336
Infotainment System .....	336

## Customer Information

### Customer Satisfaction Procedure

Your satisfaction and goodwill are important to your dealer and to Buick. Normally, any concerns with the sales transaction or the operation of the vehicle will be resolved by your dealer's sales or service departments. Sometimes, however, despite the best intentions of all concerned, misunderstandings can occur. If your concern has not been resolved to your satisfaction, the following steps should be taken:

**STEP ONE :** Discuss your concern with a member of dealership management. Normally, concerns can be quickly resolved at that level. If the matter has already been reviewed with the sales, service, or parts manager, contact the owner of your dealership or the general manager.

**STEP TWO :** If after contacting a member of dealership management, it appears your concern cannot be

resolved by your dealership without further help, in the U.S., call 1-800-521-7300. In Canada, contact General Motors of Canada Customer Care Centre at 1-800-263-3777 (English) or 1-800-263-7854 (French).

We encourage you to call the toll-free number in order to give the inquiry prompt attention. Have the following information available to give the Customer Assistance representative:

- Vehicle Identification Number (VIN). This is available from the vehicle registration or title, or the plate at the top left of the instrument panel and visible through the windshield.
- Dealership name and location.
- Vehicle delivery date and present mileage.

When contacting Buick, remember that your concern will likely be resolved at a dealer's facility. That is why we suggest following Step One first.

### **STEP THREE — U.S. Owners :**

Both General Motors and your dealer are committed to making sure you are completely satisfied with the new vehicle. However, if you continue to remain unsatisfied after following the procedure outlined in Steps One and Two, you can file with the Better Business Bureau (BBB) Auto Line<sup>®</sup> Program to enforce your rights.

The BBB Auto Line Program is an out-of-court program administered by the Council of Better Business Bureaus to settle automotive disputes regarding vehicle repairs or the interpretation of the New Vehicle Limited Warranty. Although you may be required to resort to this informal dispute resolution program prior to filing a court action, use of the program is free of charge and your case will generally be heard within 40 days. If you do not agree with the decision given in your case, you may reject it and proceed with any other venue for relief available to you.

You may contact the BBB Auto Line Program using the toll-free telephone number or write them at the following address:

BBB Auto Line Program  
Council of Better Business Bureaus, Inc.  
3033 Wilson Boulevard  
Suite 600  
Arlington, VA 22201

Telephone: 1-800-955-5100  
<http://www.bbb.org/council/programs-services/dispute-handling-and-resolution/bbb-auto-line>

This program is available in all 50 states and the District of Columbia. Eligibility is limited by vehicle age, mileage, and other factors. General Motors reserves the right to change eligibility limitations and/or discontinue its participation in this program.

**STEP THREE — Canadian Owners :** In the event that you do not feel your concerns have been addressed after following the procedure outlined in Steps One and Two, General Motors of Canada

Company wants you to be aware of its participation in a no-charge Mediation/Arbitration program. General Motors of Canada Company has committed to binding arbitration of owner disputes involving factory-related vehicle service claims. The program provides for the review of the facts involved by an impartial third party arbiter, and may include an informal hearing before the arbiter. The program is designed so that the entire dispute settlement process, from the time you file your complaint to the final decision, should be completed in about 70 days. We believe our impartial program offers advantages over courts in most jurisdictions because it is informal, quick, and free of charge.

For further information concerning eligibility in the Canadian Motor Vehicle Arbitration Plan (CAMVAP), call toll-free 1-800-207-0685, or call the General Motors Customer Care Centre, 1-800-263-3777 (English), 1-800-263-7854 (French), or write to:

Mediation/Arbitration Program  
c/o Customer Care Centre  
General Motors of Canada  
Company  
Mail Code: CA1-163-005  
1908 Colonel Sam Drive  
Oshawa, Ontario L1H 8P7

The inquiry should be accompanied by the Vehicle Identification Number (VIN).

## **Customer Assistance Offices**

Buick encourages customers to call the toll-free number for assistance. However, if a customer wishes to write or e-mail Buick, the letter should be addressed to:

### **United States and Puerto Rico**

Buick Customer Assistance Center  
P.O. Box 33136  
Detroit, MI 48232-5136  
[www.Buick.com](http://www.Buick.com)

1-800-521-7300  
1-800-832-8425 (For Text Telephone devices (TTYs))  
Roadside Assistance:  
1-800-252-1112

From U.S. Virgin Islands:  
1-800-496-9994

### **Canada**

General Motors of Canada  
Company  
Customer Care Centre, Mail Code:  
CA1-163-005  
1908 Colonel Sam Drive  
Oshawa, Ontario L1H 8P7  
[www.gm.ca](http://www.gm.ca)

1-800-263-3777 (English)  
1-800-263-7854 (French)  
1-800-263-3830 (For Text Telephone devices (TTYs))  
Roadside Assistance:  
1-800-268-6800

### **All Overseas Locations**

Please contact the local General Motors Business Unit.

## **Customer Assistance for Text Telephone (TTY) Users**

To assist customers who are deaf, hard of hearing, or speech-impaired and who use Text Telephones

(TTYs), Buick has TTY equipment available at its Customer Assistance Center. Any TTY user can communicate with Buick by dialing: 1-800-832-8425. TTY users in Canada can dial 1-800-263-3830.

## Online Owner Center

### Online Owner Experience (U.S.) [my.buick.com](http://my.buick.com)

The Buick online owner experience allows interaction with Buick and keeps important vehicle-specific information in one place.

#### Membership Benefits

 : Download owner manuals and view vehicle-specific how-to videos.

 : View maintenance schedules, alerts, and OnStar onboard vehicle diagnostic information. Schedule service appointments.

 : View and print dealer-recorded service records and self-recorded service records.

 : Select a dealer and view locations, maps, phone numbers, and hours.

 : Track your vehicle's warranty information.

 : View active recalls by Vehicle Identification Number (VIN). See *Vehicle Identification Number (VIN)* ⇨ 321.

 : View GM Card, SiriusXM Satellite radio (if equipped), and OnStar account information.

 : Chat with online help representatives.

See [my.buick.com](http://my.buick.com) to register your vehicle.

### Buick Owner Centre (Canada) [buickowner.ca](http://buickowner.ca)

Visit the Buick Owner Centre:

- Chat live with online help representatives.
- Use the Vehicle Tools section.
- Access third party enthusiast sites and social media networks.
- Locate owner resources such as lease-end, financing, and warranty information.

- Retrieve your favorite articles, quizzes, tips, and multimedia galleries organized into the Featured Articles and Auto Care Sections.
- Download the owner manual for your vehicle, quickly and easily.
- Find the Buick-recommended maintenance services for your vehicle.

## GM Mobility Reimbursement Program



This program is available to qualified applicants for cost reimbursement of eligible aftermarket adaptive equipment required for the vehicle, such as hand controls or a wheelchair/scooter lift for the vehicle.



For more information on the limited offer, visit [www.gmmobility.com](http://www.gmmobility.com) or call the GM Mobility Assistance Center at 1-800-323-9935. Text Telephone (TTY) users, call 1-800-833-9935.

General Motors of Canada also has a Mobility Program. Visit [www.gm.ca](http://www.gm.ca) or call 1-800-GM-DRIVE (463-7483) for details. TTY users call 1-800-263-3830.

## Roadside Assistance Program

For U.S.-purchased vehicles, call 1-800-252-1112; (Text Telephone (TTY): 1-888-889-2438).

For Canadian-purchased vehicles, call 1-800-268-6800.

Service is available 24 hours a day, 365 days a year.

### Calling for Assistance

When calling Roadside Assistance, have the following information ready:

- Your name, home address, and home telephone number.

- Telephone number of your location.
- Location of the vehicle.
- Model, year, color, and license plate number of the vehicle.
- Odometer reading, Vehicle Identification Number (VIN), and delivery date of the vehicle.
- Description of the problem.

### Coverage

Services are provided for the duration of the vehicle's powertrain warranty.

In the U.S., anyone driving the vehicle is covered. In Canada, a person driving the vehicle without permission from the owner is not covered.

Roadside Assistance is not a part of the New Vehicle Limited Warranty. General Motors North America and Buick reserve the right to make any changes or discontinue the Roadside Assistance program at any time without notification.

General Motors North America and Buick reserve the right to limit services or payment to an owner or driver if they decide the claims are made too often, or the same type of claim is made many times.

### Services Provided

- **Emergency Fuel Delivery:** Delivery of enough fuel for the vehicle to get to the nearest service station.
- **Lock-Out Service:** Service to unlock the vehicle if you are locked out. A remote unlock may be available if you have OnStar<sup>®</sup>. For security reasons, the driver must present identification before this service is given.
- **Emergency Tow from a Public Road or Highway:** Tow to the nearest Buick dealer for warranty service, or if the vehicle was in a crash and cannot be driven. Assistance is not given when the vehicle is stuck in sand, mud, or snow.

- **Flat Tire Change:** Service to change a flat tire with the spare tire. The spare tire, if equipped, must be in good condition and properly inflated. It is the owner's responsibility for the repair or replacement of the tire if it is not covered by the warranty.
- **Battery Jump Start:** Service to jump start a dead battery.
- **Trip Interruption Benefits and Assistance:** If your trip is interrupted due to a warranty event, incidental expenses may be reimbursed within the Powertrain warranty period. Items considered are reasonable and customary hotel, meals, rental car, or a vehicle being delivered back to the customer, up to 805 km (500 mi).

### Services Not Included in Roadside Assistance

- Impound towing caused by violation of any laws.
- Legal fines.

- Mounting, dismounting, or changing of snow tires, chains, or other traction devices.

Service is not provided if a vehicle is in an area that is not accessible to the service vehicle or is not a regularly traveled or maintained public road, which includes ice and winter roads. Off-road use is not covered.

### Services Specific to Canadian-Purchased Vehicles

- **Fuel Delivery:** Reimbursement is up to 7 liters. Diesel fuel delivery may be restricted. Propane and other fuels are not provided through this service.
- **Lock-Out Service:** Vehicle registration is required.
- **Trip Interruption Benefits and Assistance:** Must be over 150 km from where your trip was started to qualify. Pre-authorization, original detailed receipts, and a copy of the repair orders are required. Once authorization has been received, the Roadside

Assistance advisor will help you make arrangements and explain how to receive payment.

- **Alternative Service:** If assistance cannot be provided right away, the Roadside Assistance advisor may give permission to get local emergency road service. You will receive payment, up to \$100, after sending the original receipt to Roadside Assistance. Mechanical failures may be covered, however any cost for parts and labor for repairs not covered by the warranty are the owner responsibility.

### Scheduling Service Appointments

When the vehicle requires warranty service, contact your dealer and request an appointment. By scheduling a service appointment and advising the service consultant of your transportation needs, your dealer can help minimize your inconvenience.

If the vehicle cannot be scheduled into the service department immediately, keep driving it until it can be scheduled for service, unless, of course, the problem is safety related. If it is, please call your dealership, let them know this, and ask for instructions.

If your dealer requests you to bring the vehicle for service, you are urged to do so as early in the work day as possible to allow for same-day repair.

## **Courtesy Transportation Program**

To enhance your ownership experience, we and our participating dealers are proud to offer Courtesy Transportation, a customer support program for vehicles with the Bumper-to-Bumper (Base Warranty Coverage period in Canada), extended powertrain, and/or hybrid-specific warranties in both the U.S. and Canada.

Several Courtesy Transportation options are available to assist in reducing inconvenience when warranty repairs are required.

Courtesy Transportation is not a part of the New Vehicle Limited Warranty. A separate booklet entitled "Limited Warranty and Owner Assistance Information" furnished with each new vehicle provides detailed warranty coverage information.

### **Transportation Options**

Warranty service can generally be completed while you wait. However, if you are unable to do so, your dealer may offer the following transportation options:

#### **Shuttle Service**

This includes one-way or round-trip shuttle service within reasonable time and distance parameters of your dealer's area.

### **Public Transportation or Fuel Reimbursement**

If overnight warranty repairs are needed, and public transportation is used, the expense must be supported by original receipts and within the maximum amount allowed by GM for shuttle service. If U.S. customers arrange their own transportation, limited reimbursement for reasonable fuel expenses may be available. Claim amounts should reflect actual costs and be supported by original receipts. See your dealer for information.

#### **Courtesy Rental Vehicle**

For an overnight warranty repair, the dealer may provide an available courtesy rental vehicle or provide for reimbursement of a rental vehicle. Reimbursement is limited and must be supported by original receipts as well as a signed and completed rental agreement and meet state/provincial, local, and rental vehicle provider requirements. Requirements vary and may include minimum age requirements,

insurance coverage, credit card, etc. Additional fees such as fuel usage charges, taxes, levies, usage fees, excessive mileage, or rental usage beyond the completion of the repair are also your responsibility.

It may not be possible to provide a like vehicle as a courtesy rental.

### **Additional Program Information**

All program options, such as shuttle service, may not be available at every dealer. Contact your dealer for specific availability.

General Motors reserves the right to unilaterally modify, change, or discontinue Courtesy Transportation at any time and to resolve all questions of claim eligibility pursuant to the terms and conditions described herein at its sole discretion.

### **Collision Damage Repair**

If the vehicle is involved in a collision and it is damaged, have the damage repaired by a qualified technician using the proper

equipment and quality replacement parts. Poorly performed collision repairs diminish the vehicle resale value, and safety performance can be compromised in subsequent collisions.

### **Collision Parts**

Genuine GM Collision parts are new parts made with the same materials and construction methods as the parts with which the vehicle was originally built. Genuine GM Collision parts are the best choice to ensure that the vehicle's designed appearance, durability, and safety are preserved. The use of Genuine GM parts can help maintain the GM New Vehicle Limited Warranty.

Recycled original equipment parts may also be used for repair. These parts are typically removed from vehicles that were total losses in prior crashes. In most cases, the parts being recycled are from undamaged sections of the vehicle. A recycled original equipment GM part may be an acceptable choice to maintain the vehicle's originally designed appearance and safety

performance; however, the history of these parts is not known. Such parts are not covered by the GM New Vehicle Limited Warranty, and any related failures are not covered by that warranty.

Aftermarket collision parts are also available. These are made by companies other than GM and may not have been tested for the vehicle. As a result, these parts may fit poorly, exhibit premature durability/corrosion problems, and may not perform properly in subsequent collisions. Aftermarket parts are not covered by the GM New Vehicle Limited Warranty, and any vehicle failure related to such parts is not covered by that warranty.

### **Repair Facility**

GM also recommends that you choose a collision repair facility that meets your needs before you ever need collision repairs. Your dealer may have a collision repair center with GM-trained technicians and state-of-the-art equipment, or be able to recommend a collision repair

center that has GM-trained technicians and comparable equipment.

### **Insuring the Vehicle**

Protect your investment in the GM vehicle with comprehensive and collision insurance coverage. There are significant differences in the quality of coverage afforded by various insurance policy terms. Many insurance policies provide reduced protection to the GM vehicle by limiting compensation for damage repairs through the use of aftermarket collision parts. Some insurance companies will not specify aftermarket collision parts. When purchasing insurance, we recommend that you ensure that the vehicle will be repaired with GM original equipment collision parts. If such insurance coverage is not available from your current insurance carrier, consider switching to another insurance carrier.

If the vehicle is leased, the leasing company may require you to have insurance that ensures repairs with Genuine GM Original Equipment

Manufacturer (OEM) parts or Genuine Manufacturer replacement parts. Read the lease carefully, as you may be charged at the end of the lease for poor quality repairs.

### **If a Crash Occurs**

If there has been an injury, call emergency services for help. Do not leave the scene of a crash until all matters have been taken care of. Move the vehicle only if its position puts you in danger, or you are instructed to move it by a police officer.

Give only the necessary information to police and other parties involved in the crash.

For emergency towing see *Roadside Assistance Program* ⇨ 328.

Gather the following information:

- Driver name, address, and telephone number.
- Driver license number.
- Owner name, address, and telephone number.

- Vehicle license plate number.
- Vehicle make, model, and model year.
- Vehicle Identification Number (VIN).
- Insurance company and policy number.
- General description of the damage to the other vehicle.

Choose a reputable repair facility that uses quality replacement parts. See “Collision Parts” earlier in this section.

If the airbag has inflated, see *What Will You See after an Airbag Inflates?* ⇨ 72.

### **Managing the Vehicle Damage Repair Process**

In the event that the vehicle requires damage repairs, GM recommends that you take an active role in its repair. If you have a pre-determined repair facility of choice, take the vehicle there, or have it towed there. Specify to the facility that any required replacement collision parts be original equipment parts, either

new Genuine GM parts or recycled original GM parts. Remember, recycled parts will not be covered by the GM vehicle warranty.

Insurance pays the bill for the repair, but you must live with the repair. Depending on your policy limits, your insurance company may initially value the repair using aftermarket parts. Discuss this with the repair professional, and insist on Genuine GM parts. Remember, if the vehicle is leased, you may be obligated to have the vehicle repaired with Genuine GM parts, even if your insurance coverage does not pay the full cost.

If another party's insurance company is paying for the repairs, you are not obligated to accept a repair valuation based on that insurance company's collision policy repair limits, as you have no contractual limits with that company. In such cases, you can have control of the repair and parts choices as long as the cost stays within reasonable limits.

## Service Publications Ordering Information

### Service Manuals

Service Manuals have the diagnosis and repair information on the engines, transmission, axle, suspension, brakes, electrical, steering, body, etc.

### Owner Information

Owner publications are written specifically for owners and intended to provide basic operational information about the vehicle. The Owner Manual includes the Maintenance Schedule for all models.

In-Portfolio: Includes a Portfolio, Owner Manual, and Warranty Manual.

RETAIL SELL PRICE: \$35.00 – \$40.00 (U.S.) plus handling and shipping fees.

Without Pouch: Owner Manual only.

RETAIL SELL PRICE:  
\$25.00 (U.S.) plus handling and shipping fees.

## Current and Past Models

Service and Owner publications are available for many current and past model year GM vehicles.

### ORDER TOLL FREE:

1-800-551-4123 Monday – Friday  
8:00 AM – 6:00 PM Eastern Time

For Credit Card Orders Only  
(VISA-MasterCard-Discover), see  
Helm, Inc. at: [www.helminc.com](http://www.helminc.com).

Or write to:

Helm, Incorporated  
Attention: Customer Service  
47911 Halyard Drive  
Plymouth, MI 48170

Prices are subject to change without notice and without incurring obligation. Allow ample time for delivery.

All listed prices are quoted in U.S. funds. Make checks payable in U.S. funds.

## Radio Frequency Statement

This vehicle has systems that operate on a radio frequency that complies with Part 15/Part 18 of the Federal Communications Commission (FCC) rules and with Industry Canada Standards RSS-GEN/210/216/220/251/310, ICES-001.

Operation is subject to the following two conditions:

1. The device may not cause harmful interference.
2. The device must accept any interference received, including interference that may cause undesired operation of the device.

Changes or modifications to any of these systems by other than an authorized service facility could void authorization to use this equipment.

## Reporting Safety Defects

### Reporting Safety Defects to the United States Government

If you believe that your vehicle has a defect which could cause a crash or could cause injury or death, you should immediately inform the National Highway Traffic Safety Administration (NHTSA) in addition to notifying General Motors.

If NHTSA receives similar complaints, it may open an investigation, and if it finds that a safety defect exists in a group of vehicles, it may order a recall and remedy campaign. However, NHTSA cannot become involved in individual problems between you, your dealer, or General Motors.

To contact NHTSA, you may call the Vehicle Safety Hotline toll-free at 1-888-327-4236 (TTY: 1-800-424-9153); go to <http://www.safercar.gov>; or write to:

Administrator, NHTSA  
1200 New Jersey Avenue, S.E.  
Washington, D.C. 20590

You can also obtain other information about motor vehicle safety from <http://www.safercar.gov>.

### Reporting Safety Defects to the Canadian Government

If you live in Canada, and you believe that the vehicle has a safety defect, notify Transport Canada immediately, and notify General Motors of Canada Company. Call Transport Canada at 1-800-333-0510 or write to:

Transport Canada  
Road Safety Branch  
80 rue Noel  
Gatineau, QC J8Z 0A1

## Reporting Safety Defects to General Motors

In addition to notifying NHTSA (or Transport Canada) in a situation like this, notify General Motors.

Call 1-800-521-7300, or write:

Buick Customer Assistance Center  
P.O. Box 33136  
Detroit, MI 48232-5136

In Canada, call 1-800-263-3777  
(English) or 1-800-263-7854  
(French), or write:

General Motors of Canada  
Company  
Customer Care Centre, Mail Code:  
CA1-163-005  
1908 Colonel Sam Drive  
Oshawa, Ontario L1H 8P7

## Vehicle Data Recording and Privacy

The vehicle has a number of computers that record information about the vehicle's performance and how it is driven. For example, the vehicle uses computer modules to monitor and control engine and transmission performance, to monitor the conditions for airbag deployment and deploy them in a crash, and, if equipped, to provide antilock braking to help the driver control the vehicle. These modules may store data to help the dealer technician service the vehicle. Some modules may also store data about how the vehicle is operated, such as rate of fuel consumption or average speed. These modules may retain personal preferences, such as radio presets, seat positions, and temperature settings.

## Event Data Recorders

This vehicle is equipped with an event data recorder (EDR). The main purpose of an EDR is to record, in certain crash or near crash-like situations, such as an air bag deployment or hitting a road obstacle, data that will assist in understanding how a vehicle's systems performed. The EDR is designed to record data related to vehicle dynamics and safety systems for a short period of time, typically 30 seconds or less. The EDR in this vehicle is designed to record such data as:

- How various systems in your vehicle were operating;
- Whether or not the driver and passenger safety belts were buckled/fastened;
- How far (if at all) the driver was depressing the accelerator and/or brake pedal; and,
- How fast the vehicle was traveling.



These data can help provide a better understanding of the circumstances in which crashes and injuries occur.

**Note**

EDR data are recorded by your vehicle only if a non-trivial crash situation occurs; no data are recorded by the EDR under normal driving conditions and no personal data (e.g., name, gender, age, and crash location) are recorded. However, other parties, such as law enforcement, could combine the EDR data with the type of personally identifying data routinely acquired during a crash investigation.

To read data recorded by an EDR, special equipment is required, and access to the vehicle or the EDR is needed. In addition to the vehicle manufacturer, other parties, such as law enforcement, that have the special equipment, can read the information if they have access to the vehicle or the EDR.

GM will not access these data or share it with others except: with the consent of the vehicle owner or, if the vehicle is leased, with the consent of the lessee; in response to an official request by police or similar government office; as part of GM's defense of litigation through the discovery process; or, as required by law. Data that GM collects or receives may also be used for GM research needs or may be made available to others for research purposes, where a need is shown and the data is not tied to a specific vehicle or vehicle owner.

**OnStar®**

If the vehicle is equipped with OnStar® and has an active subscription, additional data may be collected through the OnStar system. This includes information about the vehicle's operation; collisions involving the vehicle; the use of the vehicle and its features; and, in certain situations, the location and approximate GPS speed of the vehicle. Refer to the

OnStar Terms and Conditions and Privacy Statement on the OnStar website.

See *OnStar Additional Information* ⇨ 342.

**Infotainment System**

If the vehicle is equipped with a navigation system as part of the infotainment system, use of the system may result in the storage of destinations, addresses, telephone numbers, and other trip information. See the infotainment manual for information on stored data and for deletion instructions.

# OnStar



**OnStar Overview**  
 OnStar Overview ..... 337

**OnStar Services**  
 Emergency ..... 338  
 Security ..... 338  
 Navigation ..... 338  
 Connections ..... 339  
 Diagnostics ..... 341

**OnStar Additional Information**  
 OnStar Additional Information ..... 342

## OnStar Overview





-  Voice Command Button
-  Blue OnStar Button
-  Red Emergency Button

This vehicle may be equipped with a comprehensive, in-vehicle system that can connect to an OnStar Advisor for Emergency, Security, Navigation, Connections, and Diagnostics Services. OnStar services may require a paid subscription and data plan. OnStar requires the vehicle battery and electrical system, cellular service, and GPS satellite signals to be available and operating. OnStar acts as a link to existing emergency service providers. OnStar may collect information about you and your vehicle, including location information. See OnStar User

Terms, Privacy Statement, and Software Terms for more details including system limitations at [www.onstar.com](http://www.onstar.com) (U.S.) or [www.onstar.ca](http://www.onstar.ca) (Canada).

The OnStar system status light is next to the OnStar buttons. If the status light is:

- Solid Green: System is ready.
- Flashing Green: On a call.
- Red: Indicates a problem.
- Off: System is active. Press  twice to speak with an OnStar Advisor.

Press  or call 1-888-4ONSTAR (1-888-466-7827) to speak to an Advisor.

Press  to:

- Make a call, end a call, or answer an incoming call.
- Give OnStar Hands-Free Calling voice commands.
- Give OnStar Turn-by-Turn Navigation voice commands.

- Obtain and customize the Wi-Fi® hotspot name or SSID and password, if equipped.

Press **On** to connect to an Advisor to:

- Verify account information or update contact information.
- Get driving directions.
- Receive a Diagnostic check of the vehicle's key operating systems.
- Receive Roadside Assistance.
- Manage Wi-Fi Settings, if equipped.

Press **SOS** to get a priority connection to an OnStar Advisor available 24/7 to:

- Get help for an emergency.
- Be a Good Samaritan or respond to an AMBER Alert.
- Get assistance in severe weather or other crisis situations and find evacuation routes.

## OnStar Services

### Emergency

Emergency Services require an active, OnStar service plan (excludes Basic Plan). With Automatic Crash Response, built-in sensors can automatically alert a specially trained OnStar Advisor who is immediately connected in to the vehicle to help.

Press **SOS** for a priority connection to an OnStar Advisor who can contact emergency service providers, direct them to your exact location, and relay important information.

With OnStar Crisis Assist, specially trained Advisors are available 24 hours a day, 7 days a week, to provide a central point of contact, assistance, and information during a crisis.

With Roadside Assistance, Advisors can locate a nearby service provider to help with a flat tire, a battery jump, or an empty gas tank.

## Security

If equipped, OnStar provides these services:

- With Stolen Vehicle Assistance, OnStar Advisors can use GPS to pinpoint the vehicle and help authorities quickly recover it.
- With Remote Ignition Block™, if equipped, OnStar can block the engine from being restarted.
- With Stolen Vehicle Slowdown®, if equipped, OnStar can work with law enforcement to gradually slow the vehicle down.

### Theft Alarm Notification

If equipped, if the doors are locked and the vehicle alarm sounds, a notification by text, e-mail, or phone call will be sent. If the vehicle is stolen, an OnStar Advisor can work with authorities to recover the vehicle.

## Navigation

OnStar navigation requires a specific OnStar service plan.

Press  to receive Turn-by-Turn directions or have them sent to the vehicle's navigation screen, if equipped.

### Turn-by-Turn Navigation

1. Press  to connect to an Advisor.
2. Request directions to be downloaded to the vehicle.
3. Follow the voice-guided commands.

### Using Voice Commands During a Planned Route

#### Cancel Route

1. Press . System responds: "OnStar ready," then a tone.
2. Say "Cancel route." System responds: "Do you want to cancel directions?"
3. Say "Yes." System responds: "OK, request completed, thank you, goodbye."

#### Route Preview

1. Press . System responds: "OnStar ready," then a tone.
2. Say "Route preview." System responds with the next three maneuvers.

#### Repeat

1. Press . System responds: "OnStar ready," then a tone.
2. Say "Repeat." System responds with the last direction given, then responds with "OnStar ready," then a tone.

#### Get My Destination

1. Press . System responds: "OnStar ready," then a tone.
2. Say "Get my destination." System responds with the address and distance to the destination, then responds with "OnStar ready," then a tone.

#### Send Destination to Vehicle

Subscribers can have directions sent to the vehicle's navigation screen, if equipped.

Press , then ask the Advisor to download directions to the vehicle's navigation system, if equipped. After the call ends, the navigation screen will provide prompts to begin driving directions. Routes that are sent to the navigation screen can only be canceled through the navigation system.

See [www.onstar.com](http://www.onstar.com) (U.S.) or [www.onstar.ca](http://www.onstar.ca) (Canada).

### Connections

The following OnStar services help with staying connected.

For coverage maps, see [www.onstar.com](http://www.onstar.com) (U.S.) or [www.onstar.ca](http://www.onstar.ca) (Canada).

#### Ensuring Security

- Change the default passwords for the Wi-Fi hotspot and RemoteLink mobile application. Make these passwords different from each other and use a combination of letters, numbers, and symbols to increase the security.

- Change the default name of the SSID (Service Set Identifier). This is your network's name that is visible to other wireless devices. Choose a unique name and avoid family names or vehicle descriptions.

### OnStar Wi-Fi® Hotspot (If Equipped)

The vehicle may have a built-in Wi-Fi hotspot that provides access to the Internet and web content at 4G LTE speed. Up to seven mobile devices can be connected. A data plan is required. Use the in-vehicle controls only when it is safe to do so.

1. To retrieve Wi-Fi hotspot information, press , wait for the prompt, then say "Wi-Fi settings." On some vehicles, touch Wi-Fi Settings on the screen.
2. The Wi-Fi settings will display the Wi-Fi hotspot name (SSID), password, and on some vehicles, the connection type

(no Internet connection, 3G, 4G, 4G LTE), and signal quality (poor, good, excellent).

3. To change the SSID or password, press  or call 1-888-4ONSTAR to connect with an Advisor.

After initial set-up, your vehicle's Wi-Fi hotspot will connect automatically to your mobile devices. Manage data usage by turning Wi-Fi on or off on your mobile device, using the RemoteLink mobile app, or by contacting an OnStar Advisor.

### OnStar RemoteLink® Mobile App (If Equipped)

Download the OnStar RemoteLink mobile app to select Apple® iOS, Android™, BlackBerry®, or Windows® mobile devices. OnStar Subscribers can access the following services from a mobile device:

- Remotely start/stop the vehicle, if factory-equipped.
- Lock/unlock doors, if equipped with automatic locks.

- Activate the horn and lamps.
- Check the vehicle's fuel level, oil life, or tire pressure, if factory-equipped with the Tire Pressure Monitor System.
- Send directions to the vehicle.
- Locate the vehicle on a map (U.S. market only).
- Turn the vehicle's Wi-Fi hotspot on/off, manage settings, and monitor data consumption, if equipped.

For OnStar RemoteLink information and compatibility, see [www.onstar.com](http://www.onstar.com) (U.S.) or [www.onstar.ca](http://www.onstar.ca) (Canada).

### Remote Services

Contact an OnStar Advisor to unlock the doors or sound the horn and flash the lamps.

### OnStar AtYourService

OnStar Advisors can provide offers from restaurants and retailers on your route, help locate hotels, or book a room. These services vary by market.

## OnStar Hands-Free Calling

Make and receive calls with the built-in wireless calling service, which requires available minutes.

### Make a Call

1. Press . System responds: "OnStar ready."
2. Say "Call." System responds: "Call. Please say the name or number to call."
3. Say the entire number without pausing, including a "1" and the area code. System responds: "OK, calling."

### Calling 911 Emergency

1. Press . System responds: "OnStar ready."
2. Say "Call." System responds: "Call. Please say the name or number to call."
3. Say "911" without pausing. System responds: "911."
4. Say "Call." System responds: "OK, dialing 911."

## Retrieve My Number

1. Press . System responds: "OnStar ready."
2. Say "My number." System responds: "Your OnStar Hands-Free Calling number is," then says the number.

### End a Call

Press . System responds: "Call ended."

### Verify Minutes and Expiration

Press  and say "Minutes" then "Verify" to check how many minutes remain and their expiration date.

## Diagnostics

Advanced Diagnostics provides a status of the vehicle's key systems with a monthly e-mail, or by pressing . If equipped, Diagnostic Alerts can be received in real-time via e-mail or text. The Proactive Alerts feature (if available) can help predict and alert of potential

upcoming maintenance issues with select components on the vehicle, before they become a problem.

OnStar can also monitor and report tire pressure, if the vehicle is equipped with a Tire Pressure Monitoring System.

## OnStar Additional Information

### In-Vehicle Audio Messages

Audio messages may play important information at the following times:

- Prior to vehicle purchase.  
Press  to set up an account.
- With the OnStar Basic Plan, every 60 days.
- After change in ownership and at 90 days.

### Transferring Service

Press  to request account transfer eligibility information. The Advisor can cancel or change account information.

### Selling/Transferring the Vehicle

Call 1-888-4ONSTAR (1-888-466-7827) immediately to terminate your OnStar services if the vehicle is disposed of, sold, transferred, or if the lease ends.

### Reactivation for Subsequent Owners

Press  and follow the prompts to speak to an Advisor as soon as possible. The Advisor will update vehicle records and explain OnStar service options.

### How OnStar Service Works

Automatic Crash Response, Emergency Services, Crisis Assist, Stolen Vehicle Assistance, Advanced Vehicle Diagnostics, Remote Services, Roadside Assistance, Turn-by-Turn Navigation, and Hands-Free Calling are available on most vehicles. Not all OnStar services are available everywhere or on all vehicles. For more information, a full description of OnStar services, system limitations, and OnStar User Terms, Privacy Statement, and Software Terms:

- Call 1-888-4ONSTAR (1-888-466-7827).
- See [www.onstar.com](http://www.onstar.com) (U.S.).
- See [www.onstar.ca](http://www.onstar.ca) (Canada).

- Call TTY 1-877-248-2080.
- Press  to speak with an Advisor.

OnStar services cannot work unless the vehicle is in a place where OnStar has an agreement with a wireless service provider for service in that area. The wireless service provider must also have coverage, network capacity, reception, and technology compatible with OnStar services. Service involving location information about the vehicle cannot work unless GPS signals are available, unobstructed, and compatible with the OnStar hardware. OnStar services may not work if the OnStar equipment is not properly installed or it has not been properly maintained. If equipment or software is added, connected, or modified, OnStar services may not work. Other problems beyond the control of OnStar — such as hills, tall buildings, tunnels, weather, electrical system design and architecture of the vehicle, damage

to the vehicle in a crash, or wireless phone network congestion or jamming — may prevent service.

See *Radio Frequency Statement* ⇨ 334.

## Services for People with Disabilities

Advisors provide services to help Subscribers with physical disabilities and medical conditions.

Press  to help:

- Locate a gas station with an attendant to pump gas.
- Find a hotel, restaurant, etc., that meets accessibility needs.
- Provide directions to the closest hospital or pharmacy in urgent situations.

## TTY Users

OnStar has the ability to communicate to deaf, hard-of-hearing, or speech-impaired customers while in the vehicle. The available dealer-installed TTY system can provide in-vehicle

access to all OnStar services, except Virtual Advisor and OnStar Turn-by-Turn Navigation.

## OnStar Personal Identification Number (PIN)

A PIN is needed to access some OnStar services. The PIN will need to be changed the first time when speaking with an Advisor. To change the OnStar PIN, contact an OnStar Advisor by pressing  or calling 1-888-4ONSTAR.

## Warranty

OnStar equipment may be warranted as part of the vehicle warranty.

## Languages

The vehicle can be programmed to respond in multiple languages.

Press  and ask for an Advisor. Advisors are available in English, Spanish, and French. Available languages may vary by country.

## Potential Issues

OnStar cannot perform Remote Door Unlock or Stolen Vehicle Assistance after the vehicle has been off continuously for 10 days without an ignition cycle. If the vehicle has not been started for five days, OnStar can contact Roadside Assistance or a locksmith to help gain access to the vehicle.

## Global Positioning System (GPS)

- Obstruction of the GPS can occur in a large city with tall buildings; in parking garages; around airports; in tunnels and underpasses; or in an area with very dense trees. If GPS signals are not available, the OnStar system should still operate to call OnStar. However, OnStar could have difficulty identifying the exact location.
- In emergency situations, OnStar can use the last stored GPS location to send to emergency responders.



A temporary loss of GPS can cause loss of the ability to send a Turn-by-Turn Navigation route. The Advisor may give a verbal route or may ask for a call back after the vehicle is driven into an open area.

### Cellular and GPS Antennas

Cellular reception is required for OnStar to send remote signals to the vehicle. Do not place items over or near the antenna to prevent blocking cellular and GPS signal reception.

### Unable to Connect to OnStar Message

If there is limited cellular coverage or the cellular network has reached maximum capacity, this message may come on. Press  to try the call again or try again after driving a few miles into another cellular area.

### Vehicle and Power Issues

OnStar services require a vehicle electrical system, wireless service, and GPS satellite technologies to be available and operating for features

to function properly. These systems may not operate if the battery is discharged or disconnected.

### Add-on Electrical Equipment

The OnStar system is integrated into the electrical architecture of the vehicle. Do not add any electrical equipment. See *Add-On Electrical Equipment* ⇨ 233. Added electrical equipment may interfere with the operation of the OnStar system and cause it to not operate.

### Vehicle Software Updates

OnStar or GM may remotely deliver software updates or changes to the vehicle without further notice or consent. These updates or changes may enhance or maintain safety, security, or the operation of the vehicle or the vehicle systems. Software updates or changes may affect or erase data or settings that are stored in the vehicle, such as OnStar Hands-Free Calling name tags, saved navigation destinations, or pre-set radio stations. Neither OnStar nor GM is responsible for any affected or erased data or

settings. These updates or changes may also collect personal information. Such collection is described in the OnStar privacy statement or separately disclosed at the time of installation. These updates or changes may also cause a system to automatically communicate with GM servers to collect information about vehicle system status, identify whether updates or changes are available, or deliver updates or changes. An active OnStar agreement constitutes consent to these software updates or changes and agreement that either OnStar or GM may remotely deliver them to the vehicle.

### Privacy

The complete OnStar Privacy Statement may be found at [www.onstar.com](http://www.onstar.com) (U.S.), or [www.onstar.ca](http://www.onstar.ca) (Canada). We recommend that you review it. If you have any questions, call 1-888-4ONSTAR (1-888-466-7827) or press  to speak with an Advisor. Users of wireless communications are cautioned that

the privacy of any information sent via wireless cellular communications cannot be assured. Third parties may unlawfully intercept or access transmissions and private communications without consent.

### **OnStar - Software Acknowledgements**

Certain OnStar components include libcurl and unzip software and other third party software. Below are the notices and licenses associated with libcurl and unzip and for other third party software please see <http://www.lg.com/global/support/opensource/index> and <https://www.onstar.com/us/en/support/getdocuments.html>

#### **libcurl:**

#### **COPYRIGHT AND PERMISSION NOTICE**

Copyright (c) 1996 - 2010, Daniel Stenberg, <[daniel@haxx.se](mailto:daniel@haxx.se)>.

All rights reserved.

Permission to use, copy, modify, and distribute this software for any purpose with or without fee is

hereby granted, provided that the above copyright notice and this permission notice appear in all copies.

THE SOFTWARE IS PROVIDED "AS IS," WITHOUT WARRANTY OF ANY KIND, EXPRESS OR IMPLIED, INCLUDING BUT NOT LIMITED TO THE WARRANTIES OF MERCHANTABILITY, FITNESS FOR A PARTICULAR PURPOSE AND NONINFRINGEMENT OF THIRD PARTY RIGHTS. IN NO EVENT SHALL THE AUTHORS OR COPYRIGHT HOLDERS BE LIABLE FOR ANY CLAIM, DAMAGES OR OTHER LIABILITY, WHETHER IN AN ACTION OF CONTRACT, TORT OR OTHERWISE, ARISING FROM, OUT OF OR IN CONNECTION WITH THE SOFTWARE OR THE USE OR OTHER DEALINGS IN THE SOFTWARE.

Except as contained in this notice, the name of a copyright holder shall not be used in advertising or otherwise to promote the sale, use

or other dealings in this Software without prior written authorization of the copyright holder.

#### **unzip:**

This is version 2005-Feb-10 of the Info-ZIP copyright and license. The definitive version of this document should be available at <ftp://ftp.info-zip.org/pub/infozip/license.html> indefinitely.

Copyright (c) 1990-2005 Info-ZIP. All rights reserved.

For the purposes of this copyright and license, "Info-ZIP" is defined as the following set of individuals:

Mark Adler, John Bush, Karl Davis, Harald Denker, Jean-Michel Dubois, Jean-loup Gailly, Hunter Goatley, Ed Gordon, Ian Gorman, Chris Herborth, Dirk Haase, Greg Hartwig, Robert Heath, Jonathan Hudson, Paul Kienitz, David Kirschbaum, Johnny Lee, Onno van der Linden, Igor Mandrichenko, Steve P. Miller, Sergio Monesi, Keith Owens, George Petrov, Greg Roelofs, Kai Uwe Rommel, Steve Salisbury, Dave Smith, Steven M. Schweda,

Christian Spieler, Cosmin Truta, Antoine Verheijen, Paul von Behren, Rich Wales, Mike White.

This software is provided “as is,” without warranty of any kind, express or implied. In no event shall Info-ZIP or its contributors be held liable for any direct, indirect, incidental, special or consequential damages arising out of the use of or inability to use this software.

Permission is granted to anyone to use this software for any purpose, including commercial applications, and to alter it and redistribute it freely, subject to the following restrictions:

1. Redistributions of source code must retain the above copyright notice, definition, disclaimer, and this list of conditions.
2. Redistributions in binary form (compiled executables) must reproduce the above copyright notice, definition, disclaimer, and this list of conditions in documentation and/or other materials provided with the distribution. The sole exception

to this condition is redistribution of a standard UnZipSFX binary (including SFXWiz) as part of a self-extracting archive; that is permitted without inclusion of this license, as long as the normal SFX banner has not been removed from the binary or disabled.

3. Altered versions—including, but not limited to, ports to new operating systems, existing ports with new graphical interfaces, and dynamic, shared, or static library versions—must be plainly marked as such and must not be misrepresented as being the original source. Such altered versions also must not be misrepresented as being Info-ZIP releases—including, but not limited to, labeling of the altered versions with the names “Info-ZIP” (or any variation thereof, including, but not limited to, different capitalizations), “Pocket UnZip,” “WiZ” or “MacZip” without the explicit permission

of Info-ZIP. Such altered versions are further prohibited from misrepresentative use of the Zip-Bugs or Info-ZIP e-mail addresses or of the Info-ZIP URL(s).

4. Info-ZIP retains the right to use the names “Info-ZIP,” “Zip,” “UnZip,” “UnZipSFX,” “WiZ,” “Pocket UnZip,” “Pocket Zip,” and “MacZip” for its own source and binary releases.

## Index

<b>A</b>	
About Driving the Vehicle .....	2
Accessories and Modifications .....	236
Accessory Power .....	189
Adaptive Cruise Control .....	202
Adaptive Forward Lighting (AFL) .....	160
Adaptive Forward Lighting (AFL) Light .....	128
Add-On Electrical Equipment ...	233
Additional Information OnStar® .....	342
Additional Maintenance and Care .....	315
Adjustments Lumbar, Front Seats .....	53
Thigh Support .....	53
Air Cleaner/Filter, Engine .....	245
Air Conditioning .....	166, 169
Air Filter, Passenger Compartment .....	171
Air Vents .....	170
Airbag System Check .....	78
How Does an Airbag Restrain? .....	71
Passenger Sensing System ...	73
Airbag System (cont'd) What Makes an Airbag Inflate? .....	71
What Will You See after an Airbag Inflates? .....	72
When Should an Airbag Inflate? .....	70
Where Are the Airbags? .....	68
Airbags Adding Equipment to the Vehicle .....	78
Passenger Status Indicator ...	120
Readiness Light .....	119
Servicing Airbag-Equipped Vehicles .....	77
System Check .....	67
Alarm Vehicle Security .....	42
Alert Lane Change .....	219
Side Blind Zone (SBZA) .....	218
All-Season Tires .....	267
All-Wheel Drive .....	195, 255
Antilock Brake System (ABS) ...	195
Warning Light .....	124
Appearance Care Exterior .....	299
Interior .....	304

Armrest			
Rear Seat .....	59		
Assistance Program, Roadside .....	328		
Assistance Systems for Driving .....	214		
Assistance Systems for Parking and Backing .....	210		
Automatic			
Dimming Mirrors .....	45		
Door Locks .....	36		
Forward Braking .....	217		
Headlamp System .....	159		
Transmission .....	192		
Transmission Fluid .....	244		
Automatic Transmission			
Manual Mode .....	194		
Shift Lock Control Function Check .....	256		
<b>B</b>			
Battery			
Exterior Lighting Battery			
Saver .....	164		
Power Protection .....	164		
Voltage and Charging			
Messages .....	138		
Battery - North America .....	254, 292		
Blade Replacement, Wiper .....	257		
Brake			
Parking, Electric .....	196		
System Warning Light .....	123		
Brakes .....	252		
Antilock .....	195		
Assist .....	197		
Fluid .....	253		
System Messages .....	139		
Braking .....	175		
Automatic Forward .....	217		
Break-In, New Vehicle .....	184		
Bulb Replacement .....	260		
Halogen Bulbs .....	259		
Headlamp Aiming .....	258		
Headlamps .....	259		
High Intensity Discharge (HID) Lighting .....	259		
License Plate Lamps .....	259		
Buying New Tires .....	280		
<b>C</b>			
Calibration .....	110		
California			
Fuel Requirements .....	223		
California (cont'd)			
Perchlorate Materials Requirements .....	235		
California			
Proposition 65 Warning .....	235, 254, 292		
Canadian Vehicle Owners .....	2		
Capacities and Specifications .....	322		
Carbon Monoxide			
Engine Exhaust .....	191		
Liftgate .....	37		
Winter Driving .....	178		
Cargo			
Cover .....	101		
Management System .....	102		
Tie-Downs .....	102		
Caution, Danger, and Warning ....	3		
Center Console Storage .....	100		
Chains, Tire .....	285		
Charging System Light .....	121		
Check			
Malfunction Indicator Engine Light .....	121		
Child Restraints			
Infants and Young Children .....	81		
Lower Anchors and Tethers for Children .....	86		

- |                                   |                                    |                                      |
|-----------------------------------|------------------------------------|--------------------------------------|
| Child Restraints (cont'd)         | Coolant                            | <b>D</b>                             |
| Older Children .....79            | Engine ..... 248                   | Damage Repair, Collision ..... 331   |
| Securing ..... 93, 95             | Engine Temperature Gauge ...118    | Danger, Warning, and Caution .... 3  |
| Systems .....83                   | Engine Temperature                 | Data Collection                      |
| Circuit Breakers ..... 261        | Warning Light ..... 126            | Infotainment System ..... 336        |
| Cleaning                          | Cooling ..... 166, 169             | OnStar ..... 336                     |
| Exterior Care ..... 299           | Cooling System ..... 246           | Data Recorders, Event ..... 335      |
| Interior Care ..... 304           | Engine Messages ..... 141          | Daytime Running                      |
| Climate Control Systems           | Courtesy Lamps ..... 162           | Lamps (DRL) ..... 159                |
| Dual Automatic ..... 166          | Courtesy Transportation            | Defensive Driving ..... 174          |
| Rear ..... 169                    | Program ..... 330                  | Delayed Locking ..... 35             |
| Clock ..... 110                   | Cover                              | Diagnostics                          |
| Cluster, Instrument ..... 113     | Cargo ..... 101                    | OnStar® ..... 341                    |
| Collision Damage Repair ..... 331 | Cruise Control ..... 200           | Distracted Driving ..... 174         |
| Compact Spare Tire ..... 291      | Light ..... 129                    | Dome Lamps ..... 162                 |
| Compartments                      | Messages ..... 139                 | Door                                 |
| Storage ..... 99                  | Cruise Control, Adaptive ..... 202 | Ajars Light ..... 129                |
| Compass ..... 110                 | Cupholders ..... 99                | Ajars Messages ..... 140             |
| Messages ..... 139                | Customer Assistance ..... 326      | Delayed Locking ..... 35             |
| Connections                       | Offices ..... 326                  | Locks ..... 34                       |
| OnStar® ..... 339                 | Text Telephone (TTY)               | Power Locks ..... 35                 |
| Control                           | Users ..... 326                    | Drive Belt Routing, Engine ..... 323 |
| Traction and Electronic           | Customer Information               | Drive Systems                        |
| Stability ..... 198               | Service Publications               | All-Wheel Drive ..... 195, 255       |
| Control of a Vehicle ..... 175    | Ordering Information ..... 333     | Driver Assistance Systems ..... 209  |
| Convenience Net ..... 103         | Customer Satisfaction              | Driver Behavior ..... 173            |
| Convex Mirrors ..... 44           | Procedure ..... 324                | Driver Information                   |
|                                   |                                    | Center (DIC) ..... 130, 132          |

- Driving  
Assistance Systems ..... 214  
Characteristics and  
Towing Tips ..... 226  
Defensive ..... 174  
Drunk ..... 175  
Environment ..... 173  
For Better Fuel Economy ..... 25  
Hill and Mountain Roads ..... 178  
If the Vehicle is Stuck ..... 179  
Loss of Control ..... 176  
Off-Road Recovery ..... 176  
Vehicle Load Limits ..... 180  
Wet Roads ..... 177  
Winter ..... 178  
Driving the Vehicle ..... 2  
Dual Automatic Climate  
Control System ..... 166
- E**  
Electric Parking Brake ..... 196  
Electric Parking Brake Light ..... 123  
Electrical Equipment,  
Add-On ..... 233  
Electrical System  
Engine Compartment Fuse  
Block ..... 261  
Fuses and Circuit Breakers ... 261
- Electrical System (cont'd)  
Instrument Panel Fuse  
Block ..... 264  
Overload ..... 260  
Rear Compartment Fuse  
Block ..... 265  
Emergency  
OnStar® ..... 338  
Engine  
Air Cleaner/Filter ..... 245  
Check and Service Engine  
Soon Light ..... 121  
Compartment Overview ..... 238  
Coolant ..... 248  
Coolant Temperature  
Gauge ..... 118  
Coolant Temperature  
Warning Light ..... 126  
Cooling System ..... 246  
Cooling System Messages ... 141  
Drive Belt Routing ..... 323  
Exhaust ..... 191  
Heater ..... 187  
Oil Life System ..... 243  
Oil Messages ..... 141  
Oil Pressure Light ..... 127  
Overheating ..... 250  
Power Messages ..... 142
- Engine (cont'd)  
Running While Parked ..... 191  
Starting ..... 186  
Entry Lighting ..... 163  
Equipment, Towing ..... 232  
Event Data Recorders ..... 335  
Exit Lighting ..... 164  
Extended Parking ..... 190  
Extender, Safety Belt ..... 65  
Exterior Lamp Controls ..... 157  
Exterior Lamps Off Reminder ... 159  
Exterior Lighting Battery  
Saver ..... 164
- F**  
Features  
Memory ..... 11  
Filter,  
Engine Air Cleaner ..... 245  
Flash-to-Pass ..... 159  
Flashers, Hazard Warning ..... 161  
Flat Tire ..... 285  
Changing ..... 287  
Floor Mats ..... 307  
Fluid  
Automatic Transmission ..... 244  
Brakes ..... 253  
Washer ..... 252  
Fog Lamps ..... 161

Folding Mirrors .....	45
Forward Automatic Braking .....	217
Forward Collision Alert (FCA) System .....	215
Frequency Statement Radio .....	334
Front Fog Lamp Light .....	129
Front Seats Heated and Ventilated .....	56
Front Storage .....	99
Fuel .....	222
Additives .....	224
Economy Driving .....	25
Filling a Portable Fuel Container .....	225
Filling the Tank .....	224
Foreign Countries .....	224
Gauge .....	117
Low Fuel Warning Light .....	127
Requirements, California .....	223
System Messages .....	142
Fuses	
Engine Compartment Fuse Block .....	261
Fuses and Circuit Breakers ...	261
Instrument Panel Fuse Block .....	264

Fuses (cont'd)	
Rear Compartment Fuse Block .....	265
<b>G</b>	
Garage Door Opener .....	154
Programming .....	154
Gauges	
Engine Coolant Temperature .....	118
Fuel .....	117
Odometer .....	116
Speedometer .....	116
Tachometer .....	116
Trip Odometer .....	116
Warning Lights and Indicators .....	112
General Information	
Service and Maintenance .....	309
Towing .....	226
Vehicle Care .....	235
Glove Box .....	99
GM Mobility Reimbursement Program .....	327

<b>H</b>	
Halogen Bulbs .....	259
Hazard Warning Flashers .....	161
Head Restraints .....	51
Head-up Display .....	135
Headlamp Leveling Control .....	160
Headlamps	
Adaptive Forward Lighting (AFL) .....	160
Aiming .....	258
Automatic .....	159
Bulb Replacement .....	259
Daytime Running Lamps (DRL) .....	159
Flash-to-Pass .....	159
High Intensity Discharge (HID) Lighting .....	259
High-Beam On Light .....	128
High/Low Beam Changer .....	159
Lamps On Reminder .....	129
Washer .....	110
Heated	
Rear Seats .....	59
Steering Wheel .....	106
Heated and Ventilated Front Seats .....	56
Heated Mirrors .....	45



- Heater  
  Engine ..... 187  
Heating ..... 166, 169  
High-Beam On Light ..... 128  
Hill and Mountain Roads ..... 178  
Hill Start Assist (HSA) ..... 197  
Hood ..... 237  
Horn ..... 107  
How to Wear Safety Belts  
  Properly ..... 61  
HVAC ..... 166, 169
- I**  
Ignition Positions ..... 184  
Immobilizer ..... 43  
Indicator  
  Vehicle Ahead ..... 125  
Infants and Young Children,  
  Restraints ..... 81  
Infotainment ..... 165  
Infotainment System ..... 336  
Instrument Cluster ..... 113  
Instrument Panel Overview ..... 6  
Interior Rearview Mirrors ..... 45  
Introduction ..... 2
- J**  
Jump Starting - North  
  America ..... 292
- K**  
Key and Lock Messages ..... 142  
Keyless Entry  
  Remote (RKE) System ..... 27  
Keys ..... 26
- L**  
Labeling, Tire Sidewall ..... 268  
Lamps  
  Courtesy ..... 162  
  Daytime Running (DRL) ..... 159  
  Dome ..... 162  
  Exterior Controls ..... 157  
  Exterior Lamps Off  
    Reminder ..... 159  
  Exterior Lighting Battery  
    Saver ..... 164  
  License Plate ..... 259  
  Malfunction Indicator ..... 121  
  On Reminder ..... 129  
  Reading ..... 163  
Lane Change Alert (LCA) ..... 219  
Lane Departure  
  Warning (LDW) ..... 220  
Lane Keep Assist (LKA) ..... 221  
Lane Keep Assist Light ..... 124  
Lap-Shoulder Belt ..... 62  
LATCH System  
  Replacing Parts after a  
    Crash ..... 93  
LATCH, Lower Anchors and  
  Tethers for Children ..... 86  
Leveling Control  
  Headlamp ..... 160  
Liftgate ..... 37  
Light  
  Adaptive Forward Lighting  
    (AFL) Light ..... 128  
Lighting  
  Adaptive Forward ..... 160  
  Entry ..... 163  
  Exit ..... 164  
  Illumination Control ..... 162  
Lights ..... 124  
  Airbag Readiness ..... 119  
  Antilock Brake System  
    (ABS) Warning ..... 124  
  Brake System Warning ..... 123  
  Charging System ..... 121  
  Cruise Control ..... 129  
  Door Ajar ..... 129  
  Electric Parking Brake ..... 123

- |                                  |   |   |
|----------------------------------|---|---|
| Lights (cont'd)                  | Lower Anchors and Tethers<br>for Children (LATCH<br>System) . . . . . | Messages (cont'd)                       |
| Engine Coolant                   | . . . . . 86  | Key and Lock . . . . . 142              |
| Temperature Warning . . . . .    | Lumbar Adjustment . . . . .   | Object Detection System . . . . .       |
| . . . . . 126                    | . . . . . 53  | Ride Control System . . . . .           |
| Engine Oil Pressure . . . . .    | Front Seats . . . . .   | . . . . . 144                           |
| . . . . . 127                    | . . . . . 53  | Security . . . . . 145                  |
| Flash-to-Pass . . . . . 159      | <b>M</b>  | Steering System . . . . . 145           |
| Front Fog Lamp . . . . . 129     | Maintenance   | Tire . . . . . 146                      |
| High-Beam On . . . . . 128       | Records . . . . . 320   | Transmission . . . . . 146              |
| High/Low Beam Changer . . . . .  | Maintenance and Care  | Vehicle . . . . . 138                   |
| . . . . . 159                    | Additional . . . . . 315  | Washer Fluid . . . . . 147              |
| Low Fuel Warning . . . . . 127   | Maintenance Schedule . . . . .  | Window . . . . . 147                    |
| Safety Belt Reminders . . . . .  | . . . . . 310   | Mirrors                                 |
| . . . . . 119                    | Recommended Fluids and  | Automatic Dimming . . . . . 45          |
| Security . . . . . 128           | Lubricants . . . . . 318  | Automatic Dimming                       |
| Service Electric Parking         | Malfunction Indicator Lamp . . . . .                                  | Rearview . . . . . 45                   |
| Brake . . . . . 124              | . . . . . 121   | Convex . . . . . 44                     |
| StabiliTrak® OFF . . . . . 125   | Manual Mode . . . . . 194   | Folding . . . . . 45                    |
| Tire Pressure . . . . . 126      | Memory Features . . . . . 11  | Heated . . . . . 45                     |
| Traction Control System          | Memory Seats . . . . . 54   | Power . . . . . 44                      |
| (TCS)/StabiliTrak® . . . . .     | Messages  | Tilt in Reverse . . . . . 45            |
| . . . . . 126                    | Airbag System . . . . . 145   | Mirrors, Interior Rearview . . . . . 45 |
| Traction Off . . . . . 125       | Battery Voltage and   | Monitor System, Tire                    |
| Locks                            | Charging . . . . . 138  | Pressure . . . . . 274                  |
| Automatic Door . . . . . 36      | Brake System . . . . . 139  | <b>N</b>                                |
| Delayed Locking . . . . . 35     | Compass . . . . . 139   | Navigation                              |
| Door . . . . . 34                | Door Ajar . . . . . 140   | OnStar® . . . . . 338                   |
| Lockout Protection . . . . . 36  | Engine Cooling System . . . . .                                       | Net, Convenience . . . . . 103          |
| Power Door . . . . . 35          | . . . . . 141   | New Vehicle Break-In . . . . . 184      |
| Safety . . . . . 36              | Engine Oil . . . . . 141  |   |
| Loss of Control . . . . . 176    | Engine Power . . . . . 142  |   |
| Low Fuel Warning Light . . . . . | Fuel System . . . . . 142   |   |
| . . . . . 127                    |   |   |

**O**

Object Detection System	
Messages .....	142
Odometer .....	116
Trip .....	116
Off-Road	
Recovery .....	176
Oil	
Engine .....	241
Engine Oil Life System .....	243
Messages .....	141
Pressure Light .....	127
Older Children, Restraints .....	79
Online Owner Center .....	327
OnStar .....	336
OnStar <sup>®</sup> Additional	
Information .....	342
OnStar <sup>®</sup> Connections .....	339
OnStar <sup>®</sup> Diagnostics .....	341
OnStar <sup>®</sup> Emergency .....	338
OnStar <sup>®</sup> Navigation .....	338
OnStar <sup>®</sup> Overview .....	337
OnStar <sup>®</sup> Security .....	338
Operation	
Fog Lamps .....	161
Ordering	
Service Publications .....	333

**Outlets**

Power .....	111
Overheating, Engine .....	250

**P****Park**

Shifting Into .....	189
Shifting Out of .....	190

**Parking**

Brake and P (Park)	
Mechanism Check .....	256
Extended .....	190
Over Things That Burn .....	190
Parking Assist .....	210

**Parking or Backing**

Assistance Systems .....	210
--------------------------	-----

**Passenger Airbag Status**

Indicator .....	120
-----------------	-----

**Passenger Compartment Air**

Filter .....	171
--------------	-----

**Passenger Sensing System** .....**Perchlorate Materials**

Requirements, California .....	235
--------------------------------	-----

**Personalization**

Vehicle .....	147
---------------	-----

**Power**

Door Locks .....	35
Mirrors .....	44
Outlets .....	111

**Power (cont'd)**

Protection, Battery .....	164
Retained Accessory (RAP) ...	189
Seat Adjustment .....	53
Windows .....	46
Pregnancy, Using Safety Belts ...	65
Privacy	
Vehicle Data Recording .....	335
Program	
Courtesy Transportation .....	330
Proposition	
65 Warning,	
California .....	235, 254, 292

**R**

Radio Frequency Statement ....	334
Reading Lamps .....	163
Rear Climate Control System ...	169
Rear Seat Armrest .....	59
Rear Seats .....	57
Heated .....	59
Rear Storage .....	100
Rear Vision Camera (RVC) .....	210
Rear Window Washer/Wiper ....	109
Rearview Mirrors	
Automatic Dimming .....	45
Reclining Seatbacks .....	54
Recommended Fluids and	
Lubricants .....	318

Records		
Maintenance .....	320	
Recreational Vehicle Towing .....	297	
Reimbursement Program,		
GM Mobility .....	327	
Remote Keyless Entry (RKE)		
System .....	27	
Remote Vehicle Start .....	33	
Replacement Bulbs .....	260	
Replacement Parts		
Airbags .....	79	
Maintenance .....	319	
Replacing Airbag System .....	79	
Replacing LATCH System		
Parts after a Crash .....	93	
Replacing Safety Belt System		
Parts after a Crash .....	66	
Reporting Safety Defects		
Canadian Government .....	334	
General Motors .....	335	
U.S. Government .....	334	
Restraints		
Where to Put .....	85	
Retained Accessory		
Power (RAP) .....	189	
Reverse Tilt Mirrors .....	45	
Ride Control Systems		
Messages .....	144	
Roads		
Driving, Wet .....	177	
Roadside Assistance		
Program .....	328	
Roof		
Sunroof .....	48	
Roof Rack System .....	103	
Rotation, Tires .....	279	
Routing, Engine Drive Belt .....	323	
Running the Vehicle While		
Parked .....	191	
<b>S</b>		
Safety Belts .....	60	
Care .....	65	
Extender .....	65	
How to Wear Safety Belts		
Properly .....	61	
Lap-Shoulder Belt .....	62	
Reminders .....	119	
Replacing after a Crash .....	66	
Use During Pregnancy .....	65	
Safety Defects Reporting		
Canadian Government .....	334	
General Motors .....	335	
U.S. Government .....	334	
Safety Locks .....	36	
Safety System Check .....	65	
Scheduling Appointments .....	329	
Seats		
Head Restraints .....	51	
Heated and Ventilated Front .....	56	
Heated, Rear .....	59	
Lumbar Adjustment, Front .....	53	
Memory .....	54	
Power Adjustment, Front .....	53	
Rear .....	57	
Reclining Seatbacks .....	54	
Securing Child Restraints .....	93, 95	
Security		
Light .....	128	
Messages .....	145	
OnStar® .....	338	
Vehicle .....	42	
Vehicle Alarm .....	42	
Service		
Accessories and		
Modifications .....	236	
Doing Your Own Work .....	236	
Engine Soon Light .....	121	
Maintenance Records .....	320	
Maintenance, General		
Information .....	309	
Parts Identification Label .....	321	
Publications Ordering		
Information .....	333	
Scheduling Appointments .....	329	

Service Electric Parking			
Brake Light .....	124		
Services			
Special Application .....	315		
Servicing the Airbag .....	77		
Shift Lock Control Function			
Check, Automatic			
Transmission .....	256		
Shifting			
Into Park .....	189		
Out of Park .....	190		
Side Blind Zone Alert (SBZA) ...	218		
Signals, Turn and			
Lane-Change .....	161		
Spare Tire			
Compact .....	291		
Special Application Services ...	315		
Specifications and			
Capacities .....	322		
Speedometer .....	116		
StabiliTrak			
OFF Light .....	125		
Start Assist, Hill .....	197		
Start Vehicle, Remote .....	33		
Starter Switch Check .....	256		
Starting the Engine .....	186		
Steering .....	175		
Heated Wheel .....	106		
Steering (cont'd)			
Wheel Adjustment .....	106		
Wheel Controls .....	106		
Steering System Messages .....	145		
Storage			
Rear .....	100		
Storage Areas			
Cargo Cover .....	101		
Cargo Management			
System .....	102		
Center Console .....	100		
Convenience Net .....	103		
Front .....	99		
Glove Box .....	99		
Roof Rack System .....	103		
Sunglasses .....	99		
Storage Compartments .....	99		
Stuck Vehicle .....	179		
Summer Tires .....	268		
Sun Visors .....	48		
Sunglass Storage .....	99		
Sunroof .....	48		
Symbols .....	3		
System			
Forward Collision			
Alert (FCA) .....	215		
Infotainment .....	165, 336		
Roof Rack .....	103		
Systems			
Driver Assistance .....	209		
<b>T</b>			
Tachometer .....	116		
Text Telephone (TTY) Users .....	326		
Theft-Deterrent Systems .....	43		
Immobilizer .....	43		
Thigh Support Adjustment .....	53		
Time .....	110		
Tires .....	266		
All-Season .....	267		
Buying New Tires .....	280		
Chains .....	285		
Changing .....	287		
Compact Spare .....	291		
Designations .....	270		
Different Size .....	282		
If a Tire Goes Flat .....	285		
Inspection .....	278		
Messages .....	146		
Pressure .....	273		
Pressure Light .....	126		
Pressure Monitor Operation ..	275		
Pressure Monitor System .....	274		
Rotation .....	279		
Sidewall Labeling .....	268		
Terminology and Definitions ..	271		

Tires (cont'd)			
Uniform Tire Quality Grading .....	282		
Wheel Alignment and Tire Balance .....	284		
Wheel Replacement .....	284		
When It Is Time for New Tires .....	280		
Winter .....	267		
Towing			
Driving Characteristics .....	226		
Equipment .....	232		
General Information .....	226		
Recreational Vehicle .....	297		
Trailer .....	229		
Vehicle .....	295		
Traction			
Control System (TCS)/StabiliTrak® Light .....	126		
Off Light .....	125		
Traction Control/Electronic Stability Control .....	198		
Trailer			
Towing .....	229		
Transmission			
Automatic .....	192		
Fluid, Automatic .....	244		
Messages .....	146		
Transportation Program, Courtesy .....	330		
Trip Odometer .....	116		
Turn and Lane-Change Signals .....	161		
<b>U</b>			
Uniform Tire Quality Grading .....	282		
Universal Remote System .....	154		
Operation .....	156		
Programming .....	154		
Using This Manual .....	2		
<b>V</b>			
Vehicle			
Alarm System .....	42		
Canadian Owners .....	2		
Control .....	175		
Design .....	173		
Identification Number (VIN) .....	321		
Load Limits .....	180		
Messages .....	138		
Personalization .....	147		
Remote Start .....	33		
Security .....	42		
Towing .....	295		
Vehicle Ahead Indicator .....	125		
Vehicle Care			
Tire Pressure .....	273		
Vehicle Data Recording and Privacy .....	335		
Ventilation, Air .....	170		
Visors .....	48		
<b>W</b>			
Warning			
Brake System Light .....	123		
Caution and Danger .....	3		
Lane Departure (LDW) .....	220		
Warning Lights, Gauges, and Indicators .....	112		
Warnings			
Hazard Flashers .....	161		
Washer Fluid .....	252		
Messages .....	147		
Washer, Headlamps .....	110		
Wheels			
Alignment and Tire Balance ..	284		
Different Size .....	282		
Replacement .....	284		
When It Is Time for New Tires .....	280		
Where to Put the Restraint .....	85		
Wi-Fi .....	339		
Windows			
Messages .....	147		

Windows (cont'd)	
Power .....	46
Windshield	
Replacement .....	258
Wiper/Washer .....	107
Winter	
Driving .....	178
Winter Tires .....	267
Wiper Blade Replacement .....	257
Wipers	
Rear Washer .....	109