



owner.ford.com



ford.ca

2019 **MUSTANG** Owner's Manual



January 2019  
Second Printing  
Litho in U.S.A.



KR3J19A321 AB



The information contained in this publication was correct at the time of going to print. In the interest of continuous development, we reserve the right to change specifications, design or equipment at any time without notice or obligation. No part of this publication may be reproduced, transmitted, stored in a retrieval system or translated into any language in any form by any means without our written permission. Errors and omissions excepted.

© Ford Motor Company 2018

All rights reserved.

Part Number: 201804 20181218192122

## California Proposition 65



**WARNING:** Operating, servicing and maintaining a passenger vehicle or off-highway motor vehicle can expose you to chemicals including engine exhaust, carbon monoxide, phthalates, and lead, which are known to the State of California to cause cancer and birth defects or other reproductive harm. To minimize exposure, avoid breathing exhaust, do not idle the engine except as necessary, service your vehicle in a well-ventilated area and wear gloves or wash your hands frequently when servicing your vehicle. For more information go to [www.P65Warnings.ca.gov/passenger-vehicle](http://www.P65Warnings.ca.gov/passenger-vehicle).



**WARNING:** Battery posts, terminals and related accessories contain lead and lead compounds, chemicals known to the State of California to cause cancer and reproductive harm.  
**Wash your hands after handling.**



# Table of Contents

---

## Introduction

About This Manual .....	7
Symbols Glossary .....	7
Data Recording .....	9
Perchlorate .....	11
Ford Credit .....	11
Replacement Parts Recommendation .....	12
Special Notices .....	12
Mobile Communications Equipment .....	14
Export Unique Options .....	14

## Environment

Protecting the Environment .....	15
----------------------------------	----

## At a Glance

Instrument Panel Overview .....	16
---------------------------------	----

## Child Safety

General Information .....	18
Installing Child Restraints .....	20
Booster Seats .....	25
Child Restraint Positioning .....	27

## Seatbelts

Principle of Operation .....	30
Fastening the Seatbelts .....	31
Seatbelt Warning Lamp and Indicator Chime .....	33
Seatbelt Reminder .....	34
Child Restraint and Seatbelt Maintenance .....	36
Seatbelt Extension .....	36

## Personal Safety System™

Personal Safety System™ .....	37
-------------------------------	----

## Supplementary Restraints System

Principle of Operation .....	38
Driver and Passenger Airbags .....	39
Front Passenger Sensing System .....	40
Side Airbags .....	43
Driver and Passenger Knee Airbags .....	44
Safety Canopy™ - Coupe .....	44
Crash Sensors and Airbag Indicator .....	46
Airbag Disposal .....	47

## MyKey™

Principle of Operation .....	48
Creating a MyKey .....	49
Clearing All MyKeys .....	49
Checking MyKey System Status .....	50
Using MyKey With Remote Start Systems .....	50
MyKey – Troubleshooting .....	50

## Keys and Remote Controls

General Information on Radio Frequencies .....	52
Remote Control .....	52
Replacing a Lost Key or Remote Control .....	57

## Doors and Locks

Locking and Unlocking .....	58
Interior Luggage Compartment Release .....	63

## Security

Passive Anti-Theft System .....	64
Anti-Theft Alarm .....	65

## Steering Wheel

Adjusting the Steering Wheel .....	66
Audio Control .....	66
Voice Control .....	67

# Table of Contents

---

Cruise Control .....	67
Information Display Control .....	68
Heated Steering Wheel .....	68

## Wipers and Washers

Windshield Wipers .....	69
Autowipers .....	69
Windshield Washers .....	70

## Lighting

General Information .....	71
Lighting Control .....	71
Autolamps .....	72
Instrument Lighting Dimmer .....	72
Headlamp Exit Delay .....	73
Daytime Running Lamps .....	73
Automatic High Beam Control .....	74
Front Fog Lamps .....	75
Direction Indicators .....	75
Welcome Lighting .....	75
Interior Lamps .....	76
Ambient Lighting .....	76

## Windows and Mirrors

Power Windows .....	77
Global Opening .....	77
Exterior Mirrors .....	78
Interior Mirror .....	79
Sun Visors .....	80

## Instrument Cluster

Gauges .....	81
Warning Lamps and Indicators .....	84
Audible Warnings and Indicators .....	87

## Information Displays

General Information .....	88
Information Messages .....	97

## Climate Control

Manual Climate Control .....	109
Automatic Climate Control .....	111
Hints on Controlling the Interior Climate .....	113
Heated Rear Window .....	115
Heated Exterior Mirrors .....	115
Cabin Air Filter .....	115
Remote Start .....	116

## Seats

Sitting in the Correct Position .....	117
Head Restraints .....	117
Manual Seats .....	119
Power Seats .....	120
Memory Function .....	120
Rear Seats .....	122
Climate Controlled Seats .....	122

## Garage Door Opener

Universal Garage Door Opener .....	124
------------------------------------	-----

## Auxiliary Power Points

Auxiliary Power Points .....	128
------------------------------	-----

## Storage Compartments

Center Console .....	129
Glasses Holder .....	129

## Starting and Stopping the Engine

General Information .....	130
Keyless Starting .....	130
Steering Wheel Lock .....	131
Starting a Gasoline Engine .....	131
Engine Block Heater .....	134

## Fuel and Refueling

Safety Precautions .....	136
--------------------------	-----

# Table of Contents

---

Fuel Quality .....	136	Using Adaptive Cruise Control .....	167
Fuel Filler Funnel Location .....	137	<b>Driving Aids</b>	
Running Out of Fuel .....	137	Driver Alert .....	173
Refueling .....	139	Lane Keeping System .....	174
Fuel Consumption .....	141	Blind Spot Information System .....	178
<b>Engine Emission Control</b>		Cross Traffic Alert .....	180
Emission Law .....	143	Steering .....	183
Catalytic Converter .....	144	Pre-Collision Assist .....	183
<b>Transmission</b>		Drive Control .....	187
Manual Transmission .....	147	<b>Load Carrying</b>	
Automatic Transmission .....	148	Load Limit .....	191
<b>Rear Axle</b>		<b>Towing</b>	
Limited Slip Differential .....	153	Towing a Trailer .....	196
<b>Brakes</b>		Recommended Towing Weights .....	197
General Information .....	154	Essential Towing Checks .....	198
Hints on Driving With Anti-Lock Brakes .....	154	Towing the Vehicle on Four Wheels .....	199
Parking Brake .....	155	<b>Convertible Top</b>	
Hill Start Assist .....	155	Opening the Convertible Top .....	201
<b>Traction Control</b>		Closing the Convertible Top .....	202
Principle of Operation .....	157	<b>Driving Hints</b>	
Using Traction Control .....	157	Breaking-In .....	204
<b>Stability Control</b>		Reduced Engine Performance .....	204
Principle of Operation .....	158	Economical Driving .....	205
Using Stability Control .....	159	Cold Weather Precautions .....	205
<b>Parking Aids</b>		Driving Through Water .....	205
Principle of Operation .....	161	Floor Mats .....	206
Rear Parking Aid .....	161	<b>Roadside Emergencies</b>	
Rear View Camera .....	162	Roadside Assistance .....	207
<b>Cruise Control</b>		Hazard Flashers .....	208
Principle of Operation .....	166	Fuel Shutoff .....	208
Using Cruise Control .....	166	Jump Starting the Vehicle .....	209
		Post-Crash Alert System .....	211
		Transporting the Vehicle .....	212

# Table of Contents

## Customer Assistance

Getting the Services You Need .....	213
In California (U.S. Only) .....	214
The Better Business Bureau (BBB) Auto Line Program (U.S. Only) .....	215
Utilizing the Mediation/Arbitration Program (Canada Only) .....	216
Getting Assistance Outside the U.S. and Canada .....	216
Ordering Additional Owner's Literature .....	218
Reporting Safety Defects (U.S. Only) .....	218
Reporting Safety Defects (Canada Only) .....	218

## Fuses

Fuse Specification Chart .....	220
Changing a Fuse .....	228

## Maintenance

General Information .....	230
Opening and Closing the Hood .....	230
Under Hood Overview - 2.3L EcoBoost™ .....	232
Under Hood Overview - 5.0L .....	233
Under Hood Overview - 5.0L, Bullitt .....	234
Engine Oil Dipstick .....	235
Engine Oil Check .....	235
Oil Change Indicator Reset .....	236
Engine Coolant Check .....	237
Manual Transmission Fluid Check .....	241
Automatic Transmission Fluid Check .....	241
Brake Fluid Check .....	241
Clutch Fluid Check - Manual Transmission .....	242
Power Steering Fluid Check .....	242
Washer Fluid Check .....	242
Fuel Filter .....	243
Changing the 12V Battery .....	243

Checking the Wiper Blades .....	245
Changing the Wiper Blades .....	245
Adjusting the Headlamps .....	245
Changing a Bulb .....	247
Changing the Engine Air Filter - 2.3L EcoBoost™/5.0L .....	247
Changing the Engine Air Filter - 5.0L, Bullitt .....	248

## Track Use

Track Use .....	250
-----------------	-----

## Vehicle Care

General Information .....	253
Cleaning Products .....	253
Cleaning the Exterior .....	253
Waxing .....	255
Cleaning the Engine .....	255
Cleaning the Windows and Wiper Blades .....	255
Cleaning the Interior .....	256
Cleaning the Instrument Panel and Instrument Cluster Lens .....	256
Cleaning Leather Seats .....	257
Repairing Minor Paint Damage .....	258
Cleaning the Wheels .....	258
Vehicle Storage .....	258
Cleaning the Convertible Top .....	260
Body Styling Kits .....	260

## Wheels and Tires

General Information .....	261
Tire Sealant and Inflator Kit .....	261
Tire Care .....	267
Using Summer Tires .....	282
Using Winter Tires .....	282
Using Snow Chains .....	282
Tire Pressure Monitoring System .....	284
Changing a Road Wheel .....	287
Driving at High Speed .....	292

# Table of Contents

Technical Specifications .....	293
--------------------------------	-----

## Capacities and Specifications

Engine Specifications - 2.3L EcoBoost™ .....	294
Engine Specifications - 5.0L .....	294
Motorcraft Parts - 2.3L EcoBoost™ .....	295
Motorcraft Parts - 5.0L .....	296
Motorcraft Parts - 5.0L, Bullitt .....	297
Vehicle Identification Number .....	298
Vehicle Certification Label .....	299
Transmission Code Designation .....	299
Capacities and Specifications - 2.3L EcoBoost™ .....	300
Capacities and Specifications - 5.0L .....	305
Bulb Specification Chart .....	310
Vehicle Performance Specifications .....	312

## Audio System

General Information .....	313
Audio Unit - Vehicles With: AM/FM/CD/ SYNC/Touchscreen Display .....	314
Audio Unit - Vehicles With: SYNC .....	315
Digital Radio .....	317
Satellite Radio .....	320
USB Port .....	323
Media Hub .....	323

## SYNC™

General Information .....	324
Using Voice Recognition .....	325
Using SYNC™ With Your Phone .....	327
SYNC™ Applications and Services .....	328
Using SYNC™ With Your Media Player .....	332
SYNC™ Troubleshooting .....	333

## SYNC™ 3

General Information .....	341
Home Screen .....	353
Using Voice Recognition .....	354
Entertainment .....	361
Climate .....	371
Phone .....	373
Navigation .....	379
Apps .....	387
Settings .....	390
SYNC™ 3 Troubleshooting .....	404

## Accessories

Accessories .....	418
-------------------	-----

## Ford Protect

Ford Protect .....	420
--------------------	-----

## Scheduled Maintenance

General Maintenance Information .....	422
Normal Scheduled Maintenance .....	425
Special Operating Conditions Scheduled Maintenance .....	428
Scheduled Maintenance Record .....	430

## Appendices

Electromagnetic Compatibility .....	440
End User License Agreement .....	442
Type Approvals .....	468





# Introduction

## ABOUT THIS MANUAL

Thank you for choosing Ford. We recommend that you take some time to get to know your vehicle by reading this manual. The more that you know about your vehicle, the greater the safety and pleasure you will get from driving it.



**WARNING:** Driving while distracted can result in loss of vehicle control, crash and injury. We strongly recommend that you use extreme caution when using any device that may take your focus off the road. Your primary responsibility is the safe operation of your vehicle. We recommend against the use of any hand-held device while driving and encourage the use of voice-operated systems when possible. Make sure you are aware of all applicable local laws that may affect the use of electronic devices while driving.

**Note:** This manual describes product features and options available throughout the range of available models, sometimes even before they are generally available. It may describe options not fitted to the vehicle you have purchased.

**Note:** Some of the illustrations in this manual may show features as used in different models, so may appear different to you on your vehicle.

**Note:** Always use and operate your vehicle in line with all applicable laws and regulations.

**Note:** Pass on this manual when selling your vehicle. It is an integral part of your vehicle.

This manual may qualify the location of a component as left-hand side or right-hand side. The side is determined when facing forward in the seat.



E154903

- A Right-hand side.
- B Left-hand side.

## SYMBOLS GLOSSARY

These are some of the symbols you may see on your vehicle.



Air conditioning system



Air conditioning system lubricant type



Anti-lock braking system



Avoid smoking, flames or sparks



Battery



Battery acid



Brake fluid - non petroleum based



Brake system

# Introduction



Brake system



Flammable



Cabin air filter



Front airbag



Check fuel cap



Front fog lamps



Child safety door lock or unlock



Fuel pump reset



Child seat lower anchor



Fuse compartment



Child seat tether anchor



Hazard flashers



Cruise control



Heated rear window



Do not open when hot



Windshield defrosting system



Engine air filter



Interior luggage compartment release



Engine coolant



Jack



Engine coolant temperature



Keep out of reach of children



Engine oil



Lighting control



Explosive gas



Low tire pressure warning



Fan warning



Maintain correct fluid level



Fasten seatbelt



Note operating instructions

# Introduction



Horn control



Panic alarm



Parking aid



Parking brake



Power steering fluid



Power windows front/rear



Power window lockout



Requires registered technician



Safety alert



See Owner's Manual



See Service Manual



Service engine soon



Passenger airbag activated



Passenger airbag deactivated



Side airbag



Shield the eyes



Stability control



Hill descent control



Trail control



Windshield wiping system



Windshield wash and wipe

## DATA RECORDING

### Service Data Recording

Service data recorders in your vehicle are capable of collecting and storing diagnostic information about your vehicle. This potentially includes information about the performance or status of various systems and modules in the vehicle, such as engine, throttle, steering or brake systems. In order to properly diagnose and service your vehicle, Ford Motor Company (Ford of Canada, in Canada), and service and repair facilities may access or share among them vehicle diagnostic information received through a direct connection to your vehicle when diagnosing or servicing your vehicle. Additionally, Ford Motor Company (Ford of Canada, in Canada) may, where permitted by law, use vehicle diagnostic information for vehicle improvement or with other information we may have about you, (for example, your contact information), to offer you products or services that may interest you. Data may be provided to our service providers such

# Introduction

as part suppliers that may help diagnose malfunctions, and who are similarly obligated to protect data. We retain this data only as long as necessary to perform these functions or to comply with law. We may provide information where required in response to official requests to law enforcement or other government authorities or third parties acting with lawful authority or court order, and such information may be used in legal proceedings. For U.S. only (if equipped), if you choose to use connected apps and services, such as SYNC Vehicle Health Report or MyFord Mobile App, you consent that certain diagnostic information may also be accessed electronically by Ford Motor Company and Ford authorized service facilities, and that the diagnostic information may be used to provide services to you, personalizing your experience, troubleshoot, and to improve products and services and offer you products and services that may interest you, where permitted by law. For Canada only, for more information, please review the Ford of Canada privacy policy at [www.ford.ca](http://www.ford.ca), including our U.S. data storage and use of service providers in other jurisdictions who may be subject to legal requirements in Canada, the United States and other countries applicable to them, for example, lawful requirements to disclose personal information to governmental authorities in those countries. See **SYNCTM** (page 324).

## Event Data Recording

**This vehicle is equipped with an event data recorder. The main purpose of an event data recorder is to record, in certain crash or near crash-like situations, such as an airbag deployment or hitting a road obstacle;**

**this data will assist in understanding how a vehicle's systems performed. The event data recorder is designed to record data related to vehicle dynamics and safety systems for a short period of time, typically 30 seconds or less.**

**The event data recorder in this vehicle is designed to record such data as:**

- **How various systems in your vehicle were operating;**
- **Whether or not the driver and passenger safety belts were buckled/fastened;**
- **How far (if at all) the driver was depressing the accelerator and/or the brake pedal; and**
- **How fast the vehicle was traveling; and**
- **Where the driver was positioning the steering wheel.**

**This data can help provide a better understanding of the circumstances in which crashes and injuries occur.**

**Note:** *Event data recorder data is recorded by your vehicle only if a non-trivial crash situation occurs; no data is recorded by the event data recorder under normal driving conditions and no personal data or information (e.g., name, gender, age, and crash location) is recorded (see limitations regarding 911 Assist and Traffic, directions and Information privacy below). However, parties, such as law enforcement, could combine the event data recorder data with the type of personally identifying data routinely acquired during a crash investigation.*

**To read data recorded by an event data recorder, special equipment is required, and access to the vehicle or the event data recorder is needed. In addition to the vehicle manufacturer, other parties, such as law enforcement, that have such special equipment, can read**

# Introduction

the information if they have access to the vehicle or the event data recorder. Ford Motor Company and Ford of Canada do not access event data recorder information without obtaining consent, unless pursuant to court order or where required by law enforcement, other government authorities or other third parties acting with lawful authority. Other parties may seek to access the information independently of Ford Motor Company and Ford of Canada.

**Note:** *Including to the extent that any law pertaining to Event Data Recorders applies to SYNC or its features, please note the following: Once 911 Assist (if equipped) is enabled (set ON), 911 Assist may, through any paired and connected cell phone, disclose to emergency services that the vehicle has been in a crash involving the deployment of an airbag or, in certain vehicles, the activation of the fuel pump shut-off. Certain versions or updates to 911 Assist may also be capable of being used to electronically or verbally provide to 911 operators the vehicle location (such as latitude and longitude), and/or other details about the vehicle or crash or personal information about the occupants to assist 911 operators to provide the most appropriate emergency services. If you do not want to disclose this information, do not activate the 911 Assist feature. See SYNC™ (page 324).*

**Additionally, when you connect to Traffic, Directions and Information (if equipped, U.S. only), the service uses GPS technology and advanced vehicle sensors to collect the vehicle's current location, travel direction, and speed ("vehicle travel information"), only to help provide you with the directions, traffic reports, or business searches that you request. If you do not want**

**Ford or its vendors to receive this information, do not activate the service. For more information, see Traffic, Directions and Information, Terms and Conditions. See SYNC™ (page 324).**

## PERCHLORATE

Certain components in your vehicle such as airbag modules, seatbelt pretensioners and remote control batteries may contain perchlorate material. Special handling may apply for service or vehicle end of life disposal.

**For more information visit:**

Web Address
<a href="http://www.dtsc.ca.gov/hazardouswaste/perchlorate">www.dtsc.ca.gov/hazardouswaste/perchlorate</a>

## FORD CREDIT

### US Only

Ford Credit offers a full range of financing and lease plans to help you acquire your vehicle. If you have financed or leased your vehicle through Ford Credit, thank you for your business.

We offer a number of convenient ways for you to contact us, and to manage your account.

Call 1-800-727-7000.

For more information about Ford Credit and access to Account Manager, go to [www.ford.com/finance](http://www.ford.com/finance).

# Introduction

---

## REPLACEMENT PARTS RECOMMENDATION

We have built your vehicle to the highest standards using quality parts. We recommend that you demand the use of genuine Ford and Motorcraft parts whenever your vehicle requires scheduled maintenance or repair. You can clearly identify genuine Ford and Motorcraft parts by looking for the Ford, FoMoCo or Motorcraft branding on the parts or their packaging.

## Scheduled Maintenance and Mechanical Repairs

One of the best ways for you to make sure that your vehicle provides years of service is to have it maintained in line with our recommendations using parts that conform to the specifications detailed in this Owner's Manual. Genuine Ford and Motorcraft parts meet or exceed these specifications.

## Collision Repairs

We hope that you never experience a collision, but accidents do happen. Genuine Ford replacement collision parts meet our stringent requirements for fit, finish, structural integrity, corrosion protection and dent resistance. During vehicle development we validate that these parts deliver the intended level of protection as a whole system. A great way to know for sure you are getting this level of protection is to use genuine Ford replacement collision parts.

## Warranty on Replacement Parts

Genuine Ford and Motorcraft replacement parts are the only replacement parts that benefit from a Ford Warranty. The Ford Warranty may not cover damage caused to your vehicle as a result of failed non-Ford parts. For additional information, refer to the terms and conditions of the Ford Warranty.

## SPECIAL NOTICES

### New Vehicle Limited Warranty

For a detailed description of what is covered and what is not covered by your vehicle's New Vehicle Limited Warranty, see the **Warranty Guide** that is provided to you along with your Owner's Manual.

### Additional Warranty Information

Your vehicle carries the same warranty as other Ford models. This information is covered in its entirety in the Ford Warranty Guide. You can obtain warranty service for your vehicle at any authorized dealer nationwide.

We design and build our vehicles for our customers to drive as delivered from the factory. The Ford Warranty Guide discusses vehicle use and the installation of aftermarket parts and their effect on warranty coverage. See the Ford Warranty Guide for complete information.

Using your vehicle on a dedicated road course may result in degraded function and failure of major systems such as the engine, transmission and rear axle due to the overheating of these systems. If you intend to use your vehicle on a dedicated road course, we suggest that you equip your vehicle with racing-type coolers to protect these three systems.

# Introduction

In addition, if the vehicle is subjected to dedicated road course use, we recommend the following vehicle durability maintenance:

- Change your axle lubricant and friction modifier after the initial (first) hour of high-speed operation; thereafter change the axle lubricant and friction modifier every 12 hours (under these conditions).
- Change your transmission oil after each event where your vehicle is subjected to individual on-track sessions exceeding 15 minutes.
- Change your engine oil and filter after each event.

Additionally, perform a multi-point inspection on items specified in the scheduled maintenance section of this owner guide before and after dedicated road course use. See **General**

**Maintenance Information** (page 422). See the vehicle service manual for removal and installation procedures. Replace with Genuine Ford and Motorcraft™ service parts as needed.

These actions may not necessarily protect your powertrain from damage in dedicated road course use. Subjecting your vehicle to dedicated road course use even with these proposed precautions may render repairs non-reimbursable under the warranty.

## Special Instructions

For your added safety, your vehicle is fitted with sophisticated electronic controls.



**WARNING:** You risk death or serious injury to yourself and others if you do not follow the instruction highlighted by the warning symbol. Failure to follow the specific warnings and instructions could result in personal injury.



**WARNING:** Never place front seat mounted rear-facing child or infant seats in front of an active passenger airbag.

## On Board Diagnostics Data Link Connector



**WARNING:** Do not connect wireless plug-in devices to the data link connector. Unauthorized third parties could gain access to vehicle data and impair the performance of safety related systems. Only allow repair facilities that follow our service and repair instructions to connect their equipment to the data link connector.

Your vehicle has an OBD Data Link Connector (DLC) that is used in conjunction with a diagnostic scan tool for vehicle diagnostics, repairs and reprogramming services. Installing an aftermarket device that uses the DLC during normal driving for purposes such as remote insurance company monitoring, transmission of vehicle data to other devices or entities, or altering the performance of the vehicle, may cause interference with or even damage to vehicle systems. We do not recommend or endorse the use of aftermarket plug-in devices unless approved by Ford. The vehicle Warranty will not cover damage caused by an aftermarket plug-in device.



# Introduction

## MOBILE COMMUNICATIONS EQUIPMENT



**WARNING:** Driving while distracted can result in loss of vehicle control, crash and injury. We strongly recommend that you use extreme caution when using any device that may take your focus off the road. Your primary responsibility is the safe operation of your vehicle. We recommend against the use of any hand-held device while driving and encourage the use of voice-operated systems when possible. Make sure you are aware of all applicable local laws that may affect the use of electronic devices while driving.

market unique supplement, if provided, you can properly identify those features, recommendations and specifications that are unique to your vehicle. This Owner's Manual is written primarily for the U.S. and Canadian Markets. Features or equipment listed as standard may be different on units built for export. **Refer to this Owner's Manual for all other required information and warnings.**

Using mobile communications equipment is becoming increasingly important in the conduct of business and personal affairs. However, you must not compromise your own or others' safety when using such equipment. Mobile communications can enhance personal safety and security when appropriately used, particularly in emergency situations. Safety must be paramount when using mobile communications equipment to avoid negating these benefits. Mobile communication equipment includes, but is not limited to, cellular phones, pagers, portable email devices, text messaging devices and portable two-way radios.

## EXPORT UNIQUE OPTIONS

For your particular global region, your vehicle may be equipped with features and options that are different from the features and options that are described in this Owner's Manual. A market unique supplement may be supplied that complements this book. By referring to the

# Environment

---

## **PROTECTING THE ENVIRONMENT**

You should play your part in protecting the environment. Correct vehicle usage and the authorized disposal of waste, cleaning and lubrication materials are significant steps toward this aim.

**For details about Ford Motor Company's sustainability progress and initiatives visit:**

<b>Web Address</b>
<a href="http://www.sustainability.ford.com">www.sustainability.ford.com</a>

# At a Glance

## INSTRUMENT PANEL OVERVIEW

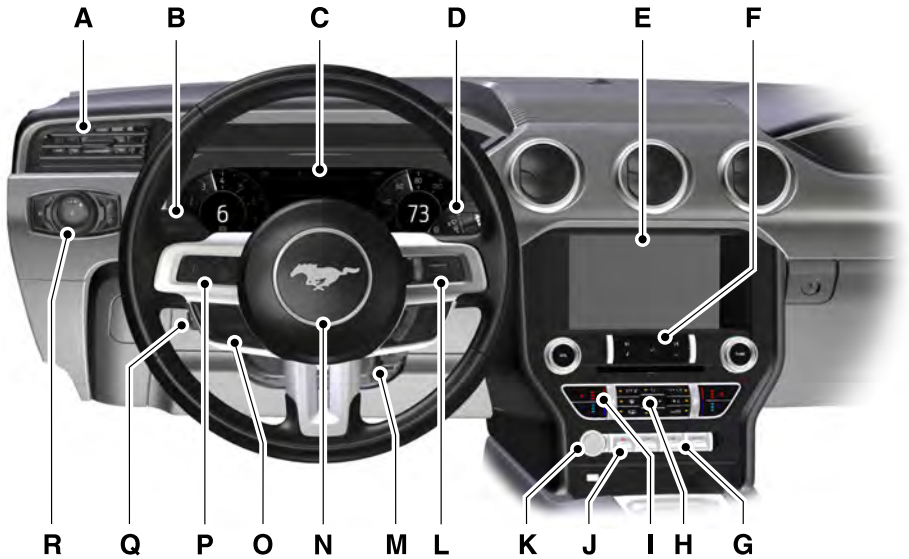

E250044

- A Air vents.
- B Direction indicators. See **Direction Indicators** (page 75).
- C Instrument cluster. See **Instrument Cluster** (page 81).
- D Wiper lever. See **Wipers and Washers** (page 69).
- E Information and entertainment display. See **General Information** (page 341).
- F Audio unit. See **Audio System** (page 313).
- G Drive control switches. See **Drive Control** (page 187).
- H Climate controls. See **Climate Control** (page 109).
- I Climate controlled seats. See **Climate Controlled Seats** (page 122).
- J Hazard flasher switch. See **Hazard Flashers** (page 208).
- K Keyless start button. See **Keyless Starting** (page 130).
- L Information display controls. See **Information Display Control** (page 68).
- M Steering wheel adjustment. See **Adjusting the Steering Wheel** (page 66).

## At a Glance

---

- N Horn.
- O Cruise control switches. See **Cruise Control** (page 166).
- P Audio control. See **Audio Control** (page 66).
- Q Luggage compartment release button. See **Locking and Unlocking** (page 58).
- R Lighting control. See **Lighting** (page 71).

# Child Safety

## GENERAL INFORMATION

See the following sections for directions on how to properly use safety restraints for children.



**WARNING:** Always make sure your child is secured properly in a device that is appropriate for their height, age and weight. Child safety restraints must be bought separately from your vehicle. Failure to follow these instructions and guidelines may result in an increased risk of serious injury or death to your child.



**WARNING:** All children are shaped differently. The National Highway Traffic Safety Administration and other safety organizations, base their recommendations for child restraints on probable child height, age and weight thresholds, or on the minimum requirements of the law. We recommend that you check with a NHTSA Certified Child Passenger Safety Technician

(CPST) to make sure that you properly install the child restraint in your vehicle and that you consult your pediatrician to make sure you have a child restraint appropriate for your child. To locate a child restraint fitting station and CPST, contact NHTSA toll free at 1-888-327-4236 or go to [www.nhtsa.dot.gov](http://www.nhtsa.dot.gov). In Canada, contact Transport Canada toll free at 1-800-333-0371 or go to [www.tc.gc.ca](http://www.tc.gc.ca) to find a Child Car Seat Clinic in your area. Failure to properly restrain children in child restraints made especially for their height, age and weight, may result in an increased risk of serious injury or death to your child.



**WARNING:** On hot days, the temperature inside the vehicle can rise very quickly. Exposure of people or animals to these high temperatures for even a short time can cause death or serious heat related injuries, including brain damage. Small children are particularly at risk.

# Child Safety

## Recommendations for Safety Restraints for Children

Child	Child Size, Height, Weight, or Age	Recommended Restraint Type
Infants or toddlers	Children weighing 40 lb (18 kg) or less (generally age four or younger).	Use a child restraint (sometimes called an infant carrier, convertible seat, or toddler seat).
Small children	Children who have outgrown or no longer properly fit in a child restraint (generally children who are less than 57 in (1.45 m) tall, are greater than age four and less than age 12, and between 40 lb (18 kg) and 80 lb (36 kg) and upward to 100 lb (45 kg) if recommended by your child restraint manufacturer).	Use a belt-positioning booster seat.
Larger children	Children who have outgrown or no longer properly fit in a belt-positioning booster seat (generally children who are at least 57 in (1.45 m) tall or greater than 80 lb (36 kg) or 100 lb (45 kg) if recommended by child restraint manufacturer).	Use a vehicle seatbelt having the lap belt snug and low across the hips, shoulder belt centered across the shoulder and chest, and seat backrest upright.

- You are required by law to properly use child restraints for infants and toddlers in the United States and Canada.
- Many states and provinces require that small children use approved booster seats until they reach age eight, a height of 57 in (1.45 m) tall, or 80 lb (36 kg). Check your local and state or provincial laws for specific requirements about the safety of children in your vehicle.
- When possible, always properly restrain children 12 years of age and under in a rear seating position of your vehicle. Accident statistics suggest that children are safer when properly restrained in the rear seating positions than in a front seating position. See **Front Passenger Sensing System** (page 40).
- When installing a rear facing child restraint, adjust the vehicle seats to avoid interference between the child restraint and the vehicle seat in front of the child restraint.

# Child Safety

## INSTALLING CHILD RESTRAINTS

### Child Seats



E142594

Use a child restraint (sometimes called an infant carrier, convertible seat, or toddler seat) for infants, toddlers, or children weighing 40 lb (18 kg) or less (generally age four or younger).

### Using Lap and Shoulder Belts



**WARNING:** Do not place a rearward facing child restraint in front of an active airbag. Failure to follow this instruction could result in personal injury or death.



**WARNING:** Properly secure children 12 years old and under in a rear seating position whenever possible. If you are unable to properly secure all children in a rear seating position, properly secure the largest child on the front seat. If you must use a forward facing child restraint on the front seat, move the seat as far back as possible. Failure to follow these instructions could result in personal injury or death.



**WARNING:** Depending on where you secure a child restraint, and depending on the child restraint design, you may block access to certain seatbelt buckle assemblies and LATCH lower anchors, rendering those features potentially unusable. To avoid risk of injury, make sure occupants only use seating positions where they are able to be properly restrained.

When installing a child restraint with combination lap and shoulder belts:

- Use the correct seatbelt buckle for that seating position.
- Insert the belt tongue into the proper buckle until you hear a snap and feel it latch. Make sure the tongue is securely fastened in the buckle.
- Keep the buckle release button pointing up and away from the child restraint, with the tongue between the child restraint and the release button, to prevent accidental unbuckling.
- Place the vehicle seat in the upright position before you install the child restraint.
- Put the seatbelt in the automatic locking mode. See Step 5. This vehicle does not require the use of a locking clip.

Perform the following steps when installing the child restraint with combination lap and shoulder belts:

**Note:** *Although the child restraint illustrated is a forward facing child restraint, the steps are the same for installing a rear facing child restraint.*

# Child Safety



E142528

1. Position the child restraint in a seat with a combination lap and shoulder belt.



E142529

2. Pull down on the shoulder belt and then grasp the shoulder belt and lap belt together.



E142530

3. While holding the shoulder and lap belt portions together, route the tongue through the child restraint according to the child restraint manufacturer's instructions. Make sure that you have not twisted the belt webbing.

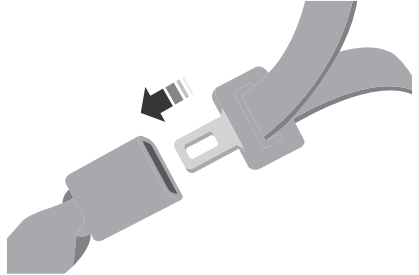

E142531

4. Insert the belt tongue into the proper buckle (the buckle closest to the direction the tongue is coming from) for that seating position until you hear a snap and feel the latch engage. Make sure the tongue is latched securely by pulling on it.



E142875

5. To put the retractor in the automatic locking mode, grasp the shoulder portion of the belt and pull downward until all of the belt is pulled out.



# Child Safety

**Note:** The automatic locking mode is available on the front passenger and rear seats. This vehicle does not require the use of a locking clip.

6. Allow the belt to retract to remove slack. The belt will click as it retracts to indicate it is in the automatic locking mode.
7. Try to pull the belt out of the retractor to make sure the retractor is in the automatic locking mode. You should not be able to pull more belt out. If the retractor does not lock, unbuckle the belt and repeat Steps 5 and 6.



E142533

8. Remove remaining slack from the belt. Force the seat down with extra weight, for example, by pressing down or kneeling on the child restraint while pulling up on the shoulder belt in order to force slack from the belt. This is necessary to remove the remaining slack that exists once you add the extra weight of the child to the child restraint. It also helps to achieve the proper snugness of the child restraint to your vehicle. Sometimes, a slight lean toward the buckle will additionally help to remove remaining slack from the belt.
9. If the child restraint has a tether strap, attach it.

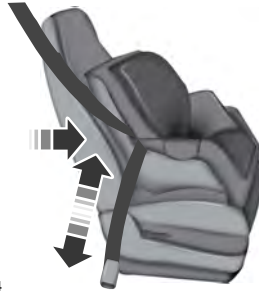

E142534

10. Before placing the child in the seat, forcibly move the seat forward and back to make sure the seat is securely held in place. To check this, grab the seat at the belt path and attempt to move it side to side and forward and back. There should be no more than 1 in (2.5 cm) of movement for proper installation.

We recommend checking with a NHTSA Certified Child Passenger Safety Technician to make certain the child restraint is properly installed. In Canada, check with Transport Canada for referral to a Child Car Seat Clinic.

## Using Lower Anchors and Tethers for Children (LATCH)



**WARNING:** Do not attach two child safety restraints to the same anchor. In a crash, one anchor may not be strong enough to hold two child safety restraint attachments and may break, causing serious injury or death.

# Child Safety



**WARNING:** Depending on where you secure a child restraint, and depending on the child restraint design, you may block access to certain seatbelt buckle assemblies and LATCH lower anchors, rendering those features potentially unusable. To avoid risk of injury, make sure occupants only use seating positions where they are able to be properly restrained.



**WARNING:** The center of the rear seat is not designed as a seating position and is not equipped with seatbelts. The LATCH anchors were not designed to be used with a child restraint in the center position and there is no tether anchor available at the center. Do not attempt to use the center as a seating position as this will increase the risk of injury or death in the event of a crash.

The LATCH system has three vehicle anchor points: two lower anchors where the seat backrest and seat cushion meet (called the seat bight) and one top tether anchor behind that seating position.

LATCH compatible child restraints have two rigid or webbing mounted attachments that connect to the two lower anchors at the LATCH equipped seating positions in your vehicle. This type of attachment method eliminates the need to use seatbelts to attach the child restraint. However, you can still use the seatbelt to attach the child restraint. For forward-facing child restraints, you must also attach the top tether strap to the proper top tether anchor, if a top tether strap has been provided with your child restraint.

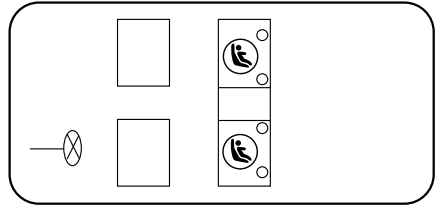

E174449

Your vehicle has LATCH lower anchors for child restraint installation at the seating positions marked with the child restraint symbol.

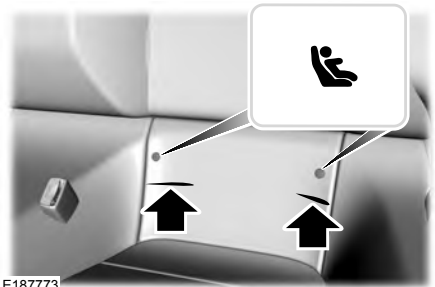

E187773

The LATCH anchors are at the rear section of the rear seat between the cushion and seat backrest below the symbols as shown. Follow the child restraint manufacturer's instructions to properly install a child restraint with LATCH attachments. Follow the instructions on attaching child restraints with tether straps.

Only attach LATCH lower attachments of the child restraint to the anchors shown.

# Child Safety

## Combining Seatbelt and LATCH Lower Anchors for Attaching Child Restraints

When used in combination, you can attach either the seatbelt or the LATCH lower anchors first, provided a proper installation is achieved. Attach the tether strap afterward, if included with the child restraint.

## Using Tether Straps



Many forward-facing child restraints include a tether strap which extends from the back of the child restraint and hooks to an anchoring point called the top tether anchor. Tether straps are available as an accessory for many older child restraints.

Contact the manufacturer of your child restraint for information about ordering a tether strap, or to obtain a longer tether strap if the tether strap on your child restraint does not reach the appropriate top tether anchor in your vehicle.

Once you install the child restraint using either the seatbelt, the lower anchors of the LATCH system, or both, you can attach the top tether strap.

The tether strap anchors in your vehicle are in the following positions (shown from top view):

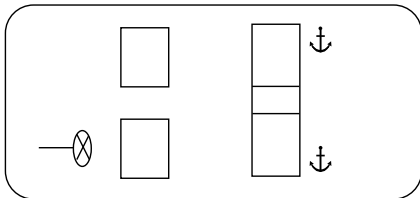

E174399

Perform the following steps to install a child restraint with tether anchors:

### For coupe:

**Note:** If you install a child restraint with rigid LATCH attachments, do not tighten the tether strap enough to lift the child restraint off your vehicle seat cushion when the child is seated in it. Keep the tether strap just snug without lifting the front of the child restraint. Keeping the child restraint just touching your vehicle seat gives the best protection in a severe crash.

1. Route the tether strap over the top of the seat backrest.



E174400

2. Locate the correct anchor for the selected seating position.
3. Open the tether anchor cover.



E174401

4. Clip the tether strap to the anchor as shown.

# Child Safety

5. Tighten the child restraint tether strap according to the manufacturer's instructions. If your child restraint system has a tether strap, and the child restraint manufacturer recommends its use, we also recommend its use.

If you have not properly anchored the child restraint, the risk of a child being injured in a crash greatly increases.

## For vehicles with a convertible top:

**Note:** For easier access, attach the tether with the convertible top up.

1. Route the child restraint tether strap over the top of the seat backrest.

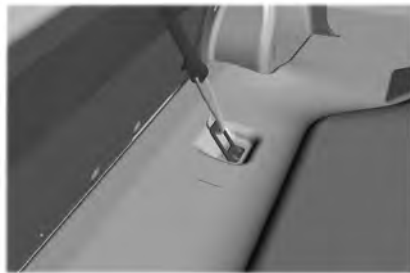
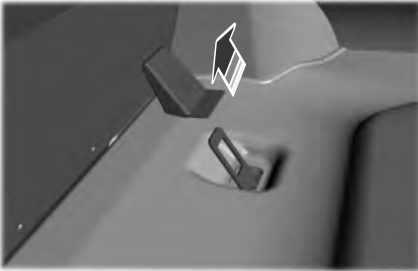

E185416

2. Access the tether anchors behind the seat backrest.
3. Remove the tether anchor cap.
4. Clip the tether strap to the anchor.

5. Tighten the child restraint tether strap according to the manufacturer's instructions.

If you have not properly anchored the child restraint, the risk of a child being injured in a crash greatly increases.

If your child restraint system has a tether strap, and the child restraint manufacturer recommends its use, we also recommend its use.

## BOOSTER SEATS

 **WARNING:** Do not put the shoulder section of the seatbelt or allow the child to put the shoulder section of the seatbelt under their arm or behind their back. Failure to follow this instruction could reduce the effectiveness of the seatbelt and increase the risk of injury or death in a crash.

Use a belt-positioning booster seat for children who have outgrown or no longer properly fit in a child safety restraint (generally children who are less than 57 in (1.45 m) tall, are greater than age 4 and less than age 12, and between 40 lb (18 kg) and 80 lb (36 kg) and upward to 100 lb (45 kg) if recommended by your child restraint manufacturer). Many state and provincial laws require that children use approved booster seats until they reach age eight, a height of 57 in (1.45 m) tall, or 80 lb (36 kg).

Booster seats should be used until you can answer YES to ALL of these questions when seated without a booster seat:

# Child Safety

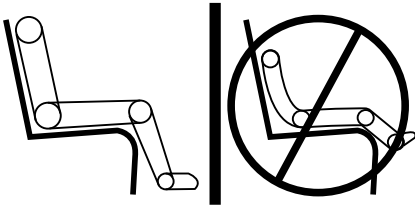

E142595

- Can the child sit all the way back against their vehicle seat backrest with knees bent comfortably at the edge of the seat cushion?
- Can the child sit without slouching?
- Does the lap belt rest low across the hips?
- Is the shoulder belt centered on the shoulder and chest?
- Can the child stay seated like this for the whole trip?

Always use booster seats in conjunction with your vehicle lap and shoulder belt.

## Types of Booster Seats



E68924

- Backless booster seats

If your backless booster seat has a removable shield, remove the shield. If a vehicle seating position has a low seat backrest or no head restraint, a backless booster seat may place your child's head (as measured at the tops of the ears) above the top of the seat. In this case, move the backless booster to another seating position with a higher seat backrest or head restraint and lap and shoulder belts, or consider using a high back booster seat.



E70710

- High back booster seats

If, with a backless booster seat, you cannot find a seating position that adequately supports your child's head, a high back booster seat would be a better choice.

Children and booster seats vary in size and shape. Choose a booster that keeps the lap belt low and snug across the hips, never up across the stomach, and lets you adjust the shoulder belt to cross the chest and rest snugly near the center of the shoulder. The following drawings compare the ideal fit (center) to a shoulder belt uncomfortably close to the neck and a shoulder belt that could slip off the shoulder. The drawings also show how the lap belt should be low and snug across the child's hips.

# Child Safety



E142596



E142597

If the booster seat slides on the vehicle seat upon which it is being used, placing a rubberized mesh sold as shelf or carpet liner under the booster seat may improve this condition. Do not introduce any item thicker than this under the booster seat. Check with the booster seat manufacturer's instructions.

## CHILD RESTRAINT POSITIONING



**WARNING:** Do not place a rearward facing child restraint in front of an active airbag. Failure to follow this instruction could result in personal injury or death.



**WARNING:** Properly secure children 12 years old and under in a rear seating position whenever possible. If you are unable to properly secure all children in a rear seating position, properly secure the largest child on the front seat. If you must use a forward facing child restraint on the front seat, move the seat as far back as possible. Failure to follow these instructions could result in personal injury or death.



**WARNING:** Always carefully follow the instructions and warnings provided by the manufacturer of any child restraint to determine if the restraint device is appropriate for your child's size, height, weight, or age. Follow

# Child Safety

the child restraint manufacturer's instructions and warnings provided for installation and use in conjunction with the instructions and warnings provided by your vehicle manufacturer. A safety seat that is improperly installed or utilized, is inappropriate for your child's height, age, or weight or does not properly fit the child may increase the risk of serious injury or death.



**WARNING:** Do not allow a passenger to hold a child on their lap when your vehicle is moving. Failure to follow this instruction could result in personal injury or death in the event of a sudden stop or crash.



**WARNING:** Do not use pillows, books or towels to boost your child's height. Failure to follow this instruction could result in personal injury or death.



**WARNING:** Properly secure child restraints or booster seats when they are not in use. They could become projectiles in a sudden stop or crash. Failure to follow this instruction could result in personal injury or death.



**WARNING:** Do not put the shoulder section of the seatbelt or allow the child to put the shoulder section of the seatbelt under their arm or behind their back. Failure to follow this instruction could reduce the effectiveness of the seatbelt and increase the risk of injury or death in a crash.



**WARNING:** Do not leave children or pets unattended in your vehicle. Failure to follow this instruction could result in personal injury or death.

# Child Safety

## Recommendations for Attaching Child Safety Restraints for Children

Restraint Type	Combined Weight of Child and Child Restraint	Use Any Attachment Method as Indicated Below by X				
		LATCH (Lower Anchors and Top Tether Anchor)	LATCH (Lower Anchors Only)	Seatbelt and Top Tether Anchor	Seatbelt and LATCH (Lower Anchors and Top Tether Anchor)	Seatbelt Only
Rear facing child restraint	Up to 65 lb (29.5 kg)		X			X
Rear facing child restraint	Over 65 lb (29.5 kg)					X
Forward facing child restraint	Up to 65 lb (29.5 kg)	X		X	X	
Forward facing child restraint	Over 65 lb (29.5 kg)			X	X	

**Note:** *The child restraint must rest tightly against the vehicle seat upon which it is installed. It may be necessary to lift or remove the head restraint. See **Seats** (page 117).*



# Seatbelts

## PRINCIPLE OF OPERATION



**WARNING:** Always drive and ride with your seatback upright and the lap belt snug and low across the hips.



**WARNING:** Children must always be properly restrained.



**WARNING:** Never let a passenger hold a child on his or her lap while the vehicle is moving. The passenger cannot protect the child from injury in a crash.



**WARNING:** All occupants of your vehicle, including the driver, should always properly wear their seatbelts, even when an airbag supplemental restraint system is provided. Failure to properly wear your seatbelt could seriously increase the risk of injury or death.



**WARNING:** It is extremely dangerous to ride in a cargo area, inside or outside of a vehicle. In a crash, people riding in these areas are more likely to be seriously injured or killed. Do not allow people to ride in any area of your vehicle that is not equipped with seats and seatbelts. Make sure everyone in your vehicle is in a seat and properly using a seatbelt. Failure to follow this warning could result in serious personal injury or death.



**WARNING:** In a rollover crash, an unbelted person is significantly more likely to die than a person wearing a seatbelt.



**WARNING:** Each seating position in your vehicle has a specific seatbelt assembly made up of one buckle and one tongue designed to be used as a pair. Use the shoulder belt on the outside shoulder only. Never wear the shoulder belt under the arm. Never use a single seatbelt for more than one person.



**WARNING:** Airbags can kill or injure a child in a child restraint. Properly restrain children 12 and under in the rear seat whenever possible.



**WARNING:** Seatbelts and seats may be hot in a vehicle that is in the sunshine. The hot seatbelts or seats may burn a small child. Check seat covers and buckles before you place a child anywhere near them.



**WARNING:** The center of the rear seat is not designed as a seating position and is not equipped with seatbelts. The LATCH anchors were not designed to be used with a child restraint in the center position and there is no tether anchor available at the center. Do not attempt to use the center as a seating position as this will increase the risk of injury or death in the event of a crash.

All seating positions in your vehicle have lap and shoulder seatbelts. All occupants of the vehicle should always properly wear their seatbelts, even when an airbag supplemental restraint system is provided.

The seatbelt system consists of:

- Lap and shoulder seatbelts.
- Seatbelt pretensioner at the front outboard seating positions.
- Belt tension sensor at the front outboard passenger seating position.

# Seatbelts



· Seatbelt warning light and chime.



· Crash sensors and monitoring system with readiness indicator.

The seatbelt pretensioners at the front seating positions are designed to tighten the seatbelts when activated. In frontal and near-frontal crashes, the seatbelt pretensioners may be activated alone or, if the crash is of sufficient severity, together with the front airbags. The pretensioners may also activate in side impacts and rollovers.

## FASTENING THE SEATBELTS

The front outboard and rear safety restraints in the vehicle are combination lap and shoulder belts.

A web guide is included on the outboard side of the front seats. Depending on occupant size and seating position, you may need to route the belt through the guide for a proper fit. If the seatbelt does not route across the middle of the shoulder, route the belt through the web guide.

### Convertible



E175860

### Coupe

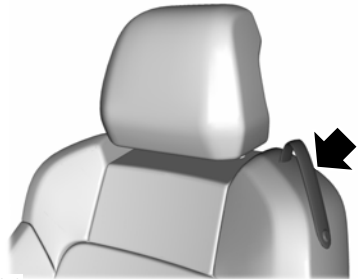

E175859

### Recaro

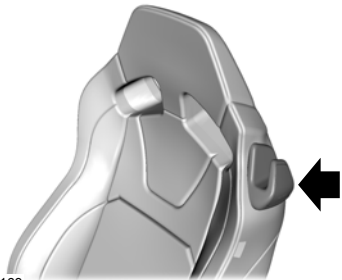

E175163

### Recaro SVT

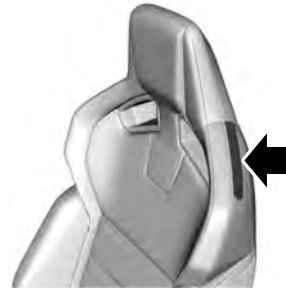

E216814

# Seatbelts

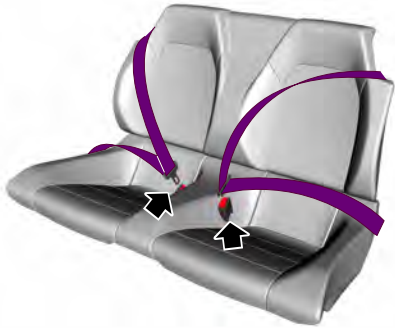

E204921

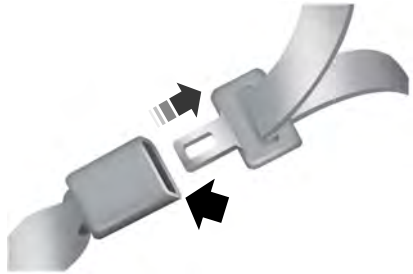

E142588

2. To unfasten, press the release button and remove the tongue from the buckle.

## Using Seatbelts During Pregnancy



**WARNING:** Always ride and drive with your seatback upright and properly fasten your seatbelt. Fit the lap portion of the seatbelt snugly and low across the hips. Position the shoulder portion of the seatbelt across your chest. Pregnant women must follow this practice. See the following figure.



E142587

1. Insert the belt tongue into the proper buckle (the buckle closest to the direction the tongue is coming from) until you hear a snap and feel it latch. Make sure you securely fasten the tongue in the buckle.

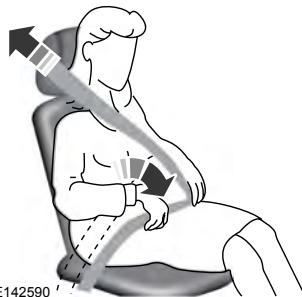

E142590

# Seatbelts

Pregnant women should always wear their seatbelt. Position the lap belt portion of a combination lap and shoulder belt low across the hips below the belly and worn as tight as comfort allows. Position the shoulder belt to cross the middle of the shoulder and the center of the chest.

## Seatbelt Locking Modes



**WARNING:** If your vehicle is involved in a crash, have the seatbelts and associated components inspected as soon as possible. Failure to follow this instruction could result in personal injury or death.

All safety restraints in the vehicle are combination lap and shoulder belts and have vehicle sensitive locking mode. In addition, the front outboard passenger and rear seat seatbelts have the automatic locking mode.

### Vehicle Sensitive Mode

This is the normal retractor mode, which allows free shoulder belt length adjustment to your movements and locking in response to vehicle movement. For example, if the driver brakes suddenly or turns a corner sharply, or the vehicle receives an impact of about 5 mph (8 km/h) or more, the combination seatbelts lock to help reduce forward movement of the driver and passengers.

In addition, the retractor is designed to lock if you pull the webbing out too quickly. If the seatbelt retractor locks, slowly lower the height adjuster to allow the seatbelt to retract. If the retractor does not unlock, pull the seatbelt out slowly then feed a

small length of webbing back toward the stowed position. For rear seatbelts, recline the rear seat backrest or push the seat backrest cushion away from the seatbelt. Feed a small length of webbing back toward the stowed position.

### Automatic Locking Mode

In this mode, the shoulder belt automatically pre-locks. The belt still retracts to remove any slack in the shoulder belt. The automatic locking mode is not available on the driver seatbelt.

### When to Use the Automatic Locking Mode

Use this mode any time a child safety seat, except a booster, is installed in passenger front or rear seating positions. Properly restrain children 12 years old and under in a rear seating position whenever possible. See **Child Safety** (page 18).

### How to Disengage the Automatic Locking Mode

Unbuckle the combination lap and shoulder belt and allow it to retract completely to disengage the automatic locking mode and activate the vehicle sensitive (emergency) locking mode.

## SEATBELT WARNING LAMP AND INDICATOR CHIME



This lamp illuminates and an indicator chime will sound if the driver seatbelt has not been fastened when the vehicle's ignition is turned on.

# Seatbelts

## Conditions of operation

If	Then
The driver seatbelt is not buckled before the ignition switch is turned to the on position...	The seatbelt warning lamp illuminates and the indicator chime sounds for a few seconds.
The driver seatbelt is buckled while the warning lamp is illuminated and the indicator chime is sounding...	The seatbelt warning lamp and indicator chime turn off.
The driver seatbelt is buckled before the ignition switch is turned to the on position...	The seatbelt warning lamp and indicator chime remain off.

## SEATBELT REMINDER

### Belt-Minder™

This feature supplements the seatbelt warning function by providing additional reminders that intermittently sound a tone and illuminate the seatbelt warning light when you are in the driver seat or you have a front seat passenger and a seatbelt is unbuckled.

The system uses information from the front passenger sensing system to determine if a front seat passenger is present and therefore potentially in need of a warning. To avoid activating the Belt-Minder feature for objects you place in the front passenger seat, only the front seat passengers receive warnings as determined by the front passenger sensing system.

If the Belt-Minder warnings expire (warnings for about five minutes) for one passenger (driver or front passenger), the other passenger can still cause the Belt-Minder feature to turn on.

# Seatbelts

If...	Then...
You and the front seat passenger buckle your seatbelts before you switch the ignition on or less than 1-2 minutes elapse after you switch the ignition on...	The Belt-Minder feature will not activate.
You or the front seat passenger do not buckle your seatbelts before your vehicle reaches at least 6 mph (9.7 km/h) and 1-2 minutes elapse after you switch the ignition on...	The Belt-Minder feature activates, the seatbelt warning light illuminates and a warning tone sounds for 6 seconds every 25 seconds, repeating for about 5 minutes or until you and the front seat passenger buckle your seatbelts.
The seatbelt for the driver or front passenger is unbuckled for about 1 minute while the vehicle is traveling at least 6 mph (9.7 km/h) and more than 1-2 minutes elapse after you switch the ignition on...	The Belt-Minder feature activates, the seatbelt warning light illuminates and a warning tone sounds for 6 seconds every 25 seconds, repeating for about 5 minutes or until you and the front seat passenger buckle your seatbelts.

## Deactivating and Activating the Belt-Minder Feature



**WARNING:** While the system allows you to deactivate it, this system is designed to improve your chances of being safely belted and surviving an accident. We recommend you leave the system activated for yourself and others who may use the vehicle.

**Note:** The driver and front passenger warnings switch on and off independently. When you perform this procedure for one seating position, do not buckle the other position as this will terminate the process.

**Note:** If you are using MyKey, you cannot disable the Belt-Minder. Also, if you have previously disabled the Belt-Minder, it will be re-enabled during the use of MyKey.

Read Steps 1 - 4 thoroughly before proceeding with the programming procedure.

Before following the procedure, make sure that:

- You set the parking brake.
  - You put the transmission in park (P) (automatic transmission) or neutral (N) (manual transmission).
  - You switch the ignition off.
  - You unbuckle the driver and front passenger seatbelts.
1. Switch the ignition on. Do not start the vehicle.
  2. Wait until the seatbelt warning light turns off (about one minute). After Step 2, wait an additional 5 seconds before proceeding with Step 3. Once you start Step 3, you must complete the procedure within 30 seconds.
  3. For the seating position you are switching off, buckle then unbuckle the seatbelt three times at a moderate speed, ending in the unbuckled state. After Step 3, the seatbelt warning light turns on.

# Seatbelts

4. While the seatbelt warning light is on, buckle and then unbuckle the seatbelt. After Step 4, the seatbelt warning light flashes for confirmation.
  - This will switch the feature off for that seating position if it is currently on.
  - This will switch the feature on for that seating position if it is currently off.

## CHILD RESTRAINT AND SEATBELT MAINTENANCE

Inspect the vehicle seatbelts and child safety seat systems periodically to make sure they work properly and are not damaged. Inspect the vehicle and child restraint seatbelts to make sure there are no nicks, tears or cuts. Replace if necessary. All vehicle seatbelt assemblies, including retractors, buckles, front seatbelt buckle assemblies, buckle support assemblies (slide bar-if equipped), shoulder belt height adjusters (if equipped), shoulder belt guide on seat backrest (if equipped), child safety seat LATCH and tether anchors, and attaching hardware, should be inspected after a crash. Read the child restraint manufacturer's instructions for additional inspection and maintenance information specific to the child restraint.

We recommend that all seatbelt assemblies in use in vehicles involved in a crash be replaced. However, if the crash was minor and an authorized dealer finds that the belts do not show damage and continue to operate properly, they do not need to be replaced. Seatbelt assemblies not in use during a crash should also be inspected and replaced if either damage or improper operation is noted.

Properly care for seatbelts. See **Vehicle Care** (page 253).

## SEATBELT EXTENSION



**WARNING:** Persons who fit into the vehicle's seatbelt should not use an extension. Unnecessary use could result in serious personal injury in the event of a crash.



**WARNING:** Only use extensions provided free of charge by Ford Motor Company dealers. The dealer will provide an extension designed specifically for this vehicle, model year and seating position. The use of an extension intended for another vehicle, model year or seating position may not offer you the full protection of your vehicle's seatbelt restraint system.



**WARNING:** Never use seatbelt extensions to install child restraints.



**WARNING:** Do not use a seatbelt extension with an inflatable seatbelt.



**WARNING:** Do not use extensions to change the fit of the belt across the torso, over the lap or to make the seatbelt buckle easier to reach.

If, because of body size or driving position, it is not possible to properly fasten the seatbelt over your lap and shoulder, an extension that is compatible with the seatbelts is available free of charge from Ford Motor Company dealers. Only Ford seatbelt extensions made by the original equipment seatbelts manufacturer should be used with Ford seatbelts. Ask your authorized dealer if your extension is compatible with your Ford vehicle restraint system.

# Personal Safety System™

---

The Personal Safety System provides an improved overall level of frontal crash protection to front seat occupants and is designed to help further reduce the risk of airbag-related injuries. The system is able to analyze different occupant conditions and crash severity before activating the appropriate safety devices to help better protect a range of occupants in a variety of frontal crash situations.

The Vehicle Personal Safety System consists of:

- Driver and passenger dual-stage airbag supplemental restraints.
- Front seat outermost seatbelts with pretensioners, energy management retractors and seatbelt usage sensors.
- Driver seat position sensor.
- Passenger seat position sensor.
- Front passenger sensing system.
- Passenger airbag off and on indicators.
- Front crash severity sensors.
- Restraints control module with impact and safing sensors.
- Restraint system warning lamp and tone.
- The electrical wiring for the airbags, crash sensors, seatbelt pretensioners, front seatbelt usage sensors, driver seat position sensor, front passenger sensing system and indicators.

## **How Does the Personal Safety System Work?**

The Personal Safety System can adapt the deployment strategy of the safety devices according to crash severity and occupant conditions. A collection of crash and occupant sensors provides information to the restraints control module. During a crash, the restraints control module may deploy the seatbelt pretensioners, one or both stages of the dual-stage airbags based on crash severity and occupant conditions.





# Supplementary Restraints System

## PRINCIPLE OF OPERATION

 **WARNING:** Airbags do not inflate slowly or gently, and the risk of injury from a deploying airbag is the greatest close to the trim covering the airbag module.

 **WARNING:** All occupants of your vehicle, including the driver, should always properly wear their seatbelts, even when an airbag supplemental restraint system is provided. Failure to properly wear your seatbelt could seriously increase the risk of injury or death.

 **WARNING:** Even with advanced restraints systems, properly restrain children 12 and under in a rear seating position. Failure to follow this could seriously increase the risk of injury or death.

 **WARNING:** Do not place your arms on the airbag cover or through the steering wheel. Failure to follow this instruction could result in personal injury.

 **WARNING:** Keep the areas in front of the airbags free from obstruction. Do not affix anything to or over the airbag covers. Objects could become projectiles during airbag deployment or in a sudden stop. Failure to follow this instruction could result in personal injury or death.

 **WARNING:** Airbags can kill or injure a child in a child restraint. Never place a rear-facing child restraint in front of an active airbag. If you must use a forward-facing child restraint in the front seat, move the seat upon which the child restraint is installed all the way back.

 **WARNING:** Do not attempt to service, repair, or modify the supplementary restraint system or associated components. Failure to follow this instruction could result in personal injury or death.

 **WARNING:** Several airbag system components get hot after inflation. To reduce the risk of injury, do not touch them after inflation.

 **WARNING:** If a supplementary restraint system component has deployed, it will not function again. Have the system and associated components inspected as soon as possible. Failure to follow this instruction could result in personal injury or death.

The airbags are a supplemental restraint system and are designed to work with the seatbelts to help protect the driver and right front passenger from certain upper body injuries. Airbags do not inflate slowly; there is a risk of injury from a deploying airbag.

**Note:** *You will hear a loud bang and see a cloud of harmless powdery residue if an airbag deploys. This is normal.*

The airbags inflate and deflate rapidly upon activation. After airbag deployment, it is normal to notice a smoke-like, powdery residue or smell the burnt propellant. This may consist of cornstarch, talcum powder (to lubricate the bag) or sodium compounds (for example, baking soda) that result from the combustion process that inflates the airbag. Small amounts of sodium hydroxide may be present which may irritate the skin and eyes, but none of the residue is toxic.

# Supplementary Restraints System

While the system is designed to help reduce serious injuries, contact with a deploying airbag may also cause abrasions or swelling. Temporary hearing loss is also a possibility as a result of the noise associated with a deploying airbag. Because airbags must inflate rapidly and with considerable force, there is the risk of death or serious injuries such as fractures, facial and eye injuries or internal injuries, particularly to occupants who are not properly restrained or are otherwise out of position at the time of airbag deployment. Thus, it is extremely important that occupants be properly restrained as far away from the airbag module as possible while maintaining vehicle control.

Routine maintenance of the airbags is not required.

## DRIVER AND PASSENGER AIRBAGS



**WARNING:** Do not place your arms on the airbag cover or through the steering wheel. Failure to follow this instruction could result in personal injury.



**WARNING:** Keep the areas in front of the airbags free from obstruction. Do not affix anything to or over the airbag covers. Objects could become projectiles during airbag deployment or in a sudden stop. Failure to follow this instruction could result in personal injury or death.



**WARNING:** Airbags can kill or injure a child in a child restraint. Never place a rear-facing child restraint in front of an active airbag. If you must use a forward-facing child restraint in the front seat, move the seat upon which the child restraint is installed all the way back.

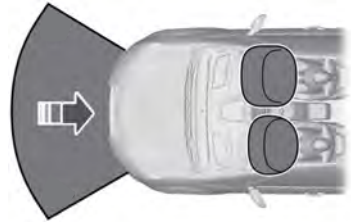

E151127

The driver and front passenger airbags will deploy during significant frontal and near frontal crashes.

The driver and passenger front airbag system consists of:

- Driver and passenger airbag modules.
- Front passenger sensing system.



• Crash sensors and monitoring system with readiness indicator. See **Crash Sensors and Airbag Indicator** (page 46).

## Proper Driver and Front Passenger Seating Adjustment



**WARNING:** National Highway Traffic Safety Administration (NHTSA) recommends a minimum distance of at least 10 in (25 cm) between an occupant's chest and the driver airbag module.

To properly position yourself away from the airbag:

- Move your seat to the rear as far as you can while still reaching the pedals comfortably.
- Recline the seat slightly (one or two degrees) from the upright position.

# Supplementary Restraints System

After all occupants have adjusted their seats and put on seatbelts, it is very important that they continue to sit properly. A properly seated occupant sits upright, leaning against the seatback, and centered on the seat cushion, with their feet comfortably extended on the floor. Sitting improperly can increase the chance of injury in a crash event. For example, if an occupant slouches, lies down, turns sideways, sits forward, leans forward or sideways, or puts one or both feet up, the chance of injury during a crash is greatly increased.

## Children and Airbags

**WARNING:** Airbags can kill or injure a child in a child restraint. Never place a rear-facing child restraint in front of an active airbag. If you must use a forward-facing child restraint in the front seat, move the seat upon which the child restraint is installed all the way back.



E142846

Children must always be properly restrained. Accident statistics suggest that children are safer when properly restrained in the rear seating positions than in the front seating position. Failure to follow these instructions may increase the risk of injury in a crash.

## FRONT PASSENGER SENSING SYSTEM

**WARNING:** Even with advanced restraints systems, properly restrain children 12 and under in a rear seating position. Failure to follow this could seriously increase the risk of injury or death.

**WARNING:** Sitting improperly, out of position or with the seatback reclined too far can take weight off the seat cushion and affect the decision of the passenger sensing system, resulting in serious injury or death in the event of a crash. Always sit upright against your seat back, with your feet on the floor.

**WARNING:** Do not stow objects in the seatback map pocket or hang objects off a seatback if a child is in the front passenger seat. Do not place objects under the front passenger seat or between the seat and the center console. Check the passenger airbag indicator lamp for proper airbag status. Failure to follow these instructions may interfere with the front passenger seat sensing system and increase the risk of serious injury.

**WARNING:** Any alteration or modification to the front passenger seat may affect the performance of the front passenger sensing system. This could seriously increase the risk of injury or death.

This system works with sensors that are part of the front passenger seat and seatbelt to detect the presence of a properly-seated occupant and determine if the front passenger frontal airbag should be enabled (may inflate) or not.

# Supplementary Restraints System



E253573

The front passenger sensing system uses a passenger airbag status indicator that illuminates indicating that the front passenger frontal airbag is either on (enabled) or off (disabled).

The indicator lamp is on the overhead console.

**Note:** *The passenger airbag status indicator lamps illuminate for a short period of time when you first switch the ignition on to confirm it is functional.*

The front passenger sensing system is designed to disable (will not inflate) the front passenger frontal airbag when the front passenger seat is unoccupied, or a rear facing infant seat, a forward-facing child restraint, or a booster seat is detected. Even with this technology, parents are **strongly** encouraged to always properly restrain children in the rear seat.

- When the front passenger sensing system disables (will not inflate) the front passenger frontal airbag, the passenger airbag status indicator illuminates the off lamp and stays lit to remind you that the front passenger frontal airbag is disabled.
- If you install the child restraint and the passenger airbag status indicator illuminates the on lamp, switch the vehicle off, remove the child restraint from the vehicle and reinstall the restraint following the child restraint manufacturer's instructions.

The front passenger sensing system is designed to enable (may inflate) the front passenger frontal airbag anytime the system senses that a person of adult size is sitting properly in the front passenger seat.

- When the front passenger sensing system enables the front passenger frontal airbag (may inflate), the passenger airbag status indicator illuminates the on lamp and remains illuminated.

If a person of adult size is sitting in the front passenger seat, but the airbag off indicator lamp is lit, it is possible that the person is not sitting properly in the seat. If this happens:

- Switch the vehicle off and ask the person to place the seat backrest in an upright position.
- Have the person sit upright in the seat, centered on the seat cushion, with the person's legs comfortably extended.
- Restart the vehicle and have the person remain in this position for about two minutes. This allows the system to detect that person and enables (may inflate) the passenger frontal airbag.
- If the indicator off lamp remains lit even after this, advise the person to ride in the rear seat.

# Supplementary Restraints System

Occupant	Passenger Airbag Status Indicator	Passenger Airbag
Empty	OFF: Lit	Disabled
	ON: Unlit	
Child	OFF: Lit	Disabled
	ON: Unlit	
Adult	OFF: Unlit	Enabled
	ON: Lit	

After all occupants have adjusted their seats and put on seatbelts, it is very important that they continue to sit properly. A properly seated occupant sits upright, leaning against the seat backrest, and centered on the seat cushion, with their feet comfortably extended on the floor. Sitting improperly can increase the chance of injury in a crash event. For example, if an occupant slouches, lies down, turns sideways, sits forward, leans forward or sideways, or puts one or both feet up, the chance of injury during a crash greatly increases.

If you think that the status of the passenger airbag off indicator lamp is incorrect, check for the following:

- Objects lodged underneath the seat.
- Objects between the seat cushion and the center console.
- Objects hanging off the seat backrest.
- Objects stowed in the seat backrest map pocket.
- Objects placed on the occupant's lap.
- Cargo interference with the seat.
- Other passengers pushing or pulling on the seat.
- Rear passenger feet and knees resting or pushing on the seat.

The conditions listed above may cause the weight of a properly seated occupant to be incorrectly interpreted by the front passenger sensing system. The person in the front passenger seat may appear heavier or lighter due to the conditions described in the list above.



Make sure the front passenger sensing system is operating properly. See **Crash Sensors and Airbag Indicator** (page 46).

If the airbag readiness light is lit, do the following:

The driver and adult passengers should check for objects lodged underneath the front passenger seat, or cargo interfering with the seat.

If there are lodged objects, or cargo is interfering with the seat, take the following steps to remove the obstruction:

- Pull the vehicle over.
- Switch the vehicle off.
- Driver and adult passengers should check for any objects lodged underneath the front passenger seat or cargo interfering with the seat.
- Remove the obstruction(s) (if found).
- Restart the vehicle.

# Supplementary Restraints System

- Wait at least two minutes and verify that the airbag readiness light is no longer illuminated.
- If the airbag readiness light remains illuminated, this may or may not be a problem due to the front passenger sensing system.

Do not attempt to repair or service the system. Take your vehicle immediately to an authorized dealer.

If it is necessary to modify an advanced front airbag system to accommodate a person with disabilities, contact the Ford Customer Relationship Center. See **Getting the Services You Need** (page 213).

## SIDE AIRBAGS



**WARNING:** Do not place objects or mount equipment on or near the airbag cover, on the side of the seatbacks (of the front seats), or in front seat areas that may come into contact with a deploying airbag. Failure to follow these instructions may increase the risk of personal injury in the event of a crash.



**WARNING:** Do not use accessory seat covers. The use of accessory seat covers may prevent the deployment of the side airbags and increase the risk of injury in an accident.



**WARNING:** Do not lean your head on the door. The side airbag could injure you as it deploys from the side of the seatback.



**WARNING:** Do not attempt to service, repair, or modify the supplementary restraint system or associated components. Failure to follow this instruction could result in personal injury or death.



**WARNING:** If a supplementary restraint system component has deployed, it will not function again. Have the system and associated components inspected as soon as possible. Failure to follow this instruction could result in personal injury or death.

The side airbags are on the outboard side of the seatbacks of the front seats. In certain sideways crashes, the side airbags will be inflated. The airbag was designed to inflate between the door panel and occupant to further enhance the protection provided occupants in side impact crashes.

### Coupe



E152533

# Supplementary Restraints System

## Convertible



E174777

The system consists of the following:

- A label or embossed side panel indicating that side airbags are fitted to your vehicle.
- Side airbags inside the driver and front passenger seatbacks.
- Front passenger sensing system.



Crash sensors and monitoring system with readiness indicator. See **Crash Sensors and Airbag Indicator** (page 46).

The design and development of the side airbag system included recommended testing procedures that were developed by a group of automotive safety experts known as the Side Airbag Technical Working Group. These recommended testing procedures help reduce the risk of injuries related to the deployment of side airbags.

## DRIVER AND PASSENGER KNEE AIRBAGS



**WARNING:** To reduce risk of injury, do not obstruct or place objects in the deployment path of the airbag.



**WARNING:** Close the glove box door when your vehicle is moving. Failure to follow this instruction could reduce the effectiveness of the passenger knee airbag and increase the risk of injury in a crash.

A driver knee airbag is located under or within the instrument panel. A passenger knee airbag is located within or under the glove box door. During a crash, the restraints control module may activate the driver and passenger knee airbags based on crash severity and occupant conditions. Under certain crash and occupant conditions, the driver and passenger knee airbag may deploy but the driver front airbag may not activate. As with front and side airbags, it is important to be properly seated and restrained to reduce the risk of death or serious injury.



Make sure the knee airbags are operating properly. See **Crash Sensors and Airbag Indicator** (page 46).

## SAFETY CANOPY™ - COUPE



**WARNING:** Do not place objects or mount equipment on or near the headliner at the siderail that may come into contact with a deploying curtain airbag. Failure to follow these instructions may increase the risk of personal injury in the event of a crash.



**WARNING:** Do not lean your head on the door. The curtain airbag could injure you as it deploys from the headliner.

# Supplementary Restraints System



**WARNING:** Do not attempt to service, repair, or modify the supplementary restraint system or associated components. Failure to follow this instruction could result in personal injury or death.



**WARNING:** All occupants of your vehicle, including the driver, should always properly wear their seatbelts, even when an airbag supplemental restraint system is provided. Failure to properly wear your seatbelt could seriously increase the risk of injury or death.



**WARNING:** To reduce risk of injury, do not obstruct or place objects in the deployment path of the airbag.



**WARNING:** If a supplementary restraint system component has deployed, it will not function again. Have the system and associated components inspected as soon as possible. Failure to follow this instruction could result in personal injury or death.

The Safety Canopy deploys during significant side crashes or when a certain likelihood of a rollover event is detected by the rollover sensor. The Safety Canopy is mounted to the roof side rail sheet metal, behind the headliner, above each row of seats. In certain sideways crashes or rollover events, the Safety Canopy will be activated, regardless of which seats are occupied. The Safety Canopy is designed to inflate between the side window area and occupants to further enhance protection provided in side impact crashes and rollover events.

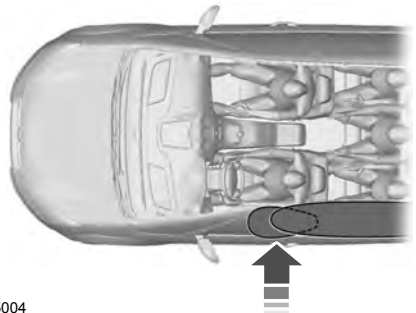

E75004

The system consists of the following:

- Safety Canopy curtain airbags above the trim panels over the front and rear side windows identified by a label or wording on the headliner or roof-pillar trim.
- A flexible headliner which opens above the side doors to allow air curtain deployment



• Crash sensors and monitoring system with a readiness indicator. See **Crash Sensors and Airbag Indicator** (page 46).

Properly restrain children 12 years old and under in the rear seats. The Safety Canopy will not interfere with children restrained using a properly installed child or booster seat because it is designed to inflate downward from the headliner above the doors along the side window opening.

The design and development of the Safety Canopy included recommended testing procedures that were developed by a group of automotive safety experts known as the Side Airbag Technical Working Group. These recommended testing procedures help reduce the risk of injuries related to the deployment of side airbags (including the Safety Canopy).



# Supplementary Restraints System

## CRASH SENSORS AND AIRBAG INDICATOR



**WARNING:** Modifying or adding equipment to the front end of your vehicle (including hood, bumper system, frame, front end body structure, tow hooks and hood pins) may affect the performance of the airbag system, increasing the risk of injury. Do not modify or add equipment to the front end of your vehicle.

Your vehicle has a collection of crash and occupant sensors which provide information to the restraints control module. The restraints control module deploys (activates) the front seatbelt pretensioners, driver airbag, passenger airbag, knee airbag(s), seat mounted side airbags and Safety Canopy airbags. Based on the type of crash, the restraints control module will deploy the appropriate safety devices.

The restraints control module also monitors the readiness of the above safety devices plus the crash and occupant sensors. The readiness of the safety system is indicated by a warning indicator light in the instrument cluster or by a backup tone if the warning light is not working. Routine maintenance of the airbag is not required.

A difficulty with the system is indicated by one or more of the following:



The readiness light will not illuminate immediately after you switch the ignition on.

- The readiness light either flashes or stays lit.
- You will hear a series of five beeps. The tone pattern repeats periodically until the problem, the light or both are repaired.

If any of these things happen, even intermittently, have the supplemental restraint system serviced at an authorized dealer immediately. Unless serviced, the system may not function properly in the event of a crash.

The seatbelt pretensioners and the front airbag supplemental restraint system are designed to activate when the vehicle sustains frontal deceleration sufficient to cause the restraints control module to deploy a safety device.

The fact that the seatbelt pretensioners or front airbags did not activate for both front seat occupants in a crash does not mean that something is wrong with the system. Rather, it means the restraints control module determined the accident conditions (crash severity, belt usage) were not appropriate to activate these safety devices.

- The design of the front airbags is to activate only in frontal and near-frontal crashes (not rollovers, side impacts or rear impacts unless the crash causes sufficient frontal deceleration).
- The design of the seatbelt pretensioners is to activate in frontal, near-frontal, side crashes and rollovers.

# Supplementary Restraints System

---

- The knee airbag(s) may deploy based on crash severity and occupant conditions.
- The design of the side airbags is to inflate in certain side crashes. The design of the Safety Canopy is to inflate in certain side impact crashes and when a certain likelihood of rollover is detected by the rollover sensor. Side airbags and Safety Canopy airbags may activate in other types of crashes if the vehicle experiences sufficient sideways motion or deformation.

## **AIRBAG DISPOSAL**

Contact your authorized dealer as soon as possible. Airbags must be disposed of by qualified personnel.

## PRINCIPLE OF OPERATION

MyKey allows you to program keys with restricted driving modes to promote good driving habits. All but one of the keys programmed to the vehicle can be activated with these restricted modes.

Any keys that have not been programmed are referred to as administrator keys or admin keys. These can be used to:

- Create a MyKey.
- Program configurable MyKey settings.
- Clear all MyKey features.

When you have programmed a MyKey, you can access the following information using the information display:

- How many admin keys and MyKeys are programmed to your vehicle.
- The total distance your vehicle has traveled using a MyKey.

**Note:** All MyKeys are programmed to the same settings. You cannot program them individually.

**Note:** For vehicles with intelligent access with push-button start, when both a MyKey and an admin intelligent access key fob are present, the admin fob will be recognized by the vehicle while switching the ignition on to start the vehicle.

## Non-configurable Settings

The following settings cannot be changed by an admin key user:

- Seatbelt reminder. You cannot disable this feature. The audio system will mute when the front seat occupants' safety belts are not fastened.
- Early low fuel. The low-fuel warning activates earlier, giving the MyKey user more time to refuel.

- Driver assist features, if equipped on your vehicle, are forced on: rear parking aid, blind spot information system (BLIS) with cross traffic alert, lane departure warning and forward collision warning system.
- Track Mode, if your vehicle is equipped with this feature, is restricted.
- Drag Strip, if your vehicle is equipped with this feature, is restricted.
- MyMode, if your vehicle is equipped with this feature, is restricted.
- Satellite radio adult content restrictions (available only in some markets).

**Note:** You may be able to temporarily disable the lane departure warning feature. This feature is automatically enabled with every new key cycle.

## Configurable Settings

With an admin key, you can configure certain MyKey settings when you first create a MyKey and before you recycle the key or restart the vehicle. You can also change the settings afterward with an admin key.

- A vehicle speed limit can be set. Warnings will be shown in the display followed by an audible tone when your vehicle reaches the set speed. You cannot override the set speed by fully depressing the accelerator pedal or by setting cruise control.



**WARNING:** Do not set MyKey maximum speed limit to a limit that will prevent the driver from maintaining a safe speed considering posted speed limits and prevailing road conditions. The driver is always responsible to drive in accordance with local laws and prevailing conditions. Failure to do so could result in accident or injury.

- Various vehicle speed minders can be set. Once you select a speed, it will be shown in the display, followed by an audible tone when the preselected vehicle speed is exceeded.
  - Audio system maximum volume of 45%. A message will be shown in the display when you attempt to exceed the limited volume. Also, the speed-sensitive or compensated automatic volume control will be disabled.
  - Always on setting. When this is selected, you will not be able to turn off traction control, Emergency Assistance and Do Not Disturb (if your vehicle is equipped with these features), and Sport Mode will not be available to MyKey drivers.
4. When prompted, hold the **OK** button until you see a message informing you to label this key as a MyKey. The programmed restrictions apply when you key off, open and close the driver door and restart your vehicle with the programmed key or transmitter.

MyKey is successfully created. Make sure you label it so you can distinguish it from the admin keys.

You can also program configurable settings for the key(s). See **Programming and Changing Configurable Settings**.

## Programming and Changing Configurable Settings

Use the information display to access your configurable MyKey settings.

1. Switch the ignition on using an admin key or transmitter you want to program.
2. Access the main menu in the information display and then scroll through the menus to change the settings of your MyKey. See **Information Displays** (page 88).
3. Follow the instructions in the display.

**Note:** *You can clear or change your MyKey settings at any time during the same key cycle as you created the MyKey. Once you have switched the vehicle off, however, you will need an admin key to change or clear your MyKey settings.*

## CREATING A MYKEY

Use the information display to create a MyKey:

1. Insert the key you want to program into the ignition. See **Starting a Gasoline Engine** (page 131). If your vehicle is equipped with a push-button start, place the remote control into the backup slot. See **Passive Anti-Theft System** (page 64).
2. Switch the ignition on.
3. Access the main menu in the information display and then scroll through the menus to change the settings of your MyKey. From the MyKey menu select the option Create MyKey. See **Information Displays** (page 88).

## CLEARING ALL MYKEYS

When you clear your MyKeys, you remove all restrictions and return all MyKeys to their original admin key status at once. To clear all MyKeys of all MyKey settings, use the information display.

1. Switch the ignition on using an admin key.

2. Access the main menu in the information display and then scroll through the menus to begin clearing your MyKey programming. See **Information Displays** (page 88).
3. Follow the instructions in the display.
4. A confirmation message appears in the display after you finish clearing your MyKeys.

**Note:** *When you clear your MyKeys, you remove all restrictions and return all MyKeys to their original admin key status. You cannot remove the MyKey restrictions individually.*

## CHECKING MYKEY SYSTEM STATUS

You can find information about your programmed MyKeys by using the information display. See **Information Displays** (page 88).

### MyKey Distance

Tracks the distance when drivers use a MyKey. The only way to delete the accumulated distance is by using an admin key to clear all MyKeys. If the distance does not accumulate as expected, then the intended user is not using the MyKey, or an admin key user recently cleared and then recreated a MyKey.

## MYKEY – TROUBLESHOOTING

Condition	Potential Causes
I cannot create a MyKey.	<ul style="list-style-type: none"> <li>• The key or transmitter used to start the vehicle does not have admin privileges.</li> <li>• The key or transmitter used to start the vehicle is the only admin key (there always has to be at least one admin key).</li> </ul>

### Number of MyKeys

Indicates the number of MyKeys programmed to your vehicle. Use this feature to detect how many MyKeys you have for your vehicle and determine when all MyKeys have been deleted.

### Number of Admin Keys

Indicates how many admin keys are programmed to your vehicle. Use this feature to determine how many admin keys you have for your vehicle, and detect if an additional MyKey has been programmed.

## USING MYKEY WITH REMOTE START SYSTEMS

MyKey is not compatible with non Ford-approved, aftermarket remote start systems. If you choose to install a remote start system, see an authorized dealer for a Ford-approved remote start system.

# MyKey™

Condition	Potential Causes
	<ul style="list-style-type: none"> <li>• Vehicles with keyless start: The keyless start transmitter is not placed in the backup position. See <b>Passive Anti-Theft System</b> (page 64).</li> <li>• SecuriLock passive anti-theft system is disabled or in unlimited mode.</li> </ul>
I cannot program the configurable settings.	<ul style="list-style-type: none"> <li>• The key or transmitter used to start your vehicle does not have admin privileges.</li> <li>• No MyKeys are created. See <b>Creating a MyKey</b> (page 49).</li> </ul>
I cannot clear the MyKeys.	<ul style="list-style-type: none"> <li>• The key or transmitter used to start your vehicle does not have admin privileges.</li> <li>• No MyKeys are created. See <b>Creating a MyKey</b> (page 49).</li> </ul>
I lost the only admin key.	Purchase a new key from an authorized dealer.
I lost a key.	Program a spare key. See <b>Passive Anti-Theft System</b> (page 64).
MyKey distances do not accumulate.	<ul style="list-style-type: none"> <li>• The MyKey user is not using the MyKey.</li> <li>• An admin key holder cleared the MyKeys and created new MyKeys.</li> <li>• The key system has been reset.</li> </ul>
No MyKey functions with the keyless entry transmitter.	<ul style="list-style-type: none"> <li>• An admin transmitter is present at vehicle start.</li> <li>• No MyKeys are created. See <b>Creating a MyKey</b> (page 49).</li> </ul>

# Keys and Remote Controls

## GENERAL INFORMATION ON RADIO FREQUENCIES

This device complies with Part 15 of the FCC Rules and with Licence exempt RSS Standards of Industry Canada. Operation is subject to the following two conditions:

- This device may not cause harmful interference, and
- This device must accept any interference received, including interference that may cause undesired operation.



**WARNING:** Changes or modifications not expressly approved by the party responsible for compliance could void the user's authority to operate the equipment. The term "IC:" before the radio certification number only signifies that Industry Canada technical specifications were met.

The typical operating range for your transmitter is approximately 33 ft (10 m). Vehicles with the remote start feature will have a greater range. One of the following could cause a decrease in operating range:

- weather conditions
- nearby radio towers
- structures around the vehicle
- other vehicles parked next to your vehicle

Other short-distance radio transmitters, such as amateur radios, medical equipment, wireless headphones, remote controls and alarm systems may operate on the same frequency as your remote control. If other transmitters are operating on those frequencies, you may not be able to use your remote control. Using your remote control near some types of electronic equipment, such as USB devices,

computers or cell phones can interfere with remote operation. Operating your remote control near metal or metallic-finished purses, bags or clothing can interfere with remote operation. You can lock and unlock the doors with the key.

**Note:** *Make sure to lock your vehicle before leaving it unattended.*

**Note:** *If you are in range, the remote control will operate if you press any button unintentionally.*

## Intelligent Access

The system uses a radio frequency signal to communicate with your vehicle and authorize your vehicle to unlock when one of the following conditions are met:

- You touch the inside of any exterior door handle within 3 ft (1 m) proximity of an intelligent access key.
- You press the luggage compartment button.
- You press a button on the transmitter.

If excessive radio frequency interference is present in the area or if the transmitter battery is low, you may need to mechanically unlock your door. You can use the mechanical key blade in your intelligent access key to open the driver door in this situation. See **Remote Control** (page 52).

## REMOTE CONTROL

### Intelligent Access Key

**Note:** *You may not be able to shift out of park (P) unless the intelligent access key is inside your vehicle.*

# Keys and Remote Controls



E218399

The intelligent access keys operate the power locks and the remote start system. The key must be in your vehicle to use the push button start.

## Removable Key Blade

The intelligent access key also contains a removable key blade that you can use to unlock your vehicle.



E218400

Push the release button and pull the key blade out.



E151795

**Note:** Your vehicle keys came with a security label that provides important key cut information. Keep the label in a safe place for future reference.

## Using the Key Blade

The key cylinder is under a cap on the driver door handle.

To remove the cap:



# Keys and Remote Controls

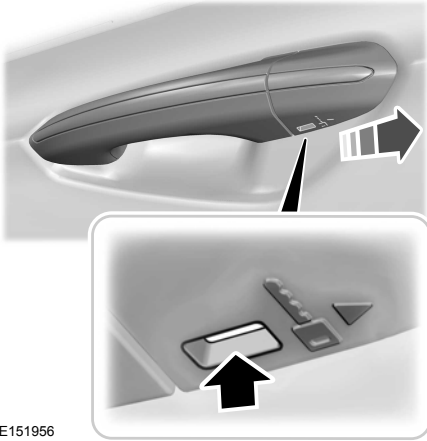

E151956

1. Insert the key blade into the slot on the bottom of the handle and apply upward pressure.
2. While maintaining upward pressure, move the cap rearward to release it. Gently remove the key while doing so.

To install the cap:



E151957

1. Place the cap just forward of the key cylinder.
2. Applying pressure to the cap, move it forward until it is in place. You may hear a snap as it engages.

Make sure you have properly installed the cap by trying to move it rearward.

## Replacing the Battery

**Note:** Refer to local regulations when disposing of transmitter batteries.

**Note:** Do not wipe off any grease on the battery terminals or on the back surface of the circuit board.

**Note:** Replacing the battery does not erase the programmed key from your vehicle. The transmitter should operate normally.

A message appears in the information display when the remote control battery is low. See **Information Messages** (page 97).

The remote control uses one coin-type three-volt lithium battery.



E218400

1. Push the release button and pull the key blade out.

## Keys and Remote Controls



E252404

2. Twist a thin coin under the tab hidden behind the key blade head to remove the battery cover.



E218402

3. Insert a suitable tool, for example a screwdriver, in the position shown and carefully remove the battery.
4. Install a new battery with the + facing upward.
5. Reinstall the battery cover and the key blade.

### Car Finder



Press the button twice within three seconds. The horn sounds and the direction indicators flash. We recommend you use this method to locate your vehicle, rather than using the panic alarm.

### Sounding the Panic Alarm

**Note:** *The panic alarm only operates when the ignition is off.*



Press the button to sound the panic alarm. Press the button again or switch the ignition on to turn it off.

# Keys and Remote Controls

## Remote Start (If Equipped)



**WARNING:** To avoid exhaust fumes, do not use remote start if your vehicle is parked indoors or in areas that are not well ventilated.

**Note:** Do not use remote start if your fuel level is low.



The remote start button is on the transmitter.

This feature allows you to start your vehicle from the outside. The transmitter has an extended operating range.

If your vehicle has automatic climate control, you can configure it to operate when you remote start your vehicle. See **Climate Control** (page 109). A manual climate control system will run at the setting it was set to when you switched your vehicle off.

Many states and provinces have restrictions for the use of remote start. Check your local and state or provincial laws for specific requirements regarding remote start systems.

The remote start system does not work when any of the following conditions occur:

- The ignition is on.
- The anti-theft alarm triggers.
- You switch the feature off in the information display.
- The hood is open.
- The transmission is not in park (P).
- The battery voltage is below the minimum operating voltage.

## Remote Control Feedback

An LED on the remote control provides status feedback of remote start or stop commands.

LED	Status
Solid green	Remote start successful
Solid red	Remote stop successful
Blinking red	Request failed or status not received
Blinking green	Status incomplete

## Remote Starting your Vehicle

**Note:** You must press each button within three seconds of each other. Your vehicle will not remote start if you do not follow this sequence.

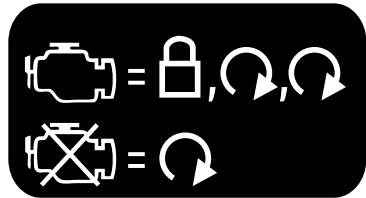

E138626

To remote start your vehicle:

1. Press the lock button to lock all the doors.
2. Press the remote start button twice. The exterior lamps flash twice.

The horn sounds if the system fails to start.

**Note:** You must press the push button ignition switch on the instrument panel once while applying the brake pedal before driving your vehicle.

The power windows do not work during remote start and the radio does not turn on automatically.

# Keys and Remote Controls

---

The parking lamps remain on and your vehicle will run for 5, 10 or 15 minutes, depending on the setting.

## ***Extending the Engine Running Time***

To extend the engine running time duration of your vehicle during remote start, repeat steps 1 and 2 while the engine is running. If the duration is set to 15 minutes, the duration extends by another 15 minutes. For example, if your vehicle had been running from the first remote start for 10 minutes, your vehicle continues to run now for a total of 30 minutes. You can extend the engine running time duration to a maximum of 30 minutes.

Wait at least five seconds before remote starting after the engine stops running.

## ***Turning Your Vehicle Off After Remote Starting***



Press the button once. Your vehicle and the parking lamps turn off.

You may have to be closer to your vehicle than when starting due to ground reflection and the added noise of your running vehicle.

You can switch this feature on or off in the information display.

## ***Memory Feature***

You can program your intelligent access key to recall memory positions. See **Memory Function** (page 120).

## **REPLACING A LOST KEY OR REMOTE CONTROL**

Replacement keys or remote controls can be purchased from an authorized dealer. Authorized dealers can program remote controls for your vehicle. See **Passive Anti-Theft System** (page 64).

# Doors and Locks

## LOCKING AND UNLOCKING

You can use the power door lock control or the remote control to lock and unlock your vehicle.

### Power Door Locks

The power door lock control is on the driver and front passenger door panels.

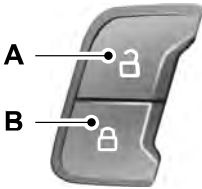

E138628

- A Unlock.
- B Lock.

### Door Lock Indicator

An LED on each door window trim illuminates when you lock the door. It remains on for up to 10 minutes after you switch the ignition off.

### Door Lock Switch Inhibitor

When you electronically lock your vehicle, the power door lock switch no longer operates after 20 seconds. You must unlock your vehicle with the remote control, or switch the ignition on, to restore function to these switches. You can switch this feature on or off in the information display. See **General Information** (page 88).

### Remote Control

You can use the remote control at any time. The luggage compartment release button only works when your vehicle speed is less than 5 mph (8 km/h).

## Unlocking the Doors



Press the button to unlock the driver door. Press the button again within three seconds to unlock all doors. The direction indicators flash.

**Note:** You can unlock the driver door with the key blade if the remote control is not functioning. See **Replacing a Lost Key or Remote Control** (page 57).

**Note:** When you leave your vehicle unattended for several weeks, remote unlocking turns off. Unlock your vehicle using the key blade, then start your vehicle to restore the remote unlocking function. See **Locking and Unlocking the Doors with the Key Blade** later in this section.

## Reprogramming the Unlocking Function

You can reprogram the unlocking function so that all doors unlock.

Press and hold both the lock and unlock buttons on the remote control for three seconds to change between driver door or all doors unlock mode. The direction indicators flash twice to confirm the change. Driver door mode only unlocks the driver door when you press the unlock button once. All door mode unlocks all doors when you press the unlock button once. The unlocking mode applies to the remote control and intelligent access. You can also change between the unlocking modes using the information display. See **General Information** (page 88).

# Doors and Locks

## Locking the Doors



Press the button to lock all doors. The direction indicators flash. Press the button again within three seconds to confirm that all the doors are closed. The doors lock again, the horn sounds and the direction indicators flash if all the doors and the luggage compartment are closed.

## Mislock

If any door or the luggage compartment is open, or if the hood is open on vehicles with an anti-theft alarm or remote start, the horn will sound twice and the direction indicators do not flash. You can switch this feature on or off in the information display. See **General Information** (page 88).

## Auto Relock (If Equipped)

The doors automatically relock if you do not open a door within 45 seconds of unlocking the doors with the remote control. The door locks and the alarm return to their previous state.

## Opening the Luggage Compartment



Press twice within three seconds to open the luggage compartment.

Make sure to close and latch the luggage compartment before driving your vehicle. Objects may fall from an unlatched luggage compartment. An unlatched luggage compartment may block your rear view.

## Activating Intelligent Access

### General Information

You can unlock and lock the vehicle without taking the keys out of your pocket or purse when your intelligent access key is within 3 ft (1 m) of your vehicle. Intelligent access uses a sensor on the back of the door handle for unlocking and a separate sensor on the face of each door handle for locking.

The system does not function if:

- Your vehicle battery has no charge.
- The key battery has no charge.
- The key frequencies are jammed.

**Note:** *The system may not function if the key is close to metal objects or electronic devices, for example keys or a cell phone.*

**Note:** *If the system does not function, use the key blade to lock and unlock your vehicle. See **Remote Control** (page 52).*

## Unlocking Using Intelligent Access



E248553

With your intelligent access key within 3 ft (1 m) of your vehicle, touch the unlock sensor on the back of the door handle for a brief period and then pull on the door handle to unlock, being careful to not touch the lock sensor at the same time or pulling the door handle too quickly. The intelligent access system requires a brief delay to authenticate your intelligent access key fob.

# Doors and Locks

## Locking Using Intelligent Access



E248554

With your intelligent access key within 3 ft (1 m) of your vehicle, touch the outer door handle lock sensor for approximately one second to lock, being careful not to touch the unlock sensor on the back of the door handle at the same time. After locking, you can immediately pull on the door handle to confirm locking occurred without inadvertently unlocking.

## Opening the Luggage Compartment

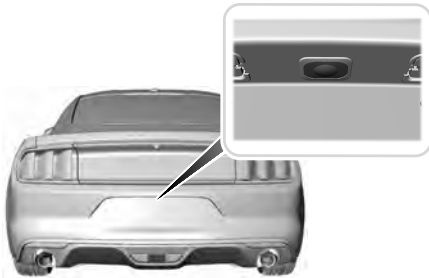

E175208

Press the exterior release button hidden above the license plate.

## Smart Unlocks

This feature helps to prevent you from unintentionally locking your intelligent access key inside your vehicle's passenger compartment or luggage compartment.

When you electronically lock your vehicle (with any door open, vehicle in park and ignition off), your vehicle searches for an intelligent access key in the passenger compartment after you close the last door. If your vehicle finds a key, all of the doors immediately unlock and the horn sounds twice, indicating that a key is inside.

- Pressing the lock button on another intelligent access key.
- Touching the locking area on the handle with another intelligent access key in your hand.

When you open one of the front doors and lock your vehicle using the power door lock control, all doors lock then unlock if:

- The ignition is on.
- The ignition is off and the transmission is not in park (P).

## Autolock (If Equipped)

Autolock locks all the doors when:

- All doors are closed.
- The ignition is on.
- You shift into any gear putting your vehicle in motion.
- Your vehicle reaches a speed greater than 12 mph (20 km/h).

Autolock repeats when:

- You open then close any door while the ignition is on and your vehicle speed is 9 mph (15 km/h) or lower.
- Your vehicle reaches a speed greater than 12 mph (20 km/h).

# Doors and Locks

## Autounlock

Autounlock unlocks all the doors when:

- The ignition is on, you have closed all the doors, and your vehicle has been moving at a speed greater than 12 mph (20 km/h).
- Your vehicle comes to a stop and you switch the ignition off or to the accessory position.
- You open the driver door within 10 minutes of switching the ignition off or to accessory.

**Note:** *The doors do not autounlock if you electronically lock your vehicle after you switch the ignition off and before you open the driver door.*

## Enabling or Disabling Autounlock

You can enable or disable the autounlock feature in the information display or an authorized dealer can do it for you. See **General Information** (page 88).

## Locking and Unlocking the Doors with the Key Blade

Turn the top of the key toward the front of your vehicle once to lock all doors.

Turn the top of the key toward the rear of your vehicle once to unlock the driver door only. See **Remote Control** (page 52).

## Locking the Doors Individually



If the central locking function does not operate, lock the doors individually using the key in the position shown.

### Left-Hand Side

Turn clockwise to lock.

### Right-Hand Side

Turn counterclockwise to lock.

## Unlocking the Doors

If the central locking function does not operate, unlock the driver door and then unlock all other doors individually by pulling the interior door handles.



# Doors and Locks

**Note:** If you have unlocked the doors using this method, you must lock the doors individually to restore the central locking function.

## Unlocking the Luggage Compartment (Convertible Only)

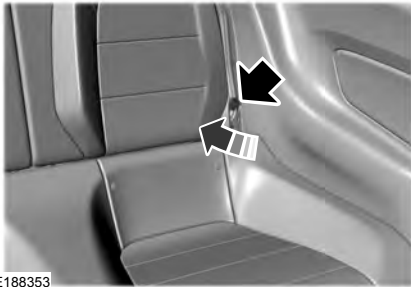

E188353

If the power decklid release does not operate because of a discharged battery, pull the rear seat left-hand side seatback cushion aside, insert the mechanical key blade into the key slot and turn the key to release the decklid latch.

## Opening the Luggage Compartment

### From Inside Your Vehicle



E188015

Press the button on the instrument panel to open the luggage compartment.

### From Outside Your Vehicle

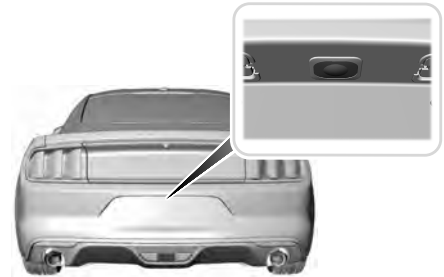

E175208

Press the exterior release button hidden above the license plate. You need to have your vehicle unlocked or have an intelligent access key within 3 ft (1 m) of the luggage compartment.

### With the Remote Control



Press twice within three seconds to open the luggage compartment.

## Illuminated Entry

The interior lamps and select exterior lamps illuminate when you unlock the doors with the remote entry system.

The illuminated entry system turns off the lights if:

- The ignition is on.
- You press the remote control lock button.
- After 25 seconds of illumination.

The lights do not turn off if:

- You switch them on with the lamp control.
- Any door is open.

# Doors and Locks

## Illuminated Exit

The interior lamps and select exterior lamps illuminate when all doors are closed and you switch the ignition off.

The lamps turn off if all the doors remain closed and:

- 25 seconds elapse.
- You press the **START/STOP** button.

## Battery Saver

If you leave on the courtesy lamps, dome lamps or headlamps, the battery saver turns them off 10 minutes after you switch off the ignition.

## Accessory Mode Battery Saver for Intelligent Access Keys

If you leave your vehicle in the run ignition state, it turns off once it detects a certain amount of battery drain or after 45 minutes.

## INTERIOR LUGGAGE COMPARTMENT RELEASE



**WARNING:** Keep vehicle doors and luggage compartment locked and keep keys and remote transmitters out of a child's reach. Unsupervised children could lock themselves in the trunk and risk injury. Children should be taught not to play in vehicles.



**WARNING:** Do not leave children or animals unattended in the vehicle. On hot days, the temperature in the trunk or vehicle interior can rise very quickly. Exposure of people or animals to these high temperatures for even a short time can cause death or serious heat-related injuries, including brain damage. Small children are particularly at risk.

Your vehicle is equipped with a release handle that provides a means of escape for children and adults if they become locked inside the luggage compartment.

Adults should familiarize themselves with the operation and location of the release handle.

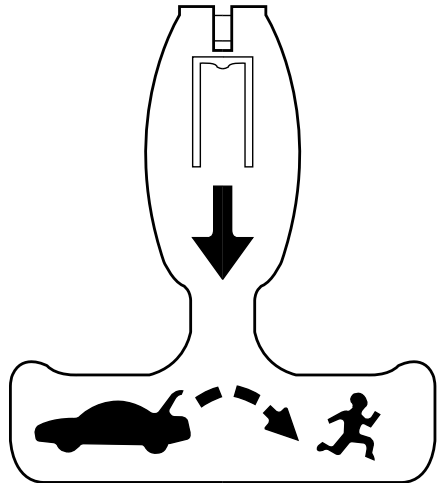

E144403

The handle is located inside the luggage compartment either on the luggage compartment door (lid) or near the tail lamps. It is composed of a material that will glow for hours in darkness following brief exposure to ambient light.

Pull the handle and push up on the luggage compartment door (lid) to open from within the luggage compartment.

# Security

---

## PASSIVE ANTI-THEFT SYSTEM

**Note:** *The system is not compatible with non-Ford aftermarket remote start systems. Use of these systems may result in vehicle starting problems and a loss of security protection.*

**Note:** *Metallic objects, electronic devices or a second coded key on the same key chain may cause vehicle starting problems if they are too close to the key when starting your vehicle. Prevent these objects from touching the coded key while starting your vehicle. Switch the ignition off, move all objects on the key chain away from the coded key and restart your vehicle if a problem occurs.*

**Note:** *Do not leave a duplicate coded key in your vehicle. Always take your keys and lock all doors when leaving your vehicle.*

## SecuriLock

The system helps prevent your vehicle from starting unless you use a coded key programmed to your vehicle. Using the wrong key may prevent your vehicle from starting. A message may appear in the information display.

If you are unable to start your vehicle with a correctly coded key, it is not operating properly. A message may appear in the information display.

## Automatic Arming

Your vehicle arms immediately after switching the ignition off.

## Automatic Disarming

Switching the ignition on with a coded key disarms your vehicle.

## Replacement Keys

**Note:** *Your vehicle comes equipped with two intelligent access keys.*

The intelligent access key functions as a programmed key that operates the driver door lock and activates the intelligent access with push button start system, as well as a remote control.

If your programmed transmitters are lost or stolen and you do not have an extra coded key, you need to have your vehicle towed to an authorized dealer. You need to erase the key codes from your vehicle and program new coded keys.

Store an extra programmed key away from your vehicle in a safe place to help prevent any inconveniences. See your authorized dealer to purchase additional spare or replacement keys.

## Programming a Spare Intelligent Access Key

**Note:** *You can program a maximum of four intelligent access keys to your vehicle.*

You must have two previously programmed intelligent access keys inside your vehicle and the new unprogrammed intelligent access keys readily accessible. See an authorized dealer to have the spare key programmed if two previously programmed keys are not available.

Make sure that your vehicle is off before beginning this procedure. Make sure that you close all the doors before beginning and that they remain closed throughout the procedure. Perform all steps within 30 seconds of starting the sequence. Stop and wait for at least one minute before starting again if you perform any steps out of sequence.

Read and understand the entire procedure before you begin.

# Security

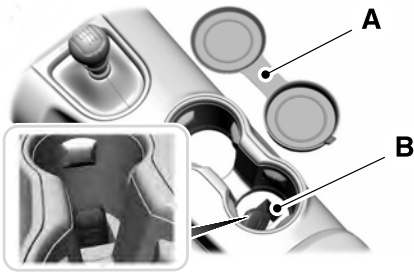

E174956

1. Remove the rubber covering (A) from the cupholder. Place the first programmed key in the backup slot (B) at the bottom of the cupholder, then press the push button ignition switch.
2. Wait five seconds and then press the push button ignition switch again.
3. Remove the intelligent access key.
4. Within 10 seconds, place a second programmed intelligent access key in the backup slot. Press the push button ignition switch.
5. Wait five seconds and then press the push button ignition switch again.
6. Remove the intelligent access key.
7. Place the unprogrammed intelligent access key in the backup slot and press the push button ignition switch.

Programming is now complete. Verify the remote control functions operate and your vehicle starts with the new intelligent access key.

If programming was not successful, wait 10 seconds and repeat Steps 1 through 7. If you are still unsuccessful, take your vehicle to your authorized dealer.

## ANTI-THEFT ALARM

The system will warn you of an unauthorized entry to your vehicle. It will be triggered if any door, the luggage compartment or the hood is opened without using the key, remote control or keyless entry keypad.

The direction indicators will flash and the horn will sound if unauthorized entry is attempted while the alarm is armed.

Take all remote controls to an authorized dealer if there is any potential alarm problem with your vehicle.

### Arming the Alarm

The alarm is ready to arm when there is not a key in your vehicle. Electronically lock your vehicle to arm the alarm.

### Disarming the Alarm

Disarm the alarm by any of the following actions:

- Unlock the doors or luggage compartment with the remote control or keyless entry keypad.
- Switch your vehicle on or start your vehicle.
- Use a key in the driver door to unlock your vehicle, then switch your vehicle on within 12 seconds.

**Note:** *Pressing the panic button on the remote control will stop the horn and signal indicators, but will not disarm the system.*

# Steering Wheel

## ADJUSTING THE STEERING WHEEL



**WARNING:** Do not adjust the steering wheel when your vehicle is moving.

**Note:** Make sure that you sit in the correct position. See **Sitting in the Correct Position** (page 117).

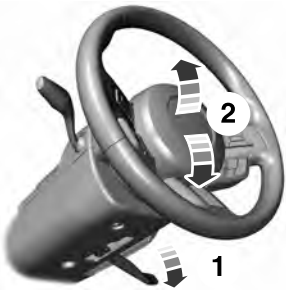

E176634

1. Unlock the steering column.
2. Adjust the steering wheel to the desired position.



E176635

3. Lock the steering column.

## AUDIO CONTROL

You can operate the following functions with the control:

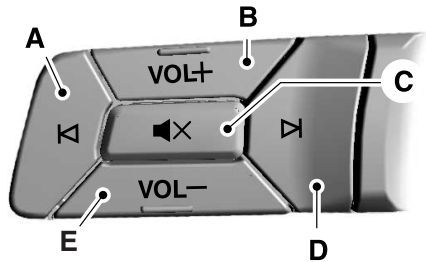

E248469

- A Seek down or previous.
- B Volume up.
- C Mute.
- D Seek up or next.
- E Volume down.

## Seek, Next or Previous

Press the seek button to:

- Tune the radio to the next or previous stored preset.
- Play the next or the previous track.

Press and hold the seek button to:

- Tune the radio to the next station up or down the frequency band.
- Seek or fast forward through a track.

# Steering Wheel

## VOICE CONTROL

### Type One

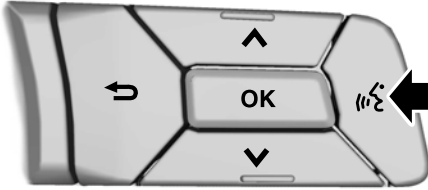

E248479

### Type Two

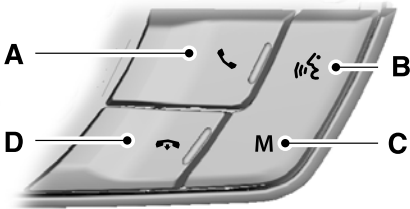

E248439

- A Make or answer a call.
- B Voice recognition.
- C Media.
- D End call.

## CRUISE CONTROL

### Type One

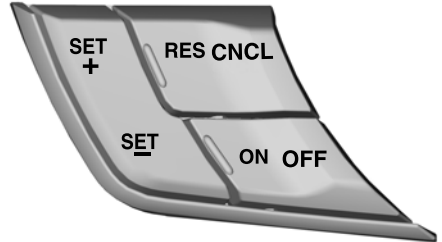

E174594

See **Using Cruise Control** (page 166).

### Type Two

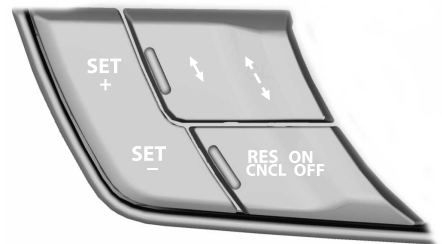

E177068

See **Using Adaptive Cruise Control** (page 167).

# Steering Wheel

## INFORMATION DISPLAY CONTROL

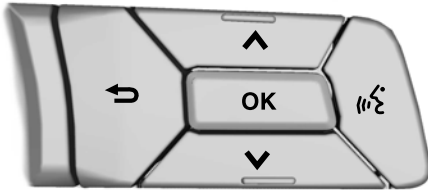

E248474

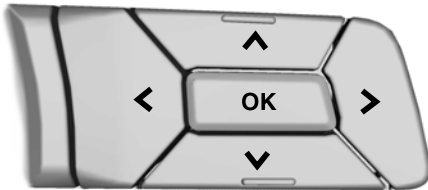

E248475

## Quick Action Menus



E248531

See **Information Displays** (page 88).

## HEATED STEERING WHEEL (IF EQUIPPED)

Switch the heated steering wheel on and off using the touchscreen.



Touch the button to switch the heated steering wheel on and off.

**Note:** You can use the heated steering wheel only when the engine is running.

**Note:** The system uses a sensor and is designed to control the temperature of the steering wheel and to prevent it from overheating.

**Note:** In warm temperatures, the steering wheel quickly reaches its maximum temperature and the system reduces the current to the heating element. This could cause you to think that the system has stopped working but it has not. This is normal.

# Wipers and Washers

## WINDSHIELD WIPERS

**Note:** Fully defrost the windshield before you switch the windshield wipers on.

**Note:** Make sure you switch the windshield wipers off before entering a car wash.

**Note:** If streaks or smears appear on the windshield, clean the windshield and the wiper blades. If that does not resolve the issue, install new wiper blades.

**Note:** Do not operate the wipers on a dry windshield. This may scratch the glass, damage the wiper blades or cause the wiper motor to burn out. Always use the windshield washers before wiping a dry windshield.

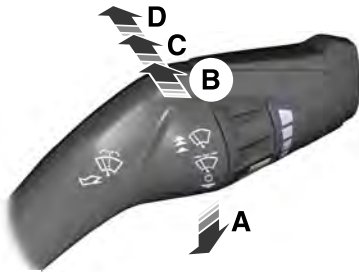

E173728

- A Single wipe.
- B Intermittent wipe.
- C Normal wipe.
- D High speed wipe.

## Intermittent Wipe

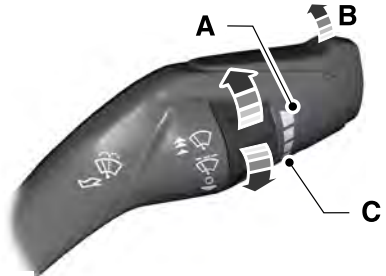

E173729

- A Shortest wipe interval.
- B Intermittent wipe.
- C Longest wipe interval.

Use the rotary control to adjust the intermittent wipe interval.

## Speed Dependent Wipers

When your vehicle speed increases, the interval between wipes decreases.

## AUTOWIPERS (IF EQUIPPED)

**Note:** Fully defrost the windshield before you switch the windshield wipers on.

**Note:** Make sure you switch the windshield wipers off before entering a car wash.

**Note:** If streaks or smears appear on the windshield, clean the windshield and the wiper blades. If that does not resolve the issue, install new wiper blades.

**Note:** If you switch autolamps and autowipers on, the headlamps turn on when the windshield wipers continuously operate.

Wet or winter driving conditions with ice, snow or salty road mist can cause inconsistent and unexpected wiping or smearing.



# Wipers and Washers

The feature uses a rain sensor that is in the area around the interior mirror. The rain sensor monitors the amount of moisture on the windshield and turns on the wipers. It adjusts the wiper speed by the amount of moisture that the sensor detects on the windshield. You can switch this feature on and off in the information display. See **Information Displays** (page 88).

In these conditions, you can do the following:

- Lower the sensitivity of the autowipers to reduce the amount of smearing on the windshield.
- Switch to normal or high-speed wipe.
- Switch autowipers off.

## WINDSHIELD WASHERS

**Note:** Do not operate the washers when the washer reservoir is empty. This may cause the washer pump to overheat.

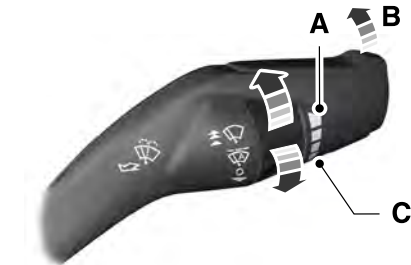

E173730

- A Highest sensitivity.
- B On.
- C Lowest sensitivity.



E173731

To operate the washers and spray the windshield, pull the lever toward you.

Use the rotary control to adjust the sensitivity of the autowipers. When you select low sensitivity, the wipers operate when the sensor detects a large amount of water on the windshield. When you select high sensitivity, the wipers operate when the sensor detects a small amount of water on the windshield.

Keep the outside of the windshield clean. The rain sensor is very sensitive and the wipers may operate if dirt, mist or insects hit the windshield.

# Lighting

## GENERAL INFORMATION

### Condensation in the Exterior Front Lamps and Rear Lamps

Exterior front lamps and rear lamps have vents to accommodate normal changes in air pressure.

Condensation can be a natural by-product of this design. When moist air enters the lamp assembly through the vents, there is a possibility that condensation can occur when the temperature is cold. When normal condensation occurs, a fine mist can form on the interior of the lens. The fine mist eventually clears and exits through the vents during normal operation.

Clearing time may take as long as 48 hours under dry weather conditions.

Examples of acceptable condensation are:

- The presence of a fine mist (no streaks, drip marks or large droplets).
- A fine mist covers less than 50% of the lens.

Examples of unacceptable condensation are:

- A water puddle inside the lamp.
- Streaks, drip marks or large droplets present on the interior of the lens.

If you see any unacceptable condensation, have your vehicle checked by an authorized dealer.

## LIGHTING CONTROL

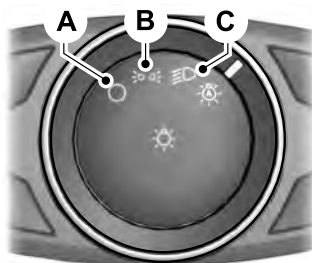

E142449

- A Lamps off.
- B Parking lamps, instrument panel lamps, license plate lamps and tail lamps.
- C Headlamps.

### Headlamp High Beam



E162679



Push the lever away from you to switch the high beam on.

Push the lever forward again or pull the lever toward you to switch the high beams off.

# Lighting

## Flashing the Headlamp High Beam



E162680

Slightly pull the lever toward you and release it to flash the headlamps.

## AUTOLAMPS



**WARNING:** The system does not relieve you of your responsibility to drive with due care and attention. You may need to override the system if it does not turn the headlamps on in low visibility conditions, for example daytime fog.

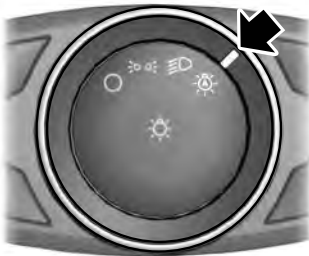

E142451

When the lighting control is in the autolamps position, the headlamps turn on in low light situations, or when the wipers turn on.

The headlamps remain on for a period of time after you switch the ignition off. Use the information display controls to adjust the period of time that the headlamps remain on.

**Note:** If you switch the autolamps on, you cannot switch the high beams on until the system turns the low beams on.

## Windshield Wiper Activated Headlamps

When you switch the autolamps on, the headlamps turn on within 10 seconds of switching the wipers on. They turn off approximately 60 seconds after you switch the windshield wipers off.

The headlamps do not turn on with the wipers:

- During a single wipe.
- When using the windshield washers.
- If the wipers are in intermittent mode.

**Note:** If you switch the autolamps and the autowipers on, the headlamps turn on when the windshield wipers continuously operate.

## INSTRUMENT LIGHTING DIMMER

**Note:** When disconnecting the battery or when it runs out of charge, the illuminated components turn to the maximum setting.

# Lighting

## Vehicles With Front Fog Lamps

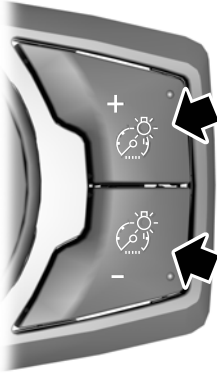

E231828

Press repeatedly or press and hold until you reach the desired level.

## Vehicles Without Front Fog Lamps



E165366

- A Press repeatedly or press and hold to dim.
- B Press repeatedly or press and hold to brighten.

## HEADLAMP EXIT DELAY

After you switch the ignition off, you can switch the headlamps on by pulling the direction indicator lever toward you. You will hear a short tone. The headlamps will switch off automatically after three minutes with any door open or 30 seconds after the last door has been closed. You can cancel this feature by pulling the direction indicator toward you again or switching the ignition on.

## DAYTIME RUNNING LAMPS



**WARNING:** The daytime running lamps system does not activate the rear lamps and may not provide adequate lighting during low visibility driving conditions. Make sure you switch the headlamps on, as appropriate, during all low visibility conditions. Failure to do so may result in a crash.

### Type One - Conventional (Non-Configurable)

The daytime running lamps turn on when:

1. Switching the ignition on.
2. The transmission is not in park (P) for vehicles with automatic transmissions, or releasing the parking brake for vehicles with manual transmissions.
3. The lighting control is in the off, parking lamp or autolamps positions.
4. The headlamps are off.

### Type Two - Configurable

Switch the daytime running lamps on or off using the information display. See **Information Displays** (page 88).

# Lighting

The daytime running lamps turn on when:

1. The lamps are on in the information display.
2. Switching the ignition on.
3. The transmission is not in park (P) for vehicles with automatic transmissions, or releasing the parking brake for vehicles with manual transmissions.
4. The lighting control is in the autolamps position.
5. The headlamps are off.

The other lighting control switch positions do not turn on the daytime running lamps.

If the daytime running lamps are off in the information display, the lamps stay off in all switch positions.

## AUTOMATIC HIGH BEAM CONTROL (IF EQUIPPED)



**WARNING:** The system does not relieve you of your responsibility to drive with due care and attention. You may need to override the system if it does not turn the high beams on or off.

The system turns on high beams if it is dark enough and no other traffic is present. If it detects an approaching vehicle's headlamps or tail lamps, or street lighting ahead, the system turns off high beams before they can distract other road users. Low beams remain on.

**Note:** The system may not operate properly if the sensor is blocked. Keep the windshield free from obstruction or damage.

**Note:** The system may not operate properly in cold or inclement conditions. You can switch on the high beams by overriding the system.

**Note:** If the system detects a blockage, for example bird droppings, bug splatter, snow or ice, the system goes into low beam mode until you clear the blockage. A message may appear in the information display if the camera is blocked.

**Note:** Using much larger tires or equipping vehicle accessories such as snowplows can modify your vehicle's ride height and degrade automatic high beam control performance.

A camera sensor, centrally mounted behind the windshield of your vehicle, continuously monitors conditions to turn the high beams on and off.

Once the system is active, the high beams turn on if:

- The ambient light level is low enough.
- There is no traffic in front of your vehicle.
- The vehicle speed is greater than approximately 32 mph (51 km/h).

The system turns the high beams off if:

- The ambient light level is high enough that high beams are not required.
- The system detects an approaching vehicle's headlamps or tail lamps.
- The vehicle speed falls below approximately 27 mph (44 km/h).
- The system detects severe rain, snow or fog.
- The camera is blocked.

## Switching the System On and Off

Switch the system on using the information display. See **Information Displays** (page 88).

# Lighting

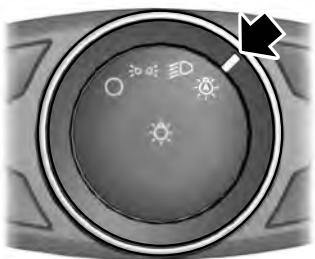

E142451

Switch the lighting control to the autolamps position. See **Autolamps** (page 72).

## Overriding the System

Push the lever away from you to switch between high beam and low beam.

## Automatic High Beam Indicator



The indicator illuminates to confirm when the system is ready to assist.

## FRONT FOG LAMPS (IF EQUIPPED)



E142453

Press the control to switch the fog lamps on or off.

You can switch the fog lamps on when the lighting control is in any position except Off and the high beams are not on.

## DIRECTION INDICATORS



E162681

Push the lever up or down to use the direction indicators.

**Note:** Tap the lever up or down to make the direction indicators flash three times to indicate a lane change.

## WELCOME LIGHTING

The projection lights are on the bottom of the exterior mirror housings. They project an image onto the ground a short distance from your vehicle when welcome lighting or lighted entry turns on.

**Note:** Moisture, frost and ice build-up or other types of contamination on the surface of the light lens can cause non-permanent distortion or reduced brightness of the image. Do not use abrasive materials to clean the lens.

**Note:** For vehicles with manual transmission, you may need to engage the parking brake for this feature to operate.

# Lighting

---

## INTERIOR LAMPS

The lamps turn on under the following conditions:

- You open any door.
- You press a remote control button.
- You press a map lamp button.

### Map Lamps



E175199

- A Left-hand side map lamp.
- B Right-hand side map lamp.

Press the button to switch the lamps on or off.

## AMBIENT LIGHTING (IF EQUIPPED)

Adjust the ambient lighting in the information display. See **General Information** (page 88).

# Windows and Mirrors

## POWER WINDOWS



**WARNING:** Do not leave children unattended in your vehicle and do not let them play with the power windows. Failure to follow this instruction could result in personal injury.



**WARNING:** When closing the power windows, verify they are free of obstruction and make sure that children and pets are not in the proximity of the window openings.



E180087

**Note:** You may hear a pulsing noise when just one of the windows is open. Lower the opposite window slightly to reduce this noise.

**Note:** Use the singular control (if equipped) to open both rear windows.

Press the control to open the window.

Lift the control to close the window.

### One-Touch Down

Press the switch fully and release it. Press again or lift it to stop the window.

### One-Touch Up

Lift the switch fully and release it. Press again or lift it to stop the window.

## Bounce-Back

The window will automatically stop and reverse some distance if it detects an obstacle while closing.

### Overriding the Bounce-Back Feature



**WARNING:** When you override the bounce-back feature the window will not reverse if it detects an obstacle. Take care when closing the windows to avoid personal injury or damage to your vehicle.

Pull up the window switch and hold within two seconds of the window reaching the bounce-back position. The window will travel up with no bounce-back protection. The window will stop if you release the switch before the window is fully closed.

### Accessory Delay

The window switches remain operational for several minutes when you switch the ignition off or until you open either front door.

## GLOBAL OPENING

You can use the remote control to open the windows with the ignition off.

**Note:** You can enable or disable this feature in the information display, or see an authorized dealer. See **General Information** (page 88).

**Note:** To operate this feature, accessory delay must not be active.



# Windows and Mirrors

## Opening the Windows

You can open the windows for a short time after you unlock your vehicle with the remote control. After you unlock your vehicle, press and hold the remote control unlock button to open the windows. Release the button once movement starts. Press the lock or unlock button to stop movement.

## EXTERIOR MIRRORS

### Power Exterior Mirrors



**WARNING:** Do not adjust the mirrors when your vehicle is moving. This could result in the loss of control of your vehicle, serious personal injury or death.

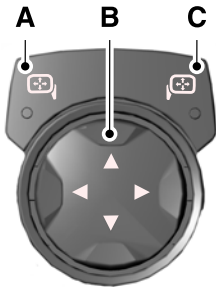

E176804

- A Left-hand mirror
- B Adjustment control
- C Right-hand mirror

To adjust a mirror:

1. Select the mirror you want to adjust. The control will illuminate.
2. Adjust the position of the mirror.
3. Press the mirror switch again.

### Fold-Away Exterior Mirrors

Push the mirror toward the door window glass. Make sure that you fully engage the mirror in its support when returning it to its original position.

### Heated Exterior Mirrors (If Equipped)

See **Heated Rear Window** (page 115).

### Memory Mirrors (If Equipped)

You can save and recall the mirror positions through the memory function. See **Power Seats** (page 120).

### Signal Indicator Mirrors (If Equipped)

The outer portion of the appropriate mirror housing will blink when you switch on the turn signal.

### Projection Lights (If Equipped)

The lights are on the bottom of the mirror housings. See **Welcome Lighting** (page 75).

### Integrated Blind Spot Mirrors (If Equipped)



**WARNING:** Objects in the mirror are closer than they appear.

Blind spot mirrors have an integrated convex mirror built into the upper outboard corner of the exterior mirrors. They can increase your visibility along the side of your vehicle.

# Windows and Mirrors

Check the main mirror first before a lane change, then check the blind spot mirror. If the blind spot mirror does not show any vehicles in its viewing area and the traffic in the adjacent lane is at a safe distance, signal that you intend to change lanes. Glance over your shoulder to verify traffic is clear and carefully change lanes.

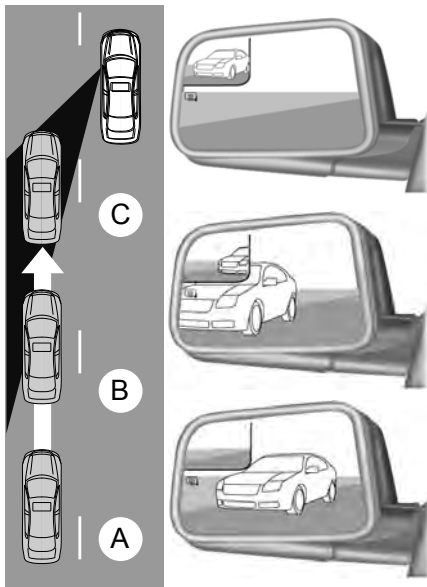

E138665

The image of the approaching vehicle is small and near the inboard edge of the main mirror when it is at a distance. The image becomes larger and begins to move outboard across the main mirror as the vehicle approaches (A). The image will transition from the main mirror and begin to appear in the blind spot mirror as the vehicle approaches (B). The vehicle will transition to your peripheral field of view as it leaves the blind spot mirror (C).

## Blind Spot Monitor (If Equipped)

See **Blind Spot Information System** (page 178).

## INTERIOR MIRROR

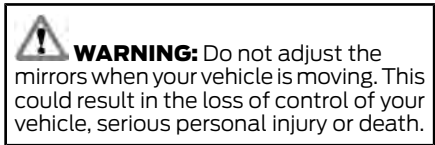

**Note:** Do not clean the housing or glass of any mirror with harsh abrasives, fuel or other petroleum or ammonia-based cleaning products.

You can adjust the interior mirror to your preference. In addition to the standard pivot point, this mirror also includes a second pivot point, letting you move the mirror head up or down and from side to side.

## Auto-Dimming Mirror (If Equipped)

**Note:** Do not block the sensors on the front and back of the mirror. Mirror performance may be affected. A rear center passenger or raised rear center head restraint may also block light from reaching the sensor.

To reduce glare, the mirror dims automatically when it detects bright lights from behind your vehicle. It automatically returns to normal reflection when you select reverse (R) gear to make sure you have a clear view when backing up.

# Windows and Mirrors

---

## SUN VISORS

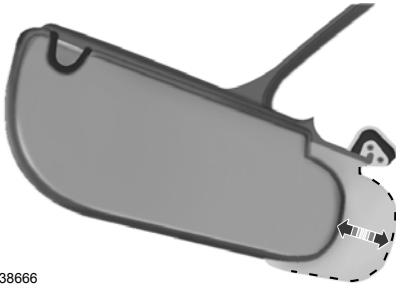

E138666

Rotate the sun visor toward the side window and extend it rearward for extra shade.

## Illuminated Vanity Mirror

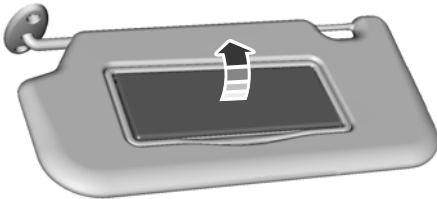

E162197

Lift the cover to switch the lamp on.

# Instrument Cluster

## GAUGES

### Type I

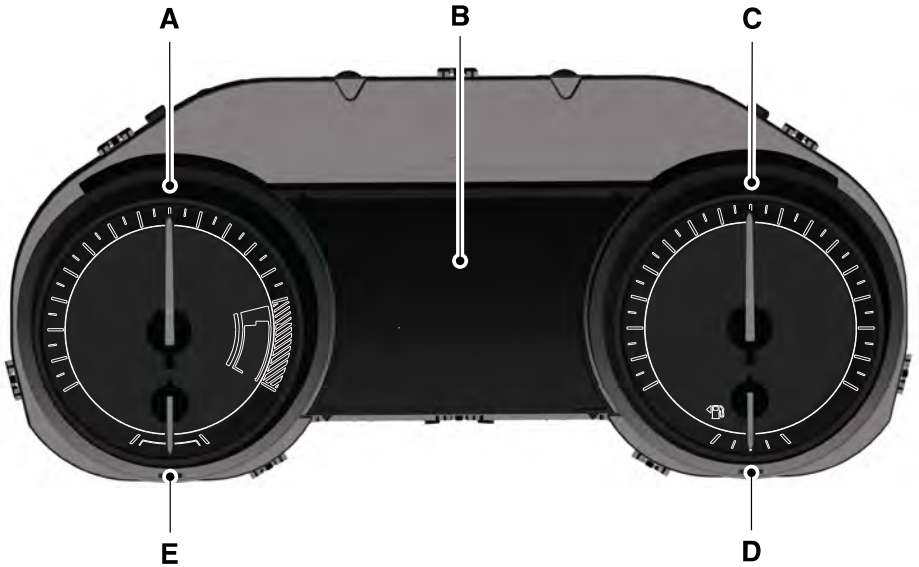

E230872

- A Tachometer.
- B Information Display.
- C Speedometer.
- D Fuel Gauge.
- E Engine Coolant Temperature Gauge.

# Instrument Cluster

## Type 2

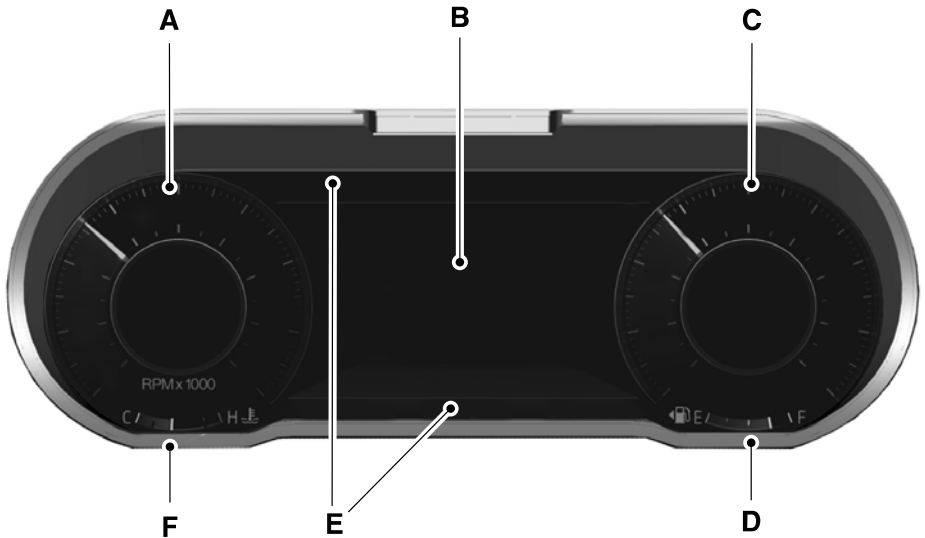

E270688

- A Tachometer.
- B Information Display.
- C Speedometer.
- D Fuel Gauge.
- E Information Bar
- F Engine Coolant Temperature Gauge.

### Information Display

#### Odometer

Located in the bottom of the information display. Registers the accumulated distance your vehicle has traveled.

#### Trip Computer

See **General Information** (page 88).

#### Vehicle Settings and Personalization

See **General Information** (page 88).

# Instrument Cluster

## Fuel Gauge

**Note:** *The fuel gauge may vary slightly when your vehicle is moving or on a slope.*

The fuel gauge indicates about how much fuel is in the fuel tank.

The arrow adjacent to the fuel pump symbol indicates on which side of your vehicle the fuel filler door is located.

## Low Fuel Reminder

For MyKey users, a warning tone sounds and a message appears in the information display when the distance to empty reaches 75 mi (120 km).

For all keys, a warning tone sounds and a message appears in the information display when the distance to empty reaches 50 mi (80 km). A warning tone sounds and a message appears in the information display again at the following distance to empty parameters:

- 25 mi (40 km)
- 10 mi (20 km)
- 0 mi (0 km)

**Note:** *The low fuel reminder can appear at different fuel gauge positions depending on fuel economy conditions. This variation is normal.*

## Information Bar

Displays information such as compass direction, outside air temperature, odometer and transmission gear selector.

## Engine Coolant Temperature Gauge

 **WARNING:** Do not remove the coolant reservoir cap when the cooling system is hot. Wait 10 minutes for the cooling system to cool down. Cover the coolant reservoir cap with a thick cloth to prevent the possibility of scalding and slowly remove the cap. Failure to follow this instruction could result in personal injury.

Indicates engine coolant temperature. At normal operating temperature, the level indicator will be in the normal range. If the engine coolant temperature exceeds the normal range, stop your vehicle as soon as safely possible, switch off the engine and let it cool.

## Gauge Package (If Equipped)



E196366

## Oil Pressure Gauge

Indicates the engine oil pressure.

## Vacuum or Vacuum and Boost Gauge

Indicates the vacuum or vacuum and boost pressure in the intake.

# Instrument Cluster

## WARNING LAMPS AND INDICATORS

The following warning lamps and indicators alert you to a vehicle condition that may become serious. Some lamps illuminate when you start your vehicle to make sure they work. If any lamps remain on after starting your vehicle, refer to the respective system warning lamp for further information.

**Note:** *Some warning indicators appear in the information display and operate the same as a warning lamp but do not illuminate when you start your vehicle.*

### Adaptive Cruise Control Indicator (If Equipped)



It illuminates when you switch the system on.

It illuminates white when the system is in standby mode. It illuminates green when you set the adaptive cruise speed.

See **Using Adaptive Cruise Control** (page 167).

### Airbag Warning Lamp



If it does not illuminate when you switch the ignition on, continues to flash or remains on when the engine is running, this indicates a malfunction. Have your vehicle checked as soon as possible.

### Anti-Lock Brake System Warning Lamp



If it illuminates when you are driving, this indicates a malfunction. Your vehicle continues to have normal braking without the anti-lock brake system function. Have your vehicle checked as soon as possible.

### Automatic Headlamp High Beam Indicator (If Equipped)



It illuminates when the system automatically turns the headlamp high beam on.

See **Automatic High Beam Control** (page 74).

### Battery



If it illuminates while driving, it indicates a malfunction. Switch off all unnecessary electrical equipment and have the system checked by your authorized dealer immediately.

### Blind Spot Information System Indicator (If Equipped)



It illuminates when you switch the system off.

See **Blind Spot Information System** (page 178).

### Brake System Warning Lamp



**WARNING:** Driving your vehicle with the warning lamp on is dangerous. A significant decrease in braking performance may occur. It may take you longer to stop your vehicle. Have your vehicle checked as soon as possible. Driving extended distances with the parking brake engaged can cause brake failure and the risk of personal injury.

**Note:** *Indicators vary depending on region.*

This lamp is a dual function lamp and will illuminate when:

# Instrument Cluster

- You apply the parking brake with the ignition on.
- Your vehicle has a brake fault or low brake fluid level, regardless of parking brake position.

**BRAKE** If the lamp illuminates when you are moving, you may have the parking brake applied. Make sure the parking brake is off. Have your vehicle checked as soon as possible if the lamp continues to illuminate.



## Cruise Control Indicator (If Equipped)



It illuminates when you switch the system on.

See **Using Cruise Control** (page 166).

## Direction Indicator



Illuminates when the left or right direction indicator or the hazard warning flasher is turned on.

Flashes during operation. An increase in the rate of flashing warns of a failed indicator bulb.

## Door Ajar Warning Lamp



Displays when the ignition is on and any door is not completely closed.

## Engine Coolant Temperature Warning Lamp



If it illuminates when your vehicle is moving, this indicates that the engine is overheating. Stop your vehicle as soon as it is safe to do so and switch the engine off. Have your vehicle checked as soon as possible.

## Fasten Seatbelt Warning Lamp



It illuminates and a chime sounds until you fasten the seatbelts.

## Front Fog Lamp Indicator (If Equipped)



It illuminates when you switch the front fog lamps on.

## Heads Up Display (If Equipped)



A red beam of lights will illuminate on the windshield in certain instances when using adaptive cruise control or the collision warning system. It will also illuminate momentarily when you start your vehicle to make sure the display works.

## Headlamp High Beam Indicator



It will illuminate when you switch the high beam headlamps on. It will flash when you use the headlamp flasher.

## Hood Ajar



It illuminates when the ignition is on and the hood is not completely closed.

## Lane Keeping System Lamp (If

Equipped)



It illuminates when the system activates.

## Launch Control



Illuminates when this feature is ready, including both slip control and engine RPM hold.



# Instrument Cluster



Illuminates when only engine RPM hold is active. See **Track Use** (page 250).

## Low Beam Malfunction



Lights when there is a malfunction with the low beam headlamp bulb.

## Low Fuel Level Warning Lamp



If it illuminates when you are driving, refuel as soon as possible.

## Low Tire Pressure Warning Lamp



Illuminates when your tire pressure is low. If the lamp remains on with the engine running or when driving, check your tire pressure as soon as possible.

It also illuminates momentarily when you switch the ignition on to confirm the lamp is functional. If it does not illuminate when you switch the ignition on, or begins to flash at any time, have the system checked by your authorized dealer.

## Low Washer Fluid Level Warning Lamp



It illuminates when the washer fluid is low.

## Oil Pressure Warning Lamp



It illuminates when you switch the ignition on.

If it illuminates when the engine is running this indicates a malfunction. Stop your vehicle as soon as it is safe to do so and switch the engine off. Check the engine oil level. If the oil level is sufficient, this indicates a system malfunction. Have your vehicle checked as soon as possible.

See **Engine Oil Check** (page 235).

## Parking Lamps



It will illuminate when you switch the parking lamps on.

## Service Engine Soon



If it illuminates when the engine is running this indicates a malfunction. The On Board Diagnostics system has detected a malfunction of the vehicle emission control system.

If it flashes, engine misfire may be occurring. Increased exhaust gas temperatures could damage the catalytic converter or other vehicle components. Drive in a moderate fashion (avoid heavy acceleration and deceleration) and have your vehicle immediately serviced.

It illuminates when you switch the ignition on prior to engine start to check the bulb and to indicate whether your vehicle is ready for Inspection and Maintenance (I/M) testing.

Normally, it illuminates until the engine is cranked and automatically turns off if no malfunctions are present. However, if after 15 seconds it flashes eight times, this indicates that your vehicle is not ready for Inspection and Maintenance (I/M) testing.

See **Catalytic Converter** (page 144).

# Instrument Cluster

## Stability Control and Traction Control Indicator



Flashes during operation.

If it does not illuminate when you switch the ignition on, or remains on when the engine is running, this indicates a malfunction. Have your vehicle checked as soon as possible.

**Note:** *The system automatically turns off if there is a malfunction.*

See **Using Stability Control** (page 159).  
See **Using Traction Control** (page 157).

## Stability Control and Traction Control Off Warning Lamp



It illuminates when you switch the system off.

## Trunk Ajar



It illuminates when the ignition is on and the trunk is not completely closed.

## AUDIBLE WARNINGS AND INDICATORS

### Keyless Warning Alert

The horn will sound twice when you exit your vehicle with the intelligent access key and your vehicle is in ON, indicating your vehicle is still on. The horn will also sound twice when you exit your vehicle and attempt to lock the doors manually while the intelligent access key is still in the vehicle. The doors will not lock if the intelligent access key remains in the vehicle.

## Headlamps On Warning Chime

Sounds when you remove the key from the vehicle and you have left the headlamps or parking lamps on.

## Parking Brake On Warning Chime (If Equipped)

Sounds when you have left the parking brake on and drive your vehicle. If the warning chime remains on after you have released the parking brake, have the system checked by your authorized dealer immediately.

## Transmission Not in Park

Sounds when the gear selector is in any position other than park (P), and the vehicle ignition is turned to OFF or the accessory position. If the door is ajar, the chime is continuous. Once the door is closed, the chime continues for a period of time.

## Turn Signal Left On

Sounds when the turn signal is not disengaged after 2.0 mi (3.2 km) of driving.

# Information Displays

## GENERAL INFORMATION



**WARNING:** Driving while distracted can result in loss of vehicle control, crash and injury. We strongly recommend that you use extreme caution when using any device that may take your focus off the road. Your primary responsibility is the safe operation of your vehicle. We recommend against the use of any hand-held device while driving and encourage the use of voice-operated systems when possible. Make sure you are aware of all applicable local laws that may affect the use of electronic devices while driving.

You can control various systems on your vehicle using the information display controls on the steering wheel. The information display shows the corresponding information.

**Note:** *Some options may appear slightly different or not at all if the items are optional.*

## Information Display Controls

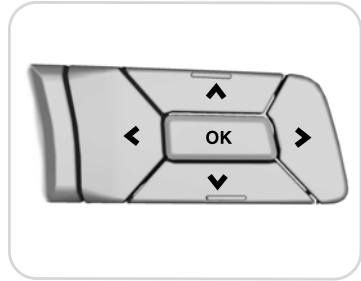
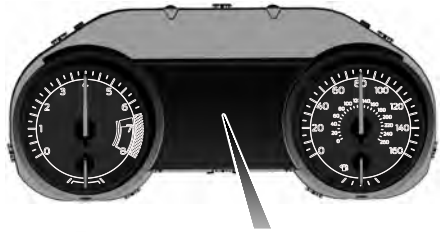

E249039

- Press the up and down arrow buttons to scroll through and highlight the options within a menu.
- Press the right arrow button to enter a sub-menu.
- Press the left arrow button to exit a menu.
- Press and hold the left arrow button at any time to return to the main menu display (escape button).
- Press the **OK** button to choose and confirm settings or messages.

# Information Displays

## Main Menu

Gauge Mode
Trip/Fuel
Track Apps™
Driver Assist

Settings



This icon gives you the ability to switch a feature on or off. A check in the box indicates the feature is enabled, and unchecked indicates the feature is disabled.

<b>Gauge Mode</b>	
Distance to Empty	<b><i>Speedometer km/h</i></b> or <b><i>Speedometer MPH</i></b>
Tire Pressure	
Gauge Detail	Air/Fuel Ratio
	Axle Oil Temp
	Boost/Vacuum
	Cylinder Head Temp
	Inlet Air Temp
	Oil Pressure
	Oil Temp
Trans Oil Temp	

# Information Displays

Gauge Mode	
	Vacuum
	Voltage

- **Air/Fuel Ratio** - Displays the current air to fuel mixture in the engine.
- **Axle Oil Temp** - Displays the axle's oil temperature.
- **Boost/Vacuum** - Displays the vacuum or boost pressure for the 2.3L engine.
- **Cylinder Head Temp** - Displays the engine's cylinder head temperature.
- **Inlet Air Temp** - Displays the temperature of the air in the cold air inlet tube.
- **Oil Pressure** - Displays the engine oil pressure.
- **Oil Temp** - Displays the engine oil temperature. If the temperature rises to the red area, stop in a safe place and let your vehicle cool. If the problem persists, see an authorized dealer.
- **Trans Oil Temp** - Displays the transmission fluid operating temperature. If the temperature rises to the red area, stop in a safe place and let the transmission cool. If the problem persists, see an authorized dealer.
- **Vacuum** - Displays the vacuum pressure for the 5.0L engine.
- **Voltage** - Displays your vehicle's battery voltage. If the voltage is consistently too high or very low, contact an authorized dealer.

**Note:** In order to provide real-time values, some gauges may display more value fluctuation than other gauges during normal operation.

Trip/Fuel	
Trip 1 or Trip 2 - Trip timer, Trip distance, distance to E and avg mpg	
Fuel Economy	Instant fuel economy
	AVG MPG
	mi to E
Fuel History	Last 30 minutes
	AVG MPG
	mi to E

**Note:** Press and hold **OK** to reset the currently displayed information.

## Information Displays

Menu Item	Description
Trip Timer	Registers the time of individual journeys.
Trip Distance	Registers the distance of individual journeys.
Mi to E	Shows the approximate distance your vehicle can travel before running out of fuel.
Avg MPG	Shows the average fuel usage based on time.
Instant fuel economy	Shows your instantaneous fuel usage.
Fuel History	Shows fuel usage as a bar graph based on time. The graph is updated each minute with the fuel economy that you achieved during 30 minutes of driving.



**WARNING:** *Track Apps™* is for track use only. Remember that even advanced technology cannot defy the laws of physics. It is always possible to lose control of a vehicle due to inappropriate driver input for the conditions. Aggressive driving on any road condition can cause you to lose control of your vehicle increasing the risk of personal injury or property damage.

*Track Apps™* provides a suite of options to record and optimize your track performances. See **Track Use** (page 250).

<b>Track Apps™</b>	
Status Screen	
Accelerometer	Virtual gauge shown
Acceleration Timer	Select your speed, distance and start settings
Brake Performance	Choose your applicable setting.
Line Lock	
Lap Timer	Track (XXX)
Launch Control	Launch Control

## Information Displays

<b>Track Apps™</b>	
	RPM
Rev Match	
View/Clear Results	Acceleration Timer
	Brake Performance
	Lap Timer
	All Time Best
	Clear Saved Data
	Clear All Time Best
	Clear Accel.

**Note:** *Some items are optional and may not appear.*

<b>Driver Assist</b>	
AdvanceTrac	
Auto Engine Off	
Blindspot	
Driver Alert	
Pre-Collision Assist	Sensitivity
	Active Braking
	Distance Indication
Cross Traffic Alert	
Rear Park Aid	
Cruise Control	Choose your applicable setting.
Hill Start Assist	
Lane Keeping Assist	Mode
	Intensity
Tire Monitor	Hold <b>OK</b> to Reset

# Information Displays

**Note:** Some items are optional and may not appear.

<b>Settings</b>	
Exhaust Mode	Choose your applicable setting. <sup>1</sup>
	Quiet Start
Vehicle	Alarm
	Easy Entry/Exit
	Lighting
	Locks
	Oil Life Reset
	Park Lock Control
	Remote Start
	Tire Mobility Kit
	Windows
	Wipers
MyColor	Gauge Color
	Halo
	Ambient Light
	Set MyColor
MyKey	MyKey Status
	Create MyKey
	911 Assist
	AdvanceTrac
	Do Not Disturb
	Max Speed
	Speed Minder
	Volume Limiter
	Clear MyKeys



# Information Displays

Settings	
Display Setup	Distance
	Temperature
	Tire Pressure
	Language

<sup>1</sup> See **Track Use** (page 250).

**Note:** **Quiet Start** allows you to schedule when the **Exhaust Mode** turns on the **Quiet** setting. The time window can be from 1 to 24 hours.

## Information Display Controls - Type 2

You can control various systems on your vehicle using the information display controls on the steering wheel. The information display shows the corresponding information.

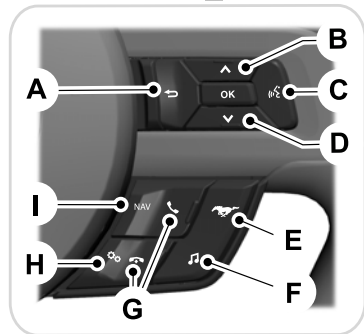

E249038

- A Back Button.
- B Arrow Up.
- C Voice Control Button.
- D Arrow Down.
- E Pony Button.

# Information Displays

- F Audio Button.
- G Phone Buttons.
- H Settings Button.
- I Navigation Button.
- Press one of the quick action menu (QAM) buttons to enter a menu.
- Toggle **(B)** and **(D)** to scroll through and highlight the options within a menu.
- Press the **OK** button to enter a sub-menu.
- Press **(A)** to exit a menu.
- Press the open menu's QAM button at any time to close the menu (escape button).
- Press the **OK** button to choose and confirm settings or messages.

## Settings

<b>Settings</b>	
Trip/Fuel Info	
Driver Assist	Auto Engine Off
	Blindspot
	Pre-Collision Assist
	Cross Traffic Assist
	Cruise Control
	Driver Alert
	Hill Start Assist
	Rear Park Aid
	Lane Keeping System
	Tire Monitor
Wipers	
<b>Speedometer km/h or Speedometer MPH</b>	
Advanced Settings	Vehicle
	MyKey
	Display Setup

# Information Displays

## Pony



**WARNING:** *Track Apps™* is for track use only. Remember that even advanced technology cannot defy the laws of physics. It is always possible to lose control of a vehicle due to

inappropriate driver input for the conditions. Aggressive driving on any road condition can cause you to lose control of your vehicle increasing the risk of personal injury or property damage.

*Track Apps™* provides a suite of options to record and optimize your track performances. See **Track Use** (page 250).

Pony		
MyMode	Show Status	
	Add MyMode	MyMode must be configured and saved before selection enabled.
Exhaust Mode	Choose your applicable setting. <sup>1</sup>	
	Quiet Start	
Track Apps	Acceleration Timer	
	Brake Performance	
	Line Lock	
	Lap Timer	
	Start Option	
Performance Shift Indicator	Shift Point	
	Shift Tone	
	Shift Light Mode	
Launch Control	Launch Control	
	RPM	
Rev Match		
Gauges	Show Gauges	
	Configure MyGauges	
MyColor	Primary Color	
	Secondary Color	
	Ambient Light	

# Information Displays

Pony	
	Create MyColor
Cluster Appearance	Change with Drive Mode
	Normal
	Sport
	Track

<sup>1</sup> See **Track Use** (page 250).

**Note:** **Quiet Start** allows you to schedule when the **Exhaust Mode** turns on the **Quiet** setting. The time window can be from 1 to 24 hours.

**Note:** Depending on your vehicle configuration, some features such as Exhaust Mode and Line Lock may be if equipped.

**Note:** The menu options for Performance Shift Indicator, Launch Control, and Rev Match are for manual transmissions only.

## Phone

See **General Information** (page 341).

## Audio

See **General Information** (page 341).

## Navigation (If Equipped)

See **General Information** (page 341).

## INFORMATION MESSAGES

**Note:** Depending on your vehicle options and instrument cluster type, not all of the messages display or are available. The information display may abbreviate or shorten certain messages.

Press the **OK** button to acknowledge and remove some messages from the information display. See **Information Display Control** (page 68). The information display automatically removes other messages after a short time.

You need to confirm certain messages before you can access the menus.

## Information Displays

### Adaptive Cruise Control

Message	Action
Adaptive Cruise Malfunction	A radar malfunction is preventing the adaptive cruise control from engaging. See <b>Using Adaptive Cruise Control</b> (page 167).
Adaptive Cruise Not Available	A condition exists such that the adaptive cruise cannot function properly. See <b>Using Adaptive Cruise Control</b> (page 167).
Adaptive Cruise Not Available Sensor Blocked See Manual	You have a blocked sensor due to bad weather, ice, mud or water in front of the radar sensor. You can typically clean the sensor to resolve. See <b>Using Adaptive Cruise Control</b> (page 167).
Normal Cruise Active Automatic Braking Turned Off	The system has disabled the automatic braking.
Front Sensor Not Aligned	A radar malfunction is preventing the adaptive cruise control from engaging.
Adaptive Cruise - Driver Resume Control	The adaptive cruise has reinstated controls to the driver.
Adaptive Cruise Speed Too Low to Activate	Your vehicle speed is too slow to activate the adaptive cruise.
Adaptive Cruise Shift Down	The adaptive cruise is automatically adjusting the gap distance and the driver needs to shift the transmission into a lower gear.

### AdvanceTrac™

Message	Action
Service AdvanceTrac	The system detects a malfunction due to a blocked sensor.
AdvanceTrac Off On	The driver has disabled or enabled the traction control.
AdvanceTrac SPORT MODE	The system is in sport mode.

# Information Displays

## Airbag

Message	Action
Occupant Sensor BLOCKED Remove Objects Near Passenger Seat	The system detects a malfunction due to a blocked sensor. Remove blockage.

## Alarm

Message	Action
Vehicle Alarm To Stop Alarm, Start Vehicle.	Alarm triggered due to unauthorized entry. See <b>Anti-Theft Alarm</b> (page 65).
Alarm All Sensors Peri- meter Sensing	All perimeter sensors are active. See <b>Anti-Theft Alarm</b> (page 65).

## Battery and Charging System

Message	Action
Check Charging System	The charging system needs servicing. If the warning stays on or continues to come on, contact an authorized dealer as soon as possible.
Charging System Service Soon	The charging system needs servicing. If the warning stays on or continues to come on, contact an authorized dealer as soon as possible.
Charging System Service Now	The charging system needs servicing. Contact an authorized dealer as soon as possible.

## Information Displays

Message	Action
Battery State of Charge Low	The battery management system determines that the battery is at a low state of charge. Turn your ignition off as soon as possible to protect the battery. This message clears once you restart your vehicle and the battery state of charge has recovered.
Low Battery Features Temporarily Turned Off	The battery management system detects an extended low-voltage condition. Your vehicle disables various features to help preserve the battery. Turn off as many of the electrical loads as soon as possible to improve system voltage. If the system voltage has recovered, the disabled features operate again as normal.
Turn Power Off To Save Battery	The battery management system determines that the battery is at a low state of charge. Turn your ignition off as soon as possible to protect the battery. This message clears once you restart your vehicle and the battery state of charge has recovered. Turning off unnecessary electrical loads allow faster battery state-of-charge recovery.

## Blind Spot Information and Cross Traffic Alert System

Message	Action
Blindspot System Fault	A fault with the system has occurred. Contact an authorized dealer as soon as possible.
Blindspot Not Available Sensor Blocked See Manual	The system sensors are blocked. See <b>Blind Spot Information System</b> (page 178).
Cross Traffic Not Available Sensor Blocked See Manual	The blind spot information system and cross traffic alert system sensors are blocked. See <b>Blind Spot Information System</b> (page 178).
Cross Traffic System Fault	A fault with the system has occurred. Contact an authorized dealer as soon as possible.

# Information Displays

## Collision Warning System

Message	Action
Collision Warning Malfunction	A fault with the system has occurred. Contact an authorized dealer as soon as possible. See <b>Driving Aids</b> (page 173).
Collision Warning Not Available Sensor Blocked See Manual	You have a blocked sensor due to bad weather, ice, mud or water in front of the radar sensor. You can typically clean the sensor to resolve. See <b>Driving Aids</b> (page 173).
Collision Warning Not Available	A fault with the system has occurred. Contact an authorized dealer as soon as possible. See <b>Driving Aids</b> (page 173).

## Doors and Locks

Message	Action
X Door Ajar	The door(s) listed is not completely closed.
Trunk Ajar	The trunk is not completely closed.
Hood Ajar	The hood is not completely closed.
Switches Inhibited Security Mode	The system has disabled the door switches.

## Engine

Message	Action
Power Reduced to Lower Engine Temp	The engine is overheating and the power has been reduced to assist in lowering the temperature. Stop in a safe place as soon as it is possible.

## Exhaust Mode

Message	Action
For Track Use See Manual	Indicates that the exhaust state selected, through the menu or drive mode selection, is for use on the track and may not comply with local noise regulations. Only on vehicles equipped with active exhaust.



# Information Displays

## Fuel

Message	Action
Fuel Level Low	An early reminder of a low fuel condition.
Check Fuel Fill Inlet	The fuel fill inlet may not be properly closed.

## Hill Start Assist

Message	Action
Hill Start Assist Not Available	Hill start assist is not available. Contact an authorized dealer. See <b>Hill Start Assist</b> (page 155).

## Keys and Intelligent Access

Message	Action
To START Press Brake	A reminder to press the brake while starting the vehicle.
To START Press Clutch	A reminder to depress the clutch pedal on manual transmission while starting the vehicle.
No Key Detected	The system does not detect a key in your vehicle. See <b>Keyless Starting</b> (page 130).
Restart Now or Key is Needed	You pressed the start/stop button to switch off the engine and your vehicle does not detect your intelligent access key inside your vehicle.
Accessory Power is Active	Your vehicle is in the accessory ignition state.
Starting System Fault	There is a problem with your vehicle's starting system. See an authorized dealer for service.
Key Program Successful	You have successfully programmed an intelligent access key to the system.
Key Program Failure	You have failed to program an intelligent access key to the system.
Max Number of Keys Learned	You have programmed the maximum number of keys to the system.

## Information Displays

Message	Action
Not Enough Keys Learned	You have not programmed enough keys to the system.
Key Battery Low Replace Soon	The key battery is low. Change the battery as soon as possible.
Engine ON	Inform the driver that they are exiting the vehicle and the engine is on.

## Maintenance

Message	Action
Low Engine Oil Pressure	Stop your vehicle as soon as safely possible and turn off the engine. Check the oil level. If the warning stays on or continues to come on with your engine running, contact an authorized dealer as soon as possible.
Change Engine Oil Soon	The engine oil life remaining is 10% or less. See <b>General Maintenance Information</b> (page 422).
Oil Change Required	The oil life left is at 0%. See <b>General Maintenance Information</b> (page 422).
Brake Fluid Level Low	The brake fluid level is low, inspected the brake system immediately. See <b>Brake Fluid Check</b> (page 241).
Check Brake System	The brake system needs servicing. Stop your vehicle in a safe place. Contact an authorized dealer.
Transport / Factory Mode	Your vehicle is still in Transport or Factory mode. This may not allow some features to operate properly. See an authorized dealer.
See Manual	The powertrain needs service due to a powertrain malfunction.

## Information Displays

### MyKey

Message	Action
MyKey not Created	You cannot program a MyKey.
MyKey Active Drive Safely	MyKey is active.
Speed Limited to XX MPH/km/h	When switching on your vehicle and MyKey is in use, displays that the MyKey speed limit is on.
Near Vehicle Top Speed	MyKey is in use and the MyKey speed limit is on and the vehicle speed is approaching 80 mph (130 km/h).
Vehicle at Top Speed of MyKey Setting	You have reached the speed limit set for your MyKey.
Check Speed Drive Safely	You have an active MyKey with a programmed set speed limit.
Buckle Up to Unmute Audio	Belt-Minder turns on with a MyKey in use.
AdvanceTrac On - MyKey Setting	With a MyKey in use, AdvanceTrac turns on.
Traction Control On - MyKey Setting	With a MyKey in use, traction control turns on.
MyKey Park Aid Cannot be Deactivated	With a MyKey in use, park aid is always on.

### Park Aid

Message	Action
Check Rear Park Aid	The system has detected a condition that requires service. Contact an authorized dealer. See <b>Rear Parking Aid</b> (page 161).
Rear Park Aid On Off	Displays the park aid status.

# Information Displays

## Park Brake

Message	Action
Park Brake Engaged	You have set the parking brake and you have driven the vehicle more than 3 mph (5 km/h). If the warning stays on after you have released the parking brake, contact an authorized dealer.

## Rear Axle

Message	Action
Axle Over Temperature Reduce Speed	This message appears when the oil temperature in the rear differential exceeds a safe limit. Reduce speed to allow the oil temperature to return to normal levels.

## Remote Start

Message	Action
To Drive: Press Brake and Start Button	A reminder to apply the brake and push the start button to drive your vehicle after a remote start.

## Seats

Message	Action
Memory Recall Not Permitted While Driving	A reminder that memory seats are not available while driving.
Memory {0} Saved	Shows where you have saved your memory setting.

# Information Displays

## Starting System

Message	Action
To START Press Brake	A reminder to apply the brake when starting your vehicle.
To START Press Clutch	A reminder to apply the clutch when starting your vehicle.
Cranking Time Exceeded	The starter has exceeded its cranking time in attempting to start your vehicle.
Engine Start Pending Please Wait	The starter is attempting to start your vehicle.
Pending Start Cancelled	The system has cancelled the pending start.

## Steering System

Message	Action
Steering Fault Service Now	The power steering system has detected a condition that requires service. See an authorized dealer.
Steering Loss Stop Safely	The power steering system is not working. Stop your vehicle in a safe place. Contact an authorized dealer.
Steering Assist Fault Service Required	The power steering system has detected a condition within the power steering system or passive entry or passive start system requires service. Contact an authorized dealer.
Steering Lock Malfunc- tion Service Now	The steering lock system has detected a condition that requires service. See an authorized dealer.
Steering Column Lock Remove and re-insert key while turning wheel to unlock	You need to turn your steering wheel while start your vehicle to unlock your steering column.

## Suspension System

Message	Action
Suspension Fault Speed Limited to XX MPH/km/ h	Displays if the adaptive damping system detects a condition that requires service. Your vehicle speed is limited to 80 mph (130 km/h). Have your vehicle serviced soon.

# Information Displays

## Tire Mobility Kit

Message	Action
Service Tire Mobility Kit	This message appears when the tire sealing compound in the Temporary Mobility Kit expires and you need to replace it.

## Tire Pressure Monitoring System

Message	Action
Tire Pressure Low	One or more tires on your vehicle has low tire pressure. See <b>Tire Pressure Monitoring System</b> (page 284).
Tire Pressure Monitor Fault	The tire pressure monitoring system is malfunctioning. If the warning stays on or continues to come on, contact an authorized dealer. See <b>Tire Pressure Monitoring System</b> (page 284).
Tire Pressure Sensor Fault	A tire pressure sensor is malfunctioning or your spare tire is in use. See <b>Tire Pressure Monitoring System</b> (page 284). If the warning stays on or continues to come on, contact an authorized dealer as soon as possible.

## Traction Control

Message	Action
Traction Control Off / Traction Control On	The status of the traction control system after you switched it off or on. See <b>Using Traction Control</b> (page 157).
Spinout Detected Hazards Activated	A spinout has occurred and the hazards are on.

# Information Displays

## Transmission

Message	Action
Transmission Malfunction Service Now	See your authorized dealer.
Transmission Overheating Stop Safely	The transmission is overheating and needs to cool. Stop in a safe place as soon as it is possible.
Transmission Over Temperature Stop Safely	The transmission has overheated and needs to cool. Stop in a safe place as soon as it is possible.
Transmission Service Required	See your authorized dealer.
Transmission Too Hot Press Brake	Transmission is getting hot. Stop to let it cool.
Transmission Limited Function See Manual	Displays when the transmission has overheated and has limited functionality.
Transmission Warming Up Please Wait	Transmission is too cold. Wait for it to warm up before you drive.
Transmission Not in Park	Displays as a reminder to shift into park.
Press Brake Pedal	Displays as a reminder to press the brake pedal in order to select a gear.
Transmission Adjusted	Displays when the transmission has adjusted the shift strategy.
Transmission Adapt-Mode	Displays when the transmission is adjusting the shift strategy.
Transmission Indicating Mode Lockup On	Displays when the transmission shift lever is locked and unable to select gears.
Transmission Indicating Mode Lockup Off	Displays when the transmission shift lever is unlocked and free to select gears.

# Climate Control

## MANUAL CLIMATE CONTROL

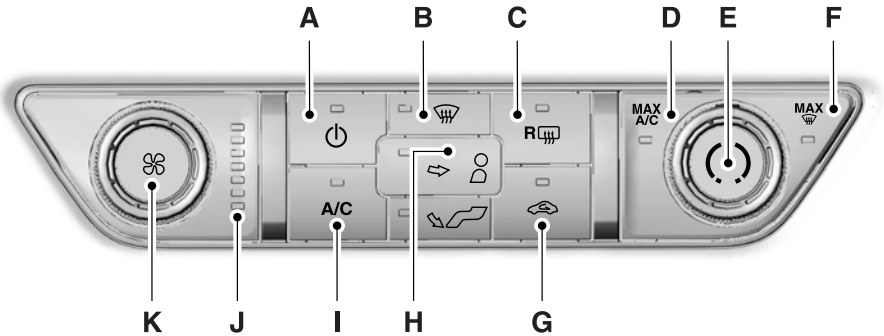

E174095

- A Power.
- B Defrost.
- C Heated rear window.
- D MAX A/C.
- E Temperature control.
- F MAX defrost.
- G Recirculated air.
- H Air distribution control.
- I A/C.
- J Fan speed indicator.
- K Fan speed control.

### Power

Press to switch the system on and off. When the system is off, it prevents outside air from entering the vehicle.

### Defrost

Press to distribute air through the windshield air vents and de-mister. Air distribution to the instrument panel and footwell vents turns off. You can also use this setting to defog and clear the windshield of a thin covering of ice.



# Climate Control

---

## Heated Rear Window

Press to switch the heated rear window on and off. See **Heated Rear Window** (page 115).

## Max A/C

Adjust the control for maximum cooling. Recirculated air flows through the instrument panel vents, air conditioning turns on and the fan adjusts to the highest speed.

**Note:** *Note: In certain conditions (for example, maximum defrost), the air conditioning compressor may continue to operate even though you switch off the air conditioning.*

## Temperature Control

Adjust the temperature using the control.

## Max Defrost

Adjust the control to switch on defrost. Air flows through the windshield vents and the fan adjusts to the highest speed. You can also use this setting to defog and clear the windshield of a thin covering of ice. The heated rear window also turns on when you select maximum defrost.

**Note:** *To prevent window fogging, you cannot select recirculated air when maximum defrost is on.*

## Recirculated Air

Press to switch between outside air and recirculated air. The air currently in the passenger compartment recirculates. This may reduce the time needed to cool the interior (when used with A/C) and reduce unwanted odors from entering your vehicle.

**Note:** *Recirculated air may turn off (or prevent you from switching on) in all air flow modes except MAX A/C to reduce the risk of fogging. Recirculation may also turn on and off in various air distribution control combinations during hot weather in order to improve cooling efficiency.*

## Air Distribution Control

Press to switch air flow from the windshield, instrument panel or footwell vents on or off. You can distribute air through any combination of these vents.

## A/C

Press the button to switch the air conditioning on or off. Use air conditioning with recirculated air to improve cooling performance and efficiency.

**Note:** *In certain conditions (for example, maximum defrost), the air conditioning compressor may continue to operate even though you switch off the air conditioning.*

## Fan Speed Indicator

Illuminates to indicate fan speed.

## Fan Speed Control

Adjust the volume of air circulated in the vehicle.

# Climate Control

## AUTOMATIC CLIMATE CONTROL

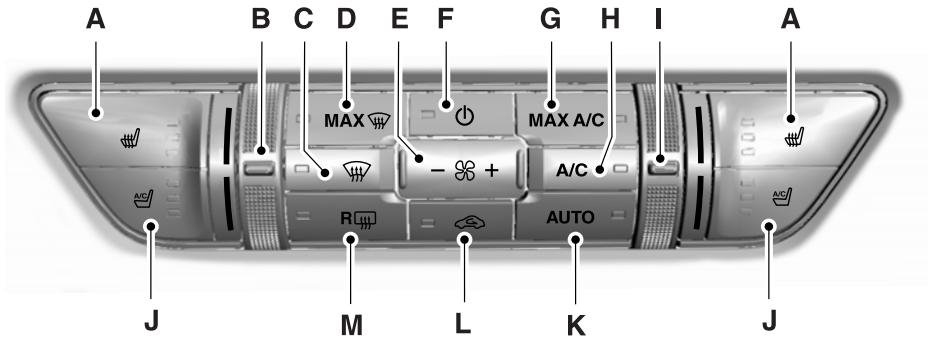

E174096

- A Heated seats.
- B Left-hand temperature control.
- C Defrost.
- D MAX defrost.
- E Fan speed control.
- F Power.
- G MAX A/C.
- H A/C.
- I Right-hand temperature control.
- J Climate controlled seats.
- K AUTO.
- L Recirculated air.
- M Heated rear window.

### Heated Seats

Press to cycle through the various heat settings and off. See **Climate Controlled Seats** (page 122).

### Left-hand Temperature Control

Adjusts the temperature setting on the left-hand side.

# Climate Control

---

**Note:** The system may limit the maximum difference between driver and passenger settings. Whenever you make an adjustment that would result in a larger difference, both settings change together.

## Defrost

Press to distribute air through the windshield air vents and de-mister. Air distribution to the instrument panel and footwell vents turns off. You can also use this setting to defog and clear the windshield of a thin covering of ice.

## Max Defrost

Press to switch on defrost. The left-hand and right-hand settings set to HI, air flows through the windshield vents, and the fan adjusts to the highest speed. You can also use this setting to defog and clear the windshield of a thin covering of ice. The heated rear window also turns on when you select maximum defrost.

**Note:** To prevent window fogging, you cannot select recirculated air when maximum defrost is on.

## Fan Speed Control

Adjust the volume of air circulated in the vehicle.

## Power

Press to switch the system on and off. When the system is off, it prevents outside air from entering the vehicle.

## Max A/C

Press for maximum cooling. The left-hand and right-hand settings set to LO, recirculated air flows through the instrument panel vents, air conditioning turns on and the fan adjusts to the highest speed.

## A/C

Press the button to switch the air conditioning on or off. Use air conditioning with recirculated air to improve cooling performance and efficiency.

**Note:** In certain conditions (for example, maximum defrost), the air conditioning compressor may continue to operate even though you switch off the air conditioning.

## Right-hand Temperature Control

Adjusts the temperature setting on the right-hand side.

## Climate Controlled Seats

Press to cycle through the various climate controlled seat settings and off. See **Climate Controlled Seats** (page 122).

## Auto

Press to switch on automatic operation, then adjust the temperature control to select the desired temperature. Fan speed, air distribution, air conditioning operation, and outside or recirculated air adjust to heat or cool the vehicle to maintain the desired temperature. You can also switch off dual zone mode by pressing and holding for more than two seconds.

## Recirculated Air

Press to switch between outside air and recirculated air. The air currently in the passenger compartment recirculates. This may reduce the time needed to cool the interior (when used with A/C) and reduce unwanted odors from entering your vehicle.

**Note:** Recirculated air may turn off (or prevent you from switching on) in all air flow modes except MAX A/C to reduce the risk of fogging. Recirculation may also turn on and off in various air distribution control combinations during hot weather to improve cooling efficiency.

# Climate Control

## Heated Rear Window

Press to switch the heated rear window on and off. See **Heated Rear Window** (page 115).

## HINTS ON CONTROLLING THE INTERIOR CLIMATE

### General Hints

**Note:** Prolonged use of recirculated air may cause the windows to fog up.

**Note:** You may feel a small amount of air from the footwell air vents regardless of the air distribution setting.

**Note:** To reduce humidity build-up inside your vehicle, do not drive with the system switched off or with recirculated air always switched on.

**Note:** Do not place objects under the front seats as this may interfere with the airflow to the rear seats.

**Note:** Remove any snow, ice or leaves from the air intake area at the base of the windshield.

**Note:** To improve the time to reach a comfortable temperature in hot weather, drive with the windows open until you feel cold air through the air vents.

### Quickly Heating the Interior

	Manual climate control	Automatic climate control
1	Adjust the fan speed to the highest setting.	Press <b>AUTO</b> .
2	Adjust the temperature control to the full heat setting.	Adjust the temperature control to the desired setting.
3	Direct air to the footwell using the air distribution buttons.	

## Manual Climate Control

**Note:** To reduce fogging of the windshield during humid weather, adjust the air distribution control to the windshield air vents position.

## Automatic Climate Control

**Note:** Adjusting the settings when your vehicle interior is extremely hot or cold is not necessary. The system automatically adjusts to heat or cool the interior to your selected temperature as quickly as possible. For the system to function efficiently, the instrument panel and side air vents should be fully open.

**Note:** If you select **AUTO** during cold temperatures, the system directs airflow to the windshield and side window vents. In addition, the fan may run at a slower speed until the engine warms up.

**Note:** If you select **AUTO** during hot temperatures and the inside of the vehicle is hot, the system automatically uses recirculated air to maximize interior cooling. Fan speed may also reduce until the air cools.

# Climate Control

## Recommended Settings for Heating

	<b>Manual climate control</b>	<b>Automatic climate control</b>
1	Adjust the fan speed to the center setting.	Press <b>AUTO</b> .
2	Adjust the temperature control to the midway point of the hot settings.	Adjust the temperature control to the desired setting. Use 72°F (22°C) as a starting point, then adjust the setting as necessary.
3	Direct air to the footwell using the air distribution buttons.	

## Quickly Cooling the Interior

	<b>Manual climate control</b>	<b>Automatic climate control</b>
1	Select <b>MAX A/C</b> .	Select <b>MAX A/C</b> .
2	Drive with the windows open until you feel cold air through the air vents.	

## Recommended Settings for Cooling

	<b>Manual climate control</b>	<b>Automatic climate control</b>
1	Adjust the fan speed to the center setting.	Press <b>AUTO</b> .
2	Adjust the temperature control to the midway point of the cold settings.	Adjust the temperature control to the desired setting. Use 72°F (22°C) as a starting point, then adjust the setting as necessary.
3	Direct air to the instrument panel using the air distribution buttons.	

# Climate Control

## Defogging the Side Windows in Cold Weather

	Manual climate control	Automatic climate control
1	Direct air to the windshield using the air distribution buttons.	Press the defrost button.
2	Press <b>A/C</b> .	Adjust the temperature control to the desired setting. Use 72°F (22°C) as a starting point, then adjust the setting as necessary.
3	Adjust the temperature control to the desired setting.	
4	Adjust the fan speed to the highest setting.	

## HEATED REAR WINDOW



Press the button to clear the rear window of thin ice and fog. The heated rear window turns off after a short period of time.

**Note:** Do not use harsh chemicals, razor blades or other sharp objects to clean or remove decals from the inside of the heated rear window. The vehicle warranty may not cover damage to the heated rear window grid lines.

## HEATED EXTERIOR MIRRORS

(IF EQUIPPED)

When you switch the heated rear window on, the heated exterior mirrors turn on.

**Note:** Do not remove ice from the mirrors with a scraper or adjust the mirror glass when it is frozen in place.

**Note:** Do not clean the mirror housing or glass with harsh abrasives, fuel or other petroleum-based cleaning products. The vehicle warranty may not cover damage caused to the mirror housing or glass.

## CABIN AIR FILTER

Your vehicle is equipped with a cabin air filter, which gives you and your passengers the following benefits:

- It improves your driving comfort by reducing particle concentration.
- It improves the interior compartment cleanliness.
- It protects the climate control components from particle deposits.

You can locate the cabin air filter behind the glove box.

**Note:** Make sure you have a cabin air filter installed at all times. This prevents foreign objects from entering the system. Running the system without a filter in place could result in degradation or damage to the system.

Replace the filter at regular intervals. See **Scheduled Maintenance** (page 422).

For additional cabin air filter information, or to replace the filter, see an authorized dealer.

# Climate Control

---

## REMOTE START (IF EQUIPPED)

You can switch this feature on or off and adjust the settings using the information display.

The system adjusts the interior temperature depending on your chosen settings during remote start.

You cannot adjust the climate control setting during remote start operation. When you switch the ignition on, the climate control system returns to the previous settings. You can now make adjustments.

You need to switch on certain vehicle-dependent features, such as:

- Heated seats.
- Cooled seats.
- Heated steering wheel.
- Heated mirrors.
- Heated rear window.

## Automatic Settings

In hot weather, the system sets to 72°F (22°C). The cooled seats are set to high (if available, and **AUTO** is on in the information display).

In moderate weather, the system either heats or cools (based on previous settings). The rear defroster, heated mirrors and heated or cooled seats do not turn on.

In cold weather, the system sets to 72°F (22°C). The heated seats are set to high (if available, and **AUTO** is on in the information display). The heated rear window and heated mirrors turn on.

# Seats

## SITTING IN THE CORRECT POSITION



**WARNING:** Sitting improperly, out of position or with the seatback reclined too far can take weight off the seat cushion and affect the decision of the passenger sensing system, resulting in serious injury or death in the event of a crash. Always sit upright against your seat back, with your feet on the floor.



**WARNING:** Do not recline the seatback too far as this can cause the occupant to slide under the seatbelt, resulting in serious injury in the event of a collision.



**WARNING:** Do not place objects higher than the top of the seat backrest. Failure to follow this instruction could result in personal injury or death in the event of a sudden stop or crash.

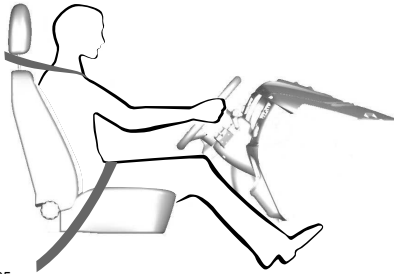

E68595

When you use them properly, the seat, head restraint, seatbelt and airbags will provide optimum protection in the event of a crash.

We recommend that you follow these guidelines:

- Sit in an upright position with the base of your spine as far back as possible.
- Do not recline the seat backrest so that your torso is more than 30° from the upright position.
- Adjust the head restraint so that the top of it is level with the top of your head and as far forward as possible. Make sure that you remain comfortable.
- Keep sufficient distance between yourself and the steering wheel. We recommend a minimum of 10 in (25 cm) between your breastbone and the airbag cover.
- Hold the steering wheel with your arms slightly bent.
- Bend your legs slightly so that you can press the pedals fully.
- Position the shoulder strap of the seatbelt over the center of your shoulder and position the lap strap tightly across your hips.

Make sure that your driving position is comfortable and that you can maintain full control of your vehicle.

## HEAD RESTRAINTS



**WARNING:** Fully adjust the head restraint before you operate your vehicle. This will help minimize the risk of neck injury in the event of a crash. Do not adjust the head restraint when your vehicle is moving.



# Seats



**WARNING:** The adjustable head restraint is a safety device. Whenever possible it should be installed and properly adjusted when the seat is occupied. Failure to adjust the head restraint properly could reduce its effectiveness during certain impacts.



**WARNING:** Install the head restraint properly to help minimize the risk of neck injury in the event of a crash.

**Note:** Adjust the seatback to an upright driving position before adjusting the head restraint. Adjust the head restraint so that the top of it is level with the top of your head and as far forward as possible. Make sure that you remain comfortable. If you are extremely tall, adjust the head restraint to its highest position.

## Front seat head restraints (if equipped)

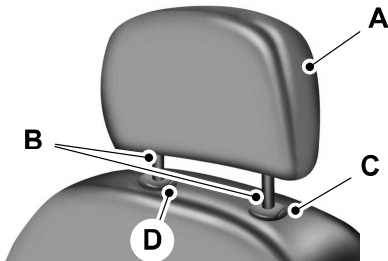

E138642

The head restraints consist of:

- A An energy absorbing head restraint.
- B Two steel stems.

- C Guide sleeve adjust and release button.
- D Guide sleeve unlock and remove button.

## Adjusting the Head Restraint

### Raising the Head Restraint

Pull the head restraint up.

### Lowering the Head Restraint

1. Press and hold button C.
2. Push the head restraint down.

### Removing the Head Restraint

1. Pull the head restraint up until it reaches its highest position.
2. Press and hold buttons C and D.
3. Pull the head restraint up.

### Installing the Head Restraint

Align the steel stems into the guide sleeves and push the head restraint down until in locks.

## Front Seat Non-Adjustable Head Restraints (If Equipped)



E174407

The non-adjustable head restraints consist of a trimmed foam covering over the upper structure of the seatback.

# Seats

Properly adjust the seatback to an upright driving or riding position, so that the head restraint is positioned as close as possible to the back of your head.

## Tilting Head Restraints (if Equipped)

The front head restraints tilt for extra comfort. To tilt the head restraint, do the following:



E144727

1. Adjust the seatback to an upright driving or riding position.
2. Pivot the head restraint forward toward your head to the desired position.

After the head restraint reaches the forward-most tilt position, pivoting it forward again will then release it to the rearward, un-tilted position.

## MANUAL SEATS (IF EQUIPPED)



**WARNING:** Do not adjust the driver's seat or seatback when your vehicle is moving.



**WARNING:** Rock the seat backward and forward after releasing the lever to make sure that it is fully engaged.



**WARNING:** Reclining the seatback can cause an occupant to slide under the seat's safety belt, resulting in severe personal injuries in the event of a crash.

The manual front seats may consist of:



E174553

- A A bar to move the seat backward and forward.
- B A lever to adjust the height of the seat.
- C A lever to adjust the angle of the seatback.

# Seats

## POWER SEATS (IF EQUIPPED)



**WARNING:** Do not adjust the driver seat or seatback when your vehicle is moving.



**WARNING:** Do not place cargo or any objects behind the seatback before returning it to the original position.

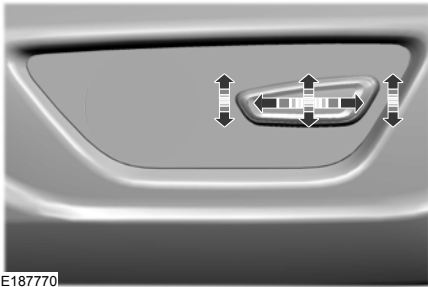

E187770

The power seat control is located on the outboard side of the seat. Move the control in the direction of the arrows to raise or lower the seat cushion or to move the seat forward, backward, up or down.

### Power Lumbar (If Equipped)

The power lumbar control is located on the side of the driver seat.

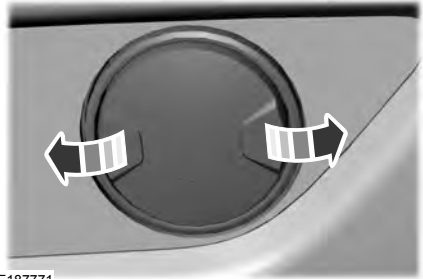

E187771

Press one side of the control to increase lower back firmness. Press the other side of the control to decrease lower back firmness.

## MEMORY FUNCTION (IF EQUIPPED)



**WARNING:** Before activating the memory seat, make sure that the area immediately surrounding the seat is clear of obstructions and that all occupants are clear of moving parts.



**WARNING:** Do not use the memory function when your vehicle is moving.

This feature automatically recalls the position of the following.

- Driver seat.
- MyColor settings.
- Power mirrors.

The memory control is on the driver door.

# Seats



E142554

## Saving a PreSet Position

1. Switch the ignition on.
2. Adjust the memory features to your desired position.
3. Press and hold the desired preset button until you hear a single tone.

You can save up to three preset memory positions. You can save a memory preset at any time.

## Recalling a PreSet Position

Press and release the preset button associated with your desired driving position. The memory features move to the position stored for that preset.

**Note:** You can only recall a preset memory position when the ignition is off, or when the transmission is in park (P) or neutral (N) if the ignition is on.

You can also recall a preset memory position by:

- Pressing the unlock button on your intelligent access key fob if it is linked to a preset position.
- Unlocking the intelligent driver door handle if a linked key fob is present.

**Note:** When the ignition is off and you use a linked key fob to recall your memory position, the seat moves to the Easy Entry position.

**Note:** Pressing any active memory feature adjustment control (or any memory button) during a memory recall cancels the operation.

Seat recall movement also stops if you drive your vehicle.

## Linking a PreSet Position to your Remote Control or Intelligent Access Key Fob

You can save preset memory positions for up to three remote controls or intelligent access (IA) keys.

1. With the ignition on, move the memory positions to the desired positions.
2. Press and hold the desired preset button for about five seconds. A tone sounds after about two seconds. Continue holding until you hear a second tone.
3. Within three seconds, press the lock button on the remote control you are linking.

To unlink a remote control, follow the same procedure – except in step 3, press the unlock button on the remote control.

**Note:** If more than one linked remote control or intelligent access key is in range, the memory function moves to the settings of the first key to initiate a memory recall.

## Easy Entry and Exit Feature

If you enable the easy entry and exit feature, it automatically moves the driver seat position rearward up to 2 in (5 cm) when you switch the ignition off.

The driver seat returns to the previous position when you switch the ignition on.

You can enable or disable this feature through the information display. See **Information Displays** (page 88).

# Seats

## REAR SEATS



**WARNING:** When folding the seat backrest down, take care not to get your fingers caught in the mechanism.



**WARNING:** Make sure that the seats and the seat backrests are secure and fully locked in their catches.

## Accessing the Rear Seats



E207088

Use the seatback release to fold the back of the front seat forward for rear seat access. The release handle is on the upper back of the front seat. The seatback has memory and locks automatically in the original position.

## Second Row Split-Folding Rear Seat (If Equipped)

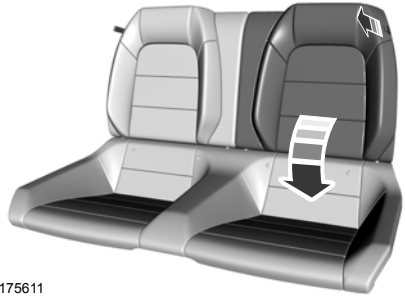

E175611

To lower the seatback(s):

1. Pull the strap to release the seatback.
2. Fold the seatback down.

## Returning the Seatbacks to the Upright Position

When raising the seatback(s), push the top of the seatback rearward and make sure you hear the seat latch into place. Pull down on the seatback to make sure that it has locked into position.

## CLIMATE CONTROLLED SEATS

(IF EQUIPPED)

### Heated Seats



**WARNING:** People who are unable to feel pain to their skin because of advanced age, chronic illness, diabetes, spinal cord injury, medication, alcohol use, exhaustion or other physical conditions, must use caution when using the heated seat. The heated seat may cause burns even at low temperatures, especially if used for long periods of time. Do not place anything on the seat that

# Seats

may block the heat, such as a blanket or cushion. This can cause the heated seat to overheat. Do not puncture the seat with pins, needles or other pointed objects. This damages the heating element and can cause the heated seat to overheat. An overheated seat may cause serious personal injury.

Press the cooled seat symbol to cycle through the various cool settings and off. More indicator lights indicate cooler settings.

If the engine falls below 350 RPM while the cooled seats are on, the feature turns itself off. You will need to reactivate it.

**Note:** Do not do the following:

- Place heavy objects on the seat.
- Operate the seat heater if water or any other liquid spills on the seat. Allow the seat to dry thoroughly.
- Operate the heated seats unless the engine is running. Doing so can cause the battery to lose charge.



E146322

Press the heated seat symbol to cycle through the various heat settings and off. More indicator lights indicate warmer settings.

## Cooled Seats

The cooled seats only function when the engine is running.



E146309

## Garage Door Opener (If Equipped)

### UNIVERSAL GARAGE DOOR OPENER

#### HomeLink Wireless Control System



**WARNING:** Make sure that the garage door and security device are free from obstruction when you are programming. Do not program the system with the vehicle in the garage.



**WARNING:** Do not use the system with any garage door opener that does not have the safety stop and reverse feature as required by U.S. Federal Safety Standards (this includes any garage door opener manufactured before April 1, 1982). A garage door opener which cannot detect an object, signaling the door to stop and reverse, does not meet current federal safety standards. Using a garage door opener without these features increases the risk of serious injury or death.

**Note:** Make sure you keep the original remote control transmitter for use in other vehicles as well as for future system programming.

**Note:** We recommend that upon the sale or lease termination of your vehicle, you erase the programmed function buttons for security reasons. See **Erasing the Function Button Codes** later in this section.

**Note:** You can program a maximum of three devices. To change or replace any of the three devices after it has been initially programmed, you must first erase the current settings. See **Erasing the Function Button Codes**.



E188211

The universal garage door opener replaces the common hand-held garage door opener with a three-button transmitter integrated into the driver's sun visor.

The system includes two primary features, a garage door opener and a platform for remote activation of devices within the home. You can program garage doors as well as entry gate operators, security systems, entry door locks and home or office lighting.

Additional system information can be found online at [www.homelink.com](http://www.homelink.com), [www.youtube.com/user/HomeLinkGentex](http://www.youtube.com/user/HomeLinkGentex) or by calling the toll-free help line at 1-800-355-3515.

#### In-Vehicle Programming

This process is to program your in-vehicle HomeLink function button with your hand-held transmitter.

**Note:** The programming steps below assume you will be programming HomeLink that was not previously programmed. If your HomeLink was previously programmed, you may need to erase your HomeLink buttons. See **Erasing the Function Button Codes**.

**Note:** Put a new battery in the hand-held transmitter. This helps ensure quicker training and accurate transmission of the radio-frequency signal.

## Garage Door Opener (If Equipped)

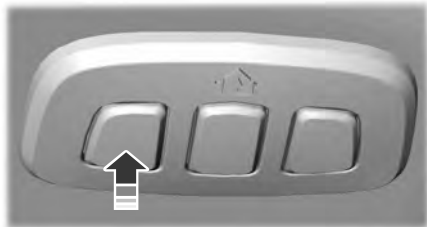

E188212

1. With your vehicle parked outside of the garage, switch your ignition to the **on** position, but do not start your vehicle.
2. Press and release the function button that you would like to program.
3. Hold your hand-held garage door transmitter 1–3 in (2–8 cm) away from the HomeLink button you want to program.
4. Press and hold the hand-held transmitter button you want to program while watching the indicator light on HomeLink. Continue to hold the hand-held button until the HomeLink indicator light flashes rapidly or is continuously on.

**Note:** *You may need to use a different method if you live in Canada or have difficulties programming your gate operator or garage door opener. See **Gate Operator / Canadian Programming.***

5. Press and hold the HomeLink button you programmed for two seconds, then release. You may need to do this twice to activate the door. If your garage door does not operate, watch the HomeLink indicator light.

**If the indicator light stays on, the programming is complete. Your device should activate when the HomeLink button is pressed and released.**

If the indicator light flashes rapidly, press and hold for two seconds and release the programmed HomeLink button. Repeat the "press/hold/release" sequence up to three times to complete the programming process. If your device still does not operate, you must program your garage door. See **Programming Your Garage Door Opener Motor.**

To program additional buttons, repeat Steps 1 – 4.

For questions or comments, please contact HomeLink at [www.homelink.com](http://www.homelink.com), [www.youtube.com/user/HomeLinkGentex](http://www.youtube.com/user/HomeLinkGentex) or by calling the toll-free help line at 1-800-355-3515.

### Programming Your Garage Door Opener Motor

**Note:** *You may need a ladder to reach the unit and you may need to remove the cover or lamp lens on your garage door opener.*



E142659

1. Press the learn button on the garage door opener motor and then you have 30 seconds to complete the next two steps.
2. Return to your vehicle.



## Garage Door Opener (If Equipped)



E188212



E188213

3. Press and hold the function button you want to program for 2 seconds, then release. Repeat this step. Depending on your brand of garage door opener, you may need to repeat this sequence a third time.

### Gate Operator / Canadian Programming

Canadian radio-frequency laws require transmitter signals to “time-out” (or quit) after several seconds of transmission – which may not be long enough for HomeLink to pick up the signal during programming. Similar to this Canadian law, some U.S. gate operators are designed to “time-out” in the same manner.

**Note:** *If programming a garage door opener or gate operator, it is advised to unplug the device during the “cycling” process to prevent possible overheating.*

1. Press and release, **every two seconds**, your hand-held transmitter until the HomeLink indicator light changes to a rapidly blinking or continuously on light.
2. Release the hand-held transmitter button.
3. Continue programming HomeLink. See **In-Vehicle Programming, Step 4.**

### Erasing the Function Button Codes

**Note:** *You cannot erase individual buttons.*

1. Press and hold the outer two function buttons simultaneously for approximately 10 seconds until the indicator light above the buttons flashes rapidly.
2. When the indicator light flashes, release the buttons. You erased the codes for all buttons.

### Reprogramming a Single Button

To program a device to a previously trained button, follow these steps:

1. Press and hold the desired button. Do NOT release the button.
2. The indicator light begins to flash after 20 seconds. Without releasing the button, follow Step 1 in the Programming section.

For questions or comments, contact HomeLink at [www.homelink.com](http://www.homelink.com), [www.youtube.com/user/HomeLinkGentex](http://www.youtube.com/user/HomeLinkGentex) or by calling the toll-free help line at 1-800-355-3515.

## Garage Door Opener (If Equipped)

---

### **FCC and RSS-210 Industry Canada Compliance**

This device complies with Part 15 of the FCC Rules and with RSS-210 of Industry Canada. Operation is subject to the following two conditions: (1) this device may not cause harmful interference, and (2) this device must accept any interference received, including interference that may cause undesired operation.

**Note:** *Changes or modifications to your device not expressly approved by the party responsible for compliance can void the user's authority to operate the equipment.*

This equipment complies with FCC radiation exposure limits set forth for an uncontrolled environment. End Users must follow the specific operating instructions for satisfying RF exposure compliance. This transmitter must be at least 8 in (20 cm) from the user and must not be co-located or operating in conjunction with any other antenna or transmitter.

The term "IC:" before the certification/registration number only signifies that Industry Canada technical specifications were met.

# Auxiliary Power Points

---

## 12 Volt DC Power Point



**WARNING:** Do not plug optional electrical accessories into the cigar lighter socket. Incorrect use of the cigar lighter can cause damage not covered by the vehicle warranty, and can result in fire or serious injury.

**Note:** *When you switch the ignition on, you can use the socket to power 12 volt appliances with a maximum current rating of 15 amps.*

*If the power supply does not work after you switch the ignition off, switch the ignition on.*

**Note:** *Do not hang any accessory from the accessory plug.*

**Note:** *Do not use the power point over the vehicle capacity of 12 volt DC 180 watts or a fuse may blow.*

**Note:** *Always keep the power point caps closed when not in use.*

Do not insert objects other than an accessory plug into the power point. This damages the power point and may blow the fuse.

Run the vehicle for full capacity use of the power point.

To prevent the battery from running out of charge:

- Do not use the power point longer than necessary when the vehicle is not running.
- Do not leave devices plugged in overnight or when you park your vehicle for extended periods.

## Locations

Power points may be in the following locations:

- On the front of the center console.
- Inside the center console.

# Storage Compartments

## CENTER CONSOLE

Stow items in the cup holder carefully as items may become loose during hard braking, acceleration or crashes, including hot drinks which may spill.

The console includes:

- Cup holder.
- Storage compartment.



E209039

Lift the latch to open the storage compartment to access the following features:

- Auxiliary power point.
- USB port.

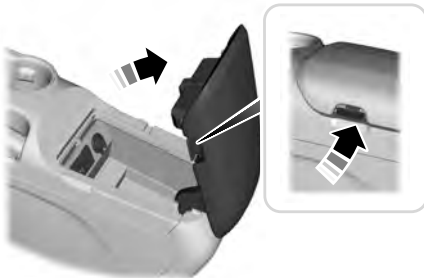

E175706

## Locking Storage Bin (If Equipped)

**Note:** You cannot lock the storage bin when the vehicle is on.

The storage bin locks when you electronically lock the doors. The bin unlocks when you use the remote control to unlock the driver door.

## GLASSES HOLDER

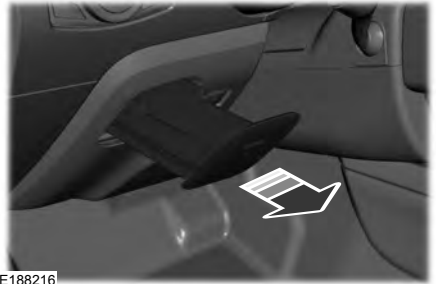

E188216

Press near the center of the door to open it. Pull out the tray.

# Starting and Stopping the Engine

## GENERAL INFORMATION



**WARNING:** Extended idling at high engine speeds can produce very high temperatures in the engine and exhaust system, creating the risk of fire or other damage.



**WARNING:** Do not park, idle or drive your vehicle on dry grass or other dry ground cover. The emission system heats up the engine compartment and exhaust system, creating the risk of fire.



**WARNING:** Do not start the engine in a closed garage or in other enclosed areas. Exhaust fumes can be toxic. Always open the garage door before you start the engine.



**WARNING:** Exhaust leaks may result in entry of harmful and potentially lethal fumes into the passenger compartment. If you smell exhaust fumes inside your vehicle, have your vehicle inspected immediately. Do not drive if you smell exhaust fumes.

If you disconnect the battery, your vehicle may exhibit some unusual driving characteristics for approximately 5 mi (8 km) after you reconnect it. This is because the engine management system must realign itself with the engine. You can disregard any unusual driving characteristics during this period.

The powertrain control system meets all Canadian interference-causing equipment standard requirements regulating the impulse electrical field or radio noise.

When you start the engine, avoid pressing the accelerator pedal before and during operation. Only use the accelerator pedal when you have difficulty starting the engine.

## KEYLESS STARTING

**Note:** The keyless starting system may not function if the key is close to metal objects or electronic devices such as cellular phones.

**Note:** A valid key must be located inside your vehicle to switch the ignition on and start the engine.

## Ignition Modes



E248637

The keyless starting system has three modes:

**Off:** Turns the ignition off.

- Without applying the brake pedal, press and release the button once when the ignition is in the on mode, or when the engine is running but the vehicle is not moving.

**On:** All electrical circuits are operational and the warning lamps and indicators illuminate.

# Starting and Stopping the Engine

- Without applying the brake pedal, press and release the button once.

**Start:** Starts the engine.

- Press the brake pedal (automatic transmission) or clutch pedal (manual transmission), and then press the button for any length of time. An indicator light on the button illuminates when the ignition is on and when the engine starts.

## STEERING WHEEL LOCK

Your vehicle has an electronically controlled steering wheel lock that automatically operates.

The steering wheel will lock shortly after you have parked your vehicle and the passive key is outside it or when you lock your vehicle.

**Note:** *The steering wheel will not lock when the ignition is on or when your vehicle is moving.*

## Unlocking the Steering Wheel

The steering wheel unlocks when the system detects a valid passive key inside your vehicle. If the steering wheel relocks, switch the ignition on to unlock it.

**Note:** *You may have to slightly rotate the steering wheel to assist unlocking it.*

## STARTING A GASOLINE ENGINE

When you start the engine, the idle speed increases, this helps to warm up the engine. If the engine idle speed does not slow down automatically, have your vehicle checked by an authorized dealer.

**Note:** *You can crank the engine for a total of 60 seconds (without the engine starting) before the starting system temporarily disables. The 60 seconds does not have to be all at once. For example, if you crank the engine three times for 20 seconds each time, without the engine starting, you reached the 60-second time limit. A message appears in the information display alerting you that you exceeded the cranking time. You cannot attempt to start the engine for at least 15 minutes. After 15 minutes, you are limited to a 15-second engine cranking time. You need to wait 60 minutes before you can crank the engine for 60 seconds again.*

Before starting the engine, check the following:

- Make sure all occupants have fastened their seatbelts.
- Make sure the headlamps and electrical accessories are off.
- Make sure the parking brake is on.
- Move the transmission selector lever to park (P) (automatic transmission) or neutral (manual transmission)

**Note:** *Do not touch the accelerator pedal.*

**Note:** *You must have your intelligent access key in the vehicle in order to shift the transmission out of position **P**.*

1. Fully press the brake pedal.
2. Press the button.

The system does not function if:

- The key frequencies are jammed.
- The key battery has no charge.

If you are unable to start the engine, do the following:

# Starting and Stopping the Engine

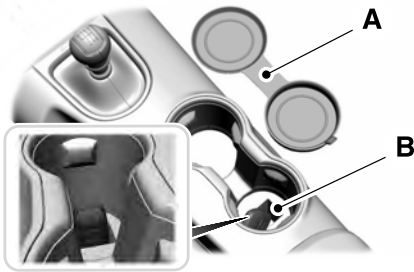

E174956

1. Remove the rubber covering (A) in the cupholder.
2. Place the remote in the backup slot (B) with the buttons facing up and the keyring toward the front of the vehicle.
3. With the key in this position, press the brake pedal (automatic transmission) or clutch pedal (manual transmission), then the START button to switch the ignition on and start your vehicle.

## Fast Restart

The fast restart feature allows you to restart the engine within 20 seconds of switching it off, even if a valid key is not present.

Within 20 seconds of switching the engine off, press the brake pedal (automatic transmission) or clutch pedal (manual transmission) and press the button. After 20 seconds have expired, you can no longer restart the engine without the key present inside your vehicle.

Once the engine has started, it remains running until you press the button, even if the system does not detect a valid key. If you open and close a door while the engine is running, the system searches for a valid key. You cannot restart the engine if the system does not detect a valid key within 20 seconds.

## Failure to Start

If you cannot start the engine after three attempts, wait 10 seconds and follow this procedure:

1. If your vehicle is equipped with an automatic transmission, fully press the brake pedal. If your vehicle is equipped with a manual transmission, fully press the clutch pedal and apply the handbrake.
2. Move the transmission selector lever to park (P) (automatic transmission) or neutral (manual transmission).
3. Fully press the accelerator pedal and hold it there.
4. Start the engine.

## Automatic Engine Shutdown

Your vehicle is equipped with a feature that automatically shuts down the engine if it has been idling for an extended period. The ignition also turns off in order to save battery power. Before the engine shuts down, a message appears in the information display showing a timer counting down from 30 seconds. If you do not intervene within 30 seconds, the engine shuts down. Another message appears in the information display to inform you that the engine has shut down in order to save fuel. Start your vehicle as you normally do.

## Automatic Engine Shutdown Override

**Note:** *You cannot permanently switch off the automatic engine shutdown feature. When you switch it off temporarily, it turns on at the next ignition cycle.*

You can stop the engine shutdown, or reset the timer, at any point before the 30-second countdown has expired by doing any of the following:

# Starting and Stopping the Engine

- You can reset the timer by interacting with your vehicle (such as pressing the brake pedal or accelerator pedal).
- You can temporarily switch off the shutdown feature any time the ignition is on (for the current ignition cycle only). Use the information display to do so. See **Information Displays** (page 88).
- During the countdown before engine shutdown, you are prompted to press OK or RESET (depending on your type of information display) to temporarily switch the feature off (for the current ignition cycle only).

## Stopping the Engine When Your Vehicle is Stationary

1. Move the transmission selector lever to park (P) (automatic transmission) or neutral (manual transmission).
2. Press the button once.
3. Apply the parking brake.

**Note:** This switches off the ignition, all electrical circuits, warning lamps and indicators.

**Note:** If the engine is idling for 30 minutes, the ignition and engine automatically shut down.

## Stopping the Engine When Your Vehicle is Moving



**WARNING:** Switching off the engine when the vehicle is still moving will result in a loss of brake and steering assistance. The steering will not lock, but higher effort will be required. When the ignition is switched off, some electrical circuits, including air bags, warning lamps and indicators may also be off. If the ignition was turned off accidentally, you can shift into neutral (N) and re-start the engine.

1. Move the transmission selector lever to the neutral position and use the brakes to bring your vehicle to a safe stop.
2. When your vehicle has stopped, move the transmission selector lever to park (P) (automatic transmission) or neutral (manual transmission).
3. Press and hold the button for one second, or press it three times within two seconds.
4. Apply the parking brake.

## Guarding Against Exhaust Fumes



**WARNING:** If you smell exhaust fumes inside your vehicle, have your vehicle checked by your authorized dealer immediately. Do not drive your vehicle if you smell exhaust fumes. Carbon monoxide is present in exhaust fumes. Take precautions to avoid its dangerous effects.



# Starting and Stopping the Engine

## Important Ventilating Information

If you stop your vehicle and leave the engine idling for long periods, we recommend that you do one of the following:

- Open the windows at least 1 in (2.5 cm).
- Set your climate control to outside air.

## ENGINE BLOCK HEATER (IF EQUIPPED)



**WARNING:** Failure to follow engine block heater instructions could result in property damage or serious personal injury.



**WARNING:** Do not use your heater with ungrounded electrical systems or two-pronged adapters. There is a risk of electrical shock.



**WARNING:** Do not fully close the hood, or allow it to drop under its own weight when using the engine block heater. This could damage the power cable and may cause an electrical short resulting in fire, injury and property damage.

**Note:** The heater is most effective when outdoor temperatures are below 0°F (-18°C).

The heater acts as a starting aid by warming the engine coolant. This allows the climate control system to respond quickly. The equipment includes a heater element (installed in the engine block) and a wire harness. You can connect the system to a grounded 120-volt AC electrical source.

We recommend that you do the following for a safe and correct operation:

- Use a 16-gauge outdoor extension cord that is product certified by Underwriter's Laboratory (UL) or Canadian Standards Association (CSA). This extension cord must be suitable for use outdoors, in cold temperatures, and be clearly marked Suitable for Use with Outdoor Appliances. Do not use an indoor extension cord outdoors. This could result in an electric shock or become a fire hazard.
- Use as short an extension cord as possible.
- Do not use multiple extension cords.
- Make sure that when in operation, the extension cord plug and heater cord plug connections are free and clear of water. This could cause an electric shock or fire.
- Make sure your vehicle is parked in a clean area, clear of combustibles.
- Make sure the heater, heater cord and extension cord are firmly connected.
- Check for heat anywhere in the electrical hookup once the system has been operating for approximately 30 minutes.
- Make sure the system is unplugged and properly stowed before starting and driving your vehicle. Make sure the protective cover seals the prongs of the block heater cord plug when not in use.
- Make sure the heater system is checked for proper operation before winter.

## Using the Engine Block Heater

Make sure the receptacle terminals are clean and dry prior to use. Clean them with a dry cloth if necessary.

## Starting and Stopping the Engine

---

The heater uses 0.4 to 1.0 kilowatt-hours of energy per hour of use. The system does not have a thermostat. It achieves maximum temperature after approximately three hours of operation. Using the heater longer than three hours does not improve system performance and unnecessarily uses electricity.

# Fuel and Refueling

## SAFETY PRECAUTIONS



**WARNING:** Do not overfill the fuel tank. The pressure in an overfilled tank may cause leakage and lead to fuel spray and fire.



**WARNING:** The fuel system may be under pressure. If you hear a hissing sound near the fuel filler inlet, do not refuel until the sound stops. Otherwise, fuel may spray out, which could cause serious personal injury.



**WARNING:** Fuels can cause serious injury or death if misused or mishandled.



**WARNING:** Fuel may contain benzene, which is a cancer-causing agent.



**WARNING:** When refueling always shut the engine off and never allow sparks or open flames near the fuel tank filler valve. Never smoke or use a cell phone while refueling. Fuel vapor is extremely hazardous under certain conditions. Avoid inhaling excess fumes.

- Avoid inhaling fuel vapors. Inhaling fuel vapor can lead to eye and respiratory tract irritation. In severe cases, excessive or prolonged breathing of fuel vapor can cause serious illness and permanent injury.
- Avoid getting fuel in your eyes. If you splash fuel in your eyes, immediately remove contact lenses (if worn), flush with water for 15 minutes and seek medical attention. Failure to seek proper medical attention could lead to permanent injury.
- Fuels can be harmful if absorbed through the skin. If you splash fuel on your skin, clothing or both, promptly remove contaminated clothing and thoroughly wash your skin with soap and water. Repeated or prolonged skin contact causes skin irritation.
- Be particularly careful if you are taking Antabuse or other forms of Disulfiram for the treatment of alcoholism. Breathing fuel vapors could cause an adverse reaction, serious personal injury or sickness. Immediately call a physician if you experience any adverse reactions.

## FUEL QUALITY

### Choosing the Right Fuel

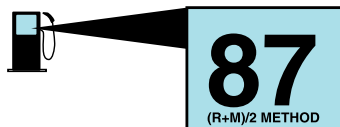

E161513

Your vehicle is designed to operate on regular unleaded gasoline with a minimum pump (R+M)/2 octane rating of 87.

Follow these guidelines when refueling:

- Extinguish all smoking materials and any open flames before refueling your vehicle.
- Always switch the engine off before refueling.
- Automotive fuels can be harmful or fatal if swallowed. Fuel is highly toxic and if swallowed can cause death or permanent injury. If fuel is swallowed immediately call a physician, even if no symptoms are immediately apparent. The toxic effects of fuel may not be apparent for hours.

# Fuel and Refueling

Some fuel stations, particularly those in high altitude areas, offer fuels posted as regular unleaded gasoline with an octane rating below 87. The use of these fuels could result in engine damage that will not be covered by the vehicle warranty.

For best overall vehicle and engine performance, premium fuel with an octane rating of 91 or higher is recommended. The performance gained by using premium fuel is most noticeable in hot weather as well as other conditions, for example when towing a trailer. See **Towing** (page 196).

Do not be concerned if the engine sometimes knocks lightly. However, if the engine knocks heavily while using fuel with the recommended octane rating, contact an authorized dealer to prevent any engine damage.

We recommend Top Tier detergent gasolines, where available to help minimize engine deposits and maintain optimal vehicle and engine performance. For additional information, refer to [www.toptiergas.com](http://www.toptiergas.com).

**Note:** *Use of any fuel for which the vehicle was not designed can impair the emission control system, cause loss of vehicle performance, and cause damage to the engine which may not be covered by the vehicle Warranty.*

Do not use:

- Diesel fuel.
- Fuels containing kerosene or paraffin.
- Fuel containing more than 15% ethanol or E85 fuel.
- Fuels containing methanol.
- Fuels containing metallic-based additives, including manganese-based compounds.

- Fuels containing the octane booster additive, methylcyclopentadienyl manganese tricarbonyl (MMT).
- Leaded fuel, using leaded fuel is prohibited by law.

The use of fuels with metallic compounds such as methylcyclopentadienyl manganese tricarbonyl (commonly known as MMT), which is a manganese-based fuel additive, will impair engine performance and affect the emission control system.

## FUEL FILLER FUNNEL LOCATION

The fuel filler funnel is under the luggage compartment floor covering.

## RUNNING OUT OF FUEL

Running out of fuel can cause damage not covered by the vehicle Warranty.

If your vehicle runs out of fuel:

- Add a minimum of 1.3 gal (5 L) of fuel to restart the engine.
- You may need to switch the ignition from off to on several times after refueling to allow the fuel system to pump the fuel from the tank to the engine. When restarting, cranking time takes a few seconds longer than normal.

**Note:** *If your vehicle is on a steep slope, more fuel may be required.*

## Filling a Portable Fuel Container



**WARNING:** Flow of fuel through a fuel pump nozzle can produce static electricity. This can cause a fire if you are filling an ungrounded fuel container.

# Fuel and Refueling

Use the following guidelines to avoid electrostatic charge build-up, which can produce a spark, when filling an ungrounded fuel container:

- Only use an approved fuel container to transfer fuel to your vehicle. Place the container on the ground when filling it.
- Do not fill a fuel container when it is inside your vehicle (including the cargo area).
- Keep the fuel pump nozzle in contact with the fuel container when filling it.
- Do not use a device that holds the fuel pump nozzle lever in the fill position.

## Adding Fuel From a Portable Fuel Container



**WARNING:** Do not insert the nozzle of a fuel container or an aftermarket funnel into the fuel filler neck. This may damage the fuel system filler neck or its seal and cause fuel to run onto the ground.



**WARNING:** Do not try to pry open or push open the capless fuel system with foreign objects. This could damage the fuel system and its seal and cause injury to you or others.



**WARNING:** Do not dispose of fuel in the household refuse or the public sewage system. Use an authorized waste disposal facility.

When refueling the vehicle fuel tank from a fuel container, use the fuel filler funnel included with your vehicle. See **Fuel Filler Funnel Location** (page 137).

**Note:** Do not use aftermarket funnels as they may not work with the capless fuel system and can damage it.

When refueling the vehicle fuel tank from a fuel container, do the following:

1. Fully open the fuel filler door.
2. Fully insert the fuel filler funnel into the fuel filler inlet.



E157452

3. Add fuel to your vehicle from the fuel container.
4. Remove the fuel filler funnel.
5. Fully close the fuel filler door.
6. Clean the fuel filler funnel and place it back in your vehicle or correctly dispose of it.

**Note:** Extra funnels can be purchased from an authorized dealer if you choose to dispose of the funnel.

# Fuel and Refueling

## REFUELING

### Refueling System Overview

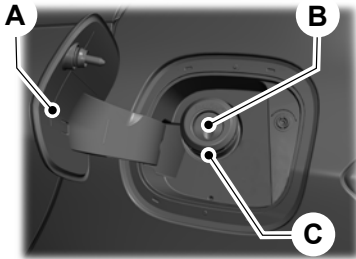

E267248

- A Fuel filler door.
- B Fuel tank filler valve.
- C Fuel tank filler pipe.

Your vehicle does not have a fuel tank filler cap.

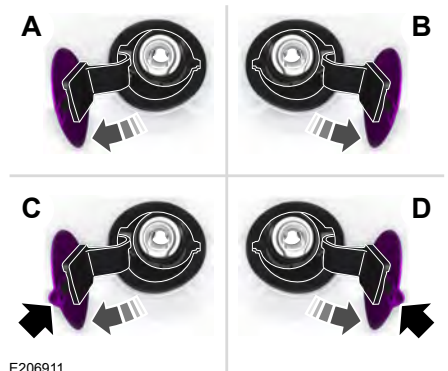

E206911

- A Left-hand side. To open the fuel filler door, press the center rear edge of the fuel filler door and then release.
- B Right-hand side. To open the fuel filler door, press the center rear edge of the fuel filler door and then release.
- C Left-hand side. Pull the rear of the fuel filler door to open it.
- D Right-hand side. Pull the rear of the fuel filler door to open it.

### Refueling Your Vehicle



**WARNING:** When refueling always shut the engine off and never allow sparks or open flames near the fuel tank filler valve. Never smoke or use a cell phone while refueling. Fuel vapor is extremely hazardous under certain conditions. Avoid inhaling excess fumes.

# Fuel and Refueling

**WARNING:** The fuel system may be under pressure. If you hear a hissing sound near the fuel filler inlet, do not refuel until the sound stops. Otherwise, fuel may spray out, which could cause serious personal injury.

**WARNING:** Do not pry open the fuel tank filler valve. This could damage the fuel system. Failure to follow this instruction could result in fire, personal injury or death.

**WARNING:** Do not remove the fuel pump nozzle from its fully inserted position when refueling.

**WARNING:** Stop refueling when the fuel pump nozzle automatically shuts off for the first time. Failure to follow this will fill the expansion space in the fuel tank and could lead to fuel overflowing.

**WARNING:** Do not overfill the fuel tank. The pressure in an overfilled tank may cause leakage and lead to fuel spray and fire.

**WARNING:** Wait at least five seconds before removing the fuel pump nozzle to allow any residual fuel to drain into the fuel tank.

1. Fully open the fuel filler door.
2. Select the correct fuel pump nozzle for your vehicle.

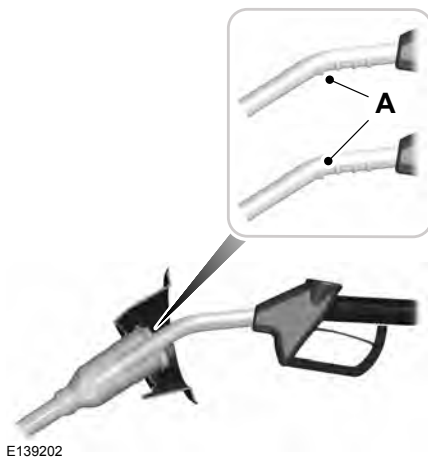

3. Insert the fuel pump nozzle up to the first notch on the nozzle A. Keep the fuel pump nozzle resting on the fuel tank filler pipe.

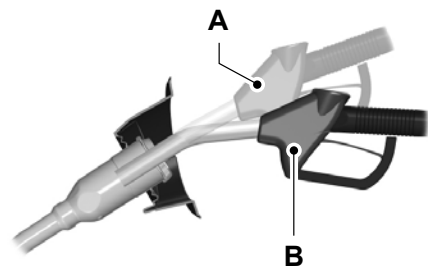

4. Hold the fuel pump nozzle in position B when refueling. Holding the fuel pump nozzle in position A can affect the flow of fuel and shut off the fuel pump nozzle before the fuel tank is full.

# Fuel and Refueling

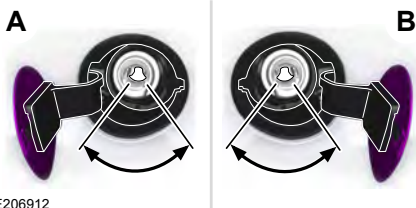

E206912

5. Operate the fuel pump nozzle within the area shown.

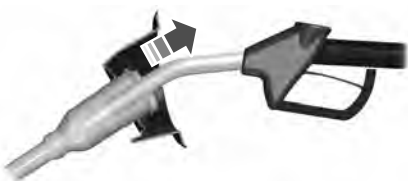

E119081

6. When you finish refueling slightly raise the fuel pump nozzle and slowly remove it.
7. Fully close the fuel filler door.

Do not attempt to start the engine if you have filled the fuel tank with incorrect fuel. Incorrect fuel use could cause damage not covered by the vehicle Warranty. Have your vehicle immediately checked.

## Refueling System Warning (If Equipped)

If the fuel tank filler valve does not fully close, a message could appear in the information display.

Message
Check Fuel Fill Inlet

If the message appears, do the following:

1. Stop your vehicle as soon as it is safe to do so and switch the engine off.
2. Shift into park (P) or neutral (N).

3. Apply the parking brake.
4. Fully open the fuel filler door.
5. Check the fuel tank filler valve for any debris that may be restricting its movement.
6. Remove any debris from the fuel tank filler valve.
7. Fully insert a fuel pump nozzle or the fuel filler funnel provided with your vehicle into the fuel filler pipe. See **Fuel Filler Funnel Location** (page 137). This action should dislodge any debris that may be preventing the fuel tank filler valve from fully closing.
8. Remove the fuel pump nozzle or fuel filler funnel from the fuel filler pipe.
9. Fully close the fuel filler door.

**Note:** The message may not immediately reset. If the message continues to appear and a warning lamp illuminates, have your vehicle checked as soon as possible.

## FUEL CONSUMPTION

### Advertised Capacity

The advertised capacity is the maximum amount of fuel that you can add to the fuel tank when the fuel gauge indicates empty. See **Capacities and Specifications** (page 300).

In addition, the fuel tank contains an empty reserve. The empty reserve is an unspecified amount of fuel that remains in the fuel tank when the fuel gauge indicates empty.

**Note:** The amount of fuel in the empty reserve varies and should not be relied upon to increase driving range.



# Fuel and Refueling

---

## Filling the Fuel Tank

For consistent results when refueling:

- Turn the ignition off before fueling; an inaccurate reading results if the engine is left running.
- Use the same fill rate (low-medium-high) each time the tank is filled.
- Allow no more than one automatic shut-off when refueling.

Results are most accurate when the filling method is consistent.

## Calculating Fuel Economy

Your vehicle calculates fuel economy figures through the trip computer average fuel function. See **Information Displays** (page 88).

The first 1,000 mi (1,500 km) of driving is the break-in period of the engine. A more accurate measurement is obtained after 2,000 mi (3,000 km).

1. Completely fill the fuel tank and record the initial odometer reading. See **Refueling** (page 139).
2. Each time you fill the fuel tank, record the amount of fuel added.
3. After at least three fill ups, fill the fuel tank and record the current odometer reading.
4. Subtract your initial odometer reading from the current odometer reading.

To calculate L/100 km (liters per 100 kilometers) fuel consumption, multiply the liters used by 100, then divide by kilometers traveled. To calculate MPG (miles per gallon) fuel consumption, divide miles traveled by gallons used.

Keep a record for at least one month and record the type of driving, for example city or highway. This provides an accurate estimate of your vehicle's fuel economy under current driving conditions. Keeping records during summer and winter shows how temperature impacts fuel economy.

## Conditions

- Heavily loading your vehicle reduces fuel economy.
- Carrying unnecessary weight in your vehicle may reduce fuel economy.
- Avoid adding accessories that increase aerodynamic drag to your vehicle such as bug deflectors, car top carriers and ski or bike racks.
- Using fuel blended with alcohol may lower fuel economy.
- Fuel economy may decrease with lower temperatures.
- Fuel economy may decrease when driving short distances.
- You will get better fuel economy when driving on flat terrain than when driving on hilly terrain.

# Engine Emission Control

## EMISSION LAW



**WARNING:** Do not remove or alter the original equipment floor covering or insulation between it and the metal floor of the vehicle. The floor covering and insulation protect occupants of the vehicle from the engine and exhaust system heat and noise. On vehicles with no original equipment floor covering insulation, do not carry passengers in a manner that permits prolonged skin contact with the metal floor. Failure to follow these instructions may result in fire or personal injury.

U.S. federal laws and certain state laws prohibit removing or rendering inoperative emission control system components. Similar federal or provincial laws may apply in Canada. We do not approve of any vehicle modification without first determining applicable laws.



Tampering with emissions control systems including related sensors or the Diesel Exhaust Fluid system can result in reduced engine power and the illumination of the service engine soon light.

## Tampering With a Noise Control System

Federal laws prohibit the following acts:

- Removal or rendering inoperative by any person other than for purposes of maintenance.
- Repair or replacement of any device or element of the design incorporated into a new vehicle for the purpose of noise control prior to its sale or delivery to the ultimate purchaser or while it is in use.
- The use of the vehicle after any person removes or renders inoperative any device or element of the design.

The U.S. Environmental Protection Agency may presume to constitute tampering as follows:

- Removal of hood blanket, fender apron absorbers, fender apron barriers, underbody noise shields or acoustically absorptive material.
- Tampering or rendering inoperative the engine speed governor, to allow engine speed to exceed manufacturer specifications.

If the engine does not start, runs rough, experiences a decrease in engine performance, experiences excess fuel consumption or produces excessive exhaust smoke, check for the following:

- A plugged or disconnected air inlet system hose.
- A plugged engine air filter element.
- Water in the fuel filter and water separator.
- A clogged fuel filter.
- Contaminated fuel.
- Air in the fuel system, due to loose connections.
- An open or pinched sensor hose.
- Incorrect engine oil level.

# Engine Emission Control

- Incorrect fuel for climatic conditions.
- Incorrect engine oil viscosity for climactic conditions.

**Note:** *Some vehicles have a lifetime fuel filter that is integrated with the fuel tank. Regular maintenance or replacement is not needed.*

**Note:** *If these checks do not help you correct the concern, have your vehicle checked as soon as possible.*

## Noise Emissions Warranty, Prohibited Tampering Acts and Maintenance

On January 1, 1978, Federal regulation became effective governing the noise emission on trucks over 10,000 lb (4,536 kg) Gross Vehicle Weight Rating (GVWR). The preceding statements concerning prohibited tampering acts and maintenance, and the noise warranty found in the Warranty Guide, are applicable to complete chassis cabs over 10,000 lb (4,536 kg) GVWR.

## CATALYTIC CONVERTER



**WARNING:** Do not park, idle or drive your vehicle on dry grass or other dry ground cover. The emission system heats up the engine compartment and exhaust system, creating the risk of fire.



**WARNING:** The normal operating temperature of the exhaust system is very high. Never work around or attempt to repair any part of the exhaust system until it has cooled. Use special care when working around the catalytic converter. The catalytic converter heats up to a very high temperature after only a short period of engine operation and stays hot after the engine is switched off.



**WARNING:** Exhaust leaks may result in entry of harmful and potentially lethal fumes into the passenger compartment. If you smell exhaust fumes inside your vehicle, have your vehicle inspected immediately. Do not drive if you smell exhaust fumes.

Your vehicle has various emission control components and a catalytic converter that enables it to comply with applicable exhaust emission standards.

To make sure that the catalytic converter and other emission control components continue to work properly:

- Do not crank the engine for more than 10 seconds at a time.
- Do not run the engine with a spark plug lead disconnected.
- Do not push-start or tow-start your vehicle. Use booster cables. See **Jump Starting the Vehicle** (page 209).
- Use only the specified fuel listed.
- Do not switch the ignition off when your vehicle is moving.
- Avoid running out of fuel.
- Have the items listed in scheduled maintenance information performed according to the specified schedule.

**Note:** *Resulting component damage may not be covered by the vehicle Warranty.*

The scheduled maintenance items listed in scheduled maintenance information are essential to the life and performance of your vehicle and to its emissions system.

If you use anything other than Ford, Motorcraft or Ford-authorized parts for maintenance replacements or for service of components affecting emission control, such non-Ford parts should be equivalent to genuine Ford Motor Company parts in performance and durability.

# Engine Emission Control

Illumination of the service engine soon indicator, charging system warning light or the temperature warning light, fluid leaks, strange odors, smoke or loss of engine power could indicate that the emission control system is not working properly.

An improperly operating or damaged exhaust system may allow exhaust to enter the vehicle. Have a damaged or improperly operating exhaust system inspected and repaired immediately.

Do not make any unauthorized changes to your vehicle or engine. By law, vehicle owners and anyone who manufactures, repairs, services, sells, leases, trades vehicles, or supervises a fleet of vehicles are not permitted to intentionally remove an emission control device or prevent it from working. Information about your vehicle's emission system is on the Vehicle Emission Control Information Decal located on or near the engine. This decal also lists engine displacement.

Please consult your warranty information for complete details.

## On-Board Diagnostics (OBD-II)

Your vehicle has a computer known as the on-board diagnostics system (OBD-II) that monitors the engine's emission control system. The system protects the environment by making sure that your vehicle continues to meet government emission standards. The OBD-II system also assists a service technician in properly servicing your vehicle.



When the service engine soon indicator illuminates, the OBD-II system has detected a malfunction. Temporary malfunctions may cause the service engine soon indicator to illuminate. Examples are:

1. Your vehicle has run out of fuel—the engine may misfire or run poorly.
2. Poor fuel quality or water in the fuel—the engine may misfire or run poorly.
3. The fuel fill inlet may not have closed properly. See **Refueling** (page 139).
4. Driving through deep water—the electrical system may be wet.

You can correct these temporary malfunctions by filling the fuel tank with good quality fuel, properly closing the fuel fill inlet or letting the electrical system dry out. After three driving cycles without these or any other temporary malfunctions present, the service engine soon indicator should stay off the next time you start the engine. A driving cycle consists of a cold engine startup followed by mixed city and highway driving. No additional vehicle service is required.

If the service engine soon indicator remains on, have your vehicle serviced at the first available opportunity. Although some malfunctions detected by the OBD-II may not have symptoms that are apparent, continued driving with the service engine soon indicator on can result in increased emissions, lower fuel economy, reduced engine and transmission smoothness and lead to more costly repairs.

## Readiness for Inspection and Maintenance (I/M) Testing

Some state and provincial and local governments may have Inspection/Maintenance (I/M) programs to inspect the emission control equipment on your vehicle. Failure to pass this inspection could prevent you from getting a vehicle registration.



If the service engine soon indicator is on or the bulb does not work, your vehicle may need service. See On-Board Diagnostics.

# Engine Emission Control

---

Your vehicle may not pass the I/M test if the service engine soon indicator is on or not working properly (bulb is burned out), or if the OBD-II system has determined that some of the emission control systems have not been properly checked. In this case, the vehicle is not ready for I/M testing.

If the vehicle's engine or transmission has just been serviced, or the battery has recently run down or been replaced, the OBD-II system may indicate that the vehicle is not ready for I/M testing. To determine if the vehicle is ready for I/M testing, turn the ignition key to the on position for 15 seconds without cranking the engine. If the service engine soon indicator blinks eight times, it means that the vehicle is not ready for I/M testing; if the service engine soon indicator stays on solid, it means that your vehicle is ready for I/M testing.

The OBD-II system checks the emission control system during normal driving. A complete check may take several days.

If the vehicle is not ready for I/M testing, you can perform the following driving cycle consisting of mixed city and highway driving:

1. 15 minutes of steady driving on an expressway or highway followed by 20 minutes of stop-and-go driving with at least four 30-second idle periods.
2. Allow your vehicle to sit for at least eight hours with the ignition off. Then, start the vehicle and complete the above driving cycle. The vehicle must warm up to its normal operating temperature. Once started, do not turn off the vehicle until the above driving cycle is complete.

If the vehicle is still not ready for I/M testing, you need to repeat the above driving cycle.

# Transmission

## MANUAL TRANSMISSION (IF EQUIPPED)

### Using the Clutch

**Note:** Failure to fully press the clutch pedal to the floor may cause increased shift efforts, prematurely wear transmission components or damage the transmission.

**Note:** Do not drive with your foot resting on the clutch pedal or use the clutch pedal to hold your vehicle at a standstill while waiting on a hill. These actions will reduce the life of the clutch and could nullify a clutch warranty claim.

**Note:** The engine may not start unless the intelligent access key is inside your vehicle.

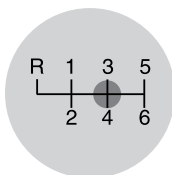

E144954

Manual transmission vehicles have a starter interlock that prevents cranking the engine unless the clutch pedal is fully pressed.

To start the vehicle:

1. Make sure the parking brake is fully set.
2. Press the clutch pedal to the floor, then put the gearshift lever in the neutral position.
3. Start the engine.
4. Press the brake pedal and move the gearshift lever to the desired gear; first (1) or reverse (R).

5. Release the parking brake, then slowly release the clutch pedal while slowly pressing on the accelerator.

During each shift, the clutch pedal must be fully pressed to the floor. Make sure the floor mat is properly positioned so it doesn't interfere with the full extension of the clutch pedal.

### Recommended Shift Speeds

**Note:** Do not downshift into first (1) when your vehicle is moving faster than 15 mph (24 km/h). This will damage the clutch.

#### 2.3L

Upshifts When Accelerating - Recommended for Best Fuel Economy	
Shift from:	
1 - 2	15 mph (24 km/h)
2 - 3	24 mph (39 km/h)
3 - 4	35 mph (56 km/h)
4 - 5	41 mph (66 km/h)
5 - 6	50 mph (80 km/h)

#### 5.0L

Upshifts When Accelerating - Recommended for Best Fuel Economy	
Shift from:	
1 - 2	14 mph (23 km/h)
2 - 3	25 mph (40 km/h)
3 - 4	35 mph (56 km/h)
4 - 5	41 mph (66 km/h)
5 - 6	48 mph (77 km/h)

# Transmission

## Reverse

**Note:** Make sure that your vehicle is at a complete stop before you shift into reverse (R). Failure to do so may damage the transmission.

1. Press the clutch pedal to the floor to disengage clutch.
2. Shift into reverse (R) by raising the collar below the gearshift knob up, then moving the lever fully to the left, then forward.

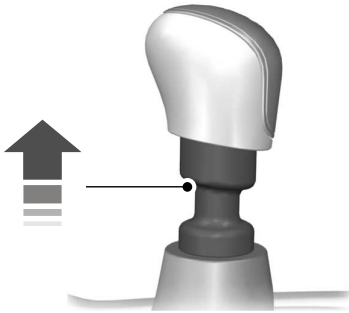

E99067

**Note:** The gearshift lever can only be moved to reverse (R) by raising the collar below the gearshift knob up before shifting to reverse. This is a lockout feature which protects the transmission from accidentally engaging reverse (R) when intending to select first (1).

If reverse (R) is not fully engaged, press the clutch pedal down and return the gearshift to the neutral position. Release the clutch pedal for a moment, then raise the collar and shift to reverse (R) again.

## Parking Your Vehicle



**WARNING:** Always set the parking brake fully and make sure you shift the gearshift lever to first gear. Switch the ignition off and remove the key whenever you leave your vehicle.

To park your vehicle:

1. Apply the brake and shift into the neutral position.
2. Fully apply the parking brake, hold the clutch pedal down, then shift into first (1).
3. Turn the ignition off.

## AUTOMATIC TRANSMISSION

(IF EQUIPPED)



**WARNING:** Always fully apply the parking brake and make sure you shift into park (P). Failure to follow this instruction could result in personal injury or death.



**WARNING:** Do not apply the brake pedal and accelerator pedal simultaneously. Applying both pedals simultaneously for more than a few seconds will limit engine performance, which may result in difficulty maintaining speed in traffic and could lead to serious injury.

**Note:** You may not be able to shift out of park (P) unless the intelligent access key is inside your vehicle.

# Transmission

## Understanding the Positions of Your Automatic Transmission

### Putting your vehicle in gear:

1. Fully press down on the brake pedal.
2. Press and hold the button on the top of the gearshift lever.
3. Move the gearshift lever into the desired gear.
4. Release the button and your transmission remains in the selected gear.



E174572

### Transmission Selector Positions

The instrument cluster displays the current gear.

#### Park (P)

This position locks the transmission and prevents the rear wheels from turning. Come to a complete stop before putting your vehicle into and out of park (P).

#### Reverse (R)

With the selector in reverse (R), your vehicle moves backward. Always come to a complete stop before shifting into and out of reverse (R).

#### Neutral (N)

With the selector in neutral (N), you can start your vehicle and it is free to roll. Hold the brake pedal down when in this position.

#### Drive (D)

Drive (D) is the normal driving position for the best fuel economy. The overdrive function allows automatic upshifts and downshifts through all gears.

#### Sport (S)

Putting your vehicle in sport (S):

- Provides additional engine braking and extends lower gear operation to enhance performance for uphill climbs, hilly terrain or mountainous areas. This increases engine RPM during engine braking.
- Provides additional lower gear operation through the automatic transmission shift strategy.
- Provides gear upshifts and downshifts more quickly at higher engine speeds.

### SelectShift Automatic™ Transmission

This feature gives you the ability to change gears up or down as desired.

As long as the engine speed does not exceed the maximum allowable limit, downshifts are allowed. SelectShift automatically downshifts at low engine speeds in order to prevent engine stalls.

**Note:** *Engine damage may occur if you maintain excessive engine revving without shifting.*

In drive (D) SelectShift automatically upshifts at the optimal max engine speed, regardless of accelerator pedal travel.

In sport (S) mode SelectShift does not automatically upshift, even if the engine is approaching the RPM limit.



# Transmission

## Pull the + paddle on the steering wheel to activate SelectShift.

- Pull the right paddle (+) to upshift.
- Pull the left paddle (-) to downshift.



E144821

## SelectShift in drive (D):

- Provides a temporary manual mode for performing more demanding maneuvers where extra control of gear selection is required (for example, when towing or overtaking). This mode holds a selected gear for a temporary period of time dependent on driver inputs (for example, steering or accelerator pedal input).

## SelectShift in sport (S):

- Provides a permanent manual gear selection where full control of gear selection is required.

To exit SelectShift mode shift the transmission into another gear, for example, drive (D) or holding the (+) paddle for 1 second.

The instrument cluster displays your currently selected gear. If a gear is requested but not available due to vehicle conditions (low speed, too high engine speed for requested gear selection), the current gear flashes two times.

Upshift to the recommended shift speeds according to this following chart:

<b>Upshifts When Accelerating (Recommended for Best Fuel Economy)</b>			
Shift from:	3.15 Final Drive Ratio	3.31 Final Drive Ratio	3.55 Final Drive Ratio
1 - 2	9 mph (14 km/h)	9 mph (14 km/h)	8 mph (13 km/h)
2 - 3	13 mph (21 km/h)	12 mph (19 km/h)	11 mph (18 km/h)
3 - 4	18 mph (29 km/h)	17 mph (27 km/h)	16 mph (26 km/h)
4 - 5	24 mph (39 km/h)	23 mph (37 km/h)	21 mph (34 km/h)
5 - 6	26 mph (42 km/h)	25 mph (40 km/h)	23 mph (37 km/h)
6 - 7	32 mph (51 km/h)	31 mph (50 km/h)	28 mph (45 km/h)
7 - 8	39 mph (63 km/h)	37 mph (60 km/h)	34 mph (55 km/h)
8 - 9	44 mph (71 km/h)	42 mph (68 km/h)	39 mph (63 km/h)
9 - 10	49 mph (79 km/h)	47 mph (76 km/h)	43 mph (70 km/h)

# Transmission

## Brake-Shift Interlock



**WARNING:** Do not drive your vehicle until you verify that the stoplamps are working.



**WARNING:** When doing this procedure, you need to take the transmission out of park (P) which means your vehicle can roll freely. To avoid unwanted vehicle movement, always fully apply the parking brake prior to doing this procedure. Use wheels chocks if appropriate.



**WARNING:** If the parking brake is fully released, but the brake warning lamp remains illuminated, the brakes may not be working properly. Have your vehicle checked as soon as possible.

**Note:** Contact an authorized dealer as soon as possible if this procedure is used.

**Note:** For some markets, this feature is disabled.

Use the brake shift interlock lever to move the gearshift lever from the park position in the event of an electrical malfunction or if your vehicle has a dead battery.

Apply the parking brake and switch the ignition off before performing this procedure.



E184747

1. Using a flat head screwdriver or similar tool, remove the chrome bezel and gearshift bracket at the base of the gearshift lever.

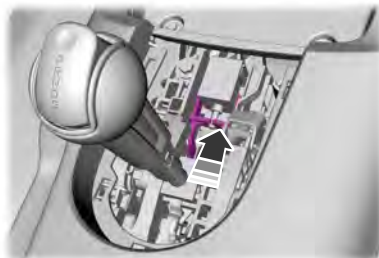

E174501

2. Locate the white release lever and slide the lever forward when pulling the gearshift lever out of the park (P) position and into the neutral (N) position.
3. Reinstall the console.
4. Start your vehicle and release the parking brake.

# Transmission

---

## **Automatic Transmission Adaptive Learning**

This feature is designed to increase durability and provide consistent shift feel over the life of your vehicle. A new vehicle or transmission may have firm or soft shifts. This operation is normal and does not affect function or durability of the transmission. Over time, the adaptive learning process fully updates transmission operation.

## **If Your Vehicle Gets Stuck In Mud or Snow**

**Note:** *Do not rock your vehicle if the engine is not at normal operating temperature or damage to the transmission may occur.*

**Note:** *Do not rock your vehicle for more than a minute or damage to the transmission and tires may occur, or the engine may overheat.*

If your vehicle gets stuck in mud or snow, you may rock it out by shifting between forward and reverse gears, stopping between shifts in a steady pattern. Press lightly on the accelerator in each gear.

# Rear Axle

---

## LIMITED SLIP DIFFERENTIAL

(IF EQUIPPED)

### **Traction-Lok™ and TORSEN™ Axles**

These axles provide improved traction on slippery and loose surfaces, particularly when one wheel is on a poor traction surface. Under normal conditions, these axles function like a standard rear axle.

Extended use of tire sizes other than the manufacturer's specified tire size on these axles could result in a permanent reduction in effectiveness. This loss does not affect your normal driving and should not be noticeable.

# Brakes

## GENERAL INFORMATION

**Note:** Occasional brake noise is normal. If a metal-to-metal, continuous grinding or continuous squeal sound is present, the brake linings may be worn-out and an authorized dealer should check them. If the vehicle has continuous vibration or shudder in the steering wheel while braking, an authorized dealer should check your vehicle.

**Note:** Brake dust may accumulate on the wheels, even under normal driving conditions. Some dust is inevitable as the brakes wear and does not contribute to brake noise. See **Cleaning the Wheels** (page 258).

Wet brakes result in reduced braking efficiency. Gently press the brake pedal a few times when driving from a car wash or standing water to dry the brakes.

### Brake Over Accelerator

In the event the accelerator pedal becomes stuck or entrapped, apply steady and firm pressure to the brake pedal to slow the vehicle and reduce engine power. If you experience this condition, apply the brakes and bring your vehicle to a safe stop. Switch the engine off, move the transmission to park (P) and apply the parking brake. Inspect the accelerator pedal and the area around it for any items or debris that may be obstructing its movement. If none are found and the condition persists, have your vehicle towed to the nearest authorized dealer.

### Emergency Brake Assist

Emergency brake assist detects when you brake heavily by measuring the rate at which you press the brake pedal. It provides maximum braking efficiency as long as you press the pedal. Emergency brake assist can reduce stopping distances in critical situations.

## Anti-lock Brake System

This system helps you maintain steering control during emergency stops by keeping the brakes from locking.



This lamp momentarily illuminates when you switch the ignition on. If the light does not illuminate during start up, remains on or flashes, the anti-lock braking system may be disabled. Have the system checked by an authorized dealer. If the anti-lock brake system is disabled, normal braking is still effective.

See **Warning Lamps and Indicators** (page 84).

**Note:** Indicators vary depending on region.



This lamp also illuminates momentarily when you switch the ignition on to confirm the lamp is functional. If it does not illuminate when you switch the ignition on, or begins to flash at any time, have the system checked by an authorized dealer. If the brake warning lamp illuminates with the parking brake released, have the system checked immediately.

## HINTS ON DRIVING WITH ANTI-LOCK BRAKES

The anti-lock braking system does not eliminate the risks when:

- You drive too closely to the vehicle in front of you.
- Your vehicle is hydroplaning.
- You take corners too fast.
- The road surface is poor.

# Brakes

**Note:** If the system activates, the brake pedal may pulse and may travel further. Maintain pressure on the brake pedal. You may also hear a noise from the system. This is normal.

## PARKING BRAKE

### Vehicles With Automatic Transmission



**WARNING:** Always set the parking brake and leave your vehicle with the transmission in park (P).

**Note:** If you park your vehicle on a hill and facing uphill, shift into park (P) and turn the steering wheel away from the curb.

**Note:** If you park your vehicle on a hill and facing downhill, shift into park (P) and turn the steering wheel toward the curb.

### Vehicles with Manual Transmission



**WARNING:** If your vehicle has a manual transmission, shift into first or reverse gear. If your vehicle has an automatic transmission, shift into park (P).

**Note:** If you park your vehicle on a hill and facing uphill, select first gear and turn the steering wheel away from the curb.

**Note:** If you park your vehicle on a hill and facing downhill, select reverse gear and turn the steering wheel toward the curb.

## All Vehicles



**WARNING:** If the parking brake is fully released, but the brake warning lamp remains illuminated, the brakes may not be working properly. Have your vehicle checked as soon as possible.



E223664

To set the parking brake, pull the parking brake handle up as far as possible.

To release the parking brake:

1. Press and hold the button at the end of the parking brake handle.
2. Pull the handle up slightly, then push the handle down.

## HILL START ASSIST



**WARNING:** The system does not replace the parking brake. When you leave your vehicle, always apply the parking brake and shift the transmission into park (P) for automatic transmission or first gear for manual transmission.

# Brakes



**WARNING:** You must remain in your vehicle when the system turns on. At all times, you are responsible for controlling your vehicle, supervising the system and intervening, if required. Failure to take care may result in the loss of control of your vehicle, serious personal injury or death.



**WARNING:** The system turns off if there is a malfunction or if you excessively rev the engine.

3. When you remove your foot from the brake pedal, your vehicle remains on the slope without rolling away for a few seconds. This hold time increases if you are in the process of driving off.
4. Pull away in the normal manner.

## Switching the System On and Off

### Vehicles with Manual Transmission

You can switch this feature on or off in the information display. The system remembers the last setting when you start your vehicle.

### Vehicles with Automatic Transmission

The system turns on when you switch the ignition on and you cannot switch the system off.

The system makes it easier to pull away when your vehicle is on a slope without the need to use the parking brake.

When the system activates, your vehicle remains stationary on a slope for a few seconds after you release the brake pedal. This allows you time to move your foot from the brake to the accelerator pedal. The brakes release when the engine has developed sufficient torque to prevent your vehicle from rolling down the slope. This is an advantage when pulling away on a slope, for example from a car park ramp, traffic lights or when reversing uphill into a parking space.

The system activates on any slope that causes your vehicle to roll.

**Note:** *There is no warning lamp to indicate the system is either on or off.*

## Using Hill Start Assist

1. Press the brake pedal to bring your vehicle to a complete standstill. Keep the brake pedal pressed and shift into first gear when facing uphill or reverse (R) when facing downhill.
2. The system activates if the sensors detect that your vehicle is on a slope.

# Traction Control

## PRINCIPLE OF OPERATION

The traction control system helps avoid drive wheel spin and loss of traction.

If your vehicle begins to slide, the system applies the brakes to individual wheels and, when needed, reduces engine power at the same time. If the wheels spin when accelerating on slippery or loose surfaces, the system reduces engine power in order to increase traction.

## USING TRACTION CONTROL



**WARNING:** The stability and traction control light illuminates steadily if the system detects a failure. Make sure you did not manually disable the traction control system using the information display controls or the switch. If the stability control and traction control light is still illuminating steadily, have the system serviced by an authorized dealer immediately. Operating your vehicle with the traction control disabled could lead to an increased risk of loss of vehicle control, vehicle rollover, personal injury and death.

The system automatically turns on each time you switch the ignition on.

If your vehicle is stuck in mud or snow, switching traction control off may be beneficial as this allows the wheels to spin.

**Note:** *When you switch traction control off, stability control remains fully active.*

## Switching the System Off

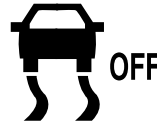

E166706

The switch for the stability and traction control system is on the instrument panel.

When you switch the system off, a message and an illuminated icon appear on the instrument cluster.

Use the switch again to return the traction control system to normal operation.

Your vehicle may have MyKey restrictions regarding this feature. See **Principle of Operation** (page 48).

## System Indicator Lights and Messages



The stability and traction control light temporarily illuminates on engine start-up and flashes:

- When a driving condition activates either of the systems.
- If a problem occurs in either of the systems.



The stability and traction control off light temporarily illuminates on engine start-up and stays on:

- When you switch the traction control system off.
- When you select an alternative stability control mode.



# Stability Control

## PRINCIPLE OF OPERATION



**WARNING:** Vehicle modifications involving braking system, aftermarket roof racks, suspension, steering system, tire construction and wheel and tire size may change the handling characteristics of your vehicle and may adversely affect the performance of the electronic stability control system. In addition, installing any stereo loudspeakers may interfere with and adversely affect the electronic stability control system. Install any aftermarket stereo loudspeaker as far as possible from the front center console, the tunnel, and the front seats in order to minimize the risk of interfering with the electronic stability control sensors. Reducing the effectiveness of the electronic stability control system could lead to an increased risk of loss of vehicle control, vehicle rollover, personal injury and death.



**WARNING:** Remember that even advanced technology cannot defy the laws of physics. It's always possible to lose control of a vehicle due to inappropriate driver input for the conditions. Aggressive driving on any road condition can cause you to lose control of your vehicle increasing the risk of personal injury or property damage. Activation of the electronic stability control system is an indication that at least some of the tires have exceeded their ability to grip the road; this could reduce the operator's ability to control the vehicle potentially resulting in a loss of vehicle control, vehicle rollover, personal injury and death. If your electronic stability control system activates, SLOW DOWN.

The system automatically turns on each time you switch the ignition on.

If a fault occurs in either the stability control or the traction control system, you may experience the following conditions:

- The stability and traction control light illuminates steadily.
- The stability control and traction control systems do not enhance your vehicle's ability to maintain traction of the wheels.

If a driving condition activates either the stability control or the traction control system you may experience the following conditions:

- The stability and traction control light flashes.
- Your vehicle slows down.
- Reduced engine power.
- A vibration in the brake pedal.
- The brake pedal is stiffer than usual.
- If the driving condition is severe and your foot is not on the brake, the brake pedal may move as the system applies higher brake force.

The stability control system has several features built into it to help you maintain control of your vehicle:

### Electronic Stability Control

The system enhances your vehicle's ability to prevent skids or lateral slides by applying brakes to one or more of the wheels individually and, if necessary, reducing engine power.

### Traction Control

The system enhances your vehicle's ability to maintain traction of the wheels by detecting and controlling wheel spin. See **Using Traction Control** (page 157).

# Stability Control

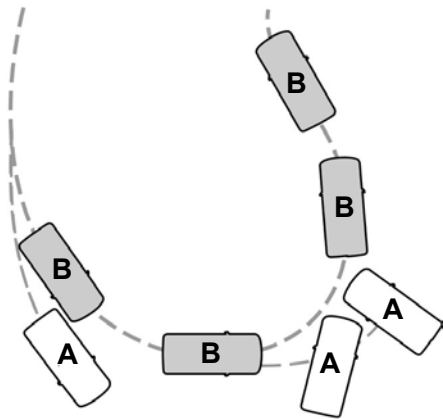

E72903

A Vehicle without stability control

B Vehicle with stability control maintaining control on a slippery surface.

## USING STABILITY CONTROL

### Electronic Stability Control

The system automatically turns on each time you switch the ignition on. The electronic stability control portion of the system is disabled when the transmission is in reverse (R) or, on some models, if you press and hold the electronic stability control button for more than five seconds when you apply the brakes and the vehicle is at a stop. You can switch off the traction control portion of the system independently. See **Using Traction Control** (page 157).

ESC features				
Button functions	Mode	Stability control off light	Electronic stability control	Traction control system
Default at start-up	-	On during bulb check	Enabled	Enabled
Button pressed momentarily	Traction control off	On	Enabled	Disabled
Button pressed twice rapidly	Sport mode (if equipped)	On	Enabled	Enabled
Button pressed and held more than five seconds	ESC disabled	On	Disabled	Disabled
Button pressed again after deactivation	ESC fully enabled	Off	Enabled	Enabled

# Stability Control

---

**Note:** *Do not use the Sport stability control setting on public roadways.*

Some models may also come equipped with a sport mode which allows the driver to reduce normal electronic stability control system intervention and provide a more spirited driving experience. To enter sport mode, toggle the stability control button twice rapidly. The message appears in the information display that the system is now in sport mode.

For vehicles equipped with the selectable drive mode feature, electronic stability control sport mode is not available. You can utilize the performance oriented electronic stability control mode by selecting track drive mode. In this mode, electronic stability control intervention is reduced and tuned specifically for track use only and is not for use on public roads. In all of the selectable drive modes, you can disable traction control and electronic stability control with the electronic stability control switch.

# Parking Aids

## PRINCIPLE OF OPERATION



**WARNING:** To help avoid personal injury, always use caution when in reverse (R) and when using the sensing system.



**WARNING:** The system may not detect objects with surfaces that absorb reflection. Always drive with due care and attention. Failure to take care may result in a crash.



**WARNING:** Traffic control systems, inclement weather, air brakes, external motors and fans may affect the correct operation of the sensing system. This may cause reduced performance or false alerts.



**WARNING:** The system may not detect small or moving objects, particularly those close to the ground.

**Note:** If your vehicle has MyKey™, the sensing system cannot be switched off when a MyKey™ is present. See **Principle of Operation** (page 48).

**Note:** Keep the sensors on the bumper or fascia free from snow, ice and large accumulations of dirt. If the sensors are covered, the system's accuracy can be affected. Do not clean the sensors with sharp objects.

**Note:** If your vehicle sustains damage to the bumper or fascia, leaving it misaligned or bent, the sensing zone may be altered causing inaccurate measurement of obstacles or false alerts.

**Note:** Certain add-on devices installed around the bumper or fascia may create false alerts. For example, large trailer hitches, bike or surfboard racks, license plate brackets, bumper covers or any other device that may block the normal detection zone of the system. Remove the add-on device to prevent false alerts.

**Note:** When you connect a trailer to your vehicle, the rear parking aid may detect the trailer and therefore provide an alert. Disable the rear parking aid when you connect a trailer to prevent the alert.

The sensing system warns the driver of obstacles within a certain range of your vehicle. The system turns on automatically whenever you switch the ignition on.

You can switch the system off through the information display menu or from the pop-up message that appears once you shift the transmission into reverse (R). See **General Information** (page 88). If your vehicle has a parking aid button, you can switch the system off by pressing the button.

If a fault is present in the system, a warning message appears in the information display. See **Information Messages** (page 97).

## REAR PARKING AID (IF EQUIPPED)

The rear sensors are only active when the transmission is in reverse (R). As your vehicle moves closer to the obstacle, the rate of the audible warning increases. When the obstacle is less than 12 in (30 cm) away, the warning sounds continuously. If the system detects a stationary or receding object farther than 12 in (30 cm) from the corners of the bumper, the tone sounds for only three seconds. Once the system detects an object approaching, the warning sounds again.

# Parking Aids



E130178

Coverage area of up to 6 ft (1.8 m) from the rear bumper. There may be decreased coverage area at the outer corners of the bumper.

The system detects certain objects while the transmission is in reverse (R):

- Your vehicle is moving toward a stationary object at a speed of 3 mph (5 km/h) or less.
- Your vehicle is not moving, but a moving object is approaching the rear of your vehicle at a speed of 3 mph (5 km/h) or less.
- Your vehicle is moving at a speed of less than 3 mph (5 km/h) and a moving object is approaching the rear of your vehicle at a speed of less than 3 mph (5 km/h).

The system provides audio warnings only when your vehicle is moving or when your vehicle is stationary and the detected obstacle is less than 12 in (30 cm) away from the bumper.

## Obstacle Distance Indicator (If Equipped)

The system provides obstacle distance indication through the information display. The distance indicator displays when the transmission is in reverse (R).

The indicator displays:

- As the distance to the obstacle decreases the indicator blocks illuminate and move towards the vehicle icon.
- If there is no obstacle detected, the distance indicator blocks are greyed out.

## REAR VIEW CAMERA



**WARNING:** The rear view camera system is a reverse aid supplement device that still requires the driver to use it in conjunction with the interior and exterior mirrors for maximum coverage.



**WARNING:** Objects that are close to either corner of the bumper or under the bumper, might not be seen on the screen due to the limited coverage of the camera system.



**WARNING:** Reverse your vehicle as slow as possible, higher speeds may limit your reaction time to stop your vehicle.



**WARNING:** Use caution when the rear cargo door is ajar. If the rear cargo door is ajar, the camera will be out of position and the video image may be incorrect. All guidelines disappear when the rear cargo door is ajar. Some vehicles may not come equipped with guidelines.

# Parking Aids



**WARNING:** Do not switch the camera features on or off when your vehicle is moving.

The rear view camera system provides a video image of the area behind your vehicle.

During operation, lines appear in the display which represent your vehicle's path and proximity to objects behind your vehicle.

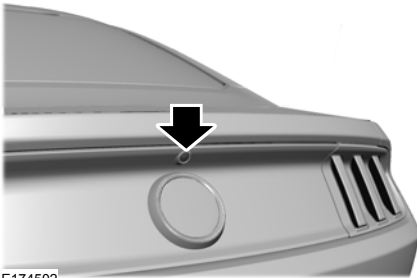

The camera is located on the rear cargo door.

## Using the Rear View Camera System

The rear view camera system displays what is behind your vehicle when you place the transmission in reverse (R).

**Note:** The reverse sensing system is not effective at speeds above 3 mph (5 km/h) and may not detect certain angular or moving objects.

The system uses two types of guides to help you see what is behind your vehicle:

- Fixed guidelines: Show the actual path your vehicle is moving in while reversing in a straight line. This can be helpful when backing into a parking space or aligning your vehicle with another object behind you.
- Centerline: Helps align the center of your vehicle with an object.

**Note:** If the transmission is in reverse (R) and the luggage compartment is open, no camera features will display.

The camera may not operate correctly under the following conditions:

- Nighttime or dark areas if the reverse lamps are not operating.
- Mud, water or debris obstructs the camera's view. Clean the lens with a soft, lint-free cloth and non-abrasive cleaner.
- The camera is misaligned due to damage to the rear of your vehicle.

## Camera Guidelines

**Note:** Active guidelines are only available when the transmission is in reverse (R).

**Note:** Upon a battery disconnect, the active guidelines may not be functional until your vehicle has been driven a short distance and exceeds a speed of 12 mph (20 km/h).

# Parking Aids

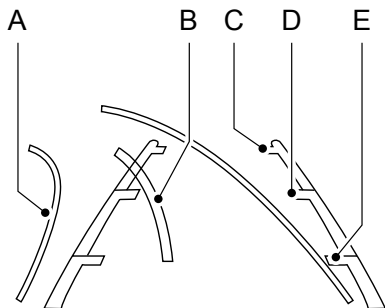

E142436

- A Active guidelines
- B Centerline
- C Fixed guideline: Green zone
- D Fixed guideline: Yellow zone
- E Fixed guideline: Red zone
- F Rear bumper

Active guidelines only show with fixed guidelines. To use active guidelines, turn the steering wheel to point the guidelines toward an intended path. If the steering wheel position changes while reversing, your vehicle might deviate from the original intended path.

The fixed and active guidelines fade in and out depending on the steering wheel position. The active guidelines do not show when the steering wheel position is straight.

Always use caution while reversing. Objects in the red zone are closest to your vehicle and objects in the green zone are farther away. Objects are getting closer to your vehicle as they move from the green zone to the yellow or red zones. Use the side view mirrors and rear view mirror to get better coverage on both sides and rear of your vehicle.

## Manual Zoom

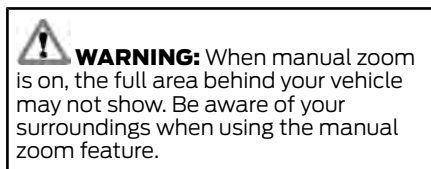

**Note:** *Manual zoom is only available when the transmission is in reverse (R). When manual zoom is enabled, only the centerline is shown.*

Selectable settings for this feature are Zoom in (+) and Zoom out (-). Press the symbol in the camera screen to change the view. The default setting is Zoom OFF.

This feature allows you to get a closer view of an object behind your vehicle. The zoomed image keeps the bumper in the image to provide a reference. The zoom is only active while the transmission is in reverse (R). When the transmission shifts out of reverse (R), the feature automatically turns off and must be reset when it is used again.

## Camera System Settings

The rear view camera system settings can be accessed through the display screen. See **General Information** (page 88).

# Parking Aids

## **Enhanced Park Aids or Park Pilot**

Selectable settings for this feature are ON and OFF.

The system uses red, yellow and green highlights that appear on top of the video image when any of the sensing systems detect an object.

## **Vehicles equipped with touchscreen**

The system will provide an image of your vehicle and the sensor zones. The zones will highlight green, yellow and red when the parking aid sensors detect an object in the coverage area.

The coverage area is up to 6 ft (1.8 m) from the rear bumper. There is decreased coverage area at the outer corners of the bumper.

When shifting the transmission out of reverse (R) and into any gear other than park (P), the camera image remains in the display until:

- Your vehicle speed sufficiently increases.
- You shift your vehicle into park (P).
- You pull the hand brake on vehicles with a manual transmission.



E130178

For additional information of the zone coverage and the rear sensing system. See **Principle of Operation** (page 161).

## **Rear Camera Delay**

Selectable settings for this feature are ON and OFF.

The default setting for the rear camera delay is OFF.



# Cruise Control

## PRINCIPLE OF OPERATION

Cruise control lets you maintain a set speed without keeping your foot on the accelerator pedal. You can use cruise control when your vehicle speed is greater than 20 mph (30 km/h).

## USING CRUISE CONTROL (IF EQUIPPED)



**WARNING:** Do not use cruise control on winding roads, in heavy traffic or when the road surface is slippery. This could result in loss of vehicle control, serious injury or death.



**WARNING:** When you are going downhill, your vehicle speed could increase above the set speed. The system does not apply the brakes.

**Note:** Cruise control disengages if the vehicle speed decreases more than 10 mph (16 km/h) below the set speed when driving uphill.

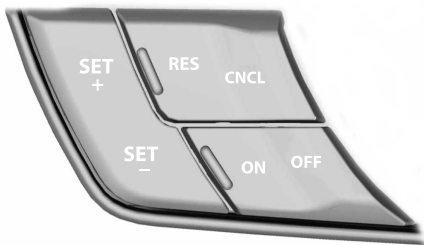

E176993

The cruise controls are on the steering wheel.

## Switching Cruise Control On

Press **ON**.



The indicator appears in the information display.

## Setting the Cruise Speed

1. Drive to your preferred speed.
2. Press **SET+** or **SET-**.
3. Take your foot off the accelerator pedal.

**Note:** The indicator changes color in the information display.

## Changing the Set Speed

**Note:** If you accelerate by pressing the accelerator pedal, the set speed will not change. When you release the accelerator pedal, your vehicle returns to the speed that you previously set.

- Press **SET+** or **SET-** to change the set speed in small increments.
- Press the accelerator or brake pedal until you reach the desired speed. Press **SET+** or **SET-**.
- Press and hold **SET+** or **SET-** to change the set speed in large increments. Release the control when you reach the desired speed.

## Canceling the Set Speed

Press **CNCL** or tap the brake pedal. The set speed does not erase.

**Note:** For vehicles with manual transmission, if you press the clutch pedal for an extended period, this action also cancels the set speed.

## Resuming the Set Speed

Press **RES**.

# Cruise Control

## Switching Cruise Control Off

**Note:** You erase the set speed when you switch the system off.

Press **OFF** when the system is in standby mode, or switch the ignition off.

## USING ADAPTIVE CRUISE CONTROL (IF EQUIPPED)



**WARNING:** Always pay close attention to changing road conditions when using adaptive cruise control. The system does not replace attentive driving. Failing to pay attention to the road may result in a crash, serious injury or death.



**WARNING:** Adaptive cruise control only warns of vehicles detected by the radar sensor. In some cases there may be no warning or a delayed warning. Always apply the brakes when necessary. Failure to do so may result in a crash, serious injury or death.



**WARNING:** Do not use the adaptive cruise control when entering or leaving a highway, on roads with intersections or roundabouts or non-vehicular traffic or roads that are winding, slippery, unpaved, or steep slopes.



**WARNING:** Do not use the system in poor visibility, for example fog, heavy rain, spray or snow.



**WARNING:** Do not use tire sizes other than those recommended because this can affect the normal operation of the system. Failure to do so may result in a loss of vehicle control, which could result in serious injury.



**WARNING:** Adaptive cruise control may not detect stationary or slow moving vehicles below 6 mph (10 km/h).



**WARNING:** Adaptive cruise control does not detect pedestrians or objects in the road.



**WARNING:** Adaptive cruise control does not detect oncoming vehicles in the same lane.



**WARNING:** Adaptive cruise control is not a crash warning or avoidance system.

**Note:** It is your responsibility to stay alert, drive safely and be in control of the vehicle at all times.

The system adjusts your vehicle speed to maintain the set gap between you and the vehicle in front of you in the same lane. You can select four gap settings.

The system uses a radar sensor that projects a beam directly in front of your vehicle.

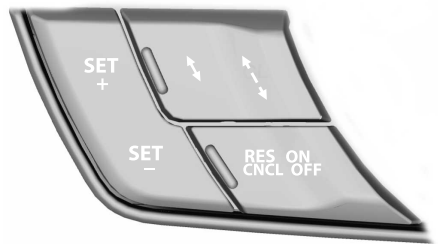

E177068

The adaptive cruise controls are on the steering wheel.

# Cruise Control

## Switching Adaptive Cruise Control On

Press **ON**.



The indicator, current gap setting and set speed appear in the information display.

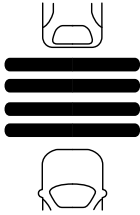

E164805

## Setting the Adaptive Cruise Speed

**Note:** When adaptive cruise control is active, the speedometer may vary slightly from the set speed displayed in the information display.

1. Drive to desired speed.
2. Press **SET+** or **SET-**.
3. A green indicator light, the current gap setting and your set speed appear in the information display.
4. Take your foot off the accelerator pedal.

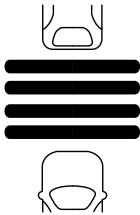

E164805

5. A vehicle image illuminates if the system detects a vehicle in front of you.

## Following a Vehicle



**WARNING:** When following a vehicle, your vehicle does not decelerate automatically to a stop, nor does your vehicle always decelerate quickly enough to avoid a crash without driver intervention. Always apply the brakes when necessary. Failing to do so may result in a crash, serious injury or death.



**WARNING:** Adaptive cruise control only warns of vehicles detected by the radar sensor. In some cases there may be no warning or a delayed warning. You should always apply the brakes when necessary. Failure to do so may result in a crash, serious injury or death.

**Note:** When you are following a vehicle and you switch on a direction indicator, adaptive cruise control may provide a small temporary acceleration to help you pass.

**Note:** The brakes may emit noise when applied by the system.

When a vehicle ahead of you enters the same lane or a slower vehicle is ahead in the same lane, the vehicle speed adjusts to maintain a preset gap distance. A vehicle graphic illuminates in the instrument cluster.

Your vehicle maintains a consistent gap from the vehicle ahead until:

- The vehicle in front of you accelerates to a speed above the set speed.
- The vehicle in front of you moves out of the lane you are in.
- Your vehicle speed falls below 12 mph (20 km/h).
- You set a new gap distance.

# Cruise Control

The system applies the brakes to slow your vehicle to maintain a safe gap distance from the vehicle in front. The system only applies limited braking. You can override the system by applying the brakes.

If the system determines that its maximum braking level is not sufficient, an audible warning sounds, a message appears in the information display and an indicator flashes when the system continues to brake. Take immediate action.

## Setting the Gap Distance

**Note:** *The gap setting is time dependent and therefore the distance adjusts with your vehicle speed.*

**Note:** *It is your responsibility to select a gap appropriate to the driving conditions.*

You can decrease or increase the distance between your vehicle and the vehicle in front by pressing the gap control.

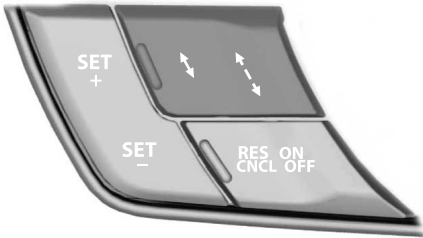

E177070

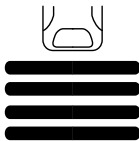

E164805

The selected gap appears in the information display as shown by the bars in the image.

## Adaptive Cruise Control Gap Settings

Graphic Display, Bars Indicated Between Vehicles	Distance Gap	Dynamic Behavior
1	Closest.	Sport.
2	Close.	Normal.
3	Medium.	Normal.
4	Far.	Comfort.

Each time you switch the system on, it selects the last chosen gap setting.

## Overriding the Set Speed



**WARNING:** If you override the system by pressing the accelerator pedal, it does not automatically apply the brakes to maintain a gap from any vehicle ahead.

When you press the accelerator pedal, you override the set speed and gap distance.



When you override the system, the green indicator light illuminates and the vehicle

image does not appear in the information display.

The system resumes operation when you release the accelerator pedal. The vehicle speed decreases to the set speed, or a lower speed if following a slower vehicle.

# Cruise Control

## Changing the Set Speed

- Press **SET+** or **SET-** to change the set speed in small increments.
- Press the accelerator or brake pedal until you reach the desired speed. Press **SET+** or **SET-**.
- Press and hold **SET+** or **SET-** to change the set speed in large increments. Release the control when you reach the desired speed.

The system may apply the brakes to slow the vehicle to the new set speed. The set speed displays continuously in the information display when the system is active.

## Canceling the Set Speed

Press **CNCL** or tap the brake pedal. The set speed does not erase.

**Note:** For vehicles with manual transmission, if you press the clutch pedal for an extended period, this action also cancels the set speed.

## Resuming the Set Speed

**Note:** Only use **resume** if you are aware of the set speed and intend to return to it.

Press **RES**. Your vehicle speed returns to the previously set speed and gap setting. The set speed displays continuously in the information display when the system is active.

## Automatic Cancellation

**Note:** If the engine speed drops too low, an audible warning sounds and a message appears in the information display. Automatic braking releases.

The system does not operate below 12 mph (20 km/h).

## Hilly Condition Usage

**Note:** An audible alarm sounds and the system shuts down if it applies brakes for an extended period of time. This allows the brakes to cool. The system functions normally again after the brakes cool.

Select a lower gear when the system is active in situations such as prolonged downhill driving on steep grades, for example in mountainous areas. The system needs additional engine braking in these situations to reduce the load on the vehicle's regular brake system to prevent it from overheating.

## Switching Adaptive Cruise Control Off

**Note:** You erase the set speed and gap setting when you switch the system off.

Press **OFF** when the system is in standby mode, or switch the ignition off.

## Detection Issues



**WARNING:** On rare occasions, detection issues can occur due to the road infrastructures, for example bridges, tunnels and safety barriers. In these cases, the system may brake late or unexpectedly. At all times, you are responsible for controlling your vehicle, supervising the system and intervening, if required.



**WARNING:** If the system malfunctions, have your vehicle checked as soon as possible.

The radar sensor has a limited field of view. It may not detect vehicles at all or detect a vehicle later than expected in some situations. The lead vehicle graphic does not illuminate if the system does not detect a vehicle in front of you.

# Cruise Control

A

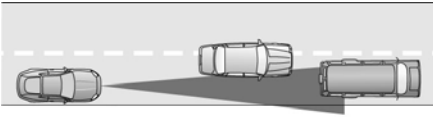

B

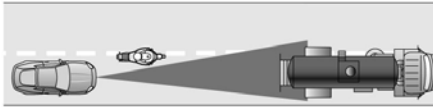

C

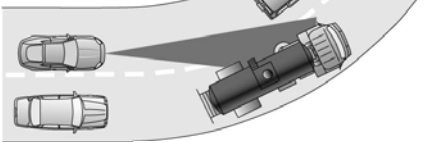

E71621

Detection issues can occur:

- When driving on a different line than the vehicle in front.
- With vehicles that edge into your lane. The system can only detect these vehicles once they move fully into your lane.
- There may be issues with the detection of vehicles in front when driving into and coming out of a bend or curve in the road.

In these cases, the system may brake late or unexpectedly. You should stay alert and take action when necessary.

If something hits the front end of your vehicle or damage occurs, the radar-sensing zone may change. This could cause missed or false vehicle detection.

## System Not Available

The system may not turn on if there is:

- A blocked sensor.
- High brake temperature.
- A failure in the system or a related system.

## Blocked Sensor

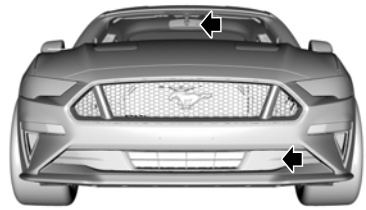

E252419

**Note:** *You cannot see the sensor. It is behind a fascia panel.*

A message displays if something obstructs the radar signals from the sensor. The sensor is in the lower grille. The system cannot detect a vehicle ahead and does not function when something blocks the sensor.

# Cruise Control

## Possible Causes and Actions for This Message Displaying:

Cause	Action
The surface of the radar is dirty or obstructed.	Clean the grille surface in front of the radar or remove the object causing the obstruction.
The surface of the radar is clean but the message remains in the display.	Wait a short time. It may take several minutes for the radar to detect that it is free from obstruction.
Heavy rain or snow is interfering with the radar signals.	Do not use the system in these conditions because it may not detect any vehicles ahead.
Water, snow or ice on the surface of the road may interfere with the radar signals.	Do not use the system in these conditions because it may not detect any vehicles ahead.

Due to the nature of radar technology, it is possible to get a blockage warning with no actual block. This happens, for example, when driving in sparse rural or desert environments. A false blocked condition either self clears, or clears after you restart your vehicle.

## Switching to Normal Cruise Control



**WARNING:** Normal cruise control will not brake when your vehicle is approaching slower vehicles. Always be aware of which mode you have selected and apply the brakes when necessary.

You can change from adaptive cruise control to normal cruise control through the information display.



The cruise control indicator light replaces the adaptive cruise control indicator light if you select normal cruise control. The gap setting does not display, and the system does not respond to lead vehicles. Automatic braking remains active to maintain set speed.

# Driving Aids

## DRIVER ALERT (IF EQUIPPED)



**WARNING:** You are responsible for controlling your vehicle at all times. The system is designed to be an aid and does not relieve you of your responsibility to drive with due care and attention. Failure to follow this instruction could result in the loss of control of your vehicle, personal injury or death.



**WARNING:** The system may not function if the sensor is blocked.



**WARNING:** Take regular rest breaks if you feel tired. Do not wait for the system to warn you.



**WARNING:** Certain driving styles may result in the system warning you even if you are not feeling tired.



**WARNING:** In cold and severe weather conditions the system may not function. Rain, snow and spray can all limit sensor performance.



**WARNING:** The system will not operate if the sensor cannot track the road lane markings.



**WARNING:** If damage occurs in the immediate area surrounding the sensor, have your vehicle checked as soon as possible.



**WARNING:** The system may not correctly operate if your vehicle is fitted with a suspension kit not approved by us.

**Note:** Keep the windshield free from obstructions. For example, bird droppings, insects and snow or ice.

**Note:** If the camera is blocked or if the windshield is damaged, the system may not function.

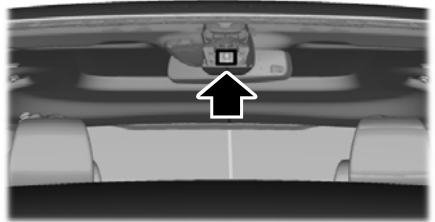

E249505

The system automatically monitors your driving behavior using various inputs including the front camera sensor.

If the system detects that your driving alertness is reduced below a certain threshold, the system will alert you using a tone and a message in the information display.

## Using Driver Alert

### Switching the system on and off

You may switch the system on or off through the information display. See **General Information** (page 88). When activated, the system will monitor your alertness level based upon your driving behavior in relation to the lane markings and other factors.

### System Warnings

**Note:** The system does not issue warnings below approximately 40 mph (64 km/h).



# Driving Aids

The warning system is in two stages. At first the system issues a temporary warning that you need to take a rest. This message will only appear for a short time. If the system detects further reduction in driving alertness, another warning may be issued which will remain in the information display for a longer time. Press OK on the steering wheel control to clear the warning

## System Display

When active the system will run automatically in the background and only issue a warning if required.

**Note:** *If the camera sensor cannot track the road lane markings or if your vehicle speed drops below approximately 40 mph (64 km/h), the system does not issue warnings.*

## Resetting the System

You can reset the system by either:

- Switching the ignition off and on.
- Stopping the vehicle and then opening and closing the driver's door.

## LANE KEEPING SYSTEM (IF

EQUIPPED)



**WARNING:** You are responsible for controlling your vehicle at all times. The system is designed to be an aid and does not relieve you of your responsibility to drive with due care and attention. Failure to follow this instruction could result in the loss of control of your vehicle, personal injury or death.



**WARNING:** Always drive with due care and attention when using and operating the controls and features on your vehicle.



**WARNING:** In cold and severe weather conditions the system may not function. Rain, snow and spray can all limit sensor performance.



**WARNING:** The system will not operate if the sensor cannot track the road lane markings.



**WARNING:** The sensor may incorrectly track lane markings as other structures or objects. This can result in a false or missed warning.



**WARNING:** Large contrasts in outside lighting can limit sensor performance.



**WARNING:** The system may not operate properly if the sensor is blocked. Keep the windshield free from obstruction.



**WARNING:** If damage occurs in the immediate area surrounding the sensor, have your vehicle checked as soon as possible.



**WARNING:** The system may not correctly operate if your vehicle is fitted with a suspension kit not approved by us.

**Note:** *The system works above 40 mph (64 km/h).*

**Note:** *The system works as long as the camera can detect one lane marking.*

**Note:** *The system may not function if the camera is blocked, or if the windshield is damaged or dirty.*

# Driving Aids

**Note:** When you select aid or both modes and the system detects no steering activity for a short period, the system alerts you to put your hands on the steering wheel. **The system may detect a light grip or touch on the steering wheel as hands off driving.**

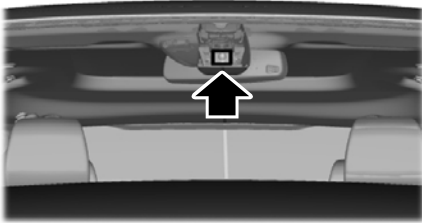

E249505

When you switch the system on and it detects an unintentional drift out of your lane is likely to occur, the system notifies or assists you to stay in your lane through the steering system and information display. In Alert mode, the system provides a warning by vibrating the steering wheel. In Aid mode, the system provides steering assistance by gently counter steering your vehicle back into the lane.

When the system is functioning in the combined Alert and Aid mode, the system first provides steering assistance by gently counter steering your vehicle back into the lane, followed by a warning by vibrating the steering wheel if the vehicle is still out of the lane markings.

## Switching the System On and Off

**Note:** The system on or off setting remains stored until you manually change it unless the system detects a MyKey. If the system detects a MyKey, it defaults to on and the mode sets to alert.



E132099

Press the button on the direction indicator stalk to switch the system on or off.

## System Settings

The system allows you to change the following settings; Mode and Intensity. To view or adjust the settings, See **Settings** (page 390). The system stores the last-known selection for each of these settings. You do not need to readjust your settings each time you switch on the system.

**Mode:** This setting allows you to select which of the system features you can enable.

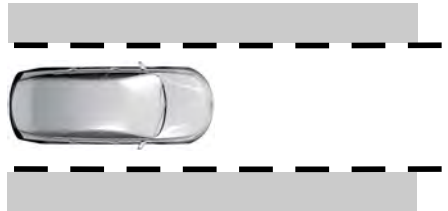

E165515

Alert only – Provides a steering wheel vibration when the system detects an unintended lane departure.

# Driving Aids

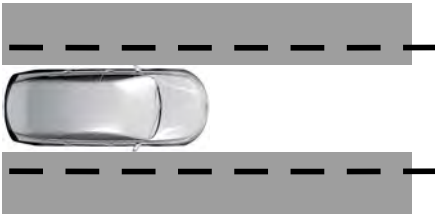

E165516

Aid only – Provides steering assistance toward the lane center when the system detects an unintended lane departure.

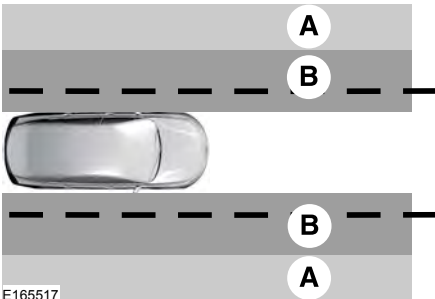

E165517

- A Alert
- B Aid

Alert + Aid – Provides steering assistance toward the lane center.

If your vehicle continues drifting out of the lane after the lane keeping aid corrects the vehicle, the system provides a steering wheel vibration.

**Note:** The alert and aid diagrams illustrate general zone coverage. They do not provide exact zone parameters.

**Intensity:** This setting affects the intensity of the steering wheel vibration used for the alert and alert + aid modes. **This setting does not affect the aid mode.**

- Low
- Normal
- High

## System Display



E267130

If you switch the system on in alert mode, a graphic with lane markings appears in the information display.

**Note:** Graphics can vary depending on the instrument cluster available in your vehicle.

If you switch the system on in aid or alert and aid mode, arrows appear with the lane markings.



E267131

If you have adaptive cruise control enabled and you are following a vehicle, additional graphics appear in the display.

When you switch off the system, the lane marking graphics do not display.

# Driving Aids

When the system is on, the color of the lane markings change to indicate the system status.

Gray: Indicates that the system is temporarily unable to provide a warning or intervention on the indicated side(s). This may be because:

- Your vehicle is under the activation speed.
- The direction indicator is active.
- Your vehicle is in a dynamic maneuver.
- The road has no or poor lane markings in the camera field-of-view.
- The camera is obscured or unable to detect the lane markings due to environmental, traffic or vehicle conditions. For example, significant sun angles, shadows, snow, heavy rain or fog, following a large vehicle that is blocking or shadowing the lane or poor headlamp illumination.

See **Troubleshooting** for additional information.

Green: Indicates that the system is available or ready to provide a warning or intervention, on the indicated side(s).

Yellow or Moving Walls: Indicates that the system is providing or has just provided a lane keeping aid intervention.

Red: Indicates that the system is providing or has just provided a lane keeping alert warning.

The system can be temporarily suppressed at any time by the following:

- Quick braking.
- Fast acceleration.
- Using the direction indicator.
- Evasive steering maneuver.
- Driving too close to the lane markings.

## Troubleshooting

<b>Why is the feature not available (lane markings are gray) when I can see the lane markings on the road?</b>
Your vehicle speed is outside the operational range of the feature.
The sun is shining directly into the camera lens.
A quick intentional lane change has occurred.
Your vehicle stays too close to the lane markings.
Driving at high speeds in curves.
The last alert warning or aid intervention occurred a short time ago.
Ambiguous lane markings, for example in construction zones.
Rapid transition from light to dark, or from dark to light.
Sudden offset in lane markings.
ABS or AdvanceTrac™ is active.
There is a camera blockage due to dirt, grime, fog, frost or water on the windshield.

# Driving Aids

<b>Why is the feature not available (line markings are gray) when I can see the lane markings on the road?</b>
--

You are driving too close to the vehicle in front of you.
---

Transitioning between no lane markings to lane markings or vice versa.
--

There is standing water on the road.
--------------------------------------

Faint lane markings, for example partial yellow lane markings on concrete roads.
--

Lane width is too narrow or too wide.
---------------------------------------

The camera has not been calibrated after a windshield replacement.
--

Driving on tight roads or on uneven roads.
--

<b>Why does the vehicle not come back toward the middle of the lane, as expected, in the Aid or Aid + Alert mode?</b>
---

High cross winds are present.
-------------------------------

There is a large road crown.
------------------------------

Rough roads, grooves or shoulder drop-offs.
---

Heavy uneven loading of the vehicle or improper tire inflation pressure.
--

The tires have been changed, or the suspension has been modified.
---

## BLIND SPOT INFORMATION SYSTEM (IF EQUIPPED)



**WARNING:** Do not use the blind spot information system as a replacement for using the interior and exterior mirrors or looking over your shoulder before changing lanes. The blind spot information system is not a replacement for careful driving.

# Driving Aids



**WARNING:** The system may not operate properly during severe weather conditions, for example snow, ice, heavy rain and spray. Always drive with due care and attention. Failure to take care may result in a crash.

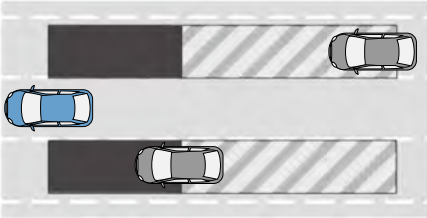

E255695

The system is designed to detect vehicles that may have entered the blind spot zone. The detection area is on both sides of your vehicle, extending rearward from the exterior mirrors to approximately 13 ft (4 m) beyond the rear bumper. The detection area extends to approximately 59 ft (18 m) beyond the rear bumper when the vehicle speed is greater than 30 mph (48 km/h) to alert you of faster approaching vehicles.

**Note:** *The system does not prevent contact with other vehicles. It is not designed to detect parked vehicles, pedestrians, animals or other infrastructures.*

## Using the Blind Spot Information System

### Vehicles with Automatic Transmission

The system turns on when all of the following occur:

- You start your vehicle.
- You shift into drive (D).
- The vehicle speed is greater than 6 mph (10 km/h).

**Note:** *The system does not operate in park (P) or reverse (R).*

### Vehicles with Manual Transmission

The system turns on when all of the following occur:

- You start your vehicle.
- The vehicle speed is greater than 6 mph (10 km/h).

**Note:** *The system does not operate in reverse (R).*

## System Lights and Messages



E142442

When the system detects a vehicle, an alert indicator illuminates in the exterior mirror on the side the approaching vehicle is coming from. If you turn the direction indicator on for that side of your vehicle, the alert indicator flashes.

# Driving Aids

**Note:** The system may not alert you if a vehicle quickly passes through the detection zone.

## Blocked Sensors



E205199

The sensors are behind the rear bumper on both sides of your vehicle.

**Note:** Keep the sensors free from snow, ice and large accumulations of dirt.

**Note:** Do not cover the sensors with bumper stickers, repair compound or other objects.

**Note:** Blocked sensors could affect system performance.

If the sensors become blocked, a message may appear in the information display. See **Information Messages** (page 97). The alert indicators remain illuminated but the system does not alert you.

## System Errors

If the system detects a fault, a warning lamp illuminates and a message displays. See **Information Messages** (page 97).

## Switching the System On and Off

You can switch the system off using the information display. See **General Information** (page 88). When you switch the system off, a warning lamp illuminates and a message displays. When you switch the system on or off, the alert indicators flash twice.

**Note:** The system remembers the last setting when you start your vehicle.

**Note:** The system may not correctly operate when towing a trailer. For vehicles with a trailer tow module and tow bar approved by us, the system turns off when you attach a trailer. For vehicles with an aftermarket trailer tow module or tow bar, we recommend that you switch the system off when you attach a trailer.

To permanently switch the system off, contact an authorized dealer.

## CROSS TRAFFIC ALERT (IF EQUIPPED)



**WARNING:** Do not use the cross traffic alert system as a replacement for using the interior and exterior mirrors or looking over your shoulder before reversing out of a parking space. The cross traffic alert system is not a replacement for careful driving.



**WARNING:** The system may not operate properly during severe weather conditions, for example snow, ice, heavy rain and spray. Always drive with due care and attention. Failure to take care may result in a crash.

The system is designed to alert you of vehicles approaching from the sides when you shift into reverse (R).

## Using the Cross Traffic Alert System

The system is designed to detect vehicles that approach with a speed up to 37 mph (60 km/h). Coverage decreases when the sensors are partially, mostly or fully obstructed. Slowly reversing helps increase the coverage area and effectiveness.

# Driving Aids

The system turns on when you start the engine and you shift into reverse (R). The

system turns off when you shift out of reverse (R).

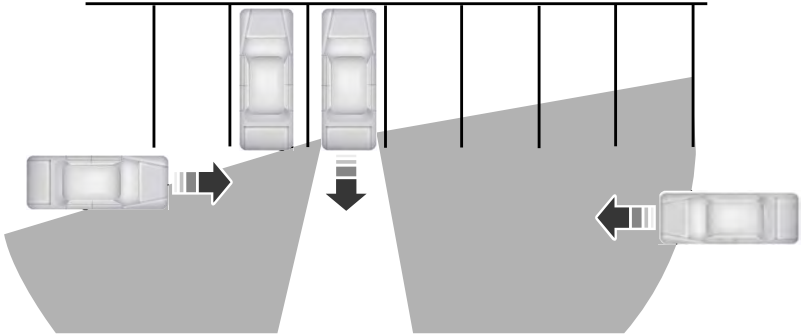

E142440

The sensor on the left-hand side is only partially obstructed and zone coverage on the right-hand side is maximized.

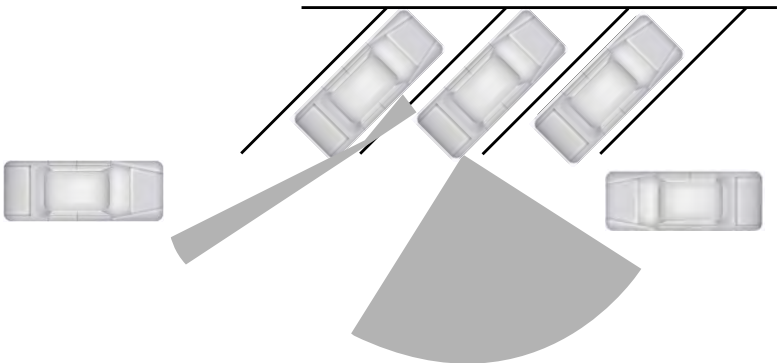

E142441



# Driving Aids

Zone coverage also decreases when parking at narrow angles. The sensor on the left-hand side is mostly obstructed and zone coverage on that side is severely reduced.

## System Lights, Messages and Audible Alerts



E142442

When the system detects a vehicle, an indicator illuminates in the exterior mirror on the side the approaching vehicle is coming from. A tone sounds and a message appears in the information display.

**Note:** *In exceptional conditions, the system could alert you even when there is nothing in the detection zone, for example a vehicle passing in the distance.*

## Blocked Sensors

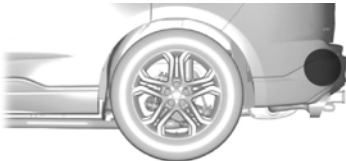

E205199

The sensors are behind the rear bumper on both sides of your vehicle.

**Note:** *Keep the sensors free from snow, ice and large accumulations of dirt.*

**Note:** *Do not cover the sensors with bumper stickers, repair compound or other objects.*

**Note:** *Blocked sensors could affect system performance.*

If the sensors are blocked, a message may appear in the information display when you shift into reverse (R). See **Information Messages** (page 97).

## System Limitations

The system may not correctly operate when any of the following occur:

- The sensors are blocked.
- Adjacently parked vehicles or objects are obstructing the sensors.
- Vehicles approach at speeds greater than 37 mph (60 km/h).
- The vehicle speed is greater than 7 mph (12 km/h).
- You reverse out of an angled parking space.

## System Errors

If the system detects a fault a message displays. See **General Information** (page 88).

## Switching the System Off and On

You can temporarily switch the system off using the information display. See **General Information** (page 88). When you switch system off, a message displays. See **Information Messages** (page 97).

**Note:** *The system turns on each time you switch the ignition on and you shift into reverse (R). If you temporarily switch the system off, it turns on the next time you switch the ignition on.*

# Driving Aids

**Note:** *The system may not correctly operate when towing a trailer. For vehicles with a trailer tow module and tow bar approved by us, the system turns off when you attach a trailer. For vehicles with an aftermarket trailer tow module or tow bar, we recommend that you switch the system off when you attach a trailer.*

To permanently switch the system off, contact an authorized dealer.

## STEERING

### Electric Power Steering



**WARNING:** If the system detects an error, you may not feel a difference in the steering, however a serious condition may exist. Have your vehicle checked as soon as possible. Failure to do so may result in loss of steering control.

Your vehicle has an electric power steering system, there is no fluid reservoir, no maintenance is required.

If your vehicle loses electrical power while you are driving, electric power steering assistance is lost. The steering system still operates and you can steer your vehicle manually. Manually steering your vehicle requires more effort.

Extreme continuous steering may increase the effort required for you to steer your vehicle, this increased effort prevents overheating and permanent damage to the steering system. You do not lose the ability to steer your vehicle manually. Typical steering and driving maneuvers allow the system to cool and return to normal operation.

### Steering Tips

If the steering wanders or pulls, check for:

- Correct tire pressures.
- Uneven tire wear.
- Loose or worn suspension components.
- Loose or worn steering components.
- Improper vehicle alignment.

**Note:** *A high crown in the road or high crosswinds may also make the steering seem to wander or pull.*

### Adaptive Learning

The electronic power steering system adaptive learning helps correct road irregularities and improves overall handling and steering feel. It communicates with the brake system to help operate advanced stability control and accident avoidance systems. Additionally, whenever the battery is disconnected or a new battery installed, you must drive your vehicle a short distance before the system relearns the strategy and reactivates all systems.

### PRE-COLLISION ASSIST (IF EQUIPPED)



**WARNING:** At all times, you are responsible for controlling your vehicle, supervising the system and intervening, if required. Failure to take care may result in the loss of control of your vehicle, serious personal injury or death.

# Driving Aids



**WARNING:** The system does not detect vehicles that are driving in a different direction, cyclists or animals. Failure to take care may result in the loss of control of your vehicle, serious personal injury or death.



**WARNING:** The system does not operate during hard acceleration or steering. Failure to take care may lead to a crash or personal injury.



**WARNING:** The system may fail or operate with reduced function during cold and severe weather conditions. Snow, ice, rain, spray and fog can adversely affect the system. Keep the front camera and radar free of snow and ice. Failure to take care may result in the loss of control of your vehicle, serious personal injury or death.



**WARNING:** In situations where the vehicle camera has limited detection capability, this may reduce system performance. These situations include but are not limited to direct or low sunlight, vehicles at night without tail lights, unconventional vehicle types, pedestrians with complex backgrounds, running pedestrians, partly obscured pedestrians, or pedestrians that the system cannot distinguish from a group. Failure to take care may result in the loss of control of your vehicle, serious personal injury or death.



**WARNING:** The system cannot help prevent all crashes. Do not rely on this system to replace driver judgment and the need to maintain a safe distance and speed.

## Using the Pre-Collision Assist System

The system is active at speeds above approximately 3 mph (5 km/h) and pedestrian detection is active at speeds up to 50 mph (80 km/h).

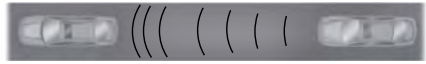

E156130

If your vehicle is rapidly approaching another stationary vehicle, a vehicle traveling in the same direction as yours, or a pedestrian within your driving path, the system is designed to provide three levels of functionality:

1. Alert
2. Brake Support
3. Active Braking

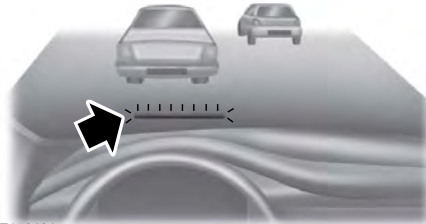

E156131

**Alert:** When activated, a flashing visual warning and an audible warning tone sounds.

**Brake Support:** Assists the driver in reducing collision speed by preparing the brake system for rapid braking. Brake support does not automatically activate the brakes, but if the driver presses the brake pedal even lightly, brake support could add additional braking up to full force.

# Driving Aids

**Active Braking:** Active braking may activate if the system determines that a collision is imminent. The system may help the driver reduce impact damage or avoid the crash completely.

**Note:** *If you perceive Pre-Collision Assist alerts as being too frequent or disturbing, then you can reduce the alert sensitivity, though the manufacturer recommends using the highest sensitivity setting where possible. Setting lower sensitivity would lead to fewer and later system warnings.*

**Note:** *The system turns off when you manually disable AdvanceTrac™, or when you select **Track** mode.*

## Distance Indication and Alert

Distance Indication and Alert is a function that provides a graphical indication of the time gap to other preceding vehicles traveling in the same direction. The Distance Indication and Alert screen in the information display shows a graphic similar to the one that follows.



E190004

If the time gap to a preceding vehicle is small, a red visual indication displays.

**Note:** *Distance Indication and Alert deactivates and the graphics do not display when adaptive cruise control is active.*

Speed	Sensitivity	Graphics	Distance Gap	Time Gap
62 mph (100 km/h)	Normal	Grey	>82 ft (25 m)	>0.9sec
62 mph (100 km/h)	Normal	Yellow	56–82 ft (17–25 m)	0.6sec - 0.9sec
62 mph (100 km/h)	Normal	Red	<56 ft (17 m)	<0.6sec

## Adjusting Pre-Collision Assist Settings

You can adjust the Alert and Distance Alert sensitivity to one of three possible settings by using the information display control. See **General Information** (page 88).

You can switch the distance alert and indication function off using the information display controls. See **General Information** (page 88).

If required, you can switch active braking off using the information display controls. See **General Information** (page 88).

**Note:** *Active braking automatically turns on every time you switch your vehicle on.*

# Driving Aids

## Blocked Sensors

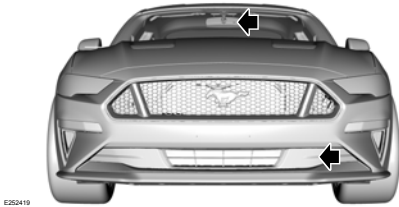

If a message regarding a blocked sensor or camera appears in the information display, the radar signals or camera images are obstructed. The radar sensor is located behind a fascia cover near the driver side of the lower grille. With an obstructed radar, the Pre-Collision Assist system does not function and cannot detect a vehicle ahead. With the front camera obstructed, the Pre-Collision Assist system does not respond to pedestrians or stationary vehicles and the system performance on moving vehicles reduces. The following table lists possible causes and actions for when this message displays.

Cause	Action
The surface of the radar in the grille is dirty or obstructed in some way.	Clean the grille surface in front of the radar or remove the object causing the obstruction.
The surface of the radar in the grille is clean but the message remains in the display.	Wait a short time. It may take several minutes for the radar to detect that there is no obstruction.
Heavy rain, spray, snow, or fog is interfering with the radar signals.	The Pre-Collision Assist system is temporarily disabled. Pre-Collision Assist should automatically reactivate a short time after the weather conditions improve.
Swirling water, or snow or ice on the surface of the road may interfere with the radar signals.	The Pre-Collision Assist system is temporarily disabled. Pre-Collision Assist should automatically reactivate a short time after the weather conditions improve.
Radar is out of alignment due to a front end impact.	Contact an authorized dealer to have the radar checked for proper coverage and operation.
The windshield in front of the camera is dirty or obstructed in some way.	Clean the outside of the windshield in front of the camera.
The windshield in front of the camera is clean but the message remains in the display.	Wait a short time. It may take several minutes for the camera to detect that there is no obstruction.

# Driving Aids

**Note:** Proper system operation requires a clear view of the road by the camera. Have any windshield damage in the area of the camera's field of view repaired.

**Note:** If something hits the front end of your vehicle or damage occurs, the radar sensing zone may change. This could cause missed or false vehicle detections. Contact an authorized dealer to have the radar checked for proper coverage and operation.

**Note:** If your vehicle detects excessive heat at the camera or a potential misalignment condition, a message may display in the information display indicating temporary sensor unavailability. When operational conditions are correct, the message deactivates. For example, when the ambient temperature around the sensor decreases or the sensor automatically recalibrates successfully.

## DRIVE CONTROL (IF EQUIPPED)

### Selectable Drive Modes (If Equipped)

Selectable drive modes deliver a customized driving experience using a variety of electronic vehicle systems. The systems optimize vehicle dynamics and powertrain response based on your selected mode. Systems associated with selectable drive modes are:

- Electronically power assisted steering. See **Steering** (page 183).
- Electronic stability control and traction control maintain your vehicle control in adverse conditions or high performance driving. See **Stability Control** (page 158).
- Electronic throttle control enhances the powertrain response to your driving input.

- Adaptive dampers (if equipped).
- Active exhaust adjusts the sound characteristics of your vehicle (if equipped).

### Using Selectable Drive Modes

**Note:** Your vehicle may have some of the drive modes that follow.



To change the drive mode setting, press the mode button on the instrument panel under the display. The first press illuminates the selected mode, subsequent presses change the selected mode.

**Note:** Mode changes are not available when the ignition is off or when the transmission is in reverse (R). Some modes may be unavailable when the transmission is in drive (D) or sport (S).

# Driving Aids

Modes:

- **Normal** – Best suited for everyday driving. If your vehicle has adaptive dampers, the suspension delivers a balanced combination of comfort and handling. Selectable steering defaults to **Normal** but can be changed using the steering button.
- **Sport** – Engages when you shift your automatic transmission into sport (S). Sport mode increases throttle response and helps your vehicle accelerate faster, but does not change the vehicle dynamics or stability system.
- **Sport +** – Best suited for spirited driving. This mode increases throttle response, and if your vehicle has active exhaust, it takes on a more powerful tone. If your vehicle has adaptive dampers, the suspension becomes stiffer, body motion reduces and the steering becomes more precise. Selectable steering defaults to **Sport**. Depending on vehicle configuration, you may be able to change the selectable steering setting by pressing the steering button.
- **Track** – Provides a performance driving experience. Throttle response increases, and if your vehicle has active exhaust, it takes on a more powerful tone. A performance oriented traction control mode is automatically utilized. In this mode, traction control intervention is reduced and tuned specifically for track usage only. This mode is not intended for public roads. See **Using Stability Control** (page 159). If your vehicle is equipped with adaptive dampers, the suspension is optimized for transient handling maneuvers. This mode offers maximum control and confidence in

handling on road courses or auto-cross style events. Selectable steering defaults to **Sport**. Depending on vehicle configuration, you could change the selectable steering setting by pressing the steering button.

- **Drag Strip** – Provides a performance driving experience tailored to driving on a drag strip. The engine responds directly to your inputs, and if your vehicle has active exhaust, it takes on a more powerful tone. This mode is not intended for public roads. If your vehicle has adaptive dampers, the setting is optimized for straight line maximum acceleration. Selectable steering defaults to **Sport**. Depending on vehicle configuration, you could change the selectable steering setting by pressing the steering button.
- **Snow / Wet** – Provides a confident handling driving experience during poor weather. If your vehicle has adaptive dampers, the suspension delivers a balanced combination of comfort and handling. Selectable steering defaults to **Normal**. Depending on vehicle configuration, you could change the selectable steering setting by pressing the steering button.

## Using MyMode (If Equipped)



You can use **MyMode** to create a unique drive mode.

# Driving Aids

To create or save **MyMode**, press the button on the steering wheel and access the menu. See **General Information** (page 88). The available systems display. Select your desired settings using the appropriate buttons and menus. Press and hold OK to save your settings. **MyMode** is added to the drive mode list and can be selected the next time you drive your vehicle.

**Note:** *The system has diagnostic checks that continuously monitor the system to make sure it properly operates. If a mode is unavailable due to a system fault or change in gear position, the selected mode defaults to **Normal**.*

**Note:** *Pre-Collision Assist is automatically disabled when **Track** mode is selected. See **Pre-Collision Assist** (page 183).*

**Note:** *If your vehicle has adaptive dampers, the steering setting is optimized to work with each drive mode. Other steering settings may not be available.*

## Selectable Steering

**Note:** *The steering setting defaults to **Normal** if the battery is disconnected or removed.*



Press the steering button on the instrument panel to change the steering feel. The first press illuminates the selected mode. Each time you press the button, it changes the mode.

Modes:

- **Normal** - Default factory setting.
- **Sport** - Slightly higher effort required for steering with more road force felt through the steering wheel.
- **Comfort** - Slightly less effort required for steering with less road force felt through the steering wheel.

**Note:** *A soft feedback bump in the steering wheel may be felt after you make a selection.*

## Adaptive Dampers (If Equipped)



Press the button on the steering wheel to adjust the suspension. The first press illuminates the current mode. Each time you press the button, it changes the mode.

Adaptive damper modes:

- **Normal** — Available in **Normal** and **Sport** drive modes.
- **Sport** — Available in **Normal**, **Sport** and **Track** drive modes.
- **Track** — Available only in **Track** drive mode.
- **Drag Strip**— Available only in **Drag Strip** drive mode.

## Active Exhaust (If Equipped)



Press the button on the instrument panel under the display to adjust the tone of the exhaust.

Active Exhaust modes:

- **Quiet** - Lowers the noise of the exhaust.
- **Normal** - Default factory setting.
- **Sport** - Raises the noise of the exhaust.
- **Track** - Tunes the exhaust for track performance.



# Driving Aids

---

**Note:** The **Track** exhaust mode setting is only for use at tracks and not for use on public roadways. Use of this setting results in increased exterior noise, which may not meet state and local laws and regulations. It is the obligation of the driver to operate the vehicle in a manner that complies with state and local requirements. Only use the **Track Exhaust Mode** setting at a competition track or an off-road course where elevated exterior vehicle noise is acceptable.

## **Rev Match** (If Equipped)

This feature provides a heel and toe driving experience by predicting shifts and then quickly matching engine RPM to the new gear as it performs the shift.

You can switch this feature on or off through the information display. See **General Information** (page 88).

# Load Carrying

## LOAD LIMIT

### Vehicle Loading - with and without a Trailer

This section guides you in the proper loading of your vehicle, trailer, or both. Keep your loaded vehicle weight within its design rating capability, with or without a trailer. Properly loading your vehicle provides maximum return of vehicle design performance. Before you load your vehicle, become familiar with the following terms for determining your vehicle's weight rating, with or without a trailer, from the vehicle's Tire and Loading Information label or Safety Compliance Certification label.

### Tire and Loading Label Information Example:



#### TIRE AND LOADING INFORMATION

SEATING CAPACITY TOTAL: 5 FRONT: 2 REAR: 3

The combined weight of occupants and cargo should never exceed: **385 kg or 850 lbs.**

TIRE	SIZE	COLD TIRE PRESSURE	SEE OWNERS MANUAL FOR ADDITIONAL INFORMATION
FRONT	235/45R18 94V	235 KPA, 34 PSI	
REAR	235/45R18 94V	235 KPA, 34 PSI	
SPARE	NONE	NONE	



#### TIRE AND LOADING INFORMATION RENSEIGNEMENTS SUR LES PNEUS ET LE CHARGEMENT

SEATING CAPACITY / NOMBRE DE PLACES TOTAL: 5 FRONT: 2 REAR: 3

The combined weight of occupants and cargo should never exceed 396 kg or 875 lbs. / Le poids total des occupants et du chargement ne doit jamais dépasser 396 kg ou 875 lbs.

TIRE / PNEU	SIZE / DIMENSIONS	COLD TIRE PRESSURE / PRESSION DES PNEUS À FROID	SEE OWNER'S MANUAL FOR ADDITIONAL INFORMATION VOIR LE MANUEL DE L'USAGER POUR PLUS DE RENSEIGNEMENTS
FRONT / AVANT	235/40R19 96V	255 KPA, 37 PSI	
REAR / ARRIÈRE	235/40R19 96V	255 KPA, 37 PSI	
SPARE / DE SECOURS	T125/80R16 97M	415 KPA, 60 PSI	

E198719

## Payload

Payload is the combined weight of cargo and passengers that your vehicle is carrying. The maximum payload for your vehicle appears on the Tire and Loading label. The label is either on the B-pillar or the edge of the driver door. Vehicles exported outside the US and Canada may not have a tire and loading label. Look for "The combined weight of occupants and cargo should never exceed XXX kg OR XXX lb" for maximum payload. The payload listed on the Tire and Loading Information label

# Load Carrying

is the maximum payload for your vehicle as built by the assembly plant. If you install any additional equipment on your vehicle, you must determine the new payload. Subtract the weight of the equipment from the payload listed on the Tire and Loading label. When towing, trailer tongue weight or king pin weight is also part of payload.

The total load on each axle must never exceed its Gross Axle Weight Rating.

## GVWR (Gross Vehicle Weight Rating)

GVWR is the maximum allowable weight of the fully loaded vehicle. This includes all options, equipment, passengers and cargo. It appears on the Safety Compliance Certification label. The label is located on the door hinge pillar, door-latch post, or the door edge that meets the door-latch post, next to the driver seating position.

The gross vehicle weight must never exceed the Gross Vehicle Weight Rating.



## Safety Compliance Certification Label Example:



**WARNING:** The appropriate loading capacity of your vehicle can be limited either by volume capacity (how much space is available) or by payload capacity (how much weight the vehicle should carry). Once you have reached the maximum payload of your vehicle, do not add more cargo, even if there is space available. Overloading or improperly loading your vehicle can contribute to loss of vehicle control and vehicle rollover.

## GAWR (Gross Axle Weight Rating)

GAWR is the maximum allowable weight that a single axle (front or rear) can carry. These numbers are on the Safety Compliance Certification label. The label is located on the door hinge pillar, door-latch post, or the door edge that meets the door-latch post, next to the driver seating position.

<p>MFD. BY FORD MOTOR CO.          DATE: XXXX GWR: XXXXKG/XXXXLB          FRONT GAWR: XXXX REAR GAWR: XXXX          XXXXKG/XXXXLB WITH XXXXKG/XXXXLB W/HT          XXXXKG/XXXXXXX TRES XXXXKG/XXXXXXX TRES          XXXXKG TRES XXXXKG TRES          AT XXXX kPa/ XXX PSI(COLD) AT XXXX kPa/ XXX PSI(COLD)</p> <p>THE VEHICLE CONFORMS TO ALL APPLICABLE FEDERAL MOTOR VEHICLE SAFETY AND TRAFFIC PREVENTION STANDARDS IN EFFECT ON THE DATE OF MANUFACTURE SHOWN ABOVE.</p> <p>VIN: XXXXXXXXXXXXXXXXXXXX XXXXX          TRES: XXXX XXXXX</p>  <p>EXPIRES: XX XXXXX XX XX XXXX          00 1M10 1999 10 101E 110 150 1 XXXX          XXX XX 202 1 XX 1 XXXX 202E          XXXXXXXXXXXX XXX XXXXXXXXXXXX-XX</p>	<p>MFD. BY FORD MOTOR CO.          DATE: XXXX GWR: XXXXKG/XXXXLB          FRONT GAWR: XXXX REAR GAWR: XXXX          XXXXKG/XXXXLB WITH XXXXKG/XXXXLB W/HT          XXXXKG/XXXXXXX TRES XXXXKG/XXXXXXX TRES          XXXXKG TRES XXXXKG TRES          AT XXXX kPa/ XXX PSI(COLD) AT XXXX kPa/ XXX PSI(COLD)</p> <p>THE VEHICLE CONFORMS TO ALL APPLICABLE FEDERAL MOTOR VEHICLE SAFETY AND TRAFFIC PREVENTION STANDARDS IN EFFECT ON THE DATE OF MANUFACTURE SHOWN ABOVE.</p> <p>VIN: XXXXXXXXXXXXXXXXXXXX XXXXX          TRES: XXXX XXXXX</p>  <p>EXPIRES: XX XXXXX XX XX XXXX          00 1M10 1999 10 101E 110 150 1 XXXX          XXX XX 202 1 XX 1 XXXX 202E          XXXXXXXXXXXX XXX XXXXXXXXXXXX-XX</p>
---	---

E19888

# Load Carrying



**WARNING:** Exceeding the Safety Compliance Certification label vehicle weight limits can adversely affect the performance and handling of your vehicle, cause vehicle damage and can result in the loss of control of your vehicle, serious personal injury or death.

## Maximum Loaded Trailer Weight

Maximum loaded trailer weight is the highest possible weight of a fully loaded trailer the vehicle can tow. Consult an authorized dealer (or the RV and Trailer Towing Guide available at an authorized dealer) for more detailed information.

## GCWR (Gross Combined Weight Rating)

GCWR is the maximum allowable weight of the vehicle and the loaded trailer, including all cargo and passengers, that the vehicle can handle without risking damage. (Important: The towing vehicle's braking system is rated for operation at Gross Vehicle Weight Rating, not at Gross Combined Weight Rating.) Separate functional brakes should be used for safe control of towed vehicles and for trailers where the Gross Combined Weight of the towing vehicle plus the trailer exceed the Gross Vehicle Weight Rating of the towing vehicle.

The gross combined weight must never exceed the Gross Combined Weight Rating.

**Note:** For trailer towing information refer to the *RV and Trailer Towing Guide* available at an authorized dealer.



**WARNING:** Do not exceed the GVWR or the GAWR specified on the certification label.



**WARNING:** Do not use replacement tires with lower load carrying capacities than the original tires because they may lower your vehicle's GVWR and GAWR limitations. Replacement tires with a higher limit than the original tires do not increase the GVWR and GAWR limitations.



**WARNING:** Exceeding any vehicle weight rating can adversely affect the performance and handling of your vehicle, cause vehicle damage and can result in the loss of control of your vehicle, serious personal injury or death.

## Steps for determining the correct load limit:

1. Locate the statement "The combined weight of occupants and cargo should never exceed XXX kg or XXX lb." on your vehicle's placard.

## Load Carrying

---

- Determine the combined weight of the driver and passengers that will be riding in your vehicle.
- Subtract the combined weight of the driver and passengers from XXX kg or XXX lb.
- The resulting figure equals the available amount of cargo and luggage load capacity. For example, if the “XXX” amount equals 1,400 lb. and there will be five 150 lb. passengers in your vehicle, the amount of available cargo and luggage load capacity is 650 lb.  $(1400 - 750 (5 \times 150) = 650 \text{ lb.})$
- Determine the combined weight of luggage and cargo being loaded on the vehicle. That weight may not safely exceed the available cargo and luggage load capacity calculated in Step 4.
- If your vehicle will be towing a trailer, load from your trailer will be transferred to your vehicle. Consult this manual to determine how this reduces the available cargo and luggage load capacity of your vehicle.

### ***Helpful examples for calculating the available amount of cargo and luggage load capacity***

Suppose your vehicle has a 1400-pound (635-kilogram) cargo and luggage capacity. You decide to go golfing. Is there enough load capacity to carry you, four of your friends and all the golf bags? You and four friends average 220 pounds (99 kilograms) each and the golf bags weigh approximately 30 pounds (13.5 kilograms) each. The calculation would be:  $1400 - (5 \times 220) - (5 \times 30) = 1400 - 1100 - 150 = 150$  pounds. Yes, you have enough load capacity in your vehicle to transport four friends and your golf bags. In metric units, the calculation would be:  $635 \text{ kilograms} - (5 \times 99 \text{ kilograms}) - (5 \times 13.5 \text{ kilograms}) = 635 - 495 - 67.5 = 72.5$  kilograms.

Suppose your vehicle has a 1400-pound (635-kilogram) cargo and luggage capacity. You and one of your friends decide to pick up cement from the local home improvement store to finish that patio you have been planning for the past two years. Measuring the inside of the vehicle with the rear seat folded down, you have room for twelve 100-pound (45-kilogram) bags of cement. Do you have enough load capacity to transport the cement to your home? If you and your friend each weigh 220 pounds (99 kilograms), the calculation would be:  $1400 - (2 \times 220) - (12 \times 100) = 1400 - 440$

## Load Carrying

- 1200 = - 240 pounds. No, you do not have enough cargo capacity to carry that much weight. In metric units, the calculation would be: 635 kilograms - (2 x 99 kilograms) - (12 x 45 kilograms) = 635 - 198 - 540 = -103 kilograms. You will need to reduce the load weight by at least 240 pounds (104 kilograms). If you remove three 100-pound (45-kilogram) cement bags, then the load calculation would be: 1400 - (2 x 220) - (9 x 100) = 1400 - 440 - 900 = 60 pounds. Now you have the load capacity to transport the cement and your friend home. In metric units, the calculation would be: 635 kilograms - (2 x 99 kilograms) - (9 x 45 kilograms) = 635 - 198 - 405 = 32 kilograms.

The above calculations also assume that the loads are positioned in your vehicle in a manner that does not overload the front or the rear gross axle weight rating specified for your vehicle on the Safety Compliance Certification label.

### Special Loading Instructions for Owners of Pick-up Trucks and Utility-type Vehicles



**WARNING:** When loading the roof racks, we recommend you evenly distribute the load, as well as maintain a low center of gravity. Loaded vehicles, with higher centers of gravity, may

handle differently than unloaded vehicles. Take extra precautions, such as slower speeds and increased stopping distance, when driving a heavily loaded vehicle.

# Towing

## TOWING A TRAILER



**WARNING:** Do not exceed the GVWR or the GAWR specified on the certification label.



**WARNING:** Towing trailers beyond the maximum recommended gross trailer weight exceeds the limit of your vehicle and could result in engine damage, transmission damage, structural damage, loss of vehicle control, vehicle rollover and personal injury.

**Note:** *There may be electrical items such as fuses or relays that can affect trailer towing operation. See **Fuses** (page 220).*

The load capacity of your vehicle is designated by weight not volume. You may not necessarily be able to use all available space when loading your vehicle or trailer.

Towing a trailer places extra load on the engine, transmission, axle, brakes, tires, and suspension. Inspect these components before, during and after towing.

## Load Placement

To help minimize how trailer movement affects the vehicle when driving:

- Load the heaviest items closest to the trailer floor.
- Load the heaviest items in the center of the left and right side trailer tires.
- Load the heaviest items above the trailer axles or just slightly forward toward the trailer tongue. Do not allow the final trailer tongue weight to go above or below 10-15% of the loaded trailer weight.
- Select a ball mount with the correct rise or drop. When both the loaded vehicle and trailer are connected, the trailer frame should be level, or slightly angled down toward the vehicle, when viewed from the side.

When driving with a trailer or payload, a slight takeoff vibration or shudder may be present due to the increased payload weight. Additional information regarding proper trailer loading and setting your vehicle up for towing is located in the Load Carrying chapter. See **Load Limit** (page 191).

You can also find information in the **RV & Trailer Towing Guide** available at your authorized dealer, or online.

# Towing

## RV & Trailer Towing Guide Online

Website | <http://www.fleet.ford.com/towing-guides/>

### RECOMMENDED TOWING WEIGHTS

**Note:** Do not exceed the trailer weight for your vehicle configuration listed in the chart below.

**Note:** Be sure to take into consideration trailer frontal area. Do not exceed 12 feet<sup>2</sup> (1.11 meters<sup>2</sup>).

**Note:** For high altitude operation, reduce the gross combined weight by 2% per 1,000 ft (300 m) starting at the 1,000 ft (300 m) elevation point.

**Note:** Certain states require separate trailer brakes for trailers over a specified weight. Be sure to check state regulations for this specified weight. The maximum trailer weights listed may be limited to this specified weight, as the vehicle's electrical system may not include the wiring connector needed to activate electric trailer brakes.

Your vehicle may tow a trailer provided the maximum trailer weight is less than or equal to the maximum trailer weight listed for your vehicle configuration on the following chart.

Powertrain	Maximum Trailer Weight
2.3L GTDI	1,000 lb (454 kg)
5.0L TiVCT	1,000 lb (454 kg)



# Towing

## ESSENTIAL TOWING CHECKS

Follow these guidelines for safe towing:

- Do not tow a trailer until you drive your vehicle at least 1,000 mi (1,600 km).
- Consult your local motor vehicle laws for towing a trailer.
- See the instructions included with towing accessories for the proper installation and adjustment specifications.
- Service your vehicle more frequently if you tow a trailer. See your scheduled maintenance information.
- If you use a rental trailer, follow the instructions the rental agency gives you.

You can find information on load specification terms found on the tire label and Safety Compliance label as well as instructions on calculating your vehicle's load in the Load Carrying chapter. See **Load Limit** (page 191).

Remember to account for the trailer tongue weight as part of your vehicle load when calculating the total vehicle weight.

### Hitches

Do not use a hitch that either clamps onto the bumper or attaches to the axle.

Distribute the trailer load so 10-15% of the total trailer weight is on the tongue.

### Safety Chains

**Note:** *Never attach safety chains to the bumper.*

Always connect the safety chains to the hook retainers of your vehicle hitch.

To connect the safety chains, cross them under the trailer tongue and allow enough slack for turning tight corners. Do not allow the chains to drag on the ground.

## Trailer Brakes



**WARNING:** Do not connect a trailer's hydraulic brake system directly to your vehicle's brake system. Your vehicle may not have enough braking power and your chances of having a collision greatly increase.

Electric brakes and manual, automatic or surge-type trailer brakes are safe if you install them properly and adjust them to the manufacturer's specifications. The trailer brakes must meet local and federal regulations.

**The rating for the tow vehicle's braking system operation is at the gross vehicle weight rating, not the gross combined weight rating.**

## Trailer Lamps



**WARNING:** Never connect any trailer lamp wiring to the vehicle's tail lamp wiring; this may damage the electrical system resulting in fire. Contact your authorized dealer as soon as possible for assistance in proper trailer tow wiring installation. Additional electrical equipment may be required.

Trailer lamps are required on most towed vehicles. Make sure all running lights, brake lights, direction indicators and hazard lights are working.

## Before Towing a Trailer

Practice turning, stopping and backing up to get the feel of your vehicle-trailer combination before starting on a trip. When turning, make wider turns so the trailer wheels clear curbs and other obstacles.

# Towing

## When Towing a Trailer

- Do not drive faster than 70 mph (113 km/h) during the first 500 mi (800 km).
- Do not make full-throttle starts.
- Check your hitch, electrical connections and trailer wheel lug nuts thoroughly after you have traveled 50 mi (80 km).
- When stopped in congested or heavy traffic during hot weather, place the transmission in park (P) or neutral (N) to aid engine and transmission cooling and to help air conditioning performance.
- Switch off the speed control with heavy loads or in hilly terrain. The speed control may turn off automatically when you are towing on long, steep grades.
- Shift to a lower gear when driving down a long or steep hill. Do not apply the brakes continuously, as they may overheat and become less effective.
- If your transmission is equipped with a Grade Assist or Tow/Haul feature, use this feature when towing. This provides engine braking and helps eliminate excessive transmission shifting for optimum fuel economy and transmission cooling.
- Allow more distance for stopping with a trailer attached. Anticipate stops and brake gradually.
- Avoid parking on a slope. However, if you must park on a slope:
  1. Turn the steering wheel to point your vehicle tires away from traffic flow.
  2. Set your vehicle parking brake.
  3. Place the automatic transmission in park (P) or manual transmission in a low gear.

4. Place wheel chocks in front and back of the trailer wheels. Chocks are not included with your vehicle.

## Launching or Retrieving a Boat or Personal Watercraft (PWC)

**Note:** *Disconnect the wiring to the trailer before backing the trailer into the water.*

**Note:** *Reconnect the wiring to the trailer after removing the trailer from the water.*

When backing down a ramp during boat launching or retrieval:

- Do not allow the static water level to rise above the bottom edge of the rear bumper.
- Do not allow waves to break higher than 6 in (15 cm) above the bottom edge of the rear bumper.

Exceeding these limits may allow water to enter vehicle components:

- Causing internal damage to the components.
- Affecting driveability, emissions, and reliability.

Any time the rear axle submerges in water, replace the rear axle lubricant. Water may contaminate the rear axle lubricant, which is not a normal maintenance inspection item unless there is a possibility of a leak or other axle repair is required.

## TOWING THE VEHICLE ON FOUR WHEELS

### Emergency Towing



**WARNING:** If your vehicle has a steering wheel lock make sure the ignition is in the accessory or on position when being towed.

# Towing

---

You can flat-tow (all wheels on the ground, regardless of the powertrain or transmission configuration) your disabled vehicle (without access to wheel dollies or vehicle transport trailer) under the following conditions:

- Your vehicle is facing forward so you tow it in a forward direction.
- You shift into neutral (N). If you cannot shift into neutral (N), you may need to override the gearshift lever. See **Transmission** (page 147).
- Maximum speed is 35 mph (56 km/h).
- Maximum distance is 50 mi (80 km).

## Recreational Towing

**Note:** *Put your climate control system in recirculated air mode to prevent exhaust fumes from entering the vehicle. See **Climate Control** (page 109).*

Follow these guidelines if you have a need for recreational (RV) towing. An example of recreational towing would be towing your vehicle behind a motorhome. These guidelines are to make sure you do not damage the transmission during towing.

Do not tow your vehicle with any wheels on the ground, as vehicle or transmission damage may occur. It is required to recreational tow your vehicle with all four wheels off the ground, for example when using a vehicle transport trailer. Otherwise, you cannot tow your vehicle.

## Convertible Top (If Equipped)

### OPENING THE CONVERTIBLE TOP

When you use the top, you must first unlatch it from the windshield and then use the convertible top control.

**Note:** *The convertible top does not operate unless the vehicle is stationary or traveling under 3 mph (5 km/h). A chime sounds and a warning message appears in the instrument panel. When you slow down, the top operates.*

**Note:** *When you latch or unlatch the convertible top, the audio system mutes briefly. This allows the vehicle to optimize the cabin's sound quality depending on the position of the convertible top.*

To unlatch the convertible top:

1. Bring the vehicle to a complete stop. The ignition must be on. We recommend that the vehicle remains running when you open the top to prevent draining the battery.
2. Check the convertible top stowage compartment behind the rear seat to be sure it is empty. Make sure the convertible top outer surface is free of debris.
3. Move the latch handle, above the interior mirror, down toward the windshield and rotate the handle clockwise to release the convertible top.



E174571

The windows open automatically when you press the convertible top control.

To open the convertible top:

1. Press and hold the convertible top control on the overhead console, until the windows are completely down and the top stores completely.
2. Release the convertible top control.



E174568

**Note:** *Do not store articles behind the rear seat. Articles in the convertible top stowage compartment may break the rear glass window when you open the top.*

**Note:** *Opening the convertible top when the top material is wet may cause mold or mildew.*

## Convertible Top (If Equipped)

### Using the Tonneau Caps

Your convertible top also includes two tonneau caps, one for each side of the vehicle. These caps stow inside the trunk.

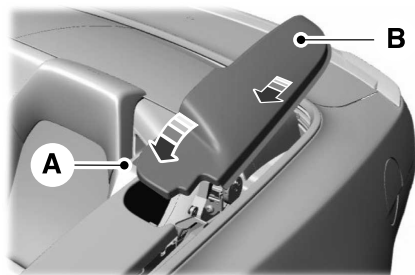

E205441

- A. Leading edge.
- B. Side edge.

After opening your convertible top, place the tonneau caps between the top and your vehicle trim moulding:

1. Insert tab A under the trim.
2. When tab A is under the trim slot, angle B down so the edges slide under the surrounding moulding and secure into place between the trim edges.
3. Repeat Steps 1 and 2 on the opposite side of the vehicle to install the second tonneau cap.

### CLOSING THE CONVERTIBLE TOP

Closing the convertible top is a three-step process: Remove both of the tonneau caps, press the convertible top control to close the top, and then close the latch.

To remove the tonneau caps:

1. Slide B toward the center of the vehicle to release the edges from the surrounding trim.
2. Lift up on B, and then pull the piece back to release tab A from the trim.
3. Repeat Steps 1 and 2 on the opposite side of the vehicle.
4. Make sure you stow both pieces in the trunk.

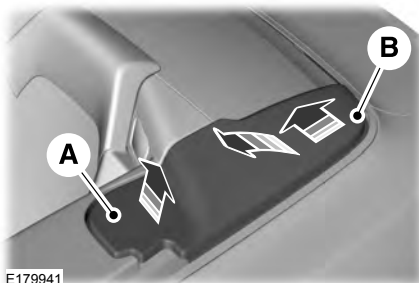

E179941

**Note:** The convertible top does not operate unless the vehicle is stationary or traveling under 3 mph (5 km/h). A chime sounds and a warning message appears in the instrument panel. When you slow down, the top operates.

**Note:** You must remove the tonneau caps before you are able to close the top or a chime sounds and a warning message appears in the instrument panel. Remove and stow the caps in the trunk, and then press the convertible top control again.

**Note:** When you latch or unlatch the convertible top, the audio system mutes briefly. This allows the vehicle to optimize the cabin's sound quality depending on the position of the convertible top.

## Convertible Top (If Equipped)

To close the convertible top:

1. Bring the vehicle to a complete stop and make sure you switch the ignition on. We recommend that the vehicle remains running when you open the top to prevent draining the battery.
2. Press and hold the convertible top control. When the convertible latch handle is within reach, make sure it is down and that you rotate it clockwise so the latch is in the fully opened position. Continue pressing the convertible top control until the convertible top control until the windows lower completely, and the top unfolds and moves forward toward the windshield header.
3. When the top lines up evenly with the windshield header, release the convertible top control.



E178453

**Note:** *If you keep the top open for an extended period of time or if the temperature is low, the top material may shrink slightly. If this happens, pull on the latch handle to secure the top.*



E174568

The final step when closing the convertible top is to lock the latch.

To lock the latch on the convertible top:

1. Pull down on the latch handle and rotate it counter-clockwise to secure the convertible top.
2. After securing the convertible top fully, push the latch handle up into the stowed position to secure the latch.

# Driving Hints

## BREAKING-IN

### Tires

New tires need to be run-in for approximately 300 mi (500 km). During this time, you may experience different driving characteristics.

### Brakes and Clutch

Avoid heavy use of the brakes and clutch if possible for the first 100 mi (150 km) in town and for the first 1,000 mi (1,500 km) on freeways.

### Engine

Avoid driving too fast during the first 1,000 mi (1,500 km). Vary your speed frequently and change up through the gears early. Do not labor the engine.

### Ground Clearance

#### GT Performance Package Level 2 Only

Since ground clearance is reduced, use caution when approaching curbs or curb stops from the front and rear as vehicle damage may occur. Additionally, when crossing speed bumps or driveway curbs, you should approach at a 45 degree angle to reduce the risk of vehicle damage.

Your vehicle carries the same warranty as other Ford models. Damage caused by accidents, crashes or objects striking the vehicle, including driving through a car wash, or misuse of the vehicle, such as driving over curbs, overloading or racing is not covered under the new vehicle limited warranty. See the Warranty Guide for complete information.

## REDUCED ENGINE PERFORMANCE



**WARNING:** If you continue to drive your vehicle when the engine is overheating, the engine could stop without warning. Failure to follow this instruction could result in the loss of control of your vehicle.

If the engine coolant temperature gauge needle moves to the upper limit position, the engine is overheating. See **Gauges** (page 81).

You must only drive your vehicle for a short distance if the engine overheats. The distance you can travel depends on ambient temperature, vehicle load and terrain. The engine continues to operate with limited power for a short period of time.

If the engine temperature continues to rise, the fuel supply to the engine reduces. The air conditioning switches off and the engine cooling fan operates continually.

1. Gradually reduce your speed and stop your vehicle as soon as it is safe to do so.
2. Immediately switch the engine off to prevent severe engine damage.
3. Wait for the engine to cool down.
4. Check the coolant level. See **Engine Coolant Check** (page 237).
5. Have your vehicle checked as soon as possible.

# Driving Hints

## Reduced Vehicle Top Speed

Your vehicle's ability to reach and maintain top speed is partially dependent upon ambient temperature. Under certain environmental conditions, your vehicle's top speed may be reduced to protect powertrain components.

## ECONOMICAL DRIVING

Fuel economy is affected by several things such as how you drive, the conditions you drive under and how you maintain your vehicle.

There are some things to keep in mind that may improve your fuel economy:

- Accelerate and slow down in a smooth, moderate fashion.
- Drive at steady speeds.
- Anticipate stops; slowing down may eliminate the need to stop.
- Combine errands and minimize stop-and-go driving (When running errands, go to the furthest destination first and then work your way back home).
- Close the windows for high-speed driving.
- Drive at reasonable speeds.
- Keep the tires properly inflated and use only the recommended size.
- Use the recommended engine oil.
- Perform all regularly scheduled maintenance.

There are also some things you may want to avoid doing because they reduce your fuel economy:

- Avoid sudden or hard accelerations.
- Avoid revving the engine before turning off the car.
- Avoid long idle periods.

- Do not warm up your vehicle on cold mornings.
- Reduce the use of air conditioning and heat.
- Avoid using speed control in hilly terrain.
- Do not rest your foot on the brake pedal while driving.
- Avoid carrying unnecessary weight.
- Avoid adding particular accessories to your vehicle (e.g. bug deflectors, rollbars/light bars, running boards, ski racks).
- Avoid driving with the wheels out of alignment.

## COLD WEATHER PRECAUTIONS

The functional operation of some components and systems can be affected at temperatures below -13°F (-25°C).

## DRIVING THROUGH WATER

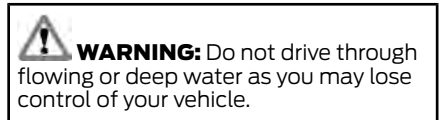

**Note:** *Driving through standing water can cause vehicle damage.*

**Note:** *Engine damage can occur if water enters the air filter.*

Before driving through standing water, check the depth. Never drive through water that is higher than the bottom of the front rocker area of your vehicle.



## Driving Hints



E266447

When driving through standing water, drive very slowly and do not stop your vehicle. Your brake performance and traction may be limited. After driving through water and as soon as it is safe to do so:

- Lightly press the brake pedal to dry the brakes and to check that they work.
- Check that the horn works.
- Check that the exterior lights work.
- Turn the steering wheel to check that the steering power assist works.

### FLOOR MATS



**WARNING:** Use a floor mat designed to fit the footwell of your vehicle that does not obstruct the pedal area. Failure to follow this instruction could result in the loss of control of your vehicle, personal injury or death.



**WARNING:** Pedals that cannot move freely can cause loss of vehicle control and increase the risk of serious personal injury.



**WARNING:** Secure the floor mat to both retention devices so that it cannot slip out of position and interfere with the pedals. Failure to follow this instruction could result in the loss of control of your vehicle, personal injury or death.



**WARNING:** Do not place additional floor mats or any other covering on top of the original floor mats. This could result in the floor mat interfering with the operation of the pedals. Failure to follow this instruction could result in the loss of control of your vehicle, personal injury or death.



**WARNING:** Always make sure that objects cannot fall into the driver foot well while your vehicle is moving. Objects that are loose can become trapped under the pedals causing a loss of vehicle control.



E142666

To install the floor mats, position the floor mat eyelet over the retention post and press down to lock in position.

To remove the floor mat, reverse the installation procedure.

**Note:** Regularly check the floor mats to make sure they are secure.

# Roadside Emergencies

---

## ROADSIDE ASSISTANCE

### Vehicles Sold in the United States: Getting Roadside Assistance

To fully assist you should you have a vehicle concern, Ford Motor Company offers a complimentary roadside assistance program. This program is separate from the New Vehicle Limited Warranty.

The service is available:

- 24 hours a day, seven days a week.
- For the coverage period listed on the Roadside Assistance Card included in your Owner's Manual portfolio.

Roadside Assistance covers:

- A flat tire change with a good spare (except vehicles supplied with a tire inflation kit).
- Battery jump start.
- Lock-out assistance (key replacement cost is the customer's responsibility).
- Fuel delivery — independent service contractors, if not prohibited by state, local or municipal law, shall deliver up to 2 gal (8 L) of gasoline or 5 gal (20 L) of diesel fuel to a disabled vehicle. Roadside Assistance limits fuel delivery service to two no-charge occurrences within a 12-month period.
- Winch out — available within 100 ft (30 m) of a paved or county maintained road, no recoveries.

- Towing — independent service contractors, if not prohibited by state, local or municipal law, shall tow Ford eligible vehicles to an authorized dealer within 35 mi (56 km) of the disablement location or to the nearest authorized dealer. If a member requests a tow to an authorized dealer that is more than 35 mi (56 km) from the disablement location, the member shall be responsible for any mileage costs in excess of 35 mi (56 km).
- Roadside Assistance includes up to \$200 for a towed trailer if the disabled eligible vehicle requires service at the nearest authorized dealer. If the towing vehicle is operational but the trailer is not, then the trailer does not qualify for any roadside services.

### Vehicles Sold in the United States: Using Roadside Assistance

Complete the roadside assistance identification card and place it in your wallet for quick reference. This card is in the owner's information portfolio in the glove compartment.

United States vehicle customers who require Roadside Assistance, call 1-800-241-3673.

If you need to arrange roadside assistance for yourself, Ford Motor Company reimburses a reasonable amount for towing to the nearest dealership within 35 mi (56 km). To obtain reimbursement information, United States vehicle customers call 1-800-241-3673. Customers need to submit their original receipts.

# Roadside Emergencies

## Vehicles Sold in Canada: Getting Roadside Assistance

To fully assist you should you have a vehicle concern, Ford Motor Company of Canada, Limited offers a complimentary roadside assistance program. This program is eligible within Canada or the continental United States.

The service is available 24 hours a day, seven days a week.

This program is separate from the New Vehicle Limited Warranty, but the coverage is concurrent with the powertrain coverage period of your vehicle. Canadian roadside coverage and benefits may differ from the U.S. coverage.

If you require more information, please call us in Canada at 1-800-665-2006, or visit our website at [www.ford.ca](http://www.ford.ca).

## HAZARD FLASHERS

**Note:** *The hazard flashers operate when the ignition is in any position, or if the key is not in the ignition. If used when the vehicle is not running, the battery loses charge. As a result, there may be insufficient power to restart your vehicle.*



The flasher control is on the instrument panel. Use your hazard flashers when your vehicle is creating a safety hazard for other motorists.

- Press the flasher control and all front and rear direction indicators flash.
- Press the button again to switch them off.

## FUEL SHUTOFF



**WARNING:** If your vehicle has been involved in a crash, have the fuel system checked. Failure to follow this instruction could result in fire, personal injury or death.

**Note:** *When you try to restart your vehicle after a fuel shutoff, the vehicle makes sure that various systems are safe to restart. Once the vehicle determines the systems are safe, then the vehicle allows you to restart.*

**Note:** *In the event that your vehicle does not restart after your third attempt, contact a qualified technician.*

The fuel pump shutoff stops the flow of fuel to the engine in the event of a moderate to severe crash. Not every impact causes a shutoff.

Should your vehicle shut off after a crash, you may restart your vehicle.

1. Press **START/STOP** to switch off your vehicle.
2. Press the brake pedal and **START/STOP** to switch on your vehicle.
3. Remove your foot from the brake pedal and press **START/STOP** to switch off your vehicle.
4. You can attempt to start the vehicle by pressing the brake pedal and **START/STOP**, or press **START/STOP** without pressing the brake pedal.

# Roadside Emergencies

## JUMP STARTING THE VEHICLE



**WARNING:** Batteries normally produce explosive gases which can cause personal injury. Therefore, do not allow flames, sparks or lighted substances to come near the battery. When working near the battery, always shield your face and protect your eyes. Always provide correct ventilation.



**WARNING:** Keep batteries out of reach of children. Batteries contain sulfuric acid. Avoid contact with skin, eyes or clothing. Shield your eyes when working near the battery to protect against possible splashing of acid solution. In case of acid contact with skin or eyes, flush immediately with water for a minimum of 15 minutes and get prompt medical attention. If acid is swallowed, call a physician immediately.



**WARNING:** Use only adequately sized cables with insulated clamps.

**Note:** Do not attempt to push-start your automatic transmission vehicle. Attempting to push-start a vehicle with an automatic transmission may cause transmission damage.

**Note:** Do not disconnect the battery of the disabled vehicle as this could damage the vehicle electrical system.

### Preparing Your Vehicle

**Note:** Use only a 12-volt supply to start your vehicle.

Park the booster vehicle close to the hood of the disabled vehicle, making sure the two vehicles do not touch.

## Removing the Battery Shield

The battery is on the passenger side underneath the battery shield.

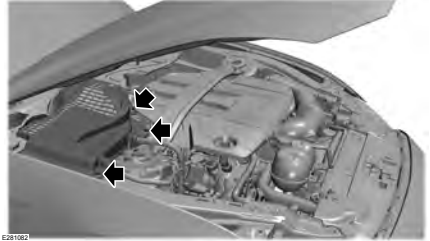

1. Rotate and release three fasteners by hand from the battery shield.
2. Remove the battery shield from the vehicle.

## Connecting the Jumper Cables



**WARNING:** Do not connect the end of the second cable to the negative (-) terminal of the battery to be jumped. A spark may cause an explosion of the gases that surround the battery.



**WARNING:** Do not use fuel lines, engine valve covers, windshield wiper arms, the intake manifold, or hood latch as ground points.

**Note:** If you are using a jump pack or booster box, follow that manufacturer's instructions.

**Note:** In the illustration, the vehicle shown is being jumped.

# Roadside Emergencies

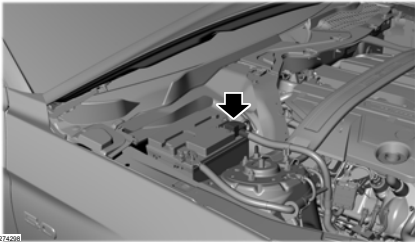

**Note:** In the illustration that follows, the bottom vehicle represents the booster vehicle.

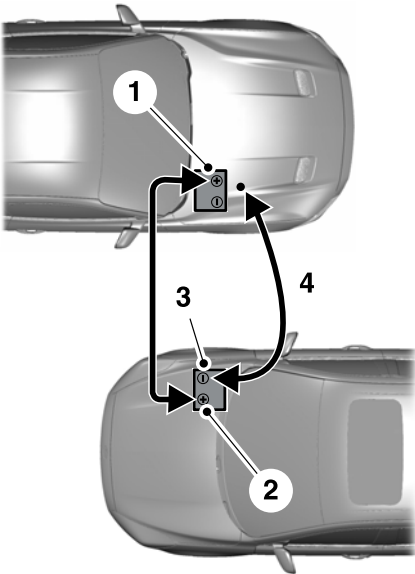

E281345

1. Pull the red rubber boot backwards. Connect the positive (+) jumper cable to the positive (+) terminal of the discharged battery.

2. Connect the other end of the positive (+) jumper cable to the positive (+) terminal of the booster vehicle battery.
3. Connect the negative (-) jumper cable to the negative (-) terminal of the booster vehicle battery.
4. Make the final connection of the negative (-) jumper cable to an exposed metal part of the stalled vehicle's engine, as shown in the following illustration, away from the battery and the fuel injection system, or connect the negative (-) jumper cable to a ground connection point if available.

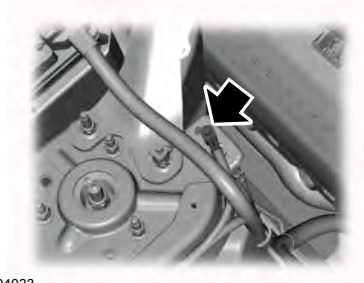

E204033

## Starting the Engine

1. Start the engine of the booster vehicle and moderately rev the engine, or gently press the accelerator to keep your engine speed between 2000 and 3000 RPM, as shown in your tachometer.
2. Start the engine of the disabled vehicle.
3. Once you start the disabled vehicle, run both vehicle engines for an additional three minutes before disconnecting the jumper cables.

## Removing the Jumper Cables

Remove the jumper cables in the reverse order that they were connected.

# Roadside Emergencies

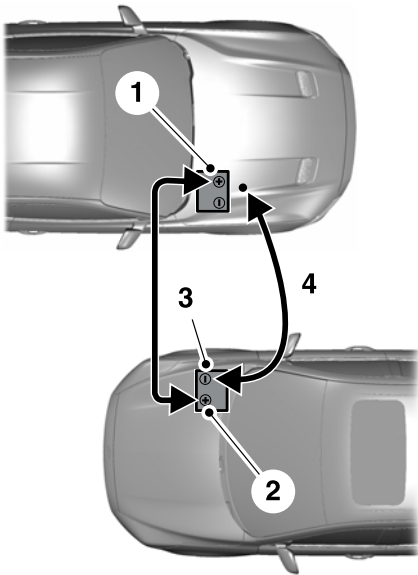

E281345

1. Remove the negative (-) jumper cable from the disabled vehicle.
2. Remove the jumper cable on the negative (-) terminal of the booster vehicle battery.
3. Remove the jumper cable from the positive (+) terminal of the booster vehicle battery.
4. Remove the jumper cable from the positive (+) terminal of the disabled vehicle.
5. Allow the engine to idle for at least one minute.

## Installing the Battery Shield

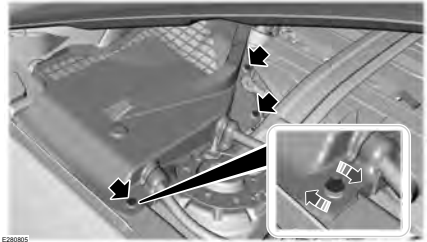

1. Install the battery shield on the vehicle.
2. Install in reverse direction. Tighten three fasteners by hand.

## POST-CRASH ALERT SYSTEM

The system flashes the direction indicators and sounds the horn (intermittently) in the event of a serious impact that deploys an airbag (front, side, side curtain or Safety Canopy) or the seatbelt pretensioners.

The horn and indicators turn off when:

- You press the hazard control button.
- You press the panic button on the remote entry transmitter (if equipped).
- Your vehicle runs out of power.
- Sounding of the horn is only enabled in specific markets.

# Roadside Emergencies

## TRANSPORTING THE VEHICLE

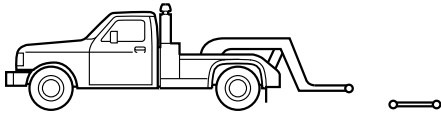

The front wheels must be on a tow dolly when towing your vehicle from the rear using wheel lift equipment. This prevents damage to the front fascia.

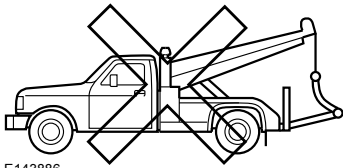
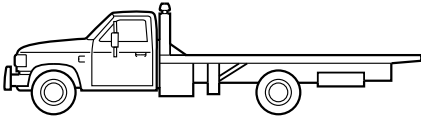

E143886

If you need to have your vehicle towed, contact a professional towing service or, if you are a member of a roadside assistance program, your roadside assistance service provider.

We recommend the use of a wheel lift and dollies or flatbed equipment to tow your vehicle. Do not tow with a slingbelt. We do not approve a slingbelt towing procedure. If you tow your vehicle incorrectly, or by any other means, vehicle damage may occur.

The rear wheels must be on a tow dolly when towing your vehicle from the front using wheel lift equipment. This prevents damage to the transmission.

# Customer Assistance

## GETTING THE SERVICES YOU NEED

Warranty repairs to your vehicle must be performed by an authorized dealer. While any authorized dealer handling your vehicle line will provide warranty service, we recommend you return to your selling authorized dealer who wants to ensure your continued satisfaction.

Please note that certain warranty repairs require special training and equipment, so not all authorized dealers are authorized to perform all warranty repairs. This means that, depending on the warranty repair needed, you may have to take your vehicle to another authorized dealer.

A reasonable time must be allowed to perform a repair after taking your vehicle to the authorized dealer. Repairs will be made using Ford or Motorcraft® parts, or remanufactured or other parts that are authorized by Ford.

### Away From Home

If you are away from home when your vehicle needs service, contact the Ford Customer Relationship Center or use the online resources listed below to find the nearest authorized dealer.

In the United States:

#### Mailing address

Ford Motor Company  
Customer Relationship Center  
P.O. Box 6248  
Dearborn, MI 48126

#### Telephone

1-800-392-3673 (FORD)  
(TDD for the hearing impaired:  
1-800-232-5952)

Additional information and resources are available online:

Website
<a href="http://www.owner.ford.com">www.owner.ford.com</a>

These are some of the items that can be found online:

- U.S. dealer locator by Dealer Name, City/State or Zip Code.
- Owner Manuals.
- Maintenance Schedules.
- Recalls.
- Ford Extended Service Plans.
- Ford Genuine Accessories.
- Service specials and promotions.

In Canada:

#### Mailing address

Customer Relationship Centre  
Ford Motor Company of Canada, Limited  
P.O. Box 2000  
Oakville, Ontario L6K 0C8

#### Telephone

1-800-565-3673 (FORD)

Website
<a href="http://www.ford.ca">www.ford.ca</a>

#### Twitter

@FordServiceCA (English Canada)  
@FordServiceQC (Quebec)

#### Additional Assistance

If you have questions or concerns, or are unsatisfied with the service you are receiving, follow these steps:

1. Contact your Sales Representative or Service Advisor at your selling or servicing authorized dealer.



# Customer Assistance

---

2. If your inquiry or concern remains unresolved, contact the Sales Manager, Service Manager or Customer Relations Manager.
3. If you require assistance or clarification on Ford Motor Company policies, please contact the Ford Customer Relationship Center.

In order to help us serve you better, please have the following information available when contacting a Customer Relationship Center:

- Vehicle Identification Number.
- Your telephone number (home and business).
- The name of the authorized dealer and city where located.
- The vehicle's current odometer reading.

In some states within the United States, you must directly notify Ford in writing before pursuing remedies under your state's warranty laws, and Ford is also allowed a final repair attempt.

Additionally, in some states within the United States, a consumer has the option of submitting a warranty dispute to the BBB Auto Line before taking action under the Magnuson-Moss Warranty Act, or to the extent allowed by state law, before pursuing replacement or repurchase remedies provided by certain state laws. This dispute handling procedure is not required prior to enforcing state created rights or other rights which are independent of the Magnuson-Moss Warranty Act or state replacement or repurchase laws.

## IN CALIFORNIA (U.S. ONLY)

California Civil Code Section 1793.2(d) requires that, if a manufacturer or its representative is unable to repair a motor vehicle to conform to the vehicle's applicable express warranty after a reasonable number of attempts, the manufacturer shall be required to either replace the vehicle with one substantially identical or repurchase the vehicle and reimburse the buyer in an amount equal to the actual price paid or payable by the consumer (less a reasonable allowance for consumer use). The consumer has the right to choose whether to receive a refund or replacement vehicle.

California Civil Code Section 1793.22(b) presumes that the manufacturer has had a reasonable number of attempts to conform the vehicle to its applicable express warranties if, within the first 18 months of ownership of a new vehicle or the first 18,000 mi (29,000 km), whichever occurs first:

1. Two or more repair attempts are made on the same non-conformity likely to cause death or serious bodily injury OR
2. Four or more repair attempts are made on the same nonconformity (a defect or condition that substantially impairs the use, value or safety of the vehicle) OR
3. The vehicle is out of service for repair of nonconformities for a total of more than 30 calendar days (not necessarily all at one time).

In the case of 1 or 2 above, the consumer must also notify the manufacturer of the need for the repair of the nonconformity at the following address:

Ford Motor Company  
16800 Executive Plaza Drive  
Mail Drop 3NE-B  
Dearborn, MI 48126

# Customer Assistance

---

You are required to submit your warranty dispute to BBB AUTO LINE before asserting in court any rights or remedies conferred by California Civil Code Section 1793.22(b). You are also required to use BBB AUTO LINE before exercising rights or seeking remedies created by the Federal Magnuson-Moss Warranty Act, 15 U.S.C. sec. 2301 et seq. If you choose to seek redress by pursuing rights and remedies not created by California Civil Code Section 1793.22(b) or the Magnuson-Moss Warranty Act, resort to BBB AUTO LINE is not required by those statutes.

## **THE BETTER BUSINESS BUREAU (BBB) AUTO LINE PROGRAM (U.S. ONLY)**

Your satisfaction is important to Ford Motor Company and to your dealer. If a warranty concern has not been resolved using the three-step procedure outlined earlier in this chapter in the Getting the Services you need section, you may be eligible to participate in the BBB AUTO LINE program.

The BBB AUTO LINE program consists of two parts – mediation and arbitration. During mediation, a representative of the BBB will contact both you and Ford Motor Company to explore options for settlement of the claim. If an agreement is not reached during mediation or you do not want to participate in mediation, and if your claim is eligible, you may participate in the arbitration process. An arbitration hearing will be scheduled so that you can present your case in an informal setting before an impartial person. The arbitrator will consider the testimony provided and make a decision after the hearing.

Disputes submitted to the BBB AUTO LINE program are usually decided within forty days after you file your claim with the BBB. You are not bound by the decision, and may reject the decision and proceed to court where all findings of the BBB Auto Line dispute, and decision, are admissible in the court action. Should you choose to accept the BBB AUTO LINE decision, Ford is then bound by the decision, and must comply with the decision within 30 days of receipt of your acceptance letter.

**BBB AUTO LINE Application:** Using the information provided below, please call or write to request a program application. You will be asked for your name and address, general information about your new vehicle, information about your warranty concerns, and any steps you have already taken to try to resolve them. A Customer Claim Form will be mailed that will need to be completed, signed and returned to the BBB along with proof of ownership. Upon receipt, the BBB will review the claim for eligibility under the Program Summary Guidelines.

**You can get more information by calling BBB AUTO LINE at 1-800-955-5100, or writing to:**

**BBB AUTO LINE  
3033 Wilson Boulevard, Suite 600  
Arlington, Virginia 22201**

BBB AUTO LINE applications can also be requested by calling the Ford Motor Company Customer Relationship Center at 1-800-392-3673.

**Note:** *Ford Motor Company reserves the right to change eligibility limitations, modify procedures, or to discontinue this process at any time without notice and without obligation.*

# Customer Assistance

---

## UTILIZING THE MEDIATION/ARBITRATION PROGRAM (CANADA ONLY)

For vehicles delivered to authorized Canadian dealers. In those cases where you continue to feel that the efforts by Ford of Canada and the authorized dealer to resolve a factory-related vehicle service concern have been unsatisfactory, Ford of Canada participates in an impartial third party mediation/arbitration program administered by the Canadian Motor Vehicle Arbitration Plan (CAMVAP).

The CAMVAP program is a straight forward and relatively speedy alternative to resolve a disagreement when all other efforts to produce a settlement have failed. This procedure is without cost to you and is designed to eliminate the need for lengthy and expensive legal proceedings.

In the CAMVAP program, impartial third-party arbitrators conduct hearings at mutually convenient times and places in an informal environment. These impartial arbitrators review the positions of the parties, make decisions and, when appropriate, render awards to resolve disputes. CAMVAP decisions are fast, fair, and final as the arbitrator's award is binding on both you and Ford of Canada.

CAMVAP services are available in all Canadian territories and provinces. For more information, without charge or obligation, call your CAMVAP Provincial Administrator directly at 1-800-207-0685 or visit [www.camvap.ca](http://www.camvap.ca).

## GETTING ASSISTANCE OUTSIDE THE U.S. AND CANADA

Before exporting your vehicle to a foreign country, contact the appropriate foreign embassy or consulate. These officials can inform you of local vehicle registration regulations and where to find unleaded fuel or petrol/gas engines or the proper sulfur fuel for diesel engines.

If you cannot find the proper fuel recommended for your vehicle, contact our Customer Relationship Center.

The use of improper fuels in your vehicle without proper conversion may damage the effectiveness of your emission control system and may cause engine knocking or serious engine damage. Ford Motor Company or Ford of Canada is not responsible for any damage caused by use of improper fuel. Using improper fuels may also result in difficulty importing your vehicle back into the United States.

If your vehicle must be serviced while you are traveling or living in Asia-Pacific Region, Sub-Saharan Africa, U.S. Virgin Islands and/or Puerto Rico, Central America, the Caribbean, and Israel and the Middle East, contact the nearest authorized dealer. If the authorized dealer cannot help you, contact the corresponding Ford Customer Assistance Center:

**FORD MOTOR COMPANY**  
**Customer Relationship Centers in:**

## Customer Assistance

Customer Relationship Center	Phone	Fax	E-mail
Asia Pacific	N/A	N/A	apemcrc@ford.com
Caribbean and Central America	+1 313 594 4857	-	expcac@ford.com
Middle East	Ford 80004443673	971 4 3327 266	menacac@ford.com
	Lincoln 80004441067		
	UAE 80004441066		
	Saudi Arabia 8008443673		
	Mobily and Zain cell phone users in Saudi 800850078		
Kuwait 22280384			
North Africa	N/A	N/A	nafcrc@ford.com
Puerto Rico and U.S. Virgin Islands	+1-800-841-3673	N/A	prcac@ford.com
Sub-Saharan Africa	N/A	N/A	ssacrc@ford.com
South Korea	+82-02-1600-6003	N/A	infokr1@ford.com or infokr@lincoln.com

If you buy your vehicle in North America and then relocate to any of the above locations, register your vehicle identification number (VIN) and new address with Ford Global Trade Services by emailing, [expcso@ford.com](mailto:expcso@ford.com).

If you are in another foreign country, contact the nearest authorized dealer. In the event your inquiry is unresolved, communicate your concern with the dealership's Sales Manager, Service Manager or Customer Relations Manager. If you require additional assistance or clarification, please contact the respective Customer Relationship Center as previously listed.

**Customers in the U.S. should call 1-800-392-3673.**

## Customer Assistance

---

### **ORDERING ADDITIONAL OWNER'S LITERATURE**

To order the publications in this portfolio, contact Helm, Incorporated at:

HELM, INCORPORATED  
47911 Halyard Drive  
Plymouth, Michigan 48170  
Attention: Customer Service

Or to order a free publication catalog, call toll free: 1-800-782-4356

Monday-Friday 8:00 a.m. - 6:00 p.m. EST

Helm, Incorporated can also be reached by their website:

[www.helminc.com](http://www.helminc.com)

(Items in this catalog may be purchased by credit card, check or money order.)

### **Obtaining a French Owner's Manual**

French Owner's Manual can be obtained from your authorized dealer or by contacting Helm, Incorporated using the contact information listed previously in this section.

### **REPORTING SAFETY DEFECTS (U.S. ONLY)**

If you believe that your vehicle has a defect which could cause a crash or could cause injury or death, you should immediately inform the National Highway Traffic Safety Administration (NHTSA) in addition to notifying Ford Motor Company.

If NHTSA receives similar complaints, it may open an investigation, and if it finds that a safety defect exists in a group of vehicles, it may order a recall and remedy campaign. However, NHTSA cannot become involved in individual problems between you, your dealer, or Ford Motor Company.

To contact NHTSA, you may call the Vehicle Safety Hotline toll-free at 1-888-327-4236 (TTY: 1-800-424-9153); go to <http://www.safercar.gov>; or write to:

Administrator

1200 New Jersey Avenue,  
Southeast

Washington, D.C. 20590

You can also obtain other information about motor vehicle safety from <http://www.safercar.gov>.

### **REPORTING SAFETY DEFECTS (CANADA ONLY)**

If you believe that your vehicle has a defect which could cause a crash or could cause injury or death, you should immediately inform Transport Canada and Ford of Canada.

# Customer Assistance

---

<b>Transport Canada Contact Information</b>	
Website	<a href="http://www.tc.gc.ca/eng/motorvehiclesafety/reporting-defects-motor-vehicles.html">http://www.tc.gc.ca/eng/motorvehiclesafety/reporting-defects-motor-vehicles.html</a> (English)
Website	<a href="http://www.tc.gc.ca/fra/securiteautomobile/signaler-defauts-vehicules-automobiles.html">http://www.tc.gc.ca/fra/securiteautomobile/signaler-defauts-vehicules-automobiles.html</a> (French)
Phone	1-800-333-0510

<b>Ford of Canada Contact Information</b>	
Website	<a href="http://www.ford.ca">www.ford.ca</a>
Phone	1-800-565-3673

# Fuses

## FUSE SPECIFICATION CHART

### Power Distribution Box



**WARNING:** Always disconnect the battery before servicing high current fuses.



**WARNING:** To reduce risk of electrical shock, always replace the cover to the power distribution box before reconnecting the battery or refilling fluid reservoirs.

The power distribution box is in the engine compartment. It has high-current fuses that protect your vehicle's main electrical systems from overloads.

If you disconnect and reconnect the battery, you need to reset some features. See **Changing the 12V Battery** (page 243).

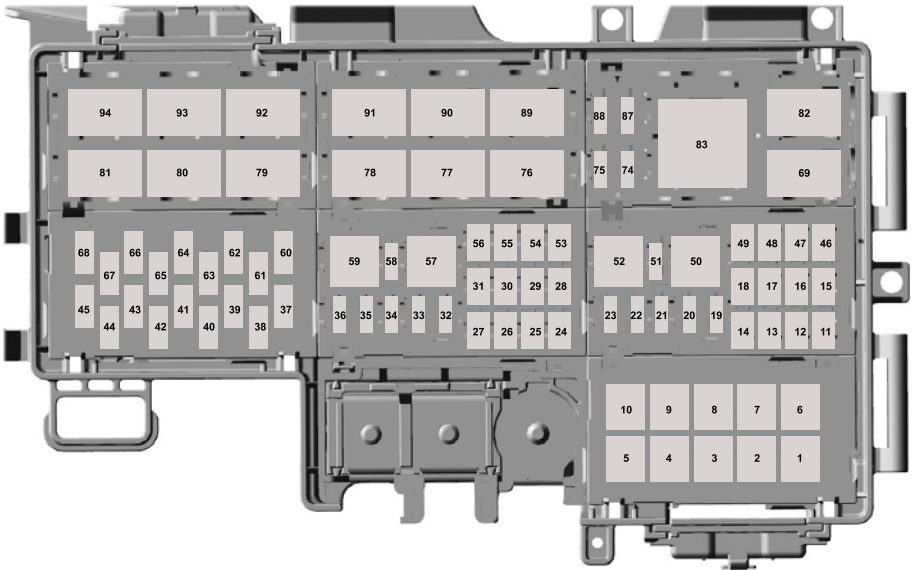

E286912

## Fuses

Fuse or Relay Number	Fuse Rating	Protected Component
1	—	Not used.
2	—	Not used.
3	30A <sup>1</sup>	Electronic fan 1 (except GT350).
4	40A <sup>1</sup>	Electronic fan 3 (except GT350).
5	50A <sup>1</sup>	Automatic brake system pump.
6	50A <sup>1</sup>	Body control module.
7	60A <sup>1</sup>	Body control module.
8	50A <sup>1</sup>	Body control module.
9	40A <sup>1</sup>	Rear window defroster.
10	40A <sup>1</sup>	Blower motor.
11	30A <sup>2</sup>	Left-hand front window.
12	30A <sup>2</sup>	Driver seat.
13	30A <sup>2</sup>	Passenger seat.
14	30A <sup>2</sup>	Climate-controlled seat module.
15	20A <sup>2</sup>	Convertible top motor.
16	—	Not used.
17	20A <sup>2</sup>	Convertible top motor.
18	—	Not used.
19	20A <sup>3</sup>	Steering column lock relay.
20	10A <sup>3</sup>	Brake on-off switch.
21	20A <sup>3</sup>	Horn.



## Fuses

Fuse or Relay Number	Fuse Rating	Protected Component
22	10A <sup>3</sup>	Powertrain control module relay.
23	10A <sup>3</sup>	Air conditioning clutch.
24	30A <sup>2</sup>	Voltage quality module.
25	—	Not used.
26	25A <sup>2</sup>	Windshield wiper motor.
27	—	Not used.
28	30A <sup>2</sup>	Automatic brake system valve.
29	30A <sup>2</sup>	Electronic fan 1 (GT350).
30	30A <sup>2</sup>	Starter motor solenoid.
31	40A <sup>2</sup>	Electronic fan 3 (GT350).
32	10A <sup>3</sup>	Latch relay coil.
33	15A <sup>3</sup>	Run/Start (except GT350).
	20A <sup>3</sup>	Left-hand high-intensity discharge headlamps (GT350).
34	15A <sup>3</sup>	Exhaust valves.
35	20A <sup>3</sup>	Right-hand high-intensity discharge headlamps (GT350).
36	10A <sup>3</sup>	Alternator sense.
37	—	Not used.
38	20A <sup>3</sup>	Vehicle power 1.
39	—	Not used.
40	20A <sup>3</sup>	Vehicle power 2.
41	15A <sup>3</sup>	Fuel injectors.

# Fuses

Fuse or Relay Number	Fuse Rating	Protected Component
42	15A <sup>3</sup>	Vehicle power 3.
43	—	Not used.
44	15A <sup>3</sup>	Vehicle power 4 (except GT350).
	30A <sup>3</sup>	Ignition coils (GT350).
45	—	Not used.
46	20A <sup>2</sup>	Differential pump (GT350).
47	—	Not used.
48	30A <sup>2</sup>	Fuel pump #2 (GT350).
49	30A <sup>2</sup>	Fuel pump.
50	—	Steering column lock relay.
51	—	Not used.
52	—	Horn relay.
53	20A <sup>2</sup>	Cigar lighter.
54	20A <sup>2</sup>	Auxiliary power point.
55	25A <sup>2</sup>	Electronic fan 2.
56	—	Not used.
57	—	Air conditioning clutch relay.
58	—	Not used.
59	—	Exhaust valves relay.
60	5A <sup>3</sup>	Powertrain control module.
61	—	Not used.
62	5A <sup>3</sup>	Anti-lock brakes run-start switch.
63	—	Not used.

## Fuses

Fuse or Relay Number	Fuse Rating	Protected Component
64	5A <sup>3</sup>	Electronic power assist steering.
65	—	Not used.
66	5A <sup>3</sup>	Blind spot information system. Rear view camera. Rear defrost relay coils. Vehicle dynamics module.
67	—	Not used.
68	10A <sup>3</sup>	Headlamp leveling switch.
69	—	Auxiliary power point relay.
74	5A <sup>3</sup>	Mass air flow sensor.
75	5A <sup>3</sup>	Rain sensor module.
76	—	Rear window defroster relay.
77	—	Electronic cooling fan 2 relay.
78	—	Run/Start relay (except GT350).
79	—	Not used.
80	—	Windshield wiper relay.
81	—	Starter motor solenoid relay.
82	—	Powertrain control module relay.
83	—	Not used.
87	10A <sup>3</sup>	Heated exterior mirrors.
88	—	Not used.
89	—	Electronic fan 1 relay.
90	—	Differential pump relay (GT350).
91	—	Electronic fan 3 relay.
92	—	Blower motor relay.
93	—	Fuel pump #2 relay (GT350).

# Fuses

Fuse or Relay Number	Fuse Rating	Protected Component
94	—	Fuel pump relay.

<sup>1</sup> J-case fuses.

<sup>2</sup> M-case fuses.

<sup>3</sup> Micro fuses.

## Passenger Compartment Fuse Panel

The fuse panel is in the right-hand side of the passenger footwell behind a trim panel and plastic key code card.

To remove the trim panel, lift it from the rear retaining hooks, while pulling it toward you and swinging it away from the side. To reinstall it, line up the tabs with the grooves on the panel, drop the panel back into place, and then push it shut.

To reach the fuse panel, first remove the key code card.

After replacing a fuse, return the key code card to the original position. To reinstall the trim panel, lineup the tabs with the grooves on the panel, drop the panel back into place, and then push it shut to reinstall the trim panel.

# Fuses

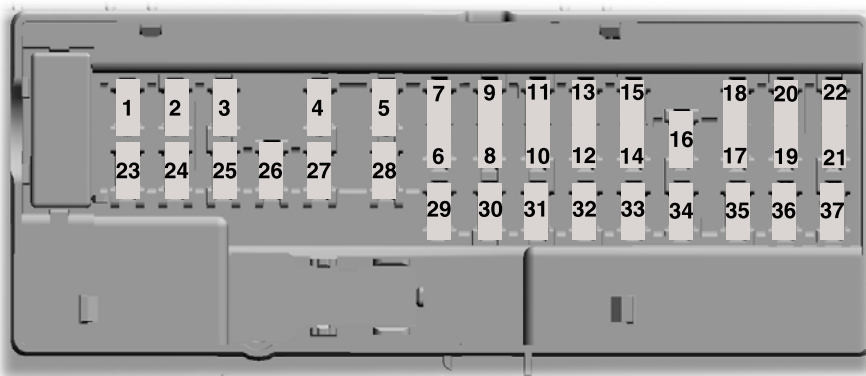

E174564

Fuse or Relay Number	Fuse Rating	Protected Component
1	—	Not used.
2	7.5A	Power mirror memory module (driver side mirror). Memory seat module.
3	20A	Driver console unlock.
4	—	Not used.
5	20A	Subwoofer amplifier.
6	—	Not used.
7	—	Not used.
8	—	Not used.
9	—	Not used.

## Fuses

Fuse or Relay Number	Fuse Rating	Protected Component
10	5A	Telematics.
11	—	Not used.
12	7.5A	Climate control module.
13	7.5A	Gateway module. Steering column control module. Instrument cluster.
14	10A	Electronic power module.
15	10A	Gateway module.
16	15A	Decklid release.
17	5A	Battery backed sounder.
18	5A	Intrusion sensor module.
19	7.5A	Electronic power module.
20	7.5A	Headlamp control module.
21	5A	In-vehicle temperature and humidity sensor. Front camera.
22	5A	Not used (spare).
23	10A	Switches. Power windows. Rear-view mirror.
24	20A	Central lock/unlock.
25	30A	Vehicle dynamics module.
26	30A	Right-hand front-window motor (power distribution module).
27	30A	Amplifier.
28	20A	Auxiliary body module.
29	30A	Left-hand rear-window power.
30	30A	Right-hand rear-window power.
31	—	Not used.

# Fuses

Fuse or Relay Number	Fuse Rating	Protected Component
32	10A	Remote keyless entry. Multi-function display. SYNC. Global positioning system module. Gauges.
33	20A	Audio head unit.
34	30A	Run-start bus.
35	5A	Not used (spare).
36	15A	Auxiliary body module.
37	20A	Heated steering wheel module. Run/start fuse (GT350).

## CHANGING A FUSE

### Fuses



**WARNING:** Always replace a fuse with one that has the specified amperage rating. Using a fuse with a higher amperage rating can cause severe wire damage and could start a fire.



E217331

If electrical components in the vehicle are not working, a fuse may have blown. Blown fuses are identified by a broken wire within the fuse. Check the appropriate fuses before replacing any electrical components.

# Fuses

## Fuse Types

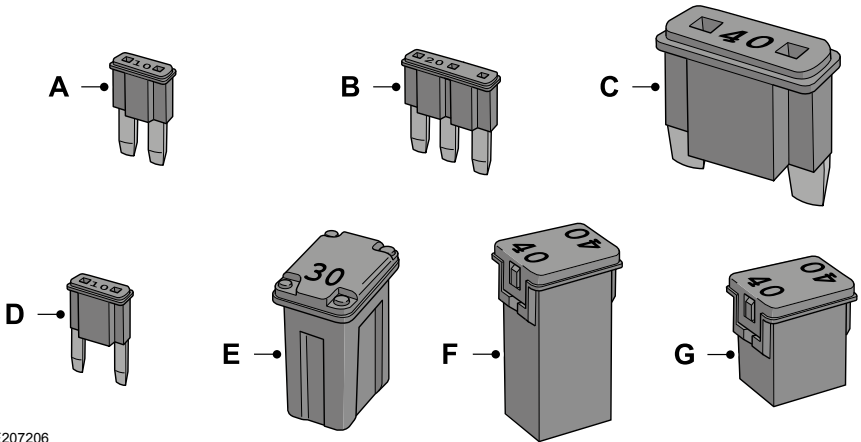

E207206

Callout	Fuse Type
A	Micro 2
B	Micro 3
C	Maxi
D	Mini
E	M Case
F	J Case
G	J Case Low Profile



# Maintenance

## GENERAL INFORMATION

Have your vehicle serviced regularly to help maintain its roadworthiness and resale value. There is a large network of authorized dealers that are there to help you with their professional servicing expertise. We believe that their specially trained technicians are best qualified to service your vehicle properly and expertly. They are supported by a wide range of highly specialized tools developed specifically for servicing your vehicle.

If your vehicle requires professional service, an authorized dealer can provide the necessary parts and service. Check your warranty information to find out which parts and services are covered.

Use only recommended fuels, lubricants, fluids and service parts conforming to specifications. Motorcraft® parts are designed and built to provide the best performance in your vehicle.

## Precautions

- Do not work on a hot engine.
- Make sure that nothing gets caught in moving parts.
- Do not work on a vehicle with the engine running in an enclosed space, unless you are sure you have enough ventilation.
- Keep all open flames and other burning material (such as cigarettes) away from the battery and all fuel related parts.

## Working with the Engine Off

1. Set the parking brake and shift the transmission to park (P).
2. Switch off the engine.
3. Block the wheels.

## Working with the Engine On



**WARNING:** To reduce the risk of vehicle damage and personal burn injuries, do not start your engine with the air cleaner removed and do not remove it while the engine is running.

1. Set the parking brake and shift the transmission to park (P).
2. Block the wheels.

## OPENING AND CLOSING THE HOOD

### Opening the Hood



E142457

1. Inside the vehicle, pull the hood release handle located under the left-hand side of the instrument panel.
2. Slightly lift the hood.

# Maintenance

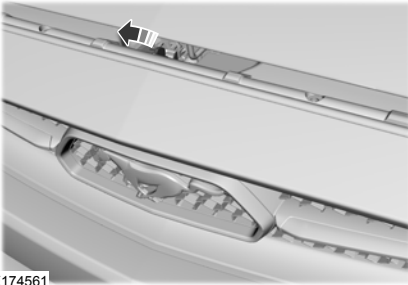

E174561

3. Release the hood latch by pushing the secondary release lever to your left-hand side.



E256471

4. Open the hood. Support the hood with the strut.

## Closing the Hood

1. Remove the hood strut from the catch and secure it correctly after use.
2. Lower the hood and allow it to drop under its own weight for the last 8–12 in (20–30 cm).

**Note:** Make sure that the hood is correctly closed.

# Maintenance

## UNDER HOOD OVERVIEW - 2.3L ECOBOOST™

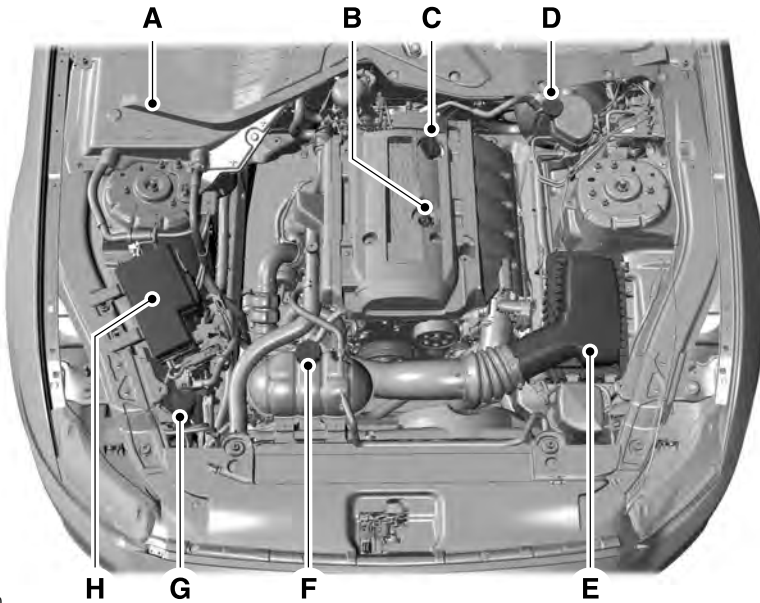

E174450

- A Battery (out of view). See **Changing the 12V Battery** (page 243).
- B Engine oil dipstick. See **Engine Oil Dipstick** (page 235).
- C Engine oil filler cap. See **Engine Oil Check** (page 235).
- D Brake fluid reservoir. See **Brake Fluid Check** (page 241).
- E Air filter assembly. See **Changing the Engine Air Filter** (page 247).
- F Engine coolant reservoir. See **Engine Coolant Check** (page 237).
- G Windshield washer fluid reservoir. See **Washer Fluid Check** (page 242).
- H Power distribution box. See **Fuses** (page 220).

# Maintenance

## UNDER HOOD OVERVIEW - 5.0L

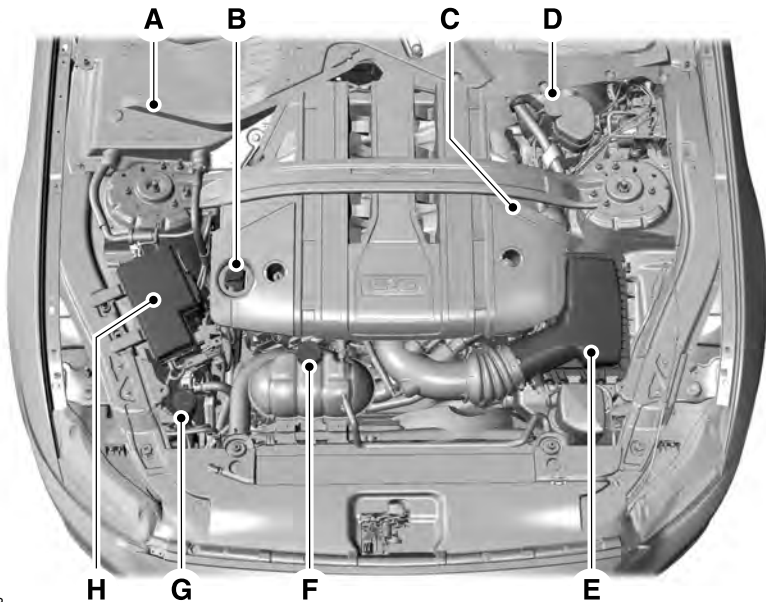

E250052

- A. Battery. See **Changing the 12V Battery** (page 243).
- B. Engine oil filler cap. See **Engine Oil Check** (page 235).
- C. Engine oil dipstick. See **Engine Oil Dipstick** (page 235).
- D. Brake fluid reservoir. See **Brake Fluid Check** (page 241).
- E. Air filter. See **Changing the Engine Air Filter** (page 247).
- F. Engine coolant reservoir. See **Engine Coolant Check** (page 237).
- G. Washer system fluid reservoir. See **Washer Fluid Check** (page 242).
- H. Engine compartment fuse box. See **Fuses** (page 220).

# Maintenance

## UNDER HOOD OVERVIEW - 5.0L, BULLITT

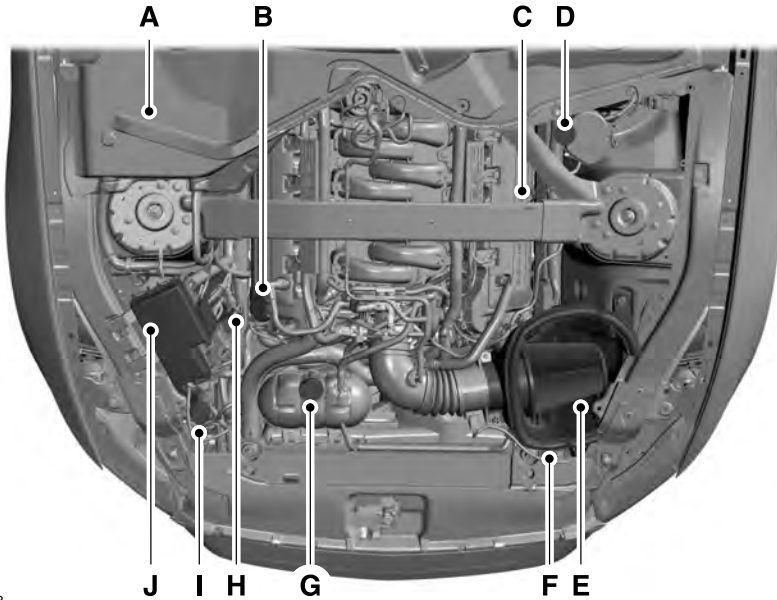

E193853

- A Battery. See **Changing the 12V Battery** (page 243).
- B Engine oil filler cap. See **Engine Oil Check** (page 235).
- C Engine oil dipstick. See **Engine Oil Dipstick** (page 235).
- D Brake fluid reservoir. See **Brake Fluid Check** (page 241).
- E Air filter assembly. See **Changing the Engine Air Filter** (page 247).
- F Cold air induction system. See **Changing the Engine Air Filter** (page 247).
- G Engine coolant reservoir. See **Engine Coolant Check** (page 237).
- H Powertrain control module. See **Changing a Fuse** (page 228).
- I Windshield washer reservoir. See **Washer Fluid Check** (page 242).
- J Power distribution box. See **Changing a Fuse** (page 228).

# Maintenance

## ENGINE OIL DIPSTICK



E161560

- A MIN
- B MAX

## ENGINE OIL CHECK

To check the engine oil level consistently and accurately, do the following:

1. Make sure the parking brake is on. Make sure the transmission is in park (P) or neutral (N).
2. Run the engine until it reaches normal operating temperature.
3. Make sure that your vehicle is on level ground.
4. Switch the engine off and wait 15 minutes for the oil to drain into the oil pan. Checking the engine oil level too soon after you switch the engine off may result in an inaccurate reading.
5. Open the hood. See **Opening and Closing the Hood** (page 230).
6. Remove the dipstick and wipe it with a clean, lint-free cloth. See **Under Hood Overview** (page 232).
7. Reinstall the dipstick and remove it again to check the oil level. See **Engine Oil Dipstick** (page 235).

8. Make sure that the oil level is between the maximum and minimum marks. If the oil level is at the minimum mark, add oil immediately. See **Capacities and Specifications** (page 300).
9. If the oil level is correct, replace the dipstick and make sure it is fully seated.

**Note:** Do not remove the dipstick when the engine is running.

**Note:** If the oil level is between the maximum and minimum marks, the oil level is acceptable. Do not add oil.

**Note:** The oil consumption of new engines reaches its normal level after approximately 3,000 mi (5,000 km).

## Adding Engine Oil

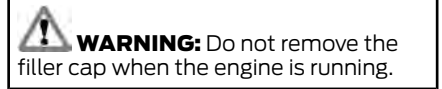

**WARNING:** Do not remove the filler cap when the engine is running.

Do not use supplemental engine oil additives because they are unnecessary and could lead to engine damage that may not be covered by the vehicle Warranty.



E142732

# Maintenance

Only use oils certified for gasoline engines by the American Petroleum Institute (API). An oil with this trademark symbol conforms to the current engine and emission system protection standards and fuel economy requirements of the International Lubricants Specification Advisory Committee (ILSAC).

To top up the engine oil level do the following:

1. Clean the area surrounding the engine oil filler cap before you remove it.
2. Remove the engine oil filler cap. See **Under Hood Overview** (page 232). Turn it counterclockwise and remove it.
3. Add engine oil that meets our specifications. See **Capacities and Specifications** (page 300). You may have to use a funnel to pour the engine oil into the opening.
4. Recheck the oil level.
5. If the oil level is correct, replace the dipstick and make sure it is fully seated.
6. Replace the engine oil filler cap. Turn it clockwise until you feel a strong resistance.

**Note:** Do not add oil further than the maximum mark. Oil levels above the maximum mark may cause engine damage.

**Note:** Make sure you install the oil filler cap correctly.

**Note:** Soak up any spillage with an absorbent cloth immediately.

## OIL CHANGE INDICATOR RESET

Use the information display controls on the steering wheel to reset the oil change indicator.

### From the main menu scroll to:

Message	Action and description
Settings	Press the right arrow button, then from this menu scroll to the following message.
Advanced Settings	Press OK
Vehicle	Press the right arrow button, then from this menu scroll to the following message.
Oil Life	Press the right arrow button, then from this menu scroll to the following message.
Hold OK to Reset	Press and hold the <b>OK</b> button until the instrument cluster displays the following message.
	Reset Successful
	When the oil change indicator resets the instrument cluster displays 100%. Remaining Life {00}%
	If the instrument cluster displays one of the following messages, repeat the process. Not Reset Reset Cancelled

# Maintenance

## ENGINE COOLANT CHECK



**WARNING:** Do not remove the coolant reservoir cap when the engine is on or the cooling system is hot. Wait 10 minutes for the cooling system to cool down. Cover the coolant reservoir cap with a thick cloth to prevent the possibility of scalding and slowly remove the cap. Failure to follow this instruction could result in personal injury.



**WARNING:** Do not put coolant in the windshield washer reservoir. If sprayed on the windshield, coolant could make it difficult to see through the windshield.



**WARNING:** To reduce the risk of personal injury, make sure the engine is cool before unscrewing the coolant pressure relief cap. The cooling system is under pressure. Steam and hot liquid can come out forcefully when you loosen the cap slightly.



**WARNING:** Do not add coolant further than the **MAX** mark.

When the engine is cold, check the concentration and level of the coolant at the intervals listed in the scheduled maintenance information. See **Scheduled Maintenance** (page 422).

**Note:** Make sure that the coolant level is between the **MIN** and **MAX** marks on the coolant reservoir.

**Note:** Coolant expands when it is hot. The level may extend beyond the **MAX** mark.

Maintain coolant concentration within 48% to 50%, which equates to a freeze point between  $-29^{\circ}\text{F}$  ( $-34^{\circ}\text{C}$ ) and  $-35^{\circ}\text{F}$  ( $-37^{\circ}\text{C}$ ). Coolant concentration should be checked using a refractometer. We do not recommend the use of hydrometers or coolant test strips for measuring coolant concentration.

## Adding Coolant



**WARNING:** Do not add engine coolant when the engine is hot. Failure to follow this instruction could result in personal injury.



**WARNING:** Do not remove the coolant reservoir cap when the engine is on or the cooling system is hot. Wait 10 minutes for the cooling system to cool down. Cover the coolant reservoir cap with a thick cloth to prevent the possibility of scalding and slowly remove the cap. Failure to follow this instruction could result in personal injury.



**WARNING:** Do not put coolant in the windshield washer reservoir. If sprayed on the windshield, coolant could make it difficult to see through the windshield.

**Note:** Do not use stop leak pellets, cooling system sealants, or non-specified additives as they can cause damage to the engine cooling or heating systems. Resulting component damage may not be covered by the vehicle Warranty.

**Note:** Automotive fluids are not interchangeable.



# Maintenance

---

It is very important to use prediluted coolant approved to the correct specification in order to avoid plugging the small passageways in the engine cooling system. See **Capacities and Specifications** (page 294). Do not mix different colors or types of coolant in your vehicle. Mixing of engine coolants or using an incorrect coolant may harm the engine or cooling system components and may not be covered by the vehicle Warranty.

**Note:** *If prediluted coolant is not available, use the approved concentrated coolant diluting it to 50/50 with distilled water. See **Capacities and Specifications** (page 294). Using water that has not been deionised may contribute to deposit formation, corrosion and plugging of the small cooling system passageways.*

**Note:** *Coolants marketed for all makes and models may not be approved to our specifications and may cause damage to the cooling system. Resulting component damage may not be covered by the vehicle Warranty.*

If the coolant level is at or below the minimum mark, add prediluted coolant immediately.

To top up the coolant level do the following:

1. Unscrew the cap slowly. Any pressure escapes as you unscrew the cap.
2. Add prediluted coolant approved to the correct specification. See **Capacities and Specifications** (page 294).
3. Add enough prediluted coolant to reach the correct level.
4. Replace the coolant reservoir cap, turn it clockwise until you feel a strong resistance.

5. Check the coolant level in the coolant reservoir the next few times you drive your vehicle. If necessary, add enough prediluted engine coolant to bring the coolant level to the correct level.

If you have to add more than 1.1 qt (1 L) of engine coolant per month, have your vehicle checked as soon as possible. Operating an engine with a low level of coolant can result in engine overheating and possible engine damage.

In case of emergency, you can add a large amount of water without engine coolant in order to reach a vehicle service location. In this instance, qualified personnel:

1. Must drain the cooling system.
2. Chemically clean the coolant system.
3. Refill with engine coolant as soon as possible.

Water alone, without engine coolant, can cause engine damage from corrosion, overheating or freezing.

Do not use the following as a coolant substitute:

- Alcohol.
- Methanol.
- Brine.
- Any coolant mixed with alcohol or methanol antifreeze.

Alcohol and other liquids can cause engine damage from overheating or freezing.

Do not add extra inhibitors or additives to the coolant. These can be harmful and compromise the corrosion protection of the coolant.

## Recycled Coolant

We do not recommend the use of recycled coolant as an approved recycling process is not yet available.

**Note:** *Dispose of used coolant in the appropriate manner.*

# Maintenance

Follow your community's regulations and standards for recycling and disposing of automotive fluids.

## Severe Climates

If you drive in extremely cold climates:

- It may be necessary to increase the coolant concentration above 50%.
- A coolant concentration of 60% provides improved freeze point protection. Coolant concentrations above 60% decrease the overheat protection characteristics of the coolant and may cause engine damage.

If you drive in extremely hot climates:

- You can decrease the coolant concentration to 40%.
- Coolant concentrations below 40% decrease the freeze and corrosion protection characteristics of the coolant and may cause engine damage.

Vehicles driven year-round in non-extreme climates should use prediluted coolant for optimum cooling system and engine protection.

## Coolant Change

At specific mileage intervals, as listed in the scheduled maintenance information, the coolant should be changed. Add prediluted coolant approved to the correct specification. See **Capacities and Specifications** (page 294).

## Fail-Safe Cooling

Fail-safe cooling allows you to temporarily drive your vehicle before any incremental component damage occurs. The fail-safe distance depends on ambient temperature, vehicle load and terrain.

## How Fail-Safe Cooling Works



If the engine begins to overheat, the coolant temperature gauge moves toward the red zone:



A warning lamp illuminates and a message may appear in the information display.

If the engine reaches a preset over-temperature condition, the engine automatically switches to alternating cylinder operation. Each disabled cylinder acts as an air pump and cools the engine.

When this occurs, your vehicle still operates, however:

- Engine power is limited.
- The air conditioning system turns off.

Continued operation increases the engine temperature, causing the engine to completely shut down. Your steering and braking effort increases in this situation.

When the engine temperature cools, you can re-start the engine. Have your vehicle checked as soon as possible to minimize engine damage.

## When Fail-Safe Mode Is Activated

 **WARNING:** Fail-safe mode is for use during emergencies only. Operate your vehicle in fail-safe mode only as long as necessary to bring your vehicle to rest in a safe location and seek immediate repairs. When in fail-safe mode, your vehicle will have limited power, will not be able to maintain high-speed operation, and may completely shut down without warning, potentially losing engine power, power steering assist, and power brake assist, which may increase the possibility of a crash resulting in serious injury.

# Maintenance



**WARNING:** Do not remove the coolant reservoir cap when the engine is on or the cooling system is hot. Wait 10 minutes for the cooling system to cool down. Cover the coolant reservoir cap with a thick cloth to prevent the possibility of scalding and slowly remove the cap. Failure to follow this instruction could result in personal injury.

Your vehicle has limited engine power when in the fail-safe mode, drive your vehicle with caution. Your vehicle does not maintain high-speed operation and the engine may operate poorly.

Remember that the engine is capable of automatically shutting down to prevent engine damage. In this situation:

1. Pull off the road as soon as safely possible and switch the engine off.
2. If you are a member of a roadside assistance program, we recommend that you contact your roadside assistance service provider.
3. If this is not possible, wait for a short period of time for the engine to cool.
4. Check the coolant level. If the coolant level is at or below the minimum mark, add prediluted coolant immediately.
5. When the engine temperature cools, you can re-start the engine. Have your vehicle checked as soon as possible to minimize engine damage.

**Note:** *Driving your vehicle without repair increases the chance of engine damage.*

## Engine Coolant Temperature Management (If Equipped)



**WARNING:** To reduce the risk of crash and injury, be prepared that the vehicle speed may reduce and the vehicle may not be able to accelerate with full power until the coolant temperature reduces.

If you tow a trailer with your vehicle, the engine may temporarily reach a higher temperature during severe operating conditions, for example ascending a long or steep grade in high ambient temperatures.

At this time, you may notice the coolant temperature gauge moves toward the red zone and a message may appear in the information display.

You may notice a reduction in vehicle speed caused by reduced engine power in order to manage the engine coolant temperature. Your vehicle may enter this mode if certain high-temperature and high-load conditions take place. The amount of speed reduction depends on vehicle loading, grade and ambient temperature. If this occurs, there is no need to stop your vehicle. You can continue to drive.

The air conditioning may automatically turn on and off during severe operating conditions to protect the engine from overheating. When the coolant temperature decreases to the normal operating temperature, the air conditioning turns on.

If the coolant temperature gauge moves fully into the red zone, or if the coolant temperature warning or service engine soon messages appear in your information display, do the following:

# Maintenance

1. Stop your vehicle as soon as it is safe to do so. Fully apply the parking brake, shift into park (P) or neutral (N).
2. Leave the engine running until the coolant temperature gauge needle returns to the normal position. If the temperature does not drop after several minutes, follow the remaining steps.
3. Switch the engine off and wait for it to cool. Check the coolant level.
4. If the coolant level is at or below the minimum mark, add prediluted coolant immediately.
5. If the coolant level is normal, restart the engine and continue.

## MANUAL TRANSMISSION FLUID CHECK

1. Clean the filler plug. The filler plug is on the right-hand side of the transmission.

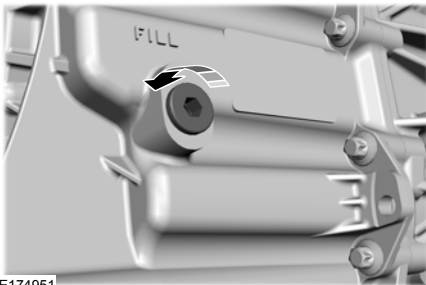

2. Remove the filler plug.
3. The correct fluid fill level is 0.0–0.1 in (0–3 mm) below the bottom edge of the filler hole.
4. Add fluid through the filler hole.
5. Install the filler plug.

6. Tighten the filler plug until you feel a strong resistance.

Only use fluid that meets Ford specifications. See **Capacities and Specifications** (page 294).

## AUTOMATIC TRANSMISSION FLUID CHECK

If required, have an authorized dealer check and change the transmission fluid at the correct service interval. See **Scheduled Maintenance** (page 422).

The automatic transmission does not have a transmission fluid dipstick.

Refer to your scheduled maintenance information for scheduled intervals for fluid checks and changes. Your transmission does not consume fluid. However, if the transmission slips, shifts slowly or if you notice a sign of leaking fluid, contact an authorized dealer.

Do not use supplemental transmission fluid additives, treatments or cleaning agents. The use of these materials may affect transmission operation and result in damage to internal transmission components.

## BRAKE FLUID CHECK



**WARNING:** Do not use any fluid other than the recommended brake fluid as this will reduce brake efficiency. Use of incorrect fluid could result in the loss of vehicle control, serious personal injury or death.

# Maintenance

 **WARNING:** Only use brake fluid from a sealed container. Contamination with dirt, water, petroleum products or other materials may result in brake system damage or failure. Failure to adhere to this warning could result in the loss of vehicle control, serious personal injury or death.

 **WARNING:** Do not allow the fluid to touch your skin or eyes. If this happens, rinse the affected areas immediately with plenty of water and contact your physician.

 **WARNING:** A fluid level between the **MAX** and **MIN** lines is within the normal operating range and there is no need to add fluid. A fluid level not in the normal operating range could compromise the performance of the system. Have your vehicle checked immediately.



E170684

To avoid fluid contamination, the reservoir cap must remain in place and fully tight, unless you are adding fluid.

Only use fluid that meets Ford specifications. See **Capacities and Specifications** (page 294).

## CLUTCH FLUID CHECK - MANUAL TRANSMISSION

The clutch and brake systems share the same fluid reservoir. See **Brake Fluid Check** (page 241).

## POWER STEERING FLUID CHECK

Your vehicle is equipped with an electric power steering (EPS) system. There is no fluid reservoir to check or fill.

## WASHER FLUID CHECK

 **WARNING:** If you operate your vehicle in temperatures below 40°F (5°C), use washer fluid with antifreeze protection. Failure to use washer fluid with antifreeze protection in cold weather could result in impaired windshield vision and increase the risk of injury or accident.

Add fluid to fill the reservoir if the level is low. Only use a washer fluid that meets Ford specifications. See **Capacities and Specifications** (page 294).

# Maintenance

State or local regulations on volatile organic compounds may restrict the use of methanol, a common windshield washer antifreeze additive. Washer fluids containing non-methanol antifreeze agents should be used only if they provide cold weather protection without damaging the vehicle's paint finish, wiper blades or washer system.

## FUEL FILTER

Your vehicle is equipped with a lifetime fuel filter that is integrated with the fuel tank. Regular maintenance or replacement is not needed.

## CHANGING THE 12V BATTERY



**WARNING:** Batteries normally produce explosive gases which can cause personal injury. Therefore, do not allow flames, sparks or lighted substances to come near the battery. When working near the battery, always shield your face and protect your eyes. Always provide correct ventilation.



**WARNING:** When lifting a plastic-cased battery, excessive pressure on the end walls could cause acid to flow through the vent caps, resulting in personal injury and damage to the vehicle or battery. Lift the battery with a battery carrier or with your hands on opposite corners.



**WARNING:** Keep batteries out of reach of children. Batteries contain sulfuric acid. Avoid contact with skin, eyes or clothing. Shield your eyes when working near the battery to protect against possible splashing of acid solution. In case of acid contact with skin or eyes, flush immediately with water for a minimum of 15 minutes and get prompt medical attention. If acid is swallowed, call a physician immediately.



**WARNING:** Battery posts, terminals and related accessories contain lead and lead compounds, chemicals known to the State of California to cause cancer and reproductive harm. **Wash your hands after handling.**



**WARNING:** This vehicle may have more than one battery. Removing the battery cables from only one battery does not disconnect your vehicle electrical system. Make sure you disconnect the battery cables from all batteries when disconnecting power. Failure to do so may cause serious personal injury or property damage.

Your vehicle is fitted with a Motorcraft maintenance-free battery which normally does not require additional water.

When a battery replacement is required, you must use a recommended replacement battery that matches the electrical requirements of the vehicle.

**Note:** *After cleaning or replacing the battery, make sure you reinstall the battery cover or shield.*

For longer, trouble-free operation, keep the top of the battery clean and dry.

# Maintenance

---

If you see any corrosion on the battery or terminals, remove the cables from the terminals and clean with a wire brush. You can neutralize the acid with a solution of baking soda and water.

Because your vehicle's engine is electronically controlled by a computer, some control conditions are maintained by power from the battery. When the battery is disconnected or a new battery is installed, the engine must relearn its idle and fuel trim strategy for optimum driveability and performance. Flexible fuel vehicles (FFV) must also relearn the ethanol content of the fuel for optimum driveability and performance.

To restore the settings, do the following:

1. Apply the parking brake.
2. Shift into park (P) or neutral (N).
3. Switch off all accessories.
4. Press the brake pedal and start your vehicle.
5. Run the engine until it reaches normal operating temperature. While the engine is warming up, complete the following: Reset the clock. Reset the power windows bounce-back feature. See **Windows and Mirrors** (page 77). Reset the radio station presets. See **Audio System** (page 313).
6. Allow the engine to idle for at least one minute.
7. Drive the vehicle at least 10 mi (16 km) to completely relearn the idle trim and fuel trim strategy.

**Note:** *If you do not allow the engine to relearn the idle and fuel trim strategy, the idle quality of your vehicle may be adversely affected until the engine computer eventually relearns the idle trim and fuel trim strategy.*

**Note:** *For flexible fuel vehicles, if you are operating on E85, you may experience poor starts or an inability to start the engine and driveability problems until the fuel trim and ethanol content have been relearned.*

Make sure that you dispose of old batteries in an environmentally friendly way. Seek advice from your local authority about recycling old batteries.

If storing your vehicle for more than 30 days without recharging the battery, we recommend that you disconnect the negative battery cable to maintain battery charge for quick starting.

## **Battery Management System (If Equipped)**

The battery management system monitors battery conditions and takes actions to extend battery life. If excessive battery drain is detected, the system temporarily disables some electrical systems to protect the battery.

Systems included are:

- Heated rear window.
- Heated seats.
- Climate control.
- Heated steering wheel.
- Audio unit.
- Navigation system.

A message may appear in the information displays to alert you that battery protection actions are active. These messages are only for notification that an action is taking place, and not intended to indicate an electrical problem or that the battery requires replacement.

# Maintenance

After battery replacement, or in some cases after charging the battery with an external charger, the battery management system requires eight hours of vehicle sleep time to relearn the battery state of charge. During this time your vehicle must remain fully locked with the ignition switched off.

**Note:** *Prior to relearning the battery state of charge, the battery management system may temporarily disable some electrical systems.*

## Electrical Accessory Installation

To make sure the battery management system works correctly, do not connect an electrical device ground connection directly to the battery negative post. This can cause inaccurate measurements of the battery condition and potential incorrect system operation.

**Note:** *If you add electrical accessories or components to the vehicle, it may adversely affect battery performance and durability. This may also affect the performance of other electrical systems in the vehicle.*

## CHECKING THE WIPER BLADES



E142463

Run the tip of your fingers over the edge of the blade to check for roughness.

Clean the wiper blades with washer fluid or water applied with a soft sponge or cloth.

## CHANGING THE WIPER BLADES

1. Pull the wiper blade and arm away from the glass and press the locking buttons together.

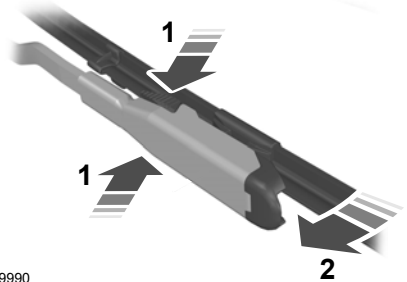

E129990

2. Rotate and remove the wiper blade.
3. Attach the new blade to the arm and snap it into place.

Replace wiper blades at least once per year for optimum performance.

Poor wiper quality can be improved by cleaning the wiper blades and the windshield. See **Cleaning the Windows and Wiper Blades** (page 255).

## ADJUSTING THE HEADLAMPS

### Vertical Aim Adjustment

The headlamps on your vehicle are properly aimed at the assembly plant. If your vehicle has been in an accident, have the alignment of your headlamps checked by an authorized dealer.



# Maintenance

## Headlamp Aiming Target

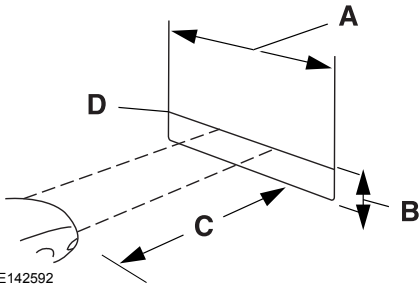

E142592

- A 8 feet (2.4 meters)
- B Center height of lamp to ground
- C 25 feet (7.6 meters)
- D Horizontal reference line



E142465

4. On the wall or screen you will observe a flat zone of high intensity light located at the top of the right hand portion of the beam pattern. If the top edge of the high intensity light zone is not at the horizontal reference line, the headlamp will need to be adjusted.

## Vertical Aim Adjustment

1. Park the vehicle directly in front of a wall or screen on a level surface, approximately 25 ft (7.6 m) away.
2. Measure the height from the center of your headlamp indicated by a 3mm circle on the lens to the ground and mark an 8 ft (2.4 m) horizontal reference line on the vertical wall or screen at this height, a piece of masking tape works well.

**Note:** To see a clearer light pattern for adjusting, you may want to block the light from one headlamp while adjusting the other.

3. Turn on the low beam headlamps to illuminate the wall or screen and open the hood. Cover one of the headlamps so no light hits the wall.

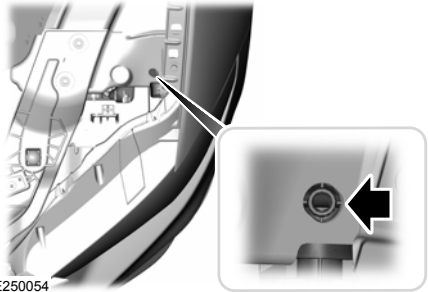

E250054

5. Locate the vertical adjuster on each headlamp. Use a Phillips #2 screwdriver to turn the adjuster either clockwise or counterclockwise to adjust the vertical aim of the headlamp.
6. Repeat steps 3 through 7 to adjust the other headlamp.
7. Close the hood and turn off the lamps.

# Maintenance

## Horizontal Aim Adjustment

The horizontal aim does not require any adjustment for this vehicle. If a fault occurs, have the system checked by an authorized dealer.

## CHANGING A BULB

### Replacing Reverse Lamp Bulbs

1. Make sure the lighting control is in the off position.
2. Locate the reverse lamp bulb under the rear bumper of your vehicle. To access the bulb, reach behind the bumper.
3. Disconnect the electrical sensor from the bulb by pulling it straight off.

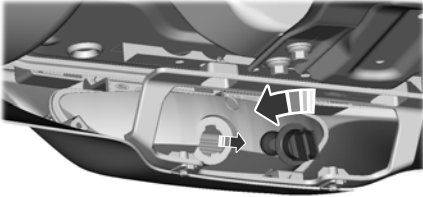

E177487

4. Rotate the bulb counterclockwise and remove it from the reverse lamp assembly.

## LED Lamps

LED lamps are not serviceable items. Contact an authorized dealer if they fail.

The following are LED lamps:

- Headlamps.
- Rear lamp.
- Brake lamp.
- Front fog lamp.
- Front sidemarker

- Daytime running lamp.
- Central high mounted brake lamp.
- Front direction indicator.
- Rear direction indicator lamp.
- License plate lamp.

## CHANGING THE ENGINE AIR FILTER - 2.3L ECOBOOST™/ 5.0L

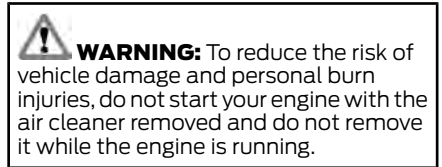

**Note:** Failure to use the correct air filter element may result in severe engine damage. Your warranty may not cover these damages.

Only use the specified replacement air filter. See **Motorcraft Parts** (page 295).

For EcoBoost equipped vehicles: When servicing the air cleaner, it is important that no foreign material enter the air induction system. The engine and turbocharger are susceptible to damage from even small particles.

Change the air filter element at the proper intervals. See **Scheduled Maintenance** (page 422).

# Maintenance

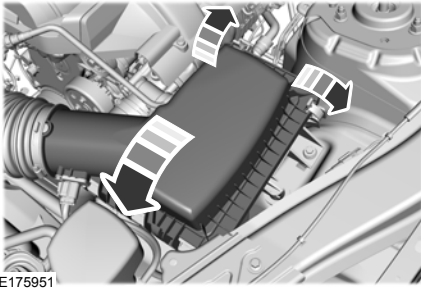

1. Release the two clamps that secure the air filter housing cover.
2. Carefully lift the air filter housing cover.
3. Remove the air filter element from the air filter housing.
4. Wipe any dirt or debris from the air filter housing and cover to make sure no dirt gets in the engine and that you have a good seal.
5. Install a new air filter element. Be careful not to crimp the filter element edges between the air filter housing and cover. This could cause filter damage and allow unfiltered air to enter the engine if it is not properly seated.
6. Replace the air filter housing cover.
7. Engage the clamps to secure the air filter housing cover to the air filter housing.

## CHANGING THE ENGINE AIR FILTER - 5.0L, BULLITT



**WARNING:** To reduce the risk of vehicle damage and personal burn injuries, do not start your engine with the air cleaner removed and do not remove it while the engine is running.

See the scheduled maintenance information for the appropriate intervals for changing the air filter element.

When changing the air filter element, use only the Motorcraft™ air filter element listed. See the Motorcraft part numbers in the Capacities and Specifications chapter.

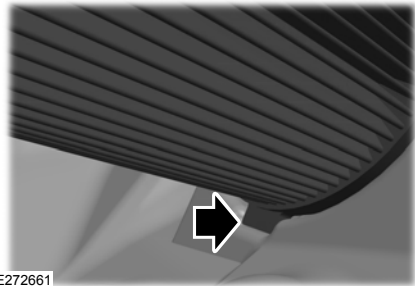
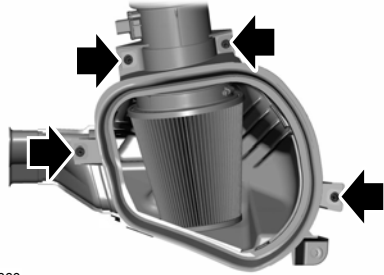

1. Remove the two sensor wire harness retainers from the air box studs located on the front side of the air box.
2. Remove the four studs that fasten the upper air box housing to the lower air box housing.
3. Separate the upper air box housing from the lower air box housing.
4. Loosen the air filter clamp enough to allow the filter to slip off the housing easily.

# Maintenance

---

5. Remove the air filter from the air filter housing.
6. Wipe the newly-exposed air filter outlet tube clamping area clean to remove any dirt or debris.
7. Install a new air filter, taking care not to damage the air filter element. Align the tab on the closed end of the filter with the notch in the air filter housing.
8. Tighten the air filter clamp down.

**Note:** *Do not overtighten the clamp or studs when reinstalling.*

9. Reinstall the upper air box piece to the lower air box piece. Tighten the 4 studs down.
10. Reinstall the two sensor wire harness retainers to the mating air box studs.

# Track Use



**WARNING:** *Track Apps™* is for track use only. Remember that even advanced technology cannot defy the laws of physics. It is always possible to lose control of a vehicle due to inappropriate driver input for the conditions. Aggressive driving on any road condition can cause you to lose control of your vehicle increasing the risk of personal injury or property damage.

Appropriately change the engine oil for racing and other track events:

- 2.3L: Prior to the track event, drain the engine oil, replace the oil filter and change the engine oil to 5W-50. After the track event, drain the engine oil, replace the oil filter and refill the engine oil with 5W-30. See **Capacities and Specifications** (page 300).
- 5.0L: Prior to the track event, drain the engine oil, replace the oil filter and change the engine oil to 5W-30. After the track event, drain the engine oil, replace the oil filter and refill the engine oil with 5W-20. See **Capacities and Specifications** (page 300).

Regularly check the engine oil level during the event. Maintain the engine oil level at or near the max mark on the engine oil dipstick. See **Engine Oil Check** (page 235).

## Track Apps

This information display driven feature provides a suite of menu options to record and optimize your track performances. See **General Information** (page 88).

**Note:** *Track Apps* are for track use only. Do not use them under any other driving conditions.

**Note:** You cannot view or clear your results unless your vehicle is at a complete stop with the right arrow on the display menu inactive. If your vehicle does not reach 100 mph (160 km/h) during the track run, your display may not show your selected interval's results.

**Note:** The pre-collision assist system turns off when using **Track Apps** or when you switch off your stability control system.

## Acceleration Timer

Displays your vehicle's rate of acceleration for a given speed or distance range.

## Accelerometer

Displays your vehicle's rate of acceleration or deceleration. A dot moves toward the area of acceleration or deceleration.

## LEFT Acceleration or Deceleration

When accelerating or decelerating left, the dot moves to the right on the accelerometer.

## RIGHT Acceleration or Deceleration

When accelerating or decelerating right, the dot moves to the left on the accelerometer.

## Brake Performance

Displays your vehicle's rate of deceleration for a given speed range.

## Exhaust Mode

Gives the driver the ability to choose the vehicle's exhaust mode.

# Track Use

---

**Note:** The **Track Exhaust Mode** setting is only for use at tracks and not for use on public roadways. Use of this setting results in increased exterior noise, which may not meet state and local laws and regulations. It is the obligation of the driver to operate the vehicle in a manner that complies with state and local requirements. Only use the **Track Exhaust Mode** setting at a competition track or an off-road course where elevated exterior vehicle noise is acceptable.

## Lap Timer

Gives you the ability to record lap times at three separate tracks.

## Launch Control (if Equipped)

Maximizes your vehicle's traction from a standing start.

Use launch control, follow these steps:

1. Bring your vehicle to a complete stop.
2. Make sure launch control is enabled. The indicator illuminates in the instrument display when launch control is enabled. See **Warning Lamps and Indicators** (page 84).
3. Fully depress the clutch pedal.
4. Shift the transmission into 1st gear.
5. Fully depress the accelerator pedal and allow the engine RPM to stabilize.
6. Release the clutch pedal.

## Line Lock

Line lock is a feature intended for use at tracks only and should not be used on public roadways. Use of this feature may result in significantly increased rear tire wear. It is intended to condition the rear tires to maximize traction prior to track use. Line lock maintains brake force at the front wheels, allowing the rear wheels to spin with minimal vehicle movement.

This feature is located in the **Track Apps** menu. Make selections through the 5-way information display control and OK button located on the steering wheel.

## Using Line Lock

There are three line lock stages:

- Initiated.
- Engaged.
- Off.

## Initiating Line Lock

The initiation stage verifies that the vehicle is ready for line lock function, and confirms driver intent. Follow the prompts in the information display to initiate line lock.

The following conditions must be met to initialize line lock:

- The vehicle is on a level surface.
- The engine is running.
- The vehicle is traveling less than 25 mph (40 km/h).
- Selectable drive mode is not in wet mode (if equipped).
- There are no electronic stability control faults.

If you want to cancel line lock once it is initialized, press the left information display control. Once initiated, line lock is prepared for activation and remains initiated up to 25 mph (40 km/h). If vehicle speed exceeds 25 mph (40 km/h), line lock automatically cancels.

# Track Use

---

## Engaging Line Lock

Follow the prompts in the information display to engage line lock after it is initialized. To engage, firmly apply the brakes. Then press the OK button. Once engaged, release the brake pedal. The front brakes remain applied and the rear brakes release. At this point, the engagement timer is initiated and shown on the driver information display.

The following conditions must be met to engage line lock:

- The vehicle is on a level surface.
- The engine is running.
- The vehicle is stopped.
- The parking brake is not applied.
- The driver door is closed.
- The transmission is in a forward gear.
- Selectable drive mode is not in wet mode (if equipped).
- There are no electronic stability control faults.
- The steering wheel must be in the straight ahead position.

## Releasing Line Lock

While line lock is engaged, you can exit (release) the feature using the OK button. When you press the OK button, line lock releases immediately and normal vehicle function resumes. When line lock engages, a countdown timer shows the remaining time before line lock is released automatically. If you exceed the time limit, or another vehicle condition requires line lock to release, the system safely disengages and normal vehicle function resumes.

**Note:** *If you apply the brake pedal while line lock is engaged, line lock automatically cancels and normal brake function resumes.*

## Start Option

Allows you to select the type of countdown the information display shows before starting an event.

## Status Screen

Provides the status of your chosen performance-related settings.

## View/Clear Results

Allows you to view and clear the last and saved results of the **Acceleration Timer**, **Brake Performance**, and **All Time Best** results.

# Vehicle Care

## GENERAL INFORMATION

Your dealer has many quality products available to clean your vehicle and protect its finishes.

## CLEANING PRODUCTS

### Materials

For best results, use the following products or products of equivalent quality:

Name	Specification
Motorcraft® Bug and Tar Remover, ZC-42 (U.S. & Canada)	
Motorcraft® Custom Bright Metal Cleaner, ZC-15 (U.S. & Canada)	ESR-M5B194-B
Motorcraft® Detail Wash, ZC-3-A (U.S. & Canada)	ESR-M14P4-A
Motorcraft® Engine Shampoo and Degreaser, ZC-20 (U.S.)	ESR-M14P3-A
Motorcraft® Engine Shampoo, CXC-66-A (Canada)	
Motorcraft® Premium Leather and Vinyl Cleaner, ZC-56 (U.S. & Canada)	
Motorcraft® Multi-Purpose Cleaner, CXC-101 (Canada)	
Motorcraft® Premium Windshield Wash Concentrate with Bitterant, ZC-32-B2 (U.S.)	WSS-M14P19-A
Motorcraft® Premium Quality Windshield Washer Fluid, CXC-37-A/B/D/F (Canada)	WSS-M14P19-A
Motorcraft® Professional Strength Carpet & Upholstery Cleaner, ZC-54 (U.S. & Canada)	
Motorcraft® Premium Glass Cleaner, CXC-100 (Canada)	ESR-M14P5-A
Motorcraft® Spot and Stain Remover, ZC-14 (U.S.)	
Motorcraft® Ultra-Clear Spray Glass Cleaner, ZC-23 (U.S.)	ESR-M14P5-A
Motorcraft® Wheel and Tire Cleaner, ZC-37-A (U.S. & Canada)	

## CLEANING THE EXTERIOR

Wash your vehicle regularly with cool or lukewarm water and a neutral pH shampoo, we recommend Motorcraft Detail Wash.

- Never use strong household detergents or soap, for example dish washing or laundry liquid. These products can discolor and spot painted surfaces.
- Never wash your vehicle when it is hot to the touch, or during strong or direct sunlight.



# Vehicle Care

---

- Dry your vehicle with a chamois or soft terry cloth towel to eliminate water spotting.
- Immediately remove fuel spillages, bird droppings, insect deposits and road tar. These may cause damage to your vehicle's paintwork or trim over time. We recommend Motorcraft Bug and Tar Remover.
- Remove any exterior accessories, for example antennas, before entering a car wash.
- When filling with AdBlue®, remove any residue on painted surfaces immediately.

**Note:** *Suntan lotions and insect repellents can damage painted surfaces. If these substances come in contact with your vehicle, wash the affected area as soon as possible.*

## Cleaning the Headlamps

**Note:** *Do not scrape the headlamp lenses or use abrasives, alcoholic solvents or chemical solvents to clean them.*

**Note:** *Do not wipe the headlamps when they are dry.*

## Exterior Chrome Parts

- Apply a high quality-cleaning product to bumpers and other chrome parts. Follow the manufacturer's instructions. We recommend Motorcraft Custom Bright Metal Cleaner.
- Do not apply the cleaning product to hot surfaces. Do not leave the cleaning product on chrome surfaces longer than the time recommended.
- Using non-recommended cleaners can result in severe and permanent cosmetic damage.

**Note:** *Never use abrasive materials, for example steel wool or plastic pads as they can scratch the chrome surface.*

**Note:** *Do not use chrome cleaner, metal cleaner or polish on wheels or wheel covers.*

## Exterior Plastic Parts

For routine cleaning we recommend Motorcraft Detail Wash. If tar or grease spots are present, we recommend Motorcraft Bug and Tar Remover.

## Stripes or Graphics (If Equipped)

Hand washing your vehicle is preferred however, pressure washing may be used under the following conditions:

- Do not use water pressure higher than 2,000 psi (14,000 kPa).
- Do not use water hotter than 179°F (82°C).
- Use a spray with a 40° wide spray angle pattern.
- Keep the nozzle at a 12 in (305 mm) distance and 90° angle to your vehicle's surface.

**Note:** *Holding the pressure washer nozzle at an angle to the vehicle's surface may damage graphics and cause the edges to peel away from the vehicle's surface.*

## Underbody

Regularly clean the underside of your vehicle using water. Keep body and door drain holes free of debris or foreign material.

## Under Hood

For removing black rubber marks from under the hood we recommend Motorcraft Wheel and Tire Cleaner or Motorcraft Bug and Tar Remover.

# Vehicle Care

---

## WAXING

Regular waxing is necessary to protect your car's paint from the elements. We recommend that you wash and wax the painted surface once or twice a year.

When washing and waxing, park your vehicle in a shaded area out of direct sunlight. Always wash your vehicle before applying wax.

- Use a quality wax that does not contain abrasives.
- Follow the manufacturer's instructions to apply and remove the wax.
- Apply a small amount of wax in a back-and-forth motion, not in circles.
- Do not allow wax to come in contact with any non-body (low-gloss black) colored trim. The wax will discolor or stain the parts over time.
  - Roof racks.
  - Bumpers.
  - Grained door handles.
  - Side moldings.
  - Mirror housings.
  - Windshield cowl area.
- Do not apply wax to glass areas.
- After waxing, your car's paint should feel smooth, and be free of streaks and smudges.

## CLEANING THE ENGINE

Engines are more efficient when they are clean because grease and dirt buildup keep the engine warmer than normal.

When washing:

- Take care when using a power washer to clean the engine. The high-pressure fluid could penetrate the sealed parts and cause damage.
- Do not spray a hot engine with cold water to avoid cracking the engine block or other engine components.
- Spray Motorcraft Engine Shampoo and Degreaser on all parts that require cleaning and pressure rinse clean. In Canada, use Motorcraft Engine Shampoo.

**Note:** *If your vehicle has an engine cover remove the cover before application of Motorcraft Engine Shampoo and Degreaser. Immediately rinse away any over spray.*

- Never wash or rinse the engine while it is hot or running; water in the running engine may cause internal damage.
- Never wash or rinse any ignition coil, spark plug wire or spark plug well, or the area in and around these locations.
- Cover the battery, power distribution box, and air filter assembly to prevent water damage when cleaning the engine.

## CLEANING THE WINDOWS AND WIPER BLADES

Car wash chemicals and environmental fallout can result in windshield and wiper blade contamination. Dirty windshield and wipers will result in poor windshield wiper operation. Keep the windshield and wiper blades clean to maintain windshield wiper performance.

# Vehicle Care

To clean the windshield and wiper blades:

- Clean the windshield with a non-abrasive glass cleaner. When cleaning the interior of the windshield, avoid getting any glass cleaner on the instrument panel or door panels. Wipe any glass cleaner off these surfaces immediately.
- For windshields contaminated with tree sap, chemicals, wax or bugs, clean the entire windshield using steel wool (no greater than 0000 grade) in a circular motion and rinse with water.
- Clean the wiper blades with isopropyl rubbing alcohol or windshield washer concentrate.

**Note:** Do not use razor blades or other sharp objects to clean or remove decals from the inside of the heated rear window. The vehicle warranty does not cover damage caused to the heated rear window grid lines.

## CLEANING THE INTERIOR



**WARNING:** Do not use cleaning solvents, bleach or dye on the vehicle's seatbelts, as these actions may weaken the belt webbing.



**WARNING:** On vehicles equipped with seat-mounted airbags, do not use chemical solvents or strong detergents. Such products could contaminate the side airbag system and affect performance of the side airbag in a crash.

For fabric, carpets, cloth seats and seats equipped with side airbags:

- Remove dust and loose dirt with a vacuum cleaner.
- Remove light stains and soil with Motorcraft Professional Strength Carpet & Upholstery Cleaner.
- If grease or tar is present on the material, spot-clean the area first with Motorcraft Spot and Stain Remover. In Canada, use Motorcraft Multi-Purpose Cleaner.
- If a ring forms on the fabric after spot cleaning, clean the entire area immediately (but do not oversaturate) or the ring will set.
- Do not use household cleaning products or glass cleaners, which can stain and discolor the fabric and affect the flame retardant abilities of the seat materials.

## Mirrors

Do not clean the housing or glass of any mirror with harsh abrasives, fuel or other petroleum or ammonia-based cleaning products.

## CLEANING THE INSTRUMENT PANEL AND INSTRUMENT CLUSTER LENS



**WARNING:** Do not use chemical solvents or strong detergents when cleaning the steering wheel or instrument panel to avoid contamination of the airbag system.

**Note:** Follow the same procedure as cleaning leather seats for cleaning leather instrument panels and leather interior trim surfaces. See **Cleaning Leather Seats** (page 257).

# Vehicle Care

---

Clean the instrument panel and cluster lens with a clean, damp and soft cloth, then use a clean, dry and soft cloth to dry these areas.

- Avoid cleaners or polishes that increase the gloss of the upper portion of the instrument panel. The dull finish in this area helps protect you from undesirable windshield reflection.
- Do not use any household cleaning products or glass cleaners as these may damage the finish of the instrument panel, interior trim and cluster lens.
- Wash or wipe your hands clean if you have been in contact with certain products such as insect repellent and suntan lotion to avoid possible damage to the interior painted surfaces.
- Do not allow air fresheners and hand sanitizers to spill onto interior surfaces. If a spill occurs, wipe off immediately. Your warranty may not cover these damages.

If a staining liquid like coffee or juice has been spilled on the instrument panel or on interior trim surfaces:

1. Wipe up spilled liquid using a clean, soft cloth as quickly as possible.
2. Use Motorcraft Premium Leather and Vinyl Cleaner or a commercially available leather cleaning product for automotive interiors. Test any cleaner or stain remover on an inconspicuous area.
3. Alternatively, wipe the surface with a clean, soft cloth and a mild soap and water solution. Dry the area with a clean, soft cloth.
4. If necessary, apply more soap and water solution or cleaning product to a clean, soft cloth and press it onto the soiled area. Allow this to set at room temperature for 30 minutes.

5. Remove the soaked cloth, then with a clean, damp cloth, use a rubbing motion for 60 seconds on the soiled area.
6. Dry the area with a clean, soft cloth.

## CLEANING LEATHER SEATS (IF EQUIPPED)

**Note:** *Follow the same procedure as cleaning leather seats for cleaning leather instrument panels and leather interior trim surfaces.*

For routine cleaning, wipe the surface with a soft, damp cloth and a mild soap and water solution. Dry the area with a clean, soft cloth.

For cleaning and removing stains such as dye transfer, use Motorcraft Premium Leather and Vinyl Cleaner or a commercially available leather cleaning product for automotive interiors.

**Note:** *Test any cleaner or stain remover on an inconspicuous area.*

You should:

- Remove dust and loose dirt with a vacuum cleaner.
- Clean and treat spills and stains as soon as possible.

Do not use the following products as these may damage the leather:

- Oil and petroleum or silicone-based leather conditioners.
- Household cleaners.
- Alcohol solutions.
- Solvents or cleaners intended specifically for rubber, vinyl and plastics.

# Vehicle Care

## REPAIRING MINOR PAINT DAMAGE

Authorized dealers have touch-up paint to match your vehicle's color. Your vehicle color code is printed on a sticker on the front, left-hand side door jamb. Take your color code to your authorized dealer to make sure you get the correct color.

Before repairing minor paint damage, use a cleaner such as Motorcraft Bug and Tar Remover to remove particles such as bird droppings, tree sap, insect deposits, tar spots, road salt and industrial fallout.

Always read the instructions before using cleaning products.

## CLEANING THE WHEELS (IF EQUIPPED)

1. Regularly clean them with a wheel cleaner. We recommend that you use Ford approved wheel cleaner if available.
2. Remove dirt and brake dust with a sponge.
3. Remove tar and grease with a bug and tar remover. We recommend that you use Ford approved bug and tar remover if available.
4. Thoroughly rinse the wheels with water after cleaning.

If you intend on parking your vehicle for an extended period after cleaning the wheels with a wheel cleaner, drive your vehicle for a few minutes before doing so. This reduces the risk of corrosion of the brake discs, brake pads and linings.

Do not clean the wheels when they are hot.

**Note:** *Some car washes could damage wheel rims and covers.*

**Note:** *Using non-recommended cleaners, harsh cleaning products, chrome wheel cleaners or abrasive materials could damage wheel rims and covers.*

## VEHICLE STORAGE

If you plan on storing your vehicle for 30 days or more, read the following maintenance recommendations to make sure your vehicle stays in good operating condition.

We engineer and test all motor vehicles and their components for reliable, regular driving. Under various conditions, long-term storage may lead to degraded engine performance or failure unless you use specific precautions to preserve engine components.

### General

- Store all vehicles in a dry, ventilated place.
- Protect from sunlight, if possible.
- If vehicles are stored outside, they require regular maintenance to protect against rust and damage.

### Body

- Wash your vehicle thoroughly to remove dirt, grease, oil, tar or mud from exterior surfaces, rear-wheel housing and the underside of front fenders.
- Periodically wash your vehicle if it is stored in exposed locations.
- Touch-up exposed or primed metal to prevent rust.
- Cover chrome and stainless steel parts with a thick coat of auto wax to prevent discoloration. Re-wax as necessary when you wash your vehicle.
- Lubricate all hood, door and luggage compartment hinges and latches with a light grade oil.

# Vehicle Care

---

- Cover interior trim to prevent fading.
- Keep all rubber parts free from oil and solvents.

## Engine

- Change the engine oil and filter prior to storage because used engine oil contains contaminants which may cause engine damage.
- Start the engine every 15 days for a minimum of 15 minutes. Run at fast idle with the climate controls set to defrost until the engine reaches normal operating temperature.
- With your foot on the brake, shift through all the gears while the engine is running.
- We recommend that you change the engine oil before you use your vehicle again.

## Fuel system

- Fill the fuel tank with high-quality fuel until the first automatic shutoff of the fuel pump nozzle.

## Cooling system

- Protect against freezing temperatures.
- When removing your vehicle from storage, check coolant fluid level. Confirm that there are no cooling system leaks and that fluid is at the recommended level.

## Battery

- Check and recharge as necessary. Keep connections clean.
- If storing your vehicle for more than 30 days without recharging the battery, we recommend that you disconnect the battery cables to maintain battery charge for quick starting.

**Note:** *It is necessary to reset memory features if battery cables are disconnected.*

## Brakes

- Make sure the brakes and parking brake release fully.

## Tires

- Maintain recommended air pressure.

## Miscellaneous

- Make sure all linkages, cables, levers and pins under your vehicle are covered with grease to prevent rust.
- Move vehicles at least 25 ft (7.5 m) every 15 days to lubricate working parts and prevent corrosion.

## Removing Vehicle From Storage

When your vehicle is ready to come out of storage, do the following:

- Wash your vehicle to remove any dirt or grease film build-up on window surfaces.
- Check windshield wipers for any deterioration.
- Check under the hood for any foreign material that may have collected during storage such as mice or squirrel nests.
- Check the exhaust for any foreign material that may have collected during storage.
- Check tire pressures and set tire inflation per the Tire Label.
- Check brake pedal operation. Drive your vehicle 15 ft (4.5 m) back and forth to remove rust build-up.

# Vehicle Care

---

- Check fluid levels (including coolant, oil and gas) to make sure there are no leaks, and fluids are at recommended levels.
- If you remove the battery, clean the battery cable ends and check for damage.

Contact an authorized dealer if you have any concerns or issues.

## **CLEANING THE CONVERTIBLE TOP (IF EQUIPPED)**

Remove lint with a lint roller or a vacuum with a soft bristle brush.

For cloth and vinyl tops, wash with an approved high-quality convertible top cleaner and protectant.

**Note:** *Do not use stiff bristle brushes, abrasive materials or household cleaning products.*

**Note:** *High-pressure water may cause water leaks and possible seal damage to the convertible top.*

**Note:** *Do not fold the convertible top when it is wet.*

**Note:** *Avoid hot wax on vinyl materials during car washes.*

## **BODY STYLING KITS**

The distance between the underside of your vehicle and the ground is less than that of other models. Drive with extreme care to avoid damage to your vehicle.

# Wheels and Tires

## GENERAL INFORMATION

The recommended tire inflation pressures are on the tire information label on the driver side B-pillar.

Check and set the tire pressure at the ambient temperature in which you are intending to drive your vehicle and when the tires are cold.

**Note:** Check your tire pressures regularly to optimize fuel economy.

Only use approved wheel and tire sizes. Using other sizes could damage your vehicle and could make the National Type Approval invalid.

Installation of any tires that are not the original equipment tire size can cause the speedometer to display incorrect vehicle speed.

## TIRE SEALANT AND INFLATOR KIT (IF EQUIPPED)

**Note:** The temporary mobility kit contains enough sealant compound in the canister for one tire repair only. See your authorized dealer for replacement sealant canisters.

The kit is under the load floor in the cargo area. The kit consists of an air compressor to re-inflate the tire and a canister of sealing compound that effectively seals most punctures caused by nails or similar objects. This kit provides a temporary tire repair, allowing you to drive your vehicle up to 120 mi (200 km) at a maximum speed of 50 mph (80 km/h) to reach a tire service location.

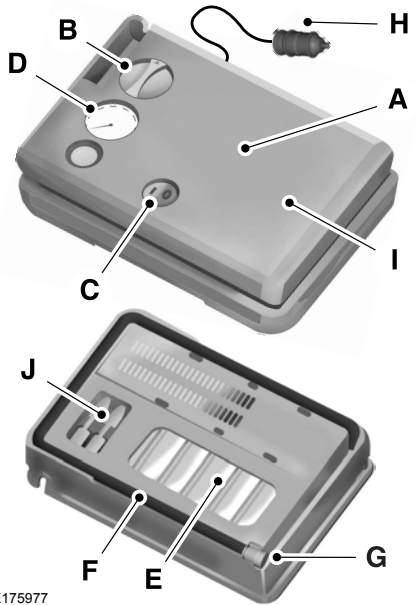

- A Air compressor (inside).
- B Selector switch.
- C On and off button.
- D Air pressure gauge.
- E Sealant bottle and canister.
- F Dual purpose hose: air and repair.
- G Tire valve connector.
- H Accessory power plug.
- I Casing/housing.
- J Bike/raft/sports ball adapters.



# Wheels and Tires

## General Information



**WARNING:** Failure to follow these guidelines could result in an increased risk of loss of vehicle control, injury or death.

**Note:** Do not use the kit if you have severely damaged a tire. Only seal punctures within the tire tread with the kit.

Do not attempt to repair punctures larger than ¼ inch (6 millimeters) or damage to the tire's sidewall. The tire may not completely seal.

Loss of air pressure may adversely affect tire performance. For this reason:

**Note:** Do not drive the vehicle above 50 mph (80 km/h).

**Note:** Do not drive further than 120 mi (200 km). Drive only to the closest authorized dealer or tire repair shop to have your tire inspected.

- Drive carefully and avoid abrupt steering maneuvers.
- Periodically monitor tire inflation pressure in the affected tire; if the tire is losing pressure, have the vehicle towed.
- Read the information in the Tips for Use of the Kit section to make sure safe operation of the kit and your vehicle.

## Tips for Use of the Kit

To ensure safe operation of the kit:

- Read all instructions and cautions fully.
- Before operating the kit, make sure your vehicle is safely off the road and away from moving traffic. Switch on the hazard lights.
- Always set the parking brake to ensure the vehicle does not move unexpectedly.

- Do not remove any foreign objects, such as nails or screws, from the tire.
- When using the kit, leave the engine running (only if the vehicle is outdoors or in a well-ventilated area) so the compressor does not drain the vehicle's battery.
- Do not allow the compressor to operate continuously for more than 15 minutes. This will help prevent the compressor from overheating.
- Never leave the kit unattended during operation.
- Sealant compound contains latex. Those with latex sensitivities should use appropriate precautions to avoid an allergic reaction.
- Keep the kit away from children.
- Only use the kit when the ambient temperature is between -22°F (-30°C) and 158°F (70°C).
- Only use the sealing compound before the use-by date. The use-by date is on a label on the sealant canister, which you can see through the rectangular viewing window on the bottom of the compressor. Check the use-by date regularly and replace the canister when the sealant expires.
- Do not store the kit unsecured inside the passenger compartment of the vehicle as it may cause injury during a sudden stop or crash. Always store the kit in its original location.
- After sealant use, an authorized dealer must replace the tire pressure monitoring system sensor and valve stem on the wheel.
- Operating the kit could cause an electrical disturbance in radio, CD and DVD player operation.

# Wheels and Tires



\* When inflation only is required for a tire or other objects, the selector must be in the Air position.

## What to do When a Tire Is Punctured

You can repair a tire puncture within the tire's tread area in two stages with the kit.

- In the first stage, inflate the tire with a sealing compound and air. After you inflate the tire, you will need to drive the vehicle a short distance 4 mi (6 km) to distribute the sealant in the tire.
- In the second stage, check the tire pressure and adjust, if necessary, to the vehicle's specified tire inflation pressure.

## First Stage: Inflating the Tire with Sealing Compound and Air



**WARNING:** Do not stand directly over the kit while inflating the tire. If you notice any unusual bulges or deformations in the tire's sidewall during inflation, stop and call roadside assistance.



**WARNING:** If the tire does not inflate to the recommended tire pressure within 15 minutes, stop and call roadside assistance.



**WARNING:** Do not run the engine when operating the air compressor unless the vehicle is outdoors or in a well-ventilated area.

Preparation: Park the vehicle in a safe, level and secure area, away from moving traffic.

Switch the hazard lights on. Apply the parking brake and switch the engine off. Inspect the flat tire for visible damage.

Sealant compound contains latex. Use appropriate precautions to avoid any allergic reactions.

Do not remove any foreign object that has pierced the tire. If a puncture is in the tire sidewall, stop and call roadside assistance.

1. Remove the valve cap from the tire valve.
2. Unwrap the dual purpose hose (black tube) from the back of the compressor housing.
3. Fasten the hose to the tire valve by turning the connector clockwise. Tighten the connection securely.

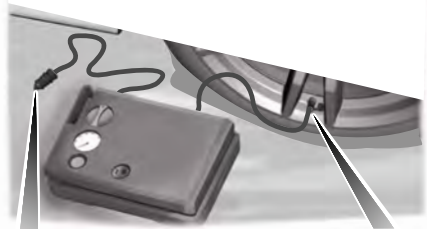

E200523

4. Plug the power cable into the 12-volt power point in the vehicle.
5. Remove the warning sticker found on the casing/housing and place it on the top of the instrument panel or the center of the dash.

## Wheels and Tires

6. Start the vehicle and leave the engine running so the compressor does not drain the vehicle's battery.



7. Turn dial (A) clockwise to the sealant position. Switch the kit on by pressing the on/off button (B).
8. Inflate the tire to the pressure listed on the tire label on the driver's door or the door jamb area. The initial air pressure gauge reading may indicate a value higher than the label pressure while you pump the sealing compound into the tire. This is normal and should be no reason for concern. The pressure gauge reading will indicate the tire inflation pressure after about 30 seconds of operation. You should check the final tire pressure with the compressor turned OFF in order to get an accurate pressure reading.

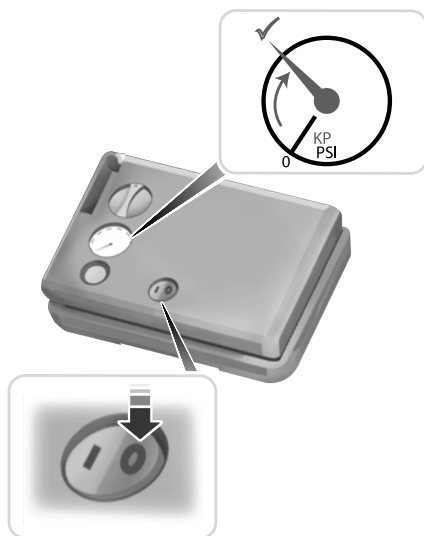

9. When the tire reaches the recommended tire pressure, switch off the kit, unplug the power cable, and disconnect the hose from the tire valve. Re-install the valve cap on the tire valve and return the kit to the stowage area.
10. Immediately and cautiously, drive the vehicle 4 mi (6 km) to distribute the sealant evenly inside the tire. Do not exceed 50 mph (80 km/h).
11. After 4 mi (6 km), stop and check the tire pressure. See Second Stage: Checking Tire Pressure.

# Wheels and Tires

**Note:** If you experience any unusual vibration, ride disturbance or noise while driving, reduce your speed until you can safely pull off to the side of the road to call for roadside assistance. Note: Do not proceed to the second stage of this operation.

## Second Stage: Checking Tire Pressure

**Note:** If you are proceeding from the First Stage: Re-inflating the Tire with Sealing Compound and Air section and have injected sealant in the tire and the pressure is below 20 psi (1.4 bar), continue to the next step.

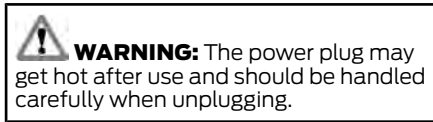

Check the air pressure of your tires as follows:



E175983

1. Remove the valve cap from the tire valve.
2. Firmly screw the air compressor hose onto the valve stem by turning clockwise.
3. Push and turn the dial clockwise to the air position.

4. If required, switch on the compressor and adjust the tire to the recommended inflation pressure shown on the tire label on the driver's door or door jamb area. You should check the tire pressure with the compressor turned OFF in order to get an accurate pressure reading.
5. Unplug the hoses, re-install the valve cap on the tire and return the kit to the stowage area.

## What to Do After the Tire Has Been Sealed

After using the kit to seal your tire, you will need to replace the sealant canister. You can obtain sealant canisters and spare parts at an authorized dealer. You can dispose of empty sealant canisters at home. However, you should dispose of canisters still containing liquid sealant through your local authorized dealer or tire dealer, or in accordance with local waste disposal regulation.

**Note:** After you use the sealing compound, the maximum vehicle speed is 50 mph (80 km/h) and the maximum driving distance is 120 mi (200 km). You should inspect the sealed tire immediately.

You can check the tire pressure any time within the 120 mi (200 km) by performing the steps listed previously in the Second Stage: Checking Tire Pressure procedure.

# Wheels and Tires

## Removal of the sealant canister from the kit

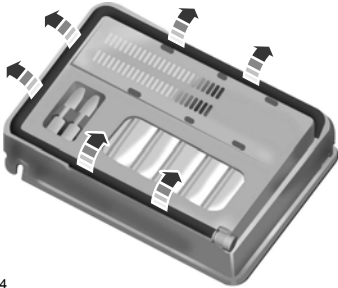

E175984

1. Unwrap the dual purpose hose (black tube) from the compressor housing.



E175985

2. Unwrap the power cord.



E175986

3. Remove the back cover.



E175987

4. Rotate the sealant canister up 90 degrees and pull away from casing/housing to remove.

## Installation of the sealant canister to the kit

1. With the canister held perpendicular to the housing, insert the canister nozzle into the connector and push until seated.
2. Rotate the canister 90 degrees down into the housing/casing.



E175988

3. Snap the back cover back into place.

# Wheels and Tires



E175989

4. Wrap the dual purpose hose (black tube) around the channel on the bottom of the housing/casing.

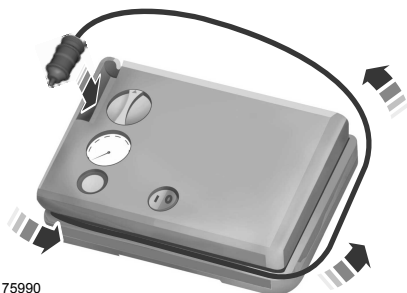

E175990

5. Wrap the power cord around the housing and stow the accessory power plug into its storage area.

**Note:** *If you experience any difficulties with the removal or installation of the sealant canister, consult an authorized dealer for assistance.*

Make sure you check the sealant compound's use-by date regularly. The use-by date is on a label on the sealant canister, which you can see through the rectangular viewing window on the bottom of the kit. Replace the sealant canister when the sealant expires.

## TIRE CARE

### Information About Uniform Tire Quality Grading



E142542

Tire Quality Grades apply to new pneumatic passenger car tires. The Quality grades can be found where applicable on the tire sidewall between tread shoulder and maximum section width. For example: **Treadwear 200 Traction AA Temperature A.**

These Tire Quality Grades are determined by standards that the United States Department of Transportation has set.

Tire Quality Grades apply to new pneumatic passenger car tires. They do not apply to deep tread, winter-type snow tires, space-saver or temporary use spare tires, light truck or LT type tires, tires with nominal rim diameters of 10 to 12 inches or limited production tires as defined in Title 49 Code of Federal Regulations Part 575.104 (c)(2).

# Wheels and Tires

## U.S. Department of Transportation Tire quality grades:

The U.S. Department of Transportation requires Ford Motor Company to give you the following information about tire grades exactly as the government has written it.

### Treadwear

The treadwear grade is a comparative rating based on the wear rate of the tire when tested under controlled conditions on a specified government test course. For example, a tire graded 150 would wear 1 ½ times as well on the government course as a tire graded 100. The relative performance of tires depends upon the actual conditions of their use, however, and may depart significantly from the norm due to variations in driving habits, service practices, and differences in road characteristics and climate.

### Traction AA A B C



**WARNING:** The traction grade assigned to this tire is based on straight-ahead braking traction tests, and does not include acceleration, cornering, hydroplaning or peak traction characteristics.

The traction grades, from highest to lowest are AA, A, B, and C. The grades represent the tire's ability to stop on wet pavement as measured under controlled conditions on specified government test surfaces of asphalt and concrete. A tire marked C may have poor traction performance.

### Temperature A B C



**WARNING:** The temperature grade for this tire is established for a tire that is properly inflated and not overloaded. Excessive speed, underinflation, or excessive loading, either separately or in combination, can cause heat buildup and possible tire failure.

The temperature grades are A (the highest), B and C, representing the tire's resistance to the generation of heat and its ability to dissipate heat when tested under controlled conditions on a specified indoor laboratory test wheel. Sustained high temperature can cause the material of the tire to degenerate and reduce tire life, and excessive temperature can lead to sudden tire failure. The grade C corresponds to a level of performance which all passenger car tires must meet under the

# Wheels and Tires

---

Federal Motor Vehicle Safety Standard No. 139. Grades B and A represent higher levels of performance on the laboratory test wheel than the minimum required by law.

## Glossary of Tire Terminology

\***Tire label:** A label showing the original equipment tire sizes, recommended inflation pressure and the maximum weight the vehicle can carry.

\***Tire Identification Number (TIN):** A number on the sidewall of each tire providing information about the tire brand and manufacturing plant, tire size and date of manufacture. Also referred to as DOT code.

\***Inflation pressure:** A measure of the amount of air in a tire.

\***Standard load:** A class of P-metric or Metric tires designed to carry a maximum load at set pressure. For example: For P-metric tires 35 psi (2.4 bar) and for Metric tires 36 psi (2.5 bar). Increasing the inflation pressure beyond this pressure will not increase the tire capability.

\***Extra load:** A class of P-metric or Metric tires designed to carry a heavier maximum load at 42 psi (2.9 bar). Increasing the inflation pressure beyond this pressure will not increase the tire's load carrying capability.

\***kPa:** Kilopascal, a metric unit of air pressure.

\***PSI:** Pounds per square inch, a standard unit of air pressure.

\***Cold tire pressure:** The tire pressure when the vehicle has been stationary and out of direct sunlight for an hour or more and prior to the vehicle being driven for 1 mi (1.6 km).

\***Recommended inflation pressure:** The cold inflation pressure found on the Safety Compliance Certification Label (affixed to either the door hinge pillar, door-latch post, or the door edge that meets the door-latch post, next to the driver's seating position), or Tire Label located on the B-Pillar or the edge of the driver's door.

\***B-pillar:** The structural member at the side of the vehicle behind the front door.

\***Bead area of the tire:** Area of the tire next to the rim.

\***Sidewall of the tire:** Area between the bead area and the tread.

\***Tread area of the tire:** Area of the perimeter of the tire that contacts the road when mounted on the vehicle.

\***Rim:** The metal support (wheel) for a tire or a tire and tube assembly upon which the tire beads are seated.



# Wheels and Tires

## Information Contained on the Tire Sidewall

Both United States and Canada Federal regulations require tire manufacturers to place standardized information on the sidewall of all tires. This information identifies and describes the fundamental characteristics of the tire and also provides a U.S. DOT Tire Identification Number for safety standard certification and in case of a recall.

## Information on P Type Tires

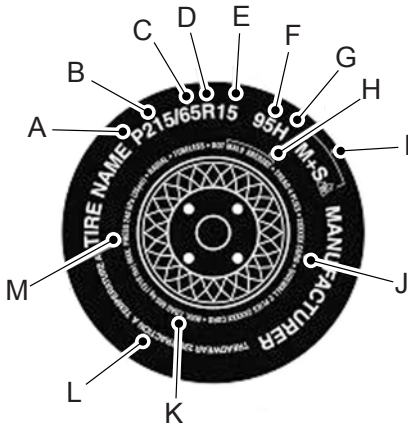

E142543

P215/65R15 95H is an example of a tire size, load index and speed rating. The definitions of these items are listed below. (Note that the tire size, load index and speed rating for your vehicle may be different from this example.)

**A. P:** Indicates a tire, designated by the Tire and Rim Association, that may be used for service on cars, sport utility vehicles, minivans and light trucks. **Note:** If your tire size does not begin with a letter this may mean it is designated by either the European Tire and Rim Technical Organization or the Japan Tire Manufacturing Association.

**B. 215:** Indicates the nominal width of the tire in millimeters from sidewall edge to sidewall edge. In general, the larger the number, the wider the tire.

**C. 65:** Indicates the aspect ratio which gives the tire's ratio of height to width.

**D. R:** Indicates a radial type tire.

**E. 15:** Indicates the wheel or rim diameter in inches. If you change your wheel size, you will have to purchase new tires to match the new wheel diameter.

**F. 95:** Indicates the tire's load index. It is an index that relates to how much weight a tire can carry. You may find this information in your owner's manual. If not, contact a local tire dealer.

**Note:** You may not find this information on all tires because it is not required by federal law.

## Wheels and Tires

**G. H:** Indicates the tire's speed rating. The speed rating denotes the speed at which a tire is designed to be driven for extended periods of time under a standard condition of load and inflation pressure. The tires on your vehicle may operate at different conditions for load and inflation pressure. These speed ratings may need to be adjusted for the difference in conditions. The ratings range from 81 mph (130 km/h) to 186 mph (299 km/h). These ratings are listed in the following chart.

**Note:** *You may not find this information on all tires because it is not required by federal law.*

Letter rating	Speed rating - mph (km/h)
M	81 (130)
N	87 (140)
Q	99 (159)
R	106 (171)
S	112 (180)
T	118 (190)
U	124 (200)
H	130 (210)
V	149 (240)

Letter rating	Speed rating - mph (km/h)
W	168 (270)
Y	186 (299)

**Note:** *For tires with a maximum speed capability over 149 mph (240 km/h), tire manufacturers sometimes use the letters ZR. For those with a maximum speed capability over 186 mph (299 km/h), tire manufacturers always use the letters ZR.*

**H. U.S. DOT Tire Identification Number (TIN):** This begins with the letters DOT and indicates that the tire meets all federal standards. The next two numbers or letters are the plant code designating where it was manufactured, the next two are the tire size code and the last four numbers represent the week and year the tire was built. For example, the numbers 317 mean the 31st week of 1997. After 2000 the numbers go to four digits. For example, 2501 means the 25th week of 2001. The numbers in between are identification codes used for traceability. This information is used to contact customers if a tire defect requires a recall.

**I. M+S or M/S:** Mud and Snow, or  
**AT:** All Terrain, or  
**AS:** All Season.

## Wheels and Tires

---

**J. Tire Ply Composition and Material Used:** Indicates the number of plies or the number of layers of rubber-coated fabric in the tire tread and sidewall. Tire manufacturers also must indicate the ply materials in the tire and the sidewall, which include steel, nylon, polyester, and others.

**K. Maximum Load:** Indicates the maximum load in kilograms and pounds that can be carried by the tire. See the Safety Compliance Certification Label (affixed to either the door hinge pillar, door-latch post, or the door edge that meets the door-latch post, next to the driver's seating position), for the correct tire pressure for your vehicle.

### **L. Treadwear, Traction and Temperature Grades:**

**\*Treadwear:** The treadwear grade is a comparative rating based on the wear rate of the tire when tested under controlled conditions on a specified government test course. For example, a tire graded 150 would wear one and one-half times as well on the government course as a tire graded 100.

**\*Traction:** The traction grades, from highest to lowest are AA, A, B, and C. The grades represent the tire's ability to stop on wet pavement as measured under controlled conditions on specified government test surfaces of asphalt and concrete. A tire marked C may have poor traction performance.

**\*Temperature:** The temperature grades are A (the highest), B and C, representing the tire's resistance to the generation of heat and its ability to dissipate heat when tested under controlled conditions on a specified indoor laboratory test wheel.

**M. Maximum Inflation Pressure:** Indicates the tire manufacturers' maximum permissible pressure or the pressure at which the maximum load can be carried by the tire. This pressure is normally higher than the vehicle manufacturer's recommended cold inflation pressure which can be found on the Safety Compliance Certification Label (affixed to either the door hinge pillar, door-latch post, or the door edge that meets the door-latch post, next to the driver's seating position), or Tire Label which is located on the B-Pillar or the edge of the driver's door. The cold inflation pressure should never be set lower than the recommended pressure on the vehicle label.

# Wheels and Tires

The tire suppliers may have additional markings, notes or warnings such as standard load or radial tubeless.

## Additional Information Contained on the Tire Sidewall for LT Type Tires

**Note:** *Tire Quality Grades do not apply to this type of tire.*

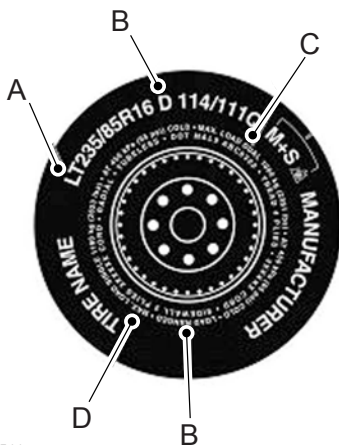

E142544

LT type tires have some additional information beyond those of P type tires; these differences are described below.

**A. LT:** Indicates a tire, designated by the Tire and Rim Association, that is intended for service on light trucks.

**B. Load Range and Load Inflation Limits:** Indicates the tire's load-carrying capabilities and its inflation limits.

**C. Maximum Load Dual lb (kg) at psi (kPa) cold:** Indicates the maximum load and tire pressure when the tire is used as a dual, defined as four tires on the rear axle (a total of six or more tires on the vehicle).

**D. Maximum Load Single lb (kg) at psi (kPa) cold:** Indicates the maximum load and tire pressure when the tire is used as a single, defined as two tires (total) on the rear axle.

## Information on T Type Tires

T145/80D16 is an example of a tire size.

**Note:** *The temporary tire size for your vehicle may be different from this example. Tire Quality Grades do not apply to this type of tire.*

# Wheels and Tires



E142545

T type tires have some additional information beyond those of P type tires; these differences are described below:

**A. T:** Indicates a type of tire, designated by the Tire and Rim Association, that is intended for temporary service on cars, sport utility vehicles, minivans and light trucks.

**B. 145:** Indicates the nominal width of the tire in millimeters from sidewall edge to sidewall edge. In general, the larger the number, the wider the tire.

**C. 80:** Indicates the aspect ratio which gives the tire's ratio of height to width. Numbers of 70 or lower indicate a short sidewall.

**D. D:** Indicates a diagonal type tire.

**R:** Indicates a radial type tire.

**E. 16:** Indicates the wheel or rim diameter in inches. If you change your wheel size, you will have to purchase new tires to match the new wheel diameter.

## Location of the Tire Label

You will find a Tire Label containing tire inflation pressure by tire size and other important information located on the B-Pillar or the edge of the driver's door.

## Inflating Your Tires

Safe operation of your vehicle requires that your tires are properly inflated. Remember that a tire can lose up to half of its air pressure without appearing flat.

Every day before you drive, check your tires. If one looks lower than the others, use a tire gauge to check pressure of all tires and adjust if required.

At least once a month and before long trips, inspect each tire and check the tire pressure with a tire gauge (including spare, if equipped). Inflate all tires to the inflation pressure recommended by Ford Motor Company.

## Wheels and Tires

You are strongly urged to buy a reliable tire pressure gauge, as automatic service station gauges may be inaccurate. Ford recommends the use of a digital or dial-type tire pressure gauge rather than a stick-type tire pressure gauge.

Use the recommended cold inflation pressure for optimum tire performance and wear. Under-inflation or over-inflation may cause uneven treadwear patterns.



**WARNING:** Under-inflation is the most common cause of tire failures and may result in severe tire cracking, tread separation or blowout, with unexpected loss of vehicle control and increased risk of injury. Under-inflation increases sidewall flexing and rolling resistance, resulting in heat buildup and internal damage to the tire. It also may result in unnecessary tire stress, irregular wear, loss of vehicle control and accidents. A tire can lose up to half of its air pressure and not appear to be flat!

Always inflate your tires to the Ford recommended inflation pressure even if it is less than the maximum inflation pressure information found on the tire. The Ford recommended tire inflation pressure is found on the Safety Compliance Certification Label

(affixed to either the door hinge pillar, door-latch post, or the door edge that meets the door-latch post, next to the driver's seating position), or Tire Label which is located on the B-Pillar or the edge of the driver's door. Failure to follow the tire pressure recommendations can cause uneven treadwear patterns and adversely affect the way your vehicle handles.

**Maximum Inflation Pressure** is the tire manufacturer's maximum permissible pressure and the pressure at which the maximum load can be carried by the tire. This pressure is normally higher than the manufacturer's recommended cold inflation pressure which can be found on the Safety Compliance Certification Label (affixed to either the door hinge pillar, door-latch post, or the door edge that meets the door-latch post, next to the driver's seating position), or Tire Label which is located on the B-Pillar or the edge of the driver's door. The cold inflation pressure should never be set lower than the recommended pressure on the Safety Compliance Certification Label or Tire Label.

## Wheels and Tires

---

When weather temperature changes occur, tire inflation pressures also change. A 43°F (6°C) temperature drop can cause a corresponding drop of 1 psi (7 kPa) in inflation pressure. Check your tire pressures frequently and adjust them to the proper pressure which can be found on the Safety Compliance Certification Label or Tire Label.

To check the pressure in your tire(s):

1. Make sure the tires are cool, meaning they are not hot from driving even a mile.

**Note:** *If you are checking tire pressure when the tire is hot, for example, driven more than 1 mi (1.6 km), never bleed or reduce air pressure. The tires are hot from driving and it is normal for pressures to increase above recommended cold pressures. A hot tire at or below recommended cold inflation pressure could be significantly under-inflated.*

**Note:** *If you have to drive a distance to get air for your tire(s), check and record the tire pressure first and add the appropriate air pressure when you get to the pump. It is normal for tires to heat up and the air pressure inside to go up as you drive.*

2. Remove the cap from the valve on one tire, then firmly press the tire gauge onto the valve and measure the pressure.

3. Add enough air to reach the recommended air pressure.

**Note:** *If you overfill the tire, release air by pressing on the metal stem in the center of the valve. Then recheck the pressure with your tire gauge.*

4. Replace the valve cap.
5. Repeat this procedure for each tire, including the spare.

**Note:** *Some spare tires operate at a higher inflation pressure than the other tires. For T type mini-spare tires, see the Dissimilar spare wheel and tire assembly information for a description. Store and maintain at 60 psi (4.15 bar). For full-size and dissimilar spare tires, see the Dissimilar spare wheel and tire assembly information for a description. Store and maintain at the higher of the front and rear inflation pressure as shown on the Tire Label.*

6. Visually inspect the tires to make sure there are no nails or other objects embedded that could poke a hole in the tire and cause an air leak.
7. Check the sidewalls to make sure there are no gouges, cuts or bulges.

# Wheels and Tires

## Inspecting Your Tires and Wheel Valve Stems

Periodically inspect the tire treads for uneven or excessive wear and remove objects such as stones, nails or glass that may be wedged in the tread grooves. Check the tire and valve stems for holes, cracks, or cuts that may permit air leakage and repair or replace the tire and replace the valve stem. Inspect the tire sidewalls for cracking, cuts, bruises and other signs of damage or excessive wear. If internal damage to the tire is suspected, have the tire demounted and inspected in case it needs to be repaired or replaced. For your safety, tires that are damaged or show signs of excessive wear should not be used because they are more likely to blow out or fail.

Improper or inadequate vehicle maintenance can cause tires to wear abnormally. Inspect all your tires, including the spare, frequently, and replace them if one or more of the following conditions exist:

## Tire Wear

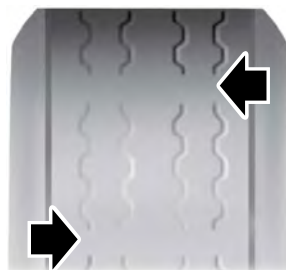

E142546

When the tread is worn down to one sixteenth of an inch (2 mm), tires must be replaced to help prevent your vehicle from skidding and hydroplaning. Built-in treadwear indicators, or wear bars, which look like narrow strips of smooth rubber across the tread will appear on the tire when the tread is worn down to one sixteenth of an inch (2 mm).

When the tire tread wears down to the same height as these wear bars, the tire is worn out and must be replaced.

## Damage

Periodically inspect the tire treads and sidewalls for damage (such as bulges in the tread or sidewalls, cracks in the tread groove and separation in the tread or sidewall). If damage is observed



# Wheels and Tires

or suspected have the tire inspected by a tire professional. Tires can be damaged during off-road use, so inspection after off-road use is also recommended.

## Age



**WARNING:** Tires degrade over time depending on many factors such as weather, storage conditions, and conditions of use (load, speed, inflation pressure) the tires experience throughout their lives.



**WARNING:** In general, tires should be replaced after six years regardless of tread wear. However, heat caused by hot climates or frequent high loading conditions can accelerate the aging process and may require tires to be replaced more frequently.



**WARNING:** You should replace your spare tire when you replace the road tires or after six years due to aging even if it has not been used.

## U.S. DOT Tire Identification Number

Both United States and Canada Federal regulations require tire manufacturers to place standardized information on the sidewall of all tires. This information identifies and

describes the fundamental characteristics of the tire and also provides a U.S. DOT Tire Identification Number for safety standard certification and in case of a recall.

This begins with the letters DOT and indicates that the tire meets all federal standards. The next two numbers or letters are the plant code designating where it was manufactured, the next two are the tire size code and the last four numbers represent the week and year the tire was built. For example, the numbers 317 mean the 31st week of 1997. After 2000 the numbers go to four digits. For example, 2501 means the 25th week of 2001. The numbers in between are identification codes used for traceability. This information is used to contact customers if a tire defect requires a recall.

## Tire Replacement Requirements

Your vehicle is equipped with tires designed to provide a safe ride and handling capability.



**WARNING:** Only use replacement tires and wheels that are the same size, load index, speed rating and type (such as P-metric versus LT-metric or all-season versus all-terrain) as those originally provided by Ford. The

## Wheels and Tires

recommended tire and wheel size may be found on either the Safety Compliance Certification Label (affixed to either the door hinge pillar, door-latch post, or the door edge that meets the door-latch post, next to the driver's seating position), or the Tire Label which is located on the B-Pillar or edge of the driver's door. If this information is not found on these labels, then you should contact your authorized dealer as soon as possible. Use of any tire or wheel not recommended by Ford can affect the safety and performance of your vehicle, which could result in an increased risk of loss of vehicle control, vehicle rollover, personal injury and death.



**WARNING:** To reduce the risk of serious injury, when mounting replacement tires and wheels, you should not exceed the maximum pressure indicated on the sidewall of the tire to set the beads without additional precautions listed below. If the beads do not seat at the maximum pressure indicated, re-lubricate and try again.



**WARNING:** For a mounting pressure more than 20 psi (1.38 bar) greater than the maximum pressure, a Ford dealer or other tire service professional should do the mounting.



**WARNING:** Always inflate steel carcass tires with a remote air fill with the person inflating standing at a minimum of 12 ft (3.66 m) away from the wheel and tire assembly.



**WARNING:** When inflating the tire for mounting pressures up to 20 psi (1.38 bar) greater than the maximum pressure on the tire sidewall, the following precautions must be taken to protect the person mounting the tire:

- Make sure that you have the correct tire and wheel size.
- Lubricate the tire bead and wheel bead seat area again.
- Stand at a minimum of 12 ft (3.66 m) away from the wheel and tire assembly.
- Use both eye and ear protection.

**Important:** Remember to replace the wheel valve stems when the road tires are replaced on your vehicle.

It is recommended that the two front tires or two rear tires generally be replaced as a pair.

The tire pressure sensors mounted in the wheels (originally installed on your vehicle) are not designed to be used in aftermarket wheels.

# Wheels and Tires

The use of wheels or tires not recommended by Ford Motor Company may affect the operation of your tire pressure monitoring system.

If the tire pressure monitoring system indicator is flashing, your system is malfunctioning. Your replacement tire might be incompatible with your tire pressure monitoring system, or some component of the system may be damaged.

## Safety Practices



**WARNING:** If your vehicle is stuck in snow, mud or sand, do not rapidly spin the tires; spinning the tires can tear the tire and cause an explosion. A tire can explode in as little as three to five seconds.



**WARNING:** Do not spin the wheels at over 34 mph (55 km/h). The tires may fail and injure a passenger or bystander.

## Driving habits have a great deal to do with your tire mileage and safety.

- \*Observe posted speed limits.
- \*Avoid fast starts, stops and turns.
- \*Avoid potholes and objects on the road.
- \*Do not run over curbs or hit the tire against a curb when parking.

## Highway Hazards

No matter how carefully you drive there's always the possibility that you may eventually have a flat tire on the highway. Drive slowly to the closest safe area out of traffic. This may further damage the flat tire, but your safety is more important.

If you feel a sudden vibration or ride disturbance while driving, or you suspect your tire or vehicle has been damaged, immediately reduce your speed. Drive with caution until you can safely pull off the road. Stop and inspect the tires for damage. If a tire is under-inflated or damaged, deflate it, remove wheel and replace it with your spare tire and wheel. If you cannot detect a cause, have the vehicle towed to the nearest repair facility or tire dealer to have the vehicle inspected.

## Tire and Wheel Alignment

A bad jolt from hitting a curb or pothole can cause the front end of your vehicle to become misaligned or cause damage to your tires. If your vehicle seems to pull to one side when you're driving, the wheels may be out of alignment. Have an authorized dealer check the wheel alignment periodically.

# Wheels and Tires

Wheel misalignment in the front or the rear can cause uneven and rapid treadwear of your tires and should be corrected by an authorized dealer. Front-wheel drive vehicles and those with an independent rear suspension (if equipped) may require alignment of all four wheels.

The tires should also be balanced periodically. An unbalanced tire and wheel assembly may result in irregular tire wear.

## Tire Rotation

**Note:** If your tires show uneven wear ask an authorized dealer to check for and correct any wheel misalignment, tire imbalance or mechanical problem involved before tire rotation.

**Note:** Your vehicle may be equipped with a dissimilar spare wheel and tire assembly. A dissimilar spare wheel and tire assembly is defined as a spare wheel and tire assembly that is different in brand, size or appearance from the road tires and wheels. If you have a dissimilar spare wheel and tire assembly it is intended for temporary use only and should not be used in a tire rotation.

**Note:** After having your tires rotated, inflation pressure must be checked and adjusted to the vehicle requirements.

Rotating your tires at the recommended interval (as indicated in the Scheduled Maintenance chapter) will help your tires wear more evenly, providing better tire performance and longer tire life. Sometimes irregular tire wear can be corrected by rotating the tires.

Rear-wheel drive vehicles (front tires on the left side of the diagram).

## Non-directional tires

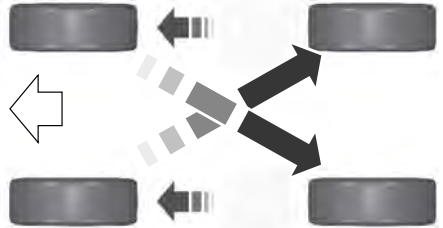

E142548

## Vehicles equipped with different size tires on the front and rear axle

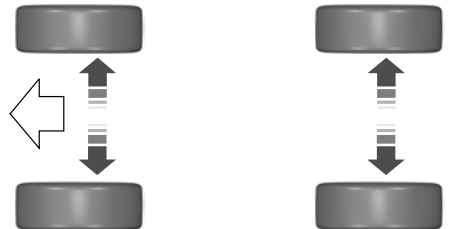

E209823

# Wheels and Tires

## USING SUMMER TIRES

Summer tires provide superior performance on wet and dry roads. Summer tires do not have the Mud and Snow (M+S or M/S) tire traction rating on the tire side wall. Since summer tires do not have the same traction performance as All-season or Snow tires, we do not recommend using summer tires when temperatures drop to about 45°F (7°C) or below (depending on tire wear and environmental conditions) or in snow and ice conditions. Like any tire, summer tire performance is affected by tire wear and environmental conditions. If you must drive in those conditions, we recommend using Mud and Snow (M+S, M/S), All-season or Snow tires.

Always store your summer tires indoors at temperatures above 19°F (-7°C). The rubber compounds used in these tires lose flexibility and may develop surface cracks in the tread area at temperatures below 19°F (-7°C). If the tires have been subjected to 19°F (-7°C) or less, warm them in a heated space to at least 41°F (5°C) for at least 24 hours before installing them on a vehicle, or moving the vehicle with the tires installed, or checking tire inflation. Do not place tires near heaters or heating devices used to warm the room where the tires are stored. Do not apply heat or blow heated air directly on the tires. Always inspect the tires after storage periods and before use.

## USING WINTER TIRES



E278852

We recommend that you use winter or all-season tires carrying this symbol when the temperature is 45°F (7°C) or lower, or in snow and ice conditions.

Inflate the winter tires to the same tire pressures as those listed in the tire pressures table. See **Technical Specifications** (page 293).

## USING SNOW CHAINS



**WARNING:** Aggressive driving in any road conditions can cause you to lose control of your vehicle increasing the risk of severe personal injury or property damage. The traction control activating is an indication that at least some of the tires have exceeded their ability to grip the road; this may lead to an increased risk of loss of vehicle control, vehicle rollover, personal injury and death. If you experience a severe road event, **slow down**.

# Wheels and Tires



**WARNING:** Snow tires must be the same size, load index and speed rating as those originally provided by Ford. Use of any tire or wheel not recommended by Ford can affect the safety and performance of your vehicle, which could result in an increased risk of loss of control, vehicle rollover, personal injury and death. Additionally, the use of non-recommended tires and wheels can cause steering, suspension, axle, transfer case or power transfer unit failure. Follow the Ford recommended tire inflation pressure found on the Safety Compliance Certification Label (on the door hinge pillar, door latch post or the door edge that meets the door latch post, next to the driver seat), or Tire Label on the B-Pillar or the edge of the driver door. Failure to follow the tire pressure recommendations can cause uneven treadwear patterns and adversely affect the way your vehicle handles.

The tires on your vehicle could have all-weather treads to provide traction in rain and snow. In some climates you will need to use snow tires and chains on your vehicle in emergency situations or if required by law.

**Note:** *The suspension insulation and bumpers will help prevent vehicle damage. Do not remove these components from your vehicle when using snow tires and chains.*

Follow these guidelines when using snow tires and chains:

- When possible, avoid fully loading your vehicle.
- Chains could damage aluminum wheels.

- Use ultra low profile cables, 10 mm or less in dimension as measured on the sidewall of your tire, with 235/55R17, 235/50R18 and 255/40R19 on the rear axle only.
- Do not use snow chains or cables with 265/40R19, 275/40R19 and 265/35R20 tires.
- Not all S-class snow chains or cables meet these restrictions. Chains of this size restriction will include a tensioning device.
- Purchase chains or cables from a manufacturer that clearly labels body to tire dimension restrictions. The snow chains or cables must be mounted in pairs on the front or the rear tires only.
- Do not exceed 30 mph (50 km/h) if recommended by the chain manufacturer while using snow chains.
- Install cables securely, verifying that the cables do not touch any wiring, brake lines or fuel lines.
- Drive cautiously. If you hear the cables rub or bang against the vehicle, stop and retighten them. If this does not work, remove the cables to prevent vehicle damage.
- Remove the tire chains when they are no longer needed. Do not use tire chains on dry roads.

If you have any questions regarding snow chains or cables, please contact your authorized dealer.

# Wheels and Tires

## TIRE PRESSURE MONITORING SYSTEM



**WARNING:** The tire pressure monitoring system is not a substitute for manually checking tire pressures. You should periodically check tire pressures using a pressure gauge. Failure to correctly maintain tire pressures could increase the risk of tire failure, loss of control, vehicle rollover and personal injury.

**Note:** *You should only use tire sealants in roadside emergencies as they may cause damage to the tire pressure monitoring system sensor.*

**Note:** *If the tire pressure monitoring system sensor becomes damaged, it may not function.*



Each tire, including the spare (if provided), should be checked monthly when cold and inflated to the inflation pressure recommended by the vehicle manufacturer on the vehicle placard or tire inflation pressure label. (If your vehicle has tires of a different size than the size indicated on the vehicle placard or tire inflation pressure label, you should determine the proper tire inflation pressure for those tires).

As an added safety feature, your vehicle has been equipped with a Tire Pressure Monitoring System (TPMS) that illuminates a low tire pressure telltale when one or more of your tires is significantly under-inflated. Accordingly, when the low tire pressure telltale illuminates, you should stop and check your tires as soon as possible, and inflate

them to the proper pressure. Driving on a significantly under-inflated tire causes the tire to overheat and can lead to tire failure. Under-inflation also reduces fuel efficiency and tire tread life, and may affect the vehicle's handling and stopping ability.

Please note that the TPMS is not a substitute for proper tire maintenance, and it is the driver's responsibility to maintain correct tire pressure, even if under-inflation has not reached the level to trigger illumination of the TPMS low tire pressure telltale.

Your vehicle has also been equipped with a TPMS malfunction indicator to indicate when the system is not operating properly. The TPMS malfunction indicator is combined with the low tire pressure telltale. When the system detects a malfunction, the telltale will flash for approximately one minute and then remain continuously illuminated. This sequence will continue upon subsequent vehicle start-ups as long as the malfunction exists.

When the malfunction indicator is illuminated, the system may not be able to detect or signal low tire pressure as intended. TPMS malfunctions may occur for a variety of reasons, including the installation of replacement or alternate tires or wheels on the vehicle that prevent the TPMS from functioning properly. Always check the TPMS malfunction telltale after replacing one or more tires or wheels on your vehicle to ensure that the replacement or alternate tires and wheels allow the TPMS to continue to function properly.

This device complies with Part 15 of the FCC Rules and with License exempt RSS Standards of Industry Canada. Operation is subject to the following two conditions:

1. This device may not cause harmful interference, and

# Wheels and Tires

- This device must accept any interference received, including interference that may cause undesired operation.

**Note:** Changes or modifications not expressly approved by the party responsible for compliance could void the user's authority to operate the equipment. The term "IC:" before the radio certification number only signifies that Industry Canada technical specifications were met.

## Changing Tires With a Tire Pressure Monitoring System



E142549

**Note:** Each road tire is equipped with a tire pressure sensor located inside the wheel and tire assembly cavity. The pressure sensor is attached to the valve stem. The pressure sensor is covered by the tire and is not visible unless the tire is removed. Take care when changing the tire to avoid damaging the sensor.

You should always have your tires serviced by an authorized dealer.

Check the tire pressure periodically (at least monthly) using an accurate tire gauge. See **When Inflating Your Tires** in this chapter.

## Understanding Your Tire Pressure Monitoring System



The tire pressure monitoring system measures pressure in your road tires and sends the tire pressure readings to your vehicle. You can view the tire pressure readings through the information display. See **General Information** (page 88). The low tire pressure warning light will turn on if the tire pressure is significantly low. Once the light is illuminated, your tires are under-inflated and need to be inflated to the manufacturer's recommended tire pressure. Even if the light turns on and a short time later turns off, your tire pressure still needs to be checked.

## When Your Temporary Spare Tire is Installed

When one of your road tires needs to be replaced with the temporary spare, the system will continue to identify an issue to remind you that the damaged road wheel and tire assembly needs to be repaired and put back on your vehicle.

To restore the full function of the tire pressure monitoring system, have the damaged road wheel and tire assembly repaired and remounted on your vehicle.



# Wheels and Tires

## When You Believe Your System is Not Operating Properly

The main function of the tire pressure monitoring system is to warn you when

your tires need air. It can also warn you in the event the system is no longer capable of functioning as intended. See the following chart for information concerning your tire pressure monitoring system:

Low tire pressure warning light	Possible cause	Customer action required
Solid warning light	Tire(s) under-inflated	Make sure tires are at the proper pressure. See <b>Inflating your tires</b> in this chapter. After inflating your tires to the manufacturer's recommended pressure as shown on the Tire Label (located on the edge of driver's door or the B-Pillar), the vehicle must be driven for at least two minutes over 20 mph (32 km/h) before the light turns off.
	Spare tire in use	Repair the damaged road wheel and tire assembly and reinstall it on the vehicle to restore system function. For a description on how the system functions, see <b>When Your Temporary Spare Tire is Installed</b> in this section.
	TPMS malfunction	If the tires are properly inflated and the spare tire is not in use but the light remains on, contact your authorized dealer as soon as possible.
Flashing warning light	Spare tire in use	Repair the damaged road wheel and tire assembly and reinstall it on the vehicle to restore system function. For a description on how the system functions, see <b>When Your Temporary Spare Tire is Installed</b> in this section.
	TPMS malfunction	If the tires are properly inflated and the spare tire is not in use but the light remains on, contact your authorized dealer as soon as possible.

# Wheels and Tires

## When Inflating Your Tires



**WARNING:** Do not use the tire pressure displayed in the information display as a tire pressure gauge. Failure to follow this instruction could result in personal injury or death.

When putting air into your tires (such as at a gas station or in your garage), the tire pressure monitoring system may not respond immediately to the air added to your tires.

It may take up to two minutes of driving over 20 mph (32 km/h) for the light to turn off after you have filled your tires to the recommended inflation pressure.

## How Temperature Affects Your Tire Pressure

The tire pressure monitoring system monitors tire pressure in each pneumatic tire. While driving in a normal manner, a typical passenger tire inflation pressure may increase about 2–4 psi (14–28 kPa) from a cold start situation. If the vehicle is stationary overnight with the outside temperature significantly lower than the daytime temperature, the tire pressure may decrease about 3 psi (21 kPa) for a drop of 30°F (17°C) in ambient temperature. This low tire pressure value may be detected by the tire pressure monitoring system as being significantly lower than the recommended inflation pressure and activate the system warning light for low tire pressure. If the low tire pressure warning light is on, visually check each tire to verify that no tire is flat. If one or more tires are flat, repair as necessary. Check the air pressure in the road tires. If any tire is under-inflated, carefully drive the vehicle to the nearest location where air can be added to the tires. Inflate all the tires to the recommended inflation pressure.

## CHANGING A ROAD WHEEL (IF EQUIPPED)



**WARNING:** If the tire pressure monitor sensor becomes damaged it may not function.

**Note:** You should only use tire sealants in roadside emergencies as they may cause damage to the tire pressure monitoring system sensor.

**Note:** The tire pressure monitoring system indicator light illuminates when the spare tire is in use. To restore the full function of the monitoring system, all road wheels equipped with tire pressure monitoring sensors must be mounted on the vehicle.

If you get a flat tire when driving, do not apply the brake heavily. Instead, gradually decrease your speed. Hold the steering wheel firmly and slowly move to a safe place on the side of the road.

Have a flat serviced by an authorized dealer in order to prevent damage to the tire pressure monitoring system sensors. See **Tire Pressure Monitoring System** (page 284). Replace the spare tire with a road tire as soon as possible. During repairing or replacing of the flat tire, have the authorized dealer inspect the tire pressure monitoring system sensor for damage.

## Dissimilar Spare Wheel and Tire Assembly Information



**WARNING:** Failure to follow these guidelines could result in an increased risk of loss of vehicle control, injury or death.

# Wheels and Tires

If you have a dissimilar spare wheel and tire, then it is intended for temporary use only. This means that if you need to use it, you should replace it as soon as possible with a road wheel and tire assembly that is the same size and type as the road tires and wheels that were originally provided by Ford. If the dissimilar spare tire or wheel is damaged, it should be replaced rather than repaired.

A dissimilar spare wheel and tire assembly is defined as a spare wheel and tire assembly that is different in brand, size or appearance from the road tires and wheels and can be one of three types:

1. **T-type mini-spare:** This spare tire begins with the letter T for tire size and may have Temporary Use Only molded in the sidewall.

2. **Full-size dissimilar spare with label on wheel:** This spare tire has a label on the wheel that states: THIS WHEEL AND TIRE ASSEMBLY FOR TEMPORARY USE ONLY.

When driving with one of the dissimilar spare tires listed above, do not:

- Exceed 50 mph (80 km/h).
- Load the vehicle beyond maximum vehicle load rating listed on the Safety Compliance Label.
- Use snow chains on the end of the vehicle with the dissimilar spare tire.
- Use more than one dissimilar spare tire at a time.
- Use commercial car washing equipment.
- Try to repair the dissimilar spare tire.

Use of one of the dissimilar spare tires listed above at any one wheel location can lead to impairment of the following:

- Handling, stability and braking performance.
- Comfort and noise.

- Ground clearance and parking at curbs.
- Winter weather driving capability.
- Wet weather driving capability.
- All-wheel driving capability.

### 3. Full-size dissimilar spare without label on wheel

When driving with the full-size dissimilar spare wheel and tire assembly, do not:

- Exceed 75 mph (120 km/h).
- Use more than one dissimilar spare wheel and tire assembly at a time.
- Use commercial car washing equipment.
- Use snow chains on the end of the vehicle with the dissimilar spare wheel and tire assembly.

The usage of a full-size dissimilar spare wheel and tire assembly can lead to impairment of the following:

- Handling, stability and braking performance.
- Comfort and noise.
- Ground clearance and parking at curbs.
- Winter weather driving capability.
- Wet weather driving capability.
- All-wheel driving capability.

When driving with the full-size dissimilar spare wheel and tire assembly additional caution should be given to:

- Driving vehicles with a load on the cargo rack.

Drive cautiously when using a full-size dissimilar spare wheel and tire assembly and seek service as soon as possible.

# Wheels and Tires

## Tire Change Procedure



**WARNING:** When one of the front wheels is off the ground, the transmission alone will not prevent the vehicle from moving or slipping off the jack, even if the transmission is in park (P).



**WARNING:** To help prevent your vehicle from moving when changing a wheel, shift the transmission into park (P), set the parking brake and use an appropriate block or wheel chock to secure the wheel diagonally opposite to the wheel being changed. For example, when changing the front left wheel, place an appropriate block or wheel chock on the right rear wheel.



**WARNING:** Do not get under a vehicle that is only supported by a vehicle jack.



**WARNING:** Do not attempt to change a tire on the side of the vehicle close to moving traffic. Pull far enough off the road to avoid the danger of being hit when operating the jack or changing the wheel.



**WARNING:** Always use the jack provided as original equipment with your vehicle. If using a jack other than the one provided, make sure the jack capacity is adequate for the vehicle weight, including any vehicle cargo or modifications. If you are unsure if the jack capacity is adequate, contact the authorized dealer.



**WARNING:** Check that the vehicle jack is not damaged or deformed and the thread is lubricated and clean.



**WARNING:** It is recommended that the wheels of the vehicle be chocked, and that no person should remain in a vehicle that is being jacked.

1. Park on a surface, set the parking brake and activate the hazard flashers.
2. Place the transmission in park (P) and turn the engine off. For vehicles with a manual transmission, place the transmission in reverse (R) after the engine is turned off.

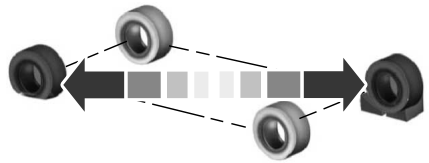

E175447

3. Block both the front and rear of the wheel diagonally opposite the flat tire. For example, if the left front tire is flat, block the right rear wheel.

## Wheels and Tires

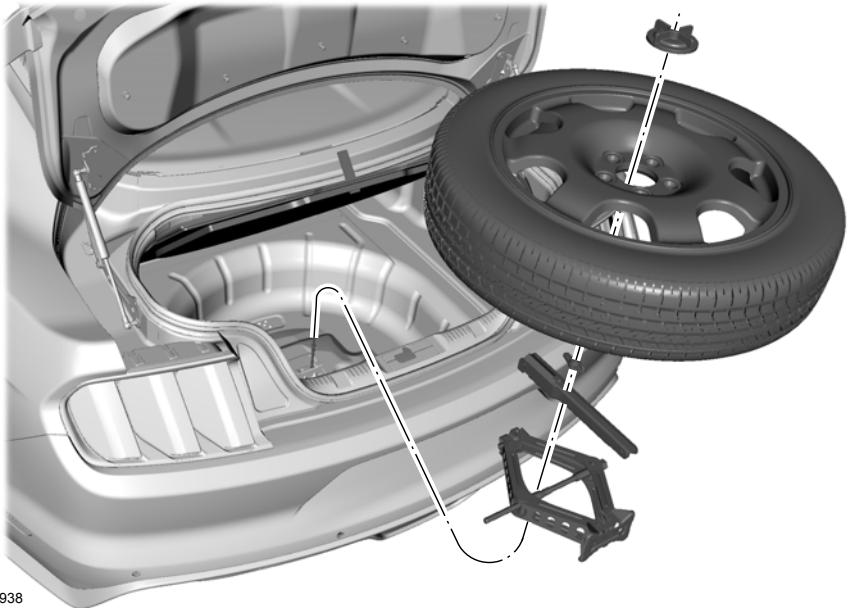

E174938

4. Remove the lug wrench, spare tire and jack.
5. Remove the center ornament from the wheel if required to access the lug nuts.
6. To remove the wrench from the jack, turn the hex nut on the jack counterclockwise. This lowers the jack and loosens the mechanical lock.
7. Loosen each wheel lug nut one-half turn counterclockwise but do not remove them until the wheel is raised off the ground.

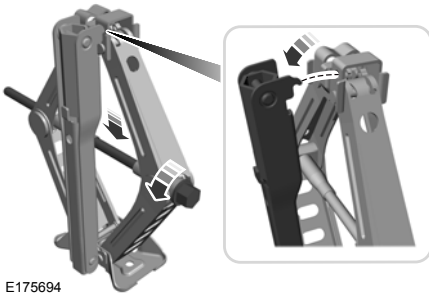

E175694

# Wheels and Tires

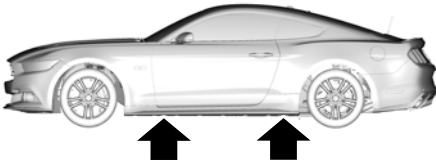

E176084

**Note:** Jack at the specified locations to avoid damage to the vehicle.

8. The vehicle jacking points are shown here, and can be identified by the triangle markings on the vehicle. Details are depicted on the warning label on the jack.



E174939

9. Place the jack at the jacking point next to the tire you are changing. Turn the jack handle clockwise until the wheel is completely off the ground.
10. Remove the lug nuts with the lug wrench.

11. Replace the flat tire with the spare tire, making sure the valve stem is facing outward. Reinstall lug nuts until the wheel is snug against the hub. Do not fully tighten the lug nuts until the wheel has been lowered. If you are using the temporary tire, the lug nut washers do not appear to be flush with the rim. This is normal only when using the temporary spare tire.
12. Lower the wheel by turning the jack handle counterclockwise.

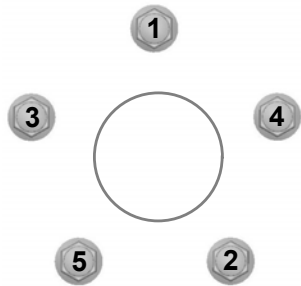

E75442

13. Remove the jack and fully tighten the lug nuts in the order shown. See **Technical Specifications** (page 293).
14. To store the folded wrench on the jack, engage the bracket of the jack base on the wrench feature as shown. Swing the wrench upwards and adjust the height of the jack until the pin engages the hole. Tighten the hex nut clockwise by hand until secure.

# Wheels and Tires



E176165

15. Put the flat tire, wheel ornament, jack and lug wrench away. Make sure the jack is fastened so it does not rattle when you drive.
16. Unblock the wheel.

## DRIVING AT HIGH SPEED

### Tire pressure - Speeds greater than 100 mph (160 km/h)



**WARNING:** To reduce the risk of potential tire failure that could lead to serious injury or death, increase the front and rear tire placard pressures by the amount shown on the warning label, located on either the driver side B-pillar or door, when driving over 100 mph (160 km/h). Only travel at speeds over 100 mph (160 km/h) where it is legal and conditions allow. The tire placard pressure can be found on the tire placard located on either the driver side B-pillar or door of your vehicle.



**Warning:** Failure to follow these instructions can result in a loss of vehicle stability due to tire failure that could lead to serious injury or death. If you are not sure about the proper tire inflation pressures, contact an authorized dealer or service center.

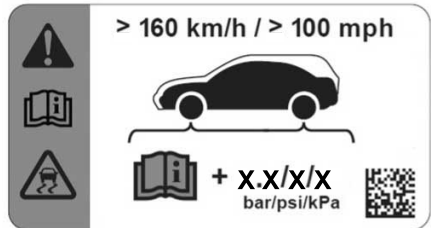

E184089

Your tires may require additional inflation pressure for operation at speeds greater than 100 mph (160 km/h). If this label is present on your vehicle, you must adjust the tire pressure accordingly.

# Wheels and Tires

## TECHNICAL SPECIFICATIONS

### Wheel Lug Nut Torque Specifications



**WARNING:** When you install a wheel, always remove any corrosion, dirt or foreign materials present on the mounting surfaces of the wheel or the surface of the wheel hub, brake drum or brake disc that contacts the wheel. Make sure to secure any fasteners that attach the rotor to the hub so they do not interfere with the mounting surfaces of the wheel. Installing wheels without correct metal-to-metal contact at the wheel mounting surfaces can cause the wheel nuts to loosen and the wheel to come off while your vehicle is in motion, resulting in loss of vehicle control, personal injury or death.

Bolt size	lb-ft (Nm) <sup>1</sup>
M14 X 1.5	150 (204)

<sup>1</sup> Torque specifications are for nut and bolt threads free of dirt and rust. Use only Ford recommended replacement fasteners.

Retighten the lug nuts to the specified torque within 100 miles (160 kilometers) after any wheel disturbance (such as tire rotation, changing a flat tire, wheel removal).



E145950

A Wheel pilot bore

Inspect the wheel pilot bore and mounting surface prior to installation. Remove any visible corrosion or loose particles.



# Capacities and Specifications

## ENGINE SPECIFICATIONS - 2.3L ECOBOOST™

Measurement	Specification
Cubic inches	138
Firing order	1-3-4-2
Ignition system	Coil on plug
Spark plug gap	0.028 in (0.7 mm) - 0.031 in (0.8 mm)
Compression ratio	9.5:1

### Drivebelt Routing

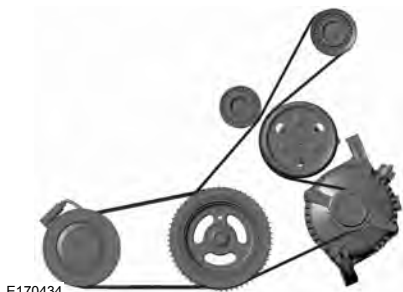

E170434

## ENGINE SPECIFICATIONS - 5.0L

Measurement	Specification
Cubic inches	302
Firing order	1-5-4-8-6-3-7-2
Ignition system	Coil on plug
Spark plug gap	0.049 in (1.25 mm) - 0.053 in (1.35 mm)
Compression ratio	12.0:1

# Capacities and Specifications

## Drivebelt Routing

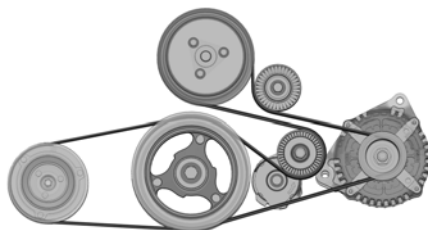

E198573

## MOTORCRAFT PARTS - 2.3L ECOBOOST™

Component	Part Number
Air filter element.	FA-1918
Oil filter.	FL-910-S
Battery.	BXT-96R-590
Spark plugs.	SP-537
Transmission filter	FT-188
Cabin air filter.	FP-78
Windshield wiper blade.	WW-1964 (passenger side) WW-2160 (driver side)

We recommend Motorcraft replacement parts available at your Ford dealer or at [fordparts.com](http://fordparts.com) for scheduled maintenance. These parts meet or exceed Ford Motor Company's specifications and are engineered for your vehicle. Use of other parts may impact vehicle performance, emissions and durability. Your warranty may be void for any damage related to use of other parts.

If a Motorcraft oil filter is not available, use an oil filter that meets industry performance specification SAE/USCAR-36.

For spark plug replacement, contact an authorized dealer. Replace the spark plugs at the appropriate intervals. See **Scheduled Maintenance** (page 422).

# Capacities and Specifications

---

## MOTORCRAFT PARTS - 5.0L

Component	Part Number
Air filter element.	FA-1918
Oil filter.	FL-500-S
Battery.	BXT-96R-590
Spark plugs.	SP-548
Transmission filter.	FT-188
Cabin air filter.	FP-78
Windshield wiper blade.	WW-1964 (passenger side) WW-2160 (driver side)

We recommend Motorcraft replacement parts available at your Ford dealer or at [fordparts.com](http://fordparts.com) for scheduled maintenance. These parts meet or exceed Ford Motor Company's specifications and are engineered for your vehicle. Use of other parts may impact vehicle performance, emissions and durability. Your warranty may be void for any damage related to use of other parts.

If a Motorcraft oil filter is not available, use an oil filter that meets industry performance specification SAE/USCAR-36.

For spark plug replacement, contact an authorized dealer. Replace the spark plugs at the appropriate intervals. See **Scheduled Maintenance** (page 422).

# Capacities and Specifications

---

## MOTORCRAFT PARTS - 5.0L, BULLITT

Component	Part Number
Air filter element.	FA-1922
Oil filter.	FL-500-S
Battery.	BXT-96R-590
Spark plugs.	SP-548
Transmission filter.	FT-188
Cabin air filter.	FP-78
Windshield wiper blade.	WW-1964 (passenger side) WW-2160 (driver side)

We recommend Motorcraft replacement parts available at your Ford dealer or at [fordparts.com](http://fordparts.com) for scheduled maintenance. These parts meet or exceed Ford Motor Company's specifications and are engineered for your vehicle. Use of other parts may impact vehicle performance, emissions and durability. Your warranty may be void for any damage related to use of other parts.

If a Motorcraft oil filter is not available, use an oil filter that meets industry performance specification SAE/USCAR-36.

For spark plug replacement, contact an authorized dealer. Replace the spark plugs at the appropriate intervals. See **Scheduled Maintenance** (page 422).

# Capacities and Specifications

## VEHICLE IDENTIFICATION NUMBER

The vehicle identification number is located on the left-hand side of the instrument panel.

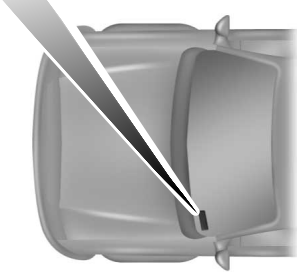

E142476

Please note that in the graphic, XXXX is representative of your vehicle identification number.

The Vehicle Identification Number contains the following information:

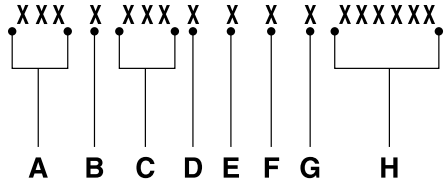

E142477

- A World manufacturer identifier
- B Brake system, Gross Vehicle Weight Rating, Restraint Devices and their locations
- C Make, vehicle line, series, body type
- D Engine type
- E Check digit
- F Model year
- G Assembly plant
- H Production sequence number

# Capacities and Specifications

## VEHICLE CERTIFICATION LABEL

MFD. BY FORD MOTOR CO.

DATE: XX/XX GVWR: XXXX KG (XXXX LB)  
 FRONT GAWR: REAR GAWR:  
 XXXX KG (XXXX LB) WITH XXXX KG (XXXX LB) WITH  
 XXXXXXXXXXXXXXXX TIRES XXXXXXXXXXXXXXXX TIRES  
 XXXXXXXX RIMS XXXXXXXX RIMS  
 AT XXXX kPa/ XXX PSI COLD AT XXXX kPa/ XXX PSI COLD

THIS VEHICLE CONFORMS TO ALL APPLICABLE FEDERAL MOTOR VEHICLE SAFETY AND THEFT PREVENTION STANDARDS IN EFFECT ON THE DATE OF MANUFACTURE SHOWN ABOVE.

VIN: XXXXXXXXXXXXXXXX XXXXX  
 TYPE: XXXX XXXXX



EXT PNT: XX XXXXXX RC: XX DSO: XXXX  
 WB INT TR TP/PS R AXLE TR SPR XXXX  
 XXX XX XXX X XX X XXXX XXXX  
 XXXXXXXXXXXXXXX XXX XXXX-XXXXXXXX-XX

E167469

The National Highway Traffic Safety Administration Regulations require that a Safety Compliance Certification Label be affixed to a vehicle and prescribe where the Safety Compliance Certification Label may be located. The Safety Compliance Certification Label shall be affixed to either the door hinge pillar, the door latch post, or the edge of the door near the door latch, next to the driver's seating position.

## TRANSMISSION CODE DESIGNATION

MFD. BY FORD MOTOR CO.

DATE: XX/XX GVWR: XXXX KG (XXXX LB)  
 FRONT GAWR: REAR GAWR:  
 XXXX KG (XXXX LB) WITH XXXX KG (XXXX LB) WITH  
 XXXXXXXXXXXXXXXX TIRES XXXXXXXXXXXXXXXX TIRES  
 XXXXXXXX RIMS XXXXXXXX RIMS  
 AT XXXX kPa/ XXX PSI COLD AT XXXX kPa/ XXX PSI COLD

THIS VEHICLE CONFORMS TO ALL APPLICABLE FEDERAL MOTOR VEHICLE SAFETY AND THEFT PREVENTION STANDARDS IN EFFECT ON THE DATE OF MANUFACTURE SHOWN ABOVE.

VIN: XXXXXXXXXXXXXXXX XXXXX  
 TYPE: XXXX XXXXX



EXT PNT: XX XXXXXX RC: XX DSO: XXXX  
 WB INT TR TP/PS R AXLE TR SPR XXXX  
 XXX XX XXX X XX X XXXX XXXX  
 XXXXXXXXXXXXXXX XXX XXXX-XXXXXXXX-XX

↑

E167814

The transmission code is on the Safety Compliance Certification Label. The following table shows the transmission code along with the transmission description.

Description	Code
Ten-speed automatic transmission 10R80	U
Six-speed manual transmission MT82	X

# Capacities and Specifications

## CAPACITIES AND SPECIFICATIONS - 2.3L ECOBOOST™

### Capacities



**WARNING:** The air conditioning refrigerant system contains refrigerant under high pressure. Only qualified personnel should service the air conditioning refrigerant system. Opening the air conditioning refrigerant system can cause personal injury.

Item	Capacity
Engine oil (with oil filter).	6.0 qt (5.67 L)
Engine coolant.	9.5 qt (8.96 L)
Brake fluid.	Between MIN/MAX on brake fluid reservoir
Rear axle fluid.	3.2 pt (1.5L)
Rear axle friction modifier.	3.28 fl oz (97 ml)
Automatic transmission fluid.	12.7 qt (12 L) <sup>1</sup>
Manual transmission fluid.	2.7 qt (2.6 L) <sup>1</sup>
Windshield washer fluid.	Fill as required
Fuel tank.	15.5 gal (58.8 L)
A/C Refrigerant (U.S. and Canada).	1.2 lb (0.54 kg)
A/C Refrigerant (Mexico).	23 oz (0.64 kg)
A/C Refrigerant Compressor Oil.	3.4 fl oz (100 ml)

<sup>1</sup> Approximate dry fill capacity. Actual amount may vary during fluid changes.

# Capacities and Specifications

## Specifications

### Materials

Name	Specification
Motor oil (U.S.): Motorcraft® SAE 5W-30 Premium Synthetic Blend Motor Oil XO-5W30-QSP	WSS-M2C946-B1
Motor oil (Canada): Motorcraft® SAE 5W-30 Super Premium Motor Oil CXO-5W30-LSP12	WSS-M2C946-B1
Motor oil (Mexico): Motorcraft® SAE 5W-30 Premium Synthetic Blend Motor Oil MXO-5W30-QSP	WSS-M2C946-B1
Motor oil for track use: Motorcraft® SAE 5W-50 Full Synthetic Motor Oil XO-5W50-QGT	WSS-M2C931-C <sup>2</sup>
Engine coolant (U.S. and Mexico): Motorcraft® Orange Prediluted Antifreeze/Coolant VC-3DIL-B	WSS-M97B44-D2
Engine coolant (Canada): Motorcraft® Orange Prediluted Antifreeze/Coolant CVC-3DIL-B	WSS-M97B44-D2
Brake fluid: Motorcraft® DOT 4 Low Viscosity (LV) High Performance Motor Vehicle Brake Fluid PM-20	WSS-M6C65-A2
Rear axle fluid: Motorcraft® SAE 75W-85 Premium Synthetic Hypoid Gear Lubricant XY-75W85-QL	WSS-M2C942-A
Rear axle friction modifier (U.S. and Mexico): Motorcraft® Additive Friction Modifier XL-3	EST-M2C118-A <sup>1</sup>
Rear axle friction modifier (Canada): Motorcraft® Additive Friction Modifier CXL-3	EST-M2C118-A <sup>1</sup>
Automatic transmission fluid (U.S. and Mexico):	WSS-M2C949-A



## Capacities and Specifications

Name	Specification
Motorcraft® MERCON® ULV Automatic Transmission Fluid XT-12-QULV	MERCON® ULV
Automatic transmission fluid (Canada): Motorcraft® MERCON® ULV Automatic Transmission Fluid XT-12-QULV	WSS-M2C949-A MERCON® ULV
Manual transmission fluid: Motorcraft® Dual Clutch Transmission Fluid XT-11-QDC	WSS-M2C200-D2
Windshield washer fluid (U.S. and Mexico): Motorcraft® Premium Windshield Wash Concentrate with Bitterant ZC-32-B2	WSS-M14P19-A
Windshield washer fluid (Canada): Motorcraft® Premium Quality Windshield Washer Fluid CXC-37-(A, B, D, F)	WSS-M14P19-A
A/C refrigerant (U.S.): R-1234yf Refrigerant YN-33-A	WSS-M17B21-A
A/C refrigerant (Canada): R-1234yf Refrigerant HS7Z-19B519-BA	WSS-M17B21-A
A/C refrigerant (Mexico): Motorcraft® R-134a Refrigerant MYN-19	WSH-M17B19-A
A/C refrigerant compressor oil (U.S. and Canada): Motorcraft® R-1234yf Refrigerant PAG Oil YN-35	WSS-M2C300-A2
A/C refrigerant compressor oil (Mexico): Motorcraft® PAG Refrigerant Compressor Oil YN-12-D	WSH-M1C231-B
Multi-purpose grease: Motorcraft® Multi-Purpose Grease Spray XL-5-A	ESB-M1C93-B
Lock cylinders (U.S.): Motorcraft® Penetrating and Lock Lubricant XL-1	-

## Capacities and Specifications

Name	Specification
Lock cylinders (Canada): Motorcraft® Penetrating Fluid CXC-51-A	-
Lock cylinders (Mexico): Motorcraft® Penetrating and Lock Lubricant MXL-1	-

<sup>1</sup> For complete refill of limited slip Ford axles, add 3.28 fl oz (97 ml) of Additive Friction Modifier XL-3 or equivalent meeting Ford Specification EST-M2C118-A. Ford rear axles contain a synthetic lubricant that does not require changing unless you submerge the axle in water.

<sup>2</sup> Oil must meet specification WSS-M2C931-C or use SAE 5W-50 oil that meet API SN requirements.

If you use oil and fluids that do not meet the defined specification and viscosity grade, this may lead to:

- Component damage which is not covered by the vehicle warranty.
- Longer engine cranking periods.
- Increased emission levels.
- Reduced engine performance.
- Reduced fuel economy.
- Degraded brake performance.

We recommend Motorcraft® motor oil for your vehicle. If Motorcraft® oil is not available, use motor oils of the recommended viscosity grade that meet API SN requirements and display the API Certification Mark for gasoline engines.



E142732

An oil with this trademark symbol conforms to current engine, emission system protection standards and fuel economy requirements of ILSAC.

Do not use supplemental engine oil additives because they are unnecessary and could lead to engine damage that may not be covered by your vehicle warranty.

# Capacities and Specifications

**Note:** Ford recommends using DOT 4 Low Viscosity (LV) High Performance Brake Fluid or equivalent meeting WSS-M6C65-A2. Use of any fluid other than the recommended fluid may cause degraded brake performance and not meet the Ford performance standards. Keep brake fluid clean and dry. Contamination with dirt, water, petroleum products or other materials may result in brake system damage and possible failure.

**Note:** Automatic transmissions that require MERCON® LV transmission fluid should only use MERCON® LV transmission fluid. The use of any other fluid may cause transmission damage.

## Alternative Engine Oil for Extremely Cold Climates

To improve engine cold start performance, we recommend that you use the following alternative engine oil in extremely cold climates, where the ambient temperature reaches -22.0°F (-30°C) or below.

### Materials

Name	Specification
Motorcraft® SAE 0W-30 Premium Synthetic Blend Motor Oil: Engine Oil - SAE 0W-30 XO-0W30-QSP	WSS-M2C953-A1

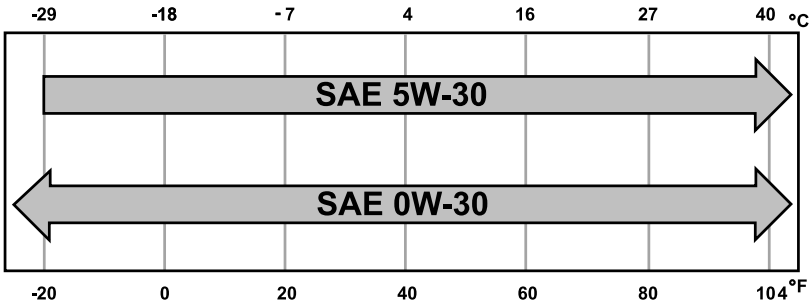

# Capacities and Specifications

## CAPACITIES AND SPECIFICATIONS - 5.0L

### Capacities



**WARNING:** The air conditioning refrigerant system contains refrigerant under high pressure. Only qualified personnel should service the air conditioning refrigerant system. Opening the air conditioning refrigerant system can cause personal injury.

Item	Capacity
Engine oil (with oil filter).	10.0 qt (9.5 L)
Engine coolant.	13.6 qt (12.88 L)
Engine coolant with Track Pack (If equipped).	15.2 qt (14.4 L)
Brake fluid.	Between MIN/MAX on brake fluid reservoir
Rear axle fluid.	3.2 pt (1.5L)
Rear axle friction modifier.	3.28 fl oz (97 ml)
Automatic transmission fluid.	12.7 qt (12 L) <sup>1</sup>
Manual transmission fluid.	2.7 qt (2.6 L) <sup>1</sup>
Windshield washer fluid.	Fill as required
Fuel tank.	16.0 gal (60.6 L)
A/C Refrigerant (U.S. and Canada).	1.2 lb (0.54 kg)
A/C Refrigerant (Mexico).	1.3 lb (0.6 kg)
A/C Refrigerant Compressor Oil.	2.7 fl oz (80 ml)

<sup>1</sup> Approximate dry fill capacity. Actual amount may vary during fluid changes.

# Capacities and Specifications

## Specifications

### Materials

Name	Specification
Motor oil (U.S.): Motorcraft® SAE 5W-20 Premium Synthetic Blend Motor Oil XO-5W20-QSP	WSS-M2C945-B1
Motor oil (Canada): Motorcraft® SAE 5W-20 Premium Synthetic Blend Motor Oil CXO-5W20-LSP12	WSS-M2C945-B1
Motor oil (Mexico): Motorcraft® SAE 5W-20 Premium Synthetic Blend Motor Oil MXO-5W20-QSP	WSS-M2C945-B1
Motor oil for track use (U.S.): Motorcraft® SAE 5W-30 Premium Synthetic Blend Motor Oil XO-5W30-QSP	WSS-M2C946-B1
Motor oil for track use (Canada): Motorcraft® SAE 5W-30 Premium Synthetic Blend Motor Oil CXO-5W30-LSP12	WSS-M2C946-B1
Motor oil for track use (Mexico): Motorcraft® SAE 5W-30 Premium Synthetic Blend Motor Oil XO-5W30-QSP	WSS-M2C946-B1
Engine coolant (U.S. and Mexico): Motorcraft® Orange Prediluted Antifreeze/Coolant VC-3DIL-B	WSS-M97B44-D2
Engine coolant (Canada): Motorcraft® Orange Prediluted Antifreeze/Coolant CVC-3DIL-B	WSS-M97B44-D2
Brake fluid: Motorcraft® DOT 4 Low Viscosity (LV) High Performance Motor Vehicle Brake Fluid PM-20	WSS-M6C65-A2
Rear axle fluid:	WSS-M2C942-A

## Capacities and Specifications

Name	Specification
Motorcraft® SAE 75W-85 Premium Synthetic Hypoid Gear Lubricant XY-75W85-QL	
Rear axle friction modifier (U.S. and Mexico): Motorcraft® Additive Friction Modifier XL-3	EST-M2C118-A <sup>1</sup>
Rear axle friction modifier (Canada): Motorcraft® Additive Friction Modifier CXL-3	EST-M2C118-A <sup>1</sup>
Automatic transmission fluid (U.S. and Mexico): Motorcraft® MERCON® ULV Automatic Transmission Fluid XT-12-QULV	WSS-M2C949-A MERCON® ULV
Automatic transmission fluid (Canada): Motorcraft® MERCON® ULV Automatic Transmission Fluid XT-12-QULV	WSS-M2C949-A MERCON® ULV
Manual transmission fluid: Motorcraft® Dual Clutch Transmission Fluid XT-11-QDC	WSS-M2C200-D2
Windshield washer fluid (U.S. and Mexico): Motorcraft® Premium Windshield Wash Concentrate with Bitterant ZC-32-B2	WSS-M14P19-A
Windshield washer fluid (Canada): Motorcraft® Premium Quality Windshield Washer Fluid CXC-37-(A, B, D, F)	WSS-M14P19-A
A/C refrigerant (U.S.): R-1234yf Refrigerant YN-33-A	WSS-M17B21-A
A/C refrigerant (Canada): R-1234yf Refrigerant HS7Z-19B519-BA	WSS-M17B21-A
A/C refrigerant (Mexico): Motorcraft® R-134a Refrigerant MYN-19	WSH-M17B19-A
A/C refrigerant compressor oil (U.S. and Canada): Motorcraft® R-1234yf Refrigerant PAG Oil	WSS-M2C300-A2

## Capacities and Specifications

Name	Specification
YN-35	
A/C refrigerant compressor oil (Mexico): Motorcraft® PAG Refrigerant Compressor Oil YN-12-D	WSH-M1C231-B
Multi-purpose grease: Motorcraft® Multi-Purpose Grease Spray XL-5-A	ESB-M1C93-B
Lock cylinders (U.S.): Motorcraft® Penetrating and Lock Lubricant XL-1	-
Lock cylinders (Canada): Motorcraft® Penetrating Fluid CXC-51-A	-
Lock cylinders (Mexico): Motorcraft® Penetrating and Lock Lubricant MXL-1	-

<sup>1</sup>For complete refill of limited slip Ford axles, add 3.28 fl oz (97 ml) of Additive Friction Modifier XL-3 or equivalent meeting Ford Specification EST-M2C118-A. Ford rear axles contain a synthetic lubricant that does not require changing unless you submerge the axle in water.

If you use oil and fluids that do not meet the defined specification and viscosity grade, this may lead to:

- Component damage which is not covered by the vehicle warranty.
- Longer engine cranking periods.
- Increased emission levels.
- Reduced engine performance.
- Reduced fuel economy.
- Degraded brake performance.

Only use fluid that meets Ford specifications.

We recommend Motorcraft® motor oil for your vehicle. If Motorcraft® oil is not available, use motor oils of the recommended viscosity grade that meet API SN requirements and display the API Certification Mark for gasoline engines. Do not use oil labeled with API SN service category unless the label also displays the API certification mark.

# Capacities and Specifications



E142732

An oil with this trademark symbol conforms to current engine, emission system protection standards and fuel economy requirements of ILSAC.

Do not use supplemental engine oil additives because they are unnecessary and could lead to engine damage that may not be covered by your vehicle warranty.

**Note:** Ford recommends using DOT 4 Low Viscosity (LV) High Performance Brake Fluid or equivalent meeting WSS-M6C65-A2. Use of any fluid other than the recommended fluid may cause degraded brake performance and not meet the Ford performance standards. Keep brake fluid clean and dry. Contamination with dirt, water, petroleum products or other materials may result in brake system damage and possible failure.

**Note:** Automatic transmissions that require MERCON® LV transmission fluid should only use MERCON® LV transmission fluid. The use of any other fluid may cause transmission damage.

## Alternative Engine Oil for Extremely Cold Climates

To improve engine cold start performance, we recommend that you use the following alternative engine oil in extremely cold climates, where the ambient temperature reaches -22.0°F (-30°C) or below.

## Materials

Name	Specification
Motorcraft® SAE 0W-20 Premium Synthetic Blend Motor Oil: Engine Oil - SAE 0W-20 XO-0W20-QSP	WSS-M2C947-B1



# Capacities and Specifications

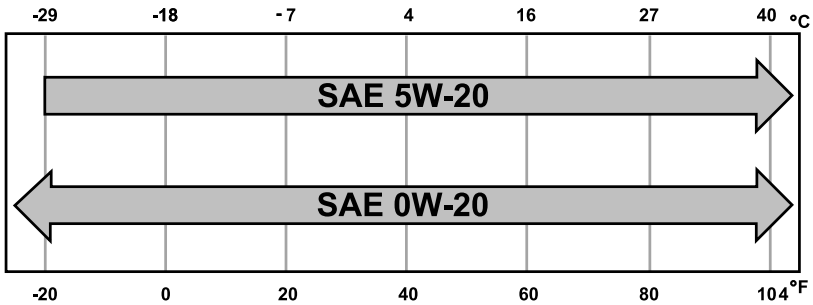

## BULB SPECIFICATION CHART

Replacement bulbs are specified in the chart below. Headlamp bulbs must be marked with an authorized "D.O.T." for North America and an "E" for Europe to make sure lamp performance, light brightness and pattern and safe visibility. The correct bulbs do not damage the lamp assembly or void the lamp assembly warranty and provide quality bulb illumination time.

Function	Trade name
Headlamps.	LED
Front park and Direction indicators.	LED
Front sidemarker.	LED
Front fog lamp.	LED
Rear lamp, brake lamp and direction indicator lamp. <sup>1</sup>	LED
Rear sidemarker.	194
High-mount brake lamp. <sup>1</sup>	LED
Backup lamp.	3156 or 3157

## Capacities and Specifications

---

<b>Function</b>	<b>Trade name</b>
License plate lamp. <sup>1</sup>	LED
Dome and Map lamp.	W5W
Glove box and Cargo lamp.	W5W
Daytime Running Lamp.	LED

<sup>1</sup>Contact an authorized dealer to replace the bulb.

To replace all instrument panel lights, contact an authorized dealer.

# Capacities and Specifications

---

## VEHICLE PERFORMANCE SPECIFICATIONS

### Performance Pack Level 2 Road Course Alignment Recommendations

**Note:** *If you plan to participate in road course track days with your Performance Pack Level 2, we recommend the following chassis settings for optimal tire wear and handling performance.*

Front	Performance Pack Level 2
Front camber	-1.5 –0/+0.75°

Tire Pressure (Hot)	Performance Pack Level 2
Front	36.0 psi (2.48 bar)*
Rear	

All settings are at curb loading condition.

\*Tire pressure is measured after track use (hot). We recommend starting at 28.0 psi (1.93 bar)(cold).

**Note:** *After your track day is complete, return your car to the street alignment and tire pressures.*

# Audio System

## GENERAL INFORMATION



**WARNING:** Driving while distracted can result in loss of vehicle control, crash and injury. We strongly recommend that you use extreme caution when using any device that may take your focus off the road. Your primary responsibility is the safe operation of your vehicle. We recommend against the use of any hand-held device while driving and encourage the use of voice-operated systems when possible. Make sure you are aware of all applicable local laws that may affect the use of electronic devices while driving.

## Radio Frequencies and Reception Factors

AM and FM frequencies are established by the Federal Communications Commission (FCC) and the Canadian Radio and Telecommunications Commission (CRTC). Those frequencies are:

- AM: 530-1710 kHz
- FM: 87.9-107.9 MHz

**Note:** *Listening to loud audio for long periods of time could damage your hearing.*

### Radio Reception Factors

<b>Distance and strength</b>	The further you travel from an AM or FM station, the weaker the signal and the weaker the reception.
<b>Terrain</b>	Hills, mountains, tall buildings, bridges, tunnels, freeway overpasses, parking garages, dense tree foliage and thunderstorms can interfere with the reception.
<b>Station overload</b>	When you pass a ground-based broadcast repeating tower, a stronger signal may overtake a weaker one and result in the audio system muting.

## CD and CD Player Information

**Note:** *CD units play commercially pressed 4.7 in (12 cm) audio compact discs only. Due to technical incompatibility, certain recordable and re-recordable compact discs may not function correctly when used in the vehicle's CD player.*

**Note:** *Do not insert CDs with homemade paper (adhesive) labels into the CD player as the label may peel and cause the CD to become jammed. You should use a permanent felt tip marker rather than adhesive labels on your homemade CDs. Ballpoint pens may damage CDs. Ask an authorized dealer for more information.*

**Note:** *Do not use any irregularly shaped discs or discs with a scratch protection film attached.*

# Audio System

Always handle discs by their edges only. Clean the disc with an approved CD cleaner only. Wipe it from the center of the disc toward the edge. Do not clean in a circular motion.

Do not expose discs to direct sunlight or heat sources for extended periods.

## MP3 and WMA Track and Folder Structure

Audio systems capable of recognizing and playing MP3 and WMA individual tracks and folder structures work as follows:

- There are two different modes for MP3 and WMA disc playback: MP3 and WMA track mode (system default) and MP3 and WMA folder mode.
- MP3 and WMA track mode ignores any folder structure on the MP3 and WMA disc. The player numbers each MP3 and WMA track on the disc (noted by the MP3 or WMA file extension) from T001 to a maximum of T255. The maximum number of playable MP3 and WMA files may be less depending on the structure of the CD and exact model of radio present.
- MP3 and WMA folder mode represents a folder structure consisting of one level of folders. The CD player numbers all MP3 and WMA tracks on the disc (noted by the MP3 or WMA file extension) and all folders containing MP3 and WMA files, from F001 (folder T001 (track) to F253 T255.
- Creating discs with only one level of folders helps with navigation through the disc files.

If you are burning your own MP3 and WMA discs, it is important to understand how the system reads the structures you create. While various files may be present (files with extensions other than MP3 and WMA), only files with the MP3 and WMA

extension are played; other files are ignored by the system. This enables you to use the same MP3 and WMA disc for a variety of tasks on your work computer, home computer and your in-vehicle system.

In track mode, the system displays and plays the structure as if it were only one level deep (all MP3 and WMA files play, regardless of being in a specific folder). In folder mode, the system only plays the MP3 and WMA files in the current folder.

## AUDIO UNIT - VEHICLES WITH: AM/FM/CD/SYNC/ TOUCHSCREEN DISPLAY



**WARNING:** Driving while distracted can result in loss of vehicle control, crash and injury. We strongly recommend that you use extreme caution when using any device that may take your focus off the road. Your primary responsibility is the safe operation of your vehicle. We recommend against the use of any hand-held device while driving and encourage the use of voice-operated systems when possible. Make sure you are aware of all applicable local laws that may affect the use of electronic devices while driving.

**Note:** *The touchscreen system controls most of the audio features.*

**Note:** *Some features, such as satellite radio, may not be available in your location. Check with an authorized dealer.*

## Accessing the Sound Settings



Press and release to access settings for Treble, Midrange, Bass, Fade or Balance.

# Audio System

## Adjusting the Volume

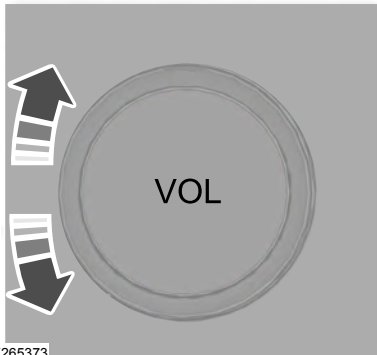

E265373

Turn to adjust the volume.

## Changing Radio Stations

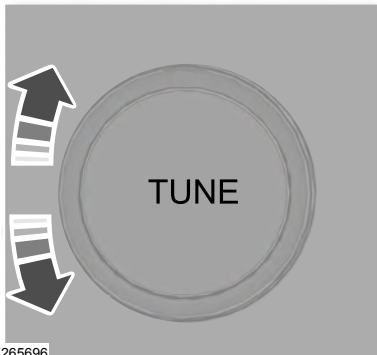

E265696

In radio mode, turn to search through the radio frequency band. In satellite radio mode, turn to find the previous or next available satellite radio station.

## Ejecting the CD (If Equipped)



Press and release the button to eject a CD.

## Inserting a CD (If Equipped)

Insert a CD into the CD slot.

## Switching the Audio Unit On and Off



Press and release the button.

## Using Seek, Fast Forward and Reverse



In radio mode, select a frequency band and press and release either button. The system stops at the first station it finds in that direction.

In CD mode, press and release to select the next or previous track. Press and hold to move quickly forward or backward through the current track.

In satellite radio mode, press and release to select the next or previous satellite radio station. If you select a specific category (such as jazz, rock or news) press to find the next or previous station in the category you select.

## AUDIO UNIT - VEHICLES WITH: SYNC



**WARNING:** Driving while distracted can result in loss of vehicle control, crash and injury. We strongly recommend that you use extreme caution when using any device that may take your focus off the road. Your primary responsibility is the safe

# Audio System

operation of your vehicle. We recommend against the use of any hand-held device while driving and encourage the use of voice-operated systems when possible. Make sure you are aware of all applicable local laws that may affect the use of electronic devices while driving.

**Note:** Some features, such as satellite radio, may not be available in your location. Check with an authorized dealer.

## Accessing the Apps Menu

 Press and release the button to access the apps menu. Follow the on-screen prompts to make your selection.

## Accessing the Clock Settings

 Press and release the button to access the clock setting. Use the center arrow controls to change the hours and minutes.

## Accessing the Media Source Menu

 Press and release to open the media source menu.

You can press this multiple times to change to a SYNC-Media device or scroll through the media sources using the arrow buttons. Press **OK** to select a source.

## Accessing the Phone Features

 Press and release the button to access the phone features of the SYNC system.

## Accessing the Settings Menu

 Press and release the button to access the settings menu. Follow the on-screen prompts to make your selection.

## Accessing the Sound Settings

 Press and release the button to access settings for Treble, Midrange, Bass, Fade and Balance.

## Adjusting the Volume

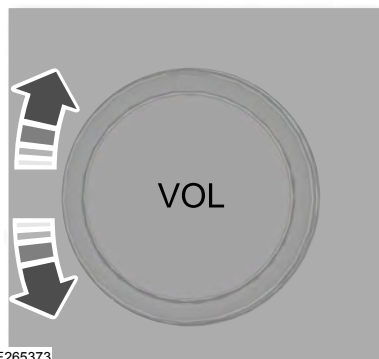

Turn to adjust the volume.

# Audio System

## Changing Radio Stations

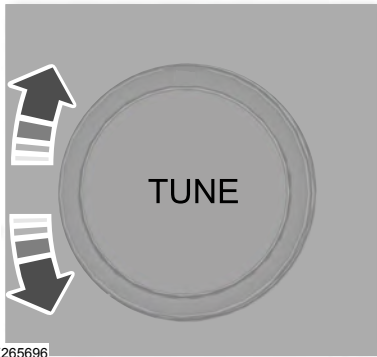

In radio mode, turn to search through the radio frequency band.

In satellite radio mode, turn to find the previous or next available satellite radio station.

## Listening to the Radio

 Press and release to listen to the radio or change radio stations.

## Muting the Audio

 Press and release the button to mute the playing audio.

## Playing or Pausing Media

 Press and release the button to either play or pause the audio.

## Switching the Audio Unit On and Off

 Press and release the button.

## Switching the Display On and Off

 Press and release the button.

## Using the Display Control

Use the up and down arrow buttons to select the various settings. When you make your selection, press the left and right arrow buttons to change the settings.

 Press and release to confirm a selection.

## Using the Number Block

In radio mode, store and recall your favorite radio stations. To store a favorite station press and hold until the sound returns. In phone mode, enter a phone number.

## Using Seek, Fast Forward and Reverse



In radio mode, select a frequency band and press and release either button. The system stops at the first station it finds in that direction.

In satellite radio mode, press and release to select the next or previous satellite radio station. If you select a specific category (such as jazz, rock or news), press to find the next or previous station in the category you select.

## DIGITAL RADIO (IF EQUIPPED)

**Note:** *HD Radio broadcasts are not available in all markets.*



# Audio System

---

HD Radio technology is the digital evolution of analog AM/FM radio. Your system has a special receiver that allows it to receive digital broadcasts (where available) in addition to the analog broadcasts, it already receives. Digital broadcasts provide a better sound quality than analog broadcasts with free, crystal-clear audio and no static or distortion. For more information, and a guide to available stations and programming, please visit [www.hdradio.com](http://www.hdradio.com).

When HD Radio is on and you tune to a station broadcasting HD Radio technology, you may notice the HD Radio logo on your screen. When this logo is available, you may also see Title and Artist fields on-screen.

The multicast indicator appears in FM mode (only) if the current station is broadcasting multiple digital broadcasts. The highlighted numbers signify available digital channels where new or different content is available. HD1 signifies the main programming status and is available in analog and digital broadcasts. Other multicast stations (HD2 through HD7) are only available digitally.

When HD Radio broadcasts are active, you can access the following functions:

- **Scan** allows you to hear a brief sampling of all available stations. This feature still works when HD Radio reception is on, although it does not scan for HD2-HD7 channels. You may see the HD logo appear if the station has a digital broadcast.
- **Memory presets** allow you to save an active channel as a memory preset. Touch and hold a memory preset slot until the sound returns. There is a brief mute while the radio saves the station. Sound returns when finished. When switching to an HD2 or HD3 memory preset, the sound mutes before the digital audio plays, because the system has to reacquire the digital signal.

**Note:** *As with any saved radio station, you cannot access a station you save if your vehicle is outside the station's reception area.*

# Audio System

## HD Radio Reception and Station Troubleshooting

<b>Potential Reception Issues</b>	
Reception area	If you are listening to a multicast station and you are on the fringe of the reception area, the station may mute due to weak signal strength.
	If you are listening to HD1, the system switches back to the analog broadcast until the digital broadcast is available again. However, if you are listening to any of the possible HD2-HD7 multicast channels, the station mutes and stays muted unless it is able to connect to the digital signal again.
Station blending	When the system first receives a station (aside from HD2-HD7 multicast stations), it first plays the station in the analog version. Once the receiver verifies the station is an HD Radio station, it shifts to the digital version. Depending on the station quality, you may hear a slight sound change when the station changes from analog to digital. Blending is the shift from analog to digital sound or digital back to analog sound.

In order to provide the best possible experience, use the contact form to report any station issues found while listening to a station broadcasting with HD Radio technology. Independent entities own and operate each station. These stations are responsible for ensuring all audio streams and data fields are accurate.

# Audio System

Potential Station Issues		
Issues	Cause	Action
Echo, stutter, skip or repeat in audio. Increase or decrease in audio volume.	This is poor time alignment by the radio broadcaster.	No action required. This is a broadcast issue.
Sound fading or blending in and out.	The radio is shifting between analog and digital audio.	No action required. The reception issue may clear up as you continue to drive.
There is an audio mute delay when selecting HD2 or HD3, multicast preset or <b>Direct Tune</b> .	The digital multicast is not available until the HD Radio broadcast is decoded. Once decoded, the audio is available.	No action required. This is normal behavior. Wait until the audio is available.
Cannot access HD2 or HD3 multicast channel when recalling a preset or from a direct tune.	The previously stored multicast preset or direct tune is not available in your current reception area.	No action required. The station is not available in your current location.
Text information does not match currently playing audio.	Data service issue by the radio broadcaster.	Fill out the station issue form at website listed below.*
There is no text information shown for currently selected frequency.	Data service issue by the radio broadcaster.	Fill out the station issue form at website listed below.*
HD2-HD7 stations not found when <b>Scan</b> is pressed.	Pressing <b>Scan</b> disables HD2-HD7 channel search.	No action required. This is normal behavior.

\*<http://hdradio.com/stations/feedback>

HD Radio Technology manufactured under license from iBiquity Digital Corporation and foreign patents. HD Radio and the HD and HD Radio logos are proprietary trademarks of DTS Ford Motor Company and DTS are not responsible for the content sent using HD Radio technology. Content may be changed, added or deleted at any time at the station owner's discretion.

## SATELLITE RADIO (IF EQUIPPED)

SiriusXM® Satellite Radio broadcasts a variety of music, news, sports, weather, traffic and entertainment satellite radio channels. For more information and a complete list of SiriusXM satellite radio channels, visit [www.siriusxm.com](http://www.siriusxm.com) in the United States, [www.siriusxm.ca](http://www.siriusxm.ca) in Canada, or call SiriusXM at 1-888-539-7474.

# Audio System

**Note:** This receiver includes the eCos real-time operating system. eCos is published under the eCos License.

## Satellite Radio Reception Factors

Potential satellite radio reception issues	
Antenna obstructions	For optimal reception performance, keep the antenna clear of snow and ice build-up and keep luggage and other material as far away from the antenna as possible.
Terrain	Hills, mountains, tall buildings, bridges, tunnels, freeway overpasses, parking garages, dense tree foliage and thunderstorms can interfere with your reception.
Station overload	When you pass a ground-based broadcast-repeating tower, a stronger signal may overtake a weaker one and the audio system may mute.
Satellite radio signal interference	Your display may show ACQUIRING . . . to indicate the interference and the audio system may mute.

## SiriusXM Satellite Radio Service

**Note:** *SiriusXM reserves the unrestricted right to change, rearrange, add or delete programming including canceling, moving or adding particular channels, and its prices, at any time, with or without notice to you. Ford Motor Company shall not be responsible for any such programming changes.*



E208625

SiriusXM satellite radio is a subscription-based satellite radio service that broadcasts a variety of music, sports, news, weather, traffic and entertainment programming. Your factory-installed SiriusXM satellite radio system includes hardware and a limited subscription term, which begins on the date of sale or lease of your vehicle. See an authorized dealer for availability.

For more information on extended subscription terms (a service fee is required), the online media player and a complete list of SiriusXM satellite radio channels, and other features, please visit [www.siriusxm.com](http://www.siriusxm.com) in the United States, [www.siriusxm.ca](http://www.siriusxm.ca) in Canada, or call SiriusXM at 1-888-539-7474.

## Satellite Radio Electronic Serial Number (ESN)

You need your ESN to activate, modify or track your satellite radio account. When in satellite radio mode, tune to channel 0.

# Audio System

## Troubleshooting

Message	Condition	Action
Acquiring...	Radio requires more than two seconds to produce audio for the selected channel.	No action required. This message should disappear shortly.
Satellite antenna fault SIRIUS system failure	There is an internal module or system failure present.	If this message does not clear shortly, or with an ignition key cycle, your receiver may have a fault. See an authorized dealer for service.
Invalid Channel	The channel is no longer available.	Tune to another channel or choose another preset.
Unsubscribed Channel	Your subscription does not include this channel.	Contact SiriusXM at 1-888-539-7474 to subscribe to the channel, or tune to another channel.
No Signal	The signal is lost from the SiriusXM satellite or SiriusXM tower to your vehicle antenna.	The signal is blocked. When you move into an open area, the signal should return.
Updating...	Update of channel programming in progress.	No action required. The process may take up to three minutes.
Questions? Call 1-888-539-7474	Your satellite service is no longer available.	Contact SiriusXM at 1-888-539-7474 to resolve subscription issues.
None found Check Channel Guide	All the channels in the selected category are either skipped or locked.	Use the channel guide to turn off the Lock or Skip function on that station.
Subscription Updated	SiriusXM has updated the channels available for your vehicle.	No action required.

# Audio System

## USB PORT



**WARNING:** Driving while distracted can result in loss of vehicle control, crash and injury. We strongly recommend that you use extreme caution when using any device that may take your focus off the road. Your primary responsibility is the safe operation of your vehicle. We recommend against the use of any hand-held device while driving and encourage the use of voice-operated systems when possible. Make sure you are aware of all applicable local laws that may affect the use of electronic devices while driving.

primary responsibility is the safe operation of your vehicle. We recommend against the use of any hand-held device while driving and encourage the use of voice-operated systems when possible. Make sure you are aware of all applicable local laws that may affect the use of electronic devices while driving.

The media hub may be on the instrument panel or center console.

The media hub may contain one or more of the following inputs:

See **USB Port** (page 323).

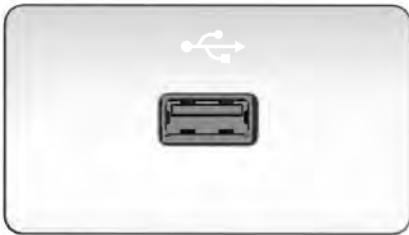

E201595

The USB port allows you to plug in media playing devices, memory sticks and charge devices, if supported.

## MEDIA HUB



**WARNING:** Driving while distracted can result in loss of vehicle control, crash and injury. We strongly recommend that you use extreme caution when using any device that may take your focus off the road. Your

## GENERAL INFORMATION

SYNC is an in-vehicle communications system that works with your Bluetooth-enabled cellular phone and portable media player. This allows you to:

- Make and receive calls.
- Access and play music from your portable music player.
- Use 911 Assist or Emergency Assistance and applications via SYNC AppLink.\*
- Access phonebook contacts and music using voice commands.
- Stream music from your connected phone.
- Text message.
- Use the advanced voice recognition system.
- Charge your USB device (if your device supports this).

\*These features are not available in all markets and may require activation. Available AppLink enabled apps vary by market.

Make sure that you review your device's manual before using it with SYNC.

## Support

SYNC support is available at your regional Ford website. See **SYNC™ Troubleshooting** (page 333).

## SYNC Owner Account

Why do I need a SYNC owner account?

- Essential for keeping up with the latest software downloads available for SYNC.
- Access to customer support for any questions you may have.

## Driving Restrictions

For your safety, certain features are speed-dependent and restricted when your vehicle is traveling over 3 mi (5 km).

## Safety Information



**WARNING:** Driving while distracted can result in loss of vehicle control, crash and injury. We strongly recommend that you use extreme caution when using any device that may take your focus off the road. Your primary responsibility is the safe operation of your vehicle. We recommend against the use of any hand-held device while driving and encourage the use of voice-operated systems when possible. Make sure you are aware of all applicable local laws that may affect the use of electronic devices while driving.

When using SYNC:

- Do not operate playing devices if the power cords or cables are broken, split or damaged. Place cords and cables out of the way, so they do not interfere with the operation of pedals, seats, compartments or safe driving abilities.
- Do not leave playing devices in your vehicle during extreme conditions as it could cause them damage. See your device's manual for further information.
- Do not attempt to service or repair the system. See an authorized dealer.

## Privacy Information

When a cellular phone is connected to SYNC, the system creates a profile within your vehicle that is linked to that cellular phone. This profile is created in order to offer you more cellular features and to operate more efficiently. Among other

things, this profile may contain data about your cellular phone book, text messages (read and unread), and call history, including history of calls when your cellular phone was not connected to the system. In addition, if you connect a media device, the system creates and retains an index of supported media content. The system also records a short development log of approximately 10 minutes of all recent system activity. The log profile and other system data may be used to improve the system and help diagnose any problems that may occur.

The cellular profile, media device index, and development log will remain in the vehicle unless you delete them and are generally accessible only in the vehicle when the cellular phone or media player is connected. If you no longer plan to use the system or the vehicle, we recommend you perform a Master Reset to erase all stored information.

System data cannot be accessed without special equipment and access to the vehicle's SYNC module. Ford Motor Company and Ford of Canada will not access the system data for any purpose other than as described absent consent, a

court order, or where required by law enforcement, other government authorities, or other third parties acting with lawful authority. Other parties may seek to access the information independently of Ford Motor Company and Ford of Canada. For further privacy information, see the section on 911 Assist. See **SYNC™ Applications and Services** (page 328).

## USING VOICE RECOGNITION

This system helps you control many features using voice commands. This allows you to keep your hands on the wheel and focus on what is around you.

### Initiating a Voice Session



Press the voice button. A list of available voice commands appears in the display.

### Global Voice Commands

These voice commands are always available. You can say them at any time.

Global voice commands	
Help	Gives you available commands you can use on the current screen.
List of Commands	Gives you a list of possible voice commands.
Cancel	This command ends the voice session. You can also cancel a session by pressing seek up, seek down, or holding the voice button for two or more seconds.



## Helpful Hints

- Make sure the interior of your vehicle is as quiet as possible. Wind noise from open windows and road vibrations may prevent the system from correctly recognizing spoken commands.
- Before giving a voice command, wait for the system announcement to finish, followed by a single tone. Any command spoken before this does not register with the system.
- Speak naturally, without long pauses between words.
- You can interrupt the system at any time while it is speaking by pressing the voice button. You can cancel a voice session by pressing and holding the voice button.

## System Interaction and Feedback

The system provides feedback through audible tones, prompts, questions and spoken confirmations depending on the situation and the chosen level of interaction. You can customize the voice recognition system to provide more or less instruction and feedback.

The default setting is to a higher level of interaction in order to help you learn to use the system. You can change these settings at any time.

### Adjusting the Interaction Level



Press the voice button. When prompted, say:

Voice Command	Action and Description
Voice Settings	
<b>Then either of the following:</b>	
Interaction Mode Standard	Provides more detailed interaction and guidance. (Recommended for first time users.)
Interaction Mode Advanced	Provides less audible interaction and guidance.

## Phone Confirmation

Using phone confirmations the system asks you to verify before placing any calls.

## SYNC™ (If Equipped)

To adjust this setting press the voice button, when prompted say:

Voice Command	Action and Description
Voice Settings	
<b>Then any of the following:</b>	
Phone Confirmation Off	When enabled, this feature will prompt you to confirm any voice initiated call command prior to the call being placed.
Phone Confirmation On	The system will make a best guess; you may still occasionally be asked to confirm settings.

### USING SYNC™ WITH YOUR PHONE

Hands-free calling is one of the main features of SYNC. While the system supports a variety of features, many are dependent on your cellular phone's functionality. At a minimum, most cellular phones with Bluetooth wireless technology support the following functions:

- Answering an incoming call.
- Ending a call.
- Dialing a number.
- Redialing.
- Call waiting notification.
- Caller ID.

Other features, such as text messaging using Bluetooth and automatic phonebook download, are phone-dependent features.

### Pairing a Phone

Wirelessly pairing your phone with SYNC allows you to make and receive hands-free calls.

**Note:** Make sure to switch on the ignition and the radio. Shift the transmission into park (P) for automatic transmission or first gear for manual transmission.

### Using the Audio System

**Note:** To scroll through the menus, press the up and down arrows on your audio system.

1. Make sure to switch on your phone's Bluetooth feature before starting the search. See your device's manual if necessary.
2. Press the **Settings** button.
3. Select Bluetooth from the menu.
4. Press the **OK** button.
5. Select the option to add. This starts the pairing process.
6. When a message to begin pairing appears in the audio display, search for SYNC on your device.

7. When prompted on your cell phone's display, confirm that the PIN provided by SYNC matches the PIN displayed on your cell phone. Your phone is now paired and the display indicates that the pairing was successful. If you are prompted to enter a PIN on your device, enter the PIN displayed on the screen. The display indicates when the pairing is successful.

Depending on your phone's capability and your market, the system may prompt you with questions, such as setting the current phone as the primary phone and downloading your phonebook.

## Using Voice Commands



Make sure to switch on your phone's Bluetooth feature before starting the search. See your device's manual if necessary.

### Press the voice button and when prompted say:

Voice Command	Action and Description
Pair Phone	Follow the instructions on the audio display.

## Phone Voice Commands



Press the voice button. You can do things like place a phone call and access text messages.

When prompted, say a command. See the following table for example commands.

Voice Command
___ List of Commands
Help
Call ___
Dial ___
Text Messages

\_\_\_ is a dynamic listing, meaning that it could be the name of anything, such as a contact or phone number.

## Phone Controls

Use the phone buttons on your steering wheel to answer, reject, or hang up a call.

## Accessing Features through the Phone Menu

You can access your call history, phonebook, sent text messages, as well as access phone and system settings.

1. Press the **PHONE** button to enter the phone menu.
2. Scroll through the menu to view contacts, text messages, and the phone dialer.

## SYNC™ APPLICATIONS AND SERVICES

- 911 Assist: Can alert 911 in the event of an emergency.
- SYNC AppLink: Allows you to connect to and use certain applications (if your phone is compatible).

These features may require activation. Available AppLink enabled apps vary by market.

## 911 Assist



**WARNING:** Unless the 911 Assist setting is set on before a crash, the system will not dial for help which could delay response time, potentially increasing the risk of serious injury or death after a crash.



**WARNING:** Do not wait for 911 Assist to make an emergency call if you can do it yourself. Dial emergency services immediately to avoid delayed response time which could increase the risk of serious injury or death after a crash. If you do not hear 911 Assist within five seconds of the crash, the system or phone may be damaged or non-functional.



**WARNING:** Always place your phone in a secure location in your vehicle so it does not become a projectile or get damaged in a crash. Failure to do so may cause serious injury to someone or damage the phone which could prevent 911 Assist from working properly.

**Note:** The SYNC 911 Assist feature must be set on before the incident.

**Note:** The SYNC 911 Assist feature only operates in the U.S., Canada or in a territory in which 911 is the emergency number.

**Note:** Before setting this feature on, make sure that you read the 911 Assist Privacy Notice later in this section for important information.

**Note:** If any user switches 911 Assist to on or off, that setting applies for all paired phones. If 911 Assist is switched off, either a voice message plays or a display message or an icon comes on when your vehicle is started and after a previously paired phone connects.

**Note:** Every phone operates differently. While SYNC 911 Assist works with most cellular phones, some may have trouble using this feature.

If a crash deploys an airbag (excluding knee airbags and rear inflatable safety belts [if equipped]) or activates the fuel pump shut-off, your SYNC-equipped vehicle may be able to contact emergency services by dialing 911 through a paired and connected Bluetooth-enabled phone.

See **Supplementary Restraints System** (page 38). Important information about airbag deployment is in this chapter.

See **Roadside Emergencies** (page 207). Important information about the fuel pump shut-off is in this chapter.

### Setting 911 Assist On or Off

**Press the Settings button then select:**

Menu Item	Action and Description
911 Assist	Select the desired option, on or off.

To make sure that 911 Assist works properly:

- SYNC must be powered and working properly at the time of the incident and throughout feature activation and use.
- The 911 Assist feature must be set on before the incident.
- You must pair and connect a Bluetooth enabled and compatible cell phone to SYNC.
- A connected Bluetooth enabled phone must have the ability to make and maintain an outgoing call at the time of the incident.

- A connected Bluetooth enabled phone must have adequate network coverage, battery power and signal strength.
- The vehicle must have battery power and be located in the U.S., Canada or in a territory in which 911 is the emergency number.

### In the Event of a Crash

Not all crashes deploy an airbag or activate the fuel pump shut-off (the triggers for 911 Assist). If a connected cell phone sustains damage or loses its connection to SYNC during a crash, SYNC searches for and tries to connect to a previously paired cell phone; SYNC then attempts to call the emergency services.

Before making the call:

- SYNC provides a short window of time (about 10 seconds) to cancel the call. If you fail to cancel the call, SYNC attempts to dial 911.
- SYNC says the following, or a similar message: "SYNC will attempt to call 911, to cancel the call, press Cancel on your screen or press and hold the phone button on your steering wheel".

If you do not cancel the call, and SYNC makes a successful call, a pre-recorded message plays for the 911 operator, and then the occupant(s) in your vehicle are able to talk with the operator. Be prepared to provide your name, phone number and location immediately, because not all 911 systems are capable of receiving this information electronically.

### 911 Assist May Not Work If

- Your cellular phone or 911 Assist hardware sustains damage in a crash.
- The vehicle's battery or the SYNC system has no power.
- The phone(s) thrown from your vehicle are the ones paired and connected to the system.

### 911 Assist Privacy Notice

When you switch on 911 Assist, it may disclose to emergency services that your vehicle has been in a crash involving the deployment of an airbag or activation of the fuel pump shut-off. Certain versions or updates to 911 Assist may also be capable of electronically or verbally disclosing to 911 operators your vehicle location or other details about your vehicle or crash to assist 911 operators to provide the most appropriate emergency services. If you do not want to disclose this information, do not switch the feature on.

### SYNC Mobile Apps

The system enables voice and steering wheel control of SYNC AppLink enabled smartphone apps. When an app is running through AppLink, you can control main features of the app through voice commands and steering wheel controls.

**Note:** *You must pair and connect your smartphone to SYNC to access AppLink.*

**Note:** *iPhone users need to connect the phone to the USB port.*

**Note:** *Android users need to connect the phone to SYNC using Bluetooth.*

**Note:** *For information on available apps, supported smartphone devices and troubleshooting tips please visit the Ford website*

**Note:** *Availability of SYNC AppLink enabled Apps will vary by region.*

**Note:** *Make sure you have an active account for the app that you have downloaded. Some apps work automatically with no setup. Other apps want you to configure your personal settings and personalize your experience by creating stations or favorites. We recommend you do this at home or outside of your vehicle.*

# SYNC™ (If Equipped)

## To Access Using the SYNC Menu

Press the **Mobile Apps** button to access the menu on-screen. Then select:

Menu Item	Action and Description
Find	Scroll through the list of

Menu Item	Action and Description
Mobile Apps	available applications and select a particular app.

**Note:** *If you cannot find a compatible SYNC AppLink app, make sure the required app is running on the mobile device.*

## To Access Using Voice Commands

Press the voice button, then when prompted say:

Voice Command	Action and Description
Mobile Applications	Say the name of the application after the tone. The app should start. When an app is running through SYNC, you can press the voice button and speak commands specific to the app, for example "Play Playlist Road Trip".
List Applications	SYNC lists all of the currently available mobile apps.
Find Applications	Searches your connected mobile device for SYNC-compatible mobile apps.
Help	Use this command to discover the available voice commands.

## App Permissions

App permissions are organized by groups. You can grant these group permissions individually. You can change a permission group status any time when not driving, by using the settings menu.

When you launch an app using SYNC, the system may ask you to grant certain permissions, for example:

- To allow your vehicle to provide vehicle information to the app such as, but not limited to: Fuel level, fuel economy, fuel consumption, engine speed, rain sensor, odometer, VIN, external temperature, gear position, tire pressure, and head lamp status.
- To allow your vehicle to provide driving characteristic information such as, but not limited to: MyKey, seat belt status, engine revolutions per minute, gear position, braking events, steering wheel angle, and accelerator pedal position.

## SYNC™ (If Equipped)

- To allow your vehicle to provide location information, including: GPS and speed.
- To allow the app to send push notifications using the vehicle display and voice capabilities while running in a background state. Push notifications may be particularly useful for news or location based apps.

**Note:** *You only need to grant permissions the first time you use an app with SYNC.*

**Note:** *Ford is not responsible or liable for any damages or loss of privacy relating to usage of an app, or dissemination of any vehicle data that you approve Ford to provide to an app.*

### Enabling SYNC Mobile Apps

In order to enable mobile apps, SYNC requires user consent to send and receive app authorization information and updates using the data plan associated with the connected device.

Data is sent to Ford in the United States through the connected device. The information is encrypted and includes your VIN, SYNC module number, anonymous usage statistics and debugging information. Updates may take place.

**Note:** *You must enable mobile apps for each connected device the first time you select a mobile app using the system.*

**Note:** *Standard data rates apply. Ford is not responsible for any additional charges you may receive from your service provider, when your vehicle sends or receives data through the connected device. This includes any additional charges incurred due to driving in areas when roaming out of a home network.*

## USING SYNC™ WITH YOUR MEDIA PLAYER

SYNC supports digital media sources including: iPod, Bluetooth devices, and most USB drives. SYNC also supports audio formats, such as MP3, WMA, WAV and ACC.

### Media Sources

The **AUX** or **MEDIA** button allows you to view and select available media sources.

Press the **AUX** or **MEDIA** button to view your sources. Use the directional arrows and OK button to select your source. You can also use the steering wheel audio controls.

### Audio Voice Commands



Press the voice button. You can do things like play a specific song or album, skip to the next song, or tune to a radio station. When prompted, say a command. See the following table for example commands. Not all commands may be available on your vehicle.

Command
___ List of Commands
Help
Pause
Play
Next Track
Previous Track
AM ___
FM ___
CD Player

## SYNC™ (If Equipped)

Command
Sirius Channel ___
USB
Bluetooth Audio

Use your regional Ford website at any time to check your phone's compatibility, register your account and set preferences as well as access a customer representative via an online chat (during certain hours).

\_\_\_ is a dynamic listing, meaning that it could be the name of anything, such as an artist, station, or media source.

### SYNC™ TROUBLESHOOTING

Your SYNC system is easy to use. However, should questions arise, see the tables below.

Market	Website(s)
North America	<a href="http://www.SYNCMyRide.com">www.SYNCMyRide.com</a> <a href="http://www.SYNCMyRide.ca">www.SYNCMyRide.ca</a> <a href="http://www.sync-maroute.ca">www.sync-maroute.ca</a>

Phone issues		
Issue	Possible cause(s)	Possible solution(s)
There is excessive background noise during a phone call.	The audio control settings on your phone may be affecting SYNC performance.	Review your phone's manual about audio adjustments.
During a call, I can hear the other person but they cannot hear me.	This may be a possible phone malfunction.	Try turning off the device, resetting the device, removing the device's battery, then trying again.
SYNC is not able to download my phonebook.	<p>This is a phone-dependent feature.</p> <p>This may be a possible phone malfunction.</p>	<p>Go to the website to review your phone's compatibility.</p> <p>Try turning off the device, resetting the device or removing the device's battery, then trying again.</p> <p>Try pushing your phonebook contacts to SYNC by using the Add Contacts feature.</p> <p>Use the SYNCmyphone feature available on the website.</p>



## SYNC™ (If Equipped)

<b>Phone issues</b>		
<b>Issue</b>	<b>Possible cause(s)</b>	<b>Possible solution(s)</b>
<p>The system says Phonebook Downloaded but the phonebook in SYNC is empty or missing contacts.</p>	<p>This may be a limitation on your phone's capability.</p>	<p>Try pushing your phonebook contacts to SYNC by using the Add Contacts feature.</p> <p>If the missing contacts are stored on your SIM card, try moving them to the device memory.</p> <p>Remove any pictures or special ring tones associated with the missing contact.</p> <p>Depending upon your phone, you may have to grant SYNC permission to access your phonebook contacts. Make sure to confirm when prompted by your phone during the phonebook download.</p>
<p>I am having trouble connecting my phone to SYNC.</p>	<p>This is a phone-dependent feature.</p> <p>This may be a possible phone malfunction.</p>	<p>Go to the website to review your phone's compatibility.</p> <p>Try turning off the device, resetting the device or removing the device's battery, then trying again.</p> <p>Try deleting your device from SYNC, deleting SYNC from your device and trying again.</p> <p>Check the security and auto accept and prompt always settings relative to the SYNC Bluetooth connection on your phone.</p> <p>Update your device's firmware.</p> <p>Turn off the Auto phonebook download setting.</p>

## SYNC™ (If Equipped)

<b>Phone issues</b>		
<b>Issue</b>	<b>Possible cause(s)</b>	<b>Possible solution(s)</b>
Text messaging is not working on SYNC.	<p>This is a phone-dependent feature.</p> <p>This may be a possible phone malfunction.</p>	<p>Go to the website to review your phone's compatibility.</p> <p>Try turning off the device, resetting the device or removing the device's battery, then trying again.</p>
I cannot return to the Phone menu when selecting a contact.	You are on the Select a Character screen.	Press the Phone button to return to the Phone menu.

<b>USB and media issues</b>		
<b>Issue</b>	<b>Possible cause(s)</b>	<b>Possible solution(s)</b>
I am having trouble connecting my device.	This may be a possible device malfunction.	<p>Try turning off the device, resetting the device, removing the device's battery, then trying again.</p> <p>Make sure you are using the manufacturer's cable.</p> <p>Make sure you insert the USB cable correctly into the device and the USB port.</p> <p>Make sure that the device does not have an auto-install program or active security settings.</p>
SYNC does not recognize my device when I turn on the car.	This is a device limitation.	Make sure you are not leaving the device in your vehicle during very hot or cold temperatures.
Bluetooth audio does not stream.	This is a phone-dependent feature.	Review the device compatibility chart on the SYNC website to confirm your phone supports the Bluetooth audio streaming function.

## SYNC™ (If Equipped)

<b>USB and media issues</b>		
<b>Issue</b>	<b>Possible cause(s)</b>	<b>Possible solution(s)</b>
	The device is not connected.	Make sure you correctly connect the device to SYNC, and that you have pressed play on your device.
SYNC does not recognize music that is on my device.	Your music files may not contain the correct artist, song title, album or genre information. The file may be corrupted. The song may have copy-right protection, which does not allow it to play.	Make sure that all song details are populated.  Some devices require you to change the USB settings from mass storage to MTP class.
I cannot change the Sirius station.	Sirius Replay is active.	Switch radio bands and return to Sirius or switch the feature off. You can then change the Sirius station using the directional buttons.

<b>Voice command issues</b>		
<b>Issue</b>	<b>Possible cause(s)</b>	<b>Possible solution(s)</b>
SYNC does not understand what I am saying.	You may be using the wrong voice commands.  You may be speaking too soon or at the wrong time.	Review the phone voice commands and the media voice commands at the beginning of their respective sections.  After pressing the voice icon, wait until after the tone sounds and Listening appears before saying a command. Any command spoken before this does not register with the system.
SYNC does not understand the name of a song or artist.	You may be using the wrong voice commands.	Review the media voice commands at the beginning of the media section.

## SYNC™ (If Equipped)

<b>Voice command issues</b>		
<b>Issue</b>	<b>Possible cause(s)</b>	<b>Possible solution(s)</b>
	<p>You may be saying the name differently than the way you saved it.</p> <p>The system may not be reading the name the same way you are saying it.</p>	<p>Say the song or artist exactly as listed. If you say "Play Artist Prince", the system does not play music by Prince and the Revolution or Prince and the New Power Generation.</p> <p>Make sure you are saying the complete title, such as "California remix featuring Jennifer Nettles".</p> <p>If the song titles are in all CAPS, you have to spell them. LOLA requires you to say "L-O-L-A".</p> <p>Do not use special characters in the title. The system does not recognize them.</p>
<p>SYNC does not understand or is calling the wrong contact when I want to make a call.</p>	<p>You may be using the wrong voice commands.</p> <p>You may be saying the name differently than the way you saved it.</p>	<p>Review the Phone voice commands at the beginning of the phone section.</p> <p>Make sure you are saying the contacts exactly as they are listed. For example, if you save a contact as Joe Wilson, say "Call Joe Wilson".</p> <p>Using the SYNC phone menu, open the phonebook and scroll to the name SYNC is having trouble understanding. SYNC will read the name to you, giving you some idea of the pronunciation SYNC is expecting.</p>

## SYNC™ (If Equipped)

<b>Voice command issues</b>		
<b>Issue</b>	<b>Possible cause(s)</b>	<b>Possible solution(s)</b>
	<p>The system may not be reading the name the same way you are saying it.</p> <p>Contacts in your phonebook may be very short and similar, or they may contain special characters.</p> <p>Your phonebook contacts may be in CAPS.</p>	<p>The system works better if you list full names, such as "Joe Wilson" rather than "Joe".</p> <p>Do not use special characters, such as 123 or ICE, as the system does not recognize them.</p> <p>If a contact is in CAPS, you have to spell it. JAKE requires you to say "Call J-A-K-E".</p>

<b>AppLink issues</b>		
<b>Issue</b>	<b>Possible cause(s)</b>	<b>Possible solution(s)</b>
<p>AppLink Mobile Applications: When I select "Find New Apps," SYNC does not find any applications.</p>	<p>An AppLink capable phone is not connected to SYNC.</p>	<p>Ensure you have a compatible smartphone; an Android with OS 2.3 or higher or an iPhone 3GS or newer with iOS 5.0 or higher. Additionally, ensure your phone is paired and connected to SYNC in order to find AppLink-capable apps on your device. iPhone users must also connect to SYNC's USB port with an Apple USB cable.</p>
<p>My phone is connected, but I still cannot find any apps.</p>	<p>AppLink-enabled apps are not installed and running on your mobile device.</p>	<p>Ensure you have downloaded and installed the latest version of the app from your phone's app store. Ensure the app is running on your phone. Some apps require you to register or</p>

## SYNC™ (If Equipped)

<b>AppLink issues</b>		
<b>Issue</b>	<b>Possible cause(s)</b>	<b>Possible solution(s)</b>
		login on the app on the phone before using them with AppLink. Also, some may have a "Ford SYNC" setting, so check the app's settings menu on the phone.
My phone is connected, my app(s) are running, but I still cannot find any apps.	Sometime apps do not properly close and re-open their connection to SYNC, over ignition cycles, for example.	<p>Closing and restarting apps may help SYNC find the application if you cannot discover it inside the vehicle.</p> <p>On an Android device, if apps have an "Exit" or 'Quit' option, select that then restart the app. If the app does not have that option, you can also manually "Force Close" the app by going to the phone's settings menu, selecting 'Apps.' then finding the particular app and choosing 'Force stop.' Don't forget to restart the app afterwards, then select "Find New Apps" on SYNC.</p> <p>On an iPhone with iOS7+, to force close an app, double tap the home button then swipe up on the app to close it. Tab the home button again, then select the app again to restart it. After a few seconds, the app should then appear in SYNC's Mobile App's Menu.</p>
My Android phone is connected, my app(s) are running, I restarted them, but I still cannot find any apps.	There is a Bluetooth bug on some older versions of the Android operating system that may cause apps that were found on your previous vehicle drive to not be found again if you have not turned off Bluetooth.	Reset the Bluetooth on your phone by turning it off and then turning Bluetooth back on. If you are in your vehicle, SYNC should be able to automatically re-connect to your phone if you press the "Phone" button.

## SYNC™ (If Equipped)

<b>AppLink issues</b>		
<b>Issue</b>	<b>Possible cause(s)</b>	<b>Possible solution(s)</b>
My iPhone phone is connected, my app is running, I restarted the app but I still cannot find it on SYNC.	The USB connection to SYNC may need to be reset.	Unplug the USB cable from the phone, wait a moment, and plug the USB cable back in to the phone. After a few seconds, the app should appear in SYNC's Mobile Apps Menu. If not, "Force Close" the application and restart it.
I have an Android phone. I found and started my media app on SYNC, but there is no sound or the sound is very low.	The bluetooth volume on the phone may be low.	Try increasing the Bluetooth volume of the device by using the device's volume control buttons which are most often found on the side of the device.
I can only see some of the AppLink apps running on my phone listed in SYNC's Mobile Apps Menu.	Some Android devices have a limited number of bluetooth ports apps can use to connect. If you have more AppLink apps on your phone than the number of available Bluetooth ports, you will not see all of your apps listed in SYNC's mobile apps menu.	Force close or uninstall the apps you do not want SYNC to find. If the app has a "Ford SYNC" setting, disable that setting in the app's settings menu on the phone.

### **SYNC System Reset**

The SYNC system in your vehicle has System Reset feature that can be performed if the function of a SYNC feature is lost. This reset is intended to restore functionality and will not erase any information previously stored in the system (Such as paired devices, phonebook, call history, text messages, or user settings). To perform a System Reset, press and hold the Seek Up (>>) button while pressing and holding the Radio Power button. Release both buttons after 2-3 seconds. Please allow a few minutes for the reset to complete. After a few minutes has passed you can resume using the SYNC system.

# SYNC™ 3 (If Equipped)

## GENERAL INFORMATION

 **WARNING:** Driving while distracted can result in loss of vehicle control, crash and injury. We strongly recommend that you use extreme caution when using any device that may take your focus off the road. Your primary responsibility is the safe operation of your vehicle. We recommend against the use of any hand-held device while driving and encourage the use of voice-operated systems when possible. Make sure you are aware of all applicable local laws that may affect the use of electronic devices while driving.

## Getting to Know Your System

The SYNC 3 system allows you to interact with a variety of features using the touchscreen and voice commands. By integrating with your Bluetooth enabled phone, the touchscreen provides easy interaction with audio, multimedia, climate control, navigation, and your phone's SYNC 3 compatible apps.

### Using the Touchscreen

To operate the touchscreen, you can simply touch the item or option that you want to select. The button changes color when you select it.

The SYNC 3 layout allows you to quickly select the feature you wish to use.



E269856



## SYNC™ 3 (If Equipped)

Item	Menu Item	Action and Description
A	Status Bar	This bar displays icons and messages pertaining to current system activities including climate settings, voice commands and phone functions such as text messages.
B	Home	This button is available on the main screens. Pressing it takes you to the home screen view.
C	Clock	This shows the current time. You can set the clock manually or have it controlled by the vehicle's GPS location. See <b>Settings</b> (page 390).
D	Outside Temperature	This displays the current outside temperature.
E	Feature Bar	You can touch any of the buttons on this bar to select a feature.

The touchscreen allows you quick access to all of your comfort, navigation, communication and entertainment options. Using the status and feature bar you can quickly select the feature you want to use.

**Note:** *Your system is equipped with a feature that allows you to access and control audio features for 10 minutes after you switch the ignition off (and no doors open).*

### The Status Bar

Additional icons also display in the status bar depending on market, vehicle options and current operation. If a feature is not active, the icon does not display. Certain icons may move to the left or right depending on what options are active.

## SYNCTM 3 (If Equipped)

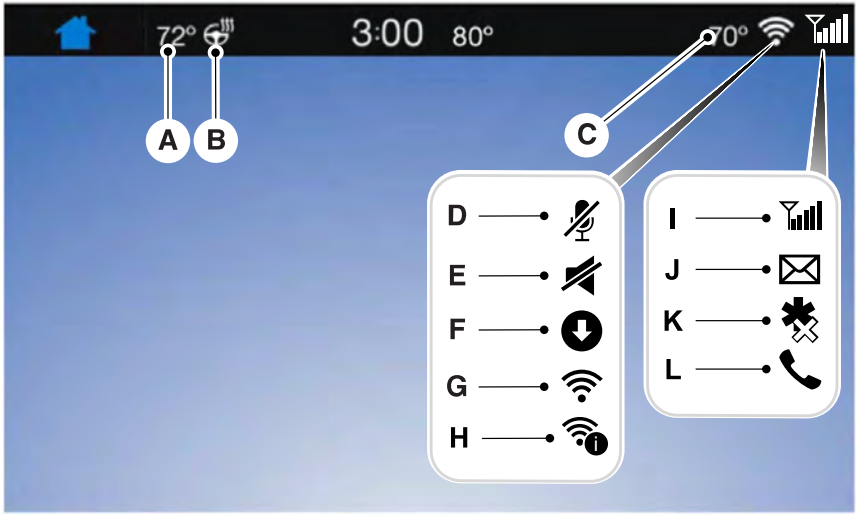

E270077

Callout	Item	Description
A	Driver Temperature	This shows the temperature the driver selects through the climate control system.
B	Heated steering wheel (If equipped)	When you activate the heated steering wheel option on the touch screen, this icon displays. It only displays when there is not a physical button for the heated steering wheel.
C	Passenger Temperature	When the passenger's temperature has been adjusted and is no longer linked to the driver's temperature, it displays here. If Dual is turned off and the temperatures are linked, the passenger's temperature does not display.
D	Microphone Mute	This icon displays when your phone's microphone is muted. A caller cannot hear you.
E	Mute	This icon displays when the audio system is muted.

## SYNC™ 3 (If Equipped)

Callout	Item	Description
F	Download	This icon appears when SYNC 3 receives a software update. Pressing the icon shows more details about the new software.
G	Wi-Fi	This icon appears if a Wi-Fi network is connected.
H	Wi-Fi in Range	An available Wi-Fi network is within range.
I	Signal Strength	This icon displays the phone signal strength and the roaming signal strength.
J	Text Message	This icon displays when you receive a text message on your phone.
K	911 Assist Off	This icon displays when 911 Assist is set to off and your phone is connected to SYNC.
L	In-Call	This icon displays when a phone call is active.

Messages may also appear in the status bar to provide you with notifications. You can select the message to view the associated feature.

### Feature Bar

Feature Bar Item	Functions
Audio	Allows you to control the media playing in your vehicle. You can control all audio features including AM, FM and satellite radio, CDs, and media streaming over a Bluetooth device or through a USB connection.
Climate	Allows you to adjust the temperature, fan speed and airflow within the vehicle.
Phone	Allows you to make calls, receive calls, and access the phonebook of your connected device.
Navigation (If equipped)	Allows you to see your vehicle's location on a virtual road map, get driving directions to your destination and find points of interest along your route.

## SYNC™ 3 (If Equipped)

Feature Bar Item	Functions
Apps	Connect and control SYNC 3 compatible apps running on your iPhone or Android device. Also, access built-in additional features such as SiriusXM Traffic and Travel Link (if equipped).
	If your vehicle is a hybrid, plug-in hybrid, or electric this is also where your settings and power information is located.
Settings	You can customize your system with various settings for the touchscreen display, feature preferences, and how you want to interact with your vehicle.

### Cleaning the Touchscreen

You can remove fingerprints with a dry, clean, soft cloth.

If dirt or fingerprints are still on the screen, apply a small amount of alcohol to the cloth and try to clean it again.

**Note:** Do not use detergent or any type of solvent to clean the touchscreen.

**Note:** Do not pour or spray alcohol onto the touchscreen.

### Using Voice Recognition

Using voice commands allows you to keep your hands on the wheel and focus on what is in front of you. The system provides feedback through audible tones, prompts, questions and spoken confirmations depending on the situation and the chosen level of interaction (voice settings).

The system also asks short questions (confirmation prompts) when it is not sure of your request or when there are multiple possible responses to your request.

When using voice commands, words and icons may appear in the status bar indicating the status of the voice command session. See **Using Voice Recognition** (page 354).

### Accessing and Adjusting Modes Through Your Vehicle Information Display (If Equipped)

Depending on your vehicle and selected options you may be able to control some of the SYNC 3 features on your information display.

You can make the following adjustments using the information display SYNC 3 screen:

Option	Information
Entertainment	Information for current audio playing.
	Select source.
Navigation	View current road and speed limit (if information is available).

## SYNC™ 3 (If Equipped)

Option	Information			
	View current route, next turn, time to your destination (depending on cluster level), distance to destination (depending on cluster level), and ability to cancel route.			
	If you do not have an active navigation route programed, the compass is shown.			
Phone	If you are not on a call, a call can be made by selecting: <sup>1</sup>			
	All calls	Incoming calls	Outgoing calls	Missed calls
	If you are on a call, the call information is displayed on the information display.			
	If you are receiving a call, you can accept it by selecting OK on the right-hand steering wheel controls.			

<sup>1</sup> Depending on your vehicle options, all of these choices may not display.

Use the **OK** and arrow buttons on the right side of your steering wheel to scroll through the available modes.

The selection menu expands and different options appear.

- Press the up and down arrows to scroll through the modes.
- Press the right arrow to enter the mode, use the left arrow to exit the mode.
- Press the up and down arrows to make adjustments within the chosen mode.
- Press **OK** to confirm your selection.

**Note:** *If your vehicle is not equipped with navigation, compass appears in the display instead of navigation. If you press the right arrow to go into the compass menu, you can see the compass graphic. The compass displays the direction in which the vehicle is traveling, not true direction (for example, if the vehicle is traveling west, the middle of the compass graphic displays west; north displays to the left of west though its true direction is to the right of west).*

### Using the Controls on the Steering Wheel

Depending on your vehicle and option package, you can use different controls on your steering wheel to interact with the touchscreen system in different ways.

**VOL:** Control the volume of audio output.

**Mute:** Mute the audio output.

**Voice:** Press to start a voice session. Press again to stop the voice prompt and immediately begin speaking. Press and hold to end a voice session.

#### SEEK NEXT:

- While in radio mode, press to seek between memory presets.
- While in USB, Bluetooth Audio or CD mode, press to seek between songs or press and hold to fast seek.

#### SEEK PREVIOUS:

- While in radio mode, press to seek between memory presets.
- While in USB, Bluetooth Audio or CD mode, press to seek between songs or press and hold to fast seek.

## SYNC™ 3 (If Equipped)

**PHONE ACCEPT:** Press to answer a call or switch between calls.

**PHONE REJECT:** Press to end a call or reject an incoming call.

**Note:** On some models, **SEEK NEXT** may be combined with **PHONE REJECT** and **SEEK PREVIOUS** may be combined with **PHONE ACCEPT**.

**M:** Touch the control repeatedly to switch between media sources (modes).

See **Steering Wheel** (page 66).

### Using the Controls on the Bezel

Depending on your vehicle and option package, you may also have these controls on your instrument panel:

- **Power:** Switch the audio system on and off.
- **VOL:** Control the volume of playing audio.
- **Seek** and **Tune:** Use as you normally would in audio modes.
- **Eject:** Eject a CD from the audio system.
- **SOURCE** or **MEDIA:** Press repeatedly to advance through available media modes.
- **SOUND:** Press to access the Sound menu where you can adjust sound and other audio settings.
- **1-6:** Press and hold to store or press to select an AM, FM or SIRIUS memory preset. See **Audio System** (page 313).
- **DISP:** Switch the display on or off. You can also touch the screen to switch the display back on.
- **Temperature, fan and climate control buttons:** Control the temperature, fan speed or settings of the climate control system. See **Climate Control** (page 109).

### 911 Assist (If Equipped)



**WARNING:** Unless the 911 Assist setting is set on before a crash, the system will not dial for help which could delay response time, potentially increasing the risk of serious injury or death after a crash.



**WARNING:** Do not wait for 911 Assist to make an emergency call if you can do it yourself. Dial emergency services immediately to avoid delayed response time which could increase the risk of serious injury or death after a crash. If you do not hear 911 Assist within five seconds of the crash, the system or phone may be damaged or non-functional.



**WARNING:** Always place your phone in a secure location in your vehicle so it does not become a projectile or get damaged in a crash. Failure to do so may cause serious injury to someone or damage the phone which could prevent 911 Assist from working properly.

**Note:** The SYNC 911 Assist feature must be set on before the incident.

**Note:** The SYNC 911 Assist feature only operates in the U.S., Canada or in a territory in which 911 is the emergency number.

**Note:** Before setting this feature on, make sure that you read the 911 Assist Privacy Notice later in this section for important information.

**Note:** If any user sets 911 Assist to on or off, that setting applies for all paired phones. If 911 Assist is switched off and the phone is connected to SYNC, an icon displays on the status bar.

## SYNC™ 3 (If Equipped)

**Note:** Every phone operates differently. While SYNC 911 Assist works with most cellular phones, some may have trouble using this feature.

If a crash deploys an airbag (excluding knee airbags and rear inflatable safety belts [if equipped]) or activates the fuel pump shut-off, your SYNC-equipped vehicle may be able to contact emergency services by dialing 911 through a paired and connected Bluetooth enabled phone. You can learn more about the 911 Assist feature, by visiting:

Website
<a href="http://www.owner.ford.com">www.owner.ford.com</a> <a href="http://www.syncmyride.ca">www.syncmyride.ca</a> <a href="http://www.syncmaroute.ca">www.syncmaroute.ca</a>

For important information about airbag deployment and the fuel pump shut-off please see the Supplementary Restraints and Roadside Emergencies sections of your owner manual.

To switch 911 Assist on and off please view the settings information. See **Settings** (page 390).

To make sure that 911 Assist works correctly:

- SYNC must be powered and working properly at the time of the incident and throughout feature activation and use.
- The 911 Assist feature must be set on before the incident.
- You must pair and connect a Bluetooth enabled and compatible cell phone to SYNC.
- A connected Bluetooth enabled phone must have the ability to make and maintain an outgoing call at the time of the incident.

- A connected Bluetooth enabled phone must have adequate network coverage, battery power and signal strength.
- The vehicle must have battery power and be located in the U.S., Canada or in a territory in which 911 is the emergency number.

### In the Event of a Crash

Not all crashes will deploy an airbag or activate the fuel pump shut-off (the triggers for 911 Assist). If a connected cell phone sustains damage or loses its connection to SYNC during a crash, SYNC will search for and try to connect to a previously paired cell phone; SYNC will then attempt to call the emergency services.

Before making the call:

- SYNC provides a short window of time (about 10 seconds) to cancel the call. If you fail to cancel the call, SYNC attempts to dial 911.
- SYNC says the following, or a similar message: "SYNC will attempt to call 911, to cancel the call, press Cancel on your screen or press and hold the phone button on your steering wheel."

If you do not cancel the call, and SYNC makes a successful call, a pre-recorded message plays for the 911 operator, and then the occupant(s) in your vehicle is able to talk with the operator. Be prepared to provide your name, phone number and location immediately, because not all 911 systems are capable of receiving this information electronically.

# SYNC™ 3 (If Equipped)

## 911 Assist May Not Work If

- Your cellular phone or 911 Assist hardware sustains damage in a crash.
- The vehicle's battery or the SYNC system has no power.
- The phone(s) thrown from your vehicle are the ones paired and connected to the system.

## 911 Assist Privacy Notice

When you switch on 911 Assist, it may disclose to emergency services that your vehicle has been in a crash involving the deployment of an airbag or activation of the fuel pump shut-off. Certain versions or updates to 911 Assist may also be capable of electronically or verbally disclosing to 911 operators your vehicle location or other details about your vehicle or crash to assist 911 operators to provide the most appropriate emergency services. If you do not want to disclose this information, do not switch the feature on.

## Safety Information



**WARNING:** Driving while distracted can result in loss of vehicle control, crash and injury. We strongly recommend that you use extreme caution when using any device that may take your focus off the road. Your primary responsibility is the safe operation of your vehicle. We recommend against the use of any hand-held device while driving and encourage the use of voice-operated systems when possible. Make sure you are aware of all applicable local laws that may affect the use of electronic devices while driving.

- Do not attempt to service or repair the system. Have an authorized dealer check your vehicle.
- Do not operate playing devices if the power cords or cables are broken, split or damaged. Place cords and cables out of the way, so they do not interfere with the operation of pedals, seats, compartments or safe driving abilities.
- Do not leave playing devices in your vehicle during extreme conditions as it could cause them damage. See your device's user guide for further information.
- For your safety, some SYNC 3 functions are speed-dependent. Their use is limited to when your vehicle is traveling at speeds under 3 mph (5 km/h). Make sure that you review your device's manual before using it with SYNC 3.

## Speed-restricted Features

Some features of this system may be too difficult to use while your vehicle is moving so they are restricted from use unless your vehicle is stationary.

- Screens crowded with information, such as Point of Interest reviews and ratings, SiriusXM Traffic and Travel Link sports scores, movie times or ski conditions.
- Any action that requires you to use a keyboard is restricted, such as entering a navigation destination or editing information.
- All lists are limited so the user can view fewer entries (such as phone contacts or recent phone call entries).

See the following table for more specific examples.



## SYNC™ 3 (If Equipped)

<b>Restricted features</b>	
Cellular Phone	Pairing a Bluetooth phone.
	Browsing of list entries is limited for phone contacts and recent phone calls.
System Functionality	Editing the keypad code.
	Enabling Valet Mode.
	Editing settings while the rear view camera or active park assist are active.
Wi-Fi	Editing Wi-Fi settings.
	Editing the list of wireless networks.
	Connecting to a new Wi-Fi network.
Text Messages	Viewing received text messages.
Navigation	Using the keyboard to enter a destination.
	Adding or editing Navigation Favorites entries or Avoid Areas.

### Creating a SYNC Owner Account

Why do I need a SYNC owner account?

- Essential for keeping up with the latest software and connected features.
- Access to customer support for any questions you may have.
- Maintain account permissions.

Visit the website to sign up and register.

<b>Website</b>
<a href="http://www.owner.ford.com">www.owner.ford.com</a> <a href="http://www.syncmyride.ca">www.syncmyride.ca</a>

<b>Website</b>
<a href="http://www.syncmaroute.ca">www.syncmaroute.ca</a>

### FordPass™ Connect (If Equipped)

With a FordPass-equipped vehicle, you can use FordPass to track your vehicle's location and remotely access vehicle features such as start, lock and unlock and vehicle status including fuel level and approximate mileage. You can also schedule specific times to remotely start your vehicle so it's ready to hit the road as soon as you are. FordPass is available through a free download via the Apple App Store® or Google Play™. Message and data rates may apply. Services may be limited by mobile phone network coverage area.

## Updating Your System

You can choose to download the update onto a USB drive or use Wi-Fi to deliver automatic updates.

### USB Updates

To use the USB update you need to log into your owner account and visit the SYNC software update page.

Website
<a href="http://www.owner.ford.com">www.owner.ford.com</a> <a href="http://www.syncmyride.ca">www.syncmyride.ca</a> <a href="http://www.syncmaroute.ca">www.syncmaroute.ca</a>

The website notifies you if an update is available. You can then select to download the update.

You will need an empty USB drive. Please check the website for minimum requirements. Once you have inserted the USB drive into your computer, choose to start the download. Follow the instructions provided to download the files to the USB drive.

The installation of most files occurs in the background, and does not interrupt your use of the system. Navigation updates cannot be installed in the background, because the files are too large.

To install the update in your vehicle, remove anything that is plugged in the USB ports on the media hub and plug in the USB drive containing the update. When the USB drive is plugged in, the installation should begin immediately. After a successful installation, the update is available the next time the vehicle is started.

Please reference the website for any further actions.

## Updating Over Wi-Fi

To update your System over Wi-Fi your vehicle must be connected to a Wi-Fi access point. Data rates may apply.

### To connect your system to Wi-Fi, select:

Menu Item	
Settings	
Wi-Fi	
Available Wi-Fi Networks	You can then select your Wi-Fi network. You may have to enter the security code if the network is secured. The system confirms when it has connected to the network.

You must also give the system permission to update automatically. Upon vehicle delivery, the System asks you if you would like to use the automatic update feature. If you agree to automatic updates, you can press OK to confirm. If this selection does not appear upon vehicle delivery you can access it through the General Settings. See **Settings** (page 390). You can also perform a master reset. See **SYNC™ 3 Troubleshooting** (page 404).

## If you would like to switch this feature on later, select:

Menu Item	
Settings	
General	
Automatic System Updates	From this menu, you can enable automatic updates. If you have not done so already, the system prompts you to set up a Wi-Fi connection when you enable this feature.

When the system is connected via Wi-Fi and automatic updates are enabled, your system checks for software updates periodically. If a new version is available, it downloads at that time. Software downloads can take place for up to 30 minutes after you have switched your vehicle off. The updates do not interrupt the normal use of your SYNC 3 system. If a download does not complete for any reason, the download continues where it left off at the next Wi-Fi connected opportunity. Upon activation of an update, a banner displays on the touchscreen indicating the system update. Select the icon to see more detail. This icon displays for two ignition cycles.

## To switch this feature off:

Menu Item	
Settings	
General	
Automatic System Updates	In this menu selection, you can change the selection for automatic updates to OFF.

## Customer Assistance

The SYNC support team is available to help you with any questions you are not able to answer on your own.

Monday-Saturday, 8:30am-8:00pm EST.

United States: 1-800-392-3673.

Canada: 1-800-565-3673.

Mexico: 01-800-719-8466.

Times are subject to change due to holidays.

## Privacy Information

When you connect a cellular phone to SYNC 3, the system creates a profile within your vehicle that links to that cellular phone. This profile helps in offering you more cellular features and operating more efficiently. Among other things, this profile may contain data about your cellular phone book, text messages (read and unread), and call history, including history of calls when your cell phone was not connected to the system. In addition, if you connect a media device, the system creates and retains an index of supported media content. The system also records a short diagnostic log of approximately 10 minutes of all recent system activity. The log profile and other system data may be used to improve the system and help diagnose any problems that may occur.

The cellular profile, media device index, and diagnostic log remain in your vehicle unless you delete them and are generally accessible only in your vehicle when the cellular phone or media player is connected.

If you no longer plan to use the system or your vehicle, we recommend you perform a Master Reset to erase all stored information. You can find more information about the Master Reset in General Settings. See **Settings** (page 390). System

## SYNC™ 3 (If Equipped)

data cannot be accessed without special equipment and access to your vehicle's SYNC 3 module. Ford Motor Company, Ford of Canada and The Lincoln Motor Company do not access the system data for any purpose other than as described absent consent, a court order, or where

required by law enforcement, other government authorities, or other third parties acting with lawful authority. Other parties may seek to access the information independently of Ford Motor Company, Ford of Canada and The Lincoln Motor Company.

### HOME SCREEN

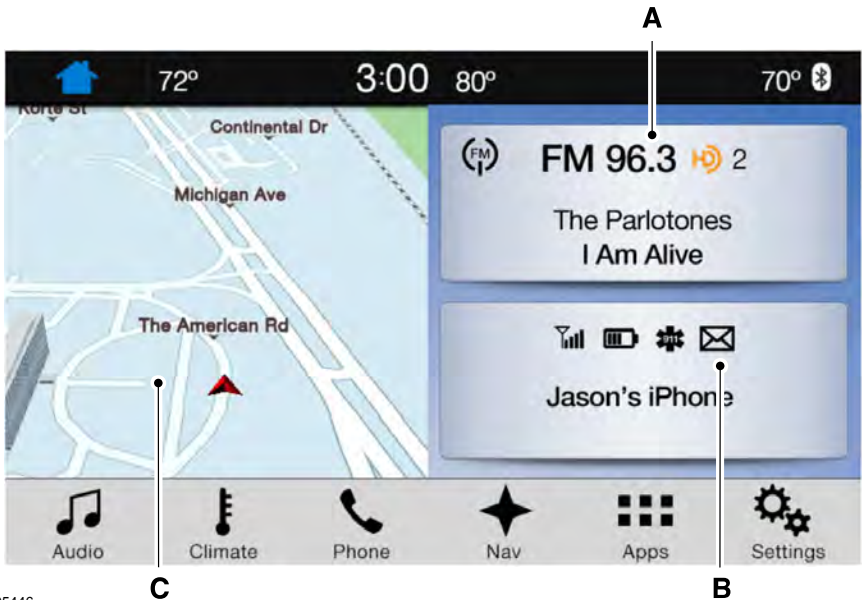

E205446

Item	Title	Home screen display
A	Audio	Shows the active media source.

## SYNC™ 3 (If Equipped)

Item	Tile	Home screen display
		If your vehicle does not have navigation, this space contains the compass.
B	Phone	The name of the connected phone appears on the screen. The status of the phone features also appear. This includes signal strength, battery charge, 911 assist setting state (On or Off), text messaging and roaming.
C	Navigation <sup>1</sup>	This map displays your current location or current route in real time. When you have navigation active, you also see the next turn and the length of time and distance to your destination. If your vehicle does not have navigation, this space contains the audio information.

<sup>1</sup> If equipped.

You can touch any of the feature displays to access that feature.

Anytime you select the home button, the system returns you to this screen.

### USING VOICE RECOGNITION

The SYNC 3 system allows you to use voice commands, to control features like audio and climate controls. By using voice commands, you can keep your hands on the wheel and your eyes on the road.

You can access each feature controlled by SYNC 3 through a variety of commands.



To activate the SYNC 3 voice commands push the voice button on the steering wheel and wait for the prompt.

\_\_\_ is a dynamic listing, meaning that it can be the name of anything, such as artist, the name of contact or number. The context and the description of the command tell you what to say for this dynamic option.

There are some commands that work for every feature, these commands are:

Voice Command	Action and Description
Main Menu	Brings you to the main menu.
Go back	Returns you to the previous screen.
Cancel	Ends the voice session.
List of Commands	Gives you a list of possible voice commands.
___ List of Commands	You can name any feature and the system gives a list of commands available for the feature. For example, you could say:

## SYNC™ 3 (If Equipped)

Voice Command	Action and Description
	Phone List of Commands
	Navigation List of Commands
Next Page	You can use this command to view the next page of options on any screen where multiple pages of choices are given.
Previous Page	You can use this command to view the previous page of options on any screen where multiple pages of choices are given.
Help	Gives you available commands you can use on the current screen.

Included here are some of the most popular commands for each SYNC 3 feature.

### Audio Voice Commands

\_\_\_ is a dynamic listing, meaning that for audio voice commands it can be the name of a Sirius channel or a channel number, a radio frequency number, or the name of an artist, album, song or a genre.

**To control the media features, press the voice button and when prompted, say:**

Voice command	Description
Sirius Channel ___ 1	You can say the Sirius channel name or number such as "Sirius channel 16".
You can also turn to a Sirius channel by saying the channel's name, such as "The Pulse".	
AM ___ FM ___	Allows you to tune to a specific FM or AM frequency such as "FM 88.7" or "AM 1580".
FM ___ HD ___ 1	Allows you to tune to a specific HD frequency such as "FM 88.7 HD 1".
Bluetooth Audio	Allows you to listen to music on your Bluetooth connected device.
USB	Allows you to listen to music on your USB connected device.
Play Genre ___ Play Playlist ___ Play Artist ___ Play Album ___	For USB audio only, you can say the name of an artist, album, song or a genre to listen to that selection. Your system must finish indexing before this option is available. For example, you could say "Play artist The Beatles" or "Play song Penny Lane".

## SYNC™ 3 (If Equipped)

Voice command	Description
Play Podcast ___ Play Song ___ Play Audiobook ___	
Browse ___ Browse Artist ___ Browse Album ___ Browse Genre ___ Browse Playlist ___ Browse Audiobook ___ Browse Podcast ___	For USB audio only, you can say the name of an artist, album, or a genre to browse by that selection. Your system must finish indexing before this option is available. For example you can say "Browse artist The Beatles" or "Browse genre folk".

<sup>1</sup> This option may not be available in all markets or may require a subscription.

### Climate Voice Commands (If Equipped)

You can control the temperature of the vehicle using voice commands.

\_\_\_ is a dynamic listing, meaning that for climate voice commands it can be the desired degrees for the temperature setting.

#### To adjust the temperature, say:

Voice command	Description
Set Temperature ___	Adjust the temperature between 60–85°F (15.5–29.5°C).

## Phone Voice Commands

### Pairing a Phone

You can use voice commands to connect your Bluetooth enabled phone to the system.

#### To pair your phone, press the voice button and when prompted, say:

Voice command	Description
Pair Phone	Follow the on-screen instructions to complete the pairing process. See <b>Settings</b> (page 390).

# SYNC™ 3 (If Equipped)

## Making Calls

\_\_\_ is a dynamic listing, meaning that for

phone voice commands it can be the name of the contact you wish to call or the digits you want to dial.

### Press the voice button and say a command similar to the following:

Voice command	Description
Call ___	Allows you to call a specific contact from your phonebook such as "Call Jenny".
Call ___ at ___	Allows you to call a specific contact from your phonebook at a specific location such as "Call Jenny at Home".
Dial ___	Allows you to dial a specific number such as "Dial 867-5309".

Please make sure that you are saying the contact name exactly as it appears in your contact list.

### Once you have provided the digits of the phone number, you can say the following commands:

Voice Command	Description
<0-9>	If you did not enter the full number with the first command, you can continue saying the number.
Dial	Tells SYNC 3 to make the phone call.
Delete	Tells SYNC 3 to erase the last block of digits you state.
Clear	Tells SYNC 3 to erase the entire number.

## Text Message Voice Commands

### To access text message options, press the voice button and say:

Voice command	Description
Listen to Message	
Listen to text message ___	You can say the number of the message you would like to hear.
Reply to Message	



# SYNC™ 3 (If Equipped)

## Navigation Voice Commands (If Equipped)

### Setting a Destination

You can use any of the following commands to set a destination or find a

point of interest.

\_\_\_ is a dynamic listing, meaning that for navigation voice commands it can be a POI category or a major brand name, where major brand name is a chain with more than 20 locations

### You can find an address, a point of interest (POI), or search for points of interest by category:

Voice command	Description
Find an Address	Allows you to enter the address search functionality. You can also search for an address in a specific state or province.
Find a ___	State the name of the POI category or major brand name you would like to search for such as "Find restaurants".
Find a POI	Allows you to enter the POI search functionality.
Find an Intersection	Allows you to enter the intersection search functionality.
Find the Nearest <POI Category>	State the name of a POI category or major brand name you would like to search for.
Show Previous Destinations	Allows you to see a list of your previous destinations.
Show Favorites	Allows you to see a list of your favorite destinations.
Drive Home	Allows you to route to your home address.
Drive to Work	Allows you to route to your work address.

### In addition, you can say these commands when a route is active:

Voice command	Description
Cancel Route	Cancels the current route.
Detour	Allows you to select an alternate route.
Repeat Instruction	Repeats the last guidance prompt.
Show Route	Displays the active route.
Route Summary	Displays the list of upcoming maneuvers.

## SYNC™ 3 (If Equipped)

Voice command	Description
Where Am I	Provides current location.
Zoom in	Allows you to zoom in on the map.
Zoom out	Allows you to zoom out from the map.

### Mobile App Voice Commands (If Equipped)

The following voice commands are always available:

Voice command	Description
Mobile Apps	SYNC 3 will prompt you to say the name of an app to start it on SYNC 3.
List Mobile Apps	SYNC 3 will list all of the currently available Mobile Apps.
Find Mobile Apps	SYNC 3 will search and connect to compatible app(s) running on your mobile device.

There are also voice commands that you can use when app(s) are connected to SYNC 3:

Voice command	Description
Say the name of an app	At any time, you can say the name of a mobile app to start the mobile app on SYNC 3.
Say the name of an app, followed by help	SYNC 3 will list the available voice commands for the specified app if the app is running on SYNC 3.

### SiriusXM Traffic and Travel Link Voice Commands (If Equipped)

SiriusXM Traffic and Travel Link may not be available in all markets. Activation and a subscription are required.

## SYNC™ 3 (If Equipped)

**You can say the following commands to access SiriusXM Traffic and Travel Link:**

Voice command	Description
Show Traffic	Displays a list of traffic incidents.
Show Weather Map	Displays the current weather map.
Show Fuel Prices	Displays a list of fuel prices.
Show 5 Day Forecast	Displays the 5 day weather forecast.
Help	

### Voice Settings Commands

**You can say the following commands to access the voice settings:**

Voice command	Description
Voice Settings	Allows you to enter the voice settings functionality.
Interaction Mode Standard	Sets standard prompting with longer prompts.
Interaction Mode Advanced	Sets advanced prompting with shorter prompts.
Call Confirmation On	Allows the system to confirm before making a phone call.
Call Confirmation Off	The system does not confirm before placing a call.
Voice Command Lists On	The system displays a short list of available commands.
Voice Command Lists Off	The system does not display the list of commands.

You can use the volume control to adjust the volume of the system voice prompts. While prompt is active, adjust the volume control up or down to your desired setting.

**Note:** Depending on the current climate control settings, the fan speed may automatically go down while issuing voice commands or while making and receiving phone calls via SYNC to reduce the amount of background noise in the vehicle. The fan speed will automatically return to normal operation once the voice session ends. You can adjust the fan speed during a voice session, simply press the fan buttons (or turn the fan knob) to increase or decrease the fan speed to the setting you prefer.

## SYNC™ 3 (If Equipped)

To disable this automatic fan speed reduction feature during voice sessions, press and hold the climate control AC and Recirculated air buttons simultaneously, release and then increase fan speed within 2 seconds. To re-enable this feature, repeat the above sequence.

### ENTERTAINMENT

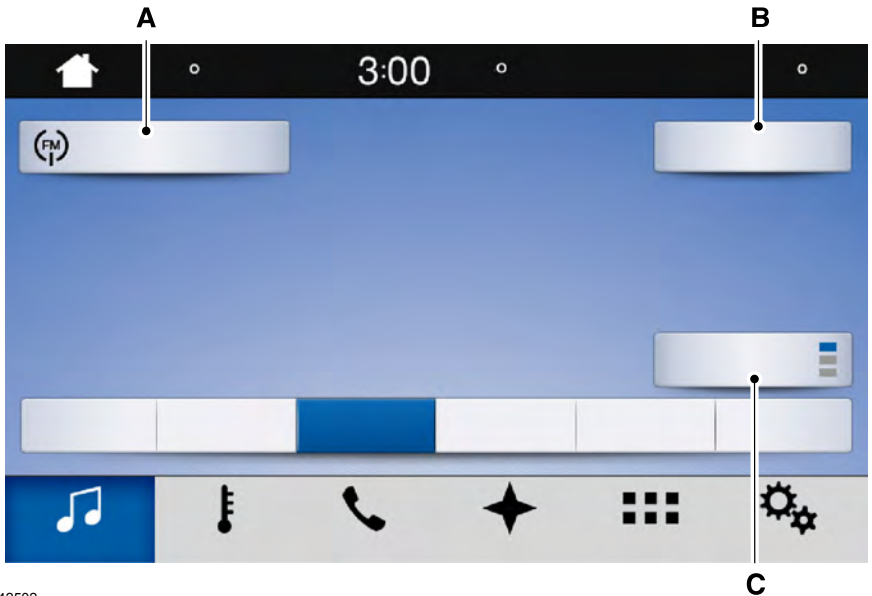

E242502

Message	Message and Description
A	Sources
B	Direct Tune
C	Presets

## SYNC™ 3 (If Equipped)

**Note:** Your vehicle may allow you to save presets from different audio sources on the same page.

You can access these options using the touchscreen or voice commands.

### Sources

Press this button to select the source of media you want to listen to.

Menu Item	
AM	
FM	
SIRIUS <sup>1</sup>	
CD <sup>1</sup>	
USB	The name of the USB that is plugged in displays here.
Bluetooth Stereo	
Apps	If you have SYNC 3 compatible apps on your connected smart phone, they display here as individual source selections.

<sup>1</sup> This feature may not be available in all markets and requires an active subscription.

### AM/FM Radio

#### Tuning a Station

You can use the tune or seek controls on the radio bezel to select a station.

#### To tune a station using the touchscreen, select:

Menu Item
Direct Tune

A pop up appears, allowing you to type in the frequency of a station. You can only enter a valid station for the source you are currently listening to.

You can press the backspace button to delete the previously entered number.

#### Once you have entered the station's call numbers, you can select:

Menu Item	Action and Description
Enter	Press to begin playing the station you have entered.
Cancel	Press to exit without changing the station.

### Presets

To set a new preset, tune to the station and then press and hold one of the memory preset buttons. The audio mutes briefly while the system saves the station and then returns.

## SYNC™ 3 (If Equipped)

There are two preset banks available for AM and three banks for FM. To access additional presets, tap the preset button. The indicator on the preset button shows which bank of presets you are currently viewing.

### SiriusXM® Satellite Radio (If Activated)

**Note:** *This feature may not be available in all markets and requires an active subscription.*



E234451

SiriusXM satellite radio is a subscription-based satellite radio service that broadcasts a variety of music, sports, news, weather, traffic and entertainment programming. Your factory-installed SiriusXM satellite radio system includes hardware and a limited subscription term that begins on the date of sale or lease of your vehicle. See an authorized dealer for availability.

For more information on extended subscription terms (a service fee is required), the online media player and a list of SiriusXM satellite radio channels, and other features, please visit [www.siriusxm.com](http://www.siriusxm.com) in the United States, [www.siriusxm.ca](http://www.siriusxm.ca) in Canada, or call SiriusXM at 1-888-539-7474.

**Note:** *SiriusXM reserves the unrestricted right to change, rearrange, add or delete programming. This includes canceling, moving or adding particular channels, and its prices, at any time, with or without notice to you. We are not responsible for any such programming changes.*

**Note:** *This receiver includes the eCos real-time operating system. eCos is published under the eCos License.*

### The following buttons are available for SiriusXM:

Menu Item	Action and Description	
Browse	Touch this button to see a list of available stations.	
Direct Tune	A pop-up appears, allowing you to type in the call numbers of a station. Once you enter the stations call numbers, you can select:	
	Enter	The system tunes to the station you select.
	Cancel	You exit the pop-up and the current station continues to play.
	You can press the backspace button to delete the previous number.	

## SYNC™ 3 (If Equipped)

Menu Item	Action and Description	
Replay	Replay audio on the current channel. You can replay approximately 45 minutes of audio as long as you remain tuned to the current station. Changing stations erases the previous audio.	
	Live	When you are in replay mode, you are not able to select a different preset until you return to live audio. Pressing this button returns you to the live broadcast.
ALERT	Save the current song, artist, or team as a favorite. The system alerts you when it plays again on any channel. Selecting this button allows you to enable and edit alerts. See <b>Settings</b> (page 390).	

### Memory Presets

To set a preset, tune to the station then press and hold one of the memory preset buttons. The audio mutes briefly while the system saves the station and returns once the station is stored.

There are three preset banks available for SiriusXM. To access additional presets, tap the preset button. The indicator on the preset button shows which bank of presets you are currently viewing.

### Satellite Radio Electronic Serial Number (ESN)

You need your ESN to activate, modify or track your satellite radio account. See **Settings** (page 390).

### SiriusXM Satellite Radio Reception Factors and Troubleshooting

Potential Reception Issues	
Antenna obstructions	For optimal reception performance, keep the antenna clear of snow and ice build-up and keep luggage and other materials as far away from the antenna as possible.
Terrain	Hills, mountains, tall buildings, bridges, tunnels, freeway overpasses, parking garages, dense tree foliage and thunderstorms can interfere with your reception.
Station overload	When you pass a ground-based broadcast-repeating tower, a stronger signal may overtake a weaker one and the audio system may mute.
Satellite radio signal interference	Your display may show ACQUIRING... to indicate the interference and the audio system may mute.

## SYNCTM 3 (If Equipped)

<b>Troubleshooting Tips</b>		
<b>Message</b>	<b>Cause</b>	<b>Action</b>
Acquiring Signal	Radio requires more than two seconds to produce audio for the selected channel.	No action required. This message should disappear shortly.
Satellite antenna fault SIRIUS system failure	There is an internal module or system failure present.	If this message does not clear shortly, or with an ignition key cycle, your receiver may have a fault. See an authorized dealer for service.
Invalid Channel	The channel is no longer available.	Tune to another channel or choose another preset.
Unsubscribed Channel	Your subscription does not include this channel.	Contact SiriusXM at 1-888-539-7474 to subscribe to the channel, or tune to another channel.
Satellite acquiring signal...	The signal is lost from the SiriusXM satellite or SiriusXM tower to your vehicle antenna.	The signal is blocked. When you move into an open area, the signal should return.
Updating...	Update of channel programming in progress.	No action required. The process may take up to three minutes.
Questions? Call 1-888-539-7474	Your satellite service is no longer available.	Contact SiriusXM at 1-888-539-7474 to resolve subscription issues.
None found. Check channel guide.	All the channels in the selected category are either skipped or locked.	Use the channel guide to turn off the Lock or Skip function on that station.
SIRIUS Subscription updated	SiriusXM has updated the channels available for your vehicle.	No action required.

### **HD Radio™ Information (If Available)**

**Note:** *This feature may not be available in all markets.*

To activate HD radio, please see the Radio Settings in the Settings Chapter. See **Settings** (page 390).

**Note:** *HD Radio broadcasts are not available in all markets.*



## SYNC™ 3 (If Equipped)

HD Radio technology is the digital evolution of analog AM/FM radio. Your system has a special receiver that allows it to receive digital broadcasts (where available) in addition to the analog broadcasts, it already receives. Digital broadcasts provide a better sound quality than analog broadcasts with free, crystal-clear audio and no static or distortion. For more information, and a guide to available stations and programming, please visit:

<b>Website</b>
<a href="http://www.hdradio.com">www.hdradio.com</a>

When HD Radio is on and you tune to a station broadcasting HD Radio technology, you may notice the following indicators on your screen:



E142616

### When HD Radio broadcasts are active, you can access the following functions:

Message	Action and Description
Presets	Allows you to save an active channel as a memory preset. Touch and hold a memory preset slot until the sound returns. There is a brief mute while the radio saves the station. Sound returns when the channel saves. When switching to an HD2 or HD3 memory preset, the sound mutes before the digital audio plays, because the system has to reacquire the digital signal.

**Note:** As with any station you save, you cannot access the saved station if your vehicle is outside the station's reception area.

The HD logo is grey when acquiring a digital station, and then changes to orange when digital audio is playing. When this logo is available, you may also see Title and Artist fields on-screen.

The multicast indicator appears in FM mode (only) if the current station is broadcasting multiple digital broadcasts. The highlighted numbers signify available digital channels where new or different content is available. HD1 signifies the main programming status and is available in analog and digital broadcasts. Other multicast stations (HD2 through HD7) are only available digitally.

**Note:** There is also an additional feature for stations that have more than 1 HD multicast (For example, HD1 or HD2). The HD logo and Radio text appears as a button. Pressing this button allows you to cycle through all of the HD stations on that specific frequency. For example, if you are on 101.1 and it has HD1, HD2, HD3, pressing the button repeatedly causes the radio to cycle through the HD stations in a cyclic increasing order.

## SYNCTM 3 (If Equipped)

### HD Radio Reception and Station Troubleshooting

<b>Potential Reception Issues</b>	
Reception area	<p>If you are listening to a multicast station and you are on the fringe of the reception area, the station may mute due to weak signal strength.</p> <p>If you are listening to HD1, the system changes back to the analog broadcast until the digital broadcast is available again. However, if you are listening to any of the possible HD2-HD7 multicast channels, the station mutes and stays muted unless it is able to connect to the digital signal again.</p>
Station blending	<p>When the system first receives a station (aside from HD2-HD7 multicast stations), it first plays the station in the analog version. Once the receiver verifies the station is an HD Radio station, it shifts to the digital version. Depending on the station quality, you may hear a slight sound change when the station changes from analog to digital. Blending is the shift from analog to digital sound or digital back to analog sound.</p>

In order to provide the best possible experience, use the contact form to report any station issues found while listening to a station broadcasting with HD Radio technology. Independent entities own and operate each station. These stations are responsible for ensuring all audio streams and data fields are accurate.

<b>Potential Station Issues</b>		
<b>Issues</b>	<b>Cause</b>	<b>Action</b>
Echo, stutter, skip or repeat in audio. Increase or decrease in audio volume.	This is poor time alignment by the radio broadcaster.	No action required. This is a broadcast issue.
Sound fading or blending in and out.	The radio is shifting between analog and digital audio.	No action required. The reception issue may clear up as you continue to drive.
There is an audio mute delay when selecting HD2 or HD3, multicast preset or Direct Tune.	The digital multicast is not available until the HD Radio broadcast is decoded. Once decoded, the audio is available.	No action required. This is normal behavior. Wait until the audio is available.

## SYNC™ 3 (If Equipped)

Potential Station Issues		
Issues	Cause	Action
Cannot access HD2 or HD3 multicast channel when recalling a preset or from a direct tune.	The previously stored multicast preset or direct tune is not available in your current reception area.	No action required. The station is not available in your current location.
Text information does not match currently playing audio.	Data service issue by the radio broadcaster.	Fill out the station issue form. <sup>1</sup>
There is no text information shown for currently selected frequency.	Data service issue by the radio broadcaster.	Fill out the station issue form. <sup>1</sup>

<sup>1</sup> You can find the form here:

Website
<a href="http://hdradio.com/stations/feedback">http://hdradio.com/stations/feedback</a>

HD Radio Technology manufactured under license from iBiquity Digital Corporation and foreign patents. HD Radio and the HD and HD Radio logos are proprietary trademarks of DTS. The vehicle manufacturer and DTS are not responsible for the content sent using HD Radio technology. Content may be changed, added or deleted at any time at the station owner's discretion.

### CD (If equipped)

Once you select this option, the system returns you to the main audio screen.

The current audio information appears on the screen.

### The following buttons are also available:

Button	Function
Browse	You can use the browse button to select a track.
Repeat	Select this button and a small number one displays to indicate the track is set to repeat.

## SYNC™ 3 (If Equipped)

Button	Function
	For MP3 CDs, this button allows you to toggle through repeat off, repeat one track (a small number one displays), and repeat current folder (a small folder displays).
Shuffle	Select the shuffle symbol to have the audio on the disk play in random order.

You can use the forward, reverse, pause or play buttons to control the audio playback.

### Bluetooth Stereo or USB

Bluetooth Stereo and USB allow you to access media that you store on your Bluetooth device or USB device such as music, audio books or podcasts.

### The following buttons are available for Bluetooth and USB:

Button	Function
Repeat	Pressing the repeat button toggles the repeat setting through three modes: repeat off (button not highlighted), repeat all (button highlighted) and repeat track (button highlighted with a small number one).
Shuffle	Play the tracks in random order.

You can use the forward, reverse, pause or play buttons to control the audio playback.

To get more information about the currently playing track, press the cover art or Info button.

For some devices, SYNC 3 is able to provide 30-second skip buttons when you listen to audio books or podcasts. These buttons allow you to skip forward or backward within a track.

While playing audio from a USB device you can look for certain music by selecting the following:

Button	Function
Browse	If available, displays the list of tracks in the Now Playing playlist.
New Search	This option, which is available under browse, allows you to play all tracks or to filter the available media into one of the below categories.
	Play All

## SYNC™ 3 (If Equipped)

Button	Function
	Playlists
	Artist
	Albums
	Songs
	Genres
	Podcasts
	Audio books
	Composers
A-Z Jump	This button allows you to choose a specific letter to view within the category you are browsing.
Explore Device	If available, this allows you to browse the folders and files on your USB device.

### USB Ports

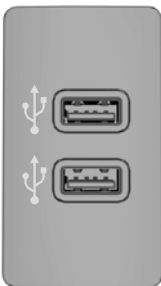

E211463

The USB ports are in the center console or behind a small access door in the instrument panel.

This feature allows you to plug in USB media devices, memory sticks, flash drives or thumb drives, and charge devices if they support this feature.

Select this option to play audio from your USB device.

### Apps

The system supports the use of certain audio apps such as iHeartRadio through a USB or Bluetooth enabled device.

Each app gives you different on-screen options depending on the app's content. See **Apps** (page 387).

### Supported Media Players, Formats and Metadata Information

The system is capable of hosting nearly any digital media player, including iPod, iPhone, and most USB drives.

Supported audio formats include MP3, WMA, WAV, AAC, and FLAC.

Supported audio file extensions include MP3, WMA, WAV, M4A, M4B, AAC, and FLAC.

## SYNC™ 3 (If Equipped)

Supported USB file systems include: FAT, exFAT, and NTFS.

SYNC 3 is also able to organize the media from your USB device by metadata tags. Metadata tags, which are descriptive software identifiers embedded in the media files, provide information about the file.

If your indexed media files contain no information embedded in these metadata tags, SYNC 3 may classify the empty metadata tags as unknown.

SYNC 3 is capable of indexing up to 50,000 songs per USB device, for up to 10 devices.

### CLIMATE

Touch the climate button on the touchscreen to access your climate control features.

**Note:** You can switch temperature units between Fahrenheit and Celsius. See **Settings** (page 390).

#### Accessing the Climate Control Menu



Touch the button to access additional controls for the front climate system.

#### Directing the Airflow



Touch the button to direct airflow to the windshield air vents and de-mister.



Touch the button to direct airflow to the instrument panel air vents.



Touch the button to direct airflow to the footwell air vents.

You can direct air through any combination of these air vents.

#### Setting the Blower Motor Speed



Touch up or down to increase or decrease the volume of air that circulates in your vehicle.

#### Setting the Temperature

Touch up or down on the left-hand temperature control to set the left-hand temperature.

**Note:** This control also adjusts the right-hand side temperature when you switch off dual zone mode.

Touch up or down on the right-hand temperature control to set the right-hand temperature.

#### Switching Auto Mode On and Off



Touch the button to switch on automatic operation, then set the temperature.

The system adjusts the blower motor speed, air distribution, air conditioning operation, and outside or recirculated air to reach and maintain the temperature you have set.

#### Switching the Air Conditioning On and Off



A pop-up appears on the screen to display the air conditioning options.

**MAX A/C:** Touch the button to activate and maximize cooling. The driver and passenger temperatures are set to LO, recirculated air flows through the instrument panel vents, air conditioning automatically turns on and the fan automatically adjusts to the highest speed.

## SYNC™ 3 (If Equipped)

**A/C:** Touch to switch the air conditioning on or off. Use A/C with recirculated air to improve cooling performance and efficiency.

**Note:** In certain conditions, such as maximum defrost, the air conditioning compressor may continue to operate even though you switch off the air conditioning.

### Switching the Climate Control On and Off



Touch the button.

### Switching the Climate Controlled Seats On and Off



Touch the button to cycle through the various climate controlled seat settings and off.

### Switching Dual Zone Mode On and Off



Touch the button to switch on temperature control for the right-hand side of the vehicle.

### Switching the Heated Exterior Mirrors On and Off



Touch the button.

### Switching the Heated Rear Window On and Off



Touch the button to clear the rear window of thin ice and fog.

### Switching the Heated Seats On and Off



Touch the button to cycle through the various heat settings and off.

### Switching the Heated Steering Wheel On and Off



Touch the button.

### Switching Maximum Air Conditioning On and Off



Touch the button for maximum cooling.

Recirculated air flows through the instrument panel air vents, air conditioning turns on and the blower motor adjusts to the highest speed.

### Switching Maximum Defrost On and Off



Touch the button for maximum defrosting.

Air flows through the windshield air vents, and the blower motor adjusts to the highest speed.

You can also use this setting to defog and clear the windshield of a thin covering of ice.

**Note:** To prevent window fogging, you cannot select recirculated air when maximum defrost is on.

**Note:** The heated rear window also turns on when you select maximum defrost.

### Switching Recirculated Air On and Off



Touch the button to switch between outside air and recirculated air.

The air currently in the passenger compartment recirculates. This may reduce the time needed to cool the interior, when used with **A/C**, and reduce unwanted odors from entering your vehicle.

## SYNCTM 3 (If Equipped)

**Note:** Recirculated air may turn off, or prevent you from switching on, in all air flow modes except **MAX A/C** to reduce the risk of fogging. Recirculation may also turn on and off in various air distribution control combinations during hot weather to improve cooling efficiency.

### Switching the Ventilated Seats On and Off



Touch the button to cycle through the various ventilated seat settings and off.

### Accessing Rear Climate Controls



Touch the button to access additional controls for the rear climate system.

### Rear Climate Control Lock Indicator



Touch the button. When on, you can only operate the rear passenger settings through the front controls.

### Switching Rear Auto Mode On and Off



Touch the button to switch on rear automatic operation, then set the temperature.

### Switching the Rear Climate Controlled Seats On and Off



Touch the button to cycle through the various climate controlled seat settings and off.

### Switching the Rear Heated Seats On and Off



Touch the button to cycle through the various heat settings and off.

### Switching the Rear Ventilated Seats On and Off



Touch the button to cycle through the various ventilated seat settings and off.

## PHONE



**WARNING:** Driving while distracted can result in loss of vehicle control, crash and injury. We strongly recommend that you use extreme caution when using any device that may take your focus off the road. Your primary responsibility is the safe operation of your vehicle. We recommend against the use of any hand-held device while driving and encourage the use of voice-operated systems when possible. Make sure you are aware of all applicable local laws that may affect the use of electronic devices while driving.

Hands-free calling is one of the main features of the system. Once you pair your cell phone, you can access many options using the touchscreen or voice commands. While the system supports a variety of features, many are dependent on your cell phone's functionality.

### Pairing Your Cell Phone for the First Time

Pair your Bluetooth enabled phone with the system before using the functions in hands-free mode.



## SYNC™ 3 (If Equipped)

Switch on Bluetooth on your device to begin pairing. See your phone's manual if necessary.

### To add a phone, select:

Menu Item
Add a Bluetooth Device

1. Follow the on-screen instructions.
2. A prompt alerts you to search for the system on your phone.
3. Select your vehicle on your phone.
4. Confirm that the six-digit number appearing on your phone matches the six-digit number on the touchscreen.
5. The touchscreen indicates when the pairing is successful.
6. Your phone may prompt you to give the system permission to access information. To check your phone's compatibility, see your phone's manual or visit the website.

### Alternatively, to add a phone, select:

Menu Item
Add a Bluetooth Device
<b>Then select:</b>
Discover Other Bluetooth Devices

1. Follow the on-screen instructions.
2. Select your phone's name when it appears on the touchscreen.
3. Confirm that the six-digit number appearing on your phone matches the six-digit number on the touchscreen.
4. The touchscreen indicates when the pairing is successful.
5. Your phone may prompt you to give the system permission to access information. To check your phone's compatibility, see your phone's manual or visit the website.

At a minimum, most cell phones with Bluetooth wireless technology support the following functions:

- Answering an incoming call.
- Ending a call.
- Dialing a number.
- Call waiting notification.
- Caller identification.

Other features, such as text messaging using Bluetooth and automatic phonebook download, are phone-dependent features.

### Phone Menu

This menu becomes available after pairing a phone.

## SYNCTM 3 (If Equipped)

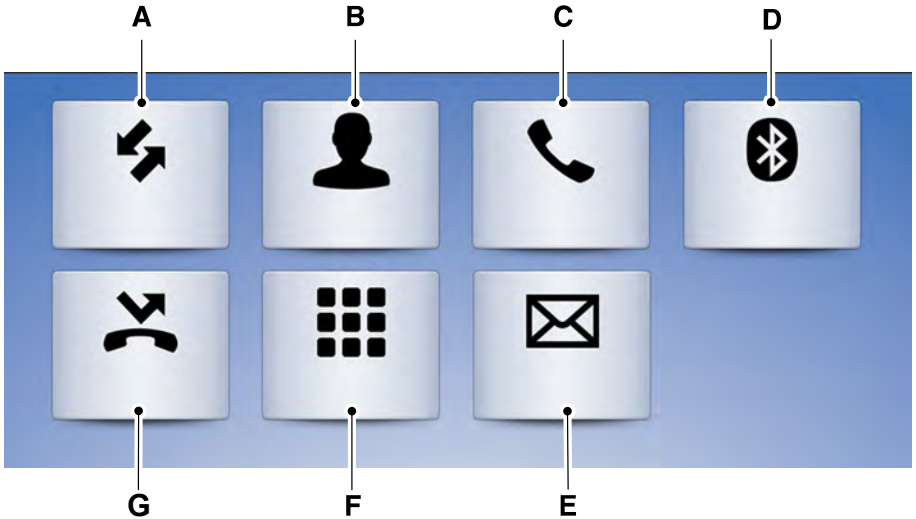

E251249

Item	Menu Item	Action and Description			
A	Recent Call List	Displays your recent calls. You can place a call by selecting an entry from this list. You can also sort the calls by selecting the drop down menu at the top of the screen. You can choose:			
		All	Incoming	Outgoing	Missed
B	Contacts	All of your contacts from your phone display in alphabetical order.			
		A-Z Jump		Selecting this button allows you to choose a specific letter to view.	
C	Phone Settings	Displays the name of your phone and takes you to the phone settings options. From this menu, you can pair subsequent devices, set ring tones and alerts.			

## SYNC™ 3 (If Equipped)

Item	Menu Item	Action and Description
D	Change Device	Gives you access to the list of paired or connected Bluetooth devices allowing you to change or select a device.
E	Text Messages	Displays all recent text messages.
F	Phone Keypad	Use this keypad to dial in a phone number. Use the backspace button to delete numbers.
		Call
G	Do Not Disturb	Touch this button to reject all incoming calls automatically. Text message notifications do not display on the screen. All ringtones and alerts are set to silent.

Users with phones having voice services may see a button to access the feature. For example, iPhone users see a Siri button. A press and hold of the voice button on the steering wheel also accesses this feature.

### Making Calls

There are many ways to make calls from the SYNC 3 system, including using voice commands. See **Using Voice Recognition** (page 354). You can use the touchscreen to place calls as well.

## SYNC™ 3 (If Equipped)

### To call a number in your contacts, select:

Menu Item	Action and Description
Contacts	You can then select the name of the contact you want to call. Any numbers stored for that contact display along with any stored contact photos. You can then select the number that you want to call. The system begins the call.

### To call a number from your recent calls, select:

Menu Item	Action and Description
Recent Call List	You can then select an entry that you want to call. The system begins the call.

### To call a number that is not stored in your phone, select:

Menu Item	Action and Description
Phone Keypad	Select the digits of the number you wish to call.
Call	The system begins the call.

Pressing the backspace button deletes the last digit you typed.

## Receiving Calls

During an incoming call, an audible tone sounds. Caller information appears in the display if it is available.

### To accept the call, select:

Menu Item
Accept

**Note:** You can also accept the call by pressing the phone button on the steering wheel.

### To reject the call, select:

Menu Item
Reject

**Note:** You can also reject the call by pressing the phone button on the steering wheel.

Ignore the call by doing nothing. SYNC 3 logs it as a missed call.

## During a Phone Call

During a phone call, the contacts name and number display on the screen along with the call duration.

The phone status items are also visible:

- Signal Strength.
- Battery.

You can select any of the following during an active phone call:

## SYNC™ 3 (If Equipped)

Item	
End Call	Immediately end a phone call. You can also press the button on the steering wheel.
Keypad	Press this to access the phone keypad.
Mute	You can switch the microphone off so the caller does not hear you.

Item	
Privacy	Transfer the call to the cell phone or back to SYNC 3.

### Text Messaging

**Note:** Downloading and sending text messages using Bluetooth are cell phone-dependent features.

**Note:** Certain features in text messaging are speed-dependent and not available when your vehicle is traveling at speeds over 3 mph (5 km/h).

### Receiving a Text Message

**When a new message arrives, an audible tone sounds and the screen displays a pop-up with the sender name and ID, if supported by your cell phone. You can select:**

Menu Item	Action and Description
Hear It	Have SYNC 3 read the message to you.
View	View the text on the touchscreen.
Call	To call the sender.
Reply	You can select from 15 preset messages. Press the message that you would like to use and confirm to send the message. SYNC 3 confirms when the message is sent successfully.
Close	To exit the screen.

### Smartphone Connectivity (If Equipped)

SYNC 3 allows you to use Apple CarPlay and Android Auto to access your phone.

When you use Apple CarPlay or Android Auto, you can:

- Make calls.
- Send and receive messages.
- Listen to music.
- Use your phone's voice assistant.

Apple CarPlay and Android Auto disable some SYNC 3 features.

Most Apple CarPlay and Android Auto features use mobile data.

#### Apple CarPlay

Apple CarPlay requires an iPhone 5 or newer with iOS 7.1 or newer. Updating to the latest iOS version is recommended.

1. Plug your phone into a USB port. See **USB Port** (page 323).

## SYNC™ 3 (If Equipped)

- Follow the prompts on the touchscreen.
- Follow the prompts that appear on your phone to allow access to Apple CarPlay.

After completing the setup, your phone connects to CarPlay automatically when plugged into a USB port.

### To disable this feature from the Settings screen, select:

Menu Item
Apple CarPlay Preferences
Your device is listed if SYNC detects Apple CarPlay. Select the name of your device and set the Apple CarPlay switch to off.

To return to SYNC 3, go to the Apple CarPlay home screen and select the SYNC app.

**Note:** Contact Apple for Apple CarPlay support.

### Android Auto

Android Auto is compatible with most devices with Android 5.0 or newer.

- Download the Android Auto app to your device from Google Play to prepare your device (this may require mobile data usage).

**Note:** The Android Auto App may not be available within your current market.

- Plug your device into a USB port. See **USB Port** (page 323).
- Follow the prompt on the touchscreen.
- Follow the prompts that appear on your device.

**Note:** You may be prompted to update additional apps on your device (this may require mobile data usage).

### To disable this feature from the Settings screen, select:

Menu Item
Android Auto Preferences
Your device is listed if SYNC detects Android Auto. Select the name of your device and set the Android Auto switch to off.

**Note:** You may need to slide your Settings screen to the left to select **Apple CarPlay Preferences** or **Android Auto Preferences**.

To return to SYNC 3, select the speedometer icon in the Android Auto menu bar at the bottom of the touchscreen, and then touch the option to return to SYNC.

**Note:** Contact Google for Android Auto support.

## NAVIGATION (IF EQUIPPED)

Your navigation system is comprised of two main features, destination mode and map mode.

### Map Mode

Map mode shows advanced viewing comprised of 2D city maps, 3D landmarks and 3D city models (when available). 2D city maps show detailed outlines of buildings, visible land use, landscape features, and detailed railroad infrastructure for the most essential cities around the globe.

3D landmarks appear as clear, visible objects that are typically recognizable and have a certain tourism value.

## SYNC™ 3 (If Equipped)

3D city models are complete 3D models of entire city areas including navigable roads, parks, rivers and rendered buildings. 3D landmarks and city models appear in 3D map mode only. Coverage of these varies and improves with updated map releases.



Select the zoom in icon to see a closer view of the map.



Select the zoom out icon to see a farther away view of the map.

You can adjust the view in preset increments. You can also pinch to zoom in or out of the map.

The information bar tells you the names of streets, cities or landmarks as you hover over them with the crosshair cursor.

You can change your view of the map by tapping on the location indicator icon on the right hand side of the screen. You can choose from the following options:



**Heading up (2D map)** This always shows the direction of forward travel to be upward on the screen. This view is available for map scales up to 3 mi (5 km).

N



**North up (2D map)** always shows the northern direction to be upward on the screen.

3D



**3D map mode** provides an elevated perspective of the map. Adjust this viewing angle and rotate the map 180 degrees by touching the map twice, and

then dragging your finger along the shaded bar with arrows at the bottom of the map.



Re-center the map by pressing this icon whenever you scroll the map away from your vehicle's current location.



**Mute:** Press to mute the audio navigation guidance. Press the button again to un-mute the guidance.



### Points of Interest (POI)

**grouping icon:** You can choose up to three POI icons to display on the map. If the chosen POIs are located close together or are

at the same location a box is used to display a single category icon instead of repeating the same icon, in order to reduce clutter. When you select the box on the map, a pop-up appears indicating how many POIs are in this location. Select the pop up to see a list of the available POIs. You can scroll through and select POIs from this list.

If your vehicle is low on charge or fuel, station icons automatically display on the map.

If you have subscribed to SiriusXM Traffic and Travel Link (where available), traffic flow will be indicated on the map by green (clear), yellow (slowing), and red (stopped) road highlights. Traffic flow is indicated where the information is available and varies across the US.

You can choose to display traffic icons on the map representing twelve different types of incidents. See **Settings** (page 390).

You can set a destination by hovering above a location and selecting:

# SYNCTM 3 (If Equipped)

<b>Button</b>
---------------

<b>Button</b>
Start

## Destination Mode

**To set a destination, press:**

Menu Item	Description
Destination	
Enter a navigation destination in any of the following formats:	
Search	Street Address (number, street, city, state) For example "12 Mainstreet Dearborn MI"
	Partial Address (number, street) if searching in current state (number, street and zip code (or postal code in Canada)) if searching out of state You can enter unique addresses that contain door number prefixes with or without the prefix. For example, you could enter "6N340 Fairway Lane" or "340 Fairway Lane".
	City (name or zip code)
	Point of Interest (name or category)
	Intersection (street 1 / street 2) (street 1 and street 2) (street 1 & street 2) (street 1 @ street 2) (street 1 at street 2)
	Latitude and Longitude (##.##### , ##.#####) This is in a decimal degrees format, one to six decimal places are accepted.
	You are given autocomplete options below the address bar to select as you type.



## SYNC™ 3 (If Equipped)

Menu Item	Description	
	If you do not give an exact destination, a menu displays with your possible selections.	
Previous Destinations	Collections of your last 40 navigation destinations display here. You can select any option from the list to select it as your destination.	
	Delete All	Select this option to remove all previous destinations.
Home	Select to navigate to your set Home destination. The time it takes to travel from your current location to Home displays. To set your Home, press:	
	Home	A prompt appears asking if you would like to create a favorite for home. Select:
	Yes	Enter a location into the search bar and press:
	Save	
Work	Select to navigate to your set Work destination. The time it takes to travel from your current location to Work displays. To set your Work:	
	Work	A prompt appears asking if you would like to create a favorite for work. Select:
	Yes	Enter a location into the search bar and press:
	Save	
Favorites	Favorites include any location you have previously saved. To add Favorites:	
	Add a Favorite	Select this button and enter a location into the destination bar.
	Search	Select this option to have the system locate the address you have entered.
	Save	Select this button when the address you have entered appears on the screen.
	The address saves as a favorite and you see the favorites screen. You can now select this address from the favorites screen.	
Point of Interest (POI) Categories	POI categories that may display (based on market and vehicle configuration):	
	Food	

## SYNCTM 3 (If Equipped)

Menu Item	Description
	Fuel
	Hotel
	ATM
See All	Press to view additional categories. Once you have selected a category, follow the menus to find what you are looking for.
	Inside of these categories you can search by:
	Nearby
	Along Route
	Near Destination
	In a City

### Once you have chosen your destination, press:

Menu Item	Action and Description	
Save	This saves the destination to your favorites.	
Start	This shows you a map of your entire route. You can then choose your route from three different options.	
	Fastest	Uses the fastest moving roads possible.
	Shortest	Uses the shortest distance possible.
	Economical Route	Uses the most fuel-efficient route.
	The time and distance for each route also displays.	
Cancel	On the route screen, you can choose to cancel the current navigation. The system asks for confirmation then returns you to the map mode screen.	

### Once you have chosen your destination, press:

Menu Item	Action and Description
Start	The system uses a variety of screens and prompts to guide you to your destination.

# SYNC™ 3 (If Equipped)

Menu Item	Action and Description
	<p>During Route guidance, you can press the maneuver arrow icon on the map if you want the system to repeat route guidance instructions. When the system repeats the last guidance instruction, it updates the distance to the next guidance instruction, since it detects that the vehicle is moving.</p> <p>The navigation map shows your estimated time of arrival, remaining travel time and the distance to your destination.</p> <p>SYNC 3 may not always announce vehicle arrival at the exact point of your destination and you may have to cancel a route manually.</p>

## Navigation Menu

In map mode and during active navigation you can access the navigation menu.

During active navigation, touch the bottom of the screen to view the menu and other buttons.

### To access the Navigation menu, press:

Button		
Menu		
<b>You can then select:</b>		
Screen View	Full Map	A full screen map displays during navigation.
	Highway Exit Info	Highway exit information displays on the right hand side of the screen during navigation. Points of interest icons display for restaurants, hotels, fuel stations and ATMs when they are present at the exit. You can select the POI icons to receive a listing of specific locations. You can select the POI location as a waypoint or destination if desired.
	Turn List	<p>Only available during an active route. Displays all of the turns on the current route.</p> <p>You can choose to avoid any road on the turn list by selecting the road from the list. A screen then appears and you can press:</p>
	Avoid	
		The system calculates a new route and displays a new turn list.
Traffic List	You can find the SiriusXM Traffic and Travel Link information by pressing this button. This information requires an active subscription to SiriusXM Traffic and Travel Link.	

## SYNCTM 3 (If Equipped)

<b>Button</b>				
	When a route is not active, a list of nearby traffic incidents displays (if any are present). When a route is active, you can choose to display a list of traffic nearby or on the route.			
Navigation Settings	Press this button to adjust your preferences. See <b>Settings</b> (page 390).			
Where Am I?	Provides your current location city and the nearest road.			
The following are only available on the menu during an active navigation route:				
Cancel Route	The system asks for confirmation and then returns you to the map mode screen.			
View Route	Press this to see a map of the full route.			
Detour	An alternate route displays in comparison with the current route.			
Edit Waypoints	Only available if you have an active waypoint on your route. See <b>Waypoints</b> later in this section for information on how to set waypoints.			
	Use this button to re-order or remove your waypoints.			
	<table border="1" style="width: 100%;"> <tr> <td style="width: 30%;">You can also have the system set the order for you by pressing:</td> <td>Optimize Order</td> </tr> <tr> <td>To return to your route press:</td> <td>Go</td> </tr> </table>	You can also have the system set the order for you by pressing:	Optimize Order	To return to your route press:
You can also have the system set the order for you by pressing:	Optimize Order			
To return to your route press:	Go			

### Waypoints

You can add a waypoint to a navigation route as a destination along your route.

To add a waypoint:

1. Select the search icon (magnifying glass) while on an active route. This brings up the destination menu.
2. Set your destination using any of the given methods. Once the destination has been selected, the screen allows you to set the destination as a waypoint by selecting:

## SYNC™ 3 (If Equipped)

Menu Item	
Add Waypoint	The waypoint list then appears and you are able to re-order all of your waypoints by selecting the menu icon on the right hand side of the location. You can select up to five waypoints.
You can also have the system set the order for you by pressing:	Optimize Order
To return to your route, press:	Go

### SYNC AppLink

The AppLink app allows you to use some SYNC 3 navigation features on your phone.

#### First Mile Navigation

When you switch your ignition off, the location of your vehicle is recorded and sent to your SYNC AppLink app. The location of your vehicle can be viewed within the app. You can also view walking directions to your vehicle.

#### Last Mile Navigation

When you park near your destination, the system provides walking directions to your destination.

#### POI Search

Your paired phone can be used to access additional points of interest (POI). These points of interest can only be accessed when your phone is paired.

#### Send To Car

You can send destinations to your navigation system using a computer or phone using AppLink.

### cityseeker (If Equipped)

**Note:** *cityseeker point of interest (POI) information is limited to approximately 1,110 cities (1,049 in the United States, 36 in Canada and 15 in Mexico).*



E225487

cityseeker, when available, is a service that provides more information about certain points of interest such as restaurants, hotels and attractions.

When you have selected a point of interest, the location and information appear, such as address, phone number and a star rating.

Press **More Information** to see a photo, a review, a list of services and facilities, the average room or meal price and the web address. This screen displays the point of interest icons.

## SYNC™ 3 (If Equipped)

For restaurants, cityseeker can provide information such as star rating, average cost, review, handicap access, hours of operation, and website address.

For hotels, cityseeker can provide information such as star rating, price category, review, check-in and checkout times, hotel service icons and website address. Hotel service icons include:

- Restaurant
- Business center
- Handicap facilities
- Laundry
- Refrigerator
- 24 hour room service
- Fitness center
- Internet access
- Pool
- Wi-Fi

Attractions include nearby landmarks, amusement parks, historic buildings and more. cityseeker can provide information such as star rating, reviews, hour of operation and admission price.

### **SiriusXM Traffic and Travel Link (If Equipped)**

SiriusXM Traffic and Travel Link is available on vehicles equipped with navigation and only in select markets. You must activate and subscribe to receive SiriusXM Traffic and Travel Link information. It helps you locate the best gas prices, find movie listings, get current traffic alerts, view the weather map, get accurate ski conditions and see current sports scores. See **Apps** (page 387).

The system calculates a reasonable efficient route based on available speed limits, traffic, and road conditions. You may know a local short cut that is more efficient at a given time than the route provided by SYNC 3, but you should expect a slight difference in minutes or miles with the SYNC 3 route.

### **Navigation Map Updates**

Annual navigation map updates are available for purchase through your dealership, by calling 1-866-462-8837 in the United States and Canada or 01-800-557-5539 in Mexico. You can also visit:

Website
<a href="http://www.navigation.com/sync">www.navigation.com/sync</a>

You need to specify the make and model of your vehicle to determine if there is an update available.

HERE is the digital map provider for the navigation application. If you find map data errors, you may report them directly to HERE by going to [www.here.com/mapcreator](http://www.here.com/mapcreator). HERE evaluates all reported map errors and responds with the result of their investigation by e-mail.

Map coverage includes the USA (including Puerto Rico and the US Virgin Islands), Canada and Mexico.

### **APPS**

The system enables voice, steering wheel, and touch screen control of SYNC 3 AppLink enabled smartphone apps.

Once an app is running through AppLink, you can control main features of the app through voice commands and steering wheel controls.

## SYNC™ 3 (If Equipped)

**Note:** Available AppLink enabled apps will vary by market.

**Note:** You must pair and connect your smartphone via Bluetooth to SYNC 3 to access AppLink.

**Note:** iPhone users may have to connect the phone to a USB port with an Apple USB cable.

**Note:** For information on available apps, supported smartphone devices and troubleshooting tips please visit:

Websites
owner.ford.com www.syncmyride.ca www.syncmaroute.ca

**Note:** Make sure you have an active account for the app that you have downloaded. Some apps will work automatically with no setup. Other apps will want you to configure your personal settings and personalize your experience by creating stations or favorites. We recommend you do this at home or outside of your vehicle.

**Note:** We encourage you to review the smartphone app's terms of service and privacy policies because Ford is not responsible for your app or its use of data.

**Note:** AppLink is a native SYNC system feature. Accessing mobile apps through AppLink is only possible when Android Auto or Apple CarPlay are disabled. Some apps may only be accessible in the car through AppLink and others only through Android Auto or Apple CarPlay. Please refer to the Smartphone Connectivity information to disable Android Auto or Apple CarPlay.

**Note:** In order to use an app with SYNC 3, the app needs to be running in the background of your phone. If you shut down the app on your phone, it shuts down the app on SYNC 3 as well.

**Note:** If a SYNC 3 AppLink compatible app is not shown in the Apps Domain, make sure the required app is running on the mobile device.

Menu Item	Action and Description
Find Mobile Apps	SYNC 3 will search and connect to compatible app(s) running on your mobile device.

### Enabling SYNC 3 Mobile Apps

In order to enable mobile apps, SYNC 3 requires user consent to send and receive app authorization information and updates using the data plan associated with the connected device.

The connected device sends data to Ford in the United States. The information is encrypted and includes your VIN, SYNC 3 module number, odometer, usage statistics and debugging information. We retain this data for only as long as necessary to provide this service, troubleshoot, and improve products and services and to offer you products and services that may interest you where allowed by law.

**Note:** You must enable mobile apps for each connected device the first time you select a mobile app using the system.

**Note:** Ford reserves the right to limit functionality or deactivate mobile apps at any time.

**Note:** Standard data rates apply. Ford is not responsible for any additional charges you may receive from your service provider, when your vehicle sends or receives data through the connected device. This includes any additional charges incurred due to driving in areas when roaming out of a home network.

## SYNC™ 3 (If Equipped)

You can enable and disable apps through settings. See **Settings** (page 390).

### App Permissions

The system organizes the App permissions into groups. You can grant these group permissions individually. You can change a permission group status any time when not driving, by using the settings menu. While in the settings menu, you can also see the data included in each group.

When you launch an app using SYNC 3, the system may ask you to grant certain permissions, for example Vehicle information, Driving characteristics, GPS and Speed, and/or Push notifications. You can enable all groups or none of them during the initial app permissions prompts. The settings menu offers individual group permission control.

**Note:** You are only prompted to grant permissions the first time you use an app with SYNC 3.

**Note:** If you disable group permissions, apps will still be enabled to work with SYNC 3 unless you deactivate All Apps in the settings menu.

### SiriusXM Traffic and Travel Link (If Equipped)



**WARNING:** Driving while distracted can result in loss of vehicle control, crash and injury. We strongly recommend that you use extreme caution when using any device that may take your focus off the road. Your

primary responsibility is the safe operation of your vehicle. We recommend against the use of any hand-held device while driving and encourage the use of voice-operated systems when possible. Make sure you are aware of all applicable local laws that may affect the use of electronic devices while driving.

**Note:** SiriusXM Traffic and Travel Link may not be available in all markets.

**Note:** In order to use SiriusXM Traffic and Travel Link, your vehicle must have navigation.

**Note:** A paid subscription is required to access and use these features. Go to [www.siriusxm.com/travellink](http://www.siriusxm.com/travellink) for more information.

**Note:** Visit [www.siriusxm.com/traffic](http://www.siriusxm.com/traffic) and click on Coverage map and details for a complete listing of all traffic areas covered by SiriusXM Traffic and Travel Link.

**Note:** Neither Sirius nor Ford is responsible for any errors or inaccuracies in the SiriusXM Traffic and Travel Link services or its use in vehicles.

When you subscribe to SiriusXM Traffic and Travel Link, it can help you locate the best gas prices, find movie listings, get current traffic alerts, view the current weather map, get accurate ski conditions and see scores to current sports games.



## SYNC™ 3 (If Equipped)

Menu Item	Action and Description	
Traffic on Route	Touch these buttons to identify traffic incidents on your route, near your vehicle's current location or near any of your favorite places, if programmed.	
Traffic Nearby		
Fuel Prices	Touch this button to view fuel prices at stations close to your vehicle's location or on an active navigation route.	
Movie Listings	Touch this button to view nearby movie theaters and their show times, if available.	
Weather	Touch this button to view the nearby weather, current weather, or the five-day forecast for the chosen area.	
	Map	Select to see the weather map, which can show storms, radar information, charts and winds.
	Area	Select to choose from a listing of weather locations.
Sports Info	Touch this button to view scores and schedules from a variety of sports. You can also save up to 10 favorite teams for easier access. The score automatically refreshes when a game is in progress.	
Ski Conditions	Touch this button to view ski conditions for a specific area.	

### Sound

Pressing this button allows you to adjust the following:

### SETTINGS

Under this menu, you can access and adjust the settings for many of the system features. To access additional settings, swipe the screen left or right.

Sound Settings	
Reset All	Returns Treble, Midrange, and Bass sound settings to factory levels.
Treble	Adjusts the high frequency level.
Midrange	Adjusts the middle frequency level.
Bass	Adjusts the low frequency level.
Balance / Fade	Adjusts the sound ratio from side to side or front to back.

## SYNC™ 3 (If Equipped)

Sound Settings	
Speed Compensated Vol.	Adjusts the amount the audio system volume increases with speed, or turns the feature off.
Occupancy Mode	Optimizes the sound based on the location of the listeners.
Sound Settings	Stereo
	Surround

Your vehicle might not have all of these features.

### Media Player

This button is available when a media device such as a Bluetooth Stereo or USB device is the active audio source. Pressing the button allows you to access the following options for active devices only.

Menu Item	Action and Description		
Podcast Speed	For some USB devices, SYNC 3 can adjust the playback speed of podcasts. When a podcast is playing, you can choose:		
	Slower	Normal	Faster
Audiobook Speed	For some USB devices, SYNC 3 can adjust the playback speed of audiobooks. When an audiobook is playing, you can choose:		
	Slower	Normal	Faster
Cover Art Priority	Media Player	Cover art displays from your device's music files. If no cover art for the files exists on the device, then the Gracenote Database provides cover art.	
	Gracenote®	The Gracenote Database supplied cover art is used for your music files. This overrides any cover art from your device.	
Gracenote® Management	Switches on and off Gracenote® to provide metadata information such as genre, artist and album.		

## SYNC™ 3 (If Equipped)

Menu Item	Action and Description
Gracenote® Database Info	This allows you to view the version level of the Gracenote Database.
Device Information	This allows you to view the manufacturer and model number of your media device.
Update Media Index	Erase the stored media information in order to re-index.

You can adjust the following features:

### Clock

To adjust the time, select the up and down arrows on either side of the screen. The arrows on the left adjust the hour and arrows on the right adjust the minute. You can then select AM or PM.

Menu Item	Action and Description
Clock Format	Select how time displays.
Auto Time Zone Update	When active, the clock adjusts to time zone changes. This feature is only available in vehicles with navigation.
Reset Clock to GPS Time	When selected, the vehicle clock resets to GPS satellite time.

The system automatically saves any updates you make to the settings.

### Bluetooth

Pressing this button allows you to access the following:

Menu Item	Action
Bluetooth	On
	Off

You must activate Bluetooth to pair a Bluetooth enabled device.

The processes of pairing a Bluetooth device is the same as pairing a phone. **See Pairing a Device** in Phone settings for how to pair a device and the available options.

### Phone

Pair your Bluetooth enabled phone with the system before using the functions in hands-free mode.

## SYNC™ 3 (If Equipped)

Switch on Bluetooth on your device to begin pairing. See your phone's manual if necessary.

### To add a phone, select:

Menu Item
Add Phone

1. Follow the on-screen instructions.
2. A prompt alerts you to search for the system on your phone.
3. Select your vehicle's make and model as it displays on your phone.
4. Confirm that the six-digit number appearing on your phone matches the six-digit number on the touchscreen.
5. The touchscreen indicates when the pairing is successful.
6. Your phone may prompt you to give the system permission to access information. To check your phone's compatibility, see your phone's manual or visit the website.

### Alternatively, to add a phone, select:

Menu Item
Add Phone
<b>Then select:</b>
Discover Other Bluetooth Devices

1. Follow the on-screen instructions.
2. Select your phone's name when it appears on the touchscreen.
3. Confirm that the six-digit number appearing on your phone matches the six-digit number on the touchscreen.
4. The touchscreen indicates when the pairing is successful.
5. Your phone may prompt you to give the system permission to access information. To check your phone's compatibility, see your phone's manual or visit the website.

Other features, such as text messaging using Bluetooth and automatic phonebook download, are phone-dependent features.

Once you have paired a device you can adjust the following options.

### To check your phone's compatibility, see your phone's manual or visit the website:

Website
owner.lincoln.com www.syncmyride.ca www.syncmaroute.ca

Once you have paired a device you can adjust the following options.

Menu Item	Action and Description
View Devices	
<b>You can then select:</b>	
Add a Bluetooth Device	You can add a Bluetooth enabled device by following the steps in the previous table.
You can select a phone by touching the name of the phone on the screen. You then have the following options:	

## SYNC™ 3 (If Equipped)

Menu Item	Action and Description
Connect	Depending on the status of the device, you can select either of these options to interact with the selected device.
Disconnect	
Make Primary	Allows you to select this device to be your preferred device.
Delete	Removes the selected device from the system.

Press the info icon next to the device name to see phone and device information.

Menu Item	Action and Description	
Manage Contacts		
<b>You can then select:</b>		
Auto-Download Contacts	Enable this option to have SYNC 3 periodically re-download your phonebook to keep your contact list up to date.	
Sort By:	Choose how you would like the system to display your contacts. You can choose:	
	<table border="1" style="width: 100%; border-collapse: collapse;"> <tr> <td style="width: 50%; text-align: center;">First Name</td> <td style="width: 50%; text-align: center;">Last Name</td> </tr> </table>	First Name
First Name	Last Name	
Re-download Contacts	Select this option to re-download your contact list manually.	
Delete Contacts	Select this option to delete the in vehicle contact list. Deleting the in vehicle list does not erase the contact list on the connected phone.	

Menu Item	Action and Description
Set Phone Ringtone	
<b>You can then select:</b>	
No Ringtone	No sound plays when a call comes to your phone.
Use Phone Ringtone	The currently selected ringtone on your phone plays when you receive a call. This option may not be available for all phones. If this option is available, it is the default setting.
You can also select one of the three available ringers.	

## SYNC™ 3 (If Equipped)

Menu Item	Action and Description
Text Messaging	
<b>You can then select:</b>	
No Alert (Silence)	No sound plays when a message comes to your phone.
You can select one of the three available notification sounds.	
Voice Readout	When enabled, a voice prompt alerts you when you receive a new message.

### You can enable and disable the following options as well:

Menu Item	Action and Description
Mute Audio in Privacy	When enabled, vehicle audio (such as radio or apps) is muted for the duration of the phone call even when the phone call is in privacy.
Roaming Warning	When enabled, an alert displays that your phone is roaming when you attempt to place a call.
Low Battery Notification	When enabled, a message displays when the battery on your phone is running low.

## 911 Assist

To activate 911 Assist from the settings screen select:

### Enabling 911 Assist

**Note:** For this feature to work, your cell phone must have Bluetooth and connect with SYNC3.

Menu Item	Action and Description
911 Assist	Press this button to enter the settings screen for this feature. You can switch this feature on and off by sliding the scrollbar as follows.

Slide the scrollbar to switch this feature on.

You can set your contacts in the phone book for emergency quick dialing.

### Setting Emergency Contacts

Ensure the phone book of your cell phone downloaded to SYNC 3.

From the settings screen select:

## SYNC™ 3 (If Equipped)

Menu Item	Action and Description
911 Assist	Press this button to enter the settings screen for this feature.
Set Emergency Contacts	Select this option as it displays on the screen.

Menu Item	Action and Description
Select a Contact	Select this option under <Emergency contact 1>.

The screen lists contacts in the phone book. Select the contact that you want to set as emergency contact. You can set Emergency Contact 2 by same process. You can set two Emergency Contacts in total.

**Note:** After SYNC3 tries to place an emergency call, the Emergency Contact button displays on the touch screen. You need to press the button to call the contact through your Bluetooth phone.

**Note:** If the vehicle is equipped with navigation, a map with your current street information displays on the screen when 911 Assist is in process.

### Radio

This button is available if a Radio source such as AM or FM is the active media source. Pressing the button allows you to access the following features:

Menu Item	Action and Description
FM HD Radio AM HD Radio (Dependent on current radio source, if Available)	Activation of this feature allows you to listen to HD radio broadcasts.
Radio Text	This feature is available when FM Radio is your active media source. Activate this feature to have the system display radio text.
Autoset Presets (AST)	Refresh Selecting this option stores the six strongest stations in your current location to the last preset bank of the currently tuned source.

# SYNCTM 3 (If Equipped)

## SiriusXM

This button is available if SiriusXM is the

active audio source. Pressing the button allows you to access the following features:

Menu Item	Action and Description
Set Category for Seek	If you select a category, seek functions only stop on channels in that category.
Parental Lockout	Select to create a personal identification number (PIN), which allows you to lock or unlock channels. Your initial PIN is 1234.
Edit Alerts	Select to switch on or off songs, artists or teams alerts or delete an alert or delete all alerts.

You can also view your satellite radio Electronic Serial Number (ESN) from this screen. You need this number when communicating with SiriusXM to activate, modify or track your account.

## Navigation

You can adjust many of the Navigation preferences by selecting the following menus.

## Map Preferences

Menu Item	Action and Description
Map Preferences	
<b>Then select any of the following:</b>	
3D City Model	When this option is active, the system shows 3D renderings of buildings.
Breadcrumbs	When enabled, your vehicle's previously traveled route displays with white dots.
POI Icons	Enable this feature to display up to 3 POI icons on the navigation map. A rest area POI icon is displayed on the map regardless of this setting.
	Once this feature is activated you can select the icons you want displayed by selecting:
Incident Map Icons	This menu allows you to choose which incident icons you would like to have displayed on the navigation map.



# SYNC™ 3 (If Equipped)

## Route Preferences

Menu Item	Second Level Messages, Actions and Descriptions		
Route Preferences			
<b>Then select any of the following:</b>			
Preferred Route	Choose to have the system display your chosen route type.		
	Shortest	Fastest	Eco
Always Use ___ Route	Bypass route selection in destination programming. The system only calculates one route based on your preferred route setting. When activated, the system uses your selected route type to calculate only one route to the desired destination.		
Use HOV Lanes	The system selects High Occupancy Vehicle or car pool lanes when providing route guidance.		
Automatically Find Parking	The system searches for and displays available parking locations as you approach your destination.		
Eco Time Penalty	Select a level of cost for the calculated Eco Route. The higher the setting, the longer the time allotment is for the route.		
Dynamic Route Guidance	Enable or disable considering traffic information when planning a route. The system can find a faster route based on heavy traffic flow information or detect a Road Closed incident and find a detour route if possible.		

## Navigation Preferences

Menu Item	Action and Description
Navigation Preferences	
Guidance Prompts	You can adjust how the system provides prompts.
<b>Then select any of the following:</b>	
Voice and Tones	
Voice Only	
Tones Only	

## SYNC™ 3 (If Equipped)

### Navigation Source Selection

The screen lists available alternative navigation sources using Applink.

### Mobile Apps

You can enable the control of compatible mobile apps running on your Bluetooth or USB device on SYNC 3. In order to enable mobile apps, SYNC 3 requires user consent to send and receive app authorization information and updates using the data plan associated with the connected device.

The connected devices send data to us in the United States. The encrypted information includes your VIN, SYNC 3 module number, anonymous usage statistics and debugging information. Updates may take place.

**Note:** *Not all Mobile Apps are compatible with the system.*

**Note:** *Standard data rates apply. We are not responsible for any additional charges you may receive from your service provider, when your vehicle sends or receives data through the connected device.*

Menu Item	Action and Description		
Mobile Apps	On	Enable or disable the use of mobile apps on SYNC 3. Disabling mobile apps in the settings menu disables automatic updates and the use of mobile apps on SYNC 3.	
	Off		
	You can view the status of mobile app permissions in the settings menu.		
Once Mobile Apps is enabled, you have the following options:			
Update Mobile Apps	This provides information on the current state of available app updates.		
	There are three possible statuses:		
	Update Needed	Up-To-Date	Updating Mobile Apps...
	The system has detected a new app requiring authorization or a general permissions update is required.	No update is required.	The system is trying to receive an update.
	Request Update		Select this button if an update is required and you want to request this update manually. For example, when your mobile device is connected to a Wi-Fi hotspot, select:

## SYNC™ 3 (If Equipped)

Menu Item	Action and Description
	Request Update
All Apps	Grant or deny permissions to all apps at once.
There may also be SYNC 3 enabled apps listed under these options.	Grant or deny an individual app particular permissions. App permissions are organized into groups. By pressing the info book icon, you can see which signals are included in each group.

**Note:** *We is not responsible or liable for any damages or loss of privacy relating to usage of an app, or dissemination of any vehicle data that you approve us to provide to an app.*

### General

Access and adjust the system settings, voice features, as well as phone, navigation and wireless settings.

Menu Item	
Language	Select to have the touch-screen display in English, Spanish or French.
Distance	Select to display units in kilometers or miles.
Temperature	Select to display units in Celsius or Fahrenheit.
Touchscreen Beep	Select to have the system beep to confirm choices made through the touch-screen.
About SYNC	Information pertaining to the system and its software.
Software Licenses	Documentation of the software license for the system.
Master Reset	Select to restore factory defaults. This erases all personal settings and personal data.

# SYNC™ 3 (If Equipped)

## Wi-Fi & Hotspot (If Equipped)

Access SYNC Wi-Fi and Vehicle Hotspot settings and information.

## System Wi-Fi

You can access the following:

Menu Item	Action and Description
Wi-Fi	Enable this option to connect to Wi-Fi for SYNC 3 vehicle software updates.
Available Networks	This provides you with a list of available Wi-Fi networks within range.
	Clicking on a network from the list allows you to connect or disconnect from that network. The system may require a security code to connect.
	When you click the information button next to a network, more information about the network displays such as the signal strength, connection status and security type.
Wi-Fi Available Notifications	The system alerts you when your vehicle is parked and a Wi-Fi network is within range if SYNC is not already connected.

## Vehicle Hotspot

You can access the following:

Menu Item	Action and Description
Wi-Fi Hotspot On/Off	Allows you to turn the hotspot on and off.
Settings	Allows you to view and edit hotspot settings such as the SSID and password.
Data Usage	Allows you to view your vehicle's hotspot plan and data usage.
Manage Devices	Allows you to manage devices connected to your hotspot.

**Note:** *The Vehicle Wi-Fi Hotspot (Vehicle Hotspot) may be operational while ignition is On and may remain operational while the ignition is Off.*

**Note:** *Vehicle Hotspot services are provided by the vehicle network carrier, subject to your vehicle network carrier agreement, coverage and availability.*

**Note:** *It is the account owner's responsibility to remove the vehicle from the vehicle network carrier account when ownership of the vehicle is transferred. If the owner would like to remove the vehicle from the account for any reason, please contact your vehicle network carrier for more information.*

## SYNC™ 3 (If Equipped)

**Note:** Data, such as the Vehicle Identification Number (VIN), SIM Card ID, and data plan usage, is shared between us and the vehicle network carrier to provide the Vehicle Hotspot service in accordance with your vehicle network carrier agreement, coverage and availability, and may be used to enable a seamless transition from an old to new embedded modem and to confirm any updates are successfully delivered.

**Note:** For your convenience data usage may be available for monitoring under Settings but may not reflect actual or current usage. The vehicle network carrier is responsible for providing information about your account. Please contact the vehicle network carrier for more information.

**Note:** We may need to update operating system software on your vehicle, including security updates and bug fixes, to keep connected services current, like Vehicle Hotspot, without prior notice to you.

### Camera Settings

**To make adjustments using the touchscreen, select:**

Message	Action and Description
Camera Settings	
<b>Then select from the following:</b>	
Rear Camera Delay	You can enable or disable this option using the slider.

You can find more information on the rear-view camera system in the parking aids chapter of your owner's manual.

### Onboard Modem Serial Number (ESN)

Selecting this button on the settings menu shows you the ESN number for your system. You need this number for certain registrations such as Satellite Radio.

### Ambient Lighting (If Equipped)

Tap a color once to active ambient lighting. This sets the color to the highest intensity.

You can drag the colors up and down to increase or decrease the intensity.

To switch ambient lighting off, press the active color once or drag the active color all the way down to zero intensity.

### Vehicle

**Note:** Your vehicle may not have all of these features.

You can select the following features to update their settings.

### Door Keypad Code

Select this button to add or erase a personal door keypad code. To add or erase a personal code, you first need to enter the five-digit factory set code. You can find this code on the owner's wallet card in the glove box or from your authorized dealer.

# SYNCTM 3 (If Equipped)

## Display

To make adjustments using the touchscreen, select:

Menu Item	Action and Description	
Display Off	The screen goes black and does not display anything. Tap the screen to switch it back on.	
Brightness	Make the screen display brighter or dimmer.	
Mode	You can select:	
	Auto	The screen automatically switches between day and night modes based on the outside light level.
	Day	The screen displays with a light background to enhance daytime viewing.
	Night	The screen displays with a darker background to make nighttime viewing easier.
Auto Dim	Enable this option to automatically dim the display brightness based on ambient lighting conditions.	
Background	Set the background.	
Calm Screen	View less information in the display.	

## Voice Control

You can adjust the voice control settings by selecting the following options.

Menu Item	
Advanced Mode	Enable this option to remove additional voice prompts and confirmations.
Phone Confirmation	Enable this option to have the system confirm a contact's name with you before making a call.
Voice Command List	Enable this option to have the system display a list of available voice commands when you press the voice.

# SYNC™ 3 (If Equipped)

## Valet Mode

Valet mode allows you to lock the system. No information is accessible until the system is unlocked with the correct PIN.

When you select valet mode, a pop up appears informing you that a four digit code must be entered to enable and disable valet mode. You can use any PIN you chose but you must use the same PIN to disable valet mode. The system asks you to input the code.

**Note:** *If the system is locked and you cannot remember the PIN, please contact the Customer Relationship Center.*

### For Lincoln

United States: 1-800-521-4140  
Canada: 1-800-387-9333

Ford	Lincoln
United States and Canada: 1-800-392-3673	United States: 1-800-521-4140
	Canada: 1-800-387-9333

To enable valet mode, enter your chosen PIN. The system then asks to confirm your PIN by reentering it. The system then locks.

To unlock the system, enter the same pin number. The system reconnects to your phone and all of your options are available again.

## SYNC™ 3 TROUBLESHOOTING

Your SYNC 3 system is easy to use. However, should questions arise, please refer to the tables below.

To check your cell phone's compatibility, refer to the regional Ford or Lincoln website.

Cell phone issues		
Issue	Possible cause	Possible solution
There is back-ground noise during a phone call.	The audio control settings on your cell phone may be affecting SYNC 3 performance.	Refer to your device's manual about audio adjustments.
During a call, I can hear the other person but they cannot hear me.	Possible cell phone malfunction.	Try switching your cell phone off, resetting it or removing the battery, then try again.
		Make sure that the microphone for SYNC 3 is not set to off. Look for the microphone icon on the phone screen.
During a call, I cannot hear the other person and they cannot hear me.	The system may need to be restarted.	To restart your system, shut down the engine, open and close the door, and then lock the door and wait for 2-3 minutes. Make sure that your SYNC 3 screen is black and the lighted USB port is off.

## SYNC™ 3 (If Equipped)

<b>Cell phone issues</b>		
<b>Issue</b>	<b>Possible cause</b>	<b>Possible solution</b>
SYNC 3 is not able to download my phonebook.	This is a cell phone-dependent feature.	Check your cell phone's compatibility.
	Possible cell phone malfunction.	Make sure you allow SYNC 3 to retrieve contacts from your phone. Refer to your cell manual.
		You must switch on your cell phone and the automatic phonebook download feature on SYNC 3.
		Try switching your cell phone off, resetting it or removing the battery, then try again.
The system says "Phonebook downloaded" but my SYNC 3 phonebook is empty or is missing contacts.	Limitations on your cell phone's capability.	Make sure you allow SYNC 3 to retrieve contacts from your phone. Refer to your cell manual.
		If the missing contacts are stored on your SIM card, move them to your cell phone's memory.
		You must switch on your cell phone and the automatic phonebook download feature on SYNC 3.
I am having trouble connecting my cell phone to SYNC 3.	This is a cell phone-dependent feature.	Check your cell phone's compatibility.
	Possible cell phone malfunction.	Try switching your cell phone off, resetting it or removing the battery, then try again.
		Try deleting your device from SYNC 3 and deleting SYNC from your device, then trying again.
		Always check the security and auto accept prompt settings relative to the SYNC 3 Bluetooth connection on your cell phone.
		Update your cell phone's firmware.
		Switch the auto download setting off.
Text messaging is not working on SYNC 3.	This is a cell phone-dependent feature.	Check your cell phone's compatibility.



## SYNC™ 3 (If Equipped)

<b>Cell phone issues</b>		
<b>Issue</b>	<b>Possible cause</b>	<b>Possible solution</b>
	Possible cell phone malfunction.	Try switching your cell phone off, resetting it or removing the battery, then try again.
	iPhone	<ul style="list-style-type: none"> <li>• Go to your cell phone's Settings.</li> <li>• Go to the Bluetooth Menu.</li> <li>• Press the blue circle to the right of the device named with your vehicle make and model to enter the next menu.</li> <li>• Turn Show Notifications on.</li> <li>• Disconnect then reconnect your iPhone from the SYNC 3 system to activate this settings update.</li> </ul> <p>Your iPhone is now set up to forward incoming text messages to SYNC 3. Repeat these steps for every other SYNC 3 vehicle that you connect. Your iPhone will only forward incoming text messages to SYNC 3 if the iPhone is not unlocked in the messaging application. Replying to text messages using SYNC 3 is not supported by iPhone. Text messages from WhatsApp and Facebook Messenger are not supported.</p>
Audible text messages do not work on my cell phone.	This is a cell phone-dependent feature.	Your cell phone must support downloading text messages through Bluetooth to receive incoming text messages.
	This is a cell phone limitation.	Because each cell phone is different, refer to your device's manual for the specific cell phone you are pairing. In fact, there can be differences between cell phones due to brand, model, service provider and software version.

## SYNC™ 3 (If Equipped)

<b>USB and Bluetooth Stereo issues</b>		
<b>Issue</b>	<b>Possible cause</b>	<b>Possible solution</b>
I am having trouble connecting my device.	Possible device malfunction.	Disconnect the device from SYNC 3. Try switching your device off, resetting it or removing the battery, then reconnect it to SYNC 3.
		Make sure you are using the manufacturer's cable.
		Make sure to correctly insert the USB cable into the device and your vehicle's USB port.
	Make sure that the device does not have an auto-install program or active security settings.	
	The device has a lock screen enabled.	Make sure your device is unlocked before connecting it to SYNC 3.
SYNC 3 does not recognize my device when I start my vehicle.	This is a device limitation.	Make sure you are not leaving the device in your vehicle during very hot or cold temperatures.
Bluetooth audio does not stream.	This is a device-dependent feature.	Make sure you connect the device to SYNC 3 and that you have started the media player on your device.
	The device is not connected.	
	The device is in a bad state.	Try switching your device off, resetting it or removing the battery, then reconnect it to SYNC 3.
SYNC 3 does not recognize music that is on my device.	Your music files may not contain the correct artist, song title, album or genre information.	Make sure that all song details are populated.
	The file may be corrupted.	Try replacing the corrupt file with a new version.
	The song may have copyright protection that does not allow it to play.	Some devices require you to change the USB settings from mass storage to media transfer protocol class.

## SYNC™ 3 (If Equipped)

<b>USB and Bluetooth Stereo issues</b>		
<b>Issue</b>	<b>Possible cause</b>	<b>Possible solution</b>
	The file format is not supported by SYNC 3.	Convert the file to a supported format. See <b>Entertainment</b> (page 361).
	The device needs to be re-indexed.	Update media index. See <b>Settings</b> (page 390).
	The device has a lock screen enabled.	Make sure your device is unlocked before connecting it to SYNC 3.
When I connect my device, I sometimes do not hear any sound.	This is a device limitation.	Disconnect the device from SYNC 3. Try switching your device off, resetting it or removing the battery, then connect it back to SYNC 3.
		To listen to Apple devices through USB, select AirPlay from the devices Control Center, then select Dock Connector.
		To listen to Apple devices through Bluetooth Stereo, select AirPlay from the devices Control Center, then select SYNC.
SYNC 3 does not display the song information, repeat, or shuffle buttons.	The device or media player is incompatible.	Connect a compatible device or media player.

<b>Wi-Fi Access Point issues</b>		
<b>Issue</b>	<b>Possible cause</b>	<b>Possible solution</b>
Failed connection.	Password error.	Verify password.
	Weak signal.	Check for a poor Wi-Fi signal.
	Multiple Access points within range with the same SSID.	Use a unique name for your SSID, don't use the default name unless it contains a unique identifier, such as part of the MAC address.

## SYNC™ 3 (If Equipped)

<b>Wi-Fi Access Point issues</b>		
<b>Issue</b>	<b>Possible cause</b>	<b>Possible solution</b>
Disconnecting after successful connection.	Weak signal probably due to distance from the access point, obstruction or high interference.	Position the vehicle close to the access point with the front of the vehicle facing the access point direction and remove obstacles if possible. Other Wi-Fi, Bluetooth, microwave and cordless phones may cause interference.
Poor signal seen by SYNC 3 despite being near a access point.	There may be an obstruction between SYNC 3 and the access point.	If the vehicle is equipped with heated windshield, try positioning the vehicle so that the windshield is not facing the access point. If you have metallic window tinting but not on the windshield, position the vehicle to face the access point. If all windows are tinted, you can open the windows in the direction of the access point if that is feasible. Try to remove other obstructions that may impact signal quality such as opening the garage door.
An access point is not listed in the list of available networks.	The access point was defined as a hidden network.	Please set the network to visible and try again.

## SYNC™ 3 (If Equipped)

<b>Wi-Fi Access Point issues</b>		
<b>Issue</b>	<b>Possible cause</b>	<b>Possible solution</b>
SYNC 3 is not seen when searching for Wi-Fi networks from your phone or other devices.	SYNC 3 does not currently provide an access point.	SYNC 3 currently does not provide an access point.
Software download takes too long.	Poor signal strength, too far from the access point, access point is supporting multiple connections, slow Internet connection or other problems.	Check the signal quality (under network details), if SYNC 3 indicates good or excellent, test with another high-speed equipped access point where the environment is more predictable.
SYNC 3 seems to connect with an access point and the signal strength is excellent but the software is not being updated.	It is possible that there is no new software. The connected access point may be a managed one and it requires either a subscription or agreeing to the terms and conditions.	Test the connection with another device, if the access point requires a subscription, you may contact the service provider.

## SYNC™ 3 (If Equipped)

<b>AppLink Issues</b>		
<b>Issue</b>	<b>Possible cause(s)</b>	<b>Possible solution(s)</b>
AppLink Mobile Applications: When I select "Find Mobile Apps," SYNC 3 does not find any applications.	You did not connect an AppLink Compatible phone to SYNC 3.	Make sure you have a compatible smartphone; an Android with OS 2.3 or higher or an iPhone 3GS or newer with iOS 5.0 or higher. Additionally, make sure you pair and connect your phone to SYNC 3 in order to find AppLink-capable apps on your device. iPhone users must also connect to a USB port with an Apple USB cable.
My phone is connected, but I still cannot find any apps.	AppLink-enabled apps are not installed and running on your mobile device.	Make sure you have downloaded and installed the latest version of the app from your phone's app store. Make sure the app is running on your phone. Some apps require you to register or login to the app on the phone before using them with AppLink. Also, some may have a "Ford SYNC" setting, so check the app's settings menu on the phone.
My phone is connected, my app(s) are running, but I still cannot find any apps.	Sometimes apps do not properly close and re-open their connection to SYNC 3, over ignition cycles, for example.	<p>Closing and restarting apps may help SYNC 3 find the application if you cannot discover it inside the vehicle. On an Android device, if apps have an 'Exit' or 'Quit' option, then select it and restart the app. If the app does not have that option, select the phone's settings menu and select 'Apps', then find the particular app and choose 'Force stop.' Do not forget to restart the app afterward, then select "Find Mobile Apps" on SYNC 3.</p> <p>On an iPhone with iOS7+, to force close an app, double tap the home button then swipe up on the app to close it. Tap the home button again, then select the app again to restart it. After a few seconds, the app should then appear in SYNC 3's Mobile App's Menu.</p>

## SYNC™ 3 (If Equipped)

<b>AppLink Issues</b>		
<b>Issue</b>	<b>Possible cause(s)</b>	<b>Possible solution(s)</b>
My Android phone is connected, my app(s) are running, I restarted them, but I still cannot find any apps.	There is a Bluetooth issue on some older versions of the Android operating system that may cause apps that were found on your previous vehicle drive to not be found again if you did not switch Bluetooth off.	Switch Bluetooth off and then on to reset it on your phone. If you are in your vehicle, SYNC 3 should be able to automatically re-connect to your phone if you press the "Phone" button.
My iPhone is connected, my app is running, I restarted the app but I still cannot find it on SYNC 3.	You may need to reset the USB connection to SYNC 3.	Unplug the USB cable from the phone, wait a moment, and plug the USB cable back in to the phone. After a few seconds, the app should appear in SYNC 3's Mobile Apps Menu. If not, "Force Close" the application and restart it.
I have an Android phone. I found and started my media app on SYNC 3, but there is no sound or the sound is very low.	The Bluetooth volume on the phone may be low.	Increase the Bluetooth volume of the device by using the device's volume control buttons which are most often found on the side of the device.
I can only see some of the AppLink apps running on my phone listed in the SYNC 3 Mobile Apps Menu.	Some Android devices have a limited number of Bluetooth ports that apps can use to connect. If you have more AppLink apps on your phone than the number of available Bluetooth ports, you will not see all of your apps listed in the SYNC 3 mobile apps menu.	Force close or uninstall the apps you do not want SYNC 3 to find. If the app has a "Ford SYNC" setting, disable that setting in the app's settings menu on the phone.

## SYNC™ 3 (If Equipped)

<b>Voice command issues</b>		
<b>Issue</b>	<b>Possible cause</b>	<b>Possible solution</b>
SYNC 3 does not understand what I am saying.	You may be using the wrong voice commands.	Review the cell phone voice commands and the media voice commands at the beginning of their respective sections.
		Refer to the audio display during an active voice session to find a list of voice commands there.
	You may be speaking too soon or at the wrong time.	Wait for the system to prompt you before you state your command.
SYNC 3 does not understand the name of a song or artist.	You may be using the wrong voice commands.	Review the media voice commands at the beginning of the media section.
	You may not be saying the name exactly as it appears on your device.	Say the song or artist name exactly as it is displayed on your device. For example, say "Play Artist Prince" or "Play song Purple Rain".
		Make sure you are saying the complete title such as "California remix featuring Jennifer Nettles".
		If there are any abbreviations in the name, like ESPN or CNN, you have to spell those: "E-S-P-N" or "C-N-N".
The song or artist name may have some special characters that are not being recognized by SYNC 3.	Make sure that song titles, artists, album, and playlists names do not have any special characters like *, - or +.	
SYNC 3 does not understand or is calling the wrong contact when I want to make a call.	You may not be saying the name exactly as it appears on your phone-book.	Make sure that you are saying the name exactly as it appears on your phone. For example, if your contact is "Joe Wilson", say "Call Joe Wilson". If your contact name is "Mom", say "Call Mom".
	The contact name may contain special characters.	Make sure that your contact names do not have any special characters like *, - or +.



## SYNC™ 3 (If Equipped)

<b>Voice command issues</b>		
<b>Issue</b>	<b>Possible cause</b>	<b>Possible solution</b>
The SYNC 3 voice control system is having trouble recognizing foreign names stored on my cell phone.	You may not be saying the name exactly as it appears on your phonebook.	SYNC 3 applies the phonetic pronunciation rules of the selected language to the contact names stored on your cell phone.
		<b>Helpful Hint:</b> You can select your contact manually. Press <b>PHONE</b> . Select the option for phonebook and then contact name. Press the soft-key option to hear it. SYNC 3 will read the contact name to you, giving you some idea of the pronunciation it is expecting.
The SYNC 3 voice control system is having trouble recognizing foreign tracks, artists, albums, genres and playlist names from my media player or USB flash drive.	You may be saying the foreign names using the currently selected language for SYNC 3.	SYNC 3 applies the phonetic pronunciation rules of the selected language to the names stored on your media player or USB flash drive. It is able to make some exceptions for very popular artist names (for example, U2) such that you can always use the English pronunciation for these artists.
The system generates voice prompts and the pronunciation of some words may not be accurate for my language.	SYNC 3 uses text-to-speech voice prompt technology.	SYNC 3 uses a synthetically generated voice rather than pre-recorded human voice.
		SYNC 3 offers several new voice control features for a wide range of languages. Dialing a contact name directly from the phonebook without pre-recording (for example, "call John Smith") or selecting a track, artist, album, genre or playlist directly from your media player (for example, "play artist Madonna").

## SYNCTM 3 (If Equipped)

<b>Personal Profiles</b>	
<b>Issue</b>	<b>Possible cause and solution</b>
I cannot create a profile.	Personal Profiles have not been set up.
	An invalid profile name was entered.
	A memory button was not selected when prompted.
	The vehicle's ignition was not On and in Park or was shifted out of Run or Park while creating a profile.
	Personal Profiles is turned off.
I cannot link a keyfob.	The lock button was not selected on a keyfob when prompted.
	The keyfob selected was already associated to another profile and an overwrite was declined.
	A profile recall was performed while linking a keyfob.
	The vehicle's ignition was not On and in Park, or was shifted out of Run or Park while linking a keyfob.
	The old linking method is used.
My personalized settings do not save.	The unsaved setting is not supported by Personal Profiles.
	A different Personal Profile is active than expected.
	Another user has changed settings for the wrong Personal Profile.
My profile will not recall.	A Personal Profile has not been created.
	Personal Profiles is turned off.
	The requested profile is already active.
	The memory button being used is not linked to a profile.

## SYNC™ 3 (If Equipped)

<b>Personal Profiles</b>	
<b>Issue</b>	<b>Possible cause and solution</b>
	The keyfob being used is not linked to a profile.
	The wrong keyfob is being used.
	A button other than unlock or remote start is being pressed on a linked keyfob.
	The Personal Profile was deleted.
My preset positions recall but my profile does not.	Personal Profiles is turned off.
My profile recalls but my preset positions do not.	The vehicle is in motion.
	The preset positions are the same as the Guest or previously active profile.
I lost a keyfob.	Unlink and relink your keyfob in the Personal Profiles menu. You may need to see your authorized dealer.
I lost all profiles.	Keyfobs had been erased and reprogramed. This could happen if you let dealership add a new keyfob to replace lost one.
	Master Reset had been performed without your acknowledgement.

## SYNC™ 3 (If Equipped)

<b>General</b>		
<b>Issue</b>	<b>Possible cause</b>	<b>Possible solution</b>
<p>The language selected for the instrument cluster and information and entertainment display does not match the SYNC 3 language (phone, USB, Bluetooth audio, voice control and voice prompts).</p>	<p>SYNC 3 does not support the currently selected language for the instrument cluster and information and entertainment display.</p>	<p>SYNC 3 only supports four languages in a single module for text display, voice control and voice prompts. The country where you bought your vehicle dictates the four languages based on the most popular languages spoken. If the selected language is not available, SYNC 3 remains in the current active language.</p> <p>SYNC 3 offers several new voice control features for a wide range of languages. Dialing a contact name directly from the phonebook without pre-recording (for example, "call John Smith") or selecting a track, artist, album, genre or playlist directly from your media player (for example, "play artist Madonna").</p>

<b>SYNC 3 System Reset</b>
<p>The system has a System Reset feature that can be performed if the function of a SYNC 3 feature is lost. This reset is intended to restore functionality and will not erase any information previously stored in the system (such as paired devices, phonebook, call history, text messages, or user settings). To perform a System Reset, press and hold the Seek Up (&gt;&gt; ) button while pressing and holding the Radio Power button. After approximately 5 seconds the screen will go black. Allow 1-2 minutes for the system reset to complete. You may then resume using the SYNC 3 system.</p>

For additional assistance with SYNC 3 troubleshooting, refer to the regional Ford or Lincoln website.

# Accessories

For a complete listing of the accessories that are available for your vehicle, please contact your authorized dealer or visit the online store web site:

<b>Web Address (United States)</b>
------------------------------------

<a href="http://www.Accessories.Ford.com">www.Accessories.Ford.com</a>
--

<b>Web Address (Canada)</b>
-----------------------------

<a href="http://www.Accessories.Ford.ca">www.Accessories.Ford.ca</a>
--

Ford Motor Company will repair or replace any properly authorized dealer-installed Ford Original Accessory found to be defective in factory-supplied materials or workmanship during the warranty period, as well as any component damaged by the defective accessories.

Ford Motor Company will warrant your Ford Original Accessory through the warranty that provides the greatest benefit:

- 24 months, unlimited mileage.
- The remainder of your new vehicle limited warranty.

Contact an authorized dealer for details and a copy of the warranty.

## Exterior Style

- Custom graphics\*.
- Grille.
- Quarter window louvers\*.
- Pony emblem.
- Rear spoilers.
- Side scoops\*.
- Sunshade.
- Wheel center caps.

## Interior Style

- Ambient lighting.
- Floor mats.
- Illuminated sill plates.
- Shift knobs.
- Sport pedals.

## Lifestyle

- Ash cup (smoker's packages).
- Bluetooth speakers.
- Cargo area protector.
- Cargo net.
- Rear seat entertainment.
- Soft cargo organizers.
- Tablet cradle\*.

## Peace of Mind

- Bumper-mounted parking assist system\*.
- Full vehicle covers.
- Remote start.
- Roadside assistance kit\*.
- Temporary spare tire kit.
- Vehicle security systems.
- Wheel locks.

\*Ford Licensed Accessory. The accessory manufacturer designs, develops and therefore warrants Ford Licensed Accessories, and does not design or test these accessories to Ford Motor Company engineering requirements. Contact an authorized Ford dealer for the manufacturer's limited warranty details and request a copy of the Ford Licensed Accessories product limited warranty from the accessory manufacturer.

# Accessories

---

For maximum vehicle performance, keep the following information in mind when adding accessories, equipment, passengers and luggage to your vehicle:

- Do not exceed the total weight capacity of the vehicle or of the front or rear axle (GVWR or GAWR as indicated on the Safety Compliance Certification label). Consult an authorized dealer for specific weight information.
- The Federal Communications Commission (FCC) and Canadian Radio Telecommunications Commission (CRTC) regulate the use of radio transmitter-equipped mobile communications systems, for example, two-way radios, telephones and theft alarms. Any such equipment should comply with the Federal Communications Commission (FCC) and Canadian Radio Telecommunications Commission (CRTC) regulations, and an authorized dealer should install this equipment.
- An authorized dealer should install mobile communications systems. Improper installation may harm the operation of your vehicle, particularly if their manufacturer did not design the mobile communication system specifically for automotive use.
- If you or an authorized dealer add any non-Ford electrical or electronic accessories or components to your vehicle, you may adversely affect battery performance and durability. In addition, you may also adversely affect the performance of other electrical systems in the vehicle.

# Ford Protect

---

PROTECT YOURSELF FROM THE RISING COST OF VEHICLE REPAIRS WITH A FORD PROTECT EXTENDED SERVICE PLAN.

## **Ford Protect Extended Service Plans (U.S. Only)**

Ford Protect extended service plan means peace of mind. It's the extended service plan backed by Ford Motor Company, and provides more protection beyond the New Vehicle Limited Warranty coverage. When you visit your Ford Dealer, Insist on Ford Protect extended service plans!

## **Ford Protect Can Quickly Pay for Itself**

One trip to the Service Center could easily exceed the price of your Ford Protect extended service plan. With Ford Protect extended service plan you minimize your risk for unexpected repair bills and rising repair costs.

## **Up to 1,000+ Covered Vehicle Components**

There are four mechanical Ford Protect extended service plans with different levels of coverage. Ask your authorized dealer for details.

1. PremiumCARE - Our most comprehensive coverage. With over 1,000 covered components, this plan is so complete it's probably easier to list what's not covered.
2. ExtraCARE - Covers 113 components, and includes many high-tech items.
3. BaseCARE - Covers 84 components.
4. PowertrainCARE - Covers 29 critical components.

Ford Protect extended service plans are honored by all authorized Ford dealers in the U.S., Canada and Mexico.

That means you get:

- Reliable, quality service at any Ford or Lincoln dealership.
- Repairs performed by factory trained technicians, using genuine parts.

## **Rental Car Reimbursement**

### ***1st day Rental Benefit***

If you bring your car into your dealer for service, we'll give you a loaner to use for the day.

### ***Extended Rental Benefits***

If your vehicle is kept overnight for covered repairs, you are eligible for rental car coverage, including warranty repairs, and Field Service Actions.

## **Roadside Assistance**

Exclusive 24/7 roadside assistance, including:

- Towing, flat-tire change and battery jump starts.
- Out of fuel and lock-out assistance.
- Travel expense reimbursement for lodging, meals and rental car.
- Assistance for taxi, shuttle, rental car coverage or other transportation.

## **Transferable Coverage**

If you sell your vehicle before your Ford Protect extended service plan coverage expires, you can transfer any remaining coverage to the new owner. Which should give you and your potential buyer a little more peace of mind.

# Ford Protect

---

## Less Cost to Properly Maintain Your Vehicle

Ford Protect extended service plan also offers a Premium Maintenance Plan that covers all scheduled maintenance, and selected wear items. The coverage is prepaid, so you never have to worry about the cost of your vehicle's maintenance.

Covered maintenance includes:

- Windshield wiper blades.
- Spark plugs.
- The clutch disc (if equipped).
- Brake pads and linings.
- Shock absorbers.
- Struts.
- Engine Belts.
- Engine coolant hoses, clamps and o-rings.
- Diesel exhaust fluid replenishment (if equipped).
- Cabin air filter replacement every 20,000 mi (32,000 km) (electric vehicles only).

## Interest Free Finance Options

Just a 10% down payment will provide you with an affordable, no interest, no fee payment program allowing you all the security and benefits Ford Protect extended service plan has to offer while paying over time. You are pre-approved with no credit check or hassles. To learn more, call our Ford Protect extended service plan specialists at 800-367-3377.

Ford Protect Extended Service Plan  
P.O. Box 321067  
Detroit, MI 48232

## Ford Protect Extended Service Plan (CANADA ONLY)

You can get more protection for your vehicle by purchasing a Ford Protect extended service plan. Ford Protect extended service plan is the only service contract backed by Ford Motor Company of Canada, Limited. Depending on the plan you purchase, Ford Protect extended service plan provides benefits such as:

- Rental reimbursement.
- Coverage for certain maintenance and wear items.
- Protection against repair costs after your New Vehicle Limited Warranty Coverage expires.
- Roadside Assistance benefits.

There are several Ford Protect extended service plans available in various time, distance and deductible combinations. Each plan is tailored to fit your own driving needs, including reimbursement for towing and rental. When you purchase Ford Protect extended service plan, you receive added peace-of-mind protection throughout Canada, the United States and Mexico, provided by a network of participating authorized Ford Motor Company dealers.

**Note:** *Repairs performed outside of Canada, the United States and Mexico are not eligible for Ford Protect extended service plan coverage.*

This information is subject to change. For more information; visit your local Ford of Canada dealer or [www.ford.ca](http://www.ford.ca) to find the Ford Protect extended service plan that is right for you.



# Scheduled Maintenance

---

## GENERAL MAINTENANCE INFORMATION

### Why Maintain Your Vehicle?

Carefully following the maintenance schedule helps protect against major repair expenses resulting from neglect or inadequate maintenance and may help to increase the value of your vehicle when you sell or trade it. Keep all receipts for completed maintenance with your vehicle.

We have established regular maintenance intervals for your vehicle based upon rigorous testing. It is important that you have your vehicle serviced at the proper times. These intervals serve two purposes; one is to maintain the reliability of your vehicle and the second is to keep your cost of owning your vehicle down.

It is your responsibility to have all scheduled maintenance performed and to make sure that the materials used meet the specifications identified in this owner's manual. See **Capacities and Specifications** (page 294).

Failure to perform scheduled maintenance invalidates warranty coverage on parts affected by the lack of maintenance.

### Why Maintain Your Vehicle at Your Dealership?

#### Factory-Trained Technicians

Service technicians participate in extensive factory-sponsored certification training to help them become experts on the operation of your vehicle. Ask your dealership about the training and certification their technicians have received.

## Genuine Ford and Motorcraft® Replacement Parts

Dealerships stock Ford, Motorcraft and Ford-authorized branded re-manufactured replacement parts. These parts meet or exceed our specifications. Parts installed at your dealership carry a nationwide 24-month or unlimited mile (kilometer) parts and labor limited warranty.

If you do not use Ford authorized parts they may not meet our specifications and depending on the part, it could affect emissions compliance.

### Convenience

Many dealerships have extended evening and Saturday hours to make your service visit more convenient and they offer one stop shopping. They can perform any services that are required on your vehicle, from general maintenance to collision repairs.

**Note:** *Not all dealers have extended hours or body shops. Please contact your dealer for details.*

### Protecting Your Investment

Maintenance is an investment that pays dividends in the form of improved reliability, durability and resale value. To maintain the proper performance of your vehicle and its emission control systems, make sure you have scheduled maintenance performed at the designated intervals.

Your vehicle is equipped with an intelligent oil-life monitor that determines oil life based on engine operating conditions.

# Scheduled Maintenance

---

- Under normal operating conditions, a message appears in the information display to indicate the regular oil change interval.
- Under severe operating conditions, the oil change interval may reduce, and the message interval may adjust.

High performance vehicles can be driven in such a way that may lead to higher oil consumption (this includes extended time at high engine speeds, high loads, engine braking, hard cornering maneuvers, and track use). Under these conditions, the engine oil level needs to be checked at every refueling and adjusted to maintain proper level to avoid engine damage.

**Note:** *Oil level should not exceed the maximum mark on the indicator. See **Engine Oil Check** (page 235).*

When the oil change message appears in the information display, it is time for an oil change. Make sure you perform the oil change within two weeks or 500 mi (800 km) of the message appearing. Make sure you reset the Intelligent Oil-Life Monitor after each oil change. See **Oil Change Indicator Reset** (page 236).

If your information display resets prematurely or becomes inoperative, you should perform the oil change interval at six months or 5,000 mi (8,000 km) from your last oil change. Never exceed one year or 10,000 mi (16,000 km) between oil change intervals.

Your vehicle is very sophisticated and built with multiple, complex, performance systems. Every manufacturer develops these systems using different specifications and performance features. That is why it is important to rely upon your dealership to properly diagnose and repair your vehicle.

Ford Motor Company has recommended maintenance intervals for various parts and component systems based upon engineering testing. Ford Motor Company relies upon this testing to determine the most appropriate mileage for replacement of oils and fluids to protect your vehicle at the lowest overall cost to you and recommends against maintenance schedules that deviate from the scheduled maintenance information.

We strongly recommend the use of only genuine Ford, Motorcraft or Ford-authorized re-manufactured replacement parts engineered for your vehicle.

## Additives and Chemicals

This owner's manual and the Ford Workshop Manual list the recommended additives and chemicals for your vehicle. We do not recommend using chemicals or additives not approved by us as part of your vehicle's normal maintenance. Please consult your warranty information.

## Oils, Fluids and Flushing

In many cases, fluid discoloration is a normal operating characteristic and, by itself, does not necessarily indicate a concern or that the fluid needs to be changed. However, a qualified expert, such as the factory-trained technicians at your dealership, should inspect discolored fluids that also show signs of overheating or foreign material contamination immediately.

# Scheduled Maintenance

Make sure to change your vehicle's oils and fluids at the specified intervals or in conjunction with a repair. Flushing is a viable way to change fluid for many vehicle sub-systems during scheduled maintenance. It is critical that systems are flushed only with new fluid that is the same as that required to fill and operate the

system or using a Ford-approved flushing chemical.

## Owner Checks and Services

Make sure you perform the following basic maintenance checks and inspections every month or at six-month intervals.

<b>Check every month</b>
Engine oil level.
For severe use, high engine speed and engine loads, engine braking and track use, check engine oil level every fuel fill-up.
Function of all interior and exterior lights.
Tires, including spare, for wear and proper pressure.
Windshield washer fluid level.

<b>Check every six months</b>
Battery connections. Clean if necessary.
Body and door drain holes for obstructions. Clean if necessary.
Cooling system fluid level and coolant strength.
Door weatherstrips for wear. Lubricate if necessary.
Hinges, latches and outside locks for proper operation. Lubricate if necessary.
Parking brake for proper operation.
Seatbelts and seat latches for wear and function.
Safety warning lamps operation for brake, ABS, airbag and seatbelt.
Washer spray and wiper operation. Clean or replace blades as necessary.

# Scheduled Maintenance

## Multi-Point Inspection

In order to keep your vehicle running right, it is important to have the systems on your vehicle checked regularly. This can help identify potential issues and prevent major

problems. We recommend having the following multi-point inspection performed at every scheduled maintenance interval to help make sure your vehicle keeps running great.

Multi-Point inspection	
Accessory drive belts.	Hazard warning system operation.
Battery performance.	Horn operation.
Engine air filter.	Radiator, cooler, heater and air conditioning hoses.
Exhaust system.	Suspension components for leaks or damage.
Exterior lamps operation.	Steering and linkage.
Fluid levels; fill if necessary. <sup>1</sup>	Tires, including spare, for wear and proper pressure. <sup>2</sup>
For oil and fluid leaks.	Windshield for cracks, chips or pits.
Half-shaft dust boots.	Washer spray and wiper operation.

<sup>1</sup> Brake, coolant recovery reservoir, automatic transmission and window washer.

<sup>2</sup> If your vehicle is equipped with a temporary mobility kit, check the tire sealant expiration Use By date on the canister. Replace as needed.

Be sure to ask your dealership service advisor or technician about the multi-point vehicle inspection. It is a comprehensive way to perform a thorough inspection of your vehicle. Your checklist gives you immediate feedback on the overall condition of your vehicle.

## NORMAL SCHEDULED MAINTENANCE

### Intelligent Oil-Life Monitor™

Your vehicle is equipped with an Intelligent Oil-Life Monitor that determines when you should change the engine oil based on how your vehicle is used. By using several important factors in its calculations, the monitor helps reduce the cost of owning your vehicle and reduces environmental waste at the same time.

# Scheduled Maintenance

This means you do not have to remember to change the oil on a mileage-based schedule. Your vehicle lets you know when an oil change is due by displaying a message in the information display.

The following table provides examples of vehicle use and its impact on oil change intervals. It is a guideline only. Actual oil change intervals depend on several factors and generally decrease with severity of use.

<b>When to expect the message prompting you to change your oil</b>	
<b>Interval</b>	<b>Vehicle use and example</b>
7,000–10,000 mi (12,000–16,000 km)	<b>Normal</b>
	Normal commuting with highway driving. No, or moderate, load or towing. Flat to moderately hilly roads. No extended idling.
5,000–7,000 mi (8,000–11,999 km)	<b>Severe</b>
	Moderate to heavy load or towing. Mountainous or off-road conditions. Extended idling. Extended hot or cold operation. High engine speeds and loads, engine braking and hard cornering.
3,000–5,000 mi (4,800–7,999 km)	<b>Extreme</b>
	Maximum load or towing. Extreme hot or cold operation.

## Normal Maintenance Intervals

<b>At every oil change interval as indicated by the information display <sup>1</sup></b>
Change engine oil and filter. <sup>2</sup>
Rotate tires, inspect tire wear and measure tread depth.
Perform a multi-point inspection (recommended).
Inspect the automatic transmission fluid level (if equipped with dipstick). Consult your dealer for requirements.
Inspect the brake pads, rotors, hoses and parking brake.
Inspect the engine cooling system strength and hoses.

# Scheduled Maintenance

<b>At every oil change interval as indicated by the information display <sup>1</sup></b>
Inspect the exhaust system and heat shields.
Inspect rear axle and U-joints. Lubricate if equipped with grease fittings.
Inspect the half-shaft boots.
Inspect the steering linkage, ball joints, suspension, tie-rod ends, driveshaft and U-joints. Lubricate any areas with grease fittings.
Inspect the wheels and related components for abnormal noise, wear, looseness or drag.

<sup>1</sup> Do not exceed one year or 10,000 mi (16,000 km) between service intervals.

<sup>2</sup> Reset the Intelligent Oil-Life Monitor after engine oil and filter changes.

<b>Other maintenance items <sup>1</sup></b>	
Every 20,000 mi (32,000 km)	Replace cabin air filter.
Every 30,000 mi (48,000 km)	Replace engine air filter.
At 100,000 mi (160,000 km)	Change engine coolant. <sup>2</sup>
Every 100,000 mi (160,000 km)	Replace spark plugs.
	Inspect accessory drive belt(s). <sup>3</sup>
Every 150,000 mi (240,000 km)	Change automatic transmission fluid and filter.
	Change manual transmission fluid.
	Replace accessory drive belt(s).
	Change rear axle fluid.

<sup>1</sup> Perform these maintenance items within 3,000 mi (4,800 km) of the last engine oil and filter change. Do not exceed the designated distance for the interval.

<sup>2</sup> Initial replacement at six years or 100,000 mi (160,000 km), then every three years or 50,000 mi (80,000 km).

<sup>3</sup> After initial inspection, inspect every other oil change until replaced.

## Scheduled Maintenance

### SPECIAL OPERATING CONDITIONS SCHEDULED MAINTENANCE

If you operate your vehicle **primarily** in any of the following conditions, you need to

perform extra maintenance, as indicated. If you operate your vehicle **occasionally** under any of these conditions, it is not necessary to perform the extra maintenance. For specific recommendations, see your dealership service advisor or technician.

<b>Towing a Trailer or Using a Car-top Carrier</b>	
As required	Change engine oil and filter as indicated by the information display and perform services listed in the Normal Scheduled Maintenance chart.
Inspect frequently, service as required	Inspect rear axle and U-joints. Lubricate if equipped with grease fittings.
	See axle maintenance items under <b>Exceptions</b> .
Every 60,000 mi (96,000 km)	Change manual transmission fluid.
	Replace spark plugs.

<b>Extensive Idling or Low-speed Driving for Long Distances, as in Heavy Commercial Use Such as Delivery, Taxi, Patrol Car or Livery</b>	
As required	Change engine oil and filter as indicated by the information display and perform services listed in the Normal Scheduled Maintenance chart.
Inspect frequently, service as required	Replace cabin air filter.
Every 15,000 mi (24,000 km)	Inspect engine air filter. Replace as required.
Every 60,000 mi (96,000 km)	Replace spark plugs.

# Scheduled Maintenance

<b>Operating in Dusty or Sandy Conditions Such as Unpaved or Dusty Roads</b>	
Inspect frequently, service as required	Replace cabin air filter.
Every 15,000 mi (24,000 km)	Inspect engine air filter. Replace as required.
Every 5,000 mi (8,000 km)	Inspect the wheels and related components for abnormal noise, wear, looseness or drag.
	Rotate tires, inspect tires for wear and measure tread depth.
Every 5,000 mi (8,000 km) or six months	Change engine oil and filter. <sup>1</sup>
Every 50,000 mi (80,000 km)	Change manual transmission fluid.

<sup>1</sup>Reset your Intelligent Oil-Life Monitor after each engine oil and filter change.

<b>Exclusive Use of E85 - Flex Fuel Vehicles Only</b>	
Every oil change interval	If ran exclusively on E85, fill the fuel tank full with regular unleaded fuel.

## Exceptions

There are several exceptions to the Normal Schedule:

### Rear Axle Maintenance

Axle fluid changes or level checks are not required unless a leak is suspected or the assembly has been submerged in water. Have the axle checked as soon as possible.

### California Fuel Filter Replacement

If you register your vehicle in California, the California Air Resources Board has determined that the failure to perform this maintenance item does not nullify the emission warranty or limit recall liability before the completion of your vehicle's useful life. Ford Motor Company, however, urges you to have all recommended maintenance services performed at the specified intervals and to record all vehicle service.



# Scheduled Maintenance

## Hot Climate Oil Change Intervals

Vehicles operating in the Middle East, North Africa, Sub-Saharan Africa or locations with similar climates using an American Petroleum Institute (API) Certified for Gasoline Engines (Certification mark) oil of SM or SN quality, the normal oil change interval is 3,000 mi (4,800 km).

If the available API SM or SN oils are not available, then the oil change interval is 1,800 mi (2,900 km).

## Engine Air Filter and Cabin Air Filter Replacement

The life of the engine air filter and cabin air filter is dependent on exposure to dusty and dirty conditions. Vehicles operated in these conditions require frequent inspection and replacement of the engine air filter and cabin air filter.

## SCHEDULED MAINTENANCE RECORD

<input type="radio"/> Repair Order #:	<b>Dealer stamp</b>
<input type="radio"/> Distance:	
<input type="radio"/> Engine hours (optional):	
<input type="radio"/> Multi-point inspection (recommended): <input type="checkbox"/>	
<input type="radio"/> Signature:	

<input type="radio"/> Repair Order #:	<b>Dealer stamp</b>
<input type="radio"/> Distance:	
<input type="radio"/> Engine hours (optional):	
<input type="radio"/> Multi-point inspection (recommended): <input type="checkbox"/>	
<input type="radio"/> Signature:	

# Scheduled Maintenance

<input type="radio"/> Repair Order #:	<p>Dealer stamp</p>
<input type="radio"/> Distance:	
<input type="radio"/> Engine hours (optional):	
<input type="radio"/> Multi-point inspection (recommended): <input type="checkbox"/>	
<input type="radio"/> Signature:	

<input type="radio"/> Repair Order #:	<p>Dealer stamp</p>
<input type="radio"/> Distance:	
<input type="radio"/> Engine hours (optional):	
<input type="radio"/> Multi-point inspection (recommended): <input type="checkbox"/>	
<input type="radio"/> Signature:	

# Scheduled Maintenance

<input type="radio"/> Repair Order #:	Dealer stamp
<input type="radio"/> Distance:	
<input type="radio"/> Engine hours (optional):	
<input type="radio"/> Multi-point inspection (recommended): <input type="checkbox"/>	
<input type="radio"/> Signature:	

<input type="radio"/> Repair Order #:	Dealer stamp
<input type="radio"/> Distance:	
<input type="radio"/> Engine hours (optional):	
<input type="radio"/> Multi-point inspection (recommended): <input type="checkbox"/>	
<input type="radio"/> Signature:	

# Scheduled Maintenance

<input type="radio"/> Repair Order #:	Dealer stamp
<input type="radio"/> Distance:	
<input type="radio"/> Engine hours (optional):	
<input type="radio"/> Multi-point inspection (recommended): <input type="checkbox"/>	
<input type="radio"/> Signature:	

<input type="radio"/> Repair Order #:	Dealer stamp
<input type="radio"/> Distance:	
<input type="radio"/> Engine hours (optional):	
<input type="radio"/> Multi-point inspection (recommended): <input type="checkbox"/>	
<input type="radio"/> Signature:	

# Scheduled Maintenance

<input type="radio"/> Repair Order #:	Dealer stamp
<input type="radio"/> Distance:	
<input type="radio"/> Engine hours (optional):	
<input type="radio"/> Multi-point inspection (recommended): <input type="checkbox"/>	
<input type="radio"/> Signature:	

<input type="radio"/> Repair Order #:	Dealer stamp
<input type="radio"/> Distance:	
<input type="radio"/> Engine hours (optional):	
<input type="radio"/> Multi-point inspection (recommended): <input type="checkbox"/>	
<input type="radio"/> Signature:	

# Scheduled Maintenance

<input type="radio"/> Repair Order #:	<p>Dealer stamp</p>
<input type="radio"/> Distance:	
<input type="radio"/> Engine hours (optional):	
<input type="radio"/> Multi-point inspection (recommended): <input type="checkbox"/>	
<input type="radio"/> Signature:	

<input type="radio"/> Repair Order #:	<p>Dealer stamp</p>
<input type="radio"/> Distance:	
<input type="radio"/> Engine hours (optional):	
<input type="radio"/> Multi-point inspection (recommended): <input type="checkbox"/>	
<input type="radio"/> Signature:	

# Scheduled Maintenance

<input type="radio"/> Repair Order #:	Dealer stamp
<input type="radio"/> Distance:	
<input type="radio"/> Engine hours (optional):	
<input type="radio"/> Multi-point inspection (recommended): <input type="checkbox"/>	
<input type="radio"/> Signature:	

<input type="radio"/> Repair Order #:	Dealer stamp
<input type="radio"/> Distance:	
<input type="radio"/> Engine hours (optional):	
<input type="radio"/> Multi-point inspection (recommended): <input type="checkbox"/>	
<input type="radio"/> Signature:	

# Scheduled Maintenance

<input type="radio"/> Repair Order #:	Dealer stamp
<input type="radio"/> Distance:	
<input type="radio"/> Engine hours (optional):	
<input type="radio"/> Multi-point inspection (recommended): <input type="checkbox"/>	
<input type="radio"/> Signature:	

<input type="radio"/> Repair Order #:	Dealer stamp
<input type="radio"/> Distance:	
<input type="radio"/> Engine hours (optional):	
<input type="radio"/> Multi-point inspection (recommended): <input type="checkbox"/>	
<input type="radio"/> Signature:	



# Scheduled Maintenance

<input type="radio"/> Repair Order #:	Dealer stamp
<input type="radio"/> Distance:	
<input type="radio"/> Engine hours (optional):	
<input type="radio"/> Multi-point inspection (recommended): <input type="checkbox"/>	
<input type="radio"/> Signature:	

<input type="radio"/> Repair Order #:	Dealer stamp
<input type="radio"/> Distance:	
<input type="radio"/> Engine hours (optional):	
<input type="radio"/> Multi-point inspection (recommended): <input type="checkbox"/>	
<input type="radio"/> Signature:	

# Scheduled Maintenance

---

<input type="radio"/> Repair Order #:	<p>Dealer stamp</p>
<input type="radio"/> Distance:	
<input type="radio"/> Engine hours (optional):	
<input type="radio"/> Multi-point inspection (recommended): <input type="checkbox"/>	
<input type="radio"/> Signature:	

<input type="radio"/> Repair Order #:	<p>Dealer stamp</p>
<input type="radio"/> Distance:	
<input type="radio"/> Engine hours (optional):	
<input type="radio"/> Multi-point inspection (recommended): <input type="checkbox"/>	
<input type="radio"/> Signature:	

# Appendices

## ELECTROMAGNETIC COMPATIBILITY



**WARNING:** Do not place objects or mount equipment on or near the airbag cover, on the side of the seatbacks (of the front seats), or in front seat areas that may come into contact with a deploying airbag. Failure to follow these instructions may increase the risk of personal injury in the event of a crash.



**WARNING:** Do not fasten antenna cables to original vehicle wiring, fuel pipes and brake pipes.



**WARNING:** Keep antenna and power cables at least 4 in (10 cm) from any electronic modules and airbags.

**Note:** We test and certify your vehicle to meet electromagnetic compatibility legislation (UNECE Regulation 10 or other applicable local requirements). It is your responsibility to make sure that any equipment an authorized dealer installs on your vehicle complies with applicable local legislation and other requirements.

**Note:** Any radio frequency transmitter equipment in your vehicle (such as cellular telephones and amateur radio transmitters) must keep to the parameters in the following table. We do not provide special provisions or conditions for installations or use.

### Car

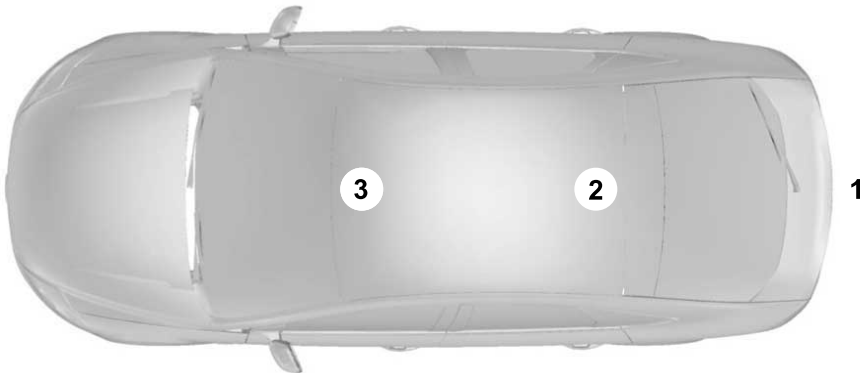

E239120

# Appendices

---

## Van



E239122

## Truck

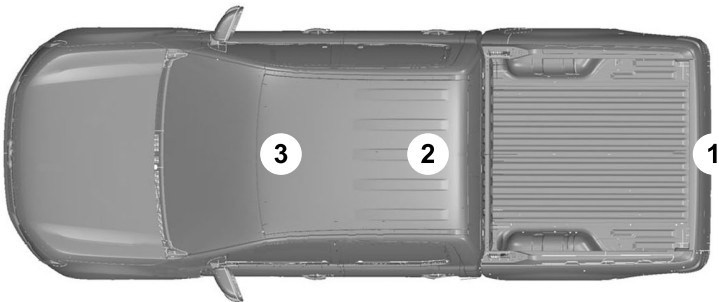

E239121

# Appendices

Frequency Band MHz	Maximum output power Watt (Peak RMS)	Antenna Positions
1-30	50	1
50-54	50	2, 3
68-88	50	2, 3
142-176	50	2, 3
380-512	50	2, 3
806-870	10	2, 3

**Note:** After the installation of radio frequency transmitters, check for disturbances from and to all electrical equipment in your vehicle, both in the standby and transmit modes.

Check all electrical equipment:

- With the ignition ON.
- With the engine running.
- During a road test at various speeds.

Check that electromagnetic fields generated inside your vehicle cabin by the transmitter installed do not exceed applicable human exposure requirements.

## END USER LICENSE AGREEMENT

### VEHICLE SOFTWARE END USER LICENSE AGREEMENT (EULA)

- You ("You" or "Your" as applicable) have acquired a vehicle having several devices, including SYNC ® and various control modules, ("DEVICES") that include software licensed or owned by Ford Motor Company and its affiliates ("FORD MOTOR COMPANY"). Those software products of FORD MOTOR COMPANY origin, as well as associated media, printed materials, and "online" or electronic documentation ("SOFTWARE") are protected by international intellectual property laws and treaties. The SOFTWARE is licensed, not sold. All rights reserved.
- The SOFTWARE may interface with and/or communicate with, or may be later upgraded to interface with and/or communicate with additional software and/or systems provided by FORD MOTOR COMPANY.

# Appendices

---

**IF YOU DO NOT AGREE TO THIS END USER LICENSE AGREEMENT ("EULA") DO NOT USE THE DEVICES OR COPY THE SOFTWARE. ANY USE OF THE SOFTWARE, INCLUDING BUT NOT LIMITED TO USE ON THE DEVICES, WILL CONSTITUTE YOUR AGREEMENT TO THIS EULA (OR RATIFICATION OF ANY PREVIOUS CONSENT).**

**GRANT OF SOFTWARE LICENSE:** This EULA grants you the following license:

- You may use the SOFTWARE as installed on the DEVICES and as otherwise interfacing with systems and/or services provide by or through FORD MOTOR COMPANY or its third party software and service providers.

## **Description of Other Rights and Limitations**

- **Speech Recognition:** If the SOFTWARE includes speech recognition component(s), you should understand that speech recognition is an inherently statistical process and that recognition errors are inherent in the process. Neither FORD MOTOR

COMPANY nor its suppliers shall be liable for any damages arising out of errors in the speech recognition process. It is your responsibility to monitor any speech recognition functions included in the system.

- **Limitations on Reverse Engineering, Decompilation and Disassembly:**

You may not reverse engineer, decompile, translate, disassemble or attempt to discover any source code or underlying ideas or algorithms of the SOFTWARE nor permit others to reverse engineer, decompile or disassemble the SOFTWARE, except and only to the extent that such activity is expressly permitted by applicable law notwithstanding this limitation or to the extent as may be permitted by the licensing terms governing use of any open source components included with the SOFTWARE.

- **Limitations on Distributing, Copying, Modifying and Creating Derivative Works:**

You may not distribute, copy, make modifications to or create derivative works based on the SOFTWARE, except and only to the extent that such activity is expressly permitted by applicable law notwithstanding this limitation or to the extent as may be permitted by the licensing terms governing use of any open source components included with the SOFTWARE.

- **Single EULA:** The end user documentation for the DEVICES and related systems and services may contain multiple EULAs, such as multiple translations and/or multiple media versions (e.g., in the user documentation and in the software). Even if you receive multiple EULAs, you are licensed to use only one (1) copy of the SOFTWARE.

## Appendices

---

- **SOFTWARE Transfer:** You may permanently transfer your rights under this EULA only as part of a sale or transfer of the DEVICES, provided you retain no copies, you transfer all of the SOFTWARE (including all component parts, the media and printed materials, any upgrades, and, if applicable, the Certificate(s) of Authenticity), and the recipient agrees to the terms of this EULA. If the SOFTWARE is an upgrade, any transfer must include all prior versions of the SOFTWARE.
- **Termination:** Without prejudice to any other rights, FORD MOTOR COMPANY may terminate this EULA if you fail to comply with the terms and conditions of this EULA.
- **Internet-Based Services Components:** The SOFTWARE may contain components that enable and facilitate the use of certain Internet-based services. You acknowledge and agree that FORD MOTOR COMPANY, third party software and service suppliers, its affiliates and/or its designated agent may automatically check the version of the SOFTWARE and/or its components that you are utilizing and may provide upgrades or supplements to the SOFTWARE that may be automatically downloaded to your DEVICES.
- **Additional Software/Services:** The SOFTWARE may permit FORD MOTOR COMPANY, third party software and service suppliers, its affiliates and/or its designated agent to provide or make available to you SOFTWARE updates, supplements, add-on components, or Internet-based services components of the SOFTWARE after the date you obtain your initial copy of the SOFTWARE ("Supplemental Components".) SOFTWARE updates may cause you to incur additional charges from your wireless service provider. If FORD MOTOR COMPANY or third party software and services suppliers provide or make available to you Supplemental Components and no other EULA terms are provided along with the Supplemental Components, then the terms of this EULA shall apply. FORD MOTOR COMPANY, its affiliates and/or its designated agent reserve the right to discontinue without liability any Internet-based services provided to you or made available to you through the use of the SOFTWARE.
- **Links to Third Party Sites:** The SOFTWARE may provide you with the ability to link to third party sites. The third party sites are not under the control of FORD MOTOR COMPANY, its affiliates and/or its designated agent. Neither FORD MOTOR COMPANY nor its affiliates nor its designated agent are responsible for (i) the contents of any third party sites, any links contained in third party sites, or any changes or updates to third party sites, or (ii) webcasting or any other form of transmission received from any third party sites. If the SOFTWARE provides links to third party sites, those links are provided to you only as a convenience, and the inclusion of any link does not imply an endorsement of the third party site by FORD MOTOR COMPANY, its affiliates and/or its designated agent.
- **Obligation to Drive Responsibly:** You recognize your obligation to drive responsibly and keep attention on the road. You will read and abide with the DEVICES operating instructions particularly as they pertain to safety and you agree to assume any risk associated with the use of the DEVICES.

# Appendices

---

## **UPGRADES AND RECOVERY MEDIA:**

If the SOFTWARE is provided by FORD MOTOR COMPANY separate from the DEVICES on media such as a ROM chip, CD ROM disk(s) or via web download or other means, and is labeled "For Upgrade Purposes Only" or "For Recovery Purposes Only" you may install one (1) copy of such SOFTWARE onto the DEVICES as a replacement copy for the existing SOFTWARE, and use it in accordance with this EULA, including any additional EULA terms accompanying the upgrade SOFTWARE.

## **INTELLECTUAL PROPERTY RIGHTS:**

All title and intellectual property rights in and to the SOFTWARE (including but not limited to any images, photographs, animations, video, audio, music, text and "applets" incorporated into the SOFTWARE), the accompanying printed materials, and any copies of the SOFTWARE, are owned by FORD MOTOR COMPANY, or its affiliates or suppliers. The SOFTWARE is licensed, not sold. You may not copy the printed materials accompanying the SOFTWARE. All title and intellectual property rights in and to the content which may be accessed through use of the SOFTWARE is the property of the respective content owner and may be protected by applicable copyright or other intellectual property laws and treaties. This EULA grants you no rights to use such content outside its intended use. All rights not specifically granted under this EULA are reserved by FORD MOTOR COMPANY, its affiliates, and third party software and service providers and suppliers. Use of any on-line services which may be accessed through the SOFTWARE may be governed by the respective terms of use relating to such services. If this SOFTWARE contains documentation that is provided only in electronic form, you may print one copy of such electronic documentation.

**EXPORT RESTRICTIONS:** You acknowledge that the SOFTWARE is subject to U.S. and European Union export jurisdiction. You agree to comply with all applicable international and national laws that apply to the SOFTWARE, including the U.S. Export Administration Regulations, as well as end-user, end-use and destination restrictions issued by U.S. and other governments.

**TRADEMARKS:** This EULA does not grant you any rights in connection with any trademarks or service marks of FORD MOTOR COMPANY, its affiliates, and third party software and service providers.

**PRODUCT SUPPORT:** Please refer to FORD MOTOR COMPANY instructions provided in the documentation for the DEVICES product support, such as the vehicle owner guide.

Should you have any questions concerning this EULA, or if you desire to contact FORD MOTOR COMPANY for any other reason, please refer to the address provided in the documentation for the DEVICES.

## **No Liability for Certain Damages:**

EXCEPT AS PROHIBITED BY LAW, FORD MOTOR COMPANY, ANY THIRD PARTY SOFTWARE OR SERVICES SUPPLIERS, AND THEIR AFFILIATES SHALL HAVE NO LIABILITY FOR ANY INDIRECT, SPECIAL, CONSEQUENTIAL OR INCIDENTAL DAMAGES ARISING FROM OR IN CONNECTION WITH THE USE OR PERFORMANCE OF THE SOFTWARE. THIS LIMITATION SHALL APPLY EVEN IF ANY REMEDY FAILS OF ITS ESSENTIAL PURPOSE. THERE ARE NO WARRANTIES OTHER THAN THOSE THAT MAY BE EXPRESSLY PROVIDED FOR YOUR NEW VEHICLE.



# Appendices

---

## **SYNC® Automotive Important Safety Information Read and follow instructions:**

- Before using your SYNC® system, read and follow all instructions and safety information provided in this end user manual ("Owner Guide".) Not following precautions found in the Owner Guide can lead to an accident or other serious injuries.

### General Operation

- **Voice Command Control:** Certain functions within the SYNC® system may be accomplished using voice commands. Using voice commands while driving helps you to operate the system without removing your hands from the wheel or eyes from the road.
- **Prolonged Views of Screen:** Do not access any function requiring a prolonged view of the screen while you are driving. Pull over in a safe and legal manner before attempting to access a function of the system requiring prolonged attention.
- **Volume Setting:** Do not raise the volume excessively. Keep the volume at a level where you can still hear outside traffic and emergency signals while driving. Driving while unable to hear these sounds could cause an accident.
- **Navigation Features:** Any navigation features included in the system are intended to provide turn by turn instructions to get you to a desired destination. Please make certain all persons using this system carefully read and follow instructions and safety information fully.
- **Distraction Hazard:** Any navigation features may require manual (non-verbal) setup. Attempting to perform such set-up or insert data while driving can distract your attention and could cause an accident or other serious injury. Stop the vehicle in a safe and legal manner before attempting these operations.
- **Let Your Judgment Prevail:** Any navigation features are provided only as an aid. Make your driving decisions based on your observations of local conditions and existing traffic regulations. Any such feature is not a substitute for your personal judgment. Any route suggestions made by this system should never replace any local traffic regulations or your personal judgment or knowledge of safe driving practices.
- **Route Safety:** Do not follow the route suggestions if doing so would result in an unsafe or illegal maneuver, if you would be placed in an unsafe situation, or if you would be directed into an area that you consider unsafe. The driver is ultimately responsible for the safe operation of the vehicle and therefore, must evaluate whether it is safe to follow the suggested directions.
- **Potential Map Inaccuracy:** Maps used by this system may be inaccurate because of changes in roads, traffic controls or driving conditions. Always use good judgment and common sense when following the suggested routes.
- **Emergency Services:** Do not rely on any navigation features included in the system to route you to emergency services. Ask local authorities or an emergency services operator for these locations. Not all emergency services such as police, fire stations, hospitals and clinics are likely to be contained in the map database for such navigation features.

## Appendices

### Your Responsibilities and Assumptions of Risk

- You agree to each of the following: (a) Any use of the SOFTWARE while driving an automobile or other vehicle in violation of applicable law or otherwise driving in an unsafe manner presents a significant risk of distracted driving and should not be attempted under any circumstances; (b) Use of the SOFTWARE at excessive volume poses a significant risk of hearing damage and should not be attempted under any circumstances; (c) The SOFTWARE may not be compatible with new or different versions of an operating system, third party software, or third party services, and the SOFTWARE may potentially cause a critical failure of an operating system, third party software, or third party service. (d) Any third party service accessed by or third party software used with the SOFTWARE (i) may charge an additional fee for access, (ii) may not work correctly, on an uninterrupted basis, or error free, (iii) may change streaming formats or discontinue operation, (iv) may contain adult, profane or offensive content; and (v) may contain inaccurate, false or misleading traffic, weather, financial or safety information or other content; and (e) Use of the SOFTWARE may cause you to incur additional charges from your wireless service provider (WSP) and any data or minute calculators that may be included in the software program are for reference only, are not warranted in any way and should not be relied upon in anyway.
- When using the SOFTWARE, you agree to be responsible for and assume the entire risk to the items set forth in Section (a) – (e) above.

### Disclaimer of Warranty

YOU EXPRESSLY ACKNOWLEDGE AND AGREE THAT USE OF THE DEVICES AND SOFTWARE IS AT YOUR SOLE RISK AND THAT THE ENTIRE RISK AS TO SATISFACTORY QUALITY, PERFORMANCE, COMPATIBILITY, ACCURACY AND EFFORT IS WITH YOU. TO THE MAXIMUM EXTENT PERMITTED BY APPLICABLE LAW, THE SOFTWARE AND ANY THIRD PARTY SOFTWARE OR THIRD-PARTY SERVICES ARE PROVIDED "AS IS" AND "AS AVAILABLE", WITH ALL FAULTS AND WITHOUT WARRANTY OF ANY KIND, AND FORD MOTOR COMPANY HEREBY DISCLAIMS ALL WARRANTIES AND CONDITIONS WITH RESPECT TO THE SOFTWARE, THIRD PARTY SOFTWARE, AND THIRD-PARTY SERVICES, EITHER EXPRESS, IMPLIED OR STATUTORY, INCLUDING, BUT NOT LIMITED TO, THE IMPLIED WARRANTIES AND/OR CONDITIONS OF MERCHANTABILITY, OF SATISFACTORY QUALITY, OF FITNESS FOR AN PARTICULAR PURPOSE, OF ACCURACY, OF QUIET ENJOYMENT, AND NON-INFRINGEMENT OF THIRD-PARTY RIGHTS. FORD MOTOR COMPANY DOES NOT WARRANT (a) AGAINST INTERFERENCE WITH YOUR ENJOYMENT OF THE SOFTWARE, THIRD PARTY SOFTWARE, OR THIRD-PARTY SERVICES, (b) THAT THE SOFTWARE, THIRD PARTY SOFTWARE, OR THIRD-PARTY SERVICES WILL MEET YOUR REQUIREMENTS, (c) THAT THE OPERATION OF THE SOFTWARE, THIRD PARTY SOFTWARE, OR THIRD-PARTY SERVICES WILL BE UNINTERRUPTED OR ERROR-FREE, (d) OR THAT DEFECTS IN THE SOFTWARE, THIRD PARTY SOFTWARE, OR THIRD-PARTY SERVICES WILL BE CORRECTED. NO ORAL OR WRITTEN INFORMATION OR ADVICE GIVEN BY FORD MOTOR COMPANY OR ITS AUTHORIZED REPRESENTATIVE SHALL

# Appendices

---

CREATE A WARRANTY. SHOULD THE SOFTWARE, THIRD PARTY SOFTWARE, OR THIRD-PARTY SERVICES PROVE DEFECTIVE, YOU ASSUME THE ENTIRE COST OF ALL NECESSARY SERVICING, REPAIR OR CORRECTION. SOME JURISDICTIONS DO NOT ALLOW THE DISCLAIMER OF IMPLIED WARRANTIES OR LIMITATIONS ON APPLICABLE STATUTORY RIGHTS OF A CONSUMER, SO THE ABOVE DISCLAIMER MAY NOT FULLY APPLY TO YOU. THE SOLE WARRANTY PROVIDED BY FORD MOTOR COMPANY SHALL BE FOUND IN THE WARRANTY INFORMATION INCLUDING WITH YOUR OWNER GUIDE. TO THE EXTENT THAT THERE IS ANY CONFLICT BETWEEN THE TERMS OF THIS SECTION AND THE WARRANTY BOOKLET, THE WARRANTY BOOKLET SHALL CONTROL.

## Applicable Law, Venue, Jurisdiction

- The laws of the State of Michigan govern this EULA and Your use of the SOFTWARE. Your use of the SOFTWARE may also be subject to other local, state, national, or international laws. Any litigation arising out of or related to this EULA shall be brought and maintained exclusively in a court of the State of Michigan located in Wayne County or in the United States District Court for the Eastern District of Michigan. You hereby consent to submit to the personal jurisdiction of a court in the State of Michigan located in Wayne County and the United States District Court for the Eastern District of Michigan for any dispute arising out of or relating to this EULA.

## Binding Arbitration and Class Action Waiver

**(a) Application.** This Section applies to any dispute EXCEPT IT DOES NOT INCLUDE A DISPUTE RELATING TO COPYRIGHT INFRINGEMENT, OR TO THE ENFORCEMENT OR VALIDITY OF YOUR, FORD MOTOR COMPANY, OR ANY OF FORD MOTOR COMPANY'S LICENSORS' INTELLECTUAL PROPERTY RIGHTS.

Dispute means any dispute, action, or other controversy between You and FORD MOTOR COMPANY, other than the exceptions listed above, concerning the SOFTWARE (including its price) or this EULA, whether in contract, warranty, tort, statute, regulation, ordinance, or any other legal or equitable basis.

**(b) Notice of Dispute.** In the event of a Dispute, You or FORD MOTOR COMPANY must give the other a "Notice of Dispute", which is a written statement of the name, address, and contact information of the party giving it, the facts giving rise to the dispute, and the relief requested. You and FORD MOTOR COMPANY will attempt to resolve any dispute through informal negotiation within 60 days from the date the Notice of Dispute is sent. After 60 days, You or FORD MOTOR COMPANY may commence arbitration.

**(c) Small claims court.** You may also litigate any dispute in small claims court in your county of residence or FORD MOTOR COMPANY'S principal place of business, if the dispute meets all requirements to be heard in the small claims court. You may litigate in small claims court whether or not You negotiated informally first.

**(d) Binding arbitration.** If You and FORD MOTOR COMPANY, do not resolve any dispute by informal negotiation or in small claims court, any other effort to resolve the dispute will be conducted exclusively by binding arbitration. You are giving up

## Appendices

the right to litigate (or participate in as a party or class member) all disputes in court before a judge or jury. Instead, all disputes will be resolved before a neutral arbitrator, whose decision will be final except for a limited right of appeal under the Federal Arbitration Act. Any court with jurisdiction over the parties may enforce the arbitrator's award.

**(e) Class action waiver.** Any proceedings to resolve or litigate any dispute in any forum will be conducted solely on an individual basis. Neither you nor FORD MOTOR COMPANY, will seek to have any dispute heard as a class action, as a private attorney general action, or in any other proceeding in which any party acts or proposes to act in a representative capacity. No arbitration or proceeding will be combined with another without the prior written consent of all parties to all affected arbitrations or proceedings.

**(f) Arbitration procedure.** Any arbitration will be conducted by the American Arbitration Association (the "AAA"), under its Commercial Arbitration Rules. If You are an individual and use the SOFTWARE for personal or vehicle use, or if the value of the dispute is \$75,000 or less whether or not You are an individual or how You use the SOFTWARE, the AAA Supplementary Procedures for Consumer-Related Disputes will also apply. To commence arbitration, submit a Commercial Arbitration Rules Demand for Arbitration form to the AAA. You may request a telephonic or in-person hearing by following the AAA rules. In a dispute involving \$10,000 or less, any hearing will be telephonic unless the arbitrator finds good cause to hold an in-person hearing instead. For more information, see [adr.org](http://adr.org) or call 1-800-778-7879. You agree to commence arbitration only in your county of residence or FORD MOTOR COMPANY'S principal place of business. The arbitrator

may award the same damages to You individually as a court could. The arbitrator may award declaratory or injunctive relief only to You individually, and only to the extent required to satisfy Your individual claim.

### **(g) Arbitration fees and incentives.**

- I. Disputes involving \$75,000 or less. FORD MOTOR COMPANY will promptly reimburse your filing fees and pay the AAA's and arbitrator's fees and expenses. If you reject FORD MOTOR COMPANY'S last written settlement offer made before the arbitrator was appointed ("last written offer"), your dispute goes all the way to an arbitrator's decision (called an "award"), and the arbitrator awards you more than the last written offer, FORD MOTOR COMPANY will give you three incentives: (1) pay the greater of the award or \$1,000; (2) pay twice your reasonable attorney's fees, if any; and (3) reimburse any expenses (including expert witness fees and costs) that your attorney reasonably accrues for investigating, preparing, and pursuing your claim in arbitration. The arbitrator will determine the amounts.
- ii. Disputes involving more than \$75,000. The AAA rules will govern payment of filing fees and the AAA's and arbitrator's fees and expenses.
- iii. Disputes involving any amount. In any arbitration you commence, FORD MOTOR COMPANY will seek its AAA or arbitrator's fees and expenses, or Your filing fees it reimbursed, only if the arbitrator finds the arbitration frivolous or brought for an improper purpose. In any arbitration FORD MOTOR COMPANY commences, it will pay all

# Appendices

---

filing, AAA, and arbitrator's fees and expenses. It will not seek its attorney's fees or expenses from you in any arbitration. Fees and expenses are not counted in determining how much a dispute involves.

**(h) Claims or disputes must be filed within one year.** To the extent permitted by law, any claim or dispute under this EULA to which this Section applies must be filed within one year in small claims court (Section c) or in arbitration (Section d). The one-year period begins when the claim or dispute first could be filed. If such a claim or dispute is not filed within one year, it is permanently barred.

**(I) Severability.** If the class action waiver (Section e) is found to be illegal or unenforceable as to all or some parts of a dispute, then that portion of Section e will not apply to those parts. Instead, those parts will be severed and proceed in a court of law, with the remaining parts proceeding in arbitration. If any other provision of that portion Section e is found to be illegal or unenforceable, that provision will be severed with the remainder of Section e remaining in full force and effect.

## **Telenav Software End User License Agreement**

Please read these terms and conditions carefully before you use the TeleNav Software. Your use of the TeleNav Software indicates that you accept these terms and conditions. If you do not accept these terms and conditions, do not break the seal of the package, launch, or otherwise use the TeleNav Software. TeleNav may revise this Agreement and the privacy policy at any time, with or without notice to you. You agree to visit <http://www.telenav.com> from time to time to review the then current version of this Agreement and of the privacy policy.

## **1. Safe and Lawful Use**

You acknowledge that devoting attention to the TeleNav Software may pose a risk of injury or death to you and others in situations that otherwise require your undivided attention, and you therefore agree to comply with the following when using the TeleNav Software:

- (a) observe all traffic laws and otherwise drive safely;
- (b) use your own personal judgment while driving. If you feel that a route suggested by the TeleNav Software instructs you to perform an unsafe or illegal maneuver, places you in an unsafe situation, or directs you into an area that you consider to be unsafe, do not follow such instructions;
- (c) do not input destinations, or otherwise manipulate the TeleNav Software, unless your vehicle is stationary and parked;
- (d) do not use the TeleNav Software for any illegal, unauthorized, unintended, unsafe, hazardous, or unlawful purposes, or in any manner inconsistent with this Agreement;
- (e) arrange all GPS and wireless devices and cables necessary for use of the TeleNav Software in a secure manner in your vehicle so that they will not interfere with your driving and will not prevent the operation of any safety device (such as an airbag).

You agree to indemnify and hold TeleNav harmless against all claims resulting from any dangerous or otherwise inappropriate use of the TeleNav Software in any moving vehicle, including as a result of your failure to comply with the directions above.

# Appendices

## 2. Account Information

You agree: (a) when registering the TeleNav Software, to provide TeleNav with true, accurate, current, and complete information about yourself, and (b) to inform TeleNav promptly of any changes to such information, and to keep it true, accurate, current and complete.

## 3. Software License

- Subject to your compliance with the terms of this Agreement, TeleNav hereby grants to you a personal, non-exclusive, non-transferable license (except as expressly permitted below in connection with your permanent transfer of the TeleNav Software license), without the right to sublicense, to use the TeleNav Software (in object code form only) in order to access and use the TeleNav Software. This license shall terminate upon any termination or expiration of this Agreement. You agree that you will use the TeleNav Software only for your personal business or leisure purposes, and not to provide commercial navigation services to other parties.

### 3.1 License Limitations

- **(a)** reverse engineer, decompile, disassemble, translate, modify, alter or otherwise change the TeleNav Software or any part thereof; **(b)** attempt to derive the source code, audio library or structure of the TeleNav Software without the prior express written consent of TeleNav; **(c)** remove from the TeleNav Software, or alter, any of TeleNav's or its suppliers' trademarks, trade names, logos, patent or copyright notices, or other notices or markings; **(d)**

distribute, sublicense or otherwise transfer the TeleNav Software to others, except as part of your permanent transfer of the TeleNav Software; or **(e)** use the TeleNav Software in any manner that

- i. infringes the intellectual property or proprietary rights, rights of publicity or privacy or other rights of any party,
- ii. violates any law, statute, ordinance or regulation, including but not limited to laws and regulations related to spamming, privacy, consumer and child protection, obscenity or defamation, or
- iii. is harmful, threatening, abusive, harassing, tortuous, defamatory, vulgar, obscene, libelous, or otherwise objectionable; and (f) lease, rent out, or otherwise permit unauthorized access by third parties to the TeleNav Software without advanced written permission of TeleNav.

## 4. Disclaimers

- To the fullest extent permissible pursuant to applicable law, in no event will TeleNav, its licensors and suppliers, or agents or employees of any of the foregoing, be liable for any decision made or action taken by you or anyone else in reliance on the information provided by the TeleNav Software. TeleNav also does not warrant the accuracy of the map or other data used for the TeleNav Software. Such data may not always reflect reality due to, among other things, road closures, construction, weather, new roads and other changing conditions. You are responsible for the entire risk arising out of your use of the TeleNav Software. For example but without limitation, you agree not to rely on the TeleNav Software for critical navigation in areas where the well-being or survival of you or others

# Appendices

---

is dependent on the accuracy of navigation, as the maps or functionality of the TeleNav Software are not intended to support such high risk applications, especially in more remote geographical areas.

- TELENV EXPRESSLY DISCLAIMS AND EXCLUDES ALL WARRANTIES IN CONNECTION WITH THE TELENV SOFTWARE, WHETHER STATUTORY, EXPRESS OR IMPLIED, INCLUDING ALL WARRANTIES WHICH MAY ARISE FROM COURSE OF DEALING, CUSTOM OR TRADE AND INCLUDING, BUT NOT LIMITED TO, THE IMPLIED WARRANTIES OF MERCHANTABILITY, FITNESS FOR A PARTICULAR PURPOSE AND NON-INFRINGEMENT OF THIRD PARTY RIGHTS WITH RESPECT TO THE TELENV SOFTWARE.
- Certain jurisdictions do not permit the disclaimer of certain warranties, so this limitation may not apply to you.

## **5. Limitation of Liability**

- TO THE EXTENT PERMITTED UNDER APPLICABLE LAW, UNDER NO CIRCUMSTANCES SHALL TELENV OR ITS LICENSORS AND SUPPLIERS BE LIABLE TO YOU OR TO ANY THIRD PARTY FOR ANY INDIRECT, INCIDENTAL, CONSEQUENTIAL, SPECIAL OR EXEMPLARY DAMAGES (INCLUDING IN EACH CASE, BUT NOT LIMITED TO, DAMAGES FOR THE INABILITY TO USE THE EQUIPMENT OR ACCESS DATA, LOSS OF DATA, LOSS OF BUSINESS, LOSS OF PROFITS, BUSINESS INTERRUPTION OR THE LIKE) ARISING OUT OF THE USE OF OR INABILITY TO USE THE TELENV SOFTWARE, EVEN IF TELENV HAS BEEN ADVISED OF THE POSSIBILITY OF SUCH DAMAGES. NOTWITHSTANDING ANY DAMAGES THAT YOU MIGHT INCUR FOR ANY

REASON WHATSOEVER (INCLUDING, WITHOUT LIMITATION, ALL DAMAGES REFERENCED HEREIN AND ALL DIRECT OR GENERAL DAMAGES IN CONTRACT, TORT (INCLUDING NEGLIGENCE) OR OTHERWISE), THE ENTIRE LIABILITY OF TELENV AND OF ALL OF TELENV'S SUPPLIERS SHALL BE LIMITED TO THE AMOUNT ACTUALLY PAID BY YOU FOR THE TELENV SOFTWARE. SOME STATES AND/OR JURISDICTIONS DO NOT ALLOW THE EXCLUSION OR LIMITATION OF INCIDENTAL OR CONSEQUENTIAL DAMAGES, SO THE ABOVE LIMITATIONS OR EXCLUSIONS MAY NOT APPLY TO YOU.

## **6. Arbitration and Governing Law**

- You agree that any dispute, claim or controversy arising out of or relating to this Agreement or the TeleNav Software shall be settled by independent arbitration involving a neutral arbitrator and administered by the American Arbitration Association in the County of Santa Clara, California. The arbitrator shall apply the Commercial Arbitration Rules of the American Arbitration Association, and the judgment upon the award rendered by the arbitrator may be entered by any court having jurisdiction. Note that there is no judge or jury in an arbitration proceeding and the decision of the arbitrator shall be binding upon both parties. You expressly agree to waive your right to a jury trial. This Agreement and performance hereunder will be governed by and construed in accordance with the laws of the State of California, without giving effect to its conflict of law provisions. To the extent judicial action is necessary in connection with the binding arbitration, both TeleNav and you agree to submit

# Appendices

---

to the exclusive jurisdiction of the courts of the County of Santa Clara, California. The United Nations Convention on Contracts for the International Sale of Goods shall not apply.

## **7. Assignment**

- You may not resell, assign, or transfer this Agreement or any of your rights or obligations, except in totality, in connection with your permanent transfer of the TeleNav Software, and expressly conditioned upon the new user of the TeleNav Software agreeing to be bound by the terms and conditions of this Agreement. Any such sale, assignment or transfer that is not expressly permitted under this paragraph will result in immediate termination of this Agreement, without liability to TeleNav, in which case you and all other parties shall immediately cease all use of the TeleNav Software. Notwithstanding the foregoing, TeleNav may assign this Agreement to any other party at any time without notice, provided the assignee remains bound by this Agreement.

## **8. Miscellaneous**

### **8.1**

This Agreement constitutes the entire agreement between TeleNav and you with respect to the subject matter hereof.

### **8.2**

Except for the limited licenses expressly granted in this Agreement, TeleNav retains all right, title and interest in and to the TeleNav Software, including without limitation all related intellectual property rights. No licenses or other rights which are not expressly granted in this Agreement are intended to, or shall be, granted or

conferred by implication, statute, inducement, estoppel or otherwise, and TeleNav and its suppliers and licensors hereby reserve all of their respective rights other than the licenses explicitly granted in this Agreement.

### **8.3**

By using the TeleNav Software, you consent to receive from TeleNav all communications, including notices, agreements, legally required disclosures or other information in connection with the TeleNav Software (collectively, "Notices") electronically. TeleNav may provide such Notices by posting them on TeleNav's Website or by downloading such Notices to your wireless device. If you desire to withdraw your consent to receive Notices electronically, you must discontinue your use of the TeleNav Software.

### **8.4**

TeleNav's or your failure to require performance of any provision shall not affect that party's right to require performance at any time thereafter, nor shall a waiver of any breach or default of this Agreement constitute a waiver of any subsequent breach or default or a waiver of the provision itself.

### **8.5**

If any provision herein is held unenforceable, then such provision will be modified to reflect the intention of the parties, and the remaining provisions of this Agreement will remain in full force and effect.



# Appendices

## 8.6

The headings in this Agreement are for convenience of reference only, will not be deemed to be a part of this Agreement, and will not be referred to in connection with the construction or interpretation of this Agreement. As used in this Agreement, the words "include" and "including" and variations thereof, will not be deemed to be terms of limitation, but rather will be deemed to be followed by the words "without limitation".

## 9. Other Vendors Terms and Conditions

- The Telenav Software utilizes map and other data licensed to Telenav by third party vendors for the benefit of you and other end users. This Agreement includes end-user terms applicable to these companies (included at the end of this Agreement), and thus your use of the Telenav Software is also subject to such terms. You agree to comply with the following additional terms and conditions, which are applicable to Telenav's third party vendor licensors::

### 9.1 End User Terms Required by HERE North America, LLC

The data ("Data") is provided for your personal, internal use only and not for resale. It is protected by copyright, and is subject to the following terms and conditions which are agreed to by you, on the one hand, and Telenav ("Telenav") and its licensors (including their licensors and suppliers) on the other hand.

© 2013 HERE. All rights reserved.

The Data for areas of Canada includes information taken with permission from Canadian authorities, including: © Her Majesty the Queen in Right of Canada, © Queen's Printer for Ontario, © Canada Post Corporation, GeoBase®, © Department of Natural Resources Canada.

HERE holds a non-exclusive license from the United States Postal Service® to publish and sell ZIP+4® information.

©United States Postal Service® 2014. Prices are not established, controlled or approved by the United States Postal Service®. The following trademarks and registrations are owned by the USPS: United States Postal Service, USPS, and ZIP+4

The Data for Mexico includes certain data from Instituto Nacional de Estadística y Geografía.

### 9.2 End User Terms Required by NAV2 (Shanghai) Co., Ltd

The data ("Data") is provided for your personal, internal use only and not for resale. It is protected by copyright, and is subject to the following terms and conditions which are agreed to by you, on the one hand, and NAV2 (Shanghai) Co., Ltd ("NAV2") and its licensors (including their licensors and suppliers) on the other hand. 20xx. All rights reserved

### Terms and Conditions

**Permitted Use.** You agree to use this Data together with the Telenav Software solely for the internal business and personal purposes for which you were licensed, and not for service bureau, time-sharing or other similar purposes. Accordingly, but subject to the restrictions set forth in the following paragraphs, you agree not to otherwise reproduce, copy, modify, decompile, disassemble, create any derivative works of, or reverse engineer any portion of this Data, and may not transfer or distribute it in any form, for any purpose, except to the extent permitted by mandatory laws.

# Appendices

---

**Restrictions.** Except where you have been specifically licensed to do so by Telenav, and without limiting the preceding paragraph, you may not use this Data (a) with any products, systems, or applications installed or otherwise connected to or in communication with vehicles, capable of vehicle navigation, positioning, dispatch, real time route guidance, fleet management or similar applications; or (b) with or in communication with any positioning devices or any mobile or wireless-connected electronic or computer devices, including without limitation cellular phones, palmtop and handheld computers, pagers, and personal digital assistants or PDAs.

**Warning.** The Data may contain inaccurate or incomplete information due to the passage of time, changing circumstances, sources used and the nature of collecting comprehensive geographic data, any of which may lead to incorrect results.

**No Warranty.** This Data is provided to you “as is,” and you agree to use it at your own risk. Telenav and its licensors (and their licensors and suppliers) make no guarantees, representations or warranties of any kind, express or implied, arising by law or otherwise, including but not limited to, content, quality, accuracy, completeness, effectiveness, reliability, fitness for a particular purpose, usefulness, use or results to be obtained from this Data, or that the Data or server will be uninterrupted or error-free.

**Disclaimer of Warranty:** TELENAV AND ITS LICENSORS (INCLUDING THEIR LICENSORS AND SUPPLIERS) DISCLAIM ANY WARRANTIES, EXPRESS OR IMPLIED, OF QUALITY, PERFORMANCE, MERCHANTABILITY, FITNESS FOR A

PARTICULAR PURPOSE OR NON-INFRINGEMENT. Some States, Territories and Countries do not allow certain warranty exclusions, so to that extent the above exclusion may not apply to you.

**Disclaimer of Liability:** TELENAV AND ITS LICENSORS (INCLUDING THEIR LICENSORS AND SUPPLIERS) SHALL NOT BE LIABLE TO YOU: IN RESPECT OF ANY CLAIM, DEMAND OR ACTION, IRRESPECTIVE OF THE NATURE OF THE CAUSE OF THE CLAIM, DEMAND OR ACTION ALLEGING ANY LOSS, INJURY OR DAMAGES, DIRECT OR INDIRECT, WHICH MAY RESULT FROM THE USE OR POSSESSION OF THE INFORMATION; OR FOR ANY LOSS OF PROFIT, REVENUE, CONTRACTS OR SAVINGS, OR ANY OTHER DIRECT, INDIRECT, INCIDENTAL, SPECIAL OR CONSEQUENTIAL DAMAGES ARISING OUT OF YOUR USE OF OR INABILITY TO USE THIS INFORMATION, ANY DEFECT IN THE INFORMATION, OR THE BREACH OF THESE TERMS OR CONDITIONS, WHETHER IN AN ACTION IN CONTRACT OR TORT OR BASED ON A WARRANTY, EVEN IF TELENAV OR ITS LICENSORS HAVE BEEN ADVISED OF THE POSSIBILITY OF SUCH DAMAGES. Some States, Territories and Countries do not allow certain liability exclusions or damages limitations, so to that extent the above may not apply to you.

**Export Control.** You shall not export from anywhere any part of the Data or any direct product thereof except in compliance with, and with all licenses and approvals required under, applicable export laws, rules and regulations, including but not limited to the laws, rules and regulations administered by the Office of Foreign Assets Control of the U.S. Department of Commerce and the Bureau of Industry and Security of the U.S. Department of Commerce. To the extent that any such

# Appendices

export laws, rules or regulations prohibit HERE from complying with any of its obligations hereunder to deliver or distribute Data, such failure shall be excused and shall not constitute a breach of this Agreement.

**Entire Agreement.** These terms and conditions constitute the entire agreement between Telenav (and its licensors, including their licensors and suppliers) and you pertaining to the subject matter hereof, and supersedes in their entirety any and all written or oral agreements previously existing between us with respect to such subject matter.

**Governing Law.** The above terms and conditions shall be governed by the laws of the State of Illinois [insert "Netherlands" where European HERE Data is used], without giving effect to (i) its conflict of laws provisions, or (ii) the United Nations Convention for Contracts for the International Sale of Goods, which is explicitly excluded. You agree to submit to the jurisdiction of the State of Illinois [insert "The Netherlands" where European HERE Data is used] for any and all disputes, claims and actions arising from or in connection with the Data provided to you hereunder.

**Government End Users.** If the Data is being acquired by or on behalf of the United States government or any other entity seeking or applying rights similar to those customarily claimed by the United States government, this Data is a "commercial item" as that term is defined at 48 C.F.R. ("FAR") 2.101, is licensed in accordance with these End-User Terms, and each copy of Data delivered or otherwise furnished shall be marked and embedded as appropriate with the following "Notice of Use," and shall be treated in accordance with such Notice:

NOTICE OF USE
CONTRACTOR (MANUFACTURER/SUPPLIER) NAME: HERE
CONTRACTOR (MANUFACTURER/SUPPLIER) ADDRESS: c/o Nokia, 425 West Randolph Street, Chicago, Illinois 60606
This Data is a commercial item as defined in FAR 2.101 and is subject to these End-User Terms under which this Data was provided.
© 1987 – 2014 HERE – All rights reserved.

If the Contracting Officer, federal government agency, or any federal official refuses to use the legend provided herein, the Contracting Officer, federal government agency, or any federal official must notify HERE prior to seeking additional or alternative rights in the Data.

### I. US/Canada Territory

A. United States Data. The End-User Terms for any Application containing Data for the United States shall contain the following notices:

"HERE holds a non-exclusive license from the United States Postal Service® to publish and sell ZIP+4® information."

"©United States Postal Service® 20XX. Prices are not established, controlled or approved by the United States Postal Service®. The following trademarks and registrations are owned by the USPS: United States Postal Service, USPS, and ZIP+4."

# Appendices

---

B. Canada Data. The following provisions apply to the Data for Canada, which may include or reflect data from third party licensors (“Third Party Data”), including Her Majesty the Queen in Right of Canada (“Her Majesty”), Canada Post Corporation (“Canada Post”) and the Department of Natural Resources of Canada (“NRCan”):

1. Disclaimer and Limitation: Client agrees that its use of the Third Party Data is subject to the following provisions:

a. Disclaimer: The Third Party Data is licensed on an “as is” basis. The licensors of such data, including Her Majesty, Canada Post and NRCan, make no guarantees, representations or warranties respecting such data, either express or implied, arising by law or otherwise, including but not limited to, effectiveness, completeness, accuracy or fitness for a particular purpose.

b. Limitation on Liability: The Third Party Data licensors, including Her Majesty, Canada Post and NRCan, shall not be liable: (i) in respect of any claim, demand or action, irrespective of the nature of the cause of the claim, demand or action alleging any loss, injury or damages, direct or indirect, which may result from the use or possession of such Data; or (ii) in any way for loss of revenues or contracts, or any other consequential loss of any kind resulting from any defect in the Data.

2. Copyright Notice: In connection with each copy of all or any portion of the Data for the Territory of Canada, Client shall affix in a conspicuous manner the following copyright notice on at least one of: (i) the label for the storage media of the copy; (ii) the packaging for the copy; or (iii) other materials packaged with the copy, such as user manuals or end user license agreements: “This data includes information taken with permission from Canadian authorities, including © Her Majesty the Queen in Right of Canada, © Queen’s Printer for Ontario, © Canada Post Corporation, GeoBase®, © The Department of Natural Resources Canada. All rights reserved.”

3. End-User Terms: Except as otherwise agreed by the parties, in connection with the provision of any portion of the Data for the Territory of Canada to End-Users as may be authorized under the Agreement, Client shall provide such End-Users, in a reasonably conspicuous manner, with terms (set forth with other end user terms required to be provided under the Agreement, or as otherwise may be provided, by Client) which shall include the following provisions on behalf of the Third Party Data licensors, including Her Majesty, Canada Post and NRCan:

The Data may include or reflect data of licensors, including Her Majesty the Queen in the Right of Canada (“Her Majesty”), Canada Post Corporation (“Canada Post”) and the Department of Natural Resources Canada (“NRCan”). Such data is licensed on an “as is” basis. The licensors, including Her Majesty, Canada Post and NRCan, make no guarantees, representations or warranties respecting such data,

# Appendices

---

either express or implied, arising by law or otherwise, including but not limited to, effectiveness, completeness, accuracy or fitness for a particular purpose. The licensors, including Her Majesty, Canada Post and NRCan, shall not be liable in respect of any claim, demand or action, irrespective of the nature of the cause of the claim, demand or action alleging any loss, injury or damages, direct or indirect, which may result from the use or possession of the data or the Data. The licensors, including Her Majesty, Canada Post and NRCan, shall not be liable in any way for loss of revenues or contracts, or any other consequential loss of any kind resulting from any defect in the data or the Data.

End User shall indemnify and save harmless the licensors, including Her Majesty, Canada Post and NRCan, and their officers, employees and agents from and against any claim, demand or action, irrespective of the nature of the cause of the claim, demand or action, alleging loss, costs, expenses, damages or injuries (including injuries resulting in death) arising out of the use or possession of the data or the Data.

4. Additional Provisions: The terms contained in this Section are in addition to all of the rights and obligations of the parties under the Agreement. To the extent that any of the provisions of this Section are inconsistent with, or conflict with, any other provisions of the Agreement, the provisions of this Section shall prevail.

II. Mexico. The following provision applies to the Data for Mexico, which includes certain data from the Instituto Nacional de Estadística y Geografía (“INEGI”):

A. Any and all copies of the Data and/or packaging containing Data for Mexico shall contain the following notice: “Fuente: INEGI (Instituto Nacional de Estadística y Geografía)”

III. Latin America Territory

A. Third Party Notices. Any and all copies of the Data and/or packaging relating thereto shall include the respective Third Party Notices set forth below and used as described below corresponding to the Territory (or portion thereof) included in such copy:

Territory Notice

Argentina IGN “INSTITUTO GEOGRAFICO NACIONAL ARGENTINO”

Ecuador “INSTITUTO GEOGRAFICO MILITAR DEL ECUADOR AUTORIZACION N° IGM-2011-01- PCO-01 DEL 25 DE ENERO DE 2011”  
“source: © IGN 2009 - BD TOPO ®”

Guadeloupe, French Guiana and Martinique Mexico “Fuente: INEGI (Instituto Nacional de Estadística y Geografía)”

IV. Middle East Territory

# Appendices

---

A. Third Party Notices. Any and all copies of the Data and/or packaging relating thereto shall include the respective Third Party Notices set forth below and used as described below corresponding to the Territory (or portion thereof) included in such copy:

Country Notice

Jordan “© Royal Jordanian Geographic Centre”. The foregoing notice requirement for Jordan Data is a material term of the Agreement. If Client or any of its permitted sublicensees (if any) fail to meet such requirement, HERE shall have the right to terminate Client’s license with respect to the Jordan Data.

B. Jordan Data. Client and its permitted sublicensees (if any) are restricted from licensing and/or otherwise distributing HERE’s database for the country of Jordan (“Jordan Data”) for use in Enterprise Applications to (i) non-Jordanian entities for use of the Jordan Data solely in Jordan or (ii) Jordan-based customers. In addition, Client, its permitted sublicensees (if any) and End-Users are restricted from using the Jordan Data in Enterprise Applications if such party is (i) a non-Jordanian entity using the Jordan Data solely in Jordan or (ii) a Jordan-based customer. For purposes of the foregoing, “Enterprise Applications” shall mean Geomarketing applications, GIS applications, mobile business asset management applications, call center applications, telematics applications, public organization Internet applications or for providing geocoding services.

## V. Europe Territory

### A. Use of Certain Traffic Codes in Europe

1. General Restrictions Applicable to Traffic Codes. Client acknowledges and agrees that in certain countries of the Europe Territory, Client will need to obtain rights directly from third party RDS-TMC code providers to receive and use the Traffic Codes in the Data and to deliver to End-Users Transactions in any way derived from or based on such Traffic Codes. For such countries, HERE shall deliver the Data incorporating Traffic Codes to Client only after receiving certification from Client of its having obtained such rights.

2. Display of Third Party Rights Legends for Belgium. Client shall, for each Transaction that uses Traffic Codes for Belgium, provide the following notice to the End-User: “Traffic Codes for Belgium are provided by the Ministerie van de Vlaamse Gemeenschap and the Ministère de l’Équipement et des Transports.”

B. Paper Maps. With respect to any license granted to Client relating to making, selling or distributing paper maps (i.e., a map fixed on a paper or paper-like medium): (a) such license with respect to Data for the Territory of Great Britain is conditioned on Client’s entering into and complying with a separate written agreement with the Ordnance Survey (“OS”) to create and sell paper maps, Client’s paying to the OS any and all applicable paper map royalties, and Client’s complying with the OS copyright notice requirements; (b) such license for selling or otherwise distributing for charge with respect to Data for the Territory of Czech Republic

# Appendices

is conditioned on Client's obtaining prior written consent from Kartografie a.s.; (c) such license for selling or distributing with respect to Data for the Territory of Switzerland is conditioned on Client's obtaining a permit from Bundesamt für Landestopografie of Switzerland; (d) Client is restricted from using Data for the Territory of France to create paper maps with a scale between 1:5,000 and 1:250,000; and (e) Client is restricted from using any Data to create, sell or distribute paper maps that are the same or substantially similar, in terms of data content and specific use of color, symbols and scale, to paper maps published by the European national mapping agencies, including without limitation, Landervermessungämter of Germany, Topografische Dienst of the Netherlands, Nationaal Geografisch Instituut of Belgium, Bundesamt für Landestopografie of Switzerland, Bundesamt für Eich- und Vermessungswesen of Austria, and the National Land Survey of Sweden.

C. OS Enforcement. Without limiting Section IV(B) above, with respect to Data for the Territory of Great Britain, Client acknowledges and agrees that the Ordnance Survey ("OS") may bring a direct action against Client to enforce compliance with the OS copyright notice (see Section IV(D) below) and paper map requirements (see Section IV(B) above) contained in this Agreement.

D. Third Party Notices. Any and all copies of the Data and/or packaging relating thereto shall include the respective Third Party Notices set forth below and used as described below corresponding to the Territory (or portion thereof) included in such copy:

Country(ies) Notice

Austria	"© Bundesamt für Eich- und Vermessungswesen"
Croatia Cyprus, Estonia, Latvia, Lithuania, Moldova, Poland, Slovenia and/or Ukraine	"© EuroGeographics"
France	"source: © IGN 2009 – BD TOPO ®"
Germany	"Die Grundlagendaten wurden mit Genehmigung der zuständigen Behörden entnommen"
Great Britain	"Contains Ordnance Survey data © Crown copyright and database right 2010 Contains Royal Mail data © Royal Mail copyright and database right 2010"
Greece	"Copyright Geomatics Ltd."
Hungary	"Copyright © 2003; Top-Map Ltd."
Italy	"La Banca Dati Italiana è stata prodotta usando quale riferimento anche cartografia numerica ed al tratto prodotta e fornita dalla Regione Toscana."
Norway	"Copyright © 2000; Norwegian Mapping Authority"
Portugal	"Source: IgeoE – Portugal"

# Appendices

Spain	“Información geográfica propiedad del CNIG”
Sweden	“Based upon electronic data © National Land Survey Sweden.”
Switzerland	“Topografische Grundlage: © Bundesamt für Landestopographie.

E. Respective Country Distribution. Client acknowledges that HERE has not received approvals to distribute map data for the following countries in such respective countries: Albania, Belarus, Kyrgyzstan, Moldova and Uzbekistan. HERE may update such list from time to time. The license rights granted to Client under this TL with respect to the Data for such countries are contingent upon Client's compliance with all applicable laws and regulations, including, without limitation, any required licenses or approvals to distribute the Application incorporating such Data in such respective countries.

## VI. Australia Territory

A. Third Party Notices. Any and all copies of the Data and/or packaging relating thereto shall include the respective Third Party Notices set forth below and used as described below corresponding to the Territory (or portion thereof) included in such copy:

Copyright. Based on data provided under license from PSMA Australia Limited ([www.pasma.com.au](http://www.pasma.com.au)).

Product incorporates data which is © 20XX Telstra Corporation Limited, GM Holden Limited, Intelomatics Australia Pty Ltd and Continental Pty Ltd.

B. Third Party Notices for Australia. In addition to the foregoing, the End-User Terms for any Application containing RDS-TMC Traffic Codes for Australia shall contain the following notice: “Product incorporates traffic location codes which is © 20XX Telstra Corporation Limited and its licensors.”

## **AT&T Vehicle Network Carrier Telematics Disclosure**

END USER FOR PURPOSES OF THIS SECTION MEANS YOU AND YOUR HEIRS, EXECUTORS, LEGAL PERSONAL REPRESENTATIVES AND PERMITTED ASSIGNS. FOR PURPOSES OF THIS SECTION “UNDERLYING WIRELESS SERVICE CARRIER” INCLUDES ITS AFFILIATES AND CONTRACTORS AND THEIR RESPECTIVE OFFICERS, DIRECTORS, EMPLOYEES, SUCCESSORS AND ASSIGNS. END USER HAS NO CONTRACTUAL RELATIONSHIP WITH THE UNDERLYING WIRELESS SERVICE CARRIER AND END USER IS NOT A THIRD PARTY BENEFICIARY OF ANY AGREEMENT BETWEEN FORD AND UNDERLYING CARRIER. END USER UNDERSTANDS AND AGREES THAT THE UNDERLYING CARRIER HAS NO LEGAL, EQUITABLE, OR OTHER LIABILITY OF ANY KIND TO END USER. IN ANY EVENT, REGARDLESS OF THE FORM OF THE ACTION, WHETHER FOR BREACH OF CONTRACT, WARRANTY, NEGLIGENCE, STRICT LIABILITY IN TORT OR OTHERWISE, END USER'S EXCLUSIVE REMEDY FOR CLAIMS ARISING IN ANY WAY IN CONNECTION WITH THIS AGREEMENT, FOR ANY CAUSE WHATSOEVER, INCLUDING BUT NOT LIMITED TO ANY FAILURE OR



# Appendices

---

DISRUPTION OF SERVICE PROVIDED HEREUNDER, IS LIMITED TO PAYMENT OF DAMAGES IN AN AMOUNT NOT TO EXCEED THE AMOUNT PAID BY END USER FOR THE SERVICES DURING THE TWO-MONTH PERIOD PRECEDING THE DATE THE CLAIM AROSE.

(ii) END USER AGREES TO INDEMNIFY AND HOLD HARMLESS THE UNDERLYING WIRELESS SERVICE CARRIER AND ITS OFFICERS, EMPLOYEES, AND AGENTS AGAINST ANY AND ALL CLAIMS, INCLUDING WITHOUT LIMITATION CLAIMS FOR LIBEL, SLANDER, OR ANY PROPERTY DAMAGE, PERSONAL INJURY OR DEATH, ARISING IN ANY WAY, DIRECTLY OR INDIRECTLY, IN CONNECTION WITH THIS AGREEMENT OR THE USE, FAILURE TO USE, OR INABILITY TO USE THE DEVICE EXCEPT WHERE THE CLAIMS RESULT FROM THE UNDERLYING CARRIER'S GROSS NEGLIGENCE OR WILLFUL MISCONDUCT. THIS INDEMNITY WILL SURVIVE THE TERMINATION OF THE AGREEMENT.

(iii) END USER HAS NO PROPERTY RIGHT IN ANY NUMBER ASSIGNED TO THE DEVICE.

(iv) END USER UNDERSTANDS THAT FORD AND THE UNDERLYING CARRIER CANNOT GUARANTY THE SECURITY OF WIRELESS TRANSMISSIONS, AND WILL NOT BE LIABLE FOR ANY LACK OF SECURITY RELATING TO THE USE OF THE SERVICES

THE SERVICE IS FOR [END USER'S] USE ONLY AND END USER MAY NOT RESELL THE SERVICE TO ANY OTHER PARTY END USER UNDERSTANDS THAT THE UNDERLYING CARRIER DOES NOT GUARANTEE ANY END USER UNINTERRUPTED SERVICE OR COVERAGE. THE UNDERLYING CARRIER DOES NOT WARRANT THAT END USERS CAN OR WILL BE LOCATED USING THE SERVICE. THE UNDERLYING CARRIER

MAKES NO WARRANTY, EXPRESS OR IMPLIED, OF MERCHANTABILITY OR FITNESS FOR A PARTICULAR PURPOSE, SUITABILITY, OR PERFORMANCE REGARDING ANY SERVICES OR GOODS, AND IN NO EVENT SHALL AT&T BE LIABLE, WHETHER OR NOT DUE TO ITS OWN NEGLIGENCE, FOR ANY: (A) ACT OR OMISSION OF A THIRD PARTY; (B) MISTAKES, OMISSIONS, INTERRUPTIONS, ERRORS, FAILURES TO TRANSMIT, DELAYS, OR DEFECTS IN THE SERVICE PROVIDED BY OR THROUGH THE UNDERLYING CARRIER; (C) DAMAGE OR INJURY CAUSED BY SUSPENSION OR TERMINATION BY THE UNDERLYING CARRIER; OR (D) DAMAGE OR INJURY CAUSED BY A FAILURE OR DELAY IN CONNECTING A CALL TO ANY ENTITY, INCLUDING 911 OR ANY OTHER EMERGENCY SERVICE. TO THE FULL EXTENT ALLOWED BY LAW, THE END USER RELEASES, INDEMNIFIES AND HOLDS THE UNDERLYING CARRIER HARMLESS FROM AND AGAINST ANY AND ALL CLAIMS OF ANY PERSON OR ENTITY FOR DAMAGES OF ANY NATURE ARISING IN ANY WAY FROM OR RELATING TO, DIRECTLY OR INDIRECTLY, SERVICES PROVIDED BY THE UNDERLYING CARRIER OR ANY PERSON'S USE THEREOF, INCLUDING CLAIMS ARISING IN WHOLE OR IN PART FROM THE ALLEGED NEGLIGENCE OF THE UNDERLYING CARRIER.

## **VII. China Territory**

### ***Personal Use Only***

You agree to use this Data together with [insert name of Client Application] for the solely personal, non-commercial purposes for which you were licensed, and not for service bureau, time-sharing or other similar purposes. Accordingly, but subject to the restrictions set forth in the following paragraphs, you may copy this Data only as necessary for your personal use to (i)

# Appendices

---

view it, and (ii) save it, provided that you do not remove any copyright notices that appear and do not modify the Data in any way. You agree not to otherwise reproduce, copy, modify, decompile, disassemble or reverse engineer any portion of this Data, and may not transfer or distribute it in any form, for any purpose, except to the extent permitted by mandatory laws.

## **Restrictions**

Except where you have been specifically licensed to do so by NAV2, and without limiting the preceding paragraph, you may not (a) use this Data with any products, systems, or applications installed or otherwise connected to or in communication with vehicles, capable of vehicle navigation, positioning, dispatch, real time route guidance, fleet management or similar applications; or (b) with or in communication with any positioning devices or any mobile or wireless-connected electronic or computer devices, including without limitation cellular phones, palmtop and handheld computers, pagers, and personal digital assistants or PDAs. You agree to cease using this Data if you fail to comply with these terms and conditions.

## **Limited Warranty**

NAV2 warrants that (a) the Data will perform substantially in accordance with the accompanying written materials for a period of ninety (90) days from the date of receipt, and (b) any support services provided by NAV2 shall be substantially as described in applicable written materials provided to you by NAV2, and NAV2's support engineers will make commercially reasonable efforts to solve any problem issues.

## **rigCustomer Remedies**

NAV2 and its suppliers' entire liability and your exclusive remedy shall be, at NAV2's sole discretion, either (a) return of the price paid, if any, or (b) repair or replacement of the Data that do not meet NAV2's Limited Warranty and that are returned to NAV2 with a copy of your receipt. This Limited Warranty is void if failure of the Data has resulted from accident, abuse, or misapplication. Any replacement Data will be warranted for the remainder of the original warranty period or thirty (30) days, whichever is longer. Neither these remedies nor any product support services offered by NAV2 are available without proof of purchase from an authorized international source.

## **No Other Warranty:**

EXCEPT FOR THE LIMITED WARRANTY SET FORTH ABOVE AND TO THE EXTENT PERMITTED BY APPLICABLE LAW, NAV2 AND ITS LICENSORS (INCLUDING THEIR LICENSORS AND SUPPLIERS) DISCLAIM ANY WARRANTIES, EXPRESS OR IMPLIED, OF QUALITY, PERFORMANCE, MERCHANTABILITY, FITNESS FOR A PARTICULAR PURPOSE, OWNERSHIP OR NON-INFRINGEMENT. Certain warranty exclusions may not be permitted under applicable law, so to that extent the above exclusion may not apply to you.

## **Limited Liability:**

TO THE EXTENT PERMITTED BY APPLICABLE LAW, NAV2 AND ITS LICENSORS (INCLUDING THEIR LICENSORS AND SUPPLIERS) SHALL NOT BE LIABLE TO YOU: IN RESPECT OF ANY CLAIM, DEMAND OR ACTION, IRRESPECTIVE OF THE NATURE OF THE CAUSE OF THE CLAIM, DEMAND OR ACTION ALLEGING ANY LOSS, INJURY OR DAMAGES, DIRECT OR INDIRECT, WHICH MAY RESULT FROM THE USE OR POSSESSION OF THE INFORMATION; OR

# Appendices

---

FOR ANY LOSS OF PROFIT, REVENUE, CONTRACTS OR SAVINGS, OR ANY OTHER DIRECT, INDIRECT, INCIDENTAL, SPECIAL OR CONSEQUENTIAL DAMAGES ARISING OUT OF YOUR USE OF OR INABILITY TO USE THIS INFORMATION, ANY DEFECT IN THE INFORMATION, OR THE BREACH OF THESE TERMS OR CONDITIONS, WHETHER IN AN ACTION IN CONTRACT OR TORT OR BASED ON A WARRANTY, EVEN IF NAV2 OR ITS LICENSORS HAVE BEEN ADVISED OF THE POSSIBILITY OF SUCH DAMAGES. UNDER NO CIRCUMSTANCES SHALL NAV2'S OR ITS SUPPLIERS' LIABILITY HEREUNDER EXCEED THE PRICE PAID. Certain liability exclusions may not be permitted under applicable law, so to that extent the above exclusion may not apply to you.

## **Export Control**

You agree not to export to anywhere any part of the Data provided to you or any direct product thereof except in compliance with, and with all licenses and approvals required under, applicable export laws, rules and regulations.

## **IP Protection**

The Data are owned by NAV2 or its suppliers and are protected by applicable copyright and other intellectual property law and treaties. The Data are provided solely on the basis of a license to use, not sale.

## **Entire Agreement**

These terms and conditions constitute the entire agreement between NAV2 (and its licensors, including their licensors and suppliers) and you pertaining to the subject matter hereof, and supersedes in their entirety any and all written or oral agreements previously existing between us with respect to such subject matter.

## **Governing Law.**

The above terms and conditions shall be governed by the laws of the People's Republic of China, without giving effect to (i) its conflict of laws provisions, or (ii) the United Nations Convention for Contracts for the International Sale of Goods, which is explicitly excluded. Any dispute arising from or in connection with the Data provided to you hereunder shall be submitted to the Shanghai International Economic and Trade Arbitration Commission for arbitration.

## **Gracenote® Copyright**

CD and music-related data from Gracenote, Inc., copyright©

2000-2007 Gracenote. Gracenote Software, copyright © 2000-2007 Gracenote. This product and service may practice one or more of the following U.S. Patents 5,987,525; 6,061,680; 6,154,773; 6,161,132; 6,230,192; 6,230,207; 6,240,459; 6,330,593 and other patents issued or pending. Some services supplied under license from Open Globe, Inc. for U.S. Patent 6,304,523.

Gracenote and CDDB are registered trademarks of Gracenote. The Gracenote logo and logotype, and the "Powered by Gracenote™" logo are trademarks of Gracenote.

## **Gracenote® End User License Agreement (EULA)**

This device contains software from Gracenote, Inc. of 2000 Powell Street Emeryville, California 94608 ("Gracenote").

The software from Gracenote (the "Gracenote Software") enables this device to do disc and music file identification and obtain music-related information, including name, artist, track, and title information ("Gracenote Data") from online servers

## Appendices

---

("Gracenote Servers"), and to perform other functions. You may use Gracenote Data only by means of the intended End User functions of this device. This device may contain content belonging to Gracenote's providers. If so, all of the restrictions set forth herein with respect to Gracenote Data shall also apply to such content and such content providers shall be entitled to all of the benefits and protections set forth herein that are available to Gracenote. You agree that you will use the content from Gracenote ("Gracenote Content"), Gracenote Data, the Gracenote Software, and Gracenote Servers for your own personal, non-commercial use only. You agree not to assign, copy, transfer or transmit the Gracenote Content, Gracenote Software or any Gracenote Data (except in a Tag associated with a music file) to any third party. YOU AGREE NOT TO USE OR EXPLOIT GRACENOTE CONTENT, GRACENOTE DATA, THE GRACENOTE SOFTWARE, OR GRACENOTE SERVERS, EXCEPT AS EXPRESSLY PERMITTED HEREIN.

You agree that your non-exclusive licenses to use the Gracenote Content, Gracenote Data, the Gracenote Software, and Gracenote Servers will terminate if you violate these restrictions. If your licenses terminate, you agree to cease any and all use of the Gracenote Content, Gracenote Data, the Gracenote Software, and Gracenote Servers.

Gracenote, respectively, reserve all rights in Gracenote Data, the Gracenote Software, and the Gracenote Servers and Gracenote Content, including all ownership rights. Under no circumstances will either Gracenote become liable for any payment to you for any information that you provide,

including any copyrighted material or music file information. You agree that Gracenote may enforce its respective rights, collectively or separately, under this agreement against you, directly in each company's own name.

Gracenote uses a unique identifier to track queries for statistical purposes. The purpose of a randomly assigned numeric identifier is to allow Gracenote to count queries without knowing anything about who you are. For more information, see the web page at [www.gracenote.com](http://www.gracenote.com) for the Gracenote Privacy Policy.

THE GRACENOTE SOFTWARE, EACH ITEM OF GRACENOTE DATA AND THE GRACENOTE CONTENT ARE LICENSED TO YOU "AS IS". NEITHER GRACENOTE MAKES ANY REPRESENTATIONS OR WARRANTIES, EXPRESS OR IMPLIED, REGARDING THE ACCURACY OF ANY GRACENOTE DATA FROM THE GRACENOTE SERVERS OR GRACENOTE CONTENT. GRACENOTE COLLECTIVELY AND SEPARATELY RESERVE THE RIGHT TO DELETE DATA AND/OR CONTENT FROM THE COMPANIES' RESPECTIVE SERVERS OR, IN THE CASE OF GRACENOTE, CHANGE DATA CATEGORIES FOR ANY CAUSE THAT GRACENOTE DEEMS SUFFICIENT. NO WARRANTY IS MADE THAT EITHER GRACENOTE CONTENT OR THE GRACENOTE SOFTWARE OR GRACENOTE SERVERS ARE ERROR-FREE OR THAT THE FUNCTIONING OF THE GRACENOTE SOFTWARE OR GRACENOTE SERVERS WILL BE UNINTERRUPTED. GRACENOTE IS NOT OBLIGATED TO PROVIDE YOU WITH ANY ENHANCED OR ADDITIONAL DATA TYPES THAT GRACENOTE MAY CHOOSE TO PROVIDE IN THE FUTURE AND IS FREE TO DISCONTINUE ITS ONLINE SERVICES AT ANY TIME. GRACENOTE DISCLAIMS ALL WARRANTIES EXPRESS OR IMPLIED, INCLUDING, BUT NOT LIMITED TO,

# Appendices

IMPLIED WARRANTIES OF MERCHANTABILITY, FITNESS FOR A PARTICULAR PURPOSE, TITLE, AND NON-INFRINGEMENT. NEITHER GRACENOTE WARRANTS THE RESULTS THAT WILL BE OBTAINED BY YOUR USE OF THE GRACENOTE SOFTWARE OR ANY GRACENOTE SERVER. IN NO CASE WILL GRACENOTE BE LIABLE FOR ANY CONSEQUENTIAL OR INCIDENTAL DAMAGES OR FOR ANY LOST PROFITS OR LOST REVENUES FOR ANY REASON WHATSOEVER. © Gracenote 2007.

## Radio Frequency Statement

FCC ID: ACJ-SYNCG3-L

IC: 216B-SYNCG3-L

This device complies with Part 15 of the FCC Rules and with RSS-210 of Industry Canada. Operation is subject to the following two conditions:

- (1) This device may not cause harmful interference, and
- (2) this device must accept any interference received, including interference that may cause undesired operation.



**WARNING:** Changes or modifications not expressly approved by the party responsible for compliance could void the user's authority to operate the equipment. The term "IC:" before the radio certification number only signifies that Industry Canada technical specifications were met.

The antenna used for this transmitter must not be co-located or operating in conjunction with any other antenna or transmitter.

## Taiwan Territory

Note: In accordance with the management approach of low-power radio wave radiation motors:

Article 12: For approved and certified low-power radiation motor models, companies, firms or users must not alter the frequency, increase the power or change the characteristics and functions of the original design without authorization.

Article 14: The usage of low-power radio-frequency motors must not affect aviation safety and interfere with legal telecommunications. Should interference be detected, immediately stop using the device and only resume usage after ensuring that there is no longer any interference. For the legal telecommunication and wireless telecommunication of the telco, the low-power radio frequency motor must be able to tolerate legal limits of interference from telecommunication, industrial, scientific and radio wave equipment.

## SUNA TRAFFIC CHANNEL – TERMS AND CONDITIONS

By activating, using and/or accessing the SUNA Traffic Channel, SUNA Predictive or other content or material provided by Intellematics (together, **SUNA Products and/or Services**), you must accept certain terms and conditions. The following is a brief summary of the terms and conditions that apply to you. To view the full terms and conditions relevant to your use of the SUNA Products and/or Services, please consult:

### Website

[www.sunatrafic.com.au/termsandconditions/](http://www.sunatrafic.com.au/termsandconditions/)

## 1. Acceptance

# Appendices

By using SUNA Products and/or Services, you will be deemed to have accepted and agreed to be bound by the terms and conditions fully detailed at:

Website
<a href="http://www.sunattraffic.com.au/termsandconditions/">www.sunattraffic.com.au/termsandconditions/</a>

## 2. Intellectual Property

SUNA Products and/or Services are for your personal use. You may not record, or retransmit the content, nor use the content in association with any other traffic information or route guidance service or device not approved by Intelematics. You obtain no right of ownership in any Intellectual Property Rights (including copyright) in the data that is used to provide SUNA Products and/or Services.

## 3. Appropriate Use

SUNA Products and/or Services are intended as an aid to personal motoring and travel planning, and do not provide comprehensive or accurate information on all occasions. On occasions, you may experience additional delay as a result of using SUNA Products and/or Services. You acknowledge that it is not intended, or suitable, for use in applications where time of arrival or driving directions may impact the safety of the public or yourself.

## 4. Use of SUNA Products and Services while driving

You, and other authorised drivers of the vehicle in which SUNA Products and/or Services are available or installed and active, remain at all times responsible for observing all relevant laws and codes of safe driving. In particular, you agree to only actively operate SUNA Products and/or Services when the Vehicle is at a complete stop and it is safe to do so.

## 5. Service Continuity and Reception of the SUNA Traffic Channel

We will use reasonable endeavours to provide the SUNA Traffic Channel 24 hours a day, 365 days a year. The SUNA Traffic Channel may occasionally be unavailable for technical reasons or for planned maintenance. We will try to perform maintenance at times when congestion is light. We reserve the right to withdraw SUNA Products and/or Services at any time.

Also, we cannot assure the uninterrupted reception of the SUNA Traffic Channel RDS-TMC signal at any particular location.

## 6. Limitation of Liability

Neither Intelematics (nor its suppliers or the manufacturer of your device (the “**Suppliers**”)) shall be liable to you or to any third party for any damages either direct, indirect, incidental, consequential or otherwise arising out of the use of or inability to use SUNA Products and/or Services even if Intelematics or a Supplier has been advised of the possibility of such damages. You also acknowledge that the neither Intelematics nor any Supplier guarantees nor make any warranties that relate to the availability, accuracy or completeness of SUNA Products and/or Services, and to the extent which it is lawful to do so, both Intelematics and each Supplier excludes any warranties which might otherwise be implied by any State or Federal legislation in relation to SUNA Products and/or Services.

## 7. Please Note

Great care has been taken in preparing this manual. Constant product development may mean that some information is not entirely up-to-date. The information in this document is subject to change without notice.

# Appendices

## TYPE APPROVALS

### Radio Frequency Certifications for Tire Pressure Monitoring Sensor(s)

#### Argentina



E207816

#### Brazil



E197509

#### Canada

IC: 850K-11545917

IC: 2546A-FP3

#### European Union EU

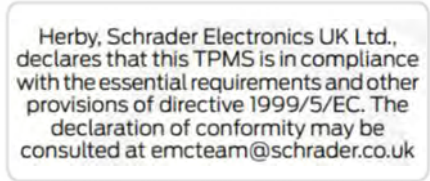

E207818

#### Ghana

NCA APPROVED: 3R88M14030

E253824

#### Jordan

Kingdom of Jordan Type approval for tyre presse sensor  
Model : AG2SZ4  
Manufacturer:Schrader Electronics Ltd  
Type Approval Number:TRC/LPD/2014/56  
Equipment Type: Low Power Device (LPD)

E253823

#### Malaysia



E253822

#### Mexico

IFT: RLVSCMR15-1238

E253812

# Appendices

IFT: RLVSCMR15-1249

E253813

## Moldova



E197811

## Morocco

AGREE PAR L'ANRT MAROC  
Numéro d'agrément: MR9098  
ANRT 2014  
Date d'agrément: 14/03/2014

E207821

## Oman

OMAN TRA  
TA-R/1752/14  
D090258

E253817

## Philippines



**NTC**

Type Approved

No:ESD-1408639C

E198001

## Russia



E253816

## Serbia



E197844

## Singapore

Complies with  
IDA Standards  
DA 105282

E253820



# Appendices

## South Africa



TA-2014/064

Approved

E198002

## South Korea



E253819

MSIP-CRM-SRD-AG2SZ4

## Taiwan



CCAM14LP0090T3

E203679

## Ukraine



E253818

**109**

## United Arab Emirates

TRA  
REGISTERED NO:EROI30238/14  
DEALER NO:DA0047074/10

E207817

## United States of America

FCC ID: OUC11545917

FCC ID: MRXFP3

## Radio Frequency Certifications for Mid Range Radar

## Argentina

MMR ID: C-20001

E269659

# Appendices

## Ghana

MRR ID:  
NCA approved: 0R2-9H-7E1-x4D.

E269662

## South Africa

MRR ID:  
TA-2017/370

E269664

## Jordan

MRR:  
Type Approval No.: TRC/LPD/2017/158  
Equipment Type: Low Power Device (LPD) ID: C-20001

E269660

## United Arab Emirates

MRR ID:  
ERS4071/17, Dealer License Number (WAC Dealer License Number: DA37380/15)

E269663

## Morocco

MRR ID:  
No. D'Agreement: MR 13639 ANRT 2017 (28 March 2017)

E269661

## Radio Frequency Certifications for Passive Anti-Theft System

### Argentina

**CNC** COMISIÓN NACIONAL  
DE COMUNICACIONES

CNC ID: H-13170

E274065

# Appendices

---

## Brazil



E269675

## Canada

IC: 850K-11545917

## Djibouti

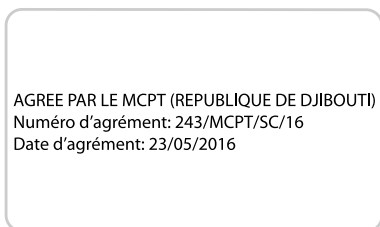

E274068

## Ghana

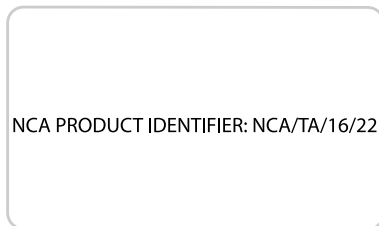

E269674

## Jamaica

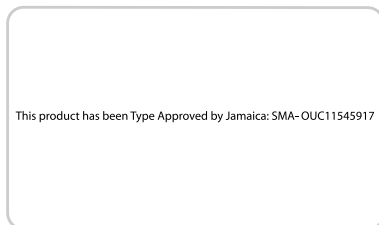

E274067

## Jordan

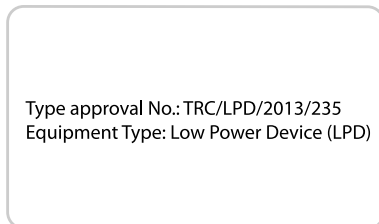

E269666

# Appendices

## Malaysia



E269673

## Morocco



E269670

## Paraguay



E274066

## Pakistan



E275754

## Serbia



E269672

## Singapore

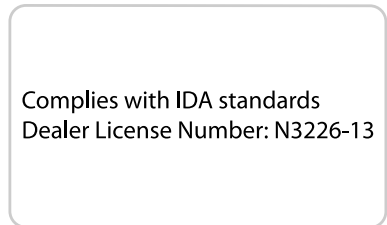

E269676

# Appendices

## South Africa



E269667

## Ukraine



E269671

## United Arab Emirates

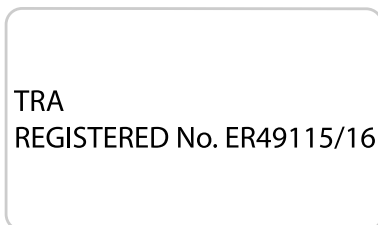

E269668

## United States of America

FCC ID: OUC11545917

## Vietnam



E269677

## Radio Frequency Certifications for Radio Transceiver Module

### Canada

IC: 3659A-F03AM315RX

IC: 3659A-F04AM902TRX

### Djibouti

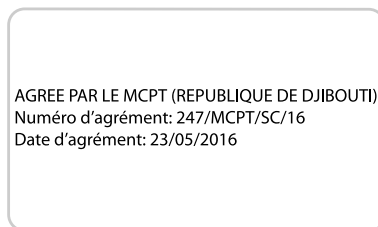

E272192

# Appendices

## Jamaica

This product has been Type Approved by Jamaica:  
SMA – F03-AM315RX

E272193

## Jordan

Type approval No.: TRC/LPD/2013/233  
Equipment Type: Low Power Device (LPD)

E272194

## Morocco

N° D'AGRÉMENT: MR 12432 ANRT 2016

E269683

## Pakistan



E269684



Date of issuance : 06/01/2015

E287633

## Paraguay



E272195

# Appendices

## Serbia



E269681

## United Arab Emirates

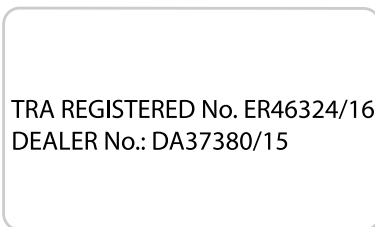

E272196

## South Africa



E269685

## United States of America

FCC ID: LTQF03AM315RX  
FCC ID: LTQF04AM902TRX

### Radio Frequency Certifications for Blind Spot Information System

#### Canada

RSS-310 compliant, per FCC Test report  
no.: 1-8707/14-01-03

#### Ghana

## Ukraine



E269682

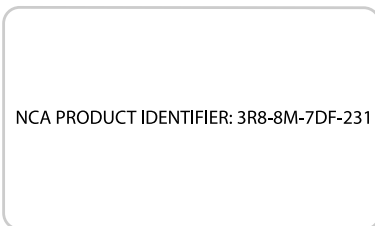

E269695

# Appendices

## Malaysia



E269697

## South Africa



E269696

## United Arab Emirates

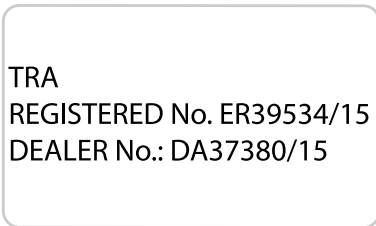

E269694

## United States of America

FCC ID: OAYSRR3B

## Vietnam

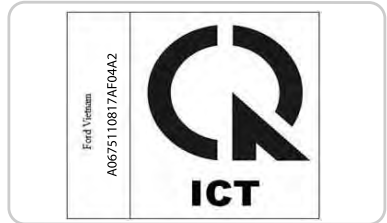

E269693

## Radio Frequency Certifications for Wireless Charging

## United Arab Emirates

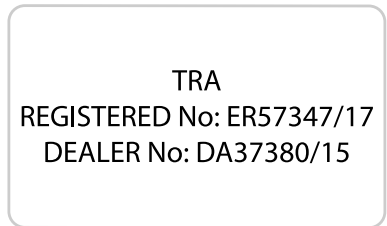

E272903



# Appendices

## South Korea



E273475

## Radio Frequency Certifications for SYNC 3

### Brazil



E252722



E282218

## China

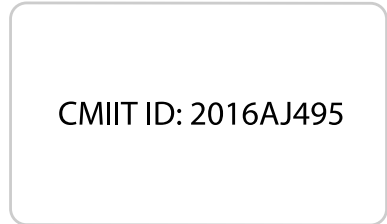

E291427

## Radio Frequency Certifications for Cruise Control Module

### Canada

IC: 3432A-0065TR

### United States of America

FCC ID: L2C0065TR

## Radio Frequency Certifications for Body Control Module

### Canada

IC: 7812A-A2C738448

Model #: M: A2C750526

Model #: M: A2C750561

### United States of America

FCC ID: M3NA2C738448

Model #: M: A2C750526

Model #: M: A2C750561

## Radio Frequency Certification for Keys and Remote Controls

### Canada

IC: 7812A-A2C931423

IC: 7812A-A2C931426

# Appendices

---

IC: 3248A-A08TAA

IC: 3248A-A08TDA

## China

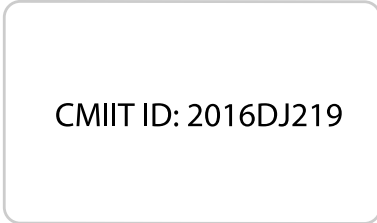

E291429

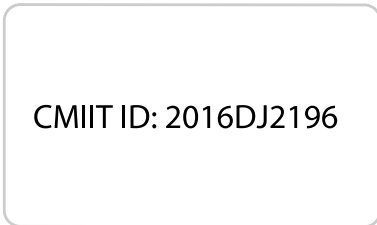

E291430

## United States of America

FCC ID : M3N-A2C931423

FCC ID : M3N-A2C931426

FCC ID : N5F-A08TAA

FCC ID : N5F-A08TDA

## Radio Frequency Statement for Audio Unit

### Canada

IC: 3043A-UP375AHU

## United States

FCC ID: NT8-16UP375AHU



# Index

## A

A/C	
See: Climate Control.....	109
About This Manual.....	7
ABS	
See: Brakes.....	154
ABS driving hints	
See: Hints on Driving With Anti-Lock Brakes.....	154
Accessories.....	418
Exterior Style.....	418
Interior Style.....	418
Lifestyle.....	418
Peace of Mind.....	418
Accessories	
See: Replacement Parts	
Recommendation.....	12
ACC	
See: Using Adaptive Cruise Control.....	167
Adjusting the Headlamps.....	245
Horizontal Aim Adjustment.....	247
Vertical Aim Adjustment.....	245
Adjusting the Steering Wheel.....	66
Airbag Disposal.....	47
Air Conditioning	
See: Climate Control.....	109
Air Filter	
See: Changing the Engine Air Filter - 2.3L EcoBoost™/5.0L.....	247
See: Changing the Engine Air Filter - 5.0L, Bullitt.....	248
Alarm	
See: Anti-Theft Alarm.....	65
Ambient Lighting.....	76
Anti-Theft Alarm.....	65
Arming the Alarm.....	65
Disarming the Alarm.....	65
Appendices.....	440
Apps.....	387
.....	387
SiriusXM Traffic and Travel Link.....	389
At a Glance.....	16
Audible Warnings and Indicators.....	87
Headlamps On Warning Chime.....	87
Keyless Warning Alert.....	87
Parking Brake On Warning Chime.....	87
Transmission Not in Park.....	87
Turn Signal Left On.....	87
Audio Control.....	66
Seek, Next or Previous.....	66
Audio System.....	313
General Information.....	313
Audio Unit - Vehicles With: AM/FM/CD/SYNC/Touchscreen Display.....	314
Accessing the Sound Settings.....	314
Adjusting the Volume.....	315
Changing Radio Stations.....	315
Ejecting the CD.....	315
Inserting a CD.....	315
Switching the Audio Unit On and Off.....	315
Using Seek, Fast Forward and Reverse.....	315
Audio Unit - Vehicles With: SYNC.....	315
Accessing the Apps Menu.....	316
Accessing the Clock Settings.....	316
Accessing the Media Source Menu.....	316
Accessing the Phone Features.....	316
Accessing the Settings Menu.....	316
Accessing the Sound Settings.....	316
Adjusting the Volume.....	316
Changing Radio Stations.....	317
Listening to the Radio.....	317
Muting the Audio.....	317
Playing or Pausing Media.....	317
Switching the Audio Unit On and Off.....	317
Switching the Display On and Off.....	317
Using Seek, Fast Forward and Reverse.....	317
Using the Display Control.....	317
Using the Number Block.....	317
Autolamps.....	72
Windshield Wiper Activated Headlamps.....	72
Automatic Climate Control.....	111
A/C.....	112
Auto.....	112
Climate Controlled Seats.....	112
Defrost.....	112
Fan Speed Control.....	112
Heated Rear Window.....	113
Heated Seats.....	111
Left-hand Temperature Control.....	111
Max A/C.....	112
Max Defrost.....	112
Power.....	112

# Index

Recirculated Air.....	112
Right-hand Temperature Control.....	112
Automatic High Beam Control.....	74
Automatic High Beam Indicator.....	75
Switching the System On and Off.....	74
Automatic Transmission.....	148
Automatic Transmission Adaptive Learning.....	152
Brake-Shift Interlock.....	151
If Your Vehicle Gets Stuck In Mud or Snow.....	152
SelectShift Automatic™ Transmission.....	149
Understanding the Positions of Your Automatic Transmission.....	149
Automatic Transmission Fluid Check.....	241
Autowipers.....	69
Auxiliary Power Points.....	128
12 Volt DC Power Point.....	128
Locations.....	128

## B

Battery	
See: Changing the 12V Battery.....	243
Blind Spot Information System.....	178
.....	179
Switching the System On and Off.....	180
System Errors.....	180
Using the Blind Spot Information System.....	179
BLIS	
See: Blind Spot Information System.....	178
Body Styling Kits.....	260
Bonnet Lock	
See: Opening and Closing the Hood.....	230
Booster Seats.....	25
Types of Booster Seats.....	26
Brake Fluid Check.....	241
Brakes.....	154
General Information.....	154
Breaking-In.....	204
Brakes and Clutch.....	204
Engine.....	204
Ground Clearance.....	204
Tires.....	204
Bulb Specification Chart.....	310

## C

Cabin Air Filter.....	115
Capacities and Specifications - 2.3L EcoBoost™.....	300
Alternative Engine Oil for Extremely Cold Climates.....	304
Specifications.....	301
Capacities and Specifications - 5.0L.....	305
Alternative Engine Oil for Extremely Cold Climates.....	309
Specifications.....	306
Capacities and Specifications.....	294
Car Wash	
See: Cleaning the Exterior.....	253
Catalytic Converter.....	144
On-Board Diagnostics (OBD-II).....	145
Readiness for Inspection and Maintenance (I/M) Testing.....	145
Center Console.....	129
Locking Storage Bin.....	129
Changing a Bulb.....	247
LED Lamps.....	247
Replacing Reverse Lamp Bulbs.....	247
Changing a Fuse.....	228
Fuses.....	228
Changing a Road Wheel.....	287
Dissimilar Spare Wheel and Tire Assembly Information.....	287
Tire Change Procedure.....	289
Changing the 12V Battery.....	243
Battery Management System.....	244
Changing the Engine Air Filter - 2.3L EcoBoost™/5.0L.....	247
Changing the Engine Air Filter - 5.0L, Bullitt.....	248
Changing the Wiper Blades.....	245
Checking MyKey System Status.....	50
MyKey Distance.....	50
Number of Admin Keys.....	50
Number of MyKeys.....	50
Checking the Wiper Blades.....	245
Child Restraint and Seatbelt Maintenance.....	36
Child Restraint Positioning.....	27
Child Safety.....	18
General Information.....	18

# Index

Cleaning Leather Seats.....	257
Cleaning Products.....	253
Materials.....	253
Cleaning the Convertible Top.....	260
Cleaning the Engine.....	255
Cleaning the Exterior.....	253
Cleaning the Headlamps.....	254
Exterior Chrome Parts.....	254
Exterior Plastic Parts.....	254
Stripes or Graphics.....	254
Underbody.....	254
Under Hood.....	254
Cleaning the Instrument Panel and Instrument Cluster Lens.....	256
Cleaning the Interior.....	256
Mirrors.....	256
Cleaning the Wheels.....	258
Cleaning the Windows and Wiper Blades.....	255
Clearing All MyKeys.....	49
Climate.....	371
Accessing Rear Climate Controls.....	373
Accessing the Climate Control Menu.....	371
Directing the Airflow.....	371
Rear Climate Control Lock Indicator.....	373
Setting the Blower Motor Speed.....	371
Setting the Temperature.....	371
Switching Auto Mode On and Off.....	371
Switching Dual Zone Mode On and Off.....	372
Switching Maximum Air Conditioning On and Off.....	372
Switching Maximum Defrost On and Off.....	372
Switching Rear Auto Mode On and Off.....	373
Switching Recirculated Air On and Off.....	372
Switching the Air Conditioning On and Off.....	371
Switching the Climate Controlled Seats On and Off.....	372
Switching the Climate Control On and Off.....	372
Switching the Heated Exterior Mirrors On and Off.....	372
Switching the Heated Rear Window On and Off.....	372
Switching the Heated Seats On and Off.....	372
Switching the Heated Steering Wheel On and Off.....	372
Switching the Rear Climate Controlled Seats On and Off.....	373
Switching the Rear Heated Seats On and Off.....	373
Switching the Rear Ventilated Seats On and Off.....	373
Switching the Ventilated Seats On and Off.....	373
Climate Control.....	109
Climate Controlled Seats.....	122
Cooled Seats.....	123
Heated Seats.....	122
Closing the Convertible Top.....	202
Clutch Fluid Check - Manual Transmission.....	242
Cold Weather Precautions.....	205
Convertible Top.....	201
Coolant Check See: Engine Coolant Check.....	237
Crash Sensors and Airbag Indicator.....	46
Creating a MyKey.....	49
Programming and Changing Configurable Settings.....	49
Cross Traffic Alert.....	180
Blocked Sensors.....	182
Switching the System Off and On.....	182
System Errors.....	182
System Lights, Messages and Audible Alerts.....	182
System Limitations.....	182
Using the Cross Traffic Alert System.....	180
Cruise Control.....	67
Principle of Operation.....	166
Cruise control See: Using Cruise Control.....	166
Customer Assistance.....	213

## D

Data Recording.....	9
Event Data Recording.....	10
Service Data Recording.....	9

# Index

Daytime Running Lamps.....	73	Fail-Safe Cooling.....	239
Type One - Conventional		Recycled Coolant.....	238
(Non-Configurable).....	73	Severe Climates.....	239
Type Two - Configurable.....	73	Engine Emission Control.....	143
Digital Radio.....	317	Engine Immobilizer	
HD Radio Reception and Station		See: Passive Anti-Theft System.....	64
Troubleshooting.....	319	Engine Oil Check.....	235
Direction Indicators.....	75	Adding Engine Oil.....	235
Doors and Locks.....	58	Engine Oil Dipstick.....	235
Drive Control.....	187	Engine Specifications - 2.3L	
Active Exhaust.....	189	EcoBoost™.....	294
Adaptive Dampers.....	189	Drivebelt Routing.....	294
Rev Match.....	190	Engine Specifications - 5.0L.....	294
Selectable Drive Modes.....	187	Drivebelt Routing.....	295
Selectable Steering.....	189	Entertainment.....	361
Driver Alert.....	173	AM/FM Radio.....	362
Using Driver Alert.....	173	Apps.....	370
Driver and Passenger Airbags.....	39	Bluetooth Stereo or USB.....	369
Children and Airbags.....	40	CD (If equipped).....	368
Proper Driver and Front Passenger Seating		HD Radio™ Information (If	
Adjustment.....	39	Available).....	365
Driver and Passenger Knee Airbags.....	44	SiriusXM® Satellite Radio (If	
Driving Aids.....	173	Activated).....	363
Driving at High Speed.....	292	Sources.....	362
Driving Hints.....	204	Supported Media Players, Formats and	
Driving Through Water.....	205	Metadata Information.....	370
DRL		USB Ports.....	370
See: Daytime Running Lamps.....	73	Environment.....	15
<b>E</b>		Essential Towing Checks.....	198
Economical Driving.....	205	Before Towing a Trailer.....	198
Electromagnetic Compatibility.....	440	Hitches.....	198
Emission Law.....	143	Launching or Retrieving a Boat or Personal	
Noise Emissions Warranty, Prohibited		Watercraft (PWC).....	199
Tampering Acts and Maintenance.....	144	Safety Chains.....	198
Tampering With a Noise Control		Trailer Brakes.....	198
System.....	143	Trailer Lamps.....	198
End User License Agreement.....	442	When Towing a Trailer.....	199
VEHICLE SOFTWARE END USER LICENSE		Event Data Recording	
AGREEMENT (EULA).....	442	See: Data Recording.....	9
Engine Block Heater.....	134	Export Unique Options.....	14
Using the Engine Block Heater.....	134	Exterior Mirrors.....	78
Engine Coolant Check.....	237	Blind Spot Monitor.....	79
Adding Coolant.....	237	Fold-Away Exterior Mirrors.....	78
Coolant Change.....	239	Heated Exterior Mirrors.....	78
Engine Coolant Temperature		Integrated Blind Spot Mirrors.....	78
Management.....	240	Memory Mirrors.....	78
		Power Exterior Mirrors.....	78
		Projection Lights.....	78

# Index

Signal Indicator Mirrors.....	78
<b>F</b>	
Fastening the Seatbelts.....	31
Seatbelt Locking Modes.....	33
Using Seatbelts During Pregnancy.....	32
Flat Tire	
See: Changing a Road Wheel.....	287
Flat Tire Inflation	
See: Tire Sealant and Inflator Kit.....	261
Floor Mats.....	206
Fog Lamps - Front	
See: Front Fog Lamps.....	75
Ford Credit.....	11
US Only.....	11
Ford Protect.....	420
Ford Protect Extended Service Plan (CANADA ONLY).....	421
Ford Protect Extended Service Plans (U.S. Only).....	420
Front Fog Lamps.....	75
Front Passenger Sensing System.....	40
Fuel and Refueling.....	136
Fuel Consumption.....	141
Advertised Capacity.....	141
Calculating Fuel Economy.....	142
Filling the Fuel Tank.....	142
Fuel Filler Funnel Location.....	137
Fuel Filter.....	243
Fuel Quality.....	136
Choosing the Right Fuel.....	136
Fuel Shutoff.....	208
Fuses.....	220
Fuse Specification Chart.....	220
Passenger Compartment Fuse Panel.....	225
Power Distribution Box.....	220
<b>G</b>	
Garage Door Opener.....	124
Garage Door Opener	
See: Universal Garage Door Opener.....	124
Gauges.....	81
Engine Coolant Temperature Gauge.....	83
Fuel Gauge.....	83
Gauge Package.....	83
Information Bar.....	83
Information Display.....	82
Type 1.....	81
Type 2.....	82
Gearbox	
See: Transmission.....	147
General Information on Radio	
Frequencies.....	52
Intelligent Access.....	52
General Maintenance Information.....	422
Multi-Point Inspection.....	425
Owner Checks and Services.....	424
Protecting Your Investment.....	422
Why Maintain Your Vehicle?.....	422
Why Maintain Your Vehicle at Your Dealership?.....	422
Getting Assistance Outside the U.S. and Canada.....	216
Getting the Services You Need.....	213
Away From Home.....	213
Glasses Holder.....	129
Global Opening.....	77
Opening the Windows.....	78
<b>H</b>	
Handbrake	
See: Parking Brake.....	155
Hazard Flashers.....	208
Headlamp Adjusting	
See: Adjusting the Headlamps.....	245
Headlamp Exit Delay.....	73
Headrest	
See: Head Restraints.....	117
Head Restraints.....	117
Adjusting the Head Restraint.....	118
Front Seat Non-Adjustable Head Restraints .....	118
Tilting Head Restraints .....	119
Heated Exterior Mirrors.....	115
Heated Rear Window.....	115
Heated Steering Wheel.....	68
Heating	
See: Climate Control.....	109
Hill Start Assist.....	155
Switching the System On and Off.....	156
Using Hill Start Assist.....	156



# Index

Hints on Controlling the Interior	
Climate.....	113
Defogging the Side Windows in Cold Weather.....	115
General Hints.....	113
Quickly Cooling the Interior.....	114
Quickly Heating the Interior.....	113
Recommended Settings for Cooling.....	114
Recommended Settings for Heating.....	114
Hints on Driving With Anti-Lock Brakes.....	154
Home Screen.....	353
Hood Lock	
See: Opening and Closing the Hood.....	230
<b>I</b>	
In California (U.S. Only).....	214
Information Display Control.....	68
Quick Action Menus.....	68
Information Displays.....	88
General Information.....	88
Information Messages.....	97
Adaptive Cruise Control.....	98
AdvanceTrac™.....	98
Airbag.....	99
Alarm.....	99
Battery and Charging System.....	99
Blind Spot Information and Cross Traffic Alert System.....	100
Collision Warning System.....	101
Doors and Locks.....	101
Engine.....	101
Exhaust Mode.....	101
Fuel.....	102
Hill Start Assist.....	102
Keys and Intelligent Access.....	102
Maintenance.....	103
MyKey.....	104
Park Aid.....	104
Park Brake.....	105
Rear Axle.....	105
Remote Start.....	105
Seats.....	105
Starting System.....	106
Steering System.....	106
Suspension System.....	106
Tire Mobility Kit.....	107
Tire Pressure Monitoring System.....	107
Traction Control.....	107
Transmission.....	108
Installing Child Restraints.....	20
Child Seats.....	20
Using Lap and Shoulder Belts.....	20
Using Lower Anchors and Tethers for Children (LATCH).....	22
Using Tether Straps.....	24
Instrument Cluster.....	81
Instrument Lighting Dimmer.....	72
Vehicles With Front Fog Lamps.....	73
Vehicles Without Front Fog Lamps.....	73
Instrument Panel Overview.....	16
Interior Lamps.....	76
Interior Luggage Compartment Release.....	63
Interior Mirror.....	79
Auto-Dimming Mirror.....	79
Introduction.....	7
<b>J</b>	
Jump Starting the Vehicle.....	209
Connecting the Jumper Cables.....	209
Installing the Battery Shield.....	211
Preparing Your Vehicle.....	209
Removing the Battery Shield.....	209
Removing the Jumper Cables.....	210
Starting the Engine.....	210
<b>K</b>	
Keyless Starting.....	130
Ignition Modes.....	130
Keys and Remote Controls.....	52
<b>L</b>	
Lane Keeping System.....	174
Switching the System On and Off.....	175
Lighting Control.....	71
Flashing the Headlamp High Beam.....	72
Headlamp High Beam.....	71
Lighting.....	71
General Information.....	71
Limited Slip Differential.....	153
Traction-Lok™ and TORSEN™ Axles.....	153

# Index

Load Carrying.....	191
Load Limit.....	191
Special Loading Instructions for Owners of Pick-up Trucks and Utility-type Vehicles.....	195
Vehicle Loading - with and without a Trailer.....	191
Locking and Unlocking.....	58
Activating Intelligent Access.....	59
Autolock.....	60
Battery Saver.....	63
Illuminated Entry.....	62
Illuminated Exit.....	63
Locking and Unlocking the Doors with the Key Blade.....	61
Opening the Luggage Compartment.....	62
Power Door Locks.....	58
Remote Control.....	58
Smart Unlocks.....	60
Lug Nuts See: Changing a Road Wheel.....	287
<b>M</b>	
Maintenance.....	230
General Information.....	230
Manual Climate Control.....	109
A/C.....	110
Air Distribution Control.....	110
Defrost.....	109
Fan Speed Control.....	110
Fan Speed Indicator.....	110
Heated Rear Window.....	110
Max A/C.....	110
Max Defrost.....	110
Power.....	109
Recirculated Air.....	110
Temperature Control.....	110
Manual Seats.....	119
Manual Transmission Fluid Check.....	241
Manual Transmission.....	147
Parking Your Vehicle.....	148
Recommended Shift Speeds.....	147
Reverse.....	148
Using the Clutch.....	147
Media Hub.....	323
Memory Function.....	120
Easy Entry and Exit Feature.....	121
Linking a PreSet Position to your Remote Control or Intelligent Access Key Fob.....	121
Saving a PreSet Position.....	121
Message Center See: Information Displays.....	88
Mirrors See: Windows and Mirrors.....	77
Mobile Communications Equipment.....	14
Motorcraft Parts - 2.3L EcoBoost™.....	295
Motorcraft Parts - 5.0L, Bullitt.....	297
Motorcraft Parts - 5.0L.....	296
MyKey – Troubleshooting.....	50
MyKey™.....	48
Principle of Operation.....	48
<b>N</b>	
Navigation.....	379
cityseeker.....	386
Destination Mode.....	381
Map Mode.....	379
Navigation Map Updates.....	387
Navigation Menu.....	384
SiriusXM Traffic and Travel Link.....	387
SYNC AppLink.....	386
Waypoints.....	385
Normal Scheduled Maintenance.....	425
Intelligent Oil-Life Monitor™.....	425
Normal Maintenance Intervals.....	426
<b>O</b>	
Oil Change Indicator Reset.....	236
Oil Check See: Engine Oil Check.....	235
Opening and Closing the Hood.....	230
Closing the Hood.....	231
Opening the Hood.....	230
Opening the Convertible Top.....	201
Using the Tonneau Caps.....	202
Ordering Additional Owner's Literature.....	218
Obtaining a French Owner's Manual.....	218

# Index

## P

Parking Aids.....	161
Principle of Operation.....	161
Parking Brake.....	155
All Vehicles.....	155
Vehicles With Automatic Transmission.....	155
Vehicles with Manual Transmission.....	155
Passive Anti-Theft System.....	64
SecuriLock.....	64
PATS	
See: Passive Anti-Theft System.....	64
Perchlorate.....	11
Personal Safety System™.....	37
How Does the Personal Safety System Work?.....	37
Phone.....	373
During a Phone Call.....	377
Making Calls.....	376
Pairing Your Cell Phone for the First Time.....	373
Phone Menu.....	374
Receiving Calls.....	377
Smartphone Connectivity.....	378
Text Messaging.....	378
Post-Crash Alert System.....	211
Power Door Locks	
See: Locking and Unlocking.....	58
Power Seats.....	120
Power Lumbar.....	120
Power Steering Fluid Check.....	242
Power Windows.....	77
Accessory Delay.....	77
Bounce-Back.....	77
One-Touch Down.....	77
One-Touch Up.....	77
Pre-Collision Assist.....	183
Adjusting Pre-Collision Assist Settings.....	185
Blocked Sensors.....	186
Distance Indication and Alert.....	185
Using the Pre-Collision Assist System.....	184
Protecting the Environment.....	15
Puncture	
See: Changing a Road Wheel.....	287

## R

Rear Axle.....	153
Rear Parking Aid.....	161
Obstacle Distance Indicator.....	162
Rear Seats.....	122
Accessing the Rear Seats.....	122
Second Row Split-Folding Rear Seat .....	122
Rear View Camera.....	162
Using the Rear View Camera System.....	163
Rear View Camera	
See: Rear View Camera.....	162
Recommended Towing Weights.....	197
Reduced Engine Performance.....	204
.....	204
Refueling.....	139
Refueling System Overview.....	139
Refueling System Warning.....	141
Refueling Your Vehicle.....	139
Remote Control.....	52
Car Finder.....	55
Intelligent Access Key.....	52
Remote Start.....	56
Replacing the Battery.....	54
Sounding the Panic Alarm.....	55
Using the Key Blade.....	53
Remote Start.....	116
Automatic Settings.....	116
Repairing Minor Paint Damage.....	258
Replacement Parts	
Recommendation.....	12
Collision Repairs.....	12
Scheduled Maintenance and Mechanical Repairs.....	12
Warranty on Replacement Parts.....	12
Replacing a Lost Key or Remote Control.....	57
Reporting Safety Defects (Canada Only).....	218
Reporting Safety Defects (U.S. Only).....	218
Roadside Assistance.....	207
Vehicles Sold in Canada: Getting Roadside Assistance.....	208
Vehicles Sold in the United States: Getting Roadside Assistance.....	207
Vehicles Sold in the United States: Using Roadside Assistance.....	207

# Index

Roadside Emergencies.....	207	Side Airbags.....	43
Running-In		Sitting in the Correct Position.....	117
See: Breaking-In.....	204	Snow Chains	
Running Out of Fuel.....	137	See: Using Snow Chains.....	282
Adding Fuel From a Portable Fuel		Spare Wheel	
Container.....	138	See: Changing a Road Wheel.....	287
Filling a Portable Fuel Container.....	137	Special Notices.....	12
<b>S</b>		Additional Warranty Information.....	12
Safety Canopy™ - Coupe.....	44	New Vehicle Limited Warranty.....	12
Safety Precautions.....	136	On Board Diagnostics Data Link	
Satellite Radio.....	320	Connector.....	13
Satellite Radio Electronic Serial Number		Special Instructions.....	13
(ESN).....	321	Special Operating Conditions Scheduled	
Satellite Radio Reception Factors.....	321	Maintenance.....	428
SiriusXM Satellite Radio Service.....	321	Exceptions.....	429
Troubleshooting.....	322	Speed Control	
Scheduled Maintenance Record.....	430	See: Cruise Control.....	166
Scheduled Maintenance.....	422	Stability Control.....	158
Seatbelt Extension.....	36	Principle of Operation.....	158
Seatbelt Reminder.....	34	Starting a Gasoline Engine.....	131
Belt-Minder™.....	34	Automatic Engine Shutdown.....	132
Seatbelts.....	30	Failure to Start.....	132
Principle of Operation.....	30	Fast Restart.....	132
Seatbelt Warning Lamp and Indicator		Guarding Against Exhaust Fumes.....	133
Chime.....	33	Important Ventilating Information.....	134
Conditions of operation.....	34	Stopping the Engine When Your Vehicle is	
Seats.....	117	Moving.....	133
Security.....	64	Stopping the Engine When Your Vehicle is	
Settings.....	390	Stationary.....	133
911 Assist.....	395	Starting and Stopping the Engine.....	130
Ambient Lighting.....	402	General Information.....	130
Bluetooth.....	392	Steering.....	183
Clock.....	392	Electric Power Steering.....	183
Display.....	403	Steering Wheel Lock.....	131
General.....	400	Unlocking the Steering Wheel.....	131
Media Player.....	391	Steering Wheel.....	66
Mobile Apps.....	399	Storage Compartments.....	129
Navigation.....	397	Sun Visors.....	80
Phone.....	392	Illuminated Vanity Mirror.....	80
Radio.....	396	Supplementary Restraints System.....	38
SiriusXM.....	397	Principle of Operation.....	38
Sound.....	390	Symbols Glossary.....	7
Valet Mode.....	404	SYNC™ 3.....	341
Vehicle.....	402	General Information.....	341
Voice Control.....	403	SYNC™ 3 Troubleshooting.....	404
Wi-Fi & Hotspot.....	401	SYNC™ Applications and	
		Services.....	328
		911 Assist.....	329

# Index

SYNC Mobile Apps.....	330
SYNC™.....	324
General Information.....	324
SYNC™ Troubleshooting.....	333

## T

### Technical Specifications

See: Capacities and Specifications.....	294
The Better Business Bureau (BBB) Auto Line Program (U.S. Only).....	215
Tire Care.....	267
Glossary of Tire Terminology.....	269
Information About Uniform Tire Quality Grading.....	267
Information Contained on the Tire Sidewall.....	270
Temperature A B C.....	268
Traction AA A B C.....	268
Treadwear.....	268

### Tire Inflation When Punctured

See: Tire Sealant and Inflator Kit.....	261
Tire Pressure Monitoring System.....	284
Changing Tires With a Tire Pressure Monitoring System.....	285
Understanding Your Tire Pressure Monitoring System.....	285

### Tire Repair Kit

See: Tire Sealant and Inflator Kit.....	261
Tire Sealant and Inflator Kit.....	261
First Stage: Inflating the Tire with Sealing Compound and Air.....	263
General Information.....	262
Second Stage: Checking Tire Pressure.....	265
Tips for Use of the Kit.....	262
What to Do After the Tire Has Been Sealed.....	265
What to do When a Tire Is Punctured.....	263

### Tires

See: Wheels and Tires.....	261
Towing a Trailer.....	196
Load Placement.....	196
Towing the Vehicle on Four Wheels.....	199
Emergency Towing.....	199
Recreational Towing.....	200

Towing.....	196
Track Use.....	250
.....	250
Traction Control.....	157
Principle of Operation.....	157
Transmission Code Designation.....	299
Transmission.....	147
Transporting the Vehicle.....	212
Type Approvals.....	468
China.....	478
Radio Frequency Certification for Keys and Remote Controls.....	478
Radio Frequency Certifications for Blind Spot Information System.....	476
Radio Frequency Certifications for Body Control Module.....	478
Radio Frequency Certifications for Cruise Control Module.....	478
Radio Frequency Certifications for Mid Range Radar.....	470
Radio Frequency Certifications for Passive Anti-Theft System.....	471
Radio Frequency Certifications for Radio Transceiver Module.....	474
Radio Frequency Certifications for SYNC 3.....	478
Radio Frequency Certifications for Tire Pressure Monitoring Sensor(s).....	468
Radio Frequency Certifications for Wireless Charging.....	477
Radio Frequency Statement for Audio Unit.....	479

## U

Under Hood Overview - 2.3L EcoBoost™.....	232
Under Hood Overview - 5.0L, Bullitt.....	234
Under Hood Overview - 5.0L.....	233
Universal Garage Door Opener.....	124
HomeLink Wireless Control System.....	124
USB Port.....	323
Using Adaptive Cruise Control.....	167
Automatic Cancellation.....	170
Blocked Sensor.....	171
Canceling the Set Speed.....	170
Changing the Set Speed.....	170

# Index

Detection Issues.....	170	Utilizing the Mediation/Arbitration Program (Canada Only).....	216
Following a Vehicle.....	168	<b>V</b>	
Hilly Condition Usage.....	170	Vehicle Care.....	253
Overriding the Set Speed.....	169	General Information.....	253
Resuming the Set Speed.....	170	Vehicle Certification Label.....	299
Setting the Adaptive Cruise Speed.....	168	Vehicle Identification Number.....	298
Setting the Gap Distance.....	169	Vehicle Performance	
Switching Adaptive Cruise Control Off.....	170	Specifications.....	312
Switching Adaptive Cruise Control On.....	168	Vehicle Storage.....	258
Switching to Normal Cruise Control.....	172	Battery.....	259
System Not Available.....	171	Body.....	258
Using Cruise Control.....	166	Brakes.....	259
Switching Cruise Control Off.....	167	Cooling system.....	259
Switching Cruise Control On.....	166	Engine.....	259
Using MyKey With Remote Start Systems.....	50	Fuel system.....	259
Using Snow Chains.....	282	General.....	258
Using Stability Control.....	159	Miscellaneous.....	259
Electronic Stability Control .....	159	Removing Vehicle From Storage.....	259
Using Summer Tires.....	282	Tires.....	259
Using SYNC™ With Your Media Player.....	332	Ventilation	
Audio Voice Commands.....	332	See: Climate Control.....	109
Media Sources.....	332	VIN	
Using SYNC™ With Your Phone.....	327	See: Vehicle Identification Number.....	298
Accessing Features through the Phone Menu.....	328	Voice Control.....	67
Pairing a Phone.....	327	<b>W</b>	
Phone Controls.....	328	Warning Lamps and Indicators.....	84
Phone Voice Commands.....	328	Adaptive Cruise Control Indicator.....	84
Using Traction Control.....	157	Airbag Warning Lamp.....	84
Switching the System Off .....	157	Anti-Lock Brake System Warning Lamp.....	84
System Indicator Lights and Messages.....	157	Automatic Headlamp High Beam Indicator.....	84
Using Voice Recognition.....	325	Battery.....	84
Audio Voice Commands.....	355	Blind Spot Information System Indicator.....	84
Climate Voice Commands.....	356	Brake System Warning Lamp.....	84
Initiating a Voice Session.....	325	Cruise Control Indicator.....	85
Mobile App Voice Commands.....	359	Direction Indicator.....	85
Navigation Voice Commands.....	358	Door Ajar Warning Lamp.....	85
Phone Voice Commands.....	356	Engine Coolant Temperature Warning Lamp.....	85
SiriusXM Traffic and Travel Link Voice Commands.....	359	Fasten Seatbelt Warning Lamp.....	85
System Interaction and Feedback.....	326	Front Fog Lamp Indicator.....	85
Voice Settings Commands.....	360		
Using Winter Tires.....	282		

# Index

---

Headlamp High Beam Indicator.....	85
Heads Up Display.....	85
Hood Ajar.....	85
Lane Keeping System Lamp.....	85
Launch Control.....	85
Low Beam Malfunction.....	86
Low Fuel Level Warning Lamp.....	86
Low Tire Pressure Warning Lamp.....	86
Low Washer Fluid Level Warning Lamp.....	86
Oil Pressure Warning Lamp.....	86
Parking Lamps.....	86
Service Engine Soon.....	86
Stability Control and Traction Control Indicator.....	87
Stability Control and Traction Control Off Warning Lamp.....	87
Trunk Ajar.....	87
Washer Fluid Check.....	242
Washers See: Cleaning the Exterior.....	253
Waxing.....	255
Welcome Lighting.....	75
Wheel Nuts See: Changing a Road Wheel.....	287
Wheels and Tires.....	261
General Information.....	261
Technical Specifications.....	293
Windows and Mirrors.....	77
Windshield Washers.....	70
Windshield Wipers.....	69
Intermittent Wipe.....	69
Speed Dependent Wipers.....	69
Winter Tires See: Using Winter Tires.....	282
Wiper Blades See: Checking the Wiper Blades.....	245
Wipers and Washers.....	69