



owner.ford.com



ford.ca

2019 EXPEDITION Owner's Manual



September 2018
First Printing
Litho in U.S.A.



KL1J19A321 AA



The information contained in this publication was correct at the time of going to print. In the interest of continuous development, we reserve the right to change specifications, design or equipment at any time without notice or obligation. No part of this publication may be reproduced, transmitted, stored in a retrieval system or translated into any language in any form by any means without our written permission. Errors and omissions excepted.

© Ford Motor Company 2018

All rights reserved.

Part Number: 201808 20180802145702

California Proposition 65



WARNING: Operating, servicing and maintaining a passenger vehicle or off-highway motor vehicle can expose you to chemicals including engine exhaust, carbon monoxide, phthalates, and lead, which are known to the State of California to cause cancer and birth defects or other reproductive harm. To minimize exposure, avoid breathing exhaust, do not idle the engine except as necessary, service your vehicle in a well-ventilated area and wear gloves or wash your hands frequently when servicing your vehicle. For more information go to www.P65Warnings.ca.gov/passenger-vehicle.



WARNING: Battery posts, terminals and related accessories contain lead and lead compounds, chemicals known to the State of California to cause cancer and reproductive harm.
Wash your hands after handling.

Table of Contents

Introduction

About This Manual	7
Symbols Glossary	7
Data Recording	9
Perchlorate	11
Ford Credit	11
Replacement Parts Recommendation	12
Special Notices	12
Mobile Communications Equipment	13
Export Unique Options	13

Environment

Protecting the Environment	14
----------------------------------	----

At a Glance

Instrument Panel Overview	15
---------------------------------	----

Child Safety

General Information	17
Installing Child Restraints	18
Booster Seats	28
Child Restraint Positioning	30
Child Safety Locks	32

Seatbelts

Principle of Operation	34
Fastening the Seatbelts	35
Seatbelt Height Adjustment	39
Seatbelt Warning Lamp and Indicator Chime	40
Seatbelt Reminder	40
Child Restraint and Seatbelt Maintenance	42
Seatbelt Extension	42

Personal Safety System™

Personal Safety System™	44
-------------------------------	----

Supplementary Restraints System

Principle of Operation	45
Driver and Passenger Airbags	46
Front Passenger Sensing System	47
Side Airbags	49
Safety Canopy™	50
Crash Sensors and Airbag Indicator	51
Airbag Disposal	52

Keys and Remote Controls

General Information on Radio Frequencies	53
Remote Control	53
Replacing a Lost Key or Remote Control	60

MyKey™

Principle of Operation	61
Creating a MyKey	62
Clearing All MyKeys	63
Checking MyKey System Status	63
Using MyKey With Remote Start Systems	64
MyKey — Troubleshooting	64

Doors and Locks

Locking and Unlocking	66
Keyless Entry	69

Liftgate

Manual Liftgate	73
Power Liftgate	74

Security

Passive Anti-Theft System	78
Anti-Theft Alarm	80

Power Running Boards

Using Power Running Boards	81
----------------------------------	----

Table of Contents

Steering Wheel

Adjusting the Steering Wheel - Vehicles With: Manual Adjustable Steering Column	83
Adjusting the Steering Wheel - Vehicles With: Power Adjustable Steering Column	83
Audio Control	84
Voice Control	85
Cruise Control	85
Information Display Control	86
Heated Steering Wheel	86

Pedals

Adjusting the Pedals	87
----------------------------	----

Wipers and Washers

Windshield Wipers	88
Autowipers	88
Windshield Washers	89
Rear Window Wiper and Washers	89

Lighting

General Information	90
Lighting Control	90
Autolamps	91
Instrument Lighting Dimmer	91
Headlamp Exit Delay	92
Daytime Running Lamps	92
Automatic High Beam Control	92
Front Fog Lamps	93
Direction Indicators	94
Welcome Lighting	94
Interior Lamps	94
Ambient Lighting	95

Windows and Mirrors

Power Windows	96
Global Opening	97
Exterior Mirrors	97

Interior Mirror	99
Childminder Mirror	99
Sun Visors	100
Moonroof - Vehicles With: Vista Roof Opening Panel	100
Liftgate Window	101

Instrument Cluster

Gauges	103
Warning Lamps and Indicators	105
Audible Warnings and Indicators	109

Information Displays

General Information	110
Information Messages	122

Climate Control

Manual Climate Control	138
Automatic Climate Control	140
Hints on Controlling the Interior Climate	142
Rear Passenger Climate Controls - Vehicles With: Automatic Temperature Control	144
Rear Passenger Climate Controls - Vehicles With: Manual Temperature Control	145
Heated Windshield	146
Heated Rear Window	146
Heated Exterior Mirrors	147
Cabin Air Filter	147
Remote Start	147

Seats

Sitting in the Correct Position	149
Head Restraints	149
Manual Seats	153
Power Seats	153
Memory Function	156
Rear Seats	157
Heated Seats	162

Table of Contents

Climate Controlled Seats	164	Four-Wheel Drive	
Garage Door Opener		Using Four-Wheel Drive	202
Universal Garage Door Opener	166	Rear Axle	
Auxiliary Power Points		Limited Slip Differential	210
Auxiliary Power Points	170	Brakes	
Wireless Accessory Charging	171	General Information	211
Storage Compartments		Hints on Driving With Anti-Lock Brakes	211
Center Console	174	Electric Parking Brake	212
Overhead Console	174	Hill Start Assist	213
Starting and Stopping the Engine		Traction Control	
General Information	175	Principle of Operation	215
Ignition Switch	175	Using Traction Control	215
Keyless Starting	176	Stability Control	
Starting a Gasoline Engine	176	Principle of Operation	216
Engine Block Heater	179	Using Stability Control	217
Unique Driving Characteristics		Hill Descent Control	
Auto-Start-Stop	181	Principle of Operation	219
Fuel and Refueling		Using Hill Descent Control	219
Safety Precautions	184	Parking Aids	
Fuel Quality	184	Principle of Operation	221
Fuel Filler Funnel Location	185	Rear Parking Aid	222
Running Out of Fuel	185	Front Parking Aid	222
Refueling	187	Side Sensing System	223
Fuel Consumption	189	Active Park Assist	225
Engine Emission Control		Rear View Camera	231
Emission Law	191	360 Degree Camera	234
Catalytic Converter	192	Cruise Control	
Transmission		Principle of Operation	237
Automatic Transmission	195	Using Cruise Control	237
		Using Adaptive Cruise Control	238

Table of Contents

Driving Aids

Driver Alert	245
Lane Keeping System	246
Blind Spot Information System	250
Cross Traffic Alert	254
Steering	257
Pre-Collision Assist	258
Drive Control	262

Load Carrying

Rear Under Floor Storage	265
Cargo Nets	267
Roof Racks and Load Carriers	268
Load Limit	269

Towing

Towing a Trailer	275
Trailer Reversing Aids	276
Trailer Sway Control	285
Recommended Towing Weights	286
Essential Towing Checks	288
Towing the Vehicle on Four Wheels	295

Driving Hints

Breaking-In	298
Reduced Engine Performance	298
Economical Driving	298
Driving Through Water	299
Floor Mats	299

Roadside Emergencies

Roadside Assistance	301
Hazard Flashers	302
Fuel Shutoff	302
Jump Starting the Vehicle	303
Post-Crash Alert System	305
Transporting the Vehicle	305
Towing Points	306

Customer Assistance

Getting the Services You Need	308
In California (U.S. Only)	309
The Better Business Bureau (BBB) Auto Line Program (U.S. Only)	310
Utilizing the Mediation/Arbitration Program (Canada Only)	311
Getting Assistance Outside the U.S. and Canada	311
Ordering Additional Owner's Literature	313
Reporting Safety Defects (U.S. Only)	313
Reporting Safety Defects (Canada Only)	313

Fuses

Fuse Box Locations	315
Fuse Specification Chart	315
Changing a Fuse	324

Maintenance

General Information	326
Opening and Closing the Hood	326
Under Hood Overview	327
Engine Oil Dipstick	328
Engine Oil Check	328
Oil Change Indicator Reset	329
Engine Coolant Check	330
Automatic Transmission Fluid Check	334
Transfer Case Fluid Check	334
Brake Fluid Check	335
Washer Fluid Check	335
Fuel Filter	336
Changing the 12V Battery	336
Checking the Wiper Blades	338
Changing the Wiper Blades	338
Adjusting the Headlamps	339
Removing a Headlamp	340
Changing a Bulb	340

Table of Contents

Changing the Engine Air Filter	342	Audio Unit - Vehicles With: Touchscreen Display	395
Vehicle Care		Digital Radio	396
General Information	344	Satellite Radio	398
Cleaning Products	344	USB Port	401
Cleaning the Exterior	344	Media Hub	401
Waxing	346	SYNC™	
Cleaning the Engine	346	General Information	402
Cleaning the Windows and Wiper Blades	346	Using Voice Recognition	403
Cleaning the Interior	347	Using SYNC™ With Your Phone	405
Cleaning the Instrument Panel and Instrument Cluster Lens	347	SYNC™ Applications and Services	406
Cleaning Leather Seats	348	Using SYNC™ With Your Media Player	410
Repairing Minor Paint Damage	349	SYNC™ Troubleshooting	411
Cleaning the Wheels	349	SYNC™ 3	
Vehicle Storage	349	General Information	419
Wheels and Tires		Home Screen	431
General Information	352	Using Voice Recognition	432
Tire Care	354	Entertainment	439
Using Snow Chains	368	Climate	449
Tire Pressure Monitoring System	369	Phone	451
Changing a Road Wheel	373	Navigation	457
Technical Specifications	378	Apps	465
Capacities and Specifications		Settings	468
Engine Specifications	380	SYNC™ 3 Troubleshooting	482
Motorcraft Parts	380	Accessories	
Vehicle Identification Number	382	Accessories	496
Vehicle Certification Label	383	Ford Protect	
Transmission Code Designation	383	Ford Protect	498
Capacities and Specifications	384	Scheduled Maintenance	
Bulb Specification Chart	389	General Maintenance Information	500
Audio System		Normal Scheduled Maintenance	503
General Information	391	Special Operating Conditions Scheduled Maintenance	506
Audio Unit - Vehicles Without: Touchscreen Display	392	Scheduled Maintenance Record	508

Table of Contents

Appendices

Electromagnetic Compatibility	519
End User License Agreement	521
Declaration of Conformity	547
Type Approvals	547

Introduction

ABOUT THIS MANUAL

Thank you for choosing Ford. We recommend that you take some time to get to know your vehicle by reading this manual. The more that you know about your vehicle, the greater the safety and pleasure you will get from driving it.



WARNING: Driving while distracted can result in loss of vehicle control, crash and injury. We strongly recommend that you use extreme caution when using any device that may take your focus off the road. Your primary responsibility is the safe operation of your vehicle. We recommend against the use of any hand-held device while driving and encourage the use of voice-operated systems when possible. Make sure you are aware of all applicable local laws that may affect the use of electronic devices while driving.

Note: This manual describes product features and options available throughout the range of available models, sometimes even before they are generally available. It may describe options not fitted to the vehicle you have purchased.

Note: Some of the illustrations in this manual may show features as used in different models, so may appear different to you on your vehicle.

Note: Always use and operate your vehicle in line with all applicable laws and regulations.

Note: Pass on this manual when selling your vehicle. It is an integral part of your vehicle.

This manual may qualify the location of a component as left-hand side or right-hand side. The side is determined when facing forward in the seat.



E154903

- A Right-hand side.
- B Left-hand side.

SYMBOLS GLOSSARY

These are some of the symbols you may see on your vehicle.



Air conditioning system



Air conditioning system lubricant type



Anti-lock braking system



Avoid smoking, flames or sparks



Battery



Battery acid



Brake fluid - non petroleum based



Brake system

Introduction



Brake system



Flammable



Cabin air filter



Front airbag



Check fuel cap



Front fog lamps



Child safety door lock or unlock



Fuel pump reset



Child seat lower anchor



Fuse compartment



Child seat tether anchor



Hazard flashers



Cruise control



Heated rear window



Do not open when hot



Windshield defrosting system



Engine air filter



Interior luggage compartment release



Engine coolant



Jack



Engine coolant temperature



Keep out of reach of children



Engine oil



Lighting control



Explosive gas



Low tire pressure warning



Fan warning



Maintain correct fluid level



Fasten seatbelt



Note operating instructions

Introduction



Horn control



Panic alarm



Parking aid



Parking brake



Power steering fluid



Power windows front/rear



Power window lockout



Requires registered technician



Safety alert



See Owner's Manual



See Service Manual



Service engine soon



Passenger airbag activated



Passenger airbag deactivated



Side airbag



Shield the eyes



Stability control



Hill descent control



Trail control



Windshield wiping system



Windshield wash and wipe

DATA RECORDING

Service Data Recording

Service data recorders in your vehicle are capable of collecting and storing diagnostic information about your vehicle. This potentially includes information about the performance or status of various systems and modules in the vehicle, such as engine, throttle, steering or brake systems. In order to properly diagnose and service your vehicle, Ford Motor Company (Ford of Canada, in Canada), and service and repair facilities may access or share among them vehicle diagnostic information received through a direct connection to your vehicle when diagnosing or servicing your vehicle. Additionally, Ford Motor Company (Ford of Canada, in Canada) may, where permitted by law, use vehicle diagnostic information for vehicle improvement or with other information we may have about you, (for example, your contact information), to offer you products or services that may interest you. Data may be provided to our service providers such

Introduction

as part suppliers that may help diagnose malfunctions, and who are similarly obligated to protect data. We retain this data only as long as necessary to perform these functions or to comply with law. We may provide information where required in response to official requests to law enforcement or other government authorities or third parties acting with lawful authority or court order, and such information may be used in legal proceedings. For U.S. only (if equipped), if you choose to use connected apps and services, such as SYNC Vehicle Health Report or MyFord Mobile App, you consent that certain diagnostic information may also be accessed electronically by Ford Motor Company and Ford authorized service facilities, and that the diagnostic information may be used to provide services to you, personalizing your experience, troubleshoot, and to improve products and services and offer you products and services that may interest you, where permitted by law. For Canada only, for more information, please review the Ford of Canada privacy policy at www.ford.ca, including our U.S. data storage and use of service providers in other jurisdictions who may be subject to legal requirements in Canada, the United States and other countries applicable to them, for example, lawful requirements to disclose personal information to governmental authorities in those countries. See **SYNCTM** (page 402).

Event Data Recording

This vehicle is equipped with an event data recorder. The main purpose of an event data recorder is to record, in certain crash or near crash-like situations, such as an airbag deployment or hitting a road obstacle;

this data will assist in understanding how a vehicle's systems performed. The event data recorder is designed to record data related to vehicle dynamics and safety systems for a short period of time, typically 30 seconds or less.

The event data recorder in this vehicle is designed to record such data as:

- **How various systems in your vehicle were operating;**
- **Whether or not the driver and passenger safety belts were buckled/fastened;**
- **How far (if at all) the driver was depressing the accelerator and/or the brake pedal; and**
- **How fast the vehicle was traveling; and**
- **Where the driver was positioning the steering wheel.**

This data can help provide a better understanding of the circumstances in which crashes and injuries occur.

Note: *Event data recorder data is recorded by your vehicle only if a non-trivial crash situation occurs; no data is recorded by the event data recorder under normal driving conditions and no personal data or information (e.g., name, gender, age, and crash location) is recorded (see limitations regarding 911 Assist and Traffic, directions and Information privacy below). However, parties, such as law enforcement, could combine the event data recorder data with the type of personally identifying data routinely acquired during a crash investigation.*

To read data recorded by an event data recorder, special equipment is required, and access to the vehicle or the event data recorder is needed. In addition to the vehicle manufacturer, other parties, such as law enforcement, that have such special equipment, can read

Introduction

the information if they have access to the vehicle or the event data recorder. Ford Motor Company and Ford of Canada do not access event data recorder information without obtaining consent, unless pursuant to court order or where required by law enforcement, other government authorities or other third parties acting with lawful authority. Other parties may seek to access the information independently of Ford Motor Company and Ford of Canada.

Note: *Including to the extent that any law pertaining to Event Data Recorders applies to SYNC or its features, please note the following: Once 911 Assist (if equipped) is enabled (set ON), 911 Assist may, through any paired and connected cell phone, disclose to emergency services that the vehicle has been in a crash involving the deployment of an airbag or, in certain vehicles, the activation of the fuel pump shut-off. Certain versions or updates to 911 Assist may also be capable of being used to electronically or verbally provide to 911 operators the vehicle location (such as latitude and longitude), and/or other details about the vehicle or crash or personal information about the occupants to assist 911 operators to provide the most appropriate emergency services. If you do not want to disclose this information, do not activate the 911 Assist feature. See SYNC™ (page 402).*

Additionally, when you connect to Traffic, Directions and Information (if equipped, U.S. only), the service uses GPS technology and advanced vehicle sensors to collect the vehicle's current location, travel direction, and speed ("vehicle travel information"), only to help provide you with the directions, traffic reports, or business searches that you request. If you do not want

Ford or its vendors to receive this information, do not activate the service. For more information, see Traffic, Directions and Information, Terms and Conditions. See SYNC™ (page 402).

PERCHLORATE

Certain components in your vehicle such as airbag modules, seatbelt pretensioners and remote control batteries may contain perchlorate material. Special handling may apply for service or vehicle end of life disposal.

For more information visit:

Web Address
www.dtsc.ca.gov/hazardouswaste/perchlorate

FORD CREDIT

US Only

Ford Credit offers a full range of financing and lease plans to help you acquire your vehicle. If you have financed or leased your vehicle through Ford Credit, thank you for your business.

We offer a number of convenient ways for you to contact us, and to manage your account.

Call 1-800-727-7000.

For more information about Ford Credit and access to Account Manager, go to www.ford.com/finance.

Introduction

REPLACEMENT PARTS RECOMMENDATION

We have built your vehicle to the highest standards using quality parts. We recommend that you demand the use of genuine Ford and Motorcraft parts whenever your vehicle requires scheduled maintenance or repair. You can clearly identify genuine Ford and Motorcraft parts by looking for the Ford, FoMoCo or Motorcraft branding on the parts or their packaging.

Scheduled Maintenance and Mechanical Repairs

One of the best ways for you to make sure that your vehicle provides years of service is to have it maintained in line with our recommendations using parts that conform to the specifications detailed in this Owner's Manual. Genuine Ford and Motorcraft parts meet or exceed these specifications.

Collision Repairs

We hope that you never experience a collision, but accidents do happen. Genuine Ford replacement collision parts meet our stringent requirements for fit, finish, structural integrity, corrosion protection and dent resistance. During vehicle development we validate that these parts deliver the intended level of protection as a whole system. A great way to know for sure you are getting this level of protection is to use genuine Ford replacement collision parts.

Warranty on Replacement Parts

Genuine Ford and Motorcraft replacement parts are the only replacement parts that benefit from a Ford Warranty. The Ford Warranty may not cover damage caused to your vehicle as a result of failed non-Ford parts. For additional information, refer to the terms and conditions of the Ford Warranty.

SPECIAL NOTICES

New Vehicle Limited Warranty

For a detailed description of what is covered and what is not covered by your vehicle's New Vehicle Limited Warranty, see the Warranty Manual that is provided to you along with your Owner's Manual.

Special Instructions

For your added safety, your vehicle is fitted with sophisticated electronic controls.



WARNING: You risk death or serious injury to yourself and others if you do not follow the instruction highlighted by the warning symbol. Failure to follow the specific warnings and instructions could result in personal injury.



WARNING: NEVER use a rearward facing child restraint on a seat protected by an ACTIVE AIRBAG in front of it, DEATH or SERIOUS INJURY to the CHILD can occur.

Introduction

On Board Diagnostics Data Link Connector



WARNING: Do not connect wireless plug-in devices to the data link connector. Unauthorized third parties could gain access to vehicle data and impair the performance of safety related systems. Only allow repair facilities that follow our service and repair instructions to connect their equipment to the data link connector.

Your vehicle has an OBD Data Link Connector (DLC) that is used in conjunction with a diagnostic scan tool for vehicle diagnostics, repairs and reprogramming services. Installing an aftermarket device that uses the DLC during normal driving for purposes such as remote insurance company monitoring, transmission of vehicle data to other devices or entities, or altering the performance of the vehicle, may cause interference with or even damage to vehicle systems. We do not recommend or endorse the use of aftermarket plug-in devices unless approved by Ford. The vehicle Warranty will not cover damage caused by an aftermarket plug-in device.

MOBILE COMMUNICATIONS EQUIPMENT



WARNING: Driving while distracted can result in loss of vehicle control, crash and injury. We strongly recommend that you use extreme caution when using any device that may take your focus off the road. Your primary responsibility is the safe operation of your vehicle. We recommend against the use of any

hand-held device while driving and encourage the use of voice-operated systems when possible. Make sure you are aware of all applicable local laws that may affect the use of electronic devices while driving.

Using mobile communications equipment is becoming increasingly important in the conduct of business and personal affairs. However, you must not compromise your own or others' safety when using such equipment. Mobile communications can enhance personal safety and security when appropriately used, particularly in emergency situations. Safety must be paramount when using mobile communications equipment to avoid negating these benefits. Mobile communication equipment includes, but is not limited to, cellular phones, pagers, portable email devices, text messaging devices and portable two-way radios.

EXPORT UNIQUE OPTIONS

For your particular global region, your vehicle may be equipped with features and options that are different from the features and options that are described in this Owner's Manual. A market unique supplement may be supplied that complements this book. By referring to the market unique supplement, if provided, you can properly identify those features, recommendations and specifications that are unique to your vehicle. This Owner's Manual is written primarily for the U.S. and Canadian Markets. Features or equipment listed as standard may be different on units built for export. **Refer to this Owner's Manual for all other required information and warnings.**

Environment

PROTECTING THE ENVIRONMENT

You should play your part in protecting the environment. Correct vehicle usage and the authorized disposal of waste, cleaning and lubrication materials are significant steps toward this aim.

For details about Ford Motor Company's sustainability progress and initiatives visit:

Web Address
www.sustainability.ford.com

At a Glance

INSTRUMENT PANEL OVERVIEW

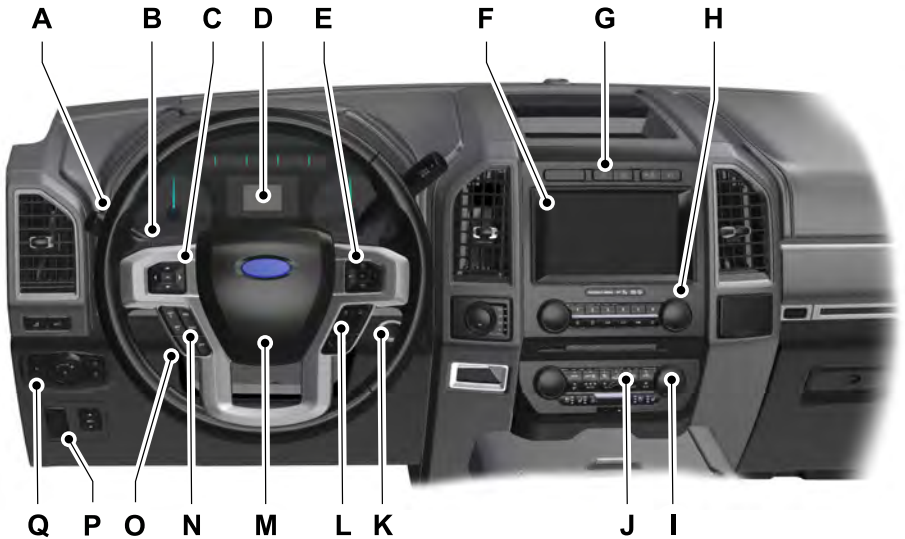

E251633

- A Direction indicators. See **Direction Indicators** (page 94).
- B Wiper lever. See **Wipers and Washers** (page 88).
- C Information display controls. See **Information Displays** (page 110).
- D Instrument cluster. See **Instrument Cluster** (page 103).
- E Navigation, media, phone.
- F Entertainment display.
- G Hazard warning flasher switch. See **Hazard Flashers** (page 302).

- H Audio. See **Audio System** (page 391).
- I Climate control. See **Climate Control** (page 138).
- J Rear defrost.
- K Start button. See **Keyless Starting** (page 176).
- L Voice control. See **Voice Control** (page 85).
- M Horn.
- N Cruise control. See **Cruise Control** (page 237).
- O Steering wheel adjustment. See **Adjusting the Steering Wheel** (page 83).

At a Glance

- P Parking brake release. See **Brakes** (page 211).
- Q Lighting control. See **Lighting Control** (page 90).

Child Safety

GENERAL INFORMATION

See the following sections for directions on how to properly use safety restraints for children.



WARNING: Always make sure your child is secured properly in a device that is appropriate for their height, age and weight. Child safety restraints must be bought separately from your vehicle. Failure to follow these instructions and guidelines may result in an increased risk of serious injury or death to your child.



WARNING: All children are shaped differently. The National Highway Traffic Safety Administration and other safety organizations, base their recommendations for child restraints on probable child height, age and weight thresholds, or on the minimum requirements of the law. We recommend that you check with a NHTSA Certified Child Passenger Safety Technician

(CPST) to make sure that you properly install the child restraint in your vehicle and that you consult your pediatrician to make sure you have a child restraint appropriate for your child. To locate a child restraint fitting station and CPST, contact NHTSA toll free at 1-888-327-4236 or go to www.nhtsa.dot.gov. In Canada, contact Transport Canada toll free at 1-800-333-0371 or go to www.tc.gc.ca to find a Child Car Seat Clinic in your area. Failure to properly restrain children in child restraints made especially for their height, age and weight, may result in an increased risk of serious injury or death to your child.



WARNING: On hot days, the temperature inside the vehicle can rise very quickly. Exposure of people or animals to these high temperatures for even a short time can cause death or serious heat related injuries, including brain damage. Small children are particularly at risk.

Child Safety

Recommendations for Safety Restraints for Children

Child	Child size, height, weight, or age	Recommended restraint type
Infants or toddlers	Children weighing 40 lb (18 kg) or less (generally age four or younger).	Use a child safety seat (sometimes called an infant carrier, convertible seat, or toddler seat).
Small children	Children who have outgrown or no longer properly fit in a child safety seat (generally children who are less than 4 ft. 9 in. (1.45 m) tall, are greater than age four and less than age 12, and between 40 lb (18 kg) and 80 lb (36 kg) and upward to 100 lb (45 kg) if recommended by your child restraint manufacturer).	Use a belt-positioning booster seat.
Larger children	Children who have outgrown or no longer properly fit in a belt-positioning booster seat (generally children who are at least 4 ft. 9 in. (1.45 m) tall or greater than 80 lb (36 kg) or 100 lb (45 kg) if recommended by child restraint manufacturer).	Use a vehicle seatbelt having the lap belt snug and low across the hips, shoulder belt centered across the shoulder and chest, and seatback upright.

- You are required by law to properly use safety seats for infants and toddlers in the United States and Canada.
- Many states and provinces require that small children use approved booster seats until they reach age eight, a height of 4 feet 9 inches (1.45 meters) tall, or 80 lb (36 kg). Check your local and state or provincial laws for specific requirements about the safety of children in your vehicle.
- When possible, always properly restrain children 12 years of age and under in a rear seating position of your vehicle. Accident statistics suggest that children are safer when properly restrained in the rear seating positions than in a front seating position.

INSTALLING CHILD RESTRAINTS

Child Seats



E142594

Child Safety

Use a child safety seat (sometimes called an infant carrier, convertible seat, or toddler seat) for infants, toddlers, or children weighing 40 lb (18 kg) or less (generally age four or younger).

Using Lap and Shoulder Belts



WARNING: Airbags can kill or injure a child in a child restraint. Never place a rear-facing child restraint in front of an active airbag. If you must use a forward-facing child restraint in the front seat, move the seat upon which the child restraint is installed all the way back.



WARNING: Airbags can kill or injure a child in a child restraint. Properly restrain children 12 and under in the rear seat whenever possible.



WARNING: Depending on where you secure a child restraint, and depending on the child restraint design, you may block access to certain seatbelt buckle assemblies and LATCH lower anchors, rendering those features potentially unusable. To avoid risk of injury, make sure occupants only use seating positions where they are able to be properly restrained.

When installing a child safety seat with combination lap and shoulder belts:

- Use the correct seatbelt buckle for that seating position.
- Insert the belt tongue into the proper buckle until you hear a snap and feel it latch. Make sure the tongue is securely fastened in the buckle.
- Keep the buckle release button pointing up and away from the safety seat, with the tongue between the child restraint and the release button, to prevent accidental unbuckling.

- Place the vehicle seat upon which the child restraint will be installed in the upright position.
- For second-row seating positions, adjust the recliner slightly to improve child restraint fit. If needed, remove the head restraints.
- For third-row seating positions, stow the head restraints to improve child restraint fit. See **Head Restraints** (page 149).
- Put the seatbelt in the automatic locking mode. See Step 5. This vehicle does not require the use of a locking clip.

Perform the following steps when installing the child restraint with combination lap and shoulder belts:

Note: *Although the child restraint illustrated is a forward facing child restraint, the steps are the same for installing a rear facing child restraint.*

Note: *The lock-off device on some child restraints may not accommodate the shoulder portion of the inflatable seatbelt. Follow all instructions provided by the manufacturer of the child restraint regarding the necessary and proper use of the lock-off device. In some instances these devices have been provided only for use in vehicles with seatbelt systems that would otherwise require a locking clip.*

Child Safety

Standard seatbelts



E142528

1. Position the child safety seat in a seat with a combination lap and shoulder belt.



E142529

2. After positioning the child safety seat in the proper seating position, pull down on the shoulder belt and then grasp the shoulder belt and lap belt together behind the belt tongue.



E142530

3. While holding the shoulder and lap belt portions together, route the tongue through the child restraint according to the child restraint manufacturer's instructions. Be sure the belt webbing is not twisted.

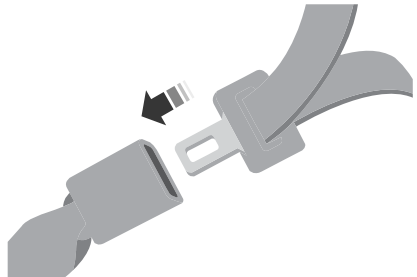

E142531

4. Insert the belt tongue into the proper buckle (the buckle closest to the direction the tongue is coming from) for that seating position until you hear a snap and feel the latch engage. Make sure the tongue is latched securely by pulling on it.

Child Safety



E142875

5. To put the retractor in the automatic locking mode, grasp the shoulder portion of the belt and pull downward until you pull all of the belt out.

Note: The automatic locking mode is available on the front passenger and rear seats.

6. Allow the belt to retract to remove slack. The belt will click as it retracts to indicate it is in the automatic locking mode.
7. Try to pull the belt out of the retractor to make sure the retractor is in the automatic locking mode (you should not be able to pull more belt out). If the retractor is not locked, unbuckle the belt and repeat Steps 5 and 6.



E142533

8. Remove remaining slack from the belt. Force the seat down with extra weight, for example, by pressing down or kneeling on the child restraint while pulling up on the shoulder belt in order to force slack from the belt. This is necessary to remove the remaining slack that exists once the extra weight of the child is added to the child restraint. It also helps to achieve the proper snugness of the child restraint to your vehicle. Sometimes, a slight lean toward the buckle provides extra help to remove remaining slack from the belt.
9. Attach the tether strap (if the child restraint is equipped).



E142534

10. Before placing the child in the seat, forcibly move the seat forward and back to make sure the seat is securely held in place. To check this, grab the seat at the belt path and attempt to move it side to side and forward and back. There should be no more than 1 in (2.5 cm) of movement for proper installation.

We recommend checking with a NHTSA Certified Child Passenger Safety Technician to make certain the child restraint is properly installed. In Canada, check with Transport Canada for referral to a Child Car Seat Clinic.

Child Safety

Inflatable seatbelts



E142528

1. Position the child safety seat in a seat with a combination lap and shoulder belt.



E142530

3. While holding the shoulder and lap belt portions together, route the tongue through the child restraint according to the child restraint manufacturer's instructions. Be sure the belt webbing is not twisted.



E146522

2. After positioning the child safety seat in the proper seating position, grasp the shoulder belt and lap belt together behind the belt tongue.

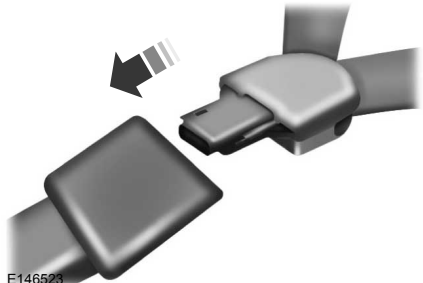

E146523

4. Insert the belt tongue into the proper buckle (the buckle closest to the direction the tongue is coming from) for that seating position until you hear a snap and feel the latch engage. Make sure the tongue is latched securely by pulling on it.

Child Safety

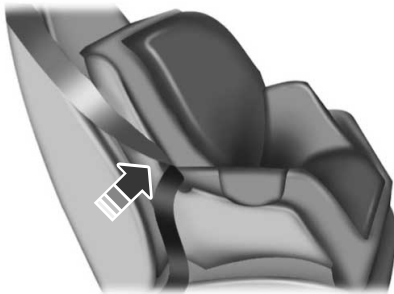

E146524

5. To put the retractor in the automatic locking mode, grasp the lap portion of the inflatable seatbelt and pull upward until you pull all of the belt out.

Note: The automatic locking mode is available on the front passenger and rear seats.

Note: Unlike the standard seatbelt, the inflatable seatbelt's unique lap portion locks the child restraint for installation. The ability for the shoulder portion of the belt to move freely is normal, even after the lap belt has been put into the automatic locking mode.

Note: The lock-off device on some child restraints may not accommodate the shoulder portion of the inflatable seatbelt. Follow all instructions provided by the manufacturer of the child restraint regarding the necessary and proper use of the lock-off device. In some instances, these devices have been provided only for use in vehicles with seatbelt systems that would otherwise require a locking clip.

6. Allow the belt to retract to remove slack. The belt clicks as it retracts to indicate it is in the automatic locking mode.

7. Try to pull the belt out of the retractor to make sure the retractor is in the automatic locking mode (you should not be able to pull more belt out). If the retractor is not locked, unbuckle the belt and repeat Steps 5 and 6.

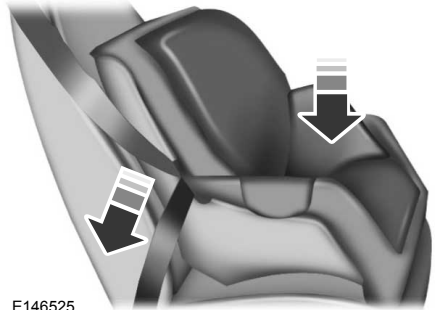

E146525

8. Remove remaining slack from the belt. Force the seat down with extra weight, for example, by pressing down or kneeling on the child restraint while pulling down on the lap belt in order to force slack from the belt. This is necessary to remove the remaining slack that exists once the extra weight of the child is added to the child restraint. It also helps to achieve the proper snugness of the child restraint to your vehicle. Sometimes, a slight lean toward the buckle will additionally help to remove remaining slack from the belt.
9. Attach the tether strap (if the child restraint is equipped).

Child Safety

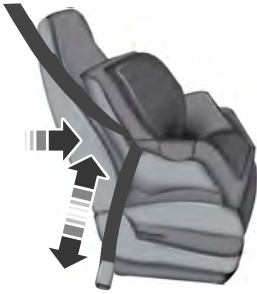

E142534

10. Before placing the child in the seat, forcibly move the seat forward and back to make sure the seat is securely held in place. To check this, grab the seat at the belt path and attempt to move it side to side and forward and back. There should be no more than 1 in (2.5 cm) of movement for proper installation.

We recommend checking with a NHTSA Certified Child Passenger Safety Technician to make certain the child restraint is properly installed. In Canada, check with Transport Canada for referral to a Child Car Seat Clinic.

Using Lower Anchors and Tethers for Children (LATCH)



WARNING: Do not attach two child safety restraints to the same anchor. In a crash, one anchor may not be strong enough to hold two child safety restraint attachments and may break, causing serious injury or death.

The LATCH system is composed of three vehicle anchor points: two lower anchors where the vehicle seatback and seat cushion meet (called the seat bight) and one top tether anchor behind that seating position.

LATCH compatible child safety seats have two rigid or webbing mounted attachments that connect to the two lower anchors at the LATCH equipped seating positions in your vehicle. This type of attachment method eliminates the need to use seatbelts to attach the child restraint. However, you can still use the seatbelt to attach the child restraint if the lower anchors are not used. For forward-facing child restraints, you must also attach the top tether strap to the proper top tether anchor if a top tether strap has been provided with your child restraint. We recommend the use of a child safety seat having a top tether strap. See Using Tether Straps in this chapter.

Your vehicle has LATCH lower anchors for child restraint installation at the seating positions marked with the child restraint symbol.

Second Row Bench Seat

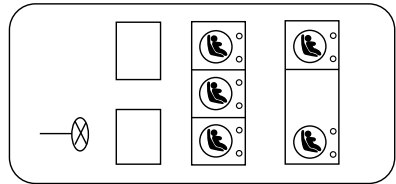

E251314

Child Safety

Second Row Bucket Seats

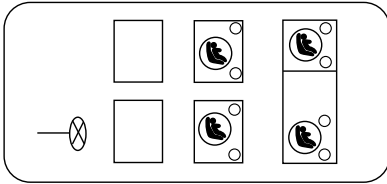

E251315

The LATCH anchors are at the rear section of the rear seat between the cushion and seatback, below the locator symbols on the seatback. Follow the child restraint manufacturer's instructions to properly install a child restraint with LATCH attachments.



E144054

The locator symbols are on round plastic buttons for the center seat and on rectangular tags for the outboard seats.

Follow the instructions on attaching child safety seats with tether straps. See Using Tether Straps in this chapter.

Attach LATCH lower attachments of the child restraint only to the anchors shown.

Each time you use the safety seat, check that the seat is properly attached to the lower anchors and tether anchor, if applicable. Tug the child restraint from side to side and forward and back where it is secured to the vehicle. The seat should move less than one inch when you do this for a proper installation.

If the safety seat is not anchored properly, the risk of a child being injured in a crash greatly increases.

Combining Seatbelt and LATCH Lower Anchors for Attaching Child Safety Seats

When used in combination, either the seatbelt or the LATCH lower anchors may be attached first, provided a proper installation is achieved. Attach the tether strap afterward, if included with the child restraint.

Using Tether Straps

Many forward-facing child safety seats include a tether strap which extends from the back of the child safety seat and hooks to an anchoring point called the top tether anchor. Tether straps are available as an accessory for many older safety seats. Contact the manufacturer of your child restraint for information about ordering a tether strap, or to obtain a longer tether strap if the tether strap on your safety seat does not reach the appropriate top tether anchor in the vehicle.

Some of the rear seats of your vehicle have built-in tether strap anchors behind the seats as described below.

The tether strap anchors in your vehicle are in the following positions (shown from top view).

Child Safety

Second Row Bench Seat

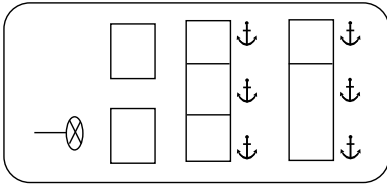

E251316

Second Row Bucket Seats

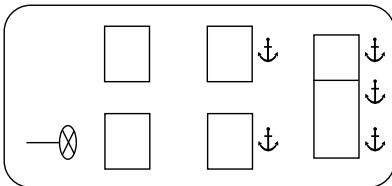

E251319

Attach the tether strap only to the appropriate tether anchor as shown. The tether strap may not work properly if attached somewhere other than the correct tether anchor.

Once the child safety seat has been installed using either the seatbelt, the lower anchors of the LATCH system, or both, you can attach the top tether strap.

If you install a child restraint with rigid LATCH attachments, do not tighten the tether strap enough to lift the child restraint off the vehicle seat cushion when the child is seated in it. Keep the tether strap just snug without lifting the front of the child restraint. Keeping the child restraint just touching the vehicle seat gives the best protection in a severe crash.

Perform the following steps to install a child safety seat with tether anchors:

Child Safety

Second Row Seating Positions

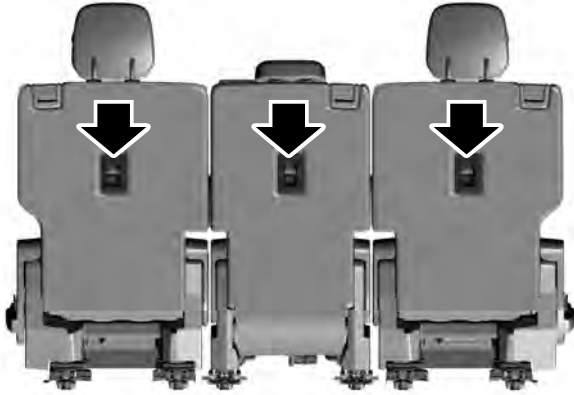

E251593

Second Row Bucket Seating Positions

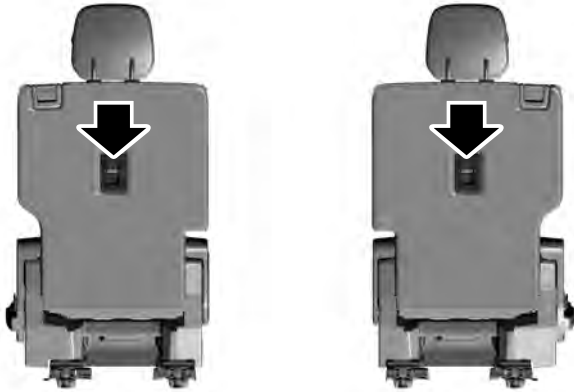

E251594

Child Safety

1. For center seating positions, route the child safety seat tether strap over the back of the seat. For outboard seating positions, route the tether strap under the head restraint and between the head restraint posts. If the top of the safety seat hits the head restraint, recline the seat back slightly to obtain proper fit.
2. Locate the correct anchor for the selected seating position.
3. Tighten the child safety seat tether strap according to the manufacturer's instructions.

Third Row Seating Positions

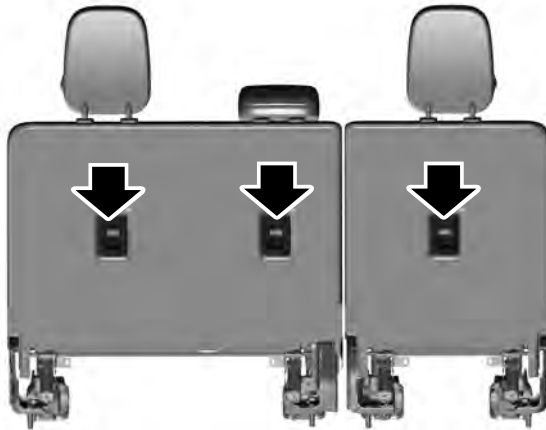

E251595

1. Route the child safety seat tether strap over the back of the seat.
2. Clip the tether strap to the anchor. If the tether strap is clipped incorrectly, the child safety seat may not be retained properly in the event of a crash.
3. Tighten the child safety seat tether strap according to the manufacturer's instructions. If the safety seat is not anchored properly, the risk of a child being injured in a crash greatly increases.

If your child restraint system has a tether strap, and the child restraint manufacturer recommends its use, we also recommend its use.

BOOSTER SEATS



WARNING: Do not put the shoulder section of the seatbelt or allow the child to put the shoulder section of the seatbelt under their arm or behind their back. Failure to follow this instruction could reduce the effectiveness of the seatbelt and increase the risk of injury or death in a crash.

Note: Some booster seat seatbelt guides may not accommodate the shoulder portion of the inflatable seatbelt.

Child Safety

Use a belt-positioning booster seat for children who have outgrown or no longer properly fit in a child safety seat (generally children who are less than 57 in (1.45 m) tall, are greater than age four (4) and less than age twelve (12), and between 40 lb (18 kg) and 80 lb (36 kg) and upward to 100 lb (45 kg) if recommended by your child restraint manufacturer). Many state and provincial laws require that children use approved booster seats until they reach age eight, a height of 57 in (1.45 m) tall, or 80 lb (36 kg).

Booster seats should be used until you can answer YES to ALL of these questions when seated without a booster seat:

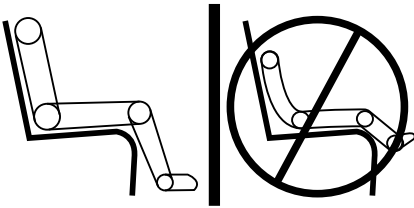

E142595

- Can the child sit all the way back against their vehicle seat backrest with knees bent comfortably at the edge of the seat cushion?
- Can the child sit without slouching?
- Does the lap belt rest low across the hips?
- Is the shoulder belt centered on the shoulder and chest?
- Can the child stay seated like this for the whole trip?

Always use booster seats in conjunction with your vehicle lap and shoulder belt.

Types of Booster Seats



E68924

- Backless booster seats

If your backless booster seat has a removable shield, remove the shield. If a vehicle seating position has a low seat backrest or no head restraint, a backless booster seat may place your child's head (as measured at the tops of the ears) above the top of the seat. In this case, move the backless booster to another seating position with a higher seat backrest or head restraint and lap and shoulder belts, or consider using a high back booster seat.



E70710

- High back booster seats

If, with a backless booster seat, you cannot find a seating position that adequately supports your child's head, a high back booster seat would be a better choice.

Child Safety

Children and booster seats vary in size and shape. Choose a booster that keeps the lap belt low and snug across the hips, never up across the stomach, and lets you adjust the shoulder belt to cross the chest and rest snugly near the center of the shoulder. The following drawings compare

the ideal fit (center) to a shoulder belt uncomfortably close to the neck and a shoulder belt that could slip off the shoulder. The drawings also show how the lap belt should be low and snug across the child's hips.



E142596



E142597

If the booster seat slides on the vehicle seat upon which it is being used, placing a rubberized mesh sold as shelf or carpet liner under the booster seat may improve this condition. Do not introduce any item thicker than this under the booster seat. Check with the booster seat manufacturer's instructions.

CHILD RESTRAINT POSITIONING



WARNING: Do not place a rearward facing child restraint in front of an active airbag. Failure to follow this instruction could result in personal injury or death.

Child Safety



WARNING: Properly secure children 12 years old and under in a rear seating position whenever possible. If you are unable to properly secure all children in a rear seating position, properly secure the largest child on the front seat. If you must use a forward facing child restraint on the front seat, move the seat as far back as possible. Failure to follow these instructions could result in personal injury or death.



WARNING: Always carefully follow the instructions and warnings provided by the manufacturer of any child restraint to determine if the restraint device is appropriate for your child's size, height, weight, or age. Follow the child restraint manufacturer's instructions and warnings provided for installation and use in conjunction with the instructions and warnings provided by your vehicle manufacturer. A safety seat that is improperly installed or utilized, is inappropriate for your child's height, age, or weight or does not properly fit the child may increase the risk of serious injury or death.



WARNING: Do not allow a passenger to hold a child on their lap when your vehicle is moving. Failure to follow this instruction could result in personal injury or death in the event of a sudden stop or crash.



WARNING: Do not use pillows, books or towels to boost your child's height. Failure to follow this instruction could result in personal injury or death.



WARNING: Properly secure child restraints or booster seats when they are not in use. They could become projectiles in a sudden stop or crash. Failure to follow this instruction could result in personal injury or death.



WARNING: Do not put the shoulder section of the seatbelt or allow the child to put the shoulder section of the seatbelt under their arm or behind their back. Failure to follow this instruction could reduce the effectiveness of the seatbelt and increase the risk of injury or death in a crash.



WARNING: Do not leave children or pets unattended in your vehicle. Failure to follow this instruction could result in personal injury or death.

Child Safety

Recommendations for Attaching Child Safety Restraints for Children

Restraint Type	Combined Weight of Child and Child Restraint	Use Any Attachment Method as Indicated Below by X				
		LATCH (Lower Anchors and Top Tether Anchor)	LATCH (Lower Anchors Only)	Seatbelt and Top Tether Anchor	Seatbelt and LATCH (Lower Anchors and Top Tether Anchor)	Seatbelt Only
Rear facing child restraint	Up to 65 lb (29.5 kg)		X			X
Rear facing child restraint	Over 65 lb (29.5 kg)					X
Forward facing child restraint	Up to 65 lb (29.5 kg)	X		X	X	
Forward facing child restraint	Over 65 lb (29.5 kg)			X	X	

Note: The child restraint must rest tightly against the vehicle seat upon which it is installed. It may be necessary to lift or remove the head restraint. See **Seats** (page 149).

CHILD SAFETY LOCKS

When these locks are set, the rear doors cannot be opened from the inside.

Child Safety



E249891

The locks are on the rear edge of each rear door and must be set separately for each door.

Left-Hand Side

Turn clockwise to lock and counterclockwise to unlock.

Right-Hand Side

Turn counterclockwise to lock and clockwise to unlock.

Seatbelts

PRINCIPLE OF OPERATION



WARNING: Always drive and ride with your seatback upright and the lap belt snug and low across the hips.



WARNING: Children must always be properly restrained.



WARNING: Never let a passenger hold a child on his or her lap while the vehicle is moving. The passenger cannot protect the child from injury in a crash.



WARNING: All occupants of your vehicle, including the driver, should always properly wear their seatbelts, even when an airbag supplemental restraint system is provided. Failure to properly wear your seatbelt could seriously increase the risk of injury or death.



WARNING: It is extremely dangerous to ride in a cargo area, inside or outside of a vehicle. In a crash, people riding in these areas are more likely to be seriously injured or killed. Do not allow people to ride in any area of your vehicle that is not equipped with seats and seatbelts. Make sure everyone in your vehicle is in a seat and properly using a seatbelt. Failure to follow this warning could result in serious personal injury or death.



WARNING: In a rollover crash, an unbelted person is significantly more likely to die than a person wearing a seatbelt.



WARNING: Each seating position in your vehicle has a specific seatbelt assembly made up of one buckle and one tongue designed to be used as a pair. Use the shoulder belt on the outside shoulder only. Never wear the shoulder belt under the arm. Never use a single seatbelt for more than one person.



WARNING: Even with advanced restraints systems, properly restrain children 12 and under in a rear seating position. Failure to follow this could seriously increase the risk of injury or death.



WARNING: Seatbelts and seats may be hot in a vehicle that is in the sunshine. The hot seatbelts or seats may burn a small child. Check seat covers and buckles before you place a child anywhere near them.

All seating positions in your vehicle have lap and shoulder seatbelts. All occupants of the vehicle should always properly wear their seatbelts, even when an airbag supplemental restraint system is provided.

The seatbelt system consists of:

- Lap and shoulder seatbelts.
- Shoulder seatbelt with automatic locking mode, (except driver seatbelt and rear inflatable seatbelt).
- Height adjuster at the front outboard seating positions.
- Seatbelt pretensioner at the front outboard seating positions.
- Belt tension sensor at the front outboard passenger seating position.



- Seatbelt warning light and chime.

Seatbelts



- Crash sensors and monitoring system with readiness indicator.

The seatbelt pretensioners and rear inflatable seatbelts are designed to activate in frontal, near-frontal and side crashes, and in rollovers. The seatbelt pretensioners at the front seating positions are designed to tighten the seatbelts firmly against the occupant's body when activated. This helps increase the effectiveness of the seatbelts. In frontal crashes, the seatbelt pretensioners can be activated alone or, if the crash is of sufficient severity, together with the front airbags.

FASTENING THE SEATBELTS

Standard belts shown, inflatable belts similar

The front outboard and rear safety restraints in the vehicle are combination lap and shoulder belts.



1. Insert the seatbelt tongue into the proper buckle (the buckle closest to the direction the tongue is coming from) until you hear a snap and feel it latch. Make sure you securely fasten the tongue in the buckle.



2. To unfasten, press the release button and remove the tongue from the buckle.

Seatbelts

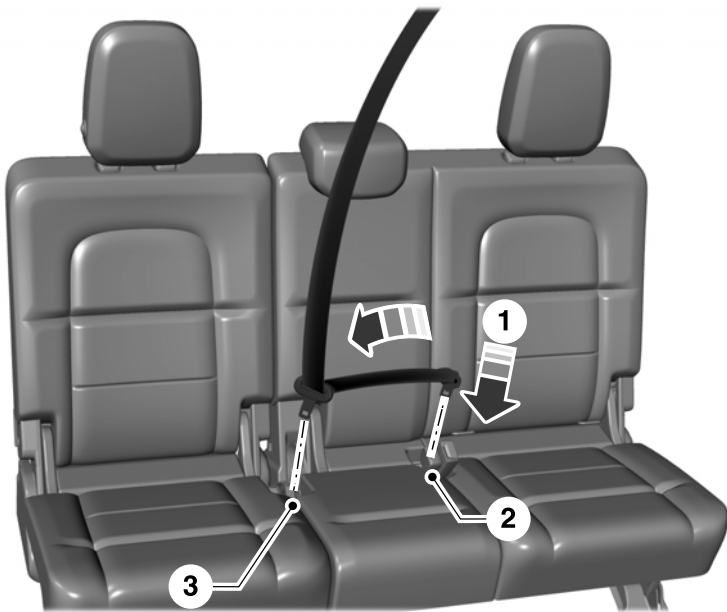

E275033

The retractor for the third row center seatbelt is in the roof.

To fasten the seatbelt:

1. Pull the belt out steadily. It may lock if you pull it sharply or if the vehicle is on a slope.
2. Insert the smaller tongue into the smaller buckle to the left of the center seat.
3. Pull the larger tongue across the lap and insert it into the buckle to the right of the center seat.

Note: *If in constant use, you can leave the belt buckled in the smaller buckle. When it is not in use, or when you fold or move the rear seats, you should release the belt from the smaller buckle. Using the tongue of the adjacent seatbelt, press the red button on the smaller buckle.*

Using Seatbelts During Pregnancy



WARNING: Always ride and drive with your seatback upright and properly fasten your seatbelt. Fit the lap portion of the seatbelt snugly and low across the hips. Position the shoulder portion of the seatbelt across your chest. Pregnant women must follow this practice. See the following figure.

Seatbelts

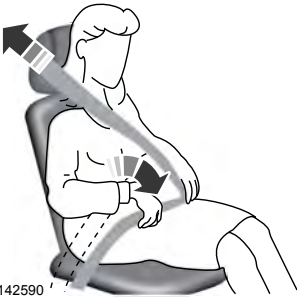

E142590

Pregnant women should always wear their seatbelt. Position the lap belt portion of a combination lap and shoulder belt low across the hips below the belly and worn as tight as comfort allows. Position the shoulder belt to cross the middle of the shoulder and the center of the chest.

Seatbelt Locking Modes



WARNING: If your vehicle is involved in a crash, have the seatbelts and associated components inspected as soon as possible. Failure to follow this instruction could result in personal injury or death.

All safety restraints in the vehicle are combination lap and shoulder belts. The driver seatbelt has the vehicle sensitive locking mode. The front outboard passenger and rear seatbelts have both the vehicle sensitive locking mode and the automatic locking mode.

Vehicle Sensitive Mode

This is the normal retractor mode, which allows free shoulder belt length adjustment to your movements and locking in response to vehicle movement. For example, if the driver brakes suddenly or turns a corner sharply, or the vehicle receives an impact of about 5 mph (8 km/h) or more, the combination seatbelts lock to help reduce forward movement of the driver and passengers.

In addition, the retractor is designed to lock if you pull the webbing out too quickly. If the seatbelt retractor locks, slowly lower the height adjuster to allow the seatbelt to retract. If the retractor does not unlock, pull the seatbelt out slowly then feed a small length of webbing back toward the stowed position. For rear seatbelts, recline the rear seat backrest or push the seat backrest cushion away from the seatbelt. Feed a small length of webbing back toward the stowed position.

Automatic Locking Mode

In this mode, the shoulder belt automatically pre-locks. The belt still retracts to remove any slack in the shoulder belt. The automatic locking mode is not available on the driver seatbelt.

When to Use the Automatic Locking Mode

Use this mode when you install a child safety seat, except a booster, in the passenger front or rear seating positions. Properly restrain children 12 years old and under in a rear seating position whenever possible. See **Seatbelts** (page 34).

How to Use the Automatic Locking Mode

Non-Inflatable Seatbelts

Seatbelts



E142591

1. Buckle the combination lap and shoulder belt.
2. Grasp the shoulder portion and pull downward until you pull the entire belt out. As the belt retracts, you will hear a clicking sound. This indicates the seatbelt is now in the automatic locking mode.

Rear Outermost Inflatable Seatbelts
(Second Row Only—If Equipped)



E146363

1. Buckle the combination lap and shoulder belt.
2. Grasp the lap portion of the belt and pull upward until you pull the entire belt out.

3. Allow the belt to retract. As the belt retracts, you will hear a clicking sound. This indicates the seatbelt is now in the automatic locking mode.

How to Disengage the Automatic Locking Mode

Unbuckle the combination lap and shoulder belt and allow it to retract completely to disengage the automatic locking mode and activate the vehicle sensitive (emergency) locking mode.

Rear Inflatable Seatbelt (If Equipped)



WARNING: Do not attempt to service, repair, or modify the supplementary restraint system or associated components. Failure to follow this instruction could result in personal injury or death.

The rear inflatable seatbelts are in the shoulder portion of the seatbelts of the second-row outermost seating positions.

Note: *The rear inflatable seatbelts are compatible with most infant and child safety car seats and belt positioning booster seats when you properly install them. This is because they are designed to fill with a cooled gas at a lower pressure and at a slower rate than traditional airbags. After inflation, the shoulder portion of the seatbelt remains cool to the touch.*

The rear inflatable seatbelt consists of the following:

- An inflatable bag in the shoulder seatbelt webbing.
- Lap seatbelt webbing with automatic locking mode.

Seatbelts

- The same warning light, electronic control and diagnostic unit as used for the front seatbelts.
- Impact sensors in various parts of the vehicle.

How does the rear inflatable seatbelt system work?



WARNING: If a supplementary restraint system component has deployed, it will not function again. Have the system and associated components inspected as soon as possible. Failure to follow this instruction could result in personal injury or death.

The rear inflatable seatbelts function like standard restraints in everyday usage.

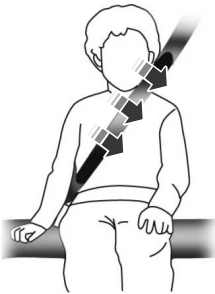

E146364

During a crash of sufficient force, the inflatable belt inflates from inside the webbing.



E146365

The fully inflated seatbelt's increased diameter more effectively holds the occupant in the appropriate seating position, and spreads crash forces over more area of the body than regular seatbelts. This helps reduce pressure on the chest and helps control head and neck motion for passengers.

The rear inflatable seatbelts are designed to inflate in frontal or near-frontal crashes, side impact crashes and rollovers. The fact that the rear inflatable seatbelt did not inflate in a crash does not mean that something is wrong with the system. Rather, it means the forces were not of the type sufficient to cause activation.

SEATBELT HEIGHT ADJUSTMENT



WARNING: Position the seatbelt height adjuster so that the belt rests across the middle of your shoulder. Failure to adjust the seatbelt properly could reduce the effectiveness of the seatbelt and increase the risk of injury in a crash.

Seatbelts



E146191

To adjust the shoulder belt height, squeeze the button and slide the height adjuster up or down. Release the button and pull down on the height adjuster to make sure it is locked in place.

SEATBELT WARNING LAMP AND INDICATOR CHIME



This lamp illuminates and an indicator chime will sound if the driver seatbelt has not been fastened when the vehicle's ignition is turned on.

Conditions of operation

If	Then
The driver seatbelt is not buckled before the ignition switch is turned to the on position...	The seatbelt warning lamp illuminates and the indicator chime sounds for a few seconds.
The driver seatbelt is buckled while the warning lamp is illuminated and the indicator chime is sounding...	The seatbelt warning lamp and indicator chime turn off.
The driver seatbelt is buckled before the ignition switch is turned to the on position...	The seatbelt warning lamp and indicator chime remain off.

SEATBELT REMINDER



WARNING: The system will only provide protection when you use the seatbelt correctly.

This system monitors all seating positions and provides audio and graphic feedback.



This lamp illuminates and a warning tone sounds if you do not fasten your seatbelt when you switch the ignition on. The lamp and tone switch off when you fasten your seatbelt or about one minute has elapsed.

When the initial warning expires for the driver, more warnings are provided for the driver and front outermost passenger. This lamp illuminates and a warning tone sounds if you or your front passenger do not fasten the seatbelt buckle and the vehicle speed exceeds 6 mph (9.7 km/h). To deactivate the warning, see Deactivating and Activating the Belt-Minder Feature.

Seatbelts

Note: To avoid inadvertent warnings, do not place large objects on the seat.



This lamp illuminates when you switch the ignition on, identifying the number of seating positions with fastened buckles. It illuminates again when a seating position changes from unfastened to fastened.



E274569

This warning displays and a tone sounds if an occupant unfastens the rear seatbelt buckle or it becomes unfastened.

Note: If a rear seat is unoccupied, or an occupant never fastens the seatbelt buckle to begin with, the warning will not display.

Note: Front seating positions appear in this warning display. Warnings for unfastened front seatbelt buckles appear in the initial warning lamp.

Seatbelt Status



E274570

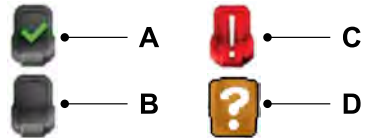

E274703

- A Seatbelt fastened.
- B Seatbelt not fastened.
- C Seatbelt recently unfastened.
- D Fault

To view the seatbelt status, use the information display controls on the steering wheel.

Deactivating and Activating the Belt-Minder Feature - Front outermost seats only



WARNING: While the system allows you to deactivate it, this system is designed to improve your chances of being safely belted and surviving an accident. We recommend you leave the system activated for yourself and others who may use the vehicle.

Seatbelts

Note: *The driver and front passenger warnings switch on and off independently. When you perform this procedure for one seating position, do not buckle the other position as this terminates the process.*

Read Steps 1 - 4 before starting the procedure.

Make sure that:

- You set the parking brake.
 - The transmission is in park (P).
 - The ignition is off.
 - You close all vehicle doors.
 - You unbuckle the driver and front passenger seatbelts.
1. Switch the ignition on. Do not start the engine.
 2. Wait until the seatbelt warning lamp turns off (about one minute). After Step 2, wait an additional five seconds before proceeding with Step 3. Once you start Step 3, you must complete the procedure within 60 seconds.
 3. For the seating position you are switching off, buckle then unbuckle the seatbelt three times at a moderate speed, ending in the unbuckled state. After Step 3, the seatbelt warning lamp turns on.
 4. When the seatbelt warning lamp is on, buckle then unbuckle the seatbelt. After Step 4, the seatbelt warning lamp flashes for confirmation.
- This switches the feature off if it is currently on.
 - This switches the feature on if it is currently off.

CHILD RESTRAINT AND SEATBELT MAINTENANCE

Inspect the vehicle seatbelts and child safety seat systems periodically to make sure they work properly and are not damaged. Inspect the vehicle and child restraint seatbelts to make sure there are no nicks, tears or cuts. Replace if necessary. All vehicle seatbelt assemblies, including retractors, buckles, front seatbelt buckle assemblies, buckle support assemblies (slide bar-if equipped), shoulder belt height adjusters (if equipped), shoulder belt guide on seat backrest (if equipped), child safety seat LATCH and tether anchors, and attaching hardware, should be inspected after a crash. Read the child restraint manufacturer's instructions for additional inspection and maintenance information specific to the child restraint.

We recommend that all seatbelt assemblies in use in vehicles involved in a crash be replaced. However, if the crash was minor and an authorized dealer finds that the belts do not show damage and continue to operate properly, they do not need to be replaced. Seatbelt assemblies not in use during a crash should also be inspected and replaced if either damage or improper operation is noted.

Properly care for seatbelts. See **Vehicle Care** (page 344).

SEATBELT EXTENSION



WARNING: Persons who fit into the vehicle's seatbelt should not use an extension. Unnecessary use could result in serious personal injury in the event of a crash.

Seatbelts



WARNING: Only use extensions provided free of charge by Ford Motor Company dealers. The dealer will provide an extension designed specifically for this vehicle, model year and seating position. The use of an extension intended for another vehicle, model year or seating position may not offer you the full protection of your vehicle's seatbelt restraint system.



WARNING: Never use seatbelt extensions to install child restraints.



WARNING: Do not use a seatbelt extension with an inflatable seatbelt.



WARNING: Do not use extensions to change the fit of the belt across the torso, over the lap or to make the seatbelt buckle easier to reach.

If, because of body size or driving position, it is not possible to properly fasten the seatbelt over your lap and shoulder, an extension that is compatible with the seatbelts is available free of charge from Ford Motor Company dealers. Only Ford seatbelt extensions made by the original equipment seatbelts manufacturer should be used with Ford seatbelts. Ask your authorized dealer if your extension is compatible with your Ford vehicle restraint system.

Personal Safety System™

This system provides an improved overall level of frontal crash protection to front seat occupants and is designed to help further reduce the risk of airbag-related injuries. The system analyzes different occupant conditions and crash severity before activating the appropriate safety devices to help better protect occupants in a variety of frontal crash situations.

Your vehicle's Personal Safety System consists of:

- Driver and passenger dual-stage airbag supplemental restraints.
- Front seat outermost seatbelts with pretensioners, energy management retractors and seatbelt usage sensors.
- Driver seat position sensor.
- Front passenger sensing system.
- Passenger airbag off and on indicators.
- Front crash severity sensors.
- Restraints control module with impact and safing sensors.
- Restraint system warning light and tone.
- The electrical wiring for the airbags, crash sensors, seatbelt pretensioners, front seatbelt usage sensors, driver seat position sensor, front passenger sensing system and indicator lights.

How Does the Personal Safety System Work?

The Personal Safety System can adapt the deployment strategy of the safety devices according to crash severity and occupant conditions. A collection of crash and occupant sensors provides information to the restraints control module. During a crash, the restraints control module may deploy the seatbelt pretensioners, one or both stages of the dual-stage airbags based on crash severity and occupant conditions.

Supplementary Restraints System

PRINCIPLE OF OPERATION



WARNING: Airbags do not inflate slowly or gently, and the risk of injury from a deploying airbag is the greatest close to the trim covering the airbag module.



WARNING: All occupants of your vehicle, including the driver, should always properly wear their seatbelts, even when an airbag supplemental restraint system is provided. Failure to properly wear your seatbelt could seriously increase the risk of injury or death.



WARNING: Even with advanced restraints systems, properly restrain children 12 and under in a rear seating position. Failure to follow this could seriously increase the risk of injury or death.



WARNING: Do not place your arms on the airbag cover or through the steering wheel. Failure to follow this instruction could result in personal injury.



WARNING: Keep the areas in front of the airbags free from obstruction. Do not affix anything to or over the airbag covers. Objects could become projectiles during airbag deployment or in a sudden stop. Failure to follow this instruction could result in personal injury or death.



WARNING: Airbags can kill or injure a child in a child restraint. Never place a rear-facing child restraint in front of an active airbag. If you must use a forward-facing child restraint in the front seat, move the seat upon which the child restraint is installed all the way back.



WARNING: Do not attempt to service, repair, or modify the supplementary restraint system or associated components. Failure to follow this instruction could result in personal injury or death.



WARNING: Several airbag system components get hot after inflation. To reduce the risk of injury, do not touch them after inflation.



WARNING: If a supplementary restraint system component has deployed, it will not function again. Have the system and associated components inspected as soon as possible. Failure to follow this instruction could result in personal injury or death.

The airbags are a supplemental restraint system and are designed to work with the seatbelts to help protect the driver and right front passenger from certain upper body injuries. Airbags do not inflate slowly; there is a risk of injury from a deploying airbag.

Note: *You will hear a loud bang and see a cloud of harmless powdery residue if an airbag deploys. This is normal.*

The airbags inflate and deflate rapidly upon activation. After airbag deployment, it is normal to notice a smoke-like, powdery residue or smell the burnt propellant. This may consist of cornstarch, talcum powder (to lubricate the bag) or sodium compounds (for example, baking soda) that result from the combustion process that inflates the airbag. Small amounts of sodium hydroxide may be present which may irritate the skin and eyes, but none of the residue is toxic.

Supplementary Restraints System

While the system is designed to help reduce serious injuries, contact with a deploying airbag may also cause abrasions or swelling. Temporary hearing loss is also a possibility as a result of the noise associated with a deploying airbag. Because airbags must inflate rapidly and with considerable force, there is the risk of death or serious injuries such as fractures, facial and eye injuries or internal injuries, particularly to occupants who are not properly restrained or are otherwise out of position at the time of airbag deployment. Thus, it is extremely important that occupants be properly restrained as far away from the airbag module as possible while maintaining vehicle control.

Routine maintenance of the airbags is not required.

DRIVER AND PASSENGER AIRBAGS



WARNING: Do not place your arms on the airbag cover or through the steering wheel. Failure to follow this instruction could result in personal injury.



WARNING: Keep the areas in front of the airbags free from obstruction. Do not affix anything to or over the airbag covers. Objects could become projectiles during airbag deployment or in a sudden stop. Failure to follow this instruction could result in personal injury or death.



WARNING: Airbags can kill or injure a child in a child restraint. Never place a rear-facing child restraint in front of an active airbag. If you must use a forward-facing child restraint in the front seat, move the seat upon which the child restraint is installed all the way back.

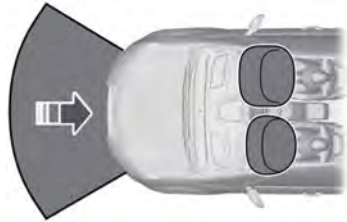

E151127

The driver and passenger front airbags will deploy during significant frontal and near frontal crashes.

The driver and passenger front airbag system consists of:

- Driver and passenger airbag modules.
- Front passenger sensing system.
- Crash sensors and monitoring system with readiness indicator. See **Crash Sensors and Airbag Indicator** (page 51).



Proper Driver and Front Passenger Seating Adjustment



WARNING: National Highway Traffic Safety Administration (NHTSA) recommends a minimum distance of at least 10 in (25 cm) between an occupant's chest and the driver airbag module.

To properly position yourself away from the airbag:

- Move your seat to the rear as far as you can while still reaching the pedals comfortably.
- Recline the seat slightly (one or two degrees) from the upright position.

Supplementary Restraints System

After all occupants have adjusted their seats and put on seatbelts, it is very important that they continue to sit properly. Properly seated occupants sit upright, lean against the seat back, and center themselves on the seat cushion, with their feet comfortably extended on the floor. Sitting improperly can increase the chance of injury in a crash event. For example, if an occupant slouches, lies down, turns sideways, sits forward, leans forward or sideways, or puts one or both feet up, the chance of injury during a crash greatly increases.

Children and Airbags

WARNING: Airbags can kill or injure a child in a child restraint. Never place a rear-facing child restraint in front of an active airbag. If you must use a forward-facing child restraint in the front seat, move the seat upon which the child restraint is installed all the way back.



E142846

Children must always be properly restrained. Accident statistics suggest that children are safer when properly restrained in the rear seating positions than in the front seating position. Failure to follow these instructions may increase the risk of injury in a crash.

FRONT PASSENGER SENSING SYSTEM

WARNING: Even with advanced restraints systems, properly restrain children 12 and under in a rear seating position. Failure to follow this could seriously increase the risk of injury or death.

WARNING: Sitting improperly, out of position or with the seatback reclined too far can take weight off the seat cushion and affect the decision of the passenger sensing system, resulting in serious injury or death in the event of a crash. Always sit upright against your seat back, with your feet on the floor.

WARNING: Any alteration or modification to the front passenger seat may affect the performance of the front passenger sensing system. This could seriously increase the risk of injury or death.

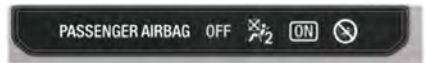

E181984

The front passenger sensing system uses a passenger airbag status indicator which illuminates indicating that the front passenger frontal airbag is either on (enabled) or off (disabled). The indicator lamp is in the center stack of the instrument panel.

Supplementary Restraints System

Note: When you first switch the ignition on, the passenger airbag status indicator off and on lamps illuminate for a short period to confirm it is functional.

The front passenger sensing system is designed to disable (will not inflate) the front passenger frontal airbag under certain conditions:

- The front passenger seat is unoccupied.
- The system determines an infant is present in a child restraint.
- A passenger takes their weight off of the seat for a period of time.
- If there is a problem with the airbag system or the passenger sensing system.

Even with this technology, parents are **strongly** encouraged to always properly restrain children in the rear seat.

- When the front passenger sensing system disables (will not inflate) the front passenger frontal airbag, the passenger airbag status indicator illuminates the off lamp and stays lit to remind you that the front passenger frontal airbag is disabled.
- If you have installed the child restraint and the passenger airbag status indicator illuminates the on lamp, then switch your vehicle off, remove the child restraint from your vehicle and reinstall the restraint following the child restraint manufacturer's instructions.

The front passenger sensing system works with sensors that are part of the front passenger seat and seatbelt. The sensors are designed to detect the presence of a properly seated occupant and determine if the front passenger frontal airbag should be enabled.

- When the front passenger sensing system enables the front passenger frontal airbag (may inflate), the passenger airbag status indicator illuminates the on lamp and remains illuminated.

If a person of adult size is sitting in the front passenger seat, but the passenger airbag status indicator off lamp is lit, it is possible that the person is not sitting properly in the seat. If this happens:

- Switch your vehicle off and ask the person to place the seatback in an upright position.
- Have the person sit upright in the seat, centered on the seat cushion, with the person's legs comfortably extended.
- Restart your vehicle and have the person remain in this position for about two minutes. This allows the system to detect that person and enable the passenger frontal airbag.
- If the indicator off lamp remains lit even after this, you should advise the person to ride in the rear seat.

Note: When the passenger airbag status indicator off lamp illuminates, the passenger side airbag (seat mounted) may be disabled to avoid the risk of airbag deployment issues.

After all occupants have adjusted their seats and put on seatbelts, it is very important that they continue to sit properly. A properly seated occupant sits upright, leaning against the seatback, and centered on the seat cushion, with their feet comfortably extended on the floor. Sitting improperly can increase the chance of injury in a crash event. For example, if an occupant slouches, lies down, turns sideways, sits forward, leans forward or sideways, or puts one or both feet up, the chance of injury during a crash greatly increases.

Supplementary Restraints System

If you think that the state of the passenger airbag status indicator lamp is incorrect, check for the following:

- Objects lodged underneath the seat.
- Objects between the seat cushion and the center console.
- Objects hanging off the seat backrest.
- Objects stowed in the seat backrest map pocket.
- Objects placed on the occupant's lap.
- Cargo interference with the seat
- Other passengers pushing or pulling on the seat.
- Rear passenger feet and knees resting or pushing on the seat.

The conditions listed above may cause the weight of a properly seated occupant to be incorrectly interpreted by the front passenger sensing system. The person in the front passenger seat may appear heavier or lighter due to the conditions described in the previous list.



Make sure the front passenger sensing system is operating properly. See **Crash Sensors and Airbag Indicator** (page 51).

If the airbag readiness light is lit, do the following:

The driver and adult passengers should check for objects lodged underneath the front passenger seat or cargo interfering with the seat.

If objects are lodged or cargo is interfering with the seat, please take the following steps to remove the obstruction:

- Pull your vehicle over.
- Switch your vehicle off.
- Driver or adult passengers should check for any objects lodged underneath the front passenger seat or cargo interfering with the seat.

- Remove the obstruction(s) (if found).
- Restart your vehicle.
- Wait at least two minutes and verify that the airbag readiness light in the instrument cluster is no longer illuminated.
- If the airbag readiness light in the instrument cluster remains illuminated, this may or may not be a problem due to the front passenger sensing system.

Do not attempt to repair or service the system. Take your vehicle immediately to an authorized dealer.

If it is necessary to modify an advanced front airbag system to accommodate a person with disabilities, contact your Customer Relationship Center.

SIDE AIRBAGS



WARNING: Do not place objects or mount equipment on or near the airbag cover, on the side of the front or rear seatbacks, or in areas that may come into contact with a deploying airbag. Failure to follow these instructions may increase the risk of personal injury in the event of a crash.



WARNING: Do not use accessory seat covers. The use of accessory seat covers may prevent the deployment of the side airbags and increase the risk of injury in an accident.



WARNING: Do not lean your head on the door. The side airbag could injure you as it deploys from the side of the seatback.

Supplementary Restraints System



WARNING: Do not attempt to service, repair, or modify the supplementary restraint system or associated components. Failure to follow this instruction could result in personal injury or death.



WARNING: If a supplementary restraint system component has deployed, it will not function again. Have the system and associated components inspected as soon as possible. Failure to follow this instruction could result in personal injury or death.

The side airbags are on the outermost side of the seat backrests of the front seats. The airbag was designed to inflate between the door panel and occupant to further enhance the protection provided occupants in side impact crashes.



E152533

The system consists of the following:

- A label or embossed side panel indicating that side airbags are found on your vehicle.
- Side airbags inside the seat backrest of the driver and front passenger seats.
- Front passenger sensing system.



• Crash sensors and monitoring system with readiness indicator. See **Crash Sensors and Airbag Indicator** (page 51).

The design and development of the side airbag system included recommended testing procedures that were developed by a group of automotive safety experts known as the Side Airbag Technical Working Group. These recommended testing procedures help reduce the risk of injuries related to the deployment of side airbags.

SAFETY CANOPY™



WARNING: Do not place objects or mount equipment on or near the headliner at the siderail that may come into contact with a deploying curtain airbag. Failure to follow these instructions may increase the risk of personal injury in the event of a crash.



WARNING: Do not lean your head on the door. The curtain airbag could injure you as it deploys from the headliner.



WARNING: Do not attempt to service, repair, or modify the supplementary restraint system or associated components. Failure to follow this instruction could result in personal injury or death.



WARNING: All occupants of your vehicle, including the driver, should always properly wear their seatbelts, even when an airbag supplemental restraint system is provided. Failure to properly wear your seatbelt could seriously increase the risk of injury or death.

Supplementary Restraints System



WARNING: To reduce risk of injury, do not obstruct or place objects in the deployment path of the airbag.



WARNING: If a supplementary restraint system component has deployed, it will not function again. Have the system and associated components inspected as soon as possible. Failure to follow this instruction could result in personal injury or death.

The Safety Canopy deploys during significant side crashes or when a certain likelihood of a rollover event is detected by the rollover sensor. The Safety Canopy is mounted to the roof side rail sheet metal, behind the headliner, above each row of seats. In certain sideways crashes or rollover events, the Safety Canopy will be activated, regardless of which seats are occupied. The Safety Canopy is designed to inflate between the side window area and occupants to further enhance protection provided in side impact crashes and rollover events.

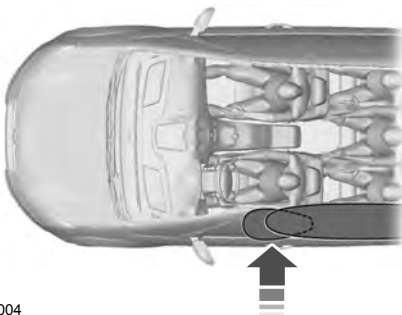

E75004

The system consists of the following:

- Safety Canopy curtain airbags above the trim panels over the front and rear side windows identified by a label or wording on the headliner or roof-pillar trim.
- A flexible headliner which opens above the side doors to allow air curtain deployment



• Crash sensors and monitoring system with a readiness indicator. See **Crash Sensors and Airbag Indicator** (page 51).

Properly restrain children 12 years old and under in the rear seats. The Safety Canopy will not interfere with children restrained using a properly installed child or booster seat because it is designed to inflate downward from the headliner above the doors along the side window opening.

The design and development of the Safety Canopy included recommended testing procedures that were developed by a group of automotive safety experts known as the Side Airbag Technical Working Group. These recommended testing procedures help reduce the risk of injuries related to the deployment of side airbags (including the Safety Canopy).

CRASH SENSORS AND AIRBAG INDICATOR



WARNING: Modifying or adding equipment to the front end of your vehicle (including hood, bumper system, frame, front end body structure, tow hooks and hood pins) may affect the performance of the airbag system, increasing the risk of injury. Do not modify or add equipment to the front end of your vehicle.

Supplementary Restraints System

Your vehicle has a collection of crash and occupant sensors which provide information to the restraints control module which deploys (activates) the front seatbelt pretensioners, driver airbag, passenger airbag, rear inflatable belts, seat mounted side airbags, and the Safety Canopy. Based on the type of crash, the restraints control module will deploy the appropriate safety devices.

The restraints control module also monitors the readiness of the above safety devices plus the crash and occupant sensors. The readiness of the safety system is indicated by a warning indicator light in the instrument cluster or by a backup tone if the warning light is not working. See **Instrument Cluster** (page 103). Routine maintenance of the airbag is not required.

A difficulty with the system is indicated by one or more of the following:



The readiness light will not illuminate immediately after you switch the ignition on.

- The readiness light either flashes or stays lit.
- A series of five beeps will be heard. The tone pattern will repeat periodically until the problem, the light or both are repaired.

If any of these things happen, even intermittently, have the supplemental restraint system serviced at an authorized dealer immediately. Unless serviced, the system may not function properly in the event of a crash.

The fact that the seatbelt pretensioners or front airbags did not activate for both front seat occupants in a crash does not mean that something is wrong with the system. Rather, it means the restraints control module determined the accident conditions (crash severity, belt usage) were not appropriate to activate these safety devices.

- The design of the front airbags is to activate only in frontal and near-frontal crashes (not rollovers, side impacts or rear impacts) unless the crash causes sufficient frontal deceleration.
- The design of the seatbelt pretensioners and rear inflatable belts is to activate in frontal, near-frontal and side crashes, and in rollovers.
- The design of the side airbags is to inflate in certain side impact crashes. Side airbags may activate in other types of crashes if the vehicle experiences sufficient sideways motion or deformation.
- The design of the Safety Canopy is to inflate in certain side impact crashes or rollover events. The Safety Canopy may activate in other types of crashes if the vehicle experiences sufficient sideways motion or deformation, or a certain likelihood of rollover.

AIRBAG DISPOSAL

Contact your authorized dealer as soon as possible. Airbags must be disposed of by qualified personnel.

Keys and Remote Controls

GENERAL INFORMATION ON RADIO FREQUENCIES

This device complies with Part 15 of the FCC Rules and with Licence exempt RSS Standards of Industry Canada. Operation is subject to the following two conditions:

- This device may not cause harmful interference, and
- This device must accept any interference received, including interference that may cause undesired operation.

Note: *Changes or modifications not expressly approved by the party responsible for compliance could void the user's authority to operate the equipment. The term "IC:" before the radio certification number only signifies that Industry Canada technical specifications were met.*

The typical operating range for your transmitter is approximately 33 ft (10 m). Vehicles with the remote start feature will have a greater range. One of the following could cause a decrease in operating range:

- Weather conditions.
- Nearby radio towers.
- Structures around the vehicle.
- Other vehicles parked next to your vehicle.

The radio frequency used by your remote control can also be used by other radio transmitters, for example amateur radios, medical equipment, wireless headphones, wireless remote controls, cell phones, battery chargers and alarm systems. If the frequencies are jammed, you will not be able to use your remote control. You can lock and unlock the doors with the key.

Note: *Make sure you lock your vehicle before leaving it unattended.*

Note: *If you are within range of your vehicle, the remote control will operate if you unintentionally press any button.*

Intelligent Access (If Equipped)

The system uses a radio frequency signal to communicate with your vehicle and authorizes your vehicle to unlock when one of the following conditions are met:

- You touch the unlock sensor on the back of the door handle with the intelligent access key within 3 ft (1 m) of your vehicle.
- You press the luggage compartment button.
- You press the unlock button on the transmitter.

If excessive radio frequency interference is present in the area or if the transmitter battery is low, you may need to mechanically unlock your door. You can use the mechanical key blade in your intelligent access key to open the driver door in this situation. See **Remote Control** (page 53).

REMOTE CONTROL

Integrated Keyhead Transmitter (If Equipped)

Note: *A two-button remote control operates similarly.*

Use the key blade to start your vehicle and unlock or lock the driver door from outside your vehicle. The integrated keyhead transmitter functions as a programmed ignition key that operates all the locks and starts your vehicle, as well as a remote control.

Keys and Remote Controls



E191532

Press the button to release the key blade. Press and hold the button to fold the key blade back in when not in use.



E253517

The intelligent access keys operate the power locks and the remote start system. The key must be in your vehicle to use the push button start.



E151795

Note: Your vehicle keys came with a security label that provides important key cut information. Keep the label in a safe place for future reference.

Intelligent Access Key (If Equipped)

Note: You may not be able to shift out of park (P) unless the intelligent access key is inside your vehicle.

Removable Key Blade

The intelligent access key also contains a removable key blade that you can use to unlock your vehicle.

Keys and Remote Controls



E254065

Push the release button and pull the key blade out.



E151795

Note: Your vehicle keys came with a security label that provides important key cut information. Keep the label in a safe place for future reference.

Using the Key Blade

The key cylinder is under the driver side door handle. To access the cylinder:



E251885

1. Pull the handle and hold it.
2. While holding the handle outward, identify the cylinder and insert the key blade into the slot.
3. Actuate the cylinder to unlock or lock the door.

Replacing the Battery

Note: Refer to local regulations when disposing of transmitter batteries.

Note: Do not wipe off any grease on the battery terminals or on the back surface of the circuit board.

Note: Replacing the battery does not erase the programmed key from your vehicle. The transmitter should operate normally.

A message appears in the information display when the remote control battery is low. See **Information Messages** (page 122).

Integrated Keyhead Transmitter

The remote control uses one coin-type three-volt lithium battery CR2032 or equivalent.

Keys and Remote Controls

Press the button to release the key blade before beginning the procedure.

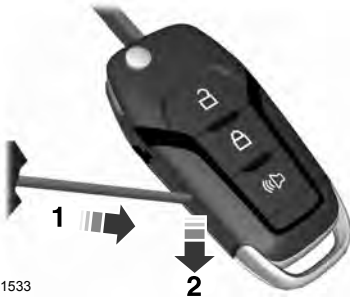

E191533

1. Insert a suitable tool, for example a screwdriver, in the position shown and gently push the clip.
2. Press the clip down to release the battery cover.



E151800

Note: Do not touch the battery contacts or the printed circuit board with the screwdriver.

4. Insert the screwdriver as shown to release the battery.

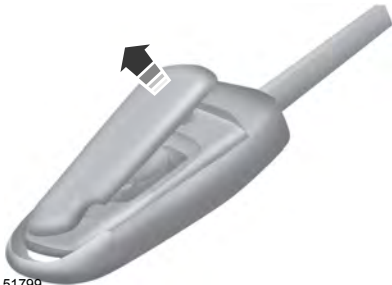

E151799

3. Carefully remove the cover.

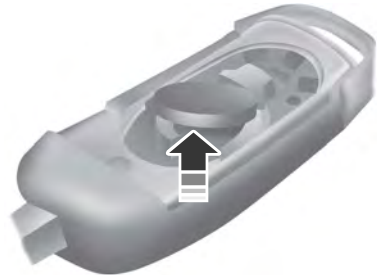

E151801

5. Remove the battery.
6. Install a new battery with the + facing upward.
7. Reinstall the battery cover.

Intelligent Access Key

The remote control uses one coin-type three-volt lithium battery CR2450 or equivalent.

Keys and Remote Controls



E254065

1. Push the release button and pull the key blade out.



E218401

2. Twist a thin coin under the tab hidden behind the key blade head to remove the battery cover.

Keys and Remote Controls



E218402

3. Insert a suitable tool, for example a screwdriver, in the position shown and carefully remove the battery.
4. Install a new battery with the + facing upward.
5. Reinstall the battery cover and the key blade.

Car Finder



Press the button twice within three seconds. The horn sounds and the direction indicators flash. We recommend you use this method to locate your vehicle, rather than using the panic alarm.

Sounding the Panic Alarm

Note: *The panic alarm only operates when the ignition is off.*



Press the button to sound the panic alarm. Press the button again or switch the ignition on to turn it off.

Remote Start (If Equipped)



WARNING: To avoid exhaust fumes, do not use remote start if your vehicle is parked indoors or in areas that are not well ventilated.

Note: *Do not use remote start if your fuel level is low.*



The remote start button is on the transmitter.

This feature allows you to start your vehicle from the outside. The transmitter has an extended operating range.

If your vehicle has automatic climate control, you can configure it to operate when you remote start your vehicle. See **Climate Control** (page 138). A manual climate control system will run at the setting it was set to when you switched your vehicle off.

Many states and provinces have restrictions for the use of remote start. Check your local and state or provincial laws for specific requirements regarding remote start systems.

The remote start system does not work when any of the following conditions occur:

- The ignition is on.
- The anti-theft alarm triggers.
- You switch the feature off in the information display.
- The hood is open.
- The transmission is not in park (P).
- The battery voltage is below the minimum operating voltage.

Remote Control Feedback

An LED on the remote control provides status feedback of remote start or stop commands.

Keys and Remote Controls

LED	Status
Solid green	Remote start successful
Solid red	Remote stop successful
Blinking red	Request failed or status not received
Blinking green	Status incomplete

Remote Starting your Vehicle

Note: You must press each button within three seconds of each other. If you do not follow this sequence, your vehicle does not start remotely, the direction indicators do not flash twice and the horn does not sound.

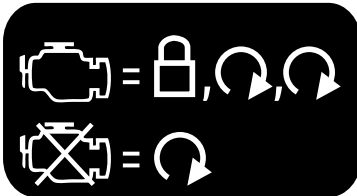

E138626

To remote start your vehicle:

1. Press the lock button to lock all the doors.
2. Press the remote start button twice. The exterior lamps flash twice.

The horn sounds if the system fails to start.

Note: Press the push button ignition switch on the instrument panel once to exit remote start.

The power windows do not work during remote start and the radio does not turn on automatically.

The parking lamps remain on and your vehicle will run for 5, 10 or 15 minutes, depending on the setting.

Extending the Engine Running Time

To extend the engine running time duration of your vehicle during remote start, repeat steps 1 and 2 while the engine is running. If the duration is set to 15 minutes, the duration extends by another 15 minutes. For example, if your vehicle had been running from the first remote start for 10 minutes, your vehicle continues to run now for a total of 30 minutes. You can extend the engine running time duration to a maximum of 30 minutes.

Wait at least five seconds before remote starting after the engine stops running.

Turning Your Vehicle Off After Remote Starting



Press the button once. Your vehicle and the parking lamps turn off.

You may have to be closer to your vehicle than when starting due to ground reflection and the added noise of your running vehicle.

You can switch this feature on or off in the information display. See **General Information** (page 110).

Memory Feature

You can program your intelligent access key to recall memory positions. See **Memory Function** (page 156).

Keys and Remote Controls

REPLACING A LOST KEY OR REMOTE CONTROL

Replacement keys or remote controls can be purchased from an authorized dealer. Authorized dealers can program remote controls for your vehicle. See **Passive Anti-Theft System** (page 78).

PRINCIPLE OF OPERATION

MyKey allows you to program keys with restricted driving modes to promote good driving habits. You can program the restrictions to all keys except one. Any keys that you did not program are administrator keys or admin keys.

You can use admin keys to:

- Create a MyKey with certain vehicle restrictions.
- Program certain MyKey settings.
- Clear all MyKey restrictions.

After you program a MyKey, you can view the following information through the information display:

- The total number of admin keys and MyKeys for your vehicle.
- The total distance a MyKey driver traveled with your vehicle.

Note: Every MyKey receives the same restrictions and settings. You cannot program them individually.

Note: For vehicles equipped with a push-button start switch: When both a MyKey and an admin key are present when you start your vehicle, the system recognizes the admin key only.

Standard Settings

Not every vehicle includes the features listed below. If your vehicle has this equipment, then you cannot change the following settings when using a MyKey:

- Seatbelt reminder or Belt-Minder™. MyKey mutes the audio system until drivers, and in some instances, passengers, fasten their seatbelts.
Note: If your vehicle includes an AM/FM radio or a very basic audio system, then the radio may not mute.
- Earlier low-fuel warning. The low-fuel warning activates earlier for MyKey drivers, giving them more time to refuel.
- Certain driver alerts, stability systems or parking aids turn on automatically when you use the MyKey system. For example, Blind Spot Information System (BLIS), cross traffic alert, lane departure warning or forward collision warning. **Note:** MyKey drivers may be able to turn the lane departure warning feature off, but this feature turns back on automatically with every new key cycle.
- Restricted touchscreen operation in some markets. For example, MyKey may prevent manual navigation destination input while the vehicle is in any gear other than park (P) or when the vehicle reaches a certain rate of speed.
- Satellite radio adult content restrictions, if this feature is available in your market.

Optional Settings

You can configure certain vehicle feature settings when you first create a MyKey. You can also change the settings afterward with an admin key.

Note: *Not every feature applies to every vehicle in every market. When they are available for your vehicle, then they appear in your information display, providing choices to switch them on or off, or to select a more specific setting.*

- Various vehicle speed limits so the MyKey driver cannot exceed certain speeds. The information display shows warnings followed by an audible tone when the MyKey driver reaches the set speed. You cannot override the set speed by fully depressing the accelerator pedal.



WARNING: Do not set MyKey maximum speed limit to a limit that will prevent the driver from maintaining a safe speed considering posted speed limits and prevailing road conditions. The driver is always responsible to drive in accordance with local laws and prevailing conditions. Failure to do so could result in accident or injury.

- Various vehicle speed reminders so MyKey drivers know when their vehicle speed approaches the limits. Warnings appear in your information display and a tone sounds when the MyKey drivers exceed the set vehicle speed.
- The audio system's maximum volume limits to 45% so MyKey drivers can concentrate on the road. A message appears in the information display when MyKey drivers attempt to exceed the limited volume. MyKey also disables the automatic volume control. **Note:** If your vehicle includes an AM/FM radio or a very basic audio system, then the radio may not limit.
- Always on setting. This setting forces certain features to remain on and active for MyKey drivers. For example, E911 or emergency assistance and the do not disturb features stay on even if a MyKey driver uses the feature's control to switch it off. When you select, you will not be able to turn off Advance Trac or traction control (if your vehicle has this feature).

CREATING A MYKEY

Use the information display to create a MyKey:

1. Insert the key you want to program into the ignition. See **Starting a Gasoline Engine** (page 176). If your vehicle is equipped with a push-button start, place the remote control into the backup slot. See **Passive Anti-Theft System** (page 78).
2. Switch the ignition on.

3. Access the main menu in the information display and then scroll through the menus to change the settings of your MyKey. From the MyKey menu select the option Create MyKey. See **Information Displays** (page 110).
4. When prompted, hold the **OK** button until you see a message informing you to label this key as a MyKey. The programmed restrictions apply when you key off, open and close the driver door and restart your vehicle with the programmed key or transmitter.

MyKey is successfully created. Make sure you label it so you can distinguish it from the admin keys.

You can also program configurable settings for the key(s). See **Programming and Changing Configurable Settings**.

Programming and Changing Configurable Settings

Use the information display to access your configurable MyKey settings.

1. Switch the ignition on using an admin key or transmitter you want to program.
2. Access the main menu in the information display and then scroll through the menus to change the settings of your MyKey. See **Information Displays** (page 110).
3. Follow the instructions in the display.

Note: *You can clear or change your MyKey settings at any time during the same key cycle as you created the MyKey. Once you have switched the vehicle off, however, you will need an admin key to change or clear your MyKey settings.*

CLEARING ALL MYKEYS

When you clear your MyKeys, you remove all restrictions and return all MyKeys to their original admin key status at once. To clear all MyKeys of all MyKey settings, use the information display.

1. Switch the ignition on using an admin key.
2. Access the main menu in the information display and then scroll through the menus to begin clearing your MyKey programming. See **Information Displays** (page 110).
3. Follow the instructions in the display.
4. A confirmation message appears in the display after you finish clearing your MyKeys.

Note: *When you clear your MyKeys, you remove all restrictions and return all MyKeys to their original admin key status. You cannot remove the MyKey restrictions individually.*

CHECKING MYKEY SYSTEM STATUS

You can find information about your programmed MyKeys by using the information display. See **Information Displays** (page 110).

MyKey Distance

Tracks the distance when drivers use a MyKey. The only way to delete the accumulated distance is by using an admin key to clear all MyKeys. If the distance does not accumulate as expected, then the intended user is not using the MyKey, or an admin key user recently cleared and then recreated a MyKey.

Number of MyKeys

Indicates the number of MyKeys programmed to your vehicle. Use this feature to detect how many MyKeys you have for your vehicle and determine when all MyKeys have been deleted.

Number of Admin Keys

Indicates how many admin keys are programmed to your vehicle. Use this feature to determine how many admin keys you have for your vehicle, and detect if an additional MyKey has been programmed.

USING MYKEY WITH REMOTE START SYSTEMS

MyKey is not compatible with non Ford-approved, aftermarket remote start systems. If you choose to install a remote start system, see an authorized dealer for a Ford-approved remote start system.

MYKEY — TROUBLESHOOTING

Condition	Potential causes
I cannot create a MyKey.	<ul style="list-style-type: none"> · The key or transmitter used to start the vehicle does not have admin privileges. · Vehicles with keyless start: Make sure you place the transmitter into the backup slot. See Passive Anti-Theft System (page 78). · The key or transmitter used to start the vehicle is the only admin key. There always has to be at least one admin key. · SecuriLock passive anti-theft system is disabled or in unlimited mode.
I cannot program the configurable settings.	<ul style="list-style-type: none"> · The key or transmitter used to start the vehicle does not have admin privileges. · There are no MyKeys programmed to the vehicle. See Creating a MyKey (page 62).
I cannot clear the MyKeys.	<ul style="list-style-type: none"> · The key or transmitter used to start the vehicle does not have admin privileges. · No MyKeys are created. See Creating a MyKey (page 62).

MyKey™

Condition	Potential causes
I lost the only admin key.	· Purchase a new key or transmitter from your authorized dealer.
I lost a key.	· Program a spare key or transmitter. You may need to see your authorized dealer. See Passive Anti-Theft System (page 78).
MyKey distances do not accumulate.	· The MyKey user is not using the MyKey. · An admin key holder cleared the MyKeys and created new MyKeys. · The key system has been reset.

Doors and Locks

LOCKING AND UNLOCKING

You can use the power door lock control or the remote control to lock and unlock your vehicle.

Power Door Locks

The power door lock control is on the driver and front passenger door panels.

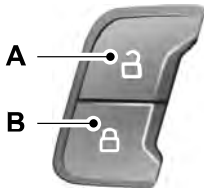

E138628

- A Unlock.
- B Lock.

Door Lock Switch Inhibitor

When you electronically lock your vehicle, the power door lock switch and interior trunk release switch will not operate after 20 seconds. You must unlock your vehicle with the remote control or keyless keypad, or switch the ignition on, to restore function to these switches. You can switch this feature on or off in the information display.

Note: Switch the ignition on and off after changing the setting in the information display.

Rear Door Unlocking and Opening

Pull the interior door handle twice to unlock and open a rear door. The first pull unlocks the door and the second pull opens the door.

Remote Control

You can use the remote control at any time. The liftgate release button only operates when the speed is less than 3 mph (5 km/h).

Unlocking the Doors (Two-Stage Unlock)



Press the button to unlock the driver door.

Press the button again within three seconds to unlock all doors. The direction indicators will flash.

Note: If the system does not function, use the key blade to lock and unlock your vehicle.

Reprogramming the Unlocking Function

Note: When you press the unlock button, either all the doors unlock, or only the driver door unlocks. Pressing the unlock button again unlocks all the doors.

Press and hold the unlock and lock buttons on the remote control simultaneously for at least four seconds with the ignition off. The direction indicators flash twice to confirm the change. The unlocking mode applies to the remote control, keyless entry keypad and intelligent access. You can also change between the unlocking modes using the information display. See

General Information (page 110).

To return to the original unlocking function, repeat the process.

Locking the Doors



Press the button to lock all doors. The direction indicators will flash.

Doors and Locks

Press the button again within three seconds to confirm that all the doors are closed. The doors will lock again, the horn will sound and the direction indicators will flash if all the doors and the liftgate are closed.

Note: *If the system does not function, use the key blade to lock and unlock your vehicle.*

Mislock

If any door or the liftgate is open, or if the hood is open on vehicles with an anti-theft alarm or remote start, the horn sounds twice and the direction indicators do not flash. You can switch this feature on or off in the information display. See **General Information** (page 110).

Opening the Liftgate



Press twice within three seconds to open the liftgate.

Activating Intelligent Access (If Equipped)

General Information

You can unlock and lock the vehicle without taking the keys out of your pocket or purse when your intelligent access key is within 3 ft (1 m) of your vehicle. Intelligent access uses a sensor on the back of the door handle for unlocking and a separate sensor on the face of each door handle for locking.

The system does not function if:

- Your vehicle battery has no charge.
- The key battery has no charge.
- The key frequencies jam.

Note: *The system may not function if the passive key is close to metal objects or electronic devices, for example keys or a cell phone.*

Note: *If the system does not function, use the key blade to lock and unlock your vehicle. See **Remote Control** (page 53).*

Unlocking Using Intelligent Access

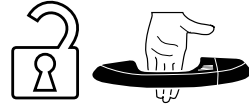

E248553

With your intelligent access key within 3 ft (1 m) of your vehicle, touch the unlock sensor on the back of the door handle for a brief period and then pull on the door handle to unlock, being careful to not touch the lock sensor at the same time or pulling the door handle too quickly. The intelligent access system requires a brief delay to authenticate your intelligent access key fob.

Locking Using Intelligent Access



E248554

With your intelligent access key within 3 ft (1 m) of your vehicle, touch the outer door handle lock sensor for approximately one second to lock, being careful to not touch the unlock sensor on the back of the door handle at the same time. After locking, you can immediately pull on the door handle to confirm locking occurred without inadvertently unlocking.

At the Luggage Compartment

With your intelligent access key within 3 ft (1 m) of your vehicle, press the exterior release button.

Doors and Locks

Smart Unlocks for Integrated Keyhead Transmitter (If Equipped)

This helps to prevent you from locking yourself out of your vehicle if the key is still in the ignition.

When you open one of the front doors and lock your vehicle with the power door lock control, all doors lock then unlock and the horn sounds twice if the key is still in the ignition.

You can still lock your vehicle with the key in the ignition by:

- Using the manual lock on the door.
- Locking the driver door with a key.
- Using the keyless entry keypad.
- Pressing the lock button on another remote control.

Smart Unlocks for Intelligent Access Keys (If Equipped)

This helps to prevent you from locking your key inside the passenger compartment or rear cargo area.

When you electronically lock your vehicle with any door open, the transmission is in park (P) and the ignition is off, the system searches for an intelligent access key inside your vehicle after you close the last door. If the system finds a key, all of the doors will immediately unlock and the horn will sound twice, indicating that a key is inside.

You can override the smart unlock feature and intentionally lock the intelligent access key inside your vehicle.

To do this, lock your vehicle after you have closed all the doors by:

- Using the keyless entry keypad.
- Pressing the lock button on another intelligent access key.
- Touching the locking area on the front of the door handle with another intelligent access key in your hand.

When you open one of the front doors and lock your vehicle using the power door lock control, all doors lock then unlock if:

- The ignition is on.
- The ignition is off and the transmission is not in park (P).

Locking and Unlocking the Doors with the Key Blade

A key cylinder is located under the driver side door handle. You can use your key blade to manually lock and unlock the driver side door. See **Remote Control** (page 53).

Autolock (If Equipped)

Autolock locks all the doors when:

- All doors are closed.
- The ignition is on.
- You shift into any gear putting your vehicle in motion.
- Your vehicle reaches a speed greater than 12 mph (20 km/h).

Autolock repeats when:

- You open then close any door while the ignition is on and your vehicle speed is 9 mph (15 km/h) or lower.
- Your vehicle reaches a speed greater than 12 mph (20 km/h).

Doors and Locks

Autounlock

Autounlock unlocks all the doors when:

- The ignition is on, all the doors are closed, and your vehicle has been moving at a speed greater than 12 mph (20 km/h).
- Your vehicle comes to a stop and you switch the ignition off, or to the accessory position.
- You open the driver door within 10 minutes of switching the ignition off or to accessory.

Note: *The doors do not autounlock if you electronically lock your vehicle after you switch the ignition off and before you open the driver door.*

Enabling or Disabling Autounlock

You can enable or disable the autounlock feature in the information display or an authorized dealer can do it for you. See **General Information** (page 110).

Illuminated Entry (If Equipped)

The interior lamps and some exterior lamps illuminate when you unlock the doors with the remote control.

The lamps turn off if:

- The ignition is on.
- You press the remote control lock button.
- 25 seconds have elapsed.

The lamps do not turn off if:

- You turn them on with the lamp control.
- Any door is open.

Illuminated Exit

The interior lamps and some exterior lamps illuminate when all doors are closed and you switch the ignition off.

The lamps turn off if all the doors remain closed and:

- 25 seconds have elapsed.
- You press the push button ignition switch.

Battery Saver

If you leave the courtesy lamps, interior lamps or headlamps on, the battery saver shuts them off 10 minutes after you switch the ignition off.

Battery Saver for Intelligent Access Keys

If you leave the ignition switched on, it shuts off when it detects a certain amount of battery drain, or after 45 minutes.

KEYLESS ENTRY

SECURICODE™ KEYLESS ENTRY KEYPAD

The keypad is near the driver window. It illuminates when touched.

Note: *If you enter your entry code too fast on the keypad, the unlock function may not work. Enter your entry code again more slowly.*

Doors and Locks

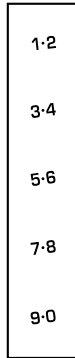

E138637

You can use the keypad to:

- Lock or unlock the doors.
- Program and erase user codes.
- Arm and disarm the anti-theft alarm.

Note: *You must have an intelligent access key within 3 ft (1 m) of your vehicle.*

You can operate the keypad with the factory-set five-digit entry code. The code is on the owner's wallet card in the glove box and is available from an authorized dealer. You can also program up to five of your own five-digit personal entry codes.

Programming a Personal Entry Code

To create your own personal entry code:

1. Enter the factory-set five-digit code.
2. Press **1-2** on the keypad within five seconds.
3. Enter your personal five-digit code. You must press each number within five seconds of each other.
4. Press **1-2** on the keypad to save personal code 1.

The doors lock then unlock to confirm that programming was successful.

To program additional personal entry codes, repeat Steps 1-3, then for Step 4:

- Press **3-4** to save personal code 2
- Press **5-6** to save personal code 3
- Press **7-8** to save personal code 4
- Press **9-0** to save personal code 5.

You may also program a personal entry code through the information display.

Tips:

- Do not set a code that uses five of the same number.
- Do not use five numbers in sequential order.
- The factory-set code works even if you have set your own personal code.

Erasing a Personal Code

1. Enter the factory-set 5-digit code.
2. Press and release **1-2** on the keypad within five seconds.
3. Press and hold **1-2** for two seconds. You must do this within five seconds of completing Step 2.

All personal codes erase and only the factory-set 5-digit code works.

Anti-Scan Feature

The keypad goes into an anti-scan mode if you enter the wrong code seven times (35 consecutive button presses). This mode disables the keypad for one minute and the keypad lamp flashes.

The anti-scan feature turns off after:

- One minute of keypad inactivity.
- Pressing the unlock button on the remote control.
- Switching the ignition on.

Displaying the Factory Set Code

Note: *You need to have two programmed keys for this procedure.*

Doors and Locks

To display the factory-set code in the information display:

1. Insert a key into the ignition and switch the ignition on for a few seconds.
2. Switch the ignition off and remove the key.
3. Insert the second key into the ignition and switch the ignition on.

The factory-set code will display for a few seconds.

Note: *The code may not display until after any other warning messages first display.*

Locking and Unlocking

To Unlock the Driver Door

Enter the factory-set 5-digit code or your personal code. You must press each number within five seconds of each other. The interior lamps illuminate.

Note: *All doors unlock if you disable the two-stage unlocking mode. See **Locking and Unlocking** (page 66).*

To Unlock All Doors

Enter the factory-set code or your personal code, then press **3-4** within five seconds.

To Lock All Doors

Press and hold **7-8** and **9-0** at the same time (with the driver door closed). You do not need to enter the keypad code first.

Displaying the Factory-Set Code

Note: *Do not place the device on the wireless accessory charging area when programming intelligent access keys.*

Note: *You can program a maximum of four keys to your vehicle.*

Read and understand all of the steps that follow before you begin.

You must have two previously programmed intelligent access keys inside your vehicle and the new unprogrammed intelligent access key readily accessible. You can purchase replacement keys or remote controls from an authorized dealer.

Make sure that you switch off the ignition before beginning this procedure. Make sure that you close all the doors before beginning and that they remain closed throughout the procedure. Carry out all steps within 30 seconds of starting the sequence. Stop and wait for at least one minute before starting again if you carry out any steps out of sequence.

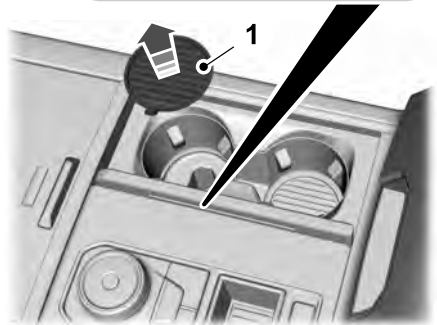

E256153

1. Access the backup slot.

Doors and Locks

2. With the buttons facing the rear of your vehicle and the key ring facing upward, place the first intelligent access key into the backup slot inside the center console.
3. Press the push button ignition switch once and wait for a few seconds.
4. Press the push button ignition switch again and remove the intelligent access key from the center console.
5. Insert the second programmed key into the backup slot in the center console, then press the push button ignition switch.

The factory-set code appears in the information display for a few seconds.

Note: *The code may not display until after any other warning messages first display.*

Liftgate

MANUAL LIFTGATE (IF EQUIPPED)



WARNING: It is extremely dangerous to ride in a cargo area, inside or outside of a vehicle. In a crash, people riding in these areas are more likely to be seriously injured or killed. Do not allow people to ride in any area of your vehicle that is not equipped with seats and seatbelts. Make sure everyone in your vehicle is in a seat and properly using a seatbelt. Failure to follow this warning could result in serious personal injury or death.



WARNING: Make sure that you fully close the liftgate to prevent exhaust fumes from entering your vehicle. If you are unable to fully close the tailgate, open the air vents or the windows to allow fresh air to enter your vehicle. Failure to follow this instruction could result in personal injury or death.



WARNING: Make sure that you fully close the liftgate to prevent passengers and cargo from falling out. Failure to follow this instruction could result in personal injury or death.

Note: Be careful when opening or closing the liftgate in a garage or other enclosed area to avoid damaging the liftgate.

Note: Do not hang anything, for example a bike rack, from the glass or liftgate. This could damage the liftgate and its components.

Note: Do not leave the liftgate open when you are driving. This could damage the liftgate and its components.

Opening the Liftgate

Manually Opening the Liftgate



E252962

1. Press the button inside the liftgate handle.
2. Pull the liftgate upward.

Remote Control



Press twice within three seconds to unlatch the liftgate.

Liftgate

Closing the Liftgate



E252964

A handle is inside the liftgate to help with closing.

POWER LIFTGATE (IF EQUIPPED)



WARNING: It is extremely dangerous to ride in a cargo area, inside or outside of a vehicle. In a crash, people riding in these areas are more likely to be seriously injured or killed. Do not allow people to ride in any area of your vehicle that is not equipped with seats and seatbelts. Make sure everyone in your vehicle is in a seat and properly using a seatbelt. Failure to follow this warning could result in serious personal injury or death.



WARNING: Make sure that you fully close the liftgate to prevent exhaust fumes from entering your vehicle. If you are unable to fully close the tailgate, open the air vents or the windows to allow fresh air to enter your vehicle. Failure to follow this instruction could result in personal injury or death.



WARNING: Make sure that you fully close the liftgate to prevent passengers and cargo from falling out. Failure to follow this instruction could result in personal injury or death.



WARNING: Keep keys out of reach of children. Do not allow children to operate or play near an open or moving power liftgate. You should supervise the operation of the power liftgate at all times.

Note: Make sure that you close the liftgate before operating or moving your vehicle, especially in an enclosure, like a garage or a parking structure. This could damage the liftgate and its components.

Note: Do not hang anything, for example a bike rack, from the glass or liftgate. This could damage the liftgate and its components.

The liftgate only operates with the transmission in park (P).

Three warning tones sound as the liftgate begins to power close. If there is a problem with the open or close request, one of the following may occur:

- One tone sounds if the ignition is on and the transmission is not in park (P).
- Three tones sound if the battery voltage is below the minimum operating voltage.
- One tone sounds if the vehicle speed is at or above 3 mph (5 km/h).

Liftgate

If the liftgate starts to close after it has fully opened, this indicates there may be excessive weight on the liftgate or a possible strut failure. A repetitive tone sounds and the liftgate closes under control. Remove any excessive weight from the liftgate. If the liftgate continues to close after opening, have the system checked as soon as possible.

Opening and Closing the Liftgate



WARNING: Make sure all persons are clear of the power liftgate area before using the power liftgate control.

Note: Make sure the area behind your vehicle is free from obstruction and that there is enough room for you to operate the liftgate. Objects too close to your vehicle, for example a wall, garage door or another vehicle may come into contact with the moving liftgate. This could damage the liftgate and its components.

Note: Be careful when opening or closing the liftgate in a garage or other enclosed area to avoid damaging the liftgate.

Note: Do not leave the liftgate open when you are driving. This could damage the liftgate and its components.

From the Instrument Panel



With the transmission in park (P), press the button on the instrument panel.

Remote Control



Press the button twice within a few seconds.

Outside Control

Opening the Liftgate

1. Unlock the liftgate with the remote control or power door unlock control. If an intelligent access key is within 3 ft (1 m) of the liftgate, the liftgate unlocks when you press the liftgate release button.



E252962

2. Press the button inside the liftgate handle.

Note: Allow the power system to open the liftgate. Manually pushing or pulling the liftgate may activate the system's obstacle detection and stop the power operation or reverse its direction, replicate a strut failure, or damage mechanical components.

Closing the Liftgate



WARNING: Keep clear of the liftgate when using the rear switch.

Liftgate



E252965

Press and release the liftgate control button.

Disabling the Liftgate Button

You can disable the liftgate button under the **Advanced Settings** menu. See **General Information** (page 110).

Opening the Liftgate Window

See **Liftgate Window** (page 101).

Stopping the Liftgate Movement

Note: Do not apply sudden excessive force to the liftgate while it is in motion. This could damage the power liftgate and its components.

You can stop the liftgate movement by doing any of the following:

- Pressing the liftgate control button.
- Pressing the liftgate button on the remote control twice.
- Pressing the liftgate button on the instrument panel.

Setting the Liftgate Open Height

1. Open the liftgate.
2. Stop the liftgate movement by pressing the control button on the liftgate when it reaches the desired height.

Note: Once the liftgate has stopped moving, you can also manually move it to the desired height.

3. Press and hold the liftgate control button on the liftgate until a tone sounds, indicating programming is complete.

Note: You can only use the liftgate control button to program the height.

Note: You cannot program the height if the liftgate position is too low.

The new open liftgate height is recalled when the power liftgate is opened. To change the programmed height, repeat the above procedure. Once you open the power liftgate, you can manually move it to a different height.

Note: The system recalls the new programmed height, even if you disconnect the battery.

When operating the power liftgate after you have programmed a lower height than fully open, you can fully open the liftgate by manually pushing it upward to the maximum open position.

Obstacle Detection

When Closing

The system stops when it detects an obstacle. Three tones sound and the system reverses to open. When you remove the obstacle, you can power close the liftgate.

Liftgate

Note: Entering your vehicle when the liftgate is closing can cause your vehicle to bounce and activate obstacle detection. To prevent this, let the power liftgate close completely before you enter your vehicle. Before driving off, check the instrument cluster for a liftgate or door ajar message or warning indicator. Failure to do this could result in unintentionally leaving the liftgate open when driving.

When Opening

The system stops when it detects an obstacle and two short tones sound. Remove the obstacle to operate the liftgate.

Using the Hands-Free Liftgate (If Equipped)

Make sure you have a passive key within 3 ft (1 m) of the liftgate.

1. Stand behind your vehicle, and face the liftgate.
2. Move your foot, in a single-kick motion, without pausing, under and away from the rear bumper detection area.
3. The liftgate power opens or closes.

Vehicles Without a Trailer Hitch



E253664

The detection area is in the center of the rear bumper.

Vehicles With a Trailer Hitch

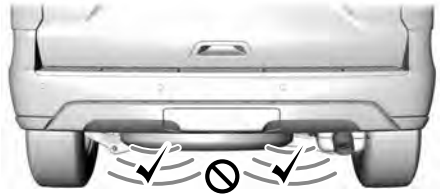

E253799

The detection area is on the left-hand side and right-hand side of the hitch, between the exhaust and the hitch.

Avoid the following actions when using hands-free opening:

- Making physical contact with the bumper.
- Holding your foot under the bumper.
- Sweeping your foot from side to side, or kicking at an odd angle.

Note: Allow the power system to open the liftgate. Manually pushing or pulling the liftgate may activate the system's obstacle detection and stop the power operation or reverse its direction, replicate a strut failure, or damage mechanical components.

Note: Splashing water may cause the hands-free liftgate to open. Keep the passive key away from the rear bumper detection area when you wash your vehicle.

Security

PASSIVE ANTI-THEFT SYSTEM

Note: *The system is not compatible with non-Ford aftermarket remote start systems. Use of these systems may result in vehicle starting problems and a loss of security protection.*

Note: *Metallic objects, electronic devices or a second coded key on the same key chain may cause vehicle starting problems if they are too close to the key when starting the engine. Prevent these objects from touching the coded key while starting the engine. Switch the ignition off, move all objects on the key chain away from the coded key and restart the engine if a problem occurs.*

Note: *Do not leave a duplicate coded key in the vehicle. Always take your keys and lock all doors when leaving the vehicle.*

SecuriLock™

The system is an engine immobilization system. The intended design is to help prevent the engine from starting unless a coded key programmed to your vehicle is used. Using the wrong key may prevent the engine from starting. A message may appear in the information display.

If you are unable to start the engine with a correctly coded key, a malfunction has happened and a message may appear in the information display.

Automatic Arming

The vehicle arms immediately after you switch the ignition off.

Automatic Disarming

If you switch the ignition on with a coded key you disarm the vehicle. If you unlock the doors with the touch handle you disarm the alarm.

Replacement Keys

Note: *Your vehicle comes equipped with two intelligent access keys.*

The intelligent access key functions as a programmed key that operates the driver door lock and activates the intelligent access with push button start system, as well as a remote control.

If your programmed transmitters are lost or stolen and you do not have an extra coded key, you will need to have your vehicle towed to an authorized dealer. You need to erase the key codes from your vehicle and program new coded keys.

Store an extra programmed key away from the vehicle in a safe place to help prevent any inconveniences. See your authorized dealer to purchase additional spare or replacement keys.

Programming a Spare Integrated Keyhead Transmitter

Note: *You can program a maximum of eight coded keys to your vehicle. All eight can be integrated keyhead transmitters.*

You can program your own integrated keyhead transmitter or standard SecuriLock coded keys to your vehicle. This procedure programs both the engine immobilizer keycode and the remote entry portion of the remote control to your vehicle.

Only use integrated keyhead transmitters or standard SecuriLock keys.

You must have two previously programmed coded keys and the new unprogrammed key readily accessible. See your authorized dealer to have the spare key programmed if two previously programmed coded keys are not available.

Read and understand the entire procedure before you begin.

Security

1. Insert the first previously programmed coded key into the ignition.
2. Switch the ignition from off to on. Keep the ignition on for at least three seconds, but no more than 10 seconds.
3. Switch the ignition off and remove the first coded key from the ignition.
4. After three seconds but within 10 seconds of switching the ignition off, insert the second previously coded key into the ignition.
5. Switch the ignition from off to on. Keep the ignition on for at least three seconds, but no more than 10 seconds.
6. Switch the ignition off and remove the second previously programmed coded key from the ignition.
7. After three seconds but within 10 seconds of switching the ignition off and removing the previously programmed coded key, insert the new unprogrammed key into the ignition.
8. Switch the ignition from off to on. Keep the ignition on for at least six seconds.
9. Remove the newly programmed coded key from the ignition.

If the key has been successfully programmed it will start the engine and operate the remote entry system (if the new key is an integrated keyhead transmitter).

If programming was not successful, wait 10 seconds and repeat Steps 1 through 8. If you are still unsuccessful, take your vehicle to your authorized dealer.

Programming a Spare Intelligent Access Key

Note: You can program a maximum of four keys to your vehicle.

You must have two previously programmed intelligent access keys inside your vehicle and the new unprogrammed intelligent access key readily accessible. You can purchase replacement keys or remote controls from an authorized dealer.

Make sure that the ignition is switched off before beginning this procedure. Make sure that you close all the doors before beginning and that they remain closed throughout the procedure. Carry out all steps within 30 seconds of starting the sequence. Stop and wait for at least one minute before starting again if you carry out any steps out of sequence.

Read and understand the entire procedure before you begin.

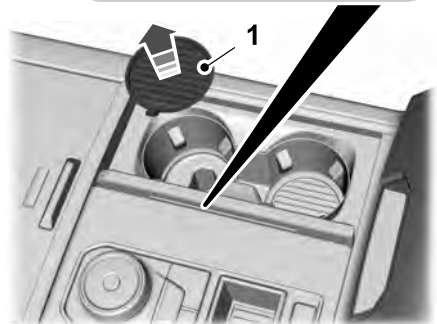

E256153

1. Access the backup slot.

Security

2. Insert the first programmed key in the backup slot.
3. Press the push button ignition switch.
4. Wait five seconds and then press the push button ignition switch again.
5. Remove the intelligent access key.
6. Within 10 seconds, place a second programmed intelligent access key in the backup slot and press the push button ignition switch.
7. Wait five seconds and then press the push button ignition switch again.
8. Remove the intelligent access key.
9. Wait five seconds, then place the unprogrammed intelligent access key in the backup slot and press the push button ignition switch.
10. Once complete, the information cluster displays a message confirming the key has been programmed. The direction indicators flash and the horn sounds.

Programming is now complete. Check that the remote control functions operate and your vehicle starts with the new intelligent access key.

If programming was unsuccessful, wait 10 seconds and repeat steps 1 through 7. If it still does not work, take your vehicle to an authorized dealer.

ANTI-THEFT ALARM

The system will warn you of an unauthorized entry to your vehicle. It will be triggered if any door, the luggage compartment or the hood is opened without using the key, remote control or keyless entry keypad.

The direction indicators will flash and the horn will sound if unauthorized entry is attempted while the alarm is armed.

Take all remote controls to an authorized dealer if there is any potential alarm problem with your vehicle.

Arming the Alarm

The alarm is ready to arm when there is not a key in your vehicle. Electronically lock your vehicle to arm the alarm.

Disarming the Alarm

Disarm the alarm by any of the following actions:

- Unlock the doors or luggage compartment with the remote control or keyless entry keypad.
- Switch your vehicle on or start your vehicle.
- Use a key in the driver door to unlock your vehicle, then switch your vehicle on within 12 seconds.

Note: *Pressing the panic button on the remote control will stop the horn and signal indicators, but will not disarm the system.*

Power Running Boards (If Equipped)

USING POWER RUNNING BOARDS



WARNING: In extreme climates, excessive ice buildup may occur, causing the running boards not to deploy. Make sure that the running boards have deployed, and have finished moving before attempting to step on them. The running boards will resume normal function once the blockage is cleared.



WARNING: Turn off the running boards before jacking or placing any object under your vehicle. Never place your hand between the extended running board and your vehicle. A moving running board may cause injury.

Note: Do not use the running boards, front and rear hinge assemblies, running board motors, or the running board underbody mounts to lift your vehicle when jacking. Always use proper jacking points.

Note: The running boards may operate more slowly in cool temperatures.

Note: The running board mechanism may trap debris such as mud, dirt, snow, ice and salt. This may cause unwanted noise. If this happens, manually set the running boards to the deployed position. Then, wash the system, in particular the front and rear hinge arms, with a high-pressure car wash wand.

Automatic Power Deploy

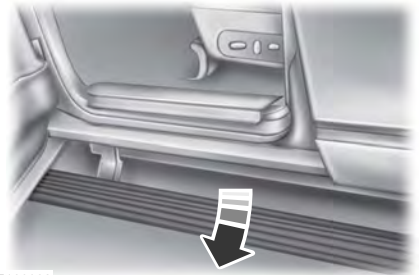

E166682

The running boards automatically extend down and out when you open the door. This can help you enter and exit your vehicle.

Automatic Power Stow

When you close the doors, the running boards return to the stowed position after a two-second delay.

Manual Power Deploy

You can manually operate the running boards in the information display. See **General Information** (page 110).

Set the running boards in the deployed position to access the roof.

The running boards return to the stowed position and enter automatic mode when the vehicle speed exceeds 5 mph (8 km/h).

Enabling and Disabling

You can enable and disable the power running board feature in the information display. See **General Information** (page 110).

Power Running Boards (If Equipped)

- When disabled (**OFF**), the running boards move to the stowed position regardless of the door position.
- When enabled (**AUTO**), the running boards move back to the correct positions based on the door position.

Bounce-back

The running board will reverse direction and move to the end of travel if it encounters an object while moving.

Steering Wheel

ADJUSTING THE STEERING WHEEL - VEHICLES WITH: MANUAL ADJUSTABLE STEERING COLUMN



WARNING: Do not adjust the steering wheel when your vehicle is moving.

Note: Make sure that you are sitting in the correct position. See **Sitting in the Correct Position** (page 149).

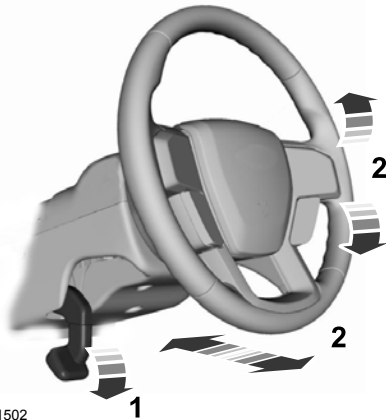

E261502

1. Unlock the steering column.
2. Adjust the steering wheel to the desired position.

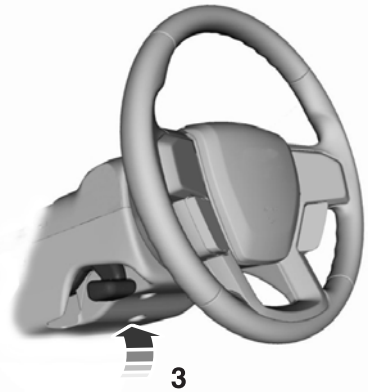

E261503

3. Lock the steering column.

ADJUSTING THE STEERING WHEEL - VEHICLES WITH: POWER ADJUSTABLE STEERING COLUMN



WARNING: Do not adjust the steering wheel when your vehicle is moving.

Note: Make sure that you are sitting in the correct position. See **Sitting in the Correct Position** (page 149).

Steering Wheel



E261582

Use the control on the side of the steering column to adjust the position.

To adjust:

- Tilt: Press the top or bottom of the control.
- Telescope: Press the front or rear of the control.

End of Travel Position

The steering column sets a stopping position just short of the end of the column position to prevent damage to the steering column. A new stopping position sets if the steering column encounters an object when tilting or telescoping.

To reset the steering column to its normal stopping position:

1. Confirm there is nothing obstructing the motion of the steering column.
2. Press and hold the steering column control until the steering column stops moving.
3. Press the steering column control again.

Note: The steering column may begin to move again.

4. When the steering column stops, continue holding the control for a few seconds.
5. Repeat for each direction as necessary.

A new stopping position sets. The next time you tilt or telescope the steering column, it stops just short of the end of the column position.

Memory Feature (If Equipped)

You can save and recall the steering column position with the memory function. See **Memory Function** (page 156).

Pressing the adjustment control during a memory recall cancels the operation.

Easy Entry and Exit Feature

The column moves up when you switch the ignition off. Switch the ignition on to return the system to its previous settings. You can switch this feature on or off in the information display. See **Information Displays** (page 110).

Note: If you press any adjustment or memory button when in easy exit mode, the system cancels the operation.

Note: Depending on your vehicle, the column may move up and in.

AUDIO CONTROL

You can operate the following functions with the control:

Steering Wheel

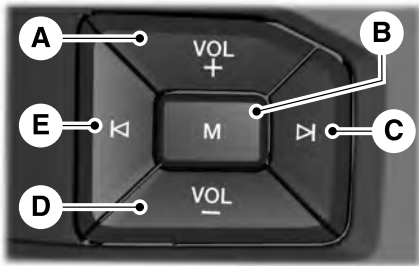

E191327

- A Volume up.
- B Media.
- C Seek up or next.
- D Volume down.
- E Seek down or previous.

Media

Press repeatedly to scroll through available audio modes.

Seek, Next or Previous

Press the seek button to:

- Tune the radio to the next or previous stored preset.
- Play the next or previous track.

Press and hold the seek button to:

- Tune the radio to the next station up or down the frequency band.
- Seek through a track.

VOICE CONTROL

The controls are on the steering wheel.



Press and release to activate voice recognition. See your SYNC information.



Press and release to enter phone mode or answer a phone call. See your SYNC information.



Press and release to end a phone call. See your SYNC information.



Press and release to silence the current media. .

CRUISE CONTROL

Type One



E191329

See **Using Cruise Control** (page 237).

Type Two



E248613

See **Using Adaptive Cruise Control** (page 238).

Steering Wheel

INFORMATION DISPLAY CONTROL



E191336

See **Information Displays** (page 110).

HEATED STEERING WHEEL (IF EQUIPPED)

The heated steering wheel button is on the climate controls.



Press the button to switch the heated steering wheel on and off.

Note: You can use the heated steering wheel only when the engine is running.

Note: The system uses a sensor and is designed to control the temperature of the steering wheel and to prevent it from overheating.

Note: In warm temperatures, the steering wheel quickly reaches its maximum temperature and the system reduces the current to the heating element. This could cause you to think that the system has stopped working but it has not. This is normal.

Pedals (If Equipped)

ADJUSTING THE PEDALS



WARNING: Never use the pedal adjustment controls when your feet are on the accelerator or brake pedal when the vehicle is moving.

You can find the control on the left side of the steering column. Press and hold the appropriate side of the control to move the pedals.

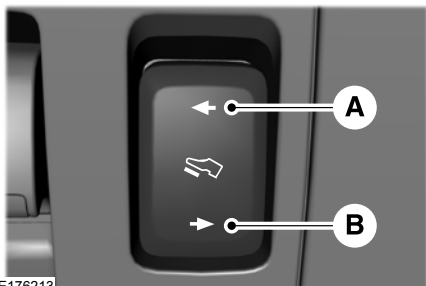

E176213

- A Farther.
- B Closer.

You can save and recall the pedal positions with the memory feature. See **Memory Function** (page 156).

Note: *Adjust the pedals only when your vehicle is in park (P).*

Wipers and Washers

WINDSHIELD WIPERS

Note: Fully defrost the windshield before you switch the windshield wipers on.

Note: Make sure you switch the windshield wipers off before entering a car wash.

Note: If streaks or smears appear on the windshield, clean the windshield and the wiper blades. If that does not resolve the issue, install new wiper blades.

Note: Do not operate the wipers on a dry windshield. This may scratch the glass, damage the wiper blades or cause the wiper motor to burn out. Always use the windshield washers before wiping a dry windshield.



E252762

- Rotate away from you for a short wipe interval.
- Rotate toward you for a long wipe interval.

Speed Dependent Wipers

When your vehicle speed increases, the interval between wipes decreases.

AUTOWIPERS (IF EQUIPPED)

Note: Fully defrost the windshield before you switch the windshield wipers on.

Note: Make sure you switch the windshield wipers off before entering a car wash.

Note: If streaks or smears appear on the windshield, clean the windshield and the wiper blades. If that does not resolve the issue, install new wiper blades.

Note: If you switch autolamps and autowipers on, the headlamps turn on when the windshield wipers continuously operate.

Wet or winter driving conditions with ice, snow or salty road mist can cause inconsistent and unexpected wiping or smearing.

The feature uses a rain sensor that is in the area around the interior mirror. The rain sensor monitors the amount of moisture on the windshield and turns on the wipers. It adjusts the wiper speed by the amount of moisture that the sensor detects on the windshield. You can switch this feature on and off in the information display. See **Information Displays** (page 110).



E205527

Use the rotary control to adjust the sensitivity of the autowipers:

- Rotate toward you for low sensitivity, the wipers operate when the sensor detects a large amount of water on the windshield.
- Rotate away from you for high sensitivity, the wipers operate when the sensor detects a small amount of water on the windshield.

Keep the outside of the windshield clean. The rain sensor is very sensitive and the wipers may operate if dirt, mist or insects hit the windshield.

Wipers and Washers

In these conditions, you can do the following:

- Lower the sensitivity of the autowipers to reduce the amount of smearing on the windshield.
- Switch to normal or high-speed wipe.
- Switch autowipers off.

Autowipers Settings

Autowipers default to on and remain on until you switch them off in the information display. When you switch off autowipers, the wipers operate in intermittent mode.

WINDSHIELD WASHERS

Note: Do not operate the wipers on a dry windshield. This may scratch the glass, damage the wiper blades or cause the wiper motor to burn out. Always use the windshield washers before wiping a dry windshield.

Note: Do not operate the washers when the washer reservoir is empty. This may cause the washer pump to overheat.



E205528

- A brief press causes a single wipe without washer fluid.
- A brief press and hold causes the wipers to swipe three times with washer fluid.
- A long press and hold turns on the wipers and washer fluid for up to 10 seconds.

A wipe occurs a few seconds after washing to clear any remaining washer fluid. You can switch this feature on or off in the information display.

Front Camera Washer (If Equipped)

Operating the windshield washer also operates the front camera washer.

REAR WINDOW WIPER AND WASHERS

Note: Make sure you switch the windshield wipers off before entering a car wash.

Rear Window Wiper Blade



E205529

Rotate the control to switch to select:

Position	Interval Length
2	Short wipe interval.
1	Long wipe interval.
0	Off.

Rear Window Washer

Rotate and hold the control to the top or bottom position to switch on the rear window washer. When you release the lever, wiping continues for a short period of time.

Lighting

GENERAL INFORMATION

Condensation in the Exterior Front Lamps and Rear Lamps

Exterior front lamps and rear lamps have vents to accommodate normal changes in air pressure.

Condensation can be a natural by-product of this design. When moist air enters the lamp assembly through the vents, there is a possibility that condensation can occur when the temperature is cold. When normal condensation occurs, a fine mist can form on the interior of the lens. The fine mist eventually clears and exits through the vents during normal operation.

Clearing time may take as long as 48 hours under dry weather conditions.

Examples of acceptable condensation are:

- The presence of a fine mist (no streaks, drip marks or large droplets).
- A fine mist covers less than 50% of the lens.

Examples of unacceptable condensation are:

- A water puddle inside the lamp.
- Streaks, drip marks or large droplets present on the interior of the lens.

If you see any unacceptable condensation, have your vehicle checked by an authorized dealer.

LIGHTING CONTROL

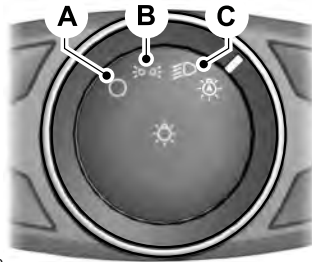

E142449

- A Lamps off.
- B Parking lamps, instrument panel lamps, license plate lamps and rear lamps.
- C Headlamps.

Headlamp High Beam

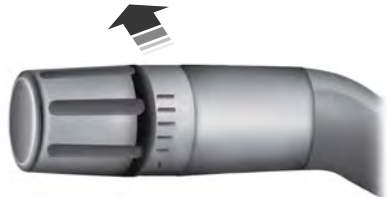

E167827



Push the lever away from you to switch the high beam on.

Push the lever forward again or pull the lever toward you to switch the high beams off.

Lighting

Flashing the Headlamp High Beam

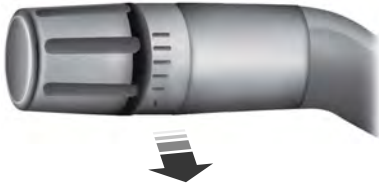

E163268

Slightly pull the lever toward you and release it to flash the headlamps.

AUTOLAMPS (IF EQUIPPED)



WARNING: The system does not relieve you of your responsibility to drive with due care and attention. You may need to override the system if it does not turn the headlamps on in low visibility conditions, for example daytime fog.

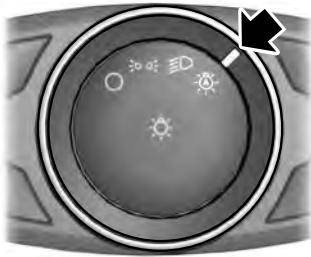

E142451

When the lighting control is in the autolamps position, the headlamps turn on in low light situations, or when the wipers turn on.

The headlamps remain on for a period of time after you switch the ignition off. Use the information display controls to adjust the period of time that the headlamps remain on.

Note: If you switch the autolamps on, you cannot switch the high beams on until the system turns the low beams on.

Windshield Wiper Activated Headlamps

When you switch the autolamps on, the headlamps turn on within 10 seconds of switching the wipers on. They turn off approximately 60 seconds after you switch the windshield wipers off.

The headlamps do not turn on with the wipers:

- During a single wipe.
- When using the windshield washers.
- If the wipers are in intermittent mode.

Note: If you switch the autolamps and the autowipers on, the headlamps turn on when the windshield wipers continuously operate.

INSTRUMENT LIGHTING DIMMER

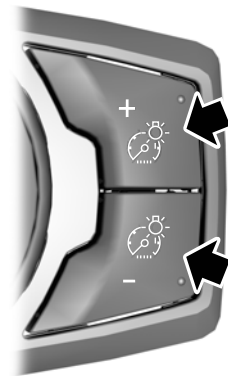

E231828

Lighting

Press repeatedly or press and hold until you reach the desired level.

HEADLAMP EXIT DELAY

After you switch the ignition off, you can switch the headlamps on by pulling the direction indicator lever toward you. You will hear a short tone. The headlamps will switch off automatically after three minutes with any door open or 30 seconds after the last door has been closed. You can cancel this feature by pulling the direction indicator toward you again or switching the ignition on.

DAYTIME RUNNING LAMPS (IF EQUIPPED)



WARNING: The daytime running lamps system does not activate the rear lamps and may not provide adequate lighting during low visibility driving conditions. Make sure you switch the headlamps on, as appropriate, during all low visibility conditions. Failure to do so may result in a crash.

Type One - Conventional (Non-Configurable)

The daytime running lamps turn on when:

1. Switching the ignition on.
2. The transmission is not in park (P) for vehicles with automatic transmissions, or releasing the parking brake for vehicles with manual transmissions.
3. The lighting control is in the off, parking lamp or autolamps positions.
4. The headlamps are off.

Type Two - Configurable

Switch the daytime running lamps on or off using the information display. See **Information Displays** (page 110).

The daytime running lamps turn on when:

1. The lamps are on in the information display.
2. Switching the ignition on.
3. The transmission is not in park (P) for vehicles with automatic transmissions, or releasing the parking brake for vehicles with manual transmissions.
4. The lighting control is in the autolamps position.
5. The headlamps are off.

The other lighting control switch positions do not turn on the daytime running lamps.

If the daytime running lamps are off in the information display, the lamps stay off in all switch positions.

AUTOMATIC HIGH BEAM CONTROL (IF EQUIPPED)



WARNING: The system does not relieve you of your responsibility to drive with due care and attention. You may need to override the system if it does not turn the high beams on or off.

The system turns on high beams if it is dark enough and no other traffic is present. If it detects an approaching vehicle's headlamps or tail lamps, or street lighting ahead, the system turns off high beams before they can distract other road users. Low beams remain on.

Note: *The system may not operate properly if the sensor is blocked. Keep the windshield free from obstruction or damage.*

Lighting

Note: The system may not operate properly in cold or inclement conditions. You can switch on the high beams by overriding the system.

Note: If the system detects a blockage, for example bird droppings, bug splatter, snow or ice, the system goes into low beam mode until you clear the blockage. A message may appear in the information display if the camera is blocked.

Note: Using much larger tires or equipping vehicle accessories such as snowplows can modify your vehicle's ride height and degrade automatic high beam control performance.

A camera sensor, centrally mounted behind the windshield of your vehicle, continuously monitors conditions to turn the high beams on and off.

Once the system is active, the high beams turn on if:

- The ambient light level is low enough.
- There is no traffic in front of your vehicle.
- The vehicle speed is greater than approximately 32 mph (51 km/h).

The system turns the high beams off if:

- The ambient light level is high enough that high beams are not required.
- The system detects an approaching vehicle's headlamps or tail lamps.
- The vehicle speed falls below approximately 27 mph (44 km/h).
- The system detects severe rain, snow or fog.
- The camera is blocked.

Switching the System On and Off

Switch the system on using the information display. See **Information Displays** (page 110).

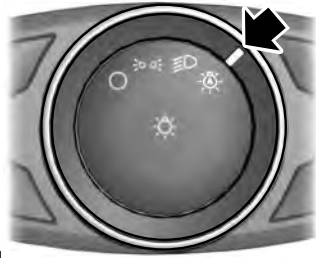

E142451

Switch the lighting control to the autolamps position. See **Autolamps** (page 91).

Overriding the System

Push the lever away from you to switch between high beam and low beam.

Automatic High Beam Indicator



The indicator illuminates to confirm when the system is ready to assist.

FRONT FOG LAMPS



E142453

Press the control to switch the fog lamps on or off.

Lighting

You can switch the fog lamps on when the lighting control is in any position except Off and the high beams are not on.

DIRECTION INDICATORS



E163272



Push the lever up or down to use the direction indicators.

Note: Tap the lever up or down to make the direction indicators flash three times.

Note: When in Tow/Haul mode, tap the lever up or down to make the direction indicators flash five times.

WELCOME LIGHTING (IF EQUIPPED)

The projection lights are on the bottom of the exterior mirror housings. They project an image onto the ground a short distance from your vehicle when welcome lighting or lighted entry turns on.

Note: Moisture, frost and ice build-up or other types of contamination on the surface of the light lens can cause non-permanent distortion or reduced brightness of the image. Do not use abrasive materials to clean the lens.

Note: For vehicles with manual transmission, you may need to engage the parking brake for this feature to operate.

INTERIOR LAMPS

The lamps turn on under the following conditions:

- You open any door.
- You press a remote control button.
- You press the all lamps on button on the overhead console.

Front Interior Lamp



E262162

The front interior lamp switches are on the overhead console.

Note: The position of each button on the overhead console depends on your vehicle.

All Lamps On



Press to switch all interior lamps on.

All Lamps Off



Press to switch all interior lamps off.

Individual Dome Lamps



Press to switch the left-hand individual dome lamp on and off.

Lighting



Press to switch the right-hand individual dome lamp on and off.

Interior Lamp Function



Press to switch the interior lamp function on and off.

When the interior lamp function is off and you open a door, the courtesy and door lamps stay off.

When the interior lamp function is on and you open a door, the courtesy and door lamps turn on.

Note: *The indicator lamp lights amber when the door function is off.*

Individual Map Lamps

Press a map lens to switch individual map lamps on and off independently.

Rear Interior Lamps

The rear interior lamps may be above the rear seat or above the rear windows.



Press to switch the lamps on or off.

AMBIENT LIGHTING (IF EQUIPPED)

Use the touchscreen to select the following:



Select the settings option on the feature bar.



Select ambient lighting.

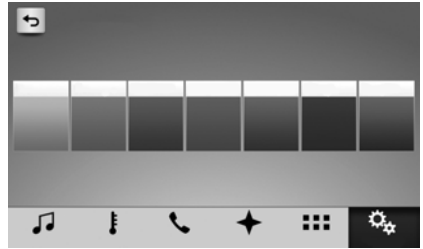

E273102

Switching Ambient Lighting On

Touch a color once.

Changing the Color

Touch any color once.

Adjusting the Brightness

Drag the selected color up or down.

Switching Ambient Lighting Off

Touch the selected color once or drag the selected color down to zero brightness.

Windows and Mirrors

POWER WINDOWS



WARNING: Do not leave children unattended in your vehicle and do not let them play with the power windows. Failure to follow this instruction could result in personal injury.



WARNING: When closing the power windows, verify they are free of obstruction and make sure that children and pets are not in the proximity of the window openings.

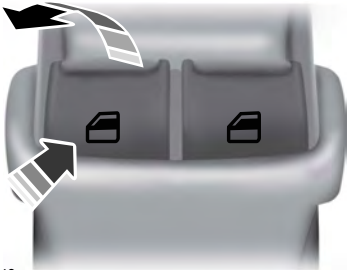

E146043

Note: You may hear a pulsing noise when just one of the windows is open. Lower the opposite window slightly to reduce this noise.

Press the control to open the window.

Lift the control to close the window.

One-Touch Down

Press the control to open the window.
Press again or lift it to stop the window.

One-Touch Up

Lift the control fully and release it. Press again or lift it to stop the window.

Bounce-Back

The window will automatically stop and reverse some distance if it detects an obstacle while closing.

Overriding the Bounce-Back Feature



WARNING: When you override the bounce-back feature the window will not reverse if it detects an obstacle. Take care when closing the windows to avoid personal injury or damage to your vehicle.

Pull up the window switch and hold within a few seconds of the window reaching the bounce-back position. The window travels up with no bounce-back protection. The window will stop if you release the switch before the window fully closes.

Window Lock



E144072

Press the control to lock or unlock the rear window controls. It will illuminate when you lock the rear window controls.

Accessory Delay

The window switches remain operational for several minutes when you switch the ignition off or until you open either front door.

Windows and Mirrors

GLOBAL OPENING

You can use the remote control to open the windows and vent the moonroof with the ignition off.

Note: You can enable or disable this feature in the information display, or see an authorized dealer.

Note: To operate this feature, accessory delay must not be active.

Remote Control Front Windows

You can open the windows for a short time after you unlock your vehicle with the remote control. After you unlock your vehicle, press and hold the remote control unlock button to open the windows. Release the button once movement starts. Press the lock or unlock button to stop movement.

Moonroof (If Equipped)

You can vent the moonroof after you unlock your vehicle with the remote control. After you unlock your vehicle, press and hold the remote control unlock button to vent the moonroof. Release the button once movement starts. Press the lock or unlock button to stop movement.

EXTERIOR MIRRORS

Power Exterior Mirrors



WARNING: Do not adjust the mirrors when your vehicle is moving. This could result in the loss of control of your vehicle, serious personal injury or death.

Note: Do not use an ice scraper on the mirror glass or housing.

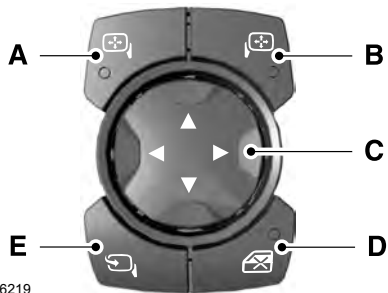

E176219

- A Left-hand mirror.
- B Right-hand mirror.
- C Adjustment control.
- D Window lockout.
- E Power-folding mirror control.

To adjust a mirror:

1. Select the mirror you want to adjust. The control will light.
2. Adjust the position of the mirror.
3. Press the mirror control again.

Fold-Away Exterior Mirrors

Push the mirror toward the door window glass. Make sure that you fully engage the mirror in its support when returning it to its original position.

Auto-Folding Mirrors (If Equipped)

The exterior mirrors automatically fold in toward the glass after you place the transmission into park (P), turn off the vehicle, open and close the driver's side door and lock the vehicle. The exterior mirrors automatically unfold and return to their driving position after you unlock the vehicle and open and close the driver's side door.

Windows and Mirrors

You can switch this feature on and off through the information display. See **General Information** (page 110).

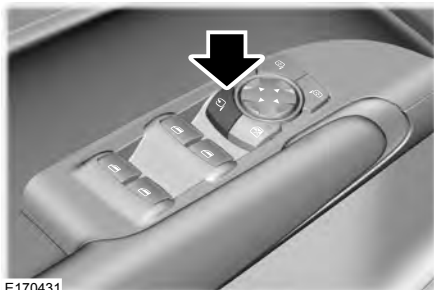

E170431

You can fold the mirrors on demand by pressing the power-folding mirror control located on the door. The control lights and the mirrors fold in toward the glass. Press the control again to unfold the mirrors. The control light turns off.

Note: *If you use the power-folding control to fold the mirrors on demand and the auto fold feature is switched on, you must use the control again to unfold them.*

Loose Mirror

If your power-folding mirrors are manually folded, they may not work properly even after you re-position them. You need to reset them if:

- The mirrors vibrate when you drive.
- The mirrors feel loose.
- The mirrors do not stay in the folded or unfolded position.
- One of the mirrors is not in its normal driving position.

To reset the power-fold feature, use the power-folding mirror control to fold and unfold the mirrors. You may hear a loud noise as you reset the power-folding mirrors. This sound is normal. Repeat this process as needed each time the mirrors are manually folded.

Heated Exterior Mirrors

See **Heated Exterior Mirrors** (page 147).

Memory Mirrors (If Equipped)

You can save and recall the mirror positions through the memory function. See **Memory Function** (page 156).

Auto-Dimming Feature (If Equipped)

The driver exterior mirror automatically dims with the auto-dimming interior mirror.

Signal Indicator Mirrors (If Equipped)

The outer portion of the appropriate mirror housing blinks when you switch on the direction indicator.

Puddle Lamps (If Equipped)

The lamps on the bottom part of the mirror housing light when you use your transmitter to unlock the doors or when you open a door.

Blind Spot Monitor (If Equipped)

See **Blind Spot Information System** (page 250).

360-Degree Camera (If Equipped)

See **360 Degree Camera** (page 234).

Integrated Blind Spot Mirror (If Equipped)



Blind spot mirrors have an integrated convex mirror built into the upper outboard corner of the exterior mirrors. They can assist you by increasing visibility along the side of your vehicle. The blind spot mirror is only on the driver exterior mirror.

Windows and Mirrors

Check the main mirror first before a lane change, then check the blind spot mirror. If no vehicles are present in the blind spot mirror and the traffic in the adjacent lane is at a safe distance, signal that you are going to change lanes. Glance over your shoulder to verify traffic is clear, and carefully change lanes.

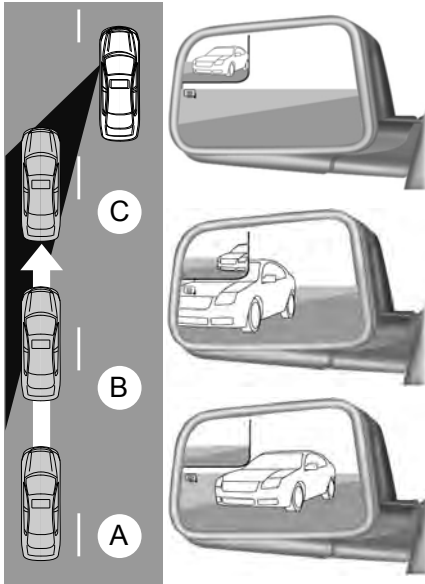

E138665

The image of the approaching vehicle is small and near the inboard edge of the main mirror when it is at a distance. The image becomes larger and begins to move outboard across the main mirror as the vehicle approaches (A). The image transitions from the main mirror and begins to appear in the blind spot mirror as the vehicle approaches (B). The vehicle transitions to your peripheral field of view as it leaves the blind spot mirror (C).

INTERIOR MIRROR

 **WARNING:** Do not adjust the mirrors when your vehicle is moving. This could result in the loss of control of your vehicle, serious personal injury or death.

Note: Do not clean the housing or glass of any mirror with harsh abrasives, fuel or other petroleum or ammonia-based cleaning products.

You can adjust the interior mirror to your preference. Some mirrors also have a second pivot point. This lets you move the mirror head up or down and from side to side.

Auto-Dimming Mirror

Note: Do not block the sensors on the front and back of the mirror. A rear center passenger or raised rear center head restraint may also block light from reaching the sensor.

The mirror dims to reduce the effect of bright light from behind. It returns to normal when the bright light from behind is no longer present or if you shift into reverse (R).

CHILDMINDER MIRROR

On overhead consoles, the childminder mirror allows the driver to view the rear seating area.

Windows and Mirrors



WARNING: Do not use the childminder mirror to view rearward traffic, do not allow rear passengers to distract you from the driving task, and make sure the rear view mirror has a clear view of rearward traffic. Failure to do so could increase the risk of a crash from an unseen vehicle, which may result in serious injury.

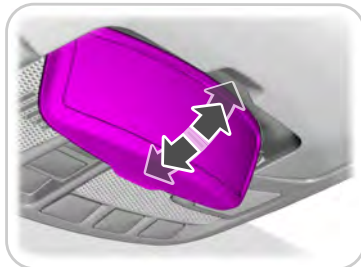
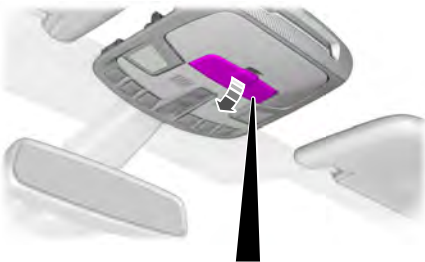

E190497

Pull down the rear edge of the childminder mirror to open. You can adjust the childminder mirror to any position up to full open to aid in visibility.

SUN VISORS

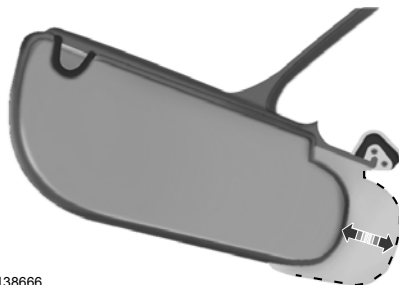

E138666

Rotate the sun visor toward the side window and extend it rearward for extra shade.

Illuminated Vanity Mirror

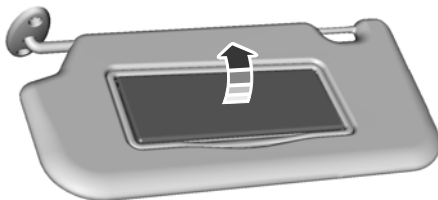

E162197

Lift the cover to switch the lamp on.

MOONROOF- VEHICLES WITH: VISTA ROOF OPENING PANEL



WARNING: Do not let children play with the moonroof or leave them unattended in the vehicle. They may seriously hurt themselves.

Windows and Mirrors



WARNING: When closing the moonroof, you should verify that it is free of obstructions and make sure that children and pets are not in the proximity of the roof opening.

The moonroof controls are located on the overhead console and have a one-touch open and close feature. To stop its movement during one-touch operation, press the control a second time.

Opening and Closing the Moonroof

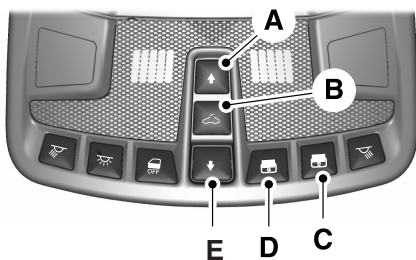

E191272

- A **Moonroof open.** Press and release to open the moonroof. The moonroof stops short of the fully opened position. Press and release the control again to open the moonroof fully.
- B **Moonroof vent.** Press and release to vent the moonroof.
- C **Sunshade open.** Press and release to open the sunshade. The sunshade opens automatically with the moonroof. You can also open the sunshade with the moonroof

closed. **Note:** The sunshade stops short of its fully opened position for the comfort of rear passengers. To open the sunshade fully, press the control again.

- D **Sunshade close.** Press and release to close the sunshade. **Note:** The sunshade does not fully close unless the moonroof glass is fully closed.
- E **Moonroof close.** Press and release to close the moonroof from either the open or vent positions.

Bounce-Back

The moonroof automatically reverses some distance if an obstacle is detected while closing.

To override this feature, press and hold the **moonroof close** control within two seconds after the roof comes to a stop following a bounce-back reversal.

LIFTGATE WINDOW

Opening the Liftgate Window

Note: To avoid vehicle damage, use care when operating the liftgate when the liftgate window is open.

Windows and Mirrors

With the Outside Control Button



E252961

1. Press the release button.
2. Pull the liftgate glass upward.

Instrument Cluster

GAUGES

Type 1 and 2

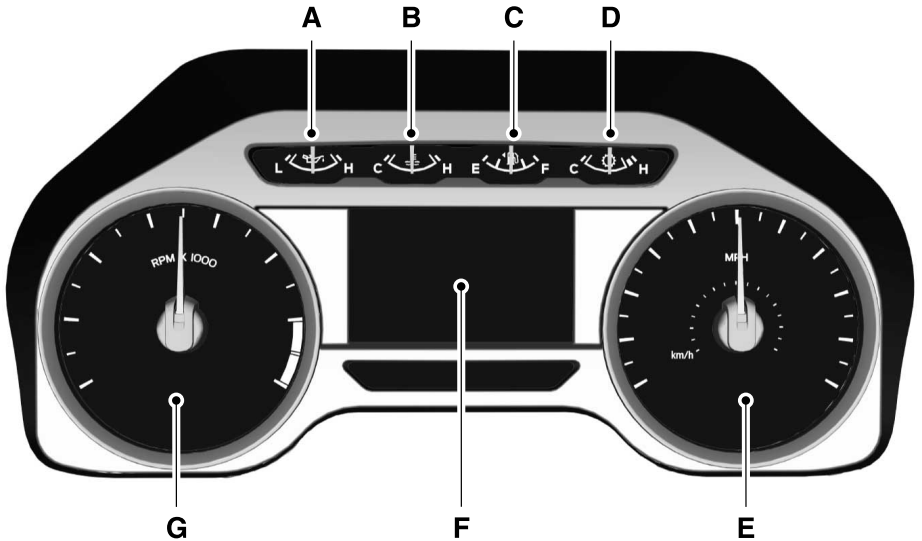

E219638

- A Engine oil pressure gauge.
- B Engine coolant temperature gauge.
- C Fuel gauge.
- D Transmission fluid temperature gauge.

- E Speedometer.
- F Information display. See **General Information** (page 110).
- G Tachometer.

Instrument Cluster

Type 3

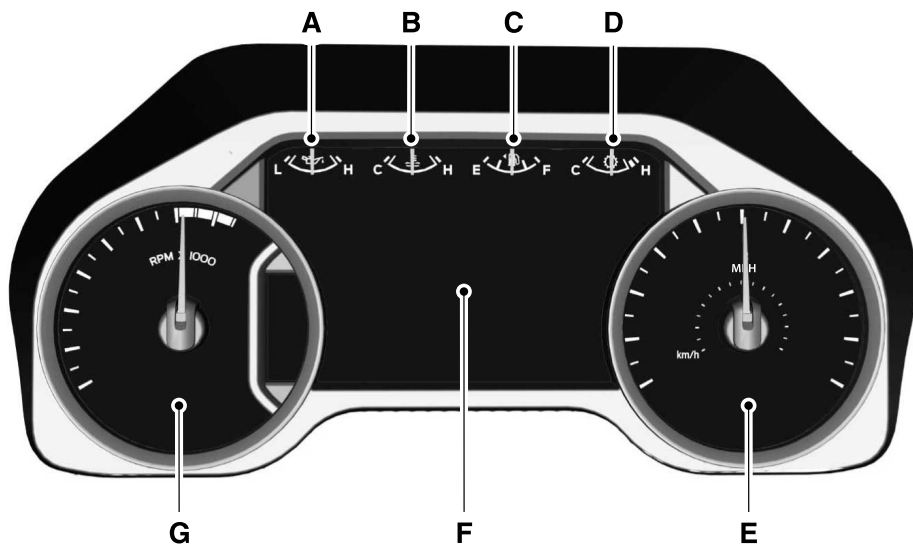

E219651

- A Engine oil pressure gauge.
- B Engine coolant temperature gauge.
- C Fuel gauge.
- D Configurable. Transmission fluid temperature or turbo boost.
- E Speedometer.
- F Information display. See **General Information** (page 110).
- G Tachometer.

Engine Oil Pressure Gauge

Indicates engine oil pressure. At normal operating temperature, the level indicator is in the normal range. If the pressure gauge falls below the normal range, stop your vehicle, switch off the engine and check the engine oil level. Add oil if needed. If the oil level is correct, have your vehicle checked by an authorized dealer.

Instrument Cluster

Engine Coolant Temperature Gauge



WARNING: Do not remove the coolant reservoir cap when the cooling system is hot. Wait 10 minutes for the cooling system to cool down. Cover the coolant reservoir cap with a thick cloth to prevent the possibility of scalding and slowly remove the cap. Failure to follow this instruction could result in personal injury.

Indicates engine coolant temperature. At normal operating temperature, the level indicator is in the normal range. If the engine coolant temperature exceeds the normal range, stop your vehicle as soon as possible, switch off the engine and let the engine cool.

Fuel Gauge

The fuel gauge indicates about how much fuel is in the fuel tank.

The arrow adjacent to the fuel pump symbol indicates on which side of your vehicle the fuel filler door is located.

Note: *The fuel gauge may vary slightly when your vehicle is moving or on a slope.*

Low Fuel Reminder

A low fuel level reminder displays and sounds when the distance to empty reaches 75 mi (120 km) to empty for MyKey, and at 50 mi (80 km), 25 mi (40 km), 10 mi (20 km) and 0 mi (0 km) for all vehicle keys.

Note: *The low fuel reminder can appear at different fuel gauge positions depending on fuel economy conditions. This variation is normal.*

Transmission Fluid Temperature Gauge

Indicates transmission fluid temperature. At normal operating temperature, the level indicator is in the normal range. If the transmission fluid temperature exceeds the normal range, stop your vehicle as soon as possible and verify the airflow is not restricted by snow or debris blocking airflow through the grille.

Special operating conditions such as snowplowing, towing, or off-road use may cause higher than normal operating temperatures. See **Special Operating Conditions Scheduled Maintenance** (page 506).

To lower the transmission temperature into the normal range, alter the severity of your driving conditions. Operating the transmission for extended periods with the gauge in the higher than normal area may cause internal transmission damage. If the gauge continues to show high temperatures, see an authorized dealer.

Turbo Boost Gauge (If Equipped)

Indicates the amount of manifold air pressure in the engine.

WARNING LAMPS AND INDICATORS

The following warning lamps and indicators alert you to a vehicle condition that may become serious. Some lamps illuminate when you start your vehicle to make sure they work. If any lamps remain on after starting your vehicle, refer to the respective system warning lamp for further information.

Note: *Some warning indicators appear in the information display and operate the same as a warning lamp but do not illuminate when you start your vehicle.*

Instrument Cluster

Adaptive Cruise Control Indicator

(If Equipped)



It illuminates when you switch the system on.

It illuminates white when the system is in standby mode. It illuminates green when you set the adaptive cruise speed.

See **Using Adaptive Cruise Control** (page 238).

Airbag Warning Lamp



If it does not illuminate when you switch the ignition on, continues to flash or remains on when the engine is running, this indicates a malfunction. Have your vehicle checked as soon as possible.

Anti-Lock Brake System Warning Lamp



If it illuminates when you are driving, this indicates a malfunction. Your vehicle continues to have normal braking without the anti-lock brake system function. Have your vehicle checked as soon as possible.

Automatic Headlamp High Beam Indicator (If Equipped)



It illuminates when the system automatically turns the headlamp high beam on.

Auto-Start-Stop Indicator (If Equipped)



It illuminates when the engine has automatically stopped. It flashes to inform you when the engine needs to restart. The indicator is shown with a



strikethrough if the system is not available.

See **Auto-Start-Stop** (page 181).

Battery



If it illuminates while driving, it indicates a malfunction. Switch off all unnecessary electrical equipment and have the system checked by your authorized dealer immediately.

Blind Spot Information System Indicator (If Equipped)



It illuminates when you switch the system off.

See **Blind Spot Information System** (page 250).

Brake System Warning Lamp



WARNING: Driving your vehicle with the warning lamp on is dangerous. A significant decrease in braking performance may occur. It may take you longer to stop your vehicle. Have your vehicle checked as soon as possible. Driving extended distances with the parking brake engaged can cause brake failure and the risk of personal injury.



It illuminates when you engage the parking brake and the ignition is on.

If it illuminates when your vehicle is moving, make sure the parking brake is disengaged. If the parking brake is disengaged, this indicates low brake fluid level or a brake system fault. Have your vehicle checked as soon as possible.

Instrument Cluster

Check Fuel Cap (If Equipped)



Illuminates when the fuel cap may not be properly installed. Continued driving with this light on may cause the service engine soon warning indicator to come on.

Cruise Control Indicator (If Equipped)



It illuminates when you switch the system on.

See **Using Cruise Control** (page 237).

Direction Indicator



Illuminates when you switch on the left or right direction indicator or the hazard flashers. Flashes during operation. An increase in the rate of flashing warns of a failed indicator bulb.

Door Ajar Warning Lamp



Displays when the ignition is on and any door is not completely closed.

Electric Park Brake



Illuminates or flashes when the electric parking brake has a malfunction. See **Electric Parking Brake** (page 212).

Electronic Limited Slip Differential (If Equipped)



Illuminates when using the electronic limited slip differential.

Engine Coolant Temperature Warning Lamp



If it illuminates when your vehicle is moving, this indicates that the engine is overheating. Stop your vehicle as soon as it is safe to do so and switch the engine off. Have your vehicle checked as soon as possible.

Fasten Seatbelt Warning Lamp



It illuminates and a chime sounds until you fasten the seatbelts.

Four-Wheel Drive Indicators (If Equipped)

Note: Some indicators will appear different depending on vehicle options.



Illuminates momentarily when you select two-wheel drive high.



Illuminates when the automatic four-wheel drive system is engaged.



Illuminates when four-wheel drive low is engaged.



Illuminates when four-wheel drive high is engaged.

Front Fog Lamp Indicator



It illuminates when you switch the front fog lamps on.

Headlamp High Beam Indicator



It illuminates when you switch the headlamp high beam on.

Instrument Cluster

Hill Descent (if Equipped)



Illuminates when hill descent is switched on.

Hood Ajar



Displays when the ignition is on and the hood is not completely closed.

Liftgate Ajar Warning Lamp



It illuminates when you switch the ignition on and remains on if the liftgate is open.

Low Fuel Level Warning Lamp



If it illuminates when you are driving, refuel as soon as possible.

Low Tire Pressure Warning Lamp



Illuminates when your tire pressure is low. If the lamp remains on with the engine running or when driving, check your tire pressure as soon as possible.

It also illuminates momentarily when you switch the ignition on to confirm the lamp is functional. If it does not illuminate when you switch the ignition on, or begins to flash at any time, have the system checked by your authorized dealer.

Oil Pressure Warning Lamp



It illuminates when you switch the ignition on.

If it illuminates when the engine is running this indicates a malfunction. Stop your vehicle as soon as it is safe to do so and switch the engine off. Check the engine oil level. If the oil level is sufficient, this indicates a system malfunction. Have your vehicle checked as soon as possible.

See **Engine Oil Check** (page 328).

Powertrain Malfunction/Reduced Power/Electronic Throttle Control



Illuminates when a powertrain or a 4WD fault has been detected. Have your vehicle checked as soon as possible.

Service Engine Soon



If it illuminates when the engine is running this indicates a malfunction. The On Board Diagnostics system has detected a malfunction of the vehicle emission control system.

If it flashes, engine misfire may be occurring. Increased exhaust gas temperatures could damage the catalytic converter or other vehicle components. Drive in a moderate fashion (avoid heavy acceleration and deceleration) and have your vehicle immediately serviced.

It illuminates when you switch the ignition on prior to engine start to check the bulb and to indicate whether your vehicle is ready for Inspection and Maintenance (I/M) testing.

Normally, it illuminates until the engine is cranked and automatically turns off if no malfunctions are present. However, if after 15 seconds it flashes eight times, this indicates that your vehicle is not ready for Inspection and Maintenance (I/M) testing.

See **Catalytic Converter** (page 192).

Instrument Cluster

Stability Control and Traction Control Indicator



Flashes during operation.

If it does not illuminate when you switch the ignition on, or remains on when the engine is running, this indicates a malfunction. Have your vehicle checked as soon as possible.

Note: *The system automatically turns off if there is a malfunction.*

See **Using Stability Control** (page 217).

Stability Control and Traction Control Off Warning Lamp



It illuminates when you switch the system off.

Tow Haul Indicator



Illuminates when the tow/haul feature has been activated. If the light flashes steadily, have the system serviced immediately, damage to the transmission could occur.

AUDIBLE WARNINGS AND INDICATORS

Key in Ignition Warning Chime

Sounds when you leave the key in the ignition and the driver door open.

Headlamps On Warning Chime

Sounds when the headlamps or parking lamps are on, the ignition is off (the key is not in the ignition) and the driver door is open.

Parking Brake On Warning Chime

Sounds when you have left the parking brake on and drive your vehicle. If the warning chime remains on after you have released the parking brake, have the system checked by an authorized dealer immediately.

Direction Indicator Chime

Sounds when you leave the direction indicator on after signaling a turn and driving the vehicle more than 1.5 miles (2.4 km).

Information Displays

GENERAL INFORMATION



WARNING: Driving while distracted can result in loss of vehicle control, crash and injury. We strongly recommend that you use extreme caution when using any device that may take your focus off the road. Your primary responsibility is the safe operation of your vehicle. We recommend against the use of any hand-held device while driving and encourage the use of voice-operated systems when possible. Make sure you are aware of all applicable local laws that may affect the use of electronic devices while driving.

Various systems on your vehicle can be controlled using the information display controls on the steering wheel. Corresponding information is displayed in the information display.

Note: *Some options may appear slightly different or not at all if the items are optional.*

Type 1

Main Menu
Trip 1
Trip 2
Fuel Economy
Driver Assist
Settings

Note: *Trailer options are not available if your vehicle speed is greater than 3 mph (5 km/h).*

Note: *Some MyKey menu options only appear if MyKey is enabled and at least one MyKey is programmed.*



This icon gives you the ability to switch a feature on or off. A check in the box indicates the feature is on, and unchecked indicates the feature is off.

Information Display Controls (Type 1 and 2)

- Press the up and down arrow buttons to scroll through and highlight the options within a menu.
- Press the right arrow button to enter a sub-menu.
- Press the left arrow button to exit a menu.
- Press the **OK** button to choose and confirm a setting or messages.

Information Displays

Trip 1
Digital Speed
Trip Odometer
Trip Timer
DTE
Average Fuel
Outside Temp

- Digital Speed - Shows a digital display of your vehicle speed.
- Trip Odometer - Registers the distance of individual trips.
- Trip Timer - Registers the time of individual trips.
- DTE - Shows the approximate distance your vehicle can travel before running out of fuel.
- Average Fuel - Shows the average fuel economy for a given trip.
- **Outside Temp** - Shows the outside air temperature.

Note: Press and hold **OK** to reset values.

Note: **Trip 2** information is the same as **Trip 1**.

Fuel Economy
Distance to E
Instant Fuel Economy
Average Fuel Economy
Average Speed
Auto StartStop

- Distance to E - Shows the approximate distance your vehicle can travel before running out of fuel.
- Instant Fuel Economy - Shows your instantaneous fuel usage.
- Average Fuel Economy - Shows the average fuel usage based on time.
- Average Speed - Shows the average speed the vehicle has driven.
- **Auto StartStop** - Shows the Auto StartStop status.

Note: Press and hold **OK** to reset values.

Information Displays

Driver Assist	
Prog Range Sel	
Engine Hours	Engine Hours
	Engine Idle
Hill Strt Asst.	
Park Lock	
Tire Pressure	Enter the submenu and select your setting
Trans. Temp.	Enter the submenu and select your setting
Rear Park Aid	
Brake Type ¹	Enter the submenu and select your setting
Brake Effort ¹	
Trailer Sway	

¹Trailer setting.

Settings		
Vehicle	DTE Calculate	Enter the submenu and select your setting
	Lighting	
	Locks	
	Neutral Tow	
	Oil Life Reset	
	Remote Start	
	Windows	
	Wiper Controls	
MyKey	MyKey Status	Enter the submenu and select your setting
	Create MyKey	
	911 Assist	

Information Displays

Settings		
	Do Not Disturb	
	AdvanceTrac	
	Max Speed	
	Speed Minder	
	Vol. Limiter	
	Clear MyKeys	Enter the submenu and select your setting
Display Setup	Units	Enter the submenu and select your setting
	Temperature	
	Tire Pressure	
	Language	

Type 2

Main Menu
Display Mode
Trip/Fuel
Towing
Off Road
Settings

Display Mode
Distance to Empty
Tire Pressure
Digital Speedometer

Information Displays

Display Mode
Engine Information
Transmission Temp.

- **Distance to Empty** - Shows the approximate distance your vehicle can travel before running out of fuel.
- **Tire Pressure** - Shows the tire pressure in your specified unit.
- **Digital Speedometer** - Shows a digital display of your vehicle speed.
- **Engine Information** - Shows engine hours, engine idle hours and oil temperature.
- **Transmission Temp.** - Shows the transmission temperature value.

Trip/Fuel	
Trip 1	
Trip 2	
Fuel Economy	
Fuel History	
Compass	Enter the submenu and select your setting
Average Speed	
Auto StartStop	

Trip 1 or 2

- Shows the time, distance and average fuel economy of an individual journey. Also shows DTE.

Fuel

- Fuel Economy - Shows your instantaneous fuel usage as a bar graph, average fuel economy and DTE.
- Fuel History - Shows your fuel usage based on time. The graph is updated each minute with the fuel economy that you achieved during 30 minutes of driving. Also shows DTE.

Auto StartStop

- Shows the **Auto StartStop** status.

Note: Press and hold **OK** to reset values.

Note: Once you select a trailer, it remains active until you set it as no longer active. An active trailer still accumulates miles even after you physically disconnect it from your vehicle.

Information Displays

Towing		
Trailer Status	Trailer Status	
	Trailer Light Check	
Trailer Options	Trailer Sway Control	
	Select Trailer	Enter the submenu and select your setting
	Change Trailer Settings	
	Add Trailer	
Connection Checklist		

Off Road
Off Road Status
Power Distribution

Off Road Status - Displays pitch, steering angle and roll.

Power Distribution - Displays a graphic of the power distribution between the front and rear wheels.

Settings		
Blind Spot		
Cross Traffic Alert		
DTE Calculation	Enter the submenu and select your setting	
Rear Park Aid		
Trailer Blind Spot		
Advanced Settings	Vehicle	Auto Engine Off
		Easy Entry/Exit
		Lighting
		Locks
		Mirrors
		Neutral Tow

Information Displays

Settings		
		Oil Life Reset
		Power Liftgate
		Remote Start
		Windows
		Wiper Controls
	MyKey	Enter the submenu and select your setting
	Display Setup	Units
		Temperature
		Tire Pressure
		Language

Information Displays

Information Display Controls (Type 3) (If Equipped)



- Press the up and down arrow buttons to scroll through and highlight the options within a menu.
- Press the right arrow button to enter a sub-menu.
- Press the left arrow button to exit a menu.
- Press the **OK** button to choose and confirm a setting or messages.



E219639

Type 3

Main Menu
MyView
Trip/Fuel
Vehicle Info
Towing
Off Road
Settings

Information Displays

MyView		
Trip 1		
Fuel Economy		
Tire Pressure		
Off Road Status		
Configure MyView	Add/Remove Screens	Enter the submenu for Trip, Fuel, Tire pressure, and Off Road selections
	Reorder Screens	Enter the submenu and select your setting

- Trip 1/2 - Shows your trip timer, fuel used, trip odometer and average fuel economy.
- Fuel Economy - Shows your instantaneous fuel usage and average fuel economy.
- Tire Pressure - Shows your car outline with tire pressure values.
- Off Road Status - Shows your pitch and roll screen.

Trip/Fuel	
Trip 1	Enter the submenu for items such as trip timer, DTE, odometer and avg fuel economy
Trip 2	Enter the submenu for items such as trip timer, DTE, odometer and avg fuel economy
Fuel Economy	Enter the submenu and select your setting
Fuel History	
Average Speed	
Navigation/Compass	

Information Displays

Trip/Fuel	
Compass	
Auto Start/Stop	

Trip 1 or 2

- Trip Timer - Registers the time of individual journeys.
- DTE - Shows the approximate distance your vehicle can travel before running out of fuel.
- Odo - Registers the distance of individual journeys.
- Avg - Shows the average fuel economy for a given trip.

Fuel

- Fuel Economy - Shows your instantaneous fuel usage as a bar graph and average fuel economy.
- Fuel History - Shows your fuel usage based on time. The graph is updated each minute with the fuel economy that you achieved during 30 minutes of driving.

Navigation/Compass

- Navigation - Shows navigation turn by turn (Compass displayed when a route in Navigation is not set).

Auto Start/Stop

- Shows the **Auto Start/Stop** status.

Vehicle Info
Gauge View
Tire Pressure
Digital Speedometer
Engine Information
Transmission Temp

- **Gauge View** - Allows you to select between either **Turbo Boost** or **Transmission Temp** gauge.
- **Tire Pressure** - Shows the tire pressure. See **Tire Pressure Monitoring System** (page 369).
- **Digital Speedometer** - Shows a digital display of your vehicle speed.
- **Engine Information** - Shows engine hours, engine idle hours and oil temperature.
- **Transmission Temp** - Shows the transmission temperature value.

Information Displays

Note: Once you select a trailer, it remains active until you set it as no longer active. An active trailer still accumulates miles even after you physically disconnect it from your vehicle.

Towing		
Towing Status	% Grade, steering angle, gain and output display	
Trailer Information	Trailer Name, Accumulated Distance, Pro Trailer Backup Assist™ Status, Trailer BLIS Status and Trailer Blind Spot	
Trailer Light Check	Provides status of the brake, park and direction indicator light for the active trailer.	
Trailer Setup	Trailer Sway Control	
	Select trailer	Enter the submenu and select your setting
	Change Trailer Settings	
	Add Trailer	
Connection Checklist		

Off Road
Off Road Status
Power Distribution

Off Road Status - Displays pitch, steering angle and roll.

Power Distribution - Displays a graphic of the power distribution between the front and rear wheels.

Settings
Blind Spot
Cross Traffic Alert
Driver Alert
Rear Park Aid
Trailer Blind Spot

Information Displays

Settings			
Pre-Collision	Enter the submenu for items such as alert sensitivity, distance indication and active braking		
Cruise Control	Enter the submenu and select your setting		
DTE Calculation	Enter the submenu and select your setting		
Lane Keeping System	Enter the submenu for items such as system modes and alert intensity		
Advanced Settings	Vehicle	Auto Engine Off	
		Easy Entry/Exit	
		Lighting	
		Locks	
		Mirrors	
		Neutral Tow	
		Oil Life Reset	
		Alarm	
		Power Liftgate	
		Power Running Boards	
		Remote Start	
		Windows	
	Wiper Controls		
		MyKey	Enter the submenu and select your setting
		Display Setup	Units
	Temperature		
	Tire Pressure		
	Language		

Information Displays

INFORMATION MESSAGES

Note: Depending on your vehicle options and instrument cluster type, not all of the messages will display or be available. The information display may abbreviate or shorten certain messages.

Press the **OK** button to acknowledge and remove some messages from the information display. The information display will automatically remove other messages after a short time.

You need to confirm certain messages before you can access the menus.



E184451

Active Park

Message	Action
Active Park Fault	The system requires service due to a malfunction. Have the system checked by an authorized dealer.

Adaptive Cruise Control

Message	Action
Adaptive Cruise Malfunction	A radar malfunction is preventing the adaptive cruise control from engaging. See Using Cruise Control (page 237).
Adaptive Cruise Not Available	A condition exists such that the adaptive cruise cannot function properly. See Using Cruise Control (page 237).
Adaptive Cruise Not Available Sensor Blocked See Manual	You have a blocked sensor due to bad weather, ice, mud or water in front of the radar sensor. You can typically clean the sensor to resolve. See Using Cruise Control (page 237).
Normal Cruise Active Adaptive Braking Off	The system has disabled the automatic braking.
Front Sensor Not Aligned	A radar malfunction is preventing the adaptive cruise control from engaging.

Information Displays

Message	Action
Adaptive Cruise - Driver Resume Control	The adaptive cruise has reinstated controls to the driver.
Adaptive Cruise Speed Too Low to Activate	Your vehicle speed is too slow to activate the adaptive cruise.
Adaptive Cruise Shift Down	The adaptive cruise is automatically adjusting the gap distance and you need to shift the transmission into a lower gear.

AdvanceTrac and Traction Control

Message	Action
Service AdvanceTrac	The system detects a condition that requires service. Contact an authorized dealer as soon as possible.
AdvanceTrac Off	The status of the AdvanceTrac system after you switched it off.
AdvanceTrac On	The status of the AdvanceTrac system after you switched it on.
AdvanceTrac SPORT MODE	The status of the AdvanceTrac sport mode after you switched it on.
Traction Control Off	The status of the traction control system after you switched it off. See Using Traction Control (page 215).
Traction Control On	The status of the traction control system after you switched it on. See Using Traction Control (page 215).

Airbag

Message	Action
Occupant Sensor BLOCKED Remove Objects Near Passenger Seat	Displays when the system detects a malfunction due to a blocked sensor.

Information Displays

Alarm and Security

Message	Action
Vehicle Alarm To Stop Alarm, Start Vehicle.	Alarm triggered due to unauthorized entry. See Anti-Theft Alarm (page 80).

Automatic Engine Shutdown

Message	Action
Engine Shuts Off In {seconds to shut off:#0} Seconds	The engine is getting ready to shut off.
Engine Shut Off For Fuel Economy	The engine has shut off to help increase fuel economy.
Engine Shuts Off in {seconds to shut off:#0} Seconds Press Ok to Override	The engine is getting ready to shut off. You can press OK on the left steering wheel button to override the shut down.

Battery and Charging System

Message	Action
Check Charging System	The charging system needs servicing. If the warning stays on or continues to come on, contact an authorized dealer as soon as possible.
Low Battery Features Temporarily Turned Off	The battery management system detects an extended low-voltage condition. Your vehicle will disable various features to help preserve the battery. Turn off as many of the electrical loads as soon as possible to improve system voltage. If the system voltage has recovered, the disabled features will operate again as normal.
Turn Power Off To Save Battery	The battery management system determines that the battery is at a low state of charge. Turn your ignition off as soon as possible to protect the battery. This message will clear once you restart your vehicle and the battery state of charge has recovered. Turning off unnecessary electrical loads will allow faster battery state-of-charge recovery.

Information Displays

Blind Spot Information and Cross Traffic Alert System

Message	Action
Blindspot System Fault	A fault with the system has occurred. Contact an authorized dealer as soon as possible.
Blindspot Not Available Sensor Blocked See Manual	The system sensors are blocked. See Blind Spot Information System (page 250).
Vehicle Coming From X	The system detects a vehicle. See Blind Spot Information System (page 250).
Cross Traffic Not Available Sensor Blocked See Manual	The blind spot information system and cross traffic alert system sensors are blocked. See Blind Spot Information System (page 250).
Cross Traffic System Fault	A fault with the system has occurred. Contact an authorized dealer as soon as possible.
Cross Traffic Alert Deactivated Trailer Attached	The system automatically turns off and displays this message when you connect a trailer to the vehicle that does not have a trailer blind spot system or when you switch the trailer blind spot system off through the information display. See Blind Spot Information System (page 250).
Blind Spot Alert Deactivated Trailer Attached	The system automatically turns off and displays this message when you connect a trailer to the vehicle that does not have a trailer blind spot system or when you switch the trailer blind spot system off through the information display. See Blind Spot Information System (page 250).
Trailer Blind Spot Not available Due to Invalid Trailer	Displays when the trailer connected is a fifth wheel or goose-neck, or when the trailer width is wider than 10 ft (2.7 m) or longer than 33 ft (10 m).

Information Displays

Collision Warning System

Message	Action
Collision Warning Malfunction	A fault with the system has occurred. Contact an authorized dealer as soon as possible.
Collision Warning Not Available Sensor Blocked See Manual	You have a blocked sensor due to bad weather, ice, mud or water in front of the radar sensor. You can typically clean the sensor to resolve.
Collision Warning Not Available	A fault with the system has occurred. Contact an authorized dealer as soon as possible.

Doors and Locks

Message	Action
X Door Ajar	The door(s) listed is not completely closed.

Driver Alert

Message	Action
Driver Alert Warning Rest Now	Stop and rest as soon as it is safe to do so.
Driver Alert Warning Rest Suggested	Take a rest soon.

Drivetrain

Message	Action
Check Electronic Limited Slip Differential	Displays if the electronic limited slip differential system encounters a hardware failure. Have your vehicle checked as soon as possible.
Electronic Limited Slip Differential Off See Owner's Manual	Displays if an electronic limited slip differential system fault is present. Have your vehicle checked as soon as possible.
Electronic Limited Slip Differential Restored to Normal	Displays when the electronic limited slip differential system resumes normal function.

Information Displays

Message	Action
Electronic Limited Slip Differential Temporarily Disabled	Displays if the electronic limited slip differential system temporarily turns off due to overheating or an undersized spare tire. If an undersized spare tire is installed, replace the spare tire with a full-sized tire as soon as possible. If not, stop the vehicle in a safe location and allow the system to cool.
Electronic Limited Slip Differential Reduced Torque	Displays if the electronic limited slip differential has limited functionality. This could be due to an undersized spare tire or caused by the system overheating. If an undersized spare tire is installed, replace the spare tire with a full-sized tire as soon as possible. If an undersized spare tire is not installed, the vehicle has reduced functionality. Have your vehicle checked as soon as possible.
Electronic Limited Slip Differential Locking Feature Not Available	Displays when you select a drive mode that does not allow the electronic limited slip differential to turn on. This may also display when the electronic limited slip differential has a fault and the vehicle requests the locking feature.
Neutral Tow Enabled Leave Transmission in Neutral	The transfer case is in the neutral position. This message indicates that your vehicle is safe to be towed with all four wheels on the ground.
Neutral Tow Disabled	The transfer case is NOT in the neutral position. This message indicates that your vehicle is NOT safe to be towed with all four wheels on the ground.

Engine

Message	Action
Power Reduced to Lower Engine Temp	The engine has reduced power to help reduce high engine temperature.

Four-Wheel Drive

Message	Action
Check 4x4	A 4X4 system fault is present. Contact an authorized dealer as soon as possible.
4x4 Shift in Progress	The 4X4 system is making a shift.
For 4x4 LOW Shift to N	Displays when you attempt to switch to 4X4 LOW and you do not shift the transmission to neutral (N).

Information Displays

Message	Action
For 4x4 LOW Slow to 3 MPH	Displays when you attempt to switch to 4X4 LOW and your vehicle's speed is greater than 3 mph (5 km/h).
To Exit 4x4 LOW Shift to N	Displays when you attempt to switch from 4X4 LOW and you do not shift the transmission to neutral (N).
To Exit 4x4 LOW Slow to 3 MPH	Displays when you attempt to switch from 4X4 LOW and your vehicle's speed is greater than 3 mph (5 km/h).
Shift Delayed Pull Forward	May display when there is a transfer case gear tooth blockage while shifting to or from 4L or to the neutral state.
4x4 Temporarily Disabled	Displays when the system turns off the clutch due to excessive stress. The system automatically turns on the clutch after it cools.
4x4 Restored	Displays when the 4X4 system has been restored to its original setting.
4x4 Temporarily Locked	Displays when the 4X4 system temporarily turns on 4H from 4A after detecting driving conditions that require greater 4X4 performance. The system automatically returns to 4A after the system no longer detects these driving conditions.

Fuel

Message	Action
Fuel Level Low	An early reminder of a low fuel condition.
Check Fuel Fill Inlet	The fuel fill inlet may not be properly closed.

Information Displays

Keys and Intelligent Access

Message	Action
To START Press Brake	A reminder to press the brake while starting the vehicle.
No Key Detected	The system does not detect a key in your vehicle. See Keyless Starting (page 176).
Restart Now or Key is Needed	You pressed the StartStop button to switch off the engine and your vehicle does not detect your intelligent access key inside your vehicle.
Full Accessory Power Active	Your vehicle is in the run ignition state.
Starting System Fault	There is a problem with your vehicle's starting system. See an authorized dealer for service.
Key Program Successful	You have successfully programmed an intelligent access key to the system.
Key Program Failure	You have failed to program an intelligent access key to the system.
Max Number of Keys Learned	You have programmed the maximum number of keys to the system.
Not Enough Keys Learned	You have not programmed enough keys to the system.
Engine ON	Informs you that you are exiting your vehicle and the engine is on.

Information Displays

Lane Keeping System

Message	Action
Lane Keeping Sys. Malfunction Service Required	The system has malfunctioned. Contact an authorized dealer as soon as possible.
Front Camera Temporarily Not Available	The system has detected a condition that has caused the system to be temporarily unavailable.
Front Camera Low Visibility Clean Screen	The system has detected a condition that requires you to clean the windshield in order for it to operate properly.
Front Camera Malfunction Service Required	The system has malfunctioned. Contact an authorized dealer as soon as possible.
Keep Hands on Steering Wheel	The system requests you to keep your hands on the steering wheel.

Maintenance

Message	Action
Low Engine Oil Pressure	Stop your vehicle as soon as safely possible and turn off the engine. Check the oil level. If the warning stays on or continues to come on with your engine running, contact an authorized dealer as soon as possible.
Change Engine Oil Soon	The engine oil life remaining is 10% or less. See General Maintenance Information (page 500).
Oil Change Required	The oil life left is at 0%. See General Maintenance Information (page 500).
Brake Fluid Level Low	The brake fluid level is low, inspected the brake system immediately. See Brake Fluid Check (page 335).
Check Brake System	The brake system needs servicing. Stop your vehicle in a safe place. Contact an authorized dealer.
Transport / Factory Mode Contact Dealer	Your vehicle is still in Transport or Factory mode. This may not allow some features to operate properly. See an authorized dealer.
See Manual	The powertrain needs service due to a powertrain malfunction.

Information Displays

MyKey

Message	Action
MyKey not Created	You did not program a MyKey.
MyKey Active Drive Safely	MyKey is active.
Speed Limited to XX MPH/km/h	When switching on your vehicle and MyKey is in use, displays that the MyKey speed limit is on.
Near Vehicle Top Speed	MyKey is in use and the MyKey speed limit is on and the vehicle speed is approaching 81 mph (130 km/h).
Vehicle at Top Speed of MyKey Setting	You have reached the speed limit set for your MyKey.
Check Speed Drive Safely	You have an active MyKey with a programmed set speed limit.
Buckle Up to Unmute Audio	Belt-Minder turns on with a MyKey in use.
AdvanceTrac On - MyKey Setting	With a MyKey in use, AdvanceTrac turns on.
Traction Control On - MyKey Setting	With a MyKey in use, traction control turns on.
MyKey Park Aid Cannot be Deactivated	With a MyKey in use, park aid is always on.
Lane Keeping Alert On MyKey Setting	With a MyKey in use, lane keeping alert turns on.

Off Road

Message	Action
Hill Descent Control Active	Hill descent control mode is active.
Hill Descent Control OFF	Hill descent control mode is inactive.
For Hill Descent Reduce Speed XX MPH/km/h or Less	Your vehicle speed requirement for off-road mode entry has not been met.
For Hill Descent Select Gear	You need to select a transmission gear for hill descent mode.

Information Displays

Message	Action
Hill Descent Driver Resume Control	Hill descent control mode is deactivated and you must resume control.
Hill Descent Control Fault	A hill descent system fault is present.
Hill Descent Control Off System Cooling	The hill descent system is cooling due to overuse.
Hill Descent Control Ready	The hill descent control system is ready.

Park Aid

Message	Action
Check Front Park Aid	The system has detected a condition that requires service. Contact an authorized dealer. See Rear Parking Aid (page 222).
Check Rear Park Aid	The system has detected a condition that requires service. Contact an authorized dealer. See Rear Parking Aid (page 222).
Front Park Aid On Off	Displays the park aid status.
Rear Park Aid On Off	Displays the park aid status.
Front Park Aid Not Available Sensor Blocked See Manual	Displays if the front park aid sensor is blocked.
Rear Park Aid Not Available Sensor Blocked See Manual	Displays if the rear park aid sensor is blocked.
Park Aid Not Available Sensor Blocked See Manual	Displays if the park aid sensor is blocked.

Information Displays

Park Brake

Message	Action
To Release: Press Brake and Switch	The electric parking brake is set and a manual release is attempted without the brake pedal being pressed.
Park Brake Use Switch to Release	The electric park brake is set and an automatic release is attempted but cannot be performed. Perform a manual release.
Release Park Brake	The electric park brake is set and your vehicle speed exceeds 3 mph (5 km/h). Release park brake before continued driving.
Park Brake Not Applied	The electric park brake is not fully applied.
Park Brake Not Released	The electric park brake is not fully released.
Park Brake Maintenance Mode	The electric park brake system has been put into a special mode that is used to allow service of the rear brakes. Contact an authorized dealer.
Park Brake Limited Function Service Required	The electric park brake system has detected a condition that requires service. Some functionality may still be available. Contact an authorized dealer.
Park Brake Malfunction Service Now	The electric park brake system has detected a condition that requires service. Contact an authorized dealer.

Power Steering

Message	Action
Steering Fault Service Now	The power steering system has detected a condition that requires service. See an authorized dealer.
Steering Loss Stop Safely	The power steering system is not working. Stop your vehicle in a safe place. Contact an authorized dealer.
Steering Assist Fault Service Required	The power steering system has detected a condition within the power steering system or passive entry or passive start system requires service. Contact an authorized dealer.
Steering Lock Malfunction Service Now	The steering lock system has detected a condition that requires service. See an authorized dealer.

Information Displays

Pro Trailer Backup Assist™

Message	Action
Pro Trailer Backup Assist™ Not Active Stop Vehicle to Activate	Pro Trailer Backup Assist™ can only be activated when the vehicle is stopped.
Pro Trailer Backup Assist™ Locating Sticker Please wait... Press Knob to Exit	Camera System is locating the sticker. Wait until the sticker is found before attempting to use Pro Trailer Backup Assist.
Pro Trailer Backup Assist™ Stop now Maximum trailer angle Press Knob to Exit	Stop Now. Pro Trailer Backup Assist™ has reached max trailer angle.
Pro Trailer Backup Assist™ Stop Now Take Control of Steering Wheel	Stop Now. Pro Trailer Backup Assist™ is no longer controlling steering.
Pro Trailer Backup Assist™ Reduce Speed Turn Knob to Steer Press Knob to Exit	Slow vehicle speed. Vehicle is approaching the exit speed for the Pro Trailer Backup Assist™ feature.
Pro Trailer Backup Assist™ System is Not Available	Conditions for Pro Trailer Backup Assist™ operation are not met. See Trailer Reversing Aids (page 276).
Pro Trailer Backup Assist™ Remove Hands from Steering Wheel to Activate Press Knob to Exit	Pro Trailer Backup Assist™ cannot operate with hands on wheel. Remove hands to activate.
Pro Trailer Backup Assist™ Cancelled by Driver Take Control of Steering Wheel	Pro Trailer Backup Assist™ knob has been pushed to deactivate the system.
Pro Trailer Backup Assist™ Shift to Reverse to Activate. Press Knob to Exit	Pro Trailer Backup Assist operation is only available in reverse gear. Shift gear selector into reverse to activate.
Pro Trailer Backup Assist™ Sticker Not Found Shift to Park Press Knob to Exit	Camera system cannot locate sticker. Shift to park.

Information Displays

Message	Action
Pro Trailer Backup Assist™ Sticker Not Found Refer to Owner's Manual. Press Knob to Exit	Camera system cannot locate sticker. See Trailer Reversing Aids (page 276).
Pro Trailer Backup Assist™ Drive Straight Forward to Calib- rate. Press Knob to Exit	Drive between 4–24 mph (6–39 km/h) straight forward to calibrate Pro Trailer Backup Assist™.
Pro Trailer Backup Assist™ Calibration Complete Stop Vehicle	The system has completed calibration. Stop the vehicle to use Pro Trailer Backup Assist™ feature.

Remote Start

Message	Action
To Drive: Press Brake and Gear Shift Button	A reminder to apply the brake and push the gearshift button to drive your vehicle after a remote start.

Seats

Message	Action
Memory Recall Not Permitted While Driving	A reminder that memory seats are not available while driving.
Memory {0} Saved	Shows where you have saved your memory setting.

Starting System

Message	Action
To START Press Brake	A reminder to apply the brake when starting your vehicle .
Cranking Time Exceeded	The starter has exceeded its cranking time in attempting to start your vehicle.
Engine Start Pending Please Wait	The starter is attempting to start your vehicle.
Pending Start Cancelled	The system has cancelled the pending start.

Information Displays

Tire Pressure Monitoring System

Message	Action
Tire Pressure Low	One or more tires on your vehicle has low tire pressure. See Tire Pressure Monitoring System (page 369).
Tire Pressure Monitor Fault	The tire pressure monitoring system is malfunctioning. If the warning stays on or continues to come on, contact an authorized dealer. See Tire Pressure Monitoring System (page 369).
Tire Pressure Sensor Fault	A tire pressure sensor is malfunctioning or your spare tire is in use. See Tire Pressure Monitoring System (page 369). If the warning stays on or continues to come on, contact an authorized dealer as soon as possible.

Trailer

Message	Action
Trailer Brake Gain: {trailer gain value:#0.0}	The current gain setting for the trailer brake.
Trailer Brake Gain: {trailer gain value:#0.0} No Trailer	The current gain setting for the trailer brake when a trailer is not connected.
Trailer Brake Module Fault	Faults sensed in the Integrated Trailer Brake Control Module followed by a single chime. See Towing a Trailer (page 275).
Trailer Connected	A correct trailer connection is sensed during a given ignition cycle.
Trailer Disconnected	A trailer connection becomes disconnected, either intentionally or unintentionally, and has been sensed during a given ignition cycle.
Trailer Sway Reduce Speed	The trailer sway control has detected trailer sway.
Trailer Wiring Fault	There are certain faults in your vehicle wiring and trailer wiring/brake system. See Towing a Trailer (page 275).
Trailer Left Turn Lamps Fault Check Lamps	There is a fault with your trailer turn lamp. Check your lamp.
Trailer Right Turn Lamps Fault Check Lamps	There is a fault with your trailer turn lamp. Check your lamp.

Information Displays

Message	Action
Trailer Battery Not Charging See Manual	There is a fault with your trailer battery. See Towing a Trailer (page 275).
Trailer Lighting Module Fault See Manual	There is a fault with your vehicle trailer lighting module. See Towing a Trailer (page 275).
Trailer Tire Low Specified:	One or more tires on your trailer is below the specified tire pressure.
Trailer Tire Pressure Sensor Fault	A trailer tire pressure sensor is malfunctioning. If the warning stays on or continues to come on, contact an authorized dealer as soon as possible.
Trailer Tire Pressure Monitor Fault	The trailer tire pressure monitoring system is malfunctioning. If the warning stays on or continues to come on, contact an authorized dealer.
Trailer Tire Pressure Monitor Capability Not Detected	The system cannot detect the trailer tire pressure monitoring system.
Trailer Tire Pressure Indication Not Setup See Manual	The trailer tire pressure monitoring system is not setup. See General Information (page 110).

Transmission

Message	Action
Transmission Not in Park	A reminder to shift into park.

Climate Control

MANUAL CLIMATE CONTROL

Directing Air to the Instrument Panel Air Vents



Press and release the button to direct airflow to instrument panel air vents.

Directing Air to the Footwell Air Vents



Press and release the button to direct airflow to footwell air vents.

Setting the Blower Motor Speed

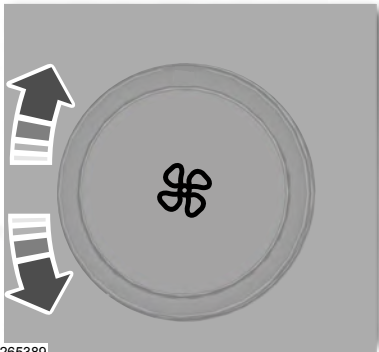

Turn the control to adjust the volume of air circulated in the vehicle.

Setting the Temperature

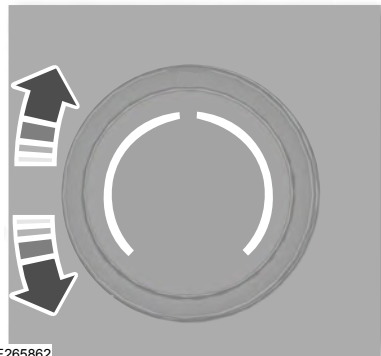

Turn the control to set the temperature.

Switching the Air Conditioning On and Off



Press and release the button.

Use air conditioning with recirculated air to improve cooling performance and efficiency.

Note: *In certain conditions (for example, maximum defrost) the air conditioning compressor may continue to operate even though you switch off the air conditioning.*

Switching the Climate Control On and Off



Press and release the button.

Switching Defrost On and Off



Press and release the button to distribute air through the windshield air vents and de-mister.

Climate Control

Air directed to the instrument panel and footwell air vents turns off. You can also use this setting to defog and clear the windshield of a thin covering of ice.

Switching Maximum Air Conditioning On and Off



Turn the temperature control counterclockwise to the lowest setting for maximum cooling.

The left-hand and right-hand settings set to LO, recirculated air flows through the instrument panel air vents, air conditioning turns on and the blower motor adjusts to the highest speed.

Switching Maximum Defrost On and Off



Turn the temperature control clockwise to the highest setting for maximum defrosting.

The left-hand and right-hand settings set to HI, air flows through the windshield air vents, and the blower motor adjusts to the highest speed.

You can also use this setting to defog and clear the windshield of a thin covering of ice.

Note: To prevent window fogging, you cannot select recirculated air when maximum defrost is on.

Note: The heated rear window also turns on when you select maximum defrost.

Switching Recirculated Air On and Off



Press and release the button to switch between outside air and recirculated air.

The air currently in the passenger compartment recirculates. This may reduce the time needed to cool the interior (when used with **A/C**) and reduce unwanted odors from entering your vehicle.

Note: Recirculated air may turn off (or prevent you from switching on) in all air flow modes except **MAX A/C** to reduce the risk of fogging. Recirculation may also turn on and off in various air distribution control combinations during hot weather to improve cooling efficiency.

Locking the Rear Climate Control



Press and release the button.

When illuminated, you can only operate the rear passenger settings through the front controls.

Setting the Rear Blower Motor Speed



Press and release **+** or **-** to adjust the volume of air circulated in the rear passenger compartment.

Setting the Rear Temperature



Press and release **+** or **-** to set the temperature in the rear passenger compartment.

Switching the Rear Climate Control On and Off



Press and release the button.

Climate Control

AUTOMATIC CLIMATE CONTROL

Note: The touchscreen system controls some of the climate features.

Accessing Rear Climate Controls

 Press and release the button to access additional controls for the rear climate system. See **Climate Control** (page 138).

Directing Air to the Instrument Panel Air Vents



Press and release the button to direct airflow to instrument panel air vents.

Directing Air to the Footwell Air Vents



Press and release the button to direct airflow to footwell air vents.

Setting the Blower Motor Speed



Press and release + or - to adjust the volume of air circulated in the vehicle.

Setting the Temperature

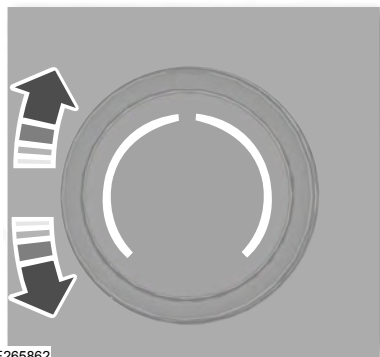

E265862

Turn the control on the left-hand side of the climate control to set the left-hand temperature.

Note: This control also sets the right-hand side temperature when you switch off dual zone mode.

Turn the control on the right-hand side of the climate control to set the right-hand temperature.

Switching Auto Mode On and Off

 Press and release the button to cycle through the automatic settings and off, then set the temperature.

When three indicators are on, the blower motor adjusts to the highest speed to reach the selected temperature as quickly as possible.

When two indicators are on, the blower motor adjusts to a medium speed to reach the selected temperature with a reduced amount of cabin noise.

Climate Control

When one indicator is on, the blower motor adjusts to the lowest speed to reach the selected temperature with the least amount of cabin noise.

Note: *The system starts at the previous fan setting when you switch on **AUTO**.*

Note: *You can also switch off dual zone mode by pressing and holding the button for more than two seconds.*

Switching Defrost On and Off



Press and release the button to distribute air through the windshield air vents and de-mister.

Air directed to the instrument panel and footwell air vents turns off. You can also use this setting to defog and clear the windshield of a thin covering of ice.

Switching the Air Conditioning On and Off



Press and release the button.

Use air conditioning with recirculated air to improve cooling performance and efficiency.

Note: *In certain conditions (for example, maximum defrost) the air conditioning compressor may continue to operate even though you switch off the air conditioning.*

Switching the Climate Control On and Off



Press and release the button.

Switching Dual Zone Mode On and Off



Press and release the button to switch on temperature control for the right-hand side of the vehicle.

Switching the Heated Seats On and Off



Press and release the button to cycle through the various heat settings and off.

See **Heated Seats** (page 162).

Switching Maximum Air Conditioning On and Off



Press and release the button for maximum cooling.

The left-hand and right-hand settings set to LO, recirculated air flows through the instrument panel air vents, air conditioning turns on and the blower motor adjusts to the highest speed.

Switching Maximum Defrost On and Off



Press and release the button for maximum defrosting.

The left-hand and right-hand settings set to HI, air flows through the windshield air vents, and the blower motor adjusts to the highest speed.

You can also use this setting to defog and clear the windshield of a thin covering of ice.

Note: *To prevent window fogging, you cannot select recirculated air when maximum defrost is on.*

Note: *The heated rear window also turns on when you select maximum defrost.*

Climate Control

Switching Recirculated Air On and Off



Press and release the button to switch between outside air and recirculated air.

The air currently in the passenger compartment recirculates. This may reduce the time needed to cool the interior (when used with **A/C**) and reduce unwanted odors from entering your vehicle.

Note: *Recirculated air may turn off (or prevent you from switching on) in all air flow modes except **MAX A/C** to reduce the risk of fogging. Recirculation may also turn on and off in various air distribution control combinations during hot weather to improve cooling efficiency.*

Switching the Ventilated Seats On and Off



Press and release the button to cycle through the various ventilated seat settings and off.

See **Climate Controlled Seats** (page 164).

HINTS ON CONTROLLING THE INTERIOR CLIMATE

General Hints

Note: *Prolonged use of recirculated air may cause the windows to fog up.*

Note: *You may feel a small amount of air from the footwell air vents regardless of the air distribution setting.*

Note: *To reduce humidity build-up inside your vehicle, do not drive with the system switched off or with recirculated air always switched on.*

Note: *Do not place objects under the front seats as this may interfere with the airflow to the rear seats.*

Note: *Remove any snow, ice or leaves from the air intake area at the base of the windshield.*

Note: *To improve the time to reach a comfortable temperature in hot weather, drive with the windows open until you feel cold air through the air vents.*

Manual Climate Control

Note: *To reduce fogging of the windshield during humid weather, adjust the air distribution control to the windshield air vents position.*

Automatic Climate Control

Note: *Adjusting the settings when your vehicle interior is extremely hot or cold is not necessary. The system automatically adjusts to heat or cool the interior to your selected temperature as quickly as possible. For the system to function efficiently, the instrument panel and side air vents should be fully open.*

Note: *If you select **AUTO** during cold temperatures, the system directs airflow to the windshield and side window vents. In addition, the fan may run at a slower speed until the engine warms up.*

Note: *If you select **AUTO** during hot temperatures and the inside of the vehicle is hot, the system automatically uses recirculated air to maximize interior cooling. Fan speed may also reduce until the air cools.*

Climate Control

Quickly Heating the Interior

	Manual climate control	Automatic climate control
1	Adjust the fan speed to the highest setting.	Press AUTO .
2	Adjust the temperature control to the full heat setting.	Adjust the temperature control to the desired setting.
3	Direct air to the footwell using the air distribution buttons.	

Recommended Settings for Heating

	Manual climate control	Automatic climate control
1	Adjust the fan speed to the center setting.	Press AUTO .
2	Adjust the temperature control to the midway point of the hot settings.	Adjust the temperature control to the desired setting. Use 72°F (22°C) as a starting point, then adjust the setting as necessary.
3	Direct air to the footwell using the air distribution buttons.	

Quickly Cooling the Interior

	Manual climate control	Automatic climate control
1	Select MAX A/C .	Select MAX A/C .
2	Drive with the windows open until you feel cold air through the air vents.	

Climate Control

Recommended Settings for Cooling

	Manual climate control	Automatic climate control
1	Adjust the fan speed to the center setting.	Press AUTO .
2	Adjust the temperature control to the midway point of the cold settings.	Adjust the temperature control to the desired setting. Use 72°F (22°C) as a starting point, then adjust the setting as necessary.
3	Direct air to the instrument panel using the air distribution buttons.	

Defogging the Side Windows in Cold Weather

	Manual climate control	Automatic climate control
1	Direct air to the windshield using the air distribution buttons.	Press the defrost button.
2	Press A/C .	Adjust the temperature control to the desired setting. Use 72°F (22°C) as a starting point, then adjust the setting as necessary.
3	Adjust the temperature control to the desired setting.	
4	Adjust the fan speed to the highest setting.	

REAR PASSENGER CLIMATE CONTROLS - VEHICLES WITH: AUTOMATIC TEMPERATURE CONTROL

Directing Air to the Overhead Air Vents



Press and release the button to direct airflow to the overhead air vents.

Directing Air to the Rear Footwell Air Vents



Press and release the button to direct airflow to rear footwell air vents.

Rear Climate Control Lock Indicator



When illuminated, you can only operate the rear passenger settings through the front controls.

Climate Control

Setting the Rear Blower Motor Speed

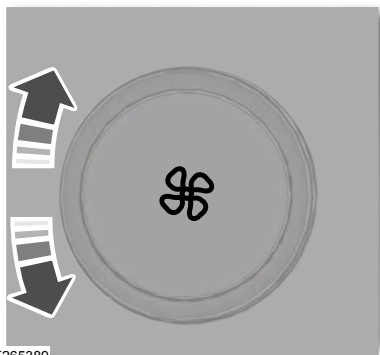

Turn the control to adjust the volume of air circulated in the rear passenger compartment.

Setting the Rear Temperature

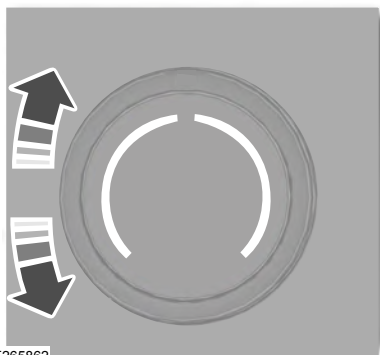

Turn the control to set the temperature in the rear passenger compartment.

Switching Rear Auto Mode On and Off



Press and release the button to switch on rear automatic operation, then set the temperature.

Switching the Rear Climate Control On and Off



Press and release the button.

Switching the Rear Heated Seats On and Off



Press and release the button to cycle through the various heat settings and off.

See **Heated Seats** (page 162).

REAR PASSENGER CLIMATE CONTROLS - VEHICLES WITH: MANUAL TEMPERATURE CONTROL

Directing Air to the Overhead Air Vents



Press and release the button to direct airflow to the overhead air vents.

Directing Air to the Rear Footwell Air Vents



Press and release the button to direct airflow to rear footwell air vents.

Climate Control

Rear Climate Control Lock Indicator



When illuminated, you can only operate the rear passenger settings through the front controls.

Setting the Rear Blower Motor Speed

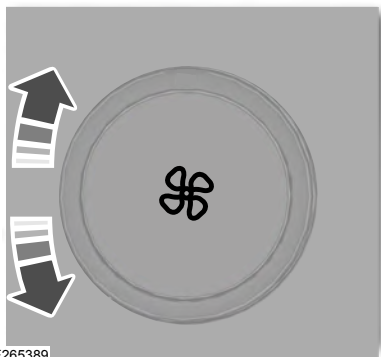

Turn the control to adjust the volume of air circulated in the rear passenger compartment.

Setting the Rear Temperature

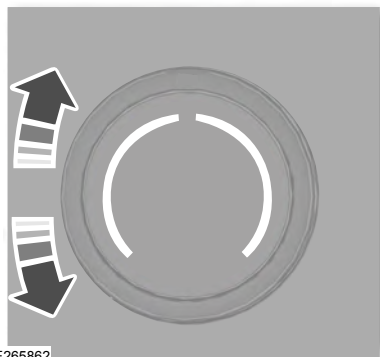

Turn the control to set the temperature in the rear passenger compartment.

Switching the Rear Climate Control On and Off



Press and release the button.

HEATED WINDSHIELD (IF EQUIPPED)

Windshield Wiper De-Icer

The windshield wiper de-icer turns on in low temperatures.

HEATED REAR WINDOW



Press the button to clear the rear window of thin ice and fog. The heated rear window turns off after a short period of time.

Note: Make sure the engine is on before operating the heated windows.

Climate Control

Note: Do not use razor blades or other sharp objects to clean or remove decals from the inside of the heated rear window. The vehicle Warranty may not cover damage caused to the heated rear window grid lines.

HEATED EXTERIOR MIRRORS

When you switch the heated rear window on, the heated exterior mirrors turn on.

Note: Do not remove ice from the mirrors with a scraper or adjust the mirror glass when it is frozen in place.

Note: Do not clean the mirror housing or glass with harsh abrasives, fuel or other petroleum-based cleaning products. The vehicle warranty may not cover damage caused to the mirror housing or glass.

CABIN AIR FILTER

Your vehicle is equipped with a cabin air filter, which gives you and your passengers the following benefits:

- It improves your driving comfort by reducing particle concentration.
- It improves the interior compartment cleanliness.
- It protects the climate control components from particle deposits.

You can locate the cabin air filter behind the glove box.

Note: Make sure you have a cabin air filter installed at all times. This prevents foreign objects from entering the system. Running the system without a filter in place could result in degradation or damage to the system.

Replace the filter at regular intervals. See **Scheduled Maintenance** (page 500).

For additional cabin air filter information, or to replace the filter, see an authorized dealer.

REMOTE START (IF EQUIPPED)

The climate control system adjusts the interior temperature during remote start.

You can switch this feature on or off and adjust the settings using the information display controls. See **Information Displays** (page 110).

You cannot adjust the climate control setting during remote start operation. Switch the ignition on to make adjustments.

Based on your remote start settings, the following vehicle-dependent features may or may not remain on after remote starting your vehicle:

- Climate controlled seats.
- Heated steering wheel.
- Heated mirrors.
- Heated rear window.
- Windshield wiper de-icer.

Note: For dual zone climate controlled seats, the passenger seat setting defaults to match the driver seat during remote start.

Automatic Settings

If **Auto** is on, the system sets the interior temperature to 72°F (22°C) and heats or cools the vehicle interior as required to achieve comfort.

Note: In cold weather, the heated rear window and heated mirrors turn on.

Last Settings

If **Last Settings** is on, the system uses the settings last selected before you turned off the vehicle.

Climate Control

Heated and Cooled Features

In **Auto** mode, certain heated features may switch on during cold weather, and cooled features during hot weather.

Seats

SITTING IN THE CORRECT POSITION



WARNING: Sitting improperly, out of position or with the seatback reclined too far can take weight off the seat cushion and affect the decision of the passenger sensing system, resulting in serious injury or death in the event of a crash. Always sit upright against your seat back, with your feet on the floor.



WARNING: Do not recline the seatback too far as this can cause the occupant to slide under the seatbelt, resulting in serious injury in the event of a collision.



WARNING: Do not place objects higher than the top of the seat backrest. Failure to follow this instruction could result in personal injury or death in the event of a sudden stop or crash.

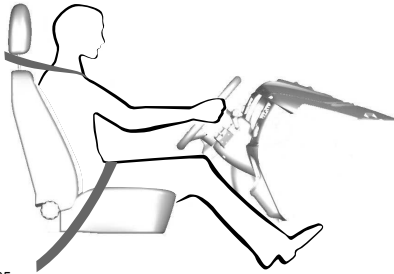

E68595

When you use them properly, the seat, head restraint, seatbelt and airbags will provide optimum protection in the event of a crash.

We recommend that you follow these guidelines:

- Sit in an upright position with the base of your spine as far back as possible.
- Do not recline the seat backrest so that your torso is more than 30° from the upright position.
- Adjust the head restraint so that the top of it is level with the top of your head and as far forward as possible. Make sure that you remain comfortable.
- Keep sufficient distance between yourself and the steering wheel. We recommend a minimum of 10 in (25 cm) between your breastbone and the airbag cover.
- Hold the steering wheel with your arms slightly bent.
- Bend your legs slightly so that you can press the pedals fully.
- Position the shoulder strap of the seatbelt over the center of your shoulder and position the lap strap tightly across your hips.

Make sure that your driving position is comfortable and that you can maintain full control of your vehicle.

HEAD RESTRAINTS



WARNING: Fully adjust the head restraint before you sit in or operate your vehicle. This will help minimize the risk of neck injury in the event of a crash. Do not adjust the head restraint when your vehicle is moving.

Seats



WARNING: The head restraint is a safety device. Whenever possible it should be installed and properly adjusted when the seat is occupied. Failure to adjust the head restraint properly could reduce its effectiveness during certain impacts.

Note: Adjust the seat backrest to an upright driving position before adjusting the head restraint. Adjust the head restraint so that the top of it is level with the top of your head and as far forward as possible. Make sure that you remain comfortable. If you are extremely tall, adjust the head restraint to its highest position.

Front Seat Manual Head Restraints

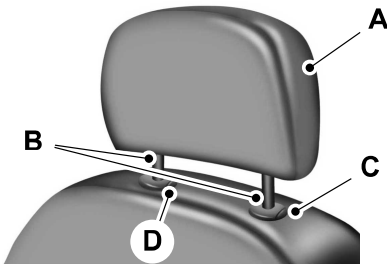

E138642

The head restraints consist of:

- A An energy absorbing foam and structure.
- B Two steel stems.
- C Guide sleeve adjust and release button.
- D Guide sleeve unlock and remove button.

Adjusting the Head Restraint

Raising the Head Restraint

Pull the head restraint up.

Lowering the Head Restraint

1. Press and hold button C.
2. Push the head restraint down.

Removing the Head Restraint

1. Pull the head restraint up until it reaches its highest position.
2. Press and hold buttons C and D.
3. Pull the head restraint up.

Note: You cannot remove front seat head restraints that have entertainment system video screens.

Installing the Head Restraint

Align the steel stems into the guide sleeves and push the head restraint down until it locks.

Tilting Manual Head Restraints (If Equipped)

The front seat head restraints tilt for extra comfort.



E144727

Seats

1. Adjust the seat backrest to an upright driving or riding position.
2. Pivot the head restraint forward toward your head to the desired position.

After the head restraint reaches the forward-most tilt position, pivot it forward again to release it to the rearward, un-tilted position.

Second Row Outermost Head Restraints

The outermost head restraints are non-adjustable, but you can fold them rearward.

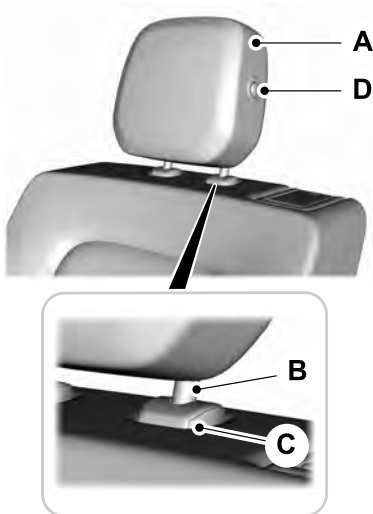

E257663

The head restraints consist of:

- A An energy absorbing foam and structure.
- B Two steel stems.

- C Guide sleeve unlock and remove button.
- D A fold button.

Removing the Head Restraint

1. Press and hold both C buttons.
2. Pull the head restraint up.

Installing the Head Restraint

Align the steel stems into the guide sleeves and push the head restraint down until it locks.

Note: Make sure the head restraint fold button is facing the outermost side of the seat.

Folding the Head Restraint

1. Press button D to fold the head restraint.
2. Pull the head restraint up to place it back to the upright position.

Second Row Center Seat Head Restraint

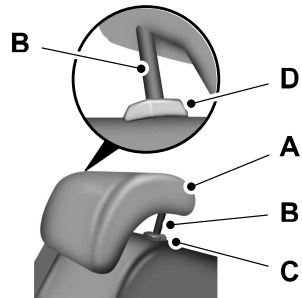

E138645

The head restraints consist of:

- A An energy absorbing foam and structure.
- B Two steel stems.

Seats

- C Guide sleeve adjust and release button.
- D Guide sleeve unlock and remove button.

Raising the Head Restraint

Pull the head restraint up.

Lowering the Head Restraint

1. Press and hold button C.
2. Push the head restraint down.

Removing the Head Restraint

1. Pull the head restraint up until it reaches its highest position.
2. Press and hold buttons C and D.
3. Pull the head restraint up.

Installing the Head Restraint

Align the steel stems into the guide sleeves and push the head restraint down until it locks.

Third Row Head Restraints

The third row head restraints are non-adjustable, but you can fold them.

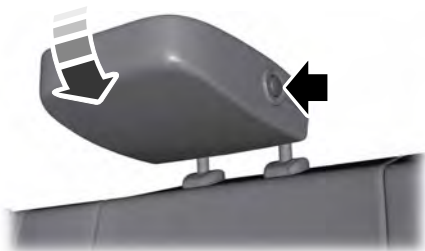

E193964

The head restraints consist of:

- A trimmed energy absorbing foam and structure.
- A fold button.

Folding the Head Restraint

1. Press the button to fold the head restraint.
2. Pull the head restraint up to place it back in the upright position.

Power Rear Head Restraints (If Equipped)

The third row outermost head restraints are fixed and cannot be removed.



E272543

Press the button on the head restraint or the button on the instrument panel to the left of the steering wheel to fold the third row outermost head restraints. Pull the head restraint up to place it in the upright position.

Note: These head restraints fold when you press the fold flat button.

Seats

MANUAL SEATS (IF EQUIPPED)



WARNING: Do not adjust the driver seat or seat backrest when your vehicle is moving. This may result in sudden seat movement, causing the loss of control of your vehicle.



WARNING: Make sure the seat fully locks into place by rocking it backward and forward. Not securing the seat into the locked position can be dangerous in a crash and could cause serious personal injury or death.



E175315

Manual Lumbar (If Equipped)

Moving the Seat Backward and Forward



E175314



E205042

The lumbar support control is on the outboard side of the seat. Turn the control to adjust your support.

Recline Adjustment (If Equipped)



WARNING: Do not place cargo or any objects behind the seat backrest before returning it to the original position. Pull on the seat backrest to make sure that it has fully latched after returning the seat backrest to its original position. An unlatched seat may become dangerous if you stop suddenly or have a crash.

POWER SEATS (IF EQUIPPED)



WARNING: Do not adjust the driver seat or seat backrest when your vehicle is moving. This may result in sudden seat movement, causing the loss of control of your vehicle.



WARNING: Do not place cargo or any objects behind the seatback before returning it to the original position.

Seats

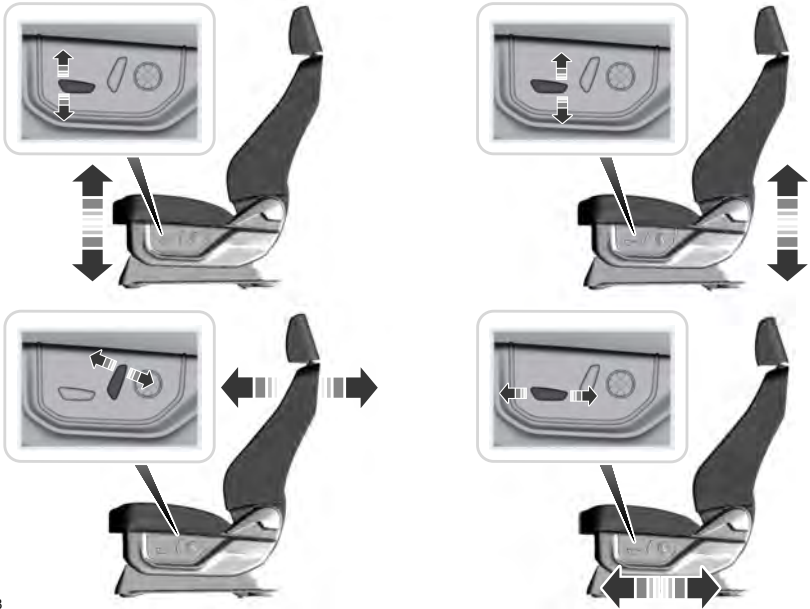

E176038

Adjusting the Lumbar Support



E176039

Adjusting the Multi-Contour Front Seats With Active Motion (If Equipped)

Note: The engine must be running or the vehicle must be in accessory mode to activate the seats.

Note: Allow a few seconds for any selection to activate. When the seat backrest and cushion are both active, the massage alternates between zones.

Seats

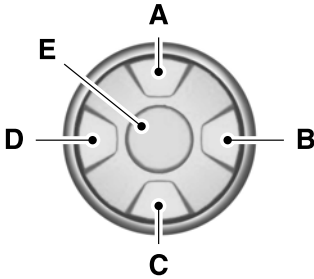

E156301

	Massage Mode	Lumbar and Bolster Mode
A	Back massage intensity adjustment	Upper lumbar
B	Massage intensity decrease and off*	Lumbar decrease
C	Cushion massage intensity adjustment	Lower lumbar**
D	Massage intensity increase	Lumbar increase
E	On and off	-

*The massage feature defaults to an alternating massage mode with back massage intensity adjustment. The lumbar and bolster feature defaults to the middle lumbar mode.

**Press C a second time to adjust the back bolster. Press C a third time to adjust the cushion bolster.

You can also adjust this feature through the touchscreen. When switched on, the system displays directions for you to adjust the lumbar settings in your seat or to set the massage function.

To access and make adjustments to the lumbar setting:

1. Press the Menu Settings icon > Vehicle > Multi-Contour Seat.

2. Choose the desired seat to adjust.
3. Press the + or - to adjust the lumbar intensity.

To access and make adjustments to the massage setting:

1. Press the Menu Settings icon > Vehicle > Multi-Contour Seat.
2. Choose the desired seat to adjust.
3. Press Off, Low or High.

Seats

MEMORY FUNCTION (IF EQUIPPED)



WARNING: Before activating the memory seat, make sure that the area immediately surrounding the seat is clear of obstructions and that all occupants are clear of moving parts.



WARNING: Do not use the memory function when your vehicle is moving.

This feature automatically recalls the position of the following:

- Driver seat.
- Power mirrors.
- Optional power adjustable foot pedals.
- Optional power adjustable steering column.

The memory control is on the driver door.



E142554

Saving a PreSet Position

1. Switch the ignition on.
2. Adjust the memory features to your desired position.
3. Press and hold the desired preset button until you hear a single tone.

You can save up to three preset memory positions. You can save a memory preset at any time.

Recalling a PreSet Position

Press and release the preset button associated with your desired driving position. The memory features move to the position stored for that preset.

Note: You can only recall a preset memory position when the ignition is off, or if the transmission is in park (P) or neutral (N) and the vehicle is not moving when the ignition is on.

You can also recall a preset memory position by:

- Pressing the unlock button on your intelligent access key fob if it is linked to a preset position.
- Unlocking the intelligent driver door handle if a linked key fob is present.

Note: Using a linked key fob to recall your memory position when the ignition is off moves the seat to the Easy Entry position.

Note: Pressing any active memory feature adjustment control (or any memory button) during a memory recall cancels the operation.

Linking a PreSet Position to your Remote Control or Intelligent Access Key Fob

Your vehicle can save the preset memory positions for up to three remote controls or intelligent access (IA) keys.

1. With the ignition on, move the memory positions to the desired positions.
2. Press and hold the desired preset button for about five seconds. A tone sounds after about two seconds. Continue holding until you hear a second tone.

Seats

3. Within three seconds, press the lock button on the remote control you are linking.

To unlink a remote control, follow the same procedure – except in step 3, press the unlock button on the remote control.

Note: *If more than one linked remote control or intelligent access key is in range, the memory function moves to the settings of the first key to recall a memory position.*

Easy Entry and Exit Feature

If you enable the easy entry and exit feature, it automatically moves the driver seat position rearward up to 2 in (5 cm) when you switch the ignition off.

The driver seat returns to the previous position when you switch the ignition on. You can enable or disable this feature through the information display. See

General Information (page 110).

REAR SEATS

Folding the Second Row 40% Seat



WARNING: Do not place cargo or any objects behind the seat backrest before returning it to the original position. Pull on the seat backrest to make sure that it has fully latched after returning the seat backrest to its original position. An unlatched seat may become dangerous if you stop suddenly or have a crash.



E246710

1. Locate the handle on the side of the seat cushion by the door.
2. Pull up on the handle to fold the seat backrest.

Note: *Use caution when folding the seat backrest to the flat position as the seat moves forward when you lift the release handle.*

To return the seat to the upright position:



E246709

1. Lift the seat backrest toward the rear of the vehicle.
2. Rotate the seat backrest until you hear a click, locking it in the upright position.

Seats

Adjusting the Second Row Outermost 40% Seat for Easy Entry



WARNING: Do not drive your vehicle with a seat that is unlatched or in the folded position. Failure to follow this instruction could result in personal injury or death in the event of a sudden stop or crash.



WARNING: Check under the seat cushion to make sure no cargo or objects are under the seat cushion before returning the seat cushion to its original position, and that the seat cushion locks into place. Failure to do so may prevent the seat from operating properly in the event of a crash, which could increase the risk of serious injury.



WARNING: Do not place cargo or any objects behind the seat backrest before returning it to the original position. Pull on the seat backrest to make sure that it has fully latched after returning the seat backrest to its original position. An unlatched seat may become dangerous if you stop suddenly or have a crash.

Note: You can move the outermost seats forward to allow access to the third row seats.

This feature allows for easier entry and exit to and from the third row seat.



E257686

1. Pull the lever.
2. Tilt the seat and slide the complete seat forward.

Seats



E246708

3. When exiting your vehicle from the third row seats, pull the lever up on the upper corner of the outermost seats.
4. To return the seat to the seating position, slide the seat rearward while pulling down on the seat backrest until the latch fully engages.
5. To move the seat further back, pull the lever under the front of the seat and slide it backward.

Note: You must move the seat to the full forward position before you move it rearward. Otherwise, the seat may not slide properly rearward.

Note: You can slide the outermost seats forward when using a child restraint.

Power Easy Entry (If Equipped)



WARNING: Do not drive your vehicle with a seat that is unlatched or in the folded position. Failure to follow this instruction could result in personal injury or death in the event of a sudden stop or crash.



WARNING: Check under the seat cushion to make sure no cargo or objects are under the seat cushion before returning the seat cushion to its original position, and that the seat cushion locks into place. Failure to do so may prevent the seat from operating properly in the event of a crash, which could increase the risk of serious injury.



WARNING: Do not place cargo or any objects behind the seat backrest before returning it to the original position. Pull on the seat backrest to make sure that it has fully latched after returning the seat backrest to its original position. An unlatched seat may become dangerous if you stop suddenly or have a crash.

The easy entry seat allows for easier entry and exit to and from the third row seat.

Seats



E247495

1. Press the button on the rear quarter trim panel to unlock the rear of the seat.
2. Push the seat forward to gain access to the third row seat.

Reclining the Second Row Outermost 40% Seat Backrest

WARNING: Reclining the seatback can cause an occupant to slide under the seat's seatbelt, resulting in severe personal injuries in the event of a crash.



E247681

The release handle is on the outermost side of the seat cushion. Lift it to adjust the seat backrest to your desired position.

Folding the Second Row Center 20% Seat (If Equipped)

WARNING: To prevent possible damage to the seat or seatbelts, make sure that the seatbelts are not fastened before folding the seatback.

WARNING: Do not place cargo or any objects behind the seat backrest before returning it to the original position. Pull on the seat backrest to make sure that it has fully latched after returning the seat backrest to its original position. An unlatched seat may become dangerous if you stop suddenly or have a crash.

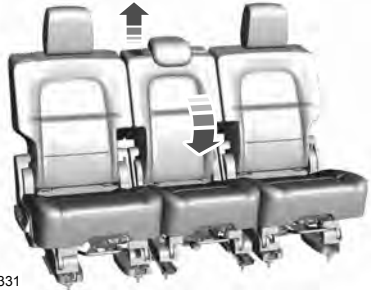

E247331

The release handle is in the upper right seat backrest. Pull the handle to release the folding seat latch.

To return the seat to the upright position, rotate the seat backrest until you hear a click, locking it in the upright position.

Note: Use the same release handle to recline the seat backrest.

Seats

Adjusting the Second-Row Center 20% Seat (If Equipped)

Note: Move this seat forward to keep a child in a child restraint close to the front seat occupants. Move the seat to the full rearward position when it is occupied by older children or adults, including children in booster seats.

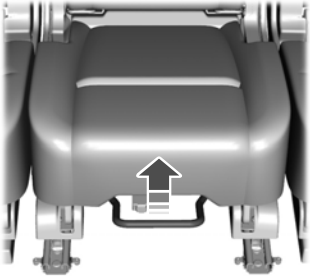

E247034

Lift the handle to move the seat forward or backward.

Power Folding Rear Seats (If Equipped)

Note: The power fold seats operate for 10 minutes after you switch the ignition off. The transmission must be in park (P) and the liftgate, or liftgate glass must be open. Similar to the battery saver feature, the power rear seat disable 10 minutes after you switch the ignition off.

Note: Be sure the third-row center head restraint is in the lowered position before you power the rear seats down. The third-row outermost head restraints fold automatically when you press the fold button.

The control buttons are on the left-hand rear quarter trim panel (accessible from the liftgate area).

With Second-Row Bench Seats

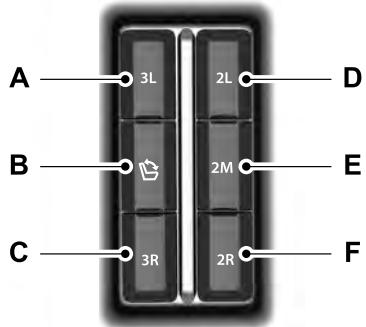

E257920

With Second-Row Captain Chairs

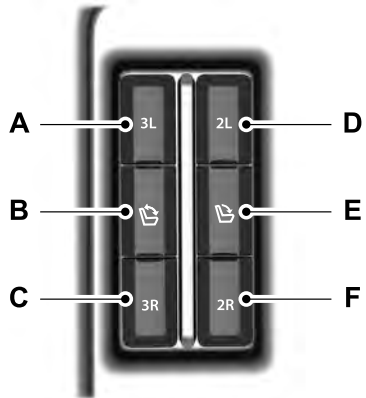

E246705

- A Folds the left-hand third-row seat.
- B Folds both third-row seats.

Seats

- C Folds the right-hand third-row seat.
- D Folds the left-hand second-row seat.
- E Folds the second-row bench center seat or both second-row captain chair seats.
- F Folds the right-hand second-row seat.

To return the second-row seat backrest to the original position, rotate the seat backrest up until it latches in the upright position. The seat backrest clicks when it is locked into position.

To return the third-row seat backrest to the original position, press the corresponding control again.

If the power rear seat is disabled after 10 minutes, you can enable the seat by:

- Opening any door.
- Pressing the unlock button on the key fob.
- Pressing any keyless entry keypad button.
- Switching the ignition on.

Folding Down the Rear Seats to the Load Floor

WARNING: To prevent possible damage to the seat or seatbelts, make sure that the seatbelts are not fastened before folding the seatback.

WARNING: Do not place cargo or any objects behind the seatback before returning it to the original position.

The third-row seats have obstacle detection that prevents the seats from folding or returning if they are obstructed.

Power Recline

WARNING: Do not recline a rear seat on which a child restraint is installed. Failure to follow this instruction could reduce the effectiveness of the child restraint.

The third-row power recline buttons are on the quarter trim panel on each side of the vehicle.

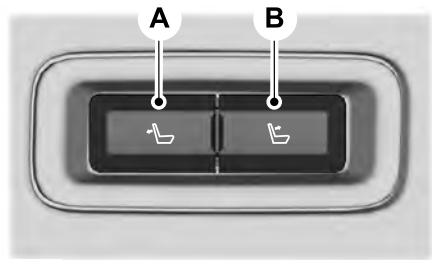

E246706

- A Moves the seat backrest rearward.
- B Moves the seat backrest forward.

HEATED SEATS (IF EQUIPPED)

Front Seats

WARNING: People who are unable to feel pain to their skin because of advanced age, chronic illness, diabetes, spinal cord injury, medication, alcohol use, exhaustion or other physical conditions, must exercise care when using the heated seat. The heated seat may cause burns even at low temperatures, especially if used for long

Seats

periods of time. Do not place anything on the seat that insulates against heat, such as a blanket or cushion. This may cause the heated seat to overheat. Do not puncture the seat with pins, needles or other pointed objects. This may damage the heating element which may cause the heated seat to overheat. An overheated seat may cause serious personal injury.

periods of time. Do not place anything on the seat that insulates against heat, such as a blanket or cushion, because this may cause the seat heater to overheat. Do not puncture the seat with pins, needles, or other pointed objects because this may damage the heating element which may cause the seat heater to overheat. An overheated seat may cause serious personal injury.

Do not do the following:

- Place heavy objects on the seat.
- Operate the heated seat if water or any other liquid spills on the seat. Allow the seat to dry thoroughly.
- Operate the heated seats unless the engine is running. Doing so can cause the battery to lose charge.



E146322

Press the heated seat symbol to cycle through the various heat settings and off. More indicator lights indicate warmer settings.

Rear Seats



WARNING: Persons who are unable to feel heat to the skin because of advanced age, chronic illness, diabetes, spinal cord injury, medication, alcohol use, exhaustion, or other physical conditions, must exercise care when using the seat heater. The seat heater may cause burns even at low temperatures, especially if used for long

Do not do the following:

- Place heavy objects on the seat.
- Operate the seat heater if water or any other liquid is spilled on the seat. Allow the seat to dry thoroughly.
- Operate the heated seats unless the engine is running. Doing so can cause the battery to lose charge.

The rear seat heat controls are located on the rear of the center console.



E146322

Press the heated seat symbol to cycle through the various heat settings and off. More indicator lights indicate warmer settings.

The heated seat module resets at every ignition run cycle. While the ignition is on, press the high or low heated seat switch to enable heating mode. When activated, they will turn off automatically when you turn the engine off.

Seats

CLIMATE CONTROLLED SEATS

(IF EQUIPPED)

Heated Seats



WARNING: People who are unable to feel pain to their skin because of advanced age, chronic illness, diabetes, spinal cord injury, medication, alcohol use, exhaustion or other physical conditions, must use caution when using the heated seat. The heated seat may cause burns even at low temperatures, especially if used for long periods of time. Do not place anything on the seat that may block the heat, such as a blanket or cushion. This can cause the heated seat to overheat. Do not puncture the seat with pins, needles or other pointed objects. This damages the heating element and can cause the heated seat to overheat. An overheated seat may cause serious personal injury.

Note: The heated seats switch on during a remote start if they are enabled through the information displays. See **General Information** (page 110).

Note: The heated seats may also switch on when you start your vehicle if they were on when you previously switched your vehicle off.

Note: Do not do the following:

- Place heavy objects on the seat.
- Operate the seat heater if water or any other liquid spills on the seat. Allow the seat to dry thoroughly.



E146322

Press this symbol to cycle through the various heat settings and off. More indicator lights indicate warmer settings.

Ventilated Seats

Note: The ventilated seats switch on during a remote start if they are enabled through the information displays. See **General Information** (page 110).

Note: The ventilated seats may also switch on when you start your vehicle if they were on when you previously switched your vehicle off.

Note: Do not do the following:

- Spill liquid on the front seats. This may cause the air vent holes to become blocked and not work properly.
- Place cargo or objects under the seats. They may block the air intake causing the air vents to not work properly.

The ventilated seats only function when the engine is running.



E224689

Press this symbol to cycle through the various ventilation settings and off. More indicator lights indicate higher fan speeds.

If the engine falls below 350 RPM while the ventilated seats are on, the feature turns itself off. You need to reactivate it.

Seats

Note: *To improve comfort, use the ventilated seats along with the vehicle's air conditioning system.*

Garage Door Opener (If Equipped)

UNIVERSAL GARAGE DOOR OPENER

HomeLink Wireless Control System



WARNING: Make sure that the garage door and security device are free from obstruction when you are programming. Do not program the system with the vehicle in the garage.



WARNING: Do not use the system with any garage door opener that does not have the safety stop and reverse feature as required by U.S. Federal Safety Standards (this includes any garage door opener manufactured before April 1, 1982). A garage door opener which cannot detect an object, signaling the door to stop and reverse, does not meet current federal safety standards. Using a garage door opener without these features increases the risk of serious injury or death.

Note: Make sure you keep the original remote control transmitter for use in other vehicles as well as for future system programming.

Note: We recommend that upon the sale or lease termination of your vehicle, you erase the programmed function buttons for security reasons. See **Erasing the Function Button Codes** later in this section.

Note: You can program a maximum of three devices. To change or replace any of the three devices after it has been initially programmed, you must first erase the current settings. See **Erasing the Function Button Codes**.



E188211

The universal garage door opener replaces the common hand-held garage door opener with a three-button transmitter integrated into the driver's sun visor.

The system includes two primary features, a garage door opener and a platform for remote activation of devices within the home. You can program garage doors as well as entry gate operators, security systems, entry door locks and home or office lighting.

Additional system information can be found online at www.homelink.com, www.youtube.com/user/HomeLinkGentex or by calling the toll-free help line at 1-800-355-3515.

In-Vehicle Programming

This process is to program your in-vehicle HomeLink function button with your hand-held transmitter.

Note: The programming steps below assume you will be programming HomeLink that was not previously programmed. If your HomeLink was previously programmed, you may need to erase your HomeLink buttons. See **Erasing the Function Button Codes**.

Note: Put a new battery in the hand-held transmitter. This helps ensure quicker training and accurate transmission of the radio-frequency signal.

Garage Door Opener (If Equipped)

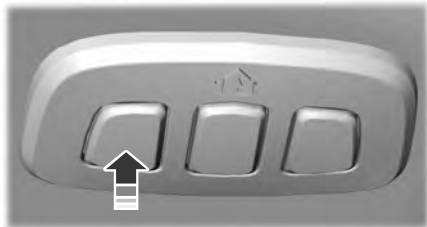

E188212

1. With your vehicle parked outside of the garage, switch your ignition to the **on** position, but do not start your vehicle.
2. Press and release the function button that you would like to program.
3. Hold your hand-held garage door transmitter 1–3 in (2–8 cm) away from the HomeLink button you want to program.
4. Press and hold the hand-held transmitter button you want to program while watching the indicator light on HomeLink. Continue to hold the hand-held button until the HomeLink indicator light flashes rapidly or is continuously on.

Note: *You may need to use a different method if you live in Canada or have difficulties programming your gate operator or garage door opener. See **Gate Operator / Canadian Programming.***

5. Press and hold the HomeLink button you programmed for two seconds, then release. You may need to do this twice to activate the door. If your garage door does not operate, watch the HomeLink indicator light.

If the indicator light stays on, the programming is complete. Your device should activate when the HomeLink button is pressed and released.

If the indicator light flashes rapidly, press and hold for two seconds and release the programmed HomeLink button. Repeat the "press/hold/release" sequence up to three times to complete the programming process. If your device still does not operate, you must program your garage door. See **Programming Your Garage Door Opener Motor.**

To program additional buttons, repeat Steps 1 – 4.

For questions or comments, please contact HomeLink at www.homelink.com, www.youtube.com/user/HomeLinkGentex or by calling the toll-free help line at 1-800-355-3515.

Programming Your Garage Door Opener Motor

Note: *You may need a ladder to reach the unit and you may need to remove the cover or lamp lens on your garage door opener.*



E142659

1. Press the learn button on the garage door opener motor and then you have 30 seconds to complete the next two steps.
2. Return to your vehicle.

Garage Door Opener (If Equipped)



E188212

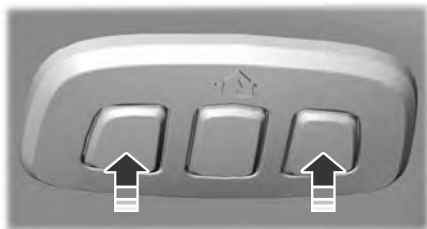

E188213

3. Press and hold the function button you want to program for 2 seconds, then release. Repeat this step. Depending on your brand of garage door opener, you may need to repeat this sequence a third time.

Gate Operator / Canadian Programming

Canadian radio-frequency laws require transmitter signals to “time-out” (or quit) after several seconds of transmission – which may not be long enough for HomeLink to pick up the signal during programming. Similar to this Canadian law, some U.S. gate operators are designed to “time-out” in the same manner.

Note: *If programming a garage door opener or gate operator, it is advised to unplug the device during the “cycling” process to prevent possible overheating.*

1. Press and release, **every two seconds**, your hand-held transmitter until the HomeLink indicator light changes to a rapidly blinking or continuously on light.
2. Release the hand-held transmitter button.
3. Continue programming HomeLink. See **In-Vehicle Programming, Step 4.**

Erasing the Function Button Codes

Note: *You cannot erase individual buttons.*

1. Press and hold the outer two function buttons simultaneously for approximately 10 seconds until the indicator light above the buttons flashes rapidly.
2. When the indicator light flashes, release the buttons. You erased the codes for all buttons.

Reprogramming a Single Button

To program a device to a previously trained button, follow these steps:

1. Press and hold the desired button. Do NOT release the button.
2. The indicator light begins to flash after 20 seconds. Without releasing the button, follow Step 1 in the Programming section.

For questions or comments, contact HomeLink at www.homelink.com, www.youtube.com/user/HomeLinkGentex or by calling the toll-free help line at 1-800-355-3515.

Garage Door Opener (If Equipped)

FCC and RSS-210 Industry Canada Compliance

This device complies with Part 15 of the FCC Rules and with RSS-210 of Industry Canada. Operation is subject to the following two conditions: (1) this device may not cause harmful interference, and (2) this device must accept any interference received, including interference that may cause undesired operation.

Note: *Changes or modifications to your device not expressly approved by the party responsible for compliance can void the user's authority to operate the equipment.*

This equipment complies with FCC radiation exposure limits set forth for an uncontrolled environment. End Users must follow the specific operating instructions for satisfying RF exposure compliance. This transmitter must be at least 8 in (20 cm) from the user and must not be co-located or operating in conjunction with any other antenna or transmitter.

The term "IC:" before the certification/registration number only signifies that Industry Canada technical specifications were met.

Auxiliary Power Points

12 Volt DC Power Point



WARNING: Do not plug optional electrical accessories into the cigar lighter socket. Incorrect use of the cigar lighter can cause damage not covered by the vehicle warranty, and can result in fire or serious injury.

Note: When you switch the ignition on, you can use the socket to power 12 volt appliances with a maximum current rating of 15 amps.

If the power supply does not work after you switch the ignition off, switch the ignition on.

Note: Do not hang any accessory from the accessory plug.

Note: Do not use the power point over the vehicle capacity of 12 volt DC 180 watts or a fuse may blow.

Note: Always keep the power point caps closed when not in use.

Do not insert objects other than an accessory plug into the power point. This damages the power point and may blow the fuse.

Run the vehicle for full capacity use of the power point.

To prevent the battery from running out of charge:

- Do not use the power point longer than necessary when the engine is not running.
- Do not leave devices plugged in overnight or when you park your vehicle for extended periods.

USB Port and Power Point Locations

USB Ports and Power Points may be in the following locations:

- On the lower instrument panel.
- Inside the center console.
- On the front of the center console.
- On the rear of the center console.
- In the cargo area.
- On the passenger side floor panel.
- 3rd row on the quarter trim panels.

Note: Some of the USB ports may not have data transfer capabilities.

110 Volt AC Power Point (If Equipped)



WARNING: Do not keep electrical devices plugged in the power point whenever the device is not in use. Do not use any extension cord with the 110 volt AC power point, since it will defeat the safety protection design. Doing so may cause the power point to overload due to powering multiple devices that can reach beyond the 150 watt load limit and could result in fire or serious injury.

Note: The power point turns off when you switch off the ignition, when the vehicle is not in accessory mode or when the battery voltage drops below 11 volts.

You can use the power point for electric devices that require up to 150 watts. It is on the rear of the center console.

Auxiliary Power Points



E247586

When the indicator light on the power point is:

- On: The power point is working, the ignition is ON or the vehicle is in accessory mode.
- Off: The power point is OFF, the ignition is OFF or the vehicle is not in accessory mode.
- Flashing: The power point is in fault mode.

Due to the different technologies used on its construction, some devices may exceed the capacity shown on its label when they are initially plugged-in.

The power outlet temporarily turns off power when in fault mode if the device exceeds the 150 watt limit. Unplug your device and switch the ignition off. Switch the ignition back on, but do not plug your device back in. Let the system cool off and switch the ignition off to reset the fault mode. Switch the ignition back on and make sure the indicator light remains on.

Do not use the power point for certain electric devices, including:

- Cathode-ray, tube-type televisions.
- Motor loads, such as vacuum cleaners, electric saws and other electric power tools or compressor-driven refrigerators.

- Measuring devices, which process precise data, such as medical equipment or measuring equipment.
- Other appliances requiring an extremely stable power supply such as microcomputer-controlled electric blankets or touch-sensor lamps.

WIRELESS ACCESSORY CHARGING (IF EQUIPPED)



WARNING: Wireless charging devices can affect the operation of implanted medical devices, including cardiac pacemakers. If you have any implanted medical devices, we recommend that you consult with your physician.

Note: *Devices without built-in Qi wireless charging receivers require an additional Qi receiver or sleeve.*

The system supports one Qi wireless charging compatible device on the charging area.

Keep the charging area clean and remove foreign objects prior to charging a device.

Do not place items with a magnetic strip, for example passports, parking tickets or credit cards, near the charging area when charging a device. Damage may occur to the magnetic strip.

Do not place metal objects, for example remote controls, coins and candy wrappers, on or near the charging area when charging a device. Metal objects may heat up and degrade the charging performance.

Auxiliary Power Points

Note: The rate of charge, or charging power, is controlled by the device. During charging, the device and the charger may heat up, this is normal. If the battery gets hotter than usual, the charger may stop charging.

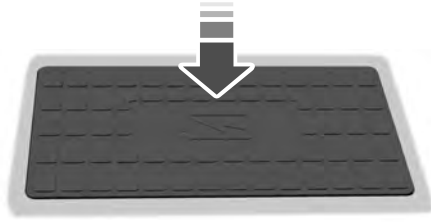

The charging area is on the center console or lower instrument panel. See **Center Console** (page 174).

You can charge a device if the vehicle is off when in accessory mode or if SYNC is on.

To begin charging, place the device on the center of the charging surface with the charging side down. The charging stops after your device reaches a full charge.

Note: If the system detects a foreign object or if the device is misaligned on the charging area, a message appears in the display.

E250812

Message	Behavior	Description
Wireless Charger Active	Message on screen display or pop-up window.	This message appears when wireless charging begins.
Charging Terminated Phone misaligned or object between phone and charger detected. Correct the condition to resume charging.	Pop-up window.	The system stops charging your device if the system detects the phone is misaligned, or a foreign metal object is on the charging surface.

FCC ID: L2C0066T

This equipment has been tested and found to comply with part 18 of the FCC Rules.

- This equipment generates, uses and can radiate radio frequency energy and may cause harmful interference to radio communications. There is no guarantee that the interference will not occur in a particular installation. If this equipment does cause harmful interference to radio or television reception, please consult the dealer.
- This product is not end-user serviceable.

This device complies with Industry Canada licence-exempt RSS standard(s).

Operation is subject to the following two conditions:

- This device may not cause interference, and
- This device must accept any interference, including interference that may cause undesired operation of the device.

Auxiliary Power Points

Note: *Changes or modifications not expressly approved by the party responsible for compliance could void the user's authority to operate the equipment. The term "IC" before the radio certification number only signifies that Industry Canada technical specifications were met.*

Storage Compartments

CENTER CONSOLE

Stow items in the cup holder carefully as items may become loose during hard braking, acceleration or crashes, including hot drinks which may spill.

Available console features include:

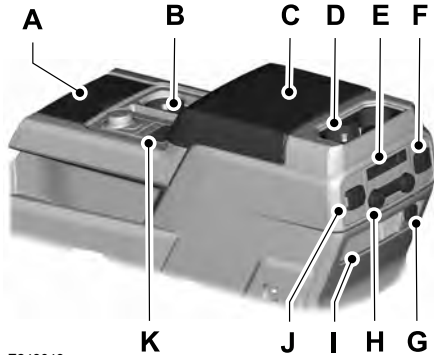

E248043

- A Front storage compartment with wireless charging port, and USB ports.
- B Cup holders.
- C Storage compartment with auxiliary power point.
- D Rear cup holders.
- E Rear audio controls.
- F AC power point.
- G Auxiliary power point.
- H Rear climate controls.
- I Rear storage compartment.
- J USB ports.
- K Switch pack.

OVERHEAD CONSOLE

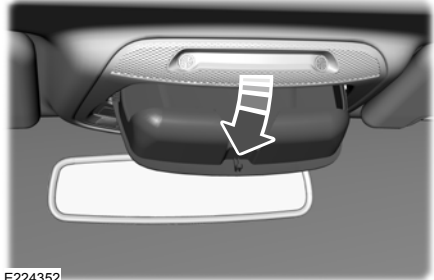

E224352

Press near the rear edge of the door to open it.

Starting and Stopping the Engine

GENERAL INFORMATION



WARNING: Extended idling at high engine speeds can produce very high temperatures in the engine and exhaust system, creating the risk of fire or other damage.



WARNING: Do not park, idle or drive your vehicle on dry grass or other dry ground cover. The emission system heats up the engine compartment and exhaust system, creating the risk of fire.



WARNING: Do not start the engine in a closed garage or in other enclosed areas. Exhaust fumes can be toxic. Always open the garage door before you start the engine.



WARNING: Exhaust leaks may result in entry of harmful and potentially lethal fumes into the passenger compartment. If you smell exhaust fumes inside your vehicle, have your vehicle inspected immediately. Do not drive if you smell exhaust fumes.

If you disconnect the battery, your vehicle may exhibit some unusual driving characteristics for approximately 5 mi (8 km) after you reconnect it. This is because the engine management system must realign itself with the engine. You can disregard any unusual driving characteristics during this period.

The powertrain control system meets all Canadian interference-causing equipment standard requirements regulating the impulse electrical field or radio noise.

When you start the engine, avoid pressing the accelerator pedal before and during operation. Only use the accelerator pedal when you have difficulty starting the engine.

IGNITION SWITCH (IF EQUIPPED)

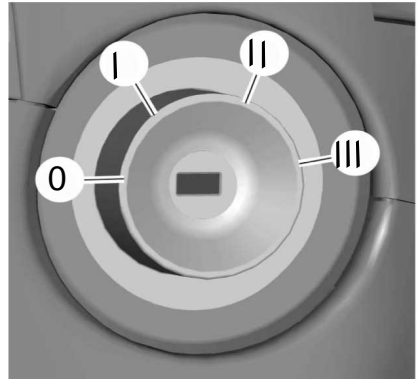

E252522

0 (off) - The ignition is off.

Note: When you switch the ignition off and leave your vehicle, do not leave your key in the ignition. This could cause your vehicle battery to lose charge.

I (accessory) - Allows the electrical accessories, such as the radio, to operate while the engine is not running.

Note: Do not leave the ignition key in this position for too long. This could cause your vehicle battery to lose charge.

II (on) - All electrical circuits are operational and the warning lamps and indicators illuminate.

III (start) - Cranks the engine.

Starting and Stopping the Engine

KEYLESS STARTING (IF EQUIPPED)

Note: The system may not function if the passive key is close to metal objects or electronic devices, for example keys or a cell phone.

Note: A valid passive key must be located inside your vehicle to switch the ignition on and start your vehicle.

Ignition Modes



E144447

The keyless starting system has three modes:

Off: Turns the ignition off.

- Without applying the brake pedal, press and release the button once when the ignition is in the on mode, or when the engine is running but your vehicle is not moving.

On: All electrical circuits are operational and the warning lamps and indicators illuminate.

- Without applying the brake pedal, press and release the button twice.

Start: Starts the engine.

- Press the brake pedal, and then press the button for any length of time. An indicator light on the button illuminates when then ignition is on and when the engine starts.

STARTING A GASOLINE ENGINE

When you start the engine, the idle speed increases. This helps to warm up the engine. If the engine idle speed does not slow down automatically, have your vehicle checked by an authorized dealer.

Note: You can crank the engine for a total of 60 seconds without the engine starting before the starting system temporarily disables. The 60 seconds does not have to be all at once. For example, if you crank the engine three times for 20 seconds each time, without the engine starting, you reached the 60-second time limit. You cannot attempt to start the engine for at least 15 minutes. After 15 minutes, you are limited to a 15-second engine cranking time. You need to wait 60 minutes before you can crank the engine for 60 seconds again.

Before starting your vehicle, check the following:

- Make sure all occupants have fastened their seatbelts.
- Make sure the headlamps and electrical accessories are off.
- Make sure the parking brake is on.
- Make sure the transmission is in park (P).
- Switch the ignition on. For vehicles with a keyless ignition, see the following instructions.

Vehicles with an Ignition Key

Note: Do not touch the accelerator pedal.

- Fully depress the brake pedal.
- Turn the key to the start position to start the engine.

Note: The engine may continue cranking for up to 15 seconds or until it starts.

Note: If you cannot start the engine on the first try, wait for a short period and try again.

Starting and Stopping the Engine

Vehicles with Keyless Start

Note: Do not touch the accelerator pedal.

Note: You must have your intelligent access key in your vehicle in order to shift the transmission out of park (P).

1. Fully depress the brake pedal.
2. Press the push button ignition switch.

The system does not function if:

- The passive key frequencies are jammed.
- The key battery has no charge.

If you are unable to start your vehicle, do the following:

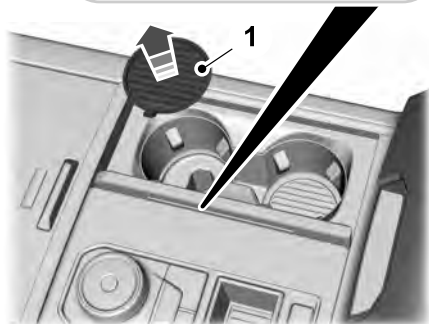
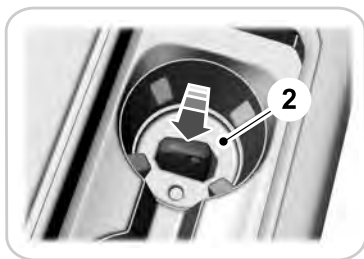

E256153

1. Access the backup slot.
2. Insert the passive key into the backup slot.

3. With the key in this position, press the brake pedal then press the push button ignition switch to switch the ignition on and start your vehicle.

Fast Restart

The fast restart feature allows you to restart your vehicle within 20 seconds of switching it off, even if it does not detect a valid passive key.

Within 20 seconds of switching the engine off, press the brake pedal and press the push button ignition switch.

After 20 seconds, you can no longer start your vehicle if it does not detect a valid passive key.

Once your vehicle starts, it remains running until you press the push button ignition switch, even if your vehicle does not detect a valid passive key. If you open and close a door while your vehicle is running, the system searches for a valid passive key. You cannot start your vehicle if the system does not detect a valid passive key within 20 seconds.

Failure to Start

If you cannot start the engine after three attempts, wait 10 seconds and follow this procedure:

1. Fully depress the brake pedal.
2. Shift into park (P).
3. Fully press the accelerator pedal and hold it there.
4. Start the engine.

Automatic Engine Shutdown

For vehicles with a keyless ignition, this automatically shuts down your vehicle if it has been idling for an extended period. The ignition also turns off to save battery power. Before your vehicle shuts down, a message appears in the information

Starting and Stopping the Engine

display showing a timer counting down. If you do not intervene within 30 seconds, your vehicle shuts down. Another message appears in the information display to inform you that your vehicle has shut down to save fuel. Start your vehicle as normal.

Automatic Engine Shutdown Override

Note: You cannot permanently switch off the automatic shutdown feature. When you switch it off temporarily, it turns on at the next ignition cycle.

You can stop the shutdown, or reset the timer, at any point before the 30-second countdown has expired by doing any of the following:

- You can reset the timer by interacting with your vehicle, for example pressing the brake or accelerator pedal.
- You can temporarily switch off the shutdown feature any time the ignition is on using the information display. See **Information Displays** (page 110). The feature only remains off for the current ignition cycle.
- During the 30-second countdown, the system prompts you to press OK or RESET to temporarily switch the feature off for the current ignition cycle only.

Stopping the Engine When Your Vehicle is Stationary

Vehicles with an Ignition Key

1. Shift into park (P).
2. Switch the ignition off.
3. Apply the parking brake.

Vehicles with Keyless Start

1. Shift into park (P).
2. Press the push button ignition switch.
3. Apply the parking brake.

Note: The ignition, all electrical circuits and all warning lamps and indicators will be turned off.

Note: If the engine is idling for 30 minutes, the ignition and engine automatically shuts down.

Stopping the Engine When Your Vehicle is Moving



WARNING: Switching off the engine when your vehicle is still moving results in a significant decrease in braking assistance. Higher effort is required to apply the brakes and to stop your vehicle. A significant decrease in steering assistance could also occur. The steering does not lock, but higher effort could be required to steer your vehicle. When you switch the ignition off, some electrical circuits, for example airbags, also turn off. If you unintentionally switch the ignition off, shift into neutral (N) and restart the engine.

Vehicles with an Ignition Key

1. Shift into neutral and use the brakes to bring your vehicle to a safe stop.
2. When your vehicle has stopped, shift into park (P) and switch the ignition off.
3. Apply the parking brake.

Vehicles with Keyless Start

1. Shift into neutral and use the brakes to bring your vehicle to a safe stop.
2. When your vehicle has stopped, shift into park (P).
3. Press and hold the push button ignition switch, or press it three times within two seconds.
4. Apply the parking brake.

Starting and Stopping the Engine

Guarding Against Exhaust Fumes



WARNING: Exhaust leaks may result in entry of harmful and potentially lethal fumes into the passenger compartment. If you smell exhaust fumes inside your vehicle, have your vehicle inspected immediately. Do not drive if you smell exhaust fumes.

Important Ventilating Information

If you stop your vehicle and then leave the engine idling for long periods, we recommend that you do one of the following:

- Open the windows at least 1 in (3 cm).
- Set your climate control to outside air.

ENGINE BLOCK HEATER (IF EQUIPPED)



WARNING: Failure to follow engine block heater instructions could result in property damage or serious personal injury.



WARNING: Do not use your heater with ungrounded electrical systems or two-pronged adapters. There is a risk of electrical shock.



WARNING: Do not fully close the hood, or allow it to drop under its own weight when using the engine block heater. This could damage the power cable and may cause an electrical short resulting in fire, injury and property damage.

Note: The heater is most effective when outdoor temperatures are below 0°F (-18°C).

The heater acts as a starting aid by warming the engine coolant. This allows the climate control system to respond quickly. The equipment includes a heater element (installed in the engine block) and a wire harness. You can connect the system to a grounded 120-volt AC electrical source.

We recommend that you do the following for a safe and correct operation:

- Use a 16-gauge outdoor extension cord that is product certified by Underwriter's Laboratory (UL) or Canadian Standards Association (CSA). This extension cord must be suitable for use outdoors, in cold temperatures, and be clearly marked Suitable for Use with Outdoor Appliances. Do not use an indoor extension cord outdoors. This could result in an electric shock or become a fire hazard.
- Use as short an extension cord as possible.
- Do not use multiple extension cords.
- Make sure that when in operation, the extension cord plug and heater cord plug connections are free and clear of water. This could cause an electric shock or fire.
- Make sure your vehicle is parked in a clean area, clear of combustibles.
- Make sure the heater, heater cord and extension cord are firmly connected.
- Check for heat anywhere in the electrical hookup once the system has been operating for approximately 30 minutes.

Starting and Stopping the Engine

- Make sure the system is unplugged and properly stowed before starting and driving your vehicle. Make sure the protective cover seals the prongs of the block heater cord plug when not in use.
- Make sure the heater system is checked for proper operation before winter.

Using the Engine Block Heater

Make sure the receptacle terminals are clean and dry prior to use. Clean them with a dry cloth if necessary.

The heater uses 0.4 to 1.0 kilowatt-hours of energy per hour of use. The system does not have a thermostat. It achieves maximum temperature after approximately three hours of operation. Using the heater longer than three hours does not improve system performance and unnecessarily uses electricity.

Unique Driving Characteristics

AUTO-START-STOP

The system helps reduce fuel consumption by automatically stopping and restarting the engine when your vehicle has stopped. The engine restarts automatically when you release the brake pedal.

In some situations, your vehicle may restart automatically, for example:

- To maintain interior comfort.
- To recharge the battery.

Note: *Power assist steering turns off when the engine is off.*

Note: *If your vehicle is flex fuel capable, Auto-Start-Stop will be inhibited for a short time after a refuel event while the system is verifying the fuel type being used.*



WARNING: Always fully apply the parking brake. Make sure you shift into park (P) for vehicles with an automatic transmission. Switch the ignition off and remove the key whenever you leave your vehicle.



WARNING: Before opening the hood or performing any maintenance, fully apply the parking brake, shift into park (P) or neutral (N) and switch the ignition off.



WARNING: Always switch the ignition off before leaving the vehicle. If the ignition is switched on an automatic restart may occur at any time.



WARNING: The system may require the engine to automatically restart when the auto-start-stop indicator illuminates green or flashes amber. Failure to follow this instruction could result in personal injury.

The Auto-Start-Stop system status is available at a glance within the information display. See **Information Displays** (page 110).

Enabling Auto-Start-Stop

The system automatically enables every time you start your vehicle if:

- You do not press the Auto-Start-Stop button (not illuminated).
- Your vehicle exceeds an initial speed of 3 mph (5 km/h) after you have initially started your vehicle.
- You have stopped your vehicle.
- Your foot is on the brake pedal.
- The driver door is closed.
- There is adequate brake vacuum.
- The interior compartment has cooled or warmed to an acceptable level.
- The front windshield defroster is off.
- You have not turned the steering wheel rapidly or you do not have it at a sharp angle.
- The vehicle is not on a steep road grade.
- The battery is within optimal operating conditions (battery state of charge and temperature in range).
- The engine coolant is at operating temperature.
- Elevation is below about 11,000 ft (3,350 m).
- Ambient temperature is moderate.
- The trailer is not connected.
- If you select Normal, Eco, Snow/Wet or Grass/Gravel/Snow modes.
- You are not in 4H or 4L.
- You have not selected Manual shift mode.

Unique Driving Characteristics

- Hill descent control is not active.
- You have not selected Tow haul, Sport, Sand or Mud/Rut modes.

Note: Note when in Sport mode it can be enabled by pressing the Auto-Start-Stop button.



The green Auto-Start-Stop indicator light on the instrument cluster will illuminate to indicate when the automatic engine stop occurs.



If the instrument cluster is equipped with a grey Auto-Start-Stop indicator light, it illuminates when automatic engine stop is not available due to one of the above noted conditions not being met.

Automatic Engine Restart

Any of the following conditions will result in an automatic restart of the engine:

- You have removed your foot from the brake pedal.
- You press the accelerator pedal.
- You press the accelerator and the brake pedal at the same time.
- The driver safety belt becomes unfastened or the driver door is ajar.
- Your vehicle is moving.
- The interior compartment does not meet customer comfort when air conditioning or heat is on.
- Fogging of the windows could occur and the air conditioning is on.
- The battery is not within optimal operating conditions.
- You have exceeded the maximum engine off time.
- When you press the Auto-Start-Stop button with the engine automatically stopped.

- The front defroster is turned to the Max setting.
- When you shift into park (P), the engine will restart.

Any of the following conditions may result in an automatic restart of the engine:

- You have increased the blower fan speed or changed the climate control temperature.
- You have an electrical accessory turned on or plugged in.

Note: You may notice that the climate seat fan fluctuates during an automatic restart.

Disabling Auto-Start-Stop



E181352

Press the Auto-Start-Stop button on the center console to switch the system off. The button will illuminate. Deactivating using the button lasts only 1 key cycle. Press the button again to restore Auto-Start-Stop function.

Note: If the Shift to park (P), Restart Engine message appears and the amber Auto-Start-Stop indicator light flashes, this indicates automatic restart is unavailable. You must restart the vehicle manually. See **Information Displays** (page 110).

Unique Driving Characteristics

If your vehicle is in an engine off Auto-Start-Stop, shifting from drive (D) to reverse (R) will not cause a restart if you do not press the brake pedal. The message Auto-Start-Stop Press Brake to Start Engine appears. You must press the brake pedal within 60 seconds or the system requires you to shift into park (P) and manually restart your vehicle.

Fuel and Refueling

SAFETY PRECAUTIONS

 **WARNING:** Do not overfill the fuel tank. The pressure in an overfilled tank may cause leakage and lead to fuel spray and fire.

 **WARNING:** The fuel system may be under pressure. If you hear a hissing sound near the fuel filler inlet, do not refuel until the sound stops. Otherwise, fuel may spray out, which could cause serious personal injury.

 **WARNING:** Fuels can cause serious injury or death if misused or mishandled.

 **WARNING:** Fuel may contain benzene, which is a cancer-causing agent.

 **WARNING:** When refueling always shut the engine off and never allow sparks or open flames near the fuel tank filler valve. Never smoke or use a cell phone while refueling. Fuel vapor is extremely hazardous under certain conditions. Avoid inhaling excess fumes.

- Avoid inhaling fuel vapors. Inhaling fuel vapor can lead to eye and respiratory tract irritation. In severe cases, excessive or prolonged breathing of fuel vapor can cause serious illness and permanent injury.
- Avoid getting fuel in your eyes. If you splash fuel in your eyes, immediately remove contact lenses (if worn), flush with water for 15 minutes and seek medical attention. Failure to seek proper medical attention could lead to permanent injury.
- Fuels can be harmful if absorbed through the skin. If you splash fuel on your skin, clothing or both, promptly remove contaminated clothing and thoroughly wash your skin with soap and water. Repeated or prolonged skin contact causes skin irritation.
- Be particularly careful if you are taking Antabuse or other forms of Disulfiram for the treatment of alcoholism. Breathing fuel vapors could cause an adverse reaction, serious personal injury or sickness. Immediately call a physician if you experience any adverse reactions.

FUEL QUALITY

Choosing the Right Fuel

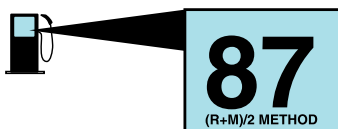

E161513

Your vehicle is designed to operate on regular unleaded gasoline with a minimum pump (R+M)/2 octane rating of 87.

Follow these guidelines when refueling:

- Extinguish all smoking materials and any open flames before refueling your vehicle.
- Always switch the engine off before refueling.
- Automotive fuels can be harmful or fatal if swallowed. Fuel is highly toxic and if swallowed can cause death or permanent injury. If fuel is swallowed immediately call a physician, even if no symptoms are immediately apparent. The toxic effects of fuel may not be apparent for hours.

Fuel and Refueling

Some fuel stations, particularly those in high altitude areas, offer fuels posted as regular unleaded gasoline with an octane rating below 87. The use of these fuels could result in engine damage that will not be covered by the vehicle warranty.

For best overall vehicle and engine performance, premium fuel with an octane rating of 91 or higher is recommended. The performance gained by using premium fuel is most noticeable in hot weather as well as other conditions, for example when towing a trailer. See **Towing** (page 275).

Do not be concerned if the engine sometimes knocks lightly. However, if the engine knocks heavily while using fuel with the recommended octane rating, contact an authorized dealer to prevent any engine damage.

We recommend Top Tier detergent gasolines, where available to help minimize engine deposits and maintain optimal vehicle and engine performance. For additional information, refer to www.toptiergas.com.

Note: *Use of any fuel for which the vehicle was not designed can impair the emission control system, cause loss of vehicle performance, and cause damage to the engine which may not be covered by the vehicle Warranty.*

Do not use:

- Diesel fuel.
- Fuels containing kerosene or paraffin.
- Fuel containing more than 15% ethanol or E85 fuel.
- Fuels containing methanol.
- Fuels containing metallic-based additives, including manganese-based compounds.

- Fuels containing the octane booster additive, methylcyclopentadienyl manganese tricarbonyl (MMT).
- Leaded fuel, using leaded fuel is prohibited by law.

The use of fuels with metallic compounds such as methylcyclopentadienyl manganese tricarbonyl (commonly known as MMT), which is a manganese-based fuel additive, will impair engine performance and affect the emission control system.

FUEL FILLER FUNNEL LOCATION

The fuel filler funnel is under the luggage compartment floor covering.

RUNNING OUT OF FUEL

Running out of fuel can cause damage not covered by the vehicle Warranty.

If your vehicle runs out of fuel:

- Add a minimum of 1.3 gal (5 L) of fuel to restart the engine.
- You may need to switch the ignition from off to on several times after refueling to allow the fuel system to pump the fuel from the tank to the engine. When restarting, cranking time takes a few seconds longer than normal.

Note: *If your vehicle is on a steep slope, more fuel may be required.*

Filling a Portable Fuel Container



WARNING: Flow of fuel through a fuel pump nozzle can produce static electricity. This can cause a fire if you are filling an ungrounded fuel container.

Fuel and Refueling

Use the following guidelines to avoid electrostatic charge build-up, which can produce a spark, when filling an ungrounded fuel container:

- Only use an approved fuel container to transfer fuel to your vehicle. Place the container on the ground when filling it.
- Do not fill a fuel container when it is inside your vehicle (including the cargo area).
- Keep the fuel pump nozzle in contact with the fuel container when filling it.
- Do not use a device that holds the fuel pump nozzle lever in the fill position.

Adding Fuel From a Portable Fuel Container



WARNING: Do not insert the nozzle of a fuel container or an aftermarket funnel into the fuel filler neck. This may damage the fuel system filler neck or its seal and cause fuel to run onto the ground.



WARNING: Do not try to pry open or push open the capless fuel system with foreign objects. This could damage the fuel system and its seal and cause injury to you or others.



WARNING: Do not dispose of fuel in the household refuse or the public sewage system. Use an authorized waste disposal facility.

When refueling the vehicle fuel tank from a fuel container, use the fuel filler funnel included with your vehicle. See **Fuel Filler Funnel Location** (page 185).

Note: Do not use aftermarket funnels as they may not work with the capless fuel system and can damage it.

When refueling the vehicle fuel tank from a fuel container, do the following:

1. Fully open the fuel filler door.
2. Fully insert the fuel filler funnel into the fuel filler inlet.



E157452

3. Add fuel to your vehicle from the fuel container.
4. Remove the fuel filler funnel.
5. Fully close the fuel filler door.
6. Clean the fuel filler funnel and place it back in your vehicle or correctly dispose of it.

Note: Extra funnels can be purchased from an authorized dealer if you choose to dispose of the funnel.

Fuel and Refueling

REFUELING

Refueling System Overview

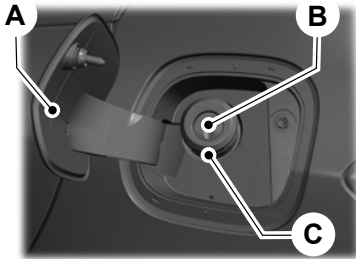

E267248

- A Fuel filler door.
- B Fuel tank filler valve.
- C Fuel tank filler pipe.

Your vehicle does not have a fuel tank filler cap.

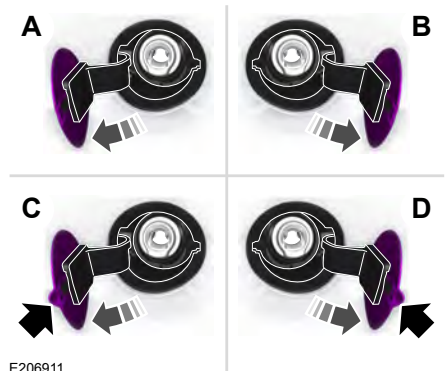

E206911

- A Left-hand side. To open the fuel filler door, press the center rear edge of the fuel filler door and then release.
- B Right-hand side. To open the fuel filler door, press the center rear edge of the fuel filler door and then release.
- C Left-hand side. Pull the rear of the fuel filler door to open it.
- D Right-hand side. Pull the rear of the fuel filler door to open it.

Refueling Your Vehicle





WARNING: When refueling always shut the engine off and never allow sparks or open flames near the fuel tank filler valve. Never smoke or use a cell phone while refueling. Fuel vapor is extremely hazardous under certain conditions. Avoid inhaling excess fumes.

Fuel and Refueling

 **WARNING:** The fuel system may be under pressure. If you hear a hissing sound near the fuel filler inlet, do not refuel until the sound stops. Otherwise, fuel may spray out, which could cause serious personal injury.

 **WARNING:** Do not pry open the fuel tank filler valve. This could damage the fuel system. Failure to follow this instruction could result in fire, personal injury or death.

 **WARNING:** Do not remove the fuel pump nozzle from its fully inserted position when refueling.

 **WARNING:** Stop refueling when the fuel pump nozzle automatically shuts off for the first time. Failure to follow this will fill the expansion space in the fuel tank and could lead to fuel overflowing.

 **WARNING:** Do not overfill the fuel tank. The pressure in an overfilled tank may cause leakage and lead to fuel spray and fire.

 **WARNING:** Wait at least five seconds before removing the fuel pump nozzle to allow any residual fuel to drain into the fuel tank.

1. Fully open the fuel filler door.
2. Select the correct fuel pump nozzle for your vehicle.

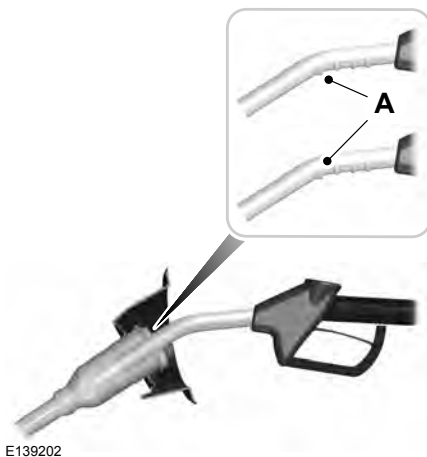

3. Insert the fuel pump nozzle up to the first notch on the nozzle A. Keep the fuel pump nozzle resting on the fuel tank filler pipe.

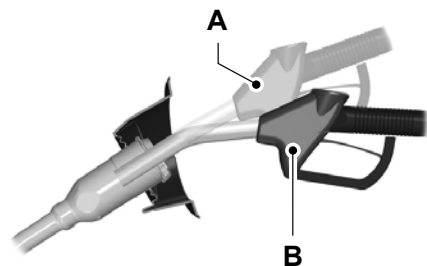

4. Hold the fuel pump nozzle in position B when refueling. Holding the fuel pump nozzle in position A can affect the flow of fuel and shut off the fuel pump nozzle before the fuel tank is full.

Fuel and Refueling

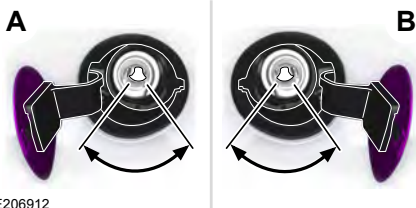

E206912

5. Operate the fuel pump nozzle within the area shown.

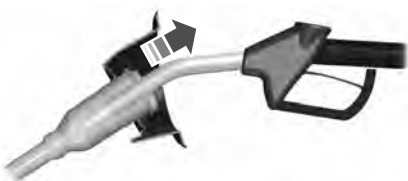

E119081

6. When you finish refueling slightly raise the fuel pump nozzle and slowly remove it.
7. Fully close the fuel filler door.

Do not attempt to start the engine if you have filled the fuel tank with incorrect fuel. Incorrect fuel use could cause damage not covered by the vehicle Warranty. Have your vehicle immediately checked.

Refueling System Warning (If Equipped)

If the fuel tank filler valve does not fully close, a message could appear in the information display.

Message
Check Fuel Fill Inlet

If the message appears, do the following:

1. Stop your vehicle as soon as it is safe to do so and switch the engine off.
2. Shift into park (P) or neutral (N).

3. Apply the parking brake.
4. Fully open the fuel filler door.
5. Check the fuel tank filler valve for any debris that may be restricting its movement.
6. Remove any debris from the fuel tank filler valve.
7. Fully insert a fuel pump nozzle or the fuel filler funnel provided with your vehicle into the fuel filler pipe. See **Fuel Filler Funnel Location** (page 185). This action should dislodge any debris that may be preventing the fuel tank filler valve from fully closing.
8. Remove the fuel pump nozzle or fuel filler funnel from the fuel filler pipe.
9. Fully close the fuel filler door.

Note: The message may not immediately reset. If the message continues to appear and a warning lamp illuminates, have your vehicle checked as soon as possible.

FUEL CONSUMPTION

Advertised Capacity

The advertised capacity is the maximum amount of fuel that you can add to the fuel tank when the fuel gauge indicates empty. See **Capacities and Specifications** (page 384).

In addition, the fuel tank contains an empty reserve. The empty reserve is an unspecified amount of fuel that remains in the fuel tank when the fuel gauge indicates empty.

Note: The amount of fuel in the empty reserve varies and should not be relied upon to increase driving range.

Fuel and Refueling

Filling the Fuel Tank

For consistent results when refueling:

- Turn the ignition off before fueling; an inaccurate reading results if the engine is left running.
- Use the same fill rate (low-medium-high) each time the tank is filled.
- Allow no more than one automatic shut-off when refueling.

Results are most accurate when the filling method is consistent.

Calculating Fuel Economy

Your vehicle calculates fuel economy figures through the trip computer average fuel function. See **Information Displays** (page 110).

The first 1,000 mi (1,500 km) of driving is the break-in period of the engine. A more accurate measurement is obtained after 2,000 mi (3,000 km).

1. Completely fill the fuel tank and record the initial odometer reading. See **Refueling** (page 187).
2. Each time you fill the fuel tank, record the amount of fuel added.
3. After at least three fill ups, fill the fuel tank and record the current odometer reading.
4. Subtract your initial odometer reading from the current odometer reading.

To calculate L/100 km (liters per 100 kilometers) fuel consumption, multiply the liters used by 100, then divide by kilometers traveled. To calculate MPG (miles per gallon) fuel consumption, divide miles traveled by gallons used.

Keep a record for at least one month and record the type of driving, for example city or highway. This provides an accurate estimate of your vehicle's fuel economy under current driving conditions. Keeping records during summer and winter shows how temperature impacts fuel economy.

Conditions

- Heavily loading your vehicle reduces fuel economy.
- Carrying unnecessary weight in your vehicle may reduce fuel economy.
- Avoid adding accessories that increase aerodynamic drag to your vehicle such as bug deflectors, car top carriers and ski or bike racks.
- Using fuel blended with alcohol may lower fuel economy.
- Fuel economy may decrease with lower temperatures.
- Fuel economy may decrease when driving short distances.
- You will get better fuel economy when driving on flat terrain than when driving on hilly terrain.

Engine Emission Control

EMISSION LAW



WARNING: Do not remove or alter the original equipment floor covering or insulation between it and the metal floor of the vehicle. The floor covering and insulation protect occupants of the vehicle from the engine and exhaust system heat and noise. On vehicles with no original equipment floor covering insulation, do not carry passengers in a manner that permits prolonged skin contact with the metal floor. Failure to follow these instructions may result in fire or personal injury.

U.S. federal laws and certain state laws prohibit removing or rendering inoperative emission control system components. Similar federal or provincial laws may apply in Canada. We do not approve of any vehicle modification without first determining applicable laws.



Tampering with emissions control systems including related sensors or the Diesel Exhaust Fluid system can result in reduced engine power and the illumination of the service engine soon light.

Tampering With a Noise Control System

Federal laws prohibit the following acts:

- Removal or rendering inoperative by any person other than for purposes of maintenance.
- Repair or replacement of any device or element of the design incorporated into a new vehicle for the purpose of noise control prior to its sale or delivery to the ultimate purchaser or while it is in use.
- The use of the vehicle after any person removes or renders inoperative any device or element of the design.

The U.S. Environmental Protection Agency may presume to constitute tampering as follows:

- Removal of hood blanket, fender apron absorbers, fender apron barriers, underbody noise shields or acoustically absorptive material.
- Tampering or rendering inoperative the engine speed governor, to allow engine speed to exceed manufacturer specifications.

If the engine does not start, runs rough, experiences a decrease in engine performance, experiences excess fuel consumption or produces excessive exhaust smoke, check for the following:

- A plugged or disconnected air inlet system hose.
- A plugged engine air filter element.
- Water in the fuel filter and water separator.
- A clogged fuel filter.
- Contaminated fuel.
- Air in the fuel system, due to loose connections.
- An open or pinched sensor hose.
- Incorrect engine oil level.

Engine Emission Control

- Incorrect fuel for climatic conditions.
- Incorrect engine oil viscosity for climactic conditions.

Note: *Some vehicles have a lifetime fuel filter that is integrated with the fuel tank. Regular maintenance or replacement is not needed.*

Note: *If these checks do not help you correct the concern, have your vehicle checked as soon as possible.*

Noise Emissions Warranty, Prohibited Tampering Acts and Maintenance

On January 1, 1978, Federal regulation became effective governing the noise emission on trucks over 10,000 lb (4,536 kg) Gross Vehicle Weight Rating (GVWR). The preceding statements concerning prohibited tampering acts and maintenance, and the noise warranty found in the Warranty Guide, are applicable to complete chassis cabs over 10,000 lb (4,536 kg) GVWR.

CATALYTIC CONVERTER



WARNING: Do not park, idle or drive your vehicle on dry grass or other dry ground cover. The emission system heats up the engine compartment and exhaust system, creating the risk of fire.



WARNING: The normal operating temperature of the exhaust system is very high. Never work around or attempt to repair any part of the exhaust system until it has cooled. Use special care when working around the catalytic converter. The catalytic converter heats up to a very high temperature after only a short period of engine operation and stays hot after the engine is switched off.



WARNING: Exhaust leaks may result in entry of harmful and potentially lethal fumes into the passenger compartment. If you smell exhaust fumes inside your vehicle, have your vehicle inspected immediately. Do not drive if you smell exhaust fumes.

Your vehicle has various emission control components and a catalytic converter that enables it to comply with applicable exhaust emission standards.

To make sure that the catalytic converter and other emission control components continue to work properly:

- Do not crank the engine for more than 10 seconds at a time.
- Do not run the engine with a spark plug lead disconnected.
- Do not push-start or tow-start your vehicle. Use booster cables. See **Jump Starting the Vehicle** (page 303).
- Use only the specified fuel listed.
- Do not switch the ignition off when your vehicle is moving.
- Avoid running out of fuel.
- Have the items listed in scheduled maintenance information performed according to the specified schedule.

Note: *Resulting component damage may not be covered by the vehicle Warranty.*

The scheduled maintenance items listed in scheduled maintenance information are essential to the life and performance of your vehicle and to its emissions system.

If you use anything other than Ford, Motorcraft or Ford-authorized parts for maintenance replacements or for service of components affecting emission control, such non-Ford parts should be equivalent to genuine Ford Motor Company parts in performance and durability.

Engine Emission Control

Illumination of the service engine soon indicator, charging system warning light or the temperature warning light, fluid leaks, strange odors, smoke or loss of engine power could indicate that the emission control system is not working properly.

An improperly operating or damaged exhaust system may allow exhaust to enter the vehicle. Have a damaged or improperly operating exhaust system inspected and repaired immediately.

Do not make any unauthorized changes to your vehicle or engine. By law, vehicle owners and anyone who manufactures, repairs, services, sells, leases, trades vehicles, or supervises a fleet of vehicles are not permitted to intentionally remove an emission control device or prevent it from working. Information about your vehicle's emission system is on the Vehicle Emission Control Information Decal located on or near the engine. This decal also lists engine displacement.

Please consult your warranty information for complete details.

On-Board Diagnostics (OBD-II)

Your vehicle has a computer known as the on-board diagnostics system (OBD-II) that monitors the engine's emission control system. The system protects the environment by making sure that your vehicle continues to meet government emission standards. The OBD-II system also assists a service technician in properly servicing your vehicle.



When the service engine soon indicator illuminates, the OBD-II system has detected a malfunction. Temporary malfunctions may cause the service engine soon indicator to illuminate. Examples are:

1. Your vehicle has run out of fuel—the engine may misfire or run poorly.
2. Poor fuel quality or water in the fuel—the engine may misfire or run poorly.
3. The fuel fill inlet may not have closed properly. See **Refueling** (page 187).
4. Driving through deep water—the electrical system may be wet.

You can correct these temporary malfunctions by filling the fuel tank with good quality fuel, properly closing the fuel fill inlet or letting the electrical system dry out. After three driving cycles without these or any other temporary malfunctions present, the service engine soon indicator should stay off the next time you start the engine. A driving cycle consists of a cold engine startup followed by mixed city and highway driving. No additional vehicle service is required.

If the service engine soon indicator remains on, have your vehicle serviced at the first available opportunity. Although some malfunctions detected by the OBD-II may not have symptoms that are apparent, continued driving with the service engine soon indicator on can result in increased emissions, lower fuel economy, reduced engine and transmission smoothness and lead to more costly repairs.

Readiness for Inspection and Maintenance (I/M) Testing

Some state and provincial and local governments may have Inspection/Maintenance (I/M) programs to inspect the emission control equipment on your vehicle. Failure to pass this inspection could prevent you from getting a vehicle registration.



If the service engine soon indicator is on or the bulb does not work, your vehicle may need service. See On-Board Diagnostics.

Engine Emission Control

Your vehicle may not pass the I/M test if the service engine soon indicator is on or not working properly (bulb is burned out), or if the OBD-II system has determined that some of the emission control systems have not been properly checked. In this case, the vehicle is not ready for I/M testing.

If the vehicle's engine or transmission has just been serviced, or the battery has recently run down or been replaced, the OBD-II system may indicate that the vehicle is not ready for I/M testing. To determine if the vehicle is ready for I/M testing, turn the ignition key to the on position for 15 seconds without cranking the engine. If the service engine soon indicator blinks eight times, it means that the vehicle is not ready for I/M testing; if the service engine soon indicator stays on solid, it means that your vehicle is ready for I/M testing.

The OBD-II system checks the emission control system during normal driving. A complete check may take several days.

If the vehicle is not ready for I/M testing, you can perform the following driving cycle consisting of mixed city and highway driving:

1. 15 minutes of steady driving on an expressway or highway followed by 20 minutes of stop-and-go driving with at least four 30-second idle periods.
2. Allow your vehicle to sit for at least eight hours with the ignition off. Then, start the vehicle and complete the above driving cycle. The vehicle must warm up to its normal operating temperature. Once started, do not turn off the vehicle until the above driving cycle is complete.

If the vehicle is still not ready for I/M testing, you need to repeat the above driving cycle.

Transmission

AUTOMATIC TRANSMISSION



WARNING: Always fully apply the parking brake. Make sure you shift into park (P) for vehicles with an automatic transmission. Switch the ignition off and remove the key whenever you leave your vehicle.



WARNING: Do not use tow/haul when the road surface is slippery. Failure to follow this instruction could result in the loss of control of your vehicle.



WARNING: When your vehicle is stationary, keep the brake pedal fully pressed when shifting gears. Failure to follow this instruction could result in personal injury, death or property damage.

Note: You may not be able to shift out of park (P) unless the intelligent access key is inside your vehicle.

Understanding the Shift Positions of your Automatic Transmission

Console Shifter



E252861

Column Shifter (If Equipped)



E249567

Note: The button on the gearshift lever can be pressed to cycle through the available drive modes. See **Drive Control** (page 262).

Putting your vehicle in or out of gear:

1. Fully press down on the brake pedal.
2. Move the transmission selector to the desired gear.

Transmission

3. When you are finished driving, come to a complete stop.
4. Move the transmission selector to park (P).

The instrument cluster displays the current gear.

Park (P)

With the transmission in park (P), your vehicle locks the transmission and prevents the wheels from turning. Always come to a complete stop before putting your vehicle into and out of park (P).

On a console shifter, when the ignition is turned off, your vehicle automatically shifts into park (P). If the ignition is turned off when the vehicle is moving, it first shifts into neutral (N) until it comes to a complete stop. Your vehicle then shifts into park (P) automatically.

The electric parking brake may apply when you shift to park (P) without the brake pedal fully pressed. The electric parking brake applies when you shift to park (P) on large slopes. The electric parking brake releases with the drive away release function or manually as described in the Releasing the Electric Parking Brake section. See **Electric Parking Brake** (page 212).

Automatic Return to Park - Console Shifter

Note: *This feature does not operate when your vehicle is in Stay in Neutral mode or neutral tow.*

Your vehicle has a feature that shifts into park (P) when any of the following conditions occur:

- You turn the vehicle off.
- You open the driver door with your seatbelt unlatched and the vehicle stopped.
- You unlatch your seatbelt when the driver door is open and the vehicle stopped.

If you turn your vehicle off when moving, your vehicle first shifts into neutral (N) until it comes to a complete stop and then shift into park (P) automatically.

Note: *If you have waited an extended period of time, 2-15 minutes before starting your vehicle, unlatching your seatbelt can cause this feature to turn on, even with the driver door closed.*

Note: *This feature may not work properly if the door ajar switch is malfunctioning. If your door ajar indicator does not illuminate when you open the driver door or the indicator illuminates with the driver door closed, see your authorized dealer.*

Reverse (R)

With the selector in reverse (R), your vehicle moves backward. Always come to a complete stop before shifting into and out of reverse (R).

Neutral (N)

With the selector in neutral (N), your vehicle can be started and is free to roll. Hold the brake pedal down when in this position.

Transmission

Stay in Neutral Mode - Console Shifter

Stay in Neutral mode allows your vehicle to stay in neutral when you exit your vehicle. Extended usage of Stay in Neutral mode may result in a battery voltage reduction to a level where the vehicle may no longer start. Your vehicle must be stationary to enter this mode.

Note: *Stay in neutral mode is a temporary vehicle state with the ignition off. Once in this mode, sufficient battery voltage must be maintained or your vehicle returns to park. Do not tow your vehicle in this mode.*

Note: *Always put your vehicle in Stay in Neutral mode if you want your vehicle to stay in neutral when you exit or turn off your vehicle. Refer to the Return to Park section for more information.*

Note: *Do not use this feature for towing your vehicle.*



WARNING: When doing this procedure, you need to take the transmission out of park (P) which means your vehicle can roll freely. To avoid unwanted vehicle movement, always fully apply the parking brake prior to doing this procedure. Use wheels chocks if appropriate.

To enter Stay in Neutral mode:

- Move the transmission selector to neutral (N).
- A message appears in your information display screen prompting you to press the manual (M) button.
- Press the manual (M) button again to enter Stay in Neutral mode.
 - This step can be completed as long as the message prompts you to remain in Neutral (N).
 - A confirmation message appears in the information display when your vehicle has entered Stay in Neutral mode.

To exit Stay in Neutral mode, apply the brake and select a different gear. See Putting your vehicle in or out of gear for more information.

Stay in Neutral Mode - Console Shifter - No Start

Use this feature to move your transmission from the park position in the event of a no start situation. If your vehicle has a dead battery, an external power source is required. Do not tow your vehicle in this mode.

Note: *This feature only functions if your 12-volt battery has power and the starter can spin the engine. If vehicle battery voltage is not sufficient, an external 12-volt power source (for example, jumper cables, battery charger or jump pack) may be required for this feature to function.*

Note: *Once in this mode, sufficient battery voltage must be maintained or your vehicle returns to park.*

Transmission



WARNING: When doing this procedure, you need to take the transmission out of park (P) which means your vehicle can roll freely. To avoid unwanted vehicle movement, always fully apply the parking brake prior to doing this procedure. Use wheels chocks if appropriate.

1. Do not press the brake pedal. Press the **START/STOP** button.
2. Fully press down on the brake pedal. Keep the brakes applied through step 6.
3. Press the accelerator pedal to the floor and hold through step 6.
4. Rotate transmission selector to Neutral (N) and press the manual (M) button.
5. Press and release the push to start button, the transmission needs a minimum of 2 seconds to exit park.
6. When neutral (N) is displayed, the brake and accelerator pedals can be released.

To exit Stay in Neutral mode, select a different gear.

A message appears in your information display screen when your vehicle has entered Stay in Neutral mode.

Drive (D)

Drive (D) is the normal driving position for the best fuel economy. The overdrive function allows automatic upshifts and downshifts through gears one through ten.

Manual (M)

With the transmission selector in manual (M), you can change gears up or down as desired. By pushing the manual (M) button, you have control of selecting the gear you desire using the + and - buttons on the transmission selector.

Tow/Haul Mode



WARNING: Do not use tow/haul when the road surface is slippery. Failure to follow this instruction could result in the loss of control of your vehicle.



With Column Shifter

To activate tow haul for the column shifter, press the button on the gearshift lever to cycle through the available drive modes until tow haul mode is selected. See **Drive Control** (page 262). The tow haul indicator light illuminates in the instrument cluster when the system is active.

Without Column Shifter

To activate tow haul, press the drive modes button or rotate the dial, to cycle through the available drive modes until tow haul is selected. See **Drive Control** (page 262). The tow haul indicator light illuminates in the instrument cluster when the system is active.

The tow/haul feature:

- Moves upshifts to higher engine speeds to reduce the frequency of transmission shifting.
- Provides engine braking in all forward gears, which slows your vehicle and assist you in controlling your vehicle when descending a slope.
- Depending on driving conditions and load conditions, may downshift the transmission, slow your vehicle to help control your vehicle speed when descending a hill. The amount of downshift braking provided varies based upon the amount the brake pedal is pressed.

The tow haul feature improves transmission operation when towing a trailer or a heavy load.

Transmission

To deactivate the tow haul feature for column shifter and return to normal driving mode, press the button on the gearshift lever twice. The indicator light deactivates when the system turns off. Tow haul mode also deactivates when you power down your vehicle.

To deactivate the tow haul feature for vehicles without a column shifter, cycle through the available drive modes with the drive modes button or rotary dial to select an alternate mode. See **Drive Control** (page 262). The indicator light deactivates when the system turns off.

SelectShift™ Automatic Transmission

Your vehicle is equipped with a SelectShift Automatic transmission. The SelectShift Automatic transmission gives you the ability to change gears up or down without a clutch as desired.

In order to prevent the engine from running at too low of an RPM, which may cause it to stall, SelectShift still automatically makes some downshifts if it has determined that you have not downshifted in time. Although SelectShift makes some downshifts for you, it still allows you to downshift at any time as long as the SelectShift determines that damage to the engine does not occur from over-revving.

Note: *Engine damage may occur if you maintain excessive engine revving without shifting.*



E252861

The SelectShift Automatic transmission feature has two modes: Progressive Range Selection (PRS) and M mode.

Progressive Range Selection - PRS

Progressive Range Selection gives you the ability to lockout gears from the automatic shifting range. This may provide you with an improved driving experience, for example, in slippery conditions or when experiencing a steep slope.

With the transmission selector in drive (D), push the – button to active PRS. The available and selected gears are indicated on the instrument cluster.

All available gears display with the current gear indicated. Push the – button again to lock out gears beginning with the highest gear. Example: push the – button twice to lock out 10th and 9th gears. Only the available gears are displayed and the

Transmission

transmission automatically shifts between the available gears. Push the + button to unlock gears and allow the transmission to shift to higher gears. The transmission shifts automatically within the gear range you select.

Manual (M)

Pushing the manual (M) button on the selector allows you to manually select the gear you desire. Only the current gear is displayed. Use the buttons on the transmission selector to manually select gears. Push the + button to upshift or the – button to downshift. Once in Manual mode, press (M) again to deactivate manual control.

SelectShift does not automatically upshift, even if the engine is approaching the RPM limit. It must be shifted manually by pushing the + button.

Brake-Shift Interlock



WARNING: When doing this procedure, you need to take the transmission out of park (P) which means your vehicle can roll freely. To avoid unwanted vehicle movement, always fully apply the parking brake prior to doing this procedure. Use wheels chocks if appropriate.



WARNING: If the parking brake is fully released, but the brake warning lamp remains illuminated, the brakes may not be working properly. Have your vehicle checked as soon as possible.

Note: Do not drive your vehicle until you verify that the brake lamps are working.

Note: See your authorized dealer as soon as possible if this procedure is used.

Note: For some markets this feature is disabled.

Your vehicle is equipped with a brake-shift interlock feature that prevents moving the transmission from park (P) when the ignition is in the on position and the brake pedal is not pressed.

If you cannot move the selector out of park (P) with the ignition in the on position and the brake pedal pressed, a malfunction may have occurred. It is possible that a fuse has blown or your vehicle's brake lamps are not operating properly. See **Fuse Specification Chart** (page 315).

If the fuse is not blown and the brake lamps are working properly, the following procedure allows you to move the gearshift lever from park (P):

1. Apply the parking brake and start the engine before performing this procedure.
2. Locate your brake-shift interlock access slot. The slot is located in your center console storage bin. The access slot does not have a label.



E253438

Transmission

3. Using a screwdriver, press and hold the brake shift interlock switch.
4. With the override switch still held, put the transmission selector in neutral (N).
5. Release the override button.
6. You can shift into gear and drive the vehicle, if possible.
7. Release the parking brake.

Automatic Transmission Adaptive Learning

This feature may increase durability and provide consistent shift feel over the life of your vehicle. A new vehicle or transmission may have firm shifts, soft shifts or both. This operation is considered normal and does not affect function or durability of the transmission. Over time, the adaptive learning process fully updates transmission operation.

If Your Vehicle Gets Stuck In Mud or Snow

Note: *Do not rock your vehicle if the engine is not at normal operating temperature or damage to the transmission may occur.*

Note: *Do not rock your vehicle for more than a minute or damage to the transmission and tires may occur, or the engine may overheat.*

If your vehicle gets stuck in mud or snow, you may rock it out by shifting between forward and reverse gears, stopping between shifts in a steady pattern. Press lightly on the accelerator in each gear.

Four-Wheel Drive (If Equipped)

USING FOUR-WHEEL DRIVE (IF EQUIPPED)

Note: For important information regarding safe operation of this type of vehicle, see General Information in the Wheels and Tires chapter.

Note: Do not use 4H or 4L mode on dry, hard surfaced roads. Doing so can produce excessive noise, increase tire wear and may damage drive components. 4H and 4L mode is only intended for consistently slippery or loose surfaces. Use of 4L mode on these surfaces may produce some noise, such as occasional clunks, but does not damage drive components.

Note: If 4L mode is selected when your vehicle is moving above 3 mph (5 km/h), the 4WD system does not perform a shift. This is normal and should be no reason for concern. Refer to Shifting to or from 4L for proper operation.

4X4 Indicator Lights

4X2

2H Momentarily illuminates when 2H is selected.

4X4 AUTO

4A Continuously illuminates when 4A is selected.

4X4 HIGH

4H Continuously illuminates when 4H is selected.

4X4 LOW

4L Continuously illuminates when 4L is selected.

CHECK 4X4



Displays when a 4X4 system fault is present.

Note: When a 4X4 system fault is present, the system typically remains in whichever 4WD mode was selected prior to the fault condition occurring. It does not default to 4X2 in all circumstances. When this warning is displayed, have your vehicle serviced by an authorized dealer.

4WD Switch Selections

 **WARNING:** Vehicles with a higher center of gravity (utility and four-wheel drive vehicles) handle differently than vehicles with a lower center of gravity (passenger cars). Avoid sharp turns, excessive speed and abrupt steering in these vehicles. Failure to drive cautiously increases the risk of losing control of your vehicle, vehicle rollover, personal injury and death.

Note: If your vehicle is equipped with AdvanceTrac® with RSC®, the system automatically turns off the stability enhancement feature when you shift the 4WD system into 4L - 4X4 LOW. You can manually turn the system off by pressing the AdvanceTrac button. See **Using Traction Control** (page 215). This turns off the engine management feature, allowing the vehicle to maintain full power and enhanced momentum through the obstacle. The brake traction enhancement feature is still turned on.

Note: The AdvanceTrac system has the ability to take over control of the transfer case clutch and disable it during driving maneuvers when necessary.

Note: 4WD mode availability is based on Drive Mode selection. See **Drive Control** (page 262).

Four-Wheel Drive (If Equipped)

Note: The information display may show messages during 4WD operation. See **Information Messages** (page 122).

Your 4X4 control is located in one of the following locations:

- On the instrument panel.
- On the **DRIVE MODE** selection switch.

2H - 4X2

Delivers power to the rear wheels only. The information display momentarily shows 2H when this mode is selected. This mode is appropriate for normal on-road driving on dry pavement and provides the best fuel economy.

Note: 2H may turn on or off automatically based on Drive Mode selection. See **Drive Control** (page 262).

4A - 4X4 AUTO

Provides electronic controlled four-wheel drive with power delivered to the front and rear wheels, as required, for increased traction. When you select this mode, the information display shows 4A. The system continuously monitors road conditions, driver input as well as other vehicle sensors and optimizes the system's behavior based on drive mode selection.

Note: On vehicles with a rotary drive mode switch, 4A should remain on in Mud/Rut and Sand but with aggressive tuning which provides electronically locked four-wheel drive power to front and rear wheels, the same as traditional 4H.

Note: 4A may turn on or off automatically based on Drive Mode selection. See **Drive Control** (page 262).

4H - 4X4 HIGH

Provides electronically locked four-wheel drive power to front and rear wheels. When you select this mode, the information display shows 4H. This mode is not recommended for use on dry pavement. This mode is only intended for severe winter or off-road conditions, such as deep snow, ice or shallow sand.

Note: 4H may turn on or off automatically based on Drive Mode selection. In configurations with a rotary Drive Mode switch, 4H functionality is within the Mud/Ruts and Sand Drive Modes even when the indicator lamp shows 4A. See **Drive Control** (page 262).

4L - 4X4 LOW

Provides electronically locked four-wheel drive power to both the front and rear wheels with additional gearing for increased torque multiplication. Intended only for off-road applications such as deep sand, steep grades, or pulling heavy objects. 4L - 4X4 low does not engage when your vehicle is moving above 3 mph (5 km/h); this is normal and should be no reason for concern. Refer to Shifting to or from 4L - 4X4 low for proper operation.

Note: 4L may turn off automatically based on Drive Mode selection. See **Drive Control** (page 262).

Shifting Between 4WD System Modes

Note: Momentarily releasing the accelerator pedal when a shift in progress message displays improves engagement and disengagement performance.

Note: Do not perform this operation if the rear wheels are slipping.

Note: Some noise may be heard as the system shifts or engages; this is normal.

Four-Wheel Drive (If Equipped)

You can change between 2H to 4A or 4H at a stop or when driving. The information display may show a message indicating a 4X4 shift is in progress and the LED light for the selected mode flashes. Once the shift is complete the information display shows the system mode selected and the LED light for the selected mode turns solid.

Shifting To or From 4L - 4X4 LOW

Note: 4L mode is not intended for use on dry pavement.

1. Bring the vehicle to a rolling speed of 3 mph (5 km/h) or less.
2. Place the gearshift in neutral (N).
3. Move the 4WD switch to the desired mode.

The information display shows a message indicating a 4X4 shift is in progress. The information display then shows the selected system mode. If any of the previous shift conditions are not present, the shift does not occur and the information display shows information guiding you through the proper shifting procedures. If the above conditions are not satisfied in 30 seconds, the system reverts back to the previous 4WD mode or drive mode.

If **Shift Delayed Pull Forward** is displayed in the information display, transfer case gear tooth blockage is present. To alleviate this condition, place the transmission in a forward gear, move the vehicle forward approximately 5 ft (2 m), and shift the transmission back to neutral (N) to allow the transfer case to complete the range shift.

Operating 4WD Vehicles With Spare or Mismatched Tires

On four-wheel drive vehicles, the size of the spare tire can affect the 4X4 system. If there is a significant difference between the size of the spare tire and the remaining tires, you may have limited four-wheel drive functionality.

When driving with the full-size dissimilar spare wheel and tire assembly, it is recommended that you do not:

- Exceed 50 mph (80 km/h) with a 4WD mode turned on.
- Turn on a 4WD mode unless the vehicle is stationary.
- Use a 4WD mode on dry pavement.

Use of a dissimilar spare wheel and tire assembly may lead to impairment of the following:

- Comfort and noise.
- Winter weather driving capability.
- Wet driving capability.
- Four-wheel drive capability.

How Your Vehicle Differs From Other Vehicles



WARNING: Vehicles with a higher center of gravity (utility and four-wheel drive vehicles) handle differently than vehicles with a lower center of gravity (passenger cars). Avoid sharp turns, excessive speed and abrupt steering in these vehicles. Failure to drive cautiously increases the risk of losing control of your vehicle, vehicle rollover, personal injury and death.

Four-Wheel Drive (If Equipped)

Truck and utility vehicles can differ from some other vehicles. Your vehicle may be higher to allow it to travel over rough terrain without getting hung up or damaging underbody components.

The differences that make your vehicle so versatile also make it handle differently than an ordinary passenger car.

Maintain steering wheel control at all times, especially in rough terrain. Since sudden changes in terrain can result in abrupt steering wheel motion, make sure you grip the steering wheel from the outside. Do not grip the spokes.

Drive cautiously to avoid vehicle damage from concealed objects such as rocks and stumps.

You should either know the terrain or examine maps of the area before driving. Map out your route before driving in the area. To maintain steering and braking control of your vehicle, you must have all four wheels on the ground and they must be rolling, not sliding or spinning.

Driving Off-Road With Truck and Utility Vehicles

Note: *On some models, the initial shift from two-wheel drive to four-wheel drive when your vehicle is moving can cause some momentary clunk and ratcheting sounds. This is the front drivetrain coming up to speed and the automatic locking hubs engaging and is not cause for concern.*

Note: *Your vehicle may have a front air dam that can become damaged, due to reduced ground clearance, when taking your vehicle off-road. You may remove this air dam by removing eight bolts.*

Four-wheel drive vehicles are specially equipped for driving on sand, snow, mud and rough terrain and have operating characteristics that are somewhat different from conventional vehicles, both on and off the road.

The transfer case supplies power to all four wheels. On four-wheel drive vehicles, the transfer case allows you to select different 4WD modes when necessary. You can find information on transfer case operation and shifting procedures in this chapter. You can find information on transfer case maintenance in the Maintenance chapter. You should become thoroughly familiar with this information before you operate your vehicle.

Four-wheel drive, when you select a 4WD mode, uses all four wheels to power your vehicle. This increases traction, enabling you to drive over terrain and road conditions that a conventional two-wheel drive vehicle cannot.

Basic Operating Principles

- Drive slower in strong crosswinds which can affect the normal steering characteristics of your vehicle.
- When driving your vehicle on surfaces made slippery by loose sand, water, gravel, snow or ice proceed with care.
- Do not use 4H or 4L on dry, hard surfaced roads. Doing so can produce excessive noise, increase tire wear and may damage drive components. 4H or 4L modes are only for consistently slippery or loose surfaces.

If Your Vehicle leaves the Road

If your vehicle leaves the road, reduce your vehicle speed and avoid severe braking. When your vehicle speed decreases, ease your vehicle back onto the road. Do not turn the steering wheel sharply when returning your vehicle to the road.

It may be safer to stay on the shoulder of the road and slow down gradually before returning to the road. You may lose control if you do not slow down or if you turn the steering wheel too sharply or abruptly.

Four-Wheel Drive (If Equipped)

It may be less risky to strike small objects, such as freeway reflectors, with minor damage to your vehicle rather than attempt a sudden return to the road which could cause your vehicle to slide sideways out of control or roll over. Remember, your safety and the safety of others should be your primary concern.

Emergency Maneuvers

In an unavoidable emergency situation where a sudden sharp turn must be made, remember to avoid over-driving your vehicle, for example, turn the steering wheel only as rapidly and as far as required to avoid the emergency. Excessive steering can result in loss of vehicle control. Apply smooth pressure to the accelerator pedal or brake pedal when changes in vehicle speed are required. Avoid abrupt steering, acceleration and braking. This could result in an increased risk of vehicle roll over, loss of vehicle control and personal injury. Use all available road surface to bring your vehicle to a safe direction of travel.

In the event of an emergency stop, avoid skidding the tires and do not attempt any sharp steering wheel movements.

If your vehicle goes from one type of surface to another, for example, from concrete to gravel, there is a change in the way your vehicle responds to a maneuver, for example, steering, acceleration or braking.

Sand

When driving over sand, try to keep all four wheels on the most solid area of the trail. Avoid reducing the tire pressures but shift to a lower gear and drive steadily through the terrain. Apply the accelerator slowly and avoid excessive wheel slip.

When driving at slow speeds in deep sand under high outside temperatures, use a low gear when possible. Low gear operation maximizes the engine and transmission cooling capability.

Avoid driving at excessive speeds, this causes vehicle momentum to work against you and your vehicle could become stuck to the point that assistance may be required from another vehicle. Remember, you may be able to back out the way you came if you proceed with caution.

Mud and Water

Mud

Be cautious of sudden changes in vehicle speed or direction when you are driving in mud. Even four-wheel drive vehicles can lose traction in slick mud. If your vehicle does slide, steer in the direction of the slide until you regain control of your vehicle.

After driving through mud, clean off residue stuck to rotating driveshafts and tires. Excess mud stuck on tires and rotating driveshafts can cause an imbalance that could damage drive components.

Water

If you must drive through high water, drive slowly. Traction or brake capability may be limited.

When driving through water, determine the depth and avoid water higher than the bottom of the hubs. If the ignition system gets wet, your vehicle may stall.

Once through water, always try the brakes. Wet brakes do not stop your vehicle as effectively as dry brakes. Drying improves by applying light pressure to the brake pedal when slowly moving.

Four-Wheel Drive (If Equipped)

Note: Driving through deep water may damage the transmission. If the front or rear axle is submerged in water, the axle lubricant and power transfer unit lubricant should be checked and changed if necessary.

Driving on Hilly or Sloping Terrain

Although natural obstacles may make it necessary to travel diagonally up or down a hill or steep incline, you should always try to drive straight up or straight down.

Note: Avoid turning on steep slopes or hills. A danger lies in losing traction, slipping sideways and possible vehicle roll over. Whenever driving on a hill, determine beforehand the route you want to use. Do not drive over the crest of a hill without seeing what conditions are on the other side. Do not drive in reverse over a hill without the aid of an observer.

When climbing a steep slope or hill, start in a lower gear rather than downshifting to a lower gear from a higher gear once the ascent has started. This reduces strain on the engine and the possibility of stalling.

If your vehicle stalls, do not try to turn around because this could cause vehicle roll over. It is better to reverse back to a safe location.

Apply just enough power to the wheels to climb the hill. Too much power can cause the tires to slip, spin or lose traction, resulting in loss of vehicle control.



E143949

Descend a hill in the same gear you would use to climb up the hill to avoid excessive brake application and brake overheating. Do not descend in neutral. Disengage overdrive or move the transmission selector lever to a lower gear. When descending a steep hill, avoid sudden hard braking as you could lose control. The front wheels have to be turning in order to steer your vehicle.

If your vehicle has anti-lock brakes, apply the brakes steadily. Do not pump the brakes.

Driving on Snow and Ice



WARNING: If you are driving in slippery conditions that require tire chains or cables, then it is critical that you drive cautiously. Keep speeds down, allow for longer stopping distances and avoid aggressive steering to reduce the chances of a loss of vehicle control which can lead to serious injury or death. If the rear end of your vehicle slides while cornering, steer in the direction of the slide until you regain control of your vehicle.

Note: Excessive tire slippage can cause transmission damage.

Four-Wheel Drive (If Equipped)

Four-wheel drive vehicles have advantages over two-wheel drive vehicles in snow and ice but can skid like any other vehicle. Should you start to slide when driving on snowy or icy roads, turn the steering wheel in the direction of the slide until you regain control.

Avoid sudden applications of power and quick changes of direction on snow and ice. Apply the accelerator slowly and steadily when starting from a full stop.

Avoid sudden braking. Although a four-wheel drive vehicle may accelerate better than a two-wheel drive vehicle in snow and ice, it does not stop any faster as braking occurs at all four wheels. Do not become overconfident as to road conditions.

Make sure you allow sufficient distance between you and other vehicles for stopping. Drive slower than usual and consider using one of the lower gears. In emergency stopping situations, apply the brake steadily. Do not pump the brake pedal. See **Hints on Driving With Anti-Lock Brakes** (page 211).

If Your Vehicle Gets Stuck In Mud or Snow



WARNING: Do not spin the wheels at over 34 mph (55 km/h). The tires may fail and injure a passenger or bystander.

If your vehicle gets stuck in mud or snow, you may rock it out by shifting between forward and reverse gears, stopping between shifts in a steady pattern. Press lightly on the accelerator in each gear.

Note: Do not rock your vehicle if the engine is not at normal operating temperature, damage to the transmission may occur.

Note: Do not rock your vehicle for more than a minute, damage to the transmission and tires may occur or the engine may overheat.

Parking



WARNING: If the parking brake is fully released, but the brake warning lamp remains illuminated, the brakes may not be working properly. Have your vehicle checked as soon as possible.



WARNING: Always fully apply the parking brake. Make sure you shift into park (P) for vehicles with an automatic transmission. Switch the ignition off and remove the key whenever you leave your vehicle.

On some four-wheel drive vehicles, when the transfer case is in the neutral (N) position, the engine and transmission disconnect from the rest of the driveline. Therefore, your vehicle is free to roll even if it is parked. Do not leave your vehicle unattended with the transfer case in the neutral (N) position. Always set the parking brake fully and turn off the ignition when leaving your vehicle.

Maintenance and Modifications

The suspension and steering systems on your vehicle have been designed and tested to provide predictable performance whether loaded or empty. For this reason, we strongly recommend that you do not make modifications such as adding or removing parts, for example, lift kits or stabilizer bars or by using replacement parts not equivalent to the original factory equipment.

Four-Wheel Drive (If Equipped)

We recommend that you use caution when your vehicle has either a high load or device, such as ladders or luggage racks. Any modifications to your vehicle that raise the center of gravity may cause your vehicle to roll over when there is a loss of vehicle control.

Failure to maintain your vehicle correctly may void the warranty, increase your repair cost, reduce vehicle performance and operational capabilities and adversely affect you and your passenger's safety. We recommend you frequently inspect your vehicle's chassis components when your vehicle is subject to off road usage.

Rear Axle

LIMITED SLIP DIFFERENTIAL

(IF EQUIPPED)

The Electronic Limited Slip Differential (eLSD) system directs torque, enabling the vehicle to drive over terrain and road conditions that a conventional axle cannot. The system is active at all times and requires no input from the driver.

Note: *If your vehicle is not at optimal operating conditions or a system fault is present, a warning may be displayed in the instrument cluster. Depending on the warning, your vehicle may need to be serviced. For more information regarding the system information messages, See **Information Messages** (page 122).*

Locking Function (If Equipped)



The lock button engages 'locker mode'.

With the locker engaged, the system electronically locks the differential causing both half shafts to turn at the same rate. This increases traction during off road events.

The locker mode may automatically disengage based on certain conditions such as vehicle speed. When engaged, a telltale in the instrument cluster will illuminate amber and the switch button will be illuminated. When the speed is exceeded the telltale will turn gray, the locker will be disengaged and be in standby mode until the speed conditions are met. If the eLSD system is faulted and the locker cannot engage, a warning message will be displayed in the instrument cluster and the switch button will flash.

Spare Tire

If your vehicle is equipped with an Electronic Limited Slip Differential, a spare tire of a different size than the tire provided, should not be used. If a spare tire is installed, a message may appear, indicating the system has disabled automatically or reduced function to prevent system overheat and damage. It is recommended to reinstall the repaired or replaced road tire as soon as possible. When the road tire is replaced, the system will resume normal operation on the next key cycle.

Trailer Towing

The Electronic Limited Slip Differential enhances vehicle stability during trailer tow operation. During high demand trailering events (such as steep grades, high speeds or with a spare tire), the system may provide a warning in the instrument cluster and reduce function or enter a temporarily disabled state. To resume normal function, stop the vehicle in a safe location and allow the unit to adequately cool. Once the system has reached normal operating temperatures, system function will be restored and the Electronic Limited Slip Differential Restored message will be displayed.

Brakes

GENERAL INFORMATION

Note: Occasional brake noise is normal. If a metal-to-metal, continuous grinding or continuous squeal sound is present, the brake linings may be worn-out and an authorized dealer should check them. If the vehicle has continuous vibration or shudder in the steering wheel while braking, an authorized dealer should check your vehicle.

Note: Brake dust may accumulate on the wheels, even under normal driving conditions. Some dust is inevitable as the brakes wear and does not contribute to brake noise. See **Cleaning the Wheels** (page 349).



See **Warning Lamps and Indicators** (page 105).

Wet brakes result in reduced braking efficiency. Gently press the brake pedal a few times when driving from a car wash or standing water to dry the brakes.

Brake Over Accelerator

In the event the accelerator pedal becomes stuck or entrapped, apply steady and firm pressure to the brake pedal to slow the vehicle and reduce engine power. If you experience this condition, apply the brakes and bring your vehicle to a safe stop. Switch the engine off, move the transmission to park (P) and apply the parking brake. Inspect the accelerator pedal and the area around it for any items or debris that may be obstructing its movement. If none are found and the condition persists, have your vehicle towed to the nearest authorized dealer.

Emergency Brake Assist

Emergency brake assist detects when you brake heavily by measuring the rate at which you press the brake pedal. It provides maximum braking efficiency as long as you press the pedal. Emergency brake assist can reduce stopping distances in critical situations.

Anti-lock Brake System

This system helps you maintain steering control during emergency stops by keeping the brakes from locking.



This lamp momentarily illuminates when you switch the ignition on. If the light does not illuminate during start up, remains on or flashes, the anti-lock braking system may be disabled. Have the system checked by an authorized dealer. If the anti-lock brake system is disabled, normal braking is still effective.



If the brake warning lamp illuminates with the parking brake released, have your brake system serviced immediately.

It also illuminates momentarily when you switch the ignition on to confirm the lamp is functional. If it does not illuminate when you switch the ignition on, or begins to flash at any time, have the system checked by an authorized dealer.

HINTS ON DRIVING WITH ANTI-LOCK BRAKES

The anti-lock braking system does not eliminate the risks when:

- You drive too closely to the vehicle in front of you.
- Your vehicle is hydroplaning.

Brakes

- You take corners too fast.
- The road surface is poor.

Note: If the system activates, the brake pedal may pulse and may travel further. Maintain pressure on the brake pedal. You may also hear a noise from the system. This is normal.

ELECTRIC PARKING BRAKE



WARNING: Always fully apply the parking brake and make sure you shift into park (P). Failure to follow this instruction could result in personal injury or death.



WARNING: If you drive extended distances with the parking brake applied, you could cause damage to the brake system.



WARNING: The electric parking brake does not operate if the vehicle battery is running out of charge.

Your vehicle has an electric parking brake. You operate it with a switch instead of a lever. The switch is on the center console or to the left-hand side of the steering wheel, on the lower part of the instrument panel.

Note: The electric parking brake makes noises during operation. This is normal.

Applying the Electric Parking Brake



Pull the switch upward.



The red warning lamp flashes during operation and illuminates when the parking brake is applied.



Note: It remains illuminated for a short period of time after you switch the ignition off.

If it continues to flash or does not illuminate, the system has malfunctioned. Have your vehicle checked as soon as possible.

Note: You can apply the electric parking brake when the ignition is off.

Note: The electric parking brake could automatically apply when you shift into park (P). See **Transmission** (page 195).

Applying the Electric Parking Brake in an Emergency

Note: Do not apply the electric parking brake when your vehicle is moving, except in an emergency. If you repeatedly use the electric parking brake to slow or stop your vehicle, you could cause damage to the brake system.

You can use the electric parking brake to slow or stop your vehicle in an emergency.



Pull the switch upward and hold it.



The red warning lamp illuminates, a tone sounds and the stoplamps turn on.



The electric parking brake continues to slow your vehicle down unless you release the switch.

Manually Releasing the Electric Parking Brake

Switch the ignition on.

Press and hold the brake pedal.

Brakes



Push the switch downward.



The red warning lamp turns off.



If it remains illuminated or flashes, the system has malfunctioned. Have your vehicle checked as soon as possible.

Pulling Away on a Hill When Towing a Trailer

Press and hold the brake pedal.



Pull the switch upward and hold it.

Shift into gear.

Press the accelerator pedal until engine has developed sufficient torque to prevent your vehicle from rolling down the hill.



Release the switch and pull away in a normal manner.

Automatically Releasing the Electric Parking Brake

Close the driver door.

Shift into gear.

Press the accelerator pedal and pull away in a normal manner.



The red warning lamp turns off.



If it remains illuminated or flashes, the electric parking brake has not released. Manually release the parking brake.

Releasing the Electric Parking Brake if the Vehicle Battery is Running Out of Charge

Connect a booster battery to the vehicle battery to release the electric parking brake if the vehicle battery is running out of charge. See **Jump Starting the Vehicle** (page 303).

HILL START ASSIST



WARNING: The system does not replace the parking brake. When you leave your vehicle, always apply the parking brake.



WARNING: You must remain in your vehicle when the system turns on. At all times, you are responsible for controlling your vehicle, supervising the system and intervening, if required. Failure to take care may result in the loss of control of your vehicle, serious personal injury or death.



WARNING: The system will turn off if a malfunction is apparent or if you rev the engine excessively. Failure to take care may result in the loss of control of your vehicle, serious personal injury or death.

The system makes it easier to pull away when your vehicle is on a slope without the need to use the parking brake.

When the system is active, your vehicle remains stationary on the slope for two to three seconds after you release the brake pedal. This allows time to move your foot from the brake to the accelerator pedal. The system releases the brakes automatically once the engine has

Brakes

developed sufficient torque to prevent your vehicle from rolling down the slope. This is an advantage when pulling away on a slope, for example from a car park ramp, traffic lights or when reversing uphill into a parking space.

The system activates on any slope that causes your vehicle to roll.

Note: *There is no warning light to indicate the system is either on or off.*

Using Hill Start Assist

1. Press the brake pedal to bring your vehicle to a complete standstill. Keep the brake pedal pressed and shift into first gear when facing uphill or reverse (R) when facing downhill.
2. If the sensors detect that your vehicle is on a slope, the system activates automatically.
3. When you remove your foot from the brake pedal, your vehicle remains on the slope without rolling away for about two to three seconds. This hold time automatically extends if you are in the process of driving off.
4. Drive off in the normal manner. The system releases the brakes automatically.

Note: *When you remove your foot from the brake pedal and press the pedal again when the system is active, you will experience significantly reduced brake pedal travel. This is normal.*

Switching the System On and Off

Vehicles with Manual Transmission

You can switch this feature on or off in the information display. The system remembers the last setting when you start your vehicle.

Vehicles with Automatic Transmission

You cannot turn the system on or off. When you switch the ignition on, the system automatically turns on.

Traction Control

PRINCIPLE OF OPERATION

The traction control system helps avoid drive wheel spin and loss of traction.

If your vehicle begins to slide, the system applies the brakes to individual wheels and, when needed, reduces engine power at the same time. If the wheels spin when accelerating on slippery or loose surfaces, the system reduces engine power in order to increase traction.

USING TRACTION CONTROL



WARNING: The stability and traction control light illuminates steadily if the system detects a failure. Make sure you did not manually disable the traction control system using the switch. If the stability control and traction control light is still illuminating steadily, have the system serviced by an authorized dealer immediately. Operating your vehicle with traction control disabled could lead to an increased risk of loss of vehicle control, vehicle rollover, personal injury and death.

The system automatically turns on each time you switch the ignition on.

If your vehicle is stuck in mud or snow, switching traction control off may be beneficial as this allows the wheels to spin.

Note: When you switch traction control off, stability control remains fully active.

Switching the System Off



E166706

The switch for the stability and traction control system is on the instrument panel.

When you switch the system off, a message and an illuminated icon appear on the instrument cluster.

Use the switch again to return the traction control system to normal operation.

Your vehicle may have MyKey restrictions regarding this feature. See **Principle of Operation** (page 61).

System Indicator Lights and Messages



The stability and traction control light temporarily illuminates on engine start-up and flashes:

- When a driving condition activates either of the systems.
- If a problem occurs in either of the systems.



The stability and traction control off light temporarily illuminates on engine start-up and stays on:

- When you switch the traction control system off.
- When you select an alternative stability control mode.

Stability Control

PRINCIPLE OF OPERATION



WARNING: Vehicle modifications involving braking system, aftermarket roof racks, suspension, steering system, tire construction and wheel and tire size may change the handling characteristics of your vehicle and may adversely affect the performance of the electronic stability control system. In addition, installing any stereo loudspeakers may interfere with and adversely affect the electronic stability control system. Install any aftermarket stereo loudspeaker as far as possible from the front center console, the tunnel, and the front seats in order to minimize the risk of interfering with the electronic stability control sensors. Reducing the effectiveness of the electronic stability control system could lead to an increased risk of loss of vehicle control, vehicle rollover, personal injury and death.



WARNING: Remember that even advanced technology cannot defy the laws of physics. It's always possible to lose control of a vehicle due to inappropriate driver input for the conditions. Aggressive driving on any road condition can cause you to lose control of your vehicle increasing the risk of personal injury or property damage. Activation of the electronic stability control system is an indication that at least some of the tires have exceeded their ability to grip the road; this could reduce the operator's ability to control the vehicle potentially resulting in a loss of vehicle control, vehicle rollover, personal injury and death. If your electronic stability control system activates, SLOW DOWN.

The system automatically turns on each time you switch the ignition on.

If a fault occurs in either the stability control or the traction control system, you may experience the following conditions:

- The stability and traction control light illuminates steadily.
- The stability control and traction control systems do not enhance your vehicle's ability to maintain traction of the wheels.

If a driving condition activates either the stability control or the traction control system you may experience the following conditions:

- The stability and traction control light flashes.
- Your vehicle slows down.
- Reduced engine power.
- A vibration in the brake pedal.
- The brake pedal is stiffer than usual.
- If the driving condition is severe and your foot is not on the brake, the brake pedal may move as the system applies higher brake force.

The stability control system has several features built into it to help you maintain control of your vehicle:

Electronic Stability Control

The system enhances your vehicle's ability to prevent skids or lateral slides by applying brakes to one or more of the wheels individually and, if necessary, reducing engine power.

Roll Stability Control

The system enhances your vehicle's ability to prevent rollovers by detecting your vehicle's roll motion and the rate at which it changes by applying the brakes to one or more wheels individually.

Stability Control

Traction Control

The system enhances your vehicle's ability to maintain traction of the wheels by detecting and controlling wheel spin. See **Using Traction Control** (page 215).

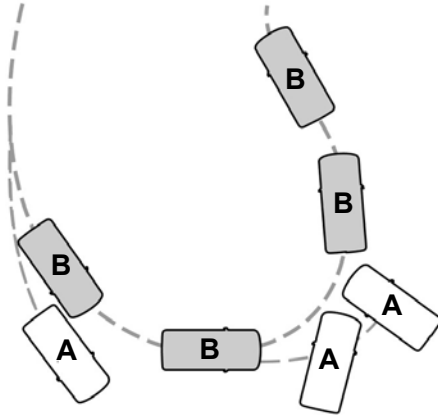

E72903

- A Vehicle without stability control skidding off its intended route.
- B Vehicle with stability control maintaining control on a slippery surface.

USING STABILITY CONTROL

Stability Control and Traction Control with Roll Stability Control™ (RSC™)

The system automatically activates when you start your engine. You can switch off the electronic stability control and roll stability control portions of the system below 35 mph (56 km/h). When the transmission is in reverse (R), they are disabled. You can switch off the traction control portion of the system independently. See **Using Traction Control** (page 215).

Stability Control and Traction Control with RSC Features				
Button functions	Stability control OFF light	Roll stability control	Electronic stability control	Traction control system
Default at start-up	Illuminated during bulb check	Enabled	Enabled	Enabled
Button pressed momentarily	Illuminated	Enabled	Enabled ¹	Disabled ¹

Stability Control

Stability Control and Traction Control with RSC Features				
Button pressed and held for more than 5 seconds at vehicle speed under 35 mph (56 km/h)	Flashes then illuminated solid ²	Disabled	Disabled	Disabled ⁴
Vehicle speed exceeds 35 mph (56 km/h) after button is pressed and held for more than 5 seconds	Illuminated	Enabled	Enabled ¹	Disabled ¹
Button pressed again after deactivation	Not illuminated	Enabled	Enabled	Enabled
Button not pressed and the transfer case is switched to 4X4 Low ³	Illuminated	Disabled	Disabled	Disabled ⁴

¹The traction control system may still be enabled but with higher entry thresholds compared to the full system. The electronic stability control entry thresholds are higher compared to the full system.

²When you press and hold the button for more than 5 seconds the indicator lamp blinks for three seconds.

³Your vehicle may or may not have this feature available. When you select 4X4 Low the stability control light illuminates and all stability control with RSC features are disabled.

⁴Engine traction control and two-wheel spin brake traction control functions are disabled. Single wheel spin traction control is always enabled.

Hill Descent Control (If Equipped)

PRINCIPLE OF OPERATION



WARNING: Hill descent control cannot control descent in all surface conditions and circumstances, such as ice or extremely steep grades. Hill descent control is a driver assist system and cannot substitute for good judgment by the driver. Failure to do so may result in loss of vehicle control, crash or serious injury.



WARNING: Hill descent control does not provide hill hold at zero miles per hour (0 kilometers per hour). When stopped, you must apply the parking brake or place the vehicle in **P** (Park), or it may roll away.

Hill descent control allows you to set and maintain vehicle speed while descending steep grades in various surface conditions.

Hill descent control can maintain vehicle speeds on downhill grades between 2 mph (3 km/h) and 12 mph (20 km/h). Above 20 mph (32 km/h), the system remains armed, but you cannot use the system to set or maintain the descent speed.

Hill descent control requires a cooling down interval after a period of sustained use. The amount of time that the feature can remain active before cooling varies with conditions. The system provides a warning in the message center and a tone sounds when the system is about to disengage for cooling. At this time, manually apply the brakes as needed to maintain descent speed.

USING HILL DESCENT CONTROL



Press and release the hill descent button on the instrument panel. The button illuminates and a chime sounds when you switch this feature on.

To increase descent speed, press the accelerator pedal until you reach the desired speed. To decrease descent speed, press the brake pedal until you reach the desired speed.

Whether accelerating or decelerating, once you reach the desired descent speed, remove your feet from the pedals and hill descent control maintains the chosen vehicle speed.

Note: You may observe noise from the ABS pump motor during hill descent control operation. This is a normal characteristic of the ABS and should be no reason for concern.

Hill Descent Modes

- At speeds between 2 mph (3 km/h) and 20 mph (32 km/h): When you press this button, the light flashes indicating this feature is active. Your vehicle maintains the speed you desire while in this mode.
- At speeds between 20 mph (32 km/h) and 40 mph (64 km/h): When you press this button, the light is solid and a message appears in the information display indicating this feature is active. Your vehicle does not maintain the speed you desire and you cannot set your descent speed.

Hill Descent Control (If Equipped)

- At speeds above 40 mph (64 km/h):
When you press this button, the system turns this feature off and no light or message appears in the information display. You need to switch this feature back on to use.

Refer to Information Displays for hill descent control messages. See **Information Messages** (page 122).

Parking Aids

PRINCIPLE OF OPERATION



WARNING: To help avoid personal injury, always use caution when in reverse (R) and when using the sensing system.



WARNING: The system may not detect objects with surfaces that absorb reflection. Always drive with due care and attention. Failure to take care may result in a crash.



WARNING: Traffic control systems, inclement weather, air brakes, external motors and fans may affect the correct operation of the sensing system. This may cause reduced performance or false alerts.



WARNING: The system may not detect small or moving objects, particularly those close to the ground.

Note: *Certain add-on devices installed around the bumper or fascia may create false beeps. For example, large trailer hitches, bike or surfboard racks, license plate brackets, bumper covers or any other device that may block the normal detection zone of the system.*

Note: *Keep the sensors, located on the bumper or fascia, free from snow, ice and large accumulations of dirt. If the sensors are covered, the system's accuracy can be affected. Do not clean the sensors with sharp objects.*

Note: *If your vehicle sustains damage to the bumper or fascia, leaving it misaligned or bent, the sensing zone may be altered causing inaccurate measurement of obstacles or false alarms. See your authorized technician.*

Note: *When a trailer is connected to your vehicle, the rear parking aid may detect the trailer and therefore provide warnings. Disable the rear parking aid when a trailer is connected to prevent these warnings.*

Note: *The sensing system cannot be turned off when a MyKey is present. See **Principle of Operation** (page 61).*

We recommend that you take some time to get to know the system and its limitations by reading this section.

The sensing system warns the driver of obstacles within a certain range of your vehicle. The system automatically turns on each time you switch the ignition on.

When receiving a detection warning, the radio volume reduces to a predetermined level. After the warning goes away, the radio volume returns to the previous level.



You can turn the system on or off by pressing the parking aid button. If your vehicle does not have a parking aid button, the system can be switched off through the information display menu or from the pop-up message that appears once you shift the transmission into reverse (R). See **General Information** (page 110).

If a fault is present in the system, a warning message appears in the information display and does not allow you to switch the system on. See **Information Messages** (page 122).

If a sensor is blocked and cannot function, the system becomes disabled and a warning message appears in the information display. The system returns to a normal state once the blockage is cleared.

Parking Aids

REAR PARKING AID (IF EQUIPPED)

The rear sensors are only active when the transmission is in reverse (R). As your vehicle moves closer to the obstacle, the rate of the audible warning increases. When the obstacle is less than 12 in (30 cm) away, the warning sounds continuously. If the system detects a stationary or receding object farther than 12 in (30 cm) from the corners of the bumper, the tone sounds for only three seconds. Once the system detects an object approaching, the warning sounds again.



E130178

Coverage area of up to 6 ft (1.8 m) from the rear bumper. There may be decreased coverage area at the outer corners of the bumper.

The system detects certain objects while the transmission is in reverse (R) :

- Your vehicle is moving toward a stationary object at a speed of 3 mph (5 km/h) or less.
- Your vehicle is not moving, but a moving object is approaching the rear of your vehicle at a speed of 3 mph (5 km/h) or less.
- Your vehicle is moving at a speed of less than 3 mph (5 km/h) and a moving object is approaching the rear of your vehicle at a speed of less than 3 mph (5 km/h).

The system provides audio warnings only when your vehicle is moving or when your vehicle is stationary and the detected obstacle is less than 12 in (30 cm) away from the bumper.

Obstacle Distance Indicator (If Equipped)

The system provides obstacle distance indication through the information display. The distance indicator displays when the transmission is in reverse (R).

The indicator displays:

- As the distance to the obstacle decreases the indicator blocks illuminate and move towards the vehicle icon.
- If there is no obstacle detected, the distance indicator blocks are grayed out.

FRONT PARKING AID (IF EQUIPPED)

The front sensors are active when the transmission is in any position other than park (P) and your vehicle is traveling at low speed.

Parking Aids



E187330

Coverage area of up to 28 in (70 cm) from the front bumper. The coverage area decreases at the outer corners.

When your vehicle approaches an object, a warning tone sounds. When your vehicle moves closer to an object, the warning tone repeat rate increases. The warning tone sounds continuously when an object is 12 in (30 cm) or less from the front bumper.

You can switch the system off through the information display menu or from the pop-up message that appears once you shift the transmission into reverse (R). See **General Information** (page 110). If your vehicle has a parking aid button, you can switch the system off by pressing the button.

Obstacle Distance Indicator (if

Equipped)

The system provides obstacle distance indication through the information display.

The indicator displays:

- As the distance to the obstacle decreases the indicator blocks illuminate and move towards the vehicle icon.
- If there is no obstacle detected, the distance indicator blocks are grayed out.

If the transmission is in reverse (R), the front sensing system provides audio warnings when your vehicle is moving and the detected obstacle is moving towards your vehicle. Once the vehicle is stationary, the audio warning will be stopped after 2 seconds. Visual indication is always present in reverse (R).

If the transmission is in drive (D) or any other forward gear (for example, low (L), sport (S) or any forward gear in a manual transmission), the front sensing system provides audio and visual warnings when your vehicle is moving below a speed of 5 mph (8 km/h) and an obstacle is located inside the detection area. Once the vehicle is stationary, the audio warning will be stopped after 2 seconds and the visual indication stops after 4 seconds. If the obstacles detected are within 12 in (30 cm), the visual indication remains on.

If the transmission is in neutral (N), the system provides visual indication only when your vehicle is moving at 5 mph (8 km/h) or below and an obstacle is located inside the detection area. Once your vehicle is stationary, the visual indication will stop after 4 seconds.

SIDE SENSING SYSTEM (IF EQUIPPED)

The side sensing system uses the front and rear side sensors to detect and map obstacles within the vehicle's driving path, located near the sides of your vehicle. The side sensors are active when the transmission is in any position other than park (P).

Note: *Obstacles that enter the side detection area without being detected and mapped by the front or rear side sensors will not be detected.*

Parking Aids

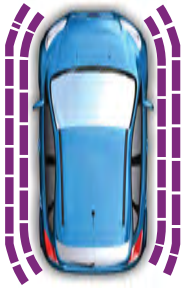

E187810

Coverage area is up to 24 in (60 cm) from the sides of your vehicle.

When the system detects an object close to the side of your vehicle, an audible warning sounds. As your vehicle moves closer to obstacles within the driving path of your vehicle, the rate of the audible warning increases.

Obstacle Distance Indicator (if Equipped)



E190459

The system provides obstacle distance indication through the information display.

As the distance to the obstacle decreases, the indicator blocks illuminate and move toward the vehicle icon. If there is no obstacle detected, the distance indicator blocks show greyed out.

When you shift to reverse (R), the side sensing system provides audible warnings when your vehicle is moving and obstacles are detected within 24 in (60 cm) and are inside the driving path of your vehicle. When you stop your vehicle the audible warning stops after two seconds.

Note: *Visual distance indication remains on when the transmission is in reverse (R).*

When you shift to drive (D) or any other forward gear, for example, low (L), sport (S) or any forward gear in manual transmission, the side sensing system provides audible and visual distance warnings when your vehicle is moving below a speed of 5 mph (8 km/h) and obstacles are detected within 24 in (60 cm) and are inside the driving path of your vehicle. Once your vehicle reaches a standstill condition, the audible warning stops after two seconds and visual indication stops after four seconds.

If the transmission is in neutral (N), the side sensing system provides visual distance indication only when your vehicle is moving below a speed of 5 mph (8 km/h) and there is a front or rear parking aid obstacle detected, and the side obstacle is within 24 in (60 cm) from the side of your vehicle. When you stop your vehicle the visual distance indication stops after four seconds.

If the side sensing system is not available, the side distance indicator blocks do not appear.

The side sensing system is not available under the following condition:

- If you switch the traction control system off.

Parking Aids

The side sensing system may not be available until you have driven approximately the length of your vehicle in order for the system to reinitialize if:

- You switch the ignition on, off and back on.
- Your vehicle remains stationary for over two minutes.
- The anti-lock brake system is activated.
- The traction control system is activated.
- When the steering wheel angle information is not available, the side sensing system is not available. The vehicle must be driven at least 492 ft (150 m) above 19 mph (30 km/h) to recover the steering wheel angle information.

ACTIVE PARK ASSIST (IF EQUIPPED)



WARNING: You must remain in your vehicle when the system turns on. At all times, you are responsible for controlling your vehicle, supervising the system and intervening, if required. Failure to take care may result in the loss of control of your vehicle, serious personal injury or death.



WARNING: The sensors may not detect objects in heavy rain or other conditions that cause interference.



WARNING: Active park assist does not apply the brakes under any circumstances.



WARNING: You are responsible for controlling your vehicle at all times. The system is designed to be an aid and does not relieve you of your responsibility to drive with due care and attention. Failure to follow this instruction could result in the loss of control of your vehicle, personal injury or death.

Active park assist is a multi-step process and may require you to shift the transmission multiple times. Follow the onscreen instructions until the parking maneuver is complete.

If you are uncomfortable with the proximity to any vehicle or object, you may choose to override the system by grabbing the steering wheel, or by taking full control of your vehicle after pressing the active park assist button.

Keep your hands, hair, clothing and any loose items clear of the steering wheel when using active park assist.

The sensors are on the front and rear bumpers.

Note: *Keep the sensors free from snow, ice and large accumulations of dirt.*

Note: *Do not cover up the sensors.*

Note: *Do not clean the sensors with sharp objects.*

Note: *The sensors may not detect objects with surfaces that absorb ultrasonic waves. The sensors may falsely detect objects due to ultrasonic interference caused by motorcycle exhausts, truck air brakes or horns, for example.*

Note: *If you change any tires, the system must recalibrate and may not correctly operate for a short time.*

Parking Aids

The system may not correctly operate in any of the following conditions:

- You use a spare tire or a tire that is significantly worn more than the other tires.
- One or more tires are incorrectly inflated.
- You try to park on a tight curve.
- Something passes between the front bumper and the parking space. For example, a pedestrian or cyclist.
- The edge of the neighboring parked vehicle is high off the ground. For example, a bus, tow truck or flatbed truck.
- The weather conditions are poor. For example, during heavy rain, snow, fog, high humidity and high temperatures.

Do not use the system if:

- You have attached an add-on accessory close to the sensors on the front or rear of your vehicle. For example, a bike rack or trailer.
- You have attached an overhanging object to the roof. For example, a surfboard.
- The front bumper, rear bumper or the side sensors are damaged.
- The correct tire size is not in use on your vehicle. For example, a mini-spare tire.

Using Active Park Assist

Selecting an Active Park Assist Mode



Press the button once to activate parallel parking. Press the button a second time to activate perpendicular parking. If you press the button again the system switches off.

If your vehicle is parked and after you switch the ignition on, you can use the information display to toggle through the modes. Press the button to switch the system on and open the system menu in the information display.

Note: *If your vehicle is parked, the default mode is parallel park out assist. However, if you did not use active park assist to parallel park your vehicle, use the information display to select park out assist.*

Note: *You can repeatedly press the active park assist button to toggle through the modes only after moving your vehicle approximately 33 ft (10 m).*

To toggle through the modes, use the buttons on the information display to select the following:

- Parallel parking.
- Perpendicular parking.
- Parallel park out assist.
- Switch the system off.

Note: *There is no time limit for toggling through the modes.*

Parallel Parking

The system detects available parallel parking spaces and steers your vehicle into the space. You control the accelerator, gearshift and brakes. The system visually and audibly guides you into a parallel parking space.



Press the button once to search for a parking space.

Note: *You can also switch the system on after you have already driven partially or completely past a parking space. Press the active park assist button and the system informs you if you have recently passed a suitable parking space.*

Parking Aids

When the vehicle speed is less than 22 mph (35 km/h), the system scans both sides of your vehicle for an available parking space. A message and a graphic appear in the information display to indicate the system is searching for a parking space. Use the direction indicator lever to search for a parking space on the driver or passenger side of your vehicle.

Note: The system scans both sides of your vehicle and offers parking spaces one side at a time if you do not use the direction indicator.

Note: The system defaults to the passenger side if you do not use the direction indicator.



Drive your vehicle approximately 3 ft (1 m) and parallel to the other parked vehicles when searching for a parking space.

Note: If you drive your vehicle less than 2 ft (0.5 m) or greater than 5 ft (1.5 m) away from other parked vehicles, the system may not be able to detect an available parking space.

When the system detects a suitable space, a message displays and a tone sounds. Stop your vehicle and follow the onscreen instructions. If your vehicle is moving very slowly, you may have to move forward a short distance before the system is ready to park.

Note: You must observe that the space the system selects remains clear of obstructions at all times during the maneuver.

Note: The system always offers the last parking space it detects. For example, if your vehicle detects multiple spaces when you are driving, it offers the last one.

Note: If the vehicle speed is greater than approximately 22 mph (35 km/h), the system shows a message to instruct you to reduce the vehicle speed.

Automatically Steering into a Parallel Parking Space

When you shift into reverse (R), with your hands off the steering wheel and nothing obstructing its movement, your vehicle steers itself into the space. The system displays instructions to move your vehicle backward and forward in the space.

Note: If the vehicle speed exceeds approximately 6 mph (9 km/h), you interrupt the maneuver, or the system switches off, you must take full control of your vehicle.

Note: If the system detects an object is very close to your vehicle and it may be unsafe to continue the maneuver, it may instruct you to stop your vehicle. The system may not provide any further instruction. Steering assistance continues to operate but you must decide if it is safe to continue the maneuver.



When you believe your vehicle is correctly parked, or a solid tone sounds and an information message appears, bring your vehicle to a complete stop.

When the Active Park Assist maneuver is complete, a tone sounds and an information message appears.

Note: You are responsible for checking how your vehicle is parked and making any necessary corrections before leaving your vehicle.

Parking Aids

Deactivating Active Park Assist

You can manually deactivate the system by:

- Pressing the Active Park Assist button during an active maneuver.
- Grabbing the steering wheel during an active maneuver.
- Driving above 22 mph (35 km/h) for 30 seconds when searching for a parking space.
- Driving above 31 mph (50 km/h).
- Driving above 6 mph (9 km/h) during an active maneuver.
- Switching the traction control system off.

Certain vehicle conditions may also deactivate the system, for example:

- The traction control system activates or fails.
- The anti-lock brake system activates or fails.

If the system malfunctions, a message appears and a tone sounds. Have your vehicle checked as soon as possible.

Perpendicular Parking

The system detects available perpendicular parking spaces and steers your vehicle into the space. You control the accelerator, gearshift and brakes. The system visually and audibly guides you into a perpendicular parking space.



Press the button twice to search for a parking space.

When the vehicle speed is less than 19 mph (30 km/h), the system scans both sides of your vehicle for an available parking space. A message and a graphic appear in the information display to indicate the system is searching for a parking space. Use the direction indicator lever to search for a parking space on the driver or passenger side of your vehicle.

Note: The system scans both sides of your vehicle and offers parking spaces one side at a time if you do not use the direction indicator.

Note: The system defaults to the passenger side if you do not use the direction indicator.



Drive your vehicle approximately 3 ft (1 m) and perpendicular to the other parked vehicles when searching for a parking space.

Note: If you drive your vehicle less than 2 ft (0.5 m) or greater than 5 ft (1.5 m) away from other parked vehicles, the system may not be able to detect an available parking space.

When the system detects a suitable space, a message displays and a tone sounds. Stop your vehicle and follow the onscreen instructions. If your vehicle is moving very slowly, you may have to move forward a short distance before the system is ready to park.

Note: You must observe that the space the system selects remains clear of obstructions at all times during the maneuver.

Note: The system always offers the last detected parking space. For example, if your vehicle detects multiple spaces when you are driving, it offers the last one.

Parking Aids

Note: If the vehicle speed is greater than approximately 19 mph (30 km/h), the system shows a message to instruct you to reduce the vehicle speed.

Automatically Steering into a Perpendicular Parking Space

When you shift into reverse (R), with your hands off the steering wheel and nothing obstructing its movement, your vehicle steers itself into the space. The system displays instructions to move your vehicle backward and forward in the space.

Note: If the vehicle speed exceeds approximately 6 mph (9 km/h), you interrupt the maneuver, or the system switches off, you must take full control of your vehicle.

Note: If the system detects an object is very close to your vehicle and it may be unsafe to continue the maneuver, it may instruct you to stop your vehicle. The system may not provide any further instruction. Steering assistance continues to operate but you must decide if it is safe to continue the maneuver.

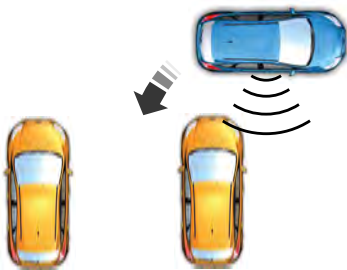

E186191

When you believe your vehicle is correctly parked, or a solid tone sounds and an information message appears, bring your vehicle to a complete stop.

When the active park assist maneuver is complete, a tone sounds and a message appears.

Note: You are responsible for checking how your vehicle is parked and making any necessary corrections before leaving your vehicle.

Deactivating Active Park Assist

You can manually deactivate the system by:

- Pressing the Active Park Assist button during an active maneuver.
- Grabbing the steering wheel during an active maneuver.
- Driving above 19 mph (30 km/h) for 30 seconds when searching for a parking space.
- Driving above 31 mph (50 km/h).
- Driving above 6 mph (9 km/h) during an active maneuver.
- Switching the traction control system off.

Certain vehicle conditions may also deactivate the system, for example:

- The traction control system activates or fails.
- The anti-lock brake system activates or fails.

If the system malfunctions, a message appears and a tone sounds. Have your vehicle checked as soon as possible.

Parallel Park Out Assist

The system steers your vehicle out of a parallel parking space. You control the accelerator, gearshift and brakes. The system visually and audibly guides you out of a parallel parking space.

Note: This system is not intended to assist when exiting a perpendicular parking space.

Parking Aids



Press the button once when your vehicle is stationary in a parallel parking space.

Note: If you did not use active park assist to parallel park your vehicle, pressing the button once selects parallel park. You must use the information display to select park out assist.

The system displays a message instructing you to switch a direction indicator on. Use the direction indicator to select which side of your vehicle you want to exit the parking space. The system displays instructions to move your vehicle backward and forward in the space.

Note: If the system detects an object is very close to your vehicle and it may be unsafe to continue the maneuver, it may instruct you to stop your vehicle. The system may not provide any further instruction. Steering assistance continues to operate but you must decide if it is safe to continue the maneuver.



After the system directs your vehicle to a position where you can exit the parking space in a forward movement, a message appears instructing you to take full control of your vehicle. Generally, hand-over is when your vehicle is still inside the parking space.

Note: Parallel Park Out Assist may not be available when the clearance to the front or the rear of your vehicle is too small.

Note: If the vehicle speed exceeds approximately 6 mph (9 km/h), you interrupt the maneuver, or the system switches off, you must take full control of your vehicle.

Note: You are responsible for controlling your vehicle and making sure the path is clear prior to pulling into traffic.

Troubleshooting

Symptom	Possible Cause
The system does not search for a parking space.	You may have switched the traction control off.
	The transmission is in reverse (R). Your vehicle must be moving forward to be able to detect a parking space.
The system does not offer a parking space.	The sensors may be blocked. For example, snow, ice or dirt buildup. Blocked sensors can affect how the system functions.
	There is not enough room in the parking space for your vehicle to safely park.
	There is not enough space for the parking maneuver on the opposite side of the parking space.
	The parking space is more than 5 ft (1.5 m) or less than 2 ft (0.5 m) away.

Parking Aids

Symptom	Possible Cause
	The vehicle speed is greater than 22 mph (35 km/h) for parallel parking or greater than 19 mph (30 km/h) for perpendicular parking.
	You recently disconnected or replaced the battery. After you reconnect the battery you must drive your vehicle on a straight road for a short period of time.
The system does not correctly position your vehicle in a parking space.	Your vehicle is rolling in the opposite direction of the current transmission position. For example, rolling forward when in reverse (R).
	An irregular curb along the parking space prevents the system from correctly aligning your vehicle.
	Vehicles or objects bordering the space may not be correctly parked.
	Your vehicle stopped too far past the parking space.
	The tires may not be correctly installed or maintained. For example, not inflated correctly, improper size, or of different sizes.
	A repair or alteration changes the detection capabilities.
	A parked vehicle has a high attachment. For example, a salt sprayer, snowplow or moving truck bed.
	The parking space length or position of parked objects changes after your vehicle passes the space.
	The temperature around your vehicle quickly changes. For example, driving from a heated garage into the cold, or after leaving a car wash.

REAR VIEW CAMERA



WARNING: The rear view camera system is a reverse aid supplement device that still requires the driver to use it in conjunction with the interior and exterior mirrors for maximum coverage.





WARNING: Objects that are close to either corner of the bumper or under the bumper, might not be seen on the screen due to the limited coverage of the camera system.



WARNING: Reverse your vehicle slowly. Failure to follow this instruction could result in the loss of control of your vehicle, personal injury or death.

Parking Aids

 **WARNING:** Use caution when the rear cargo door is ajar. If the rear cargo door is ajar, the camera will be out of position and the video image may be incorrect. All guidelines disappear when the rear cargo door is ajar. Failure to follow this instruction could result in personal injury.

 **WARNING:** Use caution when turning camera features on or off when the transmission is not in park (P). Make sure your vehicle is not moving.

The rear view camera system provides a video image of the area behind your vehicle.

During operation, lines appear in the display which represent your vehicle's path and proximity to objects behind your vehicle.



E142435

The camera is located on the luggage compartment door, above the license plate.

Using the Rear View Camera System

The rear view camera system displays what is behind your vehicle when you place the transmission in reverse (R).

Note: The reverse sensing system is not effective at speeds above 3 mph (5 km/h) and may not detect certain angular or moving objects.

The system uses three types of guides to help you see what is behind your vehicle:

- Active guidelines (if equipped): Show the intended path of your vehicle when reversing.
- Fixed guidelines: Show the actual path your vehicle is moving in while reversing in a straight line. This can be helpful when backing into a parking space or aligning your vehicle with another object behind you.
- Centerline: Helps align the center of your vehicle with an object. For example, a trailer.

Note: If the transmission is in reverse (R) and the luggage compartment door or liftgate is open, no rear view camera features display.

Note: When towing, the camera only sees what you are towing. This might not provide adequate coverage as it usually provides in normal operation and some objects might not be seen. In some vehicles, the guidelines may disappear when you connect the trailer tow connector.

The camera may not operate correctly under the following conditions:

- Nighttime or dark areas if one or both reverse lamps are not operating.
- Mud, water or debris obstructs the camera's view. Clean the lens with a soft, lint-free cloth and non-abrasive cleaner. The rear view camera has a washer that activates when you use the rear window washer. See **Rear Window Wiper and Washers** (page 89).
- The rear of your vehicle is hit or damaged, causing the camera to become misaligned.

Parking Aids

Camera System Settings

The rear view camera system settings can be accessed through the display screen. See **General Information** (page 110).

Camera Guidelines

Note: Active guidelines are only available when the transmission is in reverse (R).

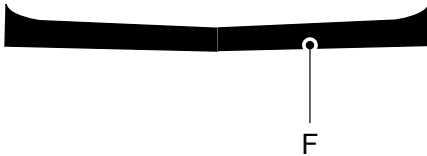
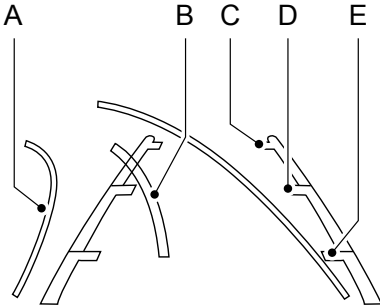

E142436

- A Active guidelines (If equipped)
- B Centerline
- C Fixed guideline: Green zone
- D Fixed guideline: Yellow zone
- E Fixed guideline: Red zone
- F Rear bumper

Active guidelines are only shown with fixed guidelines. To use active guidelines, turn the steering wheel to point the guidelines toward an intended path. If you change the steering wheel position while reversing, your vehicle might deviate from the original intended path.

The fixed and active guidelines fade in and out depending on the steering wheel position. The active guidelines do not display when the steering wheel position is straight.

Always use caution while reversing. Objects in the red zone are closest to your vehicle and objects in the green zone are farther away. Objects are getting closer to your vehicle as they move from the green zone to the yellow or red zones. Use the side view mirrors and rear view mirror to get better coverage on both sides and rear of the vehicle.

Obstacle Distance Indicator (If Equipped)



E190459

Parking Aids

The system will provide an image of your vehicle and the sensor zones. The zones will highlight green, yellow and red when the parking aid sensors detect an object in the coverage area.

Manual Zoom



WARNING: When manual zoom is on, the full area behind your vehicle may not show. Be aware of your surroundings when using the manual zoom feature.

Note: *Manual zoom is only available when the transmission is in reverse (R).*

Note: *When you enable manual zoom, only the centerline is shown.*

Selectable settings for this feature are Zoom in (+) and Zoom out (-). Press the symbol in the camera screen to change the view. The default setting is Zoom OFF.

This allows you to get a closer view of an object behind your vehicle. The zoomed image keeps the bumper in the image to provide a reference. The zoom is only active while the transmission is in reverse (R).

Rear Camera Delay

Selectable settings for this feature are ON and OFF.

The default setting for the rear camera delay is OFF.

When shifting the transmission out of reverse (R) and into any gear other than park (P), the camera image remains in the display until:

- Your vehicle speed reaches approximately 6 mph (10 km/h).
- You shift your vehicle into park (P).

360 DEGREE CAMERA (IF EQUIPPED)



WARNING: The 360 degree camera system still requires the driver to use it in conjunction with looking out of the windows, and checking the interior and exterior mirrors for maximum coverage.



WARNING: Objects that are close to either corner of the bumper or under the bumper, might not be seen on the screen due to the limited coverage of the camera system.



WARNING: Use caution when turning camera features on or off when the transmission is not in park (P). Make sure your vehicle is not moving.

Note: *The 360 degree camera system turns off when your vehicle is in motion at low speed, except when in reverse (R).*

The 360 degree camera system consists of front, side and rear cameras. The system:

- Allows you to see what is directly in front or behind your vehicle.
- Provides cross traffic view in front and behind your vehicle.
- Allows you to see a top-down view of the area outside your vehicle, including the blind spots.
- Provides visibility around your vehicle to you in parking maneuvers such as:
 - Centering in a parking space.
 - Obstacles near vehicle.
 - Parallel parking.

Parking Aids

Camera Views



The camera button is located on the instrument panel and allows you to toggle through different camera views.

When in park (P), neutral (N) or drive (D), only images from the front cameras are displayed. Press the camera button to display the front camera image on the display screen.

When in reverse (R), only images from the rear cameras are displayed. When you shift into reverse (R), the rear view camera image automatically shows on the display screen.

Advanced Camera Views (If Equipped)



Additional camera views may be available for vehicles with specific features. Press the small camera icon shown on the top left corner of the display screen to open the camera view menu.

The following camera views can be accessed in park (P), neutral (N) or drive (D) when you press the camera button:

- **Front 360 + Normal:** Contains the normal front camera view next to a 360 degree camera view.
- **Front Normal View:** Provides an image of what is directly in front of your vehicle.
- **Front Split View:** Provides an extended view of what is in front of your vehicle.

The following camera views can be accessed when you shift into reverse (R):

- **Rear 360 + Normal:** Contains the normal rear camera view next to a 360 degree camera view. Press the zoom (+) button to quickly access Rear Normal View from this screen.
- **Rear Normal View:** Provides an image of what is directly behind your vehicle.
- **Rear Split View:** Provides an extended view of what is behind your vehicle.

Keep Out Zone

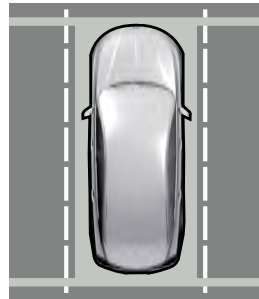

E225016

The Keep Out Zone is represented by the yellow dotted lines running parallel to your vehicle. It is designed to give you the indication on the ground of the fully extended outside mirror position.

Front Camera



WARNING: The front camera system still requires the driver to use it in conjunction with looking out of your vehicle.

Parking Aids

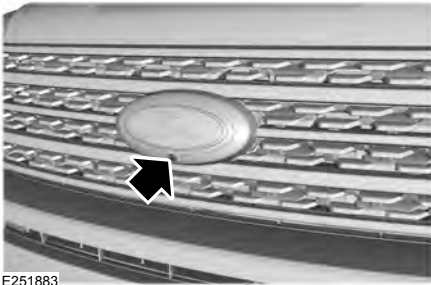

E251883

The front video camera, located in the grille, provides a video image of the area in front of your vehicle. It adds assistance to the driver while driving forward at low speeds. To use the front video camera system, place the transmission in any gear except reverse (R). An image displays once the camera enable button is pressed. The area displayed on the screen may vary according to your vehicle's orientation and/or road condition.

Note: The front camera has a washer that activates when you use the windshield washers. See **Windshield Washers** (page 89).

Side Camera

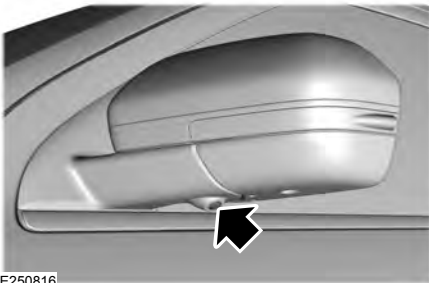

E250816

The side view camera, located in the outside mirror, provides a video image of the area on the sides of your vehicle. It aids you while parking your vehicle.

Note: Use caution when using the 360 view while any of the doors are ajar. If a door is ajar, the camera may be out of position and the video image may be incorrect.

Cruise Control

PRINCIPLE OF OPERATION

Cruise control lets you maintain a set speed without keeping your foot on the accelerator pedal. You can use cruise control when your vehicle speed is greater than 20 mph (30 km/h).

USING CRUISE CONTROL



WARNING: Do not use cruise control on winding roads, in heavy traffic or when the road surface is slippery. This could result in loss of vehicle control, serious injury or death.



WARNING: When you are going downhill, your vehicle speed could increase above the set speed. The system does not apply the brakes.

To help the system to maintain the set speed when going downhill, downshift to a lower gear.

Your vehicle speed could decrease below the set speed when driving uphill.

Note: *The system cancels if your vehicle speed drops below 10 mph (16 km/h) under the set speed when driving uphill.*



E262918

The cruise controls are on the steering wheel. See **Cruise Control** (page 85).

Switching Cruise Control On

ON

For vehicles without Speed Limiter, press and release the button.



For vehicles with Speed Limiter, press and release the button.

The indicator displays in the instrument cluster.

Setting the Cruise Speed

Drive to your preferred speed.

SET+

Press and release to set the current speed.

SET-

Press and release to set the current speed.

Take your foot off the accelerator pedal.

Note: *The indicator changes color.*

Changing the Set Speed

SET+

Press and release to increase the set speed in small increments.

SET-

Press and release to decrease the set speed in small increments.

Press and hold either button to accelerate or decelerate, respectively. Release the button when you reach your preferred speed.

Press the accelerator or brake pedal until you reach your preferred speed. Press either button.

Cruise Control

Note: If you accelerate by pressing only the accelerator pedal, the set speed does not change. When you release the accelerator pedal, your vehicle returns to the speed you previously set.

Canceling the Set Speed

CNCL Press and release the button, or tap the brake pedal to cancel the set speed.

Note: The system remembers the set speed.

Resuming the Set Speed

RES Press and release to resume the set speed.

Switching Cruise Control Off

OFF For vehicles without Speed Limiter, press and release the button when the system is in standby mode or switch the ignition off.

 For vehicles with Speed Limiter, press and release the button when the system is in standby mode or switch the ignition off.

Note: You erase the set speed when you switch the system off.

USING ADAPTIVE CRUISE CONTROL (IF EQUIPPED)

 **WARNING:** Always pay close attention to changing road conditions when using adaptive cruise control. The system does not replace attentive driving. Failing to pay attention to the road may result in a crash, serious injury or death.

 **WARNING:** Do not use the adaptive cruise control when entering or leaving a highway, on roads with intersections or roundabouts or non-vehicular traffic or roads that are winding, slippery, unpaved, or steep slopes.

 **WARNING:** Do not use the system in poor visibility, for example fog, heavy rain, spray or snow.

 **WARNING:** Do not use the system when towing a trailer that has aftermarket electronic trailer brake controls. Failure to follow this instruction could result in the loss of control of your vehicle, personal injury or death.

 **WARNING:** Do not use tire sizes other than those recommended because this can affect the normal operation of the system. Failure to do so may result in a loss of vehicle control, which could result in serious injury.

 **WARNING:** Adaptive cruise control may not detect stationary or slow moving vehicles below 6 mph (10 km/h).

 **WARNING:** Adaptive cruise control does not detect pedestrians or objects in the road.

 **WARNING:** Adaptive cruise control does not detect oncoming vehicles in the same lane.

 **WARNING:** Adaptive cruise control is not a crash warning or avoidance system.

Cruise Control



WARNING: Do not use adaptive cruise control with a snow plow blade installed.

The system adjusts your vehicle speed to maintain the set gap between you and the vehicle in front of you in the same lane. You can select four gap settings.

The system uses a radar sensor which projects a beam directly in front of your vehicle.

Note: *It is your responsibility to stay alert, drive safely and be in control of the vehicle at all times.*



E262918

The cruise controls are on the steering wheel. See **Cruise Control** (page 85).

Switching Adaptive Cruise Control On

ON

Press and release the button.



The indicator, current gap setting and set speed appear in the information display.



E164805

Setting the Adaptive Cruise Speed

Drive to your preferred speed.

SET-

Press and release the button.

Take your foot off the accelerator pedal.

The indicator, current gap setting and set speed appear in the information display.



E164805

A vehicle graphic illuminates if there is a vehicle detected in front of you.

Note: *When adaptive cruise control is active, the speedometer may vary slightly from the set speed displayed in the information display.*

Setting the Adaptive Cruise Speed When Your Vehicle is Stationary

Follow a vehicle to a complete stop.

RES+

Press while keeping the brake pedal fully pressed.

The set speed adjusts to 20 mph (30 km/h).

Cruise Control

The indicator, current gap setting and set speed appear in the information display.

Following a Vehicle



WARNING: When following a vehicle, your vehicle does not always decelerate quickly enough to avoid a crash without driver intervention. Always apply the brakes when necessary. Failing to do so may result in a crash, serious injury or death.



WARNING: Adaptive cruise control only warns of vehicles detected by the radar sensor. In some cases there may be no warning or a delayed warning. You should always apply the brakes when necessary. Failure to do so may result in a crash, serious injury or death.

When a vehicle ahead of you enters the same lane or a slower vehicle is ahead in the same lane, the vehicle speed adjusts to maintain a preset gap distance. A vehicle graphic illuminates in the instrument cluster.

Note: *The brakes may emit noise when applied by the system.*

Note: *When you are following a vehicle and you switch on a direction indicator, adaptive cruise control may provide a small temporary acceleration to help you pass.*

Your vehicle maintains a consistent gap from the vehicle ahead until:

- The vehicle in front of you accelerates to a speed above the set speed.
- The vehicle in front of you moves out of the lane you are in.
- You set a new gap distance.

The system applies the brakes to slow your vehicle to maintain a safe gap distance from the vehicle in front. The system only applies limited braking. You can override the system by applying the brakes.

If the system determines that its maximum braking level is not sufficient, an audible warning sounds when the system continues to brake. A red warning bar displays on the windshield and you must take immediate action.

Following a Vehicle to a Complete Stop

If your vehicle follows a vehicle to a complete stop and remains stationary for less than three seconds, your vehicle accelerates from a stationary position to follow the vehicle ahead.

RES+ If your vehicle follows a vehicle to a complete stop and remains stationary for more than three seconds, press to follow the vehicle ahead. Or press the accelerator pedal.

Setting the Gap Distance

You can decrease or increase the distance between your vehicle and the vehicle in front by pressing the gap control.



Press and release to decrease the gap distance.



Press and release to increase the gap distance.

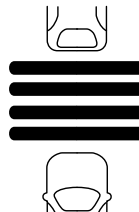

E164805

Cruise Control

The selected gap appears in the information display as shown by the bars in the image.

Note: *The gap setting is time dependent and therefore the distance adjusts with your vehicle speed.*

Note: *It is your responsibility to select a gap appropriate to the driving conditions.*

Adaptive Cruise Control Gap Settings

Graphic Display, Bars Indicated Between Vehicles	Distance Gap	Dynamic Behavior
1	Closest.	Sport.
2	Close.	Normal.
3	Medium.	Normal.
4	Far.	Comfort.

Each time you switch the system on, it selects the last chosen gap setting.

Overriding the Set Speed



WARNING: If you override the system by pressing the accelerator pedal, it does not automatically apply the brakes to maintain a gap from any vehicle ahead.

When you press the accelerator pedal, you override the set speed and gap distance.



Use the accelerator pedal normally to intentionally exceed the set speed limit.

When you override the system, the green indicator light illuminates and the vehicle image does not appear in the information display.

The system resumes operation when you release the accelerator pedal. The vehicle speed decreases to the set speed, or a lower speed if following a slower vehicle.

Changing the Set Speed

RES+ Press and release to increase the set speed in small increments.

SET- Press and release to decrease the set speed in small increments.

Press and hold either button to change the set speed in large increments. Release the button when you reach your preferred speed.

Press the accelerator or brake pedal until you reach your preferred speed. Press either button.

The system may apply the brakes to slow the vehicle to the new set speed. The set speed displays continuously in the information display when the system is active.

Canceling the Set Speed

CNCL Press and release the button or tap the brake pedal.

Note: *The system remembers the set speed.*

Resuming the Set Speed

RES+ Press and release the button.

Your vehicle speed returns to the previously set speed and gap setting. The set speed displays continuously in the information display when the system is active.

Note: *Only use resume if you are aware of the set speed and intend to return to it.*

Cruise Control

Automatic Cancellation

Automatic cancellation can also occur when:

- The tires lose traction.
- You apply the parking brake.

Park Brake Application

Automatic parking brake application and cancellation occurs if:

- You unbuckle the seatbelt and open the door after you stop the vehicle.
- You hold the vehicle at a stop continuously for more than three minutes.

Hilly Condition Usage

You should select a lower gear when the system is active in situations such as prolonged downhill driving on steep grades, for example in mountainous areas. The system needs additional engine braking in these situations to reduce the load on the vehicle's regular brake system to prevent it from overheating.

Note: *An audible alarm sounds and the system shuts down if it applies brakes for an extended period of time. This allows the brakes to cool. The system functions normally again after the brakes cool.*

Switching Adaptive Cruise Control Off

OFF

Press and release the button when the system is in standby mode or switch the ignition off.

Note: *You erase the set speed when you switch the system off.*

Detection Issues



WARNING: On rare occasions, detection issues can occur due to the road infrastructures, for example bridges, tunnels and safety barriers. In these cases, the system may brake late or unexpectedly. At all times, you are responsible for controlling your vehicle, supervising the system and intervening, if required.



WARNING: If the system malfunctions, have your vehicle checked as soon as possible.

The radar sensor has a limited field of view. It may not detect vehicles at all or detect a vehicle later than expected in some situations. The lead vehicle graphic does not illuminate if the system does not detect a vehicle in front of you.

Cruise Control

A

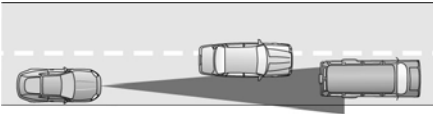

B

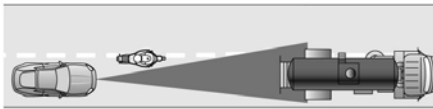

C

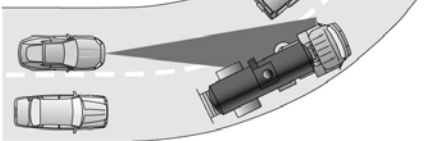

E71621

Detection issues can occur:

- A When driving on a different line than the vehicle in front.
- B With vehicles that edge into your lane. The system can only detect these vehicles once they move fully into your lane.
- C There may be issues with the detection of vehicles in front when driving into and coming out of a bend or curve in the road.

In these cases, the system may brake late or unexpectedly. You should stay alert and take action when necessary.

If something hits the front end of your vehicle or damage occurs, the radar-sensing zone may change. This could cause missed or false vehicle detection.

Optimal system performance requires a clear view of the road by the windshield-mounted camera.

Optimal performance may not occur if:

- The camera is blocked.
- There is poor visibility or lighting conditions.
- There are bad weather conditions.

System Not Available

Conditions that can cause the system to deactivate or prevent the system from activating when requested include:

- A blocked sensor.
- High brake temperature.
- A failure in the system or a related system.

Blocked Sensor

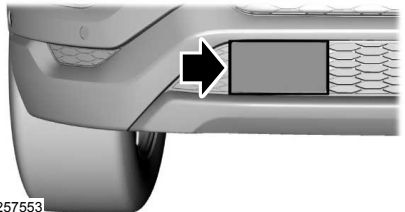
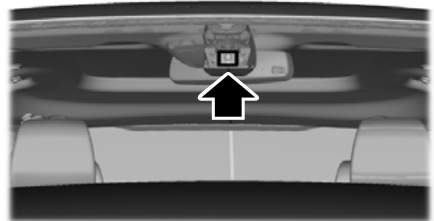

E257553

Cruise Control

A message displays if something obstructs the radar signals from the sensor. The sensor is in the lower grille. The system cannot detect a vehicle ahead and does not function when something blocks the sensor.

Note: *You cannot see the sensor. It is behind a fascia panel.*

Keep the front of your vehicle free of dirt, metal badges or objects. Vehicle front protectors and aftermarket lights may also block the sensor.

Possible Causes and Actions for This Message Displaying:

Cause	Action
The surface of the radar is dirty or obstructed.	Clean the grille surface in front of the radar or remove the object causing the obstruction.
The surface of the radar is clean but the message remains in the display.	Wait a short time. It may take several minutes for the radar to detect that it is free from obstruction.
Heavy rain or snow is interfering with the radar signals.	Do not use the system in these conditions because it may not detect any vehicles ahead.
Water, snow or ice on the surface of the road may interfere with the radar signals.	Do not use the system in these conditions because it may not detect any vehicles ahead.
You are in a desert or remote area with no other vehicles and no roadside objects.	Wait a short time or switch to normal cruise control.

Due to the nature of radar technology, it is possible to get a blockage warning with no actual block. A false blocked condition either self clears, or clears after you restart your vehicle.

Switching to Normal Cruise Control



WARNING: Normal cruise control will not brake when your vehicle is approaching slower vehicles. Always be aware of which mode you have selected and apply the brakes when necessary.



The cruise control indicator light replaces the adaptive cruise control indicator light if you select normal cruise control. The gap setting does not display, and the system does not respond to lead vehicles. Automatic braking remains active to maintain set speed.

You can change from adaptive cruise control to normal cruise control through the information display.

Driving Aids

DRIVER ALERT (IF EQUIPPED)



WARNING: The system is designed to aid the driver. It is not intended to replace your attention and judgment. You are still responsible to drive with due care and attention.



WARNING: At all times, you are responsible for controlling your vehicle, supervising the system and intervening, if required. Failure to take care may result in the loss of control of your vehicle, serious personal injury or death.



WARNING: The system may not function if the sensor is blocked.



WARNING: Take regular rest breaks if you feel tired. Do not wait for the system to warn you.



WARNING: Certain driving styles may result in the system warning you even if you are not feeling tired.



WARNING: In cold and severe weather conditions the system may not function. Rain, snow and spray can all limit sensor performance.



WARNING: The system will not operate if the sensor cannot track the road lane markings.



WARNING: If damage occurs in the immediate area surrounding the sensor, have your vehicle checked as soon as possible.



WARNING: The system may not correctly operate if your vehicle is fitted with a suspension kit not approved by us.

Note: Keep the windshield free from obstructions. For example, bird droppings, insects and snow or ice.

Note: If the camera is blocked or if the windshield is damaged, the system may not function.

Note: If enabled in the menu, the system activates at speeds above 40 mph (64 km/h).

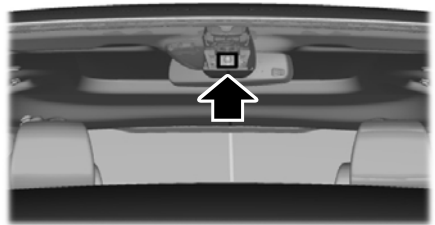

E249505

The system automatically monitors your driving behavior using various inputs including the front camera sensor.

If the system detects that your driving alertness is reduced below a certain threshold, the system will alert you using a chime and a message in the information display.

Using Driver Alert

Switching the system on and off

You may switch the system on or off through the information display. See **General Information** (page 110). When activated, the system monitors your alertness level based upon your driving behavior in relation to the lane markings, and other factors.

System Warnings

Note: The system does not issue warnings below approximately 40 mph (64 km/h).

Driving Aids

The warning system is in two stages. At first the system issues a temporary warning that you need to take a rest. This message will only appear for a short time. If the system detects further reduction in driving alertness, another warning may be issued which will remain in the information display for a longer time. Press OK on the steering wheel control to clear the warning. When active the system will run automatically in the background and only issue a warning if required.

Resetting the System

You can reset the system by either:

- Switching the ignition off and on.
- Stopping your vehicle and then opening and closing the driver's door.

LANE KEEPING SYSTEM (IF EQUIPPED)



WARNING: You are responsible for controlling your vehicle at all times. The system is designed to be an aid and does not relieve you of your responsibility to drive with due care and attention. Failure to follow this instruction could result in the loss of control of your vehicle, personal injury or death.



WARNING: Always drive with due care and attention when using and operating the controls and features on your vehicle.



WARNING: In cold and severe weather conditions the system may not function. Rain, snow and spray can all limit sensor performance.



WARNING: The system will not operate if the sensor cannot track the road lane markings.



WARNING: The sensor may incorrectly track lane markings as other structures or objects. This can result in a false or missed warning.



WARNING: The system may not operate properly if the sensor is blocked. Keep the windshield free from obstruction.



WARNING: If damage occurs in the immediate area surrounding the sensor, have your vehicle checked as soon as possible.



WARNING: The system may not correctly operate if your vehicle is fitted with a suspension kit not approved by us.

Note: The system works above 40 mph (64 km/h).

Note: The system works as long as the camera can detect one lane marking.

Note: When you select aid or alert and aid mode and the system detects no steering activity for a short period, the system alerts you to put your hands on the steering wheel. The system may detect a light grip or touch on the steering wheel as hands off driving.

Note: The system may not function if the camera is blocked, or if the windshield is damaged or dirty.

Driving Aids

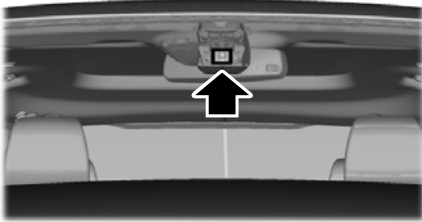

E249505

When you switch the system on and it detects an unintentional drift out of your lane is likely to occur, the system notifies or assists you to stay in your lane through the steering system and information display. In Alert mode, the system provides a warning by vibrating the steering wheel. In Aid mode, the system provides steering assistance by gently counter steering your vehicle back into the lane.

When the system is functioning in the combined Alert and Aid mode, the system first provides steering assistance by gently counter steering your vehicle back into the lane, followed by a warning that vibrates the steering wheel if the vehicle is still out of the lane markings.

Switching the System On and Off

Note: *The system on or off setting is stored until it is manually changed, unless a MyKey™ is detected. If the system detects a MyKey™, it defaults to on and the mode is set to alert.*

Note: *If a MyKey™ is detected, pressing the button does not affect the on or off status of the system. You can only change the mode and intensity settings.*



Press the button located on the center console to switch the system on or off.

System Settings

The system has optional menu settings available. See **General Information** (page 110). The system stores the last known selection for each of these settings. You do not need to readjust your settings each time you switch on the system.

Adjust the settings to enable one of the three modes:

Alert Only

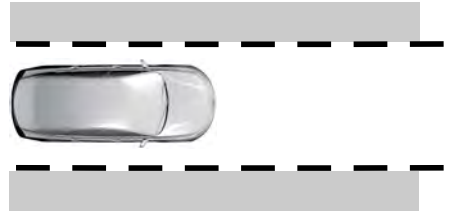

E165515

Alert Only — Provides a steering wheel vibration when an unintended lane departure is detected.

Aid Only

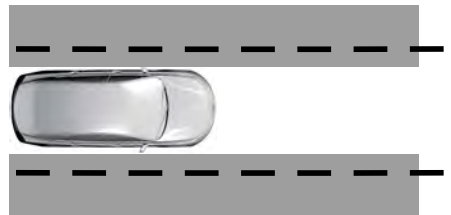

E165516

Aid Only — Provides steering assistance toward the lane center.

Driving Aids

Alert + Aid Mode

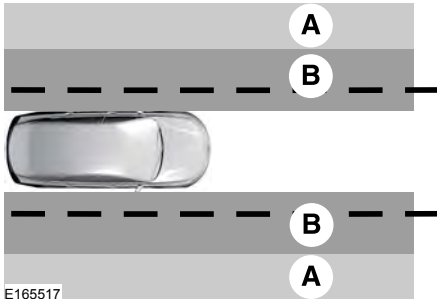

E165517

- A Alert
- B Aid

Alert + Aid — Provides steering assistance toward the lane center.

If your vehicle continues drifting out of the lane, the system provides a steering wheel vibration.

Note: *The alert and aid diagrams illustrate general zone coverage. They do not provide exact zone parameters.*

Intensity: This setting affects the intensity of the steering wheel vibration used for the alert and alert + aid modes. **This setting does not affect the aid mode.**

- Low.
- Medium.
- High.

System Display



E274073

If you switch the system on in alert mode, a graphic with lane markings appears in the information display.

If you switch the system on in aid or alert and aid mode, arrows appear with the lane markings.

When you switch the system off, the lane marking graphics do not display.

Note: *The overhead vehicle graphic may still be displayed if adaptive cruise control is enabled.*

While the system is on, the color of the lane markings change to indicate the system status.

Gray: Indicates that the system is temporarily unable to provide a warning or intervention on the indicated side. This may be because:

- Your vehicle is under the activation speed.
- The direction indicator is active.
- Your vehicle is in a dynamic maneuver.
- Quick braking.
- Fast acceleration.
- Driving too close to the lane markings.

Driving Aids

- The road has no or poor lane markings in the camera field-of-view.
 - The camera is obscured or unable to detect the lane markings due to environmental, traffic or vehicle conditions. For example, significant sun angles, shadows, snow, heavy rain or fog, following a large vehicle that is blocking or shadowing the lane or poor headlamp illumination.
- See **Troubleshooting** for additional information.
- Green: Indicates that the system is available or ready to provide a warning or intervention, on the indicated side.
- Yellow: Indicates that the system is providing or has just provided a lane keeping aid intervention.
- Red: Indicates that the system is providing or has just provided a lane keeping alert warning.

Troubleshooting

Why is the feature not available (line markings are gray) when I can see the lane markings on the road?
Your vehicle speed is outside the operational range of the feature.
The sun is shining directly into the camera lens.
A quick intentional lane change has occurred.
Your vehicle stays too close to the lane markings.
Driving at high speeds in curves.
The last alert warning or aid intervention occurred a short time ago.
Ambiguous lane markings, for example in construction zones.
Rapid transition from light to dark, or from dark to light.
Sudden offset in lane markings.
ABS or AdvanceTrac™ is active.
There is a camera blockage due to dirt, grime, fog, frost or water on the windshield.
You are driving too close to the vehicle in front of you.
Transitioning between no lane markings to lane markings or vice versa.
There is standing water on the road.
Faint lane markings, for example partial yellow lane markings on concrete roads.

Driving Aids

Why is the feature not available (line markings are gray) when I can see the lane markings on the road?

Lane width is too narrow or too wide.

The camera has not been calibrated after a windshield replacement.

Driving on tight roads or on uneven roads.

Why does the vehicle not come back toward the middle of the lane, as expected, in the Aid or Aid + Alert mode?

High cross winds are present.

There is a large road crown.

Rough roads, grooves or shoulder drop-offs.

Heavy uneven loading of the vehicle or improper tire inflation pressure.

The tires have been changed, or the suspension has been modified.

BLIND SPOT INFORMATION SYSTEM (IF EQUIPPED)



WARNING: Do not use the blind spot information system as a replacement for using the interior and exterior mirrors or looking over your shoulder before changing lanes. The blind spot information system is not a replacement for careful driving.



WARNING: The system may not operate properly during severe weather conditions, for example snow, ice, heavy rain and spray. Always drive with due care and attention. Failure to take care may result in a crash.



E255695

Driving Aids

The system is designed to detect vehicles that may have entered the blind spot zone. The detection area is on both sides of your vehicle, extending rearward from the exterior mirrors to approximately 13 ft (4 m) beyond the rear bumper. The detection area extends to approximately 59 ft (18 m) beyond the rear bumper when the vehicle speed is greater than 30 mph (48 km/h) to alert you of faster approaching vehicles.

Note: *The system does not prevent contact with other vehicles. It is not designed to detect parked vehicles, pedestrians, animals or other infrastructures.*

Using the Blind Spot Information System

Vehicles with Automatic Transmission

The system turns on when all of the following occur:

- You start your vehicle.
- You shift into drive (D).
- The vehicle speed is greater than 6 mph (10 km/h).

Note: *The system does not operate in park (P) or reverse (R).*

Vehicles with Manual Transmission

The system turns on when all of the following occur:

- You start your vehicle.
- The vehicle speed is greater than 6 mph (10 km/h).

Note: *The system does not operate in reverse (R).*

System Lights and Messages



E142442

When the system detects a vehicle, an alert indicator illuminates in the exterior mirror on the side the approaching vehicle is coming from. If you turn the direction indicator on for that side of your vehicle, the alert indicator flashes.

Note: *The system may not alert you if a vehicle quickly passes through the detection zone.*

Blocked Sensors

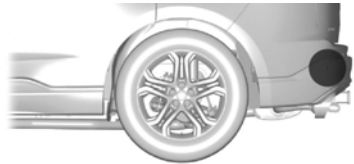

E205199

The sensors are behind the rear bumper on both sides of your vehicle.

Note: *Keep the sensors free from snow, ice and large accumulations of dirt.*

Note: *Do not cover the sensors with bumper stickers, repair compound or other objects.*

Note: *Blocked sensors could affect system performance.*

Driving Aids

If the sensors become blocked, a message may appear in the information display. See **Information Messages** (page 122). The alert indicators remain illuminated but the system does not alert you.

Blind Spot Information System with Trailer Tow (If Equipped)

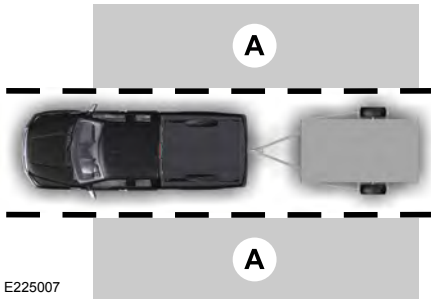

The system is designed to detect vehicles that may have entered the blind spot zone (A). The detection area is on both sides of your vehicle and trailer, extending rearward from the exterior mirrors to the end of your trailer.

The system turns on when all of the following occur:

- You attach a trailer to your vehicle.
- You have set up the trailer to work with the system through the information display.
- You start your vehicle.
- You shift into drive (D).
- The vehicle speed is greater than 6 mph (10 km/h).

Note: If you switch the Blind Spot Information System off, the Blind Spot Information System with Trailer Tow automatically turns off.

Note: If you connect a trailer to your vehicle and do not set up the trailer through the information display, the system turns off and a warning message appears. See **Information Messages** (page 122).

Note: When towing a trailer, the extended blind spot zone range decreases to a short fixed or non-variable distance behind the trailer. The extended blind spot zone range returns to 59 ft (18 m) when the trailer is disconnected.

Setting up a Trailer

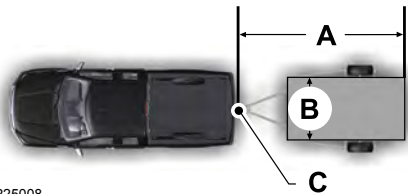

- A Trailer length
- B Trailer width
- C Trailer hitch ball

You can set-up a trailer to work with the system through the information display. See **General Information** (page 110).

When setting up a trailer, a sequence of screens appear asking for trailer information.

- Select type of trailer screen - Conventional, fifth wheel or gooseneck.

The system only supports conventional trailers. If you select fifth wheel or gooseneck, the system automatically turns off.

- Do you want to set up BLIS with trailer screen?

If no, the system turns off.

If yes, the menu goes to the next screen.

Driving Aids

- Is the width less than 9 ft (2.7 m) and length less than 33 ft (10.1 m)?

If no, the system turns off.

If yes, the menu goes to the next screen.

- Trailer width measurement:

The width of the trailer is measured at the front of the trailer. It is not measured at the widest point of the trailer. The maximum width at the front of the trailer that the system can support is 8.5 ft (2.6 m).

Note: *You do not need to enter an exact trailer width measurement. You only need to confirm that the width of the trailer is 8.5 ft (2.6 m) or less.*

- Trailer length measurement:

The trailer length is the distance between the trailer hitch ball and the rear of the trailer. The maximum length that the system can support is 33 ft (10.1 m).

- Enter length of trailer:

The default setting is 18 ft (5.5 m). Toggling up or down using the menu buttons increases or decreases the measurement by 3 ft (1 m). Select a length that is equal to or within 3 ft (1 m) of the actual measured length. For example, if the actual measured length is 25 ft (7.6 m), toggle the length in the menu to 27 ft (8.2 m). When you enter the length of the trailer, the system setup is saved.

Note: *If the trailer is actually a bike rack or cargo rack with electrical lighting, enter a length of 3 ft (1 m). Cross Traffic Alert remains on for trailers with a length of 3 ft (1 m) or less.*

Note: *Proper measurement and measurement entry is required for the system to function as designed.*

System Operation

When you connect a trailer to your vehicle, the trailer set up menu appears in the information display. This menu allows you to set up a new trailer or choose from a previously set up trailer. A warning message appears and the system turns off if you do not choose or add a new trailer.

Note: *The warning message may not appear until your vehicle speed reaches 22 mph (35 km/h).*

If you select a trailer in the information display before connecting a trailer to your vehicle, the system loads the configuration for the selected trailer. When a trailer is connected, a warning message appears.

Note: *A second warning message may appear stating that the Cross Traffic Alert system has turned off. The Blind Spot Information System with Trailer Tow continues to function normally in this situation.*

Note: *The system remembers the last selected trailer set up when you start your vehicle.*

Trailer Considerations

The system is designed to work with a trailer with a front width of 8.5 ft (2.6 m) or less, and a total length from the trailer hitch ball to the rear of the trailer of 33 ft (10.1 m) or less.

Some trailers may cause a slight change in system performance:

- Large box trailers may cause false alerts to occur when driving next to infrastructures or near parked cars. A false alert may also occur while making a 90-degree turn.
- Trailers that have a width greater than 8.5 ft (2.6 m) at the front and have a total length greater than 20 ft (6 m) may cause delayed alerts when a vehicle is passing at high speed.

Driving Aids

- Box trailers that have a width greater than 8.5 ft (2.6 m) at the front may cause early alerts when you pass a vehicle.
- Clam shell or V-Nose box trailers with a width greater than 8.5 ft (2.6 m) at the front may cause delayed alerts when a vehicle traveling the same speed as your vehicle merges lanes.

System Errors

If the system detects a fault, a warning lamp illuminates and a message displays. See **Information Messages** (page 122).

Switching the System On and Off

You can switch the system off using the information display. See **General Information** (page 110). When you switch the system off, a warning lamp illuminates and a message displays. When you switch the system on or off, the alert indicators flash twice.

Note: *The system remembers the last setting when you start your vehicle.*

Note: *The system may not correctly operate when towing a trailer. For vehicles with a trailer tow module and tow bar approved by us, the system turns off when you attach a trailer. For vehicles with an aftermarket trailer tow module or tow bar, we recommend that you switch the system off when you attach a trailer.*

To permanently switch the system off, contact an authorized dealer.

CROSS TRAFFIC ALERT (IF EQUIPPED)



WARNING: Do not use the cross traffic alert system as a replacement for using the interior and exterior mirrors or looking over your shoulder before reversing out of a parking space. The cross traffic alert system is not a replacement for careful driving.



WARNING: The system may not operate properly during severe weather conditions, for example snow, ice, heavy rain and spray. Always drive with due care and attention. Failure to take care may result in a crash.

The system is designed to alert you of vehicles approaching from the sides when you shift into reverse (R).

Using the Cross Traffic Alert System

The system is designed to detect vehicles that approach with a speed up to 37 mph (60 km/h). Coverage decreases when the sensors are partially, mostly or fully obstructed. Slowly reversing helps increase the coverage area and effectiveness.

The system turns on when you start the engine and you shift into reverse (R). The system turns off when you shift out of reverse (R).

Driving Aids

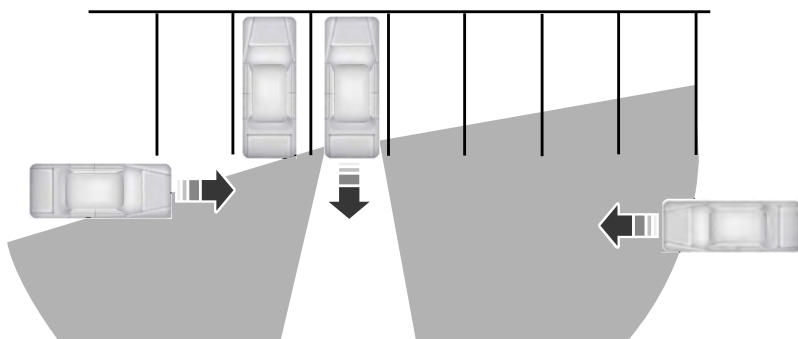

E142440

The sensor on the left-hand side is only partially obstructed and zone coverage on the right-hand side is maximized.

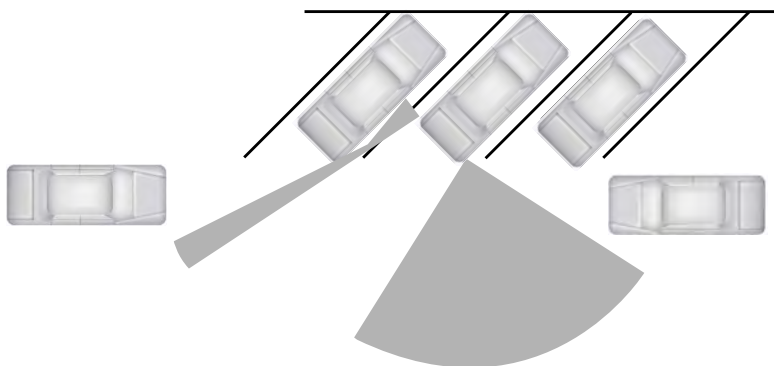

E142441

Driving Aids

Zone coverage also decreases when parking at narrow angles. The sensor on the left-hand side is mostly obstructed and zone coverage on that side is severely reduced.

System Lights, Messages and Audible Alerts



E142442

When the system detects a vehicle, an indicator illuminates in the exterior mirror on the side the approaching vehicle is coming from. A tone sounds and a message appears in the information display.

Note: *In exceptional conditions, the system could alert you even when there is nothing in the detection zone, for example a vehicle passing in the distance.*

Blocked Sensors



E205199

The sensors are behind the rear bumper on both sides of your vehicle.

Note: *Keep the sensors free from snow, ice and large accumulations of dirt.*

Note: *Do not cover the sensors with bumper stickers, repair compound or other objects.*

Note: *Blocked sensors could affect system performance.*

If the sensors are blocked, a message may appear in the information display when you shift into reverse (R). See **Information Messages** (page 122).

System Limitations

The system may not correctly operate when any of the following occur:

- The sensors are blocked.
- Adjacently parked vehicles or objects are obstructing the sensors.
- Vehicles approach at speeds greater than 37 mph (60 km/h).
- The vehicle speed is greater than 7 mph (12 km/h).
- You reverse out of an angled parking space.

System Errors

If the system detects a fault a message displays. See **General Information** (page 110).

Switching the System Off and On

You can temporarily switch the system off using the information display. See **General Information** (page 110). When you switch system off, a message displays. See **Information Messages** (page 122).

Note: *The system turns on each time you switch the ignition on and you shift into reverse (R). If you temporarily switch the system off, it turns on the next time you switch the ignition on.*

Driving Aids

Note: *The system may not correctly operate when towing a trailer. For vehicles with a trailer tow module and tow bar approved by us, the system turns off when you attach a trailer. For vehicles with an aftermarket trailer tow module or tow bar, we recommend that you switch the system off when you attach a trailer.*

To permanently switch the system off, contact an authorized dealer.

STEERING

Electric Power Steering



WARNING: The electric power steering system has diagnostic checks that continuously monitor the system. If a fault is detected, a message displays in the information display. Stop your vehicle as soon as it is safe to do so. Switch the ignition off. After at least 10 seconds, switch the ignition on and watch the information display for a steering system warning message. If a steering system warning message returns, have the system checked by an authorized dealer.



WARNING: If the system detects an error, you may not feel a difference in the steering, however a serious condition may exist. Obtain immediate service from an authorized dealer, failure to do so may result in loss of steering control.

Your vehicle has an electric power steering system. There is no fluid reservoir. No maintenance is required.

If your vehicle loses electrical power while you are driving, electric power steering assistance is lost. The steering system still operates and you can steer your vehicle manually. Manually steering your vehicle requires more effort.

Extreme continuous steering may increase the effort required for you to steer your vehicle. This increased effort prevents overheating and permanent damage to the steering system. You do not lose the ability to steer your vehicle manually. Typical steering and driving maneuvers allow the system to cool and return to normal operation.

Steering Tips

If the steering wanders or pulls, check for:

- Correct tire pressures.
- Uneven tire wear.
- Loose or worn suspension components.
- Loose or worn steering components.
- Improper vehicle alignment.

Note: *A high crown in the road or high crosswinds may also make the steering seem to wander or pull.*

Adaptive Learning

The electronic power steering system adaptive learning helps correct road irregularities and improves overall handling and steering feel. It communicates with the brake system to help operate advanced stability control and accident avoidance systems. Additionally, whenever the battery is disconnected or a new battery installed, you must drive your vehicle a short distance before the system relearns the strategy and reactivates all systems.

Driving Aids

PRE-COLLISION ASSIST (IF EQUIPPED)



WARNING: You are responsible for controlling your vehicle at all times. The system is designed to be an aid and does not relieve you of your responsibility to drive with due care and attention. Failure to follow this instruction could result in the loss of control of your vehicle, personal injury or death.



WARNING: The system does not detect vehicles that are driving in a different direction, cyclists or animals. Failure to take care may result in the loss of control of your vehicle, serious personal injury or death.



WARNING: The system does not operate during hard acceleration or steering. Failure to take care may lead to a crash or personal injury.



WARNING: The system may fail or operate with reduced function during cold and severe weather conditions. Snow, ice, rain, spray and fog can adversely affect the system. Keep the front camera and radar free of snow and ice. Failure to take care may result in the loss of control of your vehicle, serious personal injury or death.



WARNING: In situations where the vehicle camera has limited detection capability, this may reduce system performance. These situations include but are not limited to direct or low sunlight, vehicles at night without tail lights, unconventional vehicle types, pedestrians with complex backgrounds,

running pedestrians, partly obscured pedestrians, or pedestrians that the system cannot distinguish from a group. Failure to take care may result in the loss of control of your vehicle, serious personal injury or death.



WARNING: The system cannot help prevent all crashes. Do not rely on this system to replace driver judgment and the need to maintain a safe distance and speed.

Using the Pre-Collision Assist System

The Pre-Collision Assist system is active at speeds above approximately 3 mph (5 km/h) and pedestrian detection is active at speeds up to 50 mph (80 km/h).



E156130

If your vehicle is rapidly approaching another stationary vehicle, a vehicle traveling in the same direction as yours, or a pedestrian within your driving path, the system is designed to provide three levels of functionality:

1. Alert
2. Brake Support
3. Active Braking

Alert: When active, a flashing visual warning appears and an audible warning tone sounds.

Brake Support: The system is designed to help reduce the impact speed by preparing the brakes for rapid braking. Brake support does not automatically apply the brakes. If you press the brake pedal, the system could apply additional braking up to maximum braking force, even if you lightly press the brake pedal.

Driving Aids

Active Braking: Active braking may activate if the system determines that a collision is imminent. The system may help the driver reduce impact damage or avoid the crash completely.

Note: If you perceive Pre-Collision Assist alerts as being too frequent or disturbing, then you can reduce the alert sensitivity, though the manufacturer recommends using the highest sensitivity setting where possible. Setting lower sensitivity would lead to fewer and later system warnings.

Note: The Pre-Collision Assist system automatically disables when you select **4X4 LOW** or when you manually disable AdvanceTrac™.

Distance Indication and Alert

Distance Indication and Alert is a function that provides you with a graphical indication of the time gap to other preceding vehicles traveling in the same direction. The Distance Indication and Alert screen in the information display shows one of the following graphics.



E254791

If the time gap to a preceding vehicle is small, a red visual indication appears.

Note: Distance Indication and Alert deactivates and the graphics do not display when adaptive cruise control is active.

Speed	Sensitivity	Graphics	Distance Gap	Time Gap
62 mph (100 km/h)	Normal	Grey	>82 ft (25 m)	>0.9sec
62 mph (100 km/h)	Normal	Yellow	56–82 ft (17–25 m)	0.6sec – 0.9sec
62 mph (100 km/h)	Normal	Red	<56 ft (17 m)	<0.6sec

Adjusting the Pre-Collision Assist Settings

You can adjust the following settings by using the information display controls. See **General Information** (page 110).

- You can adjust the Alert and Distance Alert sensitivity to one of three possible settings.
- You can switch the Distance Indication and Alert function on or off.

Driving Aids

- If required, you can switch Active Braking on or off.
- If required, you can switch the entire Pre-Collision Assist feature on or off.

Note: Active braking automatically turns on every time you switch the ignition on.

Note: We recommended that you switch the system off if you install a snow plow or similar object in such a way that it may block the radar sensor. Your vehicle remembers the setting across key cycles.

Blocked Sensors

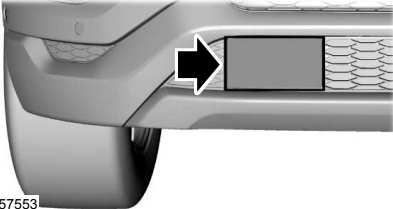
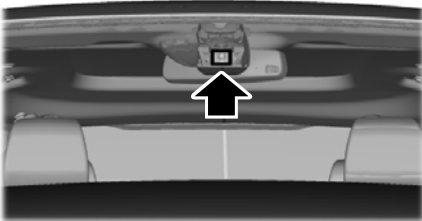

E257553

If a message regarding a blocked sensor or camera appears in the information display, the radar signals or camera images are obstructed. The radar sensor is behind a fascia cover near the driver side of the lower grille. With an obstructed radar, the Pre-Collision Assist system does not function and cannot detect a vehicle ahead. With the front camera obstructed, the Pre-Collision Assist system does not respond to pedestrians or stationary vehicles and the system performance on moving vehicles reduces. The following table lists possible causes and actions for when this message displays.

Driving Aids

Cause	Action
The surface of the radar in the grille is dirty or obstructed in some way.	Clean the grille surface in front of the radar or remove the object causing the obstruction.
The surface of the radar in the grille is clean but the message remains in the display.	Wait a short time. It may take several minutes for the radar to detect that there is no obstruction.
Heavy rain, spray, snow, or fog is interfering with the radar signals.	The Pre-Collision Assist system is temporarily disabled. Pre-Collision Assist should automatically reactivate a short time after the weather conditions improve.
Swirling water, or snow or ice on the surface of the road may interfere with the radar signals.	The Pre-Collision Assist system is temporarily disabled. Pre-Collision Assist should automatically reactivate a short time after the weather conditions improve.
Radar is out of alignment due to a front end impact.	Contact an authorized dealer to have the radar checked for proper coverage and operation.
The windshield in front of the camera is dirty or obstructed in some way.	Clean the outside of the windshield in front of the camera.
The windshield in front of the camera is clean but the message remains in the display.	Wait a short time. It may take several minutes for the camera to detect that there is no obstruction.

Note: Proper system operation requires a clear view of the road by the camera. Have any windshield damage in the area of the camera's field of view repaired.

Note: If something hits the front end of your vehicle or damage occurs, the radar sensing zone may change. This could cause missed or false vehicle detections. Contact an authorized dealer to have the radar checked for proper coverage and operation.

Note: If your vehicle detects excessive heat at the camera or a potential misalignment condition, a message may display in the information display indicating temporary sensor unavailability. This message deactivates automatically when operational conditions are correct. For example, when the ambient temperature around the sensor decreases or the sensor automatically recalibrates successfully.

Driving Aids

DRIVE CONTROL

Selectable Drive Modes

The system delivers a driving experience through a suite of sophisticated electronic vehicle systems. These systems optimize steering, handling and powertrain response. This provides a single location to control multiple systems performance settings.

Changing the drive mode automatically changes the functionality of the following systems:

- Electronically power-assisted steering system adjusts steering effort and feel based on the mode you select. See **Steering** (page 257).
- Electronic stability control and traction control maintain your vehicle control in adverse conditions or high performance driving. See **Stability Control** (page 216).
- Electronic throttle control enhances the powertrain response to your inputs.
- Driveline settings optimize with shift schedules tuned to each drive mode.

Using the System

The system automatically tailors your vehicle configuration for each mode you select.

The drive mode switch is in one of three places, depending on your vehicle configuration:

On the column shifter



E249567

On the center console



E257552

On the *DRIVE MODE* rotary switch.



E246604

Driving Aids

Note: Mode changes are not available when the vehicle ignition is off or when the engine is not running.

On-Road Modes



Normal - For everyday driving. This mode is a perfect balance of excitement, comfort and convenience.



Sport - For aggressive on-road driving. This mode increases throttle response, provides a sportier steering feel, along with quicker shifting. The suspension stiffens, with an emphasis on handling and control. The transmission also holds gears longer, helping your vehicle accelerate faster when shifting gears.



Tow/Haul - For improved transmission operation when towing a trailer or a heavy load. This mode moves upshifts to higher engine speeds to reduce the frequency of transmission shifting. This mode also provides engine braking in all forward gears, which slows your vehicle and assists you in controlling your vehicle when descending a grade. The amount of downshift braking provided varies based on the amount you press the brake pedal.

Note: All transmission gear ranges are available when using **Tow/Haul**.



ECO - For efficient and responsible driving. This mode helps deliver maximum fuel efficiency and increases driving range.

Off-Road Modes



Snow/Wet (4X2) or Grass/Gravel/Snow (4WD) - For firm surfaces covered with loose or slippery material such as packed snow, ice, water, grass or a thin layer of gravel or sand.



Sand - For soft dry sand or deep gravel.



Mud/Ruts - For muddy, rutted, soft or uneven terrain.

Note: The system has diagnostic checks that continuously monitor the system for proper operation. Certain drive modes are not available based on gear shifter position. If a mode is unavailable due to a system fault, the mode defaults to **Normal**.

Driving Aids

Transfer Case Availability

If Equipped with Rotary Drive Mode Switch

	Normal	Sport	ECO	Grass/Gravel/Snow	Tow/Haul	Mud/Ruts	Sand
2H	Default	Available	Default	Not Available	Available	Not Available	Not Available
4A	Available Normal Tuning	Default Sport Tuning	Available Normal Tuning	Default Slippery Tuning	Available	Default Off Road Tuning	Default Off Road Tuning
4L ¹	Available	Not Available	Not Available	Available	Available	Available	Available

¹ If Equipped.

If Equipped with Column Shifter Drive Mode Switch

	Normal	Sport	ECO	Grass/Gravel/Snow	Tow/Haul
2H	Default	Available	Default	Not Available	Available
4A ¹	Available Normal Tuning	Default Sport Tuning	Available Normal Tuning	Default Slippery Tuning	Available
4H ¹	Available	Not Available	Not Available	Available	Available
4L ¹	Available	Not Available	Not Available	Available	Available

¹ If Equipped.

Note: The drive mode reverts to **Normal** when you start your vehicle.

Note: Your vehicle remembers the 4WD mode across ignition cycles.

Note: Each drive mode has an associated default 4WD mode, however you can still select different 4WD modes using the 4WD switch based on your preference.

Load Carrying

REAR UNDER FLOOR STORAGE

Cargo Management System

A storage area is located in the floor of the rear cargo area. There are two types of storage systems depending on your vehicle.

Short Wheel Base System



E250821

Lift up on the handle to open the cover.

Note: The board operates with friction hinges, which allows it to be put in any position between a 0° and a 90° angle.



E250823

To close, lower the cover.

Long Wheel Base System

The long wheel base system has two separate storage compartments. To access these compartments, there is a bifolding cover.



E250822

Lift up on the handle and fold back to open the cover.

Note: The board operates with friction hinges, which allows it to be put in any position between a 0° and a 90° angle.

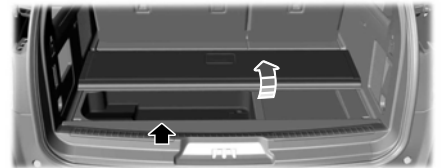

E250824

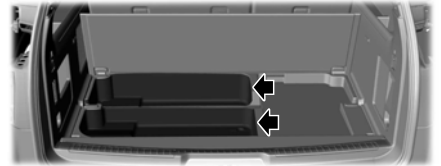

E250825

To access the second storage compartment, fold the cover back a second time.

To close, lower the cover.

Load Carrying

Advanced System: Forward Divider, Cargo Shelf and Rear Barrier (Bulkhead Position) (If Equipped)

Equipped)



WARNING: Do not load any objects on the shelf that may obstruct your vision or strike occupants of the vehicle in the case of a sudden stop or collision.



WARNING: Do not place people or pets on or under the parcel shelf.

The board moves to the same positions for both the short wheel base and long wheel base advanced systems.

Advanced Short Wheel Base System



E250826

A storage compartment is located in the floor of the rear cargo area. The cover operates on friction hinges. Lift up on the handle to open the cover. To close, lower the cover.

Advanced Long Wheel Base System



E250827

With the advanced long wheel base system, there is an additional cover with an extra storage compartment underneath. This cover also operates on friction hinges. Lift up on the handle to open the cover. To close, lower the cover.

Forward Divider

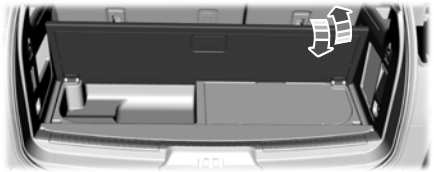

E250829

To move the board into the divider position, lift up on the handle and position the board vertically at a 90° angle.

Note: The board operates on friction hinges, which allows it to be put in any position between a 0° and a 90° angle.

Cargo Shelf

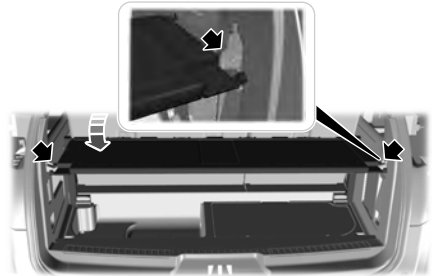

E250829

To move the board into the shelf position, lift the board and move it to the horizontal position. Once the board is horizontal, insert the forward facing nubs into the hooks on either side.

Load Carrying

For the short wheel base system, it is necessary for the second panel located toward the front of the vehicle to be raised up when the seats are folded down.

For the long wheel base system, it is necessary for the second panel located toward the front of the vehicle to be raised up.

Note: Before moving the board into the shelf position, you may need to flip down the hooks.

Note: Do not put more than 50 lb (22 kg) on shelf.

Rear Barrier (Bulkhead Position)



E250830

To move the board into the rear barrier or bulkhead position, lift the board and move it to the vertical position. Once the board is vertical, insert the rearward facing nubs into the hooks on either side.

Note: Before moving the board into the rear barrier or bulkhead position, you may need to flip down the hooks.

CARGO NETS (IF EQUIPPED)



WARNING: This net is not designed to restrain objects during a collision or heavy braking.

The cargo net secures lightweight objects in the cargo area.



E275127

1. Fold down the hooks on the top of the rear quarter trim panel.

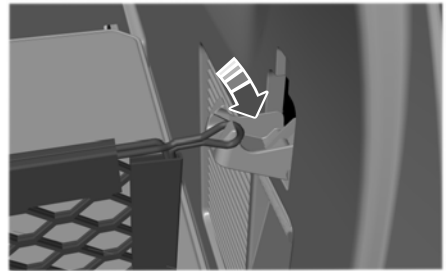

E275126

2. Attach the loop end of the net to the upper hook. Use one prong on the hook for the net attachment.



E275125

3. Attach the bottom of the net to the lower anchor point.

Load Carrying

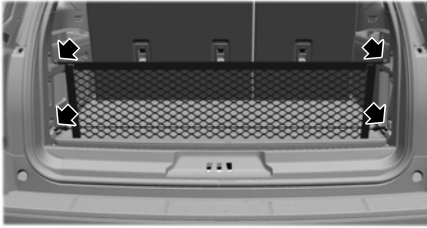

8275124

4. Repeat this procedure on the other side of your vehicle.

ROOF RACKS AND LOAD CARRIERS



WARNING: When loading the roof racks, we recommend you evenly distribute the load, as well as maintain a low center of gravity. Loaded vehicles, with higher centers of gravity, may handle differently than unloaded vehicles. Take extra precautions, such as slower speeds and increased stopping distance, when driving a heavily loaded vehicle.

For correct roof rack system function, you must place loads directly on crossbars affixed to the roof rack side rails. When using the roof rack system, we recommend you use Ford Genuine Accessory crossbars designed specifically for your vehicle.

Make sure that you securely fasten the load. Check the tightness of the load before driving and at each fuel stop.

Note: *Never place loads directly on the roof panel. The roof panel is not designed to directly carry a load.*

Maximum Recommended Load Amounts

Description	Maximum Recommended Load
Vehicles with Moonroof	125 lb (56 kg)
Vehicles without Moonroof	200 lb (90 kg)

Note: *The maximum recommended load is based on the load being evenly distributed on the crossbars.*

Load Carrying

Some Middle East Expedition vehicles are equipped with higher Gross Vehicle Weight ratings and unique capabilities. As a result, for 4WD Expeditions in the Middle East, excluding Expedition MAX, the maximum load capabilities are reduced to the following when using the roof for load carrying:

- 7,450 lb (3,379 kg) - Gross Vehicle Weight (GVW).
- 3,375 lb (1,530 kg) - Front Gross Axle Weight (GAW).

Adjusting the Crossbar (If Equipped)

Note: For less wind noise and better aerodynamics, only install the crossbars when you need them for carrying cargo. The front crossbar is fixed. There are two optional positions for the rear crossbar. Follow the steps to reposition or remove the rear crossbar.

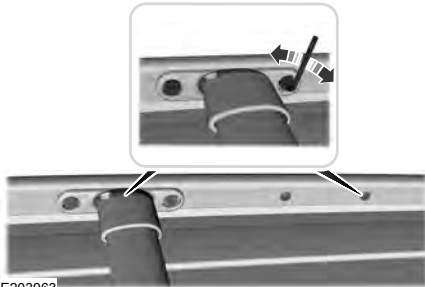

E203063

1. Remove the crossbar bolts at both sides of the rear crossbar by using the supplied torx tool or a similar tool.
2. Move the crossbar to the new position.
3. Replace and tighten the bolts at both sides of the crossbar by using the supplied torx tool or a similar tool.

Note: There may be snap caps in the new side rail position, which must be removed before installing the crossbar. These caps can be removed by using the supplied torx tool or a similar tool.

LOAD LIMIT

Vehicle Loading - with and without a Trailer

This section guides you in the proper loading of your vehicle, trailer, or both. Keep your loaded vehicle weight within its design rating capability, with or without a trailer. Properly loading your vehicle provides maximum return of vehicle design performance. Before you load your vehicle, become familiar with the following terms for determining your vehicle's weight rating, with or without a trailer, from the vehicle's Tire and Loading Information label or Safety Compliance Certification label.

Load Carrying

Tire and Loading Label Information Example:



TIRE AND LOADING INFORMATION

SEATING CAPACITY TOTAL: 5 FRONT: 2 REAR: 3

The combined weight of occupants, and cargo should never exceed • 385 kg or 850 lbs.

TIRE	SIZE	COLD TIRE PRESSURE	SEE OWNERS MANUAL FOR ADDITIONAL INFORMATION
FRONT	235/45R18 94V	235 KPA, 34 PSI	
REAR	235/45R18 94V	235 KPA, 34 PSI	
SPARE	NONE	NONE	



TIRE AND LOADING INFORMATION
RENSEIGNEMENTS SUR LES PNEUS ET LE CHARGEMENT

SEATING CAPACITY / NOMBRE DE PLACES TOTAL: 5 FRONT: 2 REAR: 3

The combined weight of occupants and cargo should never exceed 396 kg or 875 lbs. / Le poids total des occupants et du chargement ne doit jamais dépasser 396 kg ou 875 lbs.

TIRE / PNEU	SIZE / DIMENSIONS	COLD TIRE PRESSURE / PRESSION DES PNEUS A FROID	SEE OWNER'S MANUAL FOR ADDITIONAL INFORMATION VOIR LE MANUEL DE L'USAGER POUR PLUS DE RENSEIGNEMENTS
FRONT / AVANT	235/40R19 96V	255 KPA, 37 PSI	
REAR / ARRIERE	235/40R19 96V	255 KPA, 37 PSI	
SPARE / SECOURS	T125/80R16 97M	415 KPA, 60 PSI	

E198719

Payload

Payload is the combined weight of cargo and passengers that your vehicle is carrying. The maximum payload for your vehicle appears on the Tire and Loading label. The label is either on the B-pillar or the edge of the driver door. Vehicles exported outside the US and Canada may not have a tire and loading label. Look for "The combined weight of occupants and cargo should never exceed XXX kg OR XXX lb" for maximum payload. The payload listed on the Tire and Loading Information label

is the maximum payload for your vehicle as built by the assembly plant. If you install any additional equipment on your vehicle, you must determine the new payload. Subtract the weight of the equipment from the payload listed on the Tire and Loading label. When towing, trailer tongue weight or king pin weight is also part of payload.



WARNING: The appropriate loading capacity of your vehicle can be limited either by volume capacity (how much space is available) or by payload capacity (how much weight the vehicle should carry). Once you have reached the maximum payload of your vehicle, do not add more cargo, even if there is space available. Overloading or improperly loading your vehicle can contribute to loss of vehicle control and vehicle rollover.

GAWR (Gross Axle Weight Rating)

GAWR is the maximum allowable weight that a single axle (front or rear) can carry. These numbers are on the Safety Compliance Certification label. The label is located on the door hinge pillar, door-latch post, or the door edge that meets the door-latch post, next to the driver seating position.

Load Carrying

The total load on each axle must never exceed its Gross Axle Weight Rating.

GVWR (Gross Vehicle Weight Rating)

GVWR is the maximum allowable weight of the fully loaded vehicle. This includes all options, equipment, passengers and cargo. It appears on the Safety Compliance Certification label. The label is located on the door hinge pillar, door-latch post, or the door edge that meets the door-latch post, next to the driver seating position.

The gross vehicle weight must never exceed the Gross Vehicle Weight Rating.

Safety Compliance Certification Label Example:

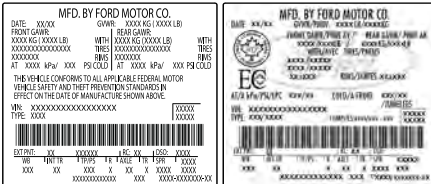

E198828



WARNING: Exceeding the Safety Compliance Certification label vehicle weight limits can adversely affect the performance and handling of your vehicle, cause vehicle damage and can result in the loss of control of your vehicle, serious personal injury or death.

Maximum Loaded Trailer Weight

Maximum loaded trailer weight is the highest possible weight of a fully loaded trailer the vehicle can tow. Consult an authorized dealer (or the RV and Trailer Towing Guide available at an authorized dealer) for more detailed information.

GCWR (Gross Combined Weight Rating)

GCWR is the maximum allowable weight of the vehicle and the loaded trailer, including all cargo and passengers, that the vehicle can handle without risking damage. (Important: The towing vehicle's braking system is rated for operation at Gross Vehicle Weight Rating, not at Gross Combined Weight Rating.) Separate functional brakes should

Load Carrying

be used for safe control of towed vehicles and for trailers where the Gross Combined Weight of the towing vehicle plus the trailer exceed the Gross Vehicle Weight Rating of the towing vehicle.

The gross combined weight must never exceed the Gross Combined Weight Rating.

Note: For trailer towing information refer to the *RV and Trailer Towing Guide* available at an authorized dealer.



WARNING: Do not exceed the GVWR or the GAWR specified on the certification label.



WARNING: Do not use replacement tires with lower load carrying capacities than the original tires because they may lower your vehicle's GVWR and GAWR limitations. Replacement tires with a higher limit than the original tires do not increase the GVWR and GAWR limitations.



WARNING: Exceeding any vehicle weight rating can adversely affect the performance and handling of your vehicle, cause vehicle damage and can result in the loss of control of your vehicle, serious personal injury or death.

Steps for determining the correct load limit:

1. Locate the statement "The combined weight of occupants and cargo should never exceed XXX kg or XXX lb." on your vehicle's placard.
2. Determine the combined weight of the driver and passengers that will be riding in your vehicle.
3. Subtract the combined weight of the driver and passengers from XXX kg or XXX lb.
4. The resulting figure equals the available amount of cargo and luggage load capacity. For example, if the "XXX" amount equals 1,400 lb. and there will be five 150 lb. passengers in your vehicle, the amount of available cargo and luggage load capacity is 650 lb. $(1400 - 750 (5 \times 150) = 650 \text{ lb.})$
5. Determine the combined weight of luggage and cargo being loaded on the vehicle. That weight may not safely exceed the available cargo and luggage load capacity calculated in Step 4.
6. If your vehicle will be towing a trailer, load from your trailer will be transferred to your vehicle. Consult this manual to determine how this reduces the available cargo and luggage load capacity of your vehicle.

Load Carrying

Helpful examples for calculating the available amount of cargo and luggage load capacity

Suppose your vehicle has a 1400-pound (635-kilogram) cargo and luggage capacity. You decide to go golfing. Is there enough load capacity to carry you, four of your friends and all the golf bags? You and four friends average 220 pounds (99 kilograms) each and the golf bags weigh approximately 30 pounds (13.5 kilograms) each. The calculation would be: $1400 - (5 \times 220) - (5 \times 30) = 1400 - 1100 - 150 = 150$ pounds. Yes, you have enough load capacity in your vehicle to transport four friends and your golf bags. In metric units, the calculation would be: $635 \text{ kilograms} - (5 \times 99 \text{ kilograms}) - (5 \times 13.5 \text{ kilograms}) = 635 - 495 - 67.5 = 72.5$ kilograms.

Suppose your vehicle has a 1400-pound (635-kilogram) cargo and luggage capacity. You and one of your friends decide to pick up cement from the local home improvement store to finish that patio you have been planning for the past two years. Measuring the inside of the vehicle with the rear seat folded down, you have room for twelve 100-pound (45-kilogram) bags of cement. Do you have enough load capacity to transport the cement to your home? If you and your friend each weigh 220 pounds (99 kilograms), the calculation would be: $1400 - (2 \times 220) - (12 \times 100) = 1400 - 440$

$- 1200 = - 240$ pounds. No, you do not have enough cargo capacity to carry that much weight. In metric units, the calculation would be: $635 \text{ kilograms} - (2 \times 99 \text{ kilograms}) - (12 \times 45 \text{ kilograms}) = 635 - 198 - 540 = -103$ kilograms. You will need to reduce the load weight by at least 240 pounds (104 kilograms). If you remove three 100-pound (45-kilogram) cement bags, then the load calculation would be: $1400 - (2 \times 220) - (9 \times 100) = 1400 - 440 - 900 = 60$ pounds. Now you have the load capacity to transport the cement and your friend home. In metric units, the calculation would be: $635 \text{ kilograms} - (2 \times 99 \text{ kilograms}) - (9 \times 45 \text{ kilograms}) = 635 - 198 - 405 = 32$ kilograms.

The above calculations also assume that the loads are positioned in your vehicle in a manner that does not overload the front or the rear gross axle weight rating specified for your vehicle on the Safety Compliance Certification label.

Special Loading Instructions for Owners of Pick-up Trucks and Utility-type Vehicles



WARNING: When loading the roof racks, we recommend you evenly distribute the load, as well as maintain a low center of gravity. Loaded vehicles, with higher centers of gravity, may

Load Carrying

handle differently than unloaded vehicles. Take extra precautions, such as slower speeds and increased stopping distance, when driving a heavily loaded vehicle.

Towing

TOWING A TRAILER



WARNING: Towing trailers beyond the maximum recommended gross trailer weight exceeds the limit of your vehicle and could result in engine damage, transmission damage, structural damage, loss of vehicle control, vehicle rollover and personal injury.



WARNING: Do not exceed the GVWR or the GAWR specified on the certification label.

Your vehicle may have electrical items, such as fuses or relays, related to towing. See **Fuses** (page 315).

Some vehicles may have the ability to modify trailer towing features. See **Towing** (page 275).

Your vehicle's load capacity designation is by weight, not by volume, so you cannot necessarily use all available space when loading a vehicle or trailer.

Towing a trailer places an extra load on your vehicle's engine, transmission, axle, brakes, tires and suspension. Inspect these components periodically during, and after, any towing operation.

Load Placement

To help minimize how trailer movement affects your vehicle when driving:

- Load the heaviest items closest to the trailer floor.
- Load the heaviest items centered between the left and right side trailer tires.
- Load the heaviest items above the trailer axles or just slightly forward toward the trailer tongue. Do not allow the final trailer tongue weight to go above or below 10-15% of the loaded trailer weight.
- Select a ball mount with the correct rise or drop and load capacity. When both the loaded vehicle and trailer are connected, the trailer frame should be level, or slightly angled down toward your vehicle, when viewed from the side.

When driving with a trailer or payload, a slight takeoff vibration or shudder may be present due to the increased payload weight. Additional information regarding proper trailer loading and setting your vehicle up for towing is located in another chapter of this manual. See **Load Limit** (page 269).

You can also find information in the **RV & Trailer Towing Guide** available at your authorized dealer, or online.

Towing

RV & Trailer Towing Guide Online

Website <http://www.fleet.ford.com/towing-guides/>

TRAILER REVERSING AIDS (IF EQUIPPED)

Pro Trailer Backup Assist™



WARNING: Driving while distracted can result in loss of vehicle control, crash and injury. We strongly recommend that you use extreme caution when using any device that may take your focus off the road. Your primary responsibility is the safe operation of your vehicle. We recommend against the use of any hand-held device while driving and encourage the use of voice-operated systems when possible. Make sure you are aware of all applicable local laws that may affect the use of electronic devices while driving.



WARNING: This system is an extra driving aid. It does not replace your attention and judgment, or the need to apply the brakes. This system does NOT automatically brake your vehicle. If you fail to press the brake pedal when necessary, you may collide with another vehicle.

Note: *The system is not a substitute for safe driving practices.*

Note: *You must always be aware of the vehicle and trailer combination and the surrounding environment.*

Note: *The system does not detect or prevent the vehicle or trailer from making contact with obstacles in the surrounding environment.*

Note: *Keep in mind that the front end of the vehicle swings out when changing the direction of the trailer.*

Note: *The system relies on user measurements to determine sticker placement and system limits. It is critical to take the key measurements correctly. Incorrect measurements can result in the improper function of the system up to and including contact between the vehicle and trailer.*

Note: *The system limits vehicle speed when backing up. The system is not a replacement for proper use of the throttle and brake pedals.*

Principle of Operation

This feature helps you to steer your vehicle when backing up with a trailer attached. Turn and hold the control knob in the direction you want the trailer to go and the system takes over the steering. This allows you to focus on checking the mirrors and operating the brake and accelerator.

Each trailer you use with your vehicle has to be setup once.

You must take care to follow the setup process accurately, to make sure the sticker is placed correctly.

Contact your dealership if you need assistance in setting up your trailer.

Towing

Setting Up Pro Trailer Backup Assist

Note: Once you have entered a trailer's information into the system, it is stored for easy recall. A maximum of 10 trailers can be added to the system.

Step 1: Position your Vehicle and Trailer

Hitch your conventional trailer to your vehicle. See **Essential Towing Checks** (page 288).

Park your vehicle and hitched trailer on a level surface.

For best results, make sure that your trailer rides level with the ground when you hitch it to your vehicle. More information on selecting your towbar is available in the Towing section. See **Towing** (page 275).



E247482

Make sure your vehicle and the trailer are in line with each other. You can do this by driving straight forward.



E247481

Step 2: Follow the Information Display Prompts

Press the button to turn the system on.



E253721

1. Select the option to add a trailer in the instrument cluster menu, using the steering wheel control. See **General Information** (page 110).
2. Add a personalized name for the trailer using the screen prompts. Use the down arrow to scroll to the desired letter and then press the right arrow to advance to the next letter. Press OK to continue.
3. Select the type of trailer brake system for the trailer you are adding.
4. Select the brake effort level for the trailer.

Note: The default option is low. This is recommended for most trailers. If the trailer's brakes require more initial voltage, or if you prefer more aggressive braking then select the other options as required.

Towing

Some examples of conventional type trailers are shown below.

Note: You cannot use the system with the types of trailers marked with the cross.

The system only works with conventional trailers. It does not work with other types including gooseneck and fifth wheel.

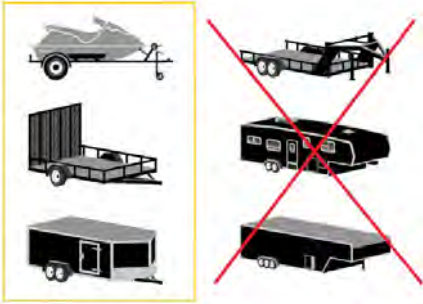

E209766

Follow the information display prompts.

Step 3: Place the Sticker on the Trailer Frame

The supplied sticker must be placed in an area visible by the rear view camera.

Note: The cargo and trailer hookup lamps turn on automatically to improve visibility.

Note: An assistant can help to carry out the following procedure.

Note: Make sure nothing can obstruct the rear view camera's view of the sticker. For example, items such as a jack handle or wiring.

Note: Position the sticker on a flat, dry and clean horizontal surface. For best results apply the sticker when temperatures are above 32°F (0°C).

Note: Do not move stickers after they are placed. Do not re-use any stickers if removed.

Note: Additional stickers may be purchased through your Ford Dealers parts department.

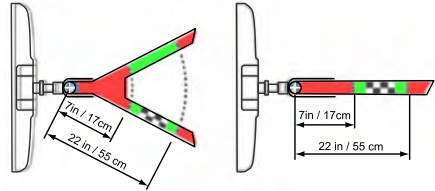

E209805

Use the supplied measurement card, a tape measure and pen to carefully mark the area where to attach the sticker (supplied in the back cover pocket of your quick start guide). Make sure the whole sticker is within the zone between the two arcs or distance markers on the diagram, and is also visible in the rear view camera display.

Step 4: Take Measurements

After the sticker is correctly placed on the trailer you must take some key measurements.

Note: Accurate measurements must be taken for the system to operate properly.

Note: When rounding in inches, round upward if the measured length is a quarter inch or greater. Round downward if the measured length is less than a quarter inch. For example 12.25 in (31.11 cm) would be rounded up to 12.50 in (31.75 cm). 12.13 in (30.8 cm) would be rounded down to 12.00 in (30.48 cm).

Note: When rounding in centimeters, round to the nearest whole centimeter. If the measurement is less than 0.2 in (0.5 cm) round downward. If the measurement is more than or equal to 0.2 in (0.5 cm) round upward. For example, 11.9 in (30.3 cm) would be rounded down to 11.8 in (30 cm). 12.0 in (30.5 cm) would be rounded up to 12.2 in (31 cm).

Towing

Note: Use consistent metric or imperial units as required by your country or vehicle.

Record the four key distances (A, B, C, D) as required by the measurement card. Record the trailer name for these measurements.

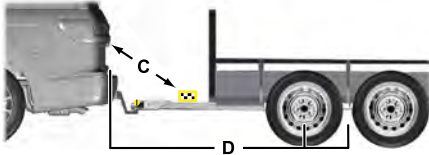
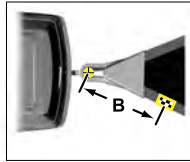
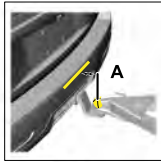

E247545

Distance A

The horizontal distance from the bumper to the center of the ball hitch on the trailer.

Distance B

The horizontal distance from the center of the ball hitch to the center of the sticker.

Distance C

The distance from the rear view camera to the center of the sticker.

Distance D

The horizontal distance from the bumper to the center of the trailer axle (single axle trailers), or the center of the axles (trailers with dual axles or more).

Note: If the distance ends in anything less than one half of an inch, round down to the current whole inch. If a distance ends in one half or greater of an inch, round up to the next whole inch. For example, 12.3 in (31.12 cm) would be rounded down to 12 in (30.48 cm). 12.5 in (31.75 cm) would be rounded up to 13 in (33 cm).

Step 5: Enter Measurements Using the Information Display

Using the recorded measurements, enter the required data into the system. Follow the on screen prompts to enter each of the measurements taken in step 4. When all four distances have been entered, a confirmation display appears. Check the values are correct before proceeding, or go back to change any if required.

Step 6: Confirming the Sticker Location

Check the rear view camera display to see if the sticker is identified by the system and marked with a red circle.

Confirm that the red circle is correctly located over the sticker image in the display. The on screen prompt asks you to confirm this.

Note: If the system cannot locate the sticker try cleaning the camera lens, and also make sure the sticker is within the green zone as indicated in step 3.

Calibrating the System

To complete setup, drive your vehicle straight forward between 4 mph (6 km/h) and 24 mph (39 km/h) following the on screen prompt.

Note: Check your measurements to make sure you measured from the correct points.

Note: If you move the steering wheel during this procedure, the calibration pauses.

Note: We recommend that you do not do this at night.

Towing

A message displays during calibration and after calibration is complete.

Using Pro Trailer Backup Assist

To use the system press the button and select the required trailer from the display.



E253721

When the sticker is located, the display prompts you to shift into reverse (R). The system turns on.

Note: The system does not function if your hands are on the steering wheel. Remove your hands to resume operation.

Follow the screen prompts to steer your vehicle and trailer.

Note: You may have to drive forward to straighten the trailer.

Take your hands off the steering wheel and turn the Pro Trailer Backup Assist control knob instead. The knob acts as the steering control for the trailer.

Note: The more you turn the knob, the sharper the trailer turns.



E246992

Turn and hold counterclockwise to make the trailer go left.



E246991

Turn and hold clockwise to make the trailer go right.



Note: Practice maneuvering with the system in a safe open area first.

Note: Try backing up in a straight line and then turning the knob slowly in the direction you want to go.

Note: Quickly turning and releasing the knob results in a jerky movement of the vehicle.

Towing



E246993

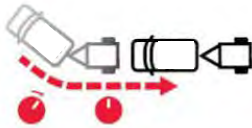

Release the knob when the trailer is moving in the direction you want. Control the accelerator and brakes while the system steers your vehicle automatically to keep the trailer moving straight back.

Note: You may have to use the knob to correct the trailer direction when attempting to move the trailer straight back under some conditions.

Note: Your vehicle speed is automatically limited.

Note: When you release the knob or turn it to the center position, your vehicle follows the trailer's path.

Troubleshooting

Note: The system requires a clear view of the sticker placed on the trailer. You must keep the camera lens and sticker clean for the system to operate correctly.

Setup

The system is designed to be used with a wide variety of trailers. However there are some trailers that do not have a proper surface and location to mount the sticker. These trailers are not supported. Attempts to place the sticker on a surface that does not meet the sticker placement requirement listed in Step 3 of the setup instruction or entering inaccurate measurements to proceed through setup can result in improper system function.

Accurate measurements are critical to correct system function. If you need to check measurements entered or change them you can access them through the trailer menus in the instrument cluster. Choose the option to change the sticker from the change trailer settings menu. It is not necessary to remove the sticker if you are just reviewing or changing measurements.

The following menu warnings or difficulties may occur during setup. Tips to resolve them are listed below.

Note: If you still experience issues with the system's ability to detect the sticker, see the information in the next section regarding sticker lost during system operation.

Measurement A has reached maximum or minimum value:

- The system is designed to work with drawbars that have a bumper to hitch ball center measurement of 4 in (10 cm) to 11 in (28 cm) when installed. Do not attempt to use drawbars that have a length outside this range as the system performance degrades and could cause improper system function.
- Make sure that the measurement being made is the horizontal distance only from bumper and the hitch ball center. A straight line distance that includes any vertical rise or drop increases the measurement and makes it inaccurate. Inaccurate measurements degrade system performance and could cause improper system function. See step 4 of the setup instruction to review measurement instructions.

Towing

Measurement B has reached maximum or minimum value:

- Make sure that the sticker placement instruction in step 3 of the setup has been followed. Stickers placed outside the allowed zone adversely affect the system performance and could cause improper feature function.
- Make sure that the measurement being made is the horizontal distance only from center of sticker to the hitch ball center. A straight line distance that includes any vertical rise or drop increases the measurement and causes an inaccurate value to be entered into the system. See step 4 of the setup for additional measurement instructions.

Measurement C has reached maximum or minimum value:

- Make sure that the sticker placement instructions in step 3 of the setup have been followed. Stickers placed outside the allowed zone adversely affect the system performance and could cause improper feature function. If you have met all the criteria for sticker placement and you see this message this sticker is either too far below or too close to the camera to properly recognize the sticker. In order for the system to operate correctly the sticker height must be lowered if you receive the minimum warning or the sticker height must be raised if you receive the maximum warning.
- Only one sticker can be placed on the trailer for correct system function. The previous sticker must be removed or covered so only one sticker is visible to the camera.
- Measurement B and C must be measured again if a new sticker is placed on the trailer.

Measurement D has reached maximum or minimum value:

- Make sure that the measurement being made is the horizontal distance only from the bumper to the center of the single axle or the center of all the axles on the trailer. See step 4 of the setup for additional measurement instructions. The TBA system does not support trailer lengths outside the range allowed by the information display.

System is circling something beside the sticker or system cannot find the sticker:

- Make sure the rear camera is clean and the sticker is clearly visible in the camera image. Clean the camera and sticker if necessary.
- The camera system uses the entered measurements to help locate the sticker. Inaccurate sticker measurements degrade the system's ability to locate the sticker. Verify the measurements entered into the system are accurate.
- Remove the incorrectly circled label or decal if possible.
- If you cannot resolve the issue a new sticker location should be tried. The sticker location must still meet the requirements noted in step 3 of the setup instructions. Only one sticker can be placed on the trailer for correct system function. The previous sticker must be removed or covered so only one sticker is visible to the camera.

Calibration

The system monitors various vehicle parameters to ensure your vehicle is being driven straight and the trailer straight behind your vehicle. Any steering input or trailer movement pauses the calibration.

Towing

For best results:

- Use a long, straight, smooth and level road when attempting to calibrate.
- Drive straight forward.
- Drive between 4 mph (6 km/h) and 24 mph (39 km/h).

System Operation

The following warnings or difficulties may occur during feature operation. Tips to resolve them are listed below.

The system is not available:

- The system relies on many sub-systems in your vehicle to operate correctly. If those sub-systems are not operating correctly the system may not be available.
- Low battery voltage is a condition which prevents the system from operating. Please make sure the battery is correctly charged if the system is not available.
- You may need to drive your vehicle straight forward above 25 mph (40 km/h) before the system is available again.
- If the message still displays take your vehicle to an authorized dealer for service.

Sticker lost:

- If the system cannot initially find the sticker, it may be necessary for you to change the lighting conditions by moving the vehicle and trailer or waiting until conditions change.
- Check for the following if you receive the lost sticker message while using the system.
- Stop your vehicle as soon as the message displays.
- Make sure the sticker is visible and the pattern is discernable in the rear view camera image.

- Clean the sticker and camera to make sure they are unobstructed.
- Clean the lens with a soft, lint-free cloth and water.
- Clean the sticker with isopropyl rubbing alcohol sprayed directly onto the sticker, and then wipe clean with a soft cloth.
- Remove any items that may be blocking the view of the sticker. Depending on your trailer configuration and any equipment mounted to your trailer it is possible for the sticker to be blocked from view of the camera as it rotates on the hitch ball but not be blocked during setup. Remove the obstruction if possible. It is necessary to remove the sticker from its current location if the obstruction cannot be cleared and place a new sticker that is visible to the camera in all positions of the trailer behind your vehicle.
- Placing the sticker on a surface angled away from the vehicle reduces performance. Use a drawbar that positions the trailer level to the ground when attached to vehicle. This typically provides a level surface to mount the sticker. Place the sticker on a bracket or other object when no level surface is available.
- Make sure the entire sticker is on a flat surface that is completely visible to the camera. Do not fold the sticker over an edge on the trailer frame. This can degrade performance.
- Shadows on the sticker may effect tracking performance under some lighting conditions. Moving the sticker to another location within the allowed placement area may improve performance. Use the change sticker option in your Towing menu if you move the sticker.

Towing

- You can change your sticker location by going into the Towing menu, selecting trailer options, selecting change trailer settings and then selecting the change sticker option. The previous sticker must be removed. **ONLY ONE STICKER SHOULD BE PLACED ON THE TRAILER FOR CORRECT SYSTEM FUNCTION.**
- The camera system uses the entered measurements to help locate the sticker. Inaccurate measurements reduce the system's ability to locate the sticker. Check the measurements entered into the system are correct. Refer to the step 4 of Pro trailer backup Assist setup for instructions on measurements.
- You can change your measurement by going into the Towing menu, selecting trailer options, selecting change trailer setting and then selecting the change sticker option. Disregard the prompt to remove this sticker and continue to the next step if you only plan to update the measurements for the current sticker location.

System does not backup straight:

- Factors such as the drawbar connection to the hitch receiver, road camber, road grade and compliance in the trailer suspension can influence how straight the system is able to back your trailer when the knob is not turned. You can compensate for the trailer drifting to the right or left by slowly turning the Pro Trailer Backup Assist knob until the trailer is following your desired path and then holding the knob in that position. If you would like to recalibrate the system for straight backing, you can do so with the following procedure.
- Go into the Towing menu, select trailer options, select change trailer setting and then select the change sticker option. Your saved measurements display. Do not change them but continue to confirm measurements. Once you confirm the measurements, the system prompts you to perform the calibration procedure.

System consistently shows Stop Now Max trailer angle reached warning:

- The system uses your measurements to determine sticker position and establish system limits. Accurate sticker placement and trailer measurements provide the best system performance. If you are consistently receiving this warning it is likely there is an issue with sticker placement or the entered measurements. Make sure that the

Towing

sticker is placed correctly based on steps 3 and the measurements were made correctly according to Step 4. The troubleshooting guide for trailer measurements can also be reviewed for help in making measurements.

- To change sticker location or change trailer measurements, go into the Towing menu, select trailer options, select change trailer setting and then select the change sticker option.
- If the sticker location needs to be changed, the previous sticker must be removed and a new sticker needs to be placed on the trailer. **ONLY ONE STICKER SHOULD BE PLACED ON THE TRAILER FOR PROPER SYSTEM FUNCTION.**
- Disregard the prompt to remove this sticker and continue to the next step if you only plan to update the measurements for the current sticker location.

System consistently shows Stop now take control of steering warning:

- The system displays this warning when it can no longer steer the vehicle and you must take over steering. There are four reasons why this warning displays and additional information regarding the reason for the warning is available on the center display.
- The steering wheel is touched while the system is controlling it. Avoid touching the wheel during system operation.
- The maximum speed for feature operation is exceeded. System performance is optimized at slower speeds. Backup slowly.

- The sticker was lost by the camera system. Once your vehicle is stopped additional warnings indicate the sticker was lost. Refer to sticker lost trouble shooting tips.
- An internal condition for system operation was not met which requires your vehicle return to manual control of the steering.

Note: *The system is designed to be used with the same trailer connection every time the trailer is chosen from the selection menu. Using a different drawbar or a different pin hole (on drawbars with more than one) when connecting the drawbar to your vehicle affects the trailer measurements. Take the measurements again and update if required.*

TRAILER SWAY CONTROL

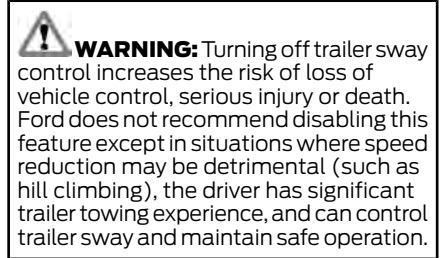

Note: *This feature does not prevent trailer sway, but reduces it once it begins.*

Note: *This feature cannot stop all trailers from swaying.*

Note: *In some cases, if vehicle speed is too high, the system may activate multiple times, gradually reducing vehicle speed.*

Towing

This feature applies your vehicle brakes at individual wheels and, if necessary, reduces engine power. If the trailer begins to sway, the stability control light flashes and the message **TRAILER SWAY REDUCE SPEED** appears in the information display. The first thing to do is slow your vehicle down, then pull safely to the side of the road and check for proper tongue load and trailer load distribution. See **Towing** (page 275).

RECOMMENDED TOWING WEIGHTS

Note: *Do not exceed the trailer weight for your vehicle configuration listed in the chart below.*

Note: *Make sure to take into consideration trailer frontal area. Do not exceed 36.5 feet² (3.39 meters²) if your vehicle is equipped with the standard towing package, or 60 feet² (5.57 meters²) if your vehicle is equipped with the optional heavy duty package.*

Note: *Exceeding this limitation may significantly reduce the performance of your towing vehicle. Selecting a trailer with a low aerodynamic drag and rounded front design helps optimize performance and fuel economy.*

Note: *For high altitude operation, reduce the gross combined weight by 2% per 1,000 ft (300 m) starting at the 1,000 ft (300 m) elevation point.*

Note: *Certain states require electric trailer brakes for trailers over a specified weight. Be sure to check state regulations for this specified weight. The maximum trailer weights listed may be limited to this specified weight, as the vehicle's electrical system may not include the wiring connector needed to activate electric trailer brakes.*

Your vehicle may tow a trailer provided the maximum trailer weight is less than or equal to the maximum trailer weight listed for your vehicle configuration on the following chart.

To calculate the maximum loaded trailer weight for your vehicle:

1. Start with the gross combined weight rating for your vehicle model and axle ratio. See the following chart.
2. Subtract all of the following that apply to your vehicle:
 - Vehicle curb weight.
 - Hitch hardware weight, such as a draw bar, ball, locks or weight distributing.
 - Driver weight.
 - Passenger weight.
 - Payload, cargo and luggage weight.
 - Aftermarket equipment weight.
3. This equals the maximum loaded trailer weight for this combination.

Towing

Note: *The trailer tongue load figures into the payload for your vehicle. Reduce the total payload by the final trailer tongue weight.*

Consult an authorized dealer to determine the maximum trailer weight allowed for your vehicle if you are not sure.

Vehicle Type	Towing Package	Maximum GCWR	Maximum Trailer Weight
Short Wheel Base 4x2	Standard	12,000 lb (5,443 kg)	6,000 lb (2,722 kg)
Short Wheel Base 4x4		12,300 lb (5,579 kg)	6,000 lb (2,722 kg)
Long Wheel Base 4x2		12,500 lb (5,670 kg)	6,300 lb (2,858 kg)
Long Wheel Base 4x4		12,400 lb (5,625 kg)	6,000 lb (2,722 kg)
Short Wheel Base 4x2	Optional Heavy Duty with 50% Load Distributing (FALR)	15,300 lb (6,940 kg)	9,300 lb (4,218 kg)
Short Wheel Base 4x4		15,500 lb (7,031 kg)	9,200 lb (4,173 kg)
Long Wheel Base 4x2		15,200 lb (6,895 kg)	9,000 lb (4,082 kg)
Long Wheel Base 4x4		15,500 lb (7,031 kg)	9,000 lb (4,082 kg)

Towing

ESSENTIAL TOWING CHECKS

Follow these guidelines for safe towing:

- Do not tow a trailer until you drive your vehicle at least 1,000 mi (1,600 km).
- Consult your local motor vehicle laws for towing a trailer.
- See the instructions included with towing accessories for the proper installation and adjustment specifications.
- Service your vehicle more frequently if you tow a trailer. See your scheduled maintenance information.
- If you use a rental trailer, follow the instructions the rental agency gives you.

For load specification terms found on the tire label and Safety Compliance label and instructions on calculating your vehicle's load, See **Load Limit** (page 269).

Remember to account for the trailer tongue weight as part of your vehicle load when calculating the total vehicle weight.

Trailer Towing Connector (Vehicles with a Trailer Towing Package and 7-Pin Connector)



E163167

When attaching the trailer wiring connector to your vehicle, only use a proper fitting connector that works with the vehicle and trailer functions. Some seven-position connectors may have the SAE J2863 logo, which confirms that it is the proper wiring connector and works correctly with your vehicle.

Color	Function
Yellow	Left direction indicator and stop lamp
White	Ground (-)
Blue	Electric brakes
Green	Right direction indicator and stop lamp
Orange	Battery (+)
Brown	Running lights
Grey	Reverse lights

Trailer Hitch Cover

Your vehicle has a removable trailer hitch cover. To remove the trailer hitch cover:

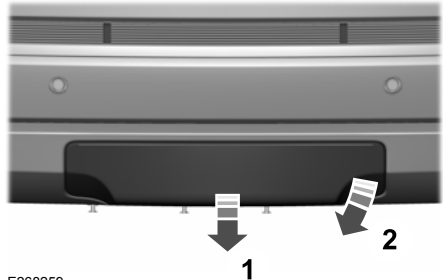

E268259

1. Grab the trailer hitch cover at the bottom and pull towards the rear of the vehicle until the bottom of the trailer hitch cover unsnaps from the bumper.

Towing

- Grab the trailer hitch cover at the edge and rotate until the top of the trailer hitch cover unsnaps from the bumper, then remove the trailer hitch cover.

To install the trailer hitch cover:

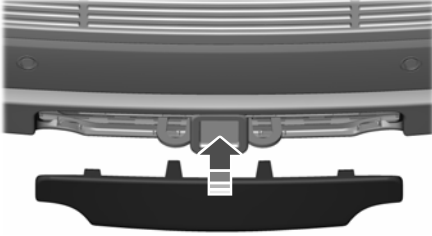

E268260

- Line up the snaps on the trailer hitch cover to the holes on the bumper and push forward until it snaps into place.

Hitches



WARNING: Do not cut, drill, weld or modify the trailer hitch. Modifying the trailer hitch could reduce the hitch rating.

Do not use a hitch that either clamps onto the bumper or attaches to the axle.

Distribute the trailer load so 10-15% of the total trailer weight is on the tongue.

Integrated Hitch Rating



WARNING: Towing trailers beyond the maximum recommended gross trailer weight exceeds the limit of your vehicle and could result in engine damage, transmission damage, structural damage, loss of vehicle control, vehicle rollover and personal injury.

The standard integrated hitch has two ratings depending on mode of operation:

- Weight-carrying mode requires a draw bar and hitch ball. The draw bar supports all the vertical tongue load of the trailer.
- Weight-distributing mode requires an aftermarket weight-distributing system, which includes draw bar, hitch ball, spring bars and snap-up brackets. This system distributes the vertical tongue load of the trailer between the truck and the trailer.

Mode	Maximum Trailer Weight	Maximum Tongue Weight
Weight carrying	6,000 lb (2,721 kg)	600 lb (272 kg)
Weight distributing	9,200 lb (4,173 kg)	920 lb (417 kg)

Note: These are hitch ratings only. Actual vehicle ratings are dependent on engine, transmission and axle combinations.

Towing

Weight-distributing Hitch



WARNING: Do not adjust the spring bars so that your vehicle's rear bumper is higher than before attaching the trailer. Doing so will defeat the function of the weight-distributing hitch, which may cause unpredictable handling, and could result in serious personal injury.

When hooking-up a trailer using a weight-distributing hitch, always use the following procedure:

1. Park the loaded vehicle, without the trailer, on a level surface.
2. Measure the height to the top of your vehicle's front wheel opening on the fender. This is H1.
3. Attach the loaded trailer to your vehicle without the weight-distributing bars connected.
4. Measure the height to the top of your vehicle's front wheel opening on the fender a second time. This is H2.
5. Install and adjust the tension in the weight-distributing bars so that the height of your vehicle's front wheel opening on the fender is approximately half the way down from H2, toward H1.
6. Check that the trailer is level or slightly nose down toward your vehicle. If not, adjust the ball height accordingly and repeat steps 2-6.

When the trailer is level or slightly nose down toward the vehicle:

- Lock the bar tension adjuster in place.
- Check that the trailer tongue securely attaches and locks onto the hitch.
- Install safety chains, lighting, and trailer brake controls as required by law or the trailer manufacturer.

Safety Chains

Note: Do not attach safety chains to the bumper. Always connect the safety chains to the frame or hook retainers of your trailer hitch.

Install trailer safety chains to the trailer hitch as recommended by the manufacturer. Cross the chains under the trailer tongue and allow enough slack for turning tight corners. Do not allow the chains to drag on the ground.

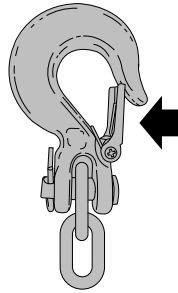

E265060

If the trailer safety chain hook has a latch, make sure the latch fully closes.

Trailer Brakes



WARNING: Do not connect a trailer's hydraulic brake system directly to your vehicle's brake system. Your vehicle may not have enough braking power and your chances of having a collision greatly increase.

Electric brakes and manual, automatic or surge-type trailer brakes are safe if you install them properly and adjust them to the manufacturer's specifications. The trailer brakes must meet local and federal regulations.

Towing

The rating for the tow vehicle's braking system operation is at the gross vehicle weight rating, not the gross combined weight rating.

Separate functioning brake systems are required for safe control of towed vehicles and trailers weighing more than 1,500 lb (680 kg) when loaded.

Integrated Trailer Brake Controller (If Equipped)



WARNING: Use the integrated trailer brake controller to properly adjust the trailer brakes and check all connections before towing a trailer. Failure to follow this instruction could result in the loss of control of your vehicle, personal injury or death.

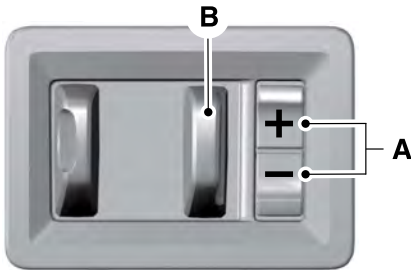

E183395

When used properly, the trailer brake controller assists in smooth and effective trailer braking by powering the trailer's electric or electric-over-hydraulic brakes with a proportional output based on the towing vehicle's brake pressure.

The controller user interface consists of the following:

A: + and - (Gain adjustment buttons): Pressing these buttons adjusts the controller's power output to the trailer brakes in 0.5 increments. You can increase the gain setting to 10.0 (maximum trailer braking) or decrease it to 0 (no trailer braking). The gain setting displays in the message center.

The controller shows gain setting, output bar graph, and trailer connectivity status in the information display. They appear in the information display as follows:

- Trailer Brake Controller Gain (without trailer connected): Shows the current gain setting during a given ignition cycle and when adjusting the gain. This also displays if you use the manual control lever or make gain adjustments with no trailer connected.
- Trailer Brake Controller Gain Output: Displays when you push your vehicle's brake pedal, or upon use of the manual control. Bar indicators illuminate in the information display to indicate the amount of power going to the trailer brakes relative to the brake pedal or manual control input. One bar indicates the least amount of output; six bars indicate maximum output.
- Trailer Connected: Displays when the system senses a correct trailer wiring connection (a trailer with electric trailer brakes) during a given ignition cycle.
- Trailer Disconnected: Displays, accompanied by a single audible time, when the system senses a trailer connection and then a disconnection, either intentional or unintentional, during a given ignition cycle. It also displays if a truck or trailer-wiring fault occurs causing the trailer to appear disconnected. This message can also display if you use the manual control

Towing

lever without a trailer connected. After disconnecting the trailer connector, press the brake pedal for approximately five seconds to allow the system to detect and update the trailer status.

B: Manual control lever: Slide the control lever to the left to turn on the trailer's electric brakes independent of the tow vehicle's. If you use the manual control when the brake is also applied, the greater of the two inputs determines the power sent to the trailer brakes.

- **Stop lamps:** Using the manual control lever illuminates both the trailer brake lamps and your vehicle brake lamps except the center high-mount stop lamp, if you make the proper electrical connection to the trailer. Pressing your vehicle brake pedal also illuminates both trailer and vehicle brake lamps.

Procedure for Adjusting Gain

Note: Only perform this procedure in a traffic-free environment at speeds of approximately 20–25 mph (30–40 km/h).

The gain setting sets the trailer brake controller for the specific towing condition. You should change the setting as towing conditions change. Changes to towing conditions include trailer load, vehicle load, road conditions and weather.

The gain should be set to provide the maximum trailer braking assistance when making sure the trailer wheels do not lock when using the brakes. Locked trailer wheels may lead to trailer instability.

1. Make sure the trailer brakes are in good working condition, functioning normally and properly adjusted. See your trailer dealer if necessary.
2. Hook up the trailer and make the electrical connections according to the trailer manufacturer's instructions.

3. When you plug in a trailer with electric or electric-over-hydraulic brakes, a message confirming connection appears in the information display.
4. Use the gain adjustment (+ and -) buttons to increase or decrease the gain setting to the desired starting point. A gain setting of 6.0 is a good starting point for heavier loads.
5. In a traffic-free environment, tow the trailer on a dry, level surface at a speed of 20–25 mph (30–40 km/h) and squeeze the manual control lever completely.
6. If the trailer wheels lock up, indicated by squealing tires, reduce the gain setting. If the trailer wheels turn freely, increase the gain setting. Repeat steps 5 and 6 until the gain setting is at a point just below trailer wheel lock-up. If towing a heavier trailer, trailer wheel lock-up may not be attainable even with the maximum gain setting of 10.

Explanation of Information Display Warning Messages

Note: An authorized dealer can diagnose the trailer brake controller to determine exactly which trailer fault has occurred. However, your Ford warranty does not cover this diagnosis if the fault is with the trailer.

A message indicating a trailer brake module fault may display in response to faults sensed by the trailer brake controller, accompanied by a single tone. If this message appears, contact an authorized dealer as soon as possible for diagnosis and repair. The controller may still function, but performance may be degraded.

A message indicating a trailer wiring fault may display when there is a short circuit on the electric brake output wire. If this message displays, accompanied by a single tone, with no trailer connected, the problem is with your vehicle wiring

Towing

between the trailer brake controller and the 7-pin connector at the bumper. If the message only displays with a trailer connected, the problem is with the trailer wiring. Consult your trailer dealer for assistance. This can be a short to ground such as a chaffed wire, short to voltage such as a pulled pin on trailer emergency breakaway battery, or the trailer brakes may be drawing too much current.

Points to Remember

Note: Do not attempt removal of the trailer brake controller without consulting the Workshop Manual. Damage to the unit may result.

- Adjust gain setting before using the trailer brake controller for the first time.
 - Adjust gain setting, using the procedure above, whenever road, weather and trailer or vehicle loading conditions change from when the gain was initially set.
 - Only use the manual control lever for proper adjustment of the gain during trailer setup. Misuse, such as application during trailer sway, could cause instability of trailer or tow vehicle.
 - Avoid towing in adverse weather conditions. The trailer brake controller does not provide anti-lock control of the trailer wheels. Trailer wheels can lock up on slippery surfaces, resulting in reduced stability of trailer and tow vehicle.
 - The trailer brake controller is equipped with a feature that reduces output at vehicle speeds below 11 mph (18 km/h) so trailer and vehicle braking is not jerky or harsh. This feature is only available when applying the brakes using your vehicle's brake pedal, not the controller.
- The controller interacts with the brake control system and powertrain control system of your vehicle to provide the best performance on different road conditions.
 - Your vehicle's brake system and the trailer brake system work independently of each other. Changing the gain setting on the controller does not affect the operation of your vehicle's brakes whether you attach a trailer or not.
 - When you switch the engine off, the controller output is disabled and the display and module shut down. The controller module and display turn on when you switch the ignition on.
 - The trailer brake controller is only a factory-installed or dealer-installed item. Ford is not responsible for warranty or performance of the controller due to misuse or customer installation.

Trailer Lamps



WARNING: Never connect any trailer lamp wiring to the vehicle's tail lamp wiring; this may damage the electrical system resulting in fire. Contact your authorized dealer as soon as possible for assistance in proper trailer tow wiring installation. Additional electrical equipment may be required.

Trailer lamps are required on most towed vehicles. Make sure all running lights, brake lights, direction indicators and hazard lights are working.

Towing

Before Towing a Trailer

Practice turning, stopping and backing up to get the feel of your vehicle-trailer combination before starting on a trip. When turning, make wider turns so the trailer wheels clear curbs and other obstacles.

When Towing a Trailer

- Do not tow during the first 1,000 mi (1,600 km).
- Do not make full-throttle starts.
- Check your hitch, electrical connections and trailer wheel lug nuts thoroughly after you have traveled 50 mi (80 km).
- When stopped in congested or heavy traffic during hot weather, place the transmission in park (P) to aid engine and transmission cooling and to help A/C performance.
- Turn off the speed control with heavy loads or in hilly terrain. The speed control may turn off automatically when you are towing on long, steep slopes.
- Shift to a lower gear when driving down a long or steep hill. Do not apply the brakes continuously, as they may overheat and become less effective.
- If your transmission is equipped with a Grade Assist or Tow/Haul feature, use this feature when towing. This provides engine braking and helps eliminate excessive transmission shifting for optimum fuel economy and transmission cooling.
- If your vehicle is equipped with AdvanceTrac with RSC, this system may turn on during typical cornering maneuvers with a heavily loaded trailer. This is normal. Turning the corner at a slower speed when towing may reduce this tendency.

- If you are towing a trailer frequently in hot weather, hilly conditions, at the gross combined weight rating (or any combination of these factors), consider refilling your rear axle with synthetic gear lubricant if the axle is not already filled with it. See **Capacities and Specifications** (page 380).
- Allow more distance for stopping with a trailer attached. Anticipate stops and brake gradually.
- Avoid parking on a slope. However, if you must park on a slope:
 1. Turn the steering wheel to point your vehicle tires away from traffic flow.
 2. Set your vehicle parking brake.
 3. Place the transmission in park (P).
 4. Place wheel chocks in front and back of the trailer wheels. Chocks are not included with your vehicle.

Your vehicle may be equipped with a temporary or conventional spare tire. A temporary spare tire is different in size, tread-type, or is from a different manufacturer than the road tires on your vehicle. Consult information on the tire label or Safety Compliance label for limitations when using these tires.

Launching or Retrieving a Boat or Personal Watercraft (PWC)

Note: *Disconnect the wiring to the trailer before backing the trailer into the water.*

Note: *Reconnect the wiring to the trailer after removing the trailer from the water.*

When backing down a ramp during boat launching or retrieval:

- Do not allow the static water level to rise above the bottom edge of the rear bumper.
- Do not allow waves to break higher than 6 in (15 cm) above the bottom edge of the rear bumper.

Towing

Exceeding these limits may allow water to enter vehicle components:

- Causing internal damage to the components.
- Affecting driveability, emissions and reliability.

Replace the rear axle lubricant anytime the rear axle has been submerged in water. Water may have contaminated the rear axle lubricant, which is not normally checked or changed unless a leak is suspected or other axle repair is required.

TOWING THE VEHICLE ON FOUR WHEELS



WARNING: If your vehicle has a steering wheel lock make sure the ignition is in the accessory or on position when being towed.

Recreational Towing

Note: Put your climate control system in recirculated air mode to prevent exhaust fumes from entering your vehicle. See **Climate Control** (page 138).

Follow these guidelines if you have a need for recreational towing, for example towing your vehicle behind a motorhome. These guidelines prevent damage to your transmission.

Two-wheel Drive Vehicles

You cannot tow a two wheel drive vehicle with any wheels on the ground as vehicle or transmission damage may occur. You must tow your vehicle with all four wheels off the ground, for example when using a car-hauling trailer.

Four-wheel Drive Vehicles Without 4x4 LOW

If your vehicle is not equipped with 4x4 Low, you cannot tow your vehicle with any wheels on the ground or vehicle damage may occur. You must tow your vehicle with all four wheels off the ground, for example when using a car-hauling trailer.

Four-wheel Drive Vehicles With 4x4 LOW

You can only tow a **4X4 LOW** equipped four-wheel drive vehicle with all wheels on the ground by placing the transfer case in its neutral position and engaging the four wheel down towing feature. Perform the steps outlined in the following section after positioning your vehicle behind the tow vehicle and properly securing them together.

Four-wheel-down Towing

Note: If completed successfully, the information display shows **Neutral Tow Enabled Leave Transmission in Neutral**. This indicates that your vehicle is safe to tow with all wheels on the ground.

Note: If you do not see the message in the information display, you must perform the procedure again from the beginning.

Note: Make sure you properly secure your vehicle to the tow vehicle.

Entering Four-wheel-down Towing

1. Start your vehicle.
2. Select **2H** on the 4WD mode selector switch.
3. For vehicles equipped with a console shifter, place the transmission in stay in neutral mode. See **Automatic Transmission** (page 195). For vehicles equipped with a column shifter, place the transmission in neutral (N).

Towing

- Once the transmission is in neutral (N) or stay in neutral mode, switch the engine off but leave the ignition in the on position. The information display shows a **Transmission Not in Park** message.

Note: If your vehicle has intelligent access, you can keep your vehicle on while switching the engine off by pressing the **START/STOP** button two times slowly without pressing the brake pedal.

- Press and hold the brake pedal.
- Enable neutral tow through the information display by selecting **Settings** from the menu. See **General Information** (page 110).
- Then select **Advanced Settings**.
- Then select **Vehicle**.
- Then select **Neutral Tow**.
- Press and hold the **OK** button until the information display confirms neutral tow is enabled.

Note: If completed successfully, the information display shows **Neutral Tow Enabled Leave Transmission in Neutral**. This indicates that your vehicle is safe to tow with all wheels on the ground.

Note: If you do not see the message in the display, you must perform the procedure again from the beginning.

Note: You may hear an audible noise as the transfer case shifts into its neutral position. This is normal.

- Leave the transmission in neutral (N). If your vehicle has intelligent access, press the engine **START/STOP** button once without pressing the brake pedal to switch the ignition off. You do not need to leave your keys in the vehicle. You can lock and unlock your vehicle as you normally do. If your vehicle has a physical ignition key, turn the ignition as far as it can go toward the off position. It does not

turn to the off position when the transmission is in neutral (N). You must leave the key in the ignition when towing. To lock and unlock your vehicle, use the keyless entry keypad or an extra set of keys.

- Release the brake pedal.



WARNING: Do not disconnect the battery during recreational towing. It prevents the transfer case from shifting properly and may cause the vehicle to roll, even if the transmission is in park (P).



WARNING: Shifting the transfer case to its neutral position for recreational towing may cause the vehicle to roll, even if the transmission is in park (P). It may injure the driver and others. Make sure you press the foot brake and the vehicle is in a secure, safe position when you shift to neutral (N).

Note: Failing to put the transfer case in its neutral position may damage vehicle components.

Note: You can check four-wheel-down towing status at any time by opening the driver door or turning the ignition to the accessory or on position and verifying the message displays in the cluster.

Exiting Four-wheel-down Towing

To exit four-wheel-down towing and return the transfer case to its **2H** position:

- With your vehicle still properly secured to the tow vehicle, start the engine.
- After starting your vehicle, switch the engine off but leave the key in the on position.

Towing

Note: *If your vehicle has intelligent access, you can keep the vehicle on when switching the engine off by pressing the **START/STOP** button two times slowly without pressing the brake pedal.*

3. Press and hold the brake pedal.
4. Shift the transmission out of neutral (N) and into park (P).
5. Release the brake pedal.

Note: *If completed successfully, the instrument cluster displays **4X2**, and **Neutral Tow Disabled**.*

Note: *If the indicator light and message do not display, you must perform the procedure again from the beginning.*

Note: *You may hear an audible noise as the transfer case shifts out of its neutral position. This is normal.*

Note: *If **Shift Delayed Pull Forward** appears in the instrument cluster, transfer case gear tooth blockage is present. See the instructions after this section.*

6. Apply the parking brake, then disconnect your vehicle from the tow vehicle.
7. Release the parking brake, start the engine and shift the transmission to drive (D) to make sure the transfer case is out neutral (N).
8. If the transfer case does not successfully shift out of neutral (N), set the parking brake until you can have your vehicle serviced.

Resolving the Shift Delayed Pull Forward Message

If the instrument cluster displays **Shift Delayed Pull Forward**, perform the following:

1. Press and hold the brake pedal.
2. Put the transmission into neutral (N), then start the engine.

3. With the engine running, shift the transmission to drive (D) and let the vehicle roll forward up to 3 ft (1 m). You may hear an audible noise as the transfer case shifts out of its neutral position. This is normal.
4. Make sure the instrument cluster displays **Neutral Tow Disabled**.

Driving Hints

BREAKING-IN

You need to break in new tires for approximately 300 mi (480 km). During this time, your vehicle may exhibit some unusual driving characteristics.

Avoid driving too fast during the first 1,000 mi (1,600 km). Vary your speed frequently and change up through the gears early. Do not labor the engine.

Do not tow during the first 1,000 mi (1,600 km).

REDUCED ENGINE PERFORMANCE



WARNING: If you continue to drive your vehicle when the engine is overheating, the engine could stop without warning. Failure to follow this instruction could result in the loss of control of your vehicle.

If the engine coolant temperature gauge needle moves to the upper limit position, the engine is overheating. See **Gauges** (page 103).

You must only drive your vehicle for a short distance if the engine overheats. The distance you can travel depends on ambient temperature, vehicle load and terrain. The engine continues to operate with limited power for a short period of time.

If the engine temperature continues to rise, the fuel supply to the engine reduces. The air conditioning switches off and the engine cooling fan operates continually.

1. Gradually reduce your speed and stop your vehicle as soon as it is safe to do so.

2. Immediately switch the engine off to prevent severe engine damage.
3. Wait for the engine to cool down.
4. Check the coolant level. See **Engine Coolant Check** (page 330).
5. Have your vehicle checked as soon as possible.

ECONOMICAL DRIVING

Fuel economy is affected by several things such as how you drive, the conditions you drive under and how you maintain your vehicle.

There are some things to keep in mind that may improve your fuel economy:

- Accelerate and slow down in a smooth, moderate fashion.
- Drive at steady speeds.
- Anticipate stops; slowing down may eliminate the need to stop.
- Combine errands and minimize stop-and-go driving (When running errands, go to the furthest destination first and then work your way back home).
- Close the windows for high-speed driving.
- Drive at reasonable speeds.
- Keep the tires properly inflated and use only the recommended size.
- Use the recommended engine oil.
- Perform all regularly scheduled maintenance.

There are also some things you may want to avoid doing because they reduce your fuel economy:

- Avoid sudden or hard accelerations.
- Avoid revving the engine before turning off the car.
- Avoid long idle periods.

Driving Hints

- Do not warm up your vehicle on cold mornings.
- Reduce the use of air conditioning and heat.
- Avoid using speed control in hilly terrain.
- Do not rest your foot on the brake pedal while driving.
- Avoid carrying unnecessary weight.
- Avoid adding particular accessories to your vehicle (e.g. bug deflectors, rollbars/light bars, running boards, ski racks).
- Avoid driving with the wheels out of alignment.

DRIVING THROUGH WATER



WARNING: Do not drive through flowing or deep water as you may lose control of your vehicle.

Note: *Driving through standing water can cause vehicle damage.*

Note: *Engine damage can occur if water enters the air filter.*

Before driving through standing water, check the depth. Never drive through water that is higher than the bottom of the wheel hubs.

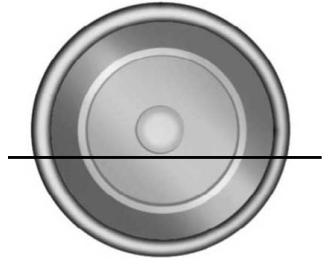

E176913

When driving through standing water, drive very slowly and do not stop your vehicle. Your brake performance and traction may be limited. After driving through water and as soon as it is safe to do so:

- Lightly press the brake pedal to dry the brakes and to check that they work.
- Check that the horn works.
- Check that the exterior lights work.
- Turn the steering wheel to check that the steering power assist works.

FLOOR MATS



WARNING: Use a floor mat designed to fit the footwell of your vehicle that does not obstruct the pedal area. Failure to follow this instruction could result in the loss of control of your vehicle, personal injury or death.



WARNING: Pedals that cannot move freely can cause loss of vehicle control and increase the risk of serious personal injury.

Driving Hints



WARNING: Secure the floor mat to both retention devices so that it cannot slip out of position and interfere with the pedals. Failure to follow this instruction could result in the loss of control of your vehicle, personal injury or death.



WARNING: Do not place additional floor mats or any other covering on top of the original floor mats. This could result in the floor mat interfering with the operation of the pedals. Failure to follow this instruction could result in the loss of control of your vehicle, personal injury or death.



WARNING: Always make sure that objects cannot fall into the driver foot well while your vehicle is moving. Objects that are loose can become trapped under the pedals causing a loss of vehicle control.



To install the floor mats, position the floor mat eyelet over the retention post and press down to lock in position.

To remove the floor mat, reverse the installation procedure.

Note: Regularly check the floor mats to make sure they are secure.

Roadside Emergencies

ROADSIDE ASSISTANCE

Vehicles Sold in the United States: Getting Roadside Assistance

To fully assist you should you have a vehicle concern, Ford Motor Company offers a complimentary roadside assistance program. This program is separate from the New Vehicle Limited Warranty.

The service is available:

- 24 hours a day, seven days a week.
- For the coverage period listed on the Roadside Assistance Card included in your Owner's Manual portfolio.

Roadside Assistance covers:

- A flat tire change with a good spare (except vehicles supplied with a tire inflation kit).
- Battery jump start.
- Lock-out assistance (key replacement cost is the customer's responsibility).
- Fuel delivery — independent service contractors, if not prohibited by state, local or municipal law, shall deliver up to 2 gal (8 L) of gasoline or 5 gal (20 L) of diesel fuel to a disabled vehicle. Roadside Assistance limits fuel delivery service to two no-charge occurrences within a 12-month period.
- Winch out — available within 100 ft (30 m) of a paved or county maintained road, no recoveries.

- Towing — independent service contractors, if not prohibited by state, local or municipal law, shall tow Ford eligible vehicles to an authorized dealer within 35 mi (56 km) of the disablement location or to the nearest authorized dealer. If a member requests a tow to an authorized dealer that is more than 35 mi (56 km) from the disablement location, the member shall be responsible for any mileage costs in excess of 35 mi (56 km).
- Roadside Assistance includes up to \$200 for a towed trailer if the disabled eligible vehicle requires service at the nearest authorized dealer. If the towing vehicle is operational but the trailer is not, then the trailer does not qualify for any roadside services.

Vehicles Sold in the United States: Using Roadside Assistance

Complete the roadside assistance identification card and place it in your wallet for quick reference. This card is in the owner's information portfolio in the glove compartment.

United States vehicle customers who require Roadside Assistance, call 1-800-241-3673.

If you need to arrange roadside assistance for yourself, Ford Motor Company reimburses a reasonable amount for towing to the nearest dealership within 35 mi (56 km). To obtain reimbursement information, United States vehicle customers call 1-800-241-3673. Customers need to submit their original receipts.

Roadside Emergencies

Vehicles Sold in Canada: Getting Roadside Assistance

To fully assist you should you have a vehicle concern, Ford Motor Company of Canada, Limited offers a complimentary roadside assistance program. This program is eligible within Canada or the continental United States.

The service is available 24 hours a day, seven days a week.

This program is separate from the New Vehicle Limited Warranty, but the coverage is concurrent with the powertrain coverage period of your vehicle. Canadian roadside coverage and benefits may differ from the U.S. coverage.

If you require more information, please call us in Canada at 1-800-665-2006, or visit our website at www.ford.ca.

HAZARD FLASHERS

Note: *The hazard flashers operate when the ignition is in any position, or if the key is not in the ignition. If used when the vehicle is not running, the battery loses charge. As a result, there may be insufficient power to restart your vehicle.*



The flasher control is on the instrument panel. Use your hazard flashers when your vehicle is creating a safety hazard for other motorists.

- Press the flasher control and all front and rear direction indicators flash.
- Press the button again to switch them off.

FUEL SHUTOFF



WARNING: If your vehicle has been involved in a crash, have the fuel system checked. Failure to follow this instruction could result in fire, personal injury or death.

Note: *When you try to restart your vehicle after a fuel shutoff, the vehicle makes sure that various systems are safe to restart. Once the vehicle determines the systems are safe, then the vehicle allows you to restart.*

Note: *In the event that your vehicle does not restart after your third attempt, contact a qualified technician.*

The fuel pump shutoff stops the flow of fuel to the engine in the event of a moderate to severe crash. Not every impact causes a shutoff.

Should your vehicle shut off after a crash, you may restart your vehicle.

If your vehicle has a key system:

1. Switch off the ignition.
2. Switch to start position.
3. Switch off the ignition.
4. Switch on the ignition to re-enable the fuel pump.
5. If the vehicle does not start, repeat steps 1 through 4.

If your vehicle has a push button start system:

1. Press **START/STOP** to switch off your vehicle.
2. Press the brake pedal and **START/STOP** to switch on your vehicle.
3. Remove your foot from the brake pedal and press **START/STOP** to switch off your vehicle.

Roadside Emergencies

4. You can attempt to start the vehicle by pressing the brake pedal and **START/STOP**, or press **START/STOP** without pressing the brake pedal.
5. If the vehicle does not start, repeat steps 1 through 4.

JUMP STARTING THE VEHICLE



WARNING: Batteries normally produce explosive gases which can cause personal injury. Therefore, do not allow flames, sparks or lighted substances to come near the battery. When working near the battery, always shield your face and protect your eyes. Always provide correct ventilation.



WARNING: Keep batteries out of reach of children. Batteries contain sulfuric acid. Avoid contact with skin, eyes or clothing. Shield your eyes when working near the battery to protect against possible splashing of acid solution. In case of acid contact with skin or eyes, flush immediately with water for a minimum of 15 minutes and get prompt medical attention. If acid is swallowed, call a physician immediately.



WARNING: Use only adequately sized cables with insulated clamps.

Note: To avoid reverse polarity connections, make sure that you correctly identify the positive (+) and negative (-) terminals on both the disabled and booster vehicles before connecting the cables. Stay clear of moving parts.

Preparing Your Vehicle

Do not attempt to push-start your automatic transmission vehicle.

Note: Attempting to push-start a vehicle with an automatic transmission may cause transmission damage.

Note: Use only a 12-volt supply to start your vehicle.

Note: Do not disconnect the battery of the disabled vehicle as this could damage the vehicle electrical system.

Park the booster vehicle close to the hood of the disabled vehicle, making sure the two vehicles do not touch.

Connecting the Jumper Cables



WARNING: Do not use fuel lines, engine valve covers, windshield wiper arms, the intake manifold, or hood latch as ground points.



WARNING: Do not connect the end of the second cable to the negative (-) terminal of the battery to be jumped. A spark may cause an explosion of the gases that surround the battery.

Note: Do not attach the end of the positive cable to the studs or L-shaped eyelet located above the positive (+) terminal of your vehicle's battery. High current may flow through and cause damage to the fuses.

Note: In the illustration, the bottom vehicle represents the booster vehicle.

Roadside Emergencies

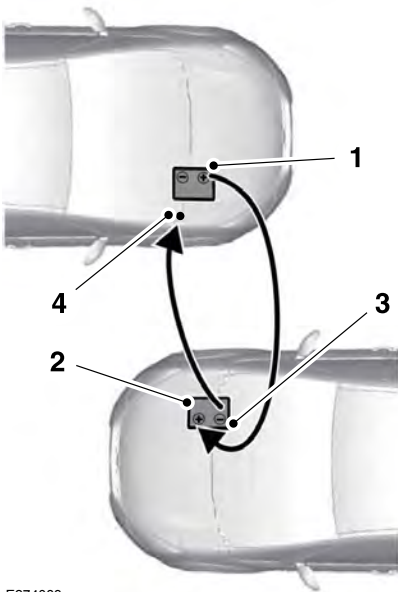

E274083

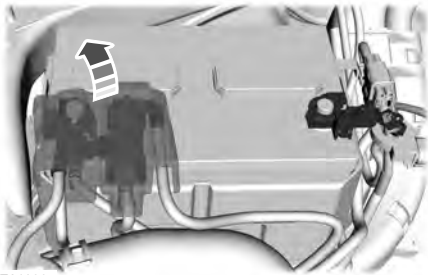

E213994

3. Connect the negative (-) cable to the negative (-) terminal of the booster vehicle battery.
4. Make the final connection of the negative (-) cable to an exposed metal part of the stalled vehicle's engine, away from the battery and the fuel injection system, or connect the negative (-) cable to a ground connection point if available.

Jump Starting

1. Start the engine of the booster vehicle and rev the engine moderately, or press the accelerator gently to keep your engine speed between 2000 and 3000 RPM, as shown in your tachometer.
2. Start the engine of the disabled vehicle.
3. Once the disabled vehicle has been started, run both vehicle engines for an additional three minutes before disconnecting the jumper cables.

Removing the Jumper Cables

Remove the jumper cables in the reverse order that they were connected.

1. Connect the positive (+) jumper cable to the positive (+) terminal of the discharged battery.
2. Connect the other end of the positive (+) cable to the positive (+) terminal of the booster vehicle battery.

Roadside Emergencies

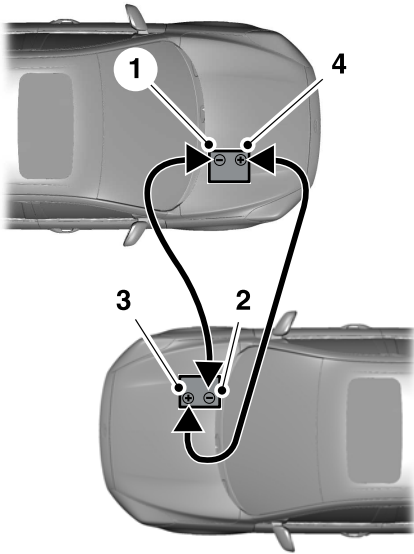

E282456

1. Remove the negative (-) jumper cable from the disabled vehicle.
2. Remove the jumper cable on the negative (-) terminal of the booster vehicle battery.
3. Remove the jumper cable from the positive (+) terminal of the booster vehicle battery.
4. Remove the jumper cable from the positive (+) terminal of the disabled vehicle battery.
5. Allow the engine to idle for at least one minute.

POST-CRASH ALERT SYSTEM

The system flashes the direction indicators and sounds the horn (intermittently) in the event of a serious impact that deploys an airbag (front, side, side curtain or Safety Canopy) or the seatbelt pretensioners.

The horn and indicators turn off when:

- You press the hazard control button.
- You press the panic button on the remote entry transmitter (if equipped).
- Your vehicle runs out of power.
- Sounding of the horn is only enabled in specific markets.

TRANSPORTING THE VEHICLE

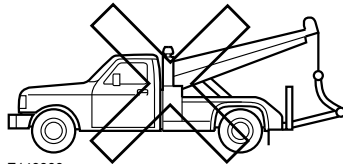
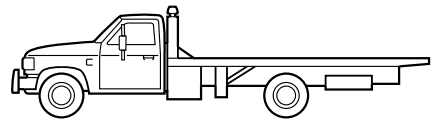
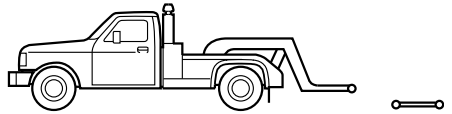

E143886

Roadside Emergencies

If you need to have your vehicle towed, contact a professional towing service or, if you are a member of a roadside assistance program, your roadside assistance service provider.

We recommend the use of a wheel lift and dollies or flatbed equipment to tow your vehicle. Do not tow with a slingbelt. Ford Motor Company has not approved a slingbelt towing procedure. Vehicle damage may occur if towed incorrectly, or by any other means.

Ford Motor Company produces a towing manual for all authorized tow truck operators. Have your tow truck operator refer to this manual for proper hook-up and towing procedures for your vehicle.

It is acceptable to have your front-wheel drive vehicle towed from the front if using proper wheel lift equipment to raise the front wheels off the ground. When towing in this manner, the rear wheels can remain on the ground.

Front-wheel drive vehicles must have the front wheels placed on a tow dolly when towing your vehicle from the rear using wheel lift equipment. This prevents damage to the transmission.

Towing an all-wheel or four-wheel drive vehicle requires that all wheels be off the ground, such as using a wheel lift and dollies or flatbed equipment. This prevents damage to the transmission, all-wheel or four-wheel drive system and vehicle.

TOWING POINTS



WARNING: Using recovery hooks is dangerous and should only be done by a person familiar with proper vehicle recovery safety practices. Improper use of recovery hooks may cause hook failure or separation from the vehicle and could result in serious injury or death.



WARNING: Always slowly remove the slack from the recovery strap prior to pulling. Failure to do so can introduce significantly higher loads which can cause the recovery hooks to break off, or the recovery strap to fail which can cause serious injury or death.



WARNING: Never link two straps together with a clevis pin. These heavy metal objects could become projectiles if the strap breaks and can cause serious injury or death.

Your vehicle comes equipped with frame-mounted front recovery hooks. These hooks should never have a load applied to them greater than the gross vehicle weight rating of your vehicle.

Before using recovery hooks:

- Make sure all attaching points are secure and capable of withstanding the applied load.
- Never use chains, cables or tow straps with metal hook ends.
- Only use recovery straps that have a minimum breaking strength two to three times the gross vehicle weight of the stuck vehicle.
- Make sure the recovery strap is in good condition and free of visible cuts, tears or damage.

Roadside Emergencies

- Use a damper device such as a tarp, heavy blanket or piece of carpet draped over the recovery strap to help absorb the energy in the event the strap breaks.
- Make sure the stuck vehicle is not loaded heavier than its gross vehicle weight rating specified on the certification label.
- Always align the tow vehicle and stuck vehicle in a straight line (within 10 degrees).
- Keep bystanders to the **sides** of the vehicle, at a distance of at least twice the length of the recovery strap. This helps avoid injury from the hazard of a recovery hook or strap breaking, or a vehicle lurching into their path.

Customer Assistance

GETTING THE SERVICES YOU NEED

Warranty repairs to your vehicle must be performed by an authorized dealer. While any authorized dealer handling your vehicle line will provide warranty service, we recommend you return to your selling authorized dealer who wants to ensure your continued satisfaction.

Please note that certain warranty repairs require special training and equipment, so not all authorized dealers are authorized to perform all warranty repairs. This means that, depending on the warranty repair needed, you may have to take your vehicle to another authorized dealer.

A reasonable time must be allowed to perform a repair after taking your vehicle to the authorized dealer. Repairs will be made using Ford or Motorcraft® parts, or remanufactured or other parts that are authorized by Ford.

Away From Home

If you are away from home when your vehicle needs service, contact the Ford Customer Relationship Center or use the online resources listed below to find the nearest authorized dealer.

In the United States:

Mailing address

Ford Motor Company
Customer Relationship Center
P.O. Box 6248
Dearborn, MI 48126

Telephone

1-800-392-3673 (FORD)
(TDD for the hearing impaired:
1-800-232-5952)

Additional information and resources are available online:

Website
www.owner.ford.com

These are some of the items that can be found online:

- U.S. dealer locator by Dealer Name, City/State or Zip Code.
- Owner Manuals.
- Maintenance Schedules.
- Recalls.
- Ford Extended Service Plans.
- Ford Genuine Accessories.
- Service specials and promotions.

In Canada:

Mailing address

Customer Relationship Centre
Ford Motor Company of Canada, Limited
P.O. Box 2000
Oakville, Ontario L6K 0C8

Telephone

1-800-565-3673 (FORD)

Website
www.ford.ca

Twitter

@FordServiceCA (English Canada)
@FordServiceQC (Quebec)

Additional Assistance

If you have questions or concerns, or are unsatisfied with the service you are receiving, follow these steps:

1. Contact your Sales Representative or Service Advisor at your selling or servicing authorized dealer.

Customer Assistance

2. If your inquiry or concern remains unresolved, contact the Sales Manager, Service Manager or Customer Relations Manager.
3. If you require assistance or clarification on Ford Motor Company policies, please contact the Ford Customer Relationship Center.

In order to help us serve you better, please have the following information available when contacting a Customer Relationship Center:

- Vehicle Identification Number.
- Your telephone number (home and business).
- The name of the authorized dealer and city where located.
- The vehicle's current odometer reading.

In some states within the United States, you must directly notify Ford in writing before pursuing remedies under your state's warranty laws, and Ford is also allowed a final repair attempt.

Additionally, in some states within the United States, a consumer has the option of submitting a warranty dispute to the BBB Auto Line before taking action under the Magnuson-Moss Warranty Act, or to the extent allowed by state law, before pursuing replacement or repurchase remedies provided by certain state laws. This dispute handling procedure is not required prior to enforcing state created rights or other rights which are independent of the Magnuson-Moss Warranty Act or state replacement or repurchase laws.

IN CALIFORNIA (U.S. ONLY)

California Civil Code Section 1793.2(d) requires that, if a manufacturer or its representative is unable to repair a motor vehicle to conform to the vehicle's applicable express warranty after a reasonable number of attempts, the manufacturer shall be required to either replace the vehicle with one substantially identical or repurchase the vehicle and reimburse the buyer in an amount equal to the actual price paid or payable by the consumer (less a reasonable allowance for consumer use). The consumer has the right to choose whether to receive a refund or replacement vehicle.

California Civil Code Section 1793.22(b) presumes that the manufacturer has had a reasonable number of attempts to conform the vehicle to its applicable express warranties if, within the first 18 months of ownership of a new vehicle or the first 18,000 mi (29,000 km), whichever occurs first:

1. Two or more repair attempts are made on the same non-conformity likely to cause death or serious bodily injury OR
2. Four or more repair attempts are made on the same nonconformity (a defect or condition that substantially impairs the use, value or safety of the vehicle) OR
3. The vehicle is out of service for repair of nonconformities for a total of more than 30 calendar days (not necessarily all at one time).

In the case of 1 or 2 above, the consumer must also notify the manufacturer of the need for the repair of the nonconformity at the following address:

Ford Motor Company
16800 Executive Plaza Drive
Mail Drop 3NE-B
Dearborn, MI 48126

Customer Assistance

You are required to submit your warranty dispute to BBB AUTO LINE before asserting in court any rights or remedies conferred by California Civil Code Section 1793.22(b). You are also required to use BBB AUTO LINE before exercising rights or seeking remedies created by the Federal Magnuson-Moss Warranty Act, 15 U.S.C. sec. 2301 et seq. If you choose to seek redress by pursuing rights and remedies not created by California Civil Code Section 1793.22(b) or the Magnuson-Moss Warranty Act, resort to BBB AUTO LINE is not required by those statutes.

THE BETTER BUSINESS BUREAU (BBB) AUTO LINE PROGRAM (U.S. ONLY)

Your satisfaction is important to Ford Motor Company and to your dealer. If a warranty concern has not been resolved using the three-step procedure outlined earlier in this chapter in the Getting the Services you need section, you may be eligible to participate in the BBB AUTO LINE program.

The BBB AUTO LINE program consists of two parts – mediation and arbitration. During mediation, a representative of the BBB will contact both you and Ford Motor Company to explore options for settlement of the claim. If an agreement is not reached during mediation or you do not want to participate in mediation, and if your claim is eligible, you may participate in the arbitration process. An arbitration hearing will be scheduled so that you can present your case in an informal setting before an impartial person. The arbitrator will consider the testimony provided and make a decision after the hearing.

Disputes submitted to the BBB AUTO LINE program are usually decided within forty days after you file your claim with the BBB. You are not bound by the decision, and may reject the decision and proceed to court where all findings of the BBB Auto Line dispute, and decision, are admissible in the court action. Should you choose to accept the BBB AUTO LINE decision, Ford is then bound by the decision, and must comply with the decision within 30 days of receipt of your acceptance letter.

BBB AUTO LINE Application: Using the information provided below, please call or write to request a program application. You will be asked for your name and address, general information about your new vehicle, information about your warranty concerns, and any steps you have already taken to try to resolve them. A Customer Claim Form will be mailed that will need to be completed, signed and returned to the BBB along with proof of ownership. Upon receipt, the BBB will review the claim for eligibility under the Program Summary Guidelines.

You can get more information by calling BBB AUTO LINE at 1-800-955-5100, or writing to:

**BBB AUTO LINE
3033 Wilson Boulevard, Suite 600
Arlington, Virginia 22201**

BBB AUTO LINE applications can also be requested by calling the Ford Motor Company Customer Relationship Center at 1-800-392-3673.

Note: *Ford Motor Company reserves the right to change eligibility limitations, modify procedures, or to discontinue this process at any time without notice and without obligation.*

Customer Assistance

UTILIZING THE MEDIATION/ARBITRATION PROGRAM (CANADA ONLY)

For vehicles delivered to authorized Canadian dealers. In those cases where you continue to feel that the efforts by Ford of Canada and the authorized dealer to resolve a factory-related vehicle service concern have been unsatisfactory, Ford of Canada participates in an impartial third party mediation/arbitration program administered by the Canadian Motor Vehicle Arbitration Plan (CAMVAP).

The CAMVAP program is a straight forward and relatively speedy alternative to resolve a disagreement when all other efforts to produce a settlement have failed. This procedure is without cost to you and is designed to eliminate the need for lengthy and expensive legal proceedings.

In the CAMVAP program, impartial third-party arbitrators conduct hearings at mutually convenient times and places in an informal environment. These impartial arbitrators review the positions of the parties, make decisions and, when appropriate, render awards to resolve disputes. CAMVAP decisions are fast, fair, and final as the arbitrator's award is binding on both you and Ford of Canada.

CAMVAP services are available in all Canadian territories and provinces. For more information, without charge or obligation, call your CAMVAP Provincial Administrator directly at 1-800-207-0685 or visit www.camvap.ca.

GETTING ASSISTANCE OUTSIDE THE U.S. AND CANADA

Before exporting your vehicle to a foreign country, contact the appropriate foreign embassy or consulate. These officials can inform you of local vehicle registration regulations and where to find unleaded fuel or petrol/gas engines or the proper sulfur fuel for diesel engines.

If you cannot find the proper fuel recommended for your vehicle, contact our Customer Relationship Center.

The use of improper fuels in your vehicle without proper conversion may damage the effectiveness of your emission control system and may cause engine knocking or serious engine damage. Ford Motor Company or Ford of Canada is not responsible for any damage caused by use of improper fuel. Using improper fuels may also result in difficulty importing your vehicle back into the United States.

If your vehicle must be serviced while you are traveling or living in Asia-Pacific Region, Sub-Saharan Africa, U.S. Virgin Islands and/or Puerto Rico, Central America, the Caribbean, and Israel and the Middle East, contact the nearest authorized dealer. If the authorized dealer cannot help you, contact the corresponding Ford Customer Assistance Center:

FORD MOTOR COMPANY
Customer Relationship Centers in:

Customer Assistance

Customer Relationship Center	Phone	Fax	E-mail
Asia Pacific	N/A	N/A	apemrc@ford.com
Caribbean and Central America	+1 313 594 4857	-	expcac@ford.com
Middle East	Ford 80004443673	971 4 3327 266	menacac@ford.com
	Lincoln 80004441066		
	UAE 80004441066		
	Saudi Arabia 8008443673		
	Mobily and Zain cell phone users in Saudi 800850078		
North Africa	N/A	N/A	nafcrc@ford.com
Puerto Rico and U.S. Virgin Islands	+1-800-841-3673	N/A	prcac@ford.com
Sub-Saharan Africa	+1-313-594-4857	N/A	ssacrc@ford.com
South Korea	+82-02-1600-6003	N/A	infokr1@ford.com or infokr@lincoln.com

If you buy your vehicle in North America and then relocate to any of the above locations, register your vehicle identification number (VIN) and new address with Ford Global Trade Services by emailing, expcco@ford.com.

If you are in another foreign country, contact the nearest authorized dealer. In the event your inquiry is unresolved, communicate your concern with the dealership's Sales Manager, Service Manager or Customer Relations Manager. If you require additional assistance or clarification, please contact the respective Customer Relationship Center as previously listed.

Customers in the U.S. should call 1-800-392-3673.

Customer Assistance

ORDERING ADDITIONAL OWNER'S LITERATURE

To order the publications in this portfolio, contact Helm, Incorporated at:

HELM, INCORPORATED
47911 Halyard Drive
Plymouth, Michigan 48170
Attention: Customer Service

Or to order a free publication catalog, call toll free: 1-800-782-4356

Monday-Friday 8:00 a.m. - 6:00 p.m. EST

Helm, Incorporated can also be reached by their website:

www.helminc.com

(Items in this catalog may be purchased by credit card, check or money order.)

Obtaining a French Owner's Manual

French Owner's Manual can be obtained from your authorized dealer or by contacting Helm, Incorporated using the contact information listed previously in this section.

REPORTING SAFETY DEFECTS (U.S. ONLY)



E142557

If you believe that your vehicle has a defect which could cause a crash or could cause injury or death, you should immediately inform the National Highway Traffic Safety Administration (NHTSA) in addition to notifying Ford Motor Company.

If NHTSA receives similar complaints, it may open an investigation, and if it finds that a safety defect exists in a group of vehicles, it may order a recall and remedy campaign. However, NHTSA cannot become involved in individual problems between you, your dealer, or Ford Motor Company.

To contact NHTSA, you may call the Vehicle Safety Hotline toll-free at 1-888-327-4236 (TTY: 1-800-424-9153); go to <http://www.safercar.gov>; or write to:

Administrator

1200 New Jersey Avenue,
Southeast

Washington, D.C. 20590

You can also obtain other information about motor vehicle safety from <http://www.safercar.gov>.

REPORTING SAFETY DEFECTS (CANADA ONLY)

If you believe that your vehicle has a defect which could cause a crash or could cause injury or death, you should immediately inform Transport Canada and Ford of Canada.

Customer Assistance

Transport Canada Contact Information	
Website	http://www.tc.gc.ca/eng/motorvehiclesafety/reporting-defects-motor-vehicles.html (English)
Website	http://www.tc.gc.ca/fra/securiteautomobile/signaler-defauts-vehicules-automobiles.html (French)
Phone	1-800-333-0510

Ford of Canada Contact Information	
Website	www.ford.ca
Phone	1-800-565-3673

Fuses

FUSE BOX LOCATIONS

Engine Compartment Fuse Box

The power distribution box is in the engine compartment. It has high-current fuses that protect your vehicle's main electrical systems from overloads.

If you disconnect and reconnect the battery, you need to reset some features. See **Changing the 12V Battery** (page 336).

Passenger Compartment Fuse Box

The fuse box is in the passenger compartment under the dashboard. You may need to remove a trim panel to access the box.

FUSE SPECIFICATION CHART

Engine Compartment Fuse Box

 **WARNING:** Always disconnect the battery before servicing high current fuses.

 **WARNING:** To reduce risk of electrical shock, always replace the cover to the power distribution box before reconnecting the battery or refilling fluid reservoirs.

The power distribution box is in the engine compartment. It has high-current fuses that protect your vehicle's main electrical systems from overloads.

Some features need to be reset when you or someone else disconnects and reconnects the battery. See **Changing the 12V Battery** (page 336).

Fuses

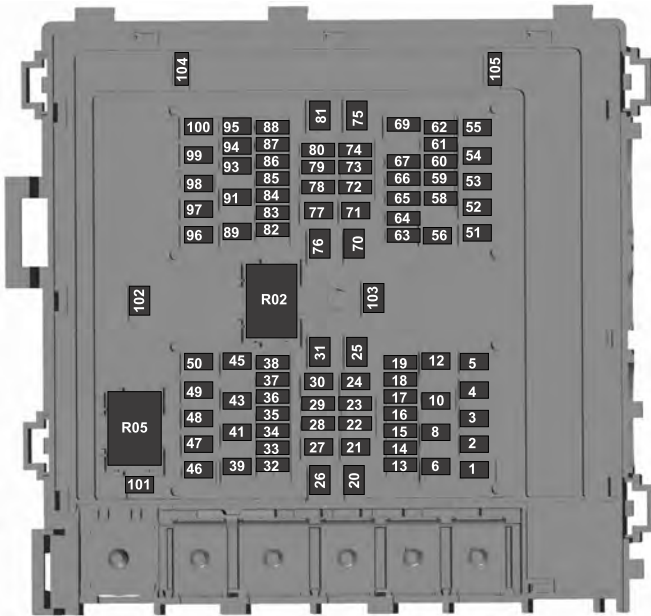

E251921

Fuse Number	Fuse Rating	Protected Component
1	25A ¹	Horn.
2	50A ²	Fan 1.
3	30A ²	Front wiper motor.
4	—	Not used.
5	30A ²	Starter relay.
6	20A ²	Power point 1.
8	20A ²	Power point 2.
10	5A ¹	Rain sensor.
12	—	Not used.

Fuses

Fuse Number	Fuse Rating	Protected Component
13	10A ¹	4x4 module. Heated backlite. Heated mirror relay coil. Heated wiper park relay coil. Transmission isolation relay coil.
14	15A ¹	Transmission control module.
15	15A ¹	Voltage quality module run/start power. Blindspot information system. Head Up Display. Image processing module B. Front view camera. Rear view camera. Cruise control module.
16	10A ¹	Powertrain control module (PCM) run/ start feed.
17	10A ¹	Antilock brake system run/ start feed.
18	10A ¹	Electronic power assist steering run / start feed.
19	—	Not used.
20	40A ²	Front blower.
21	40A ²	Passenger seat motors.
22	20A ¹	Not used.
23	10A ¹	Alternator A-line.
24	30A ²	Trailer brake control module.
25	50A ²	Body control module power 1.
26	50A ²	Electronic fan 3.
27	40A ²	Driver seat motors.
28	15A ¹	Rear heated seats.
29	10A ¹	Integrated wheel end solenoid.

Fuses

Fuse Number	Fuse Rating	Protected Component
30	25A ²	Trailer tow class II-IV battery charge.
31	50A ²	Power folding seat module.
32	10A ¹	A/C clutch.
33	—	Not used.
34	—	Not used.
35	20A ¹	Vehicle power 4.
36	10A ¹	Vehicle power 3.
37	25A ¹	Vehicle power 2.
38	25A ¹	Vehicle power 1.
39	—	Not used.
41	50A ²	Inverter.
43	20A ²	Trailer Tow Light Module Class II-IV.
45	20A ²	Front/rear washer pump.
46	7.5A ¹	Family entertainment system.
47	—	Not used.
48	—	Not used.
49	—	Not used.
50	30A ²	Fuel pump.
51	20A ²	Power point 3.
52	50A ²	Body control module (BCM) voltage quality module (VQM).
53	25A ²	Trailer tow park lamps relay.
54	40A ²	Electronic limited slip differential relay.

Fuses

Fuse Number	Fuse Rating	Protected Component
55	40A ²	AUX blower.
56	20A ²	Power point 4.
58	5A ¹	Not used (spare).
59	—	Not used.
60	5A ¹	Not used (spare).
61	25A ¹	Not used (spare).
62	25A ¹	Not used (spare).
63	25A ¹	4x4 module.
64	—	Not used.
65	—	Not used.
66	—	Not used.
67	—	Not used.
69	25A ¹	Trailer tow park lamp.
70	40A ²	Anti-lock brake system / parking brake module.
71	25A ²	4x4 module.
72	—	Not used.
73	—	Not used.
74	10A ¹	Trailer tow backup lamps.
75	—	Not used.
76	50A ²	Body control module power 2.
77	30A ²	Climate controlled (Heated/Vented) seat module.
78	20A ¹	Not used (spare).

Fuses

Fuse Number	Fuse Rating	Protected Component
79	—	Not used.
80	10A ¹	Heated wiper park.
81	—	Not used.
82	—	Not used.
83	15A ¹	Transmission control module power.
84	—	Not used.
85	—	Not used.
86	5A ¹	USB smart charger 5.
87	5A ¹	USB smart charger 3.
88	10A ¹	Multi-contour seats relay.
89	40A ²	Power running boards.
91	30A ²	Power liftgate module.
93	15A ¹	Heated mirrors.
94	5A ¹	USB smart charger 1.
95	10A ¹	USB smart charger 2.
96	30A ²	Rear wiper motor relay.
97	40A ²	Intercooler puller relay fan.
98	15A ²	Transmission oil pump.
99	40A ²	Heated backlite.
100	20A ²	Power point 5.
101	25A ²	Fan 2.
102	—	Not used.

Fuses

Fuse Number	Fuse Rating	Protected Component
103	—	Not used.
104	—	Not used.
105	—	Not used.

¹Micro fuse.

²M case use.

Relay Number	Protected Component
R02	Powertrain Control Module.
R05	Electric fan 2.

Passenger Compartment Fuse Box

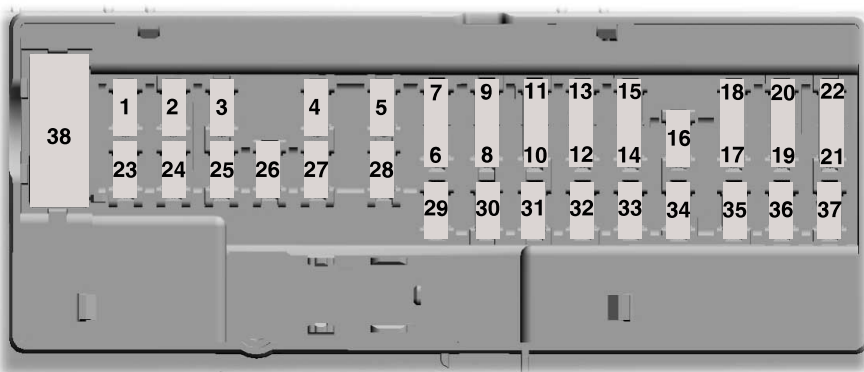

E145984

Fuses

Fuse or Relay Number	Fuse Rating	Protected Component
1	—	Not used.
2	7.5A ¹	Driver seat switch.
3	20A ¹	Driver door unlock.
4	5A ¹	Trailer brake controller.
5	20A ¹	Speaker amplifier.
6	10A ²	Not used (spare).
7	10A ²	Not used (spare).
8	—	Not used.
9	10A ²	Rear seat entertainment module. Head up display.
10	5A ²	Wireless accessory charger module. Hands free liftgate module. Power liftgate module.
11	5A ²	Keypad. Combined sensor module.
12	7.5A ²	Cluster. Electronic control panel. Smart datalink connector logic.
13	7.5A ²	Gear shift module. Steering column control module.
14	10A ²	Extended power module. Brake switch.
15	10A ²	Smart datalink connector power.
16	15A ¹	Liftglass release.
17	5A ²	Telematics control unit - modem.
18	5A ²	Ignition switch. Key inhibit solenoid.

Fuses

Fuse or Relay Number	Fuse Rating	Protected Component
		Push button start switch.
19	7.5A ²	Transmission control switch. Gearshift module.
20	7.5A ²	Not used.
21	5A ²	Humidity and in-car temperature sensor.
22	5A ²	Electrochromatic mirror. Second row heated seat module.
23	10A ¹	Moonroof logic. Inverter. Power window switch. Power mirror switch.
24	20A ¹	Central lock unlock
25	30A ¹	Left front door zone module.
26	30A ¹	Right front door zone module.
27	30A ¹	Moonroof.
28	20A ¹	Stereo amplifier.
29	30A ¹	Left rear door zone module.
30	30A ¹	Right rear door zone module.
31	15A ¹	Adjustable pedals.
32	10A ¹	SYNC Drive mode switch module. 4x4 switch. Radio frequency transceiver module. Rear heating, ventilation and air conditioning control module.
33	20A ¹	Audio control module.
34	30A ¹	Run/start relay.

Fuses

Fuse or Relay Number	Fuse Rating	Protected Component
35	5A ¹	Extended power mode module.
36	15A ¹	Image processing module A. Automated park assist module. Continuous control damping module.
37	20A ¹	Heated steering wheel.
38	30A Circuit Breaker	Left rear power window. Right rear power window.

¹Micro 2 fuse.

²Micro 3 fuse.

CHANGING A FUSE

Fuses



WARNING: Always replace a fuse with one that has the specified amperage rating. Using a fuse with a higher amperage rating can cause severe wire damage and could start a fire.



E217331

If electrical components in the vehicle are not working, a fuse may have blown. Blown fuses are identified by a broken wire within the fuse. Check the appropriate fuses before replacing any electrical components.

Fuses

Fuse Types

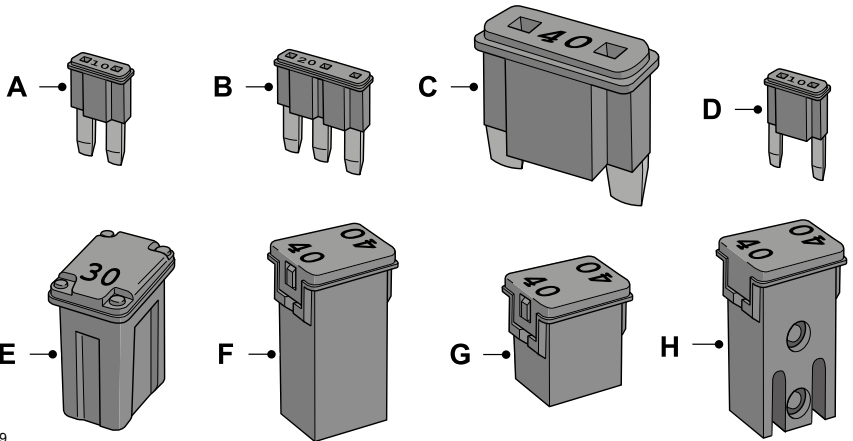

E267379

- A Micro 2.
- B Micro 3.
- C Maxi.
- D Mini.
- E M Case.
- F J Case.
- G J Case Low Profile.
- H Slotted M Case.

Maintenance

GENERAL INFORMATION

Have your vehicle serviced regularly to help maintain its roadworthiness and resale value. There is a large network of authorized dealers that are there to help you with their professional servicing expertise. We believe that their specially trained technicians are best qualified to service your vehicle properly and expertly. They are supported by a wide range of highly specialized tools developed specifically for servicing your vehicle.

If your vehicle requires professional service, an authorized dealer can provide the necessary parts and service. Check your warranty information to find out which parts and services are covered.

Use only recommended fuels, lubricants, fluids and service parts conforming to specifications. Motorcraft® parts are designed and built to provide the best performance in your vehicle.

Precautions

- Do not work on a hot engine.
- Make sure that nothing gets caught in moving parts.
- Do not work on a vehicle with the engine running in an enclosed space, unless you are sure you have enough ventilation.
- Keep all open flames and other burning material (such as cigarettes) away from the battery and all fuel related parts.

Working with the Engine Off

1. Set the parking brake and shift the transmission to park (P).
2. Switch off the engine.
3. Block the wheels.

Working with the Engine On



WARNING: To reduce the risk of vehicle damage and personal burn injuries, do not start your engine with the air cleaner removed and do not remove it while the engine is running.

1. Set the parking brake and shift the transmission to park (P).
2. Block the wheels.

OPENING AND CLOSING THE HOOD

1. Inside the vehicle, pull the hood release handle located under the left hand side of the instrument panel.



2. Go to the front of your vehicle and locate the secondary release lever under the front of the hood near the center of your vehicle.

Maintenance

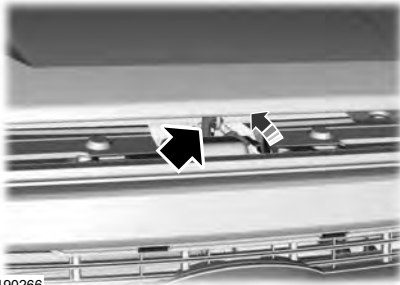

E190266

3. Raise the hood until the lift cylinders hold it open.
4. To close, lower the hood and make sure that it is properly closed and fully latched.

UNDER HOOD OVERVIEW

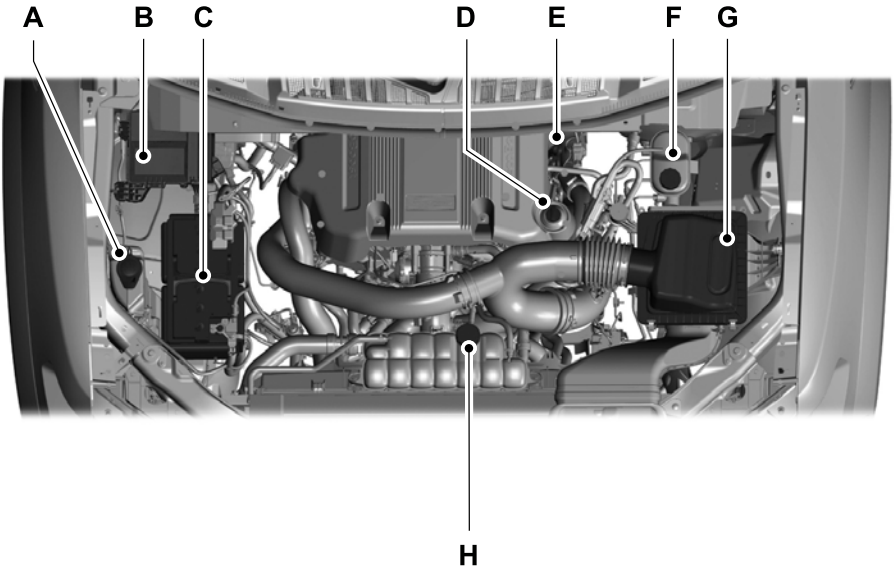

E258054

Maintenance

- A. Windshield washer fluid reservoir. See **Washer Fluid Check** (page 335).
- B. Power distribution box. See **Changing a Fuse** (page 324).
- C. Battery. See **Changing the 12V Battery** (page 336).
- D. Engine oil filler cap. See **Engine Oil Check** (page 328).
- E. Engine oil dipstick. See **Engine Oil Dipstick** (page 328).
- F. Brake fluid reservoir. See **Brake Fluid Check** (page 335).
- G. Air filter. See **Changing the Engine Air Filter** (page 342).
- H. Engine coolant reservoir. See **Engine Coolant Check** (page 330).

1. Make sure the parking brake is on. Make sure the transmission is in park (P) or neutral (N).
2. Run the engine until it reaches normal operating temperature.
3. Make sure that your vehicle is on level ground.
4. Switch the engine off and wait 15 minutes for the oil to drain into the oil pan. Checking the engine oil level too soon after you switch the engine off may result in an inaccurate reading.
5. Open the hood. See **Opening and Closing the Hood** (page 326).
6. Remove the dipstick and wipe it with a clean, lint-free cloth. See **Under Hood Overview** (page 327).
7. Replace the dipstick and remove it again to check the oil level. See **Engine Oil Dipstick** (page 328).
8. Make sure that the oil level is between the maximum and minimum marks. If the oil level is at the minimum mark, add oil immediately. See **Capacities and Specifications** (page 384).
9. If the oil level is correct, replace the dipstick and make sure it is fully seated.

Note: Do not remove the dipstick when the engine is running.

Note: If the oil level is between the maximum and minimum marks, the oil level is acceptable. Do not add oil.

Note: The oil consumption of new engines reaches its normal level after approximately 3,000 mi (5,000 km).

Adding Engine Oil

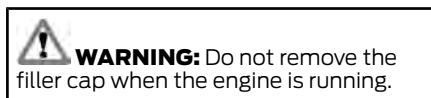

ENGINE OIL DIPSTICK

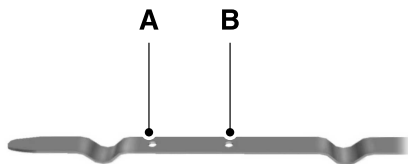

E146429

- A MIN
- B MAX

ENGINE OIL CHECK

To check the engine oil level consistently and accurately, do the following:

Maintenance

Do not use supplemental engine oil additives because they are unnecessary and could lead to engine damage that may not be covered by the vehicle Warranty.



E142732

Only use oils certified for gasoline engines by the American Petroleum Institute (API). An oil with this trademark symbol conforms to the current engine and emission system protection standards and fuel economy requirements of the International Lubricants Specification Advisory Committee (ILSAC).

To top up the engine oil level do the following:

1. Clean the area surrounding the engine oil filler cap before you remove it.
2. Remove the engine oil filler cap. See **Under Hood Overview** (page 327). Turn it counterclockwise and remove it.
3. Add engine oil that meets our specifications. See **Capacities and Specifications** (page 384). You may have to use a funnel to pour the engine oil into the opening.
4. Recheck the oil level.
5. If the oil level is correct, replace the dipstick and make sure it is fully seated.
6. Replace the engine oil filler cap. Turn it clockwise until you feel a strong resistance.

Note: Do not add oil further than the maximum mark. Oil levels above the maximum mark may cause engine damage.

Note: Make sure you install the oil filler cap correctly.

Note: Soak up any spillage with an absorbent cloth immediately.

OIL CHANGE INDICATOR RESET

Use the information display controls on the steering wheel to reset the oil change indicator.

From the main menu scroll to:

Message	Action and description
Settings	Press the right arrow button, then from this menu scroll to the following message.
Vehicle	Press the right arrow button, then from this menu scroll to the following message.
Oil Life	Press the right arrow button, then from this menu scroll to the following message.
Hold OK to Reset	Press and hold the OK button until the instrument cluster displays the following message. Reset Successful
	When the oil change indicator resets the instrument cluster displays 100%. Remaining Life {00}%

Maintenance

Message	Action and description
	If the instrument cluster displays one of the following messages, repeat the process. Not Reset Reset Cancelled

ENGINE COOLANT CHECK



WARNING: Do not remove the coolant reservoir cap when the cooling system is hot. Wait 10 minutes for the cooling system to cool down. Cover the coolant reservoir cap with a thick cloth to prevent the possibility of scalding and slowly remove the cap. Failure to follow this instruction could result in personal injury.



WARNING: Do not put coolant in the windshield washer reservoir. If sprayed on the windshield, coolant could make it difficult to see through the windshield.



WARNING: To reduce the risk of personal injury, make sure the engine is cool before unscrewing the coolant pressure relief cap. The cooling system is under pressure. Steam and hot liquid can come out forcefully when you loosen the cap slightly.



WARNING: Do not add coolant further than the **MAX** mark.

When the engine is cold, check the concentration and level of the coolant at the intervals listed in the scheduled maintenance information. See **Scheduled Maintenance** (page 500).

Note: Make sure that the coolant level is between the **MIN** and **MAX** marks on the coolant reservoir.

Note: Coolant expands when it is hot. The level may extend beyond the **MAX** mark.

Maintain coolant concentration within 48% to 50%, which equates to a freeze point between -29°F (-34°C) and -35°F (-37°C). Coolant concentration should be checked using a refractometer. We do not recommend the use of hydrometers or coolant test strips for measuring coolant concentration.

Adding Coolant



WARNING: Do not add engine coolant when the engine is hot. Failure to follow this instruction could result in personal injury.



WARNING: Do not remove the coolant reservoir cap when the cooling system is hot. Wait 10 minutes for the cooling system to cool down. Cover the coolant reservoir cap with a thick cloth to prevent the possibility of scalding and slowly remove the cap. Failure to follow this instruction could result in personal injury.

Note: Automotive fluids are not interchangeable. Take care not to put engine coolant in the windshield washer fluid reservoir or windshield washer fluid in the engine coolant reservoir.

Note: Do not use stop leak pellets, cooling system sealants, or non-specified additives as they can cause damage to the engine cooling or heating systems. Resulting component damage may not be covered by the vehicle Warranty.

Maintenance

It is very important to use prediluted coolant approved to the correct specification in order to avoid plugging the small passageways in the engine cooling system. See **Capacities and Specifications** (page 380). Do not mix different colors or types of coolant in your vehicle. Mixing of engine coolants or using an incorrect coolant may harm the engine or cooling system components and may not be covered by the vehicle Warranty.

Note: *If prediluted coolant is not available, use the approved concentrated coolant diluting it to 50/50 with distilled water. See **Capacities and Specifications** (page 380). Using water that has not been deionised may contribute to deposit formation, corrosion and plugging of the small cooling system passageways.*

Note: *Coolants marketed for all makes and models may not be approved to our specifications and may cause damage to the cooling system. Resulting component damage may not be covered by the vehicle Warranty.*

If the coolant level is at or below the minimum mark, add prediluted coolant immediately.

To top up the coolant level do the following:

1. Unscrew the cap slowly. Any pressure escapes as you unscrew the cap.
2. Add prediluted coolant approved to the correct specification. See **Capacities and Specifications** (page 380).
3. Add enough prediluted coolant to reach the correct level.
4. Replace the coolant reservoir cap, turn it clockwise until you feel a strong resistance.

5. Check the coolant level in the coolant reservoir the next few times you drive your vehicle. If necessary, add enough prediluted engine coolant to bring the coolant level to the correct level.

If you have to add more than 1.1 qt (1 L) of engine coolant per month, have your vehicle checked as soon as possible. Operating an engine with a low level of coolant can result in engine overheating and possible engine damage.

In case of emergency, you can add a large amount of water without engine coolant in order to reach a vehicle service location. In this instance, qualified personnel:

1. Must drain the cooling system.
2. Chemically clean the coolant system.
3. Refill with engine coolant as soon as possible.

Water alone, without engine coolant, can cause engine damage from corrosion, overheating or freezing.

Do not use the following as a coolant substitute:

- Alcohol.
- Methanol.
- Brine.
- Any coolant mixed with alcohol or methanol antifreeze.

Alcohol and other liquids can cause engine damage from overheating or freezing.

Do not add extra inhibitors or additives to the coolant. These can be harmful and compromise the corrosion protection of the coolant.

Recycled Coolant

We do not recommend the use of recycled coolant as an approved recycling process is not yet available.

Maintenance

Dispose of used engine coolant in an appropriate manner. Follow your community's regulations and standards for recycling and disposing of automotive fluids.

Severe Climates

If you drive in extremely cold climates:

- It may be necessary to increase the coolant concentration above 50%.
- A coolant concentration of 60% provides improved freeze point protection. Coolant concentrations above 60% decrease the overheat protection characteristics of the coolant and may cause engine damage.

If you drive in extremely hot climates:

- You can decrease the coolant concentration to 40%.
- Coolant concentrations below 40% decrease the freeze and corrosion protection characteristics of the coolant and may cause engine damage.

Vehicles driven year-round in non-extreme climates should use prediluted coolant for optimum cooling system and engine protection.

Coolant Change

At specific mileage intervals, as listed in the scheduled maintenance information, the coolant should be changed. Add prediluted coolant approved to the correct specification. See **Capacities and Specifications** (page 380).

Fail-Safe Cooling

Fail-safe cooling allows you to temporarily drive your vehicle before any incremental component damage occurs. The fail-safe distance depends on ambient temperature, vehicle load and terrain.

How Fail-Safe Cooling Works



If the engine begins to overheat, the coolant temperature gauge moves toward the red zone:



A warning lamp illuminates and a message may appear in the information display.

If the engine reaches a preset over-temperature condition, the engine automatically switches to alternating cylinder operation. Each disabled cylinder acts as an air pump and cools the engine.

When this occurs, your vehicle still operates, however:

- Engine power is limited.
- The air conditioning system turns off.

Continued operation increases the engine temperature, causing the engine to completely shut down. Your steering and braking effort increases in this situation.

When the engine temperature cools, you can re-start the engine. Have your vehicle checked as soon as possible to minimize engine damage.

When Fail-Safe Mode Is Activated



WARNING: Fail-safe mode is for use during emergencies only. Operate your vehicle in fail-safe mode only as long as necessary to bring your vehicle to rest in a safe location and seek immediate repairs. When in fail-safe mode, your vehicle will have limited power, will not be able to maintain high-speed operation, and may completely shut down without warning, potentially losing engine power, power steering assist, and power brake assist, which may increase the possibility of a crash resulting in serious injury.

Maintenance



WARNING: Do not remove the coolant reservoir cap when the cooling system is hot. Wait 10 minutes for the cooling system to cool down. Cover the coolant reservoir cap with a thick cloth to prevent the possibility of scalding and slowly remove the cap. Failure to follow this instruction could result in personal injury.

Your vehicle has limited engine power when in the fail-safe mode, drive your vehicle with caution. Your vehicle does not maintain high-speed operation and the engine may operate poorly.

Remember that the engine is capable of automatically shutting down to prevent engine damage. In this situation:

1. Pull off the road as soon as safely possible and switch the engine off.
2. If you are a member of a roadside assistance program, we recommend that you contact your roadside assistance service provider.
3. If this is not possible, wait a short period for the engine to cool.
4. Check the coolant level. If the coolant level is at or below the minimum mark, add prediluted coolant immediately.
5. When the engine temperature cools, you can re-start the engine. Have your vehicle checked as soon as possible to minimize engine damage.

Note: *Driving your vehicle without repair increases the chance of engine damage.*

Engine Coolant Temperature Management (If Equipped)



WARNING: To reduce the risk of crash and injury, be prepared that the vehicle speed may reduce and the vehicle may not be able to accelerate with full power until the coolant temperature reduces.

If you tow a trailer with your vehicle, the engine may temporarily reach a higher temperature during severe operating conditions, for example ascending a long or steep grade in high ambient temperatures.

At this time, you may notice the coolant temperature gauge moves toward the red zone and a message may appear in the information display.

You may notice a reduction in vehicle speed caused by reduced engine power in order to manage the engine coolant temperature. Your vehicle may enter this mode if certain high-temperature and high-load conditions take place. The amount of speed reduction depends on vehicle loading, grade and ambient temperature. If this occurs, there is no need to stop your vehicle. You can continue to drive.

The air conditioning may automatically turn on and off during severe operating conditions to protect the engine from overheating. When the coolant temperature decreases to the normal operating temperature, the air conditioning turns on.

If the coolant temperature gauge moves fully into the red zone, or if the coolant temperature warning or service engine soon messages appear in your information display, do the following:

Maintenance

1. Stop your vehicle as soon as it is safe to do so. Fully apply the parking brake, shift into park (P) or neutral (N).
2. Leave the engine running until the coolant temperature gauge needle returns to the normal position. After several minutes, if the temperature does not drop, follow the remaining steps.
3. Switch the engine off and wait for it to cool. Check the coolant level.
4. If the coolant level is at or below the minimum mark, add prediluted coolant immediately.
5. If the coolant level is normal, restart the engine and continue.

AUTOMATIC TRANSMISSION FLUID CHECK

If required, have an authorized dealer check and change the transmission fluid at the correct service interval. See **Scheduled Maintenance** (page 500).

The automatic transmission does not have a transmission fluid dipstick.

Refer to your scheduled maintenance information for scheduled intervals for fluid checks and changes. Your transmission does not consume fluid. However, if the transmission slips, shifts slowly or if you notice a sign of leaking fluid, contact an authorized dealer.

Do not use supplemental transmission fluid additives, treatments or cleaning agents. The use of these materials may affect transmission operation and result in damage to internal transmission components.

TRANSFER CASE FLUID CHECK (IF EQUIPPED)

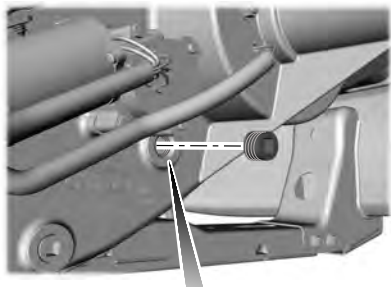

E170444

1. Clean the area around the filler plug.
2. Remove the filler plug.
3. Inspect the fluid level. The fluid level should be within 0.20 in (5 mm) from the bottom of the hole.
4. Add fluid through the filler opening. Fill to the bottom of the opening.

Use only fluid that meets our specifications. See **Capacities and Specifications** (page 380).

Maintenance

BRAKE FLUID CHECK



WARNING: Do not use any fluid other than the recommended brake fluid as this will reduce brake efficiency. Use of incorrect fluid could result in the loss of vehicle control, serious personal injury or death.



WARNING: Only use brake fluid from a sealed container. Contamination with dirt, water, petroleum products or other materials may result in brake system damage or failure. Failure to adhere to this warning could result in the loss of vehicle control, serious personal injury or death.



WARNING: Do not allow the fluid to touch your skin or eyes. If this happens, rinse the affected areas immediately with plenty of water and contact your physician.



WARNING: A fluid level between the **MAX** and **MIN** lines is within the normal operating range and there is no need to add fluid. A fluid level not in the normal operating range could compromise the performance of the system. Have your vehicle checked immediately.



E170684

To avoid fluid contamination, the reservoir cap must remain in place and fully tight, unless you are adding fluid.

Only use fluid that meets Ford specifications. See **Capacities and Specifications** (page 380).

WASHER FLUID CHECK



WARNING: If you operate your vehicle in temperatures below 41.0°F (5°C), use washer fluid with antifreeze protection. Failure to use washer fluid with antifreeze protection in cold weather could result in impaired windshield vision and increase the risk of injury or accident.

Note: *The front and rear washer systems are supplied from the same reservoir.*

Add fluid to fill the reservoir if the level is low. Only use a washer fluid that meets our specifications. See **Capacities and Specifications** (page 380).

Maintenance

State or local regulations on volatile organic compounds may restrict the use of methanol, a common windshield washer antifreeze additive. Washer fluids containing non-methanol antifreeze agents should be used only if they provide cold weather protection without damaging the vehicle's paint finish, wiper blades or washer system.

FUEL FILTER

Your vehicle is equipped with a lifetime fuel filter that is integrated with the fuel tank. Regular maintenance or replacement is not needed.

CHANGING THE 12V BATTERY



WARNING: Batteries normally produce explosive gases which can cause personal injury. Therefore, do not allow flames, sparks or lighted substances to come near the battery. When working near the battery, always shield your face and protect your eyes. Always provide correct ventilation.



WARNING: When lifting a plastic-cased battery, excessive pressure on the end walls could cause acid to flow through the vent caps, resulting in personal injury and damage to the vehicle or battery. Lift the battery with a battery carrier or with your hands on opposite corners.



WARNING: Keep batteries out of reach of children. Batteries contain sulfuric acid. Avoid contact with skin, eyes or clothing. Shield your eyes when working near the battery to protect against possible splashing of acid solution. In case of acid contact with skin or eyes, flush immediately with water for a minimum of 15 minutes and get prompt medical attention. If acid is swallowed, call a physician immediately.



WARNING: Battery posts, terminals and related accessories contain lead and lead compounds, chemicals known to the State of California to cause cancer and reproductive harm. **Wash your hands after handling.**



WARNING: This vehicle may have more than one battery. Removing the battery cables from only one battery does not disconnect your vehicle electrical system. Make sure you disconnect the battery cables from all batteries when disconnecting power. Failure to do so may cause serious personal injury or property damage.

Your vehicle is fitted with a Motorcraft maintenance-free battery which normally does not require additional water.

When a battery replacement is required, you must use a recommended replacement battery that matches the electrical requirements of the vehicle.

Note: After cleaning or replacing the battery, make sure you reinstall the battery cover or shield.

Maintenance

Note: If you add electrical accessories or components to the vehicle, it may adversely affect the low voltage battery performance and durability. This may also affect the performance of other electrical systems in the vehicle.

For longer, trouble-free operation, keep the top of the battery clean and dry.

If you see any corrosion on the battery or terminals, remove the cables from the terminals and clean with a wire brush. You can neutralize the acid with a solution of baking soda and water.

Because your vehicle's engine is electronically controlled by a computer, some control conditions are maintained by power from the battery. When the battery is disconnected or a new battery is installed, the engine must relearn its idle and fuel trim strategy for optimum driveability and performance. Flexible fuel vehicles (FFV) must also relearn the ethanol content of the fuel for optimum driveability and performance.

To restore the settings, do the following:

1. Apply the parking brake.
2. Shift into park (P) or neutral (N).
3. Switch off all accessories.
4. Press the brake pedal and start your vehicle.
5. Run the engine until it reaches normal operating temperature. While the engine is warming up, complete the following: Reset the clock. Reset the power windows bounce-back feature. See **Windows and Mirrors** (page 96). Reset the radio station presets. See **Audio System** (page 391).
6. Allow the engine to idle for at least one minute.
7. Drive the vehicle at least 10 mi (16 km) to completely relearn the idle trim and fuel trim strategy.

Note: If you do not allow the engine to relearn the idle and fuel trim strategy, the idle quality of your vehicle may be adversely affected until the engine computer eventually relearns the idle trim and fuel trim strategy.

Note: For flexible fuel vehicles, if you are operating on E85, you may experience poor starts or an inability to start the engine and driveability problems until the fuel trim and ethanol content have been relearned.

Make sure that you dispose of old batteries in an environmentally friendly way. Seek advice from your local authority about recycling old batteries.

If storing your vehicle for more than 30 days without recharging the battery, we recommend that you disconnect the negative battery cable to maintain battery charge for quick starting.

Battery Management System (if Equipped)

The battery management system monitors battery conditions and takes actions to extend battery life. If excessive battery drain is detected, the system temporarily disables some electrical systems to protect the battery.

Systems included are:

- Heated rear window.
- Heated seats.
- Climate control.
- Heated steering wheel.
- Audio unit.
- Navigation system.

A message may appear in the information displays to alert you that battery protection actions are active. These messages are only for notification that an action is taking place, and not intended to indicate an electrical problem or that the battery requires replacement.

Maintenance

After battery replacement, or in some cases after charging the battery with an external charger, the battery management system requires eight hours of vehicle sleep time to relearn the battery state of charge. During this time your vehicle must remain fully locked with the ignition switched off.

Note: Prior to relearning the battery state of charge, the battery management system may temporarily disable some electrical systems.

Electrical Accessory Installation

To make sure the battery management system works correctly, do not connect an electrical device ground connection directly to the battery negative post. This can cause inaccurate measurements of the battery condition and potential incorrect system operation.

Note: If you add electrical accessories or components to the vehicle, it may adversely affect battery performance and durability. This may also affect the performance of other electrical systems in the vehicle.

CHECKING THE WIPER BLADES



Run the tip of your fingers over the edge of the blade to check for roughness.

Clean the wiper blades with washer fluid or water applied with a soft sponge or cloth.

CHANGING THE WIPER BLADES

Note: Do not hold the wiper blade when lifting the wiper arm.



1. Pull the wiper blade and arm away from the glass.

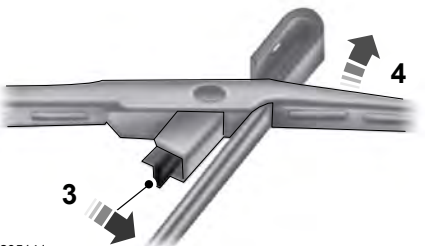
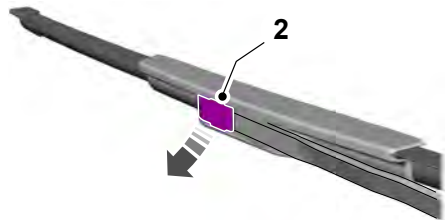

2. Lift the wiper blade primary locking clip.

Maintenance

3. Press the wiper blade secondary locking clip.
4. Remove the wiper blade.

Note: Make sure that the wiper arm does not spring back against the glass when the wiper blade is not attached.

5. Install in the reverse order.

Note: Make sure that the wiper blade locks into place.

ADJUSTING THE HEADLAMPS

Vertical Aim Adjustment

The headlamps on your vehicle are properly aimed at the assembly plant. If your vehicle has been in an accident, contact an authorized dealer to check and realign your headlamps.

Headlamp Aiming Target

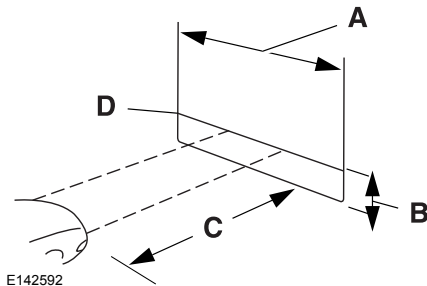

E142592

- A 8 feet (2.4 meters).
- B Center height of lamp to ground.
- C 25 feet (7.6 meters).
- D Horizontal reference line.

Vertical Aim Adjustment

1. Park your vehicle directly in front of a wall or screen on a level surface, approximately 25 ft (7.6 m) away.

2. Measure the height from the center of your headlamp (indicated by a 3 mm circle on the lens) to the ground and mark an 8 ft (2.4 m) horizontal reference line on the vertical wall or screen at this height (a piece of masking tape works well).

Note: To see a clearer light pattern for adjusting, you may want to block the light from one headlamp while adjusting the other.

3. Switch on the low beam headlamps to illuminate the wall or screen and open the hood. Cover one of the headlamps so no light hits the wall.



E167358

4. **For halogen or LED headlamps:** On the wall or screen you will observe a light pattern with a distinct horizontal edge toward the right. If this edge is not at the horizontal reference line, you will need to adjust the beam so the edge is at the same height as the horizontal reference line.

Maintenance

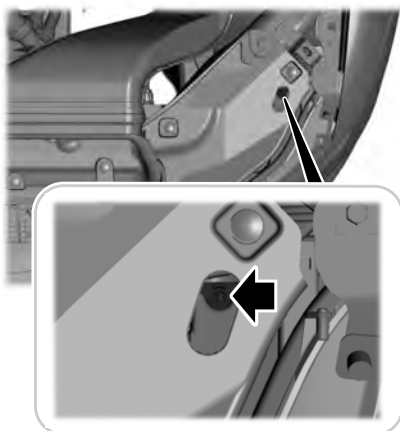

E248807

5. Locate the vertical adjuster on each headlamp. Use a #2 Phillips screwdriver to turn the adjuster either counterclockwise or clockwise in order to adjust the vertical aim of the headlamp.
6. Repeat Steps 3 through 7 to adjust the other headlamp.
7. Close the hood and turn off the lamps.

Horizontal Aim Adjustment

Horizontal aim is not required for this vehicle and is not adjustable.

REMOVING A HEADLAMP

The bumper fascia and grille must be removed in order to remove the headlamp assembly, see an authorized dealer if your headlamp assembly need replacement.

CHANGING A BULB



WARNING: Bulbs can become hot. Let the bulb cool down before removing it. Failure to do so could result in personal injury.

Install in the reverse order unless otherwise stated.

Note: *If the bulb is accidentally touched, clean it with rubbing alcohol before installing it.*

Headlamp Bulb

1. Switch all of the lamps and the ignition off.

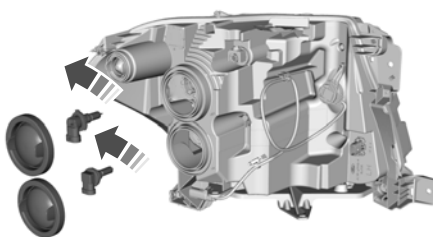

E248888

2. Carefully remove the cover.
3. Disconnect the electrical connector.
4. Turn the bulb holder counterclockwise and remove it.

Note: *You cannot separate the bulb from the bulb holder.*

Note: *Do not touch the bulb glass.*

LED Headlamp Bulb (If Equipped)

These lamps have LED bulbs. Contact an authorized dealer.

Maintenance

Front Direction Indicator Bulb

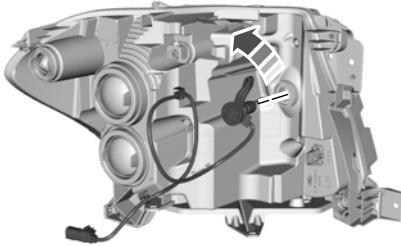

E248887

1. Switch all of the lamps and the ignition off.
2. Turn the bulb holder counterclockwise and remove it.
3. Remove the bulb by pulling it straight out.

LED Direction Indicator and Side Marker Bulbs (If Equipped)

These lamps have LED bulbs. Contact an authorized dealer.

Fog Lamp Bulb (If Equipped)

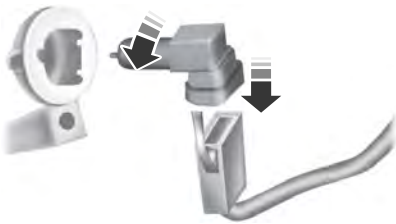

E163826

1. Switch all of the lamps and the ignition off.
2. Disconnect the electrical connector.

3. Turn the bulb holder counterclockwise and remove it.

Note: You cannot separate the bulb from the bulb holder.

Note: Do not touch the bulb glass.

Rear Lamp, Brake Lamp, Rear Direction Indicator and Reverse Lamp Bulbs

1. Switch all of the lamps and the ignition off.

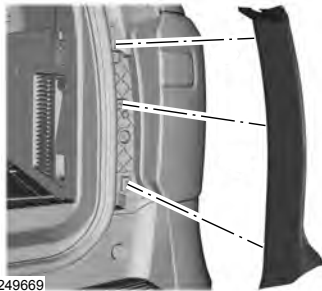

E249669

2. Carefully remove the cover.

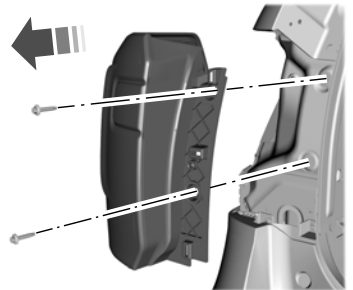

E248886

4. Remove the retaining bolts from the lamp assembly.
5. Remove the lamp assembly.
6. Disconnect the electrical connector.
7. Turn the bulb holder counterclockwise and remove it.

Maintenance

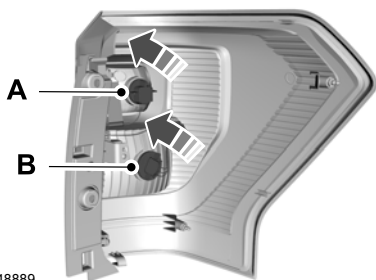

E248889

- A. Reverse lamp bulb.
- B. Rear lamp, brake lamp and direction indicator bulb.

Note: You cannot separate the bulb from the bulb holder.

LED Bulbs (If Equipped)

Note: Vehicles with LED headlamps do not contain serviceable bulbs. See an authorized dealer if they fail.

These lamps operate at a high voltage. Contact an authorized dealer.

- Rear lamp.
- Brake lamp.
- Rear direction indicator.
- Side direction indicator.
- Reverse lamp.
- Central high-mounted brake lamp.
- License plate lamp.

CHANGING THE ENGINE AIR FILTER



WARNING: To reduce the risk of vehicle damage and personal burn injuries, do not start your engine with the air cleaner removed and do not remove it while the engine is running.

Note: Failure to use the correct air filter element may result in severe engine damage. Resulting component damage may not be covered by the vehicle Warranty.

When changing the air filter element, use only the air filter element listed. See **Motorcraft Parts** (page 380).

Change the air filter element at the correct interval. See **Scheduled Maintenance** (page 500).

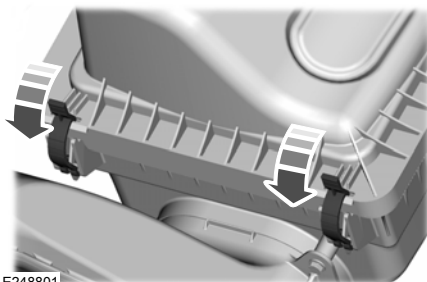

E248801

1. Release the two clamps that secure the cover to the air filter housing. Push the air filter cover toward the front of the vehicle and up slightly to release it.
2. Remove the air filter element from the air filter housing.
3. Install the new air filter element.

Maintenance

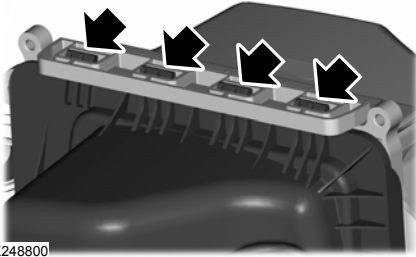

E248800

4. Replace the air filter housing cover and secure all the clamps. Be careful not to crimp the filter element edges between the air filter housing and cover and ensure that you properly align the tabs on the edge into the slots.

Vehicle Care

GENERAL INFORMATION

Your dealer has many quality products available to clean your vehicle and protect its finishes.

CLEANING PRODUCTS

Materials

For best results, use the following products or products of equivalent quality:

Name	Specification
Motorcraft® Bug and Tar Remover, ZC-42 (U.S. & Canada)	
Motorcraft® Custom Bright Metal Cleaner, ZC-15 (U.S. & Canada)	ESR-M5B194-B
Motorcraft® Detail Wash, ZC-3-A (U.S. & Canada)	ESR-M14P4-A
Motorcraft® Engine Shampoo and Degreaser, ZC-20 (U.S.)	ESR-M14P3-A
Motorcraft® Engine Shampoo, CXC-66-A (Canada)	
Motorcraft® Premium Leather and Vinyl Cleaner, ZC-56 (U.S. & Canada)	
Motorcraft® Multi-Purpose Cleaner, CXC-101 (Canada)	
Motorcraft® Premium Windshield Wash Concentrate with Bitterant, ZC-32-B2 (U.S.)	WSS-M14P19-A
Motorcraft® Premium Quality Windshield Washer Fluid, CXC-37-A/B/D/F (Canada)	WSS-M14P19-A
Motorcraft® Professional Strength Carpet & Upholstery Cleaner, ZC-54 (U.S. & Canada)	
Motorcraft® Premium Glass Cleaner, CXC-100 (Canada)	ESR-M14P5-A
Motorcraft® Spot and Stain Remover, ZC-14 (U.S.)	
Motorcraft® Ultra-Clear Spray Glass Cleaner, ZC-23 (U.S.)	ESR-M14P5-A
Motorcraft® Wheel and Tire Cleaner, ZC-37-A (U.S. & Canada)	

CLEANING THE EXTERIOR

Wash your vehicle regularly with cool or lukewarm water and a neutral pH shampoo, we recommend Motorcraft Detail Wash.

- Never use strong household detergents or soap, for example dish washing or laundry liquid. These products can discolor and spot painted surfaces.
- Never wash your vehicle when it is hot to the touch, or during strong or direct sunlight.

Vehicle Care

- Dry your vehicle with a chamois or soft terry cloth towel to eliminate water spotting.
- Immediately remove fuel spillages, bird droppings, insect deposits and road tar. These may cause damage to your vehicle's paintwork or trim over time. We recommend Motorcraft Bug and Tar Remover.
- Remove any exterior accessories, for example antennas, before entering a car wash.
- When filling with AdBlue®, remove any residue on painted surfaces immediately.

Note: *Suntan lotions and insect repellents can damage painted surfaces. If these substances come in contact with your vehicle, wash the affected area as soon as possible.*

Cleaning the Headlamps

Note: *Do not scrape the headlamp lenses or use abrasives, alcoholic solvents or chemical solvents to clean them.*

Note: *Do not wipe the headlamps when they are dry.*

Exterior Chrome Parts

- Apply a high quality-cleaning product to bumpers and other chrome parts. Follow the manufacturer's instructions. We recommend Motorcraft Custom Bright Metal Cleaner.
- Do not apply the cleaning product to hot surfaces. Do not leave the cleaning product on chrome surfaces longer than the time recommended.
- Using non-recommended cleaners can result in severe and permanent cosmetic damage.

Note: *Never use abrasive materials, for example steel wool or plastic pads as they can scratch the chrome surface.*

Note: *Do not use chrome cleaner, metal cleaner or polish on wheels or wheel covers.*

Exterior Plastic Parts

For routine cleaning we recommend Motorcraft Detail Wash. If tar or grease spots are present, we recommend Motorcraft Bug and Tar Remover.

Stripes or Graphics (If Equipped)

Hand washing your vehicle is preferred however, pressure washing may be used under the following conditions:

- Do not use water pressure higher than 2,000 psi (14,000 kPa).
- Do not use water hotter than 179°F (82°C).
- Use a spray with a 40° wide spray angle pattern.
- Keep the nozzle at a 12 in (305 mm) distance and 90° angle to your vehicle's surface.

Note: *Holding the pressure washer nozzle at an angle to the vehicle's surface may damage graphics and cause the edges to peel away from the vehicle's surface.*

Underbody

Regularly clean the underside of your vehicle using water. Keep body and door drain holes free of debris or foreign material.

Under Hood

For removing black rubber marks from under the hood we recommend Motorcraft Wheel and Tire Cleaner or Motorcraft Bug and Tar Remover.

Vehicle Care

WAXING

Regular waxing is necessary to protect your car's paint from the elements. We recommend that you wash and wax the painted surface once or twice a year.

When washing and waxing, park your vehicle in a shaded area out of direct sunlight. Always wash your vehicle before applying wax.

- Use a quality wax that does not contain abrasives.
- Follow the manufacturer's instructions to apply and remove the wax.
- Apply a small amount of wax in a back-and-forth motion, not in circles.
- Do not allow wax to come in contact with any non-body (low-gloss black) colored trim. The wax will discolor or stain the parts over time.
 - Roof racks.
 - Bumpers.
 - Grained door handles.
 - Side moldings.
 - Mirror housings.
 - Windshield cowl area.
- Do not apply wax to glass areas.
- After waxing, your car's paint should feel smooth, and be free of streaks and smudges.

CLEANING THE ENGINE

Engines are more efficient when they are clean because grease and dirt buildup keep the engine warmer than normal.

When washing:

- Take care when using a power washer to clean the engine. The high-pressure fluid could penetrate the sealed parts and cause damage.
- Do not spray a hot engine with cold water to avoid cracking the engine block or other engine components.
- Spray Motorcraft Engine Shampoo and Degreaser on all parts that require cleaning and pressure rinse clean. In Canada, use Motorcraft Engine Shampoo.
- Never wash or rinse the engine while it is hot or running; water in the running engine may cause internal damage.
- Never wash or rinse any ignition coil, spark plug wire or spark plug well, or the area in and around these locations.
- Cover the battery, power distribution box, and air filter assembly to prevent water damage when cleaning the engine.

CLEANING THE WINDOWS AND WIPER BLADES

Car wash chemicals and environmental fallout can result in windshield and wiper blade contamination. Dirty windshield and wipers will result in poor windshield wiper operation. Keep the windshield and wiper blades clean to maintain windshield wiper performance.

Vehicle Care

To clean the windshield and wiper blades:

- Clean the windshield with a non-abrasive glass cleaner. When cleaning the interior of the windshield, avoid getting any glass cleaner on the instrument panel or door panels. Wipe any glass cleaner off these surfaces immediately.
- For windshields contaminated with tree sap, chemicals, wax or bugs, clean the entire windshield using steel wool (no greater than 0000 grade) in a circular motion and rinse with water.
- Clean the wiper blades with isopropyl rubbing alcohol or windshield washer concentrate.

Note: Do not use razor blades or other sharp objects to clean or remove decals from the inside of the heated rear window. The vehicle warranty does not cover damage caused to the heated rear window grid lines.

CLEANING THE INTERIOR



WARNING: Do not use cleaning solvents, bleach or dye on the vehicle's seatbelts, as these actions may weaken the belt webbing.



WARNING: On vehicles equipped with seat-mounted airbags, do not use chemical solvents or strong detergents. Such products could contaminate the side airbag system and affect performance of the side airbag in a crash.

For fabric, carpets, cloth seats and seats equipped with side airbags:

- Remove dust and loose dirt with a vacuum cleaner.
- Remove light stains and soil with Motorcraft Professional Strength Carpet & Upholstery Cleaner.
- If grease or tar is present on the material, spot-clean the area first with Motorcraft Spot and Stain Remover. In Canada, use Motorcraft Multi-Purpose Cleaner.
- If a ring forms on the fabric after spot cleaning, clean the entire area immediately (but do not oversaturate) or the ring will set.
- Do not use household cleaning products or glass cleaners, which can stain and discolor the fabric and affect the flame retardant abilities of the seat materials.

Mirrors

Do not clean the housing or glass of any mirror with harsh abrasives, fuel or other petroleum or ammonia-based cleaning products.

CLEANING THE INSTRUMENT PANEL AND INSTRUMENT CLUSTER LENS



WARNING: Do not use chemical solvents or strong detergents when cleaning the steering wheel or instrument panel to avoid contamination of the airbag system.

Note: Follow the same procedure as cleaning leather seats for cleaning leather instrument panels and leather interior trim surfaces. See **Cleaning Leather Seats** (page 348).

Vehicle Care

Clean the instrument panel and cluster lens with a clean, damp and soft cloth, then use a clean, dry and soft cloth to dry these areas.

- Avoid cleaners or polishes that increase the gloss of the upper portion of the instrument panel. The dull finish in this area helps protect you from undesirable windshield reflection.
- Do not use any household cleaning products or glass cleaners as these may damage the finish of the instrument panel, interior trim and cluster lens.
- Wash or wipe your hands clean if you have been in contact with certain products such as insect repellent and suntan lotion to avoid possible damage to the interior painted surfaces.
- Do not allow air fresheners and hand sanitizers to spill onto interior surfaces. If a spill occurs, wipe off immediately. Your warranty may not cover these damages.

If a staining liquid like coffee or juice has been spilled on the instrument panel or on interior trim surfaces:

1. Wipe up spilled liquid using a clean, soft cloth as quickly as possible.
2. Use Motorcraft Premium Leather and Vinyl Cleaner or a commercially available leather cleaning product for automotive interiors. Test any cleaner or stain remover on an inconspicuous area.
3. Alternatively, wipe the surface with a clean, soft cloth and a mild soap and water solution. Dry the area with a clean, soft cloth.
4. If necessary, apply more soap and water solution or cleaning product to a clean, soft cloth and press it onto the soiled area. Allow this to set at room temperature for 30 minutes.

5. Remove the soaked cloth, then with a clean, damp cloth, use a rubbing motion for 60 seconds on the soiled area.
6. Dry the area with a clean, soft cloth.

CLEANING LEATHER SEATS (IF EQUIPPED)

Note: *Follow the same procedure as cleaning leather seats for cleaning leather instrument panels and leather interior trim surfaces.*

For routine cleaning, wipe the surface with a soft, damp cloth and a mild soap and water solution. Dry the area with a clean, soft cloth.

For cleaning and removing stains such as dye transfer, use Motorcraft Premium Leather and Vinyl Cleaner or a commercially available leather cleaning product for automotive interiors.

Note: *Test any cleaner or stain remover on an inconspicuous area.*

You should:

- Remove dust and loose dirt with a vacuum cleaner.
- Clean and treat spills and stains as soon as possible.

Do not use the following products as these may damage the leather:

- Oil and petroleum or silicone-based leather conditioners.
- Household cleaners.
- Alcohol solutions.
- Solvents or cleaners intended specifically for rubber, vinyl and plastics.

Vehicle Care

REPAIRING MINOR PAINT DAMAGE

Authorized dealers have touch-up paint to match your vehicle's color. Your vehicle color code is printed on a sticker on the front, left-hand side door jamb. Take your color code to your authorized dealer to make sure you get the correct color.

Before repairing minor paint damage, use a cleaner such as Motorcraft Bug and Tar Remover to remove particles such as bird droppings, tree sap, insect deposits, tar spots, road salt and industrial fallout.

Always read the instructions before using cleaning products.

CLEANING THE WHEELS

1. Regularly clean them with a wheel cleaner. We recommend that you use Ford approved wheel cleaner if available.
2. Remove dirt and brake dust with a sponge.
3. Remove tar and grease with a bug and tar remover. We recommend that you use Ford approved bug and tar remover if available.
4. Thoroughly rinse the wheels with water after cleaning.

If you intend on parking your vehicle for an extended period after cleaning the wheels with a wheel cleaner, drive your vehicle for a few minutes before doing so. This reduces the risk of corrosion of the brake discs, brake pads and linings.

Do not clean the wheels when they are hot.

Note: *Some car washes could damage wheel rims and covers.*

Note: *Using non-recommended cleaners, harsh cleaning products, chrome wheel cleaners or abrasive materials could damage wheel rims and covers.*

VEHICLE STORAGE

If you plan on storing your vehicle for 30 days or more, read the following maintenance recommendations to make sure your vehicle stays in good operating condition.

We engineer and test all motor vehicles and their components for reliable, regular driving. Under various conditions, long-term storage may lead to degraded engine performance or failure unless you use specific precautions to preserve engine components.

General

- Store all vehicles in a dry, ventilated place.
- Protect from sunlight, if possible.
- If vehicles are stored outside, they require regular maintenance to protect against rust and damage.

Body

- Wash your vehicle thoroughly to remove dirt, grease, oil, tar or mud from exterior surfaces, rear-wheel housing and the underside of front fenders.
- Periodically wash your vehicle if it is stored in exposed locations.
- Touch-up exposed or primed metal to prevent rust.
- Cover chrome and stainless steel parts with a thick coat of auto wax to prevent discoloration. Re-wax as necessary when you wash your vehicle.
- Lubricate all hood, door and luggage compartment hinges and latches with a light grade oil.

Vehicle Care

- Cover interior trim to prevent fading.
- Keep all rubber parts free from oil and solvents.

Engine

- Change the engine oil and filter prior to storage because used engine oil contains contaminants which may cause engine damage.
- Start the engine every 15 days for a minimum of 15 minutes. Run at fast idle with the climate controls set to defrost until the engine reaches normal operating temperature.
- With your foot on the brake, shift through all the gears while the engine is running.
- We recommend that you change the engine oil before you use your vehicle again.

Fuel system

- Fill the fuel tank with high-quality fuel until the first automatic shutoff of the fuel pump nozzle.

Cooling system

- Protect against freezing temperatures.
- When removing your vehicle from storage, check coolant fluid level. Confirm that there are no cooling system leaks and that fluid is at the recommended level.

Battery

- Check and recharge as necessary. Keep connections clean.
- If storing your vehicle for more than 30 days without recharging the battery, we recommend that you disconnect the battery cables to maintain battery charge for quick starting.

Note: *It is necessary to reset memory features if battery cables are disconnected.*

Brakes

- Make sure the brakes and parking brake release fully.

Tires

- Maintain recommended air pressure.

Miscellaneous

- Make sure all linkages, cables, levers and pins under your vehicle are covered with grease to prevent rust.
- Move vehicles at least 25 ft (7.5 m) every 15 days to lubricate working parts and prevent corrosion.

Removing Vehicle From Storage

When your vehicle is ready to come out of storage, do the following:

- Wash your vehicle to remove any dirt or grease film build-up on window surfaces.
- Check windshield wipers for any deterioration.
- Check under the hood for any foreign material that may have collected during storage such as mice or squirrel nests.
- Check the exhaust for any foreign material that may have collected during storage.
- Check tire pressures and set tire inflation per the Tire Label.
- Check brake pedal operation. Drive your vehicle 15 ft (4.5 m) back and forth to remove rust build-up.

Vehicle Care

- Check fluid levels (including coolant, oil and gas) to make sure there are no leaks, and fluids are at recommended levels.
- If you remove the battery, clean the battery cable ends and check for damage.

Contact an authorized dealer if you have any concerns or issues.

Wheels and Tires

GENERAL INFORMATION

Use only approved wheel and tire sizes, using other sizes could damage your vehicle. If you change the diameter of the tires from that fitted at the factory, the speedometer may not display the correct speed. If you intend to change the size of the wheels from that fitted by the manufacturer, you can check the suitability with an authorized dealer.

Additional information related to the functionality and maintenance of your tires can be found later in this chapter. See **Tire Care** (page 354).

You can find the recommended tire inflation pressures can on the Tire Label, which is on the B-pillar or the edge of the driver door. You can also find this information on the Safety Compliance Certification Label, affixed to either the door hinge pillar, door-latch post, or the door edge that meets the door latch post; next to the driver seating position.

We strongly recommend maintaining these tire pressures at all times. Failure to follow the tire pressure recommendations can cause uneven treadwear patterns, reduced fuel economy, and adversely affect the way your vehicle handles.

Note: *Check and set the tire pressure at the ambient temperature in which you are intending to drive your vehicle and when the tires are cold.*

Note: *Check your tire pressures at least once per month.*

If your vehicle has a spare tire, set the pressure to the highest value given for your vehicle and tire size combination.

Notice to utility vehicle and truck owners



WARNING: Utility vehicles have a significantly higher rollover rate than other types of vehicles.



WARNING: Vehicles with a higher center of gravity (utility and four-wheel drive vehicles) handle differently than vehicles with a lower center of gravity (passenger cars). Avoid sharp turns, excessive speed and abrupt steering in these vehicles. Failure to drive cautiously increases the risk of losing control of your vehicle, vehicle rollover, personal injury and death.



WARNING: In a rollover crash, an unbelted person is significantly more likely to die than a person wearing a seatbelt.



WARNING: Do not become overconfident in the ability of four-wheel drive vehicles. Although a four-wheel drive vehicle may accelerate better than a two-wheel drive vehicle in low traction situations, it won't stop any faster than two-wheel drive vehicles. Always drive at a safe speed.

Utility vehicles and trucks handle differently than passenger cars in the various driving conditions that are encountered on streets, highways and off-road. Utility vehicles and trucks are not designed for cornering at speeds as high as passenger cars any more than low-slung sports cars are designed to perform satisfactorily under off-road conditions.

Wheels and Tires

Study your owner's manual and any supplements for specific information about equipment features, instructions for safe driving and additional precautions to reduce the risk of an accident or serious injury.

Four-wheel drive system (If Equipped)



WARNING: Do not become overconfident in the ability of four-wheel drive vehicles. Although a four-wheel drive vehicle may accelerate better than a two-wheel drive vehicle in low traction situations, it won't stop any faster than two-wheel drive vehicles. Always drive at a safe speed.

A vehicle equipped with four-wheel drive, when selected, has the ability to use all four wheels to power itself. This increases traction which may enable you to safely drive over terrain and road conditions that a conventional two-wheel drive vehicle cannot.

Power is supplied to all four wheels through a transfer case or power transfer unit. Four-wheel drive vehicles allow you to select different modes as necessary. For information on transfer case operation and shifting procedures, See **Four-Wheel Drive** (page 202). For information on transfer case maintenance, See **Maintenance** (page 326). You should become thoroughly familiar with this information before you operate your vehicle.

On some four-wheel drive vehicles, the initial shift from two-wheel to four-wheel drive when the vehicle is moving can cause a momentary clunk and ratcheting sound. These sounds are normal and are not cause for concern.

In four-wheel drive vehicles, the size of the spare tire relative to the remaining tires can have an effect on the 4x4 system. If there is a significant difference between the size of a spare and the remaining tires, four-wheel drive functionality may be limited. See **Using Four-Wheel Drive** (page 202).

How your vehicle differs from other vehicles

Sport utility vehicles and trucks can differ from some other vehicles in a few noticeable ways. Your vehicle may be:

- Higher - to allow higher load carrying capacity and to allow it to travel over rough terrain without getting hung up or damaging underbody components.
- Shorter - to give it the capability to approach inclines and drive over the crest of a hill without getting hung up or damaging underbody components. All other things held equal, a shorter wheelbase may make your vehicle quicker to respond to steering inputs than a vehicle with a longer wheelbase.
- Narrower - to provide greater maneuverability in tight spaces, particularly in off-road use.

As a result of the above dimensional differences, Sport utility vehicles and trucks often have a higher center of gravity and a greater difference in center of gravity between the loaded and unloaded condition. These differences that make your vehicle so versatile also make it handle differently than an ordinary passenger car.

Wheels and Tires

TIRE CARE

Information About Uniform Tire Quality Grading



E142542

Tire Quality Grades apply to new pneumatic passenger car tires. The Quality grades can be found where applicable on the tire sidewall between tread shoulder and maximum section width. For example: **Treadwear 200 Traction AA Temperature A.**

These Tire Quality Grades are determined by standards that the United States Department of Transportation has set.

Tire Quality Grades apply to new pneumatic passenger car tires. They do not apply to deep tread, winter-type snow tires, space-saver or temporary use spare tires, light truck or LT type tires, tires with nominal rim diameters of 10 to 12 inches or limited production tires as defined in Title 49 Code of Federal Regulations Part 575.104 (c)(2).

U.S. Department of Transportation Tire quality grades:

The U.S. Department of Transportation requires us to give you the following information about tire grades exactly as the government has written it.

Treadwear

The treadwear grade is a comparative rating based on the wear rate of the tire when tested under controlled conditions on a specified government test course. For example, a tire graded 150 would wear one and one-half (1 1/2) times as well on the government course as a tire graded 100. The relative performance of tires depends upon the actual conditions of their use, however, and may depart significantly from the norm due to variations in driving habits, service practices, and differences in road characteristics and climate.

Traction AA A B C



WARNING: The traction grade assigned to this tire is based on straight-ahead braking traction tests, and does not include acceleration, cornering, hydroplaning or peak traction characteristics.

Wheels and Tires

The traction grades, from highest to lowest are AA, A, B, and C. The grades represent the tire's ability to stop on wet pavement as measured under controlled conditions on specified government test surfaces of asphalt and concrete. A tire marked C may have poor traction performance.

Temperature A B C



WARNING: The temperature grade for this tire is established for a tire that is properly inflated and not overloaded. Excessive speed, underinflation, or excessive loading, either separately or in combination, can cause heat buildup and possible tire failure.

The temperature grades are A (the highest), B and C, representing the tire's resistance to the generation of heat and its ability to dissipate heat when tested under controlled conditions on a specified indoor laboratory test wheel. Sustained high temperature can cause the material of the tire to degenerate and reduce tire life, and excessive temperature can lead to sudden tire failure. The grade C corresponds to a level of performance which all passenger car tires must meet under the

Federal Motor Vehicle Safety Standard No. 139. Grades B and A represent higher levels of performance on the laboratory test wheel than the minimum required by law.

Glossary of Tire Terminology

***Tire label:** A label showing the original equipment tire sizes, recommended inflation pressure and the maximum weight the vehicle can carry.

***Tire Identification Number (TIN):** A number on the sidewall of each tire providing information about the tire brand and manufacturing plant, tire size and date of manufacture. Also referred to as DOT code.

***Inflation pressure:** A measure of the amount of air in a tire.

***Standard load:** A class of P-metric or Metric tires designed to carry a maximum load at set pressure. For example: For P-Metric tires 35 psi (2.4 bar) and for Metric 36 psi (2.5 bar). Increasing the inflation pressure beyond this pressure will not increase the tire's load carrying capability.

***Extra load:** A class of P-metric or Metric tires designed to carry a heavier maximum load at 42 psi (2.9 bar). Increasing the inflation pressure beyond this pressure will not increase the tire's load carrying capability.

Wheels and Tires

***kPa:** Kilopascal, a metric unit of air pressure.

***PSI:** Pounds per square inch, a standard unit of air pressure.

***Cold tire pressure:** The tire pressure when the vehicle has been stationary and out of direct sunlight for an hour or more and prior to the vehicle being driven for 1 mile (1.6 kilometers).

***Recommended inflation pressure:** The cold inflation pressure found on the Safety Compliance Certification Label (affixed to either the door hinge pillar, door-latch post, or the door edge that meets the door-latch post, next to the driver's seating position), or Tire Label located on the B-pillar or the edge of the driver's door.

B-pillar: The structural member at the side of the vehicle behind the front door.

***Bead area of the tire:** Area of the tire next to the rim.

***Sidewall of the tire:** Area between the bead area and the tread.

***Tread area of the tire:** Area of the perimeter of the tire that contacts the road when mounted on the vehicle.

***Rim:** The metal support (wheel) for a tire or a tire and tube assembly upon which the tire beads are seated.

Information Contained on the Tire Sidewall

Both United States and Canada Federal regulations require tire manufacturers to place standardized information on the sidewall of all tires. This information identifies and describes the fundamental characteristics of the tire and also provides a U.S. DOT Tire Identification Number for safety standard certification and in case of a recall.

Information on P Type Tires

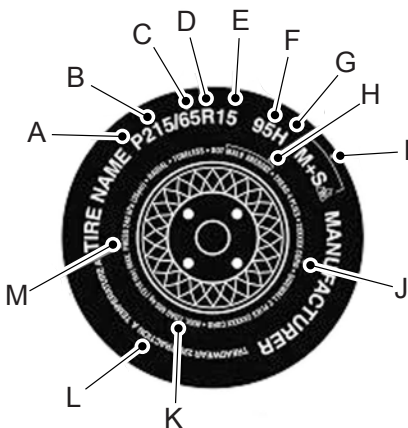

E142543

P215/65R15 95H is an example of a tire size, load index and speed rating. The definitions of these items are listed below. (Note that the tire size, load index and speed rating for your vehicle may be different from this example.)

Wheels and Tires

A. **P:** Indicates a tire, designated by the Tire and Rim Association, that may be used for service on cars, sport utility vehicles, minivans and light trucks. **Note:** If your tire size does not begin with a letter this may mean it is designated by either the European Tire and Rim Technical Organization or the Japan Tire Manufacturing Association.

B. **215:** Indicates the nominal width of the tire in millimeters from sidewall edge to sidewall edge. In general, the larger the number, the wider the tire.

C. **65:** Indicates the aspect ratio which gives the tire's ratio of height to width.

D. **R:** Indicates a radial type tire.

E. **15:** Indicates the wheel or rim diameter in inches. If you change your wheel size, you will have to purchase new tires to match the new wheel diameter.

F. **95:** Indicates the tire's load index. It is an index that relates to how much weight a tire can carry. You may find this information in your owner's manual. If not, contact a local tire dealer.

Note: *You may not find this information on all tires because it is not required by federal law.*

G. **H:** Indicates the tire's speed rating. The speed rating denotes the speed at which a tire is designed to be driven for extended periods of time under a standard condition of load and inflation pressure. The tires on your vehicle may operate at different conditions for load and inflation pressure. These speed ratings may need to be adjusted for the difference in conditions. The ratings range from 81 mph (130 km/h) to 186 mph (299 km/h). These ratings are listed in the following chart.

Note: *You may not find this information on all tires because it is not required by federal law.*

Letter rating	mph (km/h)
M	81 (130)
N	87 (140)
Q	99 (159)
R	106 (171)
S	112 (180)
T	118 (190)
U	124 (200)
H	130 (210)
V	149 (240)

Wheels and Tires

Letter rating	mph (km/h)
W	168 (270)
Y	186 (299)

Note: For tires with a maximum speed capability over 149 mph (240 km/h), tire manufacturers sometimes use the letters ZR. For those with a maximum speed capability over 186 mph (299 km/h), tire manufacturers always use the letters ZR.

H. U.S. DOT Tire Identification

Number: This begins with the letters DOT and indicates that the tire meets all federal standards. The next two numbers or letters are the plant code designating where it was manufactured, the next two are the tire size code and the last four numbers represent the week and year the tire was built. For example, the numbers 317 mean the 31st week of 1997. After 2000 the numbers go to four digits. For example, 2501 means the 25th week of 2001. The numbers in between are identification codes used for traceability. This information is used to contact customers if a tire defect requires a recall.

I. **M+S or M/S:** Mud and Snow, or

AT: All Terrain, or

AS: All Season.

J. Tire Ply Composition and

Material Used: Indicates the number of plies or the number of layers of rubber-coated fabric in the tire tread and sidewall. Tire manufacturers also must indicate the ply materials in the tire and the sidewall, which include steel, nylon, polyester, and others.

K. **Maximum Load:** Indicates the maximum load in kilograms and pounds that can be carried by the tire (affixed to either the door hinge pillar, door-latch post, or the door edge that meets the door-latch post, next to the driver's seating position), or Tire Label located on the B-pillar or the edge of the driver's door.

L. Treadwear, Traction and Temperature Grades:

***Treadwear:** The treadwear grade is a comparative rating based on the wear rate of the tire when tested under controlled conditions on a specified government test course. For example, a tire graded 150 would wear 1½ times as well on the government course as a tire graded 100.

Wheels and Tires

***Traction:** The traction grades, from highest to lowest are AA, A, B, and C. The grades represent the tire's ability to stop on wet pavement as measured under controlled conditions on specified government test surfaces of asphalt and concrete. A tire marked C may have poor traction performance.

***Temperature:** The temperature grades are A (the highest), B and C, representing the tire's resistance to the generation of heat and its ability to dissipate heat when tested under controlled conditions on a specified indoor laboratory test wheel.

M. Maximum Inflation

Pressure: Indicates the tire manufacturers' maximum permissible pressure or the pressure at which the maximum load can be carried by the tire. This pressure is normally higher than the vehicle manufacturer's recommended cold inflation pressure which can be found on the Safety Compliance Certification Label (affixed to either the door hinge pillar, door-latch post, or the door edge that meets the door-latch post, next to the driver's seating position), or Tire Label located on the B-pillar or the edge of the driver's door. The cold inflation pressure should never be set lower than the recommended pressure on the vehicle label.

The tire suppliers may have additional markings, notes or warnings such as standard load or radial tubeless.

Additional Information Contained on the Tire Sidewall for LT Type Tires

Note: *Tire Quality Grades do not apply to this type of tire.*

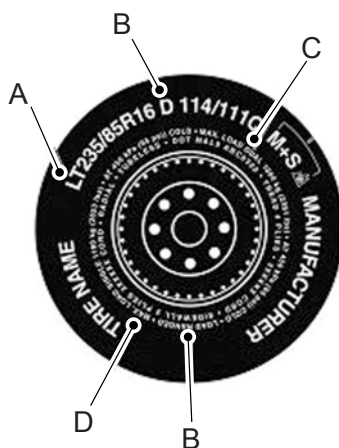

E142544

LT type tires have some additional information beyond those of P type tires. These differences are described below.

A. LT: Indicates a tire, designated by the Tire and Rim Association, that is intended for service on light trucks.

B. Load Range and Load Inflation Limits: Indicates the tire's load-carrying capabilities and its inflation limits.

Wheels and Tires

C. Maximum Load Dual lb (kg) at psi (kPa) cold: Indicates the maximum load and tire pressure when the tire is used as a dual; defined as four tires on the rear axle (a total of six or more tires on the vehicle).

D. Maximum Load Single lb (kg) at psi (kPa) cold: Indicates the maximum load and tire pressure when the tire is used as a single; defined as two tires (total) on the rear axle.

Information on T Type Tires

T145/80D16 is an example of a tire size.

Note: *The temporary tire size for your vehicle may be different from this example. Tire Quality Grades do not apply to this type of tire.*

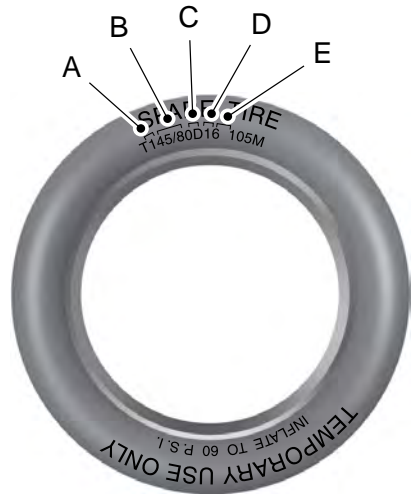

E142545

T type tires have some additional information beyond those of P type tires. These differences are described below:

A. T: Indicates a type of tire, designated by the Tire and Rim Association, that is intended for temporary service on cars, sport utility vehicles, minivans and light trucks.

B. 145: Indicates the nominal width of the tire in millimeters from sidewall edge to sidewall edge. In general, the larger the number, the wider the tire.

Wheels and Tires

C. 80: Indicates the aspect ratio which gives the tire's ratio of height to width. Numbers of 70 or lower indicate a short sidewall.

D. D: Indicates a diagonal type tire.

R: Indicates a radial type tire.

E. 16: Indicates the wheel or rim diameter in inches. If you change your wheel size, you will have to purchase new tires to match the new wheel diameter.

Location of the Tire Label

You will find a Tire Label containing tire inflation pressure by tire size and other important information located on the B-Pillar or the edge of the driver's door. See **Load Carrying** (page 265).

Inflating Your Tires

Safe operation of your vehicle requires that your tires are properly inflated. Remember that a tire can lose up to half of its air pressure without appearing flat.

Every day before you drive, check your tires. If one looks lower than the others, use a tire gauge to check pressure of all tires and adjust if required.

At least once a month and before long trips, inspect each tire and check the tire pressure with a tire gauge (including spare, if equipped). Inflate all tires to the inflation pressure recommended by us.

You are strongly urged to buy a reliable tire pressure gauge, as automatic service station gauges may be inaccurate. We recommend the use of a digital or dial-type tire pressure gauge rather than a stick-type tire pressure gauge.

Use the recommended cold inflation pressure for optimum tire performance and wear. Under-inflation or over-inflation may cause uneven treadwear patterns.



WARNING: Under-inflation is the most common cause of tire failures and may result in severe tire cracking, tread separation or blowout, with unexpected loss of vehicle control and increased risk of injury. Under-inflation increases sidewall flexing and rolling resistance, resulting in heat buildup and internal damage to the tire. It also may result in unnecessary tire stress, irregular wear, loss of vehicle control and accidents. A tire can lose up to half of its air pressure and not appear to be flat!

Always inflate your tires to the our recommended inflation pressure even if it is less than the maximum inflation pressure information found on the tire. Our recommended tire inflation pressure is found on the Safety Compliance Certification Label or

Wheels and Tires

Tire Label (affixed to either the door hinge pillar, door-latch post, or the door edge that meets the door-latch post, next to the driver's seating position), or Tire Label located on the B-pillar or the edge of the driver's door. Failure to follow the tire pressure recommendations can cause uneven treadwear patterns and adversely affect the way your vehicle handles.

Note: *Do not reduce tire pressure to change the ride characteristics of the vehicle. If you do not maintain the inflation pressure at the levels specified by us, your vehicle may experience a condition known as shimmy. Shimmy is a severe vibration and oscillation in the steering wheel after the vehicle travels over a bump or dip in the road that does not dampen out by itself. Shimmy may result from significant under-inflation of the tires, improper tires (load range, size, or type), or vehicle modifications such as lift-kits. In the event that your vehicle experiences shimmy, you should slowly reduce speed by either lifting off the accelerator pedal or lightly applying the brakes. The shimmy will cease as the vehicle speed decreases.*

Maximum Inflation Pressure is the tire manufacturer's maximum permissible pressure and the pressure at which the maximum load can be carried by the tire. This pressure is normally higher than

the manufacturer's recommended cold inflation pressure which can be found on the Safety Compliance Certification Label (affixed to either the door hinge pillar, door-latch post, or the door edge that meets the door-latch post, next to the driver's seating position), or Tire Label located on the B-pillar or the edge of the driver's door. The cold inflation pressure should never be set lower than the recommended pressure on the Safety Compliance Certification Label or Tire Label.

When weather temperature changes occur, tire inflation pressures also change. A 10°F (6°C) temperature drop can cause a corresponding drop of 1 psi (7 kPa) in inflation pressure. Check your tire pressures frequently and adjust them to the proper pressure which can be found on the Safety Compliance Certification Label or Tire Label.

To check the pressure in your tire(s):

1. Make sure the tires are cool, meaning they are not hot from driving even a mile.

Wheels and Tires

Note: *If you are checking tire pressure when the tire is hot, (for example, driven more than 1 mile [1.6 kilometers]), never bleed or reduce air pressure. The tires are hot from driving and it is normal for pressures to increase above recommended cold pressures. A hot tire at or below recommended cold inflation pressure could be significantly under-inflated.*

Note: *If you have to drive a distance to get air for your tire(s), check and record the tire pressure first and add the appropriate air pressure when you get to the pump. It is normal for tires to heat up and the air pressure inside to go up as you drive.*

2. Remove the cap from the valve on one tire, then firmly press the tire gauge onto the valve and measure the pressure.

3. Add enough air to reach the recommended air pressure.

Note: *If you overfill the tire, release air by pressing on the metal stem in the center of the valve. Then recheck the pressure with your tire gauge.*

4. Replace the valve cap.

5. Repeat this procedure for each tire, including the spare.

Note: *Some spare tires operate at a higher inflation pressure than the other tires. For T type mini-spare tires, see the Dissimilar spare wheel and tire assembly information for a description. Store and maintain at 60 psi (4.15 bar). For full-size and dissimilar spare tires, see the Dissimilar spare wheel and tire assembly information for a description. Store and maintain at the higher of the front and rear inflation pressure as shown on the Safety Compliance Certification Label or Tire Label.*

6. Visually inspect the tires to make sure there are no nails or other objects embedded that could poke a hole in the tire and cause an air leak.

7. Check the sidewalls to make sure there are no gouges, cuts or bulges.

Inspecting Your Tires and Wheel Valve Stems

Periodically inspect the tire treads for uneven or excessive wear and remove objects such as stones, nails or glass that may be wedged in the tread grooves. Check the tire and valve stems for holes, cracks, or cuts that may permit air leakage and repair or replace the tire and replace the valve stem. Inspect the tire sidewalls for cracking, cuts, bruises and other signs of damage or excessive wear. If internal damage to the tire is suspected, have the tire demounted and inspected in case

Wheels and Tires

it needs to be repaired or replaced. For your safety, tires that are damaged or show signs of excessive wear should not be used because they are more likely to blow out or fail.

Improper or inadequate vehicle maintenance can cause tires to wear abnormally. Inspect all your tires, including the spare, frequently, and replace them if one or more of the following conditions exist:

Tire Wear



E142546

When the tread is worn down to one sixteenth of an inch (2 millimeters), tires must be replaced to help prevent your vehicle from skidding and hydroplaning. Built-in treadwear indicators, or wear bars, which look like narrow strips of smooth rubber across the tread will appear on the tire when the tread is worn down to one sixteenth of an inch (2 millimeters).

When the tire tread wears down to the same height as these wear bars, the tire is worn out and must be replaced.

Damage

Periodically inspect the tire treads and sidewalls for damage (such as bulges in the tread or sidewalls, cracks in the tread groove and separation in the tread or sidewall). If damage is observed or suspected have the tire inspected by a tire professional. Tires can be damaged during off-road use, so inspection after off-road use is also recommended.

Age

 **WARNING:** Tires degrade over time depending on many factors such as weather, storage conditions, and conditions of use (load, speed, inflation pressure) the tires experience throughout their lives.

 **WARNING:** In general, tires should be replaced after six years regardless of tread wear. However, heat caused by hot climates or frequent high loading conditions can accelerate the aging process and may require tires to be replaced more frequently.

Wheels and Tires



WARNING: You should replace your spare tire when you replace the road tires or after six years due to aging even if it has not been used.

U.S. DOT Tire Identification Number

Both United States and Canada Federal regulations require tire manufacturers to place standardized information on the sidewall of all tires. This information identifies and describes the fundamental characteristics of the tire and also provides a U.S. DOT Tire Identification Number for safety standard certification and in case of a recall.

This begins with the letters DOT and indicates that the tire meets all federal standards. The next two numbers or letters are the plant code designating where it was manufactured, the next two are the tire size code and the last four numbers represent the week and year the tire was built. For example, the numbers 317 mean the 31st week of 1997. After 2000 the numbers go to four digits. For example, 2501 means the 25th week of 2001. The numbers in between are identification codes used for traceability. This information is used to contact customers if a tire defect requires a recall.

Tire Replacement Requirements

Your vehicle is equipped with tires designed to provide a safe ride and handling capability.



WARNING: Only use replacement tires and wheels that are the same size, load index, speed rating and type (such as P-metric versus LT-metric or all-season versus all-terrain) as those originally provided by Ford. The recommended tire and wheel size may be found on either the Safety Compliance Certification Label (affixed to either the door hinge pillar, door-latch post, or the door edge that meets the door-latch post, next to the driver's seating position), or the Tire Label which is located on the B-Pillar or edge of the driver's door. If this information is not found on these labels, then you should contact your authorized dealer as soon as possible. Use of any tire or wheel not recommended by Ford can affect the safety and performance of your vehicle, which could result in an increased risk of loss of vehicle control, vehicle rollover, personal injury and death.

Wheels and Tires



WARNING: To reduce the risk of serious injury, when mounting replacement tires and wheels, you should not exceed the maximum pressure indicated on the sidewall of the tire to set the beads without additional precautions listed below. If the beads do not seat at the maximum pressure indicated, re-lubricate and try again.



WARNING: When inflating the tire for mounting pressures up to 20 psi (1.38 bar) greater than the maximum pressure on the tire sidewall, the following precautions must be taken to protect the person mounting the tire:

- Make sure that you have the correct tire and wheel size.
- Lubricate the tire bead and wheel bead seat area again.
- Stand at a minimum of 12 ft (3.66 m) away from the wheel and tire assembly.
- Use both eye and ear protection.



WARNING: For a mounting pressure more than 20 psi (1.38 bar) greater than the maximum pressure, a Ford dealer or other tire service professional should do the mounting.



WARNING: Always inflate steel carcass tires with a remote air fill with the person inflating standing at a minimum of 12 ft (3.66 m) away from the wheel and tire assembly.

Important: Remember to replace the wheel valve stems when the road tires are replaced on your vehicle.

The two front tires or two rear tires should generally be replaced as a pair, except if the vehicle is equipped with four wheel drive. Vehicles equipped with four wheel drive should have all four tires replaced simultaneously. Unevenly worn tires, mismatched makes, models or brands can be different in size, resulting in potential damage to the four wheel drive system.

The tire pressure sensors mounted in the wheels are not designed to be used in aftermarket wheels.

The use of wheels or tires not recommended by us may affect the operation of your tire pressure monitoring system.

If the tire pressure monitoring system indicator is flashing, the system is malfunctioning. Your replacement tire might be incompatible with your tire pressure monitoring system, or some component of the system may be damaged.

Wheels and Tires

Safety Practices



WARNING: If your vehicle is stuck in snow, mud or sand, do not rapidly spin the tires; spinning the tires can tear the tire and cause an explosion. A tire can explode in as little as three to five seconds.



WARNING: Do not spin the wheels at over 34 mph (55 km/h). The tires may fail and injure a passenger or bystander.

Driving habits have a great deal to do with your tire mileage and safety.

- *Observe posted speed limits
- *Avoid fast starts, stops and turns
- *Avoid potholes and objects on the road
- *Do not run over curbs or hit the tire against a curb when parking

Highway Hazards

No matter how carefully you drive there's always the possibility that you may eventually have a flat tire on the highway. Drive slowly to the closest safe area out of traffic. This may further damage the flat tire, but your safety is more important.

If you feel a sudden vibration or ride disturbance while driving, or you suspect your tire or vehicle has been damaged, immediately reduce your speed. Drive with caution until you can safely pull off the road. Stop and inspect the tires for damage. If a tire is under-inflated or damaged, deflate it, remove wheel and replace it with your spare tire and wheel. If you cannot detect a cause, have the vehicle towed to the nearest repair facility or tire dealer to have the vehicle inspected.

Tire and Wheel Alignment

A bad jolt from hitting a curb or pothole can cause the front end of your vehicle to become misaligned or cause damage to your tires. If your vehicle seems to pull to one side when you're driving, the wheels may be out of alignment. Have an authorized dealer check the wheel alignment periodically.

Wheel misalignment in the front or the rear can cause uneven and rapid treadwear of your tires and should be corrected by an authorized dealer. Front-wheel drive vehicles and those with an independent rear suspension may require alignment of all four wheels.

The tires should also be balanced periodically. An unbalanced tire and wheel assembly may result in irregular tire wear.

Wheels and Tires

Tire Rotation



WARNING: If the tire label shows different tire pressures for the front and rear tires and the vehicle has a tire pressure monitoring system, then you need to update the settings for the system sensors. Always perform the system reset procedure after tire rotation. If you do not reset the system, it may not provide a low tire pressure warning when necessary.

Note: If your tires show uneven wear ask an authorized dealer to check for and correct any wheel misalignment, tire imbalance or mechanical problem involved before tire rotation.

Note: Your vehicle may be equipped with a dissimilar spare wheel and tire assembly. A dissimilar spare wheel and tire assembly is defined as a spare wheel and tire assembly that is different in brand, size or appearance from the road tires and wheels. If you have a dissimilar spare wheel and tire assembly it is intended for temporary use only and should not be used in a tire rotation.

Note: After having your tires rotated, inflation pressure must be checked and adjusted to the vehicle requirements.

Rotating your tires at the recommended interval (as indicated in the Scheduled Maintenance chapter) will help your tires wear more evenly, providing better tire performance and longer tire life.

Rear-wheel drive vehicles and four-wheel drive vehicles (front tires at left of diagram)

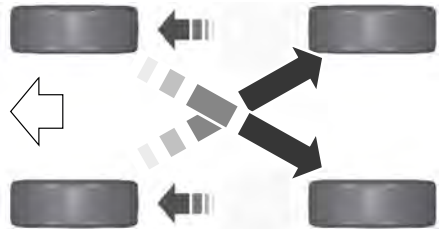

E142548

Sometimes irregular tire wear can be corrected by rotating the tires.

USING SNOW CHAINS



WARNING: Snow tires must be the same size, load index and speed rating as those originally provided by Ford. Use of any tire or wheel not recommended by Ford can affect the safety and performance of your vehicle, which could result in an increased risk of loss of control, vehicle rollover, personal injury and death. Additionally, the use of non-recommended tires and wheels can cause steering, suspension, axle, transfer case or power transfer unit failure. Follow the Ford recommended tire inflation pressure found on the Safety

Wheels and Tires

Compliance Certification Label (on the door hinge pillar, door latch post or the door edge that meets the door latch post, next to the driver seat), or Tire Label on the B-Pillar or the edge of the driver door. Failure to follow the tire pressure recommendations can cause uneven treadwear patterns and adversely affect the way your vehicle handles.

Note: *The suspension insulation and bumpers will help prevent vehicle damage. Do not remove these components from your vehicle when using snow tires and chains.*

The tires on your vehicle have all-weather treads to provide traction in rain and snow. However, in some climates, you may need to use snow tires and cables. If you need to use cables, it is recommended that steel wheels (of the same size and specifications) be used, as cables may chip aluminum wheels.

Follow these guidelines when using snow tires and chains:

- If possible, avoid fully loading your vehicle.
- Use only cable type chains or chains offered by Ford/Lincoln as an accessory or equivalent. Other conventional link type chains may contact and cause damage to the vehicle's wheel house and/or body.
- Do not install chains on the front tires as this may interfere with suspension components.
- Only certain snow cables or chains have been approved by Ford/Lincoln as safe for use on your vehicle with the following tires: 265/70R17 and 275/65R18.
- You should install snow cables or chains that have been rated as SAE Class S.

- Install chains securely, verifying that the chains do not touch any wiring, brake lines, or fuel lines.
- Do not exceed 31 mph (50 km/h) or less if recommended by the chain manufacturer while using snow chains.
- Drive cautiously. If you hear the chains rub or bang against your vehicle, stop and retighten the chains. If this does not work, remove the chains to prevent damage to your vehicle.
- Remove the tire chains when they are no longer needed. Do not use tire chains on dry roads.
- Purchase chains or cables from a manufacturer that clearly labels body to tire dimension restrictions. The snow chains or cables must be mounted in pairs on the rear tires only.

If you have any questions regarding snow chains or cables, please contact your authorized dealer.

TIRE PRESSURE MONITORING SYSTEM



WARNING: The tire pressure monitoring system is not a substitute for manually checking tire pressures. You should periodically check tire pressures using a pressure gauge. Failure to correctly maintain tire pressures could increase the risk of tire failure, loss of control, vehicle rollover and personal injury.

Note: *You should only use tire sealants in roadside emergencies as they may cause damage to the tire pressure monitoring system sensor.*

Note: *If the tire pressure monitoring system sensor becomes damaged, it may not function.*

Wheels and Tires



Each tire, including the spare (if provided), should be checked monthly when cold and inflated to the inflation pressure recommended by the vehicle manufacturer on the vehicle placard or tire inflation pressure label. (If your vehicle has tires of a different size than the size indicated on the vehicle placard or tire inflation pressure label, you should determine the proper tire inflation pressure for those tires).

As an added safety feature, your vehicle has been equipped with a Tire Pressure Monitoring System (TPMS) that illuminates a low tire pressure telltale when one or more of your tires is significantly under-inflated. Accordingly, when the low tire pressure telltale illuminates, you should stop and check your tires as soon as possible, and inflate them to the proper pressure. Driving on a significantly under-inflated tire causes the tire to overheat and can lead to tire failure. Under-inflation also reduces fuel efficiency and tire tread life, and may affect the vehicle's handling and stopping ability.

Please note that the TPMS is not a substitute for proper tire maintenance, and it is the driver's responsibility to maintain correct tire pressure, even if under-inflation has not reached the level to trigger illumination of the TPMS low tire pressure telltale.

Your vehicle has also been equipped with a TPMS malfunction indicator to indicate when the system is not operating properly. The TPMS malfunction indicator is combined with the low tire pressure telltale. When the system detects a malfunction, the telltale will flash for approximately one minute and then remain continuously illuminated. This sequence will continue upon subsequent vehicle start-ups as long as the malfunction exists.

When the malfunction indicator is illuminated, the system may not be able to detect or signal low tire pressure as intended. TPMS malfunctions may occur for a variety of reasons, including the installation of replacement or alternate tires or wheels on the vehicle that prevent the TPMS from functioning properly. Always check the TPMS malfunction telltale after replacing one or more tires or wheels on your vehicle to ensure that the replacement or alternate tires and wheels allow the TPMS to continue to function properly.

This device complies with Part 15 of the FCC Rules and with License exempt RSS Standards of Industry Canada. Operation is subject to the following two conditions:

1. This device may not cause harmful interference, and
2. This device must accept any interference received, including interference that may cause undesired operation.

Note: *Changes or modifications not expressly approved by the party responsible for compliance could void the user's authority to operate the equipment. The term "IC:" before the radio certification number only signifies that Industry Canada technical specifications were met.*

Wheels and Tires

Changing Tires With a Tire Pressure Monitoring System



E142549

Note: Each road tire is equipped with a tire pressure sensor located inside the wheel and tire assembly cavity. The pressure sensor is attached to the valve stem. The pressure sensor is covered by the tire and is not visible unless the tire is removed. Take care when changing the tire to avoid damaging the sensor.

You should always have your tires serviced by an authorized dealer.

Check the tire pressure periodically (at least monthly) using an accurate tire gauge. See **When Inflating Your Tires** in this chapter.

Understanding Your Tire Pressure Monitoring System



E250820

The tire pressure monitoring system measures pressure in your road tires and sends the tire pressure readings to your vehicle. You can view the tire pressure readings through the information display. See **General Information** (page 110). The low tire pressure warning light will turn on if the tire pressure is significantly low. Once the light is illuminated, your tires are under-inflated and need to be inflated to the manufacturer's recommended tire pressure. Even if the light turns on and a short time later turns off, your tire pressure still needs to be checked.

When Your Temporary Spare Tire is Installed

When one of your road tires needs to be replaced with the temporary spare, the system will continue to identify an issue to remind you that the damaged road wheel and tire assembly needs to be repaired and put back on your vehicle.

To restore the full function of the tire pressure monitoring system, have the damaged road wheel and tire assembly repaired and remounted on your vehicle.

When You Believe Your System is Not Operating Properly

The main function of the tire pressure monitoring system is to warn you when your tires need air. It can also warn you in the event the system is no longer capable of functioning as intended. See the following chart for information concerning your tire pressure monitoring system:

Wheels and Tires

Low tire pressure warning light	Possible cause	Customer action required
Solid warning light	Tire(s) under-inflated	Make sure tires are at the proper pressure. See Inflating your tires in this chapter. After inflating your tires to the manufacturer's recommended pressure as shown on the Tire Label (located on the edge of driver's door or the B-Pillar), the vehicle must be driven for at least two minutes over 20 mph (32 km/h) before the light turns off.
	Spare tire in use	Repair the damaged road wheel and tire assembly and reinstall it on the vehicle to restore system function. For a description on how the system functions, see When Your Temporary Spare Tire is Installed in this section.
	TPMS malfunction	If the tires are properly inflated and the spare tire is not in use but the light remains on, contact your authorized dealer as soon as possible.
Flashing warning light	Spare tire in use	Repair the damaged road wheel and tire assembly and reinstall it on the vehicle to restore system function. For a description on how the system functions, see When Your Temporary Spare Tire is Installed in this section.
	TPMS malfunction	If the tires are properly inflated and the spare tire is not in use but the light remains on, contact your authorized dealer as soon as possible.

When Inflating Your Tires



WARNING: Do not use the tire pressure displayed in the information display as a tire pressure gauge. Failure to follow this instruction could result in personal injury or death.

When putting air into your tires (such as at a gas station or in your garage), the tire pressure monitoring system may not respond immediately to the air added to your tires.

It may take up to two minutes of driving over 20 mph (32 km/h) for the light to turn off after you have filled your tires to the recommended inflation pressure.

Wheels and Tires

How Temperature Affects Your Tire Pressure

The tire pressure monitoring system monitors tire pressure in each pneumatic tire. While driving in a normal manner, a typical passenger tire inflation pressure may increase about 2–4 psi (14–28 kPa) from a cold start situation. If the vehicle is stationary overnight with the outside temperature significantly lower than the daytime temperature, the tire pressure may decrease about 3 psi (21 kPa) for a drop of 30°F (17°C) in ambient temperature. This lower pressure value may be detected by the tire pressure monitoring system as being significantly lower than the recommended inflation pressure and activate the system warning light for low tire pressure. If the low tire pressure warning light is on, visually check each tire to verify that no tire is flat. If one or more tires are flat, repair as necessary. Check the air pressure in the road tires. If any tire is under-inflated, carefully drive the vehicle to the nearest location where air can be added to the tires. Inflate all the tires to the recommended inflation pressure.

CHANGING A ROAD WHEEL



WARNING: If the tire pressure monitor sensor becomes damaged it may not function.

Note: You should only use tire sealants in roadside emergencies as they may cause damage to the tire pressure monitoring system sensor.

Note: The tire pressure monitoring system indicator light illuminates when the spare tire is in use. To restore the full function of the monitoring system, all road wheels equipped with tire pressure monitoring sensors must be mounted on this vehicle.

If you get a flat tire when driving, do not apply the brake heavily. Instead, gradually decrease your speed. Hold the steering wheel firmly and slowly move to a safe place on the side of the road.

Have a flat serviced by an authorized dealer in order to prevent damage to the system sensors. See **Tire Pressure Monitoring System** (page 369). Replace the spare tire with a road tire as soon as possible. During repairing or replacing of the flat tire, have the authorized dealer inspect the system sensor for damage.

Dissimilar Spare Wheel and Tire Assembly Information



WARNING: Failure to follow these guidelines could result in an increased risk of loss of vehicle control, injury or death.

If you have a dissimilar spare wheel and tire, then it is intended for temporary use only. This means that if you need to use it, you should replace it as soon as possible with a road wheel and tire assembly that is the same size and type as the road tires and wheels that were originally provided. If the dissimilar spare tire or wheel is damaged, it should be replaced rather than repaired.

A dissimilar spare wheel and tire assembly is defined as a spare wheel and tire assembly that is different in brand, size or appearance from the road tires and wheels.

Full-size dissimilar spare

Wheels and Tires

When driving with the full-size dissimilar spare wheel and tire assembly, do not:

- Exceed 70 mph (113 km/h).
- Use more than one dissimilar spare wheel and tire assembly at a time.
- Use snow chains on the end of the vehicle with the dissimilar spare wheel and tire assembly.

When driving with the full-size dissimilar spare wheel and tire assembly, it is recommended that you do not:

- Exceed 50 mph (80 km/h) in 4WD.
- Engage 4WD unless the vehicle is stationary.
- Use 4WD on dry pavement.

The usage of a full-size dissimilar spare wheel and tire assembly can lead to impairment of the following:

- Handling, stability and braking performance.
- Comfort and noise.

- Ground clearance and parking at curbs.
- Winter weather driving capability.
- Wet weather driving capability.
- Four-wheel driving capability.

When driving with the full-size dissimilar spare wheel and tire assembly additional caution should be given to:

- Towing a trailer.
- Driving vehicles equipped with a camper body.
- Driving vehicles with a load on the cargo rack.

Drive cautiously when using a full-size dissimilar spare wheel and tire assembly and seek service as soon as possible.

Location of the Spare Tire and Tools

The spare tire is located under the vehicle, just forward of the rear bumper. The jack, swivel wrench and lug wrench are in the following locations:

Item	Location
Spare tire	Under the vehicle, just forward of the rear bumper
Jack and tool kit bag	Under the access panel located in the floor compartment behind the rear seat

Tire Change Procedure



WARNING: Only use replacement tires and wheels that are the same size, load index, speed rating and type (such as P-metric versus LT-metric or all-season versus all-terrain) as those originally provided by Ford. The recommended tire and wheel size may be found on either the Safety Compliance Certification Label (affixed

to either the door hinge pillar, door-latch post, or the door edge that meets the door-latch post, next to the driver's seating position), or the Tire Label which is located on the B-Pillar or edge of the driver's door. If this information is not found on these labels, then you should contact your authorized dealer as soon

Wheels and Tires

as possible. Use of any tire or wheel not recommended by Ford can affect the safety and performance of your vehicle, which could result in an increased risk of loss of vehicle control, vehicle rollover, personal injury and death.



WARNING: When one of the front wheels is off the ground, the transmission alone will not prevent the vehicle from moving or slipping off the jack, even if the transmission is in park (P).



WARNING: To help prevent your vehicle from moving when changing a wheel, shift the transmission into park (P), set the parking brake and use an appropriate block or wheel chock to secure the wheel diagonally opposite to the wheel being changed. For example, when changing the front left wheel, place an appropriate block or wheel chock on the right rear wheel.



WARNING: Do not attempt to change a tire on the side of the vehicle close to moving traffic. Pull far enough off the road to avoid the danger of being hit when operating the jack or changing the wheel.



WARNING: Always use the jack provided as original equipment with your vehicle. If using a jack other than the one provided, make sure the jack capacity is adequate for the vehicle weight, including any vehicle cargo or modifications. If you are unsure if the jack capacity is adequate, contact the authorized dealer.



WARNING: Switch off the running boards before jacking or placing any object under your vehicle. Never place your hand between the extended running board and your vehicle. A moving running board may cause injury.



WARNING: Only use the spare wheel carrier to stow the wheel provided with your vehicle. Other wheel sizes could cause the spare wheel carrier to fail if it does not fit securely or is too heavy.

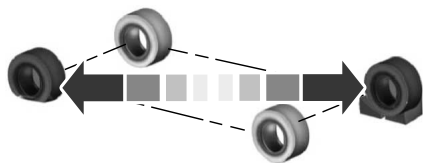

E175447

1. Park the vehicle on firm, level ground and activate the hazard flashers.
2. Apply the parking brake, place the transmission in park (P) and switch the ignition off.
3. Block the wheels diagonally opposite the flat tire, for example, if the left front tire is flat, block the right rear wheel.

Removing the Jack and Tools

Note: Pay close attention to the orientation of the jack and tool kit bag, because it needs to be reinstalled after changing the tire.

1. Open the liftgate and lift the load floor behind the third row seat. If your vehicle has an access panel, you need to then unlatch and remove this panel.

Wheels and Tires

2. Remove the wing nut by turning it counterclockwise.
3. Remove the jack and tool kit bag from the bracket, loosen the straps and remove the tool bag from the jack.



E252435

Removing the Spare Tire

1. Remove the swivel wrench from the tool kit bag, open the spare tire winch access plug at the bottom of the compartment for the jack and tools tray.
2. Insert the swivel wrench through the access hole in the floor to engage the winch. Turn the handle counterclockwise until the tire lowers to the ground and the cable is slightly slack.

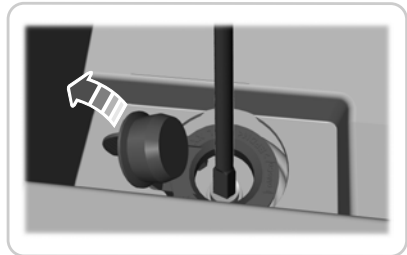
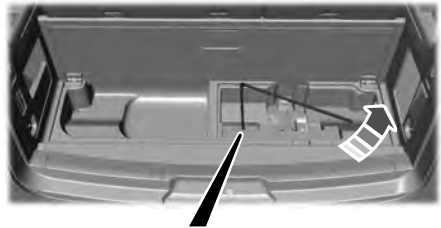

E273399

3. Slide the retainer through the center of the spare tire wheel and remove the spare tire.

Note: *If your wheel nuts are hidden, the wheel cover or ornament must be removed using the provided tool to access the wheel nuts.*

4. Use the lug wrench tip to remove any wheel trim.
5. Loosen each wheel lug one-half turn counterclockwise, but do not remove them until the wheel is off the ground.

Jacking the Vehicle



WARNING: No person should place any portion of their body under a vehicle that is supported by a jack.

Wheels and Tires



WARNING: Do not get under a vehicle that is only supported by a vehicle jack.

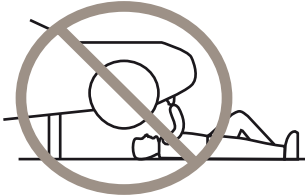

E166722



WARNING: Check that the vehicle jack is not damaged or deformed and the thread is lubricated and clean.



WARNING: The jack supplied with this vehicle is only intended for changing wheels. Do not use the vehicle jack other than when you are changing a wheel in an emergency.



WARNING: The jack should be used on level firm ground wherever possible.



WARNING: Never place anything between the vehicle jack and the ground.



WARNING: Never place anything between the vehicle jack and your vehicle.



WARNING: It is recommended that the wheels of the vehicle be chocked, and that no person should remain in a vehicle that is being jacked.



WARNING: Failure to follow these guidelines could result in an increased risk of loss of vehicle control, injury or death.

Note: The jack does not require maintenance or additional lubrication over the service life of your vehicle.

Note: Jack at the specified locations to avoid damaging your vehicle.

1. Position the jack at the jacking point indicator arrow closest to the flat tire location. Assemble the jack drive extension to the lug wrench as shown and use it to turn the jack drive clockwise to raise the vehicle until the flat tire is completely off the ground.

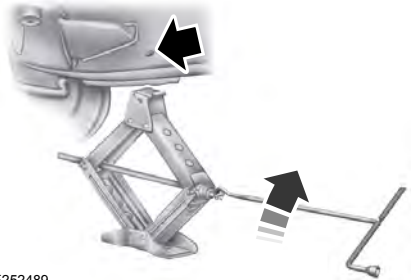

E252489

Front jacking point

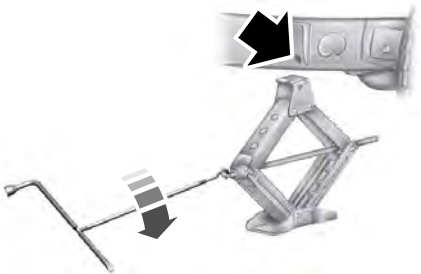

E275851

Wheels and Tires

Rear jacking point

1. Remove the lug nuts with the lug wrench. Replace the flat tire with the spare tire, making sure the valve stem is facing outward.
2. Reinstall the lug nuts until the wheel is snug against the hub. Do not fully tighten the lug nuts until the wheel has been lowered.
3. Completely lower the vehicle by turning the jack drive counterclockwise.
4. Remove the jack and fully tighten the lug nuts in the order shown. See **Technical Specifications** (page 378).



E166719

Stowing the Flat or Spare Tire

1. Lay the tire on the ground, near the rear of the vehicle, with the valve stem side facing up.
2. Slide the wheel partially under the vehicle and install the retainer through the wheel center. You may have to remove the wheel center cap prior to pushing the retainer through the center of the wheel. To remove the center cap, press it off with the jack tool from the inner side of the wheel. Pull on the cable to align the components at the end of the cable.
3. Using the swivel wrench, insert it through the access hole behind the third row seat and engage the winch.
4. Turn the swivel wrench clockwise until the tire is raised to its stowed position underneath the vehicle. The wrench becomes harder to turn and the spare tire winch ratchets or slips when the tire is raised to maximum tightness. A clicking sound can be heard from the winch indicating that the tire is properly stowed.
5. Carefully place all tools back into the tool kit bag.
6. Reinstall the tool kit bag on the jack and tighten the straps.
7. Reinstall the jack properly on the bracket and secure with the wing nut.
8. Close the access hole with the rubber plug.
9. If the vehicle has an access panel, reinstall.
10. Unblock the wheel.

TECHNICAL SPECIFICATIONS

Wheels and Tires

Wheel Lug Nut Torque Specifications



WARNING: When you install a wheel, always remove any corrosion, dirt or foreign materials present on the mounting surfaces of the wheel or the surface of the wheel hub, brake drum or brake disc that contacts the wheel. Make sure to secure any fasteners that attach the rotor to the hub so they do not interfere with the mounting surfaces of the wheel. Installing wheels without correct metal-to-metal contact at the wheel mounting surfaces can cause the wheel nuts to loosen and the wheel to come off while your vehicle is in motion, resulting in loss of vehicle control, personal injury or death.

Bolt Size	lb.ft (Nm) ¹
M14 x 1.5	150 lb.ft (204 Nm)

¹ Torque specifications are for nut and bolt threads free of dirt and rust. Use only our recommended replacement fasteners.

Retighten the lug nuts to the specified torque within 100 miles (160 kilometers) after any wheel disturbance, such as tire rotation, changing a flat tire or wheel removal.



E145950

A Wheel pilot bore.

Inspect the wheel pilot hole and mounting surface prior to installation. Remove any visible corrosion or loose particles.

Capacities and Specifications

ENGINE SPECIFICATIONS

Engine	3.5L EcoBoost
Cubic inches	214
Firing order	1-4-2-5-3-6
Ignition system	Coil on plug
Compression ratio	10.5:1
Spark plug gap	0.028 in (0.7 mm) - 0.031 in (0.8 mm)

Drivebelt Routing

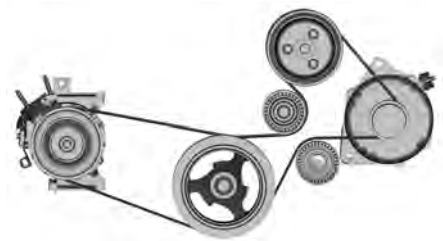

E250666

MOTORCRAFT PARTS

Component	Part Number
Air filter element.	FA-1883
Cabin air filter.	FP-79
Oil filter.	FL-500-S
Battery.	BAGM-94RH7-800
Spark plugs.	SP-550
Transmission filter.	FT-202

Capacities and Specifications

Component	Part Number
Windshield wiper blade.	WW-2247
Rear window wiper blade.	WW-1107

We recommend Motorcraft replacement parts available at your authorized dealer or at fordparts.com for scheduled maintenance. We engineer the parts for your vehicle to meet and exceed our specifications. Use of other parts may impact vehicle performance, emissions and durability. Your warranty may be void for any damage related to use of other parts.

If a Motorcraft oil filter is not available, use an oil filter that meets industry performance specification SAE/USCAR-36.

For spark plug replacement, contact an authorized dealer. Replace the spark plugs at the appropriate intervals. See **Scheduled Maintenance** (page 500).

Capacities and Specifications

VEHICLE IDENTIFICATION NUMBER

The vehicle identification number is located on the left-hand side of the instrument panel.

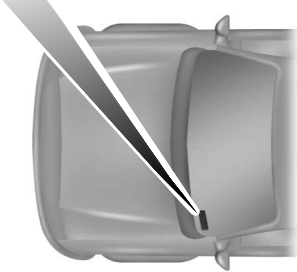

E142476

Please note that in the graphic, XXXX is representative of your vehicle identification number.

The Vehicle Identification Number contains the following information:

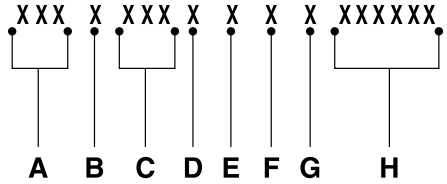

E142477

- A World manufacturer identifier
- B Brake system, Gross Vehicle Weight Rating, Restraint Devices and their locations
- C Make, vehicle line, series, body type
- D Engine type
- E Check digit
- F Model year
- G Assembly plant
- H Production sequence number

Capacities and Specifications

VEHICLE CERTIFICATION LABEL

MFD. BY FORD MOTOR CO.

DATE: XX/XX	GVWR: XXXX KG (XXXX LB)	
FRONT GAWR:	REAR GAWR:	
XXXX KG (XXXX LB)	WITH XXXX KG (XXXX LB)	WITH
XXXXXXXXXXXXXXXXXX	TIRES XXXXXXXXXXXXXXXXXXXX	TIRES
XXXXXXXX	RIMS XXXXXXXX	RIMS
AT XXXX kPa/ XXX PSI COLD	AT XXXX kPa/ XXX PSI COLD	

THIS VEHICLE CONFORMS TO ALL APPLICABLE FEDERAL MOTOR VEHICLE SAFETY AND THEFT PREVENTION STANDARDS IN EFFECT ON THE DATE OF MANUFACTURE SHOWN ABOVE.

VIN: XXXXXXXXXXXXXXXXXXXX XXXXXX
XXXXXX

TYPE: XXXX



EXT PNT: XX	XXXXXX	RC: XX	D50: XXXX
WB	INT TR	TP/PS	TR
XXX	XX	XXX X	XX X
		XXXX	XXXX
	XXXXXXXXXXXXXXXX	XXX	XXXX-XXXXXXXX-XX

E167469

The National Highway Traffic Safety Administration Regulations require that a Safety Compliance Certification Label be affixed to a vehicle and prescribe where the Safety Compliance Certification Label may be located. The Safety Compliance Certification Label shall be affixed to either the door hinge pillar, the door latch post, or the edge of the door near the door latch, next to the driver's seating position.

TRANSMISSION CODE DESIGNATION

MFD. BY FORD MOTOR CO.

DATE: XX/XX	GVWR: XXXX KG (XXXX LB)	
FRONT GAWR:	REAR GAWR:	
XXXX KG (XXXX LB)	WITH XXXX KG (XXXX LB)	WITH
XXXXXXXXXXXXXXXXXX	TIRES XXXXXXXXXXXXXXXXXXXX	TIRES
XXXXXXXX	RIMS XXXXXXXX	RIMS
AT XXXX kPa/ XXX PSI COLD	AT XXXX kPa/ XXX PSI COLD	

THIS VEHICLE CONFORMS TO ALL APPLICABLE FEDERAL MOTOR VEHICLE SAFETY AND THEFT PREVENTION STANDARDS IN EFFECT ON THE DATE OF MANUFACTURE SHOWN ABOVE.

VIN: XXXXXXXXXXXXXXXXXXXX XXXXXX
XXXXXX

TYPE: XXXX



EXT PNT: XX	XXXXXX	RC: XX	D50: XXXX
WB	INT TR	TP/PS	TR
XXX	XX	XXX X	XX X
		XXXX	XXXX
	XXXXXXXXXXXXXXXX	XXX	XXXX-XXXXXXXX-XX

E167814

The transmission code is on the Safety Compliance Certification Label. The following table shows the transmission code along with the transmission description.

Description	Code
Ten-speed automatic transmission 10R80	U

Capacities and Specifications

CAPACITIES AND SPECIFICATIONS

Capacities



WARNING: The air conditioning refrigerant system contains refrigerant under high pressure. Only qualified personnel should service the air conditioning refrigerant system. Opening the air conditioning refrigerant system can cause personal injury.

Item	Capacity
Engine oil (with oil filter)	6.0 qt (5.7 L)
Engine coolant (Base radiator with auxiliary rear heat)	18.5 qt (17.5 L)
Engine coolant (Heavy Duty trailer towing with auxiliary rear heat)	18.0 qt (17 L)
Brake fluid	Between MIN and MAX on brake fluid reservoir ¹
Front axle	1.80 qt (1.7 L)
8.8" Rear axle (Conventional differential) ²	2.5 qt (2.4 L)
9.75" Rear axle (Conventional differential) ²	2.5 qt (2.4 L)
9.75" Rear axle (Limited-slip differential) ²	2.4 qt (2.3 L) ³
Automatic transmission fluid	13.1 qt (12.4 L) ⁴
Transfer case fluid.	1.5 qt (1.4 L)
Windshield washer fluid	Fill as required
Fuel tank	23.6 gal (89.3 L)
Fuel tank (Expedition MAX)	27.8 gal (105.2 L)
A/C refrigerant (U.S. and Canada)	37 oz (1.05 kg)

Capacities and Specifications

Item	Capacity
A/C refrigerant (Mexico)	39 oz (1.11 kg)
A/C refrigerant compressor oil	6.1 fl oz (180 ml)

¹ Reference the reservoir cap for proper fluid.

² The rear axle is filled with synthetic rear axle lubricant, and it is considered lubricated for life. Do not check or change the lubricant unless you suspect a leak or submerge the axle in water. Contact an authorized dealer.

³ Add 4 fl. oz. (118 ml) of Additive Friction Modifier XL-3 or equivalent for complete refill of our limited-slip differential.

⁴ Approximate dry fill capacity. Actual amount may vary during fluid changes.

Specifications

Materials

Name	Specification
Motor oil (U.S.): Motorcraft® SAE 5W-30 Premium Synthetic Blend Motor Oil XO-5W30-Q1SP	WSS-M2C946-B1
Motor oil (Canada): Motorcraft® SAE 5W-30 Super Premium Motor Oil CXO-5W30-LSP12	WSS-M2C946-B1
Motor oil (Mexico): Motorcraft® SAE 5W-30 Synthetic Motor Oil MXO-5W30-Q1SP	WSS-M2C946-B1
Engine coolant (U.S. and Mexico): Motorcraft® Yellow Prediluted Antifreeze/Coolant VC-13DL-G	WSS-M97B57-A2
Engine coolant (Canada): Motorcraft® Yellow Prediluted Antifreeze/Coolant CVC-13DL-G	WSS-M97B57-A2
Brake fluid: Motorcraft® DOT 4 LV High Performance Motor Vehicle Brake Fluid (U.S. Canada and Mexico) PM-20	WSS-M6C65-A2
Automatic transmission fluid (U.S. and Mexico): Motorcraft® MERCON® ULV Automatic Transmission Fluid	WSS-M2C949-A MERCON® ULV

Capacities and Specifications

Name	Specification
XT-12-QULV	
Automatic transmission fluid (Canada): Motorcraft® MERCON® ULV Automatic Transmission Fluid XT-12-QULVC	WSS-M2C949-A MERCON® ULV
Front axle fluid: Motorcraft® SAE 75W-85 Hypoid Gear Lube XY-75W85-QL	WSS-M2C942-A
Rear axle fluid: Motorcraft® SAE 75W-85 Hypoid Gear Lube XY-75W85-QL	WSS-M2C942-A
Transfer case fluid (U.S. and Mexico): Motorcraft® Transfer Case Fluid XT-10-QLVC	WSS-M2C938-A MERCON® LV
Transfer case fluid (Canada): Motorcraft® Transfer Case Fluid CXT-10-LV12	WSS-M2C938-A MERCON® LV
Windshield washer fluid (U.S. and Mexico): Motorcraft® Premium Windshield Wash Concentrate with Bitterant ZC-32-B2	WSS-M14P19-A
Windshield washer fluid (Canada): Motorcraft® Premium Quality Windshield Washer Fluid CXC-37-(A, B, D, F)	WSS-M14P19-A
A/C refrigerant (U.S.): R-1234yf Refrigerant YN-33-A	WSS-M17B21-A
A/C refrigerant (Canada): R-1234yf Refrigerant HS7Z-19B519-BA	WSS-M17B21-A
A/C refrigerant (Mexico): Motorcraft® R-134a Refrigerant MYN-19	WSH-M17B19-A
A/C refrigerant compressor oil (U.S. and Canada): Motorcraft® R-1234yf Refrigerant PAG Oil YN-35	WSS-M2C300-A2
A/C refrigerant compressor oil (Mexico):	WSH-M1C231-B

Capacities and Specifications

Name	Specification
Motorcraft® PAG Refrigerant Compressor Oil YN-12-D	
Multi-purpose grease: Motorcraft® Multi-Purpose Grease Spray XL-5-A	ESB-MIC93-B
Lock cylinders (U.S.): Penetrating and Lock Lubricant XL-1	-
Lock cylinders (Canada): Penetrating Fluid CXC-51-A	-
Lock cylinders (Mexico): Penetrating and Lock Lubricant MXL-1	-

If you use oil and fluids that do not meet the defined specification and viscosity grade, this may lead to:

- Component damage that your vehicle warranty does not cover.
- Longer engine cranking periods.
- Increased emission levels.
- Reduced engine performance.
- Reduced fuel economy.
- Reduced brake performance.

We recommend Motorcraft motor oil for your vehicle. If Motorcraft oil is not available, use motor oils of the recommended viscosity grade that meet API SN PLUS requirements and display the API Certification Mark for gasoline engines.



E142732



E276075

Capacities and Specifications

An oil that displays this symbol conforms to current engine, emission system and fuel economy performance standards of the ILSAC.

Do not use supplemental engine oil additives because they are unnecessary and could lead to engine damage not covered by your vehicle warranty.

Note: We recommend using DOT 4 Low Viscosity (LV) High Performance Brake Fluid or equivalent meeting WSS-M6C65-A2. Please refer to the brake reservoir cap for the proper brake fluid. Use of any fluid other than the recommended fluid may cause degraded brake performance and not meet our performance standards. Keep brake fluid clean and dry. Contamination with dirt, water, petroleum products or other materials may result in brake system damage and possible failure.

Alternative Engine Oil for Extremely Cold Climates

To improve engine cold start performance, we recommend that you use the following alternative engine oil in extremely cold climates, where the ambient temperature reaches -22.0°F (-30°C) or below.

Materials

Name	Specification
Engine Oil - SAE 0W-30	WSS-M2C953-B1

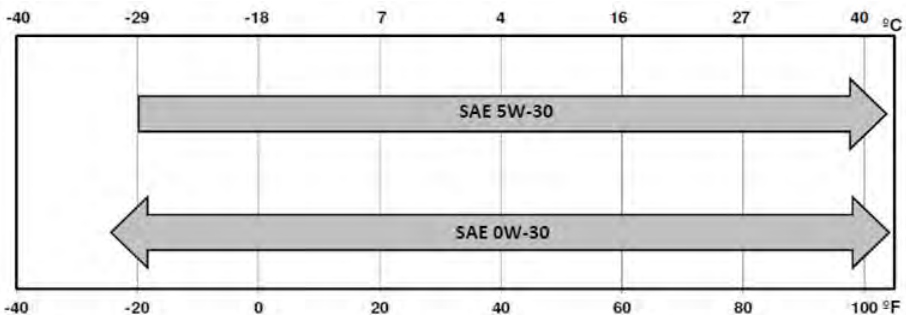

E240523

Capacities and Specifications

BULB SPECIFICATION CHART

Replacement bulbs are specified in the chart below. Headlamp bulbs must be marked with an authorized D.O.T. marking for North America to make sure they have

the proper lamp performance, light brightness, light pattern and safe visibility. The correct bulbs will not damage the lamp assembly or void the lamp assembly warranty and will provide quality bulb illumination time.

Exterior Lamps

Lamp	Specification	Power (Watt)
Front direction indicator.	7444NA	5
Daytime running lamps.	LED	LED
Halogen headlamp low beam.	H11	55
Halogen headlamp high beam.	HB3	55
LED headlamps.	LED	LED
Halogen front fog lamps.	9140	55
LED front fog lamps.	LED	LED
Front side marker lamps.	LED	LED
Side direction indicator.	LED	LED
Rear lamp, brake lamp and rear direction indicator.	3057K	27
Central high mounted brake lamp.	LED	LED
Reversing lamps.	3057K	27
License plate lamp.	W5W	5

LED lamps are not serviceable. Contact an authorized dealer if they fail.

Interior Lamps

Lamp	Specification	Power (Watt)
Glove compartment lamp if equipped.	LED	LED
Vanity mirror lamp.	LED	LED
Map lamp.	LED	LED

Capacities and Specifications

Lamp	Specification	Power (Watt)
Interior lamp. ¹	LED	LED
Rear dome lamp.	LED	LED

¹Second row rail lamp.

LED lamps are not serviceable. Contact an authorized dealer if they fail.

Audio System

GENERAL INFORMATION



WARNING: Driving while distracted can result in loss of vehicle control, crash and injury. We strongly recommend that you use extreme caution when using any device that may take your focus off the road. Your primary responsibility is the safe operation of your vehicle. We recommend against the use of any hand-held device while driving and encourage the use of voice-operated systems when possible. Make sure you are aware of all applicable local laws that may affect the use of electronic devices while driving.

Radio Frequencies and Reception Factors

AM and FM frequencies are established by the Federal Communications Commission (FCC) and the Canadian Radio and Telecommunications Commission (CRTC). Those frequencies are:

- AM: 530-1710 kHz
- FM: 87.9-107.9 MHz

Note: *Listening to loud audio for long periods of time could damage your hearing.*

Radio Reception Factors

Distance and strength	The further you travel from an AM or FM station, the weaker the signal and the weaker the reception.
Terrain	Hills, mountains, tall buildings, bridges, tunnels, freeway overpasses, parking garages, dense tree foliage and thunderstorms can interfere with the reception.
Station overload	When you pass a ground-based broadcast repeating tower, a stronger signal may overtake a weaker one and result in the audio system muting.

CD and CD Player Information

Note: *CD units play commercially pressed 4.7 in (12 cm) audio compact discs only. Due to technical incompatibility, certain recordable and re-recordable compact discs may not function correctly when used in the vehicle's CD player.*

Note: *Do not insert CDs with homemade paper (adhesive) labels into the CD player as the label may peel and cause the CD to become jammed. You should use a permanent felt tip marker rather than adhesive labels on your homemade CDs. Ballpoint pens may damage CDs. Ask an authorized dealer for more information.*

Note: *Do not use any irregularly shaped discs or discs with a scratch protection film attached.*

Audio System

Always handle discs by their edges only. Clean the disc with an approved CD cleaner only. Wipe it from the center of the disc toward the edge. Do not clean in a circular motion.

Do not expose discs to direct sunlight or heat sources for extended periods.

MP3 and WMA Track and Folder Structure

Audio systems capable of recognizing and playing MP3 and WMA individual tracks and folder structures work as follows:

- There are two different modes for MP3 and WMA disc playback: MP3 and WMA track mode (system default) and MP3 and WMA folder mode.
- MP3 and WMA track mode ignores any folder structure on the MP3 and WMA disc. The player numbers each MP3 and WMA track on the disc (noted by the MP3 or WMA file extension) from T001 to a maximum of T255. The maximum number of playable MP3 and WMA files may be less depending on the structure of the CD and exact model of radio present.
- MP3 and WMA folder mode represents a folder structure consisting of one level of folders. The CD player numbers all MP3 and WMA tracks on the disc (noted by the MP3 or WMA file extension) and all folders containing MP3 and WMA files, from F001 (folder T001 (track) to F253 T255.
- Creating discs with only one level of folders helps with navigation through the disc files.

If you are burning your own MP3 and WMA discs, it is important to understand how the system reads the structures you create. While various files may be present (files with extensions other than MP3 and WMA), only files with the MP3 and WMA

extension are played; other files are ignored by the system. This enables you to use the same MP3 and WMA disc for a variety of tasks on your work computer, home computer and your in-vehicle system.

In track mode, the system displays and plays the structure as if it were only one level deep (all MP3 and WMA files play, regardless of being in a specific folder). In folder mode, the system only plays the MP3 and WMA files in the current folder.

AUDIO UNIT - VEHICLES WITHOUT: TOUCHSCREEN DISPLAY



WARNING: Driving while distracted can result in loss of vehicle control, crash and injury. We strongly recommend that you use extreme caution when using any device that may take your focus off the road. Your primary responsibility is the safe operation of your vehicle. We recommend against the use of any hand-held device while driving and encourage the use of voice-operated systems when possible. Make sure you are aware of all applicable local laws that may affect the use of electronic devices while driving.

Note: Some features, such as satellite radio, may not be available in your location. Check with an authorized dealer.

Accessing the Apps Menu



Press and release the button to access the apps menu. Follow the on-screen prompts to make your selection.

Audio System

Accessing the Clock Settings



Press and release the button to access the clock setting.

Use the center arrow controls to change the hours and minutes.

Accessing the Media Source Menu



Press and release the button to open the media source menu.

You can press this multiple times to change to a SYNC-Media device or scroll through the media sources using the arrow buttons. Press **OK** to select a source.

Accessing the Phone Features



Press and release the button to access the phone features of the SYNC system.

Accessing the Sound Settings



Press and release the button to access settings for Treble, Midrange, Bass, Fade and Balance.

Accessing the Settings Menu



Press and release the button to access the settings menu.

Follow the on-screen prompts to make your selection.

Adjusting the Volume

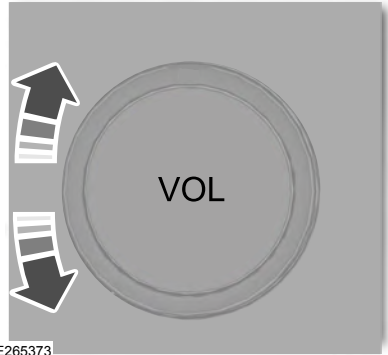

E265373

Turn to adjust the volume.

Changing Radio Stations

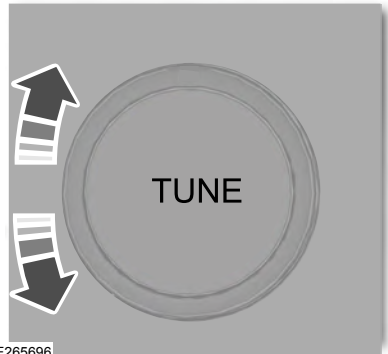

E265696

In radio mode, turn to search through the radio frequency band.

In satellite radio mode, turn to find the previous or next available satellite radio station.

Audio System

Listening to the Radio



Press and release the button to listen to the radio or change radio stations.

Playing or Pausing Media



Press and release the button to either play or pause current media source.

Switching the Audio Unit On and Off



Press and release the button.

Switching the Display On and Off



Press and release the button.

Switching Radio Text On and Off



Press and release the button to display extra information, for example, artist name.

Note: *Extra information may not always be available.*

Switching Repeat Mode On and Off



Press and release the button to repeat the current media source.

Switching Shuffle Mode On and Off



Press and release the button to shuffle the current media source.

Using the Display Control

Use the up and down arrow buttons to select the various settings. When you make your selection, press the left and right arrow buttons to change the settings.



Press and release to confirm a selection.

Press and release the function buttons below the display to select different functions of the audio system depending on which mode you are in.

Using the Number Block

In radio mode, store and recall your favorite radio stations. To store a favorite station, press and hold until the sound returns. In phone mode, enter a phone number.

Using Seek, Fast Forward and Reverse



In radio mode, select a frequency band and press and release either button. The system stops at the first station it finds in that direction.

In satellite radio mode, press and release to select the next or previous satellite radio station. If you select a specific category, such as jazz, rock or news, press to find the next or previous station in that category.

Audio System

AUDIO UNIT - VEHICLES WITH: TOUCHSCREEN DISPLAY



WARNING: Driving while distracted can result in loss of vehicle control, crash and injury. We strongly recommend that you use extreme caution when using any device that may take your focus off the road. Your primary responsibility is the safe operation of your vehicle. We recommend against the use of any hand-held device while driving and encourage the use of voice-operated systems when possible. Make sure you are aware of all applicable local laws that may affect the use of electronic devices while driving.

Note: Some features, such as satellite radio, may not be available in your location. Check with an authorized dealer.

Note: The touchscreen system controls most of the audio features. See your SYNC information.

Accessing the Sound Settings



Press and release the button to access settings.

Adjusting the Volume

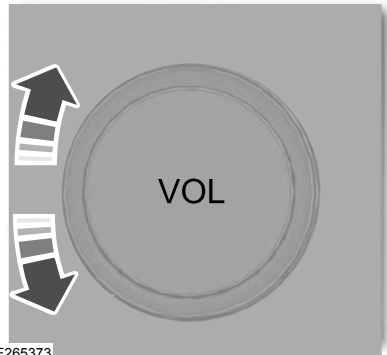

E265373

Turn to adjust the volume.

Changing Radio Stations

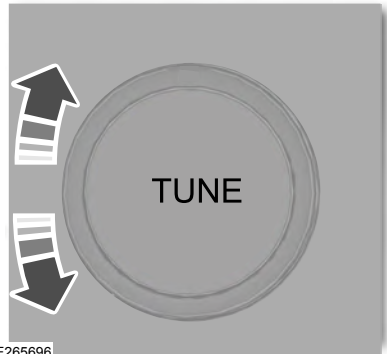

E265696

In radio mode, turn to search through the radio frequency band.

In satellite radio mode, turn to find the previous or next available satellite radio station.

Audio System

Ejecting the CD



Press and release the button to eject a CD.

Inserting a CD

Insert a CD into the CD slot.

Muting the Audio



Press and release the button to mute the playing audio.

Playing or Pausing Media



Press and release the button to either play or pause the audio.

Setting the Memory Presets

To store a radio station, tune to the station, then press and hold a numbered preset button until sound returns.

Switching the Display On and Off



Press and release the button.

Using Seek, Fast Forward and Reverse



In radio mode, select a frequency band and press and release either button. The system stops at the first station it finds in that direction.

In CD mode, press and release to select the next or previous track. Press and hold to move quickly forward or backward through the current track.

In satellite radio mode, press and release to select the next or previous satellite radio station. If you select a specific category (such as jazz, rock or news) press to find the next or previous station in the category you select.

DIGITAL RADIO (IF EQUIPPED)

Note: *HD Radio broadcasts are not available in all markets.*

HD Radio technology is the digital evolution of analog AM/FM radio. Your system has a special receiver that allows it to receive digital broadcasts (where available) in addition to the analog broadcasts, it already receives. Digital broadcasts provide a better sound quality than analog broadcasts with free, crystal-clear audio and no static or distortion. For more information, and a guide to available stations and programming, please visit www.hdradio.com.

When HD Radio is on and you tune to a station broadcasting HD Radio technology, you may notice the HD Radio logo on your screen. When this logo is available, you may also see Title and Artist fields on-screen.

The multicast indicator appears in FM mode (only) if the current station is broadcasting multiple digital broadcasts. The highlighted numbers signify available digital channels where new or different content is available. HD1 signifies the main programming status and is available in analog and digital broadcasts. Other multicast stations (HD2 through HD7) are only available digitally.

Audio System

When HD Radio broadcasts are active, you can access the following functions:

- **Scan** allows you to hear a brief sampling of all available stations. This feature still works when HD Radio reception is on, although it does not scan for HD2-HD7 channels. You may see the HD logo appear if the station has a digital broadcast.

- **Memory presets** allow you to save an active channel as a memory preset. Touch and hold a memory preset slot until the sound returns. There is a brief mute while the radio saves the station. Sound returns when finished. When switching to an HD2 or HD3 memory preset, the sound mutes before the digital audio plays, because the system has to reacquire the digital signal.

Note: *As with any saved radio station, you cannot access a station you save if your vehicle is outside the station's reception area.*

HD Radio Reception and Station Troubleshooting

Potential Reception Issues	
Reception area	If you are listening to a multicast station and you are on the fringe of the reception area, the station may mute due to weak signal strength.
	If you are listening to HD1, the system switches back to the analog broadcast until the digital broadcast is available again. However, if you are listening to any of the possible HD2-HD7 multicast channels, the station mutes and stays muted unless it is able to connect to the digital signal again.
Station blending	When the system first receives a station (aside from HD2-HD7 multicast stations), it first plays the station in the analog version. Once the receiver verifies the station is an HD Radio station, it shifts to the digital version. Depending on the station quality, you may hear a slight sound change when the station changes from analog to digital. Blending is the shift from analog to digital sound or digital back to analog sound.

In order to provide the best possible experience, use the contact form to report any station issues found while listening to a station broadcasting with HD Radio technology. Independent entities own and operate each station. These stations are responsible for ensuring all audio streams and data fields are accurate.

Audio System

Potential Station Issues		
Issues	Cause	Action
Echo, stutter, skip or repeat in audio. Increase or decrease in audio volume.	This is poor time alignment by the radio broadcaster.	No action required. This is a broadcast issue.
Sound fading or blending in and out.	The radio is shifting between analog and digital audio.	No action required. The reception issue may clear up as you continue to drive.
There is an audio mute delay when selecting HD2 or HD3, multicast preset or Direct Tune .	The digital multicast is not available until the HD Radio broadcast is decoded. Once decoded, the audio is available.	No action required. This is normal behavior. Wait until the audio is available.
Cannot access HD2 or HD3 multicast channel when recalling a preset or from a direct tune.	The previously stored multicast preset or direct tune is not available in your current reception area.	No action required. The station is not available in your current location.
Text information does not match currently playing audio.	Data service issue by the radio broadcaster.	Fill out the station issue form at website listed below.*
There is no text information shown for currently selected frequency.	Data service issue by the radio broadcaster.	Fill out the station issue form at website listed below.*
HD2-HD7 stations not found when Scan is pressed.	Pressing Scan disables HD2-HD7 channel search.	No action required. This is normal behavior.

*<http://hdradio.com/stations/feedback>

HD Radio Technology manufactured under license from iBiquity Digital Corporation and foreign patents. HD Radio and the HD and HD Radio logos are proprietary trademarks of DTS Ford Motor Company and DTS are not responsible for the content sent using HD Radio technology. Content may be changed, added or deleted at any time at the station owner's discretion.

SATELLITE RADIO (IF EQUIPPED)

SiriusXM® Satellite Radio broadcasts a variety of music, news, sports, weather, traffic and entertainment satellite radio channels. For more information and a complete list of SiriusXM satellite radio channels, visit www.siriusxm.com in the United States, www.siriusxm.ca in Canada, or call SiriusXM at 1-888-539-7474.

Audio System

Note: This receiver includes the eCos real-time operating system. eCos is published under the eCos License.

Satellite Radio Reception Factors

Potential satellite radio reception issues	
Antenna obstructions	For optimal reception performance, keep the antenna clear of snow and ice build-up and keep luggage and other material as far away from the antenna as possible.
Terrain	Hills, mountains, tall buildings, bridges, tunnels, freeway overpasses, parking garages, dense tree foliage and thunderstorms can interfere with your reception.
Station overload	When you pass a ground-based broadcast-repeating tower, a stronger signal may overtake a weaker one and the audio system may mute.
Satellite radio signal interference	Your display may show ACQUIRING . . . to indicate the interference and the audio system may mute.

SiriusXM Satellite Radio Service

Note: *SiriusXM reserves the unrestricted right to change, rearrange, add or delete programming including canceling, moving or adding particular channels, and its prices, at any time, with or without notice to you. Ford Motor Company shall not be responsible for any such programming changes.*



E208625

SiriusXM satellite radio is a subscription-based satellite radio service that broadcasts a variety of music, sports, news, weather, traffic and entertainment programming. Your factory-installed SiriusXM satellite radio system includes hardware and a limited subscription term, which begins on the date of sale or lease of your vehicle. See an authorized dealer for availability.

For more information on extended subscription terms (a service fee is required), the online media player and a complete list of SiriusXM satellite radio channels, and other features, please visit www.siriusxm.com in the United States, www.siriusxm.ca in Canada, or call SiriusXM at 1-888-539-7474.

Satellite Radio Electronic Serial Number (ESN)

You need your ESN to activate, modify or track your satellite radio account. When in satellite radio mode, tune to channel 0.

Audio System

Troubleshooting

Message	Condition	Action
Acquiring...	Radio requires more than two seconds to produce audio for the selected channel.	No action required. This message should disappear shortly.
Satellite antenna fault SIRIUS system failure	There is an internal module or system failure present.	If this message does not clear shortly, or with an ignition key cycle, your receiver may have a fault. See an authorized dealer for service.
Invalid Channel	The channel is no longer available.	Tune to another channel or choose another preset.
Unsubscribed Channel	Your subscription does not include this channel.	Contact SiriusXM at 1-888-539-7474 to subscribe to the channel, or tune to another channel.
No Signal	The signal is lost from the SiriusXM satellite or SiriusXM tower to your vehicle antenna.	The signal is blocked. When you move into an open area, the signal should return.
Updating...	Update of channel programming in progress.	No action required. The process may take up to three minutes.
Questions? Call 1-888-539-7474	Your satellite service is no longer available.	Contact SiriusXM at 1-888-539-7474 to resolve subscription issues.
None found Check Channel Guide	All the channels in the selected category are either skipped or locked.	Use the channel guide to turn off the Lock or Skip function on that station.
Subscription Updated	SiriusXM has updated the channels available for your vehicle.	No action required.

Audio System

USB PORT (IF EQUIPPED)



WARNING: Driving while distracted can result in loss of vehicle control, crash and injury. We strongly recommend that you use extreme caution when using any device that may take your focus off the road. Your primary responsibility is the safe operation of your vehicle. We recommend against the use of any hand-held device while driving and encourage the use of voice-operated systems when possible. Make sure you are aware of all applicable local laws that may affect the use of electronic devices while driving.

primary responsibility is the safe operation of your vehicle. We recommend against the use of any hand-held device while driving and encourage the use of voice-operated systems when possible. Make sure you are aware of all applicable local laws that may affect the use of electronic devices while driving.

The media hub may be on the instrument panel or center console.

The media hub may contain one or more of the following inputs:

See **USB Port** (page 401).



E201595

The USB port allows you to plug in media playing devices, memory sticks and charge devices, if supported.

MEDIA HUB



WARNING: Driving while distracted can result in loss of vehicle control, crash and injury. We strongly recommend that you use extreme caution when using any device that may take your focus off the road. Your

GENERAL INFORMATION

SYNC is an in-vehicle communications system that works with your Bluetooth-enabled cellular phone and portable media player. This allows you to:

- Make and receive calls.
- Access and play music from your portable music player.
- Use 911 Assist or Emergency Assistance and applications via SYNC AppLink.*
- Access phonebook contacts and music using voice commands.
- Stream music from your connected phone.
- Text message.
- Use the advanced voice recognition system.
- Charge your USB device (if your device supports this).

*These features are not available in all markets and may require activation. Available AppLink enabled apps vary by market.

Make sure that you review your device's manual before using it with SYNC.

Support

SYNC support is available at your regional Ford website. See **SYNC™ Troubleshooting** (page 411).

SYNC Owner Account

Why do I need a SYNC owner account?

- Essential for keeping up with the latest software downloads available for SYNC.
- Access to customer support for any questions you may have.

Driving Restrictions

For your safety, certain features are speed-dependent and restricted when your vehicle is traveling over 3 mi (5 km).

Safety Information



WARNING: Driving while distracted can result in loss of vehicle control, crash and injury. We strongly recommend that you use extreme caution when using any device that may take your focus off the road. Your primary responsibility is the safe operation of your vehicle. We recommend against the use of any hand-held device while driving and encourage the use of voice-operated systems when possible. Make sure you are aware of all applicable local laws that may affect the use of electronic devices while driving.

When using SYNC:

- Do not operate playing devices if the power cords or cables are broken, split or damaged. Place cords and cables out of the way, so they do not interfere with the operation of pedals, seats, compartments or safe driving abilities.
- Do not leave playing devices in your vehicle during extreme conditions as it could cause them damage. See your device's manual for further information.
- Do not attempt to service or repair the system. See an authorized dealer.

Privacy Information

When a cellular phone is connected to SYNC, the system creates a profile within your vehicle that is linked to that cellular phone. This profile is created in order to offer you more cellular features and to operate more efficiently. Among other

things, this profile may contain data about your cellular phone book, text messages (read and unread), and call history, including history of calls when your cellular phone was not connected to the system. In addition, if you connect a media device, the system creates and retains an index of supported media content. The system also records a short development log of approximately 10 minutes of all recent system activity. The log profile and other system data may be used to improve the system and help diagnose any problems that may occur.

The cellular profile, media device index, and development log will remain in the vehicle unless you delete them and are generally accessible only in the vehicle when the cellular phone or media player is connected. If you no longer plan to use the system or the vehicle, we recommend you perform a Master Reset to erase all stored information.

System data cannot be accessed without special equipment and access to the vehicle's SYNC module. Ford Motor Company and Ford of Canada will not access the system data for any purpose other than as described absent consent, a

court order, or where required by law enforcement, other government authorities, or other third parties acting with lawful authority. Other parties may seek to access the information independently of Ford Motor Company and Ford of Canada. For further privacy information, see the section on 911 Assist. See **SYNC™ Applications and Services** (page 406).

USING VOICE RECOGNITION

This system helps you control many features using voice commands. This allows you to keep your hands on the wheel and focus on what is around you.

Initiating a Voice Session



Press the voice button. A list of available voice commands appears in the display.

Global Voice Commands

These voice commands are always available. You can say them at any time.

Global voice commands	
Help	Gives you available commands you can use on the current screen.
List of Commands	Gives you a list of possible voice commands.
Cancel	This command ends the voice session. You can also cancel a session by pressing seek up, seek down, or holding the voice button for two or more seconds.

Helpful Hints

- Make sure the interior of your vehicle is as quiet as possible. Wind noise from open windows and road vibrations may prevent the system from correctly recognizing spoken commands.
- Before giving a voice command, wait for the system announcement to finish, followed by a single tone. Any command spoken before this does not register with the system.
- Speak naturally, without long pauses between words.
- You can interrupt the system at any time while it is speaking by pressing the voice button. You can cancel a voice session by pressing and holding the voice button.

System Interaction and Feedback

The system provides feedback through audible tones, prompts, questions and spoken confirmations depending on the situation and the chosen level of interaction. You can customize the voice recognition system to provide more or less instruction and feedback.

The default setting is to a higher level of interaction in order to help you learn to use the system. You can change these settings at any time.

Adjusting the Interaction Level



Press the voice button. When prompted, say:

Voice Command	Action and Description
Voice Settings	
Then either of the following:	
Interaction Mode Standard	Provides more detailed interaction and guidance. (Recommended for first time users.)
Interaction Mode Advanced	Provides less audible interaction and guidance.

Phone Confirmation

Using phone confirmations the system asks you to verify before placing any calls.

To adjust this setting press the voice button, when prompted say:

Voice Command	Action and Description
Voice Settings	
Then any of the following:	
Phone Confirmation Off	When enabled, this feature will prompt you to confirm any voice initiated call command prior to the call being placed.
Phone Confirmation On	The system will make a best guess; you may still occasionally be asked to confirm settings.

USING SYNC™ WITH YOUR PHONE

Hands-free calling is one of the main features of SYNC. While the system supports a variety of features, many are dependent on your cellular phone's functionality. At a minimum, most cellular phones with Bluetooth wireless technology support the following functions:

- Answering an incoming call.
- Ending a call.
- Dialing a number.
- Redialing.
- Call waiting notification.
- Caller ID.

Other features, such as text messaging using Bluetooth and automatic phonebook download, are phone-dependent features.

Pairing a Phone

Wirelessly pairing your phone with SYNC allows you to make and receive hands-free calls.

Note: Make sure to switch on the ignition and the radio. Shift the transmission into park (P) for automatic transmission or first gear for manual transmission.

Using the Audio System

Note: To scroll through the menus, press the up and down arrows on your audio system.

1. Make sure to switch on your phone's Bluetooth feature before starting the search. See your device's manual if necessary.
2. Press the **Settings** button.
3. Select Bluetooth from the menu.
4. Press the **OK** button.
5. Select the option to add. This starts the pairing process.
6. When a message to begin pairing appears in the audio display, search for SYNC on your device.

7. When prompted on your cell phone's display, confirm that the PIN provided by SYNC matches the PIN displayed on your cell phone. Your phone is now paired and the display indicates that the pairing was successful. If you are prompted to enter a PIN on your device, enter the PIN displayed on the screen. The display indicates when the pairing is successful.

Depending on your phone's capability and your market, the system may prompt you with questions, such as setting the current phone as the primary phone and downloading your phonebook.

Using Voice Commands



Make sure to switch on your phone's Bluetooth feature before starting the search. See your device's manual if necessary.

Press the voice button and when prompted say:

Voice Command	Action and Description
Pair Phone	Follow the instructions on the audio display.

Phone Voice Commands



Press the voice button. You can do things like place a phone call and access text messages. When prompted, say a command. See the following table for example commands.

Voice Command
___ List of Commands
Help
Call ___
Dial ___
Text Messages

___ is a dynamic listing, meaning that it could be the name of anything, such as a contact or phone number.

Phone Controls

Use the phone buttons on your steering wheel to answer, reject, or hang up a call.

Accessing Features through the Phone Menu

You can access your call history, phonebook, sent text messages, as well as access phone and system settings.

1. Press the **PHONE** button to enter the phone menu.
2. Scroll through the menu to view contacts, text messages, and the phone dialer.

SYNC™ APPLICATIONS AND SERVICES

- 911 Assist: Can alert 911 in the event of an emergency.
- SYNC AppLink: Allows you to connect to and use certain applications (if your phone is compatible).

These features may require activation. Available AppLink enabled apps vary by market.

911 Assist



WARNING: Unless the 911 Assist setting is set on before a crash, the system will not dial for help which could delay response time, potentially increasing the risk of serious injury or death after a crash.



WARNING: Do not wait for 911 Assist to make an emergency call if you can do it yourself. Dial emergency services immediately to avoid delayed response time which could increase the risk of serious injury or death after a crash. If you do not hear 911 Assist within five seconds of the crash, the system or phone may be damaged or non-functional.



WARNING: Always place your phone in a secure location in your vehicle so it does not become a projectile or get damaged in a crash. Failure to do so may cause serious injury to someone or damage the phone which could prevent 911 Assist from working properly.

Note: The SYNC 911 Assist feature must be set on before the incident.

Note: The SYNC 911 Assist feature only operates in the U.S., Canada or in a territory in which 911 is the emergency number.

Note: Before setting this feature on, make sure that you read the 911 Assist Privacy Notice later in this section for important information.

Note: If any user switches 911 Assist to on or off, that setting applies for all paired phones. If 911 Assist is switched off, either a voice message plays or a display message or an icon comes on when your vehicle is started and after a previously paired phone connects.

Note: Every phone operates differently. While SYNC 911 Assist works with most cellular phones, some may have trouble using this feature.

If a crash deploys an airbag (excluding knee airbags and rear inflatable safety belts [if equipped]) or activates the fuel pump shut-off, your SYNC-equipped vehicle may be able to contact emergency services by dialing 911 through a paired and connected Bluetooth-enabled phone.

See **Supplementary Restraints System** (page 45). Important information about airbag deployment is in this chapter.

See **Roadside Emergencies** (page 301). Important information about the fuel pump shut-off is in this chapter.

Setting 911 Assist On or Off

Press the Settings button then select:

Menu Item	Action and Description
911 Assist	Select the desired option, on or off.

To make sure that 911 Assist works properly:

- SYNC must be powered and working properly at the time of the incident and throughout feature activation and use.
- The 911 Assist feature must be set on before the incident.
- You must pair and connect a Bluetooth enabled and compatible cell phone to SYNC.
- A connected Bluetooth enabled phone must have the ability to make and maintain an outgoing call at the time of the incident.

- A connected Bluetooth enabled phone must have adequate network coverage, battery power and signal strength.
- The vehicle must have battery power and be located in the U.S., Canada or in a territory in which 911 is the emergency number.

In the Event of a Crash

Not all crashes deploy an airbag or activate the fuel pump shut-off (the triggers for 911 Assist). If a connected cell phone sustains damage or loses its connection to SYNC during a crash, SYNC searches for and tries to connect to a previously paired cell phone; SYNC then attempts to call the emergency services.

Before making the call:

- SYNC provides a short window of time (about 10 seconds) to cancel the call. If you fail to cancel the call, SYNC attempts to dial 911.
- SYNC says the following, or a similar message: "SYNC will attempt to call 911, to cancel the call, press Cancel on your screen or press and hold the phone button on your steering wheel".

If you do not cancel the call, and SYNC makes a successful call, a pre-recorded message plays for the 911 operator, and then the occupant(s) in your vehicle are able to talk with the operator. Be prepared to provide your name, phone number and location immediately, because not all 911 systems are capable of receiving this information electronically.

911 Assist May Not Work If

- Your cellular phone or 911 Assist hardware sustains damage in a crash.
- The vehicle's battery or the SYNC system has no power.
- The phone(s) thrown from your vehicle are the ones paired and connected to the system.

911 Assist Privacy Notice

When you switch on 911 Assist, it may disclose to emergency services that your vehicle has been in a crash involving the deployment of an airbag or activation of the fuel pump shut-off. Certain versions or updates to 911 Assist may also be capable of electronically or verbally disclosing to 911 operators your vehicle location or other details about your vehicle or crash to assist 911 operators to provide the most appropriate emergency services. If you do not want to disclose this information, do not switch the feature on.

SYNC Mobile Apps

The system enables voice and steering wheel control of SYNC AppLink enabled smartphone apps. When an app is running through AppLink, you can control main features of the app through voice commands and steering wheel controls.

Note: *You must pair and connect your smartphone to SYNC to access AppLink.*

Note: *iPhone users need to connect the phone to the USB port.*

Note: *Android users need to connect the phone to SYNC using Bluetooth.*

Note: *For information on available apps, supported smartphone devices and troubleshooting tips please visit the Ford website*

Note: *Availability of SYNC AppLink enabled Apps will vary by region.*

Note: *Make sure you have an active account for the app that you have downloaded. Some apps work automatically with no setup. Other apps want you to configure your personal settings and personalize your experience by creating stations or favorites. We recommend you do this at home or outside of your vehicle.*

To Access Using the SYNC Menu

Press the Mobile Apps button to access the menu on-screen. Then select:

Menu Item	Action and Description
Find	Scroll through the list of

Menu Item	Action and Description
Mobile Apps	available applications and select a particular app.

Note: *If you cannot find a compatible SYNC AppLink app, make sure the required app is running on the mobile device.*

To Access Using Voice Commands

Press the voice button, then when prompted say:

Voice Command	Action and Description
Mobile Applications	Say the name of the application after the tone. The app should start. When an app is running through SYNC, you can press the voice button and speak commands specific to the app, for example "Play Playlist Road Trip".
List Applications	SYNC lists all of the currently available mobile apps.
Find Applications	Searches your connected mobile device for SYNC-compatible mobile apps.
Help	Use this command to discover the available voice commands.

App Permissions

App permissions are organized by groups. You can grant these group permissions individually. You can change a permission group status any time when not driving, by using the settings menu.

When you launch an app using SYNC, the system may ask you to grant certain permissions, for example:

- To allow your vehicle to provide vehicle information to the app such as, but not limited to: Fuel level, fuel economy, fuel consumption, engine speed, rain sensor, odometer, VIN, external temperature, gear position, tire pressure, and head lamp status.
- To allow your vehicle to provide driving characteristic information such as, but not limited to: MyKey, seat belt status, engine revolutions per minute, gear position, braking events, steering wheel angle, and accelerator pedal position.

- To allow your vehicle to provide location information, including: GPS and speed.
- To allow the app to send push notifications using the vehicle display and voice capabilities while running in a background state. Push notifications may be particularly useful for news or location based apps.

Note: *You only need to grant permissions the first time you use an app with SYNC.*

Note: *Ford is not responsible or liable for any damages or loss of privacy relating to usage of an app, or dissemination of any vehicle data that you approve Ford to provide to an app.*

Enabling SYNC Mobile Apps

In order to enable mobile apps, SYNC requires user consent to send and receive app authorization information and updates using the data plan associated with the connected device.

Data is sent to Ford in the United States through the connected device. The information is encrypted and includes your VIN, SYNC module number, anonymous usage statistics and debugging information. Updates may take place.

Note: *You must enable mobile apps for each connected device the first time you select a mobile app using the system.*

Note: *Standard data rates apply. Ford is not responsible for any additional charges you may receive from your service provider, when your vehicle sends or receives data through the connected device. This includes any additional charges incurred due to driving in areas when roaming out of a home network.*

USING SYNC™ WITH YOUR MEDIA PLAYER

SYNC supports digital media sources including: iPod, Bluetooth devices, and most USB drives. SYNC also supports audio formats, such as MP3, WMA, WAV and ACC.

Media Sources

The **AUX** or **MEDIA** button allows you to view and select available media sources.

Press the **AUX** or **MEDIA** button to view your sources. Use the directional arrows and OK button to select your source. You can also use the steering wheel audio controls.

Audio Voice Commands



Press the voice button. You can do things like play a specific song or album, skip to the next song, or tune to a radio station. When prompted, say a command. See the following table for example commands. Not all commands may be available on your vehicle.

Command
___ List of Commands
Help
Pause
Play
Next Track
Previous Track
AM ___
FM ___
CD Player

SYNC™

Command
Sirius Channel ____
USB
Bluetooth Audio

Use your regional Ford website at any time to check your phone's compatibility, register your account and set preferences as well as access a customer representative via an online chat (during certain hours).

__ is a dynamic listing, meaning that it could be the name of anything, such as an artist, station, or media source.

SYNC™ TROUBLESHOOTING

Your SYNC system is easy to use. However, should questions arise, see the tables below.

Market	Website(s)
North America	www.SYNCMyRide.com www.SYNCMyRide.ca www.sync-maroute.ca

Phone issues		
Issue	Possible cause(s)	Possible solution(s)
There is excessive background noise during a phone call.	The audio control settings on your phone may be affecting SYNC performance.	Review your phone's manual about audio adjustments.
During a call, I can hear the other person but they cannot hear me.	This may be a possible phone malfunction.	Try turning off the device, resetting the device, removing the device's battery, then trying again.
SYNC is not able to download my phonebook.	<p>This is a phone-dependent feature.</p> <p>This may be a possible phone malfunction.</p>	<p>Go to the website to review your phone's compatibility.</p> <p>Try turning off the device, resetting the device or removing the device's battery, then trying again.</p> <p>Try pushing your phonebook contacts to SYNC by using the Add Contacts feature.</p> <p>Use the SYNCmyphone feature available on the website.</p>

Phone issues		
Issue	Possible cause(s)	Possible solution(s)
<p>The system says Phonebook Downloaded but the phonebook in SYNC is empty or missing contacts.</p>	<p>This may be a limitation on your phone's capability.</p>	<p>Try pushing your phonebook contacts to SYNC by using the Add Contacts feature.</p> <p>If the missing contacts are stored on your SIM card, try moving them to the device memory.</p> <p>Remove any pictures or special ring tones associated with the missing contact.</p> <p>Depending upon your phone, you may have to grant SYNC permission to access your phonebook contacts. Make sure to confirm when prompted by your phone during the phonebook download.</p>
<p>I am having trouble connecting my phone to SYNC.</p>	<p>This is a phone-dependent feature.</p> <p>This may be a possible phone malfunction.</p>	<p>Go to the website to review your phone's compatibility.</p> <p>Try turning off the device, resetting the device or removing the device's battery, then trying again.</p> <p>Try deleting your device from SYNC, deleting SYNC from your device and trying again.</p> <p>Check the security and auto accept and prompt always settings relative to the SYNC Bluetooth connection on your phone.</p> <p>Update your device's firmware.</p> <p>Turn off the Auto phonebook download setting.</p>

SYNC™

Phone issues		
Issue	Possible cause(s)	Possible solution(s)
Text messaging is not working on SYNC.	<p>This is a phone-dependent feature.</p> <p>This may be a possible phone malfunction.</p>	<p>Go to the website to review your phone's compatibility.</p> <p>Try turning off the device, resetting the device or removing the device's battery, then trying again.</p>
I cannot return to the Phone menu when selecting a contact.	You are on the Select a Character screen.	Press the Phone button to return to the Phone menu.

USB and media issues		
Issue	Possible cause(s)	Possible solution(s)
I am having trouble connecting my device.	This may be a possible device malfunction.	<p>Try turning off the device, resetting the device, removing the device's battery, then trying again.</p> <p>Make sure you are using the manufacturer's cable.</p> <p>Make sure you insert the USB cable correctly into the device and the USB port.</p> <p>Make sure that the device does not have an auto-install program or active security settings.</p>
SYNC does not recognize my device when I turn on the car.	This is a device limitation.	Make sure you are not leaving the device in your vehicle during very hot or cold temperatures.
Bluetooth audio does not stream.	This is a phone-dependent feature.	Review the device compatibility chart on the SYNC website to confirm your phone supports the Bluetooth audio streaming function.

SYNC™

USB and media issues		
Issue	Possible cause(s)	Possible solution(s)
	The device is not connected.	Make sure you correctly connect the device to SYNC, and that you have pressed play on your device.
SYNC does not recognize music that is on my device.	Your music files may not contain the correct artist, song title, album or genre information. The file may be corrupted. The song may have copy-right protection, which does not allow it to play.	Make sure that all song details are populated. Some devices require you to change the USB settings from mass storage to MTP class.
I cannot change the Sirius station.	Sirius Replay is active.	Switch radio bands and return to Sirius or switch the feature off. You can then change the Sirius station using the directional buttons.

Voice command issues		
Issue	Possible cause(s)	Possible solution(s)
SYNC does not understand what I am saying.	You may be using the wrong voice commands. You may be speaking too soon or at the wrong time.	Review the phone voice commands and the media voice commands at the beginning of their respective sections. After pressing the voice icon, wait until after the tone sounds and Listening appears before saying a command. Any command spoken before this does not register with the system.
SYNC does not understand the name of a song or artist.	You may be using the wrong voice commands.	Review the media voice commands at the beginning of the media section.

SYNC™

Voice command issues		
Issue	Possible cause(s)	Possible solution(s)
	<p>You may be saying the name differently than the way you saved it.</p> <p>The system may not be reading the name the same way you are saying it.</p>	<p>Say the song or artist exactly as listed. If you say "Play Artist Prince", the system does not play music by Prince and the Revolution or Prince and the New Power Generation.</p> <p>Make sure you are saying the complete title, such as "California remix featuring Jennifer Nettles".</p> <p>If the song titles are in all CAPS, you have to spell them. LOLA requires you to say "L-O-L-A".</p> <p>Do not use special characters in the title. The system does not recognize them.</p>
<p>SYNC does not understand or is calling the wrong contact when I want to make a call.</p>	<p>You may be using the wrong voice commands.</p> <p>You may be saying the name differently than the way you saved it.</p>	<p>Review the Phone voice commands at the beginning of the phone section.</p> <p>Make sure you are saying the contacts exactly as they are listed. For example, if you save a contact as Joe Wilson, say "Call Joe Wilson".</p> <p>Using the SYNC phone menu, open the phonebook and scroll to the name SYNC is having trouble understanding. SYNC will read the name to you, giving you some idea of the pronunciation SYNC is expecting.</p>

SYNC™

Voice command issues		
Issue	Possible cause(s)	Possible solution(s)
	<p>The system may not be reading the name the same way you are saying it.</p> <p>Contacts in your phonebook may be very short and similar, or they may contain special characters.</p> <p>Your phonebook contacts may be in CAPS.</p>	<p>The system works better if you list full names, such as "Joe Wilson" rather than "Joe".</p> <p>Do not use special characters, such as 123 or ICE, as the system does not recognize them.</p> <p>If a contact is in CAPS, you have to spell it. JAKE requires you to say "Call J-A-K-E".</p>

AppLink issues		
Issue	Possible cause(s)	Possible solution(s)
<p>AppLink Mobile Applications: When I select "Find New Apps," SYNC does not find any applications.</p>	<p>An AppLink capable phone is not connected to SYNC.</p>	<p>Ensure you have a compatible smartphone; an Android with OS 2.3 or higher or an iPhone 3GS or newer with iOS 5.0 or higher. Additionally, ensure your phone is paired and connected to SYNC in order to find AppLink-capable apps on your device. iPhone users must also connect to SYNC's USB port with an Apple USB cable.</p>
<p>My phone is connected, but I still cannot find any apps.</p>	<p>AppLink-enabled apps are not installed and running on your mobile device.</p>	<p>Ensure you have downloaded and installed the latest version of the app from your phone's app store. Ensure the app is running on your phone. Some apps require you to register or</p>

SYNC™

AppLink issues		
Issue	Possible cause(s)	Possible solution(s)
		login on the app on the phone before using them with AppLink. Also, some may have a "Ford SYNC" setting, so check the app's settings menu on the phone.
My phone is connected, my app(s) are running, but I still cannot find any apps.	Sometime apps do not properly close and re-open their connection to SYNC, over ignition cycles, for example.	<p>Closing and restarting apps may help SYNC find the application if you cannot discover it inside the vehicle.</p> <p>On an Android device, if apps have an "Exit" or 'Quit' option, select that then restart the app. If the app does not have that option, you can also manually "Force Close" the app by going to the phone's settings menu, selecting 'Apps.' then finding the particular app and choosing 'Force stop.' Don't forget to restart the app afterwards, then select "Find New Apps" on SYNC.</p> <p>On an iPhone with iOS7+, to force close an app, double tap the home button then swipe up on the app to close it. Tab the home button again, then select the app again to restart it. After a few seconds, the app should then appear in SYNC's Mobile App's Menu.</p>
My Android phone is connected, my app(s) are running, I restarted them, but I still cannot find any apps.	There is a Bluetooth bug on some older versions of the Android operating system that may cause apps that were found on your previous vehicle drive to not be found again if you have not turned off Bluetooth.	Reset the Bluetooth on your phone by turning it off and then turning Bluetooth back on. If you are in your vehicle, SYNC should be able to automatically re-connect to your phone if you press the "Phone" button.

SYNC™

AppLink issues		
Issue	Possible cause(s)	Possible solution(s)
My iPhone phone is connected, my app is running, I restarted the app but I still cannot find it on SYNC.	The USB connection to SYNC may need to be reset.	Unplug the USB cable from the phone, wait a moment, and plug the USB cable back in to the phone. After a few seconds, the app should appear in SYNC's Mobile Apps Menu. If not, "Force Close" the application and restart it.
I have an Android phone. I found and started my media app on SYNC, but there is no sound or the sound is very low.	The bluetooth volume on the phone may be low.	Try increasing the Bluetooth volume of the device by using the device's volume control buttons which are most often found on the side of the device.
I can only see some of the AppLink apps running on my phone listed in SYNC's Mobile Apps Menu.	Some Android devices have a limited number of bluetooth ports apps can use to connect. If you have more AppLink apps on your phone than the number of available Bluetooth ports, you will not see all of your apps listed in SYNC's mobile apps menu.	Force close or uninstall the apps you do not want SYNC to find. If the app has a "Ford SYNC" setting, disable that setting in the app's settings menu on the phone.

SYNC System Reset
The SYNC system in your vehicle has System Reset feature that can be performed if the function of a SYNC feature is lost. This reset is intended to restore functionality and will not erase any information previously stored in the system (Such as paired devices, phonebook, call history, text messages, or user settings). To perform a System Reset, press and hold the Seek Up (>>) button while pressing and holding the Radio Power button. Release both buttons after 2-3 seconds. Please allow a few minutes for the reset to complete. After a few minutes has passed you can resume using the SYNC system.

SYNC™ 3

GENERAL INFORMATION



WARNING: Driving while distracted can result in loss of vehicle control, crash and injury. We strongly recommend that you use extreme caution when using any device that may take your focus off the road. Your primary responsibility is the safe operation of your vehicle. We recommend against the use of any hand-held device while driving and encourage the use of voice-operated systems when possible. Make sure you are aware of all applicable local laws that may affect the use of electronic devices while driving.

Getting to Know Your System

The SYNC 3 system allows you to interact with a variety of features using the touchscreen and voice commands. By integrating with your Bluetooth enabled phone, the touchscreen provides easy interaction with audio, multimedia, climate control, navigation, and your phone's SYNC 3 compatible apps.

Using the Touchscreen

To operate the touchscreen, you can simply touch the item or option that you want to select. The button changes color when you select it.

The SYNC 3 layout allows you to quickly select the feature you wish to use.



E269856

SYNC™ 3

Item	Menu Item	Action and Description
A	Status Bar	This bar displays icons and messages pertaining to current system activities including climate settings, voice commands and phone functions such as text messages.
B	Home	This button is available on the main screens. Pressing it takes you to the home screen view.
C	Clock	This shows the current time. You can set the clock manually or have it controlled by the vehicle's GPS location. See Settings (page 468).
D	Outside Temperature	This displays the current outside temperature.
E	Feature Bar	You can touch any of the buttons on this bar to select a feature.

The touchscreen allows you quick access to all of your comfort, navigation, communication and entertainment options. Using the status and feature bar you can quickly select the feature you want to use.

Note: *Your system is equipped with a feature that allows you to access and control audio features for 10 minutes after you switch the ignition off (and no doors open).*

The Status Bar

Additional icons also display in the status bar depending on market, vehicle options and current operation. If a feature is not active, the icon does not display. Certain icons may move to the left or right depending on what options are active.

SYNC™ 3

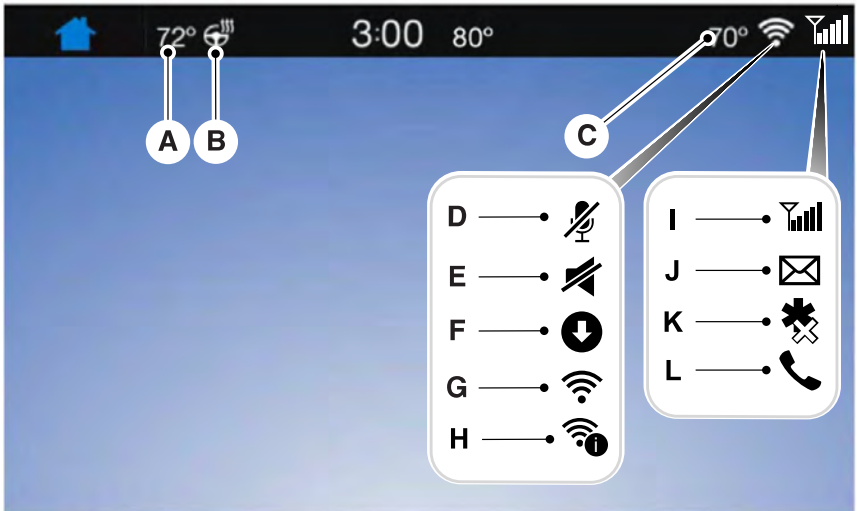

E270077

Callout	Item	Description
A	Driver Temperature	This shows the temperature the driver selects through the climate control system.
B	Heated steering wheel (If equipped)	When you activate the heated steering wheel option on the touch screen, this icon displays. It only displays when there is not a physical button for the heated steering wheel.
C	Passenger Temperature	When the passenger's temperature has been adjusted and is no longer linked to the driver's temperature, it displays here. If Dual is turned off and the temperatures are linked, the passenger's temperature does not display.
D	Microphone Mute	This icon displays when your phone's microphone is muted. A caller cannot hear you.
E	Mute	This icon displays when the audio system is muted.

SYNC™ 3

Callout	Item	Description
F	Download	This icon appears when SYNC 3 receives a software update. Pressing the icon shows more details about the new software.
G	Wi-Fi	This icon appears if a Wi-Fi network is connected.
H	Wi-Fi in Range	An available Wi-Fi network is within range.
I	Signal Strength	This icon displays the phone signal strength and the roaming signal strength.
J	Text Message	This icon displays when you receive a text message on your phone.
K	911 Assist Off	This icon displays when 911 Assist is set to off and your phone is connected to SYNC.
L	In-Call	This icon displays when a phone call is active.

Messages may also appear in the status bar to provide you with notifications. You can select the message to view the associated feature.

Feature Bar

Feature Bar Item	Functions
Audio	Allows you to control the media playing in your vehicle. You can control all audio features including AM, FM and satellite radio, CDs, and media streaming over a Bluetooth device or through a USB connection.
Climate	Allows you to adjust the temperature, fan speed and airflow within the vehicle.
Phone	Allows you to make calls, receive calls, and access the phonebook of your connected device.
Navigation (If equipped)	Allows you to see your vehicle's location on a virtual road map, get driving directions to your destination and find points of interest along your route.

SYNC™ 3

Feature Bar Item	Functions
Apps	Connect and control SYNC 3 compatible apps running on your iPhone or Android device. Also, access built-in additional features such as SiriusXM Traffic and Travel Link (if equipped).
	If your vehicle is a hybrid, plug-in hybrid, or electric this is also where your settings and power information is located.
Settings	You can customize your system with various settings for the touchscreen display, feature preferences, and how you want to interact with your vehicle.

Cleaning the Touchscreen

You can remove fingerprints with a dry, clean, soft cloth.

If dirt or fingerprints are still on the screen, apply a small amount of alcohol to the cloth and try to clean it again.

Note: Do not use detergent or any type of solvent to clean the touchscreen.

Note: Do not pour or spray alcohol onto the touchscreen.

Using Voice Recognition

Using voice commands allows you to keep your hands on the wheel and focus on what is in front of you. The system provides feedback through audible tones, prompts, questions and spoken confirmations depending on the situation and the chosen level of interaction (voice settings).

The system also asks short questions (confirmation prompts) when it is not sure of your request or when there are multiple possible responses to your request.

When using voice commands, words and icons may appear in the status bar indicating the status of the voice command session. See **Using Voice Recognition** (page 432).

Accessing and Adjusting Modes Through Your Vehicle Information Display (If Equipped)

Depending on your vehicle and selected options you may be able to control some of the SYNC 3 features on your information display.

You can make the following adjustments using the information display SYNC 3 screen:

Option	Information
Entertainment	Information for current audio playing.
	Select source.
Navigation	View current road and speed limit (if information is available).

SYNC™ 3

Option	Information			
	View current route, next turn, time to your destination (depending on cluster level), distance to destination (depending on cluster level), and ability to cancel route.			
	If you do not have an active navigation route programed, the compass is shown.			
Phone	If you are not on a call, a call can be made by selecting: ¹			
	All calls	Incoming calls	Outgoing calls	Missed calls
	If you are on a call, the call information is displayed on the information display.			
	If you are receiving a call, you can accept it by selecting OK on the right-hand steering wheel controls.			

¹ Depending on your vehicle options, all of these choices may not display.

Use the **OK** and arrow buttons on the right side of your steering wheel to scroll through the available modes.

The selection menu expands and different options appear.

- Press the up and down arrows to scroll through the modes.
- Press the right arrow to enter the mode, use the left arrow to exit the mode.
- Press the up and down arrows to make adjustments within the chosen mode.
- Press **OK** to confirm your selection.

Note: *If your vehicle is not equipped with navigation, compass appears in the display instead of navigation. If you press the right arrow to go into the compass menu, you can see the compass graphic. The compass displays the direction in which the vehicle is traveling, not true direction (for example, if the vehicle is traveling west, the middle of the compass graphic displays west; north displays to the left of west though its true direction is to the right of west).*

Using the Controls on the Steering Wheel

Depending on your vehicle and option package, you can use different controls on your steering wheel to interact with the touchscreen system in different ways.

VOL: Control the volume of audio output.

Mute: Mute the audio output.

Voice: Press to start a voice session. Press again to stop the voice prompt and immediately begin speaking. Press and hold to end a voice session.

SEEK NEXT:

- While in radio mode, press to seek between memory presets.
- While in USB, Bluetooth Audio or CD mode, press to seek between songs or press and hold to fast seek.

SEEK PREVIOUS:

- While in radio mode, press to seek between memory presets.
- While in USB, Bluetooth Audio or CD mode, press to seek between songs or press and hold to fast seek.

PHONE ACCEPT: Press to answer a call or switch between calls.

PHONE REJECT: Press to end a call or reject an incoming call.

Note: On some models, **SEEK NEXT** may be combined with **PHONE REJECT** and **SEEK PREVIOUS** may be combined with **PHONE ACCEPT**.

M: Touch the control repeatedly to switch between media sources (modes).

See **Steering Wheel** (page 83).

Using the Controls on the Bezel

Depending on your vehicle and option package, you may also have these controls on your instrument panel:

- **Power:** Switch the audio system on and off.
- **VOL:** Control the volume of playing audio.
- **Seek** and **Tune:** Use as you normally would in audio modes.
- **Eject:** Eject a CD from the audio system.
- **SOURCE** or **MEDIA:** Press repeatedly to advance through available media modes.
- **SOUND:** Press to access the Sound menu where you can adjust sound and other audio settings.
- **1-6:** Press and hold to store or press to select an AM, FM or SIRIUS memory preset. See **Audio System** (page 391).
- **DISP:** Switch the display on or off. You can also touch the screen to switch the display back on.
- **Temperature, fan and climate control buttons:** Control the temperature, fan speed or settings of the climate control system. See **Climate Control** (page 138).

911 Assist (If Equipped)



WARNING: Unless the 911 Assist setting is set on before a crash, the system will not dial for help which could delay response time, potentially increasing the risk of serious injury or death after a crash.



WARNING: Do not wait for 911 Assist to make an emergency call if you can do it yourself. Dial emergency services immediately to avoid delayed response time which could increase the risk of serious injury or death after a crash. If you do not hear 911 Assist within five seconds of the crash, the system or phone may be damaged or non-functional.



WARNING: Always place your phone in a secure location in your vehicle so it does not become a projectile or get damaged in a crash. Failure to do so may cause serious injury to someone or damage the phone which could prevent 911 Assist from working properly.

Note: The SYNC 911 Assist feature must be set on before the incident.

Note: The SYNC 911 Assist feature only operates in the U.S., Canada or in a territory in which 911 is the emergency number.

Note: Before setting this feature on, make sure that you read the 911 Assist Privacy Notice later in this section for important information.

Note: If any user sets 911 Assist to on or off, that setting applies for all paired phones. If 911 Assist is switched off and the phone is connected to SYNC, an icon displays on the status bar.

Note: *Every phone operates differently. While SYNC 911 Assist works with most cellular phones, some may have trouble using this feature.*

If a crash deploys an airbag (excluding knee airbags and rear inflatable safety belts [if equipped]) or activates the fuel pump shut-off, your SYNC-equipped vehicle may be able to contact emergency services by dialing 911 through a paired and connected Bluetooth enabled phone. You can learn more about the 911 Assist feature, by visiting:

Website
www.owner.ford.com www.syncmyride.ca www.syncmaroute.ca

For important information about airbag deployment and the fuel pump shut-off please see the Supplementary Restraints and Roadside Emergencies sections of your owner manual.

To switch 911 Assist on and off please view the settings information. See **Settings** (page 468).

To make sure that 911 Assist works correctly:

- SYNC must be powered and working properly at the time of the incident and throughout feature activation and use.
- The 911 Assist feature must be set on before the incident.
- You must pair and connect a Bluetooth enabled and compatible cell phone to SYNC.
- A connected Bluetooth enabled phone must have the ability to make and maintain an outgoing call at the time of the incident.

- A connected Bluetooth enabled phone must have adequate network coverage, battery power and signal strength.
- The vehicle must have battery power and be located in the U.S., Canada or in a territory in which 911 is the emergency number.

In the Event of a Crash

Not all crashes will deploy an airbag or activate the fuel pump shut-off (the triggers for 911 Assist). If a connected cell phone sustains damage or loses its connection to SYNC during a crash, SYNC will search for and try to connect to a previously paired cell phone; SYNC will then attempt to call the emergency services.

Before making the call:

- SYNC provides a short window of time (about 10 seconds) to cancel the call. If you fail to cancel the call, SYNC attempts to dial 911.
- SYNC says the following, or a similar message: "SYNC will attempt to call 911, to cancel the call, press Cancel on your screen or press and hold the phone button on your steering wheel."

If you do not cancel the call, and SYNC makes a successful call, a pre-recorded message plays for the 911 operator, and then the occupant(s) in your vehicle is able to talk with the operator. Be prepared to provide your name, phone number and location immediately, because not all 911 systems are capable of receiving this information electronically.

911 Assist May Not Work If

- Your cellular phone or 911 Assist hardware sustains damage in a crash.
- The vehicle's battery or the SYNC system has no power.
- The phone(s) thrown from your vehicle are the ones paired and connected to the system.

911 Assist Privacy Notice

When you switch on 911 Assist, it may disclose to emergency services that your vehicle has been in a crash involving the deployment of an airbag or activation of the fuel pump shut-off. Certain versions or updates to 911 Assist may also be capable of electronically or verbally disclosing to 911 operators your vehicle location or other details about your vehicle or crash to assist 911 operators to provide the most appropriate emergency services. If you do not want to disclose this information, do not switch the feature on.

Safety Information



WARNING: Driving while distracted can result in loss of vehicle control, crash and injury. We strongly recommend that you use extreme caution when using any device that may take your focus off the road. Your primary responsibility is the safe operation of your vehicle. We recommend against the use of any hand-held device while driving and encourage the use of voice-operated systems when possible. Make sure you are aware of all applicable local laws that may affect the use of electronic devices while driving.

- Do not attempt to service or repair the system. Have an authorized dealer check your vehicle.
- Do not operate playing devices if the power cords or cables are broken, split or damaged. Place cords and cables out of the way, so they do not interfere with the operation of pedals, seats, compartments or safe driving abilities.
- Do not leave playing devices in your vehicle during extreme conditions as it could cause them damage. See your device's user guide for further information.
- For your safety, some SYNC 3 functions are speed-dependent. Their use is limited to when your vehicle is traveling at speeds under 3 mph (5 km/h). Make sure that you review your device's manual before using it with SYNC 3.

Speed-restricted Features

Some features of this system may be too difficult to use while your vehicle is moving so they are restricted from use unless your vehicle is stationary.

- Screens crowded with information, such as Point of Interest reviews and ratings, SiriusXM Traffic and Travel Link sports scores, movie times or ski conditions.
- Any action that requires you to use a keyboard is restricted, such as entering a navigation destination or editing information.
- All lists are limited so the user can view fewer entries (such as phone contacts or recent phone call entries).

See the following table for more specific examples.

SYNC™ 3

Restricted features	
Cellular Phone	Pairing a Bluetooth phone.
	Browsing of list entries is limited for phone contacts and recent phone calls.
System Functionality	Editing the keypad code.
	Enabling Valet Mode.
	Editing settings while the rear view camera or active park assist are active.
Wi-Fi	Editing Wi-Fi settings.
	Editing the list of wireless networks.
	Connecting to a new Wi-Fi network.
Text Messages	Viewing received text messages.
Navigation	Using the keyboard to enter a destination.
	Adding or editing Navigation Favorites entries or Avoid Areas.

Creating a SYNC Owner Account

Why do I need a SYNC owner account?

- Essential for keeping up with the latest software and connected features.
- Access to customer support for any questions you may have.
- Maintain account permissions.

Visit the website to sign up and register.

Website
www.owner.ford.com www.syncmyride.ca

Website
www.syncmaroute.ca

FordPass™ Connect (If Equipped)

With a FordPass-equipped vehicle, you can use FordPass to track your vehicle's location and remotely access vehicle features such as start, lock and unlock and vehicle status including fuel level and approximate mileage. You can also schedule specific times to remotely start your vehicle so it's ready to hit the road as soon as you are. FordPass is available through a free download via the Apple App Store® or Google Play™. Message and data rates may apply. Services may be limited by mobile phone network coverage area.

Updating Your System

You can choose to download the update onto a USB drive or use Wi-Fi to deliver automatic updates.

USB Updates

To use the USB update you need to log into your owner account and visit the SYNC software update page.

Website
www.owner.ford.com www.syncmyride.ca www.syncmaroute.ca

The website notifies you if an update is available. You can then select to download the update.

You will need an empty USB drive. Please check the website for minimum requirements. Once you have inserted the USB drive into your computer, choose to start the download. Follow the instructions provided to download the files to the USB drive.

The installation of most files occurs in the background, and does not interrupt your use of the system. Navigation updates cannot be installed in the background, because the files are too large.

To install the update in your vehicle, remove anything that is plugged in the USB ports on the media hub and plug in the USB drive containing the update. When the USB drive is plugged in, the installation should begin immediately. After a successful installation, the update is available the next time the vehicle is started.

Please reference the website for any further actions.

Updating Over Wi-Fi

To update your System over Wi-Fi your vehicle must be connected to a Wi-Fi access point. Data rates may apply.

To connect your system to Wi-Fi, select:

Menu Item	
Settings	
Wi-Fi	
Available Wi-Fi Networks	You can then select your Wi-Fi network. You may have to enter the security code if the network is secured. The system confirms when it has connected to the network.

You must also give the system permission to update automatically. Upon vehicle delivery, the System asks you if you would like to use the automatic update feature. If you agree to automatic updates, you can press OK to confirm. If this selection does not appear upon vehicle delivery you can access it through the General Settings. See **Settings** (page 468). You can also perform a master reset. See **SYNC™ 3 Troubleshooting** (page 482).

SYNC™ 3

If you would like to switch this feature on later, select:

Menu Item	
Settings	
General	
Automatic System Updates	From this menu, you can enable automatic updates. If you have not done so already, the system prompts you to set up a Wi-Fi connection when you enable this feature.

When the system is connected via Wi-Fi and automatic updates are enabled, your system checks for software updates periodically. If a new version is available, it downloads at that time. Software downloads can take place for up to 30 minutes after you have switched your vehicle off. The updates do not interrupt the normal use of your SYNC 3 system. If a download does not complete for any reason, the download continues where it left off at the next Wi-Fi connected opportunity. Upon activation of an update, a banner displays on the touchscreen indicating the system update. Select the icon to see more detail. This icon displays for two ignition cycles.

To switch this feature off:

Menu Item	
Settings	
General	
Automatic System Updates	In this menu selection, you can change the selection for automatic updates to OFF.

Customer Assistance

The SYNC support team is available to help you with any questions you are not able to answer on your own.

Monday-Saturday, 8:30am-8:00pm EST.

United States: 1-800-392-3673.

Canada: 1-800-565-3673.

Mexico: 01-800-719-8466.

Times are subject to change due to holidays.

Privacy Information

When you connect a cellular phone to SYNC 3, the system creates a profile within your vehicle that links to that cellular phone. This profile helps in offering you more cellular features and operating more efficiently. Among other things, this profile may contain data about your cellular phone book, text messages (read and unread), and call history, including history of calls when your cell phone was not connected to the system. In addition, if you connect a media device, the system creates and retains an index of supported media content. The system also records a short diagnostic log of approximately 10 minutes of all recent system activity. The log profile and other system data may be used to improve the system and help diagnose any problems that may occur.

The cellular profile, media device index, and diagnostic log remain in your vehicle unless you delete them and are generally accessible only in your vehicle when the cellular phone or media player is connected.

If you no longer plan to use the system or your vehicle, we recommend you perform a Master Reset to erase all stored information. You can find more information about the Master Reset in General Settings. See **Settings** (page 468). System

SYNC™ 3

data cannot be accessed without special equipment and access to your vehicle's SYNC 3 module. Ford Motor Company, Ford of Canada and The Lincoln Motor Company do not access the system data for any purpose other than as described absent consent, a court order, or where

required by law enforcement, other government authorities, or other third parties acting with lawful authority. Other parties may seek to access the information independently of Ford Motor Company, Ford of Canada and The Lincoln Motor Company.

HOME SCREEN

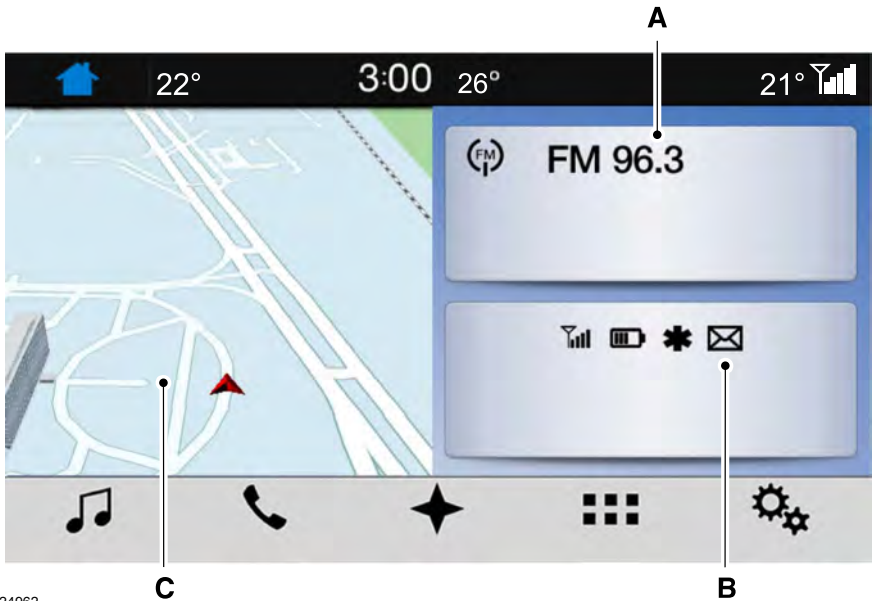

E224962

Item	Title	Home screen display
A	Audio	Shows the active media source.

SYNC™ 3

Item	Tile	Home screen display
		If your vehicle does not have navigation, this space contains the compass.
B	Phone	The name of the connected phone appears on the screen. The status of the phone features also appear. This includes signal strength, battery charge, text messaging and roaming.
C	Navigation *	This map displays your current location or current route in real time. When you have navigation active, you also see the next turn and the length of time and distance to your destination. If your vehicle does not have navigation, this space contains the audio information.

* If equipped.

You can touch any of the feature displays to access that feature.

Anytime you select the home button, the system returns you to this screen.

USING VOICE RECOGNITION

The SYNC 3 system allows you to use voice commands, to control features like audio and climate controls. By using voice commands, you can keep your hands on the wheel and your eyes on the road.

You can access each feature controlled by SYNC 3 through a variety of commands.



To activate the SYNC 3 voice commands push the voice button on the steering wheel and wait for the prompt.

___ is a dynamic listing, meaning that it can be the name of anything, such as artist, the name of contact or number. The context and the description of the command tell you what to say for this dynamic option.

There are some commands that work for every feature, these commands are:

Voice Command	Action and Description
Main Menu	Brings you to the main menu.
Go back	Returns you to the previous screen.
Cancel	Ends the voice session.
List of Commands	Gives you a list of possible voice commands.
___ List of Commands	You can name any feature and the system gives a list of commands available for the feature. For example, you could say:

SYNC™ 3

Voice Command	Action and Description
	Phone List of Commands
	Navigation List of Commands
Next Page	You can use this command to view the next page of options on any screen where multiple pages of choices are given.
Previous Page	You can use this command to view the previous page of options on any screen where multiple pages of choices are given.
Help	Gives you available commands you can use on the current screen.

Included here are some of the most popular commands for each SYNC 3 feature.

Audio Voice Commands

___ is a dynamic listing, meaning that for audio voice commands it can be the name of a Sirius channel or a channel number, a radio frequency number, or the name of an artist, album, song or a genre.

To control the media features, press the voice button and when prompted, say:

Voice command	Description
Sirius Channel ___ 1	You can say the Sirius channel name or number such as "Sirius channel 16".
You can also turn to a Sirius channel by saying the channel's name, such as "The Pulse".	
AM ___ FM ___	Allows you to tune to a specific FM or AM frequency such as "FM 88.7" or "AM 1580".
FM ___ HD ___ 1	Allows you to tune to a specific HD frequency such as "FM 88.7 HD 1".
Bluetooth Audio	Allows you to listen to music on your Bluetooth connected device.
USB	Allows you to listen to music on your USB connected device.
Play Genre ___ Play Playlist ___ Play Artist ___ Play Album ___	For USB audio only, you can say the name of an artist, album, song or a genre to listen to that selection. Your system must finish indexing before this option is available. For example, you could say "Play artist, The Beatles" or "Play song, Penny Lane".

SYNC™ 3

Voice command	Description
Play Podcast ____ Play Song ____ Play Audiobook ____	
Browse ____	For USB audio only, you can say the name of an artist, album, or a genre to browse by that selection. Your system must finish indexing before this option is available. For example you can say "Browse The Beatles" or "Browse folk".

¹ This option may not be available in all markets or may require a subscription.

Climate Voice Commands

You can control the temperature of the vehicle using voice commands.

____ is a dynamic listing, meaning that for climate voice commands it can be the desired degrees for the temperature setting.

To adjust the temperature, say:

Voice command	Description
Set Temperature ____	Adjust the temperature between 60–85°F (15.5–29.5°C).

Phone Voice Commands

Pairing a Phone

You can use voice commands to connect your Bluetooth enabled phone to the system.

To pair your phone, press the voice button and when prompted, say:

Voice command	Description
Pair Phone	Follow the on-screen instructions to complete the pairing process. See Settings (page 468).

Making Calls

____ is a dynamic listing, meaning that for phone voice commands it can be the name of the contact you wish to call or the digits you want to dial.

SYNC™ 3

Press the voice button and say a command similar to the following:

Voice command	Description
Call ___	Allows you to call a specific contact from your phonebook such as "Call Jenny".
Call ___ at ___	Allows you to call a specific contact from your phonebook at a specific location such as "Call Jenny at Home".
Dial ___	Allows you to dial a specific number such as "Dial 867-5309".

Please make sure that you are saying the contact name exactly as it appears in your contact list.

Once you have provided the digits of the phone number, you can say the following commands:

Voice Command	Description
<0-9>	If you did not enter the full number with the first command, you can continue saying the number.
Dial	Tells SYNC 3 to make the phone call.
Delete	Tells SYNC 3 to erase the last block of digits you state.
Clear	Tells SYNC 3 to erase the entire number.

Text Message Voice Commands

To access text message options, press the voice button and say:

Voice command	Description
Listen to Message	
Listen to text message ___	You can say the number of the message you would like to hear.
Reply to Message	

SYNC™ 3

Navigation Voice Commands (If Equipped)

Setting a Destination

You can use any of the following commands to set a destination or find a

point of interest.

___ is a dynamic listing, meaning that for navigation voice commands it can be a POI category or a major brand name, where major brand name is a chain with more than 20 locations

You can find an address, a point of interest (POI), or search for points of interest by category:

Voice command	Description
Find an Address	Allows you to enter the address search functionality. You can also search for an address in a specific state or province.
Find a ___	State the name of the POI category or major brand name you would like to search for such as "Find restaurants".
Find a POI	Allows you to enter the POI search functionality.
Find an Intersection	Allows you to enter the intersection search functionality.
Find the Nearest <POI Category>	State the name of a POI category or major brand name you would like to search for.
Show Previous Destinations	Allows you to see a list of your previous destinations.
Show Favorites	Allows you to see a list of your favorite destinations.
Drive Home	Allows you to route to your home address.
Drive to Work	Allows you to route to your work address.

In addition, you can say these commands when a route is active:

Voice command	Description
Cancel Route	Cancels the current route.
Detour	Allows you to select an alternate route.
Repeat Instruction	Repeats the last guidance prompt.
Show Route	Displays the active route.
Route Summary	Displays the list of upcoming maneuvers.

SYNC™ 3

Voice command	Description
Where Am I	Provides current location.
Zoom in	Allows you to zoom in on the map.
Zoom out	Allows you to zoom out from the map.

Mobile App Voice Commands (If Equipped)

The following voice commands are always available:

Voice command	Description
Mobile Apps	SYNC 3 will prompt you to say the name of an app to start it on SYNC 3.
List Mobile Apps	SYNC 3 will list all of the currently available Mobile Apps.
Find Mobile Apps	SYNC 3 will search and connect to compatible app(s) running on your mobile device.

There are also voice commands that you can use when app(s) are connected to SYNC 3:

Voice command	Description
Say the name of an app	At any time, you can say the name of a mobile app to start the mobile app on SYNC 3.
Say the name of an app, followed by help	SYNC 3 will list the available voice commands for the specified app if the app is running on SYNC 3.

SiriusXM Traffic and Travel Link Voice Commands (If Equipped)

SiriusXM Traffic and Travel Link may not be available in all markets. Activation and a subscription are required.

SYNC™ 3

You can say the following commands to access SiriusXM Traffic and Travel Link:

Voice command	Description
Show Traffic	Displays a list of traffic incidents.
Show Weather Map	Displays the current weather map.
Show Fuel Prices	Displays a list of fuel prices.
Show 5 Day Forecast	Displays the 5 day weather forecast.
Help	

Voice Settings Commands

You can say the following commands to access the voice settings:

Voice command	Description
Voice Settings	Allows you to enter the voice settings functionality.
Interaction Mode Standard	Sets standard prompting with longer prompts.
Interaction Mode Advanced	Sets advanced prompting with shorter prompts.
Call Confirmation On	Allows the system to confirm before making a phone call.
Call Confirmation Off	The system does not confirm before placing a call.
Voice Command Lists On	The system displays a short list of available commands.
Voice Command Lists Off	The system does not display the list of commands.

You can use the volume control to adjust the volume of the system voice prompts. While prompt is active, adjust the volume control up or down to your desired setting.

Note: Depending on the current climate control settings, the fan speed may automatically go down while issuing voice commands or while making and receiving phone calls via SYNC to reduce the amount of background noise in the vehicle. The fan speed will automatically return to normal operation once the voice session ends. You can adjust the fan speed during a voice session, simply press the fan buttons (or turn the fan knob) to increase or decrease the fan speed to the setting you prefer.

SYNC™ 3

To disable this automatic fan speed reduction feature during voice sessions, press and hold the climate control AC and Recirculated air buttons simultaneously, release and then increase fan speed within 2 seconds. To re-enable this feature, repeat the above sequence.

ENTERTAINMENT

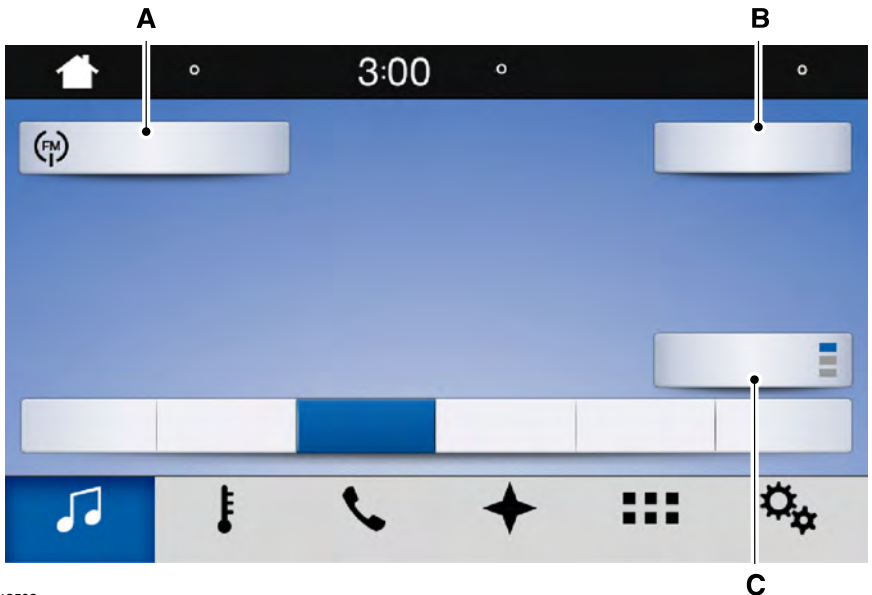

E242502

Message	Message and Description
A	Sources
B	Direct Tune
C	Presets

SYNC™ 3

Note: Your vehicle may allow you to save presets from different audio sources on the same page.

You can access these options using the touchscreen or voice commands.

Sources

Press this button to select the source of media you want to listen to.

Menu Item	
AM	
FM	
SIRIUS ¹	
CD ¹	
USB	The name of the USB that is plugged in displays here.
Bluetooth Stereo	
Apps	If you have SYNC 3 compatible apps on your connected smart phone, they display here as individual source selections.

¹ This feature may not be available in all markets and requires an active subscription.

AM/FM Radio

Tuning a Station

You can use the tune or seek controls on the radio bezel to select a station.

To tune a station using the touchscreen, select:

Menu Item
Direct Tune

A pop up appears, allowing you to type in the frequency of a station. You can only enter a valid station for the source you are currently listening to.

You can press the backspace button to delete the previously entered number.

Once you have entered the station's call numbers, you can select:

Menu Item	Action and Description
Enter	Press to begin playing the station you have entered.
Cancel	Press to exit without changing the station.

Presets

To set a new preset, tune to the station and then press and hold one of the memory preset buttons. The audio mutes briefly while the system saves the station and then returns.

SYNC™ 3

There are two preset banks available for AM and three banks for FM. To access additional presets, tap the preset button. The indicator on the preset button shows which bank of presets you are currently viewing.

SiriusXM® Satellite Radio (If Activated)

Note: *This feature may not be available in all markets and requires an active subscription.*



E234451

SiriusXM satellite radio is a subscription-based satellite radio service that broadcasts a variety of music, sports, news, weather, traffic and entertainment programming. Your factory-installed SiriusXM satellite radio system includes hardware and a limited subscription term that begins on the date of sale or lease of your vehicle. See an authorized dealer for availability.

For more information on extended subscription terms (a service fee is required), the online media player and a list of SiriusXM satellite radio channels, and other features, please visit www.siriusxm.com in the United States, www.siriusxm.ca in Canada, or call SiriusXM at 1-888-539-7474.

Note: *SiriusXM reserves the unrestricted right to change, rearrange, add or delete programming. This includes canceling, moving or adding particular channels, and its prices, at any time, with or without notice to you. We are not responsible for any such programming changes.*

Note: *This receiver includes the eCos real-time operating system. eCos is published under the eCos License.*

The following buttons are available for SiriusXM:

Menu Item	Action and Description	
Browse	Touch this button to see a list of available stations.	
Direct Tune	A pop-up appears, allowing you to type in the call numbers of a station. Once you enter the stations call numbers, you can select:	
	Enter	The system tunes to the station you select.
	Cancel	You exit the pop-up and the current station continues to play.
	You can press the backspace button to delete the previous number.	

SYNC™ 3

Menu Item	Action and Description	
Replay	Replay audio on the current channel. You can replay approximately 45 minutes of audio as long as you remain tuned to the current station. Changing stations erases the previous audio.	
	Live	When you are in replay mode, you are not able to select a different preset until you return to live audio. Pressing this button returns you to the live broadcast.
ALERT	Save the current song, artist, or team as a favorite. The system alerts you when it plays again on any channel. Selecting this button allows you to enable and edit alerts. See Settings (page 468).	

Memory Presets

To set a preset, tune to the station then press and hold one of the memory preset buttons. The audio mutes briefly while the system saves the station and returns once the station is stored.

There are three preset banks available for SiriusXM. To access additional presets, tap the preset button. The indicator on the preset button shows which bank of presets you are currently viewing.

Satellite Radio Electronic Serial Number (ESN)

You need your ESN to activate, modify or track your satellite radio account. See **Settings** (page 468).

SiriusXM Satellite Radio Reception Factors and Troubleshooting

Potential Reception Issues	
Antenna obstructions	For optimal reception performance, keep the antenna clear of snow and ice build-up and keep luggage and other materials as far away from the antenna as possible.
Terrain	Hills, mountains, tall buildings, bridges, tunnels, freeway overpasses, parking garages, dense tree foliage and thunderstorms can interfere with your reception.
Station overload	When you pass a ground-based broadcast-repeating tower, a stronger signal may overtake a weaker one and the audio system may mute.
Satellite radio signal interference	Your display may show ACQUIRING... to indicate the interference and the audio system may mute.

SYNC™ 3

Troubleshooting Tips		
Message	Cause	Action
Acquiring Signal	Radio requires more than two seconds to produce audio for the selected channel.	No action required. This message should disappear shortly.
Satellite antenna fault SIRIUS system failure	There is an internal module or system failure present.	If this message does not clear shortly, or with an ignition key cycle, your receiver may have a fault. See an authorized dealer for service.
Invalid Channel	The channel is no longer available.	Tune to another channel or choose another preset.
Unsubscribed Channel	Your subscription does not include this channel.	Contact SiriusXM at 1-888-539-7474 to subscribe to the channel, or tune to another channel.
Satellite acquiring signal...	The signal is lost from the SiriusXM satellite or SiriusXM tower to your vehicle antenna.	The signal is blocked. When you move into an open area, the signal should return.
Updating...	Update of channel programming in progress.	No action required. The process may take up to three minutes.
Questions? Call 1-888-539-7474	Your satellite service is no longer available.	Contact SiriusXM at 1-888-539-7474 to resolve subscription issues.
None found. Check channel guide.	All the channels in the selected category are either skipped or locked.	Use the channel guide to turn off the Lock or Skip function on that station.
SIRIUS Subscription updated	SiriusXM has updated the channels available for your vehicle.	No action required.

HD Radio™ Information (If Available)

Note: This feature may not be available in all markets.

To activate HD radio, please see the Radio Settings in the Settings Chapter. See **Settings** (page 468).

Note: HD Radio broadcasts are not available in all markets.

SYNC™ 3

HD Radio technology is the digital evolution of analog AM/FM radio. Your system has a special receiver that allows it to receive digital broadcasts (where available) in addition to the analog broadcasts, it already receives. Digital broadcasts provide a better sound quality than analog broadcasts with free, crystal-clear audio and no static or distortion. For more information, and a guide to available stations and programming, please visit:

Website
www.hdradio.com

When HD Radio is on and you tune to a station broadcasting HD Radio technology, you may notice the following indicators on your screen:



E142616

When HD Radio broadcasts are active, you can access the following functions:

Message	Action and Description
Presets	Allows you to save an active channel as a memory preset. Touch and hold a memory preset slot until the sound returns. There is a brief mute while the radio saves the station. Sound returns when the channel saves. When switching to an HD2 or HD3 memory preset, the sound mutes before the digital audio plays, because the system has to reacquire the digital signal.

Note: As with any station you save, you cannot access the saved station if your vehicle is outside the station's reception area.

The HD logo is grey when acquiring a digital station, and then changes to orange when digital audio is playing. When this logo is available, you may also see Title and Artist fields on-screen.

The multicast indicator appears in FM mode (only) if the current station is broadcasting multiple digital broadcasts. The highlighted numbers signify available digital channels where new or different content is available. HD1 signifies the main programming status and is available in analog and digital broadcasts. Other multicast stations (HD2 through HD7) are only available digitally.

Note: There is also an additional feature for stations that have more than 1 HD multicast (For example, HD1 or HD2). The HD logo and Radio text appears as a button. Pressing this button allows you to cycle through all of the HD stations on that specific frequency. For example, if you are on 101.1 and it has HD1, HD2, HD3, pressing the button repeatedly causes the radio to cycle through the HD stations in a cyclic increasing order.

SYNC™ 3

HD Radio Reception and Station Troubleshooting

Potential Reception Issues	
Reception area	If you are listening to a multicast station and you are on the fringe of the reception area, the station may mute due to weak signal strength.
	If you are listening to HD1, the system changes back to the analog broadcast until the digital broadcast is available again. However, if you are listening to any of the possible HD2-HD7 multicast channels, the station mutes and stays muted unless it is able to connect to the digital signal again.
Station blending	When the system first receives a station (aside from HD2-HD7 multicast stations), it first plays the station in the analog version. Once the receiver verifies the station is an HD Radio station, it shifts to the digital version. Depending on the station quality, you may hear a slight sound change when the station changes from analog to digital. Blending is the shift from analog to digital sound or digital back to analog sound.

In order to provide the best possible experience, use the contact form to report any station issues found while listening to a station broadcasting with HD Radio technology. Independent entities own and operate each station. These stations are responsible for ensuring all audio streams and data fields are accurate.

Potential Station Issues		
Issues	Cause	Action
Echo, stutter, skip or repeat in audio. Increase or decrease in audio volume.	This is poor time alignment by the radio broadcaster.	No action required. This is a broadcast issue.
Sound fading or blending in and out.	The radio is shifting between analog and digital audio.	No action required. The reception issue may clear up as you continue to drive.
There is an audio mute delay when selecting HD2 or HD3, multicast preset or Direct Tune.	The digital multicast is not available until the HD Radio broadcast is decoded. Once decoded, the audio is available.	No action required. This is normal behavior. Wait until the audio is available.

SYNC™ 3

Potential Station Issues		
Issues	Cause	Action
Cannot access HD2 or HD3 multicast channel when recalling a preset or from a direct tune.	The previously stored multicast preset or direct tune is not available in your current reception area.	No action required. The station is not available in your current location.
Text information does not match currently playing audio.	Data service issue by the radio broadcaster.	Fill out the station issue form. ¹
There is no text information shown for currently selected frequency.	Data service issue by the radio broadcaster.	Fill out the station issue form. ¹

¹ You can find the form here:

Website
http://hdradio.com/stations/feedback

HD Radio Technology manufactured under license from iBiquity Digital Corporation and foreign patents. HD Radio and the HD and HD Radio logos are proprietary trademarks of DTS. The vehicle manufacturer and DTS are not responsible for the content sent using HD Radio technology. Content may be changed, added or deleted at any time at the station owner's discretion.

CD (If equipped)

Once you select this option, the system returns you to the main audio screen.

The current audio information appears on the screen.

The following buttons are also available:

Button	Function
Browse	You can use the browse button to select a track.
Repeat	Select this button and a small number one displays to indicate the track is set to repeat.

SYNC™ 3

Button	Function
	For MP3 CDs, this button allows you to toggle through repeat off, repeat one track (a small number one displays), and repeat current folder (a small folder displays).
Shuffle	Select the shuffle symbol to have the audio on the disk play in random order.

You can use the forward, reverse, pause or play buttons to control the audio playback.

Bluetooth Stereo or USB

Bluetooth Stereo and USB allow you to access media that you store on your Bluetooth device or USB device such as music, audio books or podcasts.

The following buttons are available for Bluetooth and USB:

Button	Function
Repeat	Pressing the repeat button toggles the repeat setting through three modes: repeat off (button not highlighted), repeat all (button highlighted) and repeat track (button highlighted with a small number one).
Shuffle	Play the tracks in random order.

You can use the forward, reverse, pause or play buttons to control the audio playback.

To get more information about the currently playing track, press the cover art or Info button.

For some devices, SYNC 3 is able to provide 30-second skip buttons when you listen to audio books or podcasts. These buttons allow you to skip forward or backward within a track.

While playing audio from a USB device you can look for certain music by selecting the following:

Button	Function
Browse	If available, displays the list of tracks in the Now Playing playlist.
New Search	This option, which is available under browse, allows you to play all tracks or to filter the available media into one of the below categories.
	Play All

SYNC™ 3

Button	Function
	Playlists
	Artist
	Albums
	Songs
	Genres
	Podcasts
	Audio books
	Composers
A-Z Jump	This button allows you to choose a specific letter to view within the category you are browsing.
Explore Device	If available, this allows you to browse the folders and files on your USB device.

USB Ports

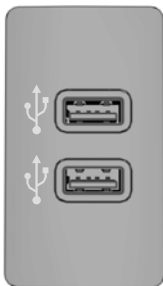

E211463

The USB ports are in the center console or behind a small access door in the instrument panel.

This feature allows you to plug in USB media devices, memory sticks, flash drives or thumb drives, and charge devices if they support this feature.

Select this option to play audio from your USB device.

Apps

The system supports the use of certain audio apps such as iHeartRadio through a USB or Bluetooth enabled device.

Each app gives you different on-screen options depending on the app's content. See **Apps** (page 465).

Supported Media Players, Formats and Metadata Information

The system is capable of hosting nearly any digital media player, including iPod, iPhone, and most USB drives.

Supported audio formats include MP3, WMA, WAV, AAC, and FLAC.

Supported audio file extensions include MP3, WMA, WAV, M4A, M4B, AAC, and FLAC.

SYNC™ 3

Supported USB file systems include: FAT, exFAT, and NTFS.

SYNC 3 is also able to organize the media from your USB device by metadata tags. Metadata tags, which are descriptive software identifiers embedded in the media files, provide information about the file.

If your indexed media files contain no information embedded in these metadata tags, SYNC 3 may classify the empty metadata tags as unknown.

SYNC 3 is capable of indexing up to 50,000 songs per USB device, for up to 10 devices.

CLIMATE

Touch the climate button on the touchscreen to access your climate control features.

Note: You can switch temperature units between Fahrenheit and Celsius. See **Settings** (page 468).

Accessing the Climate Control Menu



Touch the button to access additional controls for the front climate system.

Directing the Airflow



Touch the button to direct airflow to the windshield air vents and de-mister.



Touch the button to direct airflow to the instrument panel air vents.



Touch the button to direct airflow to the footwell air vents.

You can direct air through any combination of these air vents.

Setting the Blower Motor Speed



Touch up or down to increase or decrease the volume of air that circulates in your vehicle.

Setting the Temperature

Touch up or down on the left-hand temperature control to set the left-hand temperature.

Note: This control also adjusts the right-hand side temperature when you switch off dual zone mode.

Touch up or down on the right-hand temperature control to set the right-hand temperature.

Switching Auto Mode On and Off



Touch the button to switch on automatic operation, then set the temperature.

The system adjusts the blower motor speed, air distribution, air conditioning operation, and outside or recirculated air to reach and maintain the temperature you have set.

Switching the Air Conditioning On and Off



A pop-up appears on the screen to display the air conditioning options.

MAX A/C: Touch the button to activate and maximize cooling. The driver and passenger temperatures are set to LO, recirculated air flows through the instrument panel vents, air conditioning automatically turns on and the fan automatically adjusts to the highest speed.

A/C: Touch to switch the air conditioning on or off. Use A/C with recirculated air to improve cooling performance and efficiency.

Note: In certain conditions, such as maximum defrost, the air conditioning compressor may continue to operate even though you switch off the air conditioning.

Switching the Climate Control On and Off



Touch the button.

Switching the Climate Controlled Seats On and Off



Touch the button to cycle through the various climate controlled seat settings and off.

Switching Dual Zone Mode On and Off



Touch the button to switch on temperature control for the right-hand side of the vehicle.

Switching the Heated Exterior Mirrors On and Off



Touch the button.

Switching the Heated Rear Window On and Off



Touch the button to clear the rear window of thin ice and fog.

Switching the Heated Seats On and Off



Touch the button to cycle through the various heat settings and off.

Switching the Heated Steering Wheel On and Off



Touch the button.

Switching Maximum Air Conditioning On and Off



Touch the button for maximum cooling.

Recirculated air flows through the instrument panel air vents, air conditioning turns on and the blower motor adjusts to the highest speed.

Switching Maximum Defrost On and Off



Touch the button for maximum defrosting.

Air flows through the windshield air vents, and the blower motor adjusts to the highest speed.

You can also use this setting to defog and clear the windshield of a thin covering of ice.

Note: To prevent window fogging, you cannot select recirculated air when maximum defrost is on.

Note: The heated rear window also turns on when you select maximum defrost.

Switching Recirculated Air On and Off



Touch the button to switch between outside air and recirculated air.

The air currently in the passenger compartment recirculates. This may reduce the time needed to cool the interior, when used with **A/C**, and reduce unwanted odors from entering your vehicle.

Note: Recirculated air may turn off, or prevent you from switching on, in all air flow modes except **MAX A/C** to reduce the risk of fogging. Recirculation may also turn on and off in various air distribution control combinations during hot weather to improve cooling efficiency.

Switching the Ventilated Seats On and Off



Touch the button to cycle through the various ventilated seat settings and off.

Accessing Rear Climate Controls



Touch the button to access additional controls for the rear climate system.

Rear Climate Control Lock Indicator



Touch the button. When on, you can only operate the rear passenger settings through the front controls.

Switching Rear Auto Mode On and Off



Touch the button to switch on rear automatic operation, then set the temperature.

Switching the Rear Climate Controlled Seats On and Off



Touch the button to cycle through the various climate controlled seat settings and off.

Switching the Rear Heated Seats On and Off



Touch the button to cycle through the various heat settings and off.

Switching the Rear Ventilated Seats On and Off



Touch the button to cycle through the various ventilated seat settings and off.

PHONE



WARNING: Driving while distracted can result in loss of vehicle control, crash and injury. We strongly recommend that you use extreme caution when using any device that may take your focus off the road. Your primary responsibility is the safe operation of your vehicle. We recommend against the use of any hand-held device while driving and encourage the use of voice-operated systems when possible. Make sure you are aware of all applicable local laws that may affect the use of electronic devices while driving.

Hands-free calling is one of the main features of the system. Once you pair your cell phone, you can access many options using the touchscreen or voice commands. While the system supports a variety of features, many are dependent on your cell phone's functionality.

Pairing Your Cell Phone for the First Time

Pair your Bluetooth enabled phone with the system before using the functions in hands-free mode.

SYNC™ 3

Switch on Bluetooth on your device to begin pairing. See your phone's manual if necessary.

To add a phone, select:

Menu Item
Add a Bluetooth Device

1. Follow the on-screen instructions.
2. A prompt alerts you to search for the system on your phone.
3. Select your vehicle on your phone.
4. Confirm that the six-digit number appearing on your phone matches the six-digit number on the touchscreen.
5. The touchscreen indicates when the pairing is successful.
6. Your phone may prompt you to give the system permission to access information. To check your phone's compatibility, see your phone's manual or visit the website.

Alternatively, to add a phone, select:

Menu Item
Add a Bluetooth Device
Then select:
Discover Other Bluetooth Devices

1. Follow the on-screen instructions.
2. Select your phone's name when it appears on the touchscreen.
3. Confirm that the six-digit number appearing on your phone matches the six-digit number on the touchscreen.
4. The touchscreen indicates when the pairing is successful.
5. Your phone may prompt you to give the system permission to access information. To check your phone's compatibility, see your phone's manual or visit the website.

At a minimum, most cell phones with Bluetooth wireless technology support the following functions:

- Answering an incoming call.
- Ending a call.
- Dialing a number.
- Call waiting notification.
- Caller identification.

Other features, such as text messaging using Bluetooth and automatic phonebook download, are phone-dependent features.

Phone Menu

This menu becomes available after pairing a phone.

SYNC™ 3

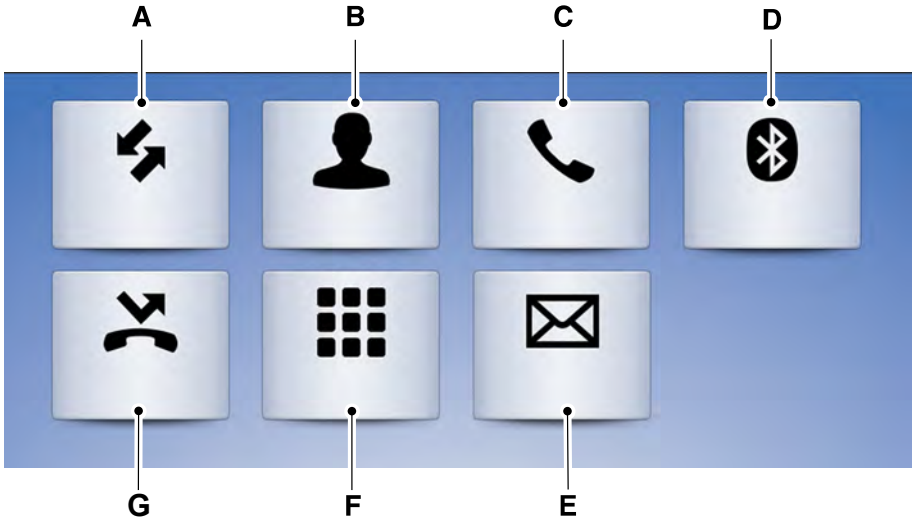

E251249

Item	Menu Item	Action and Description			
A	Recent Call List	Displays your recent calls. You can place a call by selecting an entry from this list. You can also sort the calls by selecting the drop down menu at the top of the screen. You can choose:			
		All	Incoming	Outgoing	Missed
B	Contacts	All of your contacts from your phone display in alphabetical order.			
		A-Z Jump		Selecting this button allows you to choose a specific letter to view.	
C	Phone Settings	Displays the name of your phone and takes you to the phone settings options. From this menu, you can pair subsequent devices, set ring tones and alerts.			

SYNC™ 3

Item	Menu Item	Action and Description
D	Change Device	Gives you access to the list of paired or connected Bluetooth devices allowing you to change or select a device.
E	Text Messages	Displays all recent text messages.
F	Phone Keypad	Use this keypad to dial in a phone number. Use the backspace button to delete numbers.
		Call
G	Do Not Disturb	Touch this button to reject all incoming calls automatically. Text message notifications do not display on the screen. All ringtones and alerts are set to silent.

Users with phones having voice services may see a button to access the feature. For example, iPhone users see a Siri button. A press and hold of the voice button on the steering wheel also accesses this feature.

Making Calls

There are many ways to make calls from the SYNC 3 system, including using voice commands. See **Using Voice Recognition** (page 432). You can use the touchscreen to place calls as well.

To call a number in your contacts, select:

Menu Item	Action and Description
Contacts	You can then select the name of the contact you want to call. Any numbers stored for that contact display along with any stored contact photos. You can then select the number that you want to call. The system begins the call.

To call a number from your recent calls, select:

Menu Item	Action and Description
Recent Call List	You can then select an entry that you want to call. The system begins the call.

To call a number that is not stored in your phone, select:

Menu Item	Action and Description
Phone Keypad	Select the digits of the number you wish to call.
Call	The system begins the call.

Pressing the backspace button deletes the last digit you typed.

Receiving Calls

During an incoming call, an audible tone sounds. Caller information appears in the display if it is available.

To accept the call, select:

Menu Item
Accept

Note: You can also accept the call by pressing the phone button on the steering wheel.

To reject the call, select:

Menu Item
Reject

Note: You can also reject the call by pressing the phone button on the steering wheel.

Ignore the call by doing nothing. SYNC 3 logs it as a missed call.

During a Phone Call

During a phone call, the contacts name and number display on the screen along with the call duration.

The phone status items are also visible:

- Signal Strength.
- Battery.

You can select any of the following during an active phone call:

SYNC™ 3

Item	
End Call	Immediately end a phone call. You can also press the button on the steering wheel.
Keypad	Press this to access the phone keypad.
Mute	You can switch the microphone off so the caller does not hear you.

Item	
Privacy	Transfer the call to the cell phone or back to SYNC 3.

Text Messaging

Note: Downloading and sending text messages using Bluetooth are cell phone-dependent features.

Note: Certain features in text messaging are speed-dependent and not available when your vehicle is traveling at speeds over 3 mph (5 km/h).

Receiving a Text Message

When a new message arrives, an audible tone sounds and the screen displays a pop-up with the sender name and ID, if supported by your cell phone. You can select:

Menu Item	Action and Description
Hear It	Have SYNC 3 read the message to you.
View	View the text on the touchscreen.
Call	To call the sender.
Reply	You can select from 15 preset messages. Press the message that you would like to use and confirm to send the message. SYNC 3 confirms when the message is sent successfully.
Close	To exit the screen.

Smartphone Connectivity (If Equipped)

SYNC 3 allows you to use Apple CarPlay and Android Auto to access your phone.

When you use Apple CarPlay or Android Auto, you can:

- Make calls.
- Send and receive messages.
- Listen to music.
- Use your phone's voice assistant.

Apple CarPlay and Android Auto disable some SYNC 3 features.

Most Apple CarPlay and Android Auto features use mobile data.

Apple CarPlay

Apple CarPlay requires an iPhone 5 or newer with iOS 7.1 or newer. Updating to the latest iOS version is recommended.

1. Plug your phone into a USB port. See **USB Port** (page 401).

SYNC™ 3

2. Follow the prompts on the touchscreen.
3. Follow the prompts that appear on your phone to allow access to Apple CarPlay.

After completing the setup, your phone connects to CarPlay automatically when plugged into a USB port.

To disable this feature from the Settings screen, select:

Menu Item
Apple CarPlay Preferences
Your device is listed if SYNC detects Apple CarPlay. Select the name of your device and set the Apple CarPlay switch to off.

To return to SYNC 3, go to the Apple CarPlay home screen and select the SYNC app.

Note: Contact Apple for Apple CarPlay support.

Android Auto

Android Auto is compatible with most devices with Android 5.0 or newer.

1. Download the Android Auto app to your device from Google Play to prepare your device (this may require mobile data usage).

Note: The Android Auto App may not be available within your current market.

2. Plug your device into a USB port. See **USB Port** (page 401).
3. Follow the prompt on the touchscreen.
4. Follow the prompts that appear on your device.

Note: You may be prompted to update additional apps on your device (this may require mobile data usage).

To disable this feature from the Settings screen, select:

Menu Item
Android Auto Preferences
Your device is listed if SYNC detects Android Auto. Select the name of your device and set the Android Auto switch to off.

Note: You may need to slide your Settings screen to the left to select **Apple CarPlay Preferences** or **Android Auto Preferences**.

To return to SYNC 3, select the speedometer icon in the Android Auto menu bar at the bottom of the touchscreen, and then touch the option to return to SYNC.

Note: Contact Google for Android Auto support.

NAVIGATION (IF EQUIPPED)

Your navigation system is comprised of two main features, destination mode and map mode.

Map Mode

Map mode shows advanced viewing comprised of 2D city maps, 3D landmarks and 3D city models (when available). 2D city maps show detailed outlines of buildings, visible land use, landscape features, and detailed railroad infrastructure for the most essential cities around the globe.

3D landmarks appear as clear, visible objects that are typically recognizable and have a certain tourism value.

3D city models are complete 3D models of entire city areas including navigable roads, parks, rivers and rendered buildings. 3D landmarks and city models appear in 3D map mode only. Coverage of these varies and improves with updated map releases.



Select the zoom in icon to see a closer view of the map.



Select the zoom out icon to see a farther away view of the map.

You can adjust the view in preset increments. You can also pinch to zoom in or out of the map.

The information bar tells you the names of streets, cities or landmarks as you hover over them with the crosshair cursor.

You can change your view of the map by tapping on the location indicator icon on the right hand side of the screen. You can choose from the following options:



Heading up (2D map) This always shows the direction of forward travel to be upward on the screen. This view is available for map scales up to 3 mi (5 km).

N



North up (2D map) always shows the northern direction to be upward on the screen.

3D



3D map mode provides an elevated perspective of the map. Adjust this viewing angle and rotate the map 180 degrees by touching the map twice, and

then dragging your finger along the shaded bar with arrows at the bottom of the map.



Re-center the map by pressing this icon whenever you scroll the map away from your vehicle's current location.



Mute: Press to mute the audio navigation guidance. Press the button again to un-mute the guidance.



Points of Interest (POI)

grouping icon: You can choose up to three POI icons to display on the map. If the chosen POIs are located close together or are

at the same location a box is used to display a single category icon instead of repeating the same icon, in order to reduce clutter. When you select the box on the map, a pop-up appears indicating how many POIs are in this location. Select the pop up to see a list of the available POIs. You can scroll through and select POIs from this list.

If your vehicle is low on charge or fuel, station icons automatically display on the map.

If you have subscribed to SiriusXM Traffic and Travel Link (where available), traffic flow will be indicated on the map by green (clear), yellow (slowing), and red (stopped) road highlights. Traffic flow is indicated where the information is available and varies across the US.

You can choose to display traffic icons on the map representing twelve different types of incidents. See **Settings** (page 468).

You can set a destination by hovering above a location and selecting:

SYNC™ 3

Button

Button
Start

Destination Mode

To set a destination, press:

Menu Item	Description
Destination	Enter a navigation destination in any of the following formats:
Search	Street Address (number, street, city, state) For example "12 Mainstreet Dearborn MI"
	Partial Address (number, street) if searching in current state (number, street and zip code (or postal code in Canada)) if searching out of state You can enter unique addresses that contain door number prefixes with or without the prefix. For example, you could enter "6N340 Fairway Lane" or "340 Fairway Lane".
	City (name or zip code)
	Point of Interest (name or category)
	Intersection (street 1 / street 2) (street 1 and street 2) (street 1 & street 2) (street 1 @ street 2) (street 1 at street 2)
	Latitude and Longitude (##.##### , ##.#####) This is in a decimal degrees format, one to six decimal places are accepted.
	You are given autocomplete options below the address bar to select as you type.

SYNC™ 3

Menu Item	Description	
	If you do not give an exact destination, a menu displays with your possible selections.	
Previous Destinations	Collections of your last 40 navigation destinations display here. You can select any option from the list to select it as your destination.	
	Delete All	Select this option to remove all previous destinations.
Home	Select to navigate to your set Home destination. The time it takes to travel from your current location to Home displays. To set your Home, press:	
	Home	A prompt appears asking if you would like to create a favorite for home. Select:
	Yes	Enter a location into the search bar and press:
	Save	
Work	Select to navigate to your set Work destination. The time it takes to travel from your current location to Work displays. To set your Work:	
	Work	A prompt appears asking if you would like to create a favorite for work. Select:
	Yes	Enter a location into the search bar and press:
	Save	
Favorites	Favorites include any location you have previously saved. To add Favorites:	
	Add a Favorite	Select this button and enter a location into the destination bar.
	Search	Select this option to have the system locate the address you have entered.
	Save	Select this button when the address you have entered appears on the screen.
	The address saves as a favorite and you see the favorites screen. You can now select this address from the favorites screen.	
Point of Interest (POI) Categories	POI categories that may display (based on market and vehicle configuration):	
	Food	

SYNC™ 3

Menu Item	Description
	Fuel
	Hotel
	ATM
See All	Press to view additional categories. Once you have selected a category, follow the menus to find what you are looking for.
	Inside of these categories you can search by:
	Nearby
	Along Route
	Near Destination
	In a City

Once you have chosen your destination, press:

Menu Item	Action and Description	
Save	This saves the destination to your favorites.	
Start	This shows you a map of your entire route. You can then choose your route from three different options.	
	Fastest	Uses the fastest moving roads possible.
	Shortest	Uses the shortest distance possible.
	Economical Route	Uses the most fuel-efficient route.
	The time and distance for each route also displays.	
Cancel	On the route screen, you can choose to cancel the current navigation. The system asks for confirmation then returns you to the map mode screen.	

Once you have chosen your destination, press:

Menu Item	Action and Description
Start	The system uses a variety of screens and prompts to guide you to your destination.

SYNC™ 3

Menu Item	Action and Description
	<p>During Route guidance, you can press the maneuver arrow icon on the map if you want the system to repeat route guidance instructions. When the system repeats the last guidance instruction, it updates the distance to the next guidance instruction, since it detects that the vehicle is moving.</p> <p>The navigation map shows your estimated time of arrival, remaining travel time and the distance to your destination.</p> <p>SYNC 3 may not always announce vehicle arrival at the exact point of your destination and you may have to cancel a route manually.</p>

Navigation Menu

In map mode and during active navigation you can access the navigation menu.

During active navigation, touch the bottom of the screen to view the menu and other buttons.

To access the Navigation menu, press:

Button			
Menu			
You can then select:			
Screen View	Full Map	A full screen map displays during navigation.	
	Highway Exit Info	<p>Highway exit information displays on the right hand side of the screen during navigation.</p> <p>Points of interest icons display for restaurants, hotels, fuel stations and ATMs when they are present at the exit. You can select the POI icons to receive a listing of specific locations. You can select the POI location as a waypoint or destination if desired.</p>	
	Turn List	<p>Only available during an active route. Displays all of the turns on the current route.</p> <p>You can choose to avoid any road on the turn list by selecting the road from the list. A screen then appears and you can press:</p> <table border="1" data-bbox="384 1099 970 1203"> <tr> <td data-bbox="384 1099 476 1136">Avoid</td> <td data-bbox="479 1099 970 1203">The system calculates a new route and displays a new turn list.</td> </tr> </table>	Avoid
Avoid	The system calculates a new route and displays a new turn list.		
Traffic List	You can find the SiriusXM Traffic and Travel Link information by pressing this button. This information requires an active subscription to SiriusXM Traffic and Travel Link.		

SYNC™ 3

Button				
	When a route is not active, a list of nearby traffic incidents displays (if any are present). When a route is active, you can choose to display a list of traffic nearby or on the route.			
Navigation Settings	Press this button to adjust your preferences. See Settings (page 468).			
Where Am I?	Provides your current location city and the nearest road.			
The following are only available on the menu during an active navigation route:				
Cancel Route	The system asks for confirmation and then returns you to the map mode screen.			
View Route	Press this to see a map of the full route.			
Detour	An alternate route displays in comparison with the current route.			
Edit Waypoints	Only available if you have an active waypoint on your route. See Waypoints later in this section for information on how to set waypoints.			
	Use this button to re-order or remove your waypoints.			
	<table border="1" style="width: 100%;"> <tr> <td style="width: 30%;">You can also have the system set the order for you by pressing:</td> <td>Optimize Order</td> </tr> <tr> <td>To return to your route press:</td> <td>Go</td> </tr> </table>	You can also have the system set the order for you by pressing:	Optimize Order	To return to your route press:
You can also have the system set the order for you by pressing:	Optimize Order			
To return to your route press:	Go			

Waypoints

You can add a waypoint to a navigation route as a destination along your route.

To add a waypoint:

1. Select the search icon (magnifying glass) while on an active route. This brings up the destination menu.
2. Set your destination using any of the given methods. Once the destination has been selected, the screen allows you to set the destination as a waypoint by selecting:

SYNC™ 3

Menu Item	
Add Waypoint	The waypoint list then appears and you are able to re-order all of your waypoints by selecting the menu icon on the right hand side of the location. You can select up to five waypoints.
You can also have the system set the order for you by pressing:	Optimize Order
To return to your route, press:	Go

SYNC AppLink

The AppLink app allows you to use some SYNC 3 navigation features on your phone.

First Mile Navigation

When you switch your ignition off, the location of your vehicle is recorded and sent to your SYNC AppLink app. The location of your vehicle can be viewed within the app. You can also view walking directions to your vehicle.

Last Mile Navigation

When you park near your destination, the system provides walking directions to your destination.

POI Search

Your paired phone can be used to access additional points of interest (POI). These points of interest can only be accessed when your phone is paired.

Send To Car

You can send destinations to your navigation system using a computer or phone using AppLink.

cityseeker (If Equipped)

Note: *cityseeker point of interest (POI) information is limited to approximately 1,110 cities (1,049 in the United States, 36 in Canada and 15 in Mexico).*



E225487

cityseeker, when available, is a service that provides more information about certain points of interest such as restaurants, hotels and attractions.

When you have selected a point of interest, the location and information appear, such as address, phone number and a star rating.

Press **More Information** to see a photo, a review, a list of services and facilities, the average room or meal price and the web address. This screen displays the point of interest icons.

SYNC™ 3

For restaurants, cityseeker can provide information such as star rating, average cost, review, handicap access, hours of operation, and website address.

For hotels, cityseeker can provide information such as star rating, price category, review, check-in and checkout times, hotel service icons and website address. Hotel service icons include:

- Restaurant
- Business center
- Handicap facilities
- Laundry
- Refrigerator
- 24 hour room service
- Fitness center
- Internet access
- Pool
- Wi-Fi

Attractions include nearby landmarks, amusement parks, historic buildings and more. cityseeker can provide information such as star rating, reviews, hour of operation and admission price.

SiriusXM Traffic and Travel Link (if Equipped)

SiriusXM Traffic and Travel Link is available on vehicles equipped with navigation and only in select markets. You must activate and subscribe to receive SiriusXM Traffic and Travel Link information. It helps you locate the best gas prices, find movie listings, get current traffic alerts, view the weather map, get accurate ski conditions and see current sports scores. See **Apps** (page 465).

The system calculates a reasonable efficient route based on available speed limits, traffic, and road conditions. You may know a local short cut that is more efficient at a given time than the route provided by SYNC 3, but you should expect a slight difference in minutes or miles with the SYNC 3 route.

Navigation Map Updates

Annual navigation map updates are available for purchase through your dealership, by calling 1-866-462-8837 in the United States and Canada or 01-800-557-5539 in Mexico. You can also visit:

Website
www.navigation.com/sync

You need to specify the make and model of your vehicle to determine if there is an update available.

HERE is the digital map provider for the navigation application. If you find map data errors, you may report them directly to HERE by going to www.here.com/mapcreator. HERE evaluates all reported map errors and responds with the result of their investigation by e-mail.

Map coverage includes the USA (including Puerto Rico and the US Virgin Islands), Canada and Mexico.

APPS

The system enables voice, steering wheel, and touch screen control of SYNC 3 AppLink enabled smartphone apps.

Once an app is running through AppLink, you can control main features of the app through voice commands and steering wheel controls.

SYNC™ 3

Note: Available AppLink enabled apps will vary by market.

Note: You must pair and connect your smartphone via Bluetooth to SYNC 3 to access AppLink.

Note: iPhone users need to connect the phone to the USB port.

Note: For information on available apps, supported smartphone devices and troubleshooting tips please visit:

Websites
owner.ford.com www.syncmyride.ca www.syncmaroute.ca

Note: Make sure you have an active account for the app that you have downloaded. Some apps will work automatically with no setup. Other apps will want you to configure your personal settings and personalize your experience by creating stations or favorites. We recommend you do this at home or outside of your vehicle.

Note: We encourage you to review the smartphone app's terms of service and privacy policies because Ford is not responsible for your app or its use of data.

Note: AppLink is a native SYNC system feature. Accessing mobile apps through AppLink is only possible when Android Auto or Apple CarPlay are disabled. Some apps may only be accessible in the car through AppLink and others only through Android Auto or Apple CarPlay. Please refer to the Smartphone Connectivity information to disable Android Auto or Apple CarPlay.

Note: In order to use an app with SYNC 3, the app needs to be running in the background of your phone. If you shut down the app on your phone, it shuts down the app on SYNC 3 as well.

Note: If a SYNC 3 AppLink compatible app is not shown in the Apps Domain, make sure the required app is running on the mobile device.

Menu Item	Action and Description
Find Mobile Apps	SYNC 3 will search and connect to compatible app(s) running on your mobile device.

Enabling SYNC 3 Mobile Apps

In order to enable mobile apps, SYNC 3 requires user consent to send and receive app authorization information and updates using the data plan associated with the connected device.

The connected device sends data to Ford in the United States. The information is encrypted and includes your VIN, SYNC 3 module number, odometer, usage statistics and debugging information. We retain this data for only as long as necessary to provide this service, troubleshoot, and improve products and services and to offer you products and services that may interest you where allowed by law.

Note: You must enable mobile apps for each connected device the first time you select a mobile app using the system.

Note: Ford reserves the right to limit functionality or deactivate mobile apps at any time.

Note: Standard data rates apply. Ford is not responsible for any additional charges you may receive from your service provider, when your vehicle sends or receives data through the connected device. This includes any additional charges incurred due to driving in areas when roaming out of a home network.

You can enable and disable apps through settings. See **Settings** (page 468).

App Permissions

The system organizes the App permissions into groups. You can grant these group permissions individually. You can change a permission group status any time when not driving, by using the settings menu. While in the settings menu, you can also see the data included in each group.

When you launch an app using SYNC 3, the system may ask you to grant certain permissions, for example Vehicle information, Driving characteristics, GPS and Speed, and/or Push notifications. You can enable all groups or none of them during the initial app permissions prompts. The settings menu offers individual group permission control.

Note: You are only prompted to grant permissions the first time you use an app with SYNC 3.

Note: If you disable group permissions, apps will still be enabled to work with SYNC 3 unless you deactivate All Apps in the settings menu.

SiriusXM Traffic and Travel Link (if Equipped)



WARNING: Driving while distracted can result in loss of vehicle control, crash and injury. We strongly recommend that you use extreme caution when using any device that may take your focus off the road. Your

primary responsibility is the safe operation of your vehicle. We recommend against the use of any hand-held device while driving and encourage the use of voice-operated systems when possible. Make sure you are aware of all applicable local laws that may affect the use of electronic devices while driving.

Note: *SiriusXM Traffic and Travel Link may not be available in all markets.*

Note: *In order to use SiriusXM Traffic and Travel Link, your vehicle must have navigation.*

Note: *A paid subscription is required to access and use these features. Go to www.siriusxm.com/travellink for more information.*

Note: *Visit www.siriusxm.com/traffic and click on Coverage map and details for a complete listing of all traffic areas covered by SiriusXM Traffic and Travel Link.*

Note: *Neither Sirius nor Ford is responsible for any errors or inaccuracies in the SiriusXM Traffic and Travel Link services or its use in vehicles.*

When you subscribe to SiriusXM Traffic and Travel Link, it can help you locate the best gas prices, find movie listings, get current traffic alerts, view the current weather map, get accurate ski conditions and see scores to current sports games.

SYNC™ 3

Menu Item	Action and Description	
Traffic on Route	Touch these buttons to identify traffic incidents on your route, near your vehicle's current location or near any of your favorite places, if programmed.	
Traffic Nearby		
Fuel Prices	Touch this button to view fuel prices at stations close to your vehicle's location or on an active navigation route.	
Movie Listings	Touch this button to view nearby movie theaters and their show times, if available.	
Weather	Touch this button to view the nearby weather, current weather, or the five-day forecast for the chosen area.	
	Map	Select to see the weather map, which can show storms, radar information, charts and winds.
	Area	Select to choose from a listing of weather locations.
Sports Info	Touch this button to view scores and schedules from a variety of sports. You can also save up to 10 favorite teams for easier access. The score automatically refreshes when a game is in progress.	
Ski Conditions	Touch this button to view ski conditions for a specific area.	

Sound

Pressing this button allows you to adjust the following:

SETTINGS

Under this menu, you can access and adjust the settings for many of the system features. To access additional settings, swipe the screen left or right.

Sound Settings	
Reset All	Returns Treble, Midrange, and Bass sound settings to factory levels.
Treble	Adjusts the high frequency level.
Midrange	Adjusts the middle frequency level.
Bass	Adjusts the low frequency level.
Balance / Fade	Adjusts the sound ratio from side to side or front to back.

SYNC™ 3

Sound Settings	
Speed Compensated Vol.	Adjusts the amount the audio system volume increases with speed, or turns the feature off.
Occupancy Mode	Optimizes the sound based on the location of the listeners.
Sound Settings	Stereo
	Surround

Your vehicle might not have all of these features.

Media Player

This button is available when a media device such as a Bluetooth Stereo or USB device is the active audio source. Pressing the button allows you to access the following options for active devices only.

Menu Item	Action and Description		
Podcast Speed	For some USB devices, SYNC 3 can adjust the playback speed of podcasts. When a podcast is playing, you can choose:		
	Slower	Normal	Faster
Audiobook Speed	For some USB devices, SYNC 3 can adjust the playback speed of audiobooks. When an audiobook is playing, you can choose:		
	Slower	Normal	Faster
Cover Art Priority	Media Player	Cover art displays from your device's music files. If no cover art for the files exists on the device, then the Gracenote Database provides cover art.	
	Gracenote®	The Gracenote Database supplied cover art is used for your music files. This overrides any cover art from your device.	
Gracenote® Management	Switches on and off Gracenote® to provide metadata information such as genre, artist and album.		

SYNC™ 3

Menu Item	Action and Description
Gracernote® Database Info	This allows you to view the version level of the Gracernote Database.
Device Information	This allows you to view the manufacturer and model number of your media device.
Update Media Index	Erase the stored media information in order to re-index.

You can adjust the following features:

Clock

To adjust the time, select the up and down arrows on either side of the screen. The arrows on the left adjust the hour and arrows on the right adjust the minute. You can then select AM or PM.

Menu Item	Action and Description
Clock Format	Select how time displays.
Auto Time Zone Update	When active, the clock adjusts to time zone changes. This feature is only available in vehicles with navigation.
Reset Clock to GPS Time	When selected, the vehicle clock resets to GPS satellite time.

The system automatically saves any updates you make to the settings.

Bluetooth

Pressing this button allows you to access the following:

Menu Item	Action
Bluetooth	On
	Off

You must activate Bluetooth to pair a Bluetooth enabled device.

The processes of pairing a Bluetooth device is the same as pairing a phone. **See Pairing a Device** in Phone settings for how to pair a device and the available options.

Phone

Pair your Bluetooth enabled phone with the system before using the functions in hands-free mode.

SYNC™ 3

Switch on Bluetooth on your device to begin pairing. See your phone's manual if necessary.

To add a phone, select:

Menu Item
Add Phone

1. Follow the on-screen instructions.
2. A prompt alerts you to search for the system on your phone.
3. Select your vehicle's make and model as it displays on your phone.
4. Confirm that the six-digit number appearing on your phone matches the six-digit number on the touchscreen.
5. The touchscreen indicates when the pairing is successful.
6. Your phone may prompt you to give the system permission to access information. To check your phone's compatibility, see your phone's manual or visit the website.

Alternatively, to add a phone, select:

Menu Item
Add Phone
Then select:
Discover Other Bluetooth Devices

1. Follow the on-screen instructions.
2. Select your phone's name when it appears on the touchscreen.
3. Confirm that the six-digit number appearing on your phone matches the six-digit number on the touchscreen.
4. The touchscreen indicates when the pairing is successful.
5. Your phone may prompt you to give the system permission to access information. To check your phone's compatibility, see your phone's manual or visit the website.

Other features, such as text messaging using Bluetooth and automatic phonebook download, are phone-dependent features.

Once you have paired a device you can adjust the following options.

To check your phone's compatibility, see your phone's manual or visit the website:

Website
owner.lincoln.com www.syncmyride.ca www.syncmaroute.ca

Once you have paired a device you can adjust the following options.

Menu Item	Action and Description
View Devices	
You can then select:	
Add a Bluetooth Device	You can add a Bluetooth enabled device by following the steps in the previous table.
You can select a phone by touching the name of the phone on the screen. You then have the following options:	

SYNC™ 3

Menu Item	Action and Description
Connect	Depending on the status of the device, you can select either of these options to interact with the selected device.
Disconnect	
Make Primary	Allows you to select this device to be your preferred device.
Delete	Removes the selected device from the system.

Press the info icon next to the device name to see phone and device information.

Menu Item	Action and Description	
Manage Contacts		
You can then select:		
Auto-Download Contacts	Enable this option to have SYNC 3 periodically re-download your phonebook to keep your contact list up to date.	
Sort By:	Choose how you would like the system to display your contacts. You can choose:	
	<table border="1" style="width: 100%;"> <tr> <td style="width: 50%;">First Name</td> <td style="width: 50%;">Last Name</td> </tr> </table>	First Name
First Name	Last Name	
Re-download Contacts	Select this option to re-download your contact list manually.	
Delete Contacts	Select this option to delete the in vehicle contact list. Deleting the in vehicle list does not erase the contact list on the connected phone.	

Menu Item	Action and Description
Set Phone Ringtone	
You can then select:	
No Ringtone	No sound plays when a call comes to your phone.
Use Phone Ringtone	The currently selected ringtone on your phone plays when you receive a call. This option may not be available for all phones. If this option is available, it is the default setting.
You can also select one of the three available ringers.	

SYNC™ 3

Menu Item	Action and Description
Text Messaging	
You can then select:	
No Alert (Silence)	No sound plays when a message comes to your phone.
You can select one of the three available notification sounds.	
Voice Readout	When enabled, a voice prompt alerts you when you receive a new message.

You can enable and disable the following options as well:

Menu Item	Action and Description
Mute Audio in Privacy	When enabled, vehicle audio (such as radio or apps) is muted for the duration of the phone call even when the phone call is in privacy.
Roaming Warning	When enabled, an alert displays that your phone is roaming when you attempt to place a call.
Low Battery Notification	When enabled, a message displays when the battery on your phone is running low.

911 Assist

To activate 911 Assist from the settings screen select:

Enabling 911 Assist

Note: For this feature to work, your cell phone must have Bluetooth and connect with SYNC3.

Menu Item	Action and Description
911 Assist	Press this button to enter the settings screen for this feature. You can switch this feature on and off by sliding the scrollbar as follows.

Slide the scrollbar to switch this feature on.

You can set your contacts in the phone book for emergency quick dialing.

Setting Emergency Contacts

Ensure the phone book of your cell phone downloaded to SYNC 3.

From the settings screen select:

SYNC™ 3

Menu Item	Action and Description
911 Assist	Press this button to enter the settings screen for this feature.
Set Emergency Contacts	Select this option as it displays on the screen.

Menu Item	Action and Description
Select a Contact	Select this option under <Emergency contact 1>.

The screen lists contacts in the phone book. Select the contact that you want to set as emergency contact. You can set Emergency Contact 2 by same process. You can set two Emergency Contacts in total.

Note: *After SYNC3 tries to place an emergency call, the Emergency Contact button displays on the touch screen. You need to press the button to call the contact through your Bluetooth phone.*

Note: *If the vehicle is equipped with navigation, a map with your current street information displays on the screen when 911 Assist is in process.*

Radio

This button is available if a Radio source such as AM or FM is the active media source. Pressing the button allows you to access the following features:

Menu Item	Action and Description
FM HD Radio AM HD Radio (Dependent on current radio source, if Available)	Activation of this feature allows you to listen to HD radio broadcasts.
Radio Text	This feature is available when FM Radio is your active media source. Activate this feature to have the system display radio text.
Autoset Presets (AST)	Refresh Selecting this option stores the six strongest stations in your current location to the last preset bank of the currently tuned source.

SYNC™ 3

SiriusXM

This button is available if SiriusXM is the

active audio source. Pressing the button allows you to access the following features:

Menu Item	Action and Description
Set Category for Seek	If you select a category, seek functions only stop on channels in that category.
Parental Lockout	Select to create a personal identification number (PIN), which allows you to lock or unlock channels. Your initial PIN is 1234.
Edit Alerts	Select to switch on or off songs, artists or teams alerts or delete an alert or delete all alerts.

You can also view your satellite radio Electronic Serial Number (ESN) from this screen. You need this number when communicating with SiriusXM to activate, modify or track your account.

Navigation

You can adjust many of the Navigation preferences by selecting the following menus.

Map Preferences

Menu Item	Action and Description
Map Preferences	
Then select any of the following:	
3D City Model	When this option is active, the system shows 3D renderings of buildings.
Breadcrumbs	When enabled, your vehicle's previously traveled route displays with white dots.
POI Icons	Enable this feature to display up to 3 POI icons on the navigation map. A rest area POI icon is displayed on the map regardless of this setting.
	Once this feature is activated you can select the icons you want displayed by selecting:
Incident Map Icons	This menu allows you to choose which incident icons you would like to have displayed on the navigation map.

SYNC™ 3

Route Preferences

Menu Item	Second Level Messages, Actions and Descriptions		
Route Preferences			
Then select any of the following:			
Preferred Route	Choose to have the system display your chosen route type.		
	Shortest	Fastest	Eco
Always Use ___ Route	Bypass route selection in destination programming. The system only calculates one route based on your preferred route setting. When activated, the system uses your selected route type to calculate only one route to the desired destination.		
Use HOV Lanes	The system selects High Occupancy Vehicle or car pool lanes when providing route guidance.		
Automatically Find Parking	The system searches for and displays available parking locations as you approach your destination.		
Eco Time Penalty	Select a level of cost for the calculated Eco Route. The higher the setting, the longer the time allotment is for the route.		
Dynamic Route Guidance	Enable or disable considering traffic information when planning a route. The system can find a faster route based on heavy traffic flow information or detect a Road Closed incident and find a detour route if possible.		

Navigation Preferences

Menu Item	Action and Description
Navigation Preferences	
Guidance Prompts	You can adjust how the system provides prompts.
Then select any of the following:	
Voice and Tones	
Voice Only	
Tones Only	

SYNC™ 3

Navigation Source Selection

The screen lists available alternative navigation sources using Applink.

Mobile Apps

You can enable the control of compatible mobile apps running on your Bluetooth or USB device on SYNC 3. In order to enable mobile apps, SYNC 3 requires user consent to send and receive app authorization information and updates using the data plan associated with the connected device.

The connected devices send data to us in the United States. The encrypted information includes your VIN, SYNC 3 module number, anonymous usage statistics and debugging information. Updates may take place.

Note: *Not all Mobile Apps are compatible with the system.*

Note: *Standard data rates apply. We are not responsible for any additional charges you may receive from your service provider, when your vehicle sends or receives data through the connected device.*

Menu Item	Action and Description		
Mobile Apps	On	Enable or disable the use of mobile apps on SYNC 3. Disabling mobile apps in the settings menu disables automatic updates and the use of mobile apps on SYNC 3.	
	Off		
	You can view the status of mobile app permissions in the settings menu.		
Once Mobile Apps is enabled, you have the following options:			
Update Mobile Apps	This provides information on the current state of available app updates.		
	There are three possible statuses:		
	Update Needed	Up-To-Date	Updating Mobile Apps...
	The system has detected a new app requiring authorization or a general permissions update is required.	No update is required.	The system is trying to receive an update.
	Request Update		Select this button if an update is required and you want to request this update manually. For example, when your mobile device is connected to a Wi-Fi hotspot, select:

SYNC™ 3

Menu Item	Action and Description
	Request Update
All Apps	Grant or deny permissions to all apps at once.
There may also be SYNC 3 enabled apps listed under these options.	Grant or deny an individual app particular permissions. App permissions are organized into groups. By pressing the info book icon, you can see which signals are included in each group.

Note: *We is not responsible or liable for any damages or loss of privacy relating to usage of an app, or dissemination of any vehicle data that you approve us to provide to an app.*

General

Access and adjust the system settings, voice features, as well as phone, navigation and wireless settings.

Menu Item	
Language	Select to have the touch-screen display in English, Spanish or French.
Distance	Select to display units in kilometers or miles.
Temperature	Select to display units in Celsius or Fahrenheit.
Touch Screen Beep	Select to have the system beep to confirm choices made through the touch-screen.
Automatic System Updates	When you activate this option, the system automatically updates when you have an available internet connection through a Wi-Fi network or mobile connection.

SYNC™ 3

Menu Item	
About SYNC	Information pertaining to the system and its software.
Software Licenses	Documentation of the software license for the system.
Master Reset	Select to restore factory defaults. This erases all personal settings and personal data.

Wi-Fi & Hotspot (If Equipped)

Access SYNC Wi-Fi and Vehicle Hotspot settings and information.

System Wi-Fi

You can access the following:

Menu Item	Action and Description
Wi-Fi	Enable this option to connect to Wi-Fi for SYNC 3 vehicle software updates.
Available Networks	This provides you with a list of available Wi-Fi networks within range.
	Clicking on a network from the list allows you to connect or disconnect from that network. The system may require a security code to connect.
	When you click the information button next to a network, more information about the network displays such as the signal strength, connection status and security type.
Wi-Fi Available Notifications	The system alerts you when your vehicle is parked and a Wi-Fi network is within range if SYNC is not already connected.

Vehicle Hotspot

You can access the following:

SYNC™ 3

Menu Item	Action and Description
Wi-Fi Hotspot On/Off	Allows you to turn the hotspot on and off.
Settings	Allows you to view and edit hotspot settings such as the SSID and password.
Data Usage	Allows you to view your vehicle's hotspot plan and data usage.
Manage Devices	Allows you to manage devices connected to your hotspot.

Note: *The Vehicle Wi-Fi Hotspot (Vehicle Hotspot) may be operational while ignition is On and may remain operational while the ignition is Off.*

Note: *Vehicle Hotspot services are provided by the vehicle network carrier, subject to your vehicle network carrier agreement, coverage and availability.*

Note: *It is the account owner's responsibility to remove the vehicle from the vehicle network carrier account when ownership of the vehicle is transferred. If the owner would like to remove the vehicle from the account for any reason, please contact your vehicle network carrier for more information.*

Note: *Data, such as the Vehicle Identification Number (VIN), SIM Card ID, and data plan usage, is shared between us and the vehicle network carrier to provide the Vehicle Hotspot service in accordance with your vehicle network carrier agreement, coverage and availability, and may be used to enable a seamless transition from an old to new embedded modem and to confirm any updates are successfully delivered.*

Note: *For your convenience data usage may be available for monitoring under Settings but may not reflect actual or current usage. The vehicle network carrier is responsible for providing information about your account. Please contact the vehicle network carrier for more information.*

Note: *We may need to update operating system software on your vehicle, including security updates and bug fixes, to keep connected services current, like Vehicle Hotspot, without prior notice to you.*

Ambient Lighting (If Equipped)

Tap a color once to active ambient lighting. This sets the color to the highest intensity.

You can drag the colors up and down to increase or decrease the intensity.

To switch ambient lighting off, press the active color once or drag the active color all the way down to zero intensity.

Vehicle

Note: *Your vehicle may not have all of these features.*

You can select the following features to update their settings.

Door Keypad Code

Select this button to add or erase a personal door keypad code. To add or erase a personal code, you first need to enter the five-digit factory set code. You can find this code on the owner's wallet card in the glove box or from your authorized dealer.

SYNC™ 3

Camera Settings

To make adjustments using the touchscreen, select:

Message	Action and Description
Camera Settings	

Then select from the following:

Rear Camera Delay	You can enable or disable this option using the slider.
-------------------	---

You can find more information on the rear-view camera system in the parking aids chapter of your owner's manual.

Onboard Modem Serial Number (ESN)

Selecting this button on the settings menu shows you the ESN number for your system. You need this number for certain registrations such as Satellite Radio.

Display

To make adjustments using the touchscreen, select:

Menu Item	Action and Description						
Display Off	The screen goes black and does not display anything. Tap the screen to switch it back on.						
Brightness	Make the screen display brighter or dimmer.						
Mode	You can select: <table border="1"><tbody><tr><td>Auto</td><td>The screen automatically switches between day and night modes based on the outside light level.</td></tr><tr><td>Day</td><td>The screen displays with a light background to enhance daytime viewing.</td></tr><tr><td>Night</td><td>The screen displays with a darker background to make nighttime viewing easier.</td></tr></tbody></table>	Auto	The screen automatically switches between day and night modes based on the outside light level.	Day	The screen displays with a light background to enhance daytime viewing.	Night	The screen displays with a darker background to make nighttime viewing easier.
Auto	The screen automatically switches between day and night modes based on the outside light level.						
Day	The screen displays with a light background to enhance daytime viewing.						
Night	The screen displays with a darker background to make nighttime viewing easier.						
Auto Dim	Enable this option to automatically dim the display brightness based on ambient lighting conditions.						

SYNC™ 3

Voice Control

You can adjust the voice control settings by selecting the following options.

Menu Item	
Advanced Mode	Enable this option to remove additional voice prompts and confirmations.
Phone Confirmation	Enable this option to have the system confirm a contact's name with you before making a call.
Voice Command List	Enable this option to have the system display a list of available voice commands when you press the voice.

Valet Mode

Valet mode allows you to lock the system. No information is accessible until the system is unlocked with the correct PIN.

When you select valet mode, a pop up appears informing you that a four digit code must be entered to enable and disable valet mode. You can use any PIN you chose but you must use the same PIN to disable valet mode. The system asks you to input the code.

Note: *If the system is locked and you cannot remember the PIN, please contact the Customer Relationship Center.*

For Lincoln

United States: 1-800-521-4140
Canada: 1-800-387-9333

Ford	Lincoln
United States and Canada: 1-800-392-3673	United States: 1-800-521-4140
	Canada: 1-800-387-9333

To enable valet mode, enter your chosen PIN. The system then asks to confirm your PIN by reentering it. The system then locks.

To unlock the system, enter the same pin number. The system reconnects to your phone and all of your options are available again.

SYNC™ 3 TROUBLESHOOTING

Your SYNC 3 system is easy to use. However, should questions arise, please refer to the tables below.

To check your cell phone's compatibility, refer to the regional Ford or Lincoln website.

SYNC™ 3

Cell phone issues		
Issue	Possible cause	Possible solution
There is back-ground noise during a phone call.	The audio control settings on your cell phone may be affecting SYNC 3 performance.	Refer to your device's manual about audio adjustments.
During a call, I can hear the other person but they cannot hear me.	Possible cell phone malfunction.	Try switching your cell phone off, resetting it or removing the battery, then try again. Make sure that the microphone for SYNC 3 is not set to off. Look for the microphone icon on the phone screen.
During a call, I cannot hear the other person and they cannot hear me.	The system may need to be restarted.	To restart your system, shut down the engine, open and close the door, and then lock the door and wait for 2-3 minutes. Make sure that your SYNC 3 screen is black and the lighted USB port is off.
SYNC 3 is not able to download my phone-book.	This is a cell phone-dependent feature.	Check your cell phone's compatibility.
	Possible cell phone malfunction.	Make sure you allow SYNC 3 to retrieve contacts from your phone. Refer to your cell manual.
		You must switch on your cell phone and the automatic phonebook download feature on SYNC 3.
The system says "Phone-book down-loaded" but my SYNC 3 phone-book is empty or is missing contacts.	Limitations on your cell phone's capability.	Try switching your cell phone off, resetting it or removing the battery, then try again.
		Make sure you allow SYNC 3 to retrieve contacts from your phone. Refer to your cell manual.
		If the missing contacts are stored on your SIM card, move them to your cell phone's memory.
		You must switch on your cell phone and the automatic phonebook download feature on SYNC 3.

SYNC™ 3

Cell phone issues		
Issue	Possible cause	Possible solution
I am having trouble connecting my cell phone to SYNC 3.	This is a cell phone-dependent feature.	Check your cell phone's compatibility.
	Possible cell phone malfunction.	Try switching your cell phone off, resetting it or removing the battery, then try again.
		Try deleting your device from SYNC 3 and deleting SYNC from your device, then trying again.
		Always check the security and auto accept prompt settings relative to the SYNC 3 Bluetooth connection on your cell phone.
		Update your cell phone's firmware.
		Switch the auto download setting off.
Text messaging is not working on SYNC 3.	This is a cell phone-dependent feature.	Check your cell phone's compatibility.
	Possible cell phone malfunction.	Try switching your cell phone off, resetting it or removing the battery, then try again.
	iPhone	<ul style="list-style-type: none"> • Go to your cell phone's Settings. • Go to the Bluetooth Menu. • Press the blue circle to the right of the device named with your vehicle make and model to enter the next menu. • Turn Show Notifications on. • Disconnect then reconnect your iPhone from the SYNC 3 system to activate this settings update. <p>Your iPhone is now set up to forward incoming text messages to SYNC 3. Repeat these steps for every other SYNC 3 vehicle that you connect. Your iPhone will only forward incoming text messages to SYNC 3 if the iPhone is not unlocked in the messaging application. Replying to text messages using SYNC 3 is not supported by iPhone.</p>

SYNC™ 3

Cell phone issues		
Issue	Possible cause	Possible solution
		Text messages from WhatsApp and Facebook Messenger are not supported.
Audible text messages do not work on my cell phone.	This is a cell phone-dependent feature.	Your cell phone must support downloading text messages through Bluetooth to receive incoming text messages.
	This is a cell phone limitation.	Because each cell phone is different, refer to your device's manual for the specific cell phone you are pairing. In fact, there can be differences between cell phones due to brand, model, service provider and software version.

USB and Bluetooth Stereo issues		
Issue	Possible cause	Possible solution
I am having trouble connecting my device.	Possible device malfunction.	Disconnect the device from SYNC 3. Try switching your device off, resetting it or removing the battery, then reconnect it to SYNC 3.
		Make sure you are using the manufacturer's cable.
		Make sure to correctly insert the USB cable into the device and your vehicle's USB port.
	The device has a lock screen enabled.	Make sure that the device does not have an auto-install program or active security settings.
SYNC 3 does not recognize my device when I start my vehicle.	The device has a lock screen enabled.	Make sure your device is unlocked before connecting it to SYNC 3.
Bluetooth audio does not stream.	This is a device-dependent feature.	Make sure you are not leaving the device in your vehicle during very hot or cold temperatures.
		Make sure you connect the device to SYNC 3 and that you have started the media player on your device.

SYNC™ 3

USB and Bluetooth Stereo issues		
Issue	Possible cause	Possible solution
	The device is not connected.	
	The device is in a bad state.	Try switching your device off, resetting it or removing the battery, then reconnect it to SYNC 3.
SYNC 3 does not recognize music that is on my device.	Your music files may not contain the correct artist, song title, album or genre information.	Make sure that all song details are populated.
	The file may be corrupted.	Try replacing the corrupt file with a new version.
	The song may have copyright protection that does not allow it to play.	Some devices require you to change the USB settings from mass storage to media transfer protocol class.
	The file format is not supported by SYNC 3.	Convert the file to a supported format. See Entertainment (page 439).
	The device needs to be re-indexed.	Update media index. See Settings (page 468).
	The device has a lock screen enabled.	Make sure your device is unlocked before connecting it to SYNC 3.
When I connect my device, I sometimes do not hear any sound.	This is a device limitation.	Disconnect the device from SYNC 3. Try switching your device off, resetting it or removing the battery, then connect it back to SYNC 3.
		To listen to Apple devices through USB, select AirPlay from the devices Control Center, then select Dock Connector.
		To listen to Apple devices through Bluetooth Stereo, select AirPlay from the devices Control Center, then select SYNC.
SYNC 3 does not display the song information, repeat, or shuffle buttons.	The device or media player is incompatible.	Connect a compatible device or media player.

SYNC™ 3

Wi-Fi Access Point issues		
Issue	Possible cause	Possible solution
Failed connection.	Password error.	Verify password.
	Weak signal.	Check for a poor Wi-Fi signal.
	Multiple Access points within range with the same SSID.	Use a unique name for your SSID, don't use the default name unless it contains a unique identifier, such as part of the MAC address.
Disconnecting after successful connection.	Weak signal probably due to distance from the access point, obstruction or high interference.	Position the vehicle close to the access point with the front of the vehicle facing the access point direction and remove obstacles if possible. Other Wi-Fi, Bluetooth, microwave and cordless phones may cause interference.
Poor signal seen by SYNC 3 despite being near a access point.	There may be an obstruction between SYNC 3 and the access point.	If the vehicle is equipped with heated windshield, try positioning the vehicle so that the windshield is not facing the access point. If you have metallic window tinting but not on the windshield, position the vehicle to face the access point. If all windows are tinted, you can open the windows in the direction of the access point if that is feasible. Try to remove other obstructions that may impact signal quality such as opening the garage door.
An access point is not listed in the list of available networks.	The access point was defined as a hidden network.	Please set the network to visible and try again.

SYNC™ 3

Wi-Fi Access Point issues		
Issue	Possible cause	Possible solution
SYNC 3 is not seen when searching for Wi-Fi networks from your phone or other devices.	SYNC 3 does not currently provide an access point.	SYNC 3 currently does not provide an access point.
Software download takes too long.	Poor signal strength, too far from the access point, access point is supporting multiple connections, slow Internet connection or other problems.	Check the signal quality (under network details), if SYNC 3 indicates good or excellent, test with another high-speed equipped access point where the environment is more predictable.
SYNC 3 seems to connect with an access point and the signal strength is excellent but the software is not being updated.	It is possible that there is no new software. The connected access point may be a managed one and it requires either a subscription or agreeing to the terms and conditions.	Test the connection with another device, if the access point requires a subscription, you may contact the service provider.

SYNC™ 3

AppLink Issues		
Issue	Possible cause(s)	Possible solution(s)
AppLink Mobile Applications: When I select "Find Mobile Apps," SYNC 3 does not find any applications.	You did not connect an AppLink Compatible phone to SYNC 3.	Make sure you have a compatible smartphone; an Android with OS 2.3 or higher or an iPhone 3GS or newer with iOS 5.0 or higher. Additionally, make sure you pair and connect your phone to SYNC 3 in order to find AppLink-capable apps on your device. iPhone users must also connect to a USB port with an Apple USB cable.
My phone is connected, but I still cannot find any apps.	AppLink-enabled apps are not installed and running on your mobile device.	Make sure you have downloaded and installed the latest version of the app from your phone's app store. Make sure the app is running on your phone. Some apps require you to register or login to the app on the phone before using them with AppLink. Also, some may have a "Ford SYNC" setting, so check the app's settings menu on the phone.
My phone is connected, my app(s) are running, but I still cannot find any apps.	Sometimes apps do not properly close and re-open their connection to SYNC 3, over ignition cycles, for example.	<p>Closing and restarting apps may help SYNC 3 find the application if you cannot discover it inside the vehicle. On an Android device, if apps have an 'Exit' or 'Quit' option, then select it and restart the app. If the app does not have that option, select the phone's settings menu and select 'Apps', then find the particular app and choose 'Force stop.' Do not forget to restart the app afterward, then select "Find Mobile Apps" on SYNC 3.</p> <p>On an iPhone with iOS7+, to force close an app, double tap the home button then swipe up on the app to close it. Tap the home button again, then select the app again to restart it. After a few seconds, the app should then appear in SYNC 3's Mobile App's Menu.</p>

SYNC™ 3

AppLink Issues		
Issue	Possible cause(s)	Possible solution(s)
My Android phone is connected, my app(s) are running, I restarted them, but I still cannot find any apps.	There is a Bluetooth issue on some older versions of the Android operating system that may cause apps that were found on your previous vehicle drive to not be found again if you did not switch Bluetooth off.	Switch Bluetooth off and then on to reset it on your phone. If you are in your vehicle, SYNC 3 should be able to automatically re-connect to your phone if you press the "Phone" button.
My iPhone is connected, my app is running, I restarted the app but I still cannot find it on SYNC 3.	You may need to reset the USB connection to SYNC 3.	Unplug the USB cable from the phone, wait a moment, and plug the USB cable back in to the phone. After a few seconds, the app should appear in SYNC 3's Mobile Apps Menu. If not, "Force Close" the application and restart it.
I have an Android phone. I found and started my media app on SYNC 3, but there is no sound or the sound is very low.	The Bluetooth volume on the phone may be low.	Increase the Bluetooth volume of the device by using the device's volume control buttons which are most often found on the side of the device.
I can only see some of the AppLink apps running on my phone listed in the SYNC 3 Mobile Apps Menu.	Some Android devices have a limited number of Bluetooth ports that apps can use to connect. If you have more AppLink apps on your phone than the number of available Bluetooth ports, you will not see all of your apps listed in the SYNC 3 mobile apps menu.	Force close or uninstall the apps you do not want SYNC 3 to find. If the app has a "Ford SYNC" setting, disable that setting in the app's settings menu on the phone.

SYNC™ 3

Voice command issues		
Issue	Possible cause	Possible solution
SYNC 3 does not understand what I am saying.	You may be using the wrong voice commands.	Review the cell phone voice commands and the media voice commands at the beginning of their respective sections.
		Refer to the audio display during an active voice session to find a list of voice commands there.
	You may be speaking too soon or at the wrong time.	Wait for the system to prompt you before you state your command.
SYNC 3 does not understand the name of a song or artist.	You may be using the wrong voice commands.	Review the media voice commands at the beginning of the media section.
	You may not be saying the name exactly as it appears on your device.	Say the song or artist name exactly as it is displayed on your device. For example, say "Play Artist Prince" or "Play song Purple Rain".
		Make sure you are saying the complete title such as "California remix featuring Jennifer Nettles".
		If there are any abbreviations in the name, like ESPN or CNN, you have to spell those: "E-S-P-N" or "C-N-N".
The song or artist name may have some special characters that are not being recognized by SYNC 3.	Make sure that song titles, artists, album, and playlists names do not have any special characters like *, - or +.	
SYNC 3 does not understand or is calling the wrong contact when I want to make a call.	You may not be saying the name exactly as it appears on your phone-book.	Make sure that you are saying the name exactly as it appears on your phone. For example, if your contact is "Joe Wilson", say "Call Joe Wilson". If your contact name is "Mom", say "Call Mom".
	The contact name may contain special characters.	Make sure that your contact names do not have any special characters like *, - or +.

SYNC™ 3

Voice command issues		
Issue	Possible cause	Possible solution
The SYNC 3 voice control system is having trouble recognizing foreign names stored on my cell phone.	You may not be saying the name exactly as it appears on your phonebook.	SYNC 3 applies the phonetic pronunciation rules of the selected language to the contact names stored on your cell phone.
		Helpful Hint: You can select your contact manually. Press PHONE . Select the option for phonebook and then contact name. Press the soft-key option to hear it. SYNC 3 will read the contact name to you, giving you some idea of the pronunciation it is expecting.
The SYNC 3 voice control system is having trouble recognizing foreign tracks, artists, albums, genres and playlist names from my media player or USB flash drive.	You may be saying the foreign names using the currently selected language for SYNC 3.	SYNC 3 applies the phonetic pronunciation rules of the selected language to the names stored on your media player or USB flash drive. It is able to make some exceptions for very popular artist names (for example, U2) such that you can always use the English pronunciation for these artists.
The system generates voice prompts and the pronunciation of some words may not be accurate for my language.	SYNC 3 uses text-to-speech voice prompt technology.	SYNC 3 uses a synthetically generated voice rather than pre-recorded human voice.
		SYNC 3 offers several new voice control features for a wide range of languages. Dialing a contact name directly from the phonebook without pre-recording (for example, "call John Smith") or selecting a track, artist, album, genre or playlist directly from your media player (for example, "play artist Madonna").

SYNC™ 3

Personal Profiles	
Issue	Possible cause and solution
I cannot create a profile.	Personal Profiles have not been set up.
	An invalid profile name was entered.
	A memory button was not selected when prompted.
	The vehicle's ignition was not On and in Park or was shifted out of Run or Park while creating a profile.
	Personal Profiles is turned off.
I cannot link a keyfob.	The lock button was not selected on a keyfob when prompted.
	The keyfob selected was already associated to another profile and an overwrite was declined.
	A profile recall was performed while linking a keyfob.
	The vehicle's ignition was not On and in Park, or was shifted out of Run or Park while linking a keyfob.
	The old linking method is used.
My personalized settings do not save.	The unsaved setting is not supported by Personal Profiles.
	A different Personal Profile is active than expected.
	Another user has changed settings for the wrong Personal Profile.
My profile will not recall.	A Personal Profile has not been created.
	Personal Profiles is turned off.
	The requested profile is already active.
	The memory button being used is not linked to a profile.

SYNC™ 3

Personal Profiles	
Issue	Possible cause and solution
	The keyfob being used is not linked to a profile.
	The wrong keyfob is being used.
	A button other than unlock or remote start is being pressed on a linked keyfob.
	The Personal Profile was deleted.
My preset positions recall but my profile does not.	Personal Profiles is turned off.
My profile recalls but my preset positions do not.	The vehicle is in motion.
	The preset positions are the same as the Guest or previously active profile.
I lost a keyfob.	Unlink and relink your keyfob in the Personal Profiles menu. You may need to see your authorized dealer.
I lost all profiles.	Keyfobs had been erased and reprogramed. This could happen if you let dealership add a new keyfob to replace lost one.
	Master Reset had been performed without your acknowledgement.

SYNC™ 3

General		
Issue	Possible cause	Possible solution
The language selected for the instrument cluster and information and entertainment display does not match the SYNC 3 language (phone, USB, Bluetooth audio, voice control and voice prompts).	SYNC 3 does not support the currently selected language for the instrument cluster and information and entertainment display.	SYNC 3 only supports four languages in a single module for text display, voice control and voice prompts. The country where you bought your vehicle dictates the four languages based on the most popular languages spoken. If the selected language is not available, SYNC 3 remains in the current active language.
		SYNC 3 offers several new voice control features for a wide range of languages. Dialing a contact name directly from the phonebook without pre-recording (for example, "call John Smith") or selecting a track, artist, album, genre or playlist directly from your media player (for example, "play artist Madonna").

SYNC 3 System Reset
The system has a System Reset feature that can be performed if the function of a SYNC 3 feature is lost. This reset is intended to restore functionality and will not erase any information previously stored in the system (such as paired devices, phonebook, call history, text messages, or user settings). To perform a System Reset, press and hold the Seek Up (>>) button while pressing and holding the Radio Power button. After approximately 5 seconds the screen will go black. Allow 1-2 minutes for the system reset to complete. You may then resume using the SYNC 3 system.

For additional assistance with SYNC 3 troubleshooting, refer to the regional Ford or Lincoln website.

Accessories

For a complete listing of the accessories that are available for your vehicle, please contact your authorized dealer or visit the online store web site:

Web Address (United States)

www.Accessories.Ford.com
--

Web Address (Canada)

www.Accessories.Ford.ca
--

Ford Motor Company will repair or replace any properly authorized dealer-installed Ford Original Accessory found to be defective in factory-supplied materials or workmanship during the warranty period, as well as any component damaged by the defective accessories. Ford Accessories are available for your vehicle through an authorized Ford dealer.

Ford Motor Company will warranty your Ford Original Accessory through the warranty that provides the greatest benefit:

- 24 months, unlimited mileage.
- The remainder of your new vehicle limited warranty.

Contact an authorized dealer for details and a copy of the warranty.

Exterior Style

- Keyless entry.
- Side window deflectors*.
- Sill plates.
- Splash guards.

Interior Style

- Floor liners.
- Rear seat entertainment system* (not compatible with power head restraints).
- Seat covers.

Lifestyle

- Ash cup or coin holder.
- Cargo organization and management.
- Interior light kit.
- In-vehicle safe*.
- Portable audio speaker*.
- Roof rack and carriers*.
- SUV camping tent*.
- Tablet holder.
- Trailer hitches, wiring harnesses and accessories.

Peace of Mind

- Back-up alarm.
- Hood deflector.
- Park assist sensors.
- Remote start.
- Roadside assistance kit*.
- Vehicle security system.
- Wheel locks.
- Window sunscreen*.

*Ford Licensed Accessory. The accessory manufacturer designs, develops and therefore warrants Ford Licensed Accessories, and does not design or test these accessories to Ford Motor Company engineering requirements. Contact an authorized Ford dealer for the accessory manufacturer's limited warranty details and request a copy of the Ford Licensed Accessories product limited warranty from the accessory manufacturer.

Accessories

For maximum vehicle performance, keep the following information in mind when adding accessories or equipment to your vehicle:

- When adding accessories, equipment, passengers and luggage to your vehicle, do not exceed the total weight capacity of the vehicle or of the front or rear axle (GVWR or GAWR as indicated on the Safety Compliance Certification label). Ask an authorized dealer for specific weight information.
- The Federal Communications Commission (FCC) and Canadian Radio Telecommunications Commission (CRTC) regulate the use of mobile communications systems that are equipped with radio transmitters, for example two-way radios, telephones and theft alarms. Any such equipment installed in your vehicle should comply with Federal Communications Commission (FCC) and Canadian Radio Telecommunications Commission (CRTC) regulations and should be installed only by an authorized dealer.
- Mobile communications systems may harm the operation of your vehicle, particularly if their manufacturer did not design them specifically for automotive use.
- If you or an authorized Ford dealer add any non-Ford electrical or electronic accessories or components to your vehicle, you may adversely affect battery performance and durability. In addition, you may also adversely affect the performance of other electrical systems in the vehicle.

Ford Protect

PROTECT YOURSELF FROM THE RISING COST OF VEHICLE REPAIRS WITH A FORD PROTECT EXTENDED SERVICE PLAN.

Ford Protect Extended Service Plans (U.S. Only)

Ford Protect extended service plan means peace of mind. It's the extended service plan backed by Ford Motor Company, and provides more protection beyond the New Vehicle Limited Warranty coverage. When you visit your Ford Dealer, Insist on Ford Protect extended service plans!

Ford Protect Can Quickly Pay for Itself

One trip to the Service Center could easily exceed the price of your Ford Protect extended service plan. With Ford Protect extended service plan you minimize your risk for unexpected repair bills and rising repair costs.

Up to 1,000+ Covered Vehicle Components

There are four mechanical Ford Protect extended service plans with different levels of coverage. Ask your authorized dealer for details.

1. PremiumCARE - Our most comprehensive coverage. With over 1,000 covered components, this plan is so complete it's probably easier to list what's not covered.
2. ExtraCARE - Covers 113 components, and includes many high-tech items.
3. BaseCARE - Covers 84 components.
4. PowertrainCARE - Covers 29 critical components.

Ford Protect extended service plans are honored by all authorized Ford dealers in the U.S., Canada and Mexico.

That means you get:

- Reliable, quality service at any Ford or Lincoln dealership.
- Repairs performed by factory trained technicians, using genuine parts.

Rental Car Reimbursement

1st day Rental Benefit

If you bring your car into your dealer for service, we'll give you a loaner to use for the day.

Extended Rental Benefits

If your vehicle is kept overnight for covered repairs, you are eligible for rental car coverage, including warranty repairs, and Field Service Actions.

Roadside Assistance

Exclusive 24/7 roadside assistance, including:

- Towing, flat-tire change and battery jump starts.
- Out of fuel and lock-out assistance.
- Travel expense reimbursement for lodging, meals and rental car.
- Assistance for taxi, shuttle, rental car coverage or other transportation.

Transferable Coverage

If you sell your vehicle before your Ford Protect extended service plan coverage expires, you can transfer any remaining coverage to the new owner. Which should give you and your potential buyer a little more peace of mind.

Ford Protect

Less Cost to Properly Maintain Your Vehicle

Ford Protect extended service plan also offers a Premium Maintenance Plan that covers all scheduled maintenance, and selected wear items. The coverage is prepaid, so you never have to worry about the cost of your vehicle's maintenance.

Covered maintenance includes:

- Windshield wiper blades.
- Spark plugs.
- The clutch disc (if equipped).
- Brake pads and linings.
- Shock absorbers.
- Struts.
- Engine Belts.
- Engine coolant hoses, clamps and o-rings.
- Diesel exhaust fluid replenishment (if equipped).
- Cabin air filter replacement every 20,000 mi (32,000 km) (electric vehicles only).

Interest Free Finance Options

Just a 10% down payment will provide you with an affordable, no interest, no fee payment program allowing you all the security and benefits Ford Protect extended service plan has to offer while paying over time. You are pre-approved with no credit check or hassles. To learn more, call our Ford Protect extended service plan specialists at 800-367-3377.

Ford Protect Extended Service Plan
P.O. Box 321067
Detroit, MI 48232

Ford Protect Extended Service Plan (CANADA ONLY)

You can get more protection for your vehicle by purchasing a Ford Protect extended service plan. Ford Protect extended service plan is the only service contract backed by Ford Motor Company of Canada, Limited. Depending on the plan you purchase, Ford Protect extended service plan provides benefits such as:

- Rental reimbursement.
- Coverage for certain maintenance and wear items.
- Protection against repair costs after your New Vehicle Limited Warranty Coverage expires.
- Roadside Assistance benefits.

There are several Ford Protect extended service plans available in various time, distance and deductible combinations. Each plan is tailored to fit your own driving needs, including reimbursement for towing and rental. When you purchase Ford Protect extended service plan, you receive added peace-of-mind protection throughout Canada, the United States and Mexico, provided by a network of participating authorized Ford Motor Company dealers.

Note: *Repairs performed outside of Canada, the United States and Mexico are not eligible for Ford Protect extended service plan coverage.*

This information is subject to change. For more information; visit your local Ford of Canada dealer or www.ford.ca to find the Ford Protect extended service plan that is right for you.

Scheduled Maintenance

GENERAL MAINTENANCE INFORMATION

Why Maintain Your Vehicle?

Carefully following the maintenance schedule helps protect against major repair expenses resulting from neglect or inadequate maintenance and may help to increase the value of your vehicle when you sell or trade it. Keep all receipts for completed maintenance with your vehicle.

We have established regular maintenance intervals for your vehicle based upon rigorous testing. It is important that you have your vehicle serviced at the proper times. These intervals serve two purposes; one is to maintain the reliability of your vehicle and the second is to keep your cost of owning your vehicle down.

It is your responsibility to have all scheduled maintenance performed and to make sure that the materials used meet the specifications identified in this owner's manual. See **Capacities and Specifications** (page 380).

Failure to perform scheduled maintenance invalidates warranty coverage on parts affected by the lack of maintenance.

Why Maintain Your Vehicle at Your Dealership?

Factory-Trained Technicians

Service technicians participate in extensive factory-sponsored certification training to help them become experts on the operation of your vehicle. Ask your dealership about the training and certification their technicians have received.

Genuine Ford and Motorcraft® Replacement Parts

Dealerships stock Ford, Motorcraft and Ford-authorized branded re-manufactured replacement parts. These parts meet or exceed our specifications. Parts installed at your dealership carry a nationwide 24-month or unlimited mile (kilometer) parts and labor limited warranty.

If you do not use Ford authorized parts they may not meet our specifications and depending on the part, it could affect emissions compliance.

Convenience

Many dealerships have extended evening and Saturday hours to make your service visit more convenient and they offer one stop shopping. They can perform any services that are required on your vehicle, from general maintenance to collision repairs.

Note: *Not all dealers have extended hours or body shops. Please contact your dealer for details.*

Protecting Your Investment

Maintenance is an investment that pays dividends in the form of improved reliability, durability and resale value. To maintain the proper performance of your vehicle and its emission control systems, make sure you have scheduled maintenance performed at the designated intervals.

Your vehicle is equipped with the Intelligent Oil-Life Monitor system, which displays a message in the information display at the proper oil change interval. This interval may be up to one year or 10,000 mi (16,000 km).

Scheduled Maintenance

When the oil change message appears in the information display, it is time for an oil change. Make sure you perform the oil change within two weeks or 500 mi (800 km) of the message appearing. Make sure you reset the Intelligent Oil-Life Monitor after each oil change. See **Oil Change Indicator Reset** (page 329).

If your information display resets prematurely or becomes inoperative, you should perform the oil change interval at six months or 5,000 mi (8,000 km) from your last oil change. Never exceed one year or 10,000 mi (16,000 km) between oil change intervals.

Your vehicle is very sophisticated and built with multiple, complex, performance systems. Every manufacturer develops these systems using different specifications and performance features. That is why it is important to rely upon your dealership to properly diagnose and repair your vehicle.

Ford Motor Company has recommended maintenance intervals for various parts and component systems based upon engineering testing. Ford Motor Company relies upon this testing to determine the most appropriate mileage for replacement of oils and fluids to protect your vehicle at the lowest overall cost to you and recommends against maintenance schedules that deviate from the scheduled maintenance information.

We strongly recommend the use of only genuine Ford, Motorcraft or Ford-authorized re-manufactured replacement parts engineered for your vehicle.

Additives and Chemicals

This owner's manual and the Ford Workshop Manual list the recommended additives and chemicals for your vehicle. We do not recommend using chemicals or additives not approved by us as part of your vehicle's normal maintenance. Please consult your warranty information.

Oils, Fluids and Flushing

In many cases, fluid discoloration is a normal operating characteristic and, by itself, does not necessarily indicate a concern or that the fluid needs to be changed. However, a qualified expert, such as the factory-trained technicians at your dealership, should inspect discolored fluids that also show signs of overheating or foreign material contamination immediately.

Make sure to change your vehicle's oils and fluids at the specified intervals or in conjunction with a repair. Flushing is a viable way to change fluid for many vehicle sub-systems during scheduled maintenance. It is critical that systems are flushed only with new fluid that is the same as that required to fill and operate the system or using a Ford-approved flushing chemical.

Owner Checks and Services

Make sure you perform the following basic maintenance checks and inspections every month or at six-month intervals.

Scheduled Maintenance

Check Every Month
Engine oil level.
Function of all interior and exterior lights.
Tires (including spare) for wear and proper pressure.
Windshield washer fluid level.
Fuel and water separator. Drain if necessary (or if indicated by the information display).
Holes and slots in the tail pipe to make sure they are functional and clear of debris.

Check Every Six Months
Battery connections. Clean if necessary.
Body and door drain holes for obstructions. Clean if necessary.
Cooling system fluid level and coolant strength.
Door weatherstrips for wear. Lubricate if necessary.
Hinges, latches and outside locks for proper operation. Lubricate if necessary.
Parking brake for proper operation.
Safety belts and seat latches for wear and function.
Safety warning lamps (brake, ABS, airbag and safety belt) for operation.
Washer spray and wiper operation. Clean or replace blades as necessary.

Multi-Point Inspection

In order to keep your vehicle running right, it is important to have the systems on your vehicle checked regularly. This can help identify potential issues and prevent major problems. We recommend having the following multi-point inspection performed at every scheduled maintenance interval to help make sure your vehicle keeps running great.

Scheduled Maintenance

Multi-Point Inspection	
Accessory drive belt(s)	Hazard warning system operation
Battery performance	Horn operation
Engine air filter	Radiator, cooler, heater and air conditioning hoses
Exhaust system	Suspension components for leaks or damage
Exterior lamps operation	Steering and linkage
Fluid levels ¹ ; fill if necessary	Tires (including spare) for wear and proper pressure ²
For oil and fluid leaks	Windshield for cracks, chips or pits
Half-shaft dust boots	Washer spray and wiper operation

¹ Brake, coolant recovery reservoir, automatic transmission and window washer

² If your vehicle is equipped with a temporary mobility kit, check the tire sealant expiration Use By date on the canister. Replace as needed.

Be sure to ask your dealership service advisor or technician about the multi-point vehicle inspection. It is a comprehensive way to perform a thorough inspection of your vehicle. Your checklist gives you immediate feedback on the overall condition of your vehicle.

NORMAL SCHEDULED MAINTENANCE

Intelligent Oil-Life Monitor

Your vehicle is equipped with an Intelligent Oil-Life Monitor that determines when you should change the engine oil based on how your vehicle is used. By using several important factors in its calculations, the monitor helps reduce the cost of owning your vehicle and reduces environmental waste at the same time.

This means you do not have to remember to change the oil on a mileage-based schedule. Your vehicle lets you know when an oil change is due by displaying a message in the information display.

The following table provides examples of vehicle use and its impact on oil change intervals. It is a guideline only. Actual oil change intervals depend on several factors and generally decrease with severity of use.

Scheduled Maintenance

When to expect the OIL CHANGE REQUIRED Message	
Interval	Vehicle Use and Example
7,500–10,000 mi (12,000–16,000 km)	Normal
	Normal commuting with highway driving No, or moderate, load or towing Flat to moderately hilly roads No extended idling
5,000–7,500 mi (8,000–12,000 km)	Severe
	Moderate to heavy load or towing Mountainous or off-road conditions Extended idling Extended hot or cold operation
3,000–5,000 mi (5,000–8,000 km)	Extreme
	Maximum load or towing Extreme hot or cold operation

Normal Maintenance Intervals

At Every Oil Change Interval as Indicated by the Information Display ¹
Change engine oil and filter. ²
Rotate tires, inspect tire wear and measure tread depth.
Perform a multi-point inspection - recommended.
Inspect the automatic transmission fluid level - vehicles with dipstick. Consult your dealer for requirements.
Inspect the brake pads, rotors, hoses and parking brake.
Inspect the engine cooling system strength and hoses.
Inspect the exhaust system and heat shields.
Inspect front axle and U-joints.
Inspect the half-shaft boots.

Scheduled Maintenance

At Every Oil Change Interval as Indicated by the Information Display¹

Inspect the steering linkage, ball joints, suspension, tire-rod ends, driveshaft and U-joints.

Inspect the wheels and related components for abnormal noise, wear, looseness or drag.

¹ Do not exceed one year or 10,000 mi (16,000 km) between service intervals.

² Reset the Intelligent Oil-Life Monitor after engine oil and filter changes.

Other Maintenance Items¹

Every 20,000 mi (32,000 km)	Replace cabin air filter.
Every 30,000 mi (48,000 km)	Replace engine air filter.
Every 100,000 mi (160,000 km)	Replace spark plugs.
	Inspect accessory drive belt(s). ²
Every 150,000 mi (240,000 km)	Change automatic transmission fluid.
	Change front axle fluid - Four-wheel drive vehicles.
	Change rear axle fluid.
	Change transfer case fluid - Four-wheel drive vehicles.
	Replace accessory drive belt(s).
Every 200,000 mi (320,000 km)	Change engine coolant - if your vehicles has yellow-colored coolant. ³

¹ Perform these maintenance items within 3,000 mi (4,800 km) of the last engine oil and filter change. Do not exceed the designated distance for the interval.

² After initial inspection, inspect every other oil change until replaced.

³ Initial replacement at ten years or 200,000 mi (320,000 km), then every five years or 100,000 mi (160,000 km).

Scheduled Maintenance

SPECIAL OPERATING CONDITIONS SCHEDULED MAINTENANCE

If you operate your vehicle **primarily** in any of the following conditions, you need to perform extra maintenance, as indicated. If you operate your vehicle **occasionally** under any of these conditions, it is not necessary to perform the extra maintenance. For specific recommendations, see your dealership service advisor or technician.

Perform the services shown in the following tables when specified or within 3,000 mi (4,800 km) of the message appearing in the information display prompting you to change your oil.

- **Example 1:** The message comes on at 28,751 mi (46,270 km). Perform the 30,000 mi (48,000 km) automatic transmission fluid replacement.
- **Example 2:** The message has **not** come on, but the odometer reads 30,000 mi (48,000 km) (for example, the Intelligent Oil-Life Monitor was reset at 25,000 mi (40,000 km)). Perform the engine air filter replacement.

Towing a Trailer or Using a Car-top Carrier

As required	Change engine oil and filter as indicated by the information display and perform services listed in the Normal Scheduled Maintenance chart.
Inspect frequently, service as required	Inspect and lubricate U-joints (if equipped with grease fittings).
	See axle maintenance items under Exceptions .
Every 60,000 mi (96,000 km)	Change transfer case fluid (Four-wheel drive vehicles).
	Replace spark plugs.

Extensive Idling or Low-speed Driving for Long Distances, as in Heavy Commercial Use

As required	Change engine oil and filter as indicated by the information display and perform services listed in the Normal Scheduled Maintenance chart.
Inspect frequently, service as required	Replace engine air filter.
	Replace cabin air filter.
Every 60,000 mi (96,000 km)	Change transfer case fluid (Four-wheel drive vehicles).
	Replace spark plugs.

Scheduled Maintenance

Operating in Dusty or Sandy Conditions (Such as Unpaved or Dusty Roads)	
Inspect frequently, service as required	Replace engine air filter.
	Replace cabin air filter.
Every 5,000 mi (8,000 km)	Inspect the wheels and related components for abnormal noise, wear, looseness or drag.
	Rotate tires, inspect tires for wear and measure tread depth.
Every 5,000 mi (8,000 km) or six months	Change engine oil and filter. ¹
Every 60,000 mi (96,000 km)	Change transfer case fluid (Four-wheel drive vehicles).

¹Reset your Intelligent Oil-Life Monitor after each engine oil and filter change.

Off-road Operation	
Inspect frequently, service as required	Inspect steering linkage, ball joints and U-joints. Lubricate if equipped with grease fittings.
	Replace engine air filter.
	Replace cabin air filter.
Every 5,000 mi (8,000 km) or six months	Change engine oil and filter. ¹
	Inspect the wheels and related components for abnormal noise, wear, looseness or drag.
	Rotate tires, inspect tires for wear and measure tread depth.
Every 60,000 mi (96,000 km)	Change transfer case fluid (Four-wheel drive vehicles).

¹Reset your Intelligent Oil-Life Monitor after each engine oil and filter change.

Exceptions

There are several exceptions to the Normal Schedule.

Scheduled Maintenance

Axle and Transfer Case Maintenance

Axle(s) and transfer case (Four-wheel drive vehicles) fluid changes or level checks are not required unless a leak is suspected or the assembly has been submerged in water. Contact an authorized dealer for service.

California Fuel Filter Replacement

If you register your vehicle in California, the California Air Resources Board has determined that the failure to perform this maintenance item does not nullify the emission warranty or limit recall liability before the completion of your vehicle's useful life. Ford Motor Company, however, urges you to have all recommended maintenance services performed at the specified intervals and to record all vehicle service.

Hot Climate Oil Change Intervals

Vehicles operating in the Middle East, North Africa, Sub-Saharan Africa or locations with similar climates using an American Petroleum Institute (API) Certified for Gasoline Engines (Certification mark) oil of SM or SN quality, the normal oil change interval is 3,000 mi (4,800 km).

If the available API SM or SN oils are not available, then the oil change interval is 1,800 mi (2,900 km).

Engine Air Filter Replacement

The life of the engine air filter is dependent on exposure to dusty and dirty conditions. Vehicles operated in these conditions require frequent inspection and replacement of the engine air filter.

SCHEDULED MAINTENANCE RECORD

<input type="radio"/> Repair Order #:	Dealer stamp
<input type="radio"/> Distance:	
<input type="radio"/> Engine hours (optional):	
<input type="radio"/> Multi-point inspection (recommended): <input type="checkbox"/>	
<input type="radio"/> Signature:	

Scheduled Maintenance

<input type="radio"/> Repair Order #:	<p>Dealer stamp</p>
<input type="radio"/> Distance:	
<input type="radio"/> Engine hours (optional):	
<input type="radio"/> Multi-point inspection (recommended): <input type="checkbox"/>	
<input type="radio"/> Signature:	

<input type="radio"/> Repair Order #:	<p>Dealer stamp</p>
<input type="radio"/> Distance:	
<input type="radio"/> Engine hours (optional):	
<input type="radio"/> Multi-point inspection (recommended): <input type="checkbox"/>	
<input type="radio"/> Signature:	

Scheduled Maintenance

<input type="radio"/> Repair Order #:	Dealer stamp
<input type="radio"/> Distance:	
<input type="radio"/> Engine hours (optional):	
<input type="radio"/> Multi-point inspection (recommended): <input type="checkbox"/>	
<input type="radio"/> Signature:	

<input type="radio"/> Repair Order #:	Dealer stamp
<input type="radio"/> Distance:	
<input type="radio"/> Engine hours (optional):	
<input type="radio"/> Multi-point inspection (recommended): <input type="checkbox"/>	
<input type="radio"/> Signature:	

Scheduled Maintenance

<input type="radio"/> Repair Order #:	<p>Dealer stamp</p>
<input type="radio"/> Distance:	
<input type="radio"/> Engine hours (optional):	
<input type="radio"/> Multi-point inspection (recommended): <input type="checkbox"/>	
<input type="radio"/> Signature:	

<input type="radio"/> Repair Order #:	<p>Dealer stamp</p>
<input type="radio"/> Distance:	
<input type="radio"/> Engine hours (optional):	
<input type="radio"/> Multi-point inspection (recommended): <input type="checkbox"/>	
<input type="radio"/> Signature:	

Scheduled Maintenance

<input type="radio"/> Repair Order #:	<p>Dealer stamp</p>
<input type="radio"/> Distance:	
<input type="radio"/> Engine hours (optional):	
<input type="radio"/> Multi-point inspection (recommended): <input type="checkbox"/>	
<input type="radio"/> Signature:	

<input type="radio"/> Repair Order #:	<p>Dealer stamp</p>
<input type="radio"/> Distance:	
<input type="radio"/> Engine hours (optional):	
<input type="radio"/> Multi-point inspection (recommended): <input type="checkbox"/>	
<input type="radio"/> Signature:	

Scheduled Maintenance

<input type="radio"/> Repair Order #:	<p>Dealer stamp</p>
<input type="radio"/> Distance:	
<input type="radio"/> Engine hours (optional):	
<input type="radio"/> Multi-point inspection (recommended): <input type="checkbox"/>	
<input type="radio"/> Signature:	

<input type="radio"/> Repair Order #:	<p>Dealer stamp</p>
<input type="radio"/> Distance:	
<input type="radio"/> Engine hours (optional):	
<input type="radio"/> Multi-point inspection (recommended): <input type="checkbox"/>	
<input type="radio"/> Signature:	

Scheduled Maintenance

<input type="radio"/> Repair Order #:	Dealer stamp
<input type="radio"/> Distance:	
<input type="radio"/> Engine hours (optional):	
<input type="radio"/> Multi-point inspection (recommended): <input type="checkbox"/>	
<input type="radio"/> Signature:	

<input type="radio"/> Repair Order #:	Dealer stamp
<input type="radio"/> Distance:	
<input type="radio"/> Engine hours (optional):	
<input type="radio"/> Multi-point inspection (recommended): <input type="checkbox"/>	
<input type="radio"/> Signature:	

Scheduled Maintenance

<input type="radio"/> Repair Order #:	<p>Dealer stamp</p>
<input type="radio"/> Distance:	
<input type="radio"/> Engine hours (optional):	
<input type="radio"/> Multi-point inspection (recommended): <input type="checkbox"/>	
<input type="radio"/> Signature:	

<input type="radio"/> Repair Order #:	<p>Dealer stamp</p>
<input type="radio"/> Distance:	
<input type="radio"/> Engine hours (optional):	
<input type="radio"/> Multi-point inspection (recommended): <input type="checkbox"/>	
<input type="radio"/> Signature:	

Scheduled Maintenance

<input type="radio"/> Repair Order #:	<p>Dealer stamp</p>
<input type="radio"/> Distance:	
<input type="radio"/> Engine hours (optional):	
<input type="radio"/> Multi-point inspection (recommended): <input type="checkbox"/>	
<input type="radio"/> Signature:	

<input type="radio"/> Repair Order #:	<p>Dealer stamp</p>
<input type="radio"/> Distance:	
<input type="radio"/> Engine hours (optional):	
<input type="radio"/> Multi-point inspection (recommended): <input type="checkbox"/>	
<input type="radio"/> Signature:	

Scheduled Maintenance

<input type="radio"/> Repair Order #:	<p>Dealer stamp</p>
<input type="radio"/> Distance:	
<input type="radio"/> Engine hours (optional):	
<input type="radio"/> Multi-point inspection (recommended): <input type="checkbox"/>	
<input type="radio"/> Signature:	

<input type="radio"/> Repair Order #:	<p>Dealer stamp</p>
<input type="radio"/> Distance:	
<input type="radio"/> Engine hours (optional):	
<input type="radio"/> Multi-point inspection (recommended): <input type="checkbox"/>	
<input type="radio"/> Signature:	

Scheduled Maintenance

<input type="radio"/> Repair Order #:	Dealer stamp
<input type="radio"/> Distance:	
<input type="radio"/> Engine hours (optional):	
<input type="radio"/> Multi-point inspection (recommended): <input type="checkbox"/>	
<input type="radio"/> Signature:	

Appendices

ELECTROMAGNETIC COMPATIBILITY



WARNING: Do not place objects or mount equipment on or near the airbag cover, on the side of the seatbacks (of the front seats), or in front seat areas that may come into contact with a deploying airbag. Failure to follow these instructions may increase the risk of personal injury in the event of a crash.



WARNING: Do not fasten antenna cables to original vehicle wiring, fuel pipes and brake pipes.



WARNING: Keep antenna and power cables at least 4 in (10 cm) from any electronic modules and airbags.

Note: We test and certify your vehicle to meet electromagnetic compatibility legislation (UNECE Regulation 10 or other applicable local requirements). It is your responsibility to make sure that any equipment an authorized dealer installs on your vehicle complies with applicable local legislation and other requirements.

Note: Any radio frequency transmitter equipment in your vehicle (such as cellular telephones and amateur radio transmitters) must keep to the parameters in the following table. We do not provide special provisions or conditions for installations or use.

Car

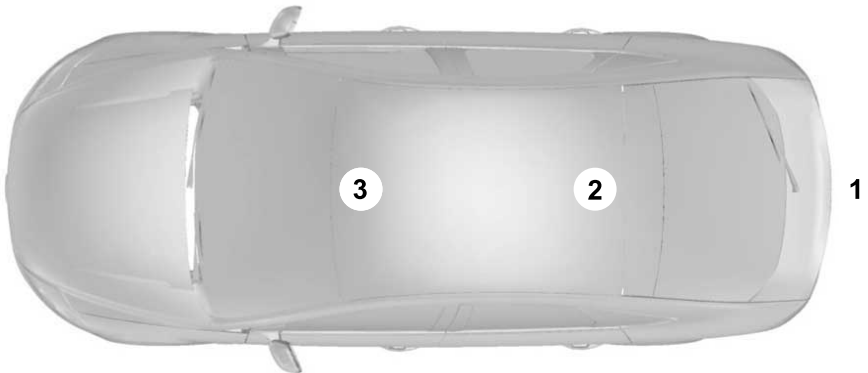

E239120

Appendices

Van



E239122

Truck

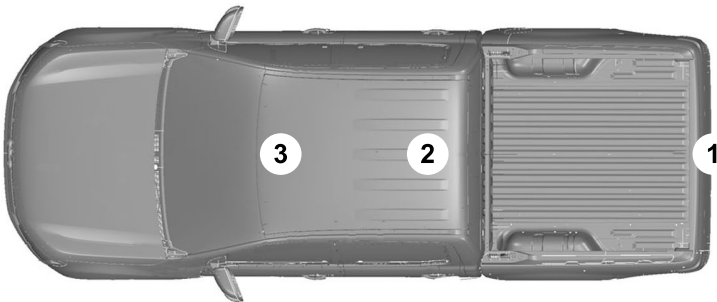

E239121

Appendices

Frequency Band MHz	Maximum output power Watt (Peak RMS)	Antenna Positions
1-30	50	1
50-54	50	2, 3
68-88	50	2, 3
142-176	50	2, 3
380-512	50	2, 3
806-870	10	2, 3

Note: After the installation of radio frequency transmitters, check for disturbances from and to all electrical equipment in your vehicle, both in the standby and transmit modes.

Check all electrical equipment:

- With the ignition ON.
- With the engine running.
- During a road test at various speeds.

Check that electromagnetic fields generated inside your vehicle cabin by the transmitter installed do not exceed applicable human exposure requirements.

END USER LICENSE AGREEMENT

VEHICLE SOFTWARE END USER LICENSE AGREEMENT (EULA)

- You ("You" or "Your" as applicable) have acquired a vehicle having several devices, including SYNC ® and various control modules, ("DEVICES") that include software licensed or owned by Ford Motor Company and its affiliates ("FORD MOTOR COMPANY"). Those software products of FORD MOTOR COMPANY origin, as well as associated media, printed materials, and "online" or electronic documentation ("SOFTWARE") are protected by international intellectual property laws and treaties. The SOFTWARE is licensed, not sold. All rights reserved.
- The SOFTWARE may interface with and/or communicate with, or may be later upgraded to interface with and/or communicate with additional software and/or systems provided by FORD MOTOR COMPANY.

Appendices

IF YOU DO NOT AGREE TO THIS END USER LICENSE AGREEMENT ("EULA") DO NOT USE THE DEVICES OR COPY THE SOFTWARE. ANY USE OF THE SOFTWARE, INCLUDING BUT NOT LIMITED TO USE ON THE DEVICES, WILL CONSTITUTE YOUR AGREEMENT TO THIS EULA (OR RATIFICATION OF ANY PREVIOUS CONSENT).

GRANT OF SOFTWARE LICENSE: This EULA grants you the following license:

- You may use the SOFTWARE as installed on the DEVICES and as otherwise interfacing with systems and/or services provide by or through FORD MOTOR COMPANY or its third party software and service providers.

Description of Other Rights and Limitations

- **Speech Recognition:** If the SOFTWARE includes speech recognition component(s), you should understand that speech recognition is an inherently statistical process and that recognition errors are inherent in the process. Neither FORD MOTOR

COMPANY nor its suppliers shall be liable for any damages arising out of errors in the speech recognition process. It is your responsibility to monitor any speech recognition functions included in the system.

- **Limitations on Reverse Engineering, Decompilation and Disassembly:**

You may not reverse engineer, decompile, translate, disassemble or attempt to discover any source code or underlying ideas or algorithms of the SOFTWARE nor permit others to reverse engineer, decompile or disassemble the SOFTWARE, except and only to the extent that such activity is expressly permitted by applicable law notwithstanding this limitation or to the extent as may be permitted by the licensing terms governing use of any open source components included with the SOFTWARE.

- **Limitations on Distributing, Copying, Modifying and Creating Derivative Works:**

You may not distribute, copy, make modifications to or create derivative works based on the SOFTWARE, except and only to the extent that such activity is expressly permitted by applicable law notwithstanding this limitation or to the extent as may be permitted by the licensing terms governing use of any open source components included with the SOFTWARE.

- **Single EULA:** The end user documentation for the DEVICES and related systems and services may contain multiple EULAs, such as multiple translations and/or multiple media versions (e.g., in the user documentation and in the software). Even if you receive multiple EULAs, you are licensed to use only one (1) copy of the SOFTWARE.

Appendices

- **SOFTWARE Transfer:** You may permanently transfer your rights under this EULA only as part of a sale or transfer of the DEVICES, provided you retain no copies, you transfer all of the SOFTWARE (including all component parts, the media and printed materials, any upgrades, and, if applicable, the Certificate(s) of Authenticity), and the recipient agrees to the terms of this EULA. If the SOFTWARE is an upgrade, any transfer must include all prior versions of the SOFTWARE.
- **Termination:** Without prejudice to any other rights, FORD MOTOR COMPANY may terminate this EULA if you fail to comply with the terms and conditions of this EULA.
- **Internet-Based Services Components:** The SOFTWARE may contain components that enable and facilitate the use of certain Internet-based services. You acknowledge and agree that FORD MOTOR COMPANY, third party software and service suppliers, its affiliates and/or its designated agent may automatically check the version of the SOFTWARE and/or its components that you are utilizing and may provide upgrades or supplements to the SOFTWARE that may be automatically downloaded to your DEVICES.
- **Additional Software/Services:** The SOFTWARE may permit FORD MOTOR COMPANY, third party software and service suppliers, its affiliates and/or its designated agent to provide or make available to you SOFTWARE updates, supplements, add-on components, or Internet-based services components of the SOFTWARE after the date you obtain your initial copy of the SOFTWARE ("Supplemental Components".) SOFTWARE updates may cause you to incur additional charges from your wireless service provider. If FORD MOTOR COMPANY or third party software and services suppliers provide or make available to you Supplemental Components and no other EULA terms are provided along with the Supplemental Components, then the terms of this EULA shall apply. FORD MOTOR COMPANY, its affiliates and/or its designated agent reserve the right to discontinue without liability any Internet-based services provided to you or made available to you through the use of the SOFTWARE.
- **Links to Third Party Sites:** The SOFTWARE may provide you with the ability to link to third party sites. The third party sites are not under the control of FORD MOTOR COMPANY, its affiliates and/or its designated agent. Neither FORD MOTOR COMPANY nor its affiliates nor its designated agent are responsible for (i) the contents of any third party sites, any links contained in third party sites, or any changes or updates to third party sites, or (ii) webcasting or any other form of transmission received from any third party sites. If the SOFTWARE provides links to third party sites, those links are provided to you only as a convenience, and the inclusion of any link does not imply an endorsement of the third party site by FORD MOTOR COMPANY, its affiliates and/or its designated agent.
- **Obligation to Drive Responsibly:** You recognize your obligation to drive responsibly and keep attention on the road. You will read and abide with the DEVICES operating instructions particularly as they pertain to safety and you agree to assume any risk associated with the use of the DEVICES.

Appendices

UPGRADES AND RECOVERY MEDIA:

If the SOFTWARE is provided by FORD MOTOR COMPANY separate from the DEVICES on media such as a ROM chip, CD ROM disk(s) or via web download or other means, and is labeled "For Upgrade Purposes Only" or "For Recovery Purposes Only" you may install one (1) copy of such SOFTWARE onto the DEVICES as a replacement copy for the existing SOFTWARE, and use it in accordance with this EULA, including any additional EULA terms accompanying the upgrade SOFTWARE.

INTELLECTUAL PROPERTY RIGHTS:

All title and intellectual property rights in and to the SOFTWARE (including but not limited to any images, photographs, animations, video, audio, music, text and "applets" incorporated into the SOFTWARE), the accompanying printed materials, and any copies of the SOFTWARE, are owned by FORD MOTOR COMPANY, or its affiliates or suppliers. The SOFTWARE is licensed, not sold. You may not copy the printed materials accompanying the SOFTWARE. All title and intellectual property rights in and to the content which may be accessed through use of the SOFTWARE is the property of the respective content owner and may be protected by applicable copyright or other intellectual property laws and treaties. This EULA grants you no rights to use such content outside its intended use. All rights not specifically granted under this EULA are reserved by FORD MOTOR COMPANY, its affiliates, and third party software and service providers and suppliers. Use of any on-line services which may be accessed through the SOFTWARE may be governed by the respective terms of use relating to such services. If this SOFTWARE contains documentation that is provided only in electronic form, you may print one copy of such electronic documentation.

EXPORT RESTRICTIONS: You acknowledge that the SOFTWARE is subject to U.S. and European Union export jurisdiction. You agree to comply with all applicable international and national laws that apply to the SOFTWARE, including the U.S. Export Administration Regulations, as well as end-user, end-use and destination restrictions issued by U.S. and other governments.

TRADEMARKS: This EULA does not grant you any rights in connection with any trademarks or service marks of FORD MOTOR COMPANY, its affiliates, and third party software and service providers.

PRODUCT SUPPORT: Please refer to FORD MOTOR COMPANY instructions provided in the documentation for the DEVICES product support, such as the vehicle owner guide.

Should you have any questions concerning this EULA, or if you desire to contact FORD MOTOR COMPANY for any other reason, please refer to the address provided in the documentation for the DEVICES.

No Liability for Certain Damages:

EXCEPT AS PROHIBITED BY LAW, FORD MOTOR COMPANY, ANY THIRD PARTY SOFTWARE OR SERVICES SUPPLIERS, AND THEIR AFFILIATES SHALL HAVE NO LIABILITY FOR ANY INDIRECT, SPECIAL, CONSEQUENTIAL OR INCIDENTAL DAMAGES ARISING FROM OR IN CONNECTION WITH THE USE OR PERFORMANCE OF THE SOFTWARE. THIS LIMITATION SHALL APPLY EVEN IF ANY REMEDY FAILS OF ITS ESSENTIAL PURPOSE. THERE ARE NO WARRANTIES OTHER THAN THOSE THAT MAY BE EXPRESSLY PROVIDED FOR YOUR NEW VEHICLE.

Appendices

SYNC® Automotive Important Safety Information Read and follow instructions:

- Before using your SYNC® system, read and follow all instructions and safety information provided in this end user manual ("Owner Guide".) Not following precautions found in the Owner Guide can lead to an accident or other serious injuries.

General Operation

- **Voice Command Control:** Certain functions within the SYNC® system may be accomplished using voice commands. Using voice commands while driving helps you to operate the system without removing your hands from the wheel or eyes from the road.
- **Prolonged Views of Screen:** Do not access any function requiring a prolonged view of the screen while you are driving. Pull over in a safe and legal manner before attempting to access a function of the system requiring prolonged attention.
- **Volume Setting:** Do not raise the volume excessively. Keep the volume at a level where you can still hear outside traffic and emergency signals while driving. Driving while unable to hear these sounds could cause an accident.
- **Navigation Features:** Any navigation features included in the system are intended to provide turn by turn instructions to get you to a desired destination. Please make certain all persons using this system carefully read and follow instructions and safety information fully.
- **Distraction Hazard:** Any navigation features may require manual (non-verbal) setup. Attempting to perform such set-up or insert data while driving can distract your attention and could cause an accident or other serious injury. Stop the vehicle in a safe and legal manner before attempting these operations.
- **Let Your Judgment Prevail:** Any navigation features are provided only as an aid. Make your driving decisions based on your observations of local conditions and existing traffic regulations. Any such feature is not a substitute for your personal judgment. Any route suggestions made by this system should never replace any local traffic regulations or your personal judgment or knowledge of safe driving practices.
- **Route Safety:** Do not follow the route suggestions if doing so would result in an unsafe or illegal maneuver, if you would be placed in an unsafe situation, or if you would be directed into an area that you consider unsafe. The driver is ultimately responsible for the safe operation of the vehicle and therefore, must evaluate whether it is safe to follow the suggested directions.
- **Potential Map Inaccuracy:** Maps used by this system may be inaccurate because of changes in roads, traffic controls or driving conditions. Always use good judgment and common sense when following the suggested routes.
- **Emergency Services:** Do not rely on any navigation features included in the system to route you to emergency services. Ask local authorities or an emergency services operator for these locations. Not all emergency services such as police, fire stations, hospitals and clinics are likely to be contained in the map database for such navigation features.

Appendices

Your Responsibilities and Assumptions of Risk

- You agree to each of the following: (a) Any use of the SOFTWARE while driving an automobile or other vehicle in violation of applicable law or otherwise driving in an unsafe manner presents a significant risk of distracted driving and should not be attempted under any circumstances; (b) Use of the SOFTWARE at excessive volume poses a significant risk of hearing damage and should not be attempted under any circumstances; (c) The SOFTWARE may not be compatible with new or different versions of an operating system, third party software, or third party services, and the SOFTWARE may potentially cause a critical failure of an operating system, third party software, or third party service. (d) Any third party service accessed by or third party software used with the SOFTWARE (i) may charge an additional fee for access, (ii) may not work correctly, on an uninterrupted basis, or error free, (iii) may change streaming formats or discontinue operation, (iv) may contain adult, profane or offensive content; and (v) may contain inaccurate, false or misleading traffic, weather, financial or safety information or other content; and (e) Use of the SOFTWARE may cause you to incur additional charges from your wireless service provider (WSP) and any data or minute calculators that may be included in the software program are for reference only, are not warranted in any way and should not be relied upon in anyway.
- When using the SOFTWARE, you agree to be responsible for and assume the entire risk to the items set forth in Section (a) – (e) above.

Disclaimer of Warranty

YOU EXPRESSLY ACKNOWLEDGE AND AGREE THAT USE OF THE DEVICES AND SOFTWARE IS AT YOUR SOLE RISK AND THAT THE ENTIRE RISK AS TO SATISFACTORY QUALITY, PERFORMANCE, COMPATIBILITY, ACCURACY AND EFFORT IS WITH YOU. TO THE MAXIMUM EXTENT PERMITTED BY APPLICABLE LAW, THE SOFTWARE AND ANY THIRD PARTY SOFTWARE OR THIRD-PARTY SERVICES ARE PROVIDED "AS IS" AND "AS AVAILABLE", WITH ALL FAULTS AND WITHOUT WARRANTY OF ANY KIND, AND FORD MOTOR COMPANY HEREBY DISCLAIMS ALL WARRANTIES AND CONDITIONS WITH RESPECT TO THE SOFTWARE, THIRD PARTY SOFTWARE, AND THIRD-PARTY SERVICES, EITHER EXPRESS, IMPLIED OR STATUTORY, INCLUDING, BUT NOT LIMITED TO, THE IMPLIED WARRANTIES AND/OR CONDITIONS OF MERCHANTABILITY, OF SATISFACTORY QUALITY, OF FITNESS FOR AN PARTICULAR PURPOSE, OF ACCURACY, OF QUIET ENJOYMENT, AND NON-INFRINGEMENT OF THIRD-PARTY RIGHTS. FORD MOTOR COMPANY DOES NOT WARRANT (a) AGAINST INTERFERENCE WITH YOUR ENJOYMENT OF THE SOFTWARE, THIRD PARTY SOFTWARE, OR THIRD-PARTY SERVICES, (b) THAT THE SOFTWARE, THIRD PARTY SOFTWARE, OR THIRD-PARTY SERVICES WILL MEET YOUR REQUIREMENTS, (c) THAT THE OPERATION OF THE SOFTWARE, THIRD PARTY SOFTWARE, OR THIRD-PARTY SERVICES WILL BE UNINTERRUPTED OR ERROR-FREE, (d) OR THAT DEFECTS IN THE SOFTWARE, THIRD PARTY SOFTWARE, OR THIRD-PARTY SERVICES WILL BE CORRECTED. NO ORAL OR WRITTEN INFORMATION OR ADVICE GIVEN BY FORD MOTOR COMPANY OR ITS AUTHORIZED REPRESENTATIVE SHALL

Appendices

CREATE A WARRANTY. SHOULD THE SOFTWARE, THIRD PARTY SOFTWARE, OR THIRD-PARTY SERVICES PROVE DEFECTIVE, YOU ASSUME THE ENTIRE COST OF ALL NECESSARY SERVICING, REPAIR OR CORRECTION. SOME JURISDICTIONS DO NOT ALLOW THE DISCLAIMER OF IMPLIED WARRANTIES OR LIMITATIONS ON APPLICABLE STATUTORY RIGHTS OF A CONSUMER, SO THE ABOVE DISCLAIMER MAY NOT FULLY APPLY TO YOU. THE SOLE WARRANTY PROVIDED BY FORD MOTOR COMPANY SHALL BE FOUND IN THE WARRANTY INFORMATION INCLUDING WITH YOUR OWNER GUIDE. TO THE EXTENT THAT THERE IS ANY CONFLICT BETWEEN THE TERMS OF THIS SECTION AND THE WARRANTY BOOKLET, THE WARRANTY BOOKLET SHALL CONTROL.

Applicable Law, Venue, Jurisdiction

- The laws of the State of Michigan govern this EULA and Your use of the SOFTWARE. Your use of the SOFTWARE may also be subject to other local, state, national, or international laws. Any litigation arising out of or related to this EULA shall be brought and maintained exclusively in a court of the State of Michigan located in Wayne County or in the United States District Court for the Eastern District of Michigan. You hereby consent to submit to the personal jurisdiction of a court in the State of Michigan located in Wayne County and the United States District Court for the Eastern District of Michigan for any dispute arising out of or relating to this EULA.

Binding Arbitration and Class Action Waiver

(a) Application. This Section applies to any dispute EXCEPT IT DOES NOT INCLUDE A DISPUTE RELATING TO COPYRIGHT INFRINGEMENT, OR TO THE ENFORCEMENT OR VALIDITY OF YOUR, FORD MOTOR COMPANY, OR ANY OF FORD MOTOR COMPANY'S LICENSORS' INTELLECTUAL PROPERTY RIGHTS.

Dispute means any dispute, action, or other controversy between You and FORD MOTOR COMPANY, other than the exceptions listed above, concerning the SOFTWARE (including its price) or this EULA, whether in contract, warranty, tort, statute, regulation, ordinance, or any other legal or equitable basis.

(b) Notice of Dispute. In the event of a Dispute, You or FORD MOTOR COMPANY must give the other a "Notice of Dispute", which is a written statement of the name, address, and contact information of the party giving it, the facts giving rise to the dispute, and the relief requested. You and FORD MOTOR COMPANY will attempt to resolve any dispute through informal negotiation within 60 days from the date the Notice of Dispute is sent. After 60 days, You or FORD MOTOR COMPANY may commence arbitration.

(c) Small claims court. You may also litigate any dispute in small claims court in your county of residence or FORD MOTOR COMPANY'S principal place of business, if the dispute meets all requirements to be heard in the small claims court. You may litigate in small claims court whether or not You negotiated informally first.

(d) Binding arbitration. If You and FORD MOTOR COMPANY, do not resolve any dispute by informal negotiation or in small claims court, any other effort to resolve the dispute will be conducted exclusively by binding arbitration. You are giving up

Appendices

the right to litigate (or participate in as a party or class member) all disputes in court before a judge or jury. Instead, all disputes will be resolved before a neutral arbitrator, whose decision will be final except for a limited right of appeal under the Federal Arbitration Act. Any court with jurisdiction over the parties may enforce the arbitrator's award.

(e) Class action waiver. Any proceedings to resolve or litigate any dispute in any forum will be conducted solely on an individual basis. Neither you nor FORD MOTOR COMPANY, will seek to have any dispute heard as a class action, as a private attorney general action, or in any other proceeding in which any party acts or proposes to act in a representative capacity. No arbitration or proceeding will be combined with another without the prior written consent of all parties to all affected arbitrations or proceedings.

(f) Arbitration procedure. Any arbitration will be conducted by the American Arbitration Association (the "AAA"), under its Commercial Arbitration Rules. If You are an individual and use the SOFTWARE for personal or vehicle use, or if the value of the dispute is \$75,000 or less whether or not You are an individual or how You use the SOFTWARE, the AAA Supplementary Procedures for Consumer-Related Disputes will also apply. To commence arbitration, submit a Commercial Arbitration Rules Demand for Arbitration form to the AAA. You may request a telephonic or in-person hearing by following the AAA rules. In a dispute involving \$10,000 or less, any hearing will be telephonic unless the arbitrator finds good cause to hold an in-person hearing instead. For more information, see adr.org or call 1-800-778-7879. You agree to commence arbitration only in your county of residence or FORD MOTOR COMPANY'S principal place of business. The arbitrator

may award the same damages to You individually as a court could. The arbitrator may award declaratory or injunctive relief only to You individually, and only to the extent required to satisfy Your individual claim.

(g) Arbitration fees and incentives.

- I. Disputes involving \$75,000 or less. FORD MOTOR COMPANY will promptly reimburse your filing fees and pay the AAA's and arbitrator's fees and expenses. If you reject FORD MOTOR COMPANY'S last written settlement offer made before the arbitrator was appointed ("last written offer"), your dispute goes all the way to an arbitrator's decision (called an "award"), and the arbitrator awards you more than the last written offer, FORD MOTOR COMPANY will give you three incentives: (1) pay the greater of the award or \$1,000; (2) pay twice your reasonable attorney's fees, if any; and (3) reimburse any expenses (including expert witness fees and costs) that your attorney reasonably accrues for investigating, preparing, and pursuing your claim in arbitration. The arbitrator will determine the amounts.
- ii. Disputes involving more than \$75,000. The AAA rules will govern payment of filing fees and the AAA's and arbitrator's fees and expenses.
- iii. Disputes involving any amount. In any arbitration you commence, FORD MOTOR COMPANY will seek its AAA or arbitrator's fees and expenses, or Your filing fees it reimbursed, only if the arbitrator finds the arbitration frivolous or brought for an improper purpose. In any arbitration FORD MOTOR COMPANY commences, it will pay all

Appendices

filing, AAA, and arbitrator's fees and expenses. It will not seek its attorney's fees or expenses from you in any arbitration. Fees and expenses are not counted in determining how much a dispute involves.

(h) Claims or disputes must be filed within one year. To the extent permitted by law, any claim or dispute under this EULA to which this Section applies must be filed within one year in small claims court (Section c) or in arbitration (Section d). The one-year period begins when the claim or dispute first could be filed. If such a claim or dispute is not filed within one year, it is permanently barred.

(i) Severability. If the class action waiver (Section e) is found to be illegal or unenforceable as to all or some parts of a dispute, then that portion of Section e will not apply to those parts. Instead, those parts will be severed and proceed in a court of law, with the remaining parts proceeding in arbitration. If any other provision of that portion Section e is found to be illegal or unenforceable, that provision will be severed with the remainder of Section e remaining in full force and effect.

Telenav Software End User License Agreement

Please read these terms and conditions carefully before you use the TeleNav Software. Your use of the TeleNav Software indicates that you accept these terms and conditions. If you do not accept these terms and conditions, do not break the seal of the package, launch, or otherwise use the TeleNav Software. TeleNav may revise this Agreement and the privacy policy at any time, with or without notice to you. You agree to visit <http://www.telenav.com> from time to time to review the then current version of this Agreement and of the privacy policy.

1. Safe and Lawful Use

You acknowledge that devoting attention to the TeleNav Software may pose a risk of injury or death to you and others in situations that otherwise require your undivided attention, and you therefore agree to comply with the following when using the TeleNav Software:

- (a) observe all traffic laws and otherwise drive safely;
 - (b) use your own personal judgment while driving. If you feel that a route suggested by the TeleNav Software instructs you to perform an unsafe or illegal maneuver, places you in an unsafe situation, or directs you into an area that you consider to be unsafe, do not follow such instructions;
 - (c) do not input destinations, or otherwise manipulate the TeleNav Software, unless your vehicle is stationary and parked;
 - (d) do not use the TeleNav Software for any illegal, unauthorized, unintended, unsafe, hazardous, or unlawful purposes, or in any manner inconsistent with this Agreement;
 - (e) arrange all GPS and wireless devices and cables necessary for use of the TeleNav Software in a secure manner in your vehicle so that they will not interfere with your driving and will not prevent the operation of any safety device (such as an airbag).
- You agree to indemnify and hold TeleNav harmless against all claims resulting from any dangerous or otherwise inappropriate use of the TeleNav Software in any moving vehicle, including as a result of your failure to comply with the directions above.

Appendices

2. Account Information

You agree: (a) when registering the TeleNav Software, to provide TeleNav with true, accurate, current, and complete information about yourself, and (b) to inform TeleNav promptly of any changes to such information, and to keep it true, accurate, current and complete.

3. Software License

- Subject to your compliance with the terms of this Agreement, TeleNav hereby grants to you a personal, non-exclusive, non-transferable license (except as expressly permitted below in connection with your permanent transfer of the TeleNav Software license), without the right to sublicense, to use the TeleNav Software (in object code form only) in order to access and use the TeleNav Software. This license shall terminate upon any termination or expiration of this Agreement. You agree that you will use the TeleNav Software only for your personal business or leisure purposes, and not to provide commercial navigation services to other parties.

3.1 License Limitations

- **(a)** reverse engineer, decompile, disassemble, translate, modify, alter or otherwise change the TeleNav Software or any part thereof; **(b)** attempt to derive the source code, audio library or structure of the TeleNav Software without the prior express written consent of TeleNav; **(c)** remove from the TeleNav Software, or alter, any of TeleNav's or its suppliers' trademarks, trade names, logos, patent or copyright notices, or other notices or markings; **(d)**

distribute, sublicense or otherwise transfer the TeleNav Software to others, except as part of your permanent transfer of the TeleNav Software; or **(e)** use the TeleNav Software in any manner that

- i. infringes the intellectual property or proprietary rights, rights of publicity or privacy or other rights of any party,
- ii. violates any law, statute, ordinance or regulation, including but not limited to laws and regulations related to spamming, privacy, consumer and child protection, obscenity or defamation, or
- iii. is harmful, threatening, abusive, harassing, tortuous, defamatory, vulgar, obscene, libelous, or otherwise objectionable; and (f) lease, rent out, or otherwise permit unauthorized access by third parties to the TeleNav Software without advanced written permission of TeleNav.

4. Disclaimers

- To the fullest extent permissible pursuant to applicable law, in no event will TeleNav, its licensors and suppliers, or agents or employees of any of the foregoing, be liable for any decision made or action taken by you or anyone else in reliance on the information provided by the TeleNav Software. TeleNav also does not warrant the accuracy of the map or other data used for the TeleNav Software. Such data may not always reflect reality due to, among other things, road closures, construction, weather, new roads and other changing conditions. You are responsible for the entire risk arising out of your use of the TeleNav Software. For example but without limitation, you agree not to rely on the TeleNav Software for critical navigation in areas where the well-being or survival of you or others

Appendices

is dependent on the accuracy of navigation, as the maps or functionality of the TeleNav Software are not intended to support such high risk applications, especially in more remote geographical areas.

- TELENAV EXPRESSLY DISCLAIMS AND EXCLUDES ALL WARRANTIES IN CONNECTION WITH THE TELENAV SOFTWARE, WHETHER STATUTORY, EXPRESS OR IMPLIED, INCLUDING ALL WARRANTIES WHICH MAY ARISE FROM COURSE OF DEALING, CUSTOM OR TRADE AND INCLUDING, BUT NOT LIMITED TO, THE IMPLIED WARRANTIES OF MERCHANTABILITY, FITNESS FOR A PARTICULAR PURPOSE AND NON-INFRINGEMENT OF THIRD PARTY RIGHTS WITH RESPECT TO THE TELENAV SOFTWARE.
- Certain jurisdictions do not permit the disclaimer of certain warranties, so this limitation may not apply to you.

5. Limitation of Liability

- TO THE EXTENT PERMITTED UNDER APPLICABLE LAW, UNDER NO CIRCUMSTANCES SHALL TELENAV OR ITS LICENSORS AND SUPPLIERS BE LIABLE TO YOU OR TO ANY THIRD PARTY FOR ANY INDIRECT, INCIDENTAL, CONSEQUENTIAL, SPECIAL OR EXEMPLARY DAMAGES (INCLUDING IN EACH CASE, BUT NOT LIMITED TO, DAMAGES FOR THE INABILITY TO USE THE EQUIPMENT OR ACCESS DATA, LOSS OF DATA, LOSS OF BUSINESS, LOSS OF PROFITS, BUSINESS INTERRUPTION OR THE LIKE) ARISING OUT OF THE USE OF OR INABILITY TO USE THE TELENAV SOFTWARE, EVEN IF TELENAV HAS BEEN ADVISED OF THE POSSIBILITY OF SUCH DAMAGES. NOTWITHSTANDING ANY DAMAGES THAT YOU MIGHT INCUR FOR ANY

REASON WHATSOEVER (INCLUDING, WITHOUT LIMITATION, ALL DAMAGES REFERENCED HEREIN AND ALL DIRECT OR GENERAL DAMAGES IN CONTRACT, TORT (INCLUDING NEGLIGENCE) OR OTHERWISE), THE ENTIRE LIABILITY OF TELENAV AND OF ALL OF TELENAV'S SUPPLIERS SHALL BE LIMITED TO THE AMOUNT ACTUALLY PAID BY YOU FOR THE TELENAV SOFTWARE. SOME STATES AND/OR JURISDICTIONS DO NOT ALLOW THE EXCLUSION OR LIMITATION OF INCIDENTAL OR CONSEQUENTIAL DAMAGES, SO THE ABOVE LIMITATIONS OR EXCLUSIONS MAY NOT APPLY TO YOU.

6. Arbitration and Governing Law

- You agree that any dispute, claim or controversy arising out of or relating to this Agreement or the TeleNav Software shall be settled by independent arbitration involving a neutral arbitrator and administered by the American Arbitration Association in the County of Santa Clara, California. The arbitrator shall apply the Commercial Arbitration Rules of the American Arbitration Association, and the judgment upon the award rendered by the arbitrator may be entered by any court having jurisdiction. Note that there is no judge or jury in an arbitration proceeding and the decision of the arbitrator shall be binding upon both parties. You expressly agree to waive your right to a jury trial. This Agreement and performance hereunder will be governed by and construed in accordance with the laws of the State of California, without giving effect to its conflict of law provisions. To the extent judicial action is necessary in connection with the binding arbitration, both TeleNav and you agree to submit

Appendices

to the exclusive jurisdiction of the courts of the County of Santa Clara, California. The United Nations Convention on Contracts for the International Sale of Goods shall not apply.

7. Assignment

- You may not resell, assign, or transfer this Agreement or any of your rights or obligations, except in totality, in connection with your permanent transfer of the TeleNav Software, and expressly conditioned upon the new user of the TeleNav Software agreeing to be bound by the terms and conditions of this Agreement. Any such sale, assignment or transfer that is not expressly permitted under this paragraph will result in immediate termination of this Agreement, without liability to TeleNav, in which case you and all other parties shall immediately cease all use of the TeleNav Software. Notwithstanding the foregoing, TeleNav may assign this Agreement to any other party at any time without notice, provided the assignee remains bound by this Agreement.

8. Miscellaneous

8.1

This Agreement constitutes the entire agreement between TeleNav and you with respect to the subject matter hereof.

8.2

Except for the limited licenses expressly granted in this Agreement, TeleNav retains all right, title and interest in and to the TeleNav Software, including without limitation all related intellectual property rights. No licenses or other rights which are not expressly granted in this Agreement are intended to, or shall be, granted or

conferred by implication, statute, inducement, estoppel or otherwise, and TeleNav and its suppliers and licensors hereby reserve all of their respective rights other than the licenses explicitly granted in this Agreement.

8.3

By using the TeleNav Software, you consent to receive from TeleNav all communications, including notices, agreements, legally required disclosures or other information in connection with the TeleNav Software (collectively, "Notices") electronically. TeleNav may provide such Notices by posting them on TeleNav's Website or by downloading such Notices to your wireless device. If you desire to withdraw your consent to receive Notices electronically, you must discontinue your use of the TeleNav Software.

8.4

TeleNav's or your failure to require performance of any provision shall not affect that party's right to require performance at any time thereafter, nor shall a waiver of any breach or default of this Agreement constitute a waiver of any subsequent breach or default or a waiver of the provision itself.

8.5

If any provision herein is held unenforceable, then such provision will be modified to reflect the intention of the parties, and the remaining provisions of this Agreement will remain in full force and effect.

Appendices

8.6

The headings in this Agreement are for convenience of reference only, will not be deemed to be a part of this Agreement, and will not be referred to in connection with the construction or interpretation of this Agreement. As used in this Agreement, the words "include" and "including" and variations thereof, will not be deemed to be terms of limitation, but rather will be deemed to be followed by the words "without limitation".

9. Other Vendors Terms and Conditions

- The Telenav Software utilizes map and other data licensed to Telenav by third party vendors for the benefit of you and other end users. This Agreement includes end-user terms applicable to these companies (included at the end of this Agreement), and thus your use of the Telenav Software is also subject to such terms. You agree to comply with the following additional terms and conditions, which are applicable to Telenav's third party vendor licensors::

9.1 End User Terms Required by HERE North America, LLC

The data ("Data") is provided for your personal, internal use only and not for resale. It is protected by copyright, and is subject to the following terms and conditions which are agreed to by you, on the one hand, and Telenav ("Telenav") and its licensors (including their licensors and suppliers) on the other hand.

© 2013 HERE. All rights reserved.

The Data for areas of Canada includes information taken with permission from Canadian authorities, including: © Her Majesty the Queen in Right of Canada, © Queen's Printer for Ontario, © Canada Post Corporation, GeoBase®, © Department of Natural Resources Canada.

HERE holds a non-exclusive license from the United States Postal Service® to publish and sell ZIP+4® information.

©United States Postal Service® 2014. Prices are not established, controlled or approved by the United States Postal Service®. The following trademarks and registrations are owned by the USPS: United States Postal Service, USPS, and ZIP+4

The Data for Mexico includes certain data from Instituto Nacional de Estadística y Geografía.

9.2 End User Terms Required by NAV2 (Shanghai) Co., Ltd

The data ("Data") is provided for your personal, internal use only and not for resale. It is protected by copyright, and is subject to the following terms and conditions which are agreed to by you, on the one hand, and NAV2 (Shanghai) Co., Ltd ("NAV2") and its licensors (including their licensors and suppliers) on the other hand. 20xx. All rights reserved

Terms and Conditions

Permitted Use. You agree to use this Data together with the Telenav Software solely for the internal business and personal purposes for which you were licensed, and not for service bureau, time-sharing or other similar purposes. Accordingly, but subject to the restrictions set forth in the following paragraphs, you agree not to otherwise reproduce, copy, modify, decompile, disassemble, create any derivative works of, or reverse engineer any portion of this Data, and may not transfer or distribute it in any form, for any purpose, except to the extent permitted by mandatory laws.

Appendices

Restrictions. Except where you have been specifically licensed to do so by Telenav, and without limiting the preceding paragraph, you may not use this Data (a) with any products, systems, or applications installed or otherwise connected to or in communication with vehicles, capable of vehicle navigation, positioning, dispatch, real time route guidance, fleet management or similar applications; or (b) with or in communication with any positioning devices or any mobile or wireless-connected electronic or computer devices, including without limitation cellular phones, palmtop and handheld computers, pagers, and personal digital assistants or PDAs.

Warning. The Data may contain inaccurate or incomplete information due to the passage of time, changing circumstances, sources used and the nature of collecting comprehensive geographic data, any of which may lead to incorrect results.

No Warranty. This Data is provided to you “as is,” and you agree to use it at your own risk. Telenav and its licensors (and their licensors and suppliers) make no guarantees, representations or warranties of any kind, express or implied, arising by law or otherwise, including but not limited to, content, quality, accuracy, completeness, effectiveness, reliability, fitness for a particular purpose, usefulness, use or results to be obtained from this Data, or that the Data or server will be uninterrupted or error-free.

Disclaimer of Warranty: TELENAV AND ITS LICENSORS (INCLUDING THEIR LICENSORS AND SUPPLIERS) DISCLAIM ANY WARRANTIES, EXPRESS OR IMPLIED, OF QUALITY, PERFORMANCE, MERCHANTABILITY, FITNESS FOR A

PARTICULAR PURPOSE OR NON-INFRINGEMENT. Some States, Territories and Countries do not allow certain warranty exclusions, so to that extent the above exclusion may not apply to you.

Disclaimer of Liability: TELENAV AND ITS LICENSORS (INCLUDING THEIR LICENSORS AND SUPPLIERS) SHALL NOT BE LIABLE TO YOU: IN RESPECT OF ANY CLAIM, DEMAND OR ACTION, IRRESPECTIVE OF THE NATURE OF THE CAUSE OF THE CLAIM, DEMAND OR ACTION ALLEGING ANY LOSS, INJURY OR DAMAGES, DIRECT OR INDIRECT, WHICH MAY RESULT FROM THE USE OR POSSESSION OF THE INFORMATION; OR FOR ANY LOSS OF PROFIT, REVENUE, CONTRACTS OR SAVINGS, OR ANY OTHER DIRECT, INDIRECT, INCIDENTAL, SPECIAL OR CONSEQUENTIAL DAMAGES ARISING OUT OF YOUR USE OF OR INABILITY TO USE THIS INFORMATION, ANY DEFECT IN THE INFORMATION, OR THE BREACH OF THESE TERMS OR CONDITIONS, WHETHER IN AN ACTION IN CONTRACT OR TORT OR BASED ON A WARRANTY, EVEN IF TELENAV OR ITS LICENSORS HAVE BEEN ADVISED OF THE POSSIBILITY OF SUCH DAMAGES. Some States, Territories and Countries do not allow certain liability exclusions or damages limitations, so to that extent the above may not apply to you.

Export Control. You shall not export from anywhere any part of the Data or any direct product thereof except in compliance with, and with all licenses and approvals required under, applicable export laws, rules and regulations, including but not limited to the laws, rules and regulations administered by the Office of Foreign Assets Control of the U.S. Department of Commerce and the Bureau of Industry and Security of the U.S. Department of Commerce. To the extent that any such

Appendices

export laws, rules or regulations prohibit HERE from complying with any of its obligations hereunder to deliver or distribute Data, such failure shall be excused and shall not constitute a breach of this Agreement.

Entire Agreement. These terms and conditions constitute the entire agreement between Telenav (and its licensors, including their licensors and suppliers) and you pertaining to the subject matter hereof, and supersedes in their entirety any and all written or oral agreements previously existing between us with respect to such subject matter.

Governing Law. The above terms and conditions shall be governed by the laws of the State of Illinois [insert “Netherlands” where European HERE Data is used], without giving effect to (i) its conflict of laws provisions, or (ii) the United Nations Convention for Contracts for the International Sale of Goods, which is explicitly excluded. You agree to submit to the jurisdiction of the State of Illinois [insert “The Netherlands” where European HERE Data is used] for any and all disputes, claims and actions arising from or in connection with the Data provided to you hereunder.

Government End Users. If the Data is being acquired by or on behalf of the United States government or any other entity seeking or applying rights similar to those customarily claimed by the United States government, this Data is a “commercial item” as that term is defined at 48 C.F.R. (“FAR”) 2.101, is licensed in accordance with these End-User Terms, and each copy of Data delivered or otherwise furnished shall be marked and embedded as appropriate with the following “Notice of Use,” and shall be treated in accordance with such Notice:

NOTICE OF USE
CONTRACTOR (MANUFACTURER/ SUPPLIER) NAME: HERE
CONTRACTOR (MANUFACTURER/ SUPPLIER) ADDRESS: c/o Nokia, 425 West Randolph Street, Chicago, Illinois 60606
This Data is a commercial item as defined in FAR 2.101 and is subject to these End-User Terms under which this Data was provided.
© 1987 – 2014 HERE – All rights reserved.

If the Contracting Officer, federal government agency, or any federal official refuses to use the legend provided herein, the Contracting Officer, federal government agency, or any federal official must notify HERE prior to seeking additional or alternative rights in the Data.

I. US/Canada Territory

A. United States Data. The End-User Terms for any Application containing Data for the United States shall contain the following notices:

“HERE holds a non-exclusive license from the United States Postal Service® to publish and sell ZIP+4® information.”

“©United States Postal Service® 20XX. Prices are not established, controlled or approved by the United States Postal Service®. The following trademarks and registrations are owned by the USPS: United States Postal Service, USPS, and ZIP+4.”

Appendices

B. Canada Data. The following provisions apply to the Data for Canada, which may include or reflect data from third party licensors (“Third Party Data”), including Her Majesty the Queen in Right of Canada (“Her Majesty”), Canada Post Corporation (“Canada Post”) and the Department of Natural Resources of Canada (“NRCan”):

1. Disclaimer and Limitation: Client agrees that its use of the Third Party Data is subject to the following provisions:

a. Disclaimer: The Third Party Data is licensed on an “as is” basis. The licensors of such data, including Her Majesty, Canada Post and NRCan, make no guarantees, representations or warranties respecting such data, either express or implied, arising by law or otherwise, including but not limited to, effectiveness, completeness, accuracy or fitness for a particular purpose.

b. Limitation on Liability: The Third Party Data licensors, including Her Majesty, Canada Post and NRCan, shall not be liable: (i) in respect of any claim, demand or action, irrespective of the nature of the cause of the claim, demand or action alleging any loss, injury or damages, direct or indirect, which may result from the use or possession of such Data; or (ii) in any way for loss of revenues or contracts, or any other consequential loss of any kind resulting from any defect in the Data.

2. Copyright Notice: In connection with each copy of all or any portion of the Data for the Territory of Canada, Client shall affix in a conspicuous manner the following copyright notice on at least one of: (i) the label for the storage media of the copy; (ii) the packaging for the copy; or (iii) other materials packaged with the copy, such as user manuals or end user license agreements: “This data includes information taken with permission from Canadian authorities, including © Her Majesty the Queen in Right of Canada, © Queen’s Printer for Ontario, © Canada Post Corporation, GeoBase®, © The Department of Natural Resources Canada. All rights reserved.”

3. End-User Terms: Except as otherwise agreed by the parties, in connection with the provision of any portion of the Data for the Territory of Canada to End-Users as may be authorized under the Agreement, Client shall provide such End-Users, in a reasonably conspicuous manner, with terms (set forth with other end user terms required to be provided under the Agreement, or as otherwise may be provided, by Client) which shall include the following provisions on behalf of the Third Party Data licensors, including Her Majesty, Canada Post and NRCan:

The Data may include or reflect data of licensors, including Her Majesty the Queen in the Right of Canada (“Her Majesty”), Canada Post Corporation (“Canada Post”) and the Department of Natural Resources Canada (“NRCan”). Such data is licensed on an “as is” basis. The licensors, including Her Majesty, Canada Post and NRCan, make no guarantees, representations or warranties respecting such data,

Appendices

either express or implied, arising by law or otherwise, including but not limited to, effectiveness, completeness, accuracy or fitness for a particular purpose. The licensors, including Her Majesty, Canada Post and NRCan, shall not be liable in respect of any claim, demand or action, irrespective of the nature of the cause of the claim, demand or action alleging any loss, injury or damages, direct or indirect, which may result from the use or possession of the data or the Data. The licensors, including Her Majesty, Canada Post and NRCan, shall not be liable in any way for loss of revenues or contracts, or any other consequential loss of any kind resulting from any defect in the data or the Data.

End User shall indemnify and save harmless the licensors, including Her Majesty, Canada Post and NRCan, and their officers, employees and agents from and against any claim, demand or action, irrespective of the nature of the cause of the claim, demand or action, alleging loss, costs, expenses, damages or injuries (including injuries resulting in death) arising out of the use or possession of the data or the Data.

4. Additional Provisions: The terms contained in this Section are in addition to all of the rights and obligations of the parties under the Agreement. To the extent that any of the provisions of this Section are inconsistent with, or conflict with, any other provisions of the Agreement, the provisions of this Section shall prevail.

II. Mexico. The following provision applies to the Data for Mexico, which includes certain data from the Instituto Nacional de Estadística y Geografía (“INEGI”):

A. Any and all copies of the Data and/or packaging containing Data for Mexico shall contain the following notice: “Fuente: INEGI (Instituto Nacional de Estadística y Geografía)”

III. Latin America Territory

A. Third Party Notices. Any and all copies of the Data and/or packaging relating thereto shall include the respective Third Party Notices set forth below and used as described below corresponding to the Territory (or portion thereof) included in such copy:

Territory	Notice
Argentina	IGN “INSTITUTO GEOGRAFICO NACIONAL ARGENTINO”
Ecuador	“INSTITUTO GEOGRAFICO MILITAR DEL ECUADOR AUTORIZACION N° IGM-2011-01- PCO-01 DEL 25 DE ENERO DE 2011” “source: © IGN 2009 - BD TOPO ®”
Guadeloupe, French Guiana and Martinique Mexico	“Fuente: INEGI (Instituto Nacional de Estadística y Geografía)”

IV. Middle East Territory

Appendices

A. Third Party Notices. Any and all copies of the Data and/or packaging relating thereto shall include the respective Third Party Notices set forth below and used as described below corresponding to the Territory (or portion thereof) included in such copy:

Country	Notice
Jordan	“© Royal Jordanian Geographic Centre”. The foregoing notice requirement for Jordan Data is a material term of the Agreement. If Client or any of its permitted sublicensees (if any) fail to meet such requirement, HERE shall have the right to terminate Client’s license with respect to the Jordan Data.

B. Jordan Data. Client and its permitted sublicensees (if any) are restricted from licensing and/or otherwise distributing HERE’s database for the country of Jordan (“Jordan Data”) for use in Enterprise Applications to (i) non-Jordanian entities for use of the Jordan Data solely in Jordan or (ii) Jordan-based customers. In addition, Client, its permitted sublicensees (if any) and End-Users are restricted from using the Jordan Data in Enterprise Applications if such party is (i) a non-Jordanian entity using the Jordan Data solely in Jordan or (ii) a Jordan-based customer. For purposes of the foregoing, “Enterprise Applications” shall mean Geomarketing applications, GIS applications, mobile business asset management applications, call center applications, telematics applications, public organization Internet applications or for providing geocoding services.

V. Europe Territory

A. Use of Certain Traffic Codes in Europe

1. General Restrictions Applicable to Traffic Codes. Client acknowledges and agrees that in certain countries of the Europe Territory, Client will need to obtain rights directly from third party RDS-TMC code providers to receive and use the Traffic Codes in the Data and to deliver to End-Users Transactions in any way derived from or based on such Traffic Codes. For such countries, HERE shall deliver the Data incorporating Traffic Codes to Client only after receiving certification from Client of its having obtained such rights.

2. Display of Third Party Rights Legends for Belgium. Client shall, for each Transaction that uses Traffic Codes for Belgium, provide the following notice to the End-User: “Traffic Codes for Belgium are provided by the Ministerie van de Vlaamse Gemeenschap and the Ministère de l’Equipeement et des Transports.”

B. Paper Maps. With respect to any license granted to Client relating to making, selling or distributing paper maps (i.e., a map fixed on a paper or paper-like medium): (a) such license with respect to Data for the Territory of Great Britain is conditioned on Client’s entering into and complying with a separate written agreement with the Ordnance Survey (“OS”) to create and sell paper maps, Client’s paying to the OS any and all applicable paper map royalties, and Client’s complying with the OS copyright notice requirements; (b) such license for selling or otherwise distributing for charge with respect to Data for the Territory of Czech Republic

Appendices

is conditioned on Client's obtaining prior written consent from Kartografie a.s.; (c) such license for selling or distributing with respect to Data for the Territory of Switzerland is conditioned on Client's obtaining a permit from Bundesamt für Landestopografie of Switzerland; (d) Client is restricted from using Data for the Territory of France to create paper maps with a scale between 1:5,000 and 1:250,000; and (e) Client is restricted from using any Data to create, sell or distribute paper maps that are the same or substantially similar, in terms of data content and specific use of color, symbols and scale, to paper maps published by the European national mapping agencies, including without limitation, Landervermessungämter of Germany, Topografische Dienst of the Netherlands, Nationaal Geografisch Instituut of Belgium, Bundesamt für Landestopografie of Switzerland, Bundesamt für Eich-und Vermessungswesen of Austria, and the National Land Survey of Sweden.

C. OS Enforcement. Without limiting Section IV(B) above, with respect to Data for the Territory of Great Britain, Client acknowledges and agrees that the Ordnance Survey ("OS") may bring a direct action against Client to enforce compliance with the OS copyright notice (see Section IV(D) below) and paper map requirements (see Section IV(B) above) contained in this Agreement.

D. Third Party Notices. Any and all copies of the Data and/or packaging relating thereto shall include the respective Third Party Notices set forth below and used as described below corresponding to the Territory (or portion thereof) included in such copy:

Country(ies) Notice

Austria	"© Bundesamt für Eich-und Vermessungswesen"
Croatia Cyprus, Estonia, Latvia, Lithuania, Moldova, Poland, Slovenia and/or Ukraine	"© EuroGeographics"
France	"source: © IGN 2009 – BD TOPO ®"
Germany	"Die Grundlagendaten wurden mit Genehmigung der zuständigen Behörden entnommen"
Great Britain	"Contains Ordnance Survey data © Crown copyright and database right 2010 Contains Royal Mail data © Royal Mail copyright and database right 2010"
Greece	"Copyright Geomatics Ltd."
Hungary	"Copyright © 2003; Top-Map Ltd."
Italy	"La Banca Dati Italiana è stata prodotta usando quale riferimento anche cartografia numerica ed al tratto prodotta e fornita dalla Regione Toscana."
Norway	"Copyright © 2000; Norwegian Mapping Authority"
Portugal	"Source: IgeoE – Portugal"

Appendices

Spain "Información geográfica propiedad del CNIG"

Sweden "Based upon electronic data © National Land Survey Sweden."

Switzerland "Topografische Grundlage: © Bundesamt für Landestopographie."

E. Respective Country Distribution. Client acknowledges that HERE has not received approvals to distribute map data for the following countries in such respective countries: Albania, Belarus, Kyrgyzstan, Moldova and Uzbekistan. HERE may update such list from time to time. The license rights granted to Client under this TL with respect to the Data for such countries are contingent upon Client's compliance with all applicable laws and regulations, including, without limitation, any required licenses or approvals to distribute the Application incorporating such Data in such respective countries.

VI. Australia Territory

A. Third Party Notices. Any and all copies of the Data and/or packaging relating thereto shall include the respective Third Party Notices set forth below and used as described below corresponding to the Territory (or portion thereof) included in such copy:

Copyright. Based on data provided under license from PSMA Australia Limited (www.pasma.com.au).

Product incorporates data which is © 20XX Telstra Corporation Limited, GM Holden Limited, Intelomatics Australia Pty Ltd and Continental Pty Ltd.

B. Third Party Notices for Australia. In addition to the foregoing, the End-User Terms for any Application containing RDS-TMC Traffic Codes for Australia shall contain the following notice:

"Product incorporates traffic location codes which is © 20XX Telstra Corporation Limited and its licensors."

AT&T Vehicle Network Carrier Telematics Disclosure

END USER FOR PURPOSES OF THIS SECTION MEANS YOU AND YOUR HEIRS, EXECUTORS, LEGAL PERSONAL REPRESENTATIVES AND PERMITTED ASSIGNS. FOR PURPOSES OF THIS SECTION "UNDERLYING WIRELESS SERVICE CARRIER" INCLUDES ITS AFFILIATES AND CONTRACTORS AND THEIR RESPECTIVE OFFICERS, DIRECTORS, EMPLOYEES, SUCCESSORS AND ASSIGNS. END USER HAS NO CONTRACTUAL RELATIONSHIP WITH THE UNDERLYING WIRELESS SERVICE CARRIER AND END USER IS NOT A THIRD PARTY BENEFICIARY OF ANY AGREEMENT BETWEEN FORD AND UNDERLYING CARRIER. END USER UNDERSTANDS AND AGREES THAT THE UNDERLYING CARRIER HAS NO LEGAL, EQUITABLE, OR OTHER LIABILITY OF ANY KIND TO END USER. IN ANY EVENT, REGARDLESS OF THE FORM OF THE ACTION, WHETHER FOR BREACH OF CONTRACT, WARRANTY, NEGLIGENCE, STRICT LIABILITY IN TORT OR OTHERWISE, END USER'S EXCLUSIVE REMEDY FOR CLAIMS ARISING IN ANY WAY IN CONNECTION WITH THIS AGREEMENT, FOR ANY CAUSE WHATSOEVER, INCLUDING BUT NOT LIMITED TO ANY FAILURE OR

Appendices

DISRUPTION OF SERVICE PROVIDED HEREUNDER, IS LIMITED TO PAYMENT OF DAMAGES IN AN AMOUNT NOT TO EXCEED THE AMOUNT PAID BY END USER FOR THE SERVICES DURING THE TWO-MONTH PERIOD PRECEDING THE DATE THE CLAIM AROSE.

(ii) END USER AGREES TO INDEMNIFY AND HOLD HARMLESS THE UNDERLYING WIRELESS SERVICE CARRIER AND ITS OFFICERS, EMPLOYEES, AND AGENTS AGAINST ANY AND ALL CLAIMS, INCLUDING WITHOUT LIMITATION CLAIMS FOR LIBEL, SLANDER, OR ANY PROPERTY DAMAGE, PERSONAL INJURY OR DEATH, ARISING IN ANY WAY, DIRECTLY OR INDIRECTLY, IN CONNECTION WITH THIS AGREEMENT OR THE USE, FAILURE TO USE, OR INABILITY TO USE THE DEVICE EXCEPT WHERE THE CLAIMS RESULT FROM THE UNDERLYING CARRIER'S GROSS NEGLIGENCE OR WILLFUL MISCONDUCT. THIS INDEMNITY WILL SURVIVE THE TERMINATION OF THE AGREEMENT.

(iii) END USER HAS NO PROPERTY RIGHT IN ANY NUMBER ASSIGNED TO THE DEVICE.

(iv) END USER UNDERSTANDS THAT FORD AND THE UNDERLYING CARRIER CANNOT GUARANTY THE SECURITY OF WIRELESS TRANSMISSIONS, AND WILL NOT BE LIABLE FOR ANY LACK OF SECURITY RELATING TO THE USE OF THE SERVICES

THE SERVICE IS FOR [END USER'S] USE ONLY AND END USER MAY NOT RESELL THE SERVICE TO ANY OTHER PARTY END USER UNDERSTANDS THAT THE UNDERLYING CARRIER DOES NOT GUARANTEE ANY END USER UNINTERRUPTED SERVICE OR COVERAGE. THE UNDERLYING CARRIER DOES NOT WARRANT THAT END USERS CAN OR WILL BE LOCATED USING THE SERVICE. THE UNDERLYING CARRIER

MAKES NO WARRANTY, EXPRESS OR IMPLIED, OF MERCHANTABILITY OR FITNESS FOR A PARTICULAR PURPOSE, SUITABILITY, OR PERFORMANCE REGARDING ANY SERVICES OR GOODS, AND IN NO EVENT SHALL AT&T BE LIABLE, WHETHER OR NOT DUE TO ITS OWN NEGLIGENCE, FOR ANY: (A) ACT OR OMISSION OF A THIRD PARTY; (B) MISTAKES, OMISSIONS, INTERRUPTIONS, ERRORS, FAILURES TO TRANSMIT, DELAYS, OR DEFECTS IN THE SERVICE PROVIDED BY OR THROUGH THE UNDERLYING CARRIER; (C) DAMAGE OR INJURY CAUSED BY SUSPENSION OR TERMINATION BY THE UNDERLYING CARRIER; OR (D) DAMAGE OR INJURY CAUSED BY A FAILURE OR DELAY IN CONNECTING A CALL TO ANY ENTITY, INCLUDING 911 OR ANY OTHER EMERGENCY SERVICE. TO THE FULL EXTENT ALLOWED BY LAW, THE END USER RELEASES, INDEMNIFIES AND HOLDS THE UNDERLYING CARRIER HARMLESS FROM AND AGAINST ANY AND ALL CLAIMS OF ANY PERSON OR ENTITY FOR DAMAGES OF ANY NATURE ARISING IN ANY WAY FROM OR RELATING TO, DIRECTLY OR INDIRECTLY, SERVICES PROVIDED BY THE UNDERLYING CARRIER OR ANY PERSON'S USE THEREOF, INCLUDING CLAIMS ARISING IN WHOLE OR IN PART FROM THE ALLEGED NEGLIGENCE OF THE UNDERLYING CARRIER.

VII. China Territory

Personal Use Only

You agree to use this Data together with [insert name of Client Application] for the solely personal, non-commercial purposes for which you were licensed, and not for service bureau, time-sharing or other similar purposes. Accordingly, but subject to the restrictions set forth in the following paragraphs, you may copy this Data only as necessary for your personal use to (i)

Appendices

view it, and (ii) save it, provided that you do not remove any copyright notices that appear and do not modify the Data in any way. You agree not to otherwise reproduce, copy, modify, decompile, disassemble or reverse engineer any portion of this Data, and may not transfer or distribute it in any form, for any purpose, except to the extent permitted by mandatory laws.

Restrictions

Except where you have been specifically licensed to do so by NAV2, and without limiting the preceding paragraph, you may not (a) use this Data with any products, systems, or applications installed or otherwise connected to or in communication with vehicles, capable of vehicle navigation, positioning, dispatch, real time route guidance, fleet management or similar applications; or (b) with or in communication with any positioning devices or any mobile or wireless-connected electronic or computer devices, including without limitation cellular phones, palmtop and handheld computers, pagers, and personal digital assistants or PDAs. You agree to cease using this Data if you fail to comply with these terms and conditions.

Limited Warranty

NAV2 warrants that (a) the Data will perform substantially in accordance with the accompanying written materials for a period of ninety (90) days from the date of receipt, and (b) any support services provided by NAV2 shall be substantially as described in applicable written materials provided to you by NAV2, and NAV2's support engineers will make commercially reasonable efforts to solve any problem issues.

Customer Remedies

NAV2 and its suppliers' entire liability and your exclusive remedy shall be, at NAV2's sole discretion, either (a) return of the price paid, if any, or (b) repair or replacement of the Data that do not meet NAV2's Limited Warranty and that are returned to NAV2 with a copy of your receipt. This Limited Warranty is void if failure of the Data has resulted from accident, abuse, or misapplication. Any replacement Data will be warranted for the remainder of the original warranty period or thirty (30) days, whichever is longer. Neither these remedies nor any product support services offered by NAV2 are available without proof of purchase from an authorized international source.

No Other Warranty:

EXCEPT FOR THE LIMITED WARRANTY SET FORTH ABOVE AND TO THE EXTENT PERMITTED BY APPLICABLE LAW, NAV2 AND ITS LICENSORS (INCLUDING THEIR LICENSORS AND SUPPLIERS) DISCLAIM ANY WARRANTIES, EXPRESS OR IMPLIED, OF QUALITY, PERFORMANCE, MERCHANTABILITY, FITNESS FOR A PARTICULAR PURPOSE, OWNERSHIP OR NON-INFRINGEMENT. Certain warranty exclusions may not be permitted under applicable law, so to that extent the above exclusion may not apply to you.

Limited Liability:

TO THE EXTENT PERMITTED BY APPLICABLE LAW, NAV2 AND ITS LICENSORS (INCLUDING THEIR LICENSORS AND SUPPLIERS) SHALL NOT BE LIABLE TO YOU: IN RESPECT OF ANY CLAIM, DEMAND OR ACTION, IRRESPECTIVE OF THE NATURE OF THE CAUSE OF THE CLAIM, DEMAND OR ACTION ALLEGING ANY LOSS, INJURY OR DAMAGES, DIRECT OR INDIRECT, WHICH MAY RESULT FROM THE USE OR POSSESSION OF THE INFORMATION; OR

Appendices

FOR ANY LOSS OF PROFIT, REVENUE, CONTRACTS OR SAVINGS, OR ANY OTHER DIRECT, INDIRECT, INCIDENTAL, SPECIAL OR CONSEQUENTIAL DAMAGES ARISING OUT OF YOUR USE OF OR INABILITY TO USE THIS INFORMATION, ANY DEFECT IN THE INFORMATION, OR THE BREACH OF THESE TERMS OR CONDITIONS, WHETHER IN AN ACTION IN CONTRACT OR TORT OR BASED ON A WARRANTY, EVEN IF NAV2 OR ITS LICENSORS HAVE BEEN ADVISED OF THE POSSIBILITY OF SUCH DAMAGES. UNDER NO CIRCUMSTANCES SHALL NAV2'S OR ITS SUPPLIERS' LIABILITY HEREUNDER EXCEED THE PRICE PAID. Certain liability exclusions may not be permitted under applicable law, so to that extent the above exclusion may not apply to you.

Export Control

You agree not to export to anywhere any part of the Data provided to you or any direct product thereof except in compliance with, and with all licenses and approvals required under, applicable export laws, rules and regulations.

IP Protection

The Data are owned by NAV2 or its suppliers and are protected by applicable copyright and other intellectual property law and treaties. The Data are provided solely on the basis of a license to use, not sale.

Entire Agreement

These terms and conditions constitute the entire agreement between NAV2 (and its licensors, including their licensors and suppliers) and you pertaining to the subject matter hereof, and supersedes in their entirety any and all written or oral agreements previously existing between us with respect to such subject matter.

Governing Law.

The above terms and conditions shall be governed by the laws of the People's Republic of China, without giving effect to (i) its conflict of laws provisions, or (ii) the United Nations Convention for Contracts for the International Sale of Goods, which is explicitly excluded. Any dispute arising from or in connection with the Data provided to you hereunder shall be submitted to the Shanghai International Economic and Trade Arbitration Commission for arbitration.

Gracenote® Copyright

CD and music-related data from Gracenote, Inc., copyright©

2000-2007 Gracenote. Gracenote Software, copyright © 2000-2007 Gracenote. This product and service may practice one or more of the following U.S. Patents 5,987,525; 6,061,680; 6,154,773; 6,161,132; 6,230,192; 6,230,207; 6,240,459; 6,330,593 and other patents issued or pending. Some services supplied under license from Open Globe, Inc. for U.S. Patent 6,304,523.

Gracenote and CDDB are registered trademarks of Gracenote. The Gracenote logo and logotype, and the "Powered by Gracenote™" logo are trademarks of Gracenote.

Gracenote® End User License Agreement (EULA)

This device contains software from Gracenote, Inc. of 2000 Powell Street Emeryville, California 94608 ("Gracenote").

The software from Gracenote (the "Gracenote Software") enables this device to do disc and music file identification and obtain music-related information, including name, artist, track, and title information ("Gracenote Data") from online servers

Appendices

("Gracenote Servers"), and to perform other functions. You may use Gracenote Data only by means of the intended End User functions of this device. This device may contain content belonging to Gracenote's providers. If so, all of the restrictions set forth herein with respect to Gracenote Data shall also apply to such content and such content providers shall be entitled to all of the benefits and protections set forth herein that are available to Gracenote. You agree that you will use the content from Gracenote ("Gracenote Content"), Gracenote Data, the Gracenote Software, and Gracenote Servers for your own personal, non-commercial use only. You agree not to assign, copy, transfer or transmit the Gracenote Content, Gracenote Software or any Gracenote Data (except in a Tag associated with a music file) to any third party. YOU AGREE NOT TO USE OR EXPLOIT GRACENOTE CONTENT, GRACENOTE DATA, THE GRACENOTE SOFTWARE, OR GRACENOTE SERVERS, EXCEPT AS EXPRESSLY PERMITTED HEREIN.

You agree that your non-exclusive licenses to use the Gracenote Content, Gracenote Data, the Gracenote Software, and Gracenote Servers will terminate if you violate these restrictions. If your licenses terminate, you agree to cease any and all use of the Gracenote Content, Gracenote Data, the Gracenote Software, and Gracenote Servers.

Gracenote, respectively, reserve all rights in Gracenote Data, the Gracenote Software, and the Gracenote Servers and Gracenote Content, including all ownership rights. Under no circumstances will either Gracenote become liable for any payment to you for any information that you provide,

including any copyrighted material or music file information. You agree that Gracenote may enforce its respective rights, collectively or separately, under this agreement against you, directly in each company's own name.

Gracenote uses a unique identifier to track queries for statistical purposes. The purpose of a randomly assigned numeric identifier is to allow Gracenote to count queries without knowing anything about who you are. For more information, see the web page at www.gracenote.com for the Gracenote Privacy Policy.

THE GRACENOTE SOFTWARE, EACH ITEM OF GRACENOTE DATA AND THE GRACENOTE CONTENT ARE LICENSED TO YOU "AS IS". NEITHER GRACENOTE MAKES ANY REPRESENTATIONS OR WARRANTIES, EXPRESS OR IMPLIED, REGARDING THE ACCURACY OF ANY GRACENOTE DATA FROM THE GRACENOTE SERVERS OR GRACENOTE CONTENT. GRACENOTE COLLECTIVELY AND SEPARATELY RESERVE THE RIGHT TO DELETE DATA AND/OR CONTENT FROM THE COMPANIES' RESPECTIVE SERVERS OR, IN THE CASE OF GRACENOTE, CHANGE DATA CATEGORIES FOR ANY CAUSE THAT GRACENOTE DEEMS SUFFICIENT. NO WARRANTY IS MADE THAT EITHER GRACENOTE CONTENT OR THE GRACENOTE SOFTWARE OR GRACENOTE SERVERS ARE ERROR-FREE OR THAT THE FUNCTIONING OF THE GRACENOTE SOFTWARE OR GRACENOTE SERVERS WILL BE UNINTERRUPTED. GRACENOTE IS NOT OBLIGATED TO PROVIDE YOU WITH ANY ENHANCED OR ADDITIONAL DATA TYPES THAT GRACENOTE MAY CHOOSE TO PROVIDE IN THE FUTURE AND IS FREE TO DISCONTINUE ITS ONLINE SERVICES AT ANY TIME. GRACENOTE DISCLAIM ALL WARRANTIES EXPRESS OR IMPLIED, INCLUDING, BUT NOT LIMITED TO,

Appendices

IMPLIED WARRANTIES OF MERCHANTABILITY, FITNESS FOR A PARTICULAR PURPOSE, TITLE, AND NON-INFRINGEMENT. NEITHER GRACENOTE WARRANTS THE RESULTS THAT WILL BE OBTAINED BY YOUR USE OF THE GRACENOTE SOFTWARE OR ANY GRACENOTE SERVER. IN NO CASE WILL GRACENOTE BE LIABLE FOR ANY CONSEQUENTIAL OR INCIDENTAL DAMAGES OR FOR ANY LOST PROFITS OR LOST REVENUES FOR ANY REASON WHATSOEVER. © Gracenote 2007.

Radio Frequency Statement

FCC ID: ACJ-SYNCG3-L

IC: 216B-SYNCG3-L

This device complies with Part 15 of the FCC Rules and with RSS-210 of Industry Canada. Operation is subject to the following two conditions:

- (1) This device may not cause harmful interference, and
- (2) this device must accept any interference received, including interference that may cause undesired operation.



WARNING: Changes or modifications not expressly approved by the party responsible for compliance could void the user's authority to operate the equipment. The term "IC:" before the radio certification number only signifies that Industry Canada technical specifications were met.

The antenna used for this transmitter must not be co-located or operating in conjunction with any other antenna or transmitter.

Taiwan Territory

Note: In accordance with the management approach of low-power radio wave radiation motors:

Article 12: For approved and certified low-power radiation motor models, companies, firms or users must not alter the frequency, increase the power or change the characteristics and functions of the original design without authorization.

Article 14: The usage of low-power radio-frequency motors must not affect aviation safety and interfere with legal telecommunications. Should interference be detected, immediately stop using the device and only resume usage after ensuring that there is no longer any interference. For the legal telecommunication and wireless telecommunication of the telco, the low-power radio frequency motor must be able to tolerate legal limits of interference from telecommunication, industrial, scientific and radio wave equipment.

SUNA TRAFFIC CHANNEL – TERMS AND CONDITIONS

By activating, using and/or accessing the SUNA Traffic Channel, SUNA Predictive or other content or material provided by Intelematics (together, **SUNA Products and/or Services**), you must accept certain terms and conditions. The following is a brief summary of the terms and conditions that apply to you. To view the full terms and conditions relevant to your use of the SUNA Products and/or Services, please consult:

Website

www.sunatraffic.com.au/termsandconditions/

1. Acceptance

Appendices

By using SUNA Products and/or Services, you will be deemed to have accepted and agreed to be bound by the terms and conditions fully detailed at:

Website
www.sunattraffic.com.au/termsandconditions/

2. Intellectual Property

SUNA Products and/or Services are for your personal use. You may not record, or retransmit the content, nor use the content in association with any other traffic information or route guidance service or device not approved by Intelematics. You obtain no right of ownership in any Intellectual Property Rights (including copyright) in the data that is used to provide SUNA Products and/or Services.

3. Appropriate Use

SUNA Products and/or Services are intended as an aid to personal motoring and travel planning, and do not provide comprehensive or accurate information on all occasions. On occasions, you may experience additional delay as a result of using SUNA Products and/or Services. You acknowledge that it is not intended, or suitable, for use in applications where time of arrival or driving directions may impact the safety of the public or yourself.

4. Use of SUNA Products and Services while driving

You, and other authorised drivers of the vehicle in which SUNA Products and/or Services are available or installed and active, remain at all times responsible for observing all relevant laws and codes of safe driving. In particular, you agree to only actively operate SUNA Products and/or Services when the Vehicle is at a complete stop and it is safe to do so.

5. Service Continuity and Reception of the SUNA Traffic Channel

We will use reasonable endeavours to provide the SUNA Traffic Channel 24 hours a day, 365 days a year. The SUNA Traffic Channel may occasionally be unavailable for technical reasons or for planned maintenance. We will try to perform maintenance at times when congestion is light. We reserve the right to withdraw SUNA Products and/or Services at any time.

Also, we cannot assure the uninterrupted reception of the SUNA Traffic Channel RDS-TMC signal at any particular location.

6. Limitation of Liability

Neither Intelematics (nor its suppliers or the manufacturer of your device (the “**Suppliers**”)) shall be liable to you or to any third party for any damages either direct, indirect, incidental, consequential or otherwise arising out of the use of or inability to use SUNA Products and/or Services even if Intelematics or a Supplier has been advised of the possibility of such damages. You also acknowledge that the neither Intelematics nor any Supplier guarantees nor make any warranties that relate to the availability, accuracy or completeness of SUNA Products and/or Services, and to the extent which it is lawful to do so, both Intelematics and each Supplier excludes any warranties which might otherwise be implied by any State or Federal legislation in relation to SUNA Products and/or Services.

7. Please Note

Great care has been taken in preparing this manual. Constant product development may mean that some information is not entirely up-to-date. The information in this document is subject to change without notice.

Appendices

DECLARATION OF CONFORMITY

Radio Frequency Statement

SYNC Version	FCC Identification Number	IC Identification Number
3.0	ACJ-SYNCG3-L	216B-SYNCG3-L
3.1	ACJ-FA-170-BCARHS	216B-FA170BCARHS
3.2	ACJ-FG-185-SG32MH	216B-FG185SG32MH



WARNING: Changes or modifications not expressly approved by the party responsible for compliance could void the user's authority to operate the equipment. The term "IC:" before the radio certification number only signifies that Industry Canada technical specifications were met.

These devices comply with Part 15 of the FCC Rules and with RSS-210 of Industry Canada. Operation is subject to the following two conditions:

1. The device does not cause harmful interference.
2. The device accepts any interference received, including interference that could cause undesired operation.

TYPE APPROVALS

Radio Frequency Certifications for Tire Pressure Monitoring Sensor(s)

Argentina

Schrader AG2SZ4 Numero de Registro
CNC: H-13498

E207816

Brazil



E197509

Appendices

Canada

IC: 850K-11545917

European Union EU

Herby, Schrader Electronics UK Ltd., declares that this TPMS is in compliance with the essential requirements and other provisions of directive 1999/5/EC. The declaration of conformity may be consulted at emcteam@schrader.co.uk

E207818

Ghana

NCA APPROVED: 3R88M14030

E253824

Jordan

Kingdom of Jordan Type approval for tyre pressure sensor

Model : AG2SZ4

Manufacturer:Schrader Electronics Ltd

Type Approval Number:TRC/LPD/2014/56

Equipment Type: Low Power Device (LPD)

E253823

Malaysia



E253822

Mexico

IFT: RLVSCMR15-1238

E253812

IFT: RLVSCMR15-1249

E253813

Moldova



E197811

Morocco

AGREE PAR L'ANRT MAROC
Numéro d'agrément: MR9098
ANRT 2014
Date d'agrément: 14/03/2014

E207821

Oman

OMAN TRA

TA-R/1752/14

D090258

E253817

Appendices

Philippines



Type Approved

NTC

No:ESD-1408639C

E198001

Russia



E253816

Serbia



E197844

Singapore

Complies with
IDA Standards
DA 105282

E253820

South Africa



TA-2014/064

Approved

E198002

South Korea



E253819

MSIP-CRM-SRD-AG2SZ4

Taiwan



CCAM14LP0090T3

E203679

Ukraine



E253818

109

Appendices

United Arab Emirates



E207817

United States of America

FCC ID: OUC11545917

Radio Frequency Certifications for Mid Range Radar

Argentina

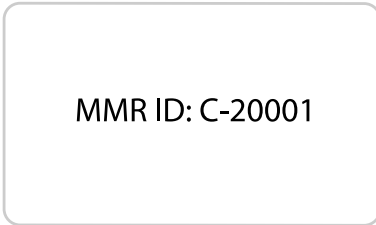

E269659

Ghana

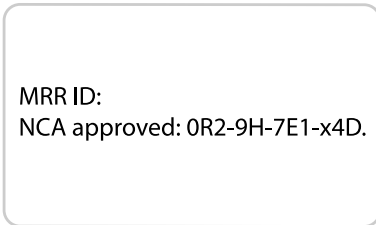

E269662

Jordan

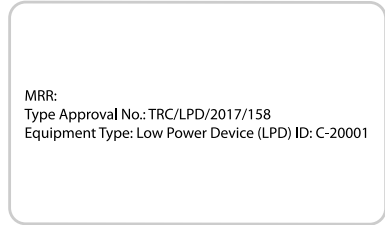

E269660

Morocco



E269661

South Africa



E269664

Appendices

United Arab Emirates

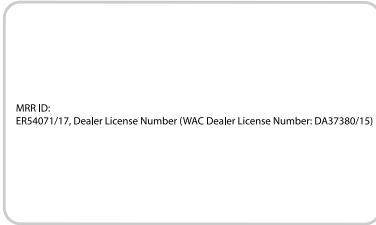

E269663

Radio Frequency Certifications for Passive Anti-Theft System

Argentina



E274065

Brazil



E269675

Canada

IC: 850K-11545917

Djibouti

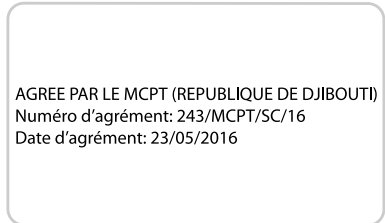

E274068

Ghana

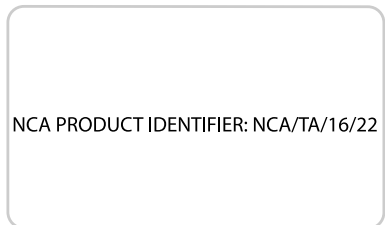

E269674

Appendices

Jamaica

This product has been Type Approved by Jamaica: SMA- OUC11545917

E274067

Morocco

N° D'AGRÉMENT: MR 8922 ANRT 2014

E269670

Jordan

Type approval No.: TRC/LPD/2013/235
Equipment Type: Low Power Device (LPD)

E269666

Paraguay



NR: 2012-11-1-0185

E274066

Malaysia



E269673

Pakistan



Date of Issuance: 06.01.2015

E275754

Appendices

Serbia

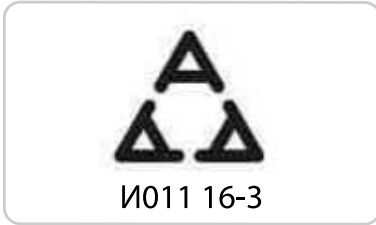

E269672

Ukraine



E269671

Singapore

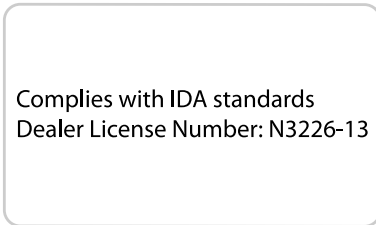

E269676

United Arab Emirates

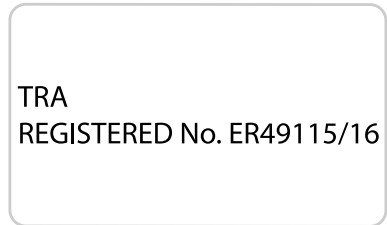

E269668

South Africa



E269667

United States of America

FCC ID: OUC11545917

Appendices

Vietnam

So.No: A0364120416AF04A2



E269677

Radio Frequency Certifications for Radio Transceiver Module

Canada

IC: 3659A-F03AM315RX

IC: 3659A-F04AM902TRX

Djibouti

AGREE PAR LE MCPT (REPUBLIQUE DE DJIBOUTI)
Numéro d'agrément: 247/MCPT/SC/16
Date d'agrément: 23/05/2016

E272192

Jamaica

This product has been Type Approved by Jamaica:
SMA – F03-AM315RX

E272193

Jordan

Type approval No.: TRC/LPD/2013/233
Equipment Type: Low Power Device (LPD)

E272194

Morocco

N° D'AGRÉMENT: MR 12432 ANRT 2016

E269683

Appendices

Pakistan



E269684

South Africa



E269685

Paraguay



E272195

Ukraine



E269682

Serbia



E269681

United Arab Emirates

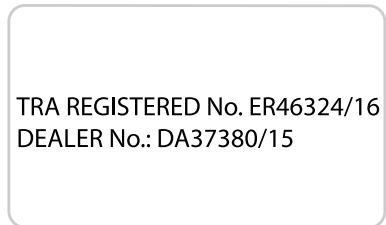

E272196

Appendices

United States of America

FCC ID: LTQF03AM315RX

FCC ID: LTQF04AM902TRX

Radio Frequency Certifications for Blind Spot Information System

Canada

RSS-310 compliant, per FCC Test report
no.: 1-8707/14-01-03

Ghana



E269695

Malaysia



E269697

South Africa

TA-2015/444
APPROVED



E269696

United Arab Emirates

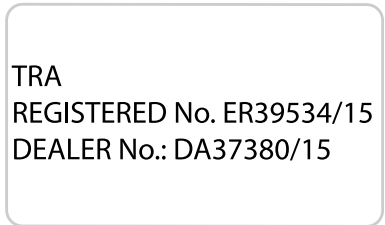

E269694

United States of America

FCC ID: OAYSRR3B

Appendices

Vietnam

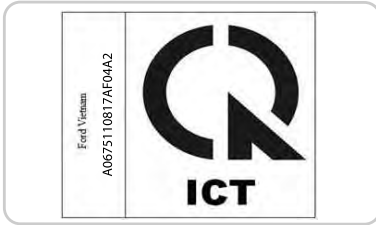

E269693

Radio Frequency Certifications for Wireless Charging

United Arab Emirates

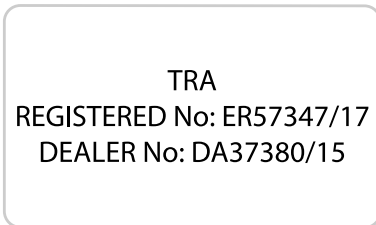

E272903

South Korea



E273475

Radio Frequency Certifications for SYNC 3

Brazil



E252722



E282218

Radio Frequency Certifications for Cruise Control Module

Canada

IC: 3432A-0065TR

United States of America

FCC ID: L2C0065TR

Radio Frequency Certifications for Body Control Module

Canada

IC: 7812A-A2C738448

Model # : M : A2C750526

Model # : M : A2C750561

Appendices

United States of America

FCC ID: M3NA2C738448

Model # : M : A2C750526

Model # : M : A2C750561

Radio Frequency Certification for Keys and Remote Controls

Canada

IC : 7812A-A2C931423

IC: 7812A-A2C931426

IC: 3248A-A08TAA

IC: 3248A-A08TDA

United States of America

FCC ID : M3N-A2C931423

FCC ID : M3N-A2C931426

FCC ID : N5F-A08TAA

FCC ID : N5F-A08TDA

Radio Frequency Statement for Audio Unit

Canada

IC: 3043A-UP375AHU

United States

FCC ID: NT8-16UP375AHU

Index

3

360 Degree Camera.....	234
Advanced Camera Views.....	235
Camera Views.....	235
Front Camera.....	235
Keep Out Zone.....	235
Side Camera.....	236

4

4WD	
See: Four-Wheel Drive.....	202

A

A/C	
See: Climate Control.....	138
About This Manual.....	7
ABS	
See: Brakes.....	211
ABS driving hints	
See: Hints on Driving With Anti-Lock Brakes.....	211
Accessories.....	496
Exterior Style.....	496
Interior Style.....	496
Lifestyle.....	496
Peace of Mind.....	496
Accessories	
See: Replacement Parts Recommendation.....	12
ACC	
See: Using Adaptive Cruise Control.....	238
Active Park Assist.....	225
Using Active Park Assist.....	226
Adjusting the Headlamps.....	339
Horizontal Aim Adjustment.....	340
Vertical Aim Adjustment.....	339
Adjusting the Pedals.....	87
Adjusting the Steering Wheel - Vehicles With: Manual Adjustable Steering Column.....	83
Adjusting the Steering Wheel - Vehicles With: Power Adjustable Steering Column.....	83
End of Travel Position.....	84
Memory Feature.....	84

Airbag Disposal.....	52
Air Conditioning	
See: Climate Control.....	138
Air Filter	
See: Changing the Engine Air Filter.....	342
Alarm	
See: Anti-Theft Alarm.....	80
Ambient Lighting.....	95
Adjusting the Brightness.....	95
Changing the Color.....	95
Switching Ambient Lighting Off.....	95
Switching Ambient Lighting On.....	95
Anti-Theft Alarm.....	80
Arming the Alarm.....	80
Disarming the Alarm.....	80
Appendices.....	519
Apps.....	465
.....	465
SiriusXM Traffic and Travel Link.....	467
At a Glance.....	15
Audible Warnings and Indicators.....	109
Direction Indicator Chime.....	109
Headlamps On Warning Chime.....	109
Key in Ignition Warning Chime.....	109
Parking Brake On Warning Chime.....	109
Audio Control.....	84
Media.....	85
Seek, Next or Previous.....	85
Audio System.....	391
General Information.....	391
Audio Unit - Vehicles With: Touchscreen Display.....	395
Accessing the Sound Settings.....	395
Adjusting the Volume.....	395
Changing Radio Stations.....	395
Ejecting the CD.....	396
Inserting a CD.....	396
Muting the Audio.....	396
Playing or Pausing Media.....	396
Setting the Memory Presets.....	396
Switching the Display On and Off.....	396
Using Seek, Fast Forward and Reverse.....	396
Audio Unit - Vehicles Without: Touchscreen Display.....	392
Accessing the Apps Menu.....	392
Accessing the Clock Settings.....	393
Accessing the Media Source Menu.....	393

Index

Accessing the Phone Features.....	393
Accessing the Settings Menu.....	393
Accessing the Sound Settings.....	393
Adjusting the Volume.....	393
Changing Radio Stations.....	393
Listening to the Radio.....	394
Playing or Pausing Media.....	394
Switching Radio Text On and Off.....	394
Switching Repeat Mode On and Off.....	394
Switching Shuffle Mode On and Off.....	394
Switching the Audio Unit On and Off.....	394
Switching the Display On and Off.....	394
Using Seek, Fast Forward and Reverse.....	394
Using the Display Control.....	394
Using the Number Block.....	394
Autolamps.....	91
Windshield Wiper Activated Headlamps.....	91
Automatic Climate Control.....	140
Accessing Rear Climate Controls.....	140
Directing Air to the Footwell Air Vents.....	140
Directing Air to the Instrument Panel Air Vents.....	140
Setting the Blower Motor Speed.....	140
Setting the Temperature.....	140
Switching Auto Mode On and Off.....	140
Switching Defrost On and Off.....	141
Switching Dual Zone Mode On and Off.....	141
Switching Maximum Air Conditioning On and Off.....	141
Switching Maximum Defrost On and Off.....	141
Switching Recirculated Air On and Off.....	142
Switching the Air Conditioning On and Off.....	141
Switching the Climate Control On and Off.....	141
Switching the Heated Seats On and Off.....	141
Switching the Ventilated Seats On and Off.....	142
Automatic High Beam Control.....	92
Automatic High Beam Indicator.....	93
Switching the System On and Off.....	93
Automatic Transmission.....	195
Automatic Transmission Adaptive Learning.....	201
Brake-Shift Interlock.....	200
If Your Vehicle Gets Stuck In Mud or Snow.....	201
SelectShift™ Automatic Transmission.....	199
Understanding the Shift Positions of your Automatic Transmission.....	195
Automatic Transmission Fluid Check.....	334
Auto-Start-Stop.....	181
Disabling Auto-Start-Stop.....	182
Enabling Auto-Start-Stop.....	181
Autowipers.....	88
Autowipers Settings.....	89
Auxiliary Power Points.....	170
110 Volt AC Power Point.....	170
12 Volt DC Power Point.....	170
USB Port and Power Point Locations.....	170
B	
Battery See: Changing the 12V Battery.....	336
Blind Spot Information System.....	250
.....	250
Blind Spot Information System with Trailer Tow.....	252
Switching the System On and Off.....	254
System Errors.....	254
Using the Blind Spot Information System.....	251
BLIS See: Blind Spot Information System.....	250
Bonnet Lock See: Opening and Closing the Hood.....	326
Booster Seats.....	28
Types of Booster Seats.....	29
Brake Fluid Check.....	335
Brakes.....	211
General Information.....	211
Breaking-In.....	298
Bulb Specification Chart.....	389

Index

C

Cabin Air Filter.....	147
Capacities and Specifications.....	384
Alternative Engine Oil for Extremely Cold Climates.....	388
Specifications.....	385
Cargo Nets.....	267
Car Wash	
See: Cleaning the Exterior.....	344
Catalytic Converter.....	192
On-Board Diagnostics (OBD-II).....	193
Readiness for Inspection and Maintenance (I/M) Testing.....	193
Center Console.....	174
Changing a Bulb.....	340
Fog Lamp Bulb.....	341
Front Direction Indicator Bulb.....	341
Headlamp Bulb.....	340
LED Bulbs.....	342
LED Direction Indicator and Side Marker Bulbs.....	341
LED Headlamp Bulb.....	340
Rear Lamp, Brake Lamp, Rear Direction Indicator and Reverse Lamp Bulbs.....	341
Changing a Fuse.....	324
Fuses.....	324
Changing a Road Wheel.....	373
Dissimilar Spare Wheel and Tire Assembly Information.....	373
Location of the Spare Tire and Tools.....	374
Tire Change Procedure.....	374
Changing the 12V Battery.....	336
Battery Management System.....	337
Changing the Engine Air Filter.....	342
Changing the Wiper Blades.....	338
Checking MyKey System Status.....	63
MyKey Distance.....	63
Number of Admin Keys.....	64
Number of MyKeys.....	64
Checking the Wiper Blades.....	338
Childminder Mirror.....	99
Child Restraint and Seatbelt	
Maintenance.....	42
Child Restraint Positioning.....	30
Child Safety.....	17
General Information.....	17
Child Safety Locks.....	32
Left-Hand Side.....	33
Right-Hand Side.....	33
Cleaning Leather Seats.....	348
Cleaning Products.....	344
Materials.....	344
Cleaning the Engine.....	346
Cleaning the Exterior.....	344
Cleaning the Headlamps.....	345
Exterior Chrome Parts.....	345
Exterior Plastic Parts.....	345
Stripes or Graphics.....	345
Underbody.....	345
Under Hood.....	345
Cleaning the Instrument Panel and Instrument Cluster Lens.....	347
Cleaning the Interior.....	347
Mirrors.....	347
Cleaning the Wheels.....	349
Cleaning the Windows and Wiper Blades.....	346
Clearing All MyKeys.....	63
Climate.....	449
Accessing Rear Climate Controls.....	451
Accessing the Climate Control Menu.....	449
Directing the Airflow.....	449
Rear Climate Control Lock Indicator.....	451
Setting the Blower Motor Speed.....	449
Setting the Temperature.....	449
Switching Auto Mode On and Off.....	449
Switching Dual Zone Mode On and Off.....	450
Switching Maximum Air Conditioning On and Off.....	450
Switching Maximum Defrost On and Off.....	450
Switching Rear Auto Mode On and Off.....	451
Switching Recirculated Air On and Off.....	450
Switching the Air Conditioning On and Off.....	449
Switching the Climate Controlled Seats On and Off.....	450
Switching the Climate Control On and Off.....	450
Switching the Heated Exterior Mirrors On and Off.....	450

Index

Switching the Heated Rear Window On and Off.....	450
Switching the Heated Seats On and Off.....	450
Switching the Heated Steering Wheel On and Off.....	450
Switching the Rear Climate Controlled Seats On and Off.....	451
Switching the Rear Heated Seats On and Off.....	451
Switching the Rear Ventilated Seats On and Off.....	451
Switching the Ventilated Seats On and Off.....	451
Climate Control.....	138
Climate Controlled Seats.....	164
Ventilated Seats.....	164
Coolant Check	
See: Engine Coolant Check.....	330
Crash Sensors and Airbag Indicator.....	51
Creating a MyKey.....	62
Programming and Changing Configurable Settings.....	63
Cross Traffic Alert.....	254
Blocked Sensors.....	256
Switching the System Off and On.....	256
System Errors.....	256
System Lights, Messages and Audible Alerts.....	256
System Limitations.....	256
Using the Cross Traffic Alert System.....	254
Cruise Control.....	85
Principle of Operation.....	237
Cruise control	
See: Using Cruise Control.....	237
Customer Assistance.....	308
D	
Data Recording.....	9
Event Data Recording.....	10
Service Data Recording.....	9
Daytime Running Lamps.....	92
Type One - Conventional (Non-Configurable).....	92
Type Two - Configurable.....	92
Declaration of Conformity.....	547
Radio Frequency Statement.....	547
Digital Radio.....	396
HD Radio Reception and Station Troubleshooting.....	397
Direction Indicators.....	94
Doors and Locks.....	66
Drive Control.....	262
Selectable Drive Modes.....	262
Driver Alert.....	245
Using Driver Alert.....	245
Driver and Passenger Airbags.....	46
Children and Airbags.....	47
Proper Driver and Front Passenger Seating Adjustment.....	46
Driving Aids.....	245
Driving Hints.....	298
Driving Through Water.....	299
DRL	
See: Daytime Running Lamps.....	92
E	
Economical Driving.....	298
Electric Parking Brake.....	212
Applying the Electric Parking Brake.....	212
Automatically Releasing the Electric Parking Brake.....	213
Manually Releasing the Electric Parking Brake.....	212
Releasing the Electric Parking Brake if the Vehicle Battery is Running Out of Charge.....	213
Electromagnetic Compatibility.....	519
Emission Law.....	191
Noise Emissions Warranty, Prohibited Tampering Acts and Maintenance.....	192
Tampering With a Noise Control System.....	191
End User License Agreement.....	521
VEHICLE SOFTWARE END USER LICENSE AGREEMENT (EULA)	521
Engine Block Heater.....	179
Using the Engine Block Heater.....	180
Engine Coolant Check.....	330
Adding Coolant.....	330
Coolant Change.....	332
Engine Coolant Temperature Management.....	333
Fail-Safe Cooling.....	332

Index

Recycled Coolant.....	331	Heated Exterior Mirrors.....	98
Severe Climates.....	332	Integrated Blind Spot Mirror.....	98
Engine Emission Control.....	191	Memory Mirrors.....	98
Engine Immobilizer		Power Exterior Mirrors.....	97
See: Passive Anti-Theft System.....	78	Puddle Lamps.....	98
Engine Oil Check.....	328	Signal Indicator Mirrors.....	98
Adding Engine Oil.....	328		
Engine Oil Dipstick.....	328	F	
Engine Specifications.....	380	Fastening the Seatbelts.....	35
Drivebelt Routing.....	380	Rear Inflatable Seatbelt.....	38
Entertainment.....	439	Seatbelt Locking Modes.....	37
AM/FM Radio.....	440	Using Seatbelts During Pregnancy.....	36
Apps.....	448	Flat Tire	
Bluetooth Stereo or USB.....	447	See: Changing a Road Wheel.....	373
CD (If equipped).....	446	Floor Mats.....	299
HD Radio™ Information (If		Fog Lamps - Front	
Available).....	443	See: Front Fog Lamps.....	93
SiriusXM® Satellite Radio (If		Foot Pedals	
Activated).....	441	See: Adjusting the Pedals.....	87
Sources.....	440	Ford Credit.....	11
Supported Media Players, Formats and		US Only.....	11
Metadata Information.....	448	Ford Protect.....	498
USB Ports.....	448	Ford Protect Extended Service Plan	
Environment.....	14	(CANADA ONLY).....	499
EPB		Ford Protect Extended Service Plans (U.S.	
See: Electric Parking Brake.....	212	Only).....	498
Essential Towing Checks.....	288	Four-Wheel Drive.....	202
Before Towing a Trailer.....	294	Front Fog Lamps.....	93
Hitches.....	289	Front Parking Aid.....	222
Launching or Retrieving a Boat or Personal		Obstacle Distance Indicator.....	223
Watercraft (PWC).....	294	Front Passenger Sensing System.....	47
Safety Chains.....	290	Fuel and Refueling.....	184
Trailer Brakes.....	290	Fuel Consumption.....	189
Trailer Hitch Cover.....	288	Advertised Capacity.....	189
Trailer Lamps.....	293	Calculating Fuel Economy.....	190
Trailer Towing Connector (Vehicles with a		Filling the Fuel Tank.....	190
Trailer Towing Package and 7–Pin		Fuel Filler Funnel Location.....	185
Connector).....	288	Fuel Filter.....	336
When Towing a Trailer.....	294	Fuel Quality.....	184
Event Data Recording		Choosing the Right Fuel.....	184
See: Data Recording.....	9	Fuel Shutoff.....	302
Export Unique Options.....	13	Fuse Box Locations.....	315
Exterior Mirrors.....	97	Engine Compartment Fuse Box.....	315
360-Degree Camera.....	98	Passenger Compartment Fuse Box.....	315
Auto-Dimming Feature.....	98	Fuses.....	315
Auto-Folding Mirrors.....	97	Fuse Specification Chart.....	315
Blind Spot Monitor.....	98	Engine Compartment Fuse Box.....	315
Fold-Away Exterior Mirrors.....	97		

Index

- Passenger Compartment Fuse Box.....321
- ## G
- Garage Door Opener.....166
Garage Door Opener
 See: Universal Garage Door Opener.....166
- Gauges.....103
 Engine Coolant Temperature Gauge.....105
 Engine Oil Pressure Gauge.....104
 Fuel Gauge.....105
 Transmission Fluid Temperature
 Gauge.....105
 Turbo Boost Gauge.....105
 Type 1 and 2.....103
 Type 3.....104
- Gearbox
 See: Transmission.....195
- General Information on Radio
 Frequencies.....53
 Intelligent Access.....53
- General Maintenance Information.....500
 Multi-Point Inspection.....502
 Owner Checks and Services.....501
 Protecting Your Investment.....500
 Why Maintain Your Vehicle?.....500
 Why Maintain Your Vehicle at Your
 Dealership?.....500
- Getting Assistance Outside the U.S. and
 Canada.....311
- Getting the Services You Need.....308
 Away From Home.....308
- Global Opening.....97
 Moonroof.....97
 Remote Control Front Windows.....97
- ## H
- Hazard Flashers.....302
- Headlamp Adjusting
 See: Adjusting the Headlamps.....339
- Headlamp Exit Delay.....92
- Headlamp Removal
 See: Removing a Headlamp.....340
- Headrest
 See: Head Restraints.....149
- Head Restraints.....149
 Adjusting the Head Restraint.....150
- Front Seat Manual Head Restraints.....150
- Heated Exterior Mirrors.....147
- Heated Rear Window.....146
- Heated Seats.....162
 Front Seats.....162
 Rear Seats.....163
- Heated Steering Wheel.....86
- Heated Windshield.....146
 Windshield Wiper De-Icer.....146
- Heating
 See: Climate Control.....138
- Hill Descent Control.....219
 Principle of Operation.....219
- Hill Start Assist.....213
 Switching the System On and Off.....214
 Using Hill Start Assist.....214
- Hints on Controlling the Interior
 Climate.....142
 Defogging the Side Windows in Cold
 Weather.....144
 General Hints.....142
 Quickly Cooling the Interior.....143
 Quickly Heating the Interior.....143
 Recommended Settings for Cooling.....144
 Recommended Settings for Heating.....143
- Hints on Driving With Anti-Lock
 Brakes.....211
- Home Screen.....431
- Hood Lock
 See: Opening and Closing the Hood.....326
- ## I
- Ignition Switch.....175
- In California (U.S. Only).....309
- Information Display Control.....86
- Information Displays.....110
 General Information.....110
- Information Messages.....122
 Active Park.....122
 Adaptive Cruise Control.....122
 AdvanceTrac and Traction Control.....123
 Airbag.....123
 Alarm and Security.....124
 Automatic Engine Shutdown.....124
 Battery and Charging System.....124
 Blind Spot Information and Cross Traffic
 Alert System.....125

Index

Collision Warning System.....	126
Doors and Locks.....	126
Driver Alert.....	126
Drivetrain.....	126
Engine.....	127
Four-Wheel Drive.....	127
Fuel.....	128
Keys and Intelligent Access.....	129
Lane Keeping System.....	130
Maintenance.....	130
MyKey.....	131
Off Road.....	131
Park Aid.....	132
Park Brake.....	133
Power Steering.....	133
Pro Trailer Backup Assist™.....	134
Remote Start.....	135
Seats.....	135
Starting System.....	135
Tire Pressure Monitoring System.....	136
Trailer.....	136
Transmission.....	137
Installing Child Restraints.....	18
Child Seats.....	18
Combining Seatbelt and LATCH Lower Anchors for Attaching Child Safety Seats.....	25
Using Lap and Shoulder Belts.....	19
Using Lower Anchors and Tethers for Children (LATCH).....	24
Using Tether Straps.....	25
Instrument Cluster.....	103
Instrument Lighting Dimmer.....	91
Instrument Panel Overview.....	15
Interior Lamps.....	94
Front Interior Lamp.....	94
Rear Interior Lamps.....	95
Interior Mirror.....	99
Auto-Dimming Mirror.....	99
Introduction.....	7
J	
Jump Starting the Vehicle.....	303
Connecting the Jumper Cables.....	303
Jump Starting.....	304
Preparing Your Vehicle.....	303
Removing the Jumper Cables.....	304

K

Keyless Entry.....	69
Displaying the Factory-Set Code.....	71
Locking and Unlocking.....	71
SECURICODE™ KEYLESS ENTRY KEYPAD.....	69
Keyless Starting.....	176
Ignition Modes.....	176
Keys and Remote Controls.....	53

L

Lane Keeping System.....	246
Switching the System On and Off.....	247
System Display.....	248
System Settings.....	247
Troubleshooting.....	249
Liftgate.....	73
Liftgate Window.....	101
Opening the Liftgate Window.....	101
Lighting Control.....	90
Flashing the Headlamp High Beam.....	91
Headlamp High Beam.....	90
Lighting.....	90
General Information.....	90
Limited Slip Differential.....	210
Locking Function.....	210
Spare Tire.....	210
Trailer Towing.....	210
Load Carriers See: Roof Racks and Load Carriers.....	268
Load Carrying.....	265
Load Limit.....	269
Special Loading Instructions for Owners of Pick-up Trucks and Utility-type Vehicles.....	273
Vehicle Loading - with and without a Trailer.....	269
Locking and Unlocking.....	66
Activating Intelligent Access.....	67
Autolock.....	68
Battery Saver.....	69
Illuminated Entry.....	69
Illuminated Exit.....	69
Locking and Unlocking the Doors with the Key Blade.....	68
Power Door Locks.....	66

Index

Remote Control.....	66
Smart Unlocks for Integrated Keyhead Transmitter.....	68
Smart Unlocks for Intelligent Access Keys.....	68
Lug Nuts See: Changing a Road Wheel.....	373

M

Maintenance.....	326
General Information.....	326
Manual Climate Control.....	138
Directing Air to the Footwell Air Vents.....	138
Directing Air to the Instrument Panel Air Vents.....	138
Locking the Rear Climate Control.....	139
Setting the Blower Motor Speed.....	138
Setting the Rear Blower Motor Speed.....	139
Setting the Rear Temperature.....	139
Setting the Temperature.....	138
Switching Defrost On and Off.....	138
Switching Maximum Air Conditioning On and Off.....	139
Switching Maximum Defrost On and Off.....	139
Switching Recirculated Air On and Off.....	139
Switching the Air Conditioning On and Off.....	138
Switching the Climate Control On and Off.....	138
Switching the Rear Climate Control On and Off.....	139
Manual Liftgate.....	73
Closing the Liftgate.....	74
Opening the Liftgate.....	73
Manual Seats.....	153
Manual Lumbar.....	153
Moving the Seat Backward and Forward.....	153
Recline Adjustment.....	153
Media Hub.....	401
Memory Function.....	156
Easy Entry and Exit Feature.....	157

Linking a PreSet Position to your Remote Control or Intelligent Access Key Fob.....	156
Saving a PreSet Position.....	156
Message Center See: Information Displays.....	110
Mirrors See: Windows and Mirrors.....	96
Mobile Communications Equipment.....	13
Moonroof - Vehicles With: Vista Roof Opening Panel.....	100
Bounce-Back.....	101
Opening and Closing the Moonroof.....	101
Motorcraft Parts.....	380
MyKey — Troubleshooting.....	64
MyKey™ Principle of Operation.....	61

N

Navigation.....	457
cityseeker.....	464
Destination Mode.....	459
Map Mode.....	457
Navigation Map Updates.....	465
Navigation Menu.....	462
SiriusXM Traffic and Travel Link.....	465
SYNC AppLink.....	464
Waypoints.....	463
Normal Scheduled Maintenance.....	503
Intelligent Oil-Life Monitor.....	503
Normal Maintenance Intervals.....	504

O

Oil Change Indicator Reset.....	329
Oil Check See: Engine Oil Check.....	328
Opening and Closing the Hood.....	326
Ordering Additional Owner's Literature.....	313
Obtaining a French Owner's Manual.....	313
Overhead Console.....	174

P

Parking Aids.....	221
Principle of Operation.....	221

Index

Passive Anti-Theft System.....	78
SecuriLock™.....	78
PATS	
See: Passive Anti-Theft System.....	78
Pedals.....	87
Perchlorate.....	11
Personal Safety System™.....	44
How Does the Personal Safety System Work?.....	44
Phone.....	451
During a Phone Call.....	455
Making Calls.....	454
Pairing Your Cell Phone for the First Time.....	451
Phone Menu.....	452
Receiving Calls.....	455
Smartphone Connectivity.....	456
Text Messaging.....	456
Post-Crash Alert System.....	305
Power Door Locks	
See: Locking and Unlocking.....	66
Power Liftgate.....	74
Disabling the Liftgate Button.....	76
Obstacle Detection.....	76
Opening and Closing the Liftgate.....	75
Opening the Liftgate Window.....	76
Setting the Liftgate Open Height.....	76
Stopping the Liftgate Movement.....	76
Using the Hands-Free Liftgate.....	77
Power Running Boards.....	81
Power Seats.....	153
Adjusting the Lumbar Support.....	154
Adjusting the Multi-Contour Front Seats With Active Motion	154
Power Windows.....	96
Accessory Delay.....	96
Bounce-Back.....	96
One-Touch Down.....	96
One-Touch Up.....	96
Window Lock.....	96
Pre-Collision Assist.....	258
Adjusting the Pre-Collision Assist Settings.....	259
Blocked Sensors.....	260
Distance Indication and Alert.....	259
Using the Pre-Collision Assist System.....	258
Protecting the Environment.....	14
Puncture	
See: Changing a Road Wheel.....	373
R	
Rear Axle.....	210
Rear Parking Aid.....	222
Obstacle Distance Indicator.....	222
Rear Passenger Climate Controls - Vehicles With: Automatic Temperature Control.....	144
Directing Air to the Overhead Air Vents.....	144
Directing Air to the Rear Footwell Air Vents.....	144
Rear Climate Control Lock Indicator.....	144
Setting the Rear Blower Motor Speed.....	145
Setting the Rear Temperature.....	145
Switching Rear Auto Mode On and Off.....	145
Switching the Rear Climate Control On and Off.....	145
Switching the Rear Heated Seats On and Off.....	145
Rear Passenger Climate Controls - Vehicles With: Manual Temperature Control.....	145
Directing Air to the Overhead Air Vents.....	145
Directing Air to the Rear Footwell Air Vents.....	145
Rear Climate Control Lock Indicator.....	146
Setting the Rear Blower Motor Speed.....	146
Setting the Rear Temperature.....	146
Switching the Rear Climate Control On and Off.....	146
Rear Seats.....	157
Adjusting the Second-Row Center 20% Seat.....	161
Adjusting the Second Row Outermost 40% Seat for Easy Entry.....	158
Folding the Second Row 40% Seat	157
Folding the Second Row Center 20% Seat	160
Power Easy Entry.....	159
Power Folding Rear Seats.....	161

Index

Reclining the Second Row Outermost 40% Seat Backrest.....	160
Rear Under Floor Storage.....	265
Advanced System: Forward Divider, Cargo Shelf and Rear Barrier (Bulkhead Position).....	266
Cargo Management System.....	265
Rear View Camera.....	231
Camera Guidelines.....	233
Manual Zoom.....	234
Obstacle Distance Indicator.....	233
Rear Camera Delay.....	234
Using the Rear View Camera System.....	232
Rear View Camera See: Rear View Camera.....	231
Rear Window Wiper and Washers.....	89
Rear Window Washer.....	89
Rear Window Wiper Blade.....	89
Recommended Towing Weights.....	286
Reduced Engine Performance.....	298
Refueling.....	187
Refueling System Overview.....	187
Refueling System Warning.....	189
Refueling Your Vehicle.....	187
Remote Control.....	53
Car Finder.....	58
Integrated Keyhead Transmitter.....	53
Intelligent Access Key.....	54
Remote Start.....	58
Replacing the Battery.....	55
Sounding the Panic Alarm.....	58
Using the Key Blade.....	55
Remote Start.....	147
Automatic Settings.....	147
Heated and Cooled Features.....	148
Last Settings.....	147
Removing a Headlamp.....	340
Repairing Minor Paint Damage.....	349
Replacement Parts Recommendation.....	12
Collision Repairs.....	12
Scheduled Maintenance and Mechanical Repairs.....	12
Warranty on Replacement Parts.....	12
Replacing a Lost Key or Remote Control.....	60
Reporting Safety Defects (Canada Only).....	313
Reporting Safety Defects (U.S. Only).....	313
Roadside Assistance.....	301
Vehicles Sold in Canada: Getting Roadside Assistance.....	302
Vehicles Sold in the United States: Getting Roadside Assistance.....	301
Vehicles Sold in the United States: Using Roadside Assistance.....	301
Roadside Emergencies.....	301
Roof Racks and Load Carriers.....	268
Adjusting the Crossbar.....	269
Maximum Recommended Load Amounts.....	268
Running-In See: Breaking-In.....	298
Running Out of Fuel.....	185
Adding Fuel From a Portable Fuel Container.....	186
Filling a Portable Fuel Container.....	185
S	
Safety Canopy™.....	50
Safety Precautions.....	184
Satellite Radio.....	398
Satellite Radio Electronic Serial Number (ESN).....	399
Satellite Radio Reception Factors.....	399
SiriusXM Satellite Radio Service.....	399
Troubleshooting.....	400
Scheduled Maintenance Record.....	508
Scheduled Maintenance.....	500
Seatbelt Extension.....	42
Seatbelt Height Adjustment.....	39
Seatbelt Reminder.....	40
Seatbelt Status.....	41
Seatbelts.....	34
Principle of Operation.....	34
Seatbelt Warning Lamp and Indicator Chime.....	40
Conditions of operation.....	40
Seats.....	149
Security.....	78
Settings.....	468
911 Assist.....	473
Ambient Lighting.....	480
Bluetooth.....	470

Index

Clock.....	470	Starting and Stopping the Engine.....	175
Display.....	481	General Information.....	175
General.....	478	Steering.....	257
Media Player.....	469	Electric Power Steering.....	257
Mobile Apps.....	477	Steering Wheel.....	83
Navigation.....	475	Storage Compartments.....	174
Phone.....	470	Sunroof	
Radio.....	474	See: Moonroof - Vehicles With: Vista Roof	
SiriusXM.....	475	Opening Panel.....	100
Sound.....	468	Sun Visors.....	100
Valet Mode.....	482	Illuminated Vanity Mirror.....	100
Vehicle.....	480	Supplementary Restraints System.....	45
Voice Control.....	482	Principle of Operation.....	45
Wi-Fi & Hotspot.....	479	Symbols Glossary.....	7
Side Airbags.....	49	SYNC™ 3.....	419
Side Sensing System.....	223	General Information.....	419
Obstacle Distance Indicator.....	224	SYNC™ 3 Troubleshooting.....	482
Sitting in the Correct Position.....	149	SYNC™ Applications and	
Snow Chains		Services.....	406
See: Using Snow Chains.....	368	911 Assist.....	407
Spare Wheel		SYNC Mobile Apps.....	408
See: Changing a Road Wheel.....	373	SYNC™.....	402
Special Notices.....	12	General Information.....	402
New Vehicle Limited Warranty.....	12	SYNC™ Troubleshooting.....	411
On Board Diagnostics Data Link		T	
Connector.....	13	Technical Specifications	
Special Instructions.....	12	See: Capacities and Specifications.....	380
Special Operating Conditions Scheduled		The Better Business Bureau (BBB) Auto	
Maintenance.....	506	Line Program (U.S. Only).....	310
Exceptions.....	507	Tire Care.....	354
Speed Control		Glossary of Tire Terminology.....	355
See: Cruise Control.....	237	Information About Uniform Tire Quality	
Stability Control.....	216	Grading.....	354
Principle of Operation.....	216	Information Contained on the Tire	
Starter Switch		Sidewall.....	356
See: Ignition Switch.....	175	Temperature A B C.....	355
Starting a Gasoline Engine.....	176	Traction AA A B C.....	354
Automatic Engine Shutdown.....	177	Treadwear.....	354
Failure to Start.....	177	Tire Pressure Monitoring System.....	369
Guarding Against Exhaust Fumes.....	179	Changing Tires With a Tire Pressure	
Important Ventilating Information.....	179	Monitoring System.....	371
Stopping the Engine When Your Vehicle is		Understanding Your Tire Pressure	
Moving.....	178	Monitoring System.....	371
Stopping the Engine When Your Vehicle is		Tires	
Stationary.....	178	See: Wheels and Tires.....	352
Vehicles with an Ignition Key.....	176		
Vehicles with Keyless Start.....	177		

Index

Towing a Trailer.....	275	Unique Driving Characteristics.....	181
Load Placement.....	275	Universal Garage Door Opener.....	166
Towing Points.....	306	HomeLink Wireless Control System.....	166
Towing the Vehicle on Four		USB Port.....	401
Wheels.....	295	Using Adaptive Cruise Control.....	238
Four-wheel-down Towing.....	295	Automatic Cancellation.....	242
Recreational Towing.....	295	Blocked Sensor.....	243
Towing.....	275	Canceling the Set Speed.....	241
Traction Control.....	215	Changing the Set Speed.....	241
Principle of Operation.....	215	Detection Issues.....	242
Trailer Reversing Aids.....	276	Following a Vehicle.....	240
Principle of Operation.....	276	Following a Vehicle to a Complete	
Pro Trailer Backup Assist™.....	276	Stop.....	240
Setting Up Pro Trailer Backup Assist.....	277	Hilly Condition Usage.....	242
Troubleshooting.....	281	Overriding the Set Speed.....	241
Using Pro Trailer Backup Assist.....	280	Park Brake Application.....	242
Trailer Sway Control.....	285	Resuming the Set Speed.....	241
Transfer Case Fluid Check.....	334	Setting the Adaptive Cruise Speed.....	239
Transmission Code Designation.....	383	Setting the Adaptive Cruise Speed When	
Transmission.....	195	Your Vehicle is Stationary.....	239
Transporting the Vehicle.....	305	Setting the Gap Distance.....	240
Type Approvals.....	547	Switching Adaptive Cruise Control	
Radio Frequency Certification for Keys and		Off.....	242
Remote Controls.....	558	Switching Adaptive Cruise Control	
Radio Frequency Certifications for Blind		On.....	239
Spot Information System.....	556	Switching to Normal Cruise Control.....	244
Radio Frequency Certifications for Body		System Not Available.....	243
Control Module.....	557	Using Cruise Control.....	237
Radio Frequency Certifications for Cruise		Canceling the Set Speed.....	238
Control Module.....	557	Changing the Set Speed.....	237
Radio Frequency Certifications for Mid		Resuming the Set Speed.....	238
Range Radar.....	550	Setting the Cruise Speed.....	237
Radio Frequency Certifications for Passive		Switching Cruise Control Off.....	238
Anti-Theft System.....	551	Switching Cruise Control On.....	237
Radio Frequency Certifications for Radio		Using Four-Wheel Drive.....	202
Transceiver Module.....	554	4WD Switch Selections.....	202
Radio Frequency Certifications for SYNC		4X4 Indicator Lights.....	202
3.....	557	Driving Off-Road With Truck and Utility	
Radio Frequency Certifications for Tire		Vehicles.....	205
Pressure Monitoring Sensor(s).....	547	How Your Vehicle Differs From Other	
Radio Frequency Certifications for Wireless		Vehicles.....	204
Charging.....	557	Operating 4WD Vehicles With Spare or	
Radio Frequency Statement for Audio		Mismatched Tires.....	204
Unit.....	558	Using Hill Descent Control.....	219
		Hill Descent Modes.....	219
		Using MyKey With Remote Start	
		Systems.....	64

U

Index

Using Power Running Boards.....	81	Cooling system.....	350
Automatic Power Deploy.....	81	Engine.....	350
Automatic Power Stow.....	81	Fuel system.....	350
Bounce-back.....	82	General.....	349
Enabling and Disabling.....	81	Miscellaneous.....	350
Manual Power Deploy.....	81	Removing Vehicle From Storage.....	350
Using Snow Chains.....	368	Tires.....	350
Using Stability Control.....	217	Ventilation	
Stability Control and Traction Control with		See: Climate Control.....	138
Roll Stability Control™ (RSC™).....	217	VIN	
Using SYNC™ With Your Media		See: Vehicle Identification Number.....	382
Player.....	410	Voice Control.....	85
Audio Voice Commands.....	410		
Media Sources.....	410	W	
Using SYNC™ With Your Phone.....	405	Warning Lamps and Indicators.....	105
Accessing Features through the Phone		Adaptive Cruise Control Indicator.....	106
Menu.....	406	Airbag Warning Lamp.....	106
Pairing a Phone.....	405	Anti-Lock Brake System Warning	
Phone Controls.....	406	Lamp.....	106
Phone Voice Commands.....	406	Automatic Headlamp High Beam	
Using Traction Control.....	215	Indicator.....	106
Switching the System Off.....	215	Auto-Start-Stop Indicator.....	106
System Indicator Lights and		Battery.....	106
Messages.....	215	Blind Spot Information System	
Using Voice Recognition.....	403	Indicator.....	106
Audio Voice Commands.....	433	Brake System Warning Lamp.....	106
Climate Voice Commands.....	434	Check Fuel Cap.....	107
Initiating a Voice Session.....	403	Cruise Control Indicator.....	107
Mobile App Voice Commands.....	437	Direction Indicator.....	107
Navigation Voice Commands.....	436	Door Ajar Warning Lamp.....	107
Phone Voice Commands.....	434	Electric Park Brake.....	107
SiriusXM Traffic and Travel Link Voice		Electronic Limited Slip Differential.....	107
Commands.....	437	Engine Coolant Temperature Warning	
System Interaction and Feedback.....	404	Lamp.....	107
Voice Settings Commands.....	438	Fasten Seatbelt Warning Lamp.....	107
Utilizing the Mediation/Arbitration		Four-Wheel Drive Indicators.....	107
Program (Canada Only).....	311	Front Fog Lamp Indicator.....	107
V		Headlamp High Beam Indicator.....	107
Vehicle Care.....	344	Hill Descent.....	108
General Information.....	344	Hood Ajar.....	108
Vehicle Certification Label.....	383	Liftgate Ajar Warning Lamp.....	108
Vehicle Identification Number.....	382	Low Fuel Level Warning Lamp.....	108
Vehicle Storage.....	349	Low Tire Pressure Warning Lamp.....	108
Battery.....	350	Oil Pressure Warning Lamp.....	108
Body.....	349	Powertrain Malfunction/Reduced	
Brakes.....	350	Power/Electronic Throttle Control.....	108
		Service Engine Soon.....	108

Index

Stability Control and Traction Control Indicator.....	109
Stability Control and Traction Control Off Warning Lamp.....	109
Tow Haul Indicator.....	109
Washer Fluid Check.....	335
Washers	
See: Cleaning the Exterior.....	344
Waxing.....	346
Welcome Lighting.....	94
Wheel Nuts	
See: Changing a Road Wheel.....	373
Wheels and Tires.....	352
General Information.....	352
Technical Specifications.....	378
Windows and Mirrors.....	96
Windshield Washers.....	89
Front Camera Washer.....	89
Windshield Wipers.....	88
Speed Dependent Wipers.....	88
Wiper Blades	
See: Checking the Wiper Blades.....	338
Wipers and Washers.....	88
Wireless Accessory Charging.....	171