



owner.ford.com



ford.ca

March 2016
First Printing
Owner's Manual
Fusion Hybrid | Fusion Energi
Litho in U.S.A.



HE5J19A321 DA



2017 **FUSION** HYBRID | **FUSION** ENERGI

Manual



The information contained in this publication was correct at the time of going to print. In the interest of continuous development, we reserve the right to change specifications, design or equipment at any time without notice or obligation. No part of this publication may be reproduced, transmitted, stored in a retrieval system or translated into any language in any form by any means without our written permission. Errors and omissions excepted.

© Ford Motor Company 2016

All rights reserved.

Part Number: 20160205122524

Table of Contents

Introduction

About This Manual.....	7
Symbols Glossary.....	7
Data Recording.....	9
California Proposition 65.....	11
Perchlorate.....	11
Ford Credit.....	11
Replacement Parts Recommendation.....	12
Special Notices.....	12
Mobile Communications Equipment.....	13
Export Unique Options.....	13

Environment

Protecting the Environment.....	15
---------------------------------	----

Child Safety

General Information.....	16
Installing Child Restraints.....	17
Booster Seats.....	25
Child Restraint Positioning.....	27
Child Safety Locks.....	28

Seatbelts

Principle of Operation.....	30
Fastening the Seatbelts.....	31
Seatbelt Height Adjustment.....	34
Seatbelt Warning Lamp and Indicator Chime.....	35
Seatbelt Reminder.....	35
Child Restraint and Seatbelt Maintenance.....	37
Seatbelt Extension.....	37

Personal Safety System™

Personal Safety System™.....	38
------------------------------	----

Supplementary Restraints System

Principle of Operation.....	39
Driver and Passenger Airbags.....	40
Front Passenger Sensing System.....	41
Side Airbags.....	43
Driver and Passenger Knee Airbags.....	44
Safety Canopy™.....	44
Crash Sensors and Airbag Indicator.....	46
Airbag Disposal.....	47

Keys and Remote Controls

General Information on Radio Frequencies.....	48
Remote Control.....	48
Replacing a Lost Key or Remote Control.....	53

MyKey™

Principle of Operation.....	54
Creating a MyKey.....	55
Clearing All MyKeys.....	56
Checking MyKey System Status.....	56
Using MyKey With Remote Start Systems.....	57
MyKey Troubleshooting.....	57

Locks

Locking and Unlocking.....	58
Keyless Entry.....	61
Interior Luggage Compartment Release.....	63

Security

Passive Anti-Theft System.....	65
Anti-Theft Alarm.....	66

Steering Wheel

Adjusting the Steering Wheel.....	67
Audio Control.....	68

Table of Contents

Voice Control.....	69
Cruise Control.....	69
Information Display Control.....	70
Heated Steering Wheel.....	70

Wipers and Washers

Windshield Wipers.....	71
Autowipers.....	71
Windshield Washers.....	72

Lighting

General Information.....	73
Lighting Control.....	73
Autolamps.....	74
Instrument Lighting Dimmer.....	75
Headlamp Exit Delay.....	75
Daytime Running Lamps.....	76
Automatic High Beam Control.....	76
Front Fog Lamps.....	78
Direction Indicators.....	78
Interior Lamps.....	78
Ambient Lighting.....	80

Windows and Mirrors

Power Windows.....	81
Global Opening and Closing.....	82
Exterior Mirrors.....	82
Interior Mirror.....	84
Sun Visors.....	84
Moonroof.....	84

Instrument Cluster

Gauges.....	86
Warning Lamps and Indicators.....	89
Audible Warnings and Indicators.....	93

Information Displays

General Information.....	94
Information Messages.....	103

Climate Control

Automatic Climate Control - Vehicles Without: Sony Audio System.....	116
Automatic Climate Control - Vehicles With: Sony Audio System.....	117
Hints on Controlling the Interior Climate.....	119
Heated Windows and Mirrors.....	120
Cabin Air Filter.....	121
Remote Start.....	121

Seats

Sitting in the Correct Position.....	122
Head Restraints.....	122
Manual Seats.....	124
Power Seats.....	124
Memory Function.....	126
Rear Seats.....	128
Heated Seats.....	129
Climate Controlled Seats.....	130
Rear Seat Armrest.....	131

Universal Garage Door Opener

Universal Garage Door Opener.....	132
-----------------------------------	-----

Auxiliary Power Points

Auxiliary Power Points.....	137
-----------------------------	-----

Storage Compartments

Center Console.....	139
Overhead Console.....	140

Starting and Stopping the Engine

General Information.....	141
Keyless Starting.....	141
Starting a Gasoline Engine.....	142
Engine Block Heater.....	144

Table of Contents

Unique Driving Characteristics

Hybrid Vehicle Operation.....	146
Plug-In Hybrid Vehicle Operation.....	148
EcoSelect.....	150
Hybrid Vehicle Frequently Asked Questions.....	151

Fuel and Refueling

Safety Precautions.....	153
Fuel Quality.....	154
Fuel Filler Funnel Location.....	155
Running Out of Fuel.....	155
Refueling.....	156
Fuel Consumption.....	158
Emission Control System.....	159

High Voltage Battery

General Information.....	162
Charging the High Voltage Battery.....	164
High Voltage Battery Cut-Off Switch.....	169

Transmission

Automatic Transmission.....	170
-----------------------------	-----

Brakes

General Information.....	174
Hints on Driving With Anti-Lock Brakes.....	175
Electric Parking Brake.....	175
Hill Start Assist.....	177

Traction Control

Principle of Operation.....	179
Using Traction Control.....	179

Stability Control

Principle of Operation.....	180
Using Stability Control.....	181

Parking Aids

Principle of Operation.....	182
Rear Parking Aid.....	182
Front Parking Aid.....	183
Side Sensing System.....	184
Active Park Assist.....	186
Rear View Camera.....	191

Cruise Control

Principle of Operation.....	195
Using Cruise Control.....	195
Using Adaptive Cruise Control.....	196

Driving Aids

Driver Alert.....	203
Lane Keeping System.....	204
Blind Spot Information System.....	208
Cross Traffic Alert.....	210
Steering.....	213
Pre-Collision Assist.....	214

Load Carrying

Load Limit.....	218
-----------------	-----

Towing

Towing a Trailer.....	223
Towing the Vehicle on Four Wheels.....	223

Driving Hints

Breaking-In.....	224
Economical Driving.....	224
Driving Through Water.....	225
Floor Mats.....	225

Roadside Emergencies

Roadside Assistance.....	227
Hazard Warning Flashers.....	228
Fuel Shutoff.....	228
Jump Starting the Vehicle.....	229

Table of Contents

Collision, Damage or Fire Event.....	231
Post-Crash Alert System.....	233
Spinout Detection.....	233
Transporting the Vehicle.....	233
Towing Points.....	234

Customer Assistance

Getting the Services You Need.....	235
In California (U.S. Only).....	236
The Better Business Bureau (BBB) Auto Line Program (U.S. Only).....	237
Utilizing the Mediation/Arbitration Program (Canada Only).....	238
Getting Assistance Outside the U.S. and Canada.....	238
Ordering Additional Owner's Literature.....	239
Reporting Safety Defects (U.S. Only).....	240
Reporting Safety Defects (Canada Only).....	240

Fuses

Fuse Specification Chart.....	242
Changing a Fuse.....	251

Maintenance

General Information.....	253
Opening and Closing the Hood.....	253
Under Hood Overview.....	254
Engine Oil Dipstick.....	255
Engine Oil Check.....	255
Oil Change Indicator Reset.....	256
Engine Coolant Check.....	256
Automatic Transmission Fluid Check.....	261
Brake Fluid Check.....	261
Washer Fluid Check.....	261
Changing the 12V Battery.....	261
Checking the Wiper Blades.....	263
Changing the Wiper Blades.....	263

Adjusting the Headlamps.....	264
Removing a Headlamp.....	265
Changing a Bulb.....	267
Bulb Specification Chart.....	268
Changing the Engine Air Filter.....	270

Vehicle Care

General Information.....	271
Cleaning Products.....	271
Cleaning the Exterior.....	271
Waxing.....	272
Cleaning the Engine.....	273
Cleaning the Windows and Wiper Blades.....	273
Cleaning the Interior.....	274
Cleaning the Instrument Panel and Instrument Cluster Lens.....	274
Cleaning Leather Seats.....	275
Repairing Minor Paint Damage.....	275
Cleaning the Alloy Wheels.....	275
Vehicle Storage.....	276

Wheels and Tires

Tire Sealant and Inflator Kit.....	279
Tire Care.....	285
Using Summer Tires.....	300
Using Snow Chains.....	300
Tire Pressure Monitoring System.....	301
Technical Specifications.....	304

Capacities and Specifications

Engine Specifications.....	306
Motorcraft Parts.....	307
Vehicle Identification Number.....	308
Vehicle Certification Label.....	309
Transmission Code Designation.....	309
Capacities and Specifications.....	310

Table of Contents

Audio System

General Information.....	314
Audio Unit - Vehicles With: AM/FM/ CD.....	315
Audio Unit - Vehicles With: AM/FM/CD/ SYNC/Satellite Radio.....	317
Audio Unit - Vehicles With: Sony AM/FM/ CD.....	319
Digital Radio.....	323
Satellite Radio.....	325
USB Port.....	328
Media Hub.....	328

SYNC™

General Information.....	329
Using Voice Recognition.....	331
Using SYNC™ With Your Phone.....	333
SYNC™ Applications and Services.....	345
Using SYNC™ With Your Media Player.....	350
SYNC™ Troubleshooting.....	359

SYNC™ 3

General Information.....	367
Home Screen.....	380
Using Voice Recognition.....	381
Entertainment.....	388
Climate.....	398
Phone.....	400
Navigation.....	406
Electric Vehicle Information.....	414
Apps.....	434
Settings.....	437
SYNC™ 3 Troubleshooting.....	450

Accessories

Accessories.....	462
------------------	-----

Extended Service Plan (ESP)

Extended Service Plan (ESP).....	464
----------------------------------	-----

Scheduled Maintenance

General Maintenance Information.....	466
Normal Scheduled Maintenance.....	469
Special Operating Conditions Scheduled Maintenance.....	472
Scheduled Maintenance Record.....	474

Appendices

End User License Agreement.....	484
Type Approvals.....	500

Introduction

ABOUT THIS MANUAL

Thank you for choosing Ford. We recommend that you take some time to get to know your vehicle by reading this manual. The more that you know about your vehicle, the greater the safety and pleasure you will get from driving it.

WARNING



Driving while distracted can result in loss of vehicle control, crash and injury. We strongly recommend that you use extreme caution when using any device that may take your focus off the road. Your primary responsibility is the safe operation of your vehicle. We recommend against the use of any hand-held device while driving and encourage the use of voice-operated systems when possible. Make sure you are aware of all applicable local laws that may affect the use of electronic devices while driving.

Note: This manual describes product features and options available throughout the range of available models, sometimes even before they are generally available. It may describe options not fitted to the vehicle you have purchased.

Note: Some of the illustrations in this manual may show features as used in different models, so may appear different to you on your vehicle.

Note: Always use and operate your vehicle in line with all applicable laws and regulations.

Note: Pass on this manual when selling your vehicle. It is an integral part of your vehicle.

This manual may qualify the location of a component as left-hand side or right-hand side. The side is determined when facing forward in the seat.

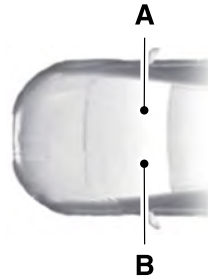

E154903

A Right-hand side.

B Left-hand side.

SYMBOLS GLOSSARY

These are some of the symbols you may see on your vehicle.



Safety alert



See Owner's Manual



Air conditioning system



Anti-lock braking system



Avoid smoking, flames or sparks



Battery



Battery acid



Brake fluid - non petroleum based

Introduction



Brake system



Cabin air filter



Check fuel cap



Child safety door lock or unlock



Child seat lower anchor



Child seat tether anchor



Cruise control



Do not open when hot



Engine air filter



Engine coolant



Engine coolant temperature



Engine oil



Explosive gas



Fan warning



Fasten seatbelt



Front airbag



Front fog lamps



Fuel pump reset



Fuse compartment



Hazard warning flashers



Heated rear window



Heated windshield



Interior luggage compartment release



Jack



Keep out of reach of children



Lighting control



Low tire pressure warning



Maintain correct fluid level



Note operating instructions



Panic alarm

Introduction



Parking aid



Parking brake



Power steering fluid



Power windows front/rear



Power window lockout



Service engine soon



Side airbag



Shield the eyes



Stability control



Windshield wash and wipe

DATA RECORDING

Service Data Recording

Service data recorders in your vehicle are capable of collecting and storing diagnostic information about your vehicle. This potentially includes information about the performance or status of various systems and modules in the vehicle, such as engine, throttle, steering or brake systems. In order to properly diagnose and service your vehicle, Ford Motor Company (Ford of Canada in Canada), and service

and repair facilities may access or share among them vehicle diagnostic information received through a direct connection to your vehicle when diagnosing or servicing your vehicle. Additionally, Ford Motor Company (Ford of Canada, in Canada) may, where permitted by law, use vehicle diagnostic information for vehicle improvement or with other information we may have about you, (e.g., your contact information), to offer you products or services that may interest you. Data may be provided to our service providers such as part suppliers that may help diagnose malfunctions, and who are similarly obligated to protect data. We retain this data only as long as necessary to perform these functions or to comply with law. We may provide information where required in response to official requests to law enforcement or other government authorities or third parties acting with lawful authority or court order, and such information may be used in legal proceedings. For U.S. only (if equipped), if you choose to use connected apps and services, such as SYNC Vehicle Health Report or MyFord Mobile App, you consent that certain diagnostic information may also be accessed electronically by Ford Motor Company and Ford authorized service facilities, and that the diagnostic information may be used to provide services to you, personalizing your experience, troubleshoot, and to improve products and services and offer you products and services that may interest you, where permitted by law. For Canada only, for more information, please review the Ford of Canada privacy policy at www.ford.ca, including our U.S. data storage and use of service providers in other jurisdictions who may be subject to

Introduction

legal requirements in Canada, the United States and other countries applicable to them, for example, lawful requirements to disclose personal information to governmental authorities in those countries. See **SYNCTM** (page 329).

Event Data Recording

This vehicle is equipped with an event data recorder. The main purpose of an event data recorder is to record, in certain crash or near crash-like situations, such as an airbag deployment or hitting a road obstacle; this data will assist in understanding how a vehicle's systems performed. The event data recorder is designed to record data related to vehicle dynamics and safety systems for a short period of time, typically 30 seconds or less.

The event data recorder in this vehicle is designed to record such data as:

- **How various systems in your vehicle were operating;**
- **Whether or not the driver and passenger safety belts were buckled/fastened;**
- **How far (if at all) the driver was depressing the accelerator and/or the brake pedal; and**
- **How fast the vehicle was traveling; and**
- **Where the driver was positioning the steering wheel.**

This data can help provide a better understanding of the circumstances in which crashes and injuries occur.

Note: Event data recorder data is recorded by your vehicle only if a non-trivial crash situation occurs; no data is recorded by the event data recorder under normal driving conditions and no personal data or information (e.g., name, gender, age, and crash location) is recorded (see limitations regarding 911 Assist and Traffic, directions and Information privacy below). However, parties, such as law enforcement, could combine the event data recorder data with the type of personally identifying data routinely acquired during a crash investigation.

To read data recorded by an event data recorder, special equipment is required, and access to the vehicle or the event data recorder is needed. In addition to the vehicle manufacturer, other parties, such as law enforcement, that have such special equipment, can read the information if they have access to the vehicle or the event data recorder. Ford Motor Company and Ford of Canada do not access event data recorder information without obtaining consent, unless pursuant to court order or where required by law enforcement, other government authorities or other third parties acting with lawful authority. Other parties may seek to access the information independently of Ford Motor Company and Ford of Canada.

Introduction

Note: *Including to the extent that any law pertaining to Event Data Recorders applies to SYNC or its features, please note the following: Once 911 Assist (if equipped) is enabled (set ON), 911 Assist may, through any paired and connected cell phone, disclose to emergency services that the vehicle has been in a crash involving the deployment of an airbag or, in certain vehicles, the activation of the fuel pump shut-off. Certain versions or updates to 911 Assist may also be capable of being used to electronically or verbally provide to 911 operators the vehicle location (such as latitude and longitude), and/or other details about the vehicle or crash or personal information about the occupants to assist 911 operators to provide the most appropriate emergency services. If you do not want to disclose this information, do not activate the 911 Assist feature. See SYNC™ (page 329).*

Additionally, when you connect to Traffic, Directions and Information (if equipped, U.S. only), the service uses GPS technology and advanced vehicle sensors to collect the vehicle's current location, travel direction, and speed ("vehicle travel information"), only to help provide you with the directions, traffic reports, or business searches that you request. If you do not want Ford or its vendors to receive this information, do not activate the service. For more information, see Traffic, Directions and Information, Terms and Conditions. See SYNC™ (page 329).

CALIFORNIA PROPOSITION 65

WARNINGS



Some constituents of engine exhaust, certain vehicle components, certain fluids contained in vehicles and certain products of component wear contain or emit chemicals known to the State of California to cause cancer and birth defects or other reproductive harm.



Battery posts, terminals and related accessories contain lead and lead compounds, chemicals known to the State of California to cause cancer and reproductive harm. Batteries also contain other chemicals known to the State of California to cause cancer. Wash your hands after handling.

PERCHLORATE

Certain components in your vehicle such as airbag modules, seatbelt pretensioners and remote control batteries may contain perchlorate material. Special handling may apply for service or vehicle end of life disposal.

For more information visit:

Web Address
www.dtsc.ca.gov/hazardouswaste/perchlorate

FORD CREDIT

US Only

Ford Credit offers a full range of financing and lease plans to help you acquire your vehicle. If you have financed or leased your vehicle through Ford Credit, thank you for your business.

Introduction

We offer a number of convenient ways for you to contact us and help to manage your account.

Call 1-800-727-7000.

For more information about Ford Credit and access to the Account Manager, go to www.fordcredit.com.

REPLACEMENT PARTS RECOMMENDATION

We have built your vehicle to the highest standards using quality parts. We recommend that you demand the use of genuine Ford and Motorcraft parts whenever your vehicle requires scheduled maintenance or repair. You can clearly identify genuine Ford and Motorcraft parts by looking for the Ford, FoMoCo or Motorcraft branding on the parts or their packaging.

Scheduled Maintenance and Mechanical Repairs

One of the best ways for you to make sure that your vehicle provides years of service is to have it maintained in line with our recommendations using parts that conform to the specifications detailed in this Owner's Manual. Genuine Ford and Motorcraft parts meet or exceed these specifications.

Collision Repairs

We hope that you never experience a collision, but accidents do happen. Genuine Ford replacement collision parts meet our stringent requirements for fit, finish, structural integrity, corrosion protection and dent resistance. During

vehicle development we validate that these parts deliver the intended level of protection as a whole system. A great way to know for sure you are getting this level of protection is to use genuine Ford replacement collision parts.

Warranty on Replacement Parts

Genuine Ford and Motorcraft replacement parts are the only replacement parts that benefit from a Ford Warranty. The Ford Warranty may not cover damage caused to your vehicle as a result of failed non-Ford parts. For additional information, refer to the terms and conditions of the Ford Warranty.

SPECIAL NOTICES

New Vehicle Limited Warranty

For a detailed description of what is covered and what is not covered by your vehicle's New Vehicle Limited Warranty, refer to the Warranty Manual that is provided to you along with your Owner's Manual.

Special Instructions

For your added safety, your vehicle is fitted with sophisticated electronic controls.

WARNINGS



You risk death or serious injury to yourself and others if you do not follow the instruction highlighted by the warning symbol. Failure to follow the specific warnings and instructions could result in personal injury.



Never place front seat mounted rear-facing child or infant seats in front of an active passenger airbag.

Introduction

On Board Diagnostics Data Link Connector

WARNING



Use of wireless plug-in devices in the OBD Data Link Connector (DLC) may allow unauthorized third parties to gain access to vehicle systems and data which could impair the function of various vehicle systems, including safety-related systems. The DLC should only be used by a repair facility that operates in accordance with Ford's service and repair instructions.

Your vehicle has an OBD Data Link Connector (DLC) that is used in conjunction with a diagnostic scan tool for vehicle diagnostics, repairs and reprogramming services. Installing an aftermarket device that uses the DLC during normal driving for purposes such as remote insurance company monitoring, transmission of vehicle data to other devices or entities, or altering the performance of the vehicle, may cause interference with or even damage to vehicle systems. We do not recommend or endorse the use of aftermarket plug-in devices unless approved by Ford. The vehicle Warranty will not cover damage caused by an aftermarket plug-in device.

MOBILE COMMUNICATIONS EQUIPMENT

WARNING



Driving while distracted can result in loss of vehicle control, crash and injury. We strongly recommend that you use extreme caution when using any device that may take your focus off the road. Your primary responsibility is the safe operation of your vehicle. We recommend against the use of any hand-held device while driving and encourage the use of voice-operated systems when possible. Make sure you are aware of all applicable local laws that may affect the use of electronic devices while driving.

Using mobile communications equipment is becoming increasingly important in the conduct of business and personal affairs. However, you must not compromise your own or others' safety when using such equipment. Mobile communications can enhance personal safety and security when appropriately used, particularly in emergency situations. Safety must be paramount when using mobile communications equipment to avoid negating these benefits. Mobile communication equipment includes, but is not limited to, cellular phones, pagers, portable email devices, text messaging devices and portable two-way radios.

EXPORT UNIQUE OPTIONS

For your particular global region, your vehicle may be equipped with features and options that are different from the features and options that are described in this Owner's Manual. A market unique supplement may be supplied that complements this book. By referring to the market unique supplement, if provided, you can properly identify those features,

Introduction

recommendations and specifications that are unique to your vehicle. This Owner's Manual is written primarily for the U.S. and Canadian Markets. Features or equipment listed as standard may be different on units built for Export. **Refer to this Owner's Manual for all other required information and warnings.**

Environment

PROTECTING THE ENVIRONMENT

You must play your part in protecting the environment. Correct vehicle usage and the authorized disposal of waste, cleaning and lubrication materials are significant steps toward this aim.

Child Safety

GENERAL INFORMATION

See the following sections for directions on how to properly use safety restraints for children.

WARNINGS



Always make sure your child is secured properly in a device that is appropriate for their height, age and weight. Child safety restraints must be bought separately from your vehicle. Failure to follow these instructions and guidelines may result in an increased risk of serious injury or death to your child.



All children are shaped differently. The recommendations for safety restraints are based on probable child height, age and weight thresholds from the National Highway Traffic Safety Administration and other safety organizations, or are the minimum requirements of law. We recommend checking with a NHTSA Certified Child Passenger Safety Technician (CPST) and

WARNINGS

consult your pediatrician to make sure your child seat is appropriate for your child, and is compatible with and properly installed in your vehicle. To locate a child seat fitting station and CPST, contact NHTSA toll free at 1-888-327-4236 or go to <http://www.nhtsa.dot.gov>. In Canada, contact Transport Canada toll free at 1-800-333-0371 or go to www.tc.gc.ca to find a Child Car Seat Clinic in your area. Failure to properly restrain children in safety seats made especially for their height, age, and weight may result in an increased risk of serious injury or death to your child.



Do not leave children or animals unattended in the vehicle. On hot days, the temperature in the trunk or vehicle interior can rise very quickly. Exposure of people or animals to these high temperatures for even a short time can cause death or serious heat-related injuries, including brain damage. Small children are particularly at risk.

Child Safety

Recommendations for Safety Restraints for Children

Child	Child size, height, weight, or age	Recommended restraint type
Infants or toddlers	Children weighing 40 lb (18 kg) or less (generally age four or younger).	Use a child safety seat (sometimes called an infant carrier, convertible seat, or toddler seat).
Small children	Children who have outgrown or no longer properly fit in a child safety seat (generally children who are less than 4 ft. 9 in. (1.45 m) tall, are greater than age four and less than age 12, and between 40 lb (18 kg) and 80 lb (36 kg) and upward to 100 lb (45 kg) if recommended by your child restraint manufacturer).	Use a belt-positioning booster seat.
Larger children	Children who have outgrown or no longer properly fit in a belt-positioning booster seat (generally children who are at least 4 ft. 9 in. (1.45 m) tall or greater than 80 lb (36 kg) or 100 lb (45 kg) if recommended by child restraint manufacturer).	Use a vehicle safety belt having the lap belt snug and low across the hips, shoulder belt centered across the shoulder and chest, and seat back upright.

- You are required by law to properly use safety seats for infants and toddlers in the United States and Canada.
- Many states and provinces require that small children use approved booster seats until they reach age eight, a height of 4 feet 9 inches (1.45 meters) tall, or 80 pounds (36 kilograms). Check your local and state or provincial laws for specific requirements about the safety of children in your vehicle.
- When possible, always properly restrain children 12 years of age and under in a rear seating position of your vehicle. Accident statistics suggest that children are safer when properly restrained in the rear seating positions than in a front seating position. See **Front Passenger Sensing System** (page 41).

INSTALLING CHILD RESTRAINTS

Child Seats



E142594

Child Safety

Use a child safety seat (sometimes called an infant carrier, convertible seat, or toddler seat) for infants, toddlers, or children weighing 40 pounds (18 kilograms) or less (generally age four or younger).

Using Lap and Shoulder Belts

WARNINGS



Airbags can kill or injure a child in a child seat. Never place a rear-facing child seat in front of an active airbag. If you must use a forward-facing child seat in the front seat, move the seat upon which the child seat is installed all the way back.



Airbags can kill or injure a child in a child seat. Children 12 and under should be properly restrained in the rear seat whenever possible.



Depending on where you secure a child restraint, and depending on the child restraint design, you may block access to certain safety belt buckle assemblies and LATCH lower anchors, rendering those features potentially unusable. To avoid risk of injury, occupants should only use seating positions where they are able to be properly restrained.

When installing a child safety seat with combination lap and shoulder belts:

- Use the correct safety belt buckle for that seating position.
- Insert the belt tongue into the proper buckle until you hear a snap and feel it latch. Make sure the tongue is securely fastened in the buckle.
- Keep the buckle release button pointing up and away from the safety seat, with the tongue between the child seat and the release button, to prevent accidental unbuckling.

- Place the vehicle seat upon which the child seat will be installed in the upright position.
- Put the safety belt in the automatic locking mode. See Step 5. This vehicle does not require the use of a locking clip.

Perform the following steps when installing the child seat with combination lap and shoulder belts:

Note: *Although the child seat illustrated is a forward facing child seat, the steps are the same for installing a rear facing child seat.*

Standard safety belts



E142528

1. Position the child safety seat in a seat with a combination lap and shoulder belt.



E142529

Child Safety

- After positioning the child safety seat in the proper seating position, pull down on the shoulder belt and then grasp the shoulder belt and lap belt together behind the belt tongue.



E142530

- While holding the shoulder and lap belt portions together, route the tongue through the child seat according to the child seat manufacturer's instructions. Be sure the belt webbing is not twisted.

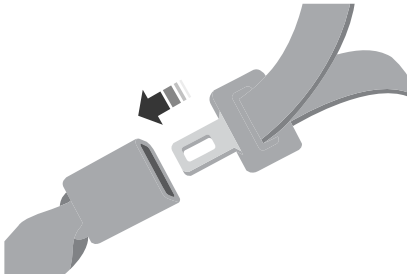

E142531

- Insert the belt tongue into the proper buckle (the buckle closest to the direction the tongue is coming from) for that seating position until you hear a snap and feel the latch engage. Make sure the tongue is latched securely by pulling on it.



E142875

- To put the retractor in the automatic locking mode, grasp the shoulder portion of the belt and pull downward until all of the belt is pulled out.

Note: *The automatic locking mode is available on the front passenger and rear seats.*

- Allow the belt to retract to remove slack. The belt will click as it retracts to indicate it is in the automatic locking mode.
- Try to pull the belt out of the retractor to make sure the retractor is in the automatic locking mode (you should not be able to pull more belt out). If the retractor is not locked, unbuckle the belt and repeat Steps 5 and 6.



E142533

Child Safety

8. Remove remaining slack from the belt. Force the seat down with extra weight, for example, by pressing down or kneeling on the child restraint while pulling up on the shoulder belt in order to force slack from the belt. This is necessary to remove the remaining slack that will exist once the extra weight of the child is added to the child restraint. It also helps to achieve the proper snugness of the child seat to your vehicle. Sometimes, a slight lean toward the buckle will provide extra help to remove remaining slack from the belt.
9. Attach the tether strap (if the child seat is equipped).

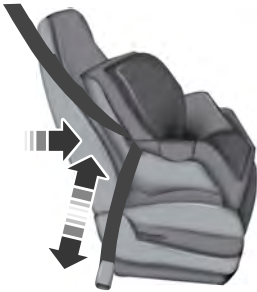

E142534

10. Before placing the child in the seat, forcibly move the seat forward and back to make sure the seat is securely held in place. To check this, grab the seat at the belt path and attempt to move it side to side and forward and back. There should be no more than 1 inch (2.5 centimeters) of movement for proper installation.

We recommend checking with a NHTSA Certified Child Passenger Safety Technician to make certain the child restraint is properly installed. In Canada, check with Transport Canada for referral to a Child Car Seat Clinic.

Inflatable safety belts



E142528

1. Position the child safety seat in a seat with a combination lap and shoulder belt.



E146522

2. After positioning the child safety seat in the proper seating position, grasp the shoulder belt and lap belt together behind the belt tongue.

Child Safety



E142530

3. While holding the shoulder and lap belt portions together, route the tongue through the child seat according to the child seat manufacturer's instructions. Be sure the belt webbing is not twisted.

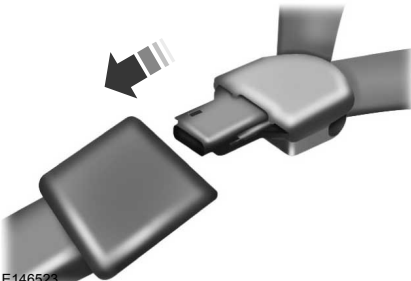

E146523

4. Insert the belt tongue into the proper buckle (the buckle closest to the direction the tongue is coming from) for that seating position until you hear a snap and feel the latch engage. Make sure the tongue is latched securely by pulling on it.

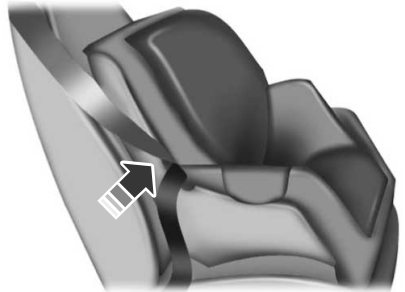

E146524

5. To put the retractor in the automatic locking mode, grasp the lap portion of the inflatable safety belt and pull upward until all of the belt is pulled out.

Note: The automatic locking mode is available on the front passenger and rear seats.

Note: Unlike the standard safety belt, the inflatable safety belt's unique lap portion locks the child seat for installation. The ability for the shoulder portion of the belt to move freely is normal, even after the lap belt has been put into the automatic locking mode.

Note: The lock-off device on some child restraints may not accommodate the shoulder portion of the inflatable safety belt. Follow all instructions provided by the manufacturer of the child restraint regarding the necessary and proper use of the lock-off device. In some instances, these devices have been provided only for use in vehicles with safety belt systems that would otherwise require a locking clip.

6. Allow the belt to retract to remove slack. The belt will click as it retracts to indicate it is in the automatic locking mode.

Child Safety

7. Try to pull the belt out of the retractor to make sure the retractor is in the automatic locking mode (you should not be able to pull more belt out). If the retractor is not locked, unbuckle the belt and repeat Steps 5 and 6.

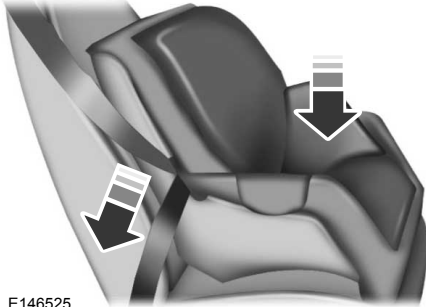

E146525

8. Remove remaining slack from the belt. Force the seat down with extra weight, for example, by pressing down or kneeling on the child restraint while pulling down on the lap belt in order to force slack from the belt. This is necessary to remove the remaining slack that will exist once the extra weight of the child is added to the child restraint. It also helps to achieve the proper snugness of the child seat to your vehicle. Sometimes, a slight lean toward the buckle will additionally help to remove remaining slack from the belt.
9. Attach the tether strap (if the child seat is equipped).

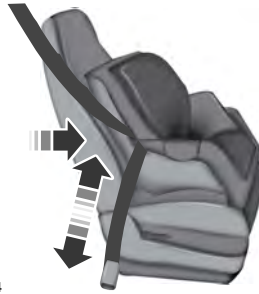

E142534

10. Before placing the child in the seat, forcibly move the seat forward and back to make sure the seat is securely held in place. To check this, grab the seat at the belt path and attempt to move it side to side and forward and back. There should be no more than 1 inch (2.5 centimeters) of movement for proper installation.

We recommend checking with a NHTSA Certified Child Passenger Safety Technician to make certain the child restraint is properly installed. In Canada, check with Transport Canada for referral to a Child Car Seat Clinic.

Using Lower Anchors and Tethers for Children (LATCH)

WARNINGS



Never attach two child safety seats to the same anchor. In a collision, one anchor may not be strong enough to hold two child safety seat attachments and may break, causing serious injury or death.

Child Safety

WARNINGS



Depending on where you secure a child restraint, and depending on the child restraint design, you may block access to certain safety belt buckle assemblies or LATCH lower anchors, rendering those features potentially unusable. To avoid risk of injury, occupants should only use seating positions where they are able to be properly restrained.

The LATCH system is composed of three vehicle anchor points: two lower anchors located where seat back and seat cushion meet (called the seat bight) and one top tether anchor located behind that seating position.

LATCH compatible child safety seats have two rigid or webbing mounted attachments that connect to the two lower anchors at the LATCH equipped seating positions in your vehicle. This type of attachment method eliminates the need to use safety belts to attach the child seat, however the safety belt can still be used to attach the child seat. For forward-facing child seats, the top tether strap must also be attached to the proper top tether anchor, if a top tether strap has been provided with your child seat.

Your vehicle has LATCH lower anchors for child seat installation at the seating positions marked with the child seat symbol.



E144054

The LATCH anchors are located at the rear section of the rear seat between the cushion and seat back below the symbols as shown. Follow the child seat manufacturer's instructions to properly install a child seat with LATCH attachments. Follow the instructions on attaching child safety seats with tether straps.

Attach LATCH lower attachments of the child seat only to the anchors shown.

Use of Inboard Lower Anchors from the Outboard Seating Positions (Center Seating Use)

WARNING



The standardized spacing for LATCH lower anchors is 11 inches (28 centimeters) center to center. Do not use LATCH lower anchors for the center seating position unless the child seat manufacturer's instructions permit and specify using anchors spaced at least as far apart as those in this vehicle.

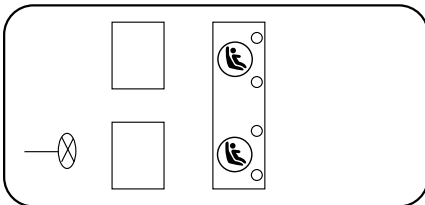

E142535

Child Safety

The lower anchors at the center of the second row rear seat are spaced 18 inches (46 centimeters) apart. A child seat with rigid LATCH attachments cannot be installed at the center seating position. LATCH compatible child seats (with attachments on belt webbing) can only be used at this seating position provided that the child seat manufacturer's instructions permit use with the anchor spacing stated. Do not attach a child seat to any lower anchor if an adjacent child seat is attached to that anchor.

Each time you use the safety seat, check that the seat is properly attached to the lower anchors and tether anchor, if applicable. Tug the child seat from side to side and forward and back where it is secured to your vehicle. The seat should move less than one inch when you do this for a proper installation.

If the safety seat is not anchored properly, the risk of a child being injured in a crash greatly increases.

Combining Safety Belt and LATCH Lower Anchors for Attaching Child Safety Seats

When used in combination, either the safety belt or the LATCH lower anchors may be attached first, provided a proper installation is achieved. Attach the tether strap afterward, if included with the child seat.

Using Tether Straps



Many forward-facing child safety seats include a tether strap which extends from the back of the child safety seat and hooks to an anchoring point called the top tether anchor. Tether straps are available as an accessory for many older safety seats.

Contact the manufacturer of your child seat for information about ordering a tether strap, or to obtain a longer tether strap if the tether strap on your safety seat does not reach the appropriate top tether anchor in your vehicle.

Once the child safety seat has been installed using either the safety belt, the lower anchors of the LATCH system, or both, you can attach the top tether strap.

The tether strap anchors in your vehicle are in the following positions (shown from top view):

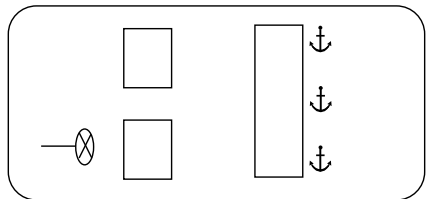

E142537

Perform the following steps to install a child safety seat with tether anchors:

Note: *If you install a child seat with rigid LATCH attachments, do not tighten the tether strap enough to lift the child seat off your vehicle seat cushion when the child is seated in it. Keep the tether strap just snug without lifting the front of the child seat. Keeping the child seat just touching your vehicle seat gives the best protection in a severe crash.*

Child Safety

1. Route the child safety seat tether strap over the back of the seat. For outboard seating positions, route the tether strap under the head restraint and between the head restraint posts. For the center seating positions, route the tether strap over the top of the head restraint. If needed, the head restraints can also be removed.



E144274

2. Locate the correct anchor for the selected seating position, then open the tether anchor cover.



E144275

3. Clip the tether strap to the anchor as shown.
4. Tighten the child safety seat tether strap according to the manufacturer's instructions.

If your child restraint system is equipped with a tether strap, and the child restraint manufacturer recommends its use, we also recommend its use.

BOOSTER SEATS

WARNING



Never place, or allow a child to place, the shoulder belt under a child's arm or behind the back because it reduces the protection for the upper part of the body and may increase the risk of injury or death in a crash.

Note: Some booster seat safety belt guides may not accommodate the shoulder portion of the inflatable safety belt.

Use a belt-positioning booster seat for children who have outgrown or no longer properly fit in a child safety seat (generally children who are less than 4 feet 9 inches (1.45 meters) tall, are greater than age four (4) and less than age twelve (12), and between 40 pounds (18 kilograms) and 80 pounds (36 kilograms) and upward to 100 pounds (45 kilograms) if recommended by your child restraint manufacturer). Many state and provincial laws require that children use approved booster seats until they reach age eight, a height of 4 feet 9 inches (1.45 meters) tall, or 80 pounds (36 kilograms).

Booster seats should be used until you can answer YES to ALL of these questions when seated without a booster seat:

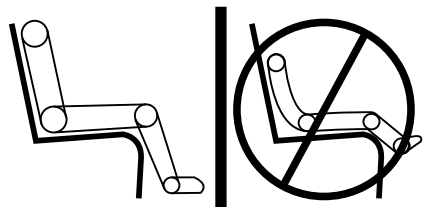

E142595

Child Safety

- Can the child sit all the way back against their vehicle seat back with knees bent comfortably at the edge of the seat cushion?
- Can the child sit without slouching?
- Does the lap belt rest low across the hips?
- Is the shoulder belt centered on the shoulder and chest?
- Can the child stay seated like this for the whole trip?

Always use booster seats in conjunction with your vehicle lap and shoulder belt.

Types of Booster Seats



E68924

- Backless booster seats

If your backless booster seat has a removable shield, remove the shield. If a vehicle seating position has a low seat back or no head restraint, a backless booster seat may place your child's head (as measured at the tops of the ears) above the top of the seat. In this case, move the backless booster to another seating position with a higher seat back or head restraint and lap and shoulder belts, or consider using a high back booster seat.



E70710

- High back booster seats

If, with a backless booster seat, you cannot find a seating position that adequately supports your child's head, a high back booster seat would be a better choice.

Children and booster seats vary in size and shape. Choose a booster that keeps the lap belt low and snug across the hips, never up across the stomach, and lets you adjust the shoulder belt to cross the chest and rest snugly near the center of the shoulder. The following drawings compare the ideal fit (center) to a shoulder belt uncomfortably close to the neck and a shoulder belt that could slip off the shoulder. The drawings also show how the lap belt should be low and snug across the child's hips.

Child Safety



E142596



E142597

If the booster seat slides on the vehicle seat upon which it is being used, placing a rubberized mesh sold as shelf or carpet liner under the booster seat may improve this condition. Do not introduce any item thicker than this under the booster seat. Check with the booster seat manufacturer's instructions.

CHILD RESTRAINT POSITIONING

WARNINGS



Airbags can kill or injure a child in a child seat. Never place a rear-facing child seat in front of an active airbag. If you must use a forward-facing child seat in the front seat, move the vehicle seat upon which the child seat is installed all

WARNINGS

the way back. When possible, all children age 12 and under should be properly restrained in a rear seating position. If all children cannot be seated and restrained properly in a rear seating position, properly restrain the largest child in the front seat.



Always carefully follow the instructions and warnings provided by the manufacturer of any child restraint to determine if the restraint device is appropriate for your child's size, height, weight, or age. Follow the child restraint manufacturer's instructions and warnings provided for installation and use in conjunction with the instructions and warnings provided by your vehicle

Child Safety

WARNINGS

manufacturer. A safety seat that is improperly installed or utilized, is inappropriate for your child's height, age, or weight or does not properly fit the child may increase the risk of serious injury or death.



Never let a passenger hold a child on his or her lap while your vehicle is moving. The passenger cannot protect the child from injury in a crash, which may result in serious injury or death.



Never use pillows, books, or towels to boost a child. They can slide around and increase the likelihood of injury or death in a crash.

WARNINGS



Always restrain an unoccupied child seat or booster seat. These objects may become projectiles in a crash or sudden stop, which may increase the risk of serious injury.



Never place, or allow a child to place, the shoulder belt under a child's arm or behind the back because it reduces the protection for the upper part of the body and may increase the risk of injury or death in a crash.



To avoid risk of injury, do not leave children or pets unattended in your vehicle.

Recommendations for attaching child safety restraints for children

Restraint Type	Combined weight of child and child seat	Use any attachment method as indicated below by X				
		LATCH (lower anchors and top tether anchor)	LATCH (lower anchors only)	Safety belt and top tether anchor	Safety belt and LATCH (lower anchors and top tether anchor)	Safety belt only
Rear facing child seat	Up to 65 lb (29.5 kg)		X			X
Rear facing child seat	Over 65 lb (29.5 kg)					X
Forward facing child seat	Up to 65 lb (29.5 kg)	X		X	X	
Forward facing child seat	Over 65 lb (29.5 kg)			X	X	

Note: The child seat must rest tightly against the vehicle seat upon which it is installed. It may be necessary to lift or remove the head restraint. See **Seats** (page 122).

CHILD SAFETY LOCKS

When these locks are set, the rear doors cannot be opened from the inside.

Child Safety



E112197

The childproof locks are located on the rear edge of each rear door and must be set separately for each door.

Left-Hand Side

Turn counterclockwise to lock and clockwise to unlock.

Right-Hand Side

Turn clockwise to lock and counterclockwise to unlock.

Seatbelts

PRINCIPLE OF OPERATION

WARNINGS



Always drive and ride with your seatback upright and the lap belt snug and low across the hips.



To reduce the risk of injury, make sure children sit where they can be properly restrained.



Never let a passenger hold a child on his or her lap while the vehicle is moving. The passenger cannot protect the child from injury in a crash.



All occupants of your vehicle, including the driver, should always properly wear their seatbelts, even when an airbag supplemental restraint system is provided. Failure to properly wear your seatbelt could seriously increase the risk of injury or death.



It is extremely dangerous to ride in a cargo area, inside or outside of a vehicle. In a crash, people riding in these areas are more likely to be seriously injured or killed. Do not allow people to ride in any area of your vehicle that is not equipped with seats and seatbelts. Be sure everyone in your vehicle is in a seat and using a seatbelt properly.



In a rollover crash, an unbelted person is significantly more likely to die than a person wearing a seatbelt.



Each seating position in your vehicle has a specific seatbelt assembly which is made up of one buckle and one tongue that are designed to be used as a pair. 1) Use the shoulder belt on the outside shoulder only. Never wear the shoulder belt under the arm. 2) Never swing the seatbelt around your neck over the inside shoulder. 3) Never use a single belt for more than one person.

WARNINGS



Airbags can kill or injure a child in a child restraint. Properly restrain children 12 and under in the rear seat whenever possible.



Seatbelts and seats can become hot in a vehicle that has been closed up in sunny weather. They could burn a small child. Check seat covers and buckles before you place a child anywhere near them.



Front and rear seat occupants, including pregnant women, should wear seatbelts for optimum protection in an accident.

All seating positions in your vehicle have lap and shoulder seatbelts. All occupants of the vehicle should always properly wear their seatbelts, even when an airbag supplemental restraint system is provided.

The seatbelt system consists of:

- Lap and shoulder seatbelts.
- Shoulder seatbelt with automatic locking mode, (except driver seatbelt).
- Height adjuster at the front outboard seating positions.
- Seatbelt pretensioner at the front outboard seating positions.



- Seatbelt warning light and chime.



- Crash sensors and monitoring system with readiness indicator.

Seatbelts

The seatbelt pretensioners at the front seating positions are designed to tighten the seatbelts when activated. In frontal and near-frontal crashes, the seatbelt pretensioners may be activated alone or, if the crash is of sufficient severity, together with the front airbags. The pretensioners may also activate when the Safety Canopy is deployed.

FASTENING THE SEATBELTS

Standard belts shown, inflatable belts similar

The front outboard and rear safety restraints in the vehicle are combination lap and shoulder belts.



E142587

1. Insert the belt tongue into the proper buckle (the buckle closest to the direction the tongue is coming from) until you hear a snap and feel it latch. Make sure you securely fasten the tongue in the buckle.

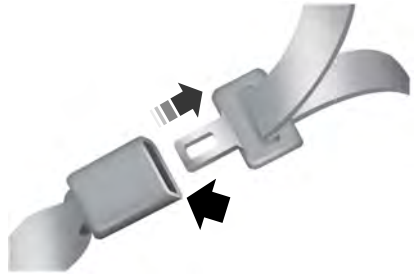

E142588

2. To unfasten, press the release button and remove the tongue from the buckle.

Using Seatbelts During Pregnancy

WARNING



Always ride and drive with your seatback upright and the belt properly fastened. The lap portion of the seatbelt should fit snug and be positioned low across the hips. The shoulder portion of the seatbelt should be positioned across the chest. Pregnant women should also follow this practice. See the following figure.

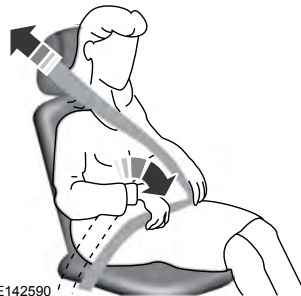

E142590

Seatbelts

Pregnant women should always wear their seatbelt. The lap belt portion of a combination lap and shoulder belt should be positioned low across the hips below the belly and worn as tight as comfort will allow. The shoulder belt should be positioned to cross the middle of the shoulder and the center of the chest.

Seatbelt Locking Modes

WARNINGS



After any vehicle crash, the seatbelt system at all passenger seating positions must be checked by an authorized dealer to verify that the automatic locking retractor feature for child seats is still functioning properly. In addition, all seatbelts should be checked for proper function.



The belt and retractor assembly must be replaced if the seatbelt assembly automatic locking retractor feature or any other seatbelt function is not operating properly when checked by an authorized dealer. Failure to replace the belt and retractor assembly could increase the risk of injury in crashes.

All safety restraints in the vehicle are combination lap and shoulder belts. The driver seatbelt has the vehicle sensitive locking mode. The front outboard passenger and rear seatbelts have both the vehicle sensitive locking mode and the automatic locking mode.

Vehicle Sensitive Mode

This is the normal retractor mode, which allows free shoulder belt length adjustment to your movements and locking in response to vehicle movement. For example, if the driver brakes suddenly or turns a corner sharply, or the vehicle receives an impact of about 5 mph (8 km/h) or more, the combination seatbelts will lock to help reduce forward movement of the driver and passengers.

In addition, the retractor is designed to lock if the webbing is pulled out too quickly. If this occurs, let the belt retract slightly and pull webbing out again in a slow and controlled manner.

Automatic Locking Mode

In this mode, the shoulder belt is automatically pre-locked. The belt will still retract to remove any slack in the shoulder belt. The automatic locking mode is not available on the driver seatbelt.

When to Use the Automatic Locking Mode

This mode should be used any time a child safety seat, except a booster, is installed in passenger front or rear seating positions. Children 12 years old and under should be properly restrained in a rear seating position whenever possible. See **Child Safety** (page 16).

How to Use the Automatic Locking Mode

Standard seatbelts

Seatbelts



E142591

1. Buckle the combination lap and shoulder belt.
2. Grasp the shoulder portion and pull downward until the entire belt is pulled out. As the belt retracts, you will hear a clicking sound. This indicates the seatbelt is now in the automatic locking mode.

Rear outboard inflatable seatbelts (second row only—if equipped)



E146363

1. Buckle the combination lap and shoulder belt.
2. Grasp the lap portion of the belt and pull upward until the entire belt is pulled out.

3. Allow the belt to retract. As the belt retracts, you will hear a clicking sound. This indicates the seatbelt is now in the automatic locking mode.

How to Disengage the Automatic Locking Mode

Unbuckle the combination lap and shoulder belt and allow it to retract completely to disengage the automatic locking mode and activate the vehicle sensitive (emergency) locking mode.

Rear Inflatable Seatbelt (if Equipped)

WARNINGS



Do not attempt to service, repair, or modify the rear inflatable seatbelt.



If the rear inflatable seatbelt deploys, it will not function again. You must have an authorized dealer replace the rear inflatable seatbelt.

The rear inflatable seatbelts are fitted in the shoulder portion of the seatbelts of the second-row outboard seating positions.

Note: *The rear inflatable seatbelts are compatible with most infant and child safety car seats and belt positioning booster seats when properly installed. This is because they are designed to fill with a cooled gas at a lower pressure and at a slower rate than traditional airbags. After inflation, the shoulder portion of the seatbelt remains cool to the touch.*

The rear inflatable seatbelt consists of the following:

- An inflatable bag located in the shoulder seatbelt webbing.
- Lap seatbelt webbing with automatic locking mode.

Seatbelts

- The same warning light, electronic control and diagnostic unit as used for the front seatbelts.
- Impact sensors located in various parts of the vehicle.

How does the rear inflatable seatbelt system work?

The rear inflatable seatbelts will function like standard restraints in everyday usage.

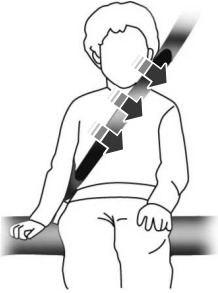

E146364

During a crash of sufficient force, the inflatable belt will inflate from inside the webbing.



E146365

The fully inflated belt's increased diameter more effectively holds the occupant in the appropriate seating position, and spreads crash forces over more area of the body than regular seatbelts. This helps reduce pressure on the chest and helps control head and neck motion for passengers.

The rear inflatable seatbelts are designed to inflate in frontal or near-frontal crashes and in some side impact crashes and rollover crashes. The fact that the rear inflatable seatbelt did not inflate in a crash does not mean that something is wrong with the system. Rather, it means the forces were not of the type sufficient to cause activation.

SEATBELT HEIGHT ADJUSTMENT

WARNING

 Position the safety belt height adjuster so that the belt rests across the middle of your shoulder. Failure to adjust the safety belt properly could reduce the effectiveness of the safety belt and increase the risk of injury in a crash.

Adjust the height of the shoulder belt so the belt rests across the middle of your shoulder.

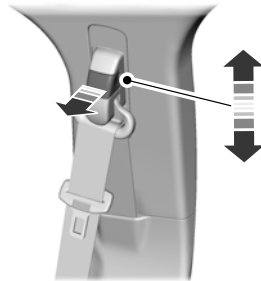

E145664

To adjust the shoulder belt height:

Seatbelts

1. Pull the button and slide the height adjuster up or down.
2. Release the button and pull down on the height adjuster to make sure it is locked in place.

SEATBELT WARNING LAMP AND INDICATOR CHIME



This lamp illuminates and an audible warning will sound if the driver's safety belt has not been fastened when the vehicle's ignition is turned on.

Conditions of operation

If...	Then...
The driver's safety belt is not buckled before the ignition switch is turned to the on position...	The safety belt warning light illuminates 1-2 minutes and the warning chime sounds 4-8 seconds.
The driver's safety belt is buckled while the indicator light is illuminated and the warning chime is sounding...	The safety belt warning light and warning chime turn off.
The driver's safety belt is buckled before the ignition switch is turned to the on position...	The safety belt warning light and indicator chime remain off.

SEATBELT REMINDER

Belt-Minder™

This feature supplements the safety belt warning function by providing additional reminders that intermittently sound a tone and illuminate the safety belt warning light when you are in the driver seat or you have a front seat passenger and a safety belt is unbuckled.

The system uses information from the front passenger sensing system to determine if a front seat passenger is present and therefore potentially in need of a warning. To avoid the system turning on the Belt-Minder feature for objects you place on the front passenger seat, only the front seat passengers receive warnings as determined by the front passenger sensing system.

If the Belt-Minder warnings expire (warnings for about five minutes) for one passenger (driver or front passenger), the other passenger can still cause the Belt-Minder feature to turn on.

Seatbelts

If...	Then...
You and the front seat passenger buckle your safety belts before you switch the ignition on or less than 1–2 minutes elapse after you switch the ignition on...	The Belt-Minder feature will not activate.
You or the front seat passenger do not buckle your safety belts before your vehicle reaches at least 6 mph (9.7 km/h) and 1–2 minutes elapse after you switch the ignition on...	The Belt-Minder feature activates, the safety belt warning light illuminates and a warning tone sounds for 6 seconds every 25 seconds, repeating for about 5 minutes or until you and the front seat passenger buckle your safety belts.
The safety belt for the driver or front passenger is unbuckled for about 1 minute while the vehicle is traveling at least 6 mph (9.7 km/h) and more than 1–2 minutes elapse after you switch the ignition on...	The Belt-Minder feature activates, the safety belt warning light illuminates and a warning tone sounds for 6 seconds every 25 seconds, repeating for about 5 minutes or until you and the front seat passenger buckle your safety belts.

Deactivating and Activating the Belt-Minder Feature

WARNING



While the system allows you to switch this feature off, the intent of the system is to remind you to wear your safety belt to improve your chance to survive an accident. We recommend you leave the system switched on for yourself and others who may use the vehicle.

Note: *The driver and front passenger warnings switch on and off independently. When you perform this procedure for one seating position, do not buckle the other position as this will terminate the process.*

Read Steps 1–4 thoroughly before proceeding with the programming procedure.

Before following the procedure, make sure that:

- The parking brake is set.
 - The transmission is in park (P) or neutral (N).
 - The ignition is off.
 - The driver and front passenger safety belts are unbuckled.
1. Switch the ignition on. Do not start the vehicle.
 2. Wait until the safety belt warning light turns off (about 1 minute). After Step 2, wait an additional 5 seconds before proceeding with Step 3. Once you start Step 3, you must complete the procedure within 30 seconds.
 3. For the seating position you are switching off, buckle then unbuckle the safety belt three times at a moderate speed, ending in the unbuckled state. After Step 3, the safety belt warning light turns on.

Seatbelts

4. While the safety belt warning light is on, buckle and then unbuckle the safety belt. After Step 4, the safety belt warning light flashes for confirmation.
 - This will switch the feature off for that seating position if it is currently on.
 - This will switch the feature on for that seating position if it is currently off.

CHILD RESTRAINT AND SEATBELT MAINTENANCE

Inspect the vehicle safety belts and child safety seat systems periodically to make sure they work properly and are not damaged. Inspect the vehicle and child seat safety belts to make sure there are no nicks, tears or cuts. Replace if necessary. All vehicle safety belt assemblies, including retractors, buckles, front safety belt buckle assemblies, buckle support assemblies (slide bar-if equipped), shoulder belt height adjusters (if equipped), shoulder belt guide on seat back (if equipped), child safety seat LATCH and tether anchors, and attaching hardware, should be inspected after a crash. Read the child restraint manufacturer's instructions for additional inspection and maintenance information specific to the child restraint.

Ford Motor Company recommends that all safety belt assemblies in use in vehicles involved in a crash be replaced. However, if the crash was minor and an authorized dealer finds that the belts do not show damage and continue to operate properly, they do not need to be replaced. Safety belt assemblies not in use during a crash should also be inspected and replaced if either damage or improper operation is noted.

Properly care for safety belts. See **Vehicle Care** (page 271).

SEATBELT EXTENSION

WARNINGS



Persons who fit into the vehicle's seatbelt should not use an extension. Unnecessary use could result in serious personal injury in the event of a crash.



Only use extensions provided free of charge by Ford Motor Company dealers. The dealer will provide an extension designed specifically for this vehicle, model year and seating position. The use of an extension intended for another vehicle, model year or seating position may not offer you the full protection of your vehicle's seatbelt restraint system.



Never use seatbelt extensions to install child restraints.



Do not use a seatbelt extension with an inflatable seatbelt.



Do not use extensions to change the fit of the belt across the torso, over the lap or to make the seatbelt buckle easier to reach.

If, because of body size or driving position, it is not possible to properly fasten the seatbelt over your lap and shoulder, an extension that is compatible with the seatbelts is available free of charge from Ford Motor Company dealers. Only Ford seatbelt extensions made by the original equipment seatbelts manufacturer should be used with Ford seatbelts. Ask your authorized dealer if your extension is compatible with your Ford vehicle restraint system.

Personal Safety System™

The Personal Safety System provides an improved overall level of frontal crash protection to front seat occupants and is designed to help further reduce the risk of airbag-related injuries. The system is able to analyze different occupant conditions and crash severity before activating the appropriate safety devices to help better protect a range of occupants in a variety of frontal crash situations.

The Vehicle Personal Safety System consists of:

- Driver and passenger dual-stage airbag supplemental restraints.
- Front seat outboard safety belts with pretensioners, energy management retractors and safety belt usage sensors.
- Driver seat position sensor.
- Front passenger sensing system.
- Passenger airbag off and on indicator lamp.
- Front crash severity sensors.
- Restraints control module with impact and safing sensors.
- Restraint system warning light and backup tone.
- The electrical wiring for the airbags, crash sensors, safety belt pretensioners, front safety belt usage sensors, driver seat position sensor, front passenger sensing system and indicator lights.

How Does the Personal Safety System Work?

The Personal Safety System can adapt the deployment strategy of the safety devices according to crash severity and occupant conditions. A collection of crash and occupant sensors provides information to the restraints control module. During a crash, the restraints control module may deploy the safety belt pretensioners, one or both stages of the dual-stage airbags based on crash severity and occupant conditions.

Supplementary Restraints System

PRINCIPLE OF OPERATION

WARNINGS

 Airbags do not inflate slowly or gently, and the risk of injury from a deploying airbag is the greatest close to the trim covering the airbag module.

 All occupants of your vehicle, including the driver, should always properly wear their safety belts, even when an airbag supplemental restraint system is provided. Failure to properly wear your safety belt could seriously increase the risk of injury or death.

 Always transport children 12 years old and under in the back seat and always properly use appropriate child restraints. Failure to follow this could seriously increase the risk of injury or death.

 Never place your arm over the airbag module as a deploying airbag can result in serious arm fractures or other injuries.

 Airbags can kill or injure a child in a child seat. Never place a rear-facing child seat in front of an active airbag. If you must use a forward-facing child seat in the front seat, move the seat upon which the child seat is installed all the way back.

 Do not attempt to service, repair, or modify the airbag supplemental restraint systems or its fuses as you could be seriously injured or killed. Contact your authorized dealer as soon as possible.

 Several airbag system components get hot after inflation. To reduce the risk of injury, do not touch them after inflation.

 If the airbag has deployed, the airbag will not function again and must be replaced immediately. If the airbag is not replaced, the unrepaired area will increase the risk of injury in a crash.

The airbags are a supplemental restraint system and are designed to work with the safety belts to help protect the driver and right front passenger from certain upper body injuries. Airbags do not inflate slowly; there is a risk of injury from a deploying airbag.

Note: *You will hear a loud bang and see a cloud of harmless powdery residue if an airbag deploys. This is normal.*

The airbags inflate and deflate rapidly upon activation. After airbag deployment, it is normal to notice a smoke-like, powdery residue or smell the burnt propellant. This may consist of cornstarch, talcum powder (to lubricate the bag) or sodium compounds (for example, baking soda) that result from the combustion process that inflates the airbag. Small amounts of sodium hydroxide may be present which may irritate the skin and eyes, but none of the residue is toxic.

While the system is designed to help reduce serious injuries, contact with a deploying airbag may also cause abrasions or swelling. Temporary hearing loss is also a possibility as a result of the noise associated with a deploying airbag. Because airbags must inflate rapidly and with considerable force, there is the risk of death or serious injuries such as fractures, facial and eye injuries or internal injuries, particularly to occupants who are not properly restrained or are otherwise out of position at the time of airbag deployment. Thus, it is extremely important that occupants be properly restrained as far away from the airbag module as possible while maintaining vehicle control.

Routine maintenance of the airbags is not required.

Supplementary Restraints System

DRIVER AND PASSENGER AIRBAGS

WARNINGS



Never place your arm or any objects over an airbag module. Placing your arm over a deploying airbag can result in serious arm fractures or other injuries. Objects placed on or over the airbag inflation area may cause those objects to be propelled by the airbag into your face and torso causing serious injury.



Airbags can kill or injure a child in a child seat. Never place a rear-facing child seat in front of an active airbag. If you must use a forward-facing child seat in the front seat, move the seat upon which the child seat is installed all the way back.

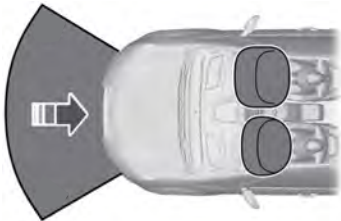

E151127

The driver and front passenger airbags will deploy during significant frontal and near frontal crashes.

The driver and passenger front airbag system consists of:

- Driver and passenger airbag modules.
- Front passenger sensing system.



• Crash sensors and monitoring system with readiness indicator. See **Crash Sensors and Airbag Indicator** (page 46).

Proper Driver and Front Passenger Seating Adjustment

WARNING



National Highway Traffic Safety Administration (NHTSA) recommends a minimum distance of at least 10 inches (25 centimeters) between an occupant's chest and the driver airbag module.

To properly position yourself away from the airbag:

- Move your seat to the rear as far as you can while still reaching the pedals comfortably.
- Recline the seat slightly (one or two degrees) from the upright position.

After all occupants have adjusted their seats and put on safety belts, it is very important that they continue to sit properly. A properly seated occupant sits upright, leaning against the seat back, and centered on the seat cushion, with their feet comfortably extended on the floor. Sitting improperly can increase the chance of injury in a crash event. For example, if an occupant slouches, lies down, turns sideways, sits forward, leans forward or sideways, or puts one or both feet up, the chance of injury during a crash is greatly increased.

Children and Airbags

WARNING



Airbags can kill or injure a child in a child seat. Never place a rear-facing child seat in front of an active airbag. If you must use a forward-facing child seat in the front seat, move the seat upon which the child seat is installed all the way back.

Supplementary Restraints System





E142846

Children must always be properly restrained. Accident statistics suggest that children are safer when properly restrained in the rear seating positions than in the front seating position. Failure to follow these instructions may increase the risk of injury in a crash.

FRONT PASSENGER SENSING SYSTEM

WARNINGS

 Even with advanced restraints systems, properly restrain children 12 and under in a rear seating position. Failure to follow this could seriously increase the risk of injury or death.

 Sitting improperly, out of position or with the seatback reclined too far can take weight off the seat cushion and affect the decision of the passenger sensing system, resulting in serious injury or death in the event of a crash. Always sit upright against your seat back, with your feet on the floor.

 To reduce the risk of possible serious injury: Do not stow objects in the seatback map pocket or hang objects off a seatback if a child is in the front passenger seat. Do not place objects underneath the front passenger seat or

WARNINGS

between the seat and the center console. Check the passenger airbag off or pass airbag off indicator lamp for proper airbag status. Failure to follow these instructions may interfere with the front passenger seat sensing system.

 Any alteration or modification to the front passenger seat may affect the performance of the front passenger sensing system. This could seriously increase the risk of injury or death.

This system works with sensors that are part of the front passenger seat and seatbelt to detect the presence of a properly-seated occupant and determine if the front passenger frontal airbag should be enabled (may inflate) or not.



E227975

The front passenger sensing system uses a passenger airbag status indicator that illuminates indicating that the front passenger frontal airbag is either ON (enabled) or OFF (disabled).

The indicator lamp is at the top center of the instrument panel.

Note: *The passenger airbag status indicator OFF and ON indicator lamps illuminate for a short period of time when you first switch the ignition on to confirm it is functional.*

Supplementary Restraints System

The front passenger sensing system is designed to disable (will not inflate) the front passenger frontal airbag when the front passenger seat is unoccupied, or a rear facing infant seat, a forward-facing child restraint, or a booster seat is detected. Even with this technology, parents are **strongly** encouraged to always properly restrain children in the rear seat. The sensor also turns off the passenger front airbag and seat-mounted side airbag when the passenger seat is empty.

- When the front passenger sensing system disables (will not inflate) the front passenger frontal airbag, the passenger airbag status indicator illuminates the OFF lamp and stays lit to remind you that the front passenger frontal airbag is disabled.
- If you install the child restraint and the passenger airbag status indicator illuminates the ON lamp, then turn the vehicle off, remove the child restraint from the vehicle and reinstall the restraint following the child restraint manufacturer's instructions.

The front passenger sensing system is designed to enable (may inflate) the front passenger frontal airbag anytime the system senses that a person of adult size is sitting properly in the front passenger seat.

- When the front passenger sensing system enables the front passenger frontal airbag (may inflate), the passenger airbag status indicator illuminates the ON lamp and remains illuminated.

If a person of adult size is sitting in the front passenger seat, but the airbag off indicator lamp is lit, it is possible that the person is not sitting properly in the seat. If this happens:

- Turn the vehicle off and ask the person to place the seatback in the full upright position.
- Have the person sit upright in the seat, centered on the seat cushion, with the person's legs comfortably extended.
- Restart the vehicle and have the person remain in this position for about two minutes. This will allow the system to detect that person and enable the passenger frontal airbag.
- If the indicator OFF lamp remains lit even after this, advise the person to ride in the rear seat.

Occupant	Passenger airbag status indicator	Passenger airbag
Empty	OFF: Lit	Disabled
	ON: Unlit	
Child	OFF: Lit	Disabled
	ON: Unlit	
Adult	OFF: Unlit	Enabled
	ON: Lit	

Supplementary Restraints System

Note: When the passenger airbag status indicator OFF light illuminates, the passenger (seat mounted) side airbag may be disabled to avoid the risk of airbag deployment injuries.

After all occupants have adjusted their seats and put on seatbelts, it is very important that they continue to sit properly. A properly seated occupant sits upright, leaning against the seatback, and centered on the seat cushion, with their feet comfortably extended on the floor. Sitting improperly can increase the chance of injury in a crash event. For example, if an occupant slouches, lies down, turns sideways, sits forward, leans forward or sideways, or puts one or both feet up, the chance of injury during a crash is greatly increased.

The conditions listed above may cause the weight of a properly seated occupant to be incorrectly interpreted by the front passenger sensing system. The person in the front passenger seat may appear heavier or lighter due to the conditions described in the list above.



Make sure the front passenger sensing system is operating properly. See **Crash Sensors and Airbag Indicator** (page 46).

Do not attempt to repair or service the system. Take your vehicle immediately to an authorized dealer.

If it is necessary to modify an advanced front airbag system to accommodate a person with disabilities, contact the Ford Customer Relationship Center. See **Getting the Services You Need** (page 235).

SIDE AIRBAGS

WARNINGS



Do not place objects or mount equipment on or near the airbag cover, on the side of the seatbacks (of the front seats), or in front seat areas that may come into contact with a deploying airbag. Failure to follow these instructions may increase the risk of personal injury in the event of a crash.



Do not use accessory seat covers. The use of accessory seat covers may prevent the deployment of the side airbags and increase the risk of injury in an accident.



Do not lean your head on the door. The side airbag could injure you as it deploys from the side of the seatback.



Do not attempt to service, repair, or modify the airbag, its fuses or the seat cover on a seat containing an airbag as you could be seriously injured or killed. Contact your authorized dealer as soon as possible.



If the side airbag has deployed, the airbag will not function again. The side airbag system (including the seat) must be inspected and serviced by an authorized dealer. If the airbag is not replaced, the unrepaired area will increase the risk of injury in a crash.

The side airbags are located on the outboard side of the seatbacks of the front seats. In certain sideways crashes, the airbag on the side affected by the crash will be inflated. The airbag was designed to inflate between the door panel and occupant to further enhance the protection provided occupants in side impact crashes.

Supplementary Restraints System



E152533

The system consists of the following:

- A label or embossed side panel indicating that side airbags are fitted to your vehicle.
- Side airbags located inside the driver and front passenger seatbacks.
- Front passenger sensing system.



- Crash sensors and monitoring system with readiness indicator. See **Crash Sensors and Airbag Indicator** (page 46).

Note: *The passenger sensing system will deactivate the passenger seat-mounted side airbag if it detects an empty passenger seat.*

The design and development of the side airbag system included recommended testing procedures that were developed by a group of automotive safety experts known as the Side Airbag Technical Working Group. These recommended testing procedures help reduce the risk of injuries related to the deployment of side airbags.

DRIVER AND PASSENGER KNEE AIRBAGS

Driver and passenger knee airbags are located under or within the instrument panel. During a crash, the restraints control module may activate the driver and passenger knee airbags (individually or both) based on crash severity and respective occupant conditions. Under certain crash and occupant conditions, the driver and passenger knee airbags may deploy (individually or both) but the corresponding front airbag may not activate. As with front and side airbags, it is important to be properly seated and restrained to reduce the risk of death or serious injury.



Make sure the knee airbags are operating properly. See **Crash Sensors and Airbag Indicator** (page 46).

SAFETY CANOPY™

WARNINGS



Do not place objects or mount equipment on or near the headliner at the siderail that may come into contact with a deploying curtain airbag. Failure to follow these instructions may increase the risk of personal injury in the event of a crash.



Do not lean your head on the door. The curtain airbag could injure you as it deploys from the headliner.



Do not attempt to service, repair, or modify the curtain airbags, its fuses, the A, B, or C pillar trim, or the headliner on a vehicle containing curtain airbags as you could be seriously injured or killed. Contact your authorized dealer as soon as possible.

Supplementary Restraints System

WARNINGS



All occupants of your vehicle including the driver should always wear their safety belts even when an airbag supplemental restraint system and curtain airbag is provided. Failure to properly wear your safety belt could seriously increase the risk of injury or death.



To reduce risk of injury, do not obstruct or place objects in the deployment path of the curtain airbag.



If the curtain airbags have deployed, the curtain airbags will not function again. The curtain airbags (including the A, B and C pillar trim and headliner) must be inspected and serviced by an authorized dealer. If the curtain airbag is not replaced, the unrepaired area will increase the risk of injury in a crash.

The Safety Canopy will deploy during significant side crashes or when a certain likelihood of a rollover event is detected by the rollover sensor. The Safety Canopy is mounted to the roof side-rail sheet metal, behind the headliner, above each row of seats. In certain sideways crashes or rollover events, the Safety Canopy will be activated, regardless of which seats are occupied. The Safety Canopy is designed to inflate between the side window area and occupants to further enhance protection provided in side impact crashes and rollover events.

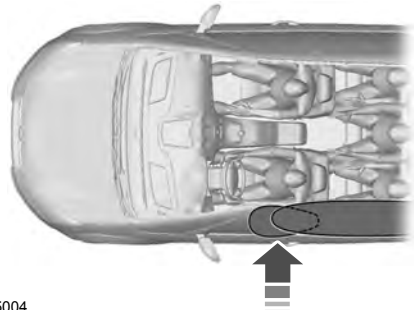

E75004

The system consists of the following:

- Safety canopy curtain airbags located above the trim panels over the front and rear side windows identified by a label or wording on the headliner or roof-pillar trim.
- A flexible headliner which opens above the side doors to allow air curtain deployment



• Crash sensors and monitoring system with a readiness indicator. See **Crash Sensors and Airbag Indicator** (page 46).

Children 12 years old and under should always be properly restrained in the rear seats. The Safety Canopy will not interfere with children restrained using a properly installed child or booster seat because it is designed to inflate downward from the headliner above the doors along the side window opening.

The design and development of the Safety Canopy included recommended testing procedures that were developed by a group of automotive safety experts known as the Side Airbag Technical Working Group. These recommended testing procedures help reduce the risk of injuries related to the deployment of side airbags (including the Safety Canopy).

Supplementary Restraints System

CRASH SENSORS AND AIRBAG INDICATOR

WARNING



Modifying or adding equipment to the front end of the vehicle (including frame, bumper, front end body structure and tow hooks) may affect the performance of the airbag system, increasing the risk of injury. Do not modify the front end of the vehicle.

Your vehicle has a collection of crash and occupant sensors which provide information to the restraints control module. The restraints control module deploys (activates) the front seatbelt system, the adaptive collapsible steering column, driver airbag, passenger airbag, knee airbag(s), seat mounted side airbags, Safety Canopy and optional rear inflatable seatbelts. Based on the type of crash, the restraints control module will deploy the appropriate safety devices.

The restraints control module also monitors the readiness of the above safety devices plus the crash and occupant sensors. The readiness of the safety system is indicated by a warning indicator light in the instrument cluster or a backup tone (if equipped). Routine maintenance of the airbag is not required.

A difficulty with the system is indicated by one or more of the following:



The readiness light will not illuminate immediately after the ignition is turned on.

- The readiness light will either flash or stay lit.
- A series of five beeps will be heard (if equipped). The tone pattern will repeat periodically until the problem, the light or both are repaired.

If any of these things happen, even intermittently, have the supplemental restraint system serviced at an authorized dealer immediately. Unless serviced, the system may not function properly in the event of a crash.

The seatbelt pretensioners and the front airbag supplemental restraint system are designed to activate when the vehicle sustains frontal deceleration sufficient to cause the restraints control module to deploy a safety device.

The fact that the seatbelt pretensioners or front airbags did not activate for both front seat occupants in a crash does not mean that something is wrong with the system. Rather, it means the restraints control module determined the accident conditions (crash severity, belt usage) were not appropriate to activate these safety devices.

- The design of the front airbags is to activate only in frontal and near-frontal crashes (not rollovers, side impacts or rear impacts) unless the crash causes sufficient frontal deceleration.
- The seatbelt pretensioners and rear inflatable seatbelts are designed to activate in frontal, near-frontal and side crashes and rollovers.
- The knee airbag(s) may deploy based on crash severity and occupant conditions.

Supplementary Restraints System

- The design of the side airbags is to inflate in certain side impact crashes. Side airbags may activate in other types of crashes if the vehicle experiences sufficient sideways motion or deformation.
- The design of the Safety Canopy is to inflate in certain side impact crashes or rollover events. The Safety Canopy may activate in other types of crashes if the vehicle experiences sufficient sideways motion or deformation, or a certain likelihood of rollover.

AIRBAG DISPOSAL

Contact your authorized dealer as soon as possible. Airbags must be disposed of by qualified personnel.

Keys and Remote Controls

GENERAL INFORMATION ON RADIO FREQUENCIES

This device complies with Part 15 of the FCC Rules and with Industry Canada license-exempt RSS standard(s). Operation is subject to the following two conditions: (1) This device may not cause harmful interference, and (2) This device must accept any interference received, including interference that may cause undesired operation.

Note: *Changes or modifications not expressly approved by the party responsible for compliance could void the user's authority to operate the equipment. The term IC before the radio certification number only signifies that Industry Canada technical specifications were met.*

The typical operating range for your transmitter is approximately 33 feet (10 meters). Vehicles with the remote start feature will have a greater range. One of the following could cause a decrease in operating range:

- Weather conditions.
- Nearby radio towers.
- Structures around the vehicle.
- Other vehicles parked next to your vehicle.

The radio frequency used by your remote control can also be used by other short distance radio transmissions, for example amateur radios, medical equipment, wireless headsets, remote controls and alarm systems. If the frequencies are jammed, you will not be able to use your remote control. You can lock and unlock the doors with the key.

Note: *Make sure to lock your vehicle before leaving it unattended.*

Note: *If you are in range, the remote control will operate if you press any button unintentionally.*

Intelligent Access (If Equipped)

The system uses a radio frequency signal to communicate with your vehicle and authorize your vehicle to unlock when one of the following conditions are met:

- You activate the front exterior door handle switch.
- You press the luggage compartment button.
- You press a button on the transmitter.

If excessive radio frequency interference is present in the area or if the transmitter battery is low, you may need to mechanically unlock your door. You can use the mechanical key blade in your intelligent access key to open the driver door in this situation. See **Remote Control** (page 48).

REMOTE CONTROL

Intelligent Access Key



E218399

Keys and Remote Controls

The intelligent access keys operate the power locks and the remote start system. The key must be in your vehicle to use the push button start.

Removable Key Blade

The intelligent access key also contains a removable key blade that you can use to unlock your vehicle.



E218400

Push the release button and pull the key blade out.



E151795

Note: Your vehicle keys came with a security label that provides important key cut information. Keep the label in a safe place for future reference.

Using the Key Blade

The key cylinder is under a cap on the driver door handle.

To remove the cap:

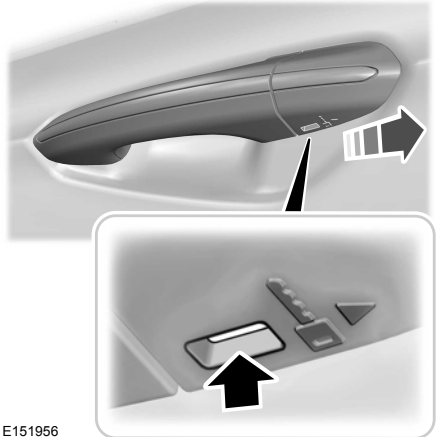

E151956

1. Insert the key blade into the slot on the bottom of the handle and apply upward pressure.
2. While maintaining upward pressure, move the cap rearward to release it. Gently remove the key while doing so.

To install the cap:



E151957

Keys and Remote Controls

1. Place the cap just forward of the key cylinder.
2. Applying pressure to the cap, move it forward until it is in place. You may hear a snap as it engages.

Make sure you have properly installed the cap by trying to move it rearward.

Replacing the Battery

Note: Refer to local regulations when disposing of transmitter batteries.

Note: Do not wipe off any grease on the battery terminals or on the back surface of the circuit board.

Note: Replacing the battery does not erase the programmed key from your vehicle. The transmitter should operate normally.

A message appears in the information display when the remote control battery is low. See **Information Messages** (page 103).

The remote control uses one coin-type three-volt lithium battery CR2032 or equivalent.

1. Push the release button and pull the key blade out.



E218401

2. Twist a thin coin under the tab hidden behind the key blade head to remove the battery cover.



E218400

Keys and Remote Controls



E218402

3. Insert a suitable tool, for example a screwdriver, in the position shown and carefully remove the battery.
4. Install a new battery with the + facing upward.
5. Reinstall the battery cover and the key blade.

Car Finder



Press the button twice within three seconds. The horn sounds and the direction indicators flash. We recommend you use this method to locate your vehicle, rather than using the panic alarm.

Sounding the Panic Alarm

Note: *The panic alarm only operates when the ignition is off.*



Press the button to sound the panic alarm. Press the button again or switch the ignition on to turn it off.

Remote Start (If Equipped)

WARNING



To avoid exhaust fumes, do not use remote start if your vehicle is parked indoors or in areas that are not well ventilated.

Note: *Do not use remote start if your fuel level is low.*



The remote start button is on the transmitter.

This feature allows you to start your vehicle from the outside. The transmitter has an extended operating range.

If your vehicle has automatic climate control, you can configure it to operate when you remote start your vehicle. See **Climate Control** (page 116). A manual climate control system will run at the setting it was set to when you switched your vehicle off.

Many states and provinces have restrictions for the use of remote start. Check your local and state or provincial laws for specific requirements regarding remote start systems.

The remote start system does not work if any of the following occur:

- The ignition is on.
- The anti-theft alarm triggers.
- You switch the feature off in the information display.
- The hood is open.
- The transmission is not in park (P).
- The battery voltage is below the minimum operating voltage.

Keys and Remote Controls

Remote Control Feedback (If Equipped)

An LED on the remote control provides status feedback of remote start or stop commands.

LED.	Status
Solid green.	Remote start or extension successful.
Solid red.	Remote stop successful; vehicle off.
Blinking red.	Remote start or stop failed.
Blinking green.	Waiting for status update.

Remote Starting your Vehicle

Note: You must press each button within three seconds of each other. Your vehicle will not remote start if you do not follow this sequence.

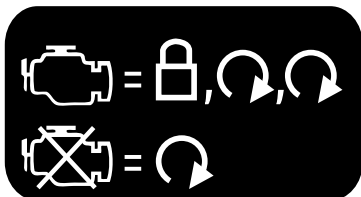

E138626

The label on your transmitter details the starting procedure.

To remote start your vehicle:

1. Press the lock button to lock all the doors.
2. Press the remote start button twice. The exterior lamps flash twice.

The horn sounds if the system fails to start, unless quiet start is on. Quiet start runs the blower fan at a slower speed to reduce noise. You can switch this feature on or off in the information display. See **General Information** (page 94).

Note: You must press the push button ignition switch on the instrument panel once while applying the brake pedal before driving your vehicle.

The power windows do not work during remote start and the radio does not turn on automatically.

The parking lamps remain on and your vehicle will run for 5, 10 or 15 minutes, depending on the setting.

Extending the Engine Running Time

To extend the engine running time duration of your vehicle during remote start, repeat steps 1 and 2 while the engine is running. If the duration is set to 10 minutes, the duration extends by another 10 minutes. For example, if your vehicle had been running from the first remote start for 5 minutes, your vehicle continues to run now for a total of 20 minutes. You can extend the engine running time duration to a maximum of 30 minutes.

Wait at least five seconds before remote starting after the engine stops running.

Turning Your Vehicle Off After Remote Starting



Press the button once. Your vehicle and the parking lamps turn off.

You may have to be closer to your vehicle than when starting due to ground reflection and the added noise of your running vehicle.

You can switch this feature on or off in the information display. See **General Information** (page 94).

Keys and Remote Controls

Memory Feature

You can program your intelligent access key to recall memory positions. See **Memory Function** (page 126).

REPLACING A LOST KEY OR REMOTE CONTROL

Replacement keys or remote controls can be purchased from an authorized dealer. Authorized dealers can program remote controls for your vehicle. See **Passive Anti-Theft System** (page 65).

PRINCIPLE OF OPERATION

MyKey allows you to program keys with restricted driving modes to promote good driving habits. You can program the restrictions to all keys but one. Any keys that you did not program are administrator keys or admin keys.

You can use admin keys to:

- Create a MyKey with certain vehicle restrictions.
- Program certain MyKey settings.
- Clear all MyKey restrictions.

After you program a MyKey, you can view the following information through the information display:

- The total number of admin keys and MyKeys for your vehicle.
- The total distance a MyKey driver traveled with your vehicle.

Note: Every MyKey receives the same restrictions and settings. You cannot program them individually.

Note: For vehicles equipped with a push-button start switch: When both a MyKey and an admin key are present when you start your vehicle, the system recognizes the admin key only.

Standard Settings

Not every vehicle includes the features listed below. If your vehicle has this equipment, then you cannot change the following settings when using a MyKey:

- Seatbelt reminder or Belt-Minder™. MyKey mutes the audio system until drivers, and in some instances, passengers, fasten their seatbelts. **Note:** If your vehicle includes an AM/FM radio or a very basic audio system, then the radio may not mute.
- Earlier low-fuel warning. The low-fuel warning activates earlier for MyKey drivers, giving them more time to refuel.
- Certain driver alerts, stability systems or parking aids turn on automatically when you use the MyKey system. For example, Blind Spot Information System (BLIS), cross traffic alert, lane departure warning or forward collision warning. **Note:** MyKey drivers may be able to turn the lane departure warning feature off, but this feature turns back on automatically with every new key cycle.
- Restricted touchscreen operation in some markets. For example, MyKey may prevent manual navigation destination input while the vehicle is in any gear other than park (P) or when the vehicle reaches a certain rate of speed.
- Satellite radio adult content restrictions, if this feature is available in your market.

Optional Settings

You can configure certain vehicle feature settings when you first create a MyKey. You can also change the settings afterward with an admin key.

Note: *Not every feature applies to every vehicle in every market. When they are available for your vehicle, then they appear in your information display, providing choices to switch them on or off, or to select a more specific setting.*

- Various vehicle speed limits so the MyKey driver cannot exceed certain speeds. The information display shows warnings followed by an audible tone when the MyKey driver reaches the set speed. You cannot override the set speed by fully depressing the accelerator pedal.

WARNING



Do not set MyKey maximum speed limit to a limit that will prevent the driver from maintaining a safe speed considering posted speed limits and prevailing road conditions. The driver is always responsible to drive in accordance with local laws and prevailing conditions. Failure to do so could result in accident or injury.

- Various vehicle speed reminders so MyKey drivers know when their vehicle speed approaches the limits. Warnings appear in your information display and a tone sounds when the MyKey drivers exceed the set vehicle speed.
- The audio system's maximum volume limits to 45% so MyKey drivers can concentrate on the road. A message appears in the information display when MyKey drivers attempt to exceed the limited volume. MyKey also disables the automatic volume control. **Note:** If your vehicle includes an AM/FM radio or a very basic audio system, then the radio may not limit.
- Always on setting. This setting forces certain features to remain on and active for MyKey drivers. For example, E911 or emergency assistance and the do not disturb features stay on even if a MyKey driver uses the feature's control to switch it off.

CREATING A MYKEY

Use the information display to create a MyKey.

1. Switch the ignition on using the key or the transmitter you want to program.
2. Access the main menu in the information display and then scroll through the menus to begin programming your MyKey. See **Information Displays** (page 94).
3. Follow the instructions in the display.
4. A confirmation message appears in the display after you finish programming your MyKey. The programmed restrictions apply when you restart your vehicle with the programmed key or transmitter.

Note: *Make sure you label the programmed MyKey so you can distinguish it from the admin keys.*

You can also program the optional MyKey settings.

Programming or Changing Configurable Settings

Use the information display to program or change your optional MyKey settings.

1. Switch the ignition on using the key or the transmitter you want to program.
2. Access the main menu in the information display and then scroll through the menus to change the settings of your MyKey. See **Information Displays** (page 94).
3. Follow the instructions in the display.
4. A confirmation message appears in the display after you finish programming your MyKey. The programmed restrictions apply when you restart your vehicle with the programmed key or transmitter.

Note: *You can clear or change your MyKey settings at any time during the same key cycle as you created the MyKey. If you switch the engine off, you must use an admin key to change or clear your optional MyKey settings.*

CLEARING ALL MYKEYS

When you clear your MyKeys, you remove all restrictions and return all MyKeys to their original admin key status at once. To clear all MyKeys of all MyKey settings, use the information display.

1. Switch the ignition on using an admin key.
2. Access the main menu in the information display and then scroll through the menus to begin clearing your MyKey programming. See **Information Displays** (page 94).
3. Follow the instructions in the display.

4. A confirmation message appears in the display after you finish clearing your MyKeys.

Note: *When you clear your MyKeys, you remove all restrictions and return all MyKeys to their original admin key status. You cannot remove the MyKey restrictions individually.*

CHECKING MYKEY SYSTEM STATUS

You can find information about your programmed MyKeys by using the information display. See **Information Displays** (page 94).

MyKey Distance

Tracks the distance when drivers use a MyKey. The only way to delete the accumulated distance is by using an admin key to clear all MyKeys. If the distance does not accumulate as expected, then the intended user is not using the MyKey, or an admin key user recently cleared and then recreated a MyKey.

Number of MyKeys

Indicates the number of MyKeys programmed to your vehicle. Use this feature to detect how many MyKeys you have for your vehicle and determine when all MyKeys have been deleted.

Number of Admin Keys

Indicates how many admin keys are programmed to your vehicle. Use this feature to determine how many admin keys you have for your vehicle, and detect if an additional MyKey has been programmed.

USING MYKEY WITH REMOTE START SYSTEMS

MyKey is not compatible with non

Ford-approved, aftermarket remote start systems. If you choose to install a remote start system, see an authorized dealer for a Ford-approved remote start system.

MYKEY TROUBLESHOOTING

Condition	Potential causes
I cannot create a MyKey.	<ul style="list-style-type: none"> · The key or transmitter used to start the vehicle does not have admin privileges. · Vehicles with keyless start: Make sure you place the transmitter into the backup position. See Starting a Gasoline Engine (page 142). · The key or transmitter used to start the vehicle is the only admin key. There always has to be at least one admin key. · SecuriLock passive anti-theft system is disabled or in unlimited mode.
I cannot program the configurable settings.	<ul style="list-style-type: none"> · The key or transmitter used to start the vehicle does not have admin privileges. · There are no MyKeys programmed to the vehicle. See Creating a MyKey (page 55).
For vehicles with keyless start: No MyKey restrictions are available when starting the vehicle.	<ul style="list-style-type: none"> · An admin transmitter is present when you started your vehicle. · There are no MyKeys programmed to the vehicle. See Creating a MyKey (page 55).
I cannot clear the MyKeys.	<ul style="list-style-type: none"> · The key or transmitter used to start the vehicle does not have admin privileges. · No MyKeys are created. See Creating a MyKey (page 55).
I lost the only admin key.	<ul style="list-style-type: none"> · Purchase a new key or transmitter from your authorized dealer.
I lost a key.	<ul style="list-style-type: none"> · Program a spare key or transmitter. You may need to see your authorized dealer. See Passive Anti-Theft System (page 65).
MyKey distances do not accumulate.	<ul style="list-style-type: none"> · The MyKey user is not using the MyKey. · An admin key holder cleared the MyKeys and created new MyKeys. · The key system has been reset.

Locks

LOCKING AND UNLOCKING

You can use the power door lock control or the remote control to lock and unlock your vehicle.

Power Door Locks

The power door lock control is on the driver and front passenger door panels.

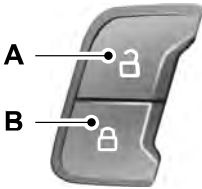

E138628

- A Unlock.
- B Lock.

Door Lock Indicator

An LED on the door window trim illuminates when you lock the door. They will remain illuminated for up to five minutes after you switch the ignition off.

Door Lock Switch Inhibitor

When you electronically lock your vehicle, the power door lock switch no longer operates after 20 seconds. You must unlock your vehicle with the remote control or keyless keypad, or switch the ignition on, to restore function to these switches. You can switch this feature off in the information display. See **General Information** (page 94).

Note: Switch the ignition on and off after changing the setting in the information display.

Rear Door Unlocking and Opening

Pull the interior door handle twice to unlock and open a rear door. The first pull unlocks the door and the second pull opens the door.

Remote Control

You can use the remote control at any time. The luggage compartment release button only works when your vehicle speed is about 3 mph (5 km/h).

Unlocking the Doors (Two-Stage Unlock)



Press the button to unlock the driver door.

Press the button again within three seconds to unlock all doors. The direction indicators will flash.

Press and hold both the lock and unlock buttons on the remote control for three seconds to change between driver door or all doors unlock mode. The direction indicators will flash twice to indicate a change to the unlocking mode. Driver door mode only unlocks the driver door when you press the unlock button once. All door mode unlocks all doors when you press the unlock button once. The unlocking mode applies to the remote control, keyless entry keypad and intelligent access. You can also change between the unlocking modes using the information display. See **General Information** (page 94).

Locking the Doors



Press the button to lock all doors. The direction indicators will flash.

Locks

Press the button again within three seconds to confirm that all the doors are closed. The doors will lock again, the horn will sound and the direction indicators will flash if all the doors and the luggage compartment are closed.

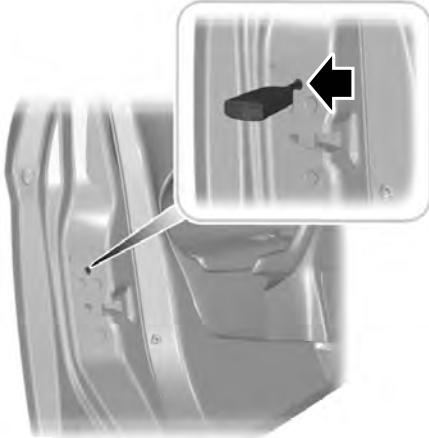

E112203

If the central locking function does not operate, lock the doors individually using the key in the position shown. On the left-hand side, turn the key clockwise to lock. On the right-hand side, turn the key counterclockwise to lock.

Mislock

If any door or the luggage compartment is open, or if the hood is open on vehicles with an anti-theft alarm or remote start, the horn will sound twice and the lamps will not flash. You can enable or disable this feature in the information display. See **Information Displays** (page 94).

Opening the Luggage Compartment



Press twice within three seconds to open the luggage compartment.

Activating Intelligent Access (if Equipped)

You must have the intelligent access key within 3 ft (1 m) of your vehicle.

Unlocking the Doors

Pull an exterior door handle to unlock and open the door. Make sure not to touch the lock sensor area on the top of the handle.

Locking the Doors

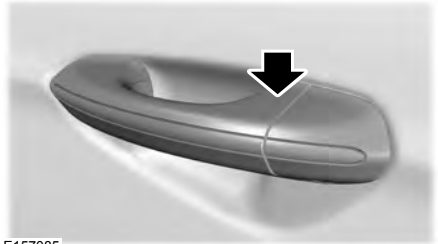

E157085

Touch the top of the door handle to lock your vehicle. There is a brief delay before you can unlock your vehicle again.

Note: *Keep the door handle clean to make sure the system operates correctly.*

Locks

Opening the Luggage Compartment



E207425

Press the exterior release button hidden above the license plate.

Smart Unlocks for Intelligent Access Keys

This feature helps to prevent you from locking your intelligent access key inside your vehicle's passenger compartment or rear cargo area.

When you electronically lock your vehicle with any door open, the transmission is in park (P) and the ignition is off, the system searches for an intelligent access key inside your vehicle after you close the last door. If the system finds a key, all of the doors will immediately unlock and the horn will sound twice, indicating that a key is inside.

You can override the smart unlock feature and intentionally lock the intelligent access key inside your vehicle.

To do this, lock your vehicle after you have closed all the doors by:

- Using the keyless entry keypad.
- Pressing the lock button on another intelligent access key.
- Touching the locking area on the front of the door handle with another intelligent access key in your hand.

When you open one of the front doors and lock your vehicle using the power door lock control, all doors will lock then unlock if:

- The ignition is on.
- The ignition is off and the transmission is not in park (P).

Autolock (If Equipped)

Autolock locks all the doors when all of the following occur:

- All doors are closed.
- The ignition is on.
- You shift into any gear putting your vehicle in motion.
- Your vehicle reaches a speed greater than 12 mph (20 km/h).

Autolock repeats when:

- You open then close any door when the ignition is on and your vehicle speed is 9 mph (15 km/h) or lower.
- Your vehicle reaches a speed greater than 12 mph (20 km/h).

Locks

Autolock

Autolock unlocks all the doors when all of the following occur:

- The ignition is on, all the doors are closed, and your vehicle has been moving at a speed greater than 12 mph (20 km/h).
- Your vehicle comes to a stop and you switch the ignition off or to the accessory position.
- You open the driver door within 10 minutes of switching the ignition off or to accessory.

Note: *If you electronically lock your vehicle after you switch the ignition off with the driver door closed, the doors will not autolock.*

Enabling or Disabling Autolock and Autounlock

Note: *You can switch autolock and autolock on or off independently of each other.*

Autolock is not configurable in all markets. If the autolock settings are not available in your information display, then the system is not configurable. See **General Information** (page 94).

Illuminated Entry

The interior lamps and some exterior lamps illuminate when you unlock the doors with the remote control.

The illuminated entry system will turn off the lights if:

- The ignition is on.
- You press the remote control lock button.
- After 25 seconds of illumination.

The lights will not turn off if:

- You turn them on with the lamp control.
- Any door is open.

Illuminated Exit

The interior lamps and some exterior lamps illuminate when all doors are closed and you switch the ignition off.

The lamps will turn off if all the doors remain closed and:

- 25 seconds have elapsed.
- You press the push button ignition switch.

Battery Saver

If you leave the courtesy lamps, interior lamps or headlamps on, the battery saver shuts them off 10 minutes after you switch the ignition off.

Battery Saver for Intelligent Access Keys

If you leave the ignition switched on, it shuts off when it detects a certain amount of battery drain, or after 45 minutes.

KEYLESS ENTRY (If Equipped)

SECURICODE™ Keyless Entry Keypad

The keypad is near the driver window. It illuminates when touched.

Note: *If you enter your entry code too fast on the keypad, the unlock function may not work. Enter your entry code again more slowly.*

Locks

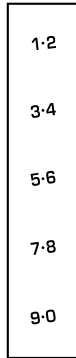

E138637

You can use the keypad to do the following:

- Lock or unlock the doors.
- Release the luggage compartment.
- Recall memory seat and mirror positions.
- Program and erase user codes.
- Arm and disarm the anti-theft alarm.

You can operate the keypad with the factory-set five-digit entry code. The code is on the owner's wallet card in the glove box and is available from an authorized dealer. You can also program up to five of your own five-digit personal entry codes.

Programming a Personal Entry Code

1. Enter the factory-set five-digit code.
2. Press **1-2** on the keypad within five seconds.
3. Enter your personal five-digit code. You must press each number within five seconds of each other.
4. Press **1-2** on the keypad to save personal code 1.

The doors lock then unlock to confirm that programming was successful.

To program additional personal entry codes, repeat steps 1 through 3, then for step 4:

- Press **3-4** to save personal code 2.
- Press **5-6** to save personal code 3.
- Press **7-8** to save personal code 4.
- Press **9-0** to save personal code 5.

You can also program a personal entry code using the touchscreen.

Hints:

- Do not set a code that uses five of the same number.
- Do not use five numbers in sequential order.
- The factory-set code works even if you have set your own personal code.

Recalling Memory Positions (If Equipped)

The programmed entry codes recall driver memory positions as follows:

- Entry code 1 recalls driver 1 memory positions.
- Entry code 2 recalls driver 2 memory positions.
- Entry code 3 recalls driver 3 memory positions.

Note: *Personal entry codes 4 and 5 will not recall memory positions.*

Erasing a Personal Code

1. Enter the factory-set five-digit code.
2. Press and release **1-2** on the keypad within five seconds.
3. Press **1-2** and hold for two seconds. You must do this within five seconds of completing step 2.

All personal codes erase and only the factory-set five-digit code works.

Locks

Anti-Scan Feature

The keypad goes into an anti-scan mode if you enter the wrong code seven times. This mode turns off the keypad for one minute and the keypad lamp flashes.

Anti-scan turns off after any of the following occur:

- One minute of keypad inactivity.
- You press the unlock button on the remote control.
- You switch the ignition on.
- You unlock the vehicle using intelligent access.

Locking and Unlocking the Doors

Locking All Doors

Press and hold **7-8** and **9-0** on the keypad simultaneously with the driver door closed. You do not need to enter a code first.

Unlocking Only the Driver Door

Enter the factory-set or your personal five-digit code. You must press each number within five seconds of each other. The interior lamps illuminate.

Note: All doors unlock if you switch on the all door unlocking mode. See **Locking and Unlocking** (page 58).

Unlocking All Doors

Enter the factory-set code or your personal code, then press **3-4** on the keypad within five seconds.

Opening the Luggage Compartment

Enter the factory-set code or your personal code, then press **3-4** on the keypad within five seconds.

Displaying the Factory-Set Code

Note: You need to have two programmed keys for this procedure.

1. Remove the key blade from the transmitter.

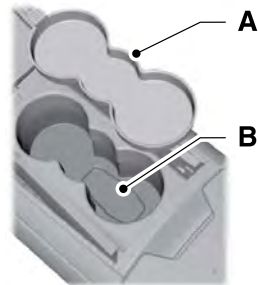

E155835

2. Remove the rubber covering (A) from the cup holder. With the buttons facing upward and the unlock button facing the front of your vehicle, place the first intelligent access key into the backup slot (B).
3. Press the push button ignition switch once and wait a few seconds.
4. Press the push button ignition switch again and remove the key.
5. Insert the second programmed key into the backup slot, and then press the push button ignition switch.

The factory-set code appears in the information display for a few seconds.

Note: The code may not display until after any other warning messages first display.

INTERIOR LUGGAGE COMPARTMENT RELEASE

WARNINGS



Keep vehicle doors and luggage compartment locked and keep keys and remote transmitters out of a child's reach. Unsupervised children could lock themselves in the trunk and risk injury. Children should be taught not to play in vehicles.

Locks

WARNINGS



Do not leave children or animals unattended in the vehicle. On hot days, the temperature in the trunk or vehicle interior can rise very quickly. Exposure of people or animals to these high temperatures for even a short time can cause death or serious heat-related injuries, including brain damage. Small children are particularly at risk.

The handle is located inside the luggage compartment either on the luggage compartment door (lid) or near the tail lamps. It is composed of a material that will glow for hours in darkness following brief exposure to ambient light.

Pull the handle and push up on the luggage compartment door (lid) to open from within the luggage compartment.

Your vehicle is equipped with a release handle that provides a means of escape for children and adults if they become locked inside the luggage compartment.

Adults should familiarize themselves with the operation and location of the release handle.

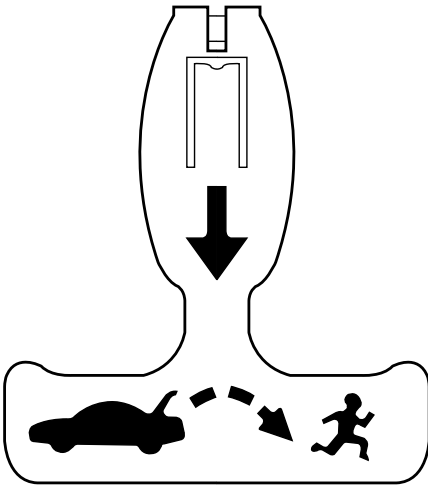

E144403

Security

PASSIVE ANTI-THEFT SYSTEM

Note: *The system is not compatible with non-Ford aftermarket remote start systems. Use of these systems may result in engine starting problems and a loss of security protection.*

Note: *Metallic objects, electronic devices or a second coded key on the same key chain may result in vehicle starting problems, especially if they are too close to the key when starting your vehicle. Prevent these objects from touching the coded key when starting your vehicle. Switch the ignition off, move all objects on the key chain away from the coded key and restart your vehicle if a problem occurs.*

Note: *Do not leave a duplicate coded key in your vehicle. Always take your keys and lock all doors when leaving your vehicle.*

SecuriLock®

The system helps prevent the engine from starting unless you use a coded key programmed to your vehicle. Using the wrong key may prevent your vehicle from starting. A message may appear in the information display.

If you are unable to start your vehicle with a coded key, it is not operating correctly. A message may appear in the information display.

Automatic Arming

The system arms when you switch the ignition off.

Automatic Disarming

The system disarms when you switch the ignition on with a coded key.

Replacement Keys

Note: *Your vehicle comes with two keys.*

The intelligent access key functions as a programmed key that operates the driver door lock and turns on the intelligent access with push button start system, as well as a remote control.

If your programmed transmitters are lost or stolen and you do not have an extra coded key, you will need to have your vehicle towed to an authorized dealer. You need to erase the key codes from your vehicle and program new coded keys.

Store a spare intelligent access key away from your vehicle in a safe place. You can purchase replacement keys or remote controls from an authorized dealer.

Programming a Spare Intelligent Access Key

Note: *You can program a maximum of four keys to your vehicle.*

You must have two previously programmed intelligent access keys inside your vehicle and the new unprogrammed intelligent access key readily accessible. You can purchase replacement keys or remote controls from an authorized dealer.

Make sure that the ignition is switched off before beginning this procedure. Make sure that you close all the doors before beginning and that they remain closed throughout the procedure. Carry out all steps within 30 seconds of starting the sequence. Stop and wait for at least one minute before starting again if you carry out any steps out of sequence.

Read and understand the entire procedure before you begin.

1. Remove the key blade from the transmitter.

Security

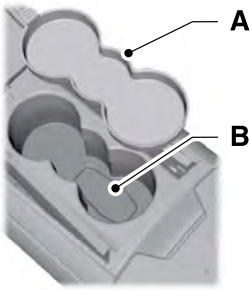

E155835

2. Remove the rubber covering (A) from the cup holder. With the buttons facing upward and the unlock button facing the front of your vehicle, place the first intelligent access key into the backup slot (B).
3. Press the push button ignition switch.
4. Wait five seconds and then press the push button ignition switch again.
5. Remove the intelligent access key.
6. Within 10 seconds, place a second programmed intelligent access key in the backup slot and press the push button ignition switch.
7. Wait five seconds and then press the push button ignition switch again.
8. Remove the intelligent access key.
9. Wait five seconds, then place the unprogrammed intelligent access key in the backup slot and press the push button ignition switch.

Programming is now complete. Check that the remote control functions operate and your vehicle starts with the new intelligent access key.

If programming was unsuccessful, wait 10 seconds and repeat steps 1 through 7. If it still does not work, take your vehicle to an authorized dealer.

ANTI-THEFT ALARM

The system will warn you of an unauthorized entry to your vehicle. It will be triggered if any door, the luggage compartment or the hood is opened without using the key, remote control or keyless entry keypad.

The direction indicators will flash and the horn will sound if unauthorized entry is attempted while the alarm is armed.

Take all remote controls to an authorized dealer if there is any potential alarm problem with your vehicle.

Arming the Alarm

The alarm is ready to arm when there is not a key in your vehicle. Electronically lock your vehicle to arm the alarm.

Disarming the Alarm

Disarm the alarm by any of the following actions:

- Unlock the doors or luggage compartment with the remote control or keyless entry keypad.
- Switch your vehicle on or start your vehicle.
- Use a key in the driver door to unlock your vehicle, then switch your vehicle on within 12 seconds.

Note: *Pressing the panic button on the remote control will stop the horn and signal indicators, but will not disarm the system.*

Steering Wheel

ADJUSTING THE STEERING WHEEL

WARNING



Do not adjust the steering wheel when your vehicle is moving.

Note: Make sure that you are sitting in the correct position. See **Sitting in the Correct Position** (page 122).

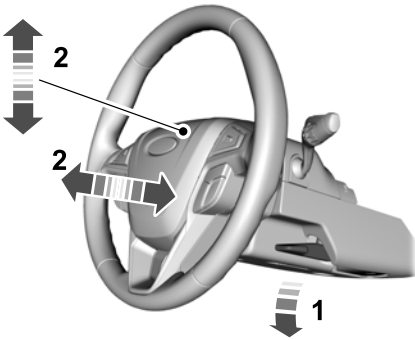

E223369

1. Unlock the steering column.
2. Adjust the steering wheel to the desired position.



E223492

3. Lock the steering column.

Power Tilt and Telescope Steering Column (If Equipped)

WARNING



Do not adjust the steering wheel when your vehicle is moving.

Note: Make sure that you are sitting in the correct position. See **Sitting in the Correct Position** (page 122).

Steering Wheel



E161834

Use the control on the side of the steering column to adjust the position.

To adjust:

- Tilt: press the top or bottom of the control.
- Telescope: press the front or rear of the control.

The steering column sets a stopping position just short of the end of the column position to prevent damage to the steering column. A new stopping position sets if the steering column encounters an object when tilting or telescoping.

To reset the steering column to its normal stopping position:

1. Press the steering column control again after encountering the new stopping position.
2. Continue pressing the control until it reaches the end of the column position.

A new stopping position is set. The next time you tilt or telescope the steering column, it will stop just short of the end of the column position.

Memory Feature

You can save and recall the steering column position with the memory function. See **Memory Function** (page 126).

Note: Pressing the adjustment control during memory recall cancels the operation. The column responds to the adjustment control.

Easy Entry and Exit Feature

When you switch the ignition off, the steering column will move to the full up position to allow extra room to exit your vehicle. The column will return to the previous setting when you switch the ignition on. You can enable or disable this feature in the information display. See **Information Displays** (page 94).

AUDIO CONTROL

Select the required source on the audio unit.

Operate the following functions with the control:

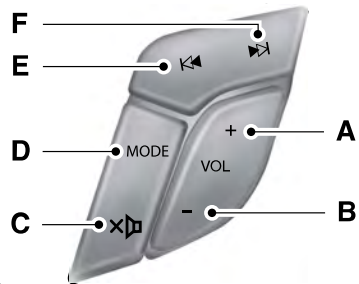

E191234

- A Volume up.
- B Volume down.
- C Mute.
- D Mode.

Steering Wheel

- E Seek down or previous.
- F Seek up or next.

MODE

Press repeatedly to scroll through available audio sources.

Seek, Next or Previous

Press the seek button to:

- tune the radio to the next or previous stored preset.
- play the next or the previous track.

Press and hold the seek button to:

- tune the radio to the next station up or down the frequency band.
- seek through a track.

VOICE CONTROL (If Equipped)

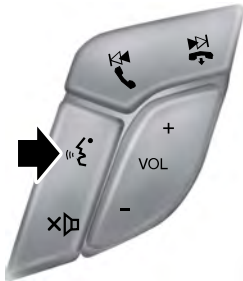

E168194

Press the button to select or deselect voice control. See your SYNC information.

CRUISE CONTROL

Type 1

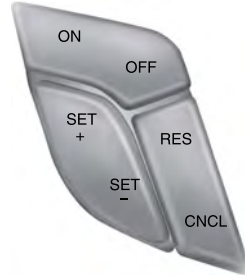

E197198

Type 2



E222797

See **Cruise Control** (page 195).

Steering Wheel

INFORMATION DISPLAY CONTROL



E144636

See **Information Displays** (page 94).

Information Display Control Features



E144811

This control functions the same as the center control on the faceplate. See **General Information** (page 314).

Use this control to adjust the right side of the information display. Navigate through the screen and press **OK** to select.

HEATED STEERING WHEEL (if Equipped)

See your SYNC information.

Wipers and Washers

WINDSHIELD WIPERS

Note: Fully defrost the windshield before you switch the windshield wipers on.

Note: Make sure you switch the windshield wipers off before entering a car wash.

Note: Clean the windshield and wiper blades if they begin to leave streaks or smears. If that does not resolve the issue, install new wiper blades.

Note: Do not operate the wipers on a dry windshield. This may scratch the glass, damage the wiper blades or cause the wiper motor to burn out. Always use the windshield washers before wiping a dry windshield.

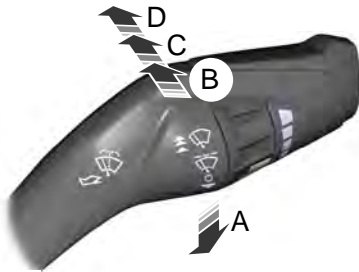

E169313

- A Single wipe
- B Intermittent wipe
- C Normal wipe
- D High speed wipe

Intermittent Wipe

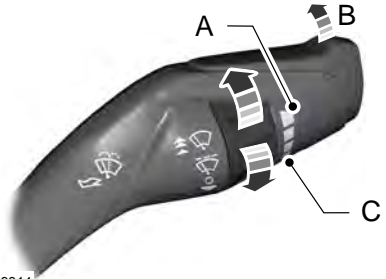

E169314

- A Shortest wipe interval
- B Intermittent wipe
- C Longest wipe interval

Use the rotary control to adjust the intermittent wipe interval.

Speed Dependent Wipers

When your vehicle speed increases, the interval between wipes decreases.

AUTOWIPERS (If Equipped)

Note: Fully defrost the windshield before you switch the windshield wipers on.

Note: Make sure you switch the windshield wipers off before entering a car wash.

Note: If streaks or smears appear on the windshield, clean the windshield and the wiper blades. See **Checking the Wiper Blades** (page 263). If that does not resolve the issue, install new wiper blades. See **Changing the Wiper Blades** (page 263).

Autowipers uses a rain sensor located in the area around the interior mirror. The rain sensor will continue to monitor the amount of water on the windshield and automatically adjust the speed of the wipers.

Wipers and Washers

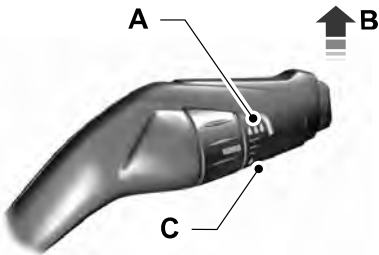

E197526

- A High sensitivity
- B On
- C Low sensitivity

Use the rotary control to adjust the sensitivity of the autowipers. When you select low sensitivity, the wipers will operate when the sensor detects a large amount of water on the windshield. When you select high sensitivity, the wipers will operate when the sensor detects a small amount of water on the windshield.

Keep the outside of the windshield clean. The rain sensor is very sensitive and the wipers may operate if dirt, mist or insects hit the windshield.

Wet or winter driving conditions with ice, snow or salty road mist can cause inconsistent and unexpected wiping or smearing.

In these conditions, you can do the following:

- Lower the sensitivity of the autowipers to reduce the amount of smearing on the windshield.
- Switch to normal or high-speed wipe.
- Switch autowipers off.

Note: *If you switch autolamps and autowipers on, the headlamps will automatically turn on when the windshield wipers continuously operate.*

Autowipers Settings (If Equipped)

Autowipers default to on and remain on until you switch it off in the information display. With autowipers switched off, the wipers operate in intermittent mode. See **General Information** (page 94).

WINDSHIELD WASHERS

Note: *Do not operate the washers when the washer reservoir is empty. This may cause the washer pump to overheat.*



E169316

To operate the washers and spray the windshield, pull the lever toward you.

A wipe will occur a few seconds after washing to clear any remaining washer fluid. This feature can be switched on or off in the information display. See **Information Messages** (page 103).

Lighting

GENERAL INFORMATION

Condensation in Lamp Assemblies

Exterior lamps have vents to accommodate normal changes in air pressure.

Condensation can be a natural by-product of this design. When moist air enters the lamp assembly through the vents, there is a possibility that condensation can occur when the temperature is cold. When normal condensation occurs, a fine mist can form on the interior of the lens. The fine mist eventually clears and exits through the vents during normal operation.

Clearing time may take as long as 48 hours under dry weather conditions.

Examples of acceptable condensation are:

- The presence of a fine mist (no streaks, drip marks or large droplets).
- A fine mist covers less than 50% of the lens.

Examples of unacceptable condensation are:

- A water puddle inside the lamp.
- Streaks, drip marks or large droplets present on the interior of the lens.

If you see any unacceptable condensation, have your vehicle checked by an authorized dealer.

LIGHTING CONTROL



E142449

- A Off
- B Parking lamps, instrument panel lamps, license plate lamps and tail lamps
- C Headlamps

High Beams



E1162679

Push the lever forward to switch the high beams on.

Push the lever forward again or pull the lever toward you to switch the high beams off.

Lighting

Headlamp Flasher



E162680

Pull the lever toward you slightly and release it to flash the headlamps.

AUTOLAMPS (If Equipped)

WARNING



The autolamps switch position may not activate the headlamps in all low visibility conditions, such as daytime fog. Always ensure that your headlamps are switched to auto or on, as appropriate, during all low visibility conditions. Failure to do so may result in a collision.

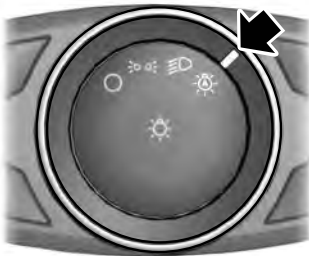

E142451

When the lighting control is in the autolamps position, the headlamps automatically turn on in low light situations or when the wipers activate.

If equipped, the following also activate when the lighting control is in the autolamps position and you switch them on in the information display:

- Configurable daytime running lamps.
- Automatic high beam control.
- Adaptive headlamp control.

The headlamps remain on for a period of time after you switch the ignition off. Use the information display controls to adjust the period of time that the headlamps remain on. See **Information Displays** (page 94).

Note: *With the headlamps in the autolamps position, you cannot switch the high beam headlamps on until the autolamps system turns the low beam headlamps on.*

Windshield Wiper Activated Headlamps

The windshield wiper activated headlamps turn on within 10 seconds when you switch the windshield wipers on and the lighting control is in the autolamps position. They turn off approximately 60 seconds after you switch the windshield wipers off.

The headlamps will not turn on by wiper activation:

- During a mist wipe.
- When the wipers are on to clear washer fluid during a wash condition.
- If the wipers are in intermittent mode.

Note: *If you switch autolamps and autowipers on, the headlamps will automatically turn on when the windshield wipers continuously operate.*

Lighting

INSTRUMENT LIGHTING DIMMER

Note: If you disconnect the battery or it becomes discharged, the illuminated components will switch to the maximum setting.

Vehicles With Front Fog Lamps

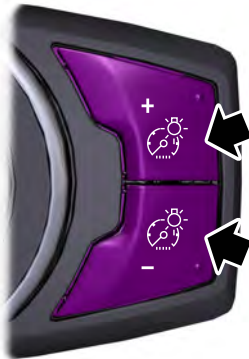

E132712

Press repeatedly or press and hold until you reach the desired level.

Vehicles Without Front Fog Lamps



E165366

- A Press repeatedly or press and hold to dim.
- B Press repeatedly or press and hold to brighten.

HEADLAMP EXIT DELAY

After you switch the ignition off, you can switch the headlamps on by pulling the direction indicator lever toward you. You will hear a short tone. The headlamps will switch off automatically after three minutes with any door open or 30 seconds after the last door has been closed. You can cancel this feature by pulling the direction indicator toward you again or switching the ignition on.

Lighting

DAYTIME RUNNING LAMPS (If

Equipped)

WARNING



The daytime running lamps system does not activate the rear lamps and may not provide adequate lighting during low visibility driving conditions. Also, the autolamps switch position may not activate the headlamps in all low visibility conditions, such as daytime fog. Make sure the headlamps are switched to auto or on, as appropriate, during all low visibility conditions. Failure to do so may result in a crash.

Type 1 - Conventional (Non-Configurable)

The daytime running lamps turn on when:

1. The ignition is switched to the on position.
2. The transmission is not in park (P) for vehicles with automatic transmissions or the parking brake is released for vehicles with manual transmissions.
3. The lighting control is in the off, parking lamp or autolamps positions.
4. The headlamps are off.

Type 2 - Configurable

Switch the daytime running lamps on or off using the information display controls. See **Information Displays** (page 94).

The daytime running lamps turn on when:

1. They are switched on in the information display. See **Information Displays** (page 94).
2. The ignition is switched to the on position.

3. The transmission is not in park (P) for vehicles with automatic transmissions or the parking brake is released for vehicles with manual transmissions.
4. The lighting control is in the autolamps position.
5. The headlamps are off.

The other lighting control switch positions do not activate the daytime running lamps, and you can use them to temporarily override autolamp control.

When switched off in the information display, the daytime running lamps are off in all lighting control switch positions.

AUTOMATIC HIGH BEAM CONTROL (If Equipped)

The system will automatically turn on your high beams if it is dark enough and no other traffic is present. When it detects the headlights of an approaching vehicle, the tail lamps of the preceding vehicle or street lighting, the system will turn off the high beams before they distract other drivers. The low beams remain on.

Note: *If it appears that automatic control of the high beams is not functioning properly, check the windshield in front of the camera for a blockage. A clear view of the road is required for proper system operation. Have any windshield damage in the area of the camera's field-of-view repaired.*

Note: *If the system detects a blockage, for example bird droppings, bug splatter, snow or ice, the system will go into low beam mode until you clear the blockage. A message may also appear in the instrument cluster display noting the front camera is blocked.*

Lighting

Note: Typical road dust, dirt and water spots will not affect the performance of the automatic high beam system. However, in cold or inclement weather conditions, you will notice a decrease in the availability of the high beam system, especially at start up. If you want to change the beam state independently of the system, you may switch the high beams on or off using the multifunction switch. Automatic control will resume when conditions are correct.

Note: Modification of the vehicle ride height such as using much larger tires, may degrade feature performance.

A camera sensor, centrally mounted behind the windshield of your vehicle, continuously monitors conditions to decide when to switch the high beams off and on.

Once the system is active, the high beams will switch on if:

- the ambient light level is low enough
- there is no traffic in front of the vehicle
- the vehicle speed is greater than approximately 32 mph (52 km/h).

The high beams will switch off if:

- the system detects the headlamps of an approaching vehicle or the tail lamps of a preceding vehicle.
- vehicle speed falls below approximately 27 mph (44 km/h)
- the ambient light level is high enough that high beams are not required
- the system detects severe rain, snow or fog
- the camera is blocked.

Activating the System

Switch the system on using the information display. See **Information Displays** (page 94). Switch the autolamps on. See **Autolamps** (page 74).

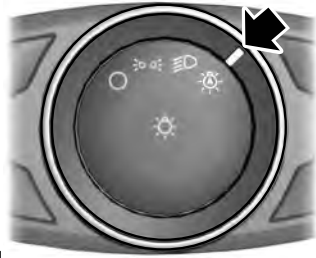

E142451

Manually Overriding the System



E169254

When the automatic control has activated the high beams, pushing or pulling the stalk will provide a temporary override to low beam.

Use the information display menu to permanently deactivate the system, or turn the lighting control switch from autolamps to headlamps.

Lighting

FRONT FOG LAMPS (If Equipped)



E142453

Press the control to switch the fog lamps on or off.

You can switch the fog lamps on when the lighting control is in any position except Off and the high beams are not on.

DIRECTION INDICATORS



E169255

Push the lever up or down to use the direction indicators.

Note: Tap the lever up or down to make the direction indicators flash three times to indicate a lane change.

INTERIOR LAMPS

The lamps will turn on when you have met one of the following conditions:

- You open any door.
- You press a remote control button.
- You press button A on the front interior lamp.

Front Interior Lamp

Note: The front interior lamp buttons are on the overhead console. The exact location of each button on the overhead console depends upon which roof, sunroof, and window shade features are equipped on the vehicle.

Note: Press button B to switch the door function off when you open any door. The indicator lamp will light amber when the door function is off. When the door function is off and you open a door, the courtesy and door lamps will stay off. Press button B again to switch the door function back on. The indicator lamp will light blue when the door function is on. When the door function is on and you open a door, the courtesy and door lamps will light.

Lighting

Type 1



E201073

- A Individual dome lamp.
- B Door function button.
- C All lamps off button.
- D Individual dome lamp.

Type 2

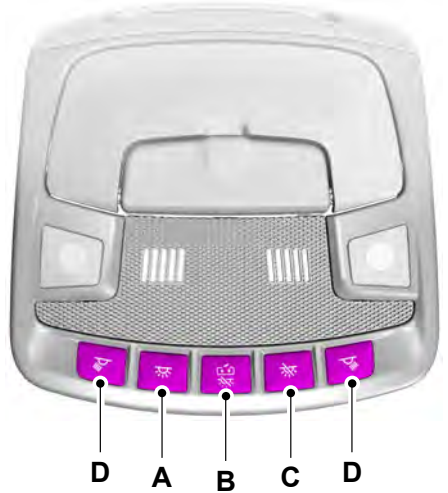

E192153

- A All lamps on button.
- B Door function button.
- C All lamps off button.
- D Individual dome lamps.

You can switch individual map lamps on independently by pressing a map lens.

Lighting

Rear Interior Lamp (If Equipped)



E169470

You can switch dome lamps on by pressing the button.

AMBIENT LIGHTING (If Equipped)

Adjust the ambient lighting using the touchscreen.

Windows and Mirrors

POWER WINDOWS

WARNINGS



Do not leave children unattended in your vehicle and do not let them play with the power windows. They may seriously injure themselves.



When closing the power windows, you should verify they are free of obstructions and make sure that children and pets are not in the proximity of the window openings.

Note: Window operation may stop or delay during low battery conditions and engine re-cranking. It will resume after the engine starts.

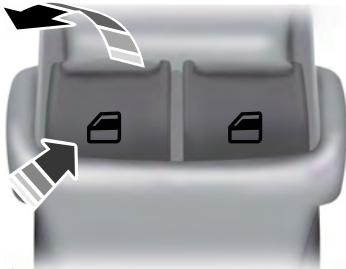

E146043

Note: You may hear a pulsing noise when just one of the windows are open. Lower the opposite window slightly to reduce this noise.

Press the switch to open the window.

Lift the switch to close the window.

One-Touch Down

Press the switch fully and release it. Press again or lift it to stop the window.

One-Touch Up

Lift the switch fully and release it. Press or lift it again to stop the window.

Bounce-Back

The window will stop automatically while closing. It will reverse some distance if there is an obstacle in the way.

Overriding the Bounce-Back Feature

WARNING



When you override the bounce-back feature, the window will not reverse if it detects an obstacle. Take care when closing the windows to avoid personal injury or damage to your vehicle.

Pull up the window switch and hold within two seconds of the window reaching the bounce-back position. The window will travel up with no bounce-back protection. The window will stop if you release the switch before the window closes fully.

Window Lock



E144072

Press the control to lock or unlock the rear window controls. It will illuminate when you lock the rear window controls.

Accessory Delay

You can use the window switches for several minutes after you switch the ignition off or until you open either front door.

Windows and Mirrors

GLOBAL OPENING AND CLOSING

You can use the remote control to operate the windows with the ignition off.

Note: You can enable or disable this feature in the information display or see an authorized dealer. See **General Information** (page 94).

Note: To operate this feature, accessory delay must not be active.

Opening the Windows

You can only open the windows for a short time after you unlock your vehicle with the remote control. After you unlock your vehicle, press and hold the remote control unlock button to open the windows and vent the moonroof. Release the button once movement starts. Press the lock or unlock button to stop movement.

Closing the Windows

WARNING



When closing the windows and moonroof, you should verify they are free of obstructions and make sure that children and pets are not in the proximity of the window openings.

To close the windows and moonroof, press and hold the remote control lock button. Release the button once movement starts. Press the lock or unlock button to stop movement.

EXTERIOR MIRRORS

Power Exterior Mirrors

WARNING



Do not adjust the mirrors when your vehicle is moving.



E144073

- A Left-hand mirror
- B Adjustment control
- C Right-hand mirror

To adjust a mirror:

1. Select the mirror you want to adjust. The control will illuminate.
2. Adjust the position of the mirror.
3. Press the mirror switch again.

Fold-Away Exterior Mirrors

Push the mirror toward the door window glass. Make sure that you fully engage the mirror in its support when returning it to its original position.

Heated Exterior Mirrors (If Equipped)

See **Heated Windows and Mirrors** (page 120).

Memory Mirrors (If Equipped)

You can save and recall the mirror positions through the memory function. See **Memory Function** (page 126).

Auto-Dimming Feature (If Equipped)

The driver exterior mirror automatically dims when the interior auto-dimming mirror turns on.

Windows and Mirrors

Signal Indicator Mirrors (If Equipped)

The outer portion of the appropriate mirror housing will blink when you switch on the turn signal.

Puddle Lamps (If Equipped)

The lamps on the bottom part of the mirror housing light when you use your transmitter to unlock the doors or when you open a door.

Integrated Blind Spot Mirrors

WARNING



Objects in the blind spot mirror are closer than they appear.

Blind spot mirrors have an integrated convex mirror built into the upper outboard corner of the exterior mirrors. They can increase your visibility along the side of your vehicle.

Check the main mirror first before a lane change, then check the blind spot mirror. If the blind spot mirror does not show any vehicles in its viewing area and the traffic in the adjacent lane is at a safe distance, signal that you intend to change lanes. Glance over your shoulder to verify traffic is clear and carefully change lanes.

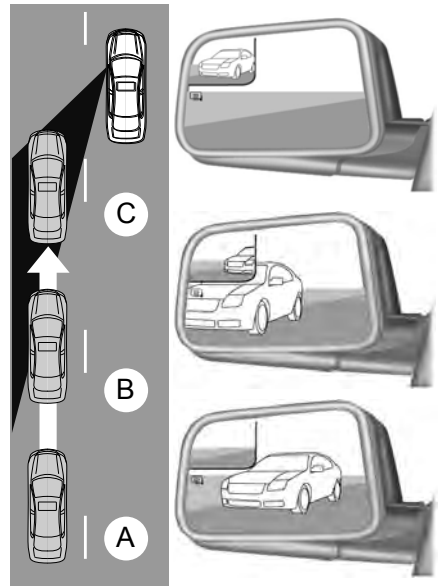

E138665

The image of the approaching vehicle is small and near the inboard edge of the main mirror when it is at a distance. The image becomes larger and begins to move outboard across the main mirror as the vehicle approaches (A). The image will transition from the main mirror and begin to appear in the blind spot mirror as the vehicle approaches (B). The vehicle will transition to your peripheral field of view as it leaves the blind spot mirror (C).

Blind Spot Monitor (If Equipped)

See **Blind Spot Information System** (page 208).

Windows and Mirrors

INTERIOR MIRROR

WARNING



Do not adjust the mirror when your vehicle is moving.

Note: Do not clean the housing or glass of any mirror with harsh abrasives, fuel or other petroleum or ammonia-based cleaning products.

You can adjust the interior mirror to your preference. Some mirrors also have a second pivot point. This lets you move the mirror head up or down and from side to side.

Pull the tab below the mirror toward you to reduce glare at night.

Auto-Dimming Mirror (If Equipped)

Note: Do not block the sensors on the front and back of the mirror. Mirror performance may be affected. A rear center passenger or raised rear center head restraint may also block light from reaching the sensor.

The mirror will dim automatically to reduce glare when bright lights are detected from behind your vehicle. It will automatically return to normal reflection when you select reverse gear to make sure you have a clear view when backing up.

SUN VISORS

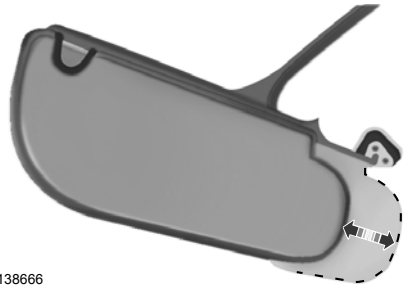

E138666

Rotate the sun visor toward the side window and extend it rearward for extra shade.

Illuminated Vanity Mirror

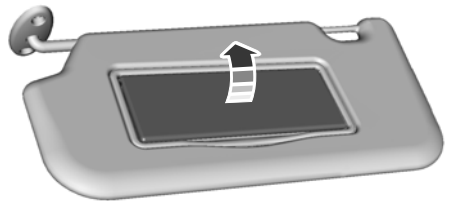

E162197

Lift the cover to switch the lamp on.

MOONROOF (If Equipped)

WARNINGS



Do not let children play with the moonroof or leave them unattended in the vehicle. They may seriously hurt themselves.

Windows and Mirrors

WARNINGS



When closing the moonroof, you should verify that it is free of obstructions and make sure that children and pets are not in the proximity of the roof opening.

The sliding shade can be manually opened or closed when the moonroof is closed. Pull the shade toward the front of the vehicle to close it.

The moonroof controls are located on the overhead console and have a one-touch open and close feature. To stop it during one-touch operation, touch the control a second time.

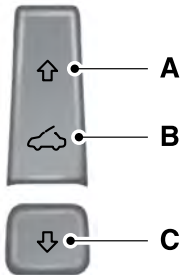

E144499

- A Open
- B Vent
- C Close

Opening and Closing the Moonroof

Touch (A) to open the moonroof. It will stop short of the fully opened position.

Note: *This position helps to reduce wind noise or rumbling which may happen with the moonroof fully open. Touch (A) again to fully open the moonroof.*

Touch (C) to close the moonroof.

Bounce-Back

The moonroof will stop automatically and reverse some distance if an obstacle is detected while closing.

Touch and hold (C) within two seconds of a bounce-back event to override this function.

Venting the Moonroof

Touch (B) to vent the moonroof. Touch (C) to close it.

Instrument Cluster

GAUGES

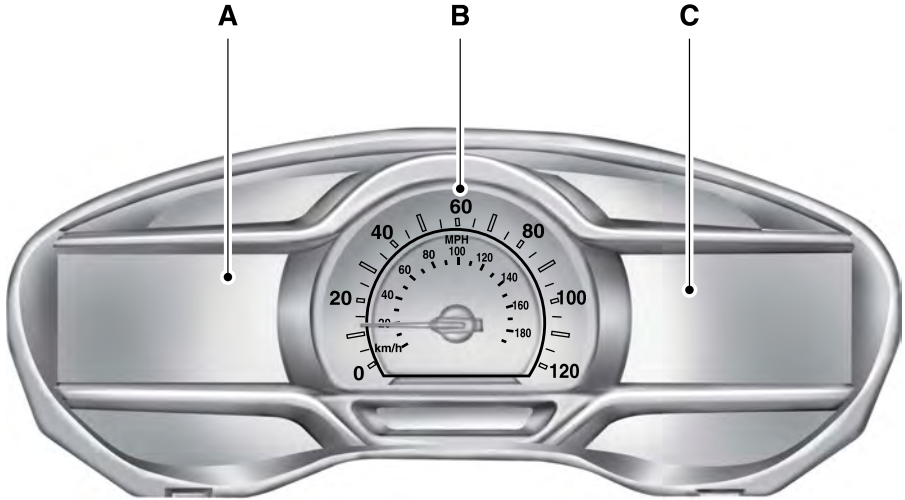

E151261

- A Left Information Display.
- B Speedometer.
- C Right Information Display.

Left Information Display

Odometer

Located in the bottom of the information display. Registers the accumulated distance your vehicle has traveled.

Battery Gauge:

For Energi vehicles, a large battery gauge is provided while the vehicle operates in Plug-In Power Mode only. See **Plug-In Hybrid Vehicle Operation** (page 148). The fill level indicates the amount of energy stored in the high voltage battery that is available for Plug-in Power Mode.

Instrument Cluster

A full fill represents the total amount of energy you can get from an external charge (plugging your vehicle in). When the fill reaches empty, your vehicle automatically enters Hybrid Mode and the large battery gauge will no longer be shown.

An optional small battery gauge is provided for Hybrid vehicles and for Hybrid Mode only in Energi vehicles. This can be enabled in the Settings menu under Battery Display. See **General Information** (page 94). The fill level, or State of Charge, indicates the amount of energy stored in the high voltage battery as a percent of total energy capacity. The level increases or decreases as the battery charges and discharges during normal operation.

Regen Display

A circular arrow symbol displays when energy is being recaptured through the regenerative braking system. Regen Display can be disabled in the Settings menu. See **General Information** (page 94).

Fuel Gauge:

Note: *The fuel gauge may vary slightly when your vehicle is moving or on a gradient.*

Switch the ignition on. The fuel gauge will indicate approximately how much fuel is in the fuel tank. The arrow adjacent to the fuel pump symbol indicates on which side of your vehicle the fuel filler door is located.

The needle should move toward F when you refuel your vehicle. If the needle points to E after adding fuel, this indicates your vehicle needs service soon.

After refueling some variability in needle position is normal:

- It may take a short time for the needle to reach full after leaving the gas station. This is normal and depends upon the slope of pavement at the gas station.
- The fuel amount dispensed into the tank is a little less or more than the gauge indicated. This is normal and depends upon the slope of pavement at the gas station.
- If the gas station nozzle shuts off before the tank is full, try a different gas pump nozzle.
- There is a small reserve left in the tank when the fuel gauge reaches empty.

Low Fuel Reminder

A low fuel reminder triggers at 50 mi (80 km) to empty.

Variations:

Note: *The low fuel reminder can appear at different fuel gauge positions depending on fuel economy conditions. This variation is normal.*

Vehicle Settings and Personalization

Display/Trip

See **General Information** (page 94).

Information

See **General Information** (page 94).

Settings

See **General Information** (page 94).

Instrument Cluster

Brake Coach Display:

The Brake Coach appears after the vehicle has come to a stop. It coaches you to brake in a manner which maximizes the amount of energy returned through the regenerative braking system. The percent displayed is an indication of the regenerative braking efficiency with 100% representing the maximum amount of energy recovery.

You can switch this feature on or off in the information displays settings menu. See **General Information** (page 94).

Trip Summary:

Trip Summary displays upon shutting off your vehicle. The information is cumulative over the last trip. A new trip begins each time you start your vehicle (when the Ready to Drive message comes on).

- Distance - Displays the total distance traveled, distance traveled on battery power only (EV distance) and Regen distance. Regen distance is the estimated range gained from energy recaptured through regenerative braking.
- Energy Use - Displays the average fuel economy. In addition for Energi, displays the total electrical energy used while in Plug-in Power Mode in kilowatt hours (kWh).
- Brake Score - The percent displayed is an indication of the regenerative braking efficiency for the trip.

Note: *Corresponding trip efficiency leaves appear on the right information display upon shutting off your Hybrid vehicle. On Energi vehicles, the trip efficiency leaves are shown on the right information display when the vehicle operates in Hybrid Mode for the entire trip. For trips with Plug-in Power Mode operation, an estimate of your EV Range/Full Charge is provided along with a listing of factors and their contributions to this estimate. See Next Full Charge under Right Information Display in this chapter.*

Right Information Display

Entertainment

See **General Information** (page 367).

Phone

See **General Information** (page 367).

Navigation or Compass

See **General Information** (page 367).

Fuel Economy

See **General Information** (page 94).

Vehicle Range

Vehicle range indicates the estimated distance your vehicle will travel with the energy currently onboard. The range is displayed at the bottom of the screen with gasoline range shown in white and electric range (Energi only) shown in blue.

- Gasoline Range: Is the estimated distance to empty based on the fuel remaining in the tank.
- Electric Range: Is the estimated distance you can travel in Plug-In Power Mode with the engine off. This range is based on a calculation determined by the amount of energy stored in the high voltage battery as a result of charging while plugged in and the energy being used while driving.

Instrument Cluster

The amount of energy being used while driving is affected by:

- Mild or aggressive acceleration or braking.
- Your vehicle speed.
- Your use of accessories such as climate control.
- The ambient temperature and other weather conditions.
- City or highway driving.
- Road grades.

Note: *It is normal for vehicle range estimates to vary due to changes in average energy usage. This is why you typically see different range estimates each time you fill up your fuel tank or fully charge your battery.*

Trip Efficiency Leaves

Trip Efficiency Leaves display upon shutting off your Hybrid vehicle. For Energi vehicles, the trip efficiency leaves display only when the vehicle operates in Hybrid Mode for the entire trip. The number of leaves represent the average for the last trip. A new trip begins each time you start your vehicle (when the Ready to Drive message comes on). Corresponding Trip Summary data displays on the left information display.

Next Full Charge

The Next Full Charge display is shown upon shutting off your Energi vehicle whenever your vehicle operates in Plug-in Power Mode for a portion of your trip.

Miles or kilometers per full charge

This is an estimate of the EV Range you would see if you plugged in and fully charged your vehicle right now. The estimate is based on your energy usage while driving. Energy usage is affected by your driving style and route, climate control use, outside temperature and other factors.

Energy usage effects (+/-)

A green bar indicates a positive effect on your EV range per full charge estimate. An amber bar indicates a negative effect. The bigger the bar the bigger the effect on your estimate.

- Driving style/route – This includes energy used to propel your vehicle based on your driving style and route. Your driving style includes how fast you drive and whether your acceleration and braking is mild or aggressive. Your route includes factors such as the amount of city or highway driving and road grades.
- Climate control use – This includes energy used by your vehicle's high voltage climate control components such as the electric A/C compressor and the electric heater.
- Outside temp./other – This includes energy losses due to outside temperature and other conditions which reduce vehicle system efficiency. Energy used for low voltage accessories such as cabin fans, heated seats, headlights, etc. is also included.

WARNING LAMPS AND INDICATORS

The following warning lamps and indicators will alert you to a vehicle condition that may become serious. Some lamps will light when you start your vehicle to make sure they work. If any lamps remain on after starting your vehicle, refer to the respective system warning lamp for further information.

Note: *Some warning indicators appear in the information display and function the same as a warning lamp but do not display when you start your vehicle.*

Instrument Cluster

Adaptive Cruise Control (If Equipped)



The speed control system indicator light changes color to indicate what mode the system is in: See **Using Adaptive Cruise Control** (page 196).

On (white light): Lights when you turn the adaptive cruise control system on. Turns off when you turn the speed control system off.

Engaged (green light): Lights when the adaptive cruise control system engages. Turns off when the speed control system disengages.

Anti-Lock Braking System



If it lights when you are driving, this indicates a malfunction. You will continue to have the normal braking system (without Anti-lock braking system) unless the brake system warning lamp also lights. Have an authorized dealer check the system.

Battery



If it lights while driving, it indicates a malfunction. Switch off all unnecessary electrical equipment and have an authorized dealer check the system immediately.

Blind Spot Monitor (If Equipped)



Lights when you switch this feature off or with a blind-spot message. See **Blind Spot Information System** (page 208). See **Information Messages** (page 103).

Brake System



Lights when you engage the parking brake with the ignition on.

If it lights when you are driving, check that the parking brake is not on. If the parking brake is not on, this Brake System lamp indicates low brake fluid level or a brake system malfunction. Have an authorized dealer check the system immediately.

WARNING



Driving your vehicle with the warning lamp on is dangerous. A significant decrease in braking performance may occur. It will take you longer to stop your vehicle. Have your vehicle checked as soon as possible. Driving extended distances with the parking brake engaged can cause brake failure and the risk of personal injury.

Cruise Control



Lights when you switch on cruise control.

Direction Indicator



Lights when the left or right turn signal or the hazard warning flasher is switched on. If the indicators stay on or flash faster, check for a burned-out bulb. See **Changing a Bulb** (page 267).

Door Ajar



Lights when the ignition is on and any door is not completely closed.

EcoSelect (If Equipped)



Lights when you switch on this feature. See **EcoSelect** (page 150).

Instrument Cluster

Electric Park Brake



Lights when the electric parking brake malfunctions.

Engine or Motor Coolant Temperature



Lights when the engine or motor cooling system is overheating. Stop your vehicle in a safe place and have an authorized dealer check the system.

Engine Oil



If it lights with the engine running or when you are driving, this indicates a malfunction. Stop your vehicle as soon as it is safe to do so and switch the engine off. Check the engine oil level. See **Engine Oil Check** (page 255).

Note: Do not resume your trip if it lights, even if the oil level is correct. Have an authorized dealer check the system immediately.

EV Now



Lights when you switch on this feature. See **Plug-In Hybrid Vehicle Operation** (page 148).

EV Later



Lights when you select this feature. See **Plug-In Hybrid Vehicle Operation** (page 148).

Fasten Seatbelt



Lights and a chime sounds to remind you to fasten your seatbelt. See **Seatbelt Reminder** (page 35).

Front Airbag



Lights when you start your vehicle. If it continues to flash or remains on, it indicates a malfunction. Have an authorized dealer check the system.

Front Fog Lamps (If Equipped)



Lights when you switch on the front fog lamps.

Grade Assist (If Equipped)



Lights when you switch on the grade assist function.

Heads Up Display (If Equipped)



A red beam of lights appears on the windshield in certain instances when using adaptive cruise control or the collision warning system. To make sure the display works, it will also appear momentarily when you start your vehicle.

High Beam



Lights when you switch on the high-beam headlamps. Flashes when you use the headlamp flasher.

Hood Ajar



Lights when the ignition is on and the hood is not completely closed.

Lane Keeping Aid (If Equipped)



Lights when you activate the lane keeping system.

Instrument Cluster

Low Fuel Level



Lights when the fuel level is low or the fuel tank is nearly empty. Refuel as soon as possible.

Low Tire Pressure Warning



Lights when your tire pressure is low. If the lamp remains on with the engine running or when driving, check your tire pressure as soon as possible.

To confirm the lamp is working, it will also light momentarily when you switch on the ignition. If it does not light when you switch on the ignition, or it begins to flash at any time, have an authorized dealer check the system.

Parking Lamps



Lights when you switch on the parking lamps.

Powertrain Fault



Lights when your vehicle detects a powertrain fault. Contact an authorized dealer as soon as possible.

Note: *If your vehicle detects certain faults, it will not allow you to operate the accelerator pedal. If this happens, press the brake pedal and release it. This will activate limp home vehicle operation. In limp home vehicle operation, your vehicle will accelerate in a controlled manner up to a maximum speed of 35 mph (56 km/h) on a flat surface. If you apply the brake pedal or move the transmission to neutral (N) you can override your vehicle's acceleration.*

Ready to Drive



Lights when you have switched on the vehicle and it is ready to drive. A corresponding message may appear stating ready to drive.

Service Engine Soon



If the service engine soon indicator light stays lit after you start the engine, it indicates that the On Board Diagnostics system (OBD) has detected a malfunction of the vehicle emissions control system. Refer to On board diagnostics (OBD) in the Fuel and Refueling chapter for more information about servicing your vehicle. See **Emission Control System** (page 159).

If the light is blinking, the engine is misfiring. This could damage your catalytic converter. Drive in a moderate fashion (avoid heavy acceleration and deceleration) and have an authorized dealer service your vehicle immediately.

Note: *If your engine is misfiring, excessive exhaust temperatures can damage the catalytic converter or other vehicle components.*

The service engine soon indicator lights when the you first switch on your vehicle, prior to engine start, to check the bulb and to indicate whether the vehicle is ready for inspection maintenance testing.

Normally, the service engine soon light will stay on until the engine cranks, then turn itself off if no malfunctions are present. However, if after 15 seconds the service engine soon light blinks eight times, it means that the vehicle is not ready for inspection maintenance testing. See **Emission Control System** (page 159).

Instrument Cluster

Stability Control



Flashes when the system is active. If it stays lit or does not light when you switch on the ignition, this indicates a malfunction. During a malfunction the system will switch off. Have an authorized dealer check the system immediately. See **Using Stability Control** (page 181).

Stability Control Off



Lights when you switch the system off. It will go out when you switch the system back on or when you switch off the ignition. See **Using Stability Control** (page 181).

Stop Safely



Lights if your vehicle has an electrical component fault or failure that will cause your vehicle to shutdown or enter into a limited operating mode. You may also see a message.

Trunk Ajar



Lights when the ignition is on and the trunk is not completely closed.

Vehicle Plugged in (If Equipped)



Lights when the vehicle is plugged in. A corresponding message may display after attempting to start the vehicle.

AUDIBLE WARNINGS AND INDICATORS

Keyless Warning Alert

The horn will sound twice when you exit your vehicle with the intelligent access key and your vehicle is in RUN, indicating your vehicle is still on.

Headlamps On Warning Chime

Sounds when you remove the key from the ignition and open the driver's door and you have left the headlamps or parking lamps on.

Parking Brake On Warning Chime

Sounds when you have left the parking brake on and drive your vehicle. If the warning chime remains on after you have released the parking brake, have the system checked by your authorized dealer immediately.

Information Displays

GENERAL INFORMATION

WARNING



Driving while distracted can result in loss of vehicle control, crash and injury. We strongly recommend that you use extreme caution when using any device that may take your focus off the road. Your primary responsibility is the safe operation of your vehicle. We recommend against the use of any handheld device while driving and encourage the use of voice-operated systems when possible. Make sure you are aware of all applicable local laws that may affect the use of electronic devices while driving.

Various systems on your vehicle can be controlled using the information display controls on the steering wheel. Corresponding information is displayed in the information display.

Left Information Display Controls



E156010

- Press the up and down arrow buttons to scroll through and highlight the options within a menu.
- Press the right arrow button to enter a sub-menu.
- Press the left arrow button to exit a menu.
- Press and hold the left arrow button at any time to return to the main menu display (escape button).
- Press the **OK** button to choose and confirm settings or messages.

Main menu

From the main menu bar on the left side of the information display, you can choose from the following categories:



Display/Trip



Information



Settings

Scroll up or down to highlight one of the categories, and then press the right arrow key or **OK** to enter into that category. Press the left arrow key as needed to exit back to the main menu.

Display/Trip



Use the up or down arrow buttons to choose between the following display options.

Note: *The cluster will remember the menu level 2 state when you change the key state from the RUN to the OFF position.*

Information Displays

Display/Trip			
Menu level 2	Menu level 3	Menu level 4	Menu level 5
Speedometer	—	—	—
Engage (Split Power + Instantaneous Fuel + Avg Fuel Economy + Battery Gauge + Fuel Gauge)	Help	—	—
Empower (Power (with engine on/off threshold) + Instantaneous Fuel + Avg Fuel Economy + Battery Gauge + Fuel Gauge)	Help	—	—
MyView (MyView + Battery Gauge + Fuel Gauge)	Change MyView	Vehicle Range	Vehicle Range
		Average Fuel	Average Fuel
		Split Power	Instantaneous Fuel
		Power + Threshold	Coolant Temp.
		Tach rpm x1000	Accessory Power
		Accessory Power	Trip 1
		Trip 1	Trip 2
		Trip 2	Fuel History
		Fuel History	Coach
		Coach	Blank
	Blank	—	
Help	Help	—	—
Miles (or km)/Full Charge (Energi only) Shown in Plug-in Power Mode	Help	—	—

Information Displays

Display/Trip			
(avg miles(or km)/full charge + instant miles(or km)/full charge gauge + battery gauge + fuel gauge)			
Fuel Economy (Energi only) Shown in Hybrid Mode (avg fuel economy + instant fuel economy gauge + battery gauge + fuel gauge)			
Tire Pressure	—	—	—
Trip 1 (Trip Data + Battery Gauge + Fuel Gauge)	Help	—	—
Trip 2 (Trip Data + Battery Gauge + Fuel Gauge)			

Engage

Engage provides separate gauges for engine power and high voltage battery power in kilowatts (kW). The engine power gauge fill is white and the high voltage battery power gauge fill is blue. You can also see an instantaneous fuel economy gauge. When your vehicle is operating on battery power only, you will see EV displayed and the gauges will appear in blue.

Empower

Empower provides a power demand gauge in kilowatts (kW) which includes an engine on or off threshold.

- When your vehicle is operating with battery power only (below the threshold), you will see EV displayed and the gauge fill is blue.
- When your vehicle is operating with both the engine and the high voltage battery providing power, the gauge fill is white.
- When power demand surpasses the amber indicator, this level of demand and associated fuel economy displays in amber.
- When the engine is on, reducing power demand to less than the threshold will allow the engine to turn off.

You can also see an instantaneous fuel economy gauge.

Note: You can reset your average fuel economy by pressing and holding the **OK** button on the left hand steering wheel controls.

Information Displays

MyView

You can choose what to display in this view. Selecting **Change MyView** in the options menu allows you to scroll through two columns of content choices.

- Press the up or down arrow to view content.
- Press **OK** to save your selected content.
- You must select content in both columns before you can save your new MyView.

Unique content available in MyView:

- **Vehicle Range (Energi vehicles only)** – Indicates the estimated distance your vehicle will travel with the energy currently onboard. Separately displays range available in Hybrid Mode fueled by gasoline, electric range available in Plug-in Power Mode, and total range. Gasoline range and electric range are also shown on the bottom of the right information display. Changes in driving pattern and climate control use will cause the values to vary.
- **Accessory Power**— Indicates electrical power demands from your vehicle's accessory systems. Accessories use power but do not contribute to propelling your vehicle. The gauge separately displays power demand in kilowatts (kW) for climate and other accessories. Climate includes the power being used by high voltage climate control components such as the electric A/C compressor and the electric heater (Energi vehicles only). Other includes all power being used by the low voltage accessories (cabin fans, headlights, heated seats, etc.).

- **Coolant Temp** – Indicates engine coolant temperature. At normal operating temperature, the level indicator will be white and will be in the normal range (between H and C). If the engine coolant temperature exceeds the normal range, the level indicator will change to red to indicate that the engine is overheating. Stop your vehicle as soon as safely possible, turn your vehicle off and let the engine cool.
- **Tach rpm x 1000** — When the gasoline engine is running, the tachometer gauge displays the engine speed in revolutions per minute (RPM). When your vehicle is operating on battery power only with the engine off, EV displays and the tachometer is greyed out.

Note: *The trip data, and average fuel economy cannot be reset in MyView.*

Miles (or km)/Full Charge (Energi only)

In Hybrid Mode the display changes to Fuel Economy. Miles or Kilometers per Full Charge is an estimate of your EV Range with a fully charged battery.

This display is only available in Plug-in Power Mode.

Average Miles or Kilometers per Full Charge is provided along with an Instantaneous gauge. This information is based on your energy usage while driving. Energy usage is affected by your driving style and route, climate control use, outside temperature and other factors. For more information refer to Next Full Charge. See **Gauges** (page 86).

When you select EV Now operation this screen will automatically be shown. You can press OK to enable the engine when viewing this screen during EV Now operation. See **Plug-In Hybrid Vehicle Operation** (page 148).

Information Displays

Fuel Economy (Energi only)

This display is only available in Hybrid Mode. In Plug-in Power Mode the display changes to Miles (or km)/Full Charge.

An Instant Fuel Economy gauge is provided along with Avg Fuel Economy. While viewing this screen you can reset your average fuel economy by pressing and holding the OK button on the left hand steering wheel controls. For more information see Common Displays in this chapter.

Trip 1 & 2

Provides trip odometer, trip average fuel economy and trip timer.

Distance traveled on battery power only with the engine off is shown in blue next to total trip distance.

For Energi vehicles total plug-in electricity used in kilowatt hours (kWh) is shown in blue next to trip average fuel economy.

Information



In this mode, you can view different vehicle system information and perform a system check.

Information		
Warnings	Tutorial	Displays a number of different system tutorials. Use the up or down arrows to scroll through the tutorials. Then press OK to view.
	Driver Alert	Displays the associated driver alert graphic.
	MyKey	MyKeys (Number of MyKeys programmed)
		MyKey Miles (km) (Distance traveled using a programmed MyKey)
		Admin Keys (Number of admin keys)
System Check	All active warnings will display first if applicable. The system check menu may appear different based upon equipment options and current vehicle status. Use the up or down arrow buttons to scroll through the list.	

Settings



In this mode, you can configure different driver setting choices.

Note: Some items are optional and may not appear.

Note: Some MyKey items will only appear if a MyKey is set.

Information Displays

Settings					
Menu level 2	Menu level 3	Menu level 4	Menu level 5	Menu level 6	
Driver Assist	Traction Ctrl	On or Off	—		
	Blindspot	On or Off	—		
	Cross Traffic	On or Off	—		
	Cruise Control	Adaptive or Normal	—		
	ECO Cruise *	On or Off	—		
	Driver Alert	On or Off	—		
	Hill Start Assist	On or Off	—		
	Lane Keeping Sys	Mode	Alert only, Aid only or Alert + Aid		
		Intensity	High, Normal or Low		
	EV+ Mode	On or Off	—		
	Pre-Collision	Alert Sensitivity	High, Normal or Low		
	Front Park Aid	On or Off	—		
	Rear Park Aid	On or Off	—		
	Tire Monitor	Hold OK to Reset			
Vehicle	Auto Engine Off	On or Off	—		
	Easy Entry / Exit	On or Off	—		
	Lighting	Auto Highbeam	On or Off		
		Autolamp Delay	Select time interval		
		Daytime Lights	On or Off		
	Locks	Autolock	On or Off		
		Autounlock	On or Off		
		Mislock	On or Off		
Remote Unlocking		All doors or Driver door			

Information Displays

Settings				
	Oil Life Reset	Set to XXX % - Hold OK to Reset		
	Remote Start	Climate Control	Heater – A/C	Auto or Last Settings
			Steering Wheel	Auto Heated or Off
			Front Defrost	Auto or Off
			Rear Defrost	Auto or Off
			Driver Seat	Auto or Off
			Passenger Seat	Auto or Off
		Duration	5, 10 or 15 minutes	
		Quiet Start	On or Off	
	System	Enable or Disable		
	Switch Inhibit	On or Off		
	Tire Mobility Kit	Select number of years		
	Windows	Remote Open	On or Off	
		Remote Close	On or Off	
	Wipers	Courtesy Wipe	On or Off	
Rain Sensing		On or Off		
MyKey	Create MyKey	Hold OK to Create MyKey		
	911 Assist	Always On or User Selectable		
	Advancetrac	Always On or User Selectable		
	Max Speed	Choose desired speed or off		
	Speed Minder	Choose desired speed or off		
	Volume Limiter	On or Off		
	Do Not Disturb	Always On or User Selectable		
	Clear MyKeys	Hold OK to Clear All MyKeys		

Information Displays

Settings			
Display	Language	Select the desired language - Hold OK to Set	
	Units	Distance	Miles & GAL, l/100km or km/L
		Temperature	Fahrenheit (°F) or Celsius (°C)
		Tire Pressure	psi, kPa or bar
	Brake Coach	On or Off	
	Battery Display	On or Off	
	Regen Display	On or Off	
	Driving History	Hold OK to Reset	

*Energi only.

Right Information Display Controls

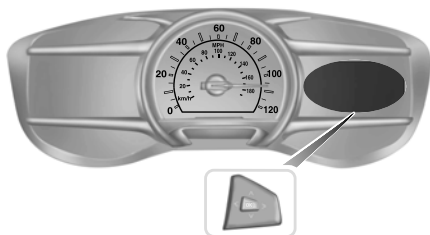

E179396

- Press the up and down arrow buttons to scroll through and highlight the options within a menu.
- Press the right arrow button to enter a sub-menu.
- Press the left arrow button to exit a menu.
- Press the **OK** button to choose and confirm your selection.

Note: The information display will remember the menu level 2 state when you change the individual key state from the RUN to the OFF position.

Main menu

From the main menu bar on the right side of the information display, you can choose from the following categories:

Entertainment

See **General Information** (page 367).

Phone

See **General Information** (page 367).

Navigation or Compass

See **General Information** (page 367).

Fuel Economy

Use the up or down arrow buttons to choose between the following display options.

Information Displays

Fuel Economy			
Menu level 2	Menu level 3	Menu level 4	Menu level 5
Efficiency Leaves	Help	—	—
Fuel History (Instantaneous Fuel Economy + Fuel Economy History + Avg Fuel Economy)	Duration	5, 10 or 30 minutes	—
	Help	—	—
Coach	Help	—	—

Efficiency Leaves

Efficiency leaves indicate short term driving efficiency measured over the last few minutes. The more leaves and vines that appear on the display, the better your fuel economy. Leaves and vines will occasionally appear and disappear to indicate a change in your driving efficiency.

Fuel History

From left to right this view includes an instantaneous fuel economy gauge, historical fuel economy data and average fuel economy. The historical data represents an average over time intervals of either 1, 2 or 6 minutes, with the leftmost interval being the most recent. Shown at the bottom of the view is the total time duration for the 5 intervals. You can select total duration in the options menu. Intervals shown in grey color are from the previous drive. The blue horizontal line represents the average fuel economy value shown to the right.

Note: Hold **OK** to reset fuel history and average fuel economy.

Coach

This view provides a comparison of your recent acceleration, braking and cruising behavior, then recommends the most efficient use of energy under present conditions. The horizontal bars fill from left to right with best behavior and appear blue when at least half full. When the bars are less than half full, the color is amber, suggesting that you need a change in your driving behavior to achieve better energy efficiency.

Note: *Fuel Economy will be impacted by your use of brakes, accelerator and accessories, as well as environmental conditions such as hills and weather.*

Note: *Fuel economy is not always a measure of appropriate driving behavior. For example, when driving uphill and maintaining an appropriate speed, your instant fuel economy may not be good (losing leaves) but the Coach may show a blue bar for Acceleration and Cruising.*

Information Displays

Common Displays

Both Average fuel economy and an instantaneous fuel economy gauge are included in Engage, Empower, MyView (if selected) and Fuel Economy (shown in Hybrid Mode) on the left-hand information display. They are also included in Fuel History on the right-hand information display.

Average Fuel Economy

Average Fuel Economy is continuously averaged since the last reset. You can reset your average fuel economy by pressing and holding the **OK** button on the corresponding steering wheel controls. For Energi vehicles both Hybrid and Plug-in Power mode operation will be included in the calculation.

Note: Average fuel economy cannot be reset in MyView.

Instantaneous Fuel Economy

If your instantaneous fuel economy is greater than the maximum value displayed, a + sign will be shown next to the maximum scale number. When your vehicle is operating on battery power only, EV will display and the gauge fill will show in blue.

Active Park

Message	Action
Active Park Fault	The system requires service due to a malfunction. Have the system checked by an authorized dealer.

INFORMATION MESSAGES

Note: Depending on the vehicle options equipped with your vehicle, not all of the messages will display or be available. Certain messages may be abbreviated or shortened depending upon which cluster type you have.



E144636

Press the OK button to acknowledge and remove some messages from the information display. Other messages will be removed automatically after a short time.

Certain messages need to be confirmed before you can access the menus.

Information Displays

Adaptive Cruise Control

Message	Action
Adaptive Cruise Malfunction	A radar malfunction is preventing the adaptive cruise control from engaging. See Using Adaptive Cruise Control (page 196).
Adaptive Cruise Not Available	A condition exists such that the adaptive cruise cannot function properly. See Using Adaptive Cruise Control (page 196).
Adaptive Cruise Not Available Sensor Blocked See Manual	You have a blocked sensor due to bad weather, ice, mud or water in front of the radar sensor. You can typically clean the sensor to resolve. See Using Adaptive Cruise Control (page 196).
Normal Cruise Active Automatic Braking Turned Off	The system has disabled the automatic braking.
Front Sensor Not Aligned	A radar malfunction is preventing the adaptive cruise control from engaging.
Adaptive Cruise - Driver Resume Control	The adaptive cruise has reinstated controls to the driver.
Adaptive Cruise Speed Too Low to Activate	The vehicle speed is too slow to activate the adaptive cruise.
Adaptive Cruise Shift Down	The adaptive cruise is automatically adjusting the gap distance and the driver needs to shift the transmission into a lower gear.

AdvanceTrac™

Message	Action
Service AdvanceTrac	Displayed when the system has detected a condition that requires service. Contact your authorized dealer as soon as possible.
AdvanceTrac Off On	The driver has disabled or enabled the traction control.

Information Displays

Airbag

Message	Action
Occupant Sensor BLOCKED Remove Objects Near Passenger Seat	The system detects a malfunction due to a blocked sensor. Remove blockage.

Alarm

Message	Action
Vehicle Alarm To Stop Alarm, Start Vehicle.	Alarm triggered due to unauthorized entry. See Anti-Theft Alarm (page 66).

Automatic Engine Shutdown

Message	Action
Engine Shuts Off In {seconds to shut off:#0} Seconds	The engine is getting ready to shut off.
Engine Shut Off For Fuel Economy	The engine has shut off to help increase fuel economy.
Engine Shuts Off in {seconds to shut off:#0} Seconds Press Ok to Override	The engine is getting ready to shut off. You can press OK on the left steering wheel button to override the shut down.

Information Displays

Battery and Charging System (12 volt)

Message	Action
Check Charging System	The charging system needs servicing. If the warning stays on or continues to come on, contact an authorized dealer as soon as possible.
Low Battery Features Temporarily Turned Off	The battery management system detects an extended low-voltage condition. The system will disable various vehicle features to help preserve the battery. Turn off as many of the electrical loads as soon as possible to improve system voltage. If the system voltage has recovered, the disabled features will operate again as normal.
Turn Power Off To Save Battery	The battery management system determines that the battery is at a low state of charge. Turn the ignition off as soon as possible to protect the battery. This message will clear once you start your vehicle and the battery state of charge has recovered. Turning off unnecessary electrical loads will allow faster battery state-of-charge recovery.

Battery and Charging System (High Voltage)

Message	Action
Vehicle Plugged In ? Yes No	Your vehicle needs confirmation it is unplugged before allowing a start. You must make sure your vehicle is unplugged and you respond to the message prompt before starting your vehicle.
Unplug Prior to Starting Vehicle	Your vehicle detects it is still plugged in after you attempt to start it.
Ready to Drive	Your vehicle is ready to drive.
Ready to Drive XXX% Charged	Your vehicle is ready to drive. You have XXX% plug-in energy available.
EV Now Battery Powered	You selected EV Now mode with the EV button.
EV Later XX% Plug-in Energy Reserved	You selected EV Later mode with the EV button.
Auto EV Normal Operation	You selected Auto EV mode with the EV button.
EV Now Not Available	EV Now is unavailable.

Information Displays

Message	Action
Engine Enabled Due to Defrost Setting	Your vehicle enables the engine due to the climate control defrost setting. This is normal operation.
Engine Enabled for System Performance	Your vehicle enables the engine for system performance. This is normal operation.
Press OK to Enable Engine	You can press OK to enable the engine temporarily for increased performance when in EV Now mode.

Blind Spot Information and Cross Traffic Alert System

Message	Action
Blindspot System Fault	A fault with the system has occurred. Contact an authorized dealer as soon as possible.
Blindspot Not Available Sensor Blocked See Manual	The system sensors are blocked. See Blind Spot Information System (page 208).
Cross Traffic Vehicle Coming From X	The system detects a vehicle. See Blind Spot Information System (page 208).
Cross Traffic Not Available Sensor Blocked See Manual	The blind spot information system and cross traffic alert system sensors are blocked. See Blind Spot Information System (page 208).
Cross Traffic System Fault	A fault with the system has occurred. Contact an authorized dealer as soon as possible.

Doors and Locks

Message	Action
X Door Ajar	The door(s) listed is not completely closed.
Trunk Ajar	The luggage compartment is not completely closed.
Hood Ajar	The hood is not completely closed.

Information Displays

Message	Action
Switches Inhibited Security Mode	The system has disabled the door switches.
Child Lock Malfunction Service Required	There is a system malfunction with the child locks. Contact an authorized dealer as soon as possible.
Factory Keypad Code {X X X X X}	The factory keypad code displays in the information display after system resets the keypad.

Driver Alert

Message	Action
Driver Alert Warning Rest Now	Stop and rest as soon as it is safe to do so.
Driver Alert Warning Rest Suggested	Take a rest soon.

Fuel

Message	Action
Fuel Level Low	An early reminder of a low fuel condition.
Check Fuel Fill Inlet	The fuel fill inlet may not be properly closed.
Fuel Freshness Engine may run to maintain fuel freshness	EV functionality is disabled and the engine is running to maintain fuel freshness. See Fuel Quality (page 154).
Fuel Door Opening	Wait for up to 15 seconds while the fuel system depressurizes.
Fuel Door Open	The fuel system has finished depressurizing and you can begin to refuel.
Close Fuel Door	A reminder to close the fuel door.
Refuel Error See Manual	There is an error in attempting to refill your vehicle.

Information Displays

Hill Start Assist

Message	Action
Hill Start Assist Not Available	Hill start assist is not available. Contact an authorized dealer. See Hill Start Assist (page 177).

Keys and Intelligent Access

Message	Action
To START Press Brake	A reminder to press the brake while starting your vehicle.
No Key Detected	The system does not detect a key in your vehicle. See Keyless Starting (page 141).
Restart Now or Key is Needed	You pressed the start/stop button to switch off the engine and your vehicle does not detect your intelligent access key inside your vehicle.
Accessory Power is Active	Your vehicle is in the run ignition state.
Starting System Fault	There is a problem with your vehicle's starting system. See an authorized dealer for service.
Key Program Successful	You have successfully programmed an intelligent access key to the system.
Key Program Failure	You have failed to program an intelligent access key to the system.
Max Number of Keys Learned	You have programmed the maximum number of keys to the system.
Not Enough Keys Learned	You have not programmed enough keys to the system.
Key Battery Low Replace Soon	The key battery is low. Change the battery as soon as possible.
Could Not Program Integrated Key	An attempt is made to program a spare key using two existing MyKeys.
Vehicle is ON	Informs you that upon exiting your vehicle that the vehicle is still on.

Information Displays

Lane Keeping System

Message	Action
Lane Keeping Sys. Malfunction Service Required	The system has malfunctioned. Contact an authorized dealer as soon as possible.
Front Camera Temporarily Not Available	The system has detected a condition that has caused the system to be temporarily unavailable.
Front Camera Low Visibility Clean Screen	The system has detected a condition that requires you to clean the windshield in order for it to operate properly.
Front Camera Malfunction Service Required	The system has malfunctioned. Contact an authorized dealer as soon as possible.
Keep Hands on Steering Wheel	The system requests the driver to keep their hands on the steering wheel.

Maintenance

Message	Action
Low Engine Oil Pressure	Stop your vehicle as soon as safely possible and turn off the engine. Check the oil level. If the warning stays on or continues to come on with your engine running, contact an authorized dealer as soon as possible.
Change Engine Oil Soon	The engine oil life remaining is 10% or less. See Engine Oil Check (page 255).
Oil Change Required	The oil life left is at 0%. See Engine Oil Check (page 255).
Brake Fluid Level Low	The brake fluid level is low, inspected the brake system immediately. See Brake Fluid Check (page 261).
Check Brake System	The brake system needs servicing. Stop your vehicle in a safe place. Contact an authorized dealer.
Engine Coolant Over Temperature	The engine coolant temperature is excessively high. See Engine Coolant Check (page 256).
Motor Coolant Over Temperature	The motor electronics are overheating. Stop your vehicle as soon as safely possible, turn off your vehicle and let it cool. If the warning stays on or continues to come on, contact an authorized dealer as soon as possible.
Power Reduced to Lower Engine Temp	The engine has reduced power to help reduce high engine temperature.

Information Displays

Message	Action
Service Tire Mobility Kit	The kit needs service. See an authorized dealer.
Transport / Factory Mode	Your vehicle is still in Transport or Factory mode. This may not allow some features to operate properly. See an authorized dealer.
See Manual	The powertrain needs service due to a powertrain malfunction.
Engine ON Due to Low Use Normal Operation	EV functionality is disabled and the engine is running to maintain oil quality. See Plug-In Hybrid Vehicle Operation (page 148).

MyKey

Message	Action
MyKey not Created	You cannot program a MyKey.
MyKey Active Drive Safely	MyKey is active.
Speed Limited to XX MPH/km/h	When switching on your vehicle and MyKey is in use, displays that the MyKey speed limit is on.
Near Vehicle Top Speed	MyKey is in use and the MyKey speed limit is on and the vehicle speed is approaching 80 mph (130 km/h).
Vehicle at Top Speed of MyKey Setting	You have reached the speed limit set for your MyKey.
Check Speed Drive Safely	You have an active MyKey with a programmed set speed limit.
Buckle Up to Unmute Audio	Belt-Minder turns on with a MyKey in use.
AdvanceTrac On - MyKey Setting	With a MyKey in use, AdvanceTrac turns on.
Traction Control On - MyKey Setting	With a MyKey in use, traction control turns on.
MyKey Park Aid Cannot be Deactivated	With a MyKey in use, park aid is always on.
Lane Keeping Alert On MyKey Setting	With a MyKey in use, lane keeping alert turns on.

Information Displays

Park Aid

Message	Action
Check Front Park Aid	The system has detected a condition that requires service. Contact an authorized dealer. See Principle of Operation (page 182).
Check Rear Park Aid	The system has detected a condition that requires service. Contact an authorized dealer. See Principle of Operation (page 182).
Front Park Aid On Off	Displays the park aid status.
Rear Park Aid On Off	Displays the park aid status.

Park Brake

Message	Action
To Release: Press Brake and Switch	The electric parking brake is set and a manual release is attempted without the brake pedal being pressed.
Park Brake Use Switch to Release	The electric parking brake is set and an automatic release is attempted but cannot be performed. Perform a manual release.
Release Park Brake	The electric parking brake is set and your vehicle speed exceeds 3 mph (5 km/h). Release park brake before continued driving.
Park Brake Not Applied	The electric parking brake is not fully applied.
Park Brake Not Released	The electric parking brake is not fully released.
Park Brake Maintenance Mode	The electric parking brake system has been put into a special mode that is used to allow service of the rear brakes. Contact an authorized dealer.
Park Brake Limited Function Service Required	The electric park brake system has detected a condition that requires service. Some functionality may still be available. See an authorized dealer.
Park Brake Malfunction Service Now	The electric parking brake system has detected a condition that requires service. See an authorized dealer.
Park Brake System Overheated	Numerous park brake applies have overheated the system. Wait 2 minutes before attempting to apply again.

Information Displays

Power Steering

Message	Action
Steering Fault Service Now	The power steering system has detected a condition that requires service. See an authorized dealer.
Steering Loss Stop Safely	The power steering system is not working. Stop your vehicle in a safe place. Contact an authorized dealer.
Steering Assist Fault Service Required	The power steering system has detected a condition within the power steering system or passive entry or passive start system requires service. Contact an authorized dealer.

Pre-Collision Assist

Message	Action
Pre-Collision Assist Malfunction	A fault with the system has occurred. Contact an authorized dealer as soon as possible.
Pre-Collision Assist Not Available Sensor Blocked	You have a blocked sensor due to bad weather, ice, mud or water in front of the radar sensor. You can typically clean the sensor to resolve.
Pre-Collision Assist Not Available	A fault with the system has occurred. Contact an authorized dealer as soon as possible.

Remote Start

Message	Action
To Drive: Turn Key to On	A reminder to turn the key on to drive your vehicle after a remote start.
To Drive: Press Brake and Start Button	A reminder to apply the brake and push the gearshift button to drive your vehicle after a remote start.

Seats

Message	Action
Memory Recall Not Permitted While Driving	A reminder that memory seats are not available while driving.
Memory {0} Saved	Shows where you have saved your memory setting.

Information Displays

Starting System

Message	Action
To START Press Brake	A reminder to apply the brake when starting your vehicle.
Cranking Time Exceeded	The starter has exceeded its cranking time in attempting to start your vehicle.
Engine Start Pending Please Wait	The starter is attempting to start your vehicle.
Pending Start Cancelled	The system has cancelled the pending start.

Tire Pressure Monitoring System

Message	Action
Tire Pressure Low	One or more tires on your vehicle has low tire pressure. See Tire Pressure Monitoring System (page 301).
Tire Pressure Monitor Fault	The tire pressure monitoring system is malfunctioning. If the warning stays on or continues to come on, contact an authorized dealer. See Tire Pressure Monitoring System (page 301).
Tire Pressure Sensor Fault	A tire pressure sensor is malfunctioning or your spare tire is in use. For more information on how the system operates under these conditions, See Tire Pressure Monitoring System (page 301). If the warning stays on or continues to come on, contact an authorized dealer as soon as possible.

Traction Control

Message	Action
Traction Control Off/On	The status of the traction control system after you switched it off or on. See Using Traction Control (page 179).
Spinout Detected Hazards Activated	A spinout has occurred and the hazards are on.

Information Displays

Transmission

Message	Action
Transmission Malfunction Service Now	See an authorized dealer.
Transmission Over Temperature Stop Safely	The transmission is overheating and needs to cool. Stop in a safe place as soon as possible.
Transmission Overheating Stop Safely	The transmission has overheated and needs to cool. Stop in a safe place as soon as possible.
Transmission Service Required	See an authorized dealer.
Transmission Too Hot Press Brake	The transmission is getting hot. Stop to let it cool.
Transmission Limited Function See Manual	The transmission has limited functionality. See an authorized dealer.
Transmission Warming Up Please Wait	The transmission is too cold. Wait for it to warm up before you drive.
Transmission Not in Park	A reminder to shift into park.
Press Brake Pedal	A request for you to apply the brake as needed by the transmission.
Select L to Confirm Stay in Neutral Mode	Displays when a button needs to be pressed again to enter neutral hold. See Automatic Transmission (page 170).
Transmission Adjusted	The transmission has adjusted the shift strategy.
Transmission Adapt-Mode	The transmission is adjusting the shift strategy.
Transmission Indicat-Mode Lockup On	The transmission is locked and unable to select gears.
Transmission Indicat-Mode Lockup Off	The transmission is unlocked and free to select gears.

Climate Control

AUTOMATIC CLIMATE CONTROL - VEHICLES WITHOUT: SONY AUDIO SYSTEM

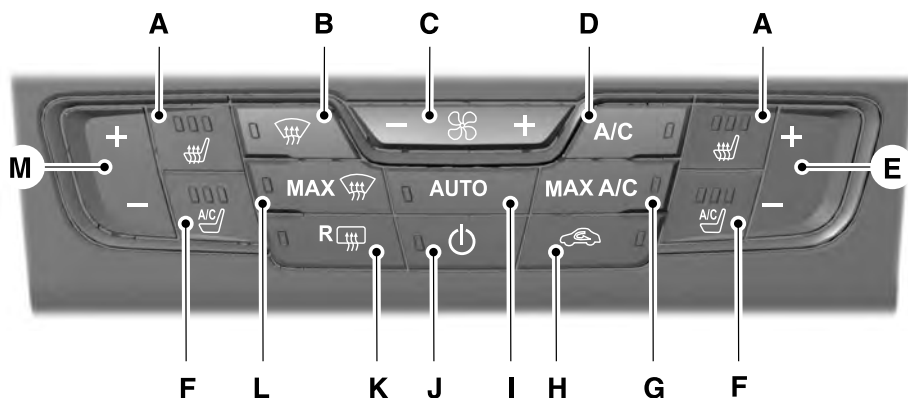

E198922

- A **Heated seats:** Press to switch the heated seats on and off. See **Heated Seats** (page I29).
- B **Defrost:** Select to distribute air through the windshield air vents. Air distribution to the instrument panel and footwell vents turns off. You can also use this setting to defrost and clear the windshield of a thin covering of ice.
- C **Fan speed control:** Adjust the volume of air circulated in the vehicle.
- D **A/C:** Press to switch the air conditioning on or off. Air conditioning cools your vehicle using outside air. To improve the time to reach a comfortable temperature in hot weather, drive with the windows open until you feel cold air through the air vents.

Note: In certain conditions (for example, maximum defrost), the air conditioning compressor may continue to operate even though the air conditioning is switched off.

Climate Control

- E **Passenger temperature control:** Adjust the temperature on the passenger side.
- F **Climate controlled seats:** Press to switch the climate controlled seats on and off. See **Climate Controlled Seats** (page 130).
- G **MAX A/C:** Press for maximum cooling. Recirculated air flows through the instrument panel vents, air conditioning automatically turns on and the fan automatically adjusts to the highest speed.
- H **Recirculated air:** Press to switch between outside air and recirculated air. The air currently in the passenger compartment recirculates. This can reduce the time needed to cool the interior and reduce unwanted odors from entering your vehicle.
Note: Recirculated air may also turn on and off automatically in instrument panel or instrument panel and floor airflow modes during hot weather to improve cooling efficiency.
- I **AUTO:** Press to switch on automatic operation. Adjust to select the desired temperature. Fan speed, air distribution, air conditioning operation, and outside or recirculated air are automatically adjusted to heat or cool the vehicle to maintain the desired temperature. You can also switch off dual zone mode by pressing and holding for more than two seconds.
- J **Power:** Press to switch the system on and off. When the system is off, it prevents outside air from entering the vehicle.
- K **Heated rear window:** Press to switch the heated rear window on and off. See **Heated Windows and Mirrors** (page 120).
- L **MAX Defrost:** Press to switch on defrost. Outside air flows through the windshield vents, air conditioning automatically turns on, and fan automatically adjusts to the highest speed. You can also use this setting to defrost and clear the windshield of a thin covering of ice. The heated rear window also automatically turns on when you select maximum defrost.
Note: To prevent window fogging, you cannot select recirculated air when maximum defrost is on.
- M **Driver temperature control:** Adjust the temperature on the driver side.

AUTOMATIC CLIMATE CONTROL - VEHICLES WITH: SONY AUDIO SYSTEM

Note: *You can switch temperature units between Fahrenheit and Celsius. See your SYNC information.*

Climate Control



E225754

- A **A/C:** Press to switch the air conditioning on or off. Air conditioning cools your vehicle using outside air. To improve the time to reach a comfortable temperature in hot weather, drive with the windows open until you feel cold air through the air vents.
Note: In certain conditions (for example, maximum defrost), the air conditioning may continue to operate even though the air conditioning is switched off.
- B **MAX A/C:** Press for maximum cooling. Recirculated air flows through the instrument panel vents, air conditioning automatically turns on, and the fan automatically adjusts to the highest speed.
- C **Recirculated air:** Press to switch between outside air and recirculated air. The air currently in the passenger compartment recirculates. This can reduce the time needed to cool the interior and reduce unwanted odors from entering your vehicle.
Note: Recirculated air may also turn on and off automatically in instrument panel or instrument panel and floor airflow modes during hot weather to improve cooling efficiency.
- D **Power:** Press to switch the system on and off. When the system is off, it prevents outside air from entering the vehicle.

Climate Control

- E **Heated seats:** Press to switch the heated seats on and off. See **Heated Seats** (page 129).
- F **Climate controlled seats:** Press to switch the climate controlled seats on and off. See **Climate Controlled Seats** (page 130).
- G **Passenger temperature control:** Adjust the temperature setting on the passenger side.
- H **Fan speed control:** Adjust the volume of air circulated in the vehicle.
- I **Driver temperature control:** Adjust the temperature setting on the driver side.
- J **Heated rear window:** Press to switch the heated rear window on and off. See **Heated Windows and Mirrors** (page 120).
- K **Defrost:** Select to distribute air through the windshield air vents. Air distribution to the instrument panel and footwell vents turns off. You can also use this setting to defrost and clear the windshield of a thin covering of ice.
- L **MAX Defrost:** Press to switch on defrost. Outside air flows through the windshield vents, air conditioning automatically turns on, and fan automatically adjusts to the highest speed. You can also use this setting to defrost and clear the windshield of a thin covering of ice. The heated rear window also automatically turns on when you select maximum defrost.
Note: To prevent window fogging, you cannot select recirculated air when maximum defrost is on.
- M **AUTO:** Press to switch on automatic operation. Adjust to select the desired temperature. Fan speed, air distribution, air conditioning operation, and outside or recirculated air are automatically adjusted to heat or cool the vehicle to maintain the desired temperature. You can also switch off dual zone mode by pressing and holding for more than two seconds.

HINTS ON CONTROLLING THE INTERIOR CLIMATE

General Hints

Note: Prolonged use of recirculated air may cause the windows to fog up.

Note: You may feel a small amount of air from the footwell air vents regardless of the air distribution setting.

Note: To reduce humidity build-up inside your vehicle, do not drive with the system switched off or with recirculated air always switched on.

Note: Do not place objects under the front seats as this may interfere with the airflow to the rear seats.

Note: Remove any snow, ice or leaves from the air intake area at the base of the windshield.

Note: To improve the time to reach comfort in hot weather, drive with the windows slightly open for 2-3 minutes after start-up or until your vehicle airs out.

Climate Control

Automatic Climate Control

Note: Adjusting the settings when your vehicle interior is extremely hot or cold is not necessary. The system automatically adjusts to heat or cool the cabin to your selected temperature as quickly as possible. For the system to function efficiently, the instrument panel and side air vents should be fully open.

Note: If you select **AUTO** during cold outside temperatures, the system directs airflow to the windshield and side window vents. In addition, the fan may run at a slower speed until the engine warms up.

Note: If you select **AUTO** during hot outside temperatures, or when the inside of the vehicle is hot, the system automatically uses recirculated air to maximize interior cooling. When the interior reaches the selected temperature, the system automatically switches to using outside air.

Heating the Interior Quickly

1. Press the **AUTO** button.
2. Adjust the temperature control to the desired setting.

Recommended Settings for Heating

1. Press the **AUTO** button.
2. Adjust the temperature control to the desired setting. Use 72°F (22°C) as a starting point, then adjust the setting as necessary.

Cooling the Interior Quickly

Press the **MAX A/C** button.

Recommended Settings for Cooling

1. Press the **AUTO** button.

2. Adjust the temperature control to the desired setting. Use 72°F (22°C) as a starting point, then adjust the setting as necessary.

Side Window Defogging in Cold Weather

1. Press the defrost button.
2. Adjust the temperature control to the desired setting. Use 72°F (22°C) as a starting point, then adjust the setting as necessary.

HEATED WINDOWS AND MIRRORS (If Equipped)

Heated Rear Window

Note: Make sure the engine is running before operating the heated windows.



Press the button to clear the heated rear window of thin ice and fog. The heated rear window will automatically turn off after a short period of time. Start the engine before you switch the heated rear window on.

Note: Do not use razor blades or other sharp objects to clean or remove decals from the inside of the heated rear window. The vehicle warranty does not cover damage caused to the heated rear window grid lines.

Heated Exterior Mirror (If Equipped)

When you switch the heated rear window on, the heated exterior mirrors will automatically turn on.

Note: Do not remove ice from the mirrors with a scraper or adjust the mirror glass when it is frozen in place.

Note: Do not clean the mirror housing or glass with harsh abrasives, fuel or other petroleum-based cleaning products.

Climate Control

CABIN AIR FILTER

Your vehicle is equipped with a cabin air filter, which gives you and your passengers the following benefits:

- It improves your driving comfort by reducing particle concentration.
- It improves the interior compartment cleanliness.
- It protects the climate control components from particle deposits.

You can locate the cabin air filter behind the glove box.

Note: *Make sure you have a cabin air filter installed at all times. This prevents foreign objects from entering the system. Running the system without a filter in place could result in degradation or damage to the system.*

Replace the filter at regular intervals. See **Scheduled Maintenance** (page 466).

For additional cabin air filter information, or to replace the filter, see an authorized dealer.

REMOTE START (If Equipped)

The remote start feature allows you to pre-condition the interior of your vehicle. The climate control system works to achieve comfort according to your previous settings.

Note: *You cannot adjust the system during remote start operation.*

Turn the ignition on to return the system to its previous settings. You can now make adjustments normally, but you need to turn certain vehicle-dependent features back on, such as:

- Heated seats.
- Cooled seats.
- Heated steering wheel.

- Heated mirrors.
- Heated rear window.

You can adjust the default remote start settings using the information display controls. See **Information Displays** (page 94).

Automatic Settings

In hot weather, the system is set to 72°F (22°C). The cooled seats are set to high (if available, and selected to AUTO in the information display).

In moderate weather, the system either heats or cools (based on previous settings). The rear defroster, heated mirrors and heated seats do not automatically turn on.

In cold weather, the system is set to 72°F (22°C). The heated seats are set to high (if available, and selected to AUTO in the information display). The rear defroster and heated mirrors automatically turn on.

Seats

SITTING IN THE CORRECT POSITION

WARNINGS



Sitting improperly, out of position or with the seatback reclined too far can take weight off the seat cushion and affect the decision of the passenger sensing system, resulting in serious injury or death in the event of a crash. Always sit upright against your seat back, with your feet on the floor.



Do not recline the seatback as this can cause the occupant to slide under the safety belt, resulting in serious injury in the event of a crash.



Do not place objects higher than the seatback to reduce the risk of serious injury in the event of a crash or during heavy braking.

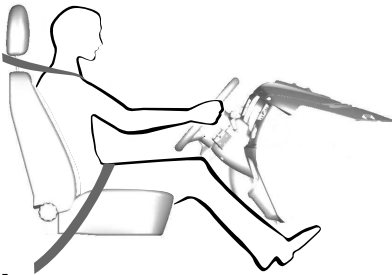

E68595

When you use them properly, the seat, head restraint, safety belt and airbags will provide optimum protection in the event of a crash.

We recommend that you follow these guidelines:

- Sit in an upright position with the base of your spine as far back as possible.
- Do not recline the seatback more than 30 degrees.
- Adjust the head restraint so that the top of it is level with the top of your head and as far forward as possible. Make sure that you remain comfortable.
- Keep sufficient distance between yourself and the steering wheel. We recommend a minimum of 10 in (25 cm) between your breastbone and the airbag cover.
- Hold the steering wheel with your arms slightly bent.
- Bend your legs slightly so that you can press the pedals fully.
- Position the shoulder strap of the safety belt over the center of your shoulder and position the lap strap tightly across your hips.

Make sure that your driving position is comfortable and that you can maintain full control of your vehicle.

HEAD RESTRAINTS

WARNINGS



Fully adjust the head restraint before you sit in or operate your vehicle. This will help minimize the risk of neck injury in the event of a crash. Do not adjust the head restraint when your vehicle is moving.



The head restraint is a safety device. Whenever possible it should be installed and properly adjusted when the seat is occupied.

Seats

WARNINGS



Install the head restraint properly to help minimize the risk of neck injury in the event of a crash.

Note: Adjust the seatback to an upright driving position before adjusting the head restraint. Adjust the head restraint so that the top of it is level with the top of your head and as far forward as possible. Make sure that you remain comfortable. If you are extremely tall, adjust the head restraint to its highest position.

Front seat and rear seat outboard head restraints

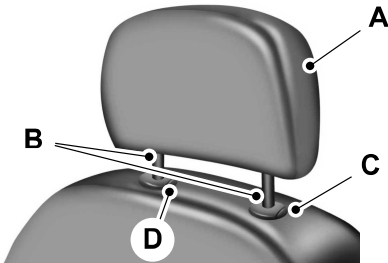

E138642

Rear center head restraint

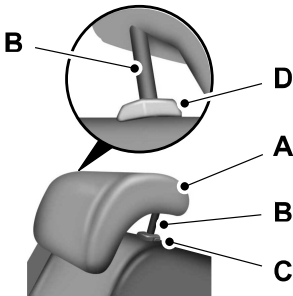

E138645

The head restraints consist of:

- A An energy absorbing head restraint.
- B Two steel stems.
- C Guide sleeve adjust and unlock button.
- D Guide sleeve unlock and remove button.

Adjusting the Head Restraint

Raising the Head Restraint

Pull the head restraint up.

Lowering the Head Restraint

1. Press and hold button C.
2. Push the head restraint down.

Removing the Head Restraint

1. Pull the head restraint up until it reaches its highest position.
2. Press and hold buttons C and D.
3. Pull the head restraint up.

Installing the Head Restraint

Align the steel stems into the guide sleeves and push the head restraint down until it locks.

Tilting Head Restraints

The front head restraints tilt for extra comfort. To tilt the head restraint, do the following:

Seats



E144727

1. Adjust the seatback to an upright driving or riding position.
2. Pivot the head restraint forward toward your head to the desired position.

After the head restraint reaches the forward-most tilt position, pivoting it forward again will then release it to the rearward, un-tilted position.

MANUAL SEATS (If Equipped)

WARNINGS



Do not adjust the driver seat or seatback when your vehicle is moving.



Rock the seat backward and forward after releasing the lever to make sure that it is fully engaged.



Reclining the seatback can cause an occupant to slide under the seat's safety belt, resulting in severe personal injuries in the event of a crash.

The driver and passenger manual seats may consist of:



E144631

- A A bar to move the seat backward and forward.
- B A control to adjust the lumbar of the seatback (driver seat only).
- C A lever to adjust the height of the seat (driver seat only).
- D A lever to adjust the angle of the seatback.

POWER SEATS (If Equipped)

WARNINGS



Do not adjust the driver seat or seatback when your vehicle is moving.



Do not place cargo or any objects behind the seatback before returning it to the original position.

Note: *Driver seat shown, passenger seat similar.*

Seats

6-way power seat

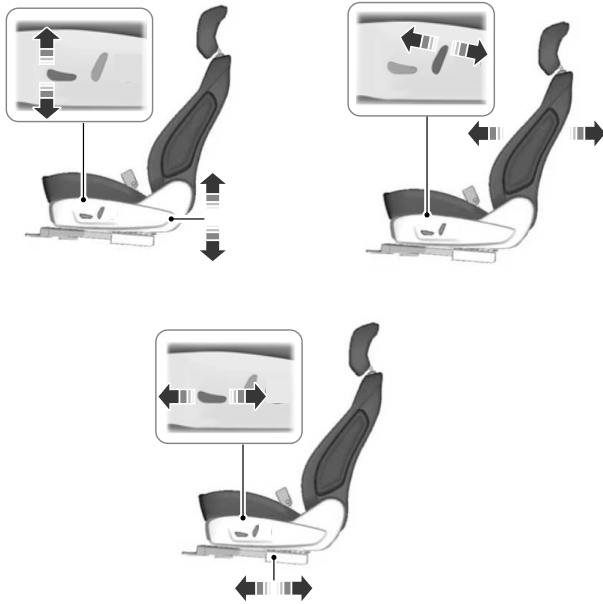

E176793

Seats

10-way power seat

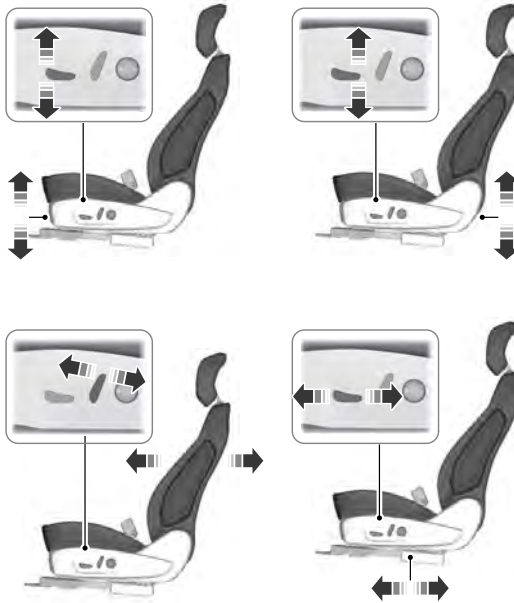

E144632

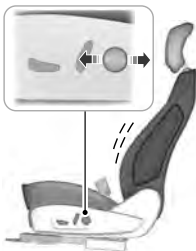

Power Lumbar (If Equipped)



E165608

MEMORY FUNCTION (If Equipped)

WARNINGS

-  Before activating the seat memory, make sure that the area immediately surrounding the seat is clear of obstructions and that all occupants are clear of moving parts.
-  Do not use the memory function when your vehicle is moving.

This feature automatically recalls the position of the following features:

Seats

- Driver seat.
- Power mirrors.
- Power steering column.

The memory control is on the driver door.



E223340

Saving a PreSet Position

1. Adjust the memory features to your desired position.
2. Press and hold the SET button until you hear a single tone.
3. Press the desired preset button until you hear a single tone.

You can save up to two preset memory positions. You can save a memory preset at any time.

Recalling a PreSet Position

Press and release the preset button associated with your desired driving position. The memory features move to the position stored for that preset.

Note: A preset memory position can only be recalled when the ignition is off, or when the transmission is in park (P) or neutral (N) if the ignition is on and the vehicle is not moving.

You can also recall a preset memory position by:

- Pressing the unlock button on your intelligent access key fob if it is linked to a preset position.
- Unlocking the intelligent driver door handle if a linked key fob is present.
- Entering a personal entry code on the Securicode keypad. See **Locks** (page 58).

Note: Using a linked key fob to recall your memory position when the ignition is off moves the seat to the Easy Entry position.

Note: Pressing any active memory feature control - power seat, mirror, or steering column (or any memory button) during a memory recall cancels the operation.

Linking a PreSet Position to your Remote Control or Intelligent Access Key Fob

Your vehicle can save the preset memory positions for up to two remote controls or intelligent access (IA) keys.

After you have saved your desired memory preset positions:

1. Press and hold the desired preset button for about three seconds until you hear a single tone.
2. Within three seconds, press the lock button on the remote control you are linking.

To unlink a remote control, follow the same procedure – except in step 2, press the unlock button on the remote control.

Note: If more than one linked remote control or intelligent access key is in range, the memory function moves to the settings of the first key to initiate a memory recall.

Seats

Easy Entry and Exit Feature

If you enable the easy entry and exit feature, it automatically moves the driver seat position rearward up to two inches (five centimeters) when you switch the ignition off.

The driver seat will return to the previous position when you switch the ignition on.

You can enable or disable this feature in the information display. See **Information Displays** (page 94).

REAR SEATS

Note: *Your vehicle may have split seatbacks that you must fold individually.*

Note: *Make sure the center safety belt is unbuckled before folding the seatback.*

To lower the seat back(s) from inside the vehicle, do the following:



E144634

1. Pull the handle to release the seatback.
2. Push the seatback forward.

Seats

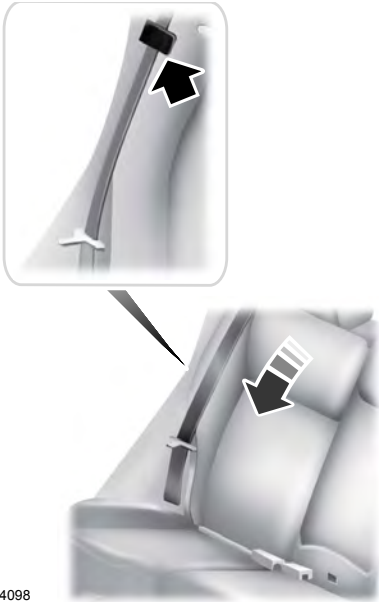

E164098

3. Stow the safety belt in the stowage clip. This will prevent the safety belt from getting caught in the seat latch.

When raising the seat back(s), make sure you hear the seat latch into place.

HEATED SEATS (If Equipped)

WARNING

 People who are unable to feel pain to their skin because of advanced age, chronic illness, diabetes, spinal cord injury, medication, alcohol use, exhaustion or other physical conditions, must exercise care when using the heated seat. The heated seat may cause burns even at low temperatures, especially if used for long periods of time. Do not place anything on the seat that insulates against heat, such as a blanket or cushion. This may cause the heated seat to overheat. Do not puncture the seat with pins, needles or other pointed objects. This may damage the heating element which may cause the heated seat to overheat. An overheated seat may cause serious personal injury.

Do not do the following:

- Place heavy objects on the seat.
- Operate the heated seat if water or any other liquid is spilled on the seat. Allow the seat to dry thoroughly.
- Operate the heated seats unless the engine is running. Doing so can cause the battery to lose charge.

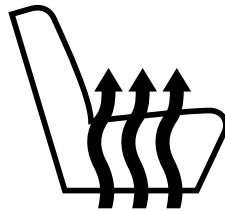

E146941

Press the heated seat symbol to cycle through the various heat settings and off. Warmer settings are indicated by more indicator lights.

Seats

CLIMATE CONTROLLED SEATS

(If Equipped)

Heated Seats

WARNING



Persons who are unable to feel pain to the skin because of advanced age, chronic illness, diabetes, spinal cord injury, medication, alcohol use, exhaustion, or other physical conditions, must exercise care when using the seat heater. The seat heater may cause burns even at low temperatures, especially if used for long periods of time. Do not place anything on the seat that insulates against heat, such as a blanket or cushion, because this may cause the seat heater to overheat. Do not puncture the seat with pins, needles, or other pointed objects because this may damage the heating element which may cause the seat heater to overheat. An overheated seat may cause serious personal injury.

Do not do the following:

- Place heavy objects on the seat.
- Operate the seat heater if water or any other liquid spills on the seat. Allow the seat to dry thoroughly.
- Operate the heated seats unless the engine is running. Doing so can cause the battery to lose charge.



E146322

Press the heated seat symbol to cycle through the various heat settings and off. More indicator lights indicate warmer settings.

Cooled Seats

The cooled seats will only function when the engine is running.



E146309

To operate the cooled seats:

Press the cooled seat symbol to cycle through the various cooling settings and off. More indicator lights indicate cooler settings.

If the engine falls below 350 RPM while the cooled seats are on, the feature will turn itself off. You will need to reactivate it.

Climate controlled seat air filter replacement

Your vehicle is equipped with lifetime air filters that are integrated with the seats. Regular maintenance or replacement is not needed.

Seats

REAR SEAT ARMREST (If Equipped)



E144635

Fold the armrest down to use the armrest and cupholder.

Universal Garage Door Opener (If Equipped)

HomeLink Wireless Control System

WARNINGS



Make sure that the garage door and security device are free from obstruction when you are programming. Do not program the system with the vehicle in the garage.



Do not use the system with any garage door opener that does not have the safety stop and reverse feature as required by U.S. Federal Safety Standards (this includes any garage door opener manufactured before April 1, 1982). A garage door opener which cannot detect an object, signaling the door to stop and reverse, does not meet current federal safety standards. Using a garage door opener without these features increases the risk of serious injury or death.

Note: Make sure you keep the original remote control transmitter for use in other vehicles as well as for future system programming.

Note: We recommend that upon the sale or lease termination of your vehicle, you erase the programmed function buttons for security reasons. See **Erasing the Function Button Codes**.

Note: You can program a maximum of three devices. To change or replace any of the three devices after it has been initially programmed, you must first erase the current settings. See **Erasing the Function Button Codes**.



E142657

The universal garage door opener replaces the common hand-held garage door opener with a three-button transmitter that is integrated into the driver's sun visor.

The system includes two primary features, a garage door opener and a platform for remote activation of devices within the home. As well as being programmed for garage doors, the system transmitter can be programmed to operate entry gate operators, security systems, entry door locks and home or office lighting.

Additional system information can be found online at www.homelink.com, www.youtube.com/HomeLinkGentex or by calling the toll-free help line on 1-800-355-3515.

In-Vehicle Programming

This process is to program your hand-held transmitter and your in-vehicle HomeLink button.

Note: The programming steps below assume you will be programming HomeLink that was not previously programmed.

Note: Put a new battery in the hand-held transmitter. This will ensure quicker training and accurate transmission of the radio-frequency signal.

Universal Garage Door Opener (If Equipped)

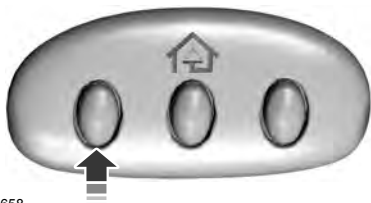

E142658

1. With your vehicle parked outside of the garage, turn your ignition to the **on** position, but do not start your vehicle.
2. Hold your hand-held garage door transmitter 2–6 in (5–14 cm) away from the HomeLink button you want to program.
3. Using both hands, simultaneously, press and hold the desired HomeLink button and the hand-held transmitter button. **DO NOT** release either one until the HomeLink indicator light flashes slowly and then rapidly. When the indicator light flashes rapidly, both buttons may be released. The rapid flashing indicates successful training.

Note: You may need to use a different method if you live in Canada or have difficulties programming your gate operator or garage door opener. See **Gate Operator / Canadian Programming**.

4. Press and hold the HomeLink button you programmed for two seconds, then release. You may need to do this twice to activate the door. If your garage door does not operate, watch the HomeLink indicator light.

If the indicator light stays on, the programming is complete. No further action is needed.

If the indicator light flashes rapidly for 2 seconds and then turns to a constant light, the HomeLink button is not programmed yet. See **Programming Your Garage Door Opener Motor**.

To program additional buttons, repeat Steps 1 – 4.

For questions or comments, please contact HomeLink at www.homelink.com, www.youtube.com/HomeLinkGentex or 1-800-355-3515.

Programming Your Garage Door Opener Motor

Note: You may need a ladder to reach the unit and you may need to remove the cover or lamp lens on your garage door opener.



E142659

1. Press the learn button on the garage door opener motor and then you have 30 seconds to complete the next two steps.
2. Return to your vehicle.

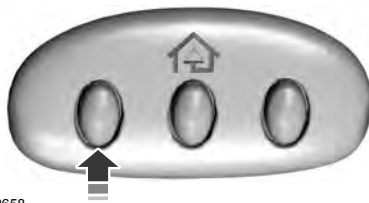

E142658

3. Press and hold the function button you want to program for 2 seconds, then release. Repeat this step. Depending on your brand of garage door opener, you may need to repeat this sequence a third time.

Universal Garage Door Opener (If Equipped)

Gate Operator / Canadian Programming

Canadian radio-frequency laws require transmitter signals to “time-out” (or quit) after several seconds of transmission – which may not be long enough for HomeLink to pick up the signal during programming. Similar to this Canadian law, some U.S. gate operators are designed to “time-out” in the same manner.

Note: *If programming a garage door opener or gate operator, it is advised to unplug the device during the “cycling” process to prevent possible overheating.*

1. Press and hold the HomeLink button while you press and release, **every two seconds**, your hand-held transmitter until the HomeLink indicator light changes from a slow to a rapidly blinking light.
2. Release both the HomeLink and hand-held transmitter buttons.
3. Continue programming HomeLink. See **In-Vehicle Programming**.

Erasing the Function Button Codes

Note: *You cannot erase individual buttons.*

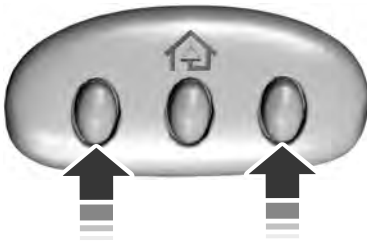

E142660

1. Press and hold the outer two function buttons simultaneously for approximately 20 seconds until the indicator lights above the buttons flash rapidly.
2. When the indicator lights flash, release the buttons. The codes for all buttons are erased.

Reprogramming a Single Button

To program a device to a previously trained button, follow these steps:

1. Press and hold the desired button. Do NOT release the button.
2. The indicator light will begin to flash after 20 seconds. Without releasing the button, follow Step 1 in the Programming section.

For questions or comments, contact HomeLink at www.homelink.com, www.youtube.com/HomeLinkGentex or 1-800-355-3515.

Programming to a Genie Intellicode 2 Garage Door Opener

Note: *The Genie Intellicode 2 transmitter must already be programmed to operate with the garage door opener.*

Note: *To program HomeLink to the transmitter you must first put the transmitter into programming mode.*

Universal Garage Door Opener (If Equipped)

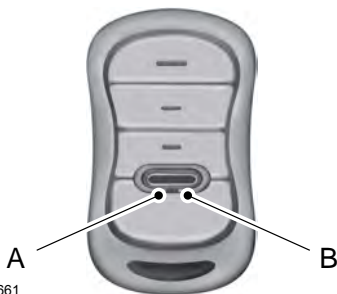

E142661

- A. Red indicator light
- B. Green indicator light

1. Press and hold one of the buttons on the hand-held transmitter for 10 seconds. The indicator light will change from green to red and green.
2. Press the same button twice to confirm the change to programming mode. If done properly the indicator light will appear red.
3. Hold the transmitter within 1–3 inches (2–8 centimeters) of the button on the visor you want to program.
4. Press and hold both the programmed Genie button on the hand-held transmitter and the button you want to program. The indicator light on the visor will flash rapidly when the programming is successful.

Note: *The Genie transmitter will transmit for up to 30 seconds. If HomeLink does not program within 30 seconds the Genie transmitter will need to be pressed again. If the Genie transmitter indicator light displays green and red, release the button until the indicator light turns off before pressing the button again.*

Once HomeLink has been programmed successfully, the Genie transmitter must be changed out of program mode. To do this:

1. Press and hold the previously programmed Genie button on the hand-held transmitter for 10 seconds. The indicator light will change from red to red and green.
2. Press the same button twice to confirm the change. If done correctly the indicator light will turn green.

Programming HomeLink to the Genie Intellicode Garage Door Opener Motor

Note: *You may need a ladder to access the garage door opener motor.*

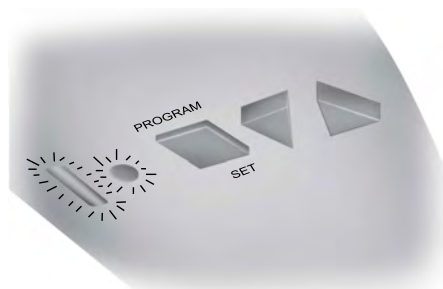

E142662

1. Press and hold the program button on the garage door opener motor until both blue indicator lights turn on.
2. Release the program button. Only the smaller round indicator light should be on.
3. Press and release the program button. The larger purple indicator light will flash.

Note: *The next two steps must be completed in 30 seconds.*

4. Press and release the Genie Intellicode 2 hand-held transmitter's previously programmed button. Both indicator lights on the garage door opener motor unit should now flash purple.

Universal Garage Door Opener (If Equipped)

5. Press and hold the previously programmed button on the visor for 2 seconds. Repeat this step up to 3 times until the garage door moves.

Programming is now complete.

Clearing a HomeLink Device

To erase programming from the three HomeLink buttons press and hold the two outer HomeLink buttons until the indicator light begins to flash. The indicator light will begin flashing in 10 to 20 seconds, at which time both buttons should be released. Programming has now been erased, and the indicator light should blink slowly to indicate the device is in train mode when any of the three HomeLink buttons are pressed.

FCC and RSS-210 Industry Canada Compliance

This device complies with Part 15 of the FCC Rules and with RSS-210 of Industry Canada. Operation is subject to the following two conditions: (1) this device may not cause harmful interference, and (2) this device must accept any interference received, including interference that may cause undesired operation.

Changes or modifications to your device not expressly approved by the party responsible for compliance can void the user's authority to operate the equipment.

Auxiliary Power Points

12 Volt DC Power Point

WARNINGS



Do not plug optional electrical accessories into the cigar lighter socket. Incorrect use of the cigar lighter can cause damage not covered by the vehicle warranty, and can result in fire or serious injury.



Do not use a power point for operating a cigar lighter. Incorrect use of the power points can cause damage not covered by the vehicle warranty, and can result in fire or serious injury.

Note: When you switch the ignition on, you can use the socket to power 12 volt appliances with a maximum current rating of 15 amps.

If the power supply does not work after you switch the ignition off, switch the ignition on.

Note: Do not hang any accessory from the accessory plug.

Note: Do not use the power point over the vehicle capacity of 12 volt DC 180 watts or a fuse may blow.

Note: Always keep the power point caps closed when not in use.

Do not insert objects other than an accessory plug into the power point. This will damage the power point and blow the fuse.

Run the vehicle for full capacity use of the power point.

To prevent the battery from running out of charge:

- Do not use the power point longer than necessary when the vehicle is not running.
- Do not leave devices plugged in overnight or when you park your vehicle for extended periods.

Locations

Power points may be in the following locations:

- On the front of the center console.
- Inside the center console.
- On the rear of the center console.

110 Volt AC Power Point (If Equipped)

WARNING



Do not keep electrical devices plugged in the power point whenever the device is not in use. Do not use any extension cord with the 110 volt AC power point, since it will defeat the safety protection design. Doing so may cause the power point to overload due to powering multiple devices that can reach beyond the 150 watt load limit and could result in fire or serious injury.

Note: The power point will turn off when the ignition is switched off or the battery voltage drops below 11 volts.

Use the power point for powering electric devices that require up to 150 watts. It is on the rear of the center console.

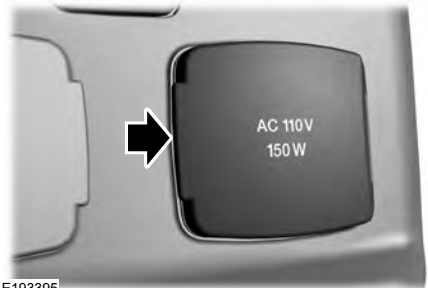

Note: Depending on your vehicle, the power point may open to the right or upward.

Auxiliary Power Points

When the indicator light on the power point is:

- On: The power point is working, the ignition is on and a device is plugged in.
- Off: The power point is off, the ignition is off or no device is plugged in.
- Flashing: The power point is in fault mode.

The power outlet temporarily turns off power when in fault mode if the device exceeds the 150 watt limit. Unplug your device and switch the ignition off. Switch the ignition back on, but do not plug your device back in. Let the system cool off and switch the ignition off to reset the fault mode. Switch the ignition back on and make sure the indicator light remains on.

Do not use the power point for certain electric devices, including:

- Cathode-ray, tube-type televisions.
- Motor loads, such as vacuum cleaners, electric saws and other electric power tools or compressor-driven refrigerators.
- Measuring devices, which process precise data, such as medical equipment or measuring equipment.
- Other appliances requiring an extremely stable power supply such as microcomputer-controlled electric blankets or touch-sensor lamps.

Storage Compartments

CENTER CONSOLE (If Equipped)

Stow items in the cup holder carefully as items may become loose during hard braking, acceleration or crashes, including hot drinks which may spill.

Available console features include:

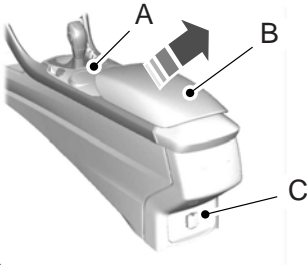

E143942

- A Cup holder.
- B Storage compartment with auxiliary power point and USB port.
- C Auxiliary power point.

Center Console with Rotary Control (If Equipped)

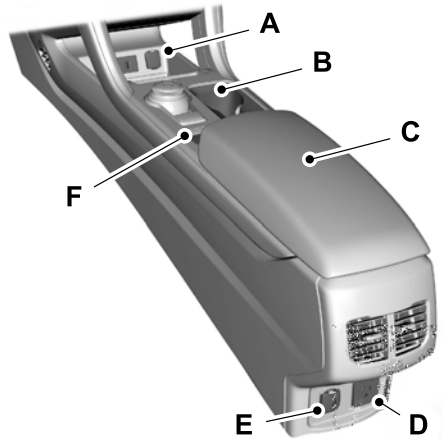

E222012

- A Front storage compartment with USB ports and auxiliary power point.
- B Cup holder.
- C Storage compartment with auxiliary power point and media hub.
- D 110 volt AC power point.
- E Auxiliary power point.
- F Switch pack.

Storage Compartments

OVERHEAD CONSOLE

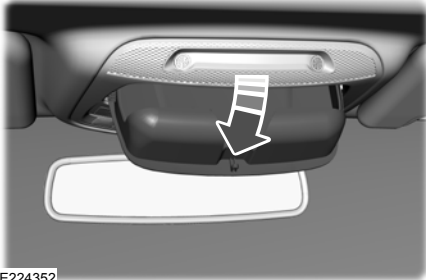

E224352

Press near the rear edge of the door to open it.

Starting and Stopping the Engine

GENERAL INFORMATION

WARNINGS

 Extended idling at high engine speeds can produce very high temperatures in the engine and exhaust system, creating the risk of fire or other damage.

 Do not park, idle or drive your vehicle on dry grass or other dry ground cover. The emission system heats up the engine compartment and exhaust system, creating the risk of fire.

 Do not start the vehicle in a closed garage or in other enclosed areas. Exhaust fumes can be toxic. Always open the garage door before you start the vehicle.

 If you smell exhaust fumes inside your vehicle, have your vehicle checked by an authorized dealer immediately. Do not drive your vehicle if you smell exhaust fumes.

If you disconnect the battery, your vehicle may exhibit some unusual driving characteristics for approximately 5 mi (8 km) after you reconnect it. This is because the engine management system must realign itself with the engine. You can disregard any unusual driving characteristics during this period.

The powertrain control system meets all Canadian interference-causing equipment standard requirements regulating the impulse electrical field or radio noise.

When you start your vehicle, avoid pressing the accelerator pedal until the ready to drive indicator illuminates. Only use the accelerator pedal when you have difficulty starting your vehicle.

KEYLESS STARTING

Note: The system may not function if the passive key is close to metal objects or electronic devices, for example keys or a cell phone.

Note: A valid passive key must be located inside your vehicle to switch the ignition on and start your vehicle.

Ignition Modes



E144447

The keyless starting system has three modes:

Off: Turns the ignition off.

- Without applying the brake pedal, press and release the button once when the ignition is in the on mode, or when your vehicle is running but is not moving.

On: All electrical circuits are operational and the warning lamps and indicators illuminate.

- Without applying the brake pedal, press and release the button once.

Start: Starts your vehicle. The engine may not start when your vehicle starts.

- Press the brake pedal, and then press the button for any length of time. An indicator light on the button illuminates when the ignition is on and when your vehicle starts.

Starting and Stopping the Engine

STARTING A GASOLINE ENGINE

When you start the engine, the idle speed increases. This helps to warm up the engine. If the engine idle speed does not slow down automatically, have your vehicle checked by an authorized dealer.

Note: You can crank the engine for a total of 60 seconds without the engine starting before the starting system temporarily disables. The 60 seconds does not have to be all at once. For example, if you crank the engine three times for 20 seconds each time, without the engine starting, you reached the 60-second time limit. A message appears in the information display alerting you that you exceeded the cranking time. You cannot attempt to start the engine for at least 15 minutes. After 15 minutes, you are limited to a 15-second engine cranking time. You need to wait 60 minutes before you can crank the engine for 60 seconds again.

Before starting your vehicle, check the following:

- Make sure all occupants have fastened their seatbelts.
- Make sure the headlamps and electrical accessories are off.
- Make sure the parking brake is on.
- Make sure the transmission is in park (P).

Starting Your Vehicle

Note: Do not touch the accelerator pedal.

Note: You must have your intelligent access key in your vehicle to shift the transmission out of park (P).

Note: The green ready indicator illuminates letting you know that the vehicle is ready for driving. Since your vehicle is equipped with a silent key start, the engine may not start at the time of the vehicle start. See **Hybrid Vehicle Operation** (page 146).

1. Fully depress the brake pedal.
2. Briefly press the push button ignition switch.

Failure to Start

The system does not function if:

- The key frequencies are jammed.
- The key battery has no charge.

If you are unable to start your vehicle, do the following:

1. Remove the key blade from the transmitter.

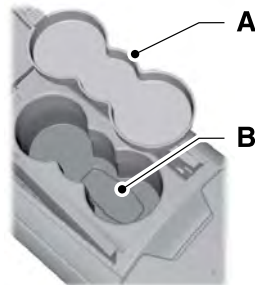

E155835

2. Remove the rubber covering (A) from the cup holder. With the buttons facing upward and the unlock button facing the front of your vehicle, place the first intelligent access key into the backup slot (B).
3. Press the push button ignition switch.

If you cannot start the engine after three attempts, wait 10 seconds and follow this procedure:

1. Apply the parking brake.
2. Fully depress the brake pedal.

Starting and Stopping the Engine

3. Shift into park (P).
4. Fully press the accelerator pedal.
5. Briefly press the push button ignition switch.

Fast Restart

The fast restart feature allows you to restart your vehicle within 20 seconds of switching it off, even if it does not detect a valid passive key.

Within 20 seconds of switching the engine off, press the brake pedal and press the push button ignition switch. After 20 seconds, you can no longer start your vehicle if it does not detect a valid passive key.

Once your vehicle starts, it remains running until you press the push button ignition switch, even if your vehicle does not detect a valid passive key. If you open and close a door while your vehicle is running, the system searches for a valid passive key. After 20 seconds, you can no longer start your vehicle if it does not detect a valid passive key.

Automatic Engine Shutdown

This feature automatically shuts down your vehicle if it has been idling for an extended period. The ignition also turns off to save battery power. Before your vehicle shuts down, a message appears in the information display showing a timer counting down. If you do not intervene within 30 seconds, your vehicle shuts down. Another message appears in the information display to inform you that your vehicle has shut down to save fuel. Start your vehicle as normal.

Automatic Engine Shutdown Override

Note: You cannot permanently switch off the automatic shutdown. When you switch it off temporarily, it turns on at the next ignition cycle.

You can stop the shutdown, or reset the timer, at any point before the 30-second countdown has expired by doing any of the following:

- Interacting with your vehicle, for example pressing the brake or accelerator pedal.
- You can temporarily switch off the shutdown any time the ignition is on using the information display. See **Information Displays** (page 94).
- During the countdown before shutdown, you are prompted to press OK or RESET (depending on your type of information display) to temporarily switch the feature off (for the current ignition cycle only).

Stopping the Engine When Your Vehicle is Stationary

Note: The ignition, all electrical circuits and all warning lamps and indicators will be turned off.

Note: If your vehicle is left running for 30 minutes without any interaction, it automatically shuts down.

1. Apply the parking brake.
2. Shift into park (P).
3. Briefly press the push button ignition switch.

Stopping the Engine When Your Vehicle is Moving

WARNING



Switching off the engine when the vehicle is still moving will result in a loss of brake and steering assistance. The steering will not lock, but higher effort will be required. When the ignition is switched off, some electrical circuits, including air bags, warning lamps and indicators may also be off. If the ignition was turned off accidentally, you can shift into neutral (N) and re-start the engine.

Starting and Stopping the Engine

1. Shift into neutral and use the brakes to bring your vehicle to a safe stop.
2. When your vehicle has stopped, shift into park (P).
3. Apply the parking brake.
4. Press and hold the push button ignition switch, or press it three times within two seconds.

Guarding Against Exhaust Fumes

WARNING



If you smell exhaust fumes inside your vehicle, have your vehicle checked by your authorized dealer immediately. Do not drive your vehicle if you smell exhaust fumes. Carbon monoxide is present in exhaust fumes. Take precautions to avoid its dangerous effects.

Important Ventilating Information

If you stop your vehicle and then leave the engine idling for long periods, we recommend that you do one of the following:

- Open the windows at least 1 in (3 cm).
- Set your climate control to outside air.

ENGINE BLOCK HEATER (If

Equipped)

WARNINGS



Failure to follow engine block heater instructions could result in property damage or serious personal injury.



Do not use your heater with ungrounded electrical systems or two-pronged adapters. There is a risk of electrical shock.

Note: *The heater is most effective when outdoor temperatures are below 0°F (-18°C).*

The heater acts as a starting aid by warming the engine coolant. This allows the climate control system to respond quickly. The equipment includes a heater element (installed in the engine block) and a wire harness. You can connect the system to a grounded 120-volt AC electrical source.

We recommend that you do the following for a safe and correct operation:

- Use a 16-gauge outdoor extension cord that is product certified by Underwriter's Laboratory (UL) or Canadian Standards Association (CSA). This extension cord must be suitable for use outdoors, in cold temperatures, and be clearly marked Suitable for Use with Outdoor Appliances. Do not use an indoor extension cord outdoors. This could result in an electric shock or become a fire hazard.
- Use as short an extension cord as possible.
- Do not use multiple extension cords.
- Make sure that when in operation, the extension cord plug and heater cord plug connections are free and clear of water. This could cause an electric shock or fire.
- Make sure your vehicle is parked in a clean area, clear of combustibles.
- Make sure the heater, heater cord and extension cord are firmly connected.
- Check for heat anywhere in the electrical hookup once the system has been operating for approximately 30 minutes.
- Make sure the heater system is checked for proper operation before winter.

Starting and Stopping the Engine

Using the Engine Block Heater

The engine block heater plug is located in a housing in the left fog lamp bezel. Open the hinged, circular door and make sure the receptacle terminals are clean and dry prior to use. Clean them with a dry cloth if necessary.

The heater uses 0.4 to 1.0 kilowatt-hours of energy per hour of use. The system does not have a thermostat. It will achieve maximum temperature after approximately three hours of operation. If you use the heater longer than three hours, this will not improve system performance and will use unnecessary electricity.

Unique Driving Characteristics

HYBRID VEHICLE OPERATION

This hybrid vehicle combines electric and gasoline propulsion to provide breakthrough performance and improved efficiency.

Familiarizing yourself with these unique characteristics will provide an optimal driving experience from your new vehicle.

Note: *You may notice higher engine speeds upon start-up. This temporary condition is normal and necessary to heat up the cabin and minimize emissions.*

Starting:



When you start your vehicle, a green ready indicator light will appear in the lower right portion of the instrument cluster and a ready to drive message will appear in the middle of the left cluster screen, letting you know that your vehicle is ready for driving.

The engine may not start because this vehicle is equipped with silent key start. This fuel saving feature allows your vehicle to be ready-to-drive without requiring the gas engine to be running. This indicator will remain on while your vehicle is on, whether the engine is running or not to indicate your vehicle is capable of movement (using its electric motor, engine, or both). Typically, the engine will not start unless the vehicle is cold, a climate control change is requested, or the accelerator is pressed.

Driving:

The gas engine automatically starts and stops to provide power when needed and to save fuel when not needed. While coasting at low speeds, coming to a stop, or standing, the gas engine normally shuts down and your vehicle operates in electric-only mode.

Conditions that may cause the engine to start up or remain running include:

- Considerable vehicle acceleration.
- Vehicle speed above 85 mph (137 km/h). However, the maximum speed for electric-only operation may be lower while driving in hot temperatures or on hilly terrain.
- Ascending a hill.
- Charge level of high voltage battery is low.
- Very high or low outside temperature (to provide system cooling or heating). For Energi vehicles, climate control demands by passengers may not directly cause the engine to run. This only occurs when the high voltage battery charge is low, or if the outside temperature is cold enough to require the engine to provide additional heat for the cabin.
- Engine not warm enough to provide passenger requested cabin temperature.

Stopping:

The gas engine may shut off to conserve fuel as you come to a stop. Restarting your vehicle is not required. Simply step on the accelerator when you are ready to drive.

Transmission Operation:

Due to the technologically advanced, electronically-controlled continuously variable transaxle, you will not feel shift changes like those of a non-hybrid vehicle.

Note: *Since engine speed is controlled by the transmission, it may seem elevated at times. This is normal hybrid operation and helps deliver fuel efficiency and performance.*

Unique Driving Characteristics

Neutral:

It is not recommended to idle the vehicle in neutral (N) for an extended period of time because this will discharge your high voltage battery and decrease fuel economy. The engine will not start or stop, and cannot provide power to the hybrid system in neutral (N).

Low:

Low (L) is designed to mimic the enhanced engine braking available in non-hybrid vehicles. Low gear will produce high engine speeds to provide necessary engine braking. This is normal and will not damage your vehicle. In low gear, the gas engine will remain on more often than in drive (D).

Reverse:

In reverse (R), vehicle speed is limited to 22 mph (35 km/h).

Battery:

Your hybrid is equipped with a high voltage battery. A cool battery maintains battery life and provides the best possible performance. The high voltage battery is cooled by cabin air drawn from vent holes in the trim panels behind the rear seats. Avoid placing objects at the vent holes that block airflow to the high voltage battery.

Engine:

The engine speed in your hybrid is not directly tied to your vehicle speed. Your vehicle's engine and transmission are designed to deliver the power you need at the most efficient engine speed. During heavy accelerations, your hybrid may reach high engine speeds (up to 6000 RPM).

In prolonged mountainous driving, you may see the engine speed changing without your input. This is intentional and maintains the battery charge level. You may also notice during extended downhill driving that your engine continues to run instead of shutting off.

During this engine braking, the engine stays on, but it is not using any fuel. You may also hear a slight whine or whistle when operating your vehicle. This is the normal operation of the electric generator in the hybrid system.

During certain events (such as vehicle servicing) your low voltage 12-volt battery may become disconnected or disabled. Once the battery is reconnected and after driving the vehicle, the engine may continue to operate for three to five seconds after the key is turned to off. This is a normal condition.

Braking:

Your hybrid is equipped with standard hydraulic braking and regenerative braking. Regenerative braking is performed by your transmission and it captures brake energy and stores it in your high voltage battery.

Driving to Optimize Fuel Economy

Note: *Having your engine running is not always an indication of inefficiency. In some cases, it is actually more efficient than driving in electric mode.*

Your fuel economy should improve throughout your hybrid's break-in period. As with any vehicle, your driving habits and accessory usage can significantly impact your fuel economy. For best results, keep in mind these tips:

Unique Driving Characteristics

- Keep the tires properly inflated and only use the recommended size.
- Aggressive driving increases the amount of energy required to move your vehicle. In general, you can achieve better fuel economy with mild to moderate acceleration and deceleration. Moderate braking is particularly important since it allows you to maximize the energy captured by the regenerative braking system.

Additional Tips:

- Do not carry extra loads.
- Be mindful of adding external accessories that may increase aerodynamic drag.
- Observe posted speed limits.
- Perform all scheduled maintenance.
- There is no need to wait for your engine to warm up. The vehicle is ready to drive immediately after starting.

EV+ Mode

Your vehicle will recognize your frequent destinations and allow for more EV driving as you approach them. For example, when nearing your home it should be easier to stay in electric mode. The EV indicator will display EV+ when this mode is active. You should see this approximately 1/8 mile (200 meters) from a frequent destination. See **Information Displays** (page 94).

Note: *Frequent destinations are learned by your vehicle after two to four weeks of use. To add a destination immediately, perform the following process: cycle the ignition on for 2 seconds, but do not start your vehicle, then off for 2 seconds. Repeat the process 10 times. This location is now programmed for EV+. You can clear these destinations with a Driving History reset through the Settings menu.*

Note: *You can switch the EV+ feature on or off through the Driver Assist section of the Settings menu.*

PLUG-IN HYBRID VEHICLE OPERATION

Plug-in Power Mode and Hybrid Mode

You must plug in your Energi vehicle regularly for optimal use of the high voltage battery's extended range capability. Charging your vehicle adds electrical energy. This energy is used to propel the vehicle in plug-in power mode.

Estimated electric range is shown in blue next to gasoline range at the bottom of the right information display. You can also configure MyView to include detailed vehicle range information. See **Gauges** (page 86).

The system maximizes the use of electric-only operation in plug-in power mode. System conditions may require engine operation; however, the system uses plug-in power whenever possible.

When your plug-in power is depleted, the powertrain system will automatically switch to hybrid mode. Hybrid mode uses both the gasoline engine and electric motor to power your vehicle and maximize fuel economy.

EV Modes

EV Your vehicle contains selectable EV modes through the EV button located on the center of the instrument panel, below the climate controls.

Unique Driving Characteristics

These modes are available when your vehicle can run under high voltage battery power. With your vehicle in driving mode, you can change EV modes with each press of the EV button. The current mode will be displayed in the left-hand instrument cluster screen.

Auto EV



This mode provides an automatic use of high voltage battery power during the drive, staying in electric mode when possible and running the engine when needed. This mode will be the only one available if the plug-in power has been depleted.

EV Now



This mode provides an electric only driving experience. The left-hand information display changes to a screen displaying your average miles or kilometers per charge along with EV specific tools and functions.

Your vehicle may accelerate more slowly and the top speed may be lower in EV Now mode than in Auto EV mode.

You can enable your engine at any time by using one of the following methods:

1. Press the OK button on the left 5-way steering wheel control while viewing the miles or kilometers per charge screen. Your vehicle will enable the engine as needed, and will automatically return to EV Now after eight seconds or when the engine is no longer needed.
2. Press the accelerator pedal fully. A pop up message will appear. Press OK on the left-hand steering wheel button to activate as needed. The message will disappear if you release the accelerator pedal.

3. Press the EV button. This will change the mode to EV Later and permit engine operation.

Your vehicle may automatically enter Engine Enabled mode if system conditions require it. A engine enabled message will display if this occurs. This is normal function, and your vehicle will return to EV Now when possible.

Your vehicle may enter Enable Engine mode if the climate control is in a defrost mode and the outside temperature is cold. A engine enabled message will display if this occurs. If defrost is not needed, select a different climate control mode to permit EV Now.

When you enable EV Now, a blue EV icon displays in the left-hand information display. If your vehicle is in the Engine Enabled mode, the EV icon will be yellow.

EV Now will automatically exit when the Plug in power has been depleted.

EV Later



This mode saves most of the high voltage battery plug in power for future use (for example, your initial drive is at high speeds on open roads, but later your drive will be at low speeds in an urban area where plug-in power usage is most efficient). Your vehicle will run the engine as needed and keep most of the high voltage battery plug in power for later use in Auto Mode or EV Now mode.

When you enable EV Later, a white EV Later icon appears on the left-hand information display.

The EV Later mode will automatically reset to EV Auto mode when you power your vehicle off. You may press the EV button twice during the next drive to return to EV Later mode, if desired.

Unique Driving Characteristics

ECO Cruise

Note: ECO Cruise is available as a separate feature on Energi vehicles only. On non plug-in vehicles it is included in EcoSelect.

This feature saves vehicle energy by relaxing acceleration compared to standard cruise control. For example, your vehicle may temporarily lose speed when going uphill. When set to on, ECO appears in the information display when cruise control is on.

You can switch it on or off in through the information display. See **General Information** (page 94).

Settings	
Driver Assist	ECO Cruise

Low Engine Use

The low engine use mode is equipped on Energi models only. The Low Engine Use mode maintains proper engine lubrication at sufficient temperature, and will activate automatically when you drive your vehicle with limited engine operation. When your vehicle is in low engine use mode, your vehicle will automatically run the engine as necessary.

Note: If your vehicle is in low engine use mode when you start your vehicle, a message will appear in the information display. See **Information Messages** (page 103).

If you select the EV Now mode while the vehicle is in the low engine use mode, EV Now mode will be suspended for as long as you are in low engine use mode. The low engine use mode will resume the next time you start your vehicle and will automatically stop when no longer needed.

Note: Cold temperatures will affect the engine warm up time and the low engine use mode may operate more frequently.

Note: An oil change is not required but gives you the option of not running a low engine use cycle. Resetting the oil life monitoring system will suspend the low engine use mode.

Fuel Freshness

See **Fuel Quality** (page 154).

ECOSELECT (If Equipped)

EcoSelect is a drive mode for non plug-in vehicles designed to offer the best possible fuel economy with tradeoffs in vehicle performance and comfort.



To switch EcoSelect on, press the **ECO** button.

A graphic displays on your information display when EcoSelect is on.

Your vehicle will remember the last selected mode whenever you start your vehicle.

EcoSelect allows your vehicle to operate more efficiently. You will notice:

- Less aggressive cooling.
- Softer acceleration.
- Increased deceleration when coasting.
- Changes in engine behavior.
- ECO cruise control activation.

Unique Driving Characteristics

HYBRID VEHICLE FREQUENTLY ASKED QUESTIONS

Question	Answer
What are the series of clicks from the cargo area when I first turn the key in the ignition?	The high voltage battery is electrically isolated from the rest of the vehicle when the key is off. When you switch the key on, high voltage contactors inside the battery are closed to make the electricity available to the motor and generator and enable the vehicle to drive. The clicks are the sound of these contactors as they close and open during start up and shut down.
Why does the engine sometimes start at key-on?	The vehicle's computer will determine if an engine start is required at key-on. Silent key start will start the engine if it is necessary for cabin heating, windshield defrost, or if the outside temperature is low. (For C-MAX Energi vehicles, the engine may not be required to operate these functions.)
Why does it take a long time before the engine shuts down?	There are several reasons the engine stays on for an extended amount of time when you first start it. One common reason is to make sure that the emissions components are warm enough to minimize tailpipe emissions. As the climate gets cooler, this engine-on time is extended.
Why does my engine never shut down above 85 mph (137 km/h)	The engine is required to turn on above this speed to protect the transmission hardware.
Why does my engine stay on when it is extremely cold outside?	In order to make sure that the climate control system can begin heating the cabin or defrosting the windshield as soon as a driver requests it, the engine coolant temperature has to be kept sufficiently hot. Keeping the engine on is required to maintain the correct coolant temperature.

Unique Driving Characteristics

Question	Answer
Why does my engine rev up so high some-times when I accelerate?	Your vehicle's engine and transmission are designed to deliver the power you need at the most efficient engine speed. This may be higher than expected during heavy accelerations, and may fluctuate when driving at a steady speed. These are characteristics of the Atkinson engine cycle and the transmission technology that help maximize your hybrid's fuel economy.
What is the fan noise I hear from the rear of my hybrid?	The fan noise comes from a fan located next to the high voltage battery pack. This fan turns on when the battery requires cooling air. The fan speed, and associated noise level, will change according to the amount of cooling required to maintain good performance. Maintaining the battery temperature at optimal conditions also prolongs the useful life of the battery and helps to achieve better fuel economy.
What is the engine oil change service interval?	Change the engine oil every 10000 miles (16000 kilometers) or once per year under normal operating conditions.
Can I put E15 or E85 in my vehicle, and how will it affect my fuel economy?	Your hybrid vehicle can use E15 (15% ethanol, 85% gasoline) fuel, but you may notice slightly reduced fuel economy because ethanol contains less energy per gallon than gasoline. Your hybrid vehicle is not designed to use E85 (85% ethanol).
How long will my high voltage battery last? Does it need maintenance?	The high voltage battery system is designed to last the life of the vehicle and requires no maintenance.
Can you charge the battery with a plug into an A/C outlet?	There are no provisions for charging the high voltage battery from a power supply external to the vehicle. (For C-MAX Energi vehicles, the vehicle can be plugged into a 110-volt outlet with charge cord provided.)
Can I tow the hybrid behind my motor home with all four wheels down?	Yes. Your hybrid vehicle can be flat towed without modification. See Towing (page 223).

Fuel and Refueling

SAFETY PRECAUTIONS

WARNINGS



Do not overfill the fuel tank. The pressure in an overfilled tank may cause leakage and lead to fuel spray and fire.



The fuel system may be under pressure. If you hear a hissing sound near the fuel filler inlet, do not refuel until the sound stops. Otherwise, fuel may spray out, which could cause serious personal injury.



Fuels can cause serious injury or death if misused or mishandled.



Flow of fuel through a fuel pump nozzle can produce static electricity. This can cause a fire if you are filling an ungrounded fuel container.



Fuel may contain benzene, which is a cancer-causing agent.



When refueling always shut the engine off and never allow sparks or open flames near the fuel tank filler valve. Never smoke or use a cell phone while refueling. Fuel vapor is extremely hazardous under certain conditions. Avoid inhaling excess fumes.

Observe the following guidelines when handling automotive fuel:

- Extinguish all smoking materials and any open flames before refueling your vehicle.
- Always turn off the vehicle before refueling.
- Automotive fuels can be harmful or fatal if swallowed. Fuel such as gasoline is highly toxic and if swallowed can cause death or permanent injury. If fuel is swallowed, call a physician immediately, even if no symptoms are immediately apparent. The toxic effects of fuel may not be visible for hours.
- Avoid inhaling fuel vapors. Inhaling too much fuel vapor of any kind can lead to eye and respiratory tract irritation. In severe cases, excessive or prolonged breathing of fuel vapor can cause serious illness and permanent injury.
- Avoid getting fuel liquid in your eyes. If fuel is splashed in the eyes, remove contact lenses (if worn), flush with water for 15 minutes and seek medical attention. Failure to seek proper medical attention could lead to permanent injury.
- Fuels can also be harmful if absorbed through the skin. If fuel is splashed on the skin, clothing or both, promptly remove contaminated clothing and wash skin thoroughly with soap and water. Repeated or prolonged skin contact with fuel liquid or vapor causes skin irritation.
- Be particularly careful if you are taking Antabuse or other forms of Disulfiram for the treatment of alcoholism. Breathing gasoline vapors could cause an adverse reaction, serious personal injury or sickness. If fuel is splashed on the skin, wash the affected areas immediately with plenty of soap and water. Consult a physician immediately if you experience any adverse reactions.

Fuel and Refueling

FUEL QUALITY

Choosing the Right Fuel

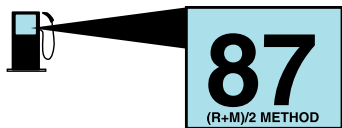

E161513

We recommend regular unleaded gasoline with a minimum pump (R+M)/2 octane rating of 87. Some fuel stations offer fuels posted as regular unleaded gasoline with an octane rating below 87, particularly in high altitude areas. We do not recommend fuels with an octane rating below 87.

Do not use any fuel other than those recommended because they could lead to engine damage that may not be covered by the vehicle Warranty.

Note: *Use of any fuel other than those recommended can impair the emission control system and cause a loss of vehicle performance.*

Do not use:

- Diesel fuel.
- Fuels containing kerosene or paraffin.
- Fuel containing more than 15% ethanol or E85 fuel.
- Fuels containing methanol.
- Fuels containing metallic-based additives, including manganese-based compounds.
- Fuels containing the octane booster additive, methylcyclopentadienyl manganese tricarbonyl (MMT).
- Leaded fuel (using leaded fuel is prohibited by law).

The use of fuels with metallic compounds such as methylcyclopentadienyl manganese tricarbonyl (commonly known as MMT), which is a manganese-based fuel additive, will impair engine performance and affect the emission control system.

Do not be concerned if the engine sometimes knocks lightly. However, if the engine knocks heavily while using fuel with the recommended octane rating, contact an authorized dealer to prevent any engine damage.

Fuel Freshness Mode (if Equipped)

This helps keep the fuel system functional and the fuel fresh.

If you mainly use your vehicle in electric power mode without refueling, the gasoline in the fuel tank may become stale due to aging. Stale gasoline can damage the engine and fuel system.

Your vehicle automatically switches to fuel freshness mode if you do not refuel your vehicle with fresh fuel within an 18-month period. Fuel freshness mode protects your vehicle from potential engine and fuel system damage caused by using stale fuel.

Note: *If you do not add new fuel during an 18-month period, fuel freshness mode will use fuel until approximately 1.2 gal (4.5 L) of fuel remains in the fuel tank.*

During fuel freshness mode:

- The information display will indicate fuel freshness mode is active.
- The vehicle will only run in hybrid mode. EV Now mode will not be available.
- Most of the plug-in power will be stored until fuel freshness mode is completed.

Note: *EV Now mode resumes when less than 1.2 gal (4.5 L) of fuel remains in the fuel tank.*

Fuel and Refueling

Note: When the fuel level is less than one-quarter full, refueling your vehicle will end fuel freshness mode.

Note: We recommend you use a fuel stabilizer if you use less than a full tank of fuel during an 18-month period.

FUEL FILLER FUNNEL LOCATION

The fuel filler funnel is located under the luggage compartment floor covering.



E163066

RUNNING OUT OF FUEL

Running out of fuel can cause damage not covered by the vehicle Warranty.

If your vehicle runs out of fuel:

- Add a minimum of 1.3 gal (5 L) of fuel to restart the engine. If your vehicle is out of fuel and on a steep slope, more fuel may be required.
- You may need to switch the ignition from off to on several times after refueling to allow the fuel system to pump the fuel from the tank to the engine. When restarting, cranking time takes a few seconds longer than normal.

Filling a Portable Fuel Container

Use the following guidelines to avoid electrostatic charge build-up, which can produce a spark, when filling an ungrounded fuel container:

- Only use an approved fuel container to transfer fuel to your vehicle. Place the container on the ground when filling it.
- Do not fill a fuel container when it is inside your vehicle (including the cargo area).
- Keep the fuel pump nozzle in contact with the fuel container when filling it.
- Do not use a device that holds the fuel pump nozzle lever in the fill position.

Adding Fuel From a Portable Fuel Container

WARNINGS

 Do not insert the nozzle of a fuel container or an aftermarket funnel into the fuel system filler neck. This may damage the fuel system filler neck or its seal and cause fuel to run onto the ground.

 Do not try to pry open or push open the capless fuel system with foreign objects. This could damage the fuel system and its seal and cause injury to you or others.

 Do not dispose of fuel in the household refuse or the public sewage system. Use an authorized waste disposal facility.

When refueling the vehicle fuel tank from a fuel container, use the plastic funnel included with your vehicle. See **Fuel Filler Funnel Location** (page 155).

Note: Do not use aftermarket funnels as they will not work with the capless fuel system and can damage it.

Fuel and Refueling

When refueling the vehicle fuel tank from a fuel container, do the following:

1. Fully open the fuel tank filler door until it engages.
2. Fully insert the plastic funnel into the fuel tank filler pipe opening.



E157452

3. Add fuel to your vehicle from the fuel container.
4. Remove the plastic funnel from the fuel tank filler pipe opening.
5. Fully close the fuel tank filler door.
6. Clean the plastic funnel and place it back in your vehicle or properly dispose of it.







Note: *Extra funnels can be purchased from an authorized dealer if you choose to dispose of the funnel.*

REFUELING

WARNINGS

-  Do not overfill the fuel tank. The pressure in an overfilled tank may cause leakage and lead to fuel spray and fire.

WARNINGS

-  Do not try to pry open or push open the capless fuel system with foreign objects. This could damage the fuel system and its seal and cause injury to you or others.
-  Do not remove the fuel pump nozzle from its fully inserted position when refueling.
-  When refueling always shut the engine off and never allow sparks or open flames near the fuel tank filler valve. Never smoke or use a cell phone while refueling. Fuel vapor is extremely hazardous under certain conditions. Avoid inhaling excess fumes.
-  Stop refueling when the fuel pump nozzle automatically shuts off for the first time. Failure to follow this will fill the expansion space in the fuel tank and could lead to fuel overflowing.
-  Wait at least 10 seconds before removing the fuel pump nozzle to allow any residual fuel to drain into the fuel tank.
-  The fuel system may be under pressure. If you hear a hissing sound near the fuel filler door, do not refuel until the sound stops. Otherwise, fuel may spray out, which could cause serious personal injury.
-  Read and follow all the instructions on the pump island.

1. When you stop your vehicle, shift into park (P) or neutral (N) and switch the ignition off.

Fuel and Refueling



E146221

2. Press the button on the driver door to open the fuel filler door. The fuel filler door can take up to 15 seconds to open before you can insert a fuel filler nozzle.

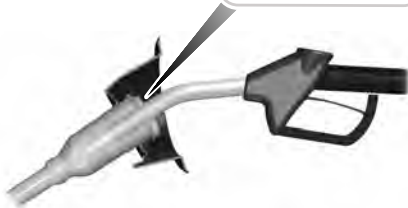
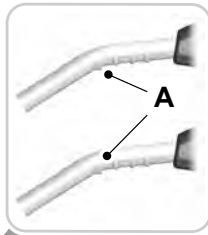

E139202

3. Insert the fuel pump nozzle up to the first notch on the nozzle A. Keep it resting on the cover of the fuel tank filler pipe opening.

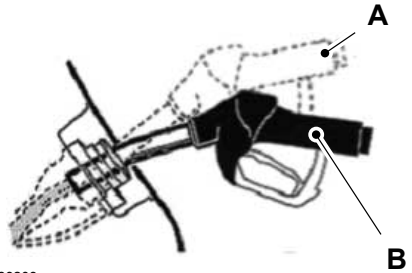

E139203

4. Hold the fuel pump nozzle in position B when refueling. Holding the fuel nozzle in position A can affect the flow of fuel and shut off the fuel nozzle before the fuel tank is full.

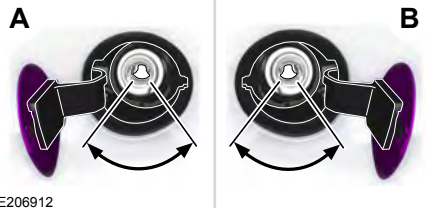

E206912

5. Operate the fuel pump nozzle within the area shown.



E119081

6. Slightly raise the fuel pump nozzle and then slowly remove it.
7. Fully close the fuel tank filler door.

Note: To close the fuel filler door, press the center rear edge of the fuel filler door and then release.

Fuel and Refueling

You must complete the refueling process within 20 minutes. If 20 minutes elapses, you must press the button on the driver door again. Fuel pump nozzle automatic shut off may occur if you do not press the button on the driver door.

System Warnings

If the fuel filler door fails to open, an information message appears in the information display.

Message	Description and Action
Refuel Error See Manual	A warning message appears in the information display when the fuel system fails to depressurize or the fuel filler door fails to open. You may have to use the fuel filler door manual override lever.

If the information message appears, do the following:

1. Check the fuel filler door for anything that may be obstructing its movement, for example ice or snow.
2. Remove any obstruction from the fuel filler door.
3. Press the button on the driver door to open the fuel filler door.
4. If the fuel filler door fails to open and the information message remains in the information display, use the fuel filler door manual override lever.

Fuel Filler Door Manual Override Lever

The manual override lever is in the luggage compartment on the left-hand side.

Note: The transmission must be in park (P) or neutral (N).

When using the manual override lever do the following:

1. Switch the ignition on.

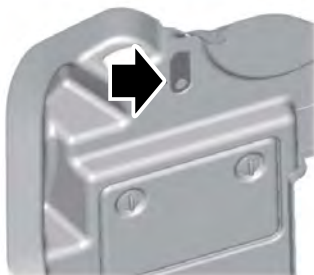

E156033

2. Pull the manual override lever.
3. Switch the ignition off.
4. Complete the refueling process within 20 minutes.

FUEL CONSUMPTION

Note: The amount of usable fuel in the empty reserve varies and should not be relied upon to increase driving range. When refueling your vehicle after the fuel gauge indicates empty, you might not be able to refuel the full amount of the advertised capacity of the fuel tank due to the empty reserve still present in the tank.

Empty reserve is the amount of fuel remaining in the tank after the fuel gauge indicates empty. Do not rely on this fuel for driving. The usable capacity of the fuel tank is the amount of fuel that can be put into the tank after the gauge indicates empty. The advertised capacity is the total fuel tank size – it is the combined usable capacity plus the empty reserve.

Filling the Tank

For consistent results when filling the fuel tank:

Fuel and Refueling

- Turn the ignition off before fueling; an inaccurate reading results if the engine is left running.
- Use the same fill rate (low-medium-high) each time the tank is filled.
- Allow no more than two automatic click-offs when filling.

Results are most accurate when the filling method is consistent.

Calculating Fuel Economy

Do not measure fuel economy during the first 1000 miles (1600 kilometers) of driving (this is your engine's break-in period); a more accurate measurement is obtained after 2000 miles - 3000 miles (3200 kilometers - 4800 kilometers). Also, fuel expense, frequency of fill ups or fuel gauge readings are not accurate ways to measure fuel economy.

1. Fill the fuel tank completely and record the initial odometer reading.
2. Each time you fill the tank, record the amount of fuel added.
3. After at least three to five tank fill ups, fill the fuel tank and record the current odometer reading.
4. Subtract your initial odometer reading from the current odometer reading.
5. Calculate fuel economy by dividing miles traveled by gallons used (For Metric: Multiply liters used by 100, then divide by kilometers traveled).

Keep a record for at least one month and record the type of driving (city or highway). This provides an accurate estimate of the vehicle's fuel economy under current driving conditions. Additionally, keeping records during summer and winter show how temperature impacts fuel economy. In general, lower temperatures mean lower fuel economy.

EMISSION CONTROL SYSTEM

WARNINGS



Do not park, idle, or drive your vehicle in dry grass or other dry ground cover. The emission system heats up the engine compartment and exhaust system, which can start a fire.



Exhaust leaks may result in entry of harmful and potentially lethal fumes into the passenger compartment. If you smell exhaust fumes inside your vehicle, have your dealer inspect your vehicle immediately. Do not drive if you smell exhaust fumes.

Your vehicle is equipped with various emission control components and a catalytic converter that will enable your vehicle to comply with applicable exhaust emission standards.

To make sure that the catalytic converter and other emission control components continue to work properly:

- Use only the specified fuel listed.
- Avoid running out of fuel.
- Do not turn off the ignition while your vehicle is moving, especially at high speeds.
- Have the items listed in scheduled maintenance information performed according to the specified schedule.

The scheduled maintenance items listed in scheduled maintenance information are essential to the life and performance of your vehicle and to its emissions system.

If you use anything other than Ford, Motorcraft or Ford-authorized parts for maintenance replacements or for service of components affecting emission control, such non-Ford parts should be equivalent to genuine Ford Motor Company parts in performance and durability.

Fuel and Refueling

Illumination of the service engine soon indicator, charging system warning light or the temperature warning light, fluid leaks, strange odors, smoke or loss of engine power could indicate that the emission control system is not working properly.

An improperly operating or damaged exhaust system may allow exhaust to enter the vehicle. Have a damaged or improperly operating exhaust system inspected and repaired immediately.

Do not make any unauthorized changes to your vehicle or engine. By law, vehicle owners and anyone who manufactures, repairs, services, sells, leases, trades vehicles, or supervises a fleet of vehicles are not permitted to intentionally remove an emission control device or prevent it from working. Information about your vehicle's emission system is on the Vehicle Emission Control Information Decal located on or near the engine. This decal also lists engine displacement.

Please consult your warranty information for complete details.

On-Board Diagnostics (OBD-II)

Your vehicle has a computer known as the on-board diagnostics system (OBD-II) that monitors the engine's emission control system. The system protects the environment by making sure that your vehicle continues to meet government emission standards. The OBD-II system also assists a service technician in properly servicing your vehicle.



When the service engine soon indicator illuminates, the OBD-II system has detected a malfunction. Temporary malfunctions may cause the service engine soon indicator to illuminate. Examples are:

1. Your vehicle has run out of fuel—the engine may misfire or run poorly.

2. Poor fuel quality or water in the fuel—the engine may misfire or run poorly.
3. The fuel fill inlet may not have closed properly. See **Refueling** (page 156).
4. Driving through deep water—the electrical system may be wet.

You can correct these temporary malfunctions by filling the fuel tank with good quality fuel, properly closing the fuel fill inlet or letting the electrical system dry out. After three driving cycles without these or any other temporary malfunctions present, the service engine soon indicator should stay off the next time you start the engine. A driving cycle consists of a cold engine startup followed by mixed city and highway driving. No additional vehicle service is required.

If the service engine soon indicator remains on, have your vehicle serviced at the first available opportunity. Although some malfunctions detected by the OBD-II may not have symptoms that are apparent, continued driving with the service engine soon indicator on can result in increased emissions, lower fuel economy, reduced engine and transmission smoothness and lead to more costly repairs.

Readiness for Inspection and Maintenance (I/M) Testing

Some state and provincial and local governments may have Inspection/Maintenance (I/M) programs to inspect the emission control equipment on your vehicle. Failure to pass this inspection could prevent you from getting a vehicle registration.



If the service engine soon indicator is on or the bulb does not work, your vehicle may need service. See On-Board Diagnostics.

Fuel and Refueling

Your vehicle may not pass the I/M test if the service engine soon indicator is on or not working properly (bulb is burned out), or if the OBD-II system has determined that some of the emission control systems have not been properly checked. In this case, the vehicle is not ready for I/M testing.

If the vehicle's engine or transmission has just been serviced, or the battery has recently run down or been replaced, the OBD-II system may indicate that the vehicle is not ready for I/M testing. To determine if the vehicle is ready for I/M testing, turn the ignition key to the on position for 15 seconds without cranking the engine. If the service engine soon indicator blinks eight times, it means that the vehicle is not ready for I/M testing; if the service engine soon indicator stays on solid, it means that your vehicle is ready for I/M testing.

The OBD-II system checks the emission control system during normal driving. A complete check may take several days.

If the vehicle is not ready for I/M testing, you can perform the following driving cycle consisting of mixed city and highway driving:

1. 15 minutes of steady driving on an expressway or highway followed by 20 minutes of stop-and-go driving with at least four 30-second idle periods.
2. Allow your vehicle to sit for at least eight hours with the ignition off. Then, start the vehicle and complete the above driving cycle. The vehicle must warm up to its normal operating temperature. Once started, do not turn off the vehicle until the above driving cycle is complete.

If the vehicle is still not ready for I/M testing, you need to repeat the above driving cycle.

High Voltage Battery

GENERAL INFORMATION

WARNING



This battery pack should only be serviced by an authorized electric vehicle technician. Improper handling can result in personal injury or death.

Note: *The high-voltage battery does not require regular service maintenance.*

Your vehicle consists of various high-voltage components and wiring. All of the high-voltage power flows through specific wiring assemblies labeled as such or covered with a solid orange convolute, or orange striped tape, or both. Do not come in contact with these components.

The high-voltage battery system is a high-voltage, lithium-ion battery system. The pack is located in the rear cargo area. The high-voltage battery system uses an air-cooled system to regulate the high-voltage battery temperature and help maximize high-voltage battery life.



E162457

Note: *The high-voltage battery is equipped with air vents in the package tray that help to regulate its temperature. It is important to keep these openings free of obstructions. Do not block the flow of cabin air to this area.*

HIGH-VOLTAGE SERVICE DISCONNECT

The high-voltage service disconnect turns off power from the high-voltage battery.

Note: *There is a disconnect circuit in your vehicle. Disconnecting the circuit will automatically disable the high-voltage battery.*

To disable the battery and stop all high-voltage electric activity in the vehicle you can access the high-voltage disconnect circuit. To do this, you must unplug the circuit from the circuit port connected to the battery.

The high-voltage service disconnect is located behind the rear fold down seats.

Note: *The service disconnect has an outer lever to aid in the proper seating of the service disconnect lever. Remove this to disconnect the high-voltage service disconnect.*

Service Disconnect Location for Non-Energi Vehicles

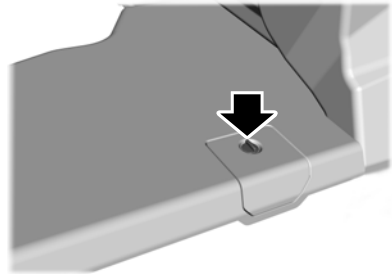

E159506

High Voltage Battery

Service Disconnect Location for Energi Vehicles

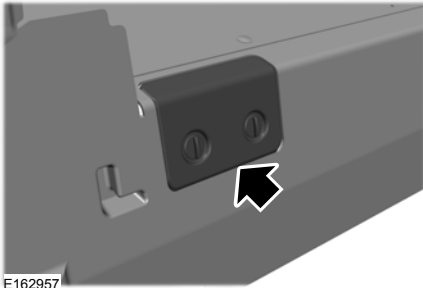

3. Pull the outer cover off to expose the service disconnect lever.

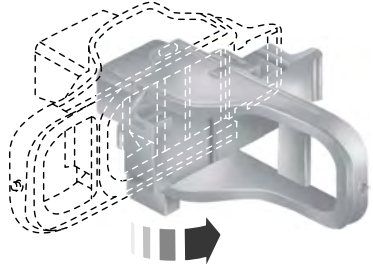

Disabling the High-Voltage Battery

1. Fold down the rear seats.
2. Locate the access door and remove the plastic cover.

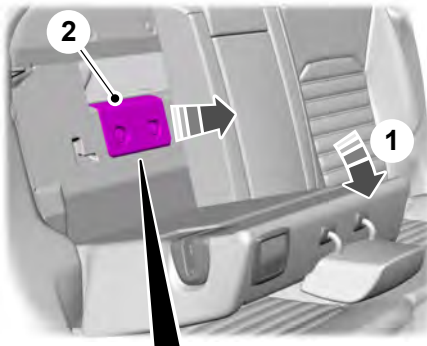

4. Slide the handle on the service disconnect outboard to the right. For Energi vehicles slide the handle outboard and to the left.

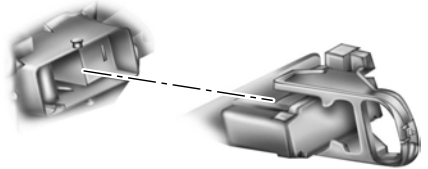

E146133

5. Pull the handle toward you and remove the circuit from the vehicle to disable the high-voltage battery.

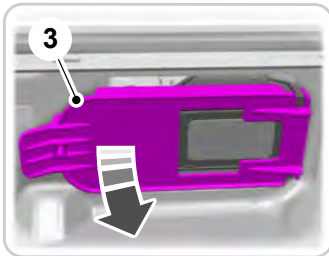

Reactivating the High-Voltage Battery

Note: If you have manually disconnected your high-voltage shut off circuit, you will need to reconnect the circuit before you can reactivate it. The vehicle will detect if the electrical system is safe and reactivate automatically.

E200939

High Voltage Battery

CHARGING THE HIGH VOLTAGE BATTERY

Energi Vehicles

WARNINGS



Do not use the 120 volt convenience cord with an extension cord, two-prong adapter, surge protector, timer or other adapter.



In Canada, do not use the 120 volt convenience cord in commercial garages.



This equipment has arcing or sparking parts, do not expose to flammable vapors. Position this equipment at least 18 in (450 mm) above the floor.



The AC wall plug must fit firmly into the AC outlet. If the connection feels loose, worn or the AC outlet is damaged, please have a qualified electrician replace the AC outlet. Using a convenience cord with a worn outlet may cause burns, property damage and increase the risk of electric shock.

Charging Equipment



E163425

Your vehicle is equipped with a standard 120 volt convenience cord. Lift the load floor carpet in the rear of your vehicle to access the 120 volt convenience cord.

Note: *The 120 volt convenience cord allows you to charge the high voltage battery using a standard 120 volt household outlet. It takes approximately seven hours to completely charge an empty battery using the standard 120 volt convenience cord.*



E145429

We recommend upgrading to the optional 240 volt charging station for faster more efficient charging. It takes approximately 2.5 hours to completely charge an empty battery using a 240 volt charging station.

Note: *The electrical source must meet certain requirements for the high-voltage batteries to charge. The AC outlet must be a three-prong 110-120 volt AC outlet that is properly grounded, 15–20 amps (or greater) and in good condition. You must use a dedicated line, which means you cannot have other appliances connected to the same circuit. If you do not use a dedicated circuit, the circuit breaker could trip or open. If you do not have a dedicated circuit, contact a licensed professional electrician for proper installation.*

High Voltage Battery

Make sure that the 120 volt convenience cord is completely unwound before charging. Always plug the cord into the AC outlet before connecting the charging coupler into the charge port on your vehicle.

120 Volt Convenience Cord

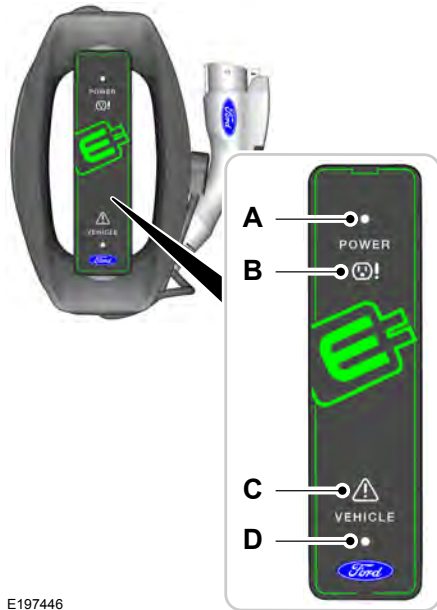

E197446

- A. Power.
- B. Check outlet.

- C. Fault.
- D. Vehicle.

Note: When the convenience cord is plugged into an outlet, use the following table to determine your vehicle charge status. If the **POWER** indicator light is off after plugging in the convenience cord, use a different outlet.

High Voltage Battery

Convenience Cord LED Indicators			Status
Check Outlet	Fault	Vehicle	
Off	Off	Off	The convenience cord is not connected to your vehicle.
Off	Off	On	The convenience cord is connected, but your vehicle is not charging.
Off	Off	Blink	Your vehicle is charging.
Off	Blink	Off	Ground Fault Circuit Interrupter (GFCI) Fault Detected. The convenience cord is attempting to charge again.
Off	On	Off	Ground Fault Circuit Interrupter (GFCI) Fault Detected. The convenience cord has exhausted its retry attempts. Your vehicle is not charging, or there is an internal fault in the charging equipment.
Blink	Off	Off	The convenience cord detected a high temperature at the AC plug and is waiting for the AC plug to return to a normal operating temperature.*
Blink	Off	On	The convenience cord detected a high temperature at the AC plug. The AC plug has returned to a normal operating temperature. Your vehicle is ready to charge at a reduced current.*
Blink	Off	Blink	The convenience cord detected a high temperature at the AC plug. The AC plug has returned to a normal operating temperature. Your vehicle is charging at a reduced current.*
Blink	On	Off	The convenience cord detected a high temperature at the AC plug. Your vehicle is not charging. The convenience cord has exhausted its retry attempts.*

*Have the outlet checked by a qualified electrician and make sure the AC plug fits firmly into the outlet. Contact an authorized EV certified dealer if problem persists.

High Voltage Battery

Charge Port

The charge port is located between the front left side door and front left wheel well. There is an indentation located on the charge port door. Press with your thumb to open and close the door.



E144779

Note: Do not force the charge port door open or closed. Forcing the door open or closed will damage the charge port.

The light ring located around the charge port indicates the charge status of the high voltage battery in your vehicle. Divided into four quadrants, the charge port light ring displays the state of charge in 25 percent increments.

There is a cord acknowledgment feature that activates when you initiate a charge cycle. The four light quadrants will individually flash clockwise starting with the top right light and ending with the top left, two full times, confirming the system detects the charging coupler.

Use the key fob to view the charge status of your vehicle at any time by pressing the unlock button. The light ring will light up the corresponding quadrant(s) so that the current state of charge can be determined. If the charge is below 25 percent, the light ring will not light. Do not forget to press the lock button on your key fob to re-lock your vehicle.

The light ring will also display the current state of charge when opening the doors.

Charging

Note: Your vehicle must be in park **P** to charge.

To charge the high-voltage battery:

1. Put the vehicle in park **P** and power down the vehicle.
2. With your thumb, press in and release the indentation located on the charge port door and the door will rotate open.
3. Plug the charging coupler into the charge port receptacle on your vehicle. Make sure the button clicks confirming that you have completely engaged the coupler.



E144780

4. Verify that the cord acknowledgment feature activates. This indicates the beginning of a normal charge cycle.
5. If using a 240-volt charging station, follow the instructions on the charge station to begin the charging process.

High Voltage Battery

The light ring will display how far along the charge is:

- When the top right quadrant is pulsing, the charge is between 0–25 percent.
- When the top right quadrant light is on and the bottom right quadrant is pulsing, the charge is between 25–50 percent.
- When the lights on both right side quadrants are on and the bottom left quadrant is pulsing, the charge is between 50–75 percent.
- When the lights on the three quadrants are on and the top left quadrant is pulsing, the charge is between 75–100 percent.
- When all lights on the entire ring are on, the charge is complete.

Note: *The light ring will turn off one minute after reaching a full charge.*

Locking the Charging Coupler

Note: *You will need a padlock or a combination lock with a shackle diameter of 0.2 in (5 mm) or less and the straight portion of the shackle of 1.0 in (25.4 mm) of length or more.*

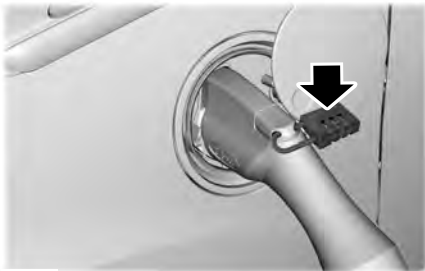

E172036

1. Insert the lock through the hole in the charging coupler button.
2. Lock the padlock or combination lock.

Waiting to Charge

Note: *See Charge Settings in the SYNC™ 3 section.*

When you select Value Charge, charging may not begin upon plugging in. Your vehicle may delay charging to take advantage of off-peak electricity rates. Your vehicle will optimize the charge schedule to be complete by the next GO Time.

When waiting to charge (not actively charging), the light ring will indicate the present state of charge of the high voltage battery as follows:

- When the top right quadrant light is off, the charge is between 0–25 percent.
- When the top right quadrant light is on, and the bottom right quadrant is off, the charge is between 25–50 percent.
- When both right side quadrant lights are on and the bottom left quadrant is off, the charge is between 50–75 percent.
- When three quadrant lights are on and the top left quadrant is off, the charge is between 75–100 percent.
- When all lights on the entire ring are on, the charge is 100 percent.

Note: *When your vehicle is waiting to charge, the light ring will turn off one minute after displaying the present state of charge. When your vehicle automatically begins charging, the light ring will turn on and display how far along the charge is per the section above.*

Note: *If the system detects a vehicle charging system fault at any point in a charge cycle, the entire light ring will flash continuously for one minute and then turn off. If this happens, unplug the charging coupler and then plug it back into the charge port receptacle. If the problem persists, contact an authorized dealer.*

High Voltage Battery

You can modify the lighting ring. See Charge Port Light Ring Settings in the SYNC™ 3 section.

Disconnecting the Charging Coupler

Note: Do not pull the wall plug from the wall while your vehicle is charging. Doing so may damage the outlet and the cord.

1. Remove the lock from the charging coupler button.
2. Press the button on the charging coupler.
3. While holding the button, remove the charging coupler from the charge port receptacle on your vehicle.

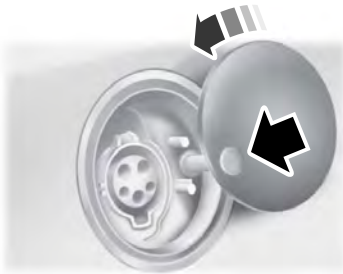

E144781

4. Close the charge port door by pressing the indentation on the charge port door. Continue pressing the indentation while the door rotates counterclockwise and closes.

HIGH VOLTAGE BATTERY CUT-OFF SWITCH

The high-voltage shut off operation shuts off power from the high-voltage battery after a collision, or if your vehicle receives a substantial physical jolt.

To reactivate your vehicle after either event, perform the following steps:

1. Turn the ignition off.

2. Turn the ignition on.
3. If your vehicle is not powered after this sequence, repeat steps 1 and 2 up to two more times.

For vehicles equipped with a push button start system:

1. Press the **START/STOP** button to turn ignition off.
2. Press the brake pedal and press the **START/STOP** button.
3. If your vehicle is not powered after this sequence, repeat steps 1 and 2 up to two more times.

Note: During this process, your vehicle will detect if the electrical system is safe and reactivate. Once your vehicle determines the electrical system safe, you can start your vehicle as you would normally by either turning the ignition key or by pressing the brake in combination with the **START/STOP** button.

Note: In the event your vehicle does not reactivate after the third key cycle, contact an authorized dealer.

Transmission

AUTOMATIC TRANSMISSION

WARNINGS



Always set the parking brake fully and make sure you shift the gearshift lever to park (P). Switch the ignition off and remove the key whenever you leave your vehicle.



Do not apply the brake pedal and accelerator pedal simultaneously. Applying both pedals simultaneously for more than a few seconds will limit engine rpm, which may result in difficulty maintaining speed in traffic and could lead to serious injury.

Understanding the Shift Positions of Your Automatic Transmission

Putting your vehicle in gear:

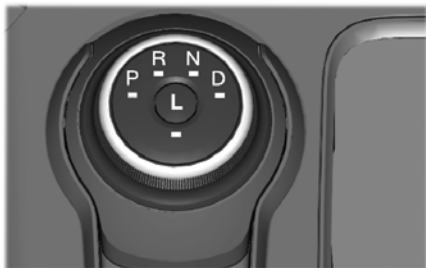

E224178

1. Fully press down the brake pedal.
2. Move the selector to the desired gear.
3. Come to a complete stop.
4. Move the selector to park (P).

Park (P)

With the transmission in park (P), your vehicle locks the transmission and prevents the wheels from turning. Always come to a complete stop before putting your vehicle into and out of park (P). An audible chime sounds once you select park (P).

When the ignition is turned off, your vehicle will automatically shift into park (P). If the ignition is turned off while the vehicle is moving, it will first shift into neutral (N) until a slow enough speed is reached. Your vehicle will then shift into park (P) automatically.

Automatic Return to Park

Note: This feature will not operate when your vehicle is in Stay in Neutral mode or neutral tow.

Your vehicle has a safety feature that will automatically shift your vehicle into park (P) when any of the following conditions occur:

- You turn the vehicle off.
- You open the driver's door with your safety belt unlatched.
- Your safety belt is unlatched while the driver's door is open.

If you turn your vehicle off while moving, your vehicle will first shift into neutral (N) until it slows down enough to shift into park (P) automatically.

Note: If you have waited an extended period of time (2-15 minutes) before starting your vehicle, unlatching your safety belt will cause this feature to activate, even with the driver's door closed.

Note: This feature may not work properly if the door ajar switch is malfunctioning. If your door ajar indicator does not illuminate when you open the driver's door or the indicator illuminates with the driver's door closed, see your authorized dealer.

Transmission

Reverse (R)

With the selector in reverse (R), your vehicle moves backward. Always come to a complete stop before shifting into and out of reverse (R).

Neutral (N)

With the selector in neutral (N), your vehicle can be started and is free to roll. Hold the brake pedal down while in this position.

Stay in Neutral Mode

Note: Always put your vehicle in Stay in Neutral mode when entering an automatic car wash. Failure to do this could result in vehicle damage not covered by warranty.

Stay in Neutral mode allows your vehicle to stay in neutral when you exit your vehicle. Your vehicle must be stationary to enter this mode.

To enter Stay in Neutral mode:

- Move the transmission selector to neutral (N).
- A message will appear in your information display screen prompting you to press the low (L) button.
- Press the low (L) button again to enter Stay in Neutral mode.

To exit Stay in Neutral mode, select a gear other than low (L).

A message will appear in your information display screen when your vehicle has entered Stay in Neutral mode.

Drive (D)

Drive (D) is the normal driving position for the best fuel economy.

Grade Assist



Press the grade assist button to activate grade assist. The grade assist lamp will appear in the instrument cluster. Press the button again to switch the system off.

Grade assist:

- Provides additional grade braking with a combination of engine motoring and high-voltage battery charging to help maintain vehicle speed when descending a grade.
- As your vehicle determines the amount of engine motoring and high-voltage battery charging, you may notice the engine speed increasing and decreasing to help maintain your vehicle speed when descending a grade.
- The grade assist lamp in the instrument cluster is illuminated.

Low (L)

- Provides maximum engine braking.
- The transmission may be shifted into low (L) at any vehicle speed.
- Is not intended for use under extended or normal driving conditions and results in lower fuel economy.

Transmission

Brake-Shift Interlock Override

WARNINGS



Do not drive your vehicle until you verify that the brake lamps are working.



When doing this procedure, you need to take the transmission out of park (P) which means your vehicle can roll freely. To avoid unwanted vehicle movement, always fully set the parking brake prior to doing this procedure. Use wheels chocks if appropriate.



If the parking brake is fully released, but the brake warning lamp remains illuminated, the brakes may not be working properly. Have your vehicle checked as soon as possible.

Note: See your authorized dealer as soon as possible if this procedure is used.

Note: For some markets this feature is disabled.

Note: This feature will only function if your 12-volt battery has power. If vehicle battery voltage is not sufficient, an external 12-volt power source (for example, jumper cables, battery charger or jump pack) may be required to function the interlock override switch.

Use the brake-shift interlock override to move your transmission from the park position in the event of an electrical malfunction. If your vehicle has a dead battery, an external power source will be required.

1. Apply the parking brake and turn your ignition off before performing this procedure.

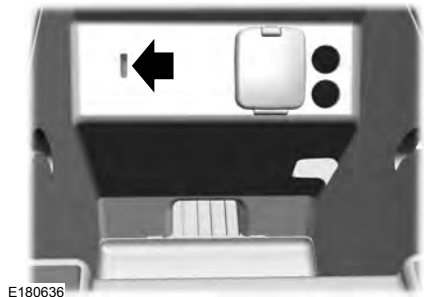

E180636

2. Locate your brake-shift interlock access slot. The slot is located in your center console storage bin. The access slot does not have a label.

Note: Make sure that you correctly identify the access hole as not to damage the media hub.

3. Using a tool, press and hold the brake shift interlock switch. The shift buttons on the instrument panel will flash when your vehicle is in override mode.
4. With the override switch still held, press the neutral button (N) to shift from park.
5. Release the override button.
6. Your vehicle will remain in Stay in Neutral mode for wrecker towing purposes or can be shifted to the desired gear and driven (if possible).
7. Release the parking brake.

If Your Vehicle Gets Stuck In Mud or Snow

Note: Do not rock the vehicle if the engine is not at normal operating temperature or damage to the transmission may occur.

Note: Do not rock the vehicle for more than a minute or damage to the transmission and tires may occur, or the engine may overheat.

Transmission

If your vehicle gets stuck in mud or snow, it may be rocked out by shifting between forward and reverse gears, stopping between shifts in a steady pattern. Press lightly on the accelerator in each gear.

Brakes

GENERAL INFORMATION

Note: Occasional brake noise is normal. If a metal-to-metal, continuous grinding or continuous squeal sound is present, the brake linings may be worn-out. Have the system checked by an authorized dealer. If the vehicle has continuous vibration or shudder in the steering wheel while braking, have it checked by an authorized dealer.

Note: Brake dust may accumulate on the wheels, even under normal driving conditions. Some dust is inevitable as the brakes wear and does not contribute to brake noise. See **Cleaning the Alloy Wheels** (page 275).



See **Warning Lamps and Indicators** (page 89).

Wet brakes result in reduced braking efficiency. Gently press the brake pedal a few times when driving from a car wash or standing water to dry the brakes.

Brake Over Accelerator

In the event the accelerator pedal becomes stuck or entrapped, apply steady and firm pressure to the brake pedal to slow the vehicle and reduce engine power. If you experience this condition, apply the brakes and bring your vehicle to a safe stop. Move the transmission to park (P), switch the engine off and apply the parking brake. Inspect the accelerator pedal for any interference. If none are found and the condition persists, have your vehicle towed to the nearest authorized dealer.

Brake Assist

Brake assist detects when you brake heavily by measuring the rate at which you press the brake pedal. It provides maximum braking efficiency as long as you press the pedal. Brake assist can reduce stopping distances in critical situations.

Anti-lock Brake System

This system helps you maintain steering control during emergency stops by keeping the brakes from locking.



This lamp momentarily illuminates when you switch the ignition on. If the light does not illuminate during start up, remains on or flashes, the anti-lock braking system may be disabled. Have the system checked by an authorized dealer. If the anti-lock brake system is disabled, normal braking is still effective.



If the brake warning lamp illuminates when you release the parking brake, have your system checked by an authorized dealer.

Regenerative Braking System

This feature is used to simulate the engine braking of an internal combustion engine and assist the standard brake system while recovering some of the energy of motion and storing it in the battery to improve fuel economy. The standard brake system is designed to fully stop the car if regenerative braking is not available. During regenerative braking, the motor is spun as a generator to create electrical current. This recharges the battery and slows the vehicle. In effect, once the accelerator pedal is released, the motor changes from an energy user to an energy producer.

When you release the accelerator pedal or press the brake pedal, the brake controller automatically detects the amount of deceleration requested and optimizes how much of the deceleration will be produced by regenerative braking. The remaining portion is generated by standard friction

Brakes

braking. When the battery is almost fully charged, the amount of regenerative braking is limited to avoid overcharging, and the requested deceleration is produced by standard friction braking alone.

Regenerative braking does not take the place of the standard friction brakes; it only assists them. Regenerative braking has also been designed to interact with the anti-lock brake system. Regenerative braking is disabled when the anti-lock brake system is activated or the battery is fully charged.

HINTS ON DRIVING WITH ANTI-LOCK BRAKES

Note: *When the system is operating, the brake pedal may pulse and may travel further. Maintain pressure on the brake pedal. You may also hear a noise from the system. This is normal.*

The anti-lock braking system will not eliminate the risks when:

- You drive too closely to the vehicle in front of you.
- Your vehicle is hydroplaning.
- You take corners too fast.
- The road surface is poor.

ELECTRIC PARKING BRAKE

The electric parking brake replaces the conventional handbrake. The operating switch is located in the center console.

WARNING



Always set the parking brake and leave your vehicle with the transmission in park (P) (automatic transmission) or in first gear (1) or reverse (R) (manual transmission).

Note: *When you apply the electric parking brake in certain conditions, for example, on a steep hill, the electric parking brake may reapply the brakes within three to ten minutes.*

Note: *You may notice various noises when you apply and release the electric parking brake. This is normal and no cause for concern.*

Parking On a Hill (Vehicles With a Manual Transmission)

If you park your vehicle facing uphill, move the transmission to first gear (1) and turn the steering wheel away from the curb. If you park your vehicle facing downhill, move the transmission to reverse (R) and turn the steering wheel toward the curb.

Applying the Electric Parking Brake

WARNINGS



The brake system warning lamp will flash during an electric parking brake apply. If the brake system warning lamp continues to flash, there could be a problem with your electric parking brake.



Applying the electric parking brake while moving will result in use of the anti-lock braking system. Do not use the electric parking brake system when the vehicle is moving unless the normal brake system is unable to stop the vehicle.



With the exception of emergency conditions (for example, the brake pedal does not work or is blocked), do not apply the electric parking brake while the vehicle is moving. On bends, or poor road surfaces or weather conditions, emergency braking can cause the vehicle to skid out of control or off the road.

Brakes

Note: The brake system warning lamp will illuminate for ten seconds, if the ignition is turned off after the electric parking brake has been applied, or the electric parking brake has been applied after the ignition has been turned off.

Note: The electric parking brake will not automatically apply. You must apply the electric parking brake using the electric parking brake switch.



E227395

Pull the switch up to apply the electric parking brake.

The brake system warning lamp will flash for approximately 2 seconds and then illuminate to confirm that the electric parking brake has been applied. See **Information Displays** (page 94).

If you apply the electric parking brake when your vehicle is moving, the brake system warning lamp will illuminate and a warning chime will sound. See **Information Displays** (page 94).

If your vehicle speed is above 4 mph (6 km/h), the braking force is applied as long as the switch is pulled. Releasing or pressing the switch or pressing the accelerator pedal will stop the braking force.

Releasing the Electric Parking Brake

You can release the electric parking brake either manually by pressing the switch or automatically.

Manual release

WARNING



If the brake system warning light remains illuminated or flashes after you have released the parking brake, there could be a problem with your braking system. Have the system checked by an authorized dealer as soon as possible.



E227515

You can manually release the electric parking brake by:

1. Turning the ignition on.
2. Pressing the brake pedal.
3. Pressing the electric parking brake switch.

When the electric parking brake is released, the brake system warning lamp will turn off.

Brakes

Automatic release - drive away release

Your vehicle will automatically release the parking brake if all of the following conditions exist:

- The driver door is closed.
- The accelerator pedal is pressed.
- There are no faults detected in the parking brake system.

Note: *If the electric parking brake warning lamp stays illuminated, the electric parking brake will not automatically release. You must release the electric parking brake using the electric parking brake switch.*

Note: *On manual transmission vehicles, if the transmission is in neutral (N) when you release the clutch pedal and press the accelerator pedal, the electric parking brake will release automatically.*

Note: *On manual transmission vehicles, you must fully press the clutch pedal before the drive away release feature will operate. Drive as normal using the accelerator and clutch pedals and the electric parking brake will be automatically released.*

The brake system warning lamp will go off to confirm that the electric parking brake has been released.

Note: *The electric parking brake drive away release makes starting on a hill easier. This feature will release the parking brake automatically when the vehicle has sufficient drive force to move up the hill. To assure drive away release when starting uphill, press the accelerator pedal quickly.*

Driving with a Trailer

Depending on the slope and the weight of the trailer, your vehicle and trailer may roll backwards slightly when you start on a slope.

To prevent this from happening, do the following:

1. Pull the switch up and hold it in this position.
2. Drive your vehicle, then release the switch when you notice that the engine has developed sufficient driving force.

Battery With No Charge

WARNING



You will not be able to apply or release the electric parking brake if the battery is low or has no charge.

If the battery is low or has no charge, use jumper cables and a booster battery.

HILL START ASSIST

WARNINGS



The system does not replace the parking brake. When you leave your vehicle, always apply the parking brake and shift the transmission into park (P) (automatic transmission) or first gear (1) (manual transmission).



You must remain in your vehicle once you have activated the system.



During all times, you are responsible for controlling your vehicle, supervising the system and intervening, if required.



If the engine is revved excessively, or if a malfunction is detected, the system will be deactivated.

The system makes it easier to pull away when your vehicle is on a slope without the need to use the parking brake.

When the system is active, your vehicle will remain stationary on the slope for two to three seconds after you release the brake pedal. This allows you time to move your foot from the brake to the accelerator pedal. The brakes release automatically

Brakes

when the engine has sufficient torque to prevent your vehicle from rolling down the grade. This is an advantage when pulling away on a slope, for example from a car park ramp, traffic lights or when reversing uphill into a parking space.

The system will activate automatically on any slope that will cause significant vehicle rollback. For vehicles with a manual transmission, you can switch this feature off using the information display. See **Information Displays** (page 94). The system will remain on or off depending on how it was last set.

Note: *There is no warning lamp to indicate the system is either on or off.*

Note: *If your vehicle is equipped with Auto Hold, Hill Start Assist will not be available while Auto Hold is active.*

Using Hill Start Assist

1. Bring your vehicle to a complete standstill. Keep the brake pedal pressed and select an uphill gear (for example, first (1) when facing uphill or reverse (R) when facing downhill).
2. If the sensors detect that your vehicle is on a slope, the system will activate automatically.
3. When you remove your foot from the brake pedal, your vehicle will remain on the slope without rolling away for about two or three seconds. This hold time will automatically be extended if you are in the process of driving off.
4. Drive off in the normal manner. The brakes will release automatically.

Switching the System On and Off

You can switch this feature on or off if your vehicle is equipped with a manual transmission and an information display. See **General Information** (page 94). The system remembers the last setting when you start your vehicle.

If your vehicle is not equipped with a manual transmission and an information display, you cannot turn the system on or off. When you switch the ignition on, the system automatically turns on.

Traction Control

PRINCIPLE OF OPERATION

The traction control system helps avoid drive wheel spin and loss of traction.

If your vehicle begins to slide, the system applies the brakes to individual wheels and, when needed, reduces engine power at the same time. If the wheels spin when accelerating on slippery or loose surfaces, the system reduces engine power in order to increase traction.

USING TRACTION CONTROL

WARNING



The stability and traction control light illuminates steadily if the system detects a failure. Make sure you did not manually disable the traction control system using the information display controls or the switch. If the stability control and traction control light is still illuminating steadily, have the system serviced by an authorized dealer immediately. Operating your vehicle with the traction control disabled could lead to an increased risk of loss of vehicle control, vehicle rollover, personal injury and death.

The system automatically turns on each time you switch the ignition on.

If your vehicle is stuck in mud or snow, switching traction control off may be beneficial as this allows the wheels to spin.

Note: *When you switch traction control off, stability control remains fully active.*

Switching the System Off

When you switch the system off or on, a message appears in the information display showing system status.

You can switch the system off by either using the information display controls or the switch.

Using the Information Display Controls

You can switch this feature off or on in the information display. See **General Information** (page 94).

Using a Switch (If Equipped)

Use the traction control switch on the instrument panel to switch the system off or on.

System Indicator Lights and Messages



The stability and traction control light:

- Temporarily illuminates on engine start-up.
- Flashes when a driving condition activates either of the systems.
- Illuminates if a problem occurs in either of the systems.



The stability and traction control off light temporarily illuminates on engine start-up and stays on when you switch the traction control system off.

Stability Control

PRINCIPLE OF OPERATION

WARNINGS



Vehicle modifications involving braking system, aftermarket roof racks, suspension, steering system, tire construction and wheel and tire size may change the handling characteristics of your vehicle and may adversely affect the performance of the electronic stability control system. In addition, installing any stereo loudspeakers may interfere with and adversely affect the electronic stability control system. Install any aftermarket stereo loudspeaker as far as possible from the front center console, the tunnel, and the front seats in order to minimize the risk of interfering with the electronic stability control sensors. Reducing the effectiveness of the electronic stability control system could lead to an increased risk of loss of vehicle control, vehicle rollover, personal injury and death.



Remember that even advanced technology cannot defy the laws of physics. It's always possible to lose control of a vehicle due to inappropriate driver input for the conditions. Aggressive driving on any road condition can cause you to lose control of your vehicle increasing the risk of personal injury or property damage. Activation of the electronic stability control system is an indication that at least some of the tires have exceeded their ability to grip the road; this could reduce the operator's ability to control the vehicle potentially resulting in a loss of vehicle control, vehicle rollover, personal injury and death. If your electronic stability control system activates, **SLOW DOWN**.

The system automatically turns on each time you switch the ignition on.

If a fault occurs in either the stability control or the traction control system, you may experience the following conditions:

- The stability and traction control light illuminates steadily.
- The stability control and traction control systems do not enhance your vehicle's ability to maintain traction of the wheels.

If a driving condition activates either the stability control or the traction control system you may experience the following conditions:

- The stability and traction control light flashes.
- Your vehicle slows down.
- Reduced engine power.
- A vibration in the brake pedal.
- The brake pedal is stiffer than usual.
- If the driving condition is severe and your foot is not on the brake, the brake pedal may move as the system applies higher brake force.

The stability control system has several features built into it to help you maintain control of your vehicle:

Electronic Stability Control

The system enhances your vehicle's ability to prevent skids or lateral slides by applying brakes to one or more of the wheels individually and, if necessary, reducing engine power.

Traction Control

The system enhances your vehicle's ability to maintain traction of the wheels by detecting and controlling wheel spin. See **Using Traction Control** (page 179).

Stability Control

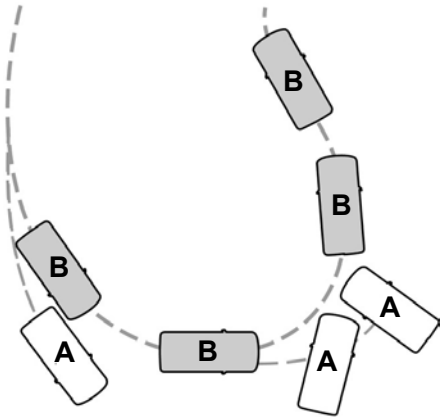

E72903

- A Vehicle without stability control skidding off its intended route.
- B Vehicle with stability control maintaining control on a slippery surface.

USING STABILITY CONTROL

The system automatically turns on each time you switch the ignition on.

You cannot switch the stability control system off, but when you shift into reverse (R), the system deactivates.

You can switch the traction control system off or on. See **Using Traction Control** (page 179).

Parking Aids

PRINCIPLE OF OPERATION

WARNINGS



To help avoid personal injury, please read and understand the limitations of the system as contained in this section. Sensing is only an aid for some (generally large and fixed) objects when moving on a flat surface at parking speeds. Certain objects with surfaces that absorb ultrasonic waves, surrounding vehicle's parking aid systems, traffic control systems, fluorescent lamps, inclement weather, air brakes, and external motors and fans may also affect the function of the sensing system; this may include reduced performance or a false activation.



To help avoid personal injury, always use caution when in reverse (R) and when using the sensing system.



This system is not designed to prevent contact with small or moving objects. The system is designed to provide a warning to assist the driver in detecting large stationary objects to avoid damaging your vehicle. The system may not detect smaller objects, particularly those close to the ground.



Certain add-on devices such as large trailer hitches, bike or surfboard racks and any device that may block the normal detection zone of the system, may create false beeps.

Note: *Keep the sensors, located on the bumper or fascia, free from snow, ice and large accumulations of dirt. If the sensors are covered, the system's accuracy can be affected. Do not clean the sensors with sharp objects.*

Note: *If your vehicle sustains damage to the bumper or fascia, leaving it misaligned or bent, the sensing zone may be altered causing inaccurate measurement of obstacles or false alarms.*

Note: *The sensing system cannot be turned off when a MyKey is present. See **Principle of Operation** (page 54).*

Note: *If you attach certain add-on devices such as a trailer or bike rack, the rear sensing system may detect that add-on device and therefore provide warnings. It is suggested that you disable the rear sensing system when you attach an add-on device to your vehicle to prevent these warnings.*

The sensing system warns the driver of obstacles within a certain range of your vehicle. The system turns on automatically whenever you switch the ignition on.



You can turn the system on or off by pressing the parking aid button. If your vehicle does not have a parking aid button, the system can be switched off through the information display menu or from the pop-up message that appears once you shift the transmission into reverse (R). See **General Information** (page 94).

If a fault is present in the system, a warning message appears in the information display. See **Information Messages** (page 103).

REAR PARKING AID (If Equipped)

The rear sensors are only active when the transmission is in reverse (R). As your vehicle moves closer to the obstacle, the rate of the audible warning increases. When the obstacle is less than 12 in (30 cm) away, the warning sounds continuously. If the system detects a stationary or receding object farther than 12 in (30 cm) from the corners of the bumper, the tone sounds for only three seconds. Once the system detects an object approaching, the warning sounds again.

Parking Aids



E130178

Coverage area of up to 6 ft (1.8 m) from the rear bumper. There may be decreased coverage area at the outer corners of the bumper.

The system detects certain objects while the transmission is in reverse (R) :

- Your vehicle is moving toward a stationary object at a speed of 3 mph (5 km/h) or less.
- Your vehicle is not moving, but a moving object is approaching the rear of your vehicle at a speed of 3 mph (5 km/h) or less.
- Your vehicle is moving at a speed of less than 3 mph (5 km/h) and a moving object is approaching the rear of your vehicle at a speed of less than 3 mph (5 km/h).

The system provides audio warnings only when your vehicle is moving or when your vehicle is stationary and the detected obstacle is less than 12 in (30 cm) away from the bumper.

Obstacle Distance Indicator (If Equipped)

The system provides obstacle distance indication through the information display. The distance indicator displays when the transmission is in reverse (R).

The indicator displays:

- As the distance to the obstacle decreases the indicator blocks illuminate and move towards the vehicle icon.
- If there is no obstacle detected, the distance indicator blocks are grayed out.

FRONT PARKING AID (If Equipped)

The front sensors are active when the transmission is in any position other than park (P) and your vehicle is traveling at low speed.



E187330

Coverage area of up to 28 in (70 cm) from the front bumper. The coverage area decreases at the outer corners.

When your vehicle approaches an object, a warning tone sounds. When your vehicle moves closer to an object, the warning tone repeat rate increases. The warning tone sounds continuously when an object is 12 in (30 cm) or less from the front bumper.

Parking Aids

You can switch the system off through the information display menu or from the pop-up message that appears once you shift the transmission into reverse (R). See **General Information** (page 94). If your vehicle has a parking aid button, you can switch the system off by pressing the button.

Obstacle Distance Indicator (If Equipped)

The system provides obstacle distance indication through the information display.

The indicator displays:

- As the distance to the obstacle decreases the indicator blocks illuminate and move towards the vehicle icon.
- If there is no obstacle detected, the distance indicator blocks are grayed out.

If the transmission is in reverse (R), the front sensing system provides audio warnings when your vehicle is moving and the detected obstacle is moving towards your vehicle. Once the vehicle is stationary, the audio warning will be stopped after 2 seconds. Visual indication is always present in reverse (R).

If the transmission is in drive (D) or any other forward gear (for example, low (L), sport (S) or any forward gear in a manual transmission), the front sensing system provides audio and visual warnings when your vehicle is moving below a speed of 7 mph (12 km/h) and an obstacle is located inside the detection area. Once the vehicle is stationary, the audio warning will be stopped after 2 seconds and the visual indication stops after 4 seconds. If the obstacles detected are within 12 in (30 cm), the visual indication remains on.

If the transmission is in neutral (N), the system provides visual indication only when your vehicle is moving at 7 mph (12 km/h) or below and an obstacle is located inside the detection area. Once your vehicle is stationary, the visual indication will stop after 4 seconds.

SIDE SENSING SYSTEM

The side sensing system uses the front and rear side sensors to detect and map obstacles that are near to the sides of your vehicle. The side sensors are active when the transmission is in any position other than park (P).

Note: *Obstacles that enter the side detection area without being detected and mapped by the front or rear side sensors will not be detected.*



E187810

Coverage area is up to 24 in (60 cm) from the sides of your vehicle.

When the system detects an object close to the side of your vehicle, an audible warning sounds. As the object comes closer to the side of your vehicle, the rate of the audible warning increases. The rate of the audible warning varies depending on whether the obstacle is inside or outside of the driving path of your vehicle.

Parking Aids

Obstacle Distance Indicator (if

Equipped)



E190459

The system provides obstacle distance indication through the information display.

As the distance to the obstacle decreases, the indicator blocks illuminate and move toward the vehicle icon. If there is no obstacle detected, the distance indicator blocks show greyed out.

When you shift to reverse (R), the side sensing system provides audible and visual distance indication when your vehicle is moving and obstacles are detected within 12 in (30 cm), or when obstacles are detected within 12–24 in (30–60 cm) and are inside the driving path of your vehicle. When you stop your vehicle the audible warning stops after two seconds.

Note: Visual distance indication remains on when the transmission is in reverse (R).

When you shift to drive (D) or any other forward gear, for example, low (L), sport (S) or any forward gear in manual transmission, the side sensing system provides audible and visual distance indication when your vehicle is moving at 7 mph (12 km/h) or below and obstacles are detected within 12 in (30 cm), or when obstacles are detected within 12–24 in (30–60 cm) and are inside the driving path of your vehicle. When you stop your vehicle the audible warning stops after 2 seconds and the visual distance indication stops after 4 seconds.

Note: If the obstacle remains within 12 in (30 cm) visual distance indication remains on.

If the transmission is in neutral (N), the side sensing system only provides visual distance indication when your vehicle is moving at 7 mph (12 km/h) or below, for example when moving on a slope, and obstacles are detected within 12 in (30 cm). When you stop your vehicle the visual distance indication stops after 4 seconds.

If the side sensing system is not available, the side distance indicator blocks will not be present.

The side sensing system is not available under the following condition:

- If you switch the traction control system off.

The side sensing system may not be available until you have driven approximately the length of your vehicle in order for the system to reinitialize if:

- You switch the ignition on, off and back on.
- Your vehicle remains stationary for over two minutes.

Parking Aids

- The anti-lock brake system is activated.
- The traction control system is activated.

ACTIVE PARK ASSIST

Parallel Parking, Perpendicular Parking, Parallel Park Out Assist

WARNINGS



You must remain in your vehicle when the system turns on. At all times, you are responsible for controlling your vehicle, supervising the system and intervening, if required. Failure to take care may result in the loss of control of your vehicle, serious personal injury or death.



The sensors may not detect objects in heavy rain or other conditions that cause interference.



Active park assist does not apply the brakes under any circumstances.



At all times, you are responsible for controlling your vehicle, supervising the system and intervening, if required. Failure to take care may result in the loss of control of your vehicle, serious personal injury or death.

The system detects an available parallel or perpendicular parking space and automatically steers your vehicle into the space (hands-free) while you control the accelerator, gearshift and brakes. The system visually and audibly guides you to park your vehicle.

If you are uncomfortable with the proximity to any vehicle or object, you may choose to override the system.

Parallel Park Out Assist automatically steers your vehicle out of a parallel parking space (hands-free) while you control the accelerator, gearshift and brakes. The system visually and audibly guides you to enter traffic.

Note: *The Blind Spot Information System does not detect traffic alongside or behind your vehicle during a park assist maneuver.*

The system may not correctly operate in any of the following conditions:

- You use a spare tire or a tire significantly worn more than the other tires.
- One or more tires are improperly inflated.
- You try to park on a tight curve.
- Something passes between the front bumper and the parking space (a pedestrian or cyclist).
- The edge of the neighboring parked vehicle is high off the ground (for example, a bus, tow truck or flatbed truck).
- The weather conditions are poor (heavy rain, snow, fog, etc).

Note: *Keep the sensors, located on the bumper or fascia, free from snow, ice and large accumulations of dirt. Covered sensors can affect the system's accuracy. Do not clean the sensors with sharp objects.*

Note: *The sensors may not detect objects with surfaces that absorb ultrasonic waves or cause ultrasonic interference (motorcycle exhaust, truck air brakes or horns).*

Do not use the system if:

- You have attached a bike rack, trailer or other object near the sensors on the front or rear of your vehicle.
- You have attached an overhanging object (surfboard) to the roof.

Parking Aids

- A foreign object damages or obstructs the front or rear bumper or side sensors.
- The correct tire size is not in use on your vehicle (for example, a mini-spare tire).

Using Active Park Assist - Parallel Parking



Press the button located on the center console near the gearshift lever or the right side of the center stack once.

When driving at a speed less than 22 mph (35 km/h) the system automatically scans both sides of your vehicle for an available parking space. The system displays a message and a corresponding graphic to indicate it is searching for a parking space. Use the direction indicator to select searching either to the left-hand side or right-hand side of your vehicle. If the direction indicators are not used, the system defaults to the passenger side of your vehicle.



E130107

Note: You can also activate the Active Park Assist system after you have already driven partially or completely past a parking space. To do so, press the Active Park button and the system will inform you if you have recently passed a suitable parking space.

When the system finds a suitable space, it displays a message and a tone sounds. Stop your vehicle and follow the instructions on the screen. If your vehicle is moving very slowly, you may need to pull forward a short distance before the system is ready to park.

Note: You must observe that the selected space remains clear of obstructions at all times during the maneuver.

Note: You should drive your vehicle within 5 ft (1.5 m) and as parallel as possible to the other vehicles while passing a parking space.

Note: The system always offers the last detected parking space (for example, if your vehicle detects multiple spaces while you are driving, it offers the last one).

Note: If driven above approximately 22 mph (35 km/h), the system shows a message to alert you to reduce your vehicle speed.

Automatic Steering into Parking Space

Note: If your vehicle speed exceeds approximately 6 mph (10 km/h) or the maneuver is interrupted (driver input), the system switches off and you need to take full control of your vehicle.

When you shift the transmission into reverse (R), with your hands off the wheel (and nothing obstructing its movement), your vehicle steers itself into the space. The system displays instructions to move your vehicle back and forth in the space.

Parking Aids



E130108

When you think your vehicle is properly parked, or you hear a solid tone from the parking aid (accompanied by a display message and a chime), bring your vehicle to a complete stop.

When automatic steering is complete, the system displays a message and a tone sounds, indicating that the active park assist process is finished. You are responsible for checking the parking job and making any necessary corrections before leaving your vehicle.

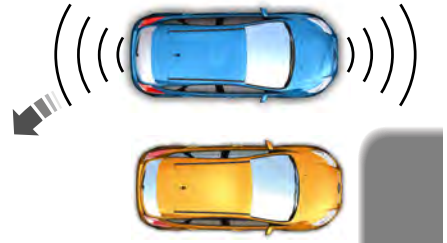

Using Active Park Assist - Perpendicular Parking



Press the button located on the center console near the gearshift lever or the right side of the center stack twice.

The system displays a message and a corresponding graphic to indicate it is searching for a parking space. Use the direction indicator to select searching either to the left-hand side or right-hand side of your vehicle.

Note: If you do not make a selection the system will default to the passenger's side.

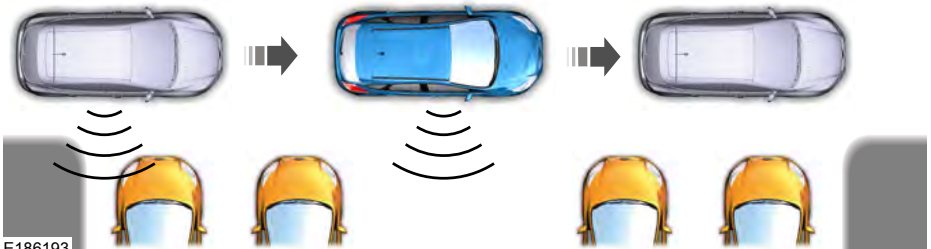

E186193

When the system finds a suitable space, it displays a message and a tone sounds. Stop your vehicle and follow the instructions on the screen. If your vehicle is moving very slowly, you may need to pull forward a short distance before the system is ready to park.

Note: You must observe that the selected space remains clear of obstructions at all times during the maneuver.

Note: You should drive your vehicle within 5 ft (1.5 m) and as perpendicular as possible to the other vehicles while passing a parking space.

Parking Aids

Note: The system always offers the last detected parking space (for example, if your vehicle detects multiple spaces while you are driving, it offers the last one).

Note: If driven above approximately 19 mph (30 km/h), the system shows a message to alert you to reduce your vehicle speed.

Automatic Steering into Parking Space

Note: If your vehicle speed exceeds 6 mph (10 km/h) or the maneuver is interrupted (driver input), the system switches off and you need to take full control of your vehicle.

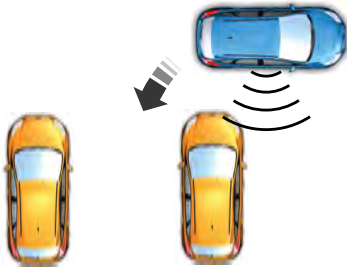

E186191

When you shift the transmission into reverse (R), with your hands off the wheel (and nothing obstructing its movement), your vehicle steers itself into the space. The system displays instructions to move your vehicle back and forth in the space.

When you think your vehicle is properly parked, or you hear a solid tone from the parking aid (accompanied by a display message and a chime), bring your vehicle to a complete stop.

When automatic steering is complete, the system displays a message and a tone sounds, indicating that the active park assist process is finished. You are responsible for checking the parking job and making any necessary corrections before leaving your vehicle.

Using Active Park Assist - Parallel Park Out Assist



While your vehicle is at rest in a parallel parking space, press the active park assist button.

The system displays a message requesting an indication of direction. Use the direction indicator to signal which side of your vehicle you want to exit the parking space.

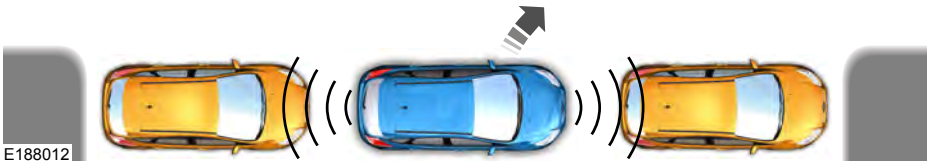

E188012

Parking Aids

The system determines the clearance to the front and rear of your vehicle and automatically steers your vehicle out of a parallel parking space (hands-free) while you control the accelerator, gearshift and brakes. The system visually and audibly guides you to enter traffic.

After the system has directed your vehicle past the adjacent vehicle or object, it guides you to take control of the steering to complete the exit from the parking spot.

Note: *If the clearance in front of your vehicle allows easy departure, the Parallel Park Out Assist feature might not be available.*

Note: *You are responsible for controlling your vehicle and making sure the path is clear prior to pulling into traffic.*

Note: *This system is not intended to assist in exiting perpendicular parking spaces, damages to your vehicle may occur.*

Note: *If your vehicle speed exceeds 3 mph (5 km/h) or the maneuver is interrupted (driver input), the system switches off and you need to take full control of your vehicle.*

Deactivating the Active Park Assist Feature

Manually deactivate the system by:

- Pressing the active park assist button during an active maneuver.
- Grabbing the steering wheel during an active maneuver.
- Driving above approximately 22 mph (35 km/h) for 30 seconds during an active park search.
- Driving above approximately 6 mph (10 km/h) during automatic steering.
- Switching off the traction control system.

Certain vehicle conditions can also deactivate the system, such as:

- Traction control has activated.
- There is an anti-lock brake system activation or failure.

If a problem occurs with the system, a warning message displays accompanied by a tone. Occasional system messages may occur in normal operation. For recurring or frequent system faults, contact an authorized dealer to have your vehicle serviced.

Troubleshooting the System

The system does not look for a space
The traction control system may be off.
The transmission is in reverse (R). Your vehicle must be moving forward to be able to detect a parking space.

Parking Aids

The system does not offer a particular space

The sensors may be covered (for example, snow, ice or dirt buildup). Covered sensors can affect the system's functionality.

There is not enough room in the parking space for your vehicle to safely park.

There is not enough space for the parking maneuver on the opposite side of the parking space.

The parking space is farther than 5 ft (1.5 m) or closer than 16 in (0.4 m) away.

Your vehicle is going faster than 22 mph (35 km/h) for parallel and 19 mph (30 km/h) for perpendicular parking.

The system does not position the vehicle where I want in the space

Your vehicle is rolling in the opposite direction of the transmission (rolling forward with reverse [R] selected).

An irregular curb along the parking space prevents the system from aligning your vehicle properly.

Vehicles or objects bordering the space may not be positioned correctly.

You pulled your vehicle too far past the parking space.

The tires may not be installed or maintained correctly (not inflated correctly, improper size, or of different sizes).

A repair or alteration has changed detection capabilities.

A parked vehicle has a high attachment (salt sprayer, snowplow or moving truck bed).

The parking space length or position of parked objects changed after your vehicle passed.

The temperature around your vehicle changes quickly (driving from a heated garage into the cold, or after leaving a car wash).

REAR VIEW CAMERA

WARNINGS



The rear view camera system is a reverse aid supplement device that still requires the driver to use it in conjunction with the interior and exterior mirrors for maximum coverage.

WARNINGS





Objects that are close to either corner of the bumper or under the bumper, might not be seen on the screen due to the limited coverage of the camera system.

Parking Aids

WARNINGS

 Reverse your vehicle as slow as possible, higher speeds may limit your reaction time to stop your vehicle.

 Use caution when the rear cargo door is ajar. If the rear cargo door is ajar, the camera will be out of position and the video image may be incorrect. All guidelines disappear when the rear cargo door is ajar. Some vehicles may not come equipped with guidelines.

 Use caution when turning camera features on or off when the transmission is not in park (P). Make sure your vehicle is not moving.

The rear view camera system provides a video image of the area behind your vehicle.

During operation, lines appear in the display which represent your vehicle's path and proximity to objects behind your vehicle.



E142435

The camera is located on the luggage compartment door.

Using the Rear View Camera System

The rear view camera system displays what is behind your vehicle when you place the transmission in reverse (R).

Note: *The reverse sensing system is not effective at speeds above 3 mph (5 km/h) and may not detect certain angular or moving objects.*

The system uses three types of guides to help you see what is behind your vehicle:

- Active guidelines: Show the intended path of your vehicle when reversing.
- Fixed guidelines: Show the actual path your vehicle is moving in while reversing in a straight line. This can be helpful when backing into a parking space or aligning your vehicle with another object behind you.
- Centerline: Helps align the center of your vehicle with an object (for example, a trailer).

Note: *If the transmission is in reverse (R) and the luggage compartment door or liftgate is open, no rear view camera features will display.*

Note: *When towing, the camera only sees what you are towing. This might not provide adequate coverage as it usually provides in normal operation and some objects might not be seen. In some vehicles, the guidelines may disappear when you connect the trailer tow connector.*

Parking Aids

The camera may not operate correctly under the following conditions:

- Nighttime or dark areas if one or both reverse lamps are not operating.
- Mud, water or debris obstructs the camera's view. Clean the lens with a soft, lint-free cloth and non-abrasive cleaner.
- The rear of your vehicle is hit or damaged, causing the camera to become misaligned.

Camera System Settings

You can access the rear view camera system settings through the display screen. See **General Information** (page 94).

Camera Guidelines

Note: *Active guidelines are only available when the transmission is in reverse (R).*

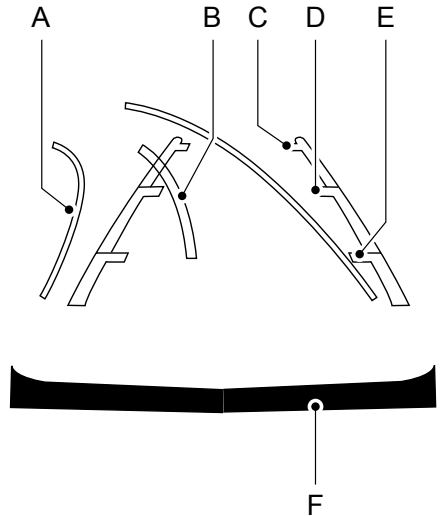

E142436

- A Active guidelines
- B Centerline
- C Fixed guideline: Green zone
- D Fixed guideline: Yellow zone
- E Fixed guideline: Red zone
- F Rear bumper

Active guidelines are only shown with fixed guidelines. To use active guidelines, turn the steering wheel to point the guidelines toward an intended path. If you change the steering wheel position while reversing, your vehicle might deviate from the original intended path.

Parking Aids

The fixed and active guidelines fade in and out depending on the steering wheel position. The active guidelines do not display when the steering wheel position is straight.

Always use caution while reversing. Objects in the red zone are closest to your vehicle and objects in the green zone are farther away. Objects are getting closer to your vehicle as they move from the green zone to the yellow or red zones. Use the side view mirrors and rear view mirror to get better coverage on both sides and rear of the vehicle.

Obstacle Distance Indicator (if

Equipped)



E190459

The system will provide an image of your vehicle and the sensor zones. The zones will highlight green, yellow and red when the parking aid sensors detect an object in the coverage area.

Manual Zoom

WARNING



When manual zoom is on, the full area behind your vehicle may not show. Be aware of your surroundings when using the manual zoom feature.

Note: Manual zoom is only available when the transmission is in reverse (R).

Note: When you enable manual zoom, only the centerline is shown.

Selectable settings for this feature are Zoom in (+) and Zoom out (-). Press the symbol in the camera screen to change the view. The default setting is Zoom OFF.

This allows you to get a closer view of an object behind your vehicle. The zoomed image keeps the bumper in the image to provide a reference. The zoom is only active while the transmission is in reverse (R).

Rear Camera Delay

Selectable settings for this feature are ON and OFF. The default setting for the rear camera delay is OFF.

When shifting the transmission out of reverse (R) and into any gear other than park (P), the camera image remains in the display until:

- Your vehicle speed sufficiently increases.
- You shift your vehicle into park (P) (automatic transmission).
- You apply the parking brake (manual transmission).

Cruise Control

PRINCIPLE OF OPERATION

Cruise control lets you maintain a set speed without keeping your foot on the accelerator pedal. You can use cruise control when your vehicle speed is greater than 20 mph (30 km/h).

USING CRUISE CONTROL

WARNINGS



Do not use cruise control on winding roads, in heavy traffic or when the road surface is slippery. This could result in loss of vehicle control, serious injury or death.



When you are going downhill, your vehicle speed may increase above the set speed. The system will not apply the brakes but a warning displays.

Note: When you are going downhill while using cruise control, the battery charging system and engine work together to help maintain the set speed. Engine noise may increase or decrease under these conditions.

Note: Cruise control disengages if the vehicle speed decreases more than 10 mph (16 km/h) below the set speed while driving uphill.



E144500

The cruise controls are on the steering wheel.

Switching Cruise Control On

Note: Using cruise control with ECO Cruise switched on may change the operation of the system. This feature saves vehicle energy by relaxing acceleration compared to standard cruise control. For example, your vehicle may temporarily lose speed when going uphill.

Energi vehicles: ECO Cruise can be turned on or off through the information display. See **Information Displays** (page 94).

Hybrid vehicles: ECO Cruise is included in EcoSelect which is turned on or off using the **ECO** button on the center console.

For additional information, refer to **ECO Cruise and EcoSelect**. See **Unique Driving Characteristics** (page 146).

Press and release **ON**.



The indicator appears in the instrument cluster.

Setting the Cruise Speed

1. Drive to desired speed.
2. Press and release **SET+**. The indicator changes color.
3. Take your foot off the accelerator pedal.

Changing the Set Speed

- Press the accelerator or brake pedal until you reach the desired speed. Press and release **SET+**.
- Press and hold **SET+** or **SET-**. Release the control when you reach the desired speed.
- Press and release **SET+** or **SET-**. The set speed will change in approximately 1 mph (2 km/h) increments.

Cruise Control

Canceling the Set Speed

Press and release **CAN** or tap the brake pedal. You will not erase the set speed.

Resuming the Set Speed

Press and release **RES**.

Switching Cruise Control Off

Press and release **OFF** when the system is in stand by mode or switch the ignition off.

Note: *You erase the set speed when you switch the system off.*

USING ADAPTIVE CRUISE CONTROL (If Equipped)

WARNINGS



Always pay close attention to changing road conditions when using adaptive cruise control. The system does not replace attentive driving. Failing to pay attention to the road may result in a crash, serious injury or death.



Adaptive cruise control does not detect stationary or slow moving vehicles below 6 mph (10 km/h).



Do not use adaptive cruise control on winding roads, in heavy traffic or when the road surface is slippery. This could result in loss of vehicle control, serious injury or death.



Do not use adaptive cruise control when towing a trailer that has trailer brakes. The auto-brake component of the adaptive cruise control system does not operate the trailer brakes. Using adaptive cruise control when towing a trailer that has trailer brakes may result in the loss of vehicle control, which could result in serious injury.

WARNINGS



Adaptive cruise control is not a crash warning or avoidance system.



Adaptive cruise control does not detect pedestrians or objects in the road.



Adaptive cruise control does not detect oncoming vehicles in the same lane.



Do not use the system in poor visibility, for example fog, heavy rain, spray or snow.



Do not use the adaptive cruise control when entering or leaving a highway, on roads with intersections or roundabouts or non-vehicular traffic or roads that are winding, slippery, unpaved, or steep slopes.



Do not use tire sizes other than those recommended because this can affect the normal operation of the system. Failure to do so may result in a loss of vehicle control, which could result in serious injury.

Note: *It is your responsibility to stay alert, drive safely and be in control of the vehicle at all times.*

The system adjusts your vehicle speed to maintain the set gap between you and the vehicle in front of you in the same lane. You can select four gap settings.

Cruise Control



E222790

The adaptive cruise controls are on the steering wheel.

Switching Adaptive Cruise Control On

Note: Using cruise control with ECO Cruise switched on may change the operation of the system. This feature saves vehicle energy by relaxing acceleration compared to standard cruise control. For example, your vehicle may temporarily lose speed when going uphill.

Energy vehicles: ECO Cruise can be turned on or off through the information display. See **Information Displays** (page 94).

Hybrid vehicles: ECO Cruise is included in EcoSelect which is turned on or off using the **ECO** button on the center console.

For additional information, refer to ECO Cruise and EcoSelect. See **Unique Driving Characteristics** (page 146).

Press and release **ON**.



The indicator appears in the information display.

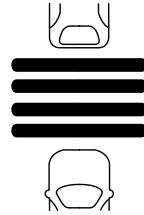

E164805

The current gap setting and set speed also appear in the information display.

Setting the Adaptive Cruise Speed

1. Drive to desired speed.
2. Press and release **SET-**. A green indicator light, the current gap setting and your set speed appear in the information display.
3. Take your foot off the accelerator pedal.

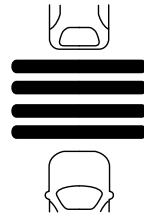

E164805

4. A vehicle graphic illuminates if there is a vehicle detected in front of you.

Note: When adaptive cruise control is active, the speedometer may vary slightly from the set speed displayed in the information display.

Setting the Adaptive Cruise Speed When Your Vehicle is Stationary

1. Follow a vehicle to a complete stop.
2. Keep the brake pedal fully pressed.

Cruise Control

3. Press and release **RES+**.
4. The set speed automatically adjusts to 20 mph (30 km/h). A green indicator light and the current gap setting appear in the information display.

Following a Vehicle

WARNINGS



When following a vehicle, your vehicle does not decelerate automatically to a stop, nor does your vehicle always decelerate quickly enough to avoid a crash without driver intervention. Always apply the brakes when necessary. Failing to do so may result in a crash, serious injury or death.



Adaptive cruise control only warns of vehicles detected by the radar sensor. In some cases there may be no warning or a delayed warning. You should always apply the brakes when necessary. Failure to do so may result in a crash, serious injury or death.

Note: *The brakes may emit noise when applied by the system.*

When a vehicle ahead of you enters the same lane or a slower vehicle is ahead in the same lane, the vehicle speed adjusts to maintain a preset gap distance. A vehicle graphic illuminates in the instrument cluster.

When you are following a vehicle and you switch on your left directional indicator, adaptive cruise control may provide a small temporary acceleration to help you pass.

Your vehicle maintains a consistent gap from the vehicle ahead until:

- The vehicle in front of you accelerates to a speed above the set speed.
- The vehicle in front of you moves out of the lane you are in.
- You set a new gap distance.

The vehicle applies brakes to slow the vehicle to maintain a safe distance from the vehicle in front. The maximum braking which the system can apply is limited. You can override the system by applying the brakes.

If the system predicts that its maximum braking level is insufficient, an audible warning sounds while the system continues to brake. The red warning bar appears on the windshield. You should take immediate action.

Following a Vehicle to a Complete Stop

If your vehicle follows a vehicle to a complete stop and remains stationary for less than three seconds, your vehicle automatically accelerates from a stationary position to follow the vehicle ahead when you release the brake pedal.

If your vehicle follows a vehicle to a complete stop and remains stationary for more than three seconds, you must press and release the **RES+** button or the accelerator pedal to accelerate from a stationary position and follow the vehicle ahead when you release the brake pedal.

Setting the Gap Distance

You can decrease or increase the distance between your vehicle and the vehicle in front by pressing the gap control.

Note: *It is your responsibility to select a gap appropriate to the driving conditions.*

Cruise Control

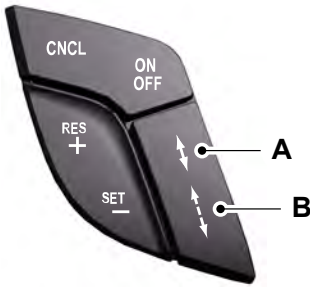

E222791

A Gap decrease.

B Gap increase.

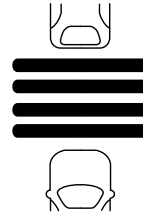

E164805

The selected gap appears in the information display as shown by the bars in the graphic. Four gap distance settings are available.

Adaptive cruise control, distance between vehicle settings

Set speed mph (km/h)	Graphic display, bars indicated between vehicles	Time gap, seconds	Distance gap yd (m)	Dynamic behav- ior
62 (100)	1	1	31 (28)	Sport
62 (100)	2	1.4	43 (39)	Normal
62 (100)	3	1.8	55 (50)	Normal
62 (100)	4	2.2	67 (61)	Comfort

Each time you start the vehicle, the system selects the last chosen gap setting.

Overriding the System

WARNING



Whenever the driver is overriding the system by pressing the accelerator pedal, the system will not automatically apply the brakes to maintain separation from any vehicle ahead.



When you override the system, the indicator light changes color and a vehicle graphic does not show in the information display.

The system will resume operation when you release the accelerator pedal. The vehicle speed will decrease to the set speed, or a lower speed if following a slower vehicle.

You can override the set speed and gap distance by pressing the accelerator pedal.

Cruise Control

Changing the Set Speed

- Press and release **RES+** or **SET-**. When you select km/h as the display measurement in the information display the set speed changes in approximately 2 km/h increments. When you select mph as the display measurement in the information display the set speed changes in approximately 1 mph increments.
- Press the accelerator or brake pedal until you reach the desired speed. Press and release **SET-**.
- Press and hold **RES+** or **SET-**. Release the control when you reach the desired speed. The set speed changes in approximately 5 mph/10 km/h increments.
- Press the **RES+** or **SET-** button to change the set speed in increments of approximately 1 mph or 2 km/h.
- Hold the **RES+** or **SET-** button to change the set speed in increments of approximately 5 mph or 10 km/h.

The system may apply the brakes to slow the vehicle to the new set speed. The set speed displays continuously in the information display when the system is active.

Canceling the Set Speed

Press and release **CNCL** or tap the brake pedal. The set speed does not erase.

Resuming the Set Speed

Press and release **RES+**. The vehicle returns to the previously set speed. The set speed displays continuously in the information display while the system is active.

Note: Only use resume if you are aware of the set speed and intend to return to it.

Automatic Cancellation

Automatic cancellation occurs if:

- The tires lose traction.
- The engine speed is too low.
- You apply the parking brake.

Note: If the engine speed drops too low, the information display indicates low engine speed. Shift to a lower gear (manual transmission only) to avoid automatic cancellation.

Hilly Condition Usage

Note: An audible alarm sounds and the system shuts down when it applies brakes for an extended period of time. This allows the brakes to cool. The system functions normally after the brakes have cooled.

You should select a lower gear position when the system is active in situations such as prolonged downhill driving on steep grades, for example in mountainous areas. The system needs additional engine braking in these situations to reduce the load on the vehicle's regular brake system to prevent them from overheating.

Switching Adaptive Cruise Control Off

Press and release **OFF** when the system is in stand by mode or switch the ignition off.

Note: You erase the set speed when you switch the system off.

Cruise Control

Detection Issues

WARNING



On rare occasions, detection issues can occur due to the road infrastructures, for example bridges, tunnels and safety barriers. In these cases, the system may brake late or unexpectedly. At all times, you are responsible for controlling your vehicle, supervising the system and intervening, if required.

The radar sensor has a limited field of vision. It may not detect vehicles at all or may detect a vehicle later than expected in some situations. The lead vehicle graphic will not illuminate if the system does not detect a vehicle in front of you.

A

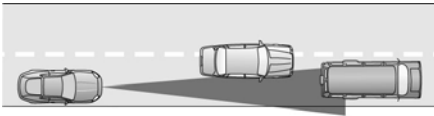

B

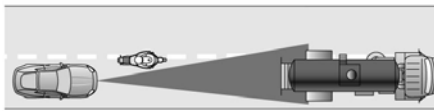

C

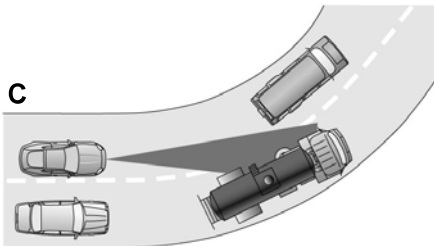

E71621

Detection issues can occur:

- A When driving on a different line than the vehicle in front.
- B With vehicles that edge into your lane. The system can only detect these vehicles once they move fully into your lane.
- C There may be issues with the detection of vehicles in front when driving into and coming out of a bend or curve in the road.

In these cases the system may brake late or unexpectedly. You should stay alert and intervene if necessary.

If something hits the front end of your vehicle or damage occurs, the radar-sensing zone may change. This could cause missed or false vehicle detections. Contact an authorized dealer to check the radar for proper coverage and operation.

System Not Available

Conditions that can cause the system to turn off or prevent the system from turning on when requested include:

- A blocked sensor.
- High brake temperature.
- A failure in the system or a related system.

Blocked Sensor



E145632

Cruise Control

A message appears if something obstructs the sensor's radar signals. The sensor is located behind a cover near the driver side of the lower grille. The system cannot detect a vehicle ahead and does not function when something obstructs the

radar signal.

Note: *You cannot see the sensor, it is behind a fascia panel.*

The following table lists possible causes and actions for this message displaying.

Cause	Action
The surface of the radar in the grille is dirty or obstructed in some way.	Clean the grille surface in front of the radar or remove the object obstructing it.
The surface of the radar in the grille is clean but the message remains in the display.	Wait a short time. It may take several minutes for the radar to detect that it is free from obstruction.
Heavy rain or snow is interfering with the radar signals.	Do not use the system in these conditions because it may not detect any vehicles ahead.
Swirling water, or snow or ice on the surface of the road may interfere with the radar signals.	Do not use the system in these conditions because it may not detect any vehicles ahead.
You are in a desert or remote area with no other vehicles and no roadside objects.	Wait a short time or switch to normal cruise control.

Due to the nature of radar technology, it is possible to get a blockage warning and not be blocked. This can happen, for example, when driving in sparse rural or desert environments. A false blocked condition will either self clear or clear after a key cycle.

Switching to Normal Cruise Control

WARNING



Normal cruise control will not brake due to slower vehicles. Always be aware of which mode you have selected and apply the brakes when necessary.

You can manually change from adaptive cruise control to normal cruise control through the information display. See **Information Displays** (page 94).



The cruise control indicator light replaces the adaptive cruise control indicator light if you select normal cruise control. The gap setting will not display, the system will not automatically respond to lead vehicles and automatic braking will not activate.

Driving Aids

DRIVER ALERT (If Equipped)

PRINCIPLE OF OPERATION

WARNING



The driver alert system is designed to aid you. It is not intended to replace your attention and judgment. You are still responsible to drive with due care and attention.

Note: The system will store the on or off setting in the information display menu through ignition cycles.

Note: If enabled in the menu, the system will be active at speeds above 40 mph (64 km/h). When below the activation speed, the information display will inform the driver that the system is unavailable.

Note: The system works as long as one lane marking can be detected by the camera.

Note: If the camera is blocked or if the windshield is damaged, the system may not function.

Note: The system may not be available in poor weather or other low visibility conditions.

The system automatically monitors your driving behavior using various inputs including the front camera sensor.

If the system detects that your driving alertness is reduced below a certain threshold, the system will alert you using a chime and a message in the cluster display.

USING DRIVER ALERT

Switching the System On and Off

Switch the system on or off using the information display. See **General Information** (page 94).

When activated, the system will monitor your alertness level based upon your driving behavior in relation to the lane markings, and other factors.

System Warnings

Note: The system will not issue warnings below approximately 40 mph (64 km/h).

The warning system has two stages. At first, the system issues a temporary warning that you need to take a rest. This message will only appear for a short time. If the system detects further reduction in driving alertness, it may issue another warning that will remain in the information display for a longer time. You can press OK on the steering wheel control to clear the warning.

System Display

When active the system will run automatically in the background and only issue a warning if required. You can view the status at any time using the information display. See **General Information** (page 94).

The alertness level is shown by six steps in a colored bar.

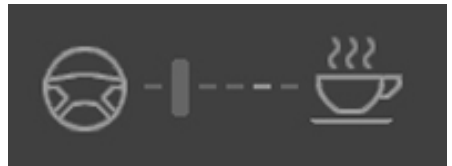

E131358

The current assessment of your alertness is within a typical range.

Driving Aids

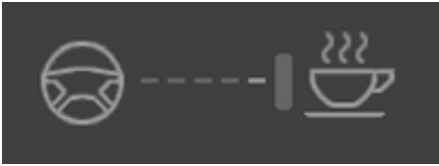

E131359

The current assessment of your alertness indicates that you should rest as soon as safely possible.

The status bar will travel from left to right as the calculated alertness level decreases. As the rest icon is approached the color turns from green to yellow to red.

The yellow position indicates the first warning is active and the red position indicates the second warning is active.

Note: *If you have recently received a warning; you should consider resting, even if the current assessment is within the typical range.*

Note: *If the camera sensor cannot track the road lane markings or if your vehicle speed drops below approximately 40 mph (64 km/h), the alertness level will change to grey for a short time and the information display will inform you that the system is unavailable.*

Resetting the System

You can reset the system by either:

- Switching the ignition off and on.
- Stopping the vehicle and then opening and closing the driver's door.

LANE KEEPING SYSTEM (if

Equipped)

WARNINGS

 Always drive with due care and attention when using and operating the controls and features on your vehicle.

 At all times, you are responsible for controlling your vehicle, supervising the system and intervening, if required. Failure to take care may result in the loss of control of your vehicle, serious personal injury or death.

 In cold and severe weather conditions the system may not function. Rain, snow and spray can all limit sensor performance.

 Large contrasts in outside lighting can limit sensor performance.

 The system will not operate if the sensor cannot track the road lane markings.

 If damage occurs in the immediate area surrounding the sensor, have your vehicle checked as soon as possible.

Note: *The system works above 40 mph (64 km/h).*

Note: *The system works as long as the camera can detect one lane marking.*

Note: *The system may not function if the camera is blocked or there is damage to the windshield.*

Note: *When Aid mode is on and the system detects no steering activity for a short period, the system will alert you to put your hands on the steering wheel. The system may detect a light grip or touch on the steering wheel as hands off driving.*

Driving Aids

The system notifies you to stay in your lane through the steering system and the instrument cluster display when the front camera detects an unintentional drift out of your lane is likely to occur. The system automatically detects and tracks the road lane markings using a camera mounted behind the interior rear view mirror.

Switching the System On and Off

Note: The system on or off setting is stored until it is manually changed, unless a MyKey is detected. If the system detects a MyKey it defaults to on and the mode is set to Alert.

Note: If a MyKey is detected, pressing the button will not affect the on or off status of the system.



Press the button on the steering wheel stalk to switch the system on or off.

System Settings

The system has optional setting menus available. The system stores the last-known selection for each of these settings. You do not need to readjust your settings each time you turn on the system.

Mode: This setting allows you to select which of the system features you can enable.

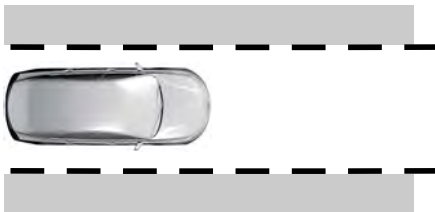

E165515

Alert only – Provides a steering wheel vibration when the system detects an unintended lane departure.

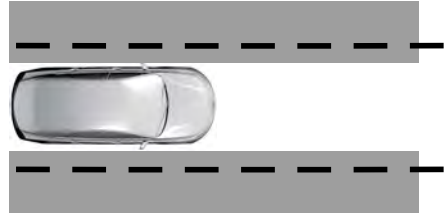

E165516

Aid only – Provides an assistance steering torque input toward the lane center when the system detects an unintended lane departure.

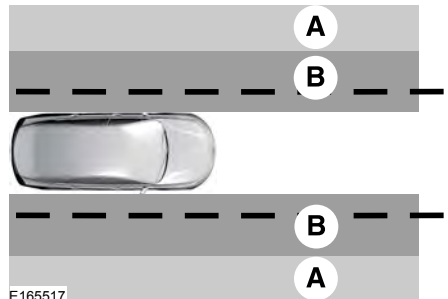

E165517

A Alert

B Aid

Alert + Aid – Provides an assistance steering torque input toward the lane center. If your vehicle continues drifting out of the lane, the system provides a steering wheel vibration.

Note: The alert and aid diagrams illustrate general zone coverage. They do not provide exact zone parameters.

Driving Aids

Intensity: This setting affects the intensity of the steering wheel vibration used for the alert and alert + aid modes. This setting does not affect the aid mode.

- Low
- Normal
- High

System Display



E151660

When you switch on the system, an overhead graphic of a vehicle with lane markings will display in the information display. If you select aid mode when you switch on the system, a separate white icon will also appear or in some vehicles arrows will display with the lane markings.

When you switch off the system, the lane marking graphics will not display.

While the system is on, the color of the lane markings will change to indicate the system status.

Gray: Indicates that the system is temporarily unable to provide a warning or intervention on the indicated side(s). This may be because:

- Your vehicle is under the activation speed.
- The turn indicator is active.
- Your vehicle is in a dynamic maneuver.
- The road has no or poor lane markings in the camera field-of-view.
- The camera is obscured or unable to detect the lane markings due to environmental conditions (significant sun angles, shadows, snow, heavy rain or fog), traffic conditions (following a large vehicle that is blocking or shadowing the lane), or vehicle conditions (poor headlamp illumination).

See **Troubleshooting** for additional information.

Green: Indicates that the system is available or ready to provide a warning or intervention, on the indicated side(s).

Yellow: Indicates that the system is providing or has just provided a lane keeping aid intervention.

Red: Indicates that the system is providing or has just provided a lane keeping alert warning.

The system can be temporarily suppressed at any time by the following:

- Quick braking.
- Fast acceleration.
- Using the turn signal indicator.
- Evasive steering maneuver.

Driving Aids

Troubleshooting

Why is the feature not available (line markings are gray) when I can see the lane markings on the road?
Vehicle speed is outside the operational range of the feature
Sun is shining directly into the camera lens
Quick intentional lane change
Staying too close to the lane marking
Driving at high speeds in curves
The last Alert warning or Aid intervention occurred a short time ago
Ambiguous lane markings (mainly in construction zones)
Rapid transition from light to dark or vice versa
Sudden offset in lane markings
ABS or AdvanceTrac activation
Camera blockage due to dirt, grime, fog, frost or water on the windshield
Driving too close to the vehicle in front of you
Transitioning between no lane markings to lane markings or vice versa
Standing water on the road
Faint lane markings (partial yellow lane markings on concrete roads)
Lane width too narrow or too wide
Camera not calibrated after a windshield replacement
Driving on tight roads or on uneven roads

Driving Aids

Why does the vehicle not come back toward the middle of the lane, as expected, in the Aid or Aid + Alert mode?
High cross winds
Large road crown
Rough roads, grooves, shoulder drop-offs
Heavy uneven loading of the vehicle or improper tire inflation pressure
If the tires have been exchanged (including snow tires), or the suspension has been modified

BLIND SPOT INFORMATION SYSTEM

WARNING



To help avoid injuries, NEVER use the Blind Spot Information System as a replacement for using the interior and exterior mirrors or looking over your shoulder before changing lanes. The Blind Spot Information System is not a replacement for careful driving.

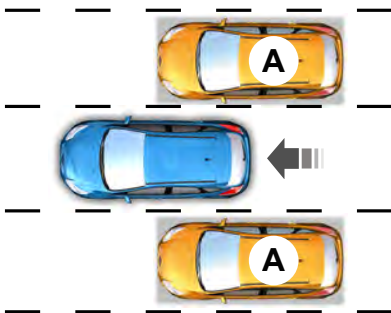

E124788

The Blind Spot Information System is designed to aid you in detecting vehicles that may have entered the blind spot zone (A). The detection area is on both sides of your vehicle, extending rearward from the exterior mirrors to approximately 13 ft (4 m) beyond the bumper. The system is designed to alert you if certain vehicles enter the blind spot zone while driving.

Note: *The Blind Spot Information System does not prevent contact with other vehicles or objects; nor detect parked vehicles, people, animals or infrastructure (fences, guardrails, trees). It's only designed to alert you to vehicles in the blind spot zones.*

Note: *When a vehicle passes quickly through the blind spot zone, typically fewer than two seconds, the system does not trigger.*

Using the System

The Blind Spot Information System turns on when you start the engine and you drive your vehicle forward above 5 mph (8 km/h).

Driving Aids

For automatic transmissions, the Blind Spot Information System remains on while the transmission is in drive (D). If shifted into reverse (R) or park (P) the Blind Spot Information System turns off. Once shifted back into drive (D), the Blind Spot Information System turns back on when you drive your vehicle above 5 mph (8 km/h).

For manual transmissions, the Blind Spot Information System is on for all gears except the reverse (R).

Note: *The Blind Spot Information System does not function in reverse (R) or park (P).*

System Lights and Messages



E142442

The Blind Spot Information System illuminates an amber alert indicator in the outside mirror on the side of your vehicle the approaching vehicle is coming from. When the Blind Spot Information System is alerting on a vehicle and the corresponding turn signal is ON, the Blind Spot Information System alert indicator flashes as an increased warning level.

The alert indicator dims when the system detects nighttime darkness.

Note: *The alert indicator flashes in case of an alert and the turn signal is set to that side at the same time.*

System Sensor Blockage

WARNING



To help avoid injuries, NEVER use the Blind Spot Information System as a replacement for using the interior and exterior mirrors or looking over your shoulder before changing lanes. The Blind Spot Information System is not a replacement for careful driving.

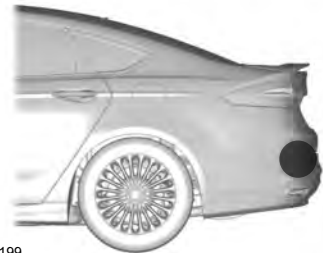

E205199

The system uses radar sensors that are located behind the bumper fascia on each side of your vehicle. Any dirt, mud and snow in front of the sensors and/or driving in heavy rain can cause system degradation. Also, other types of obstructions in front of the sensor can cause system degradation. This is referred to as a 'blocked' condition.

Driving Aids

Note: Do not apply bumper stickers and/or repair compound to these areas, this can cause degraded system performance.

If the system detects a degraded performance condition, a message warning of a blocked sensor will appear in the information display. Also the BLIS alert indicators will remain ON and BLIS will no longer provide any vehicle warnings. You can clear the information display warning but the alert indicators will remain illuminated.

A "blocked" condition can be cleared in two ways:

- After the blockage in front of the sensors is removed or the rainfall/snowfall rate decreases or stops, drive for a few minutes in traffic to allow the sensors to detect passing vehicles.
- By cycling the ignition from ON to OFF and then back ON.

Note: If your vehicle has a tow bar with a factory equipped trailer tow module and it is towing a trailer, the sensors will automatically turn the Blind Spot Information System off. If your vehicle has a tow bar but no factory equipped trailer tow module, it is recommended to turn the Blind Spot Information System off manually. Operating the Blind Spot Information System with a trailer attached will cause poor system performance.

System Errors

If the system senses a problem with the left or right sensor, the telltale will illuminate and a message will appear in the information display. See **Information Messages** (page 103).

Switching the System Off and On

You can temporarily switch the Blind Spot Information System off in the information display. See **General Information** (page 94). When the Blind Spot Information System switches off, you will not receive alerts and the information display shows a system off message. The telltale in the cluster also illuminates. When you switch the Blind Spot Information System on or off, the alert indicators flash twice.

Note: The Blind Spot Information System remembers the last selected on or off setting.

You can also have the Blind Spot Information System switched off permanently at an authorized dealer. Once switched off permanently, the system can only be switched back on at an authorized dealer.

CROSS TRAFFIC ALERT

WARNING



To help avoid personal injury, NEVER use the Cross Traffic Alert system as a replacement for using the interior and exterior mirrors and looking over your shoulder before backing out of a parking space. Cross Traffic Alert is not a replacement for careful driving.

Cross Traffic Alert is designed to warn you of vehicles approaching from the sides when the transmission is in reverse (R).

Using the System

Cross Traffic Alert turns on when you start the engine and you shift into reverse (R). Once shifted out of reverse (R), Cross Traffic Alert turns off.

Note: Cross Traffic Alert only functions while your transmission is in reverse (R).

Driving Aids

Cross Traffic Alert is designed to detect vehicles that approach with a speed up to 37 mph (60 km/h). Coverage decreases when the sensors are partially, mostly or

fully obstructed. Reversing slowly helps increase the coverage area and effectiveness.

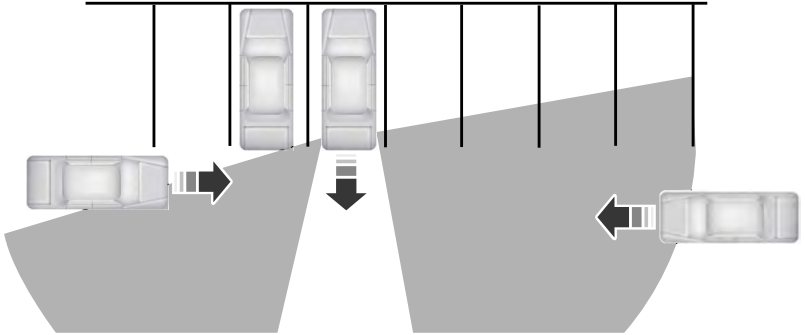

E142440

In this first example, the left sensor is only partially obstructed; zone coverage to the right is nearly maximized.

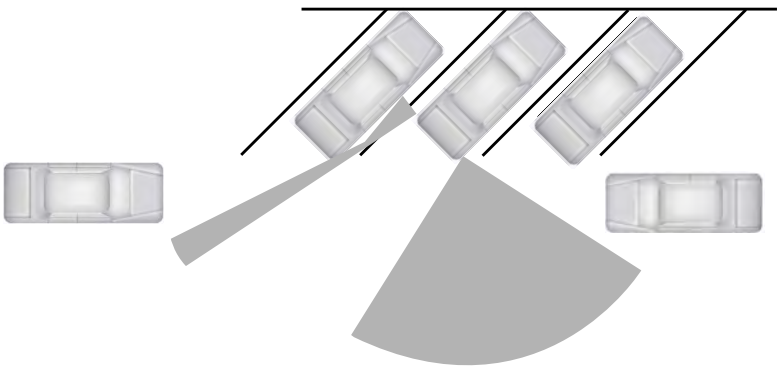

E142441

Driving Aids

Zone coverage also decreases when parking at shallow angles. Here, the left sensor is mostly obstructed; zone coverage on that side is severely limited.

System Lights, Messages and Audible Alerts



E142442

The Cross Traffic Alert illuminates an amber alert indicator in the outside mirror on the side of your vehicle the approaching vehicle is coming from. Cross Traffic Alert also sounds an audible alert and a message appears in the information display indicating a vehicle is coming from the right or left. Cross Traffic Alert works with the reverse sensing system that sounds its own series of tones. See **Rear Parking Aid** (page 182).

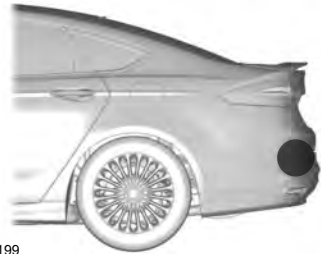

E205199

The system uses radar sensors that are located behind the bumper fascia on each side of your vehicle. Do not allow mud, snow or bumper stickers to obstruct these areas, this can cause degraded system performance. See **Blind Spot Information System** (page 208). If the Blind Spot Information System is blocked, Cross Traffic Alert is also blocked. A corresponding message appears in the information display as soon as you shift the transmission into reverse (R).

System Limitations

Cross Traffic Alert has its limitations; situations such as severe weather conditions or debris build-up on the sensor area may limit vehicle detection.

Driving Aids

The following are other situations that may limit the Cross Traffic Alert performance:

- Adjacently parked vehicles or objects obstructing the sensors.
- Approaching vehicles passing at speeds greater than 37 mph (60 km/h).
- Driving in reverse faster than 7 mph (12 km/h).
- Backing out of an angled parking spot.

False Alerts

Note: *If your vehicle has a tow bar with a factory equipped trailer tow module and it is towing a trailer, the sensors will automatically turn the Cross Traffic Alert off. If your vehicle has a tow bar but no factory equipped trailer tow module, it is recommended to turn the Cross Traffic Alert off manually. Operating Cross Traffic Alert with a trailer attached will cause poor Cross Traffic Alert performance.*

There may be certain instances when there is a false alert by the Cross Traffic Alert system that illuminates the alert indicator with no vehicle in the coverage zone. Some amount of false alerts are normal; they are temporary and self-correct.

System Errors

If Cross Traffic Alert senses a problem with the left or right sensor a message will appear in the information display. See (page 94).

Switching the System Off and On

You can temporarily switch Cross Traffic Alert off in the information display. See **General Information** (page 94). When you switch Cross Traffic Alert off, you will not receive alerts and the information display will display a system off message.

Note: *The Cross Traffic Alert switches on whenever the ignition is switched on and ready to provide appropriate alerts when the transmission is in reverse (R). Cross Traffic Alert will not remember the last selected on or off setting.*

You can also have Cross Traffic Alert switched off permanently at an authorized dealer. Once switched off permanently, the system can only be switched back on at an authorized dealer.

STEERING

Electric Power Steering

WARNINGS



The electric power steering system has diagnostic checks that continuously monitor the system. If a fault is detected, a message displays in the information display. Stop your vehicle as soon as it is safe to do so. Switch the ignition off. After at least 10 seconds, switch the ignition on and watch the information display for a steering system warning message. If a steering system warning message returns, have the system checked by an authorized dealer.



If the system detects an error, you may not feel a difference in the steering, however a serious condition may exist. Obtain immediate service from an authorized dealer, failure to do so may result in loss of steering control.

Your vehicle has an electric power steering system. There is no fluid reservoir. No maintenance is required.

If your vehicle loses electrical power while you are driving, electric power steering assistance is lost. The steering system still operates and you can steer your vehicle manually. Manually steering your vehicle requires more effort.

Driving Aids

Extreme continuous steering may increase the effort required for you to steer your vehicle. This increased effort prevents overheating and permanent damage to the steering system. You do not lose the ability to steer your vehicle manually. Typical steering and driving maneuvers allow the system to cool and return to normal operation.

Steering Tips

If the steering wanders or pulls, check for:

- Correct tire pressures.
- Uneven tire wear.
- Loose or worn suspension components.
- Loose or worn steering components.
- Improper vehicle alignment.

Note: A high crown in the road or high crosswinds may also make the steering seem to wander or pull.

Adaptive Learning

The electronic power steering system adaptive learning helps correct road irregularities and improves overall handling and steering feel. It communicates with the brake system to help operate advanced stability control and accident avoidance systems. Additionally, whenever the battery is disconnected or a new battery installed, you must drive your vehicle a short distance before the system relearns the strategy and reactivates all systems.

PRE-COLLISION ASSIST

WARNINGS



At all times, you are responsible for controlling your vehicle, supervising the system and intervening, if required. Failure to take care may result in the loss of control of your vehicle, serious personal injury or death.



The system does not detect cyclists, animals, pedestrians at night or vehicles that are driving in a different direction. Failure to take care may result in the loss of control of your vehicle, serious personal injury or death.



The system does not operate during hard acceleration or steering. Failure to take care may lead to a crash or personal injury.



The system may fail or operate with reduced function during cold and severe weather conditions. Snow, ice, rain, spray and fog can adversely affect the system. Keep the front camera and radar free of snow and ice. Failure to take care may result in the loss of control of your vehicle, serious personal injury or death.



In situations where the vehicle camera has limited detection capability, this may reduce system performance. These situations include but are not limited to direct or low sunlight, vehicles at night without tail lights, unconventional vehicle types, pedestrians with complex backgrounds, running pedestrians, partly obscured pedestrians, or pedestrians that the system cannot distinguish from a group. Failure to take care may result in the loss of control of your vehicle, serious personal injury or death.

Driving Aids

WARNINGS



This system is an extra driving aid. It does not replace your attention and judgment, or the need to apply the brakes. This system does NOT automatically brake your vehicle. If you fail to press the brake pedal when necessary, you may collide with another vehicle.



The system cannot help prevent all crashes. Do not rely on this system to replace driver judgment and the need to maintain a safe distance and speed.

Using the Pre-Collision Assist System

The Pre-Collision Assist system is active at speeds above approximately 3 mph (5 km/h) and pedestrian detection is active at speeds up to 50 mph (80 km/h).



E156130

If your vehicle is rapidly approaching another stationary vehicle, a vehicle traveling in the same direction as yours, or a pedestrian within your driving path, the system is designed to provide three levels of functionality:

1. Alert
2. Brake Support
3. Active Braking

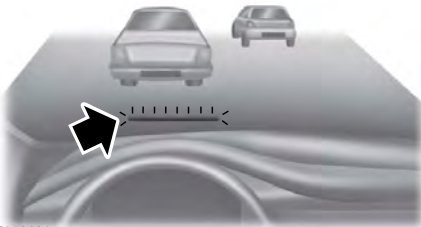

E156131

Alert: When activated, a red warning light flashes, an audible warning chime sounds and a warning message shows in the information display.

Brake Support: The brake support system assists the driver in reducing the collision speed by lightly applying the brakes. If the risk of collision further increases after the warning light illuminates, the brake support prepares the brake system for rapid braking. This may be apparent to the driver. The system does not automatically activate the brakes, but if you press the brake pedal, the system may apply full force, even if the brake pedal is lightly pressed.

Active Braking: Active braking may activate if the system determines that a collision is imminent. The system may help the driver reduce impact damage or avoid the crash completely.

Note: If you perceive Pre-Collision Assist alerts as being too frequent or disturbing, then you can reduce the alert sensitivity, though the manufacturer recommends using the highest sensitivity setting where possible. Setting lower sensitivity would lead to fewer and later system warnings.

Blocked Sensors

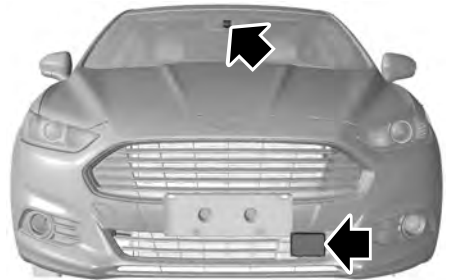

E184569

Driving Aids

If a message regarding a blocked sensor or camera appears in the information display, the radar signals or camera images are obstructed. The radar sensor is located behind a fascia cover near the driver side of the lower grille. With an obstructed radar, the Pre-Collision Assist system does not function and cannot detect a vehicle

ahead. With the front camera obstructed, the Pre-Collision Assist system does not respond to pedestrians or stationary vehicles and the system performance on moving vehicles reduces. The following table lists possible causes and actions for when this message displays.

Cause	Action
The surface of the radar in the grille is dirty or obstructed in some way.	Clean the grille surface in front of the radar or remove the object causing the obstruction.
The surface of the radar in the grille is clean but the message remains in the display.	Wait a short time. It may take several minutes for the radar to detect that there is no obstruction.
Heavy rain, spray, snow, or fog is interfering with the radar signals.	The Pre-Collision Assist system is temporarily disabled. Pre-Collision Assist should automatically reactivate a short time after the weather conditions improve.
Swirling water, or snow or ice on the surface of the road may interfere with the radar signals.	The Pre-Collision Assist system is temporarily disabled. Pre-Collision Assist should automatically reactivate a short time after the weather conditions improve.
Radar is out of alignment due to a front end impact.	Contact an authorized dealer to have the radar checked for proper coverage and operation.
The windshield in front of the camera is dirty or obstructed in some way.	Clean the outside of the windshield in front of the camera.
The windshield in front of the camera is clean but the message remains in the display.	Wait a short time. It may take several minutes for the camera to detect that there is no obstruction.

Note: *Proper system operation requires a clear view of the road by the camera. Have any windshield damage in the area of the camera's field of view repaired.*

Note: *If something hits the front end of your vehicle or damage occurs, the radar sensing zone may change. This could cause missed or false vehicle detections. Contact an authorized dealer to have the radar checked for proper coverage and operation.*

Driving Aids

Note: *If your vehicle detects excessive heat at the camera or a potential misalignment condition, a message may display in the information display indicating temporary sensor unavailability. This message deactivates automatically when operational conditions are corrected (for example, when the ambient temperature around the sensor decreases or the sensor automatically recalibrates successfully).*

Load Carrying

LOAD LIMIT

Vehicle Loading - with and without a Trailer

This section guides you in the proper loading of your vehicle, trailer, or both. Keep your loaded vehicle weight within its design rating capability, with or without a trailer. Properly loading your vehicle provides maximum return of vehicle design performance. Before you load your vehicle, become familiar with the following terms for determining your vehicle's weight rating, with or without a trailer, from the vehicle's Tire and Loading Information label or Safety Compliance Certification label.

Tire and Loading Label Information Example:

TIRE AND LOADING INFORMATION

SEATING CAPACITY TOTAL: 5 FRONT: 2 REAR: 3

The combined weight of occupants and cargo should never exceed: **385 kg or 850 lbs.**

TIRE	SIZE	COLD TIRE PRESSURE
FRONT	235/45R18 94V	235 KPA, 34 PSI
REAR	235/45R18 94V	235 KPA, 34 PSI
SPARE	NONE	NONE

SEE OWNERS MANUAL FOR ADDITIONAL INFORMATION

TIRE AND LOADING INFORMATION
RENSEIGNEMENTS SUR LES PNEUS ET LE CHARGEMENT

SEATING CAPACITY / NOMBRE DE PLACES TOTAL 5 FRONT / AVANT 2 REAR / ARRIERE 3

The combined weight of occupants and cargo should never exceed 396 kg or 875 lbs. / Le poids total des occupants et du chargement ne doit jamais dépasser 396 kg ou 875 lbs.

TIRE / PNEU	SIZE / DIMENSIONS	COLD TIRE PRESSURE / PRESSION DES PNEUS A FROID
FRONT / AVANT	235/40R19 96V	255 KPA, 37 PSI
REAR / ARRIERE	235/40R19 96V	255 KPA, 37 PSI
SPARE / SECOURS	T125/80R16 97M	415 KPA, 60 PSI

SEE OWNER'S MANUAL FOR ADDITIONAL INFORMATION
VOIR LE MANUEL DE L'USAGER POUR PLUS DE RENSEIGNEMENTS

E198719

Payload

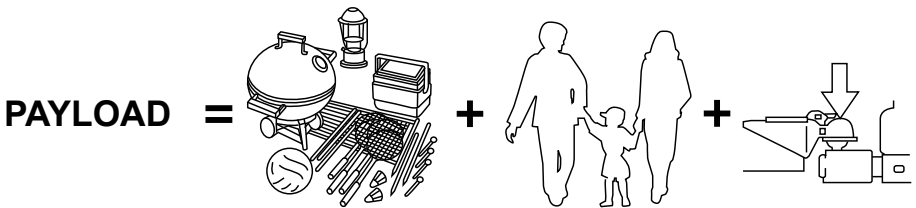

E143816

Load Carrying

Payload is the combined weight of cargo and passengers that your vehicle is carrying. The maximum payload for your vehicle appears on the Tire and Loading label. The label is either on the B-pillar or the edge of the driver door. Vehicles exported outside the US and Canada may not have a tire and loading label. Look for “The combined weight of occupants and cargo should never exceed XXX kg OR XXX lb” for maximum payload. The payload listed on the Tire and Loading Information label is the maximum payload for your vehicle as built by the assembly plant. If you install any additional equipment on your vehicle, you must determine the new payload. Subtract the weight of the equipment from the payload listed on the Tire and Loading label. When towing, trailer tongue weight or king pin weight is also part of payload.

WARNING



The appropriate loading capacity of your vehicle can be limited either by volume capacity (how much space is available) or by payload capacity (how much weight the vehicle should carry). Once you have reached the maximum payload of your vehicle, do not add more cargo, even if there is space available. Overloading or improperly loading your vehicle can contribute to loss of vehicle control and vehicle rollover.

GAWR (Gross Axle Weight Rating)

GAWR is the maximum allowable weight that a single axle (front or rear) can carry. These numbers are on the Safety Compliance Certification label. The label is located on the door hinge pillar, door-latch post, or the door edge that meets the door-latch post, next to the driver seating position.

The total load on each axle must never exceed its Gross Axle Weight Rating.

GVWR (Gross Vehicle Weight Rating)

GVWR is the maximum allowable weight of the fully loaded vehicle. This includes all options, equipment, passengers and cargo. It appears on the Safety Compliance Certification label. The label is located on the door hinge pillar, door-latch post, or the door edge that meets the door-latch post, next to the driver seating position.

The gross vehicle weight must never exceed the Gross Vehicle Weight Rating.

Load Carrying

Safety Compliance Certification Label Example:

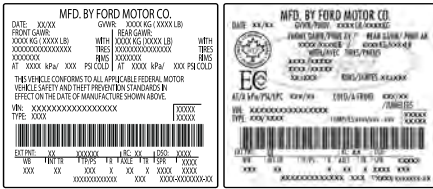

6198828

WARNING



Exceeding the Safety Compliance Certification label vehicle weight rating limits could result in substandard vehicle handling or performance, engine, transmission and/or structural damage, serious damage to the vehicle, loss of control and personal injury.

Maximum Loaded Trailer Weight

Maximum loaded trailer weight is the highest possible weight of a fully loaded trailer the vehicle can tow. Consult an authorized dealer (or the RV and Trailer Towing Guide available at an authorized dealer) for more detailed information.

GCWR (Gross Combined Weight Rating)

GCWR is the maximum allowable weight of the vehicle and the loaded trailer, including all cargo and passengers, that the vehicle can handle without risking damage. (Important: The towing

vehicle's braking system is rated for operation at Gross Vehicle Weight Rating, not at Gross Combined Weight Rating.) Separate functional brakes should be used for safe control of towed vehicles and for trailers where the Gross Combined Weight of the towing vehicle plus the trailer exceed the Gross Vehicle Weight Rating of the towing vehicle.

The gross combined weight must never exceed the Gross Combined Weight Rating.

Note: For trailer towing information refer to the *RV and Trailer Towing Guide* available at an authorized dealer.

WARNINGS



Do not exceed the GVWR or the GAWR specified on the Safety Compliance Certification label.



Do not use replacement tires with lower load carrying capacities than the original tires because they may lower your vehicle's GVWR and GAWR limitations. Replacement tires with a higher limit than the original tires do not increase the GVWR and GAWR limitations.



Exceeding any vehicle weight rating limitation could result in serious damage to your vehicle, personal injury or both.

Load Carrying

Steps for determining the correct load limit:

1. Locate the statement "The combined weight of occupants and cargo should never exceed XXX kg or XXX lb." on your vehicle's placard.
2. Determine the combined weight of the driver and passengers that will be riding in your vehicle.
3. Subtract the combined weight of the driver and passengers from XXX kg or XXX lb.
4. The resulting figure equals the available amount of cargo and luggage load capacity. For example, if the "XXX" amount equals 1,400 lb. and there will be five 150 lb. passengers in your vehicle, the amount of available cargo and luggage load capacity is 650 lb. $(1400 - 750 (5 \times 150) = 650 \text{ lb.})$
5. Determine the combined weight of luggage and cargo being loaded on the vehicle. That weight may not safely exceed the available cargo and luggage load capacity calculated in Step 4.
6. If your vehicle will be towing a trailer, load from your trailer will be transferred to your vehicle. Consult this manual to determine how this reduces the available cargo and luggage load capacity of your vehicle.

Helpful examples for calculating the available amount of cargo and luggage load capacity

Suppose your vehicle has a 1400-pound (635-kilogram) cargo and luggage capacity. You decide to go golfing. Is there enough load capacity to carry you, four of your friends and all the golf bags? You and four friends average 220 pounds (99 kilograms) each and the golf bags weigh approximately 30 pounds (13.5 kilograms) each. The calculation would be: $1400 - (5 \times 220) - (5 \times 30) = 1400 - 1100 - 150 = 150$ pounds. Yes, you have enough load capacity in your vehicle to transport four friends and your golf bags. In metric units, the calculation would be: $635 \text{ kilograms} - (5 \times 99 \text{ kilograms}) - (5 \times 13.5 \text{ kilograms}) = 635 - 495 - 67.5 = 72.5$ kilograms.

Suppose your vehicle has a 1400-pound (635-kilogram) cargo and luggage capacity. You and one of your friends decide to pick up cement from the local home improvement store to finish that patio you have been planning for the past two years. Measuring the inside of the vehicle with the rear seat folded down, you have room for twelve 100-pound (45-kilogram) bags of cement. Do you have enough load capacity to transport the cement to your home? If you and your friend each weigh 220 pounds (99 kilograms), the calculation would be: $1400 - (2 \times 220) - (12 \times 100) = 1400 - 440$

Load Carrying

- 1200 = - 240 pounds. No, you do not have enough cargo capacity to carry that much weight. In metric units, the calculation would be: $635 \text{ kilograms} - (2 \times 99 \text{ kilograms}) - (12 \times 45 \text{ kilograms}) = 635 - 198 - 540 = -103 \text{ kilograms}$. You will need to reduce the load weight by at least 240 pounds (104 kilograms). If you remove three 100-pound (45-kilogram) cement bags, then the load calculation would be: $1400 - (2 \times 220) - (9 \times 100) = 1400 - 440 - 900 = 60 \text{ pounds}$. Now you have the load capacity to transport the cement and your friend home. In metric units, the calculation would be: $635 \text{ kilograms} - (2 \times 99 \text{ kilograms}) - (9 \times 45 \text{ kilograms}) = 635 - 198 - 405 = 32 \text{ kilograms}$.

The above calculations also assume that the loads are positioned in your vehicle in a manner that does not overload the front or the rear gross axle weight rating specified for your vehicle on the Safety Compliance Certification label.

Special Loading Instructions for Owners of Pick-up Trucks and Utility-type Vehicles

WARNING



Loaded vehicles may handle differently than unloaded vehicles. Take extra precautions, such as slower speeds and increased stopping distance, when driving a heavily loaded vehicle.

Towing

TOWING A TRAILER

WARNING



Never tow a trailer with a Fusion Hybrid. This powertrain is not designed to tow.

TOWING THE VEHICLE ON FOUR WHEELS

Emergency Towing

In the event your vehicle becomes disabled (without access to wheel dollies, car-hauling trailer, or flatbed transport vehicle), it can be flat-towed (all wheels on the ground, regardless of the powertrain/transmission configuration) under the following conditions:

- The vehicle is facing forward so that it is towed in a forward direction.
- Place the transmission in position **N**. If you cannot move the transmission into **N**, you must override it and enable stay in neutral mode. Failing to do so may result in damage to the transmission. See **Transmission** (page 170).
- Maximum speed is 35 mph (56 km/h).
- Maximum distance is 50 miles (80 kilometers).

Recreational Towing

Note: Put your climate control system in recirculated air mode to prevent exhaust fumes from entering your vehicle. See **Climate Control** (page 116).

Follow these guidelines if you have a need for recreational (RV) towing. An example of recreational towing would be towing your vehicle behind a motorhome. These guidelines are designed to ensure that your transmission is not damaged.

Your vehicle can be towed with all four wheels on the ground using the Neutral Tow feature, or with all four wheels off the ground using a vehicle transport trailer. If you are using a vehicle transport trailer, follow the instruction specified by the equipment provider.

Neutral Tow

If you tow your vehicle with all four wheels on the ground:

- Tow only in the forward direction.
- Release the parking brake.
- Place the vehicle in Neutral Tow mode by doing the following:
 - Put the ignition in accessory mode (ignition on, engine off). See **Keyless Starting** (page 141).
 - Select the neutral tow option in the information display.
 - When prompted by the information display, press the brake pedal and select Neutral on the transmission. Make sure the parking brake is off. If done successfully, a confirmation message appears in the display.
 - Shut the ignition off. See **Keyless Starting** (page 141). If the process is completed successfully, the **N** on the transmission slowly blinks and a confirmation message appears in the display.
- Do not exceed 70 mph (113 km/h).
- Start the engine and allow it to run for one minute at the beginning of each day. With the engine running and your foot on the brake, shift into position **D** and then into position **R** before shifting back into position **N**.

Driving Hints

BREAKING-IN

You need to break in new tires for approximately 300 miles (480 kilometers). During this time, your vehicle may exhibit some unusual driving characteristics. The engine also needs to break in. Avoid hard accelerations and driving too fast for the first 1000 miles (1600 kilometers). If possible, avoid carrying heavy loads up steep grades during the break-in period.

ECONOMICAL DRIVING

Your fuel economy depends on:

- How you drive your vehicle.
- How you maintain your vehicle.
- The conditions you drive your vehicle in.

You may improve your fuel economy by keeping these in mind:

- Drive your vehicle at reasonable speeds. Traveling at 65 mph (105 km/h) uses about 15% less fuel than traveling at 75 mph (121 km/h).
- Drive at steady speeds without stopping.
- Anticipate stops. Slowing down your vehicle may eliminate the need to stop.
- Keep the tires properly inflated and use only the recommended size.
- Switch off the heater if you do not need it. When you have the heater on, keep it at the lowest blower and temperature setting necessary to be comfortable.
- When it is cold outside, park in a sunny location or a climate-controlled environment. This may save fuel by reducing the energy needed to heat the cabin.

- Switch off the air conditioning if you do not need it. When you have the air conditioning on, keep it at the lowest blower and highest temperature setting necessary to be comfortable.
- When it is hot or sunny outside, parking in a shaded or climate-controlled environment will save fuel by reducing the energy needed to cool the cabin.
- For Plug-In Hybrid vehicles, use preconditioning to improve your fuel economy. See **High Voltage Battery** (page 162).
- Switch off the heated seats if you are not using them.
- Switch off the defroster when you no longer need it for visibility.
- For Plug-In Hybrid vehicles, plug in and recharge the high voltage battery whenever possible.
- Use ECO Cruise Control, especially in hilly terrain. See **Cruise Control** (page 195).
- Shift into low gear (L) when enhanced engine braking is needed. Otherwise, use drive gear (D) shift position.
- Combine errands and minimize stop-and-go driving. A warmed up engine works more efficiently. When running errands, go to the farthest destination first and then work your way back home.
- Close the windows for high-speed driving.
- Use the recommended engine oil. See **Capacities and Specifications** (page 306).
- Perform all regularly scheduled maintenance. See **Scheduled Maintenance** (page 466).
- Use the coach and brake coach display to get feedback on your economical drive style. See **Information Displays** (page 94).

Driving Hints

Avoid these actions because they reduce your fuel economy:

- Avoid sudden or hard accelerations and decelerations. Accelerate and slow down in a smooth, moderate fashion.
- Avoid revving the engine before switching off your vehicle.
- Avoid long idle periods.
- Do not warm up your vehicle on cold mornings.
- Do not rest your foot on the brake pedal while driving.
- Avoid carrying unnecessary weight. Approximately 1 mile per gallon (0.4 kilometers per liter) is lost for every 400 lb (180 kg) of weight carried.
- Avoid adding accessories that increase aerodynamic drag to your vehicle such as bug deflectors, car top carriers and ski or bike racks.
- Avoid driving with the wheels out of alignment.

Things to keep in mind when you refuel your vehicle:

- Fuel generates fewer vapors when it is cool and dark outside. Refuel your vehicle in the early morning or late evening.
- Use the recommended octane-rated fuel. Using fuel below the recommended rating will lower your fuel economy.

DRIVING THROUGH WATER

WARNING



Do not drive through flowing or deep water as you may lose control of your vehicle.

Note: *Driving through standing water can cause vehicle damage.*

Note: *Engine damage can occur if water enters the air filter.*

Before driving through standing water, check the depth. Never drive through water that is higher than the bottom of the front rocker area of your vehicle.



E176360

When driving through standing water, drive very slowly and do not stop your vehicle. Your brake performance and traction may be limited. After driving through water and as soon as it is safe to do so:

- Lightly press the brake pedal to dry the brakes and to check that they work.
- Check that the horn works.
- Check that the exterior lights work.
- Turn the steering wheel to check that the steering power assist works.

FLOOR MATS

WARNINGS



Always use floor mats that are designed to fit the foot well of your vehicle. Only use floor mats that leave the pedal area unobstructed. Only use floor mats that are firmly secured to retention posts so that they cannot slip out of position and interfere with the pedals or impair safe operation of your vehicle in other ways.

Driving Hints

WARNINGS



Pedals that cannot move freely can cause loss of vehicle control and increase the risk of serious personal injury.



Always make sure that the floor mats are properly attached to the retention posts in the carpet that are supplied with your vehicle. Floor mats must be properly secured to both retention posts to make sure mats do not shift out of position.



Never place floor mats or any other covering in the vehicle foot well that cannot be properly secured to prevent them from moving and interfering with the pedals or the ability to control the vehicle.



Never place floor mats or any other covering on top of already installed floor mats. Floor mats should always rest on top of vehicle carpeting surface and not another floor mat or other covering. Additional floor mats or any other covering will reduce the pedal clearance and potentially interfere with pedal operation.



Check attachment of floor mats on a regular basis. Always properly reinstall and secure floor mats that have been removed for cleaning or replacement.



Always make sure that objects cannot fall into the driver foot well while the vehicle is moving. Objects that are loose can become trapped under the pedals causing a loss of vehicle control.



Failure to properly follow floor mat installation or attachment instructions can potentially cause interference with pedal operation causing a loss of vehicle control.



E142666

To install floor mats, position the floor mat so that the eyelet is over the retention post and press down to lock in.

To remove the floor mat, reverse the installation procedure.

Roadside Emergencies

ROADSIDE ASSISTANCE

Vehicles Sold in the United States: Getting Roadside Assistance

To fully assist you should you have a vehicle concern, Ford Motor Company offers a complimentary roadside assistance program. This program is separate from the New Vehicle Limited Warranty. The service is available:

- 24 hours a day, seven days a week.
- For the coverage period listed on the Roadside Assistance Card included in your Owner's Manual portfolio.

Roadside Assistance covers:

- A flat tire change with a good spare, if provided with the vehicle (except vehicles supplied with a tire inflation kit).
- Battery jump start.
- Lock-out assistance (key replacement cost is the customer's responsibility).
- Fuel delivery — independent service contractors, if not prohibited by state, local or municipal law, shall deliver up to 2 gal (7.6 L) of gasoline or 5 gal (18.9 L) of diesel fuel to a disabled vehicle. Roadside Assistance limits fuel delivery service to two no-charge occurrences within a 12-month period.
- Winch out — available within 100 ft (30.5 m) of a paved or county maintained road, no recoveries.
- Towing — independent service contractors, if not prohibited by state, local or municipal law, shall tow Ford eligible vehicles to an authorized dealer within 35 mi (56 km) of the disablement location or to the nearest

authorized dealer. If a member requests a tow to an authorized dealer that is more than 35 mi (56 km) from the disablement location, the member shall be responsible for any mileage costs in excess of 35 mi (56 km).

Roadside Assistance includes up to \$200 for a towed trailer if the disabled eligible vehicle requires service at the nearest authorized dealer. If the towing vehicle is operational but the trailer is not, then the trailer does not qualify for any roadside services.

Vehicles Sold in the United States: Using Roadside Assistance

Complete the roadside assistance identification card and place it in your wallet for quick reference. This card is in the owner's information portfolio in the glove compartment.

United States Ford vehicle customers who require Roadside Assistance, call 1-800-241-3673.

If you need to arrange roadside assistance for yourself, Ford Motor Company reimburses a reasonable amount for towing to the nearest dealership within 35 mi (56 km). To obtain reimbursement information, United States Ford vehicle customers call 1-800-241-3673. Customers need to submit their original receipts.

Vehicles Sold in Canada: Getting Roadside Assistance

To fully assist you should you have a vehicle concern, Ford Motor Company of Canada, Limited offers a complimentary roadside assistance program. This program is eligible within Canada or the continental United States.

Roadside Emergencies

This program is separate from the New Vehicle Limited Warranty, but the coverage is concurrent with the powertrain coverage period of your vehicle.

Canadian customers who require roadside assistance, call 1-800-665-2006.

Vehicles Sold in Canada: Using Roadside Assistance

Complete the roadside assistance identification card and place it in your wallet for quick reference.

In Canada, this card is found in the Warranty Guide in the glove compartment of your vehicle.

Vehicles Sold in Canada: Roadside Assistance Program Coverage

The service is available 24 hours a day, seven days a week.

Canadian roadside coverage and benefits may differ from the U.S. coverage.

For complete program coverage details you may contact your dealer, you can call us in Canada at 1-800-665-2006, or visit our website at www.ford.ca.

HAZARD WARNING FLASHERS

Note: *If used when the vehicle is not running, the battery will lose charge. There may be insufficient power to restart your vehicle.*



The hazard warning button is located on the instrument panel. Use it when your vehicle is creating a safety hazard for other motorists.

- Press the button to turn on the hazard warning function, and the front and rear direction indicators will flash.
- Press the button again to turn them off.

FUEL SHUTOFF

WARNING



Failure to inspect and, if necessary, repair fuel leaks after a collision may increase the risk of fire and serious injury. Ford Motor Company recommends that the fuel system be inspected by an authorized dealer after any collision.

In the event of a moderate to severe collision, this vehicle has a fuel pump shut-off feature that stops the flow of fuel to the engine. Not every impact will cause a shut-off.

Should your vehicle shut off after a collision, you may restart your vehicle.

For vehicles equipped with a key system:

1. Switch off the ignition.
2. Switch on the ignition.
3. Check the information display for the Ready to Drive light as the gasoline engine may not start, but the electric motor may be running. If you do not see the Ready to Drive light, repeat Steps 1 and 2 up to two more times.

For vehicles equipped with a push button start system:

1. Press the push button start to switch off the ignition.
2. Press the brake pedal and press the push button start to switch on the ignition.
3. Check the information display for the Ready to Drive light as the gasoline engine may not start, but the electric motor may be running. If you do not see the Ready to Drive light, repeat Steps 1 and 2 up to two more times.

Roadside Emergencies

Note: When you try to restart your vehicle after a fuel shutoff, the vehicle makes sure that the electrical system is safe to restart. Once your vehicle determines that the electrical system is safe, then the vehicle will allow you to restart.

Note: In the event that your vehicle does not restart after your third attempt, contact an authorized dealer.

JUMP STARTING THE VEHICLE

WARNINGS



The gases around the battery can explode if exposed to flames, sparks, or lit cigarettes. An explosion could result in injury or vehicle damage.



Batteries contain sulfuric acid which can burn skin, eyes and clothing, if contacted.

Do not attempt to push-start your automatic transmission vehicle. Automatic transmissions do not have push-start capability. Attempting to push-start a vehicle with an automatic transmission may cause transmission damage.

Preparing Your Vehicle

Note: Use only a 12-volt supply to start your vehicle.

Note: Do not disconnect the battery of the disabled vehicle as this could damage the vehicle's electrical system.

1. Park the booster vehicle close to the hood of the disabled vehicle making sure the two vehicles do not touch. Set the parking brake on both vehicles and stay clear of the engine cooling fan and other moving parts.
2. Check all battery terminals and remove any excessive corrosion before you attach the battery cables. Ensure that vent caps are tight and level.

3. Turn the heater fan on in both vehicles to protect from any electrical surges. Turn all other accessories off.

Connecting the Jumper Cables

Your vehicle has two battery prongs that are accessible from under the hood, even though the actual battery is located in the trunk. Your vehicle can be jumped the same way conventional vehicles can be using these prongs. The illustration below shows the two connector prongs used for jump-starting your vehicle.

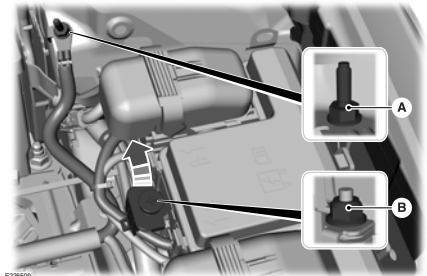

A. Negative prong (-)

B. Positive prong (+)

Note: In the illustration, the vehicle on the bottom is used to designate the assisting (boosting) battery.

Note: Remove the red cap from the positive prong (B) on your vehicle before connecting the cables.

Roadside Emergencies

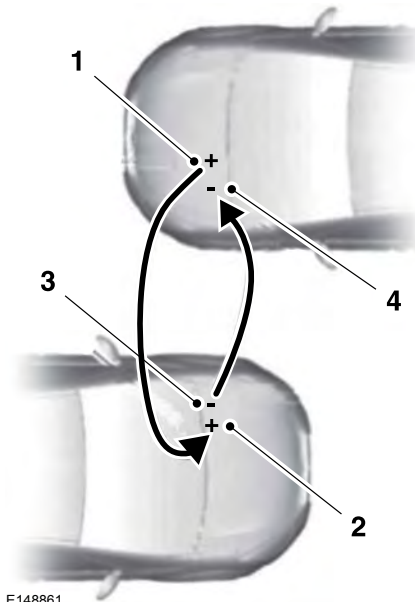

E148861

1. Connect the positive (+) jumper cable to the positive (+) prong (B) of the discharged battery.
2. Connect the other end of the positive (+) cable to the positive (+) terminal of the assisting battery.
3. Connect the negative (-) cable to the negative (-) terminal of the assisting battery.
4. Make the final connection of the negative (-) cable to the negative (-) prong (A) of your vehicle.

Note: Do not attach the negative (-) cable to fuel lines, engine rocker covers, the intake manifold or electrical components as grounding points.

WARNING



Do not connect the end of the second cable to the negative (-) terminal of the battery to be jumped. A spark may cause an explosion of the gases that surround the battery.

Ensure that the cables are clear of fan blades, belts, moving parts of both engines, or any fuel delivery system parts.

Jump Starting

1. Start the booster vehicle and press the accelerator pedal moderately.
2. Start the disabled vehicle. Check the instrument cluster for the Ready to Drive light as the gasoline engine may not start, but the electric motor may be running.
3. Once you start the disabled vehicle, run both vehicles for an additional three minutes before disconnecting the jumper cables.

Removing the Jumper Cables

Remove the jumper cables in the reverse order that they were connected.

Note: In the illustration, the vehicle on the bottom is used to designate the assisting (boosting) battery.

Roadside Emergencies

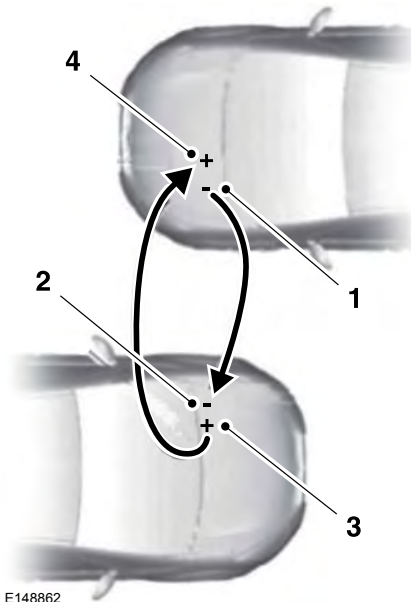

E148862

1. Remove the jumper cable from the ground metal surface.
2. Remove the jumper cable on the negative (-) terminal of the booster vehicle's battery.
3. Remove the jumper cable from the positive (+) terminal of the booster vehicle's battery.
4. Remove the jumper cable from the positive (+) terminal of the disabled vehicle's battery.

After disconnecting the jumper cables, let the disabled vehicle sit in Ready to Drive mode for several minutes to charge the 12V battery. The disabled vehicle can charge the 12V battery even if the gasoline engine may be off. The 12V battery will receive power from the high-voltage battery instead.

COLLISION, DAMAGE OR FIRE EVENT

Guidance for Ford Motor Company Electric and Hybrid-Electric Vehicles Equipped With High Voltage Batteries

(Vehicle Owner/Operator/General Public) Electric and Hybrid-Electric Vehicle Considerations

In the event of damage or fire involving an electric vehicle (EV) or hybrid-electric vehicle (HEV):

- Always assume the high-voltage battery and associated components are energized and fully charged.
- Exposed electrical components, wires and high-voltage batteries present potential high-voltage shock hazards.
- Venting/off-gassing high-voltage battery vapors are potentially toxic and flammable.
- Physical damage to the vehicle or high-voltage battery may result in immediate or delayed release of toxic, flammable gases and fire.

Vehicle Information and General Safety Practices

- Know the make and model of your vehicle.
- Review the owner's manual and become familiar with your vehicle's safety information and recommended safety practices.
- Do not attempt to repair damaged electric and hybrid-electric vehicles yourself. Contact an authorized Ford Dealer or vehicle manufacturer representative for service.

Roadside Emergencies

Crashes

A crash or impact significant enough to require an emergency response for conventional vehicles would also require the same response for an electric or hybrid-electric vehicle.

If possible

- Move your car to a safe, nearby location and remain on the scene.
- Roll down the windows before shutting your vehicle off.
- Place your vehicle in Park, set the parking brake, turn off the vehicle, activate the hazard lights, and move your key(s) at least 16 feet (5 meters) away from the vehicle.

Always

- Call 911 if assistance is needed and advise that an electric or hybrid-electric vehicle is involved.
- Do not touch exposed electrical components or the engine compartment, as a shock hazard may exist.
- Avoid contact with leaking fluids and gases, and remain out of the way of oncoming traffic until emergency responders arrive.
- When emergency responders arrive, tell them that the vehicle involved is an electric vehicle or hybrid vehicle.

Fires

As with any vehicle, call 911 immediately if you see sparks, smoke or flames coming from the vehicle.

- Exit the vehicle immediately.
- Advise 911 that an electric or hybrid-electric vehicle is involved.

- As with any vehicle fire, do not inhale smoke, vapors or gas from the vehicle, as they may be hazardous.
- Remain a safe distance from the vehicle and try to stay clear of the smoke.
- Stay out of the roadway and stay out of the way of any oncoming traffic while awaiting the arrival of emergency responders.

Post-Incident

- Do not store a severely damaged vehicle with a lithium-ion battery inside a structure or within 50 feet (15 meters) of any structure or vehicle.
- Make sure that passenger and cargo compartments remain ventilated (i.e. open window, door or trunk).
- For vehicles in the United States, notify Ford Motor Company 1-800-392-3673 (then follow the prompts on the voice response menu), an authorized Ford dealer or service center as soon as possible as there may be other steps to secure and discharge the high-voltage battery.
- For vehicles in Canada, notify Ford Motor Company 1-800-565-3673 (then follow the prompts on the voice response menu), an authorized Ford dealer or service center as soon as possible as there may be other steps to secure and discharge the high-voltage battery.
- Call 911 if you observe leaking fluids, sparks, smoke or flames, or hear gurgling or bubbling from the high-voltage battery.

Roadside Emergencies

POST-CRASH ALERT SYSTEM

The system flashes the direction indicators and sounds the horn (intermittently) in the event of a serious impact that deploys an airbag (front, side, side curtain or Safety Canopy) or the safety belt pretensioners.

The horn and indicators will turn off when:

- You press the hazard control button.
- You press the panic button on the remote entry transmitter (if equipped).
- Your vehicle runs out of power.

SPINOUT DETECTION

If your vehicle detects a spinout and it comes to a stop, the hazard warning flashers turn on. A spinout detected message appears in the information display. The message may not appear if your vehicle runs out of power.

After your vehicle's hazard warning flashers turn on, you can switch them off by:

- Pressing the hazard warning flasher button.
- Pressing the remote control unlock button.
- Pressing the remote control panic button.
- Switching the ignition on and off twice.

TRANSPORTING THE VEHICLE

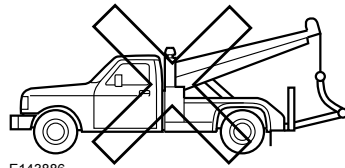
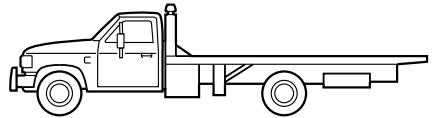
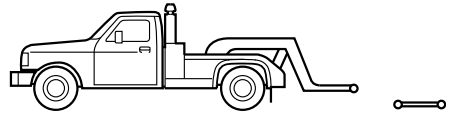

E143886

If you need to have your vehicle towed, contact a professional towing service or, if you are a member of a roadside assistance program, your roadside assistance service provider.

We recommend the use of a wheel lift and dollies or flatbed equipment to tow your vehicle. Do not tow with a slingbelt. Ford Motor Company has not approved a slingbelt towing procedure. Vehicle damage may occur if towed incorrectly, or by any other means.

Ford Motor Company produces a towing manual for all authorized tow truck operators. Have your tow truck operator refer to this manual for proper hook-up and towing procedures for your vehicle.

Roadside Emergencies

It is acceptable to have your front-wheel drive vehicle towed from the front if using proper wheel lift equipment to raise the front wheels off the ground. When towing in this manner, the rear wheels can remain on the ground.

Front-wheel drive vehicles must have the front wheels placed on a tow dolly when towing your vehicle from the rear using wheel lift equipment. This prevents damage to the transmission.

Towing an all-wheel or four-wheel drive vehicle requires that all wheels be off the ground, such as using a wheel lift and dollies or flatbed equipment. This prevents damage to the transmission, all-wheel or four-wheel drive system and vehicle.

TOWING POINTS

Due to local market requirements in some countries, some vehicles may be equipped with a recovery hook.

Recovery Hook Location

If your vehicle is equipped with a screw-in recovery hook, it is located with the spare tire kit.

Installing the Recovery Hook

There is an installation point for the recovery hook located behind the fascia.

Note: *The screw-in recovery hook has a left-hand thread. Turn it counterclockwise to install it. Make sure that the recovery hook is fully tightened.*

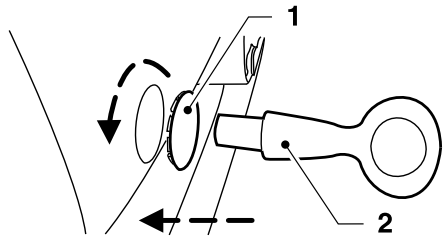

E146284



E188240

Remove the recovery hook cover by prying it off at the notch with a screwdriver or similar object.

Note: *Use a soft cloth to cover the prying tool. This helps prevent scratch marks to the vehicle's paint.*

Customer Assistance

GETTING THE SERVICES YOU NEED

Warranty repairs to your vehicle must be performed by an authorized dealer. While any authorized dealer handling your vehicle line will provide warranty service, we recommend you return to your selling authorized dealer who wants to ensure your continued satisfaction.

Please note that certain warranty repairs require special training and equipment, so not all authorized dealers are authorized to perform all warranty repairs. This means that, depending on the warranty repair needed, you may have to take your vehicle to another authorized dealer.

A reasonable time must be allowed to perform a repair after taking your vehicle to the authorized dealer. Repairs will be made using Ford or Motorcraft® parts, or remanufactured or other parts that are authorized by Ford.

Away From Home

If you are away from home when your vehicle needs service, contact the Ford Customer Relationship Center or use the online resources listed below to find the nearest authorized dealer.

In the United States:

Mailing address

Ford Motor Company
Customer Relationship Center
P.O. Box 6248
Dearborn, MI 48126

Telephone

1-800-392-3673 (FORD)
(TDD for the hearing impaired:
1-800-232-5952)

Additional information and resources are available online:

Website
www.owner.ford.com

These are some of the items that can be found online:

- U.S. dealer locator by Dealer Name, City/State or Zip Code.
- Owner Manuals.
- Maintenance Schedules.
- Recalls.
- Ford Extended Service Plans.
- Ford Genuine Accessories.
- Service specials and promotions.

In Canada:

Mailing address

Customer Relationship Centre
Ford Motor Company of Canada, Limited
P.O. Box 2000
Oakville, Ontario L6K 0C8

Telephone

1-800-565-3673 (FORD)

Website
www.ford.ca

Twitter

@FordServiceCA (English Canada)
@FordServiceQC (Quebec)

Additional Assistance

If you have questions or concerns, or are unsatisfied with the service you are receiving, follow these steps:

1. Contact your Sales Representative or Service Advisor at your selling or servicing authorized dealer.

Customer Assistance

2. If your inquiry or concern remains unresolved, contact the Sales Manager, Service Manager or Customer Relations Manager.
3. If you require assistance or clarification on Ford Motor Company policies, please contact the Ford Customer Relationship Center.

In order to help us serve you better, please have the following information available when contacting a Customer Relationship Center:

- Vehicle Identification Number.
- Your telephone number (home and business).
- The name of the authorized dealer and city where located.
- The vehicle's current odometer reading.

In some states within the United States, you must directly notify Ford in writing before pursuing remedies under your state's warranty laws, and Ford is also allowed a final repair attempt.

Additionally, in some states within the United States, a consumer has the option of submitting a warranty dispute to the BBB Auto Line before taking action under the Magnuson-Moss Warranty Act, or to the extent allowed by state law, before pursuing replacement or repurchase remedies provided by certain state laws. This dispute handling procedure is not required prior to enforcing state created rights or other rights which are independent of the Magnuson-Moss Warranty Act or state replacement or repurchase laws.

IN CALIFORNIA (U.S. ONLY)

California Civil Code Section 1793.2(d) requires that, if a manufacturer or its representative is unable to repair a motor vehicle to conform to the vehicle's applicable express warranty after a reasonable number of attempts, the manufacturer shall be required to either replace the vehicle with one substantially identical or repurchase the vehicle and reimburse the buyer in an amount equal to the actual price paid or payable by the consumer (less a reasonable allowance for consumer use). The consumer has the right to choose whether to receive a refund or replacement vehicle.

California Civil Code Section 1793.22(b) presumes that the manufacturer has had a reasonable number of attempts to conform the vehicle to its applicable express warranties if, within the first 18 months of ownership of a new vehicle or the first 18000 miles (29 000 km), whichever occurs first:

1. Two or more repair attempts are made on the same non-conformity likely to cause death or serious bodily injury OR
2. Four or more repair attempts are made on the same nonconformity (a defect or condition that substantially impairs the use, value or safety of the vehicle) OR
3. The vehicle is out of service for repair of nonconformities for a total of more than 30 calendar days (not necessarily all at one time).

In the case of 1 or 2 above, the consumer must also notify the manufacturer of the need for the repair of the nonconformity at the following address:

Ford Motor Company
16800 Executive Plaza Drive
Mail Drop 3NE-B
Dearborn, MI 48126

Customer Assistance

You are required to submit your warranty dispute to BBB AUTO LINE before asserting in court any rights or remedies conferred by California Civil Code Section 1793.22(b). You are also required to use BBB AUTO LINE before exercising rights or seeking remedies created by the Federal Magnuson-Moss Warranty Act, 15 U.S.C. sec. 2301 et seq. If you choose to seek redress by pursuing rights and remedies not created by California Civil Code Section 1793.22(b) or the Magnuson-Moss Warranty Act, resort to BBB AUTO LINE is not required by those statutes.

THE BETTER BUSINESS BUREAU (BBB) AUTO LINE PROGRAM (U.S. ONLY)

Your satisfaction is important to Ford Motor Company and to your dealer. If a warranty concern has not been resolved using the three-step procedure outlined earlier in this chapter in the Getting the Services you need section, you may be eligible to participate in the BBB AUTO LINE program.

The BBB AUTO LINE program consists of two parts – mediation and arbitration. During mediation, a representative of the BBB will contact both you and Ford Motor Company to explore options for settlement of the claim. If an agreement is not reached during mediation or you do not want to participate in mediation, and if your claim is eligible, you may participate in the arbitration process. An arbitration hearing will be scheduled so that you can present your case in an informal setting before an impartial person. The arbitrator will consider the testimony provided and make a decision after the hearing.

Disputes submitted to the BBB AUTO LINE program are usually decided within forty days after you file your claim with the BBB. You are not bound by the decision, and may reject the decision and proceed to court where all findings of the BBB Auto Line dispute, and decision, are admissible in the court action. Should you choose to accept the BBB AUTO LINE decision, Ford is then bound by the decision, and must comply with the decision within 30 days of receipt of your acceptance letter.

BBB AUTO LINE Application: Using the information provided below, please call or write to request a program application. You will be asked for your name and address, general information about your new vehicle, information about your warranty concerns, and any steps you have already taken to try to resolve them. A Customer Claim Form will be mailed that will need to be completed, signed and returned to the BBB along with proof of ownership. Upon receipt, the BBB will review the claim for eligibility under the Program Summary Guidelines.

You can get more information by calling BBB AUTO LINE at 1-800-955-5100, or writing to:

**BBB AUTO LINE
3033 Wilson Boulevard, Suite 600
Arlington, Virginia 22201**

BBB AUTO LINE applications can also be requested by calling the Ford Motor Company Customer Relationship Center at 1-800-392-3673.

Note: *Ford Motor Company reserves the right to change eligibility limitations, modify procedures, or to discontinue this process at any time without notice and without obligation.*

Customer Assistance

UTILIZING THE MEDIATION/ARBITRATION PROGRAM (CANADA ONLY)

For vehicles delivered to authorized Canadian dealers. In those cases where you continue to feel that the efforts by Ford of Canada and the authorized dealer to resolve a factory-related vehicle service concern have been unsatisfactory, Ford of Canada participates in an impartial third party mediation/arbitration program administered by the Canadian Motor Vehicle Arbitration Plan (CAMVAP).

The CAMVAP program is a straight forward and relatively speedy alternative to resolve a disagreement when all other efforts to produce a settlement have failed. This procedure is without cost to you and is designed to eliminate the need for lengthy and expensive legal proceedings.

In the CAMVAP program, impartial third-party arbitrators conduct hearings at mutually convenient times and places in an informal environment. These impartial arbitrators review the positions of the parties, make decisions and, when appropriate, render awards to resolve disputes. CAMVAP decisions are fast, fair, and final as the arbitrator's award is binding on both you and Ford of Canada.

CAMVAP services are available in all Canadian territories and provinces. For more information, without charge or obligation, call your CAMVAP Provincial Administrator directly at 1-800-207-0685 or visit www.camvap.ca.

GETTING ASSISTANCE OUTSIDE THE U.S. AND CANADA

Before exporting your vehicle to a foreign country, contact the appropriate foreign embassy or consulate. These officials can inform you of local vehicle registration regulations and where to find unleaded fuel.

If you cannot find unleaded fuel or can only get fuel with an anti-knock index lower than is recommended for your vehicle, contact our Customer Relationship Center.

The use of leaded fuel in your vehicle without proper conversion may damage the effectiveness of your emission control system and may cause engine knocking or serious engine damage. Ford Motor Company or Ford of Canada is not responsible for any damage caused by use of improper fuel. Using leaded fuel may also result in difficulty importing your vehicle back into the United States.

If your vehicle must be serviced while you are traveling or living in Asia-Pacific Region, Sub-Saharan Africa, U.S. Virgin Islands, Central America, the Caribbean, and Israel, contact the nearest authorized dealer. If the authorized dealer cannot help you, contact:

FORD MOTOR COMPANY
Customer Relationship Center
1555 Fairlane Drive
Fairlane Business Park #3
Allen Park, Michigan 48101
U.S.A.
Telephone: (313) 594-4857
Fax: (313) 390-0804
Email: expcac@ford.com

Customer Assistance

For customers in Guam, the Commonwealth of the Northern Mariana Islands (CNMI), America Samoa, and the U.S. Virgin Islands, please feel free to call our Toll-Free Number: (800) 841-FORD (3673).

If your vehicle must be serviced while you are traveling or living in Puerto Rico, contact the nearest authorized dealer. If the authorized dealer cannot help you, contact:

FORD MOTOR COMPANY
Customer Relationship Center
1555 Fairlane Drive
Fairlane Business Park #3
Allen Park, Michigan 48101
U.S.A.
Telephone: (800) 841-FORD (3673)
FAX: (313) 390-0804
Email: prcac@ford.com
www.ford.com.pr

If your vehicle must be serviced while you are traveling or living in the Middle East, contact the nearest authorized dealer. If the authorized dealer cannot help you, contact:

FORD MOTOR COMPANY
Customer Relationship Center
1555 Fairlane Drive
Fairlane Business Park #3
Allen Park, Michigan 48101
U.S.A.

Ford: 80004443673
Lincoln: 80004441067
If calling from the UAE: 80004441066
If calling from the Kingdom of Saudi Arabia: 8008443673
If calling from Kuwait: 22280384

FAX: +971 4 3327266
Email: menacac@ford.com
www.me.ford.com

If you buy your vehicle in North America and then relocate to any of the above locations, register your vehicle identification number (VIN) and new address with Ford Motor Company by emailing expcac@ford.com.

If you are in another foreign country, contact the nearest authorized dealer. In the event your inquiry is unresolved, communicate your concern with the dealership's Sales Manager, Service Manager or Customer Relations Manager. If you require additional assistance or clarification, please contact the respective Customer Relationship Center as previously listed.

Customers in the U.S. should call 1-800-392-3673.

ORDERING ADDITIONAL OWNER'S LITERATURE

To order the publications in this portfolio, contact Helm, Incorporated at:

HELM, INCORPORATED
47911 Halyard Drive
Plymouth, Michigan 48170
Attention: Customer Service

Or to order a free publication catalog, call toll free: 1-800-782-4356

Monday-Friday 8:00 a.m. - 6:00 p.m. EST

Helm, Incorporated can also be reached by their website:

www.helminc.com

(Items in this catalog may be purchased by credit card, check or money order.)

Customer Assistance

Obtaining a French Owner's Manual

French Owner's Manual can be obtained from your authorized dealer or by contacting Helm, Incorporated using the contact information listed previously in this section.

REPORTING SAFETY DEFECTS (U.S. ONLY)



E142557

If you believe that your vehicle has a defect which could cause a crash or could cause injury or death, you should immediately inform the National Highway Traffic Safety Administration (NHTSA) in addition to notifying Ford Motor Company.

If NHTSA receives similar complaints, it may open an investigation, and if it finds that a safety defect exists in a group of vehicles, it may order a recall and remedy campaign. However, NHTSA cannot become involved in individual problems between you, your dealer, or Ford Motor Company.

To contact NHTSA, you may call the Vehicle Safety Hotline toll-free at 1-888-327-4236 (TTY: 1-800-424-9153); go to <http://www.safercar.gov>; or write to:

Administrator

1200 New Jersey Avenue,
Southeast

Washington, D.C. 20590

You can also obtain other information about motor vehicle safety from <http://www.safercar.gov>.

REPORTING SAFETY DEFECTS (CANADA ONLY)

If you believe that your vehicle has a defect which could cause a crash or could cause injury or death, you should immediately inform Transport Canada and Ford of Canada.

Customer Assistance

Transport Canada Contact Information	
Website	www.tc.gc.ca/eng/motorvehiclesafety/safevehicles-defectinvestigations-index-76.htm (English)
Website	www.tc.gc.ca/fra/secureteautomobile/VehiculesSecuritaires-Enquetes-index-76.htm (French)
Phone	1-800-333-0510

Ford of Canada Contact Information	
Website	www.ford.ca
Phone	1-800-565-3673

Fuses

FUSE SPECIFICATION CHART

Power Distribution Box

WARNINGS



Always disconnect the battery before servicing high-current fuses.



To reduce risk of electrical shock, always replace the cover to the power distribution box before reconnecting the battery or refilling fluid reservoirs.

The power distribution box is located in the engine compartment. It has high-current fuses that protect your vehicle's main electrical systems from overloads.

If the battery has been disconnected and reconnected, some features will need to be reset. See **Changing the 12V Battery** (page 261).

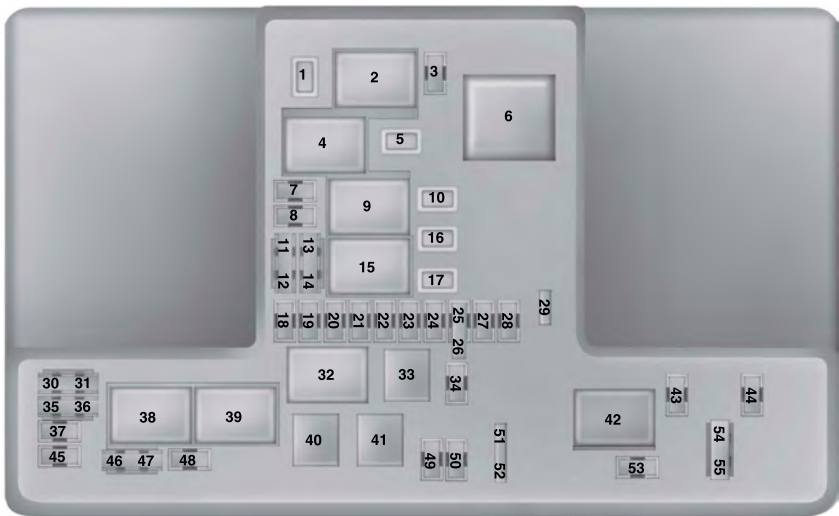

E144783

Fuses

Fuse or relay number	Fuse amp rating	Protected components
1	25A ³	Wiper motor 2.
2	—	Not used.
3	15A ¹	Rain sensor.
4	—	Blower motor relay.
5	20A ³	Power point 3 - back of console.
6	—	Not used.
7	20A ¹	Powertrain control module - vehicle power 1. Powertrain control module power.
8	20A ¹	Powertrain control module - vehicle power 2. Emission components.
9	—	Powertrain control module relay.
10	20A ³	Power point 1 - driver front.
11	15A ²	Powertrain control module - vehicle power 4. Ignition coils.
12	15A ²	Powertrain control module - vehicle power 3. Non-emission components.
13	10A ²	Not used (spare).
14	10A ²	Not used (spare).
15	—	Run-start relay.
16	20A ³	Power point 2 - console.
17	20A ³	Not used (spare).
18	10A ¹	Powertrain and hybrid powertrain control module keep alive power. Battery module.

Fuses

Fuse or relay number	Fuse amp rating	Protected components
19	10A ¹	Run/start electronic power assist steering.
20	10A ¹	Adaptive cruise control.
21	15A ¹	Run-start transmission switch. HEV inverter.
22	5A ¹	Not used (spare).
23	15A ¹	Run-start: blind spot information system, Rear view camera, Adaptive cruise control, Heads-up display, shifter.
24	10A ¹	Run-start transmission oil pump.
25	10A ²	Run-start anti-lock brake system.
26	10A ²	Run-start powertrain control module.
27	10A ¹	Fuel door solenoid.
28	20A ¹	Not used (spare).
29	20A ¹	Not used (spare).
30	—	Not used.
31	—	Not used.
32	—	HEV/PHEV pulse width modulated fan relay.
33	—	Not used.
34	—	Not used.
35	15A ¹	Charger fan.
36	15A ¹	HEV battery electronic control module fan.
37	—	Not used.
38	—	Vacuum pump #1 relay.
39	—	Vacuum pump #2 relay.
40	—	Fuel pump relay.

Fuses

Fuse or relay number	Fuse amp rating	Protected components
41	—	Horn relay.
42	—	Not used.
43	10A ¹	Not used (spare).
44	—	Not used.
45	5A ¹	Vacuum pump monitor.
46	10A ²	Charge port light ring.
47	10A ²	Brake on-off switch.
48	20A ¹	Horn.
49	5A ¹	Air flow monitor.
50	15A ¹	Hybrid content vehicle power 5. Battery energy control module fan.
51	15A ²	Hybrid content vehicle power 1. Hybrid powertrain control module.
52	15A ²	Hybrid content vehicle power 2. Battery energy control module.
53	10A ¹	Not used (spare).
54	10A ²	Hybrid content vehicle power 3. Coolant pump.
55	10A ²	Hybrid content vehicle power 4. Air conditioning compressor. Positive temperature coefficient heater (PHEV). Humidity sensor (PHEV).

¹Micro fuse.

²Dual micro fuse.

³M-type fuse.

Fuses

Power Distribution Box - Bottom

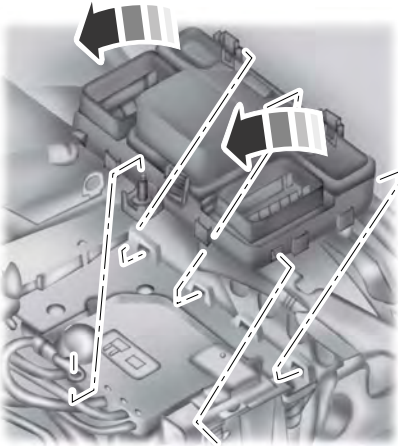

E145983

There are fuses located on the bottom of the fuse box. To access the bottom of the fuse box, do the following:

1. Release the two latches, located on both sides of the fuse box.
2. Raise the inboard side of the fuse box from the cradle.
3. Move the fuse box toward the center of the engine compartment.
4. Pivot the outboard side of the fuse box to access the bottom side.

Fuses

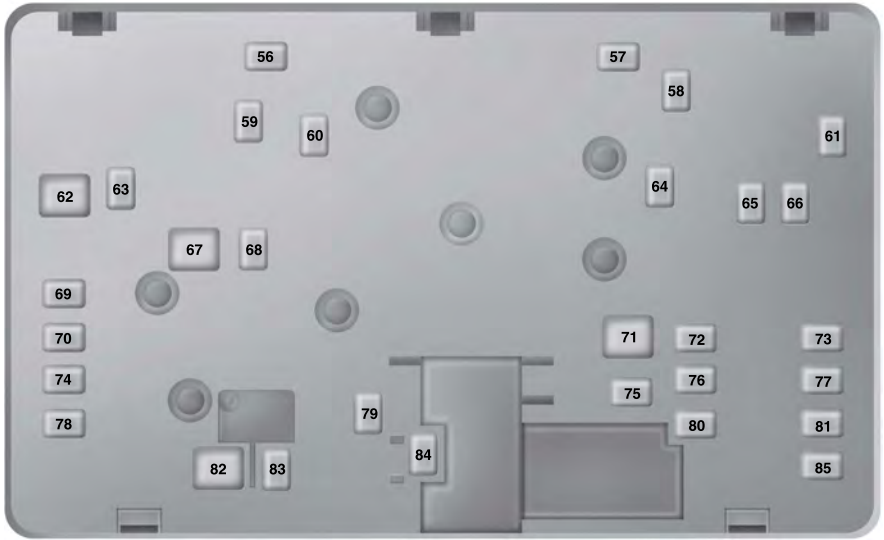

E144949

Fuse or relay number	Fuse amp rating	Protected components
56	30A ¹	Fuel pump feed.
57	—	Not used.
58	—	Not used.
59	40A ¹	Vacuum pump relay.
60	40A ²	Pulse width modulated fan.
61	—	Not used.
62	50A ²	Body control module 1.
63	—	Not used.
64	40A ¹	PHEV charger.

Fuses

Fuse or relay number	Fuse amp rating	Protected components
65	20A ¹	Front heated seat.
66	—	Not used.
67	50A ²	Body control module 2.
68	40A ¹	Heated rear window.
69	30A ¹	Anti-lock brake system valves.
70	30A ¹	Passenger seat.
71	—	Not used.
72	30A ¹	Panoramic roof #1.
73	—	Not used.
74	30A ¹	Driver seat module.
75	20A ¹	Transmission oil pump (PHEV).
76	20A ¹	e-Shifter (transmission range control module).
77	30A ¹	Front climate controlled seats.
78	—	Not used.
79	40A ²	Blower motor.
80	—	Not used.
81	40A ¹	Inverter.
82	60A ²	Anti-lock brake system pump.
83	25A ¹	Wiper motor 1.
84	—	Not used.
85	—	Not used.

¹ M-type fuse.

² J-type fuse.

Fuses

Passenger Compartment Fuse Panel

The fuse panel is located under the

instrument panel to the left of the steering column.

Note: *It may be easier to access the fuse panel if you remove the finish trim piece.*

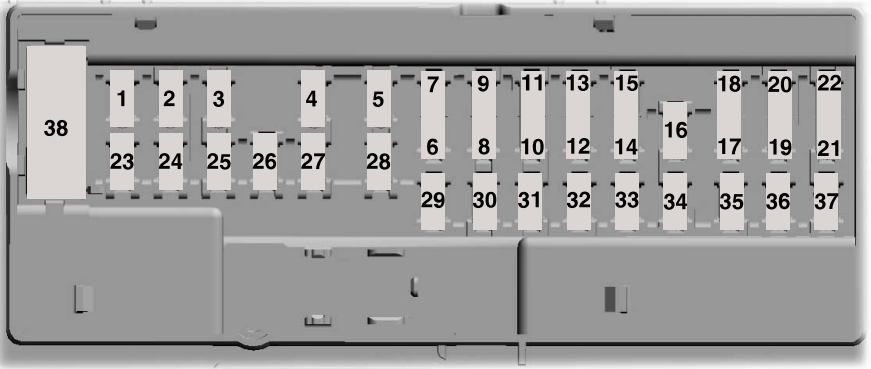

E145984

Fuse or relay number	Fuse amp rating	Protected components
1	10A ¹	Lighting (ambient, glove box, vanity, dome, trunk).
2	7.5A ¹	Lumbar.
3	20A ¹	Driver door unlock.
4	5A ¹	Not used (spare).
5	20A ¹	Subwoofer amplifier.
6	10A ²	Not used (spare).
7	10A ²	Not used (spare).
8	10A ²	Not used (spare).
9	10A ²	Not used (spare).

Fuses

Fuse or relay number	Fuse amp rating	Protected components
10	5A ²	Keypad. Cell phone passport module.
11	5A ²	Not used (spare).
12	7.5A ²	Climate control. Gear shift.
13	7.5A ²	Steering wheel column. Instrument cluster. Datalink logic.
14	10A ²	Extended power module.
15	10A ²	Datalink-gateway module.
16	15A ¹	Child lock. Decklid release.
17	5A ²	Not used (spare).
18	5A ²	Push button start stop switch.
19	7.5A ²	Extended power module.
20	7.5A ²	Adaptive headlamps.
21	5A ²	Humidity and in-car temperature sensor.
22	5A ²	Pedestrian sounder.
23	10A ¹	Delayed accessory (power inverter logic, moonroof logic, driver master switch).
24	20A ¹	Central lock unlock.
25	30A ¹	Driver door (window, mirror).
26	30A ¹	Front passenger door (window, mirror).
27	30A ¹	Moonroof.
28	20A ¹	Amplifier.
29	30A ¹	Rear driver side door (window).

Fuses

Fuse or relay number	Fuse amp rating	Protected components
30	30A ¹	Rear passenger side door (window).
31	15A ¹	Not used (spare).
32	10A ¹	GPS. Voice control. Display. Radio frequency receiver.
33	20A ¹	Radio. Active noise control.
34	30A ¹	Run-start (fuse #19, 20, 21, 22, 35, 36, 37, circuit breaker).
35	5A ¹	Not used (spare).
36	15A ¹	Auto-dimming rear view mirror.
37	20A ¹	Heated steering wheel.
38	30A	Not used (spare).

¹Micro fuse.

²Dual micro fuse.

CHANGING A FUSE

Fuses

WARNING



Always replace a fuse with one that has the specified amperage rating. Using a fuse with a higher amperage rating can cause severe wire damage and could start a fire.



E217331

If electrical components in the vehicle are not working, a fuse may have blown. Blown fuses are identified by a broken wire within the fuse. Check the appropriate fuses before replacing any electrical components.

Fuses

Fuse Types

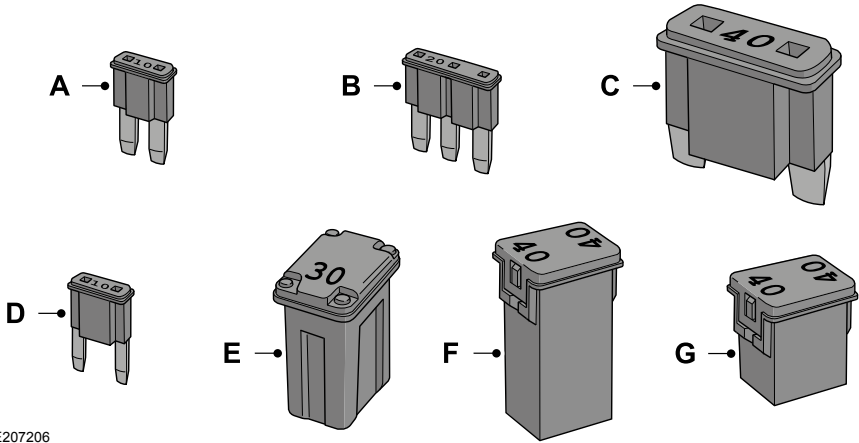

E207206

Callout	Fuse Type
A	Micro 2
B	Micro 3
C	Maxi
D	Mini
E	M Case
F	J Case
G	J Case Low Profile

Maintenance

GENERAL INFORMATION

Have your vehicle serviced regularly to help maintain its roadworthiness and resale value. There is a large network of authorized dealers that are there to help you with their professional servicing expertise. We believe that their specially trained technicians are best qualified to service your vehicle properly and expertly. They are supported by a wide range of highly specialized tools developed specifically for servicing your vehicle.

If your vehicle requires professional service, an authorized dealer can provide the necessary parts and service. Check your warranty information to find out which parts and services are covered.

Use only recommended fuels, lubricants, fluids and service parts conforming to specifications. Motorcraft® parts are designed and built to provide the best performance in your vehicle.

Precautions

- Do not work on a hot engine.
- Make sure that nothing gets caught in moving parts.
- Do not work on a vehicle with the engine running in an enclosed space, unless you are sure you have enough ventilation.
- Keep all open flames and other burning material (such as cigarettes) away from the battery and all fuel related parts.

Working with the Engine Off

1. Set the parking brake and shift to park (P).
2. Switch off the engine.
3. Block the wheels.

Working with the Engine On

WARNING



To reduce the risk of vehicle damage and/or personal burn injuries, do not start your engine with the air cleaner removed and do not remove it while the engine is running.

1. Set the parking brake and shift to park (P).
2. Block the wheels.

OPENING AND CLOSING THE HOOD

Opening the Hood



E142457

1. Inside the vehicle, pull the hood release handle located under the left-hand side of the instrument panel.
2. Slightly lift the hood.
3. Release the hood latch by pushing the secondary release lever to your left-hand side.

Maintenance



2. Lower the hood and allow it to drop under its own weight for the last 8-12 in (20-30 cm).

Note: Make sure that the hood is correctly closed.

UNDER HOOD OVERVIEW

WARNING



The inverter system controller contains various high-voltage components that can cause serious bodily harm or death. The inverter system controller is not serviceable and should never be touched, probed, or tampered with.

Note: Do not attempt to service any of the high-voltage components or wiring. For easier identification, the high-voltage wiring insulation is color coated orange.

E87786

4. Open the hood. Support the hood with the strut.

Closing the Hood

1. Remove the hood strut from the catch and secure it correctly after use.

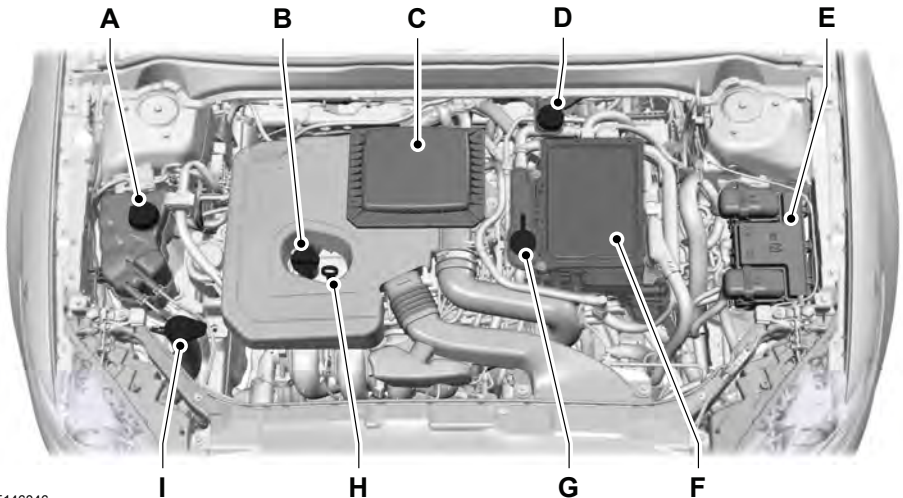

E146046

Maintenance

- A Engine coolant reservoir. See **Engine Coolant Check** (page 256).
- B Engine oil filler cap. See **Engine Oil Check** (page 255).
- C Air filter. See **Changing the Engine Air Filter** (page 270).
- D Brake fluid reservoir. See **Brake Fluid Check** (page 261).
- E Engine compartment fuse box. See **Fuses** (page 242).
- F Inverter system controller.
- G Inverter system controller coolant reservoir. See **Engine Coolant Check** (page 256).
- H Engine oil dipstick. See **Engine Oil Dipstick** (page 255).
- I Washer system fluid reservoir. See **Washer Fluid Check** (page 261).

ENGINE OIL DIPSTICK

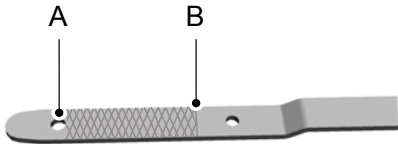

E169062

- A MIN
- B MAX

ENGINE OIL CHECK

Check the level before starting the engine and make sure that the level is between the MIN and the MAX marks.

1. Make sure that your vehicle is on level ground.
2. Switch the engine off and wait 10 minutes for the oil to drain into the oil pan.
3. Remove the dipstick and wipe it with a clean, lint-free cloth. Replace the dipstick and remove it again to check the oil level.

If the level is at the MIN mark, add oil immediately.

Adding Engine Oil

Note: Do not remove the filler cap when the engine is running.

Note: Do not add oil further than the MAX mark. Oil levels above the MAX mark may cause engine damage.

Maintenance



E142732

Only use oils certified for gasoline engines by the American Petroleum Institute (API). An oil with this trademark symbol conforms to the current engine and emission system protection standards and fuel economy requirements of the International Lubricants Specification Advisory Committee (ILSAC).

1. Remove the filler cap.
2. Add engine oil that meets the Ford specifications. See **Capacities and Specifications** (page 306).
3. Replace the filler cap. Turn it until you feel a strong resistance.

OIL CHANGE INDICATOR RESET

Use the information display controls on the steering wheel to reset the oil change indicator.

From the main menu scroll to:

Message	Action and description
Settings	Press the right arrow button, then from this menu scroll to the following message.
Vehicle	Press the right arrow button, then from this menu scroll to the following message.
Oil Life	Press the right arrow button, then from this menu scroll to the following message.
Hold OK to Reset	Press and hold the OK button until the instrument cluster displays the following message.
	Reset Successful
	When the oil change indicator resets the instrument cluster displays 100%.
	Remaining Life {00}%
	If the instrument cluster displays one of the following messages, repeat the process.
	Not Reset
	Reset Cancelled

ENGINE COOLANT CHECK

WARNINGS



Do not add engine coolant when the engine is hot. Steam and scalding liquids released from a hot cooling system can burn you badly. Also, spilling coolant on hot engine parts can burn you.

Maintenance

WARNINGS



Do not put engine coolant in the windshield washer fluid container. If sprayed on the windshield, engine coolant could make it difficult to see through the windshield.



To reduce the risk of personal injury, make sure the engine is cool before unscrewing the coolant pressure relief cap. The cooling system is under pressure. Steam and hot liquid can come out forcefully when you loosen the cap slightly.



Do not add coolant further than the **MAX** mark.

Your vehicle has two separate cooling systems. One for cooling the engine and a separate system for cooling the inverter system controller that is specific to the hybrid operating system. The two systems operate similarly, with the inverter system controller cooling system generally operating at a lower temperature and pressure.

When the engine is cold, check the concentration and level of the coolant at the intervals listed in the scheduled maintenance information. See **Scheduled Maintenance** (page 466).

Note: Make sure that the coolant level is between the **MIN** and **MAX** marks on the coolant reservoir.

Note: Coolant expands when it is hot. The level may extend beyond the **MAX** mark.

Maintain coolant concentration within 48% to 50%, which equates to a freeze point between -30°F (-34°C) and -34°F (-37°C). Coolant concentration should be checked using a refractometer. We do not recommend the use of hydrometers or coolant test strips for measuring coolant concentration.

Adding Coolant

WARNING



Never remove the coolant reservoir cap while the engine is running or hot.

Note: Automotive fluids are not interchangeable. Do not use coolant or windshield washer fluid outside of its specified function and vehicle location.

Note: Do not use stop leak pellets, cooling system sealants, or non-specified additives as they can cause damage to the engine cooling or heating systems. Resulting component damage may not be covered by the vehicle Warranty.

It is very important to use prediluted coolant approved to the correct specification in order to avoid plugging the small passageways in the engine cooling system. See **Capacities and Specifications** (page 310). Do not mix different colors or types of coolant in your vehicle. Mixing of engine coolants or using an incorrect coolant may harm the engine or cooling system components and may not be covered by the vehicle Warranty.

Note: Coolants marketed for all makes and models may not be approved to Ford specifications and may cause damage to the cooling system. Resulting component damage may not be covered by the vehicle Warranty.

If the coolant level is at or below the minimum mark, add prediluted coolant immediately.

To top up the coolant level do the following:

1. Unscrew the cap slowly. Any pressure escapes as you unscrew the cap.
2. Add prediluted coolant approved to the correct specification. See **Capacities and Specifications** (page 306).

Maintenance

3. Add enough prediluted coolant to reach the correct level.
4. Replace the coolant reservoir cap, turn it clockwise until you feel a strong resistance.
5. Check the coolant level in the coolant reservoir the next few times you drive your vehicle. If necessary, add enough prediluted engine coolant to bring the coolant level to the correct level.

Note: *If prediluted coolant is not available, use the approved antifreeze concentrate diluting it to 50/50 with distilled water. See **Capacities and Specifications** (page 306). Using water that has not been deionised may contribute to deposit formation, corrosion or plugging of the small cooling system passageways.*

If you have to add more than 1.1 qt (1 L) of engine coolant per month, have your vehicle checked as soon as possible. Operating an engine with a low level of coolant can result in engine overheating and possible engine damage.

Note: *During normal vehicle operation, the coolant may change color from orange to pink or light red. As long as the coolant is clear and uncontaminated, this color change does not indicate the coolant has degraded nor does it require the coolant to be drained, the system to be flushed, or the coolant to be replaced.*

Note: *In case of emergency, you can add a large amount of water without coolant in order to reach a vehicle service location. Water alone, without coolant, can cause engine damage from corrosion, overheating or freezing. When you reach a service location, you must have the cooling system drained, flushed and refilled using the correct specification prediluted coolant or antifreeze concentrate. See **Capacities and Specifications** (page 306).*

Do not use the following as a coolant substitute:

- Alcohol.
- Methanol.
- Brine.
- Any coolant mixed with alcohol or methanol antifreeze.

Alcohol and other liquids can cause engine damage from overheating or freezing.

Do not add extra inhibitors or additives to the coolant. These can be harmful and compromise the corrosion protection of the coolant.

Recycled Coolant

We do not recommend the use of recycled coolant as an approved recycling process is not yet available.

Dispose of used engine coolant in an appropriate manner. Follow your community's regulations and standards for recycling and disposing of automotive fluids.

Severe Climates

If you drive in extremely cold climates:

- It may be necessary to increase the coolant concentration above 50%.
- A coolant concentration of 60% provides improved freeze point protection. Coolant concentrations above 60% decrease the overheat protection characteristics of the coolant and may cause engine damage.

Maintenance

If you drive in extremely hot climates:

- You can decrease the coolant concentration to 40%.
- Coolant concentrations below 40% decrease the freeze and corrosion protection characteristics of the coolant and may cause engine damage.

Vehicles driven year-round in non-extreme climates should use prediluted coolant for optimum cooling system and engine protection.

Coolant Change

At specific mileage intervals, as listed in the scheduled maintenance information, the coolant should be changed. Add prediluted coolant approved to the correct specification. See **Capacities and Specifications** (page 306).

Fail-Safe Cooling

Fail-safe cooling allows you to temporarily drive your vehicle before any incremental component damage occurs. The fail-safe distance depends on ambient temperature, vehicle load and terrain.

How Fail-Safe Cooling Works

If the engine begins to overheat, the coolant temperature gauge moves toward the red zone:



A warning lamp illuminates and a message may appear in the information display.



If the engine reaches a preset over-temperature condition, the engine automatically switches to alternating cylinder operation. Each disabled cylinder acts as an air pump and cools the engine.

When this occurs, your vehicle still operates, however:

- Engine power is limited.
- The air conditioning system turns off.

Continued operation increases the engine temperature, causing the engine to completely shut down. Your steering and braking effort increases in this situation.

When the engine temperature cools, you can re-start the engine. Have your vehicle checked as soon as possible to minimize engine damage.

When Fail-Safe Mode Is Activated

WARNINGS



Fail-safe mode is for use during emergencies only. Operate your vehicle in fail-safe mode only as long as necessary to bring your vehicle to rest in a safe location and seek immediate repairs. When in fail-safe mode, your vehicle will have limited power, will not be able to maintain high-speed operation, and may completely shut down without warning, potentially losing engine power, power steering assist, and power brake assist, which may increase the possibility of a crash resulting in serious injury.



Never remove the coolant reservoir cap while the engine is running or hot.

Your vehicle has limited engine power when in the fail-safe mode, drive your vehicle with caution. Your vehicle does not maintain high-speed operation and the engine may operate poorly.

Remember that the engine is capable of automatically shutting down to prevent engine damage. In this situation:

1. Pull off the road as soon as safely possible and switch the engine off.

Maintenance

2. If you are a member of a roadside assistance program, we recommend that you contact your roadside assistance service provider.
3. If this is not possible, wait a short period for the engine to cool.
4. Check the coolant level. If the coolant level is at or below the minimum mark, add prediluted coolant immediately.
5. When the engine temperature cools, you can re-start the engine. Have your vehicle checked as soon as possible to minimize engine damage.

Note: *Driving your vehicle without repair increases the chance of engine damage.*

Engine Coolant Temperature Management (If Equipped)

WARNING



To reduce the risk of crash and injury, be prepared that the vehicle speed may reduce and the vehicle may not be able to accelerate with full power until the coolant temperature reduces.

If you tow a trailer with your vehicle, the engine may temporarily reach higher a temperature during severe operating conditions, for example ascending a long or steep grade in high ambient temperatures.

At this time, you may notice the coolant temperature gauge moves toward the red zone and a message may appear in the information display.

You may notice a reduction in vehicle speed caused by reduced engine power. In order to manage the engine coolant temperature. Your vehicle may enter this mode if certain high-temperature and high-load conditions take place. The amount of speed reduction depends on vehicle loading, grade and ambient temperature. If this occurs, there is no need to pull off the road. You can continue to drive your vehicle.

The air conditioning may automatically turn on and off during severe operating conditions to protect the engine from overheating. When the coolant temperature decreases to the normal operating temperature, the air conditioning turns on.

If the coolant temperature gauge moves fully into the red zone, or if the coolant temperature warning or service engine soon messages appear in your information display, do the following:

1. Pull off the road as soon as safely possible and shift the transmission into park **(P)**.
2. Leave the engine running until the coolant temperature gauge needle returns to the normal position. After several minutes, if the temperature does not drop, follow the remaining steps.
3. Switch the engine off and wait for it to cool. Check the coolant level.
4. If the coolant level is at or below the minimum mark, add prediluted coolant immediately.
5. If the coolant level is normal, restart the engine and continue.

Maintenance

AUTOMATIC TRANSMISSION FLUID CHECK

Note: *Transmission fluid should be checked by an authorized dealer. If required, fluid should be added by an authorized dealer.*

The automatic transmission does not have a transmission fluid dipstick.

Have an authorized dealer check and change the transmission fluid at the correct service interval. Your transmission does not consume fluid. However, the fluid level should be checked if the transmission is not working properly, (i.e., if the transmission slips or shifts slowly) or if you notice some sign of fluid leakage.

Do not use supplemental transmission fluid additives, treatments or cleaning agents. The use of these materials may affect transmission operation and result in damage to internal transmission components.

BRAKE FLUID CHECK

Fluid levels between the MIN and MAX lines are within the normal operating range; there is no need to add fluid. If the fluid levels are outside of the normal operating range, the performance of the system could be compromised; seek service from your authorized dealer immediately.

WASHER FLUID CHECK

WARNING



If you operate your vehicle in temperatures below 40°F (5°C), use washer fluid with antifreeze protection. Failure to use washer fluid with antifreeze protection in cold weather could result in impaired windshield vision and increase the risk of injury or accident.

Add fluid to fill the reservoir if the level is low. Only use a washer fluid that meets Ford specifications. See **Capacities and Specifications** (page 306).

State or local regulations on volatile organic compounds may restrict the use of methanol, a common windshield washer antifreeze additive. Washer fluids containing non-methanol antifreeze agents should be used only if they provide cold weather protection without damaging the vehicle's paint finish, wiper blades or washer system.

CHANGING THE 12V BATTERY

WARNINGS



Batteries normally produce explosive gases which can cause personal injury. Therefore, do not allow flames, sparks or lighted substances to come near the battery. When working near the battery, always shield your face and protect your eyes. Always provide correct ventilation.



When lifting a plastic-cased battery, excessive pressure on the end walls could cause acid to flow through the vent caps, resulting in personal injury and damage to the vehicle or battery. Lift the battery with a battery carrier or with your hands on opposite corners.



Keep batteries out of reach of children. Batteries contain sulfuric acid. Avoid contact with skin, eyes or clothing. Shield your eyes when working near the battery to protect against possible splashing of acid solution. In case of acid contact with skin or eyes, flush immediately with water for a minimum of 15 minutes and get prompt medical attention. If acid is swallowed, call a physician immediately.

Maintenance

WARNINGS



Battery posts, terminals and related accessories contain lead and lead compounds. Wash hands after handling.

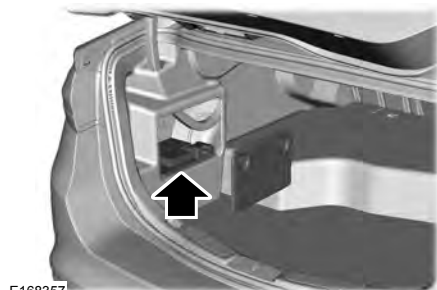

E168357

The 12V battery is located in the left-hand side of the luggage compartment. Remove the door to gain access to the battery.

Your vehicle is fitted with a Motorcraft maintenance-free battery which normally does not require additional water.

Note: After cleaning or replacing the battery, make sure you reinstall the battery cover or shield.

When a battery replacement is required, you must use a recommended replacement battery that matches the electrical requirements of the vehicle.

Note: Contact an authorized dealer for low voltage battery access, testing or replacement.

To make sure the battery management system works correctly, do not connect an electrical device ground connection directly to the low voltage battery negative post. This can cause inaccurate measurements of the battery condition and potential incorrect system operation.

Note: If you add electrical accessories or components to the vehicle, it may adversely affect the low voltage battery performance and durability. This may also affect the performance of other electrical systems in the vehicle.

For longer, trouble-free operation, keep the top of the battery clean and dry.

If you see any corrosion on the battery or terminals, remove the cables from the terminals and clean with a wire brush. You can neutralize the acid with a solution of baking soda and water.

Because your vehicle's engine is electronically-controlled by a computer, some engine control settings are maintained by power from the low-voltage battery. Some engine computer settings, like the idle trim and fuel trim strategy, optimize the driveability and performance of the engine. The clock and radio station presets are also maintained in memory by power from the low-voltage battery. These settings are erased when a technician disconnects and connects the low-voltage battery.

To restore the settings, do the following:

1. Apply the parking brake.
2. Shift into park (P) or neutral (N).
3. Switch off all accessories.
4. Press the brake pedal and start your vehicle.
5. Run the engine until it reaches normal operating temperature. While the engine is warming up, complete the following: Reset the clock. See **Audio System** (page 314). Reset the power windows bounce-back feature. See **Windows and Mirrors** (page 81). Reset the radio station presets. See **Audio System** (page 314).
6. Allow the engine to idle for at least one minute.

Maintenance

7. Drive the vehicle at least 10 mi (16 km) to completely relearn the idle trim and fuel trim strategy.

Note: *If you do not allow the engine to relearn the idle and fuel trim strategy, the idle quality of your vehicle may be adversely affected until the engine computer eventually relearns the idle trim and fuel trim strategy.*

Make sure that you dispose of old batteries in an environmentally friendly way. Seek advice from your local authority about recycling old batteries.

If storing your vehicle for more than 30 days without recharging the battery, we recommend that you disconnect the battery cables to maintain battery charge for quick starting.

CHECKING THE WIPER BLADES



E142463

Run the tip of your fingers over the edge of the blade to check for roughness.

Clean the wiper blades with washer fluid or water applied with a soft sponge or cloth.

CHANGING THE WIPER BLADES

The wiper arms can be manually moved when the ignition is off. This allows for ease of blade replacement and cleaning under the blades.

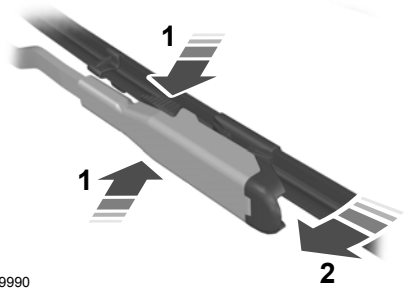

E129990

1. Pull the wiper blade and arm away from the glass. Press the locking buttons together.
2. Rotate and remove the wiper blade.
3. Install in the reverse order.

Note: *Make sure that the wiper blade locks into place. Lower the wiper arm and blade back to the windshield. The wiper arms will automatically return to their normal position when the ignition is turned on.*

Replace wiper blades at least once per year for optimum performance.

Poor wiper quality can be improved by cleaning the wiper blades and the windshield.

Maintenance

ADJUSTING THE HEADLAMPS

Vertical Aim Adjustment

The headlamps on your vehicle are properly aimed at the assembly plant. If your vehicle has been in an accident, the alignment of your headlamps should be checked by your authorized dealer.

Headlamp Aiming Target

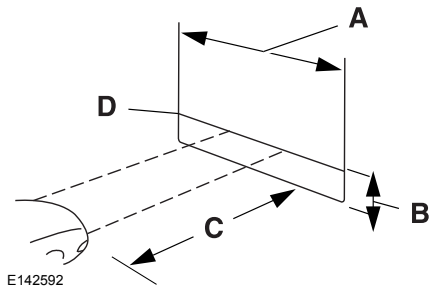

E142592

- A 8 feet (2.4 meters)
- B Center height of lamp to ground
- C 25 feet (7.6 meters)
- D Horizontal reference line

Vertical Aim Adjustment Procedure

1. Park the vehicle directly in front of a wall or screen on a level surface, approximately 25 feet (7.6 meters) away.
2. Measure the height of the headlamp bulb center from the ground and mark an 8 foot (2.4 meter) horizontal reference line on the vertical wall or screen at this height.

Note: To see a clearer light pattern for adjusting, you may want to block the light from one headlamp while adjusting the other.

3. Turn on the low beam headlamps to illuminate the wall or screen and open the hood.



E142465

4. On the wall or screen you will observe a flat zone of high intensity light located at the top of the right hand portion of the beam pattern. If the top edge of the high intensity light zone is not at the horizontal reference line, the headlamp will need to be adjusted.

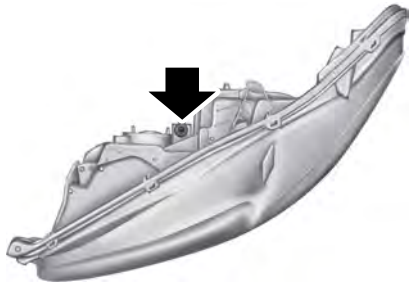

5. Locate the vertical adjuster on each headlamp. Using a Phillips #2 screwdriver, turn the adjuster either clockwise or counterclockwise in order to adjust the vertical aim of the headlamp. The horizontal edge of the brighter light should touch the horizontal reference line.
6. Close the hood and turn off the lamps.

Maintenance

Horizontal Aim Adjustment

Horizontal aim is not required for this vehicle and is not adjustable.

REMOVING A HEADLAMP

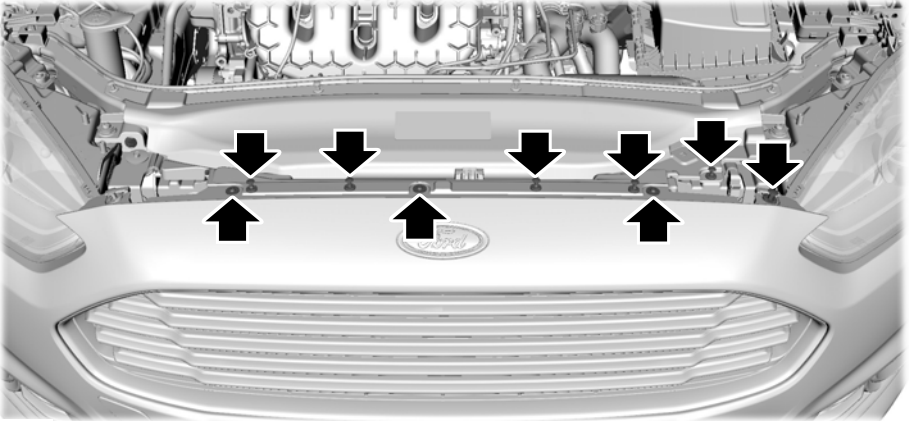

E159693

Note: To remove push pins, use a flat-bladed screwdriver to pull up the center release pin.

1. Make sure the headlamp control is in the off position and open the hood.
2. Remove the six push pins securing the front fascia to the front trim cover.
3. Remove the three bumper cover upper screws using a flat-bladed screwdriver.
4. Remove the push pin at the inboard side of the headlamp you are servicing.

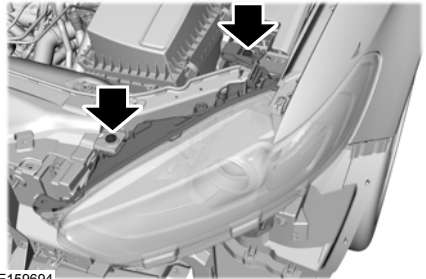

E159694

5. Remove the two screws securing the headlamp using a flat-bladed screwdriver.

Maintenance

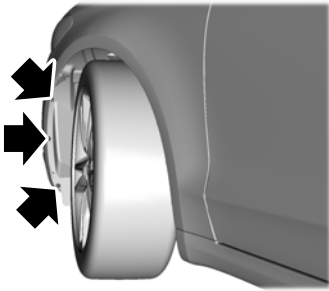

E159695

6. Remove the lower three wheel housing fasteners by turning them counterclockwise.

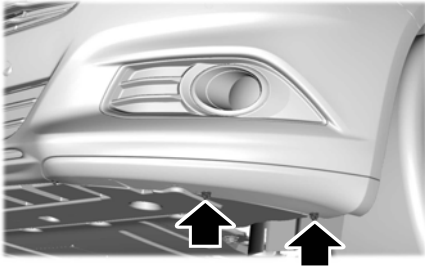

E159696

7. Remove the two outmost front bumper cover lower fasteners, only on the side of the headlamp you are servicing, by turning them counterclockwise.

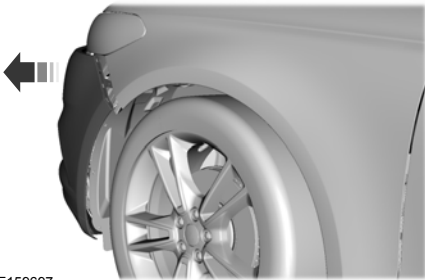

E159697

8. Separate the front bumper cover from the fender by gently pulling the front bumper cover to the outside of the vehicle 1.2 inches (3 centimeters).

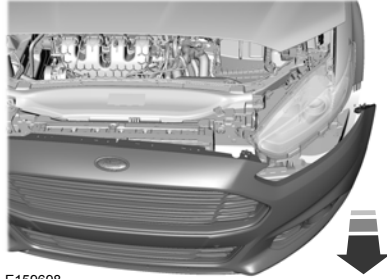

E159698

9. From the front of the vehicle, gently pull the front bumper cover forward 4 inches (10 centimeters) by grasping it next to the headlamp to be serviced and in the lower front of the wheel opening.

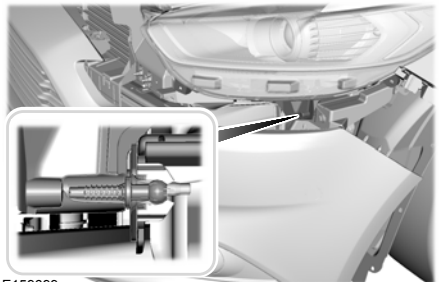

E159699

10. Gently pull the headlamp assembly outward to disengage it from the lower fixing point.
11. Carefully lift the headlamp and remove it from the vehicle.
12. Disconnect the electrical connector from the headlamp assembly by pushing the release tab on the connector.

Maintenance

CHANGING A BULB

WARNINGS



Switch the lamps and the ignition off. Failure to follow this warning could result in serious personal injury.



Bulbs become hot when in use. Let them cool down before you remove them.

Use the correct specification bulb. See **Bulb Specification Chart** (page 268).

Install in the reverse order unless otherwise stated.

Headlamp

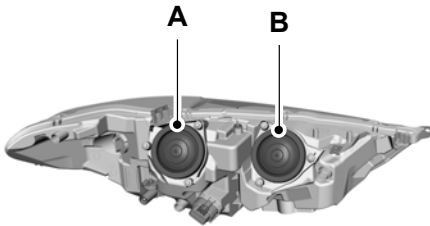

E222975

- A Headlamp high beam.
- B Headlamp low beam.

Note: LED headlamps are not serviceable. Have your vehicle checked as soon as possible.

Headlamp Low Beam

1. Carefully remove the cover.
2. Disconnect the electrical connector.
3. Turn the bulb holder counterclockwise and remove it.

Note: Do not touch the bulb glass.

Note: You cannot separate the bulb from the bulb holder.

Headlamp High Beam

1. Carefully remove the cover.
2. Disconnect the electrical connector.
3. Turn the bulb holder counterclockwise and remove it.

Note: Do not touch the bulb glass.

Note: You cannot separate the bulb from the bulb holder.

LED Lamps

LED lamps are not serviceable. Have your vehicle checked as soon as possible.

The following lamps are LED:

- Front side marker lamps.
- Front direction indicators.
- Daytime running lamps.
- Side direction indicators.
- Central high mounted brake lamp.
- Rear direction indicators.
- Brake and rear lamps.

Reversing Lamp

1. Carefully remove the luggage compartment trim panel.

Maintenance



E145779

2. Turn the bulb holder counterclockwise and remove it.



E145780

3. Press the bulb in and turn the bulb counterclockwise to remove it.

License Plate Lamp

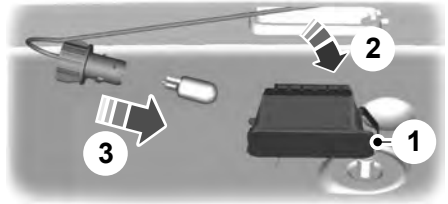

E72789

1. Use a suitable tool, for example a screwdriver, to carefully remove the lamp.
2. Remove the lamp.
3. Turn the bulb holder counterclockwise and remove it.
4. Remove the bulb by pulling it straight out.

BULB SPECIFICATION CHART

Replacement bulbs are specified in the chart below. Headlamp bulbs must be marked with an authorized "D.O.T." for North America to make sure they have the proper lamp performance, light brightness, light pattern, and safe visibility. The correct bulbs will not damage the lamp assembly or void the lamp assembly warranty and will provide quality bulb illumination time.

Maintenance

Function	Trade name
*Headlamp high beam (Halogen)	H7LL
*Headlamp low beam (Halogen)	H11LL
*Side marker lamp - front	LED
*Park lamp - front	W5W
*Turn lamp - front	PWY24W
*Fog lamp - front	H11
*Tail and brake lamp - high series	LED
*Tail and brake lamp - low series	LED
Reverse lamp	921
*Turn lamp - rear - high series	LED
*Turn lamp - rear - low series	LED
*Side marker lamp - rear	LED
License plate lamp	W5W
*Trunk lamp	W5W or LED**
*High-mount brake lamp	LED
*Side repeater lamp	LED
*Interior lamp	LED

*To replace these bulbs, see your authorized dealer.

To replace all instrument panel bulbs, see your authorized dealer.

**If so equipped.

Maintenance

CHANGING THE ENGINE AIR FILTER

WARNING



To reduce the risk of vehicle damage and/or personal burn injuries do not start your engine with the air cleaner removed and do not remove it while the engine is running.

When changing the air filter element, use only the air filter element listed. See **Capacities and Specifications** (page 306).

Change the air filter element at the proper interval. See **Scheduled Maintenance** (page 466).

Note: *Failure to use the correct air filter element may result in severe engine damage. The customer warranty may be void for any damage to the engine if the correct air filter element is not used.*

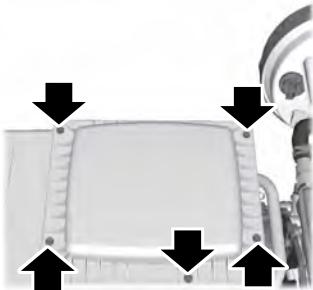

E146048

1. Loosen the 5 bolts on the air cleaner cover.
2. Remove the air cleaner cover.
3. Remove the engine air filter element from the engine air cleaner assembly.
4. Wipe any dirt or debris from the air filter housing and cover to make sure no dirt gets in the engine and to make sure you have a good seal.
5. Install the new engine air filter element to the engine air cleaner assembly.
6. Install the air cleaner cover.
7. Tighten the 5 bolts to the air cleaner cover.

Vehicle Care

GENERAL INFORMATION

Your Ford or Lincoln authorized dealer has many quality products available to clean your vehicle and protect its finishes.

Materials

Name	Specification
Motorcraft Bug and Tar Remover ZC-42	-
Motorcraft Custom Bright Metal Cleaner ZC-15	-
Motorcraft® Detail Wash ZC-3-A	ESR-M14P4-A
Motorcraft Engine Shampoo and Degreaser (U.S.) ZC-20 (U.S.)	-
Engine Shampoo	-
Motorcraft Leather and Vinyl Cleaner ZC-56	-
Multi-Purpose Cleaner	-
Motorcraft® Premium Windshield Wash Concentrate with Bitterant (U.S.) ZC-32-B2 (U.S.)	WSS-M14P19-A
Professional Strength Carpet and Upholstery Cleaner ZC-54	-
Motorcraft Spot and Stain Remover (U.S.) ZC-14 (U.S.)	-
Motorcraft® Ultra-Clear Spray Glass Cleaner (U.S.) ZC-23 (U.S.)	ESR-M14P5-A
Motorcraft® Wheel and Tire Cleaner ZC-37-A	-

CLEANING PRODUCTS

For best results, use the following products or products of equivalent quality:

CLEANING THE EXTERIOR

Wash your vehicle regularly with cool or lukewarm water and a neutral pH shampoo, we recommend Motorcraft Detail Wash.

- Never use strong household detergents or soap, for example dish washing or laundry liquid. These products can discolor and spot painted surfaces.
- Never wash your vehicle when it is hot to the touch, or during strong or direct sunlight.
- Dry your vehicle with a chamois or soft terry cloth towel to eliminate water spotting.

Vehicle Care

- Immediately remove fuel spillages, bird droppings, insect deposits and road tar. These may cause damage to your vehicle's paintwork or trim over time. We recommend Motorcraft Bug and Tar Remover.
- Remove any exterior accessories, for example antennas, before entering a car wash.

Note: *Suntan lotions and insect repellents can damage painted surfaces. If these substances come in contact with your vehicle, wash the affected area as soon as possible.*

Exterior Chrome Parts

- Apply a high quality-cleaning product to bumpers and other chrome parts. Follow the manufacturer's instructions. We recommend Motorcraft Custom Bright Metal Cleaner.
- Do not apply the cleaning product to hot surfaces. Do not leave the cleaning product on chrome surfaces longer than the time recommended.
- Using other non-recommended cleaners can result in severe and permanent cosmetic damage.

Note: *Never use abrasive materials, for example steel wool or plastic pads as they can scratch the chrome surface.*

Note: *Do not use chrome cleaner, metal cleaner or polish on wheels or wheel covers.*

Exterior Plastic Parts

For routine cleaning we recommend Motorcraft Detail Wash. If tar or grease spots are present, we recommend Motorcraft Bug and Tar Remover.

Stripes or Graphics (If Equipped)

Hand washing your vehicle is preferred however, pressure washing may be used under the following conditions:

- Do not use water pressure higher than 2,000 psi (14,000 kPa).
- Do not use water hotter than 179°F (82°C).
- Use a spray with a 40° wide spray angle pattern.
- Keep the nozzle at a 12 in (305 mm) distance and 90° angle to your vehicle's surface.

Note: *Holding the pressure washer nozzle at an angle to the vehicle's surface may damage graphics and cause the edges to peel away from the vehicle's surface.*

Underbody

Flush the complete underside of your vehicle frequently. Keep body and door drain holes free of debris or foreign material.

Under Hood

For removing black rubber marks from under the hood we recommend Motorcraft Wheel and Tire Cleaner or Motorcraft Bug and Tar Remover.

WAXING

Regular waxing is necessary to protect your car's paint from the elements. We recommend that you wash and wax the painted surface once or twice a year.

When washing and waxing, park your vehicle in a shaded area out of direct sunlight. Always wash your vehicle before applying wax.

- Use a quality wax that does not contain abrasives.
- Follow the manufacturer's instructions to apply and remove the wax.
- Apply a small amount of wax in a back-and-forth motion, not in circles.

Vehicle Care

- Do not allow wax to come in contact with any non-body (low-gloss black) colored trim. The wax will discolor or stain the parts over time.
 - Roof racks.
 - Bumpers.
 - Grained door handles.
 - Side moldings.
 - Mirror housings.
 - Windshield cowl area.
- Do not apply wax to glass areas.
- After waxing, your car's paint should feel smooth, and be free of streaks and smudges.
- Never wash or rinse any ignition coil, spark plug wire or spark plug well, or the area in and around these locations.
- Cover the battery, power distribution box, and air filter assembly to prevent water damage when cleaning the engine.

CLEANING THE WINDOWS AND WIPER BLADES

Car wash chemicals and environmental fallout can result in windshield and wiper blade contamination. Dirty windshield and wipers will result in poor windshield wiper operation. Keep the windshield and wiper blades clean to maintain windshield wiper performance.

To clean the windshield and wiper blades:

- Clean the windshield with a non-abrasive glass cleaner. When cleaning the interior of the windshield, avoid getting any glass cleaner on the instrument panel or door panels. Wipe any glass cleaner off these surfaces immediately.
- For windshields contaminated with tree sap, chemicals, wax or bugs, clean the entire windshield using steel wool (no greater than 0000 grade) in a circular motion and rinse with water.
- Clean the wiper blades with isopropyl rubbing alcohol or windshield washer concentrate.

Note: *Do not use razor blades or other sharp objects to clean or remove decals from the inside of the heated rear window. The vehicle warranty does not cover damage caused to the heated rear window grid lines.*

CLEANING THE ENGINE

Engines are more efficient when they are clean because grease and dirt buildup keep the engine warmer than normal.

When washing:

- Take care when using a power washer to clean the engine. The high-pressure fluid could penetrate the sealed parts and cause damage.
- Do not spray a hot engine with cold water to avoid cracking the engine block or other engine components.
- Spray Motorcraft Engine Shampoo and Degreaser on all parts that require cleaning and pressure rinse clean. In Canada, use Motorcraft Engine Shampoo.
- Never wash or rinse the engine while it is hot or running; water in the running engine may cause internal damage.

Vehicle Care

CLEANING THE INTERIOR

WARNINGS



Do not use cleaning solvents, bleach or dye on the vehicle's safety belts, as these actions may weaken the belt webbing.



On vehicles equipped with seat-mounted airbags, do not use chemical solvents or strong detergents. Such products could contaminate the side airbag system and affect performance of the side airbag in a collision.

For fabric, carpets, cloth seats, safety belts and seats equipped with side airbags:

- Remove dust and loose dirt with a vacuum cleaner.
- Remove light stains and soil with Motorcraft Professional Strength Carpet & Upholstery Cleaner.
- If grease or tar is present on the material, spot-clean the area first with Motorcraft Spot and Stain Remover. In Canada, use Motorcraft Multi-Purpose Cleaner.
- If a ring forms on the fabric after spot cleaning, clean the entire area immediately (but do not oversaturate) or the ring will set.
- Do not use household cleaning products or glass cleaners, which can stain and discolor the fabric and affect the flame retardant abilities of the seat materials.

CLEANING THE INSTRUMENT PANEL AND INSTRUMENT CLUSTER LENS

WARNING



Do not use chemical solvents or strong detergents when cleaning the steering wheel or instrument panel to avoid contamination of the airbag system.

Note: Follow the same procedure as cleaning leather seats for cleaning leather instrument panels and leather interior trim surfaces. See **Cleaning Leather Seats** (page 275).

Clean the instrument panel and cluster lens with a clean, damp and soft cloth, then use a clean, dry and soft cloth to dry these areas.

- Avoid cleaners or polishes that increase the gloss of the upper portion of the instrument panel. The dull finish in this area helps protect you from undesirable windshield reflection.
- Do not use any household cleaning products or glass cleaners as these may damage the finish of the instrument panel, interior trim and cluster lens.
- Wash or wipe your hands clean if you have been in contact with certain products such as insect repellent and suntan lotion to avoid possible damage to the interior painted surfaces.
- Do not allow air fresheners and hand sanitizers to spill onto interior surfaces. If a spill occurs, wipe off immediately. Your warranty may not cover these damages.

If a staining liquid like coffee or juice has been spilled on the instrument panel or on interior trim surfaces:

Vehicle Care

1. Wipe up spilled liquid using a clean, soft cloth as quickly as possible.
2. Use Motorcraft Premium Leather and Vinyl Cleaner or a commercially available leather cleaning product for automotive interiors. Test any cleaner or stain remover on an inconspicuous area.
3. Alternatively, wipe the surface with a clean, soft cloth and a mild soap and water solution. Dry the area with a clean, soft cloth.
4. If necessary, apply more soap and water solution or cleaning product to a clean, soft cloth and press it onto the soiled area. Allow this to set at room temperature for 30 minutes.
5. Remove the soaked cloth, then with a clean, damp cloth, use a rubbing motion for 60 seconds on the soiled area.
6. Dry the area with a clean, soft cloth.

CLEANING LEATHER SEATS (If Equipped)

Note: Follow the same procedure as cleaning leather seats for cleaning leather instrument panels and leather interior trim surfaces.

For routine cleaning, wipe the surface with a soft, damp cloth and a mild soap and water solution. Dry the area with a clean, soft cloth.

For cleaning and removing stains such as dye transfer, use Motorcraft Premium Leather and Vinyl Cleaner or a commercially available leather cleaning product for automotive interiors.

Note: Test any cleaner or stain remover on an inconspicuous area.

You should:

- Remove dust and loose dirt with a vacuum cleaner.
- Clean and treat spills and stains as soon as possible.

Do not use the following products as these may damage the leather:

- Oil and petroleum or silicone-based leather conditioners.
- Household cleaners.
- Alcohol solutions.
- Solvents or cleaners intended specifically for rubber, vinyl and plastics.

REPAIRING MINOR PAINT DAMAGE

Authorized dealers have touch-up paint to match your vehicle's color. Your vehicle color code is printed on a sticker on the front, left-hand side door jamb. Take your color code to your authorized dealer to make sure you get the correct color.

Before repairing minor paint damage, use a cleaner such as Motorcraft Bug and Tar Remover to remove particles such as bird droppings, tree sap, insect deposits, tar spots, road salt and industrial fallout.

Always read the instructions before using cleaning products.

CLEANING THE ALLOY WHEELS

Note: Do not apply a cleaning chemical to warm or hot wheel rims and covers.

Note: Some automatic car washes may cause damage to the finish on your wheel rims and covers.

Vehicle Care

Note: *Industrial-strength or heavy-duty cleaners in combination with brush agitation to remove brake dust and dirt, could wear away the clear coat finish over a period time.*

Note: *Do not use hydrofluoric acid-based or high caustic-based wheel cleaners, steel wool, fuels or strong household detergents.*

Note: *If you intend parking your vehicle for an extended period after cleaning the wheels with a wheel cleaner, drive your vehicle for a few minutes before doing so. This will reduce the risk of increased corrosion of the brake discs.*

Alloy wheels and wheel covers are coated with a clear coat paint finish. To maintain their condition we recommend that you:

- Clean the wheels weekly using Motorcraft Wheel and Tire Cleaner. Apply using manufacturer's instructions.
- Use a sponge to remove heavy deposits of dirt and brake dust accumulation.
- Rinse thoroughly with a strong stream of water when you have completed the cleaning process.
- To remove tar and grease, use Motorcraft Bug and Tar Remover.

VEHICLE STORAGE

If you plan on storing your vehicle for 30 days or more, read the following maintenance recommendations to make sure your vehicle stays in good operating condition.

We engineer and test all motor vehicles and their components for reliable, regular driving. Under various conditions, long-term storage may lead to degraded engine performance or failure unless you use specific precautions to preserve engine components.

General

- Store all vehicles in a dry, ventilated place.
- Protect from sunlight, if possible.
- If you store vehicles outside, they require regular maintenance to protect against rust and damage.

Body

- Wash your vehicle thoroughly to remove dirt, grease, oil, tar or mud from exterior surfaces, rear-wheel housing and the underside of front fenders.
- Periodically wash your vehicle if you store it in exposed locations.
- Touch-up exposed or primed metal to prevent rust.
- Cover chrome and stainless steel parts with a thick coat of auto wax to prevent discoloration. Re-wax as necessary when you wash your vehicle.
- Lubricate all hood, door and luggage compartment hinges and latches with a light grade oil.
- Cover interior trim to prevent fading.
- Keep all rubber parts free from oil and solvents.

Engine

- Change the engine oil and filter prior to storage because used engine oil contains contaminants which may cause engine damage.
- Start the engine every 15 days for a minimum of 15 minutes. Run at fast idle with the climate controls set to defrost until the engine reaches normal operating temperature.

Vehicle Care

- With your foot on the brake, shift through all the gears while the engine is running.
- We recommend that you change the engine oil before you use your vehicle again.

Fuel System

- Fill the fuel tank with high-quality fuel until the first automatic shutoff of the fuel pump nozzle.

Cooling System

- Protect against freezing temperatures.
- When removing your vehicle from storage, check coolant fluid level. Confirm that there are no cooling system leaks and that fluid is at the recommended level.

12V Battery

- Check and recharge as necessary. Keep connections clean.
- If storing your vehicle for more than 30 days without recharging the battery, we recommend that you disconnect the battery cables to maintain battery charge for quick starting.

Note: *It is necessary to reset memory features if you disconnect the battery cables.*

We recommend the following options for your plug-in vehicle:

- Leave your vehicle plugged in. The 12V battery maintains power if left plugged in. However, this periodically uses electricity from the household outlet.
- Connect a battery charger to your 12V battery and leave it on a continuous, slow charge.
- Disconnect the 12V battery. If your 12V battery is located in the luggage compartment, do not fully shut the luggage compartment after disconnecting the 12V battery. Only leave the luggage compartment open if your vehicle is stored in a locked location.

Brakes

- Make sure the brakes and parking brake release fully.

Tires

- Maintain recommended air pressure.

Miscellaneous

- Make sure you cover all linkages, cables, levers and pins under your vehicle with grease to prevent rust.
- Move vehicles at least 25 ft (7.5 m) every 15 days to lubricate working parts and prevent corrosion.

Removing Vehicle From Storage

When your vehicle is ready to come out of storage, do the following:

- Wash your vehicle to remove any dirt or grease film build-up on window surfaces.
- Check windshield wipers for any deterioration.

Vehicle Care

- Check under the hood for any foreign material that may have collected during storage such as mice or squirrel nests.
- Check the exhaust for any foreign material that may have collected during storage.
- Check tire pressures and set tire inflation per the Tire Label.
- Check brake pedal operation. Drive your vehicle 15 ft (4.5 m) back and forth to remove rust build-up.
- Check fluid levels (including coolant and gas) to make sure there are no leaks, and fluids are at recommended levels.
- If you remove the 12-volt battery, clean the cable ends and inspect.

Contact an authorized dealer if you have any concerns or issues.

Wheels and Tires

TIRE SEALANT AND INFLATOR KIT (If Equipped)

Note: *The temporary mobility kit contains enough sealant compound in the canister for one tire repair only. See your authorized Ford dealer for replacement sealant canisters.*

The kit is located under the load floor in the trunk. The kit consists of an air compressor to re-inflate the tire and a canister of sealing compound that will effectively seal most punctures caused by nails or similar objects. This kit will provide a temporary tire repair allowing you to drive your vehicle up to 120 mi (200 km) at a maximum speed of 50 mph (80 km/h) to reach a tire service location.

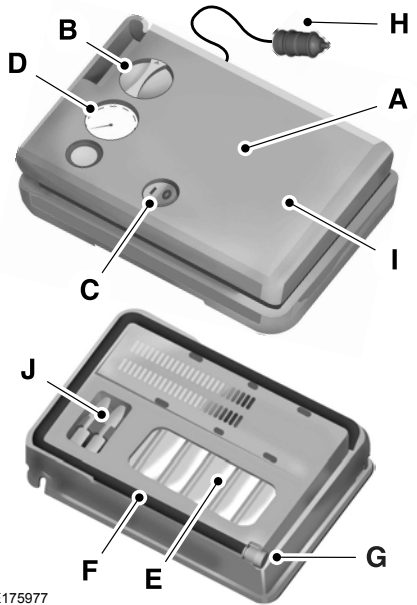

E175977

- A Air compressor (inside)
- B Selector switch
- C On and off button
- D Air pressure gauge
- E Sealant bottle and canister
- F Dual purpose hose: air and repair
- G Tire valve connector
- H Accessory power plug
- I Casing/housing
- J Bike/raft/sports ball adapters

Wheels and Tires

General Information

WARNING



Failure to follow these guidelines could result in an increased risk of loss of vehicle control, injury or death.

Note: *Do not use the kit if a tire has become severely damaged. Only punctures located within the tire tread can be sealed with the kit.*

Do not attempt to repair punctures larger than ¼ inch (6 millimeters) or damage to the tire's sidewall. The tire may not completely seal.

Loss of air pressure may adversely affect tire performance. For this reason:

Note: *Do not drive the vehicle above 50 mph (80 km/h).*

Note: *Do not drive further than 120 mi (200 km). Drive only to the closest authorized Ford dealer or tire repair shop to have your tire inspected.*

- Drive carefully and avoid abrupt steering maneuvers.
- Periodically monitor tire inflation pressure in the affected tire; if the tire is losing pressure, have the vehicle towed.
- Read the information in the Tips for Use of the Kit section to make sure safe operation of the kit and your vehicle.

Tips for Use of the Kit

To ensure safe operation of the kit:

- Read all instructions and cautions fully.
- Before operating the kit, make sure your vehicle is safely off the road and away from moving traffic. Turn on the hazard lights.
- Always set the parking brake to ensure the vehicle doesn't move unexpectedly.

- Do not remove any foreign objects, such as nails or screws, from the tire.
- When using the kit, leave the engine running (only if the vehicle is outdoors or in a well-ventilated area) so the compressor does not drain the vehicle's battery.
- Do not allow the compressor to operate continuously for more than 15 minutes. This will help prevent the compressor from overheating.
- Never leave the kit unattended during operation.
- Sealant compound contains latex. Those with latex sensitivities should use appropriate precautions to avoid an allergic reaction.
- Keep the kit away from children.
- Only use the kit when the ambient temperature is between -22°F (-30°C) and 158°F (70°C).
- Only use the sealing compound before the use-by date. The use-by date is on a label on the sealant canister and can be seen through the rectangular viewing window on the bottom of the compressor. Check the use-by date regularly and replace the canister after four years of non-use.
- Do not store the kit unsecured inside the passenger compartment of the vehicle as it may cause injury during a sudden stop or crash. Always store the kit in its original location.
- After sealant use, the tire pressure monitoring system sensor and valve stem on the wheel must be replaced by an authorized Ford dealer.
- Operating the kit could cause an electrical disturbance in radio, CD, and DVD player operation.

Wheels and Tires



* When inflation only is required for a tire or other objects, the selector must be in the Air position.

What to do when a Tire Is Punctured

A tire puncture within the tire's tread area can be repaired in two stages with the kit.

- In the first stage, the tire will be reinflated with a sealing compound and air. After the tire has been inflated, you will need to drive the vehicle a short distance (about 4 miles [6 kilometers]) to distribute the sealant in the tire.
- In the second stage, you will need to check the tire pressure and adjust, if necessary, to the vehicle's specified tire inflation pressure.

First Stage: Reinflating the Tire with Sealing Compound and Air

WARNINGS



Do not stand directly over the kit while inflating the tire. If you notice any unusual bulges or deformations in the tire's sidewall during inflation, stop and call roadside assistance.



If the tire does not inflate to the recommended tire pressure within 15 minutes, stop and call roadside assistance.



Do not run the engine during kit operation unless the vehicle is outdoors or in a well-ventilated area.

Preparation: Park the vehicle in a safe, level and secure area, away from moving traffic.

Turn the hazard lights on. Apply the parking brake and turn the engine off. Inspect the flat tire for visible damage.

Sealant compound contains latex. Use appropriate precautions to avoid any allergic reactions.

Do not remove any foreign object that has pierced the tire. If a puncture is located in the tire sidewall, stop and call roadside assistance.

1. Remove the valve cap from the tire valve.
2. Unwrap the dual purpose hose (black tube) from the back of the compressor housing.
3. Fasten the hose to the tire valve by turning the connector clockwise. Tighten the connection securely.

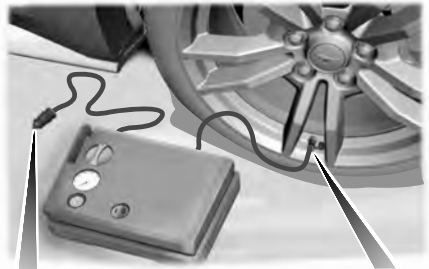

E175979

4. Plug the power cable into the 12-volt power point in the vehicle.

Wheels and Tires

- Remove the warning sticker found on the casing/housing and place it on the top of the instrument panel or the center of the dash.
- Start the vehicle leave the engine running so the compressor does not drain the vehicle's battery.

pressure gauge reading will indicate the tire inflation pressure after about 30 seconds of operation. The final tire pressure should be checked with the compressor turned OFF in order to get an accurate pressure reading.



E175981

- Turn dial (A) clockwise to the sealant position. Turn the kit on by pressing the on/off button (B).
- Inflate the tire to the pressure listed on the tire label located on the driver's door or the door jamb area. The initial air pressure gauge reading may indicate a value higher than the label pressure while the sealing compound is being pumped into the tire. This is normal and should be no reason for concern. The

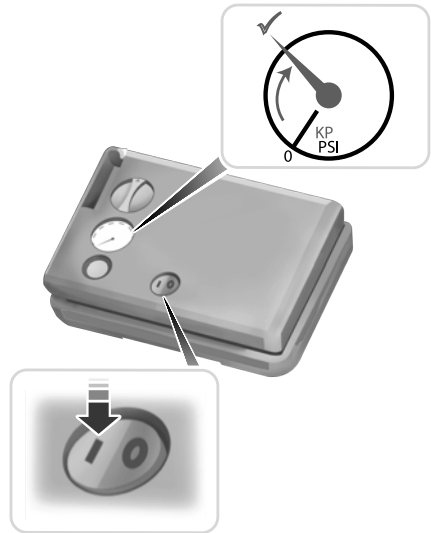

E175982

- When the recommended tire pressure is reached, turn off the kit, unplug the power cable, and disconnect the hose from the tire valve. Re-install the valve cap on the tire valve and return the kit to the stowage area.
- Immediately and cautiously, drive the vehicle 4 miles (6 kilometers) to distribute the sealant evenly inside the tire. Do not exceed 50 mph (80 km/h).
- After 4 miles (6 kilometers), stop and check the tire pressure. See Second stage: Checking tire pressure.

Wheels and Tires

Note: *If you experience any unusual vibration, ride disturbance or noise while driving, reduce your speed until you can safely pull off to the side of the road to call for roadside assistance. Note: Do not proceed to the second stage of this operation.*

Second Stage: Checking Tire Pressure

WARNINGS



If you are proceeding from the First Stage: Re-inflating the Tire with Sealing Compound and Air section and have injected sealant in the tire and the pressure is below 20 psi (1.4 bar), continue to the next step.



The power plug may get hot after use and should be handled carefully while unplugging.

Check the air pressure of your tires as follows:



E175983

1. Remove the valve cap from the tire valve.
2. Firmly screw the air compressor hose onto the valve stem by turning clockwise.
3. Push and turn the dial clockwise to the air position.

4. If required, turn on the compressor and adjust the tire to the recommended inflation pressure shown on the tire label located on the driver's door or door jamb area. The tire pressure should be checked with the compressor turned OFF in order to get an accurate pressure reading.
5. Unplug the hoses, re-install the valve cap on the tire and return the kit to the stowage area.

What to do after the Tire has been Sealed

After using the kit to seal your tire, you will need to replace the sealant canister. Sealant canisters and spare parts can be obtained at an authorized Ford dealer. Empty sealant canisters may be disposed of at home. However, canisters still containing liquid sealant should be disposed of by your local authorized Ford dealer or tire dealer, or in accordance with local waste disposal regulation.

Note: *After the sealing compound has been used, the maximum vehicle speed is 50 mph (80 km/h) and the maximum driving distance is 120 mi (200 km). The sealed tire should be inspected immediately.*

You can check the tire pressure any time within the 120 mi (200 km) by performing the steps listed previously in the Second stage: Checking Tire Pressure procedure.

Wheels and Tires

Removal of the sealant canister from the kit

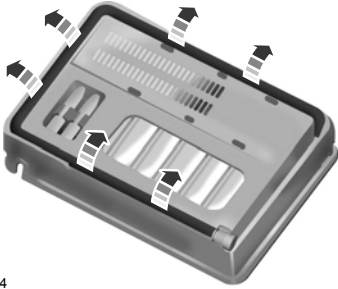

E175984

1. Unwrap the dual purpose hose (black tube) from the compressor housing.

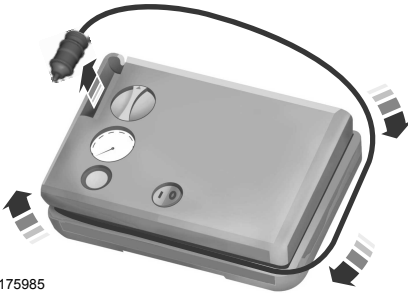

E175985

2. Unwrap the power cord.



E175986

3. Remove the back cover.



E175987

4. Rotate the sealant canister up 90 degrees and pull away from casing/housing to remove.

Installation of the sealant canister to the kit

1. With the canister held perpendicular to the housing, insert the canister nozzle into the connector and push until seated.
2. Rotate the canister 90 degrees down into the housing/casing.



E175988

3. Snap the back cover back into place.

Wheels and Tires



E175989

4. Wrap the dual purpose hose (black tube) around the channel on the bottom of the housing/casing.



E175990

5. Wrap the power cord around the housing and stow the accessory power plug into its storage area.

Note: *If you experience any difficulties with the removal or installation of the sealant canister, consult your authorized Ford dealer for assistance.*

Be sure to check the sealant compound's use-by date regularly. The use-by date is on a label located on the sealant canister and can be seen through the rectangular viewing window on the bottom of the kit. The sealant canister should be replaced after four years of non-use.

TIRE CARE

Information About Uniform Tire Quality Grading



E142542

Tire Quality Grades apply to new pneumatic passenger car tires. The Quality grades can be found where applicable on the tire sidewall between tread shoulder and maximum section width. For example: **Treadwear 200 Traction AA Temperature A.**

These Tire Quality Grades are determined by standards that the United States Department of Transportation has set.

Tire Quality Grades apply to new pneumatic passenger car tires. They do not apply to deep tread, winter-type snow tires, space-saver or temporary use spare tires, light truck or LT type tires, tires with nominal rim diameters of 10 to 12 inches or limited production tires as defined in Title 49 Code of Federal Regulations Part 575.104 (c)(2).

Wheels and Tires

U.S. Department of Transportation Tire quality grades: The U.S. Department of Transportation requires Ford Motor Company to give you the following information about tire grades exactly as the government has written it.

Treadwear

The treadwear grade is a comparative rating based on the wear rate of the tire when tested under controlled conditions on a specified government test course. For example, a tire graded 150 would wear 1½ times as well on the government course as a tire graded 100. The relative performance of tires depends upon the actual conditions of their use, however, and may depart significantly from the norm due to variations in driving habits, service practices, and differences in road characteristics and climate.

Traction AA A B C

WARNING

 The traction grade assigned to this tire is based on straight-ahead braking traction tests, and does not include acceleration, cornering, hydroplaning or peak traction characteristics.

The traction grades, from highest to lowest are AA, A, B, and C. The grades represent the tire's ability to stop on wet pavement as measured under controlled conditions on specified government test surfaces of asphalt and concrete. A tire marked C may have poor traction performance.

Temperature A B C

WARNING

 The temperature grade for this tire is established for a tire that is properly inflated and not overloaded. Excessive speed, underinflation, or excessive loading, either separately or in combination, can cause heat buildup and possible tire failure.

The temperature grades are A (the highest), B and C, representing the tire's resistance to the generation of heat and its ability to dissipate heat when tested under controlled conditions on a specified indoor laboratory test wheel. Sustained high temperature can cause the material of the tire to degenerate and reduce tire life, and excessive temperature can lead to sudden tire failure. The grade C corresponds to a level of performance which all passenger car tires must meet under the

Wheels and Tires

Federal Motor Vehicle Safety Standard No. 139. Grades B and A represent higher levels of performance on the laboratory test wheel than the minimum required by law.

Glossary of Tire Terminology

* **Tire label:** A label showing the original equipment tire sizes, recommended inflation pressure and the maximum weight the vehicle can carry.

* **Tire Identification Number (TIN):** A number on the sidewall of each tire providing information about the tire brand and manufacturing plant, tire size and date of manufacture. Also referred to as DOT code.

* **Inflation pressure:** A measure of the amount of air in a tire.

* **Standard load:** A class of P-metric or Metric tires designed to carry a maximum load at set pressure. For example: For P-metric tires 35 psi (2.4 bar) or 36 psi (2.5 bar) depending on tire size and for Metric tires 36 psi (2.5 bar). Increasing the inflation pressure beyond this pressure will not increase the tire's load carrying capability.

* **Extra load:** A class of P-metric or Metric tires designed to carry a heavier maximum load at 42 psi (2.9 bar). Increasing the inflation pressure beyond this pressure will not increase the tire's load carrying capability.

* **kPa:** Kilopascal, a metric unit of air pressure.

* **PSI:** Pounds per square inch, a standard unit of air pressure.

* **Cold tire pressure:** The tire pressure when the vehicle has been stationary and out of direct sunlight for an hour or more and prior to the vehicle being driven for 1 mile (1.6 km).

* **Recommended inflation pressure:** The cold inflation pressure found on the Safety Compliance Certification Label (affixed to either the door hinge pillar, door-latch post, or the door edge that meets the door-latch post, next to the driver's seating position), or Tire Label located on the B-Pillar or the edge of the driver's door.

* **B-pillar:** The structural member at the side of the vehicle behind the front door

* **Bead area of the tire:** Area of the tire next to the rim.

* **Sidewall of the tire:** Area between the bead area and the tread.

* **Tread area of the tire:** Area of the perimeter of the tire that contacts the road when mounted on the vehicle.

* **Rim:** The metal support (wheel) for a tire or a tire and tube assembly upon which the tire beads are seated.

Wheels and Tires

Information Contained on the Tire Sidewall

Both U.S. and Canada Federal regulations require tire manufacturers to place standardized information on the sidewall of all tires. This information identifies and describes the fundamental characteristics of the tire and also provides a U.S. DOT Tire Identification Number for safety standard certification and in case of a recall.

Information on P Type Tires

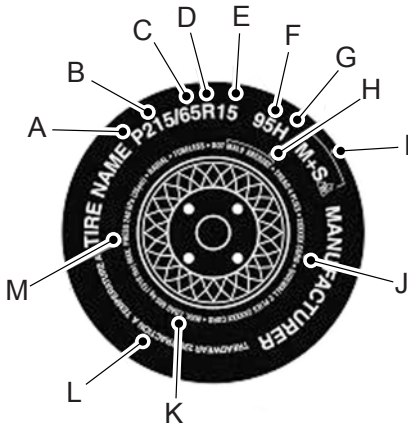

E142543

P215/65R15 95H is an example of a tire size, load index and speed rating. The definitions of these items are listed below. (Note that the tire size, load index and speed rating for your vehicle may be different from this example.)

A. P: Indicates a tire, designated by the Tire and Rim Association, that may be used for service on cars, sport utility vehicles, minivans and light trucks. **Note:** If your tire size does not begin with a letter this may mean it is designated by either the European Tire and Rim Technical Organization or the Japan Tire Manufacturing Association.

B. 215: Indicates the nominal width of the tire in millimeters from sidewall edge to sidewall edge. In general, the larger the number, the wider the tire.

C. 65: Indicates the aspect ratio which gives the tire's ratio of height to width.

D. R: Indicates a radial type tire.

E. 15: Indicates the wheel or rim diameter in inches. If you change your wheel size, you will have to purchase new tires to match the new wheel diameter.

F. 95: Indicates the tire's load index. It is an index that relates to how much weight a tire can carry. You may find this information in your owner's manual. If not, contact a local tire dealer.

Note: You may not find this information on all tires because it is not required by federal law.

Wheels and Tires

G. H: Indicates the tire's speed rating. The speed rating denotes the speed at which a tire is designed to be driven for extended periods of time under a standard condition of load and inflation pressure. The tires on your vehicle may operate at different conditions for load and inflation pressure. These speed ratings may need to be adjusted for the difference in conditions. The ratings range from 81 mph (130 km/h) to 186 mph (299 km/h). These ratings are listed in the following chart.

Note: *You may not find this information on all tires because it is not required by federal law.*

Letter rating	Speed rating
M	81 mph (130 km/h)
N	87 mph (140 km/h)
Q	99 mph (159 km/h)
R	106 mph (171 km/h)
S	112 mph (180 km/h)
T	118 mph (190 km/h)
U	124 mph (200 km/h)
H	130 mph (210 km/h)
V	149 mph (240 km/h)

Letter rating	Speed rating
W	168 mph (270 km/h)
Y	186 mph (299 km/h)

Note: *For tires with a maximum speed capability over 149 mph (240 km/h), tire manufacturers sometimes use the letters ZR. For those with a maximum speed capability over 186 mph (299 km/h), tire manufacturers always use the letters ZR.*

H. U.S. DOT Tire Identification Number (TIN): This begins with the letters DOT and indicates that the tire meets all federal standards. The next two numbers or letters are the plant code designating where it was manufactured, the next two are the tire size code and the last four numbers represent the week and year the tire was built. For example, the numbers 317 mean the 31st week of 1997. After 2000 the numbers go to four digits. For example, 2501 means the 25th week of 2001. The numbers in between are identification codes used for traceability. This information is used to contact customers if a tire defect requires a recall.

I. M+S or M/S: Mud and Snow, or
AT: All Terrain, or
AS: All Season.

Wheels and Tires

J. Tire Ply Composition and Material Used: Indicates the number of plies or the number of layers of rubber-coated fabric in the tire tread and sidewall. Tire manufacturers also must indicate the ply materials in the tire and the sidewall, which include steel, nylon, polyester, and others.

K. Maximum Load: Indicates the maximum load in kilograms and pounds that can be carried by the tire. See the Safety Compliance Certification Label (affixed to either the door hinge pillar, door-latch post, or the door edge that meets the door-latch post, next to the driver's seating position), for the correct tire pressure for your vehicle.

L. Treadwear, Traction and Temperature Grades:

* **Treadwear** The treadwear grade is a comparative rating based on the wear rate of the tire when tested under controlled conditions on a specified government test course. For example, a tire graded 150 would wear one and one-half times as well on the government course as a tire graded 100.

* **Traction:** The traction grades, from highest to lowest are AA, A, B, and C. The grades represent the tire's ability to stop on wet pavement as measured under controlled conditions on specified government test surfaces of asphalt and concrete. A tire marked C may have poor traction performance.

* **Temperature:** The temperature grades are A (the highest), B and C, representing the tire's resistance to the generation of heat and its ability to dissipate heat when tested under controlled conditions on a specified indoor laboratory test wheel.

M. Maximum Inflation Pressure: Indicates the tire manufacturers' maximum permissible pressure or the pressure at which the maximum load can be carried by the tire. This pressure is normally higher than the vehicle manufacturer's recommended cold inflation pressure which can be found on the Safety Compliance Certification Label (affixed to either the door hinge pillar, door-latch post, or the door edge that meets the door-latch post, next to the driver's seating position), or Tire Label which is located on the B-Pillar or the edge of the driver's door. The cold inflation pressure should never be set lower than the recommended pressure on the vehicle label.

Wheels and Tires

The tire suppliers may have additional markings, notes or warnings such as standard load or radial tubeless.

Additional Information Contained on the Tire Sidewall for LT Type Tires

Note: *Tire Quality Grades do not apply to this type of tire.*

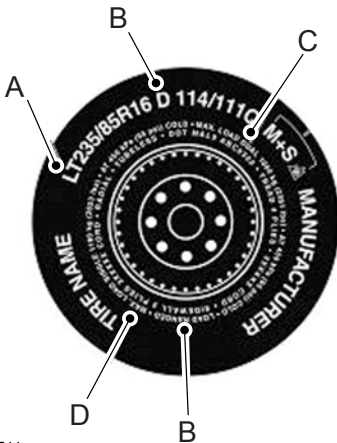

E142544

LT type tires have some additional information beyond those of P type tires; these differences are described below.

A. LT: Indicates a tire, designated by the Tire and Rim Association (T&RA), that is intended for service on light trucks.

B. Load Range and Load Inflation Limits: Indicates the tire's load-carrying capabilities and its inflation limits.

C. Maximum Load Dual lb (kg) at psi (kPa) cold: Indicates the maximum load and tire pressure when the tire is used as a dual; defined as four tires on the rear axle (a total of six or more tires on the vehicle).

D. Maximum Load Single lb (kg) at psi (kPa) cold: Indicates the maximum load and tire pressure when the tire is used as a single; defined as two tires (total) on the rear axle.

Information on T Type Tires

T145/80D16 is an example of a tire size.

Note: *The temporary tire size for your vehicle may be different from this example. Tire Quality Grades do not apply to this type of tire.*

Wheels and Tires

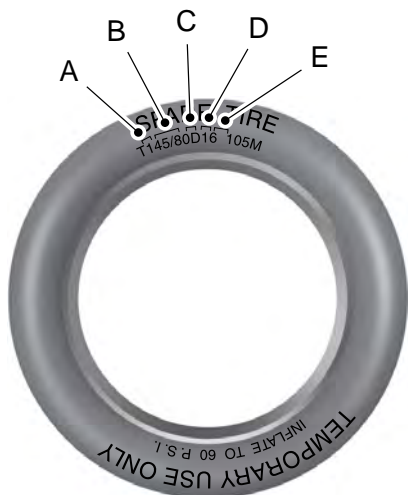

E142545

T type tires have some additional information beyond those of P type tires; these differences are described below:

A. T: Indicates a type of tire, designated by the Tire and Rim Association, that is intended for temporary service on cars, sport-utility vehicles, minivans and light trucks.

B. 145: Indicates the nominal width of the tire in millimeters from sidewall edge to sidewall edge. In general, the larger the number, the wider the tire.

C. 80: Indicates the aspect ratio which gives the tire's ratio of height to width. Numbers of 70 or lower indicate a short sidewall.

D. D: Indicates a diagonal type tire.

R: Indicates a radial type tire.

E. 16: Indicates the wheel or rim diameter in inches. If you change your wheel size, you will have to purchase new tires to match the new wheel diameter.

Location of the Tire Label

You will find a Tire Label containing tire inflation pressure by tire size and other important information located on the B-Pillar or the edge of the driver's door.

Inflating Your Tires

Safe operation of your vehicle requires that your tires are properly inflated. Remember that a tire can lose up to half of its air pressure without appearing flat.

Every day before you drive, check your tires. If one looks lower than the others, use a tire gauge to check pressure of all tires and adjust if required.

At least once a month and before long trips, inspect each tire and check the tire pressure with a tire gauge (including spare, if equipped). Inflate all tires to the inflation pressure recommended by Ford Motor Company.

Wheels and Tires

You are strongly urged to buy a reliable tire pressure gauge, as automatic service station gauges may be inaccurate. Ford recommends the use of a digital or dial-type tire pressure gauge rather than a stick-type tire pressure gauge.

Use the recommended cold inflation pressure for optimum tire performance and wear. Under-inflation or over-inflation may cause uneven treadwear patterns

WARNING



Under-inflation is the most common cause of tire failures and may result in severe tire cracking, tread separation or blowout, with unexpected loss of vehicle control and increased risk of injury. Under-inflation increases sidewall flexing and rolling resistance, resulting in heat buildup and internal damage to the tire. It also may result in unnecessary tire stress, irregular wear, loss of vehicle control and accidents. A tire can lose up to half of its air pressure and not appear to be flat!

Always inflate your tires to the Ford recommended inflation pressure even if it is less than the maximum inflation pressure information found on the tire. The Ford recommended tire inflation pressure is found on the Safety Compliance Certification Label

(affixed to either the door hinge pillar, door-latch post, or the door edge that meets the door-latch post, next to the driver's seating position), or Tire Label which is located on the B-Pillar or the edge of the driver's door. Failure to follow the tire pressure recommendations can cause uneven treadwear patterns and adversely affect the way your vehicle handles

Maximum Inflation Pressure is the tire manufacturer's maximum permissible pressure and the pressure at which the maximum load can be carried by the tire. This pressure is normally higher than the manufacturer's recommended cold inflation pressure which can be found on the Safety Compliance Certification Label (affixed to either the door hinge pillar, door-latch post, or the door edge that meets the door-latch post, next to the driver's seating position), or Tire Label which is located on the B-Pillar or the edge of the driver's door. The cold inflation pressure should never be set lower than the recommended pressure on the Safety Compliance Certification Label or Tire Label.

Wheels and Tires

When weather temperature changes occur, tire inflation pressures also change. A 10°F (6°C) temperature drop can cause a corresponding drop of 1 psi (7 kPa) in inflation pressure. Check your tire pressures frequently and adjust them to the proper pressure which can be found on the Safety Compliance Certification Label or Tire Label.

To check the pressure in your tire(s):

1. Make sure the tires are cool, meaning they are not hot from driving even a mile.

Note: *If you are checking tire pressure when the tire is hot, (for example, driven more than 1 mile [1.6 kilometers]), never bleed or reduce air pressure. The tires are hot from driving and it is normal for pressures to increase above recommended cold pressures. A hot tire at or below recommended cold inflation pressure could be significantly under-inflated.*

Note: *If you have to drive a distance to get air for your tire(s), check and record the tire pressure first and add the appropriate air pressure when you get to the pump. It is normal for tires to heat up and the air pressure inside to go up as you drive.*

2. Remove the cap from the valve on one tire, then firmly press the tire gauge onto the valve and measure the pressure.

3. Add enough air to reach the recommended air pressure.

Note: *If you overfill the tire, release air by pressing on the metal stem in the center of the valve. Then recheck the pressure with your tire gauge.*

4. Replace the valve cap.
5. Repeat this procedure for each tire, including the spare.

Note: *Some spare tires operate at a higher inflation pressure than the other tires. For T type mini-spare tires, see the Dissimilar spare wheel and tire assembly information for a description. Store and maintain at 60 psi (4.15 bar). For full-size and dissimilar spare tires, see the Dissimilar spare wheel and tire assembly information for a description. Store and maintain at the higher of the front and rear inflation pressure as shown on the Tire Label.*

6. Visually inspect the tires to make sure there are no nails or other objects embedded that could poke a hole in the tire and cause an air leak.
7. Check the sidewalls to make sure there are no gouges, cuts or bulges.

Wheels and Tires

Inspecting Your Tires and Wheel Valve Stems

Periodically inspect the tire treads for uneven or excessive wear and remove objects such as stones, nails or glass that may be wedged in the tread grooves. Check the tire and valve stems for holes, cracks, or cuts that may permit air leakage and repair or replace the tire and replace the valve stem. Inspect the tire sidewalls for cracking, cuts, bruises and other signs of damage or excessive wear. If internal damage to the tire is suspected, have the tire demounted and inspected in case it needs to be repaired or replaced. For your safety, tires that are damaged or show signs of excessive wear should not be used because they are more likely to blow out or fail.

Improper or inadequate vehicle maintenance can cause tires to wear abnormally. Inspect all your tires, including the spare, frequently, and replace them if one or more of the following conditions exist:

Tire Wear



E142546

When the tread is worn down to one sixteenth of an inch (2 millimeters), tires must be replaced to help prevent your vehicle from skidding and hydroplaning. Built-in treadwear indicators, or wear bars, which look like narrow strips of smooth rubber across the tread will appear on the tire when the tread is worn down to one sixteenth of an inch (2 millimeters)

When the tire tread wears down to the same height as these wear bars, the tire is worn out and must be replaced.

Damage

Periodically inspect the tire treads and sidewalls for damage (such as bulges in the tread or sidewalls, cracks in the tread groove and separation in the tread or sidewall). If damage is observed

Wheels and Tires

or suspected have the tire inspected by a tire professional. Tires can be damaged during off-road use, so inspection after off-road use is also recommended.

Age

WARNING



Tires degrade over time depending on many factors such as weather, storage conditions, and conditions of use (load, speed, inflation pressure) the tires experience throughout their lives.

In general, tires should be replaced after six years regardless of tread wear. However, heat caused by hot climates or frequent high loading conditions can accelerate the aging process and may require tires to be replaced more frequently.

You should replace your spare tire when you replace the road tires or after six years due to aging even if it has not been used.

U.S. DOT Tire Identification Number

Both United States and Canada Federal regulations require tire manufacturers to place standardized information on the sidewall of all tires. This information identifies and

describes the fundamental characteristics of the tire and also provides a U.S. DOT Tire Identification Number for safety standard certification and in case of a recall.

This begins with the letters DOT and indicates that the tire meets all federal standards. The next two numbers or letters are the plant code designating where it was manufactured, the next two are the tire size code and the last four numbers represent the week and year the tire was built. For example, the numbers 317 mean the 31st week of 1997. After 2000 the numbers go to four digits. For example, 2501 means the 25th week of 2001. The numbers in between are identification codes used for traceability. This information is used to contact customers if a tire defect requires a recall.

Tire Replacement Requirements

Your vehicle is equipped with tires designed to provide a safe ride and handling capability.

WARNINGS



Only use replacement tires and wheels that are the same size, load index, speed rating and type (such as P-metric versus LT-metric or all-season versus all-terrain) as those originally provided by Ford. The recommended tire and wheel size

Wheels and Tires

WARNINGS

may be found on either the Safety Compliance Certification Label (affixed to either the door hinge pillar, door-latch post, or the door edge that meets the door-latch post, next to the driver's seating position), or the Tire Label which is located on the B-Pillar or edge of the driver's door. If this information is not found on these labels then you should contact your authorized dealer as soon as possible. Use of any tire or wheel not recommended by Ford can affect the safety and performance of your vehicle, which could result in an increased risk of loss of vehicle control, vehicle rollover, personal injury and death. Additionally the use of non-recommended tires and wheels could cause steering, suspension, axle, transfer case or power transfer unit failure. If you have questions regarding tire replacement, contact your authorized dealer as soon as possible.

 To reduce the risk of serious injury when mounting replacement tires and wheels, you should not exceed the maximum pressure indicated on the sidewall of the tire to set the beads without additional precautions listed below. If the beads do not seat at the maximum pressure indicated, re-lubricate and try again

WARNINGS

When inflating the tire for mounting pressures up to 20 psi (1.38 bar) greater than the maximum pressure on the tire sidewall, the following precautions must be taken to protect the person mounting the tire:

1. Make sure that you have the correct tire and wheel size.
2. Lubricate the tire bead and wheel bead seat area again.
3. Stand at a minimum of 12 feet (3.66 meters) away from the wheel and tire assembly.
4. Use both eye and ear protection.

For a mounting pressure more than 20 psi (1.38 bar) greater than the maximum pressure, a Ford dealer or other tire service professional should do the mounting.

Always inflate steel carcass tires with a remote air fill with the person inflating standing at a minimum of 12 feet (3.66 meters) away from the wheel and tire assembly

Important: Remember to replace the wheel valve stems when the road tires are replaced on your vehicle

Wheels and Tires

It is recommended that the two front tires or two rear tires generally be replaced as a pair.

The tire pressure sensors mounted in the wheels (originally installed on your vehicle) are not designed to be used in aftermarket wheels.

The use of wheels or tires not recommended by Ford Motor Company may affect the operation of your tire pressure monitoring system.

If the tire pressure monitoring system indicator is flashing, the system is malfunctioning. Your replacement tire might be incompatible with your tire pressure monitoring system, or some component of the system may be damaged.

Safety Practices

WARNINGS



If your vehicle is stuck in snow, mud, sand, etc., do not rapidly spin the tires; spinning the tires can tear the tire and cause an explosion. A tire can explode in as little as three to five seconds.



Do not spin the wheels at over 35 mph (56 km/h). The tires may fail and injure a passenger or bystander.

Driving habits have a great deal to do with your tire mileage and safety.

- *Observe posted speed limits
- *Avoid fast starts, stops and turns
- *Avoid potholes and objects on the road
- *Do not run over curbs or hit the tire against a curb when parking

Highway Hazards

No matter how carefully you drive there's always the possibility that you may eventually have a flat tire on the highway. Drive slowly to the closest safe area out of traffic. This may further damage the flat tire, but your safety is more important.

If you feel a sudden vibration or ride disturbance while driving, or you suspect your tire or vehicle has been damaged, immediately reduce your speed. Drive with caution until you can safely pull off the road. Stop and inspect the tires for damage. If you cannot detect a cause, have the vehicle towed to the nearest repair facility or tire dealer to have the vehicle inspected.

Wheels and Tires

Tire and Wheel Alignment

A bad jolt from hitting a curb or pothole can cause the front end of your vehicle to become misaligned or cause damage to your tires. If your vehicle seems to pull to one side when you're driving, the wheels may be out of alignment. Have an authorized dealer check the wheel alignment periodically.

Wheel misalignment in the front or the rear can cause uneven and rapid treadwear of your tires and should be corrected by an authorized dealer. Front-wheel drive vehicles and those with an independent rear suspension (if equipped) may require alignment of all four wheels.

The tires should also be balanced periodically. An unbalanced tire and wheel assembly may result in irregular tire wear.

Tire Rotation

Note: *If your tires show uneven wear ask an authorized dealer to check for and correct any wheel misalignment, tire imbalance or mechanical problem involved before tire rotation.*

Note: *Your vehicle may be equipped with a dissimilar spare wheel and tire assembly. A dissimilar spare wheel and tire assembly is defined as a spare wheel and tire assembly that is different in brand, size or appearance from the road tires and wheels. If you have a dissimilar spare wheel and tire assembly it is intended for temporary use only and should not be used in a tire rotation.*

Note: *After having your tires rotated, inflation pressure must be checked and adjusted to the vehicle requirements.*

Rotating your tires at the recommended interval (as indicated in the Scheduled Maintenance chapter) will help your tires wear more evenly, providing better tire performance and longer tire life.

Front-wheel drive and all-wheel vehicles (front tires on the left side of the diagram)

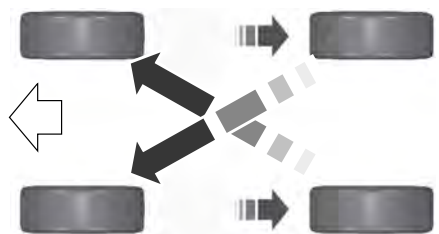

E142547

Wheels and Tires

All vehicles with directional tires (front tires on the left side of the diagram)



E147237

Sometimes irregular tire wear can be corrected by rotating the tires.

USING SUMMER TIRES

Summer tires provide superior performance on wet and dry roads. Summer tires do not have the Mud and Snow (M+S or M/S) tire traction rating on the tire side wall. Since summer tires do not have the same traction performance as All-season or Snow tires, we do not recommend using summer tires when temperatures drop to approximately 45°F (7°C) or below (depending on tire wear and environmental conditions) or in snow and ice conditions. Like any tire, summer tire performance is affected by tire wear and environmental conditions. If you must drive in those conditions, we recommend using Mud and Snow (M+S, M/S), All-season or Snow tires.

Always store your summer tires indoors at temperatures above 20°F (-7°C). The rubber compounds used in these tires lose flexibility and may develop surface cracks in the tread area at temperatures below 20°F (-7°C). If the tires have been subjected to 20°F (-7°C) or less, warm

them in a heated space to at least 40°F (5°C) for at least 24 hours before installing them on a vehicle, or moving the vehicle with the tires installed, or checking tire inflation. Do not place tires near heaters or heating devices used to warm the room where the tires are stored. Do not apply heat or blow heated air directly on the tires. Always inspect the tires after storage periods and before use.

USING SNOW CHAINS

WARNING



If you choose to install snow tires on your vehicle, they must be the same size, construction, and load range as the original tires listed on the tire placard, and they must be installed on all four wheels. Mixing tires of different size or construction on your vehicle can adversely affect your vehicle's handling and braking, and may lead to loss of vehicle control.

Do not use snow chains or cables on this vehicle as they may cause damage to your vehicle which may lead to loss of vehicle control.

Snow chains or cables have not been approved for use on your vehicle.

The original equipment tires on your vehicle may have an all-weather tread design to provide traction, handling, and braking performance in year-round driving. You may install snow tires for improved traction when driving in areas with sustained periods of snow or icy driving conditions

Wheels and Tires

TIRE PRESSURE MONITORING SYSTEM

WARNING



The tire pressure monitoring system is not a substitute for manually checking tire pressure. The tire pressure should be checked periodically (at least monthly) using a tire gauge, see *Inflating your tires* in this chapter. Failure to properly maintain your tire pressure could increase the risk of tire failure, loss of control, vehicle rollover and personal injury.



Each tire, including the spare (if provided), should be checked monthly when cold and inflated to the inflation pressure recommended by the vehicle manufacturer on the vehicle placard or tire inflation pressure label. (If your vehicle has tires of a different size than the size indicated on the vehicle placard or tire inflation pressure label, you should determine the proper tire inflation pressure for those tires.)

As an added safety feature, your vehicle has been equipped with a Tire Pressure Monitoring System (TPMS) that illuminates a low tire pressure telltale when one or more of your tires is significantly under-inflated. Accordingly, when the low tire pressure telltale illuminates, you should stop and check your tires as soon as possible, and inflate them to the proper pressure. Driving on a significantly under-inflated tire causes the tire to overheat and can lead to tire failure. Under-inflation also reduces fuel efficiency and tire tread life, and may affect the vehicle's handling and stopping ability.

Please note that the TPMS is not a substitute for proper tire maintenance, and it is the driver's responsibility to maintain correct tire pressure, even if under-inflation has not reached the level to trigger illumination of the TPMS low tire pressure telltale.

Your vehicle has also been equipped with a TPMS malfunction indicator to indicate when the system is not operating properly. The TPMS malfunction indicator is combined with the low tire pressure telltale. When the system detects a malfunction, the telltale will flash for approximately one minute and then remain continuously illuminated. This sequence will continue upon subsequent vehicle start-ups as long as the malfunction exists.

When the malfunction indicator is illuminated, the system may not be able to detect or signal low tire pressure as intended. TPMS malfunctions may occur for a variety of reasons, including the installation of replacement or alternate tires or wheels on the vehicle that prevent the TPMS from functioning properly. Always check the TPMS malfunction telltale after replacing one or more tires or wheels on your vehicle to ensure that the replacement or alternate tires and wheels allow the TPMS to continue to function properly.

The tire pressure monitoring system complies with part 15 of the FCC rules and with RSS-210 of Industry Canada. Operation is subject to the following two conditions: (1) This device may not cause harmful interference, and (2) This device must accept any interference received, including interference that may cause undesired operation.

Wheels and Tires

Changing Tires With a Tire Pressure Monitoring System



E142549

Note: Each road tire is equipped with a tire pressure sensor located inside the wheel and tire assembly cavity. The pressure sensor is attached to the valve stem. The pressure sensor is covered by the tire and is not visible unless the tire is removed. Take care when changing the tire to avoid damaging the sensor

You should always have your tires serviced by an authorized dealer.

Check the tire pressure periodically (at least monthly) using an accurate tire gauge. See *Inflating Your Tires* in this chapter.

Understanding Your Tire Pressure Monitoring System

The tire pressure monitoring system measures pressure in your four road tires and sends the tire pressure readings to your vehicle. The low tire pressure warning light will turn on if the tire pressure is significantly low. Once the light is illuminated, your tires are under-inflated and need to be inflated to the manufacturer's recommended tire pressure. Even if the light turns on and a short time later turns off, your tire pressure still needs to be checked.

When Your Temporary Spare Tire is Installed

When one of your road tires needs to be replaced with the temporary spare, the system will continue to identify an issue to remind you that the damaged road wheel and tire assembly needs to be repaired and put back on your vehicle.

To restore the full function of the tire pressure monitoring system, have the damaged road wheel and tire assembly repaired and remounted on your vehicle.

When You Believe Your System is Not Operating Properly

The main function of the tire pressure monitoring system is to warn you when your tires need air. It can also warn you in the event the system is no longer capable of functioning as intended. See the following chart for information concerning your tire pressure monitoring system:

Wheels and Tires

Low tire pressure warning light	Possible cause	Customer action required
Solid warning light	Tire(s) under-inflated	Make sure tires are at the proper pressure. See Inflating your tires in this chapter. After inflating your tires to the manufacturer's recommended pressure as shown on the Tire Label (located on the edge of driver's door or the B-Pillar), the vehicle must be driven for at least two minutes over 20 mph (32 km/h) before the light turns off.
	Spare tire in use	Repair the damaged road wheel and tire assembly and reinstall it on the vehicle to restore system function. For a description on how the system functions, see When your temporary spare tire is installed in this section.
	TPMS malfunction	If the tires are properly inflated and the spare tire is not in use but the light remains on, contact your authorized dealer as soon as possible.
Flashing warning light	Spare tire in use	Repair the damaged road wheel and tire assembly and reinstall it on the vehicle to restore system function. For a description on how the system functions, see When your temporary spare tire is installed in this section.
	TPMS malfunction	If the tires are properly inflated and the spare tire is not in use but the light remains on, contact your authorized dealer as soon as possible.

When Inflating Your Tires

When putting air into your tires (such as at a gas station or in your garage), the tire pressure monitoring system may not respond immediately to the air added to your tires.

It may take up to two minutes of driving over 20 mph (32 km/h) for the light to turn off after you have filled your tires to the recommended inflation pressure

Wheels and Tires

How Temperature Affects Your Tire Pressure

The tire pressure monitoring system monitors tire pressure in each pneumatic tire. While driving in a normal manner, a typical passenger tire inflation pressure may increase about 2 to 4 psi (14 to 28 kPa) from a cold start situation. If the vehicle is stationary overnight with the outside temperature significantly lower than the daytime temperature, the tire pressure may decrease about 3 psi (21 kPa) for a drop of 30°F (17°C) in ambient temperature. This lower pressure value

may be detected by the tire pressure monitoring system as being significantly lower than the recommended inflation pressure and activate the system warning light for low tire pressure. If the low tire pressure warning light is on, visually check each tire to verify that no tire is flat. If one or more tires are flat, repair as necessary. Check the air pressure in the road tires. If any tire is under-inflated, carefully drive the vehicle to the nearest location where air can be added to the tires. Inflate all the tires to the recommended inflation pressure.

TECHNICAL SPECIFICATIONS

Wheel Lug Nut Torque Specifications

WARNING



When a wheel is installed, always remove any corrosion, dirt or foreign materials present on the mounting surfaces of the wheel or the surface of the wheel hub, brake drum or brake disc that contacts the wheel. Make sure that any fasteners that attach the rotor to the hub are secured so they do not interfere with the mounting surfaces of the wheel. Installing wheels without correct metal-to-metal contact at the wheel mounting surfaces can cause the wheel nuts to loosen and the wheel to come off while your vehicle is in motion, resulting in loss of control.

Bolt size	lb-ft (Nm)*
M12 x 1.5	100 (135)

*Torque specifications are for nut and bolt threads free of dirt and rust. Use only Ford recommended replacement fasteners.

Retighten the lug nuts to the specified torque within 100 miles (160 kilometers) after any wheel disturbance (such as tire rotation, changing a flat tire, wheel removal).

Wheels and Tires



E145950

A Wheel pilot bore.

Inspect the wheel pilot bore and mounting surface prior to installation. Remove any visible corrosion or loose particles.

Capacities and Specifications

ENGINE SPECIFICATIONS

Engine	2.0L ATK iVCT Engine
Cubic inches	122
Required fuel	Minimum 87 octane
Firing order	1-3-4-2
Ignition system	Coil on plug (COP)
Compression ratio	12.3:1
Spark plug gap	0.051 in. \pm 0.002 in. (1.3 mm \pm 0.05 mm)

Capacities and Specifications

MOTORCRAFT PARTS

Component	2.0L ATK iVCT Engine
Air filter element	FA-1911
Oil filter	FL-910-S
Battery	BXT-99RT4
Spark plugs	SP-530
Cabin air filter	FP-71
Windshield wiper blade	WW-2601(driver side) WW-2700 (passenger side)

We recommend Motorcraft replacement parts available at your Ford dealer or at fordparts.com for scheduled maintenance. These parts meet or exceed Ford Motor Company's specifications and are engineered for your vehicle. Use of other parts may impact vehicle performance, emissions and durability. Your warranty may be void for any damage related to use of other parts.

If a Motorcraft oil filter is not available, use an oil filter that meets industry performance specification SAE/USCAR-36.

For spark plug replacement, contact an authorized dealer. Replace the spark plugs at the appropriate intervals. See **Scheduled Maintenance** (page 466).

Capacities and Specifications

VEHICLE IDENTIFICATION NUMBER

The vehicle identification number is located on the left-hand side of the instrument panel.

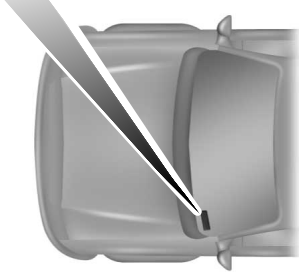

E142476

Please note that in the graphic, XXXX is representative of your vehicle identification number.

The Vehicle Identification Number contains the following information:

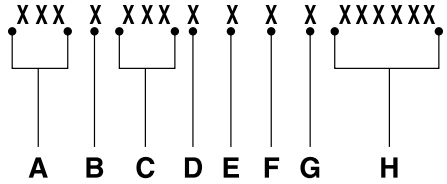

E142477

- A World manufacturer identifier
- B Brake system, Gross Vehicle Weight Rating, Restraint Devices and their locations
- C Make, vehicle line, series, body type
- D Engine type
- E Check digit
- F Model year
- G Assembly plant
- H Production sequence number

Capacities and Specifications

VEHICLE CERTIFICATION LABEL

MFD. BY FORD MOTOR CO.

DATE: XX/XX GVWR: XXXX KG (XXXX LB)
 FRONT GAWR: REAR GAWR:
 XXXX KG (XXXX LB) WITH XXXX KG (XXXX LB) WITH
 XXXXXXXXXXXXXXXX TIRES XXXXXXXXXXXXXXXX TIRES
 XXXXXXXX RIMS XXXXXXXX RIMS
 AT XXXX kPa/ XXX PSI COLD AT XXXX kPa/ XXX PSI COLD

THIS VEHICLE CONFORMS TO ALL APPLICABLE FEDERAL MOTOR VEHICLE SAFETY AND THEFT PREVENTION STANDARDS IN EFFECT ON THE DATE OF MANUFACTURE SHOWN ABOVE.

VIN: XXXXXXXXXXXXXXXX XXXXX
 TYPE: XXXX XXXXX



EXT PNT: XX XXXXXX RC: XX DSO: XXXX
 WB INT TR TP/PS R AXLE TR SPR XXXX
 XXX XX XXX X XX X XXXX XXXX
 XXXXXXXXXXXXXXXX XXX XXXX-XXXXXXXX-XX

E167469

The National Highway Traffic Safety Administration Regulations require that a Safety Compliance Certification Label be affixed to a vehicle and prescribe where the Safety Compliance Certification Label may be located. The Safety Compliance Certification Label shall be affixed to either the door hinge pillar, the door latch post, or the edge of the door near the door latch, next to the driver's seating position.

TRANSMISSION CODE DESIGNATION

MFD. BY FORD MOTOR CO.

DATE: XX/XX GVWR: XXXX KG (XXXX LB)
 FRONT GAWR: REAR GAWR:
 XXXX KG (XXXX LB) WITH XXXX KG (XXXX LB) WITH
 XXXXXXXXXXXXXXXX TIRES XXXXXXXXXXXXXXXX TIRES
 XXXXXXXX RIMS XXXXXXXX RIMS
 AT XXXX kPa/ XXX PSI COLD AT XXXX kPa/ XXX PSI COLD

THIS VEHICLE CONFORMS TO ALL APPLICABLE FEDERAL MOTOR VEHICLE SAFETY AND THEFT PREVENTION STANDARDS IN EFFECT ON THE DATE OF MANUFACTURE SHOWN ABOVE.

VIN: XXXXXXXXXXXXXXXX XXXXX
 TYPE: XXXX XXXXX



EXT PNT: XX XXXXXX RC: XX DSO: XXXX
 WB INT TR TP/PS R AXLE TR SPR XXXX
 XXX XX XXX X XX X XXXX XXXX
 XXXXXXXXXXXXXXXX XXX XXXX-XXXXXXXX-XX

E167814

The transmission code is on the Safety Compliance Certification Label. The following table shows the transmission code along with the transmission description.

Description	Code
Electronic continuously variable transmission (ECVT), automatic and power split	J

Capacities and Specifications

CAPACITIES AND SPECIFICATIONS

Capacities

WARNING



The air conditioning refrigerant system contains refrigerant under high pressure. Only qualified personnel should service the air conditioning refrigerant system. Opening the air conditioning refrigerant system can cause personal injury.

Item	Capacity
Engine oil (with oil filter).	4.5 qt (4.3 L)
Hybrid engine coolant.	8.9 qt (8.4 L)
Energi engine coolant.	9.0 qt (8.5 L)
Inverter system controller coolant.	1.1 qt (1 L)
Brake fluid.	Between MIN/MAX on brake fluid reservoir
Automatic transmission fluid.	5.7 qt (5.4 L)*
Windshield washer fluid.	Fill as required
Hybrid fuel tank.	14.0 gal (53 L)
Energi fuel tank.	14.0 gal (53 L)
A/C refrigerant.	20 oz (0.56 kg)
A/C refrigerant compressor oil.	5.24 fl oz (155 ml)

*Approximate dry fill capacity. Actual amount may vary during fluid changes.

Specifications

Materials

Name	Specification
Recommended motor oil (U.S. and Mexico): Motorcraft SAE 0W-20 Synthetic Blend Motor Oil XO-0W20-QSP	WSS-M2C947-A
Recommended motor oil (Canada): Motorcraft SAE 5W-20 Super Premium Motor Oil CXO-5W20-LSP12	WSS-M2C945-A
Optional motor oil (U.S. and Mexico):	WSS-M2C945-A

Capacities and Specifications

Name	Specification
Motorcraft SAE 5W-20 Full Synthetic Motor Oil XO-5W20-QFS	
Optional motor oil (Canada): Motorcraft SAE 5W-20 Synthetic Motor Oil CXO-5W20-LFS12	WSS-M2C945-A
Engine coolant (U.S. and Mexico): Motorcraft Orange Prediluted Antifreeze/Coolant VC-3DIL-B	WSS-M97B44-D2
Engine coolant (Canada): Motorcraft Orange Prediluted Antifreeze/Coolant CVC-3DIL-B	WSS-M97B44-D2
Inverter coolant (U.S. and Mexico): Motorcraft Orange Prediluted Antifreeze/Coolant VC-3DIL-B	WSS-M97B44-D2
Inverter coolant (Canada): Motorcraft Orange Prediluted Antifreeze/Coolant CVC-3DIL-B	WSS-M97B44-D2
Brake fluid: Motorcraft DOT 4 Low Viscosity (LV) High Performance Motor Vehicle Brake Fluid PM-20	WSS-M6C65-A2
Automatic transmission fluid (U.S. and Mexico): Motorcraft MERCON LV Automatic Transmission Fluid XT-10-QLVC	WSS-M2C938-A MERCON LV
Automatic transmission fluid (Canada): Motorcraft MERCON LV Automatic Transmission Fluid CXT-10-LV12	WSS-M2C938-A MERCON LV
Windshield washer fluid (U.S. and Mexico): Motorcraft Premium Windshield Wash Concentrate with Bitterant ZC-32-B2	WSS-M14P19-A
Windshield washer fluid (Canada): Motorcraft Premium Quality Windshield Washer Fluid CXC-37-(A, B, D, F)	WSS-M14P19-A
A/C refrigerant (U.S. and Mexico): R-1234yf Refrigerant HS7Z-19B519-AA	WSS-M17B21-A

Capacities and Specifications

Name	Specification
A/C refrigerant (Canada): R-1234yf Refrigerant HS7Z-19B519-BA	WSS-M17B21-A
A/C refrigerant compressor oil: Motorcraft® R-1234yf Refrigerant POE Oil YN-34	WSS-M2C31-B2
Multi-purpose grease: Motorcraft Multi-Purpose Grease Spray XL-5	ESB-MIC93-B
Lock cylinders (U.S.): Penetrating and Lock Lubricant XL-1	--
Lock cylinders (Canada): Penetrating Fluid CXC-51-A	--
Lock cylinders (Mexico): Penetrating and Lock Lubricant MXL-1	--

If you use oil and fluids that do not meet the defined specification and viscosity grade, this may lead to:

- Component damage which is not covered by the vehicle warranty.
- Longer engine cranking periods.
- Increased emission levels.
- Reduced engine performance.
- Reduced fuel economy.
- Degraded brake performance.

We recommend Motorcraft motor oil for your vehicle. If Motorcraft oil is not available, use motor oils of the recommended viscosity grade that meet API SN requirements and display the API Certification Mark for gasoline engines. Do not use oil labeled with API SN service category unless the label also displays the API certification mark.



E142732

An oil that displays this symbol conforms to current engine, emission system and fuel economy performance standards of the International Lubricants Specification Advisory Committee (ILSAC).

Do not use supplemental engine oil additives because they are unnecessary and could lead to engine damage that may not be covered by your vehicle warranty.

Capacities and Specifications

Note: *Ford recommends using DOT 4 Low Viscosity (LV) High Performance Brake Fluid or equivalent meeting WSS-M6C65-A2. Use of any fluid other than the recommended fluid may cause degraded brake performance and not meet the Ford performance standards. Keep brake fluid clean and dry. Contamination with dirt, water, petroleum products or other materials may result in brake system damage and possible failure.*

Note: *Automatic transmissions that require MERCON LV transmission fluid should only use MERCON LV transmission fluid. The use of any other fluid may cause transmission damage.*

Audio System

GENERAL INFORMATION

Radio Frequencies and Reception Factors

AM and FM frequencies are established by the Federal Communications Commission (FCC) and the Canadian Radio and Telecommunications Commission (CRTC). Those frequencies are:

- AM: 530, 540-1700, 1710 kHz
- FM: 87.9-107.7, 107.9 MHz

Radio Reception Factors	
Distance and strength	The further you travel from an AM or FM station, the weaker the signal and the weaker the reception.
Terrain	Hills, mountains, tall buildings, bridges, tunnels, freeway overpasses, parking garages, dense tree foliage and thunderstorms can interfere with the reception.
Station overload	When you pass a ground-based broadcast repeating tower, a stronger signal may overtake a weaker one and result in the audio system muting.

CD and CD Player Information

Note: *CD units play commercially pressed 4.7 in (12 cm) audio compact discs only. Due to technical incompatibility, certain recordable and re-recordable compact discs may not function correctly when used in Ford CD players.*

Note: *Do not insert CDs with homemade paper (adhesive) labels into the CD player as the label may peel and cause the CD to become jammed. You should use a permanent felt tip marker rather than adhesive labels on your homemade CDs. Ballpoint pens may damage CDs. Please contact an authorized dealer for further information.*

Note: *Do not use any irregularly shaped discs or discs with a scratch protection film attached.*

Always handle discs by their edges only. Clean the disc with an approved CD cleaner only. Wipe it from the center of the disc toward the edge. Do not clean in a circular motion.

Do not expose discs to direct sunlight or heat sources for extended periods.

MP3 and WMA Track and Folder Structure

Audio systems capable of recognizing and playing MP3 and WMA individual tracks and folder structures work as follows:

- There are two different modes for MP3 and WMA disc playback: MP3 and WMA track mode (system default) and MP3 and WMA folder mode.
- MP3 and WMA track mode ignores any folder structure on the MP3 and WMA disc. The player numbers each MP3 and WMA track on the disc (noted by the MP3 or WMA file extension) from T001 to a maximum of T255. The maximum number of playable MP3 and WMA files may be less depending on the structure of the CD and exact model of radio present.

Audio System

- MP3 and WMA folder mode represents a folder structure consisting of one level of folders. The CD player numbers all MP3 and WMA tracks on the disc (noted by the MP3 or WMA file extension) and all folders containing MP3 and WMA files, from F001 (folder) T001 (track) to F253 T255.
- Creating discs with only one level of folders helps with navigation through the disc files.

If you are burning your own MP3 and WMA discs, it is important to understand how the system reads the structures you create. While various files may be present (files with extensions other than MP3 and WMA), only files with the MP3 and WMA extension are played; other files are ignored by the system. This enables you to use the same MP3 and WMA disc for a variety of tasks on your work computer, home computer and your in-vehicle system.

In track mode, the system displays and plays the structure as if it were only one level deep (all MP3 and WMA files play, regardless of being in a specific folder). In folder mode, the system only plays the MP3 and WMA files in the current folder.

AUDIO UNIT - VEHICLES WITH: AM/FM/CD

WARNING



Driving while distracted can result in loss of vehicle control, crash and injury. We strongly recommend that you use extreme caution when using any device that may take your focus off the road. Your primary responsibility is the safe operation of your vehicle. We recommend against the use of any hand-held device while driving and encourage the use of voice-operated systems when possible. Make sure you are aware of all applicable local laws that may affect the use of electronic devices while driving.

Note: *Depending on your vehicle option package, your system may look different from what you see here.*

Audio System

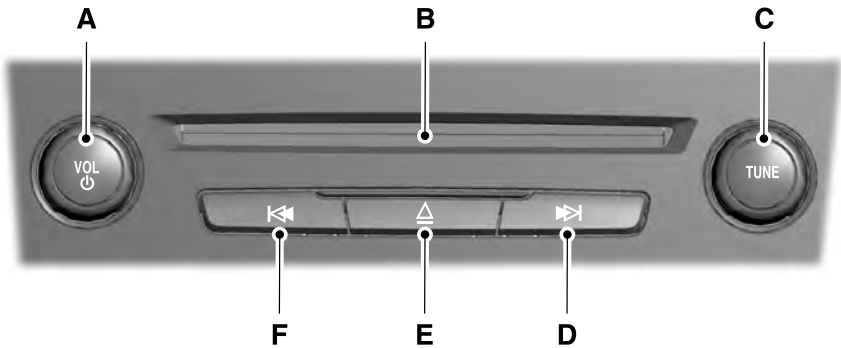

E185815

- A **VOL and Power:** Press this button to turn the system off and on. Turn it to adjust the volume.
- B **CD slot:** Insert a CD.
- C **TUNE:** Turn to search the frequency in individual increments.
- D **Seek:** In radio mode, select a frequency and press this button. The system stops at the first station up the band. Press and hold the button to move quickly to the next strong radio station. In CD mode, press this button to select the next track. Press and hold the button to move quickly forward through the current track.
- E **Eject:** Press this button to eject a CD.
- F **Seek:** In radio mode, select a frequency and press this button. The system stops at the first station down the band. Press and hold the button to move quickly to the previous strong radio station. In CD mode, press this button to select the previous track. Press and hold the button to move quickly backward through the current track.

Audio System

AUDIO UNIT - VEHICLES WITH: AM/FM/CD/SYNC/SATELLITE RADIO

WARNING



Driving while distracted can result in loss of vehicle control, crash and injury. We strongly recommend that you use extreme caution when using any device that may take your focus off the road. Your primary responsibility is the safe operation of your vehicle. We recommend against the use of any hand-held device while driving and encourage the use of voice-operated systems when possible. Make sure you are aware of all applicable local laws that may affect the use of electronic devices while driving.

Note: Depending on your vehicle option package, your system may look different from what you see here.

Note: Some features, such as Sirius satellite radio, may not be available in your location. Check with an authorized dealer.

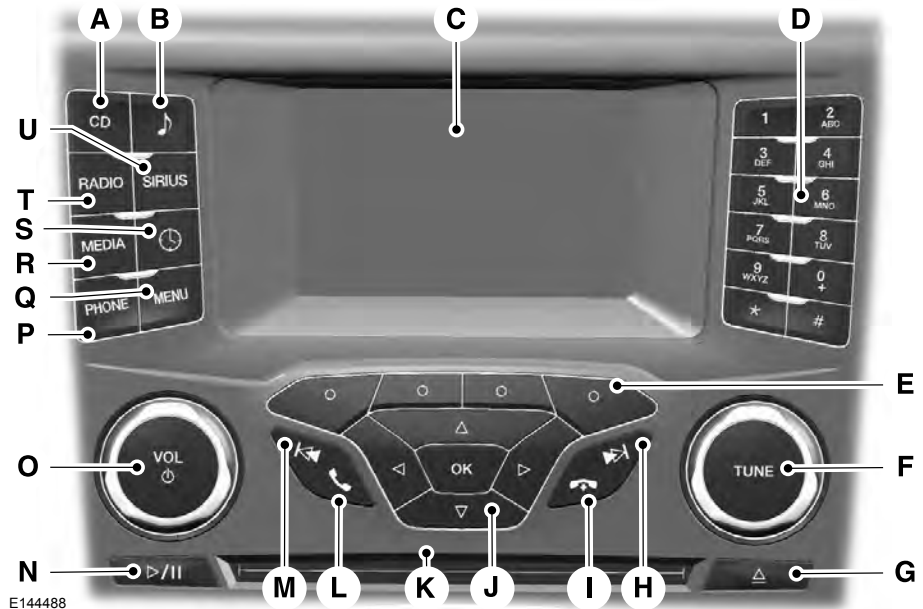

E144488

Audio System

- A **CD:** Press this button to listen to a CD. Press the function buttons below the radio screen to select on-screen options of Repeat or Shuffle.
- B **SOUND:** Press this button to access settings for Treble, Midrange, Bass, Fade and Balance. Use the up and down arrow buttons to select the various settings. When you make your selection, press the left and right arrow buttons to change the settings. Press **OK** to set or press **MENU** to exit. Sound settings can be set for each audio source independently.
- C **Display screen:** Shows audio and SYNC information.
- D **Number block:** In radio mode, store your favorite stations for later access. When tuned to any station, press and hold a preset button until sound returns. In CD mode, press a button to select a track. In phone mode, press the buttons to enter a phone number.
- E **Function buttons:** Select different functions of the audio system depending on which mode you are in (such as Radio mode or CD mode).
- F **TUNE:** Turn to search the frequency band in individual increments.
- G **Eject:** Press this button to eject a CD.
- H **Seek:** In radio mode, select a frequency band and press this button. The system stops at the first station up the band. Press and hold the button to move quickly to the next strong radio station or memory preset. In CD mode, press this button to select the next track. Press and hold the button to move quickly forward through the current track.
- I **End phone call:** Press this button to end a phone call.
- J **Cursor arrows and OK:** Use the up and down arrow buttons to select the various settings. When you make your selection, press the left and right arrow buttons to change the settings. Press **OK** to set or press **MENU** to exit.
- K **CD slot:** Insert a CD.
- L **Pick-up or Make phone call:** Press this button to either pick-up an incoming phone call or to make a phone call.
- M **Seek:** In radio mode, select a frequency band and press this button. The system stops at the first station down the band. Press and hold the button to move quickly to the previous strong radio station or memory preset. In CD mode, press this button to select the previous track. Press and hold the button to move quickly backward through the current track.
- N **Play/Pause:** Press to either play or pause a track when listening to a CD.
- O **VOL and Power:** Press this button to turn the system off and on. Turn it to adjust the volume.
- P **PHONE:** Press this button to access the phone features of the SYNC® system. See **SYNC™** (page 329).
- Q **MENU:** Press this button to access different audio system features. See **Menu Structure** later in this section.

Audio System

- R **MEDIA:** Press this button to access your auxiliary input jack or switch between devices you plug into the input jack or USB port.
- S **Clock:** Press this button to access the clock setting. Use the center arrow controls to change the hours and minutes. You can also set the clock by pressing the **MENU** button and scrolling to Clock Settings.
- T **RADIO:** Press this button to listen to the radio or change radio frequencies bands. Press the function buttons below the radio screen to select different radio functions.
- U **SIRIUS or MUTE:** If your vehicle is equipped with Sirius satellite radio, press this button to listen to Sirius satellite radio. If your vehicle is not equipped with Sirius satellite radio, press the button to mute the playing media.

AUDIO UNIT - VEHICLES WITH: SONY AM/FM/CD

Note: *The touchscreen system controls most of the audio features. See your SYNC information.*

WARNING



Driving while distracted can result in loss of vehicle control, crash and injury. We strongly recommend that you use extreme caution when using any device that may take your focus off the road. Your primary responsibility is the safe operation of your vehicle. We recommend against the use of any hand-held device while driving and encourage the use of voice-operated systems when possible. Make sure you are aware of all applicable local laws that may affect the use of electronic devices while driving.

Audio System

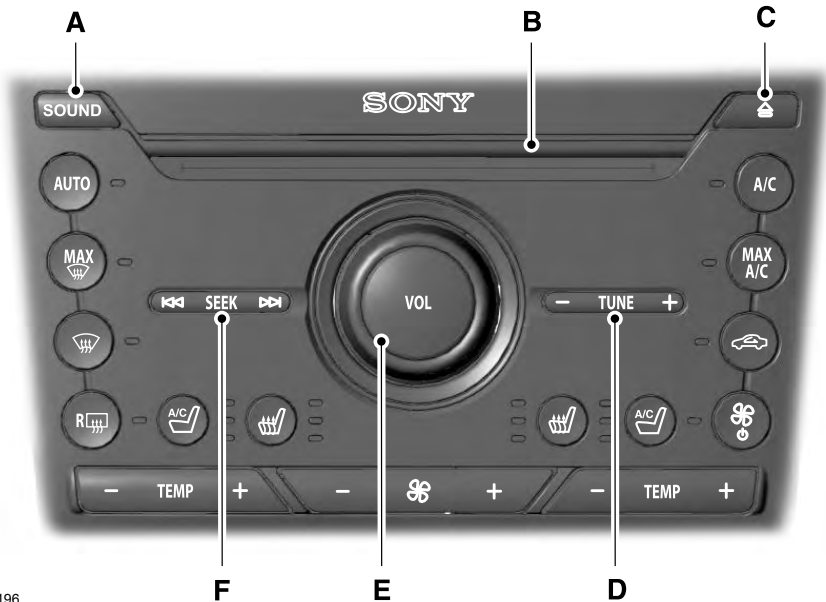

E207196

- A **SOUND:** Press to access settings for Treble, Midrange, Bass, Fade or Balance.
- B **CD slot:** Insert a CD.
- C **Eject:** Press to eject a CD.
- D **TUNE:** In radio mode, adjust to manually search through the radio frequency band.
- E **VOL and Power:** Press to switch the system on and off. Turn to adjust the volume.
- F **Seek, Fast Forward and Reverse:** In radio mode, select a frequency band and press either button. The system stops at the first station it finds in that direction. In CD mode, press to select the next or previous track. Press and hold to move quickly forward or backward through the current track.

Menu Structure

Note: Depending on your system, some options may appear slightly different.

Press **MENU**.

Press the up and down arrow buttons to scroll through the options.

Press the right arrow to enter a menu.
Press the left arrow to exit a menu.

Press **OK** to confirm a selection.

Audio System

Radio	
Manual tune	Use the left and right arrows to go up or down the frequency band.
Scan	Select for a brief sampling of all available channels.
AST	Select to store the six strongest local stations on the AM-AST and FM-AST frequency bands.
PTY/Set Category	Select to have the system search by certain music categories (such as Rock, Pop or Country).
RBDS/RDS	Select to view additional broadcast data, if available. This feature defaults to off. RBDS must be on for you to set a category.

SIRIUS	
Scan	Select for a brief sampling of all available channels.
Show ESN	Select to view your satellite radio electronic serial number (ESN). You will need this number when communicating with Sirius to activate, modify or track your account.
Channel Guide	Select to view available satellite radio channels. Press OK to open a list of the following options for this channel: Tune Channel, Skip Channel or Lock Channel. Once you skip or lock a channel, you can only access it by pressing Direct and entering the channel number. Locking or unlocking a channel requires your PIN.
Set Category	Select to view channel categories (such as Pop, Rock or News). If you select a category, seek and scan functions only stop on channels in that category.
Alerts	Select to turn off or turn on alerts for songs, artists or teams. The system alerts you when the selection is playing on another channel. Save up to 20 alerts.
Unlock All Stations	Use your PIN to unlock previously locked stations.
Skip No stations	Use to restore any channels you previously skipped.
Parental Lock (PIN)	Select to create a PIN, which allows you to lock or unlock channels. Your initial PIN is 1234.

Audio System

Audio Settings	
Speed Compensated Volume	Automatically adjusts the volume to compensate for speed and wind noise. You can set the system between 0 and +7.
Sound	Select to adjust settings for Treble, Midrange, Bass, Fade or Balance.
Occupancy Mode	Select to optimize sound quality for the chosen seating position.
RBDS/RDS Text	Select to view additional broadcast data, if available. This feature defaults to off. RBDS must be on for you to set a category.
DSP	Choose between the stereo modes.

CD Settings	
Scan All	Select to scan all disc selections.
Scan Folder	Select to scan all music in the current MP3 folder.
CD Compression	Select to bring soft and loud passages together for a more consistent listening level.

Clock Settings	
Set Time	Select to set the time.
Set Date	Select to set the calendar date.
24h Mode	Select to view clock time in a 12-hour mode or 24-hour mode.

Display Settings	
Dimming	Select to change display brightness.
Language	Select to display the language in English, French or Spanish.
Temp. setting	Select to display the outside temperature in Fahrenheit or Celsius.

Audio System

DIGITAL RADIO

Note: *HD Radio broadcasts are not available in all markets.*

HD Radio technology is the digital evolution of analog AM/FM radio. Your system has a special receiver that allows it to receive digital broadcasts (where available) in addition to the analog broadcasts it already receives. Digital broadcasts provide a better sound quality than analog broadcasts with free, crystal-clear audio and no static or distortion. For more information, and a guide to available stations and programming, please visit www.hdradio.com.

When HD Radio is on and you tune to a station broadcasting HD Radio technology, you may notice the HD Radio logo on your screen. When this logo is available, you may also see Title and Artist fields on-screen.

The multicast indicator appears in FM mode (only) if the current station is broadcasting multiple digital broadcasts. The highlighted numbers signify available digital channels where new or different content is available. HD1 signifies the main programming status and is available in analog and digital broadcasts. Other multicast stations (HD2 through HD7) are only available digitally.

When HD Radio broadcasts are active, you can access the following functions:

- **Scan** allows you to hear a brief sampling of all available stations. This feature still works when HD Radio reception is on, although it does not scan for HD2-HD7 channels. You may see the HD logo appear if the station has a digital broadcast.
- **Memory presets** allow you to save an active channel as a memory preset. Touch and hold a memory preset slot until the sound returns. There is a brief mute while the radio saves the station. Sound returns when finished. When switching to an HD2 or HD3 memory preset, the sound mutes before the digital audio plays, because the system has to reacquire the digital signal.

Note: *As with any saved radio station, you cannot access the saved station if your vehicle is outside the station's reception area.*

Audio System

HD Radio Reception and Station Troubleshooting

Potential reception issues	
Reception area	If you are listening to a multicast station and you are on the fringe of the reception area, the station may mute due to weak signal strength.
	If you are listening to HD1, the system switches back to the analog broadcast until the digital broadcast is available again. However, if you are listening to any of the possible HD2-HD7 multicast channels, the station mutes and stays muted unless it is able to connect to the digital signal again.
Station blending	When the system first receives a station (aside from HD2-HD7 multicast stations), it first plays the station in the analog version. Once the receiver verifies the station is an HD Radio station, it shifts to the digital version. Depending on the station quality, you may hear a slight sound change when the station changes from analog to digital. Blending is the shift from analog to digital sound or digital back to analog sound.

In order to provide the best possible experience, use the contact form to report any station issues found while listening to a station broadcasting with HD Radio technology. Independent entities own and operate each station. These stations are responsible for ensuring all audio streams and data fields are accurate.

Audio System

Potential station issues		
Issues	Cause	Action
Echo, stutter, skip or repeat in audio. Increase or decrease in audio volume.	This is poor time alignment by the radio broadcaster.	No action required. This is a broadcast issue.
Sound fading or blending in and out.	The radio is shifting between analog and digital audio.	No action required. The reception issue may clear up as you continue to drive.
There is an audio mute delay when selecting HD2 or HD3, multicast preset or Direct Tune .	The digital multicast is not available until the HD Radio broadcast is decoded. Once decoded, the audio is available.	No action required. This is normal behavior. Wait until the audio is available.
Cannot access HD2 or HD3 multicast channel when recalling a preset or from a direct tune.	The previously stored multicast preset or direct tune is not available in your current reception area.	No action required. The station is not available in your current location.
Text information does not match currently playing audio.	Data service issue by the radio broadcaster.	Fill out the station issue form at website listed below.*
There is no text information shown for currently selected frequency.	Data service issue by the radio broadcaster.	Fill out the station issue form at website listed below.*
HD2-HD7 stations not found when Scan is pressed.	Pressing Scan disables HD2-HD7 channel search.	No action required. This is normal behavior.

* http://www.ibiquity.com/automotive/report_radio_station_experiences

HD Radio Technology manufactured under license from iBiquity Digital Corp. U.S. and foreign patents. HD Radio and the HD and HD Radio logos are proprietary trademarks of iBiquity Digital Corp. Ford Motor Company and iBiquity Digital Corp. are not responsible for the content sent using HD Radio technology. Content may be changed, added or deleted at any time at the station owner's discretion.

SATELLITE RADIO (If Equipped)

SIRIUS® broadcasts a variety of music, news, sports, weather, traffic and entertainment satellite radio channels. For more information and a complete list of SIRIUS satellite radio channels, visit www.siriusxm.com in the United States, www.siriusxm.ca in Canada, or call SIRIUS at 1-888-539-7474.

Audio System

Note: This receiver includes the eCos real-time operating system. eCos is published under the eCos License.

Satellite Radio Reception Factors

Potential satellite radio reception issues	
Antenna obstructions	For optimal reception performance, keep the antenna clear of snow and ice build-up and keep luggage and other material as far away from the antenna as possible.
Terrain	Hills, mountains, tall buildings, bridges, tunnels, freeway overpasses, parking garages, dense tree foliage and thunderstorms can interfere with your reception.
Station overload	When you pass a ground-based broadcast-repeating tower, a stronger signal may overtake a weaker one and the audio system may mute.
Satellite radio signal interference	Your display may show ACQUIRING . . . to indicate the interference and the audio system may mute.

SIRIUS® Satellite Radio Service

Note: SIRIUS reserves the unrestricted right to change, rearrange, add or delete programming including canceling, moving or adding particular channels, and its prices, at any time, with or without notice to you. Ford Motor Company shall not be responsible for any such programming changes.



E142593

SIRIUS satellite radio is a subscription-based satellite radio service that broadcasts a variety of music, sports, news, weather, traffic and entertainment programming. Your factory-installed SIRIUS satellite radio system includes hardware and a limited subscription term, which begins on the date of sale or lease of your vehicle. See an authorized dealer for availability.

For more information on extended subscription terms (a service fee is required), the online media player and a complete list of SIRIUS satellite radio channels, and other features, please visit www.siriusxm.com in the United States, www.siriusxm.ca in Canada, or call SIRIUS at 1-888-539-7474.

Satellite Radio Electronic Serial Number (ESN)

You need your ESN to activate, modify or track your satellite radio account. When in satellite radio mode, tune to channel 0.

Audio System

Troubleshooting

Message	Condition	Action
Acquiring...	Radio requires more than two seconds to produce audio for the selected channel.	No action required. This message should disappear shortly.
Satellite antenna fault SIRIUS system failure	There is an internal module or system failure present.	If this message does not clear shortly, or with an ignition key cycle, your receiver may have a fault. See an authorized dealer for service.
Invalid Channel	The channel is no longer available.	Tune to another channel or choose another preset.
Unsubscribed Channel	Your subscription does not include this channel.	Contact SIRIUS at 1-888-539-7474 to subscribe to the channel, or tune to another channel.
No Signal	The signal is lost from the SIRIUS satellite or SIRIUS tower to your vehicle antenna.	The signal is blocked. When you move into an open area, the signal should return.
Updating...	Update of channel programming in progress.	No action required. The process may take up to three minutes.
Questions? Call 1-888-539-7474	Your satellite service is no longer available.	Contact SIRIUS at 1-888-539-7474 to resolve subscription issues.
None found Check Channel Guide	All the channels in the selected category are either skipped or locked.	Use the channel guide to turn off the Lock or Skip function on that station.
Subscription Updated	SIRIUS has updated the channels available for your vehicle.	No action required.

Audio System

USB PORT (If Equipped)

WARNING



Driving while distracted can result in loss of vehicle control, crash and injury. We strongly recommend that you use extreme caution when using any device that may take your focus off the road. Your primary responsibility is the safe operation of your vehicle. We recommend against the use of any hand-held device while driving and encourage the use of voice-operated systems when possible. Make sure you are aware of all applicable local laws that may affect the use of electronic devices while driving.

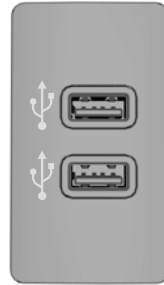

E211463

See your SYNC information.



E205592

The USB port allows you to plug in media playing devices, memory sticks and charge devices (if supported). See your SYNC information.

MEDIA HUB (If Equipped)

You can locate the media hub inside the center console or on the instrument panel.

GENERAL INFORMATION

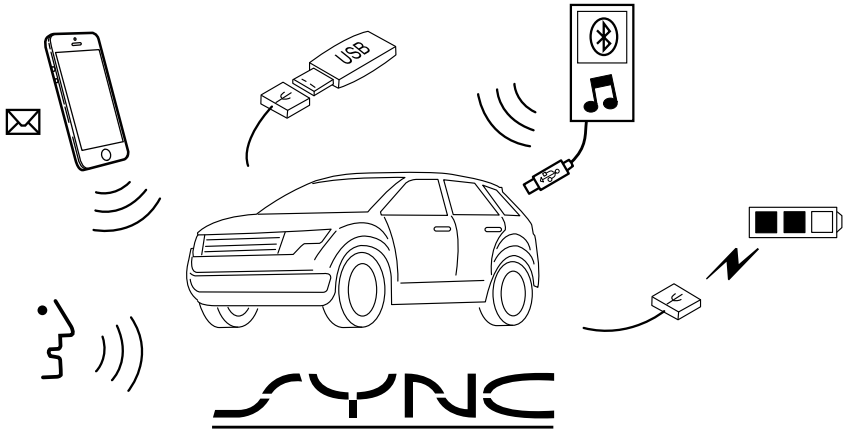

E198355

SYNC is an in-vehicle communications system that works with your Bluetooth-enabled cellular phone and portable media player. This allows you to:

- Make and receive calls.
- Access and play music from your portable music player.
- Use 911 Assist and applications, such as Spotify and Glympse, via SYNC AppLink.*
- Access phonebook contacts and music using voice commands.
- Stream music from your connected phone.
- Text message.

- Use the advanced voice recognition system.
- Charge your USB device (if your device supports this).

*These features are not available in all markets and may require activation. Available AppLink enabled apps vary by market.

Make sure that you review your device's manual before using it with SYNC.

Support

The SYNC support team is available to help you with any questions you cannot answer on your own.

Monday-Saturday, 8:30am-9:00pm EST.

Sunday, 10:30am–7:30pm EST.

In the United States, call 1-800-392-3673.

In Canada, call 1-800-565-3673.

Times are subject to change due to holidays.

SYNC Owner Account

Why do I need a SYNC owner account?

- Essential for keeping up with the latest software downloads available for SYNC.
- Access to customer support for any questions you may have.

Driving Restrictions

For your safety, certain features are speed-dependent and restricted when your vehicle is traveling over 3 mi (5 km).

Safety Information

WARNING



Driving while distracted can result in loss of vehicle control, crash and injury. We strongly recommend that you use extreme caution when using any device that may take your focus off the road. Your primary responsibility is the safe operation of your vehicle. We recommend against the use of any hand-held device while driving and encourage the use of voice-operated systems when possible. Make sure you are aware of all applicable local laws that may affect the use of electronic devices while driving.

When using SYNC:

- Do not operate playing devices if the power cords or cables are broken, split or damaged. Place cords and cables out of the way, so they do not interfere with the operation of pedals, seats, compartments or safe driving abilities.
- Do not leave playing devices in your vehicle during extreme conditions as it could cause them damage. See your device's manual for further information.
- Do not attempt to service or repair the system. See an authorized dealer.

Privacy Information

When a cellular phone is connected to SYNC, the system creates a profile within your vehicle that is linked to that cellular phone. This profile is created in order to offer you more cellular features and to operate more efficiently. Among other things, this profile may contain data about your cellular phone book, text messages (read and unread), and call history, including history of calls when your cellular phone was not connected to the system. In addition, if you connect a media device, the system creates and retains an index of supported media content. The system also records a short development log of approximately 10 minutes of all recent system activity. The log profile and other system data may be used to improve the system and help diagnose any problems that may occur.

The cellular profile, media device index, and development log will remain in the vehicle unless you delete them and are generally accessible only in the vehicle when the cellular phone or media player is connected. If you no longer plan to use the system or the vehicle, we recommend you perform a Master Reset to erase all stored information.

System data cannot be accessed without special equipment and access to the vehicle's SYNC module. Ford Motor Company and Ford of Canada will not access the system data for any purpose other than as described absent consent, a court order, or where required by law enforcement, other government authorities, or other third parties acting with lawful authority. Other parties may seek to access the information independently of Ford Motor Company and Ford of Canada. For further privacy information, see the section on 911 Assist. See **SYNC™ Applications and Services** (page 345).

USING VOICE RECOGNITION

This system helps you control many features using voice commands. This allows you to keep your hands on the wheel and focus on what is around you.

Initiating a Voice Session



Press the voice button. A list of available voice commands appears in the display.

Global Voice Commands

These voice commands are always available. You can say them at any time.

Global voice commands	
(cancel exit)	This command ends the voice session. You can also cancel a session by holding the voice button for two or more seconds.
help	This command provides you with hints, examples and instructions.
(main menu start again)	This command restarts the voice session from the initial starting point.

You can say any of the voice commands that appear within open and close brackets that are separated by |. For example, where; (cancel | exit) appears you say; cancel or exit.

Helpful Hints

- Make sure the interior of your vehicle is as quiet as possible. Wind noise from open windows and road vibrations may prevent the system from correctly recognizing spoken commands.
- Before giving a voice command, wait for the system announcement to finish, followed by a single tone. Any command spoken before this does not register with the system.
- Speak naturally, without long pauses between words.
- You can interrupt the system at any time while it is speaking by pressing the voice button. You can cancel a voice session by pressing and holding the voice button.

System Interaction and Feedback

The system provides feedback through audible tones, prompts, questions and spoken confirmations depending on the situation and the chosen level of interaction. You can customize the voice recognition system to provide more or less instruction and feedback.

The default setting is to a higher level of interaction in order to help you learn to use the system. You can change these settings at any time.

Adjusting the Interaction Level



Press the voice button. When prompted, say:

Voice Command	Action and Description
voice settings	
Then either of the following:	
interaction mode novice	Provides more detailed interaction and guidance. (Recommended for first time users.)
interaction mode advanced	Provides less audible interaction and guidance.

Confirmation Prompts

Confirmation prompts are short questions the system asks when it is not sure of your request or when there is more than one possible response to your request.

To adjust this setting press the voice button, when prompted say:

Voice Command	Action and Description
voice settings	
Then either of the following:	
confirmation prompts off	Make a best guess from the command; you may still occasionally be asked to confirm settings.
confirmation prompts on	Clarify your voice command with a short question.

Phone Confirmation

Using phone confirmations the system asks you to verify before placing any calls.

To adjust this setting press the voice button, when prompted say:

Voice Command	Action and Description
voice settings	
Then any of the following:	
phone confirmation on	When enabled, this feature will prompt you to confirm any voice initiated call command prior to the call being placed.
phone confirmation off	The system will make a best guess; you may still occasionally be asked to confirm settings.

Changing the Voice Settings

In addition to using voice commands to change the voice settings, you can also use the menu in the audio display.

To change the voice settings press the Menu button then select:

Menu Item
SYNC-Settings
Voice settings

USING SYNC™ WITH YOUR PHONE

Hands-free calling is one of the main features of SYNC. While the system supports a variety of features, many are dependent on your cellular phone's functionality. At a minimum, most cellular phones with Bluetooth wireless technology support the following functions:

- Answering an incoming call.
- Ending a call.
- Using privacy mode.
- Dialing a number.
- Redialing.

- Call waiting notification.
- Caller ID.

Other features, such as text messaging using Bluetooth and automatic phonebook download, are phone-dependent features. To check your phone's compatibility, see your phone's manual and visit www.SYNCMYRide.com, www.SYNCMYRide.ca or www.syncmaroute.ca.

Pairing a Phone for the First Time

Wirelessly pairing your phone with SYNC allows you to make and receive hands-free calls.

Note: SYNC can support downloading up to approximately 4000 entries per Bluetooth-enabled cellular phone.

Note: Make sure to switch on the ignition and the radio. Shift the transmission into park (P) for automatic transmission or first gear for manual transmission.

Using the Audio System

Note: To scroll through the menus, press the up and down arrows on your audio system.

1. Make sure to switch on your phone's Bluetooth feature before starting the search. See your device's manual if necessary.
2. Press the **PHONE** button. When the audio display indicates there is no paired phone, select the option to add.
3. When a message to begin pairing appears in the audio display, search for SYNC on your phone to start the pairing process.
4. When prompted on your cell phone's display, confirm that the PIN provided by SYNC matches the PIN displayed on your cell phone. Your phone is now paired and the display indicates that the pairing was successful. If you are prompted to enter a PIN on your device, enter the PIN displayed on the screen. The display indicates when the pairing is successful.

Depending on your phone's capability and your market, the system may prompt you with questions, such as setting the current phone as the primary phone (the phone SYNC automatically tries to connect with first upon vehicle start-up) and downloading your phonebook.

Using Voice Commands



Make sure to switch on your phone's Bluetooth feature before starting the search. See your device's manual if necessary.

Press the voice and when prompted say:

Voice Command	Action and Description
(pair ([Bluetooth] device phone Bluetooth audio) add phone)	Follow the instructions on the audio display.

You can say any of the voice commands that appear within open and close brackets that are separated by |. For example, where; (what's | what is) appears you say; what's or what is.

The commands that have [] around the word means that the word is optional.

Depending on your phone's capability and your market, the system may prompt you with questions, such as setting the current phone as the primary phone (the phone SYNC automatically tries to connect with first upon vehicle start-up) and downloading your phonebook.

Pairing Subsequent Phones

Note: Make sure to switch on the Ignition and the radio. Shift the transmission into park (P) for automatic transmission or first gear for manual transmission.

Note: To scroll through the menus, press the up and down arrows on your audio system.

1. Make sure to switch on your phone's Bluetooth feature before starting the search. See your device's manual if necessary.
2. Press the **PHONE** button.
3. Select the option for Bluetooth Devices.
4. Press the **OK** button.

5. Select the option to add. This starts the pairing process.
6. When a message to begin pairing appears in the audio display, search for SYNC on your device.
7. When prompted on your cell phone's display, confirm that the PIN provided by SYNC matches the PIN displayed on your cell phone. Your phone is now paired and the display indicates that the pairing was successful. If you are prompted to enter a PIN on your device, enter the PIN displayed on the screen. The display indicates when the pairing is successful.

SYNC may prompt you with more cell phone options. Your cell phone may also prompt you to give SYNC permission to access information. For more information on your cell phone's capability, see your cell phone's manual and visit the website.

Phone Voice Commands



Press the voice button. When prompted, say any of the following:

Voice Command
(phone Blackberry iPhone)
Then say any of the following:
call (___)
call ___ at home
call ___ ((in at) [the] office at work)
call ___ on (cell mobile)
call ___ on other
dial [[a] number] 1
([go to] privacy transfer to phone privacy on) 2

Voice Command
(hold call [on] place call on hold) 2
join (calls call) 2
mute call [on] 2
(mute call off un-mute call) 2
(turn ringer on silent mode off)
(turn ringer off silent mode [on])
[text] (messages message) 3
help

___ is a dynamic listing that should be the name of a contact in your phonebook. For example you could say "Call Home".

¹ See **Dial** table below.

² These commands are only valid while in a phone call.

³ See the text message table below.

Dial Commands

Press the voice button and when prompted say any of the following commands:

Voice Commands
411 (four-one-one), 911 (nine-one-one)
700 (seven hundred)
800 (eight hundred)
900 (nine hundred)
Clear (deletes all entered digits)
Delete (deletes last set of digits entered)
Number <0-9>

Voice Commands
Plus
Pound (#)
Star (*)

Note: To exit dial mode, press and hold the phone button or press any button on the audio system.

To access text messages say:

Voice Command
[text] (messages message)
Then say any of the following:
(listen to read) ([text] message)
forward (text [text] message)
reply to (text [text] message)
call [sender]

Phonebook Hints

To hear how the SYNC system speaks a name browse phonebook, select a contact and press:

Menu Item
Hear it

Changing Devices Using Voice Commands

Using SYNC, you can easily access multiple phones, ipods, or USB devices. to switch devices say:

Voice Command	
(connect device) ___	You can state the name of the desired device, such as “My iPhone”; “My Galaxy” or “My iPod”. SYNC may ask you to confirm the type of device (Phone, USB, or Bluetooth Audio).

Making Calls



Press the voice button. When prompted, say:

Voice Command	
call [[a] name]	
dial [[a] number]	SYNC prompts you to say the numbers that you wish to dial. After you say the numbers, the system confirms it. You can then say:

When the system has stated the number, you say any of the following:

Voice Command	
(dial send)	This initiates the call.
(delete correct)	This erases the spoken digits.

To end the call, press the end call button on the steering wheel or select the end call option in the audio display.

Receiving Calls

Accepting calls

When receiving a call, you can answer the call by pressing the accept call button on the steering wheel or use the screen.

To use the screen to accept a call select:

Menu Item
Accept

Rejecting Calls

When receiving a call, you can reject the call by pressing the reject call button on the steering wheel or use the screen.

To use the screen to reject a call select:

Menu Item
Reject

Ignore the call by doing nothing.

Phone Options during an Active Call

During an active call, you have more menu features that become available, such as putting a call on hold or joining calls.

To access this menu, choose one of the options available at the bottom of the audio display or select **More** to choose from the following options:

Menu Item	Description and action
Mic. off	Switch your vehicle's microphone off. To switch the microphone on, select the option again.
Privacy	Switch a call from an active hands-free environment to your cellular phone for a more private conversation. When selected, the audio display indicates the call is private.
Hold	Put an active call on hold. When selected, the audio display indicates the call is on hold.
Dial a number	Enter numbers using the audio system's numeric keypad (for example, numbers for passwords).
Join calls	Join two separate calls. The system supports a maximum of three callers on a multiparty or conference call. 1. Select the More option. 2. Access the desired contact through the system or use voice commands to place the second call. Once actively in the second call, select the More option. 3. Scroll to the option to join calls and press the OK button.
Phonebook	Access your phonebook contacts. 1. Select the More option. 2. Scroll to the option for phonebook and press the OK button. 3. Scroll through your phonebook contacts.

Menu Item	Description and action
	<ol style="list-style-type: none"> 4. Press the OK button again when the desired contact appears in the audio display. 5. Press the OK button or dial button to call the selection.
Call History	<p>Access your call history log.</p> <ol style="list-style-type: none"> 1. Select the More option. 2. Scroll to the option for call history and press the OK button. 3. Scroll through your call history options (incoming, outgoing or missed). 4. Press the OK button again when the desired selection appears in the audio display. 5. Press the OK button or dial button to call the selection.

Accessing Features through the Phone Menu

You can access your call history, phonebook, sent text messages, as well as access phone and system settings.

1. Press the **PHONE** button to enter the phone menu.
2. Select one of the options available.

Display	Description and action
Dial a number	Enter numbers using the audio system's numeric keypad.
Phonebook	<p>Access your downloaded phonebook.</p> <ol style="list-style-type: none"> 1. Press the OK button to confirm and enter. You can use the options at the bottom of the screen to access an alphabetical category quickly. You can also use the letters on the audio system's numeric keypad to jump in the list. 2. Scroll through your phonebook contacts. 3. Press the OK button again when the desired selection appears in the audio display. 4. Press the OK button or dial button to call the selection.
Call History	<p>Access any previously dialed, received or missed calls.</p> <ol style="list-style-type: none"> 1. Press the OK button to select. 2. Scroll to select incoming, outgoing or missed calls. Press the OK button to make your selection. 3. Press the OK button or dial button to call the selection.
Speed Dial	Select 1 of 10 speed dial entries. To set a speed dial entry, go to the phonebook and then press and hold one of the numbers on the audio system's numeric keypad.

Display	Description and action
Text messaging	Send, download and delete text messages.
BT Devices	Access the option for Bluetooth Device menu listings (add, connect, set as primary, on or off, delete).
Phone settings	View various settings and features on your phone.

Text Messaging

Note: *This is a phone-dependent feature.*

SYNC allows you to receive, send, download and delete text messages. The system can also read incoming text messages to you so that you do not have to take your eyes off the road.

Receiving a Text Message

Note: *This is a phone-dependent feature. Your phone must support downloading text messages using Bluetooth to receive incoming text messages.*

Note: *This is a speed-dependent feature and is only available when your vehicle is traveling at 3.1 mph (5 km/h) or less.*

When a new message arrives, an audible tone sounds and the audio display indicates you have a new message.

To hear the message you can say:

Voice command	Description and action
(listen to read) ([text] message)	Select this option to have the system read the message to you.

Using the screen you also have the following options:

Menu Item	Description and action
Ignore	Select this option, or do nothing, and the message goes into your text message inbox.
View	Select the view option to open the text message. Once selected, you have the ability to have the message read to you, to view other messages. For additional options select:
More...	If you select this option, use the arrow button to scroll through the following options:

Menu Item	Description and action	
	Reply to sender	Press the OK button to access, and then scroll through a list of pre-defined messages to send.
	Call sender	Press the OK button to call the sender of the message.
	Forward msg.	Press the OK button to forward the message to anyone in your phonebook or call history. You can also choose to enter a number.

Sending, Downloading and Deleting Your Text Messages

1. Press the **PHONE** button.

2. Select the text messaging option, and then press the **OK** button.

Choose from the following options:

Menu Item	Description and action
New	Allows you to send a new text message based on a pre-defined set of 15 messages.
View	Allows you to read the full message and, in addition, provides the option to have the system read the message to you. To go to the next message, select the More option. This allows you to reply to the sender, call the sender or forward the message.
Delete	Allows you to delete current text messages from the system (not your cellular phone). The audio display indicates when the system has deleted all your text messages.
More...	Allows you to delete all messages or manually trigger a download of all unread messages from your cellular phone.

Sending a Text Message

Note: You can only send a text message to one recipient at a time.

1. Select the send option when the desired selection highlights in the audio display.
2. Select the confirmation option when the contact appears.

3. Press the OK button again to confirm when the system asks if you want to send the message. A pre-defined signature appears on each text message.

Note: You can send text messages either by choosing a contact from the phonebook and selecting the text option from the audio display or by replying to a received message in the inbox.

Accessing Your Phone Settings

These are phone-dependent features. Your phone settings allow you to access and adjust features such as your ring tone and text message notification, modify your

phonebook, and set up automatic download.

1. Press the **PHONE** button.
2. Scroll until the phone settings option appears, and then press the **OK** button.

Scroll to select from the following options:

Menu Item	Description and action
Set as master	If this option is checked, the system uses the cellular phone as the master when there is more than one cellular phone paired to the system. This option can be changed for all cellular phones (not only the active phone) using the Bluetooth Devices menu.
Phone status	See the cellular phone name, provider name, cellular phone number, and signal level. When done, press the left arrow buttons to return to the phone status menu.
Set ringtone	Select which ringtone sounds during an incoming call (one of the system's tones or your cellular phone's). If your phone supports in-band ringing, your phone's ringtone sounds when you choose the cellular phone ringtone option. 1. Press the OK button to select and scroll to hear each ringtone. 2. Press the OK button to select a ringtone.
Text msg notify	Have the option of hearing an audible tone to notify you when a text message arrives. Press the OK button to switch the audible tone off or on.
Phonebook pref.	Modify the contents of your phonebook (such as add, delete or download). Press the OK button to select and scroll between the choices in the phonebook preferences table below.

Menu Item	Phonebook preferences	
Add contacts	Push the desired contacts on your cellular phone. See your device's manual on how to push contacts. Press the OK button to add more contacts from your phonebook.	
Delete	When a message asking you to delete appears, select the option to confirm. Press the OK button to delete the current phonebook and call history. The system takes you back to the menu for phone settings.	
Download now	Press the OK button to select and download your phonebook to the system.	
Auto-download	When automatic download is on, the system deletes any changes (additions or deletions) saved in the system since your last download.	
	When automatic download is off, the system does not download your phonebook when your cellular phone connects to SYNC.	
	You can only access your phonebook, call history and text messages when your paired cellular phone connects to the system. Check or uncheck this option to download your phonebook automatically each time your phone connects to the system. Download times are phone-dependent and quantity-dependent.	
Sorting Pref.	Enabling this feature allows you to select how your contacts are displayed. You can select:	
	<table border="1"> <tr> <td>First/Last name</td> <td>Last/First name</td> </tr> </table>	First/Last name
First/Last name	Last/First name	

Bluetooth Devices

The Bluetooth Devices menu allows you to add, connect and delete devices as well as set a phone as primary.

1. Press the **PHONE** button.
2. Scroll until Bluetooth Devices appears, and then press the **OK** button.

Select from the following options:

Menu Item	Description and action
Add	Pair additional phones to the system. 1. Select the option to add to start the pairing process.

Menu Item	Description and action
	<p>2. When a message to begin pairing appears in the audio display, search for SYNC on your phone. See your phone's manual if necessary.</p> <p>3. When prompted on your cell phone's display, confirm that the PIN provided by SYNC matches the PIN displayed on your cell phone. Skip the next step. If you are prompted to enter a PIN on your device, it does not support Secure Simple Pairing. To pair, enter the PIN displayed on the screen. The display indicates when the pairing is successful.</p> <p>4. When the option to set the phone as primary appears, select either yes or no.</p> <p>5. SYNC may prompt you with more cell phone options. Your cell phone may also prompt you to give SYNC permission to access information. For more information on your cell phone's capability, see your cell phone's manual and visit the website.</p>
Delete	<p>Select the delete option and confirm when the system asks to delete the selected device. After deleting a phone from the list, you have to repeat the pairing process to pair it again.</p>
Master	<p>The system attempts to connect with the primary cellular phone each time you switch on the ignition. When you select a cellular phone as primary, it appears first in the list, marked with an asterisk. Set a previously paired phone as master by selecting the master option and confirming it as the primary.</p>
Conn.	<p>Connect a previously connected phone. You can only have one phone connected at a time to use the phone's functionality. When you connect another phone, the previous phone disconnects from the telephone services. The system allows you to use different Bluetooth devices for the cellular phone functionality and the Bluetooth audio music playback feature at the same time.</p>
Discon.	<p>Disconnects the selected cellular phone. Select this option and confirm when asked. After disconnecting a phone, you can reconnect it again without repeating the full pairing process.</p>

System Settings

1. Press the **MENU** button.
2. Select the SYNC settings option, and then press the **OK** button.

Scroll to select from the following options:

Display	Description and action
Bluetooth on	Check or uncheck this option to switch the system's Bluetooth interface off or on. Select this option, and then press the OK button to change the option's status.
Set defaults	Return to the factory default settings without erasing your indexed information (such as phonebook, call history, text messages and paired devices). Select this option and confirm when prompted in the audio display.
Master reset	Completely erase all information stored in the system (such as phonebook, call history, text messages and paired devices) and return to factory default settings.
Install on SYNC	Install downloaded applications or software updates. Select this option and confirm when prompted in the audio display. There must be a valid SYNC application or update available on the USB drive in order to finish an installation successfully.
System info	Display the system's version numbers as well as its serial number. Press the OK button to select.
Voice settings	The voice settings submenu contains various options. See Using Voice Recognition (page 331).
Browse USB	Browse the actual menu structure of the connected USB device. Press the OK button and use the up and down arrow buttons to scroll through the folders and files. Use the left or right arrow buttons to enter or leave a folder. You can select media content for playback from this menu.

SYNC™ APPLICATIONS AND SERVICES (If Equipped)

In order for the following features to work, your cellular phone must be compatible with SYNC. To check your phone's compatibility, visit www.SYNCMYRide.com, www.SYNCMYRide.ca or www.syncmaroute.ca.

- 911 Assist: Can alert 911 in the event of an emergency.
- SYNC AppLink: Allows you to connect to and use certain applications such as Spotify and Glmpse (if your phone is compatible).

These features may require activation. Available AppLink enabled apps vary by market.

911 Assist

WARNINGS



Unless the 911 Assist setting is set on before a crash, the system will not dial for help which could delay response time, potentially increasing the risk of serious injury or death after a crash.



Do not wait for 911 Assist to make an emergency call if you can do it yourself. Dial emergency services immediately to avoid delayed response time which could increase the risk of serious injury or death after a crash. If you do not hear 911 Assist within five seconds of the crash, the system or phone may be damaged or non-functional.



Always place your phone in a secure location in your vehicle so it does not become a projectile or get damaged in a crash. Failure to do so may cause serious injury to someone or damage the phone which could prevent 911 Assist from working properly.

Note: The SYNC 911 Assist feature must be set on before the incident.

Note: The SYNC 911 Assist feature only operates in the U.S., Canada or in a territory in which 911 is the emergency number.

Note: Before setting this feature on, make sure that you read the 911 Assist Privacy Notice later in this section for important information.

Note: If any user switches 911 Assist to on or off, that setting applies for all paired phones. If 911 Assist is switched off, either a voice message plays or a display message or an icon comes on when your vehicle is started and after a previously paired phone connects.

Note: Every phone operates differently. While SYNC 911 Assist works with most cellular phones, some may have trouble using this feature.

If a crash deploys an airbag (excluding knee airbags and rear inflatable safety belts [if equipped]) or activates the fuel pump shut-off, your SYNC-equipped vehicle may be able to contact emergency services by dialing 911 through a paired and connected Bluetooth-enabled phone. You can learn more about the 911 Assist feature, visit www.SYNCMYRide.com, www.SYNCMYRide.ca or www.syncmaroute.ca.

See **Supplementary Restraints System** (page 39). Important information about airbag deployment is in this chapter.

See **Roadside Emergencies** (page 227). Important information about the fuel pump shut-off is in this chapter.

Setting 911 Assist On or Off

Press Menu then select

Menu Item	Action and Description
SYNC-Applications	
911 Assist	Select desired option, on or off.

If you choose not to activate this feature you will have the following options:

Menu Item	Action and Description
Voice Reminder ON	Provides a display and voice reminder at phone connection at vehicle start.
Voice Reminder OFF	Provides a display reminder only without a voice reminder at phone connection.

To make sure that 911 Assist works properly:

- SYNC must be powered and working properly at the time of the incident and throughout feature activation and use.
- The 911 Assist feature must be set on before the incident.
- You must pair and connect a Bluetooth-enabled and compatible cell phone to SYNC.
- A connected Bluetooth-enabled phone must have the ability to make and maintain an outgoing call at the time of the incident.

- A connected Bluetooth-enabled phone must have adequate network coverage, battery power and signal strength.
- The vehicle must have battery power and be located in the U.S., Canada or in a territory in which 911 is the emergency number.

In the Event of a Crash

Not all crashes deploy an airbag or activate the fuel pump shut-off (the triggers for 911 Assist). If a connected cell phone sustains damage or loses its connection to SYNC during a crash, SYNC searches for and tries to connect to a previously paired cell phone; SYNC then attempts to call the emergency services.

Before making the call:

- SYNC provides a short window of time (about 10 seconds) to cancel the call. If you fail to cancel the call, SYNC attempts to dial 911.
- SYNC says the following, or a similar message: "SYNC will attempt to call 911, to cancel the call, press Cancel on your screen or press and hold the phone button on your steering wheel".

If you do not cancel the call, and SYNC makes a successful call, a pre-recorded message plays for the 911 operator, and then the occupant(s) in your vehicle is able to talk with the operator. Be prepared to provide your name, phone number and location immediately, because not all 911 systems are capable of receiving this information electronically.

911 Assist May Not Work If

- Your cellular phone or 911 Assist hardware sustains damage in a crash.
- The vehicle's battery or the SYNC system has no power.
- The phone(s) thrown from your vehicle are the ones paired and connected to the system.

911 Assist Privacy Notice

When you switch on 911 Assist, it may disclose to emergency services that your vehicle has been in a crash involving the deployment of an airbag or activation of the fuel pump shut-off. Certain versions or updates to 911 Assist may also be capable of electronically or verbally disclosing to 911 operators your vehicle location or other details about your vehicle or crash to assist 911 operators to provide the most appropriate emergency services. If you do not want to disclose this information, do not switch the feature on.

SYNC Mobile Apps

The system enables voice and steering wheel control of SYNC AppLink enabled smartphone apps. When an app is running through AppLink, you can control main features of the app through voice commands and steering wheel controls.

Note: You must pair and connect your smartphone to SYNC to access AppLink.

Note: iPhone users need to connect the phone to the USB port.

Note: Android users need to connect the phone to SYNC using Bluetooth.

Note: For information on available apps, supported smartphone devices and troubleshooting tips please visit the Ford website.

Availability of SYNC AppLink enabled Apps will vary by region.

Note: Make sure you have an active account for the app that you have downloaded. Some apps work automatically with no setup. Other apps want you to configure your personal settings and personalize your experience by creating stations or favorites. We recommend you do this at home or outside of your vehicle.

Note: AppLink is not available if your vehicle is equipped with the MyFordTouch system.

To Access Using the SYNC Menu

Press the MENU button to access the menu on-screen. Then select:

Menu Item	Action and Description
SYNC-Apps	
Mobile Apps	Scroll through the list of available applications and select a particular app or select:
	Find New Apps

Note: If you cannot find a compatible SYNC AppLink app, make sure the required app is running on the mobile device.

Accessing an App's Menu

When an app is running through SYNC, press the right arrow button on the steering wheel control to access the app menu.

You can access various app features from here, for example thumbs up and thumbs down.

Press the left arrow button on the steering wheel control to exit the app menu.

To Access Using Voice Commands

Press the voice button then when prompted say:

Menu Item	Action and Description
mobile (apps applications)	Say the name of the application after the tone. The app should start. When an app is running through SYNC, you can press the voice button and speak commands specific to the app, for example "Play Playlist Road Trip".
help	Use this command to discover the available voice commands.

SYNC Mobile App Voice Commands

The following voice commands are always available:

Menu Item	Action and Description
mobile (apps applications)	SYNC prompts you to say the name of an app to start it on SYNC.
list [mobile] (apps applications)	SYNC lists all of the currently available mobile apps.
find [new] [mobile] (apps applications)	Searches your connected mobile device for SYNC-compatible mobile apps.
help	
You can say the name of a mobile app at any time to start the mobile app on SYNC.	

App Permissions

App permissions are organized by groups. You can grant these group permissions individually. You can change a permission group status any time when not driving, by using the settings menu.

When you launch an app using SYNC, the system may ask you to grant certain permissions, for example:

- To allow your vehicle to provide vehicle information to the app such as, but not limited to: Fuel level, fuel economy, fuel consumption, engine speed, rain sensor, odometer, VIN, external temperature, gear position, tire pressure, and head lamp status.
- To allow your vehicle to provide driving characteristic information such as, but not limited to: MyKey, seat belt status, engine revolutions per minute, gear position, braking events, steering wheel angle, and accelerator pedal position.

- To allow your vehicle to provide location information, including: GPS and speed.
- To allow the app to send push notifications using the vehicle display and voice capabilities while running in a background state. Push notifications may be particularly useful for news or

location based apps.

Note: *You only need to grant permissions the first time you use an app with SYNC.*

Note: *Ford is not responsible or liable for any damages or loss of privacy relating to usage of an app, or dissemination of any vehicle data that you approve Ford to provide to an app.*

Enabling and Disabling App Permissions Using the SYNC Menu

Press the MENU button to access the SYNC menu then select:

Menu Item	Action and Description
SYNC-Apps	
Mobile Apps	
All Apps	You can also select a specific app. If the app supports push notifications, this setting is listed. Select to enable or disable the feature as required.

Enabling SYNC Mobile Apps

In order to enable mobile apps, SYNC requires user consent to send and receive app authorization information and updates using the data plan associated with the connected device.

Data is sent to Ford in the United States through the connected device. The information is encrypted and includes your VIN, SYNC module number, anonymous usage statistics and debugging information. Updates may take place automatically.

Note: *You must enable mobile apps for each connected device the first time you select a mobile app using the system.*

Note: *Standard data rates apply. Ford is not responsible for any additional charges you may receive from your service provider, when your vehicle sends or receives data through the connected device. This includes any additional charges incurred due to driving in areas when roaming out of a home network.*

App Status

You can view the current status of an app in the settings menu.

There are three possible statuses:

Menu Item	Action and Description
Update Needed	The system has detected a new app requiring authorization or a general permissions update is required.
Up-To-Date	No update is required.
Updating...	The system is trying to receive an update.

Update settings

Menu Item	Action and Description
Request Update	Select this option from the settings menu to manually perform a needed update.
Disable Updates	Select this option from the settings menu to disable automatic updates. Doing so also disables the use of Mobile Apps on SYNC.

USING SYNC™ WITH YOUR MEDIA PLAYER

You can access and play music from your digital music player over your vehicle's speaker system using the system's media menu or voice commands. You can also sort and play your music by specific categories, such as artist and album.

Note: *The system is capable of indexing up to 15,000 songs.*

SYNC is capable of hosting nearly any digital media player including: iPod, Zune, plays from device players, and most USB drives. SYNC also supports audio formats, such as MP3, WMA, WAV and ACC.

Confirm that the USB device has been formatted correctly and has the following specifications:

- USB 2.0.
- File format must be FAT16/32.

The format of the audio files on the USB device must be:

- MP3.
- Non DRM protected WMA.
- WAV.
- AAC.

Connecting Your Digital Media Player to the USB Port

Note: *If your digital media player has a power switch, make sure you switch it on before plugging it in.*

To Connect Using Voice Commands

Plug the device into one of the vehicle's USB ports.

Press the voice button and when prompted, say:

Voice Command	Action and Description
(USB [stick] iPod MP3 [player])	You can now play music by saying any of the appropriate voice commands. See the media voice commands.

Words in brackets [] are optional and do not have to be spoken for the system to understand the command. For example, for where (USB [stick] | iPod | MP3 [player]) appears, you can say USB or USB stick.

To view USB content select:

Message	Description and Action
Browse USB	Depending on how many media files are on your connected device, an indexing message may appear in the display. When indexing is complete, the selected source starts to playback audio automatically.

You can browse the files on the USB device in categories. Select BROWSE from the buttons at the bottom of the audio display and choose from the following:

Message
Play all
Playlists
Songs
Artists

To Connect Using the System Menu

1. Plug the device into one of the vehicle's USB ports.
2. Press the **MEDIA** button and select either USB 1 or USB 2 from the media source list in the audio display.

Message
Albums
Genres
Browse USB
Reset USB

Media Voice Commands



Press the voice button and when prompted say:

Voice Command	Description and Action
(USB [stick] iPod MP3 [player])	You can now play music by saying any of the appropriate voice commands.

You can say any of the voice commands that appear within open and close brackets that are separated by |. For example, where; (what's | what is) appears you say; what's or what is.

You must say any of the voice commands that appear outside of open and close brackets. For example, where; (what's | what is) playing, you must say either "what's playing" or "what is playing".

Command	Description and Action
pause	Pauses device playback.
play	Resumes device playback.
play [album] ___	
play all	Play all media on the device from the first track to the last.
play [artist] ___	
play [genre] ___	
play [playlist] ___	
next [track title song file podcast chapter episode]	Plays the next track on the current media.
previous [track title song file podcast chapter episode]	Plays the previous track on current media.
[play] (similar music more like this)	Creates a playlist with a similar genre to the one currently playing.
play [song track title file] ___	
repeat off	
repeat (one track) [on]	Repeats the current track.

Command	Description and Action
shuffle [all] [on]	Plays the current playlist in a random order. (Not all devices support this command.)
shuffle off	
((who's who is) this who plays this (what's what is) playing [now] (what which) (song track artist) is this (who's who is) playing (what's what is) this)	At any time during playback, you can press the voice button and ask the system what is playing. The system reads the metadata tags (if populated) of the current track.

___ is a dynamic listing, meaning that it could be the name of anything, such as a group, artist or song. For example you could say "Play artist The Beatles".

Examples of USB Commands

SYNC provides the user with many intuitive ways to find and play a song using voice. For example, if we have a song called "Penny Lane" from the album "Magical Mystery Tour" we can say the following to play this song:

- Play song "Penny Lane".
- Play "Penny Lane".

If we wanted to play the entire album, we can say:

- Play album "Magical Mystery Tour".
- Play "Magical Mystery Tour".

Bluetooth Audio

The system is also capable of playing music from your cellular phone through Bluetooth.

To switch the Bluetooth audio on, use the **MEDIA** button (next to the audio display) or **Source** button, or press the voice button and when prompted say:

Voice Command
Bluetooth audio

Then any of the following:

Voice Command
pause
play
next [track title song file podcast chapter episode]
previous [track title song file podcast chapter episode]

Media Menu Features

The media menu allows you to select how to play your music (such as by artist, genre, shuffle or repeat), find similar music or

reset the index of your USB devices.

Press the **MEDIA** button and select either USB 1 or USB 2 from the media source list in the audio display to start USB playback.

Message	Description and Action
Options	This will enter the media menu.

Then any of the following:

Message	Description and Action
Shuffle	Choose to shuffle or repeat your music. Once you make your choice, it remains on until you switch it off.
Repeat track	Choose to shuffle or repeat your music. Once you make your choice, it remains on until you switch it off.
Similar music	You can play similar types of music to the current playlist from the USB port. The system uses the metadata information of each track to compile a playlist. The system then creates a new list of similar tracks and then begins playing. Each track must have the metadata tags populated for this feature. With certain playing devices, if your metadata tags are not populated, the tracks will not be available in voice recognition, the play menu or this option. However, if you place these tracks onto your playing device in mass storage device mode they are available in voice recognition, the play menu or this option. The system places unknowns into any unpopulated metadata tag.
Reset USB	Resets the USB index. After the new indexing is complete you can choose what to play from the USB song library.

Accessing Your USB Song Library

1. Plug the device into your vehicle's USB port.

2. Press the **MEDIA** button (next to the audio display) to select USB playback.

Message	Description and Action
Browse USB	This menu allows you to select and play your media files by artist, album, genre, playlist or track.

If there are no media files to access, the **NO MEDIA** display indicates there is no media.

If there are media files, you have the following options:

Display	Description and Action
Play all	Play all indexed media files from your device one at a time in numerical order.* Press the OK button to select. The first track title appears in the display.
Playlists	Access your playlists (from formats like ASX, M3U, WPL, or MTP).* 1. Press the OK button to select. 2. Scroll to select the desired playlist, and then press the OK button.
Songs	Search for and play a specific indexed track.* 1. Press the OK button to select. 2. Scroll to select the desired track, and then press the OK button.
Artists	Sort all indexed media files by artist. The system then lists and plays all artists and tracks alphabetically.* 1. Press the OK button to select. 2. Scroll to select the desired artist, and then press the OK button.
Albums	Sort all indexed media files by album.* 1. Press the OK button to select. 2. Scroll to select the desired album, and then press the OK button.
Genres	Sort all indexed media files by genre (category) type.* 1. Press the OK button to select. 2. Scroll to select the desired genre, and then press the OK button.
Browse USB	Browse all supported media files on your media player connected to the USB port. You can only view media files that are compatible with SYNC. (Other files are not visible.) 1. Press the OK button to select.

Display	Description and Action
	2. Scroll to browse indexed media files on the device, and then press the OK button.
Reset USB	Resets the USB index. After the new indexing is complete, you can choose what to play from the USB song library.

*You can use the buttons at the bottom of the audio display to jump to a certain alphabetical category quickly. You can also use the letters on the audio system's numeric keypad to jump in the list.

Using Voice Commands

You can access and view your USB songs using voice commands.

Plug the device into your vehicle's USB port.

Press the voice button and when prompted, say any of the following commands:

Accessing and Viewing USB Media
(browse search show) all (album albums)
(browse search show) all (artist artists)
(browse search show) all (genre genres)
(browse search show) all (playlist playlists)
(browse search show) all (song songs title titles file files track tracks)
(browse search show) album ____
(browse search show) artist ____
(browse search show) genre ____
(browse search show) playlist ____

USB 2 (If Equipped)

Your vehicle may come equipped with an additional USB port. If so, USB 1 is located at the front of the vehicle at the bottom of the instrument panel. USB 2 is located inside the storage compartment of the vehicle's center console.

You can plug in an additional USB device into the second USB port.

You can access both USB devices by using voice commands.

To access a USB device press the voice button and when prompted say:

Voice command
USB 1
USB 2

Note: SYNC only supports one connected iOS (Apple) devices at a time (whichever one you plug in first). When you connect a second iOS device, the systems charges it, but does not support playback from it.

Bluetooth Devices and System Settings

You can access these menus using the audio display. See **Using SYNC™ With Your Phone** (page 333).

Voice Commands for Audio Sources

Your voice system allows you to change audio sources with a simple voice command.



Press the voice button and when prompted say:

Voice Command
(music audio entertainment) [system]
Below are a few examples of voice commands you can use.
[tune [to]] AM
[tune [to]] AM1
[tune [to]] AM (autostore AST autoset)
[tune [to]] AM 2
Bluetooth (audio stereo)
(disc CD [player]) play
[tune [to]] FM
[tune [to]] FM1
[tune [to]] FM (autostore AST autoset)
[tune [to]] FM 2
Radio
tune [to] SAT *
Sirius *
(USB [stick] iPod MP3 [player])

Voice Command
((who's who is) this who plays this (what's what is) playing [now] (what which) (song track artist) is this (who's who is) playing (what's what is) this)
help

* If equipped.

Radio Voice Commands



If you are listening to the radio, press the voice button, and then say any of the commands in the following table.

If you are not listening to the radio, press the voice button and, after the tone, say:

Voice Command
Radio
You can then say any of the following commands.
[tune [to]] AM
[tune [to]] AM1
[tune [to]] AM (autostore AST autoset)
[tune [to]] AM 2
[tune [to]] (AM ___ ___ [AM])
[tune [to]] AM preset ___
[tune [to]] AM1 preset ___
[tune [to]] FM
[tune [to]] FM1
[tune [to]] FM (autostore AST autoset) preset ___

Voice Command
[tune [to]] FM 2
[tune [to]] (FM ___ ___ [FM])
[tune [to]] FM preset ___
FM ___ HD ___ *
[tune [to]] FM 2 preset ___
HD ___ *
[tune [to]] preset ___
Tune
help

* If equipped.

Sirius Satellite Radio Voice Commands (If equipped)



To listen to Sirius satellite radio, press the voice button and, after the tone, say:

Voice Commands
Sirius

When you are listening to Sirius satellite radio, you can press the voice button, and say any of the commands in the following table.

Voice Commands
tune [to] SAT
[tune [to]] SAT 1
[tune [to]] SAT 2
[tune [to]] SAT 3
[tune [to]] preset ___
[tune [to]] SAT 1 preset ___

Voice Commands	
[tune [to]] SAT 2 preset ___	
[tune [to]] SAT 3 preset ___	
tune [to] [Sirius]	
Help	
[tune [to]] Sirius [channel] ___	You can say the channel number (0-233) to listen to that Sirius station.

CD Voice Commands



If you are listening to a CD, press the voice button, and then say any of the commands in the following table.

If you are not listening to a CD, press the voice button and, after the tone, say:

Voice Command
(disc CD [player]) play
You can then say any of the following commands.
pause
play
[play] next track
[play] previous track
[play change to] track [number] ___
repeat (track song) [on]
repeat folder [on]
repeat off
(shuffle random mix) [on (tracks songs) [on]]

SYNC™

Voice Command
(shuffle random mix) (CD [player] disc) [on]
(shuffle random mix) folder [on]
shuffle off

Use the website at any time to check your phone's compatibility, register your account and set preferences as well as access a customer representative via an online chat (during certain hours). Visit www.SYNCMyRide.com, www.SYNCMyRide.ca or www.syncmaroute.ca for more information.

SYNC™ TROUBLESHOOTING

Your SYNC system is easy to use. However, should questions arise, see the tables below.

Phone issues		
Issue	Possible cause(s)	Possible solution(s)
There is excessive background noise during a phone call.	The audio control settings on your phone may be affecting SYNC performance.	Review your phone's manual about audio adjustments.
During a call, I can hear the other person but they cannot hear me.	This may be a possible phone malfunction.	Try turning off the device, resetting the device, removing the device's battery, then trying again.
SYNC is not able to download my phonebook.	This is a phone-dependent feature. This may be a possible phone malfunction.	Go to the website to review your phone's compatibility. Try turning off the device, resetting the device or removing the device's battery, then trying again. Try pushing your phonebook contacts to SYNC by using the Add Contacts feature. Use the SYNCmyphone feature available on the website.
The system says Phonebook Downloaded but the phonebook in SYNC is empty or missing contacts.	This may be a limitation on your phone's capability.	Try pushing your phonebook contacts to SYNC by using the Add Contacts feature.

SYNC™

Phone issues		
Issue	Possible cause(s)	Possible solution(s)
		<p>If the missing contacts are stored on your SIM card, try moving them to the device memory.</p> <p>Remove any pictures or special ring tones associated with the missing contact.</p> <p>Depending upon your phone, you may have to grant SYNC permission to access your phonebook contacts. Make sure to confirm when prompted by your phone during the phonebook download.</p>
<p>I am having trouble connecting my phone to SYNC.</p>	<p>This is a phone-dependent feature.</p> <p>This may be a possible phone malfunction.</p>	<p>Go to the website to review your phone's compatibility.</p> <p>Try turning off the device, resetting the device or removing the device's battery, then trying again.</p> <p>Try deleting your device from SYNC, deleting SYNC from your device and trying again.</p> <p>Check the security and auto accept and prompt always settings relative to the SYNC Bluetooth connection on your phone.</p> <p>Update your device's firmware.</p>

SYNC™

Phone issues		
Issue	Possible cause(s)	Possible solution(s)
		Turn off the Auto phone-book download setting.
Text messaging is not working on SYNC.	This is a phone-dependent feature. This may be a possible phone malfunction.	Go to the website to review your phone's compatibility. Try turning off the device, resetting the device or removing the device's battery, then trying again.

USB and media issues		
Issue	Possible cause(s)	Possible solution(s)
I am having trouble connecting my device.	This may be a possible device malfunction.	Try turning off the device, resetting the device, removing the device's battery, then trying again. Make sure you are using the manufacturer's cable. Make sure you insert the USB cable correctly into the device and the USB port. Make sure that the device does not have an auto-install program or active security settings.
SYNC does not recognize my device when I turn on the car.	This is a device limitation.	Make sure you are not leaving the device in your vehicle during very hot or cold temperatures.
Bluetooth audio does not stream.	This is a phone-dependent feature.	Review the device compatibility chart on the SYNC website to confirm your phone supports the Bluetooth audio streaming function.

SYNC™

USB and media issues		
Issue	Possible cause(s)	Possible solution(s)
	The device is not connected.	Make sure you correctly connect the device to SYNC, and that you have pressed play on your device.
SYNC does not recognize music that is on my device.	<p>Your music files may not contain the correct artist, song title, album or genre information.</p> <p>The file may be corrupted.</p> <p>The song may have copy-right protection, which does not allow it to play.</p>	<p>Make sure that all song details are populated.</p> <p>Some devices require you to change the USB settings from mass storage to MTP class.</p>

Voice command issues		
Issue	Possible cause(s)	Possible solution(s)
SYNC does not understand what I am saying.	<p>You may be using the wrong voice commands.</p> <p>You may be speaking too soon or at the wrong time.</p>	<p>Review the phone voice commands and the media voice commands at the beginning of their respective sections.</p> <p>After pressing the voice icon, wait until after the tone sounds and Listening appears before saying a command. Any command spoken before this does not register with the system.</p>
SYNC does not understand the name of a song or artist.	You may be using the wrong voice commands.	Review the media voice commands at the beginning of the media section.

SYNC™

Voice command issues		
Issue	Possible cause(s)	Possible solution(s)
	<p>You may be saying the name differently than the way you saved it.</p> <p>The system may not be reading the name the same way you are saying it.</p>	<p>Say the song or artist exactly as listed. If you say "Play Artist Prince", the system does not play music by Prince and the Revolution or Prince and the New Power Generation.</p> <p>Make sure you are saying the complete title, such as "California remix featuring Jennifer Nettles".</p> <p>If the song titles are in all CAPS, you have to spell them. LOLA requires you to say "L-O-L-A".</p> <p>Do not use special characters in the title. The system does not recognize them.</p>
<p>SYNC does not understand or is calling the wrong contact when I want to make a call.</p>	<p>You may be using the wrong voice commands.</p> <p>You may be saying the name differently than the way you saved it.</p>	<p>Review the Phone voice commands at the beginning of the phone section.</p> <p>Make sure you are saying the contacts exactly as they are listed. For example, if you save a contact as Joe Wilson, say "Call Joe Wilson".</p> <p>Using the SYNC phone menu, open the phonebook and scroll to the name SYNC is having trouble understanding. SYNC will read the name to you, giving you some idea of the pronunciation SYNC is expecting.</p>

SYNC™

Voice command issues		
Issue	Possible cause(s)	Possible solution(s)
	<p>The system may not be reading the name the same way you are saying it.</p> <p>Contacts in your phonebook may be very short and similar, or they may contain special characters.</p> <p>Your phonebook contacts may be in CAPS.</p>	<p>The system works better if you list full names, such as "Joe Wilson" rather than "Joe".</p> <p>Do not use special characters, such as 123 or ICE, as the system does not recognize them.</p> <p>If a contact is in CAPS, you have to spell it. JAKE requires you to say "Call J-A-K-E".</p>

AppLink issues		
Issue	Possible cause(s)	Possible solution(s)
<p>AppLink Mobile Applications: When I select "Find New Apps," SYNC does not find any applications.</p>	<p>An AppLink capable phone is not connected to SYNC.</p>	<p>Ensure you have a compatible smartphone; an Android with OS 2.3 or higher or an iPhone 3GS or newer with iOS 5.0 or higher. Additionally, ensure your phone is paired and connected to SYNC in order to find AppLink-capable apps on your device. iPhone users must also connect to SYNC's USB port with an Apple USB cable.</p>
<p>My phone is connected, but I still cannot find any apps.</p>	<p>AppLink-enabled apps are not installed and running on your mobile device.</p>	<p>Ensure you have downloaded and installed the latest version of the app from your phone's app store. Ensure the app is running on your phone. Some apps require you to register or</p>

SYNC™

AppLink issues		
Issue	Possible cause(s)	Possible solution(s)
		login on the app on the phone before using them with AppLink. Also, some may have a "Ford SYNC" setting, so check the app's settings menu on the phone.
My phone is connected, my app(s) are running, but I still cannot find any apps.	Sometime apps do not properly close and re-open their connection to SYNC, over ignition cycles, for example.	<p>Closing and restarting apps may help SYNC find the application if you cannot discover it inside the vehicle.</p> <p>On an Android device, if apps have an "Exit" or 'Quit' option, select that then restart the app. If the app does not have that option, you can also manually "Force Close" the app by going to the phone's settings menu, selecting 'Apps.' then finding the particular app and choosing 'Force stop.' Don't forget to restart the app afterwards, then select "Find New Apps" on SYNC.</p> <p>On an iPhone with iOS7+, to force close an app, double tap the home button then swipe up on the app to close it. Tab the home button again, then select the app again to restart it. After a few seconds, the app should then appear in SYNC's Mobile App's Menu.</p>
My Android phone is connected, my app(s) are running, I restarted them, but I still cannot find any apps.	There is a Bluetooth bug on some order versions of the Android operating system that may cause apps that were found on your previous vehicle drive to not be found again if you have not turned off Bluetooth.	Reset the Bluetooth on your phone by turning it off and then turning Bluetooth back on. If you are in your vehicle, SYNC should be able to automatically re-connect to your phone if you press the "Phone" button.

SYNC™

AppLink issues		
Issue	Possible cause(s)	Possible solution(s)
My iPhone phone is connected, my app is running, I restarted the app but I still cannot find it on SYNC.	The USB connection to SYNC may need to be reset.	Unplug the USB cable from the phone, wait a moment, and plug the USB cable back in to the phone. After a few seconds, the app should appear in SYNC's Mobile Apps Menu. If not, "Force Close" the application and restart it.
I have an Android phone. I found and started my media app on SYNC, but there is no sound or the sound is very low.	The bluetooth volume on the phone may be low.	Try increasing the Bluetooth volume of the device by using the device's volume control buttons which are most often found on the side of the device.
I can only see some of the AppLink apps running on my phone listed in SYNC's Mobile Apps Menu.	Some Android devices have a limited number of bluetooth ports apps can use to connect. If you have more AppLink apps on your phone than the number of available Bluetooth ports, you will not see all of your apps listed in SYNC's mobile apps menu.	Force close or uninstall the apps you do not want SYNC to find. If the app has a "Ford SYNC" setting, disable that setting in the app's settings menu on the phone.

SYNC System Reset
The SYNC system in your vehicle has System Reset feature that can be performed if the function of a SYNC feature is lost. This reset is intended to restore functionality and will not erase any information previously stored in the system (Such as paired devices, phonebook, call history, text messages, or user settings). To perform a System Reset, press and hold the Seek Up (>>) button while pressing and holding the Radio Power button. Release both buttons after 2-3 seconds. Please allow a few minutes for the reset to complete. After a few minutes has passed you can resume using the SYNC system.

SYNC™ 3

GENERAL INFORMATION

WARNING



Driving while distracted can result in loss of vehicle control, crash and injury. We strongly recommend that you use extreme caution when using any device that may take your focus off the road. Your primary responsibility is the safe operation of your vehicle. We recommend against the use of any hand-held device while driving and encourage the use of voice-operated systems when possible. Make sure you are aware of all applicable local laws that may affect the use of electronic devices while driving.

Getting to Know Your System

The SYNC 3 system allows you to interact with a variety of features using the touchscreen and voice commands. By integrating with your Bluetooth-enabled phone, the touchscreen provides easy interaction with audio, multimedia, climate control, navigation, and your phone's SYNC 3 compatible apps.

Using the Touchscreen

To operate the touchscreen, you can simply touch the item or option that you want to select. The button changes color when you select it.

The SYNC 3 layout allows you to quickly select the feature you wish to use.



E205444

SYNC™ 3

Item	Menu Item	Action and Description
A	Status Bar	This bar displays icons and messages pertaining to current system activities including climate settings, voice commands and phone functions such as text messages.
B	Home	This button is available on the main screens. Pressing it takes you to the home screen view.
C	Clock	This shows the current time. You can set the clock manually or have it controlled by the vehicle's GPS location. See Settings (page 437).
D	Outside Temperature	This displays the current outside temperature.
E	Feature Bar	You can touch any of the buttons on this bar to select a feature.

The touchscreen allows you quick access to all of your comfort, navigation, communication and entertainment options. Using the status and feature bar you can quickly select the feature you want to use.

Note: *Your system is equipped with a feature that allows you to access and control audio features for 10 minutes after you switch the ignition off (and no doors open).*

The Status Bar

Additional icons also display in the status bar depending on market, vehicle options and current operation. If a feature is not active, the icon does not display. Certain icons may move to the left or right depending on what options are active.

SYNC™ 3

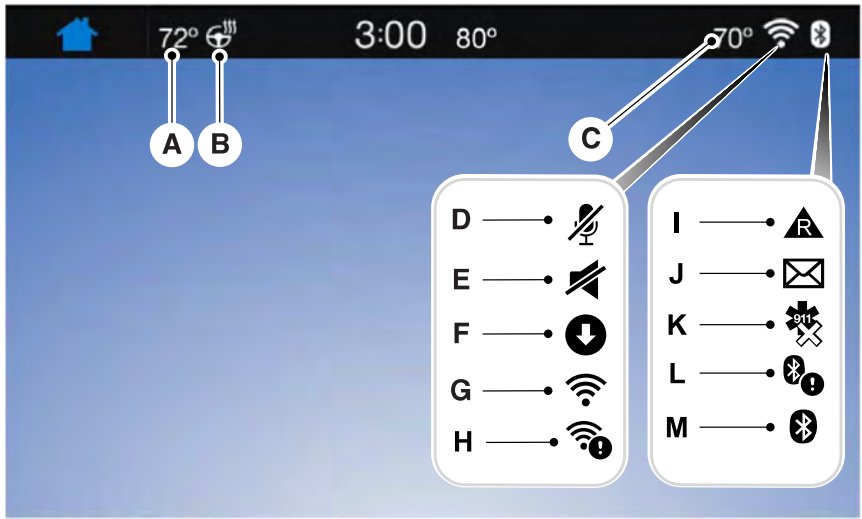

E223130

Callout	Item	Description
A	Driver Temperature	This shows the temperature the driver selects through the climate control system.
B	Heated steering wheel (If equipped)	When you activate the heated steering wheel option on the touch screen, this icon displays. It only displays when there is not a physical button for the heated steering wheel.
C	Passenger Temperature	When the passenger's temperature has been adjusted and is no longer linked to the driver's temperature, it displays here. If Dual is turned off and the temperatures are linked, the passenger's temperature does not display.
D	Microphone Mute	This icon displays when your phone's microphone is muted. A caller cannot hear you.
E	Mute	This icon displays when the audio system is muted.

SYNC™ 3

Callout	Item	Description
F	Download	This icon appears when SYNC 3 has received a software update. Pressing the icon shows more details about the new software.
G	Wi-Fi	This icon appears if a Wi-Fi network is connected.
H	Wi-Fi in Range	An available Wi-Fi network is within range.
I	Roaming	This icon displays when your cell phone is roaming.
J	Text Message	This icon displays when you receive a text message on your phone.
K	911 Assist Off	This icon displays when 911 Assist is set to off and your phone is connected to SYNC.
L	Bluetooth Alert	The Bluetooth alert icon displays when there is an active Bluetooth alert.
M	Bluetooth	This icon displays to show an active Bluetooth connection.

Messages may also appear in the status bar to provide you with notifications. You can select the message to view the associated feature.

Feature Bar

Feature Bar Item	Functions
Audio	Allows you to control the media playing in your vehicle. You can control all audio features including AM, FM and satellite radio, CDs, and media streaming over a Bluetooth device or through a USB connection.
Climate	Allows you to adjust the temperature, fan speed and airflow within the vehicle.
Phone	Allows you to make calls, receive calls, and access the phonebook of your connected device.

SYNC™ 3

Feature Bar Item	Functions
Navigation (If equipped)	Allows you to see your vehicle's location on a virtual road map, get driving directions to your destination and find points of interest along your route.
Apps	Connect and control SYNC 3 compatible apps running on your iPhone or Android device. Also, access built-in additional features such as SiriusXM Traffic and Travel Link (if equipped).
	This is where you find the Hybrid vehicle Power Flow information.
Settings	You can customize your system with various settings for the touchscreen display, feature preferences, and how you want to interact with your vehicle.
	For Energi vehicles, this is where you will find the Charge Settings information.

Cleaning the Touchscreen

You can remove fingerprints with a dry, clean, soft cloth.

If dirt or fingerprints are still on the screen, apply a small amount of alcohol to the cloth and try to clean it again.

Note: Do not use detergent or any type of solvent to clean the touchscreen.

Note: Do not pour or spray alcohol onto the touchscreen.

Using Voice Recognition

Using voice commands allows you to keep your hands on the wheel and focus on what is in front of you. The system provides feedback through audible tones, prompts, questions and spoken confirmations depending on the situation and the chosen level of interaction (voice settings).

The system also asks short questions (confirmation prompts) when it is not sure of your request or when there are multiple possible responses to your request.

When using voice commands, words and icons may appear in the status bar indicating the status of the voice command session. See **Using Voice Recognition** (page 381).

Accessing and Adjusting Modes Through Your Vehicle Information Display (If Equipped)

Depending on your vehicle and selected options you may be able to control some of the SYNC 3 features on your information display. The features are visible in the right hand display (A).

SYNC™ 3



E208626

You can make the following adjustments using the information display SYNC 3 screen:

Option	Information
Audio	Information for current audio playing.
	Select source.
Navigation	View current road and speed limit (if information is available).
	View current route, next turn, time to your destination (depending on cluster level), distance to destination (depending on cluster level), and ability to cancel route.
	If you do not have an active navigation route programmed, the compass is shown.
Phone	If you are not on a call, a call can be made by selecting: *

SYNC™ 3

Option	Information				
Quick dial	All calls	Incoming calls	Outgoing calls	Missed calls	
	If you are on a call, the call information is displayed on the information display.				
	If you are receiving a call, you can accept it by selecting OK on the right-hand steering wheel controls.				

* Depending on your vehicle options, all of these choices may not display.

Use the **OK** and arrow buttons on the right side of your steering wheel to scroll through the available modes.

The selection menu expands and different options appear.

- Press the up and down arrows to scroll through the modes.
- Press the right arrow to enter the mode, use the left arrow to exit the mode.
- Press the up and down arrows to make adjustments within the chosen mode.
- Press **OK** to confirm your selection.

Note: *If your vehicle is not equipped with navigation, compass appears in the display instead of navigation. If you press the right arrow to go into the compass menu, you can see the compass graphic. The compass displays the direction in which the vehicle is traveling, not true direction (for example, if the vehicle is traveling west, the middle of the compass graphic displays west; north displays to the left of west though its true direction is to the right of west).*

Using the Steering Wheel Controls

Depending on your vehicle and option package, you can use different controls on your steering wheel to interact with the touchscreen system in different ways.

VOL: Control the volume of audio output.

Mute: Mute the audio output.

Voice: Press to start a voice session. Press again to stop the voice prompt and immediately begin speaking. Press and hold to end a voice session.

SEEK NEXT:

- While in radio mode, press to seek between memory presets.
- While in USB, Bluetooth Audio or CD mode, press to seek between songs or press and hold to fast seek.

SEEK PREVIOUS:

- While in radio mode, press to seek between memory presets.
- While in USB, Bluetooth Audio or CD mode, press to seek between songs or press and hold to fast seek.

PHONE ACCEPT: Press to answer a call or switch between calls.

PHONE REJECT: Press to end a call or reject an incoming call.

Note: *On some models, **SEEK NEXT** may be combined with **PHONE REJECT** and **SEEK PREVIOUS** may be combined with **PHONE ACCEPT**.*

M: Touch the control repeatedly to switch between media sources (modes).

See **Steering Wheel** (page 67).

Using Your Bezel Controls

Depending on your vehicle and option package, you may also have these controls on your instrument panel:

- **Power:** Switch the audio system on and off.
- **VOL:** Control the volume of playing audio.
- **Seek and Tune:** Use as you normally would in audio modes.
- **Eject:** Eject a CD from the audio system.
- **SOURCE or MEDIA:** Press repeatedly to advance through available media modes.
- **SOUND:** Press to access the Sound menu where you can adjust sound and other audio settings.
- **1-6:** Press and hold to store or press to select an AM, FM or SIRIUS memory preset. See **Audio System** (page 314).
- **DISP:** Switch the display on or off. You can also touch the screen to switch the display back on.
- **Temperature, fan and climate control buttons:** Control the temperature, fan speed or settings of the climate control system. See **Climate Control** (page 116).

911 Assist

WARNINGS



Unless the 911 Assist setting is set on before a crash, the system will not dial for help which could delay response time, potentially increasing the risk of serious injury or death after a crash. Assist setting is set on before a crash, the system will not dial for help which could delay response time, potentially increasing the risk of serious injury or death after a crash.



Do not wait for 911 Assist to make an emergency call if you can do it yourself. Dial emergency services immediately to avoid delayed response time which could increase the risk of serious injury or death after a crash. If you

WARNINGS

do not hear 911 Assist within five seconds of the crash, the system or phone may be damaged or non-functional. Assist to make an emergency call if you can do it yourself. Dial emergency services immediately to avoid delayed response time which could increase the risk of serious injury or death after a crash. If you do not hear 911 Assist within five seconds of the crash, the system or phone may be damaged or non-functional.



Always place your phone in a secure location in your vehicle so it does not become a projectile or get damaged in a crash. Failure to do so may cause serious injury to someone or damage the phone which could prevent 911 Assist from working properly.

Note: *The SYNC 911 Assist feature must be set on before the incident.*

Note: *The SYNC 911 Assist feature only operates in the U.S., Canada or in a territory in which 911 is the emergency number.*

Note: *Before setting this feature on, make sure that you read the 911 Assist Privacy Notice later in this section for important information.*

Note: *If any user sets 911 Assist to on or off, that setting applies for all paired phones. If 911 Assist is switched off and the phone is connected to SYNC, an icon displays on the status bar.*

Note: *Every phone operates differently. While SYNC 911 Assist works with most cellular phones, some may have trouble using this feature.*

If a crash deploys an airbag (excluding knee airbags and rear inflatable safety belts [if equipped]) or activates the fuel pump shut-off, your SYNC-equipped vehicle may be able to contact emergency services by dialing 911 through a paired and connected Bluetooth-enabled phone. You can learn more about the 911 Assist feature, by visiting:

Website
<p>owner.ford.com www.syncmyride.ca www.syncmaroute.ca</p>

Important information about airbag deployment and the fuel pump shut-off See **Supplementary Restraints System** (page 39). See **Roadside Emergencies** (page 227).

To switch 911 Assist on and off please view the settings information. See **Settings** (page 437).

To make sure that 911 Assist works correctly:

- SYNC must be powered and working properly at the time of the incident and throughout feature activation and use.
- The 911 Assist feature must be set on before the incident.
- You must pair and connect a Bluetooth-enabled and compatible cell phone to SYNC.
- A connected Bluetooth-enabled phone must have the ability to make and maintain an outgoing call at the time of the incident.
- A connected Bluetooth-enabled phone must have adequate network coverage, battery power and signal strength.
- The vehicle must have battery power and be located in the U.S., Canada or in a territory in which 911 is the emergency number.

In the Event of a Crash

Not all crashes will deploy an airbag or activate the fuel pump shut-off (the triggers for 911 Assist). If a connected cell phone sustains damage or loses its connection to SYNC during a crash, SYNC will search for and try to connect to a previously paired cell phone; SYNC will then attempt to call the emergency services.

Before making the call:

- SYNC provides a short window of time (about 10 seconds) to cancel the call. If you fail to cancel the call, SYNC attempts to dial 911.
- SYNC says the following, or a similar message: "SYNC will attempt to call 911, to cancel the call, press Cancel on your screen or press and hold the phone button on your steering wheel."

If you do not cancel the call, and SYNC makes a successful call, a pre-recorded message plays for the 911 operator, and then the occupant(s) in your vehicle is able to talk with the operator. Be prepared to provide your name, phone number and location immediately, because not all 911 systems are capable of receiving this information electronically.

911 Assist May Not Work If

- Your cellular phone or 911 Assist hardware sustains damage in a crash.
- The vehicle's battery or the SYNC system has no power.
- The phone(s) thrown from your vehicle are the ones paired and connected to the system.

911 Assist Privacy Notice

When you switch on 911 Assist, it may disclose to emergency services that your vehicle has been in a crash involving the deployment of an airbag or activation of the fuel pump shut-off. Certain versions or updates to 911 Assist may also be capable of electronically or verbally disclosing to 911 operators your vehicle location or other details about your vehicle or crash to assist 911 operators to provide the most appropriate emergency services. If you do not want to disclose this information, do not switch the feature on.

Safety Information

WARNING



Driving while distracted can result in loss of vehicle control, crash and injury. We strongly recommend that you use extreme caution when using any device that may take your focus off the road. Your primary responsibility is the safe operation of your vehicle. We recommend against the use of any hand-held device while driving and encourage the use of voice-operated systems when possible. Make sure you are aware of all applicable local laws that may affect the use of electronic devices while driving.

- Do not attempt to service or repair the system. Have an authorized dealer check your vehicle.
- Do not operate playing devices if the power cords or cables are broken, split or damaged. Place cords and cables out of the way, so they do not interfere with the operation of pedals, seats, compartments or safe driving abilities.

- Do not leave playing devices in your vehicle during extreme conditions as it could cause them damage. See your device's user guide for further information.
- For your safety, some SYNC 3 functions are speed-dependent. Their use is limited to when your vehicle is traveling at speeds under 3 mph (5 km/h). Make sure that you review your device's manual before using it with SYNC 3.

Speed-restricted Features

Some features of this system may be too difficult to use while your vehicle is moving so they are restricted from use unless your vehicle is stationary.

- Screens crowded with information, such as Point of Interest reviews and ratings, SiriusXM Traffic and Travel Link sports scores, movie times or ski conditions.
- Any action that requires you to use a keyboard is restricted, such as entering a navigation destination or editing information.
- All lists are limited so the user can view fewer entries (such as phone contacts or recent phone call entries).

See the following chart for more specific examples.

SYNC™ 3

Restricted features	
Cellular Phone	Pairing a Bluetooth phone.
	Browsing of list entries is limited for phone contacts and recent phone calls.
System Functionality	Editing the keypad code.
	Enabling Valet Mode.
	Editing settings while the rear view camera or active park assist are active.
Wi-Fi	Editing Wi-Fi settings.
	Editing the list of wireless networks.
	Connecting to a new Wi-Fi network.
Text Messages	Viewing received text messages.
Navigation	Using the keyboard to enter a destination.
	Demo navigation route.
	Adding or editing Navigation Favorites entries or Avoid Areas.

Creating a SYNC Owner Account

Why do I need a SYNC owner account?

- Essential for keeping up with the latest software and connected features.
- Access to customer support for any questions you may have.
- Maintain account permissions.

Visit the website to sign up and register.

Website
owner.ford.com www.syncmyride.ca

Website
www.syncmaroute.ca

MyFord Mobile™ with Embedded Modem (If Equipped)

Connect to your vehicle using the MyFord Mobile app on your smartphone. The embedded modem in your vehicle communicates with the app and allows you to start, lock, unlock and locate your vehicle remotely. The app also connects you with other vehicle resources like a parking locator, roadside assistance, dealer locations and Ford Support. MyFord Mobile

SYNC™ 3

is supported by Android and iPhone and it is available through the App Store and Google Play. The MyFord mobile app is available through a free download. Services included for four years. Text and data rates apply to usage.

Updating Your System

You can choose to download the update onto a USB drive or use Wi-Fi to deliver automatic updates.

USB Updates

To use the USB update you need to log into your owner account and visit the SYNC software update page.

Website
owner.ford.com www.syncmyride.ca www.syncmaroute.ca

The website notifies you if an update is available. You can then select to download the update.

You will need an empty USB drive. Please check the website for minimum requirements. Once you have inserted the USB drive into your computer, choose to start the download. Follow the instructions provided to download the files to the USB drive.

The installation of most files occurs in the background, and does not interrupt your use of the system. Navigation updates cannot be installed in the background, because the files are too large.

To install the update in your vehicle, remove anything that is plugged in the USB ports on the media hub and plug in the USB drive containing the update. When the USB drive is plugged in, the installation should begin immediately. After a successful installation, the update is available the next time the vehicle is started.

Please refer to the website for any further actions.

Updating Over Wi-Fi

To update your System over Wi-Fi your vehicle must be within the range of a Wi-Fi access point. Data rates may apply.

To connect your system to Wi-Fi, select:

Menu Item	
Settings	
Wi-Fi	
Available Wi-Fi Networks	You can then select your Wi-Fi network. You may have to enter the security code if the network is secured. The system confirms when it has connected to the network.

You must also give the system permission to update automatically. Upon vehicle delivery, the System asks you if you would like to use the automatic update feature. If you agree to automatic updates, you can press OK to confirm. If this selection does not appear upon vehicle delivery you can access it through the General Settings. See **Settings** (page 437). You can also perform a master reset. See **SYNC™ 3 Troubleshooting** (page 450).

If you would like to switch this feature on later, select:

Menu Item	
Settings	
General	
Automatic System Updates	From this menu, you can enable automatic updates. If you have not done so already, the system prompts you to set up a Wi-Fi connection when you enable this feature.

When Wi-Fi and automatic updates are enabled, your system checks for software updates periodically. If a new version is available, it downloads at that time. Software downloads can take place for up to 30 minutes after you have switched your vehicle off. The updates do not interrupt the normal use of your SYNC 3 system. If a download does not complete for any reason, the download continues where it left off at the next Wi-Fi connected opportunity. Upon activation of an update, a banner displays on the touchscreen indicating the system update. Select the icon to see more detail. This icon displays for two ignition cycles.

To switch this feature off:

Menu Item	
Settings	
General	
Automatic System Updates	In this menu selection, you can change the selection for automatic updates to OFF.

Support

The SYNC support team is available to help you with any questions you are not able to answer on your own.

Monday-Saturday, 8:30am-8:00pm EST.

United States: 1-800-392-3673.

Canada: 1-800-565-3673.

Times are subject to change due to holidays.

Privacy Information

When you connect a cellular phone to SYNC 3, the system creates a profile within your vehicle that links to that cellular phone. This profile helps in offering you more cellular features and operating more efficiently. Among other things, this profile may contain data about your cellular phone book, text messages (read and unread), and call history, including history of calls when your cell phone was not connected to the system. In addition, if you connect a media device, the system creates and retains an index of supported media content. The system also records a short diagnostic log of approximately 10 minutes of all recent system activity. The log profile and other system data may be used to improve the system and help diagnose any problems that may occur.

The cellular profile, media device index, and diagnostic log remain in your vehicle unless you delete them and are generally accessible only in your vehicle when the cellular phone or media player is connected.

If you no longer plan to use the system or your vehicle, we recommend you perform a Master Reset to erase all stored information. You can find more information about the Master Reset in General Settings. See **Settings** (page 437). System data cannot be accessed without special equipment and access to your vehicle's

SYNC™ 3

SYNC 3 module. Ford Motor Company, Ford of Canada and The Lincoln Motor Company do not access the system data for any purpose other than as described absent consent, a court order, or where required by law enforcement, other

government authorities, or other third parties acting with lawful authority. Other parties may seek to access the information independently of Ford Motor Company, Ford of Canada and The Lincoln Motor Company.

HOME SCREEN

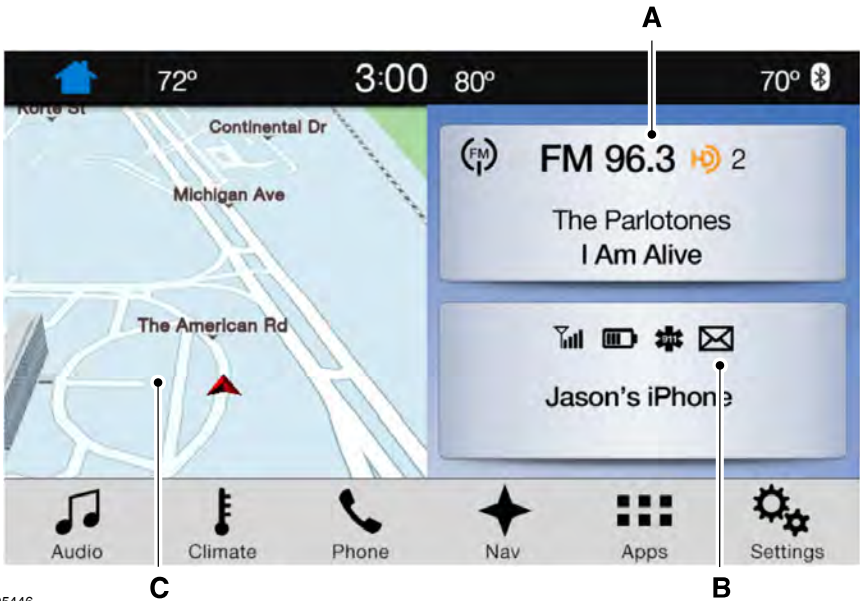

E205446

Item	Tile	Home screen display
A	Audio	Shows the active media source.

SYNC™ 3

Item	Tile	Home screen display
		If your vehicle does not have navigation, this space contains the compass.
B	Phone	The name of the connected phone appears on the screen. The status of the phone features also appear. This includes signal strength, battery charge, 911 assist setting state (On or Off), text messaging and roaming.
C	Navigation *	This map displays your current location or current route in real time. When you have navigation active, you also see the next turn and the length of time and distance to your destination. If your vehicle does not have navigation, this space contains the audio information.

* If equipped.

You can touch any of the feature displays to access that feature.

Anytime you select the home button, the system returns you to this screen.

USING VOICE RECOGNITION

The SYNC 3 system allows you to use voice commands, to control features like audio and climate controls. By using voice commands, you can keep your hands on the wheel and your eyes on the road.

You can access each feature controlled by SYNC 3 through a variety of commands.



To activate the SYNC 3 voice commands push the voice button on the steering wheel and wait for the prompt.

___ is a dynamic listing, meaning that it can be the name of anything, such as artist, the name of contact or number. The context and the description of the command tell you what to say for this dynamic option.

There are some commands that work for every feature, these commands are:

Voice Command	Action and Description
Main Menu	Brings you to the main menu.
Go back	Returns you to the previous screen.
Cancel	Ends the voice session.
List of Commands	Gives you a list of possible voice commands.
___ List of Commands	You can name any feature and the system gives a list of commands available for the feature. For example, you could say: Phone List of Commands

SYNC™ 3

Voice Command	Action and Description
	Navigation List of Commands
Next Page	You can use this command to view the next page of options on any screen where multiple pages of choices are given.
Previous Page	You can use this command to view the previous page of options on any screen where multiple pages of choices are given.
Help	Gives you available commands you can use on the current screen.

Included here are some of the most popular commands for each SYNC 3 feature.

Audio Voice Commands

___ is a dynamic listing, meaning that for audio voice commands it can be the name of a Sirius channel or a channel number, a radio frequency number, or the name of an artist, album, song or a genre.

To control the media features, press the voice button and when prompted, say:

Voice command	Description
Sirius Channel ___ *	You can say the Sirius channel name or number such as "Sirius channel 16". You can also just say the name of a Sirius station such as "The Pulse".
AM ___ FM ___	Allows you to tune to a specific FM or AM frequency such as "88.7 FM" or "1580 AM".
FM ___ HD ___ *	Allows you to tune to a specific HD frequency such as "88.7 FM HD 1".
Bluetooth Audio	Allows you to listen to music on your Bluetooth-connected device.
USB	Allows you to listen to music on your USB connected device.
Play Genre ___ Play Playlist ___ Play Artist ___ Play Album ___ Play Podcast ___	For USB audio only, you can say the name of an artist, album, song or a genre to listen to that selection. Your system must finish indexing before this option is available. For example, you could say "Play artist, The Beatles" or "Play song, Penny Lane".

SYNC™ 3

Voice command	Description
Play Song ___ Play Audiobook ___	
Browse ___	For USB audio only, you can say the name of an artist, album, or a genre to browse by that selection. Your system must finish indexing before this option is available. For example you can say "Browse The Beatles" or "Browse folk".

* This option may not be available in all markets or may require a subscription.

Climate Voice Commands

You can control the temperature of the vehicle using voice commands.

___ is a dynamic listing, meaning that for climate voice commands it can be the desired degrees for the temperature setting.

To adjust the temperature, say:

Voice command	Description
Climate Set Temperature ___	Adjust the temperature between 59.0°F (15°C)-86.0°F (30°C).
Climate Help	

Phone Voice Commands

Pairing a Phone

You can use voice commands to connect your Bluetooth-enabled phone to the system.

To pair your phone, press the voice button and when prompted, say:

Voice command	Description
Pair Phone	Follow the on-screen instructions to complete the pairing process. See Settings (page 437).

SYNC™ 3

Making Calls

___ is a dynamic listing, meaning that for

phone voice commands it can be the name of the contact you wish to call or the digits you want to dial.

Press the voice button and say a command similar to the following:

Voice command	Description
Call ___	Allows you to call a specific contact from your phonebook such as "Call Jenny".
Call ___ at ___	Allows you to call a specific contact from your phonebook at a specific location such as "Call Jenny at Home".
Dial ___	Allows you to dial a specific number such as "Dial 867-5309".

Please make sure that you are saying the contact name exactly as it appears in your contact list.

Once you have provided the digits of the phone number, you can say the following commands:

Voice Command	Description
<0-9>	If the full number was not entered with the first command, you can continue saying the number.
Dial	Tells SYNC 3 to make the phone call.
Delete	Tells SYNC 3 to erase the last block of digits stated.
Clear	Tells SYNC 3 to erase the entire number.

Text Message Voice Commands

To access text message options, press the voice button and say:

Voice command	Description
Listen to Message	
Listen to text message ___	You can say the number of the message you would like to hear.
Reply to Message	

SYNC™ 3

Navigation Voice Commands

Setting a Destination

You can use any of the following

commands to set a destination or find a point of interest.

___ is a dynamic listing, meaning that for navigation voice commands it can be a POI category or an address.

You can find an address, a point of interest (POI), or search for points of interest by category:

Voice command	Description
Find an Address	Allows you to enter the address search functionality.
Find a ___	State the name of the POI category you would like to search for such as "Find restaurants".
Find POI	Allows you to enter the POI search functionality.
Find Intersection	Allows you to enter the intersection search functionality.
Destination Nearest ___	State the name of the POI category you would like to search for nearby such as "Destination nearest restaurants".
Destination Previous Destination	Allows you to see a list of your previous destinations.
Destination Home	Allows you to route to your home address.

In addition, you can say these commands when a route is active:

Voice command	Description
Cancel Route	Cancels the current route.
Detour	Allows you to select an alternate route.
Repeat Instruction	Repeats the last guidance prompt.
Show Route	Displays the active route.
Where Am I	Provides current location.
Zoom in	Allows you to zoom in on the map.
Zoom out	Allows you to zoom out from the map.

SYNC™ 3

Mobile App Voice Commands (If Equipped)

The following voice commands are always available:

Voice command	Description
Mobile Apps	SYNC 3 will prompt you to say the name of an app to start it on SYNC 3.
List Mobile Apps	SYNC 3 will list all of the currently available Mobile Apps.
Find New Apps	SYNC 3 will search and connect to compatible app(s) running on your mobile device.

There are also voice commands that you can use when app(s) are connected to SYNC 3:

Voice command	Description
Say the name of an app	At any time, you can say the name of a mobile app to start the mobile app on SYNC 3.
Say the name of an app, followed by help	SYNC 3 will list the available voice commands for the specified app if the app is running on SYNC 3.

SiriusXM Traffic and Travel Link Voice Commands (If Equipped)

SiriusXM Traffic and Travel Link may not be available in all markets. Activation and a subscription are required.

You can say the following commands to access SiriusXM Traffic and Travel Link:

Voice command	Description
Show Traffic	Displays a list of traffic incidents.
Show Weather Map	Displays the current weather map.
Show Fuel Prices	Displays a list of fuel prices.
Show 5 Day Forecast	Displays the 5 day weather forecast.
Help	

Voice Settings Commands

You can say the following commands to access the voice settings:

Voice command	Description
Voice Settings	Allows you to enter the voice settings functionality.
Interaction Mode Standard	Sets standard prompting with longer prompts.
Interaction Mode Advanced	Sets advanced prompting with shorter prompts.
Phone Confirmation On	Allows the system to confirm before making a phone call.
Phone Confirmation Off	The system does not confirm before placing a call.
Voice Command Lists On	The system displays a short list of available commands.
Voice Command Lists Off	The system does not display the list of commands.

Note: Depending on the current climate control settings, the fan speed may automatically go down while issuing voice commands or while making and receiving phone calls via SYNC to reduce the amount of background noise in the vehicle. The fan speed will automatically return to normal operation once the voice session ends. Fan speed can also be adjusted normally during a voice session, simply press fan buttons (or turn fan knob) to increase or decrease fan speed to desired setting.

To disable this automatic fan speed reduction feature during voice sessions, press and hold the climate control AC and Recirculated air buttons simultaneously, release and then increase fan speed within 2 seconds. To re-enable this feature, repeat the above sequence.

ENTERTAINMENT



E205443

Message	Message and description
A	Sources
B	Direct Tune
C	Presets

You can access these options using the touchscreen or voice commands.

Sources

Press this button to select the source of media you want to listen to.

Menu item	
AM	
FM	
SIRIUS	*
CD	*
USB	The name of the USB that is plugged in displays here.

SYNC™ 3

Menu item	
Bluetooth Stereo	
Apps	If you have SYNC 3 compatible apps on your connected smart phone, they display here as individual source selections.

* This feature may not be available in all markets and requires an active subscription.

AM/FM Radio

Tuning a Station

You can use the tune or seek controls on the radio bezel to select a station.

To tune a station using the touchscreen, select:

Menu item
Direct Tune

A pop up appears, allowing you to type in the frequency of a station. You can only enter a valid station for the source you are currently listening to.

You can press the backspace button to delete the previously entered number.

Once you have entered the station's call numbers, you can select:

Menu item	Action and description
Enter	Press to begin playing the station you have entered.
Cancel	Press to exit without changing the station.

Presets

To set a new preset, tune to the station and then press and hold one of the memory preset buttons. The audio mutes briefly while the system saves the station and then returns.

There are two preset banks available for AM and three banks for FM. To access additional presets, tap the preset button. The indicator on the preset button shows which bank of presets you are currently viewing.

SIRIUS® Satellite Radio (If Activated)

Note: *This feature may not be available in all markets and requires an active subscription.*

SYNC™ 3



E142593

SIRIUS satellite radio is a subscription-based satellite radio service that broadcasts a variety of music, sports, news, weather, traffic and entertainment programming. Your factory-installed SIRIUS satellite radio system includes hardware and a limited subscription term that begins on the date of sale or lease of your vehicle. See an authorized dealer for availability.

For more information on extended subscription terms (a service fee is required), the online media player and a list of SIRIUS satellite radio channels, and other features, please visit www.siriusxm.com in the United States, www.siriusxm.ca in Canada, or call SIRIUS at 1-888-539-7474.

Note: *SIRIUS reserves the unrestricted right to change, rearrange, add or delete programming. This includes canceling, moving or adding particular channels, and its prices, at any time, with or without notice to you. Ford Motor Company shall not be responsible for any such programming changes.*

Note: *This receiver includes the eCos real-time operating system. eCos is published under the eCos License.*

The following buttons are available for Sirius:

Menu item	Action and description	
Browse	Touch this button to see a list of available stations.	
Direct Tune	A pop-up appears, allowing you to type in the call numbers of a station. Once you enter the stations call numbers, you can select:	
	Enter	The system tunes to the station you select.
	Cancel	You exit the pop-up and the current station continues to play.
	You can press the backspace button to delete the previous number.	

SYNC™ 3

Menu item	Action and description	
Replay	Replay audio on the current channel. You can replay approximately 45 minutes of audio as long as you remain tuned to the current station. Changing stations erases the previous audio.	
	Live	When you are in replay mode, you are not able to select a different preset until you return to live audio. Pressing this button returns you to the live broadcast.
ALERT	Save the current song, artist, or team as a favorite. The system alerts you when it plays again on any channel. Selecting this button allows you to enable and edit alerts. See Settings (page 437).	

Memory Presets

To set a preset, tune to the station then press and hold one of the memory preset buttons. The audio mutes briefly while the system saves the station and returns once the station is stored.

There are three preset banks available for SIRIUS. To access additional presets, tap the preset button. The indicator on the preset button shows which bank of presets you are currently viewing.

Satellite Radio Electronic Serial Number (ESN)

You need your ESN to activate, modify or track your satellite radio account. See **Settings** (page 437).

SIRIUS Satellite Radio Reception Factors and Troubleshooting

Potential reception issues	
Antenna obstructions	For optimal reception performance, keep the antenna clear of snow and ice build-up and keep luggage and other materials as far away from the antenna as possible.
Terrain	Hills, mountains, tall buildings, bridges, tunnels, freeway overpasses, parking garages, dense tree foliage and thunderstorms can interfere with your reception.
Station overload	When you pass a ground-based broadcast-repeating tower, a stronger signal may overtake a weaker one and the audio system may mute.
Satellite radio signal interference	Your display may show ACQUIRING... to indicate the interference and the audio system may mute.

SYNC™ 3

Troubleshooting tips		
Message	Cause	Action
Acquiring Signal	Radio requires more than two seconds to produce audio for the selected channel.	No action required. This message should disappear shortly.
Satellite antenna fault SIRIUS system failure	There is an internal module or system failure present.	If this message does not clear shortly, or with an ignition key cycle, your receiver may have a fault. See an authorized dealer for service.
Invalid Channel	The channel is no longer available.	Tune to another channel or choose another preset.
Unsubscribed Channel	Your subscription does not include this channel.	Contact SIRIUS at 1-888-539-7474 to subscribe to the channel, or tune to another channel.
Satellite acquiring signal...	The signal is lost from the SIRIUS satellite or SIRIUS tower to your vehicle antenna.	The signal is blocked. When you move into an open area, the signal should return.
Updating...	Update of channel programming in progress.	No action required. The process may take up to three minutes.
Questions? Call 1-888-539-7474	Your satellite service is no longer available.	Contact SIRIUS at 1-888-539-7474 to resolve subscription issues.
None found. Check channel guide.	All the channels in the selected category are either skipped or locked.	Use the channel guide to turn off the Lock or Skip function on that station.
SIRIUS Subscription updated	SIRIUS has updated the channels available for your vehicle.	No action required.

HD Radio™ Information (If Available)

Note: This feature may not be available in all markets.

To activate HD radio, please see the Radio Settings in the Settings Chapter. See **Settings** (page 437).

Note: HD Radio broadcasts are not available in all markets.

SYNC™ 3

HD Radio technology is the digital evolution of analog AM/FM radio. Your system has a special receiver that allows it to receive digital broadcasts (where available) in addition to the analog broadcasts, it already receives. Digital broadcasts provide a better sound quality than analog broadcasts with free, crystal-clear audio and no static or distortion. For more information, and a guide to available stations and programming, please visit:

Website
www.hdradio.com

When HD Radio is on and you tune to a station broadcasting HD Radio technology, you may notice the following indicators on your screen:



E142616

The HD logo is grey when acquiring a digital station, and then changes to orange when digital audio is playing. When this logo is available, you may also see Title and Artist fields on-screen.

The multicast indicator appears in FM mode (only) if the current station is broadcasting multiple digital broadcasts. The highlighted numbers signify available digital channels where new or different content is available. HD1 signifies the main programming status and is available in analog and digital broadcasts. Other multicast stations (HD2 through HD7) are only available digitally.

Note: *There is also an additional feature for stations that have more than 1 HD multicast (For example, HD1 or HD2). The HD logo and Radio text appears as a button. Pressing this button allows you cycle through all of the HD stations on that specific frequency. For example, if you are on 101.1 and it has HD1, HD2, HD3, pressing the button repeatedly causes the radio to cycle through the HD stations in a cyclic increasing order.*

When HD Radio broadcasts are active, you can access the following functions:

Message	Action and description
Presets	Allows you to save an active channel as a memory preset. Touch and hold a memory preset slot until the sound returns. There is a brief mute while the radio saves the station. Sound returns when the channel saves. When switching to an HD2 or HD3 memory preset, the sound mutes before the digital audio plays, because the system has to reacquire the digital signal.

Note: *As with any station you save, you cannot access the saved station if your vehicle is outside the station's reception area.*

SYNC™ 3

HD Radio Reception and Station Troubleshooting

Potential reception issues	
Reception area	<p>If you are listening to a multicast station and you are on the fringe of the reception area, the station may mute due to weak signal strength.</p> <p>If you are listening to HD1, the system changes back to the analog broadcast until the digital broadcast is available again. However, if you are listening to any of the possible HD2-HD7 multicast channels, the station mutes and stays muted unless it is able to connect to the digital signal again.</p>
Station blending	<p>When the system first receives a station (aside from HD2-HD7 multicast stations), it first plays the station in the analog version. Once the receiver verifies the station is an HD Radio station, it shifts to the digital version. Depending on the station quality, you may hear a slight sound change when the station changes from analog to digital. Blending is the shift from analog to digital sound or digital back to analog sound.</p>

In order to provide the best possible experience, use the contact form to report any station issues found while listening to a station broadcasting with HD Radio technology. Independent entities own and operate each station. These stations are responsible for ensuring all audio streams and data fields are accurate.

Potential station issues		
Issues	Cause	Action
Echo, stutter, skip or repeat in audio. Increase or decrease in audio volume.	This is poor time alignment by the radio broadcaster.	No action required. This is a broadcast issue.
Sound fading or blending in and out.	The radio is shifting between analog and digital audio.	No action required. The reception issue may clear up as you continue to drive.
There is an audio mute delay when selecting HD2 or HD3, multicast preset or Direct Tune.	The digital multicast is not available until the HD Radio broadcast is decoded. Once decoded, the audio is available.	No action required. This is normal behavior. Wait until the audio is available.

SYNC™ 3

Potential station issues		
Issues	Cause	Action
Cannot access HD2 or HD3 multicast channel when recalling a preset or from a direct tune.	The previously stored multicast preset or direct tune is not available in your current reception area.	No action required. The station is not available in your current location.
Text information does not match currently playing audio.	Data service issue by the radio broadcaster.	Fill out the station issue form. *
There is no text information shown for currently selected frequency.	Data service issue by the radio broadcaster.	Fill out the station issue form. *

HD Radio Technology manufactured under license from iBiquity Digital Corp. U.S. and foreign patents. HD Radio and the HD and HD Radio logos are proprietary trademarks of iBiquity Digital Corp. Ford Motor Company and iBiquity Digital Corp. are not responsible for the content sent using HD Radio technology. Content may be changed, added or deleted at any time at the station owner's discretion.

* You can find the form here:

Website
http://www.ibiquity.com/automotive/report_radio_station_experiences

CD (If equipped)

Once you select this option, the system returns you to the main audio screen.

The current audio information appears on the screen.

The following buttons are also available:

Button	Function
Browse	You can use the browse button to select a track.
Repeat	Select this button and a small number one displays to indicate the track is set to repeat. For MP3 CDs, this button allows you to toggle through repeat off, repeat one track (a small number one displays), and repeat current folder (a small folder displays).
Shuffle	Select the shuffle symbol to have the audio on the disk play in random order.

You can use the forward, reverse, pause or play buttons to control the audio playback.

SYNC™ 3

Bluetooth Stereo or USB

Bluetooth Stereo and USB allow you to

access media that you store on your Bluetooth device or USB device such as music, audio books or podcasts.

The following buttons are available for Bluetooth and USB:

Button	Function
Repeat	Pressing the repeat button toggles the repeat setting through three modes: repeat off (button not highlighted), repeat all (button highlighted) and repeat track (button highlighted with a small number one).
Shuffle	Play the tracks in random order.

You can use the forward, reverse, pause or play buttons to control the audio playback.

To get more information about the currently playing track, press the cover art or Info button.

For some devices, SYNC 3 is able to provide 30-second skip buttons when you listen to audio books or podcasts. These buttons allow you to skip forward or backward within a track.

While playing audio from a USB device you can look for certain music by selecting the following:

Button	Function
Browse	If available, displays the list of tracks in the Now Playing playlist.
New Search	This option, which is available under browse, allows you to play all tracks or to filter the available media into one of the below categories.
	Play All
	Playlists
	Artists
	Albums
	Songs
	Genres
	Podcasts
Audio books	

SYNC™ 3

Button	Function
	Composers
A-Z Jump	This button allows you to choose a specific letter to view within the category you are browsing.
Explore Device	If available, this allows you to browse the folders and files on your USB device.

USB Port



E229068

The USB port is on the instrument panel.

This feature allows you to plug in USB media devices, memory sticks, flash drives or thumb drives, and charge devices if they support this feature.

Select this option to play audio from your USB device.

Apps

The system supports the use of certain audio apps such as iHeartRadio through a USB or bluetooth-enabled device.

Each app gives you different on-screen options depending on the app's content. See **Apps** (page 434).

Supported Media Players, Formats and Metadata Information

The system is capable of hosting nearly any digital media player, including iPod, iPhone, and most USB drives.

Supported audio formats include MP3, WMA, WAV, AAC, and FLAC.

Supported audio file extensions include MP3, WMA, WAV, M4A, M4B, AAC, and FLAC.

Supported USB file systems include: FAT, exFAT, and NTFS.

SYNC 3 is also able to organize the media from your USB device by metadata tags. Metadata tags, which are descriptive software identifiers embedded in the media files, provide information about the file.

If your indexed media files contain no information embedded in these metadata tags, SYNC 3 may classify the empty metadata tags as unknown.

SYNC 3 is capable of indexing up to 50,000 songs per USB device, for up to 10 devices.

SYNC™ 3

CLIMATE

Touch the climate button on the touchscreen to access your climate control features. Depending on your vehicle line and option package, your climate screen

may look different from one of the screens shown below. Your screen may not contain all of the features shown.

Note: You can switch temperature units between Fahrenheit and Celsius. See **Settings** (page 437).

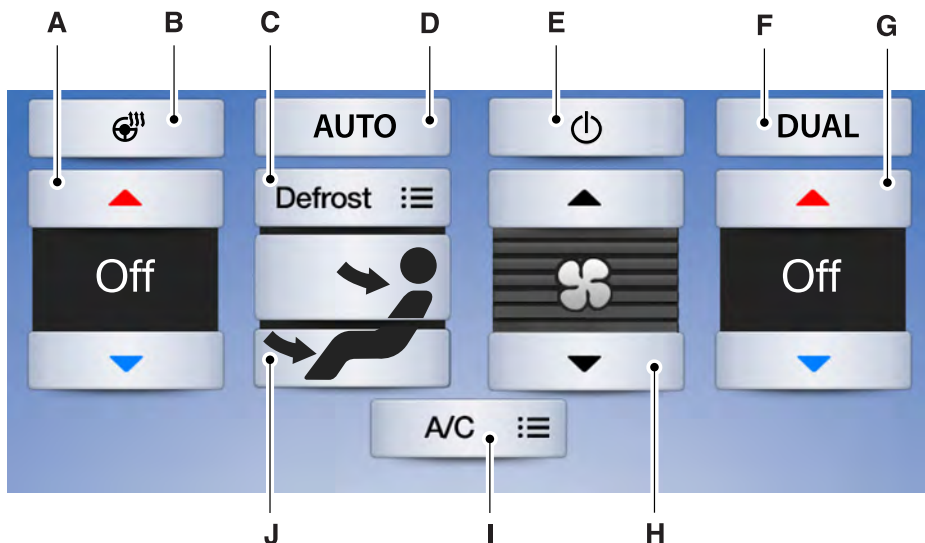

E206820

A Driver temperature: Touch up or down to adjust the temperature.

B Heated steering wheel:

Note: This feature only functions when you switch the engine on.

Touch this icon to switch the heated steering wheel on and off. It takes about 5 minutes to warm the steering wheel to 74°F in temperatures as low as -4°F. The wheel maintains an approximate temperature of 90°F and operates independently from the heated seats and other climate-control functions. The heating element is in between the leather covering and foam core to help provide maximum heat without adversely affecting the feel of the steering wheel.

Note: The heated steering wheel may remain on after remote starting the vehicle, based on your remote start settings. The heated steering wheel may also turn on when you start your vehicle, if it was on when you switched your vehicle off.

Note: For steering wheels with wood trim, the heating feature will not heat the wheel between the 10 and 2 o'clock positions.

C **Defrost:** A pop up appears on the screen to display the defrost options.

MAX Defrost: Touch the button to maximize defrosting. Air flows through the windshield vents, the fan automatically adjusts to the highest speed and the driver and passenger temperatures are set to HI. You can use this setting to defog or clear a thin covering of ice from the windshield. The heated rear window also automatically turns on when you select MAX Defrost.

Defrost: Distributes air through the windshield defroster vents and demister vents.

Heated rear window: Turns the heated rear window on and off. See **Heated Windows and Mirrors** (page 120).

D **AUTO:** Touch the button to switch on automatic operation. Select the desired temperature using the temperature control. The system adjusts fan speed, air distribution, air conditioning operation, and selects outside air or recirculated air to heat or cool the vehicle in order to maintain the desired temperature.

E **Power:** Touch the button to switch the system on and off. Switching off the climate control system prevents outside air from entering the vehicle.

F **DUAL:** This button lights up when the passenger controls are active. To switch the off and link the passenger temperature to the driver temperature, touch the DUAL button.

Note: the passenger side temperature and the DUAL indication automatically turn on when you or your passenger adjust the passenger temperature.

G **Passenger temperature:** Touch up or down to adjust the temperature.

H **Fan speed:** Touch up or down to increase or decrease the volume of air that circulates in your vehicle.

Note: You cannot adjust the fan speed when the system is set to AUTO or MAX A/C.

I **A/C:** A pop-up appears on the screen to display the air conditioning options.

MAX A/C: Touch the button to activate and maximize cooling. The driver and passenger temperatures are set to LO, recirculated air flows through the instrument panel vents, air conditioning automatically turns on and the fan automatically adjusts to the highest speed.

A/C: Touch to switch the air conditioning on or off. Use A/C with recirculated air to improve cooling performance and efficiency.

Note: In certain conditions (for example, Max Defrost), the air conditioning compressor may continue to operate even when you switch the air conditioning A/C button off.

Recirculated air: Touch to switch the recirculated air on or off. When recirculated air is on, it may reduce the amount of time needed to cool down the interior (when used with A/C) and help reduce odors from reaching the interior.

Note: Recirculated air may turn off automatically (or the system may prevent it from turning on) in all airflow modes except MAX A/C to reduce risk of fogging. It may also turn on and off automatically in Panel or Panel/Floor airflow modes during hot weather in order to improve cooling efficiency.

- J **Manual airflow distribution controls:** Select these controls individually, together, or with Defrost to direct the air flow to the area you desire.

Panel: Distributes air through the instrument panel vents.

Floor: Distributes air through the demister vents, floor vents and rear seat floor vents.

PHONE

WARNING



Driving while distracted can result in loss of vehicle control, crash and injury. We strongly recommend that you use extreme caution when using any device that may take your focus off the road. Your primary responsibility is the safe operation of your vehicle. We recommend against the use of any hand-held device while driving and encourage the use of voice-operated systems when possible. Make sure you are aware of all applicable local laws that may affect the use of electronic devices while driving.

Hands-free calling is one of the main features of the system. Once you pair your cell phone, you can access many options using the touchscreen or voice commands. While the system supports a variety of features, many are dependent on your cell phone's functionality.

Pairing Your Cell Phone for the First Time

Pair your Bluetooth-enabled phone with the system before using the functions in hands-free mode.

Switch on Bluetooth on your device to begin pairing. See your phone's manual if necessary.

To add a phone, select:

Menu Item
Add Phone

1. Follow the on-screen instructions.
2. A prompt alerts you to search for the system on your phone.
3. Select your vehicle's make and model as it displays on your phone.
4. Confirm that the six-digit number appearing on your phone matches the six-digit number on the touchscreen.
5. The touchscreen indicates when the pairing is successful.

6. Your phone may prompt you to give the system permission to access information. To check your phone's compatibility, see your phone's manual or visit the website.

Alternatively, to add a phone, select:

Menu Item
Add Phone
Then select:
Discover Other Bluetooth Devices

1. Follow the on-screen instructions.
2. A prompt alerts you to search for the system on your phone.
3. Select your phone's name when it appears on the touchscreen.
4. Confirm that the six-digit number appearing on your phone matches the six-digit number on the touchscreen.
5. The touchscreen indicates when the pairing is successful.
6. Your phone may prompt you to give the system permission to access information. To check your phone's compatibility, see your phone's manual or visit the website.

At a minimum, most cell phones with Bluetooth wireless technology support the following functions:

- Answering an incoming call.
- Ending a call.
- Dialing a number.
- Call waiting notification.
- Caller identification.

Other features, such as text messaging using Bluetooth and automatic phonebook download, are phone-dependent features.

To check your phone's compatibility, see your phone's manual or visit the website:

Websites
owner.ford.com www.syncmyride.ca www.syncmaroute.ca

Phone Menu

This menu becomes available after pairing a phone.

SYNC™ 3

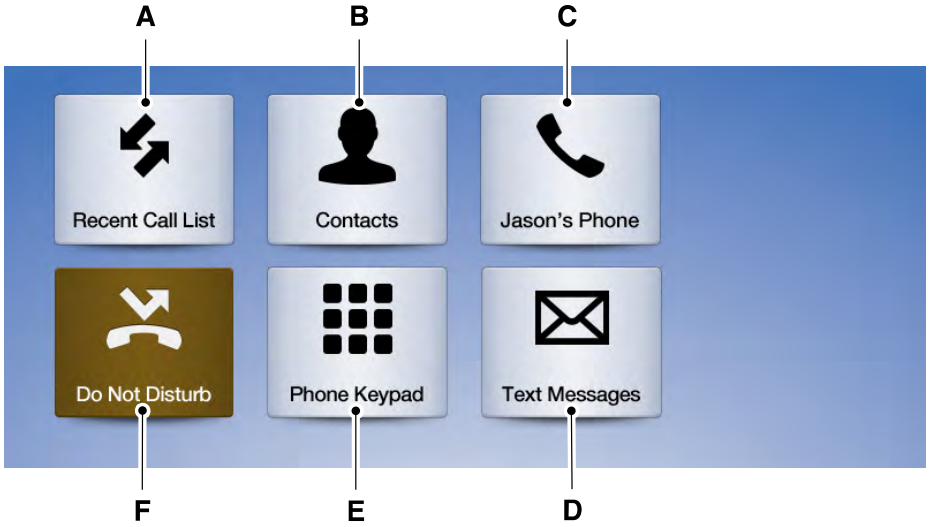

E205447

Item	Menu Item	Action and Description		
A	Recent Call List	Displays your recent calls. You can place a call by selecting an entry from this list. You can also sort the calls by selecting the drop down menu at the top of the screen. You can choose:		
		<table border="1"> <tr> <td>All</td> <td>Incoming</td> <td>Outgoing</td> <td>Missed</td> </tr> </table>	All	Incoming
All	Incoming	Outgoing	Missed	
B	Contacts	All of your contacts from your phone display in alphabetical order.		
		<table border="1"> <tr> <td>A-Z Jump</td> <td>Selecting this button allows you to choose a specific letter to view.</td> </tr> </table>	A-Z Jump	Selecting this button allows you to choose a specific letter to view.
A-Z Jump	Selecting this button allows you to choose a specific letter to view.			
C	Phone Settings	Displays the name of your phone and takes you to the phone settings options. From this menu, you can pair subsequent devices, set ring tones and alerts. See Settings (page 437).		

SYNC™ 3

Item	Menu Item	Action and Description
D	Text Messages	Displays all recent text messages.
E	Phone Keypad	Use this keypad to dial in a phone number. Use the backspace button to delete numbers.
		Call
F	Do Not Disturb	Touch this button to send all calls directly to your voicemail. New text message notifications are not displayed on the screen and all ringtones and alerts are set to silent.

Users with phones having voice services may see a button to access the feature. For example, iPhone users see a Siri button. A press and hold of the voice button on the steering wheel also accesses this feature.

Making Calls

There are many ways to make calls from the SYNC 3 system, including using voice commands. See **Using Voice Recognition** (page 331). You can use the touchscreen to place calls as well.

To call a number in your contacts, select:

Menu Item	Action and Description
Contacts	You can then select the name of the contact you want to call. Any numbers stored for that contact display along with any stored contact photos. You can then select the number that you want to call. The system begins the call.

To call a number from your recent calls, select:

Menu Item	Action and Description
Recent Call List	You can then select an entry that you want to call. The system begins the call.

To call a number that is not stored in your phone, select:

Menu Item	Action and Description
Phone Keypad	Select the digits of the number you wish to call.
Call	The system begins the call.

Pressing the backspace button deletes the last digit you typed.

Receiving Calls

During an incoming call, an audible tone sounds. Caller information appears in the display if it is available.

To accept the call, select:

Menu Item
Accept

Note: You can also accept the call by pressing the phone button on the steering wheel.

To reject the call, select:

Menu Item
Reject

Note: You can also reject the call by pressing the phone button on the steering wheel.

Ignore the call by doing nothing. SYNC 3 logs it as a missed call.

During a Phone Call

During a phone call, the contacts name and number display on the screen along with the call duration.

The phone status items are also visible:

- Signal Strength.
- Battery.
- 911 Assist (United States and Canada Only). See **Settings** (page 437).

You can select any of the following during an active phone call:

SYNC™ 3

Item	
End Call	Immediately end a phone call. You can also press the button on the steering wheel.
Keypad	Press this to access the phone keypad.
Mute	You can switch the microphone off so the caller does not hear you.

Item	
Privacy	Transfer the call to the cell phone or back to SYNC 3.

Text Messaging

Note: Downloading and sending text messages using Bluetooth are cell phone-dependent features.

Note: Certain features in text messaging are speed-dependent and not available when your vehicle is traveling at speeds over 3 mph (5 km/h).

Receiving a Text Message

When a new message arrives, an audible tone sounds and the screen displays a pop-up with the caller name and ID, if supported by your cell phone. You can select:

Menu Item	Action and Description
Hear It	Have SYNC 3 read the message to you.
View	View the text on the touchscreen.
Call	To call the sender.
Reply	You can select from 15 preset messages. Press the message that you would like to use and confirm to send the message. SYNC 3 confirms when the message is sent successfully.
Close	To exit the screen.

Smartphone Connectivity (If Equipped)

SYNC 3 allows you to use Apple CarPlay and Android Auto to access your phone.

When you use Apple CarPlay or Android Auto, you can:

- Make calls.
- Send and receive messages.
- Listen to music.
- Use your phone's voice assistant.

Smartphone connectivity disables some SYNC 3 features.

Most smartphone connectivity features require mobile data usage.

Apple CarPlay

Apple CarPlay requires an iPhone 5 or newer with iOS 7.1 or newer (Ford recommends updating to the latest iOS version). To enable this feature, plug your phone into a USB port and select Apple CarPlay on your SYNC 3 screen. See **Media Hub** (page 328).

SYNC™ 3

To disable Apple CarPlay on your iPhone, go to your SYNC 3 Settings and select:

Menu Item
Apple CarPlay Preferences
Your device is listed if SYNC detects Apple CarPlay. Select the name of your device and select:
Disable

To return to SYNC 3, go to the Apple CarPlay home screen and select the SYNC app.

Android Auto

Android Auto is compatible with most devices with Android 5.0 or newer.

Download the Android Auto app to your device from Google Play to prepare your device (this may require mobile data usage). To enable this feature, plug your device into a USB port and select Android Auto on your SYNC 3 screen. See **Media Hub** (page 328).

To disable Android Auto on your device, go to your SYNC 3 Settings and select:

Menu Item
Android Auto Preferences
Your device is listed if SYNC detects Android Auto. Select the name of your device and select:
Disable

To return to SYNC 3, select the speedometer icon in the Android Auto menu bar at the bottom of the screen and then select the option to return to SYNC.

NAVIGATION (If Equipped)

Your navigation system is comprised of two main features, destination mode and map mode.

Map Mode

Map mode shows advanced viewing comprised of 2D city maps, 3D landmarks and 3D city models (when available). 2D city maps show detailed outlines of buildings, visible land use, landscape features, and detailed railroad infrastructure for the most essential cities around the globe.

3D landmarks appear as clear, visible objects that are typically recognizable and have a certain tourism value.

3D city models are complete 3D models of entire city areas including navigable roads, parks, rivers and rendered buildings. 3D landmarks and city models appear in 3D map mode only. Coverage of these varies and improves with updated map releases.



Select the zoom in icon to see a closer view of the map.



Select the zoom out icon to see a farther away view of the map.

You can adjust the view in preset increments. You can also pinch to zoom in or out of the map.

The information bar tells you the names of streets, cities or landmarks as you hover over them with the crosshair cursor.

You can change your view of the map by tapping on the location indicator icon on the right hand side of the screen. You can choose from the following options:



Heading up (2D map) This always shows the direction of forward travel to be upward on the screen. This view is available for map scales up to 3 mi (5 km).



North up (2D map) always shows the northern direction to be upward on the screen.

3D



3D map mode provides an elevated perspective of the map. Adjust this viewing angle and rotate the map 180 degrees by touching the map twice, and

then dragging your finger along the shaded bar with arrows at the bottom of the map.



Re-center the map by pressing this icon whenever you scroll the map away from your vehicle's current location.



Points of Interest (POI)

grouping icon: You can choose up to three POI icons to display on the map. If the chosen POIs are located close together or are

at the same location a box is used to display a single category icon instead of repeating the same icon, in order to reduce clutter. When you select the box on the map, a pop-up appears indicating how many POIs are in this location. Select the pop up to see a list of the available POIs. You can scroll through and select POIs from this list.

If your vehicle is low on charge or fuel, station icons automatically display on the map.

If you have subscribed to SiriusXM Traffic and Travel Link (where available), traffic flow will be indicated on the map by green (clear), yellow (slowing), and red (stopped) road highlights. Traffic flow is indicated where the information is available and varies across the US.

You can choose to display traffic icons on the map representing twelve different types of incidents. See **Settings** (page 437).

You can set a destination by hovering above a location and selecting:

Button
Start

Range Rings and Charge Points (Energy Only)

Shaded rings appear on the map when you are driving in EV Now mode. The inner ring with no shading indicates a safe range you can travel using plug-in power only. The lightly shaded outer band reflects areas you may or may not be able to reach while

SYNC™ 3

in EV Now mode. If your destination is within this band, your vehicle may operate in Auto EV mode, running the engine as needed. The darker shaded area, beyond the rings, is not likely reachable using only the vehicle's available plug-in energy.

The rings represent approximate ranges. Actual route distances, road grades, vehicle speed, accessory usage and other conditions affect how far your vehicle can travel in EV Now mode before recharging.

Destination Mode

To set a destination, press:

Menu Item	Description
Destination	
Enter a navigation destination in any of the following formats:	
Search	Street Address (number, street, city, state) For example "12 Mainstreet Dearborn MI"
	Partial Address (number, street) if searching in current state (number, street and zip code (or postal code in Canada)) if searching out of state You can enter unique addresses that contain door number prefixes with or without the prefix. For example, you could enter "6N340 Fairway Lane" or "340 Fairway Lane".
	City (name or zip code)
	Point of Interest (name or category)
	Intersection (street 1 / street 2) (street 1 and street 2) (street 1 & street 2) (street 1 @ street 2) (street 1 at street 2)
	Latitude and Longitude (##.##### , ##.#####) One to six decimal places are accepted.

SYNC™ 3

Menu Item	Description	
	<p>You are given autocomplete options below the address bar to select as you type. If you do not give an exact destination, a menu displays with your possible selections.</p>	
Previous Destinations	<p>Collections of your last 40 navigation destinations display here. You can select any option from the list to select it as your destination. These locations cannot be deleted individually. To delete them, preform a master reset. See SYNC™ 3 Troubleshooting (page 450).</p>	
Home	<p>Select to navigate to your set Home destination. The time it takes to travel from your current location to Home displays. To set your Home, press:</p>	
	Home	<p>A prompt appears asking if you would like to create a favorite for home. Select:</p>
	Yes	<p>Enter a location into the search bar and press:</p>
	Save	
Work	<p>Select to navigate to your set Work destination. The time it takes to travel from your current location to Work displays. To set your Work:</p>	
	Work	<p>A prompt appears asking if you would like to create a favorite for work. Select:</p>
	Yes	<p>Enter a location into the search bar and press:</p>
	Save	
Favorites	<p>Favorites include any location you have previously saved. To add Favorites:</p>	
	Add a Favorite	<p>Select this button and enter a location into the destination bar.</p>
	Search	<p>Select this option to have the system locate the address you have entered.</p>
	Save	<p>Select this button when the address you have entered appears on the screen.</p>
	<p>The address saves as a favorite and you see the favorites screen. You can now select this address from the favorites screen.</p>	
Point of Interest (POI) Categories	<p>POI categories that may display (based on market and vehicle configuration):</p>	

SYNC™ 3

Menu Item	Description
	Food
	Fuel
	hotel
	ATM
See All	Press to view additional categories. Once you have selected a category, follow the menus to find what you are looking for.
	Inside of these categories you can search by:
	Nearby
	Along Route
	Near Destination
	In a City

Once you have chosen your destination, press:

Menu Item	Action and Description	
Save	This saves the destination to your favorites.	
Start	This shows you a map of your entire route. You can then choose your route from three different options.	
	Fastest	Uses the fastest moving roads possible.
	Shortest	Uses the shortest distance possible.
	Economical Route	Uses the most fuel-efficient route.
	The time and distance for each route also displays.	
Cancel	On the route screen, you can choose to cancel the current navigation. The system asks for confirmation then returns you to the map mode screen.	

SYNC™ 3

Once you have chosen your destination, press:

Menu Item	Action and Description
Start	<p>The system uses a variety of screens and prompts to guide you to your destination.</p> <p>During Route guidance, you can press the maneuver arrow icon on the map if you want the system to repeat route guidance instructions. When the system repeats the last guidance instruction, it updates the distance to the next guidance instruction, since it detects that the vehicle is moving.</p> <p>The navigation map shows your estimated time of arrival, remaining travel time and the distance to your destination.</p> <p>SYNC 3 may not always announce vehicle arrival at the exact point of your destination and you may have to cancel a route manually.</p>

Navigation Menu

In map mode and during active navigation you can access the navigation menu.

During active navigation, touch the bottom of the screen to view the menu and other buttons.

To access the Navigation menu, press:

Button		
Menu		
You can then select:		
Screen View	Full Map	A full screen map displays during navigation.
	Highway Exit Info	<p>Highway exit information displays on the right hand side of the screen during navigation.</p> <p>Points of interest icons display for restaurants, hotels, fuel stations and ATMs when they are present at the exit. You can select the POI icons to receive a listing of specific locations. You can select the POI location as a waypoint or destination if desired.</p>
	Turn List	<p>Only available during an active route. Displays all of the turns on the current route.</p> <p>You can choose to avoid any road on the turn list by selecting the road from the list. A screen then appears and you can press:</p>
		<p>Avoid</p> <p>The system calculates a new route and displays a new turn list.</p>

SYNC™ 3

Button				
Traffic List	You can find the SiriusXM Traffic and Travel Link information by pressing this button. This information requires an active subscription to SiriusXM Traffic and Travel Link. When a route is not active, a list of nearby traffic incidents displays (if any are present). When a route is active, you can choose to display a list of traffic nearby or on the route.			
Navigation Settings	Press this button to adjust your preferences. See Settings (page 437).			
Where Am I?	Provides your current location city and the nearest road.			
The following are only available on the menu during an active navigation route:				
Cancel Route	The system asks for confirmation and then returns you to the map mode screen.			
Mute Guidance	Selecting this option switches off the audio navigation guidance. Press the button again to un-mute guidance.			
View Route	Press this to see a map of the full route.			
Detour	An alternate route displays in comparison with the current route.			
Edit Waypoints	Only available if you have an active waypoint on your route. See Waypoints later in this section for information on how to set waypoints.			
	Use this button to re-order or remove your waypoints.			
	<table border="1" style="width: 100%;"> <tr> <td style="width: 30%;">You can also have the system set the order for you by pressing:</td> <td>Optimize Order</td> </tr> <tr> <td>To return to your route press:</td> <td>Go</td> </tr> </table>	You can also have the system set the order for you by pressing:	Optimize Order	To return to your route press:
You can also have the system set the order for you by pressing:	Optimize Order			
To return to your route press:	Go			

Waypoints

You can add a waypoint to a navigation route as a destination along your route.

To add a waypoint:

1. Select the search icon (magnifying glass) while on an active route. This brings up the destination menu.

SYNC™ 3

2. Set your destination using any of the given methods. Once the destination has been selected, the screen allows

you to set the destination as a waypoint by selecting:

Menu Item	
Add Waypoint	The waypoint list then appears and you are able to re-order all of your waypoints by selecting the menu icon on the right hand side of the location. You can select up to five waypoints.
You can also have the system set the order for you by pressing:	Optimize Order
To return to your route, press:	Go

cityseeker (If Equipped)

Note: *cityseeker point of interest (POI) information is limited to approximately 1110 cities (1049 in the United States, 36 in Canada and 15 in Mexico).*

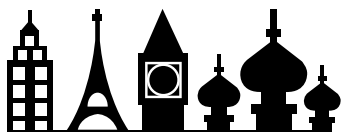

cityseeker

E225487

cityseeker, when available, is a service that provides more information about certain points of interest such as restaurants, hotels and attractions.

When you have selected a point of interest, the location and information appear, such as address, phone number and a star rating.

Press **More Information** to see a photo, a review, a list of services and facilities, the average room or meal price and the web address. This screen displays the point of interest icons.

For restaurants, cityseeker can provide information such as star rating, average cost, review, handicap access, hours of operation, and website address.

For hotels, cityseeker can provide information such as star rating, price category, review, check-in and checkout times, hotel service icons and website address. Hotel service icons include:

- Restaurant
- Business center
- Handicap facilities
- Laundry
- Refrigerator
- 24 hour room service
- Fitness center
- Internet access
- Pool
- Wi-Fi

Attractions include nearby landmarks, amusement parks, historic buildings and more. cityseeker can provide information such as star rating, reviews, hour of operation and admission price.

SiriusXM Traffic and Travel Link

SiriusXM Traffic and Travel Link is available on vehicles equipped with navigation and only in select markets. You must activate and subscribe to receive SiriusXM Traffic and Travel Link information. It helps you locate the best gas prices, find movie listings, get current traffic alerts, view the weather map, get accurate ski conditions and see current sports scores. See **Apps** (page 434).

The system calculates a reasonable efficient route based on available speed limits, traffic, and road conditions. You may know a local short cut that is more efficient at a given time than the route provided by SYNC 3, but you should expect a slight difference in minutes or miles with the SYNC 3 route.

Navigation Map Updates

Annual navigation map updates are available for purchase through your dealership, by calling 1-866-462-8837 in the United States and Canada or 01-800-557-5539 in Mexico. You can also visit:

Website
www.navigation.com/sync

You need to specify the make and model of your vehicle to determine if there is an update available.

HERE is the digital map provider for the navigation application. If you find map data errors, you may report them directly to HERE by going to www.here.com/mapcreator. HERE evaluates all reported map errors and responds with the result of their investigation by e-mail.

Map coverage includes the USA (including Puerto Rico and the US Virgin Islands), Canada and Mexico.

ELECTRIC VEHICLE INFORMATION

The power flow information for your Hybrid vehicle is available through the Apps section of the touch screen.

SYNC™ 3

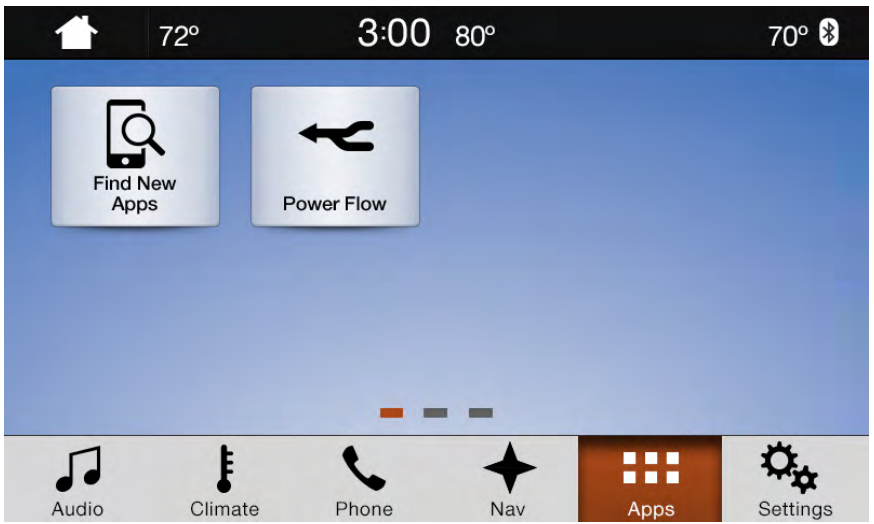

E219519

The charge settings information for your Energi vehicle is available through the Settings section of the touch screen.

SYNC™ 3



E219520

Charge Settings (Energi Vehicles Only)

This screen allows you to set up the charging convenience features.

Note: You can set up and edit these features using the MyFord Mobile internet application. For more information on MyFord Mobile and to set up your MyFord Mobile account, visit:

Website
www.myfordmobile.com

SYNC™ 3

To improve the charging experience, your vehicle has the following convenience features:

Feature	Description
Value Charge	Your vehicle schedules its charging time for when the utility rates are lowest. Contact your utility company to see what rates are available.
Charge Now	Your vehicle starts charging immediately after you connect the charging plug.
Cabin Conditioning	Get the most miles out of every charge by conditioning your plugged in vehicle. Set the cabin temperature when you set your GO Time in order to use energy from your home, or charging station, instead of your vehicle battery.
My GO Times	Setting GO Times allows you to control charging schedules and cabin conditioning settings so your vehicle is ready to drive when you are. By setting a GO Time, your vehicle can use your value charge settings to minimize your electricity costs but still prioritize getting a full charge before your GO Time. A calendar view allows you to program two GO Times per day for each day of the week. Note: Remember, you must plug in your vehicle for My GO Time to work.

Note: *Charging to 100% by your next GO Time will always be the priority. When Value Charge is selected, charging outside of off-peak times may be necessary in order to be fully charged by your GO Time.*

Charge Settings Screen

Each of the four areas highlighted below show a different feature of the charge settings screen.

SYNC™ 3

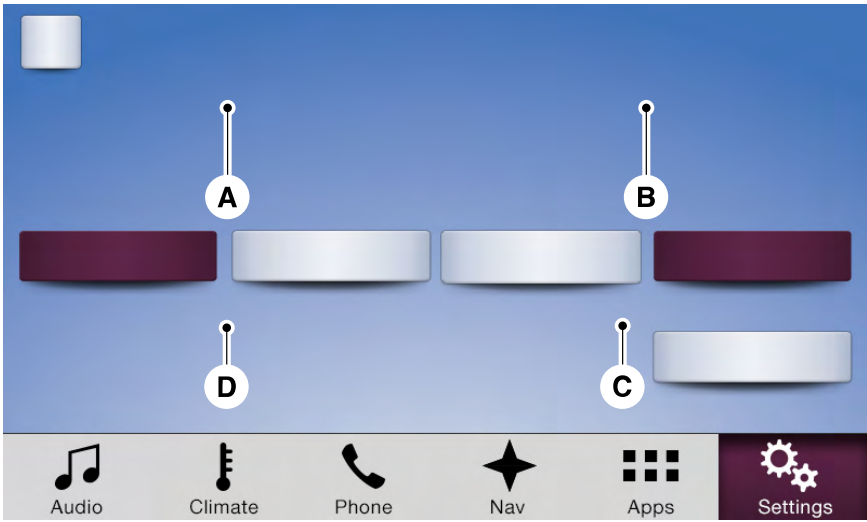

E219521

- A **My GO Time summary** displays the next GO Time and cabin temperature setting.
- B **Charging status and actual times** displays charging status with the charging start time, end time, and duration.
- C **Charge profile and mode** displays the charging profile and charging mode for the vehicle's present location.
- D **Estimated charge time limits** displays the estimated minimum and maximum times to fully charge the high-voltage battery and the battery's present state of charge as a percentage of total plug-in capacity.

My GO Time Summary

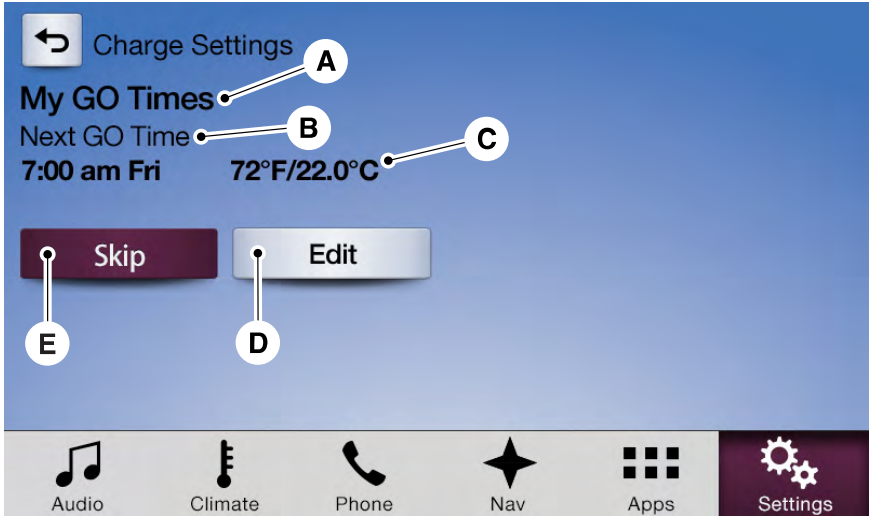

E219526

SYNC™ 3

Item	Menu Item	Action and Description
A	My GO Times	This area of the screen shows your scheduled Go Time and your cabin conditioning information.
B	Next GO Time	This is the time and date of your next set drive time. Your vehicle automatically schedules charging and cabin conditioning to finish by this time.
C	Temperature	This is the chosen cabin conditioning setting for this GO Time.
D	Edit	This accesses your GO Time Schedule (see GO Time Schedule later in this section).
E	Skip	This cancels the cabin conditioning for the present GO Time. Once you touch Skip, the GO Time and Temperature grey out, and the LED illuminates on the Skip button. Touch the button again to switch on the cabin conditioning. This feature allows you to ignore the present GO Time without having to delete it or having to switch off the entire schedule (see GO Time Schedule later in this section). After the present GO Time passes, this feature resets.

Conflict Notification

The system alerts you to any conflicts by highlighting areas of the screen in colored text.

If your battery cannot have a full charge by the scheduled drive time, the system highlights your next GO Time and Charge Complete time and the following message appears:

Menu Item	Action and Description
Charge time not sufficient to meet scheduled GO Time settings	This is normal; the vehicle is informing you of the conflicting situation. This notification only displays when the gearshift selector lever is in position P . Note: Charging occurs as soon as you plug the vehicle in. The system limits cabin conditioning to 15 minutes before your GO Time.

SYNC™ 3

To eliminate the conflict notification immediately or to prevent a conflict in the future, try the following:

- Switch the present GO Time to occur later.
- Plug the vehicle into a 240V high current charging station instead of using the 120V low current convenience cord. Higher power charging yields shorter charge times.
- Plug the vehicle in sooner.

Charging Status and Actual Times

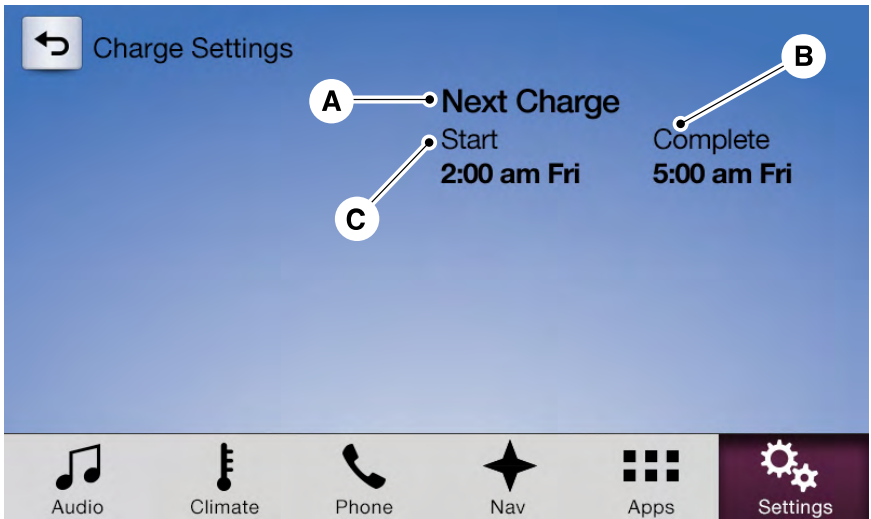

E219527

SYNC™ 3

Item	Menu Item	Action and Description	
A	Charge Status	This is the status of the charging system, which includes the charging plug, high-voltage battery and charger.	
		Next Charge	This means the vehicle is unplugged. Charge Start and Complete information is for the present vehicle location.
		Waiting to charge	This means you plugged the vehicle in and it is ready to charge. Typical of Value Charge mode, the vehicle may not start charging right away because it is set to charge at times with lower utility costs.
		Charging	This means the high-voltage battery is charging.
		Charged	This informs you that the high-voltage battery is fully charged and not currently scheduled for further charging.
		Fault	This alerts you that a fault is present and is preventing the high-voltage battery from charging. Check the charge plug connection, charge cord, and charging station.
B	Complete	This is the estimated time of charge completion.	
		Charge Now Duration	When the vehicle is in Charge Now mode, and unplugged, the system displays the charging duration in hours. Once you plug in the vehicle, the value shows the estimated time to finish charging.

SYNC™ 3

Item	Menu Item	Action and Description	
		Scheduled Charge Complete Time	When the vehicle is in Value Charge mode, the system displays the estimated charge complete time. It is normal for the estimated complete time to change when charging. The vehicle keeps charging until the high-voltage battery is fully charged.
C	Start	This is the scheduled start time of charging.	
		At Plug-In	When the vehicle is in Charge Now mode, and unplugged, the message At Plug In appears, indicating the vehicle immediately starts charging once you plug it in. Once you plug it in, the system shows the actual charge start time.
		Scheduled Charge Start Time	When the vehicle is in Value Charge mode, the system displays the scheduled charge start time (for example, 8:00 PM). Once charging starts, the system continues to display the actual charge start time.

SYNC™ 3

Value Charge Profile and Mode

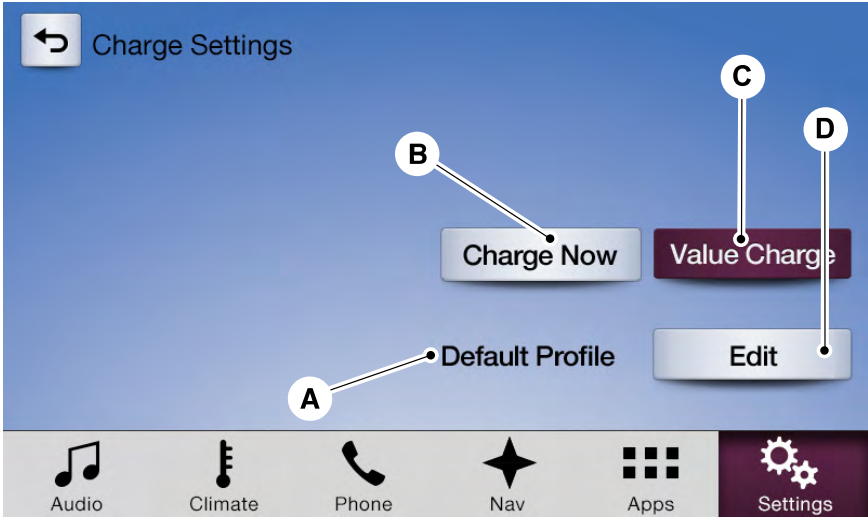

E219528

Item	Menu Item	Action and Description
A	Value Charge Profile	This is the name of the presently detected Value Charge Profile.

SYNC™ 3

Item	Menu Item	Action and Description		
		<p>The system detects a customer defined value charge profile when the vehicle is within approximately 300 ft (91.4 m) of the GPS location registered for the profile. If the vehicle is close to more than one charge profile location, it chooses the closest.</p> <table border="1" data-bbox="405 342 1004 501"> <tr> <td data-bbox="405 342 668 501">Default Profile</td> <td data-bbox="668 342 1004 501">Displays if you have not set up value charge profiles for specific locations through MyFord Mobile or if you are not close enough to a defined profile location.</td> </tr> </table>	Default Profile	Displays if you have not set up value charge profiles for specific locations through MyFord Mobile or if you are not close enough to a defined profile location.
Default Profile	Displays if you have not set up value charge profiles for specific locations through MyFord Mobile or if you are not close enough to a defined profile location.			
B	Charge Now	Touch this button if you want your vehicle to immediately charge when plugged in at this profile location. This button illuminates when Charge Now is the charge mode selected for the presently detected charge profile.		
C	Value Charge	Touch this button if you want to take advantage of off-peak electricity rates. The vehicle optimizes the charge schedule to be complete by the next GO Time. This button illuminates when Value Charge is the charge mode selected for the presently detected charge profile.		
D	Edit	Touch this button to access your Value Charge profiles settings screen (see Value Charge Profiles later in this section).		

SYNC™ 3

Estimated Charge Time Limits

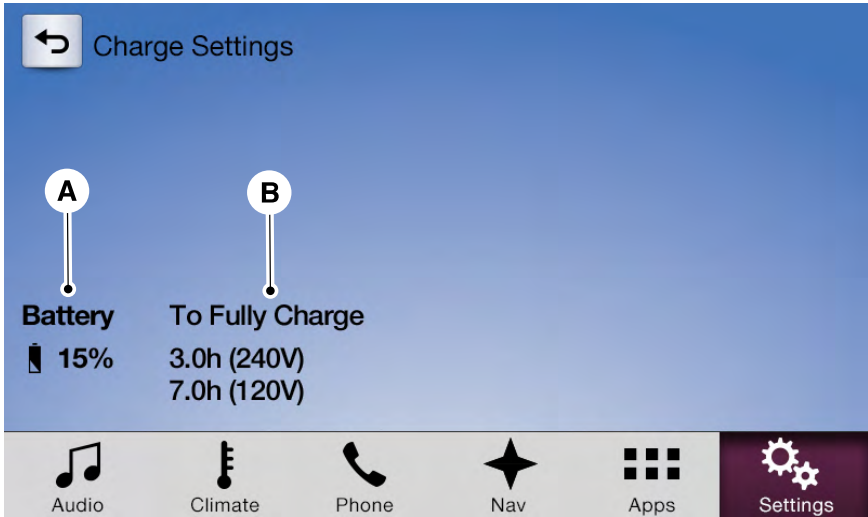

E219529

Item	Menu Item	Action and Description
A	Battery	This shows you the battery's current charge displayed as a percentage. A reading of 100% means the battery has a full charge. A reading of 0% indicates the battery has no plug-in energy left.
B	To Fully Charge	240V / High Power is the estimated minimum charging time from the present high-voltage battery level to full charge (100%). This represents the shortest amount of time you should expect the high-voltage battery to recharge under ideal conditions. Ideal conditions include a 240V charging station and a minimum 30A service and high-voltage battery at a moderate temperature.

SYNC™ 3

Item	Menu Item	Action and Description
		<p>Note: Some charging stations use lower voltage (208V), which result in longer charge times.</p> <p>120V / Low Power is the estimated maximum charging time from the present high-voltage battery level to full charge (100%). This represents the longest amount of time you should expect the high-voltage battery to recharge under normal conditions. Normal conditions include a 120V convenience cord and 12A service.</p> <p>Note: Charging may take longer when the AC line voltage is low and may indicate your electrical source is not meeting certain requirements. See Charging the High Voltage Battery (page 164).</p>

Note: These charging times are only estimates. It is normal for your actual charge duration to be longer.

GO Time Schedule

You can access the GO Time Schedule by selecting the edit option under MY GO Time on the Charge Setting screen.

Menu Item	Action and Description
On	This turns on the GO Time schedule.
Off	This turns off the GO Time schedule. This also turns off the cabin conditioning function. Use this mode to prevent using energy for cabin preconditioning when you leave your vehicle plugged in and do not plan to use it for a while, such as when on vacation. Note: If you choose to perform Value Charging with the schedule off, the vehicle schedules charging to finish at the lowest cost within 24 hours of plugging the vehicle in.
GO Time 1	This displays the GO Time day-of-week and time. The blue high-lighted GO Time is the present GO Time, which the vehicle is using for charge scheduling and cabin conditioning. You can schedule two GO Time events per day for each day of the week.

SYNC™ 3

Menu Item	Action and Description	
GO Time 2	My GO Times	Allows you to edit the GO Time and cabin conditioning temperature.
	--:--	Indicates that you can add a GO Time to this slot.
	Note: If you set GO Time 2 to occur before GO Time 1, or if you set GO Time 1 to occur after an existing GO Time 2, the GO Times will automatically sort themselves and be displayed in the correct order.	

GO Time and Cabin Conditioning

This screen allows you to enter or change the GO Time and cabin conditioning temperature.

Press any GO Time on the Schedule screen to enter the editing screen for that GO Time.

Menu Item	Action and Description			
Time (+ and -)	These change the hours and minutes of your GO Time. The minutes change in increments of five. You can also switch the settings for AM and PM by touching those buttons.			
Cabin Conditioning (+ and -)	These switch the setting for your selected cabin conditioning temperature for this GO Time event. You can select from four settings:			
	65°F (18.5°C)	72°F (22°C)	85°F (29.5°C)	Off
	Note: Cabin conditioning can perform differently depending on if you plug into a 120V convenience cord or 240V charging station. The power available for conditioning is limited to the charging station power available. Note: Your vehicle may not always reach the set cabin temperature due to charging and ambient temperature conditions. This is normal operation.			
Clear	Touching this button erases the GO Time and cabin conditioning temperature.			
Save	Touching this button stores the GO Time and temperature settings.			

Note: If you select a GO Time, but choose **Off** for the temperature setting, the vehicle schedules charging to be complete by your GO Time and does not condition the cabin.

Note: Make sure you save your settings before returning to the previous screen. If you do not touch **Save**, the system will not automatically store the settings.

SYNC™ 3

Value Charge Profiles

You can access the Value Charge Profile

screen by selecting the edit option in the bottom right hand corner of the Charge Settings screen.

Menu Item	Action and Description	
Default	This displays the charging mode and off-peak times for your Default Value Charge profile. The system displays off-peak times for weekdays; the remaining hours of the day are considered peak time. The system displays similar off-peak times for weekend days.	
	Charge Now	If you want your vehicle to immediately charge when you plug it in at this profile location.
	Value Charge	If you want to take advantage of off-peak electricity rates. The vehicle optimizes the charge schedule to be complete by the next GO Time.
	Edit	To access your Default Value Charge Profile settings screen (see Default Value Charge Profile later in this section).
Customer Defined Value Charge Profiles	Once you create profile names, this section displays the Value Charge Profile names and current Charge Mode for specific locations. You can set up and edit these profiles using the MyFord Mobile internet application. You can program up to nine unique charge profiles.	

Default Value Charge Profile

You can access your Default Value Charge Profile by selecting the edit option on the Value Charge Profiles screen.

Menu Item	Action and Description	
Weekday Weekend	Set the Weekday times and Weekend times by pressing the Weekday and Weekend buttons.	
Weekday Start	This displays the start and finish of off-peak charge times, which you can modify, using the following:	
Weekend Start	+ and -	Allows you to switch the hours of your start and finish times.

SYNC™ 3

Menu Item	Action and Description	
Weekday Finish	AM	Allows you to switch the time of your start and finish time. This setting is viewable in 12-hour mode.
Weekend Finish	PM	
240V and 120V	These buttons represent the voltage service that the default profile is using. The system uses this selection to calculate estimated charge times.	
Clear	Touching this button erases the Default Value Charge preferences.	
Save	Touching this button stores your Default Value Charge preferences. If you touch the back arrow button to return to the previous screen without saving your settings, the system does not store them and you need to enter them again.	

Note: Make sure you save your settings before returning to the previous screen. If you do not touch **Save** the system does not store your settings.

Power

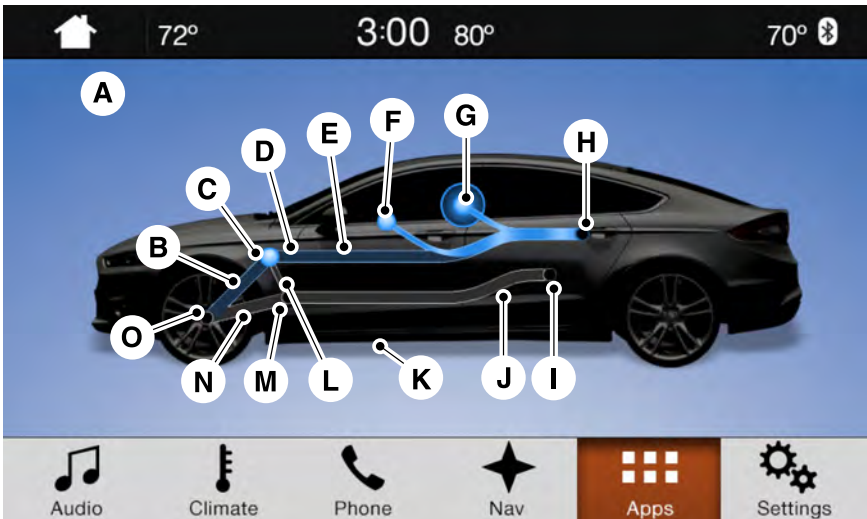

E231245

SYNC™ 3

Callout	Item	Description	
A	Power Flow	This indicates which mode is active within the vehicle system.	
		Menu Item	Action and Description
		Status: Hybrid Drive	The electric motor and gasoline engine are powering the vehicle.
		Status: Charging HV Battery	The hybrid system is storing power in the high-voltage battery.
		Status: Idle	The vehicle is either at rest, or sharing very little power between the electric system parts.
		Status: Electric Drive	The vehicle is driving in electric mode (the power is coming from the electric motor). The gasoline engine is off in this mode.
		Status: Charge Complete (Energi Only)	The high-voltage battery charging from the charging station is complete.
B	Motor-to-Wheel Flow	Shows the direction of power flow between the wheels and the electric motor.	
C	Electric Motor	Represents the hybrid electric motor. The higher the motor power is, the larger the circle around this node. Any time the vehicle is ready to be driven, the motor node illuminates.	
D	Battery-to-Motor Flow	Shows the direction of power flow between the high-voltage battery and the electric motor. Flow toward the motor indicates the battery is providing power to accelerate the vehicle (discharging the battery). Flow toward the battery indicates the electric motor is providing power to the battery (charging the battery).	
E	Plug (Energi Only)	Appears when you plug your vehicle into the charging station. When charging the high voltage battery from the charging station, you can see flow from the plug to the battery on the screen.	

SYNC™ 3

Callout	Item	Description
F	Other ²	Includes all power usage from the low voltage accessories such as the climate control fan, headlights and heated seats. The higher the power usage is from these accessories, the larger the circle around the node. This node illuminates anytime the vehicle is on since there is always some low level power in use.
G	Climate ^{2,3}	Includes the power usage from the high-voltage climate control components such as the electric A/C compressor and the electric heater (Energi only). The higher the power usage is from these components, the larger the circle around this node.
H	Battery	Represents your high-voltage battery. A circle illuminates around the node when the high-voltage battery is receiving power from regenerative braking or engine charging. The higher the power going into the high-voltage battery, the larger the circle around this node.
I	Fuel	Represents the fuel tank in the vehicle.
J	Fuel-to-Engine Flow	Shows flow from the fuel tank to the engine when the engine is on and using fuel (there are some cases where the engine is on, but not using any fuel). When the engine is on, but not using fuel, the engine node is active, but the fuel flow path is off. An example of this is when your foot is off the accelerator pedal and the vehicle is traveling at a high speed.
K	Engine On due to:	Provides you with the reason(s) the gasoline engine is on. When the gasoline engine is off, this display does not appear. Engine On due to reasons displayed by the system are in a chart following this list.
L	Motor-to-Engine Flow	Shows the direction of power flow between the engine and the electric motor. The direction indicates if the engine is providing power to the high-voltage electrical system, or if the high-voltage electrical system is providing power to control or start the engine.

SYNC™ 3

Callout	Item	Description
M	Engine	Represents the gasoline engine. It illuminates only when the gasoline engine is on. The higher the engine power is, the larger the circle around this node.
N	Engine-to-Wheels Flow	Shows the direction of the power flow between the engine and the wheels.
O	Drive	Represents the power going to the wheels. The higher the wheel power is, the larger the circle around this node. When the engine is off, drive power displays in blue. When the engine is on, drive power displays in grey.

¹The battery-to-motor flow includes battery power the vehicle is using for acceleration. It does not include energy the vehicle is using for accessories (such as air conditioning, headlights and radio). This screen displays accessories and climate usage separately.

² **Accessories** indicates electrical power demands from your vehicle's accessory systems. Accessories use power but do not contribute to making the vehicle move. The power flow displays power usage from the climate control system and other accessories separately.

³The climate control system may determine A/C is necessary even when you turn it off. In this case, you may see some climate power when the A/C is off.

Engine On due to	
Heater Setting	The engine is on because of the heater setting. Reduce or turn off the heater setting to return to electric mode.
High Speed	The engine is on because the vehicle speed exceeds the level for electric mode operation. Reduce the speed to return to electric mode.
Drive Power	The engine is on when applying pressure to the accelerator pedal or switching on the speed control. Reduce pressure on the accelerator pedal or switch off the speed control to return to full electric mode.
Neutral Gear	The engine is on because the vehicle is in neutral gear. Shift out of neutral gear to return to electric mode.
Low Gear	The engine is on because the vehicle is in low gear. Shift out of low gear to return to electric mode.

SYNC™ 3

Engine On due to	
Battery Charging	The engine is on to charge the high-voltage battery. The vehicle returns to electric mode once the battery is charged.
Low Use (Energi Only)	The engine is on to maintain engine oil quality. The vehicle returns to electric mode when low engine use mode is complete. See Engine Oil Check (page 255).
Battery Temperature (Energi Only)	The engine is on due to high or low high-voltage battery temperature. This is a normal operating condition. The vehicle returns to electric mode automatically when possible.
Normal Operation	The engine is on to optimize vehicle operation. The vehicle returns to electric mode when possible.
Engine Braking Active	The engine is on to provide increased powertrain braking. This can occur when you turn on the grade assist feature, when speed control is on or when driving with your foot off the accelerator pedal. Turning off grade assist or speed control may allow the vehicle to return to electric mode.

Privacy Notice for GPS Mapping with MyFord

MyFord allows for GPS mapping when a vehicle is registered to a MyFord Mobile account. To remove the vehicle from the account, thereby removing GPS mapping ability, a Master Reset can be performed in the vehicle. See **Settings** (page 437).

Before transferring ownership of a vehicle, owners may choose to execute a Master Reset or Factory Reset (completed via the MyFord Mobile website). Either method removes the vehicle from all MyFord Mobile accounts.

It is recommended that new owners conduct a Master Reset upon taking possession of the vehicle to remove it from any existing MyFord Mobile accounts. The new owner can activate a MyFord Mobile account by completing registration process on the website.

Website

www.myfordmobile.com
www.syncmyride.ca
www.syncmaroute.ca

APPS

The system enables voice, steering wheel, and touch screen control of SYNC 3 AppLink enabled smartphone apps. Once an app is running through AppLink, you can control main features of the app through voice commands and steering wheel controls.

Note: Available AppLink enabled apps will vary by market.

Note: You must pair and connect your smartphone via Bluetooth to SYNC 3 to access AppLink.

Note: iPhone users need to connect the phone to the USB port.

Note: For information on available apps, supported smartphone devices and troubleshooting tips please visit:

Websites
owner.ford.com www.syncmyride.ca www.syncmaroute.ca

Note: Make sure you have an active account for the app that you have downloaded. Some apps will work automatically with no setup. Other apps will want you to configure your personal settings and personalize your experience by creating stations or favorites. We recommend you do this at home or outside of your vehicle.

Note: We encourage you to review the smartphone app's terms of service and privacy policies because Ford is not responsible for your app or its use of data.

Note: AppLink is a native SYNC system feature. Accessing mobile apps through AppLink is only possible when Android Auto or Apple CarPlay are disabled. Some apps may only be accessible in the car through AppLink and others only through Android Auto or Apple CarPlay. Please refer to the Smartphone Connectivity information to disable Android Auto or Apple CarPlay.

Note: In order to use an app with SYNC 3, the App needs to be running in the background of your phone. If you shut down the app on your phone, it shuts down the app on SYNC 3 as well.

Note: If a SYNC 3 AppLink compatible app is not shown in the Apps Domain, make sure the required app is running on the mobile device.

Menu Item	Action and Description
Connect Mobile Apps	SYNC 3 will search and connect to compatible app(s) running on your mobile device.

Enabling SYNC 3 Mobile Apps

In order to enable mobile apps, SYNC 3 requires user consent to send and receive app authorization information and updates using the data plan associated with the connected device.

The connected device sends data to Ford in the United States. The information is encrypted and includes your VIN, SYNC 3 module number, odometer, usage statistics and debugging information. We retain this data for only as long as necessary to provide this service, troubleshoot, and improve products and services and to offer you products and services that may interest you where allowed by law.

Note: You must enable mobile apps for each connected device the first time you select a mobile app using the system.

Note: Ford reserves the right to limit functionality or deactivate mobile apps at any time.

Note: Standard data rates apply. Ford is not responsible for any additional charges you may receive from your service provider, when your vehicle sends or receives data through the connected device. This includes any additional charges incurred due to driving in areas when roaming out of a home network.

You can enable and disable apps through settings. See **Settings** (page 437).

App Permissions

The system organizes the App permissions into groups. You can grant these group permissions individually. You can change a permission group status any time when not driving, by using the settings menu. While in the settings menu, you can also see the data included in each group.

When you launch an app using SYNC 3, the system may ask you to grant certain permissions, for example Vehicle information, Driving characteristics, GPS and Speed, and/or Push notifications. You can enable all groups or none of them during the initial app permissions prompts. The settings menu offers individual group permission control.

Note: You are only prompted to grant permissions the first time you use an app with SYNC 3.

Note: If you disable group permissions, apps will still be enabled to work with SYNC 3 unless you deactivate All Apps in the settings menu.

SiriusXM Traffic and Travel Link (if Equipped)

WARNING



Driving while distracted can result in loss of vehicle control, crash and injury. We strongly recommend that you use extreme caution when using any device that may take your focus off the road. Your primary responsibility is the safe operation of your vehicle. We recommend against the use of any hand-held device while driving and encourage the use of voice-operated systems when possible. Make sure you are aware of all applicable local laws that may affect the use of electronic devices while driving.

Note: SiriusXM Traffic and Travel Link may not be available in all markets.

Note: In order to use SiriusXM Traffic and Travel Link, your vehicle must have navigation.

Note: A paid subscription is required to access and use these features. Go to www.siriusxm.com/travellink for more information.

Note: Visit www.siriusxm.com/traffic and click on Coverage map and details for a complete listing of all traffic areas covered by SiriusXM Traffic and Travel Link.

Note: Neither Sirius nor Ford is responsible for any errors or inaccuracies in the SiriusXM Traffic and Travel Link services or its use in vehicles.

When you subscribe to SiriusXM Traffic and Travel Link, it can help you locate the best gas prices, find movie listings, get current traffic alerts, view the current weather map, get accurate ski conditions and see scores to current sports games.

SYNC™ 3

Menu Item	Action and Description	
Traffic on Route	Touch these buttons to identify traffic incidents on your route, near your vehicle's current location or near any of your favorite places, if programmed.	
Traffic Nearby		
Fuel Prices	Touch this button to view fuel prices at stations close to your vehicle's location or on an active navigation route.	
Movie Listings	Touch this button to view nearby movie theaters and their show times, if available.	
Weather	Touch this button to view the nearby weather, current weather, or the five-day forecast for the chosen area.	
	Map	Select to see the weather map, which can show storms, radar information, charts and winds.
	Area	Select to choose from a listing of weather locations.
Sports Info	Touch this button to view scores and schedules from a variety of sports. You can also save up to 10 favorite teams for easier access. The score automatically refreshes when a game is in progress.	
Ski Conditions	Touch this button to view ski conditions for a specific area.	

Sound

Pressing this button allows you to adjust the following:

SETTINGS

Under this menu, you can access and adjust the settings for many of the system features. To access additional settings, swipe the screen left or right.

Sound Settings	
Reset All	Returns Treble, Midrange, and Bass sound settings to factory levels.
Treble	Adjusts the high frequency level.
Midrange	Adjusts the middle frequency level.
Bass	Adjusts the low frequency level.
Balance / Fade	Adjusts the sound ratio from side to side or front to back.

SYNC™ 3

Sound Settings	
Speed Adaptive Volume	Adjusts the amount the audio system volume increases with speed, or turns the feature off.
Occupancy Mode	Optimizes the sound based on the location of the listeners.
Sound Settings	Stereo
	Surround

Your vehicle might not have all of these features.

Media Player

This button is available when a media device such as a Bluetooth Stereo or USB device is the active audio source. Pressing the button allows you to access the following options for active devices only.

Menu Item	Action and Description		
Podcast Speed	For some Apple devices, SYNC 3 can adjust the playback speed of podcasts. When a podcast is playing, you can choose:		
	Slower	Normal	Faster
Audiobook Speed	For some Apple devices, SYNC 3 can adjust the playback speed of audiobooks. When an audiobook is playing, you can choose:		
	Slower	Normal	Faster
Cover Art Priority	Media Player	Cover art displays from your device's music files. If no cover art for the files exists on the device, then the Gracenote Database provides cover art.	
	Gracenote®	The Gracenote Database supplied cover art is used for your music files. This overrides any cover art from your device.	
Reset Media	Erase the stored media information in order to re-index.		
Gracenote® Data-base Info	This allows you to view the version level of the Gracenote Database.		
Device Information	This allows you to view the manufacturer and model number of your media device.		

SYNC™ 3

Clock

To adjust the time, select the up and down arrows on either side of the screen. The

arrows on the left adjust the hour and arrows on the right adjust the minute. You can then select AM or PM.

You can adjust the following features:

Menu Item	Action and Description
Clock Format	Select how time displays.
Auto Time Zone Update	When active, the clock adjusts to time zone changes. This feature is only available in vehicles with navigation.
Reset Clock to GPS Time	When selected, the vehicle clock resets to GPS satellite time.

The system automatically saves any updates you make to the settings.

Bluetooth

Pressing this button allows you to access the following:

Menu Item	Action
Bluetooth	Turning Bluetooth off disconnects all devices and does not permit new connections.

You must activate Bluetooth to pair a Bluetooth-enabled device.

The processes of pairing a Bluetooth device is the same as pairing a phone. **See Pairing a Device** in Phone settings for how to pair a device and the available options.

Phone

Pair your Bluetooth-enabled phone with the system before using the functions in hands-free mode.

Switch on Bluetooth on your device to begin pairing. See your phone's manual if necessary.

To add a phone, select:

Menu Item
Add Phone

1. Follow the on-screen instructions.
2. A prompt alerts you to search for the system on your phone.
3. Select your vehicle's make and model as it displays on your phone.
4. Confirm that the six-digit number appearing on your phone matches the six-digit number on the touchscreen.
5. The touchscreen indicates when the pairing is successful.

SYNC™ 3

- Your phone may prompt you to give the system permission to access information. To check your phone's compatibility, see your phone's manual or visit the website.

Alternatively, to add a phone, select:

Menu Item
Add Phone
Then select:
Discover Other Bluetooth Devices

- Follow the on-screen instructions.
- A prompt alerts you to search for the system on your phone.
- Select your phone's name when it appears on the touchscreen.
- Confirm that the six-digit number appearing on your phone matches the six-digit number on the touchscreen.

- The touchscreen indicates when the pairing is successful.
- Your phone may prompt you to give the system permission to access information. To check your phone's compatibility, see your phone's manual or visit the website.

Other features, such as text messaging using Bluetooth and automatic phonebook download, are phone-dependent features.

To check your phone's compatibility, see your phone's manual or visit the website:

Website
www.owner.ford.com www.syncmyride.ca www.syncmaroute.ca

Once you have paired a device you can adjust the following options.

Menu Item	Action and Description
View Devices	
You can then select:	
Add a Bluetooth Device	You can add a Bluetooth-enabled device by following the steps in the previous table.
You can select a phone by touching the name of the phone on the screen. You then have the following options:	
Connect	Depending on the status of the device, you can select either of these options to interact with the selected device.
Disconnect	
Device Information	Allows you to see phone and device information.
Make Primary	Allows you to select this device to be your preferred device.
Delete	Removes the selected device from the system.

SYNC™ 3

Menu Item	Action and Description	
Manage Contacts		
You can then select:		
Automatic Contact Download On/Off	Enable this option to have SYNC 3 periodically re-download your phonebook to keep your contact list up to date.	
Sort By:	Choose how you would like the system to display your contacts. You can choose:	
	<table border="1" style="width: 100%;"> <tr> <td style="width: 50%;">First Name</td> <td style="width: 50%;">Last Name</td> </tr> </table>	First Name
First Name	Last Name	
Re-download Contacts	Select this option to re-download your contact list manually.	
Delete Contacts	Select this option to delete the in vehicle contact list. Deleting the in vehicle list does not erase the contact list on the connected phone.	

Menu Item	Action and Description
Set Phone Ringtone	
You can then select:	
No Ringtone	No sound plays when a call comes to your phone.
Use Phone Ringtone	The currently selected ringtone on your phone plays when you receive a call. This option may not be available for all phones. If this option is available, it is the default setting.
You can also select one of the three available ringers.	

Menu Item	Action and Description
Text Messaging	
You can then select:	
No Alert (Silence)	No sound plays when a message comes to your phone.
You can select one of the three available notification sounds.	
Voice Readout	When enabled, a voice prompt alerts you when you receive a new message.

SYNC™ 3

You can enable and disable the following options as well:

Menu Item	Action and Description
Mute Audio in Privacy	When enabled, vehicle audio (such as radio or apps) is muted for the duration of the phone call even when the phone call is in privacy.
Roaming Warning	When enabled, an alert displays that your phone is roaming when you attempt to place a call.
Low Battery Notification	When enabled, a message displays when the battery on your phone is running low.

911 Assist

Note: *This service is only available in the United States and Canada.*

Select this button to modify the on or off setting for this feature. If the mobile phone's contacts have been downloaded, you can adjust the following option:

Menu Item	Action and Description
Set Emergency Contacts	You can select up to two numbers from your mobile device's phone-book as emergency contacts for quick access at the end of the 911 Assist call process.

Radio

This button is available if a Radio source such as AM or FM is the active media source. Pressing the button allows you to access the following features:

SYNC™ 3

Menu Item	Action and Description
FM HD Radio AM HD Radio (Dependent on current radio source, If Available)	Activation of this feature allows you to listen to HD radio broadcasts.
Radio Text	This feature is available when FM Radio is your active media source. Activate this feature to have the system display radio text.
Autoset Presets (AST)	Refresh
	Selecting this option stores the six strongest stations in your current location to the last preset bank of the currently tuned source.

Navigation

You can adjust many of the Navigation preferences by selecting the following menus.

Map Preferences

Menu Item	Action and Description
Map Preferences	
Then select any of the following:	
3D City Model	When this option is active, the system shows 3D renderings of buildings.
Breadcrumbs	When enabled, your vehicle's previously traveled route displays with white dots.
POI Icons	Enable this feature to display up to 3 POI icons on the navigation map.
	Once this feature is activated you can select the icons you want displayed by selecting:
Incident Map Icons	This menu allows you to choose which incident icons you would like to have displayed on the navigation map.

SYNC™ 3

Route Preferences

Menu Item	Second Level Messages, Actions and Descriptions		
Route Preferences			
Then select any of the following:			
Preferred Route	Choose to have the system display your chosen route type.		
	Shortest	Fastest	Eco
Always Use ___ Route	Bypass route selection in destination programming. The system only calculates one route based on your preferred route setting. When activated, the system uses your selected route type to calculate only one route to the desired destination.		
Use HOV Lanes	The system selects High Occupancy Vehicle or car pool lanes when providing route guidance.		
Automatically Find Parking	The system searches for and displays available parking locations as you approach your destination.		
Eco Time Penalty	Select a level of cost for the calculated Eco Route. The higher the setting, the longer the time allotment is for the route.		
Dynamic Route Guidance	Enable or disable considering traffic information when planning a route. The system can find a faster route based on heavy traffic flow information or detect a Road Closed incident and find a detour route if possible.		

Navigation Preferences

Menu Item	Action and Description
Navigation Preferences	
Guidance Prompts	You can adjust how the system provides prompts.
Then select any of the following:	
Voice and Tones	
Voice Only	
Tones Only	

SYNC™ 3

Mobile Apps

You can enable the control of compatible mobile apps running on your Bluetooth or USB device on SYNC 3. In order to enable mobile apps, SYNC 3 requires user consent to send and receive app authorization information and updates using the data plan associated with the connected device.

The connected devices sends data to Ford in the United States. The encrypted information includes your VIN, SYNC 3 module number, anonymous usage statistics and debugging information. Updates may take place automatically.

Note: *Standard data rates will apply. Ford is not responsible for any additional charges you may receive from your service provider, when your vehicle sends or receives data through the connected device. This includes any additional charges incurred due to driving in areas when roaming out of a home network.*

Menu Item	Action and Description		
Mobile Apps	Enable or disable the use of mobile apps on SYNC 3. Disabling mobile apps in the settings menu disables automatic updates and the use of mobile apps on SYNC 3.		
	You can view the status of mobile app permissions in the settings menu.		
Once Mobile Apps is enabled, you have the following options:			
Update Mobile Apps	This provides information on the current state of available app updates.		
	There are three possible statuses:		
	Update Needed	Up-To-Date	Updating Mobile Apps...
	The system has detected a new app requiring authorization or a general permissions update is required.	No update is required.	The system is trying to receive an update.
	Request Update		Select this button if an update is required and you want to request this update manually. For example, when your mobile device is connected to a Wi-Fi hotspot, select:

SYNC™ 3

Menu Item	Action and Description
	Request Update
All Apps	Grant or deny permissions to all apps at once.
There may also be SYNC 3 enabled apps listed under these options.	Grant or deny an individual app particular permissions. App permissions are organized into groups. By pressing the info book icon, you can see which signals are included in each group.

Note: Ford is not responsible or liable for any damages or loss of privacy relating to usage of an app, or dissemination of any vehicle data that you approve Ford to provide to an app.

General

Access and adjust the system settings, voice features, as well as phone, navigation and wireless settings.

Menu Item	
Language	Select to have the touch-screen display in English, Spanish or French.
Distance	Select to display units in kilometers or miles.
Temperature	Select to display units in Celsius or Fahrenheit.
Touch Screen Beep	Select to have the system beep to confirm choices made through the touch-screen.
Automatic System Updates	When you activate this option, the system automatically updates when you have an available internet connection through a Wi-Fi network or mobile connection.

SYNC™ 3

Menu Item	
About	Information pertaining to the system and its software.
Software Licenses	Documentation of the software license for the system.
Master Reset	Select to restore factory defaults. This erases all personal settings and personal data.

Wi-Fi

You can adjust the following:

Menu Item	Action and Description
Wi-Fi	Enable this option to connect to Wi-Fi for SYNC 3 vehicle software updates.
View Available Networks	This provides you with a list of available Wi-Fi networks within range.
	Clicking on a network from the list allows you to connect or disconnect from that network. The system may require a security code to connect.
	When you click the information button next to a network, more information about the network displays such as the signal strength, connection status and security type.
Wi-Fi Available Notifications	The system alerts you when your vehicle is parked and a Wi-Fi network is within range if SYNC is not already connected.

Ambient Lighting (If Equipped)

Tap a color once to active ambient lighting. This sets the color to the highest intensity.

You can drag the colors up and down to increase or decrease the intensity.

To switch ambient lighting off, press the active color once or drag the active color all the way down to zero intensity.

Vehicle

Note: *You vehicle may not have all of these features.*

You can select the following features to update their settings.

SYNC™ 3

Door Keypad Code

Select this button to add or erase a personal door keypad code. To add or erase a personal code, you first need to

enter the five-digit factory set code. You can find this code on the owner's wallet card in the glove box or from your authorized dealer.

Camera Settings

To make adjustments using the touchscreen, select:

Message	Action and Description
Camera Settings	
Then select from the following:	
Rear Camera Delay	You can enable or disable this option using the slider.

You can find more information on the rear-view camera system in the parking aids chapter of your owner manual.

Onboard Modem Serial Number (ESN)

Selecting this button on the settings menu shows you the ESN number for your system. You need this number for certain registrations such as Satellite Radio.

Charge Port Light (If Equipped)

To make adjustments using the touchscreen, select:

Menu Item	Action and Description
Charge Port Light	
You can then select:	
On	Illuminates when plugging in, opening doors, pressing the unlock button on your remote and while charging.
Off	Does not illuminate.
Limited	Illuminates only when plugging in, opening doors, or pressing the unlock button on your remote.

Note: Details on the charge port light functions are in another chapter. See **High Voltage Battery** (page 162).

SYNC™ 3

Display

To make adjustments using the touchscreen, select:

Menu Item	Action and Description	
Brightness	Make the screen display brighter or dimmer.	
Mode	You can select:	
	Auto	The screen automatically switches between day and night modes based on the outside light level.
	Day	The screen displays with a light background to enhance daytime viewing.
	Night	The screen displays with a darker background to make nighttime viewing easier.
	Off	The screen goes black and does not display anything. To switch the screen back on, simply tap the screen.

Voice Control

You can adjust the voice control settings by selecting the following options.

Menu Item	
Advanced Mode	Enable this option to remove additional voice prompts and confirmations.
Phone Confirmation	Enable this option to have the system confirm a contacts name with you before making a call.
Voice Command List	Enable this option to have the system display a list of available voice commands when the voice button is pressed.

Valet Mode

Valet mode allows you to lock the system. No information is accessible until the system is unlocked with the correct PIN.

SYNC™ 3

When you select valet mode a pop up appears informing you that a four digit code must be entered to enable and disable valet mode. You can use any PIN you chose but you must use the same PIN to disable valet mode. The system asks you to input the code.

Note: *If the system is locked and you cannot remember the PIN, please contact the Customer Relationship Center.*

United States: 1-800-392-3673

Canada: 1-800-565-3673

To enable valet mode, enter your chosen PIN. The system then asks to confirm your PIN by reentering it. The system then locks.

To unlock the system, enter the same pin number. The system reconnects to your phone and all of your options are available again.

SYNC™ 3 TROUBLESHOOTING

Your SYNC 3 system is easy to use. However, should questions arise, please refer to the tables below.

To check your cell phone's compatibility, visit the Ford website.

Website
owner.ford.com www.syncmyride.ca www.syncmaroute.ca

Cell phone issues		
Issue	Possible cause	Possible solution
There is background noise during a phone call.	The audio control settings on your cell phone may be affecting SYNC 3 performance.	Refer to your device's manual about audio adjustments.
During a call, I can hear the other person but they cannot hear me.	Possible cell phone malfunction.	Try switching your cell phone off, resetting it or removing the battery, then try again.
		Make sure that the microphone for SYNC 3 is not set to off. Look for the microphone icon on the phone screen.
During a call, I cannot hear the other person and they cannot hear me.	The system may need to be restarted.	To restart your system, shut down the engine, open and close the door, and then lock the door and wait for 2-3 minutes. Make sure that your SYNC 3 screen is black and the lighted USB port is off.
SYNC 3 is not able to download my phonebook.	This is a cell phone-dependent feature.	Check your cell phone's compatibility.
	Possible cell phone malfunction.	Make sure you allow SYNC 3 to retrieve contacts from your phone. Refer to your cell manual.

SYNC™ 3

Cell phone issues		
Issue	Possible cause	Possible solution
		You must switch on your cell phone and the automatic phonebook download feature on SYNC 3.
		Try switching your cell phone off, resetting it or removing the battery, then try again.
The system says "Phonebook downloaded" but my SYNC 3 phonebook is empty or is missing contacts.	Limitations on your cell phone's capability.	Make sure you allow SYNC 3 to retrieve contacts from your phone. Refer to your cell manual.
		If the missing contacts are stored on your SIM card, move them to your cell phone's memory.
		You must switch on your cell phone and the automatic phonebook download feature on SYNC 3.
I am having trouble connecting my cell phone to SYNC 3.	This is a cell phone-dependent feature.	Check your cell phone's compatibility.
	Possible cell phone malfunction.	Try switching your cell phone off, resetting it or removing the battery, then try again.
		Try deleting your device from SYNC 3 and deleting SYNC from your device, then trying again.
		Always check the security and auto accept prompt settings relative to the SYNC 3 Bluetooth connection on your cell phone.
		Update your cell phone's firmware.
		Switch the auto download setting off.
Text messaging is not working on SYNC 3.	This is a cell phone-dependent feature.	Check your cell phone's compatibility.
	Possible cell phone malfunction.	Try switching your cell phone off, resetting it or removing the battery, then try again.
	iPhone	<ul style="list-style-type: none"> Go to your cell phone's Settings. Go to the Bluetooth Menu.

SYNC™ 3

Cell phone issues		
Issue	Possible cause	Possible solution
		<ul style="list-style-type: none"> • Press the blue circle to the right of the device named SYNC enter the next menu. • Turn Show Notifications on. • Disconnect then reconnect your iPhone from the SYNC 3 system to activate this settings update. <p>Your iPhone is now set up to forward incoming text messages to SYNC 3. Repeat these steps for every other SYNC 3 vehicle that you connect. Your iPhone will only forward incoming text messages to SYNC 3 if the iPhone is not unlocked in the messaging application. Replying to text messages using SYNC 3 is not supported by iPhone. Text messages from WhatsApp and Facebook Messenger are not supported.</p>
Audible text messages do not work on my cell phone.	This is a cell phone-dependent feature.	Your cell phone must support downloading text messages through Bluetooth to receive incoming text messages.
	This is a cell phone limitation.	Because each cell phone is different, refer to your device's manual for the specific cell phone you are pairing. In fact, there can be differences between cell phones due to brand, model, service provider and software version.

SYNC™ 3

USB and Bluetooth Stereo issues		
Issue	Possible cause	Possible solution
I am having trouble connecting my device.	Possible device malfunction.	Disconnect the device from SYNC 3. Try switching your device off, resetting it or removing the battery, then reconnect it to SYNC 3.
		Make sure you are using the manufacturer's cable.
		Make sure to correctly insert the USB cable into the device and your vehicle's USB port.
	The device has a lock screen enabled.	Make sure that the device does not have an auto-install program or active security settings.
SYNC 3 does not recognize my device when I start my vehicle.	The device has a lock screen enabled.	Make sure your device is unlocked before connecting it to SYNC 3.
Bluetooth audio does not stream.	This is a device-dependent feature.	Make sure you are not leaving the device in your vehicle during very hot or cold temperatures.
	The device is not connected.	
SYNC 3 does not recognize music that is on my device.	Your music files may not contain the correct artist, song title, album or genre information.	Make sure you connect the device to SYNC 3 and that you have started the media player on your device.
	The file may be corrupted.	Make sure that all song details are populated.
	The song may have copyright protection that does not allow it to play.	Try replacing the corrupt file with a new version.
	The file format is not supported by SYNC 3.	Some devices require you to change the USB settings from mass storage to media transfer protocol class.
		Convert the file to a supported format. See Entertainment (page 388).

SYNC™ 3

USB and Bluetooth Stereo issues		
Issue	Possible cause	Possible solution
	The device needs to be re-indexed.	Perform a master reset. See Settings (page 437).
	The device has a lock screen enabled.	Make sure your device is unlocked before connecting it to SYNC 3.
When I connect my device, I sometimes do not hear any sound.	This is a device limitation.	Disconnect the device from SYNC 3. Try switching your device off, resetting it or removing the battery, then connect it back to SYNC 3.
		To listen to Apple devices through USB, select AirPlay from the devices Control Center, then select Dock Connector.
		To listen to Apple devices through Bluetooth Stereo, select AirPlay from the devices Control Center, then select SYNC.

Wi-Fi Issues		
Issue	Possible cause	Possible solution
Failed connection.	Password error.	Verify password.
	Weak signal.	Check for a poor Wi-Fi signal.
	Multiple Access points within range with the same SSID.	Use a unique name for your SSID, don't use the default name unless it contains a unique identifier, such as part of the MAC address.
Disconnecting after successful connection.	Weak signal probably due to distance from the hotspot, obstruction or high interference.	Position the vehicle close to the hotspot with the front of the vehicle facing the hotspot direction and remove obstacles if possible. Other Wi-Fi, Bluetooth, microwave and cordless phones may cause interference.

SYNC™ 3

Wi-Fi Issues		
Issue	Possible cause	Possible solution
Poor signal seen by SYNC 3 despite being near a hotspot.	There may be an obstruction between SYNC 3 and the hotspot.	If the vehicle is equipped with heated windshield, try positioning the vehicle so that the windshield is not facing the hotspot. If you have metallic window tinting but not on the windshield, position the vehicle to face the hotspot. If all windows are tinted, you can open the windows in the direction of the hotspot if that is feasible. Try to remove other obstructions that may impact signal quality such as opening the garage door.
A hotspot is not listed in the list of available networks.	The hotspot was defined as a hidden network.	Please set the network to visible and try again.
SYNC 3 is not seen when searching for Wi-Fi networks from your phone or other devices.	SYNC 3 does not currently provide a hotspot.	SYNC 3 currently does not provide a hotspot
Software download takes too long.	Poor signal strength, too far from the hotspot, hotspot is supporting multiple connections, slow Internet connection or other problems.	Check the signal quality (under network details), if SYNC 3 indicates good or excellent, test with another high-speed equipped hotspot where the environment is more predictable.
SYNC 3 seems to connect with a hotspot and the signal strength is excellent but the software is not being updated.	It is possible that there is no new software. The connected hotspot may be a managed one and it requires either a subscription or agreeing to the terms and conditions.	Test the connection with another device, if the hotspot requires a subscription, you may contact the service provider.

SYNC™ 3

AppLink issues		
Issue	Possible cause(s)	Possible solution(s)
AppLink Mobile Applications: When I select "Find New Apps," SYNC 3 does not find any applications.	You did not connect an AppLink Compatible phone to SYNC 3.	Make sure you have a compatible smartphone; an Android with OS 2.3 or higher or an iPhone 3GS or newer with iOS 5.0 or higher. Additionally, make sure you pair and connect your phone to SYNC 3 in order to find AppLink-capable apps on your device. iPhone users must also connect to a USB port with an Apple USB cable.
My phone is connected, but I still cannot find any apps.	AppLink-enabled apps are not installed and running on your mobile device.	Make sure you have downloaded and installed the latest version of the app from your phone's app store. Make sure the app is running on your phone. Some apps require you to register or login to the app on the phone before using them with AppLink. Also, some may have a "Ford SYNC" setting, so check the app's settings menu on the phone.
My phone is connected, my app(s) are running, but I still cannot find any apps.	Sometimes apps do not properly close and re-open their connection to SYNC 3, over ignition cycles, for example.	Closing and restarting apps may help SYNC 3 find the application if you cannot discover it inside the vehicle. On an Android device, if apps have an 'Exit' or 'Quit' option, then select it and restart the app. If the app does not have that option, select the phone's settings

SYNC™ 3

Applink issues		
Issue	Possible cause(s)	Possible solution(s)
		<p>menu and select 'Apps', then find the particular app and choose 'Force stop.' Do not forget to restart the app afterward, then select "Find New Apps" on SYNC 3.</p>
		<p>On an iPhone with iOS7+, to force close an app, double tap the home button then swipe up on the app to close it. Tap the home button again, then select the app again to restart it. After a few seconds, the app should then appear in SYNC 3's Mobile App's Menu.</p>
<p>My Android phone is connected, my app(s) are running, I restarted them, but I still cannot find any apps.</p>	<p>There is a Bluetooth issue on some older versions of the Android operating system that may cause apps that were found on your previous vehicle drive to not be found again if you did not switch Bluetooth off.</p>	<p>Switch Bluetooth off and then on to reset it on your phone. If you are in your vehicle, SYNC 3 should be able to automatically re-connect to your phone if you press the "Phone" button.</p>

SYNC™ 3

AppLink issues		
Issue	Possible cause(s)	Possible solution(s)
My iPhone is connected, my app is running, I restarted the app but I still cannot find it on SYNC 3.	You may need to reset the USB connection to SYNC 3.	Unplug the USB cable from the phone, wait a moment, and plug the USB cable back in to the phone. After a few seconds, the app should appear in SYNC 3's Mobile Apps Menu. If not, "Force Close" the application and restart it.
I have an Android phone. I found and started my media app on SYNC 3, but there is no sound or the sound is very low.	The Bluetooth volume on the phone may be low.	Increase the Bluetooth volume of the device by using the device's volume control buttons which are most often found on the side of the device.
I can only see some of the AppLink apps running on my phone listed in the SYNC 3 Mobile Apps Menu.	Some Android devices have a limited number of Bluetooth ports that apps can use to connect. If you have more AppLink apps on your phone than the number of available Bluetooth ports, you will not see all of your apps listed in the SYNC 3 mobile apps menu.	Force close or uninstall the apps you do not want SYNC 3 to find. If the app has a "Ford SYNC" setting, disable that setting in the app's settings menu on the phone.

Voice command issues		
Issue	Possible cause	Possible solution
SYNC 3 does not understand what I am saying.	You may be using the wrong voice commands.	Review the cell phone voice commands and the media voice commands at the beginning of their respective sections.
	You may be speaking too soon or at the wrong time.	Refer to the audio display during an active voice session to find a list of voice commands there. Wait for the system to prompt you before you state your command.

SYNC™ 3

Voice command issues		
Issue	Possible cause	Possible solution
SYNC 3 does not understand the name of a song or artist.	You may be using the wrong voice commands.	Review the media voice commands at the beginning of the media section.
	You may not be saying the name exactly as it appears on your device.	Say the song or artist name exactly as it is displayed on your device. For example, say "Play Artist Prince" or "Play song Purple Rain".
		Make sure you are saying the complete title such as "California remix featuring Jennifer Nettles".
		If there are any abbreviations in the name, like ESPN or CNN, you have to spell those: "E-S-P-N" or "C-N-N".
The song or artist name may have some special characters that are not being recognized by SYNC 3.	Make sure that song titles, artists, album, and playlists names do not have any special characters like *, - or +.	
SYNC 3 does not understand or is calling the wrong contact when I want to make a call.	You may not be saying the name exactly as it appears on your phone-book.	Make sure that you are saying the name exactly as it appears on your phone. For example, if your contact is "Joe Wilson", say "Call Joe Wilson". If your contact name is "Mom", say "Call Mom".
	The contact name may contain special characters.	Make sure that your contact names do not have any special characters like *, - or +.
The SYNC 3 voice control system is having trouble recognizing foreign names stored on my cell phone.	You may not be saying the name exactly as it appears on your phone-book.	SYNC 3 applies the phonetic pronunciation rules of the selected language to the contact names stored on your cell phone.
		Helpful Hint: You can select your contact manually. Press PHONE . Select the option for phonebook and then contact name. Press the soft-key option to hear it. SYNC 3 will read the contact name to you, giving you some idea of the pronunciation it is expecting.

SYNC™ 3

Voice command issues		
Issue	Possible cause	Possible solution
The SYNC 3 voice control system is having trouble recognizing foreign tracks, artists, albums, genres and playlist names from my media player or USB flash drive.	You may be saying the foreign names using the currently selected language for SYNC 3.	SYNC 3 applies the phonetic pronunciation rules of the selected language to the names stored on your media player or USB flash drive. It is able to make some exceptions for very popular artist names (for example, U2) such that you can always use the English pronunciation for these artists.
The system generates voice prompts and the pronunciation of some words may not be accurate for my language.	SYNC 3 uses text-to-speech voice prompt technology.	SYNC 3 uses a synthetically generated voice rather than pre-recorded human voice.
		SYNC 3 offers several new voice control features for a wide range of languages. Dialing a contact name directly from the phonebook without pre-recording (for example, "call John Smith") or selecting a track, artist, album, genre or playlist directly from your media player (for example, "play artist Madonna").

SYNC™ 3

General		
Issue	Possible cause	Possible solution
The language selected for the instrument cluster and information and entertainment display does not match the SYNC 3 language (phone, USB, Bluetooth audio, voice control and voice prompts).	SYNC 3 does not support the currently selected language for the instrument cluster and information and entertainment display.	SYNC 3 only supports four languages in a single module for text display, voice control and voice prompts. The country where you bought your vehicle dictates the four languages based on the most popular languages spoken. If the selected language is not available, SYNC 3 remains in the current active language.
		SYNC 3 offers several new voice control features for a wide range of languages. Dialing a contact name directly from the phonebook without pre-recording (for example, "call John Smith") or selecting a track, artist, album, genre or playlist directly from your media player (for example, "play artist Madonna").

SYNC 3 System Reset
The system has a System Reset feature that can be performed if the function of a SYNC 3 feature is lost. This reset is intended to restore functionality and will not erase any information previously stored in the system (such as paired devices, phonebook, call history, text messages, or user settings). To perform a System Reset, press and hold the Seek Up (>>) button while pressing and holding the Radio Power button. After approximately 5 seconds the screen will go black. Allow 1-2 minutes for the system reset to complete. You may then resume using the SYNC 3 system.

For additional assistance with SYNC 3 troubleshooting please call or visit the Ford Website.

Ford Support	
Customer Relationship Center	United States: 1-800-392-3673
	Canada: 1-800-565-3673
Website	owner.ford.com www.syncmyride.ca www.syncmaroute.ca

Accessories

For a complete listing of the accessories that are available for your vehicle, please contact your authorized dealer or visit the online store web site:

Web Address (United States)

www.Accessories.Ford.com
--

Web Address (Canada)

www.Accessories.Ford.ca
--

Ford Motor Company will repair or replace any properly authorized dealer-installed Ford Original Accessory found to be defective in factory-supplied materials or workmanship during the warranty period, as well as any component damaged by the defective accessories.

Ford Motor Company warrants your vehicle's accessory through the warranty that provides the greatest benefit:

- 24 months, unlimited mileage.
- The remainder of your new vehicle limited warranty.

Contact an authorized dealer for details and a copy of the warranty.

Exterior Style

- Bumper protectors.
- Graphics.
- Rear spoiler.
- Side-window deflectors.
- Splash guards.
- Wheels.

Interior Style

- All-weather floor mats.
- Door sill plates.

- Electrochromatic compass/temperature interior mirrors.
- Premium carpeted floor mats.

Lifestyle

- Ash cup or smoker's packages.
- Cargo area protectors.
- Cargo net.
- Cargo organizers.
- Charge cord bag*.
- Interior light kit.
- Roof racks and carriers*.
- Tablet cradle*.

Peace of Mind

- Bumper-mounted parking sensor*.
- Keyless entry keypad.
- Remote start.
- Roadside assistance kit*.
- Vehicle security systems.
- Wheel locks.

*Ford Licensed Accessories. The accessory manufacturer designs, develops and therefore warrants Ford Licensed Accessories, and does not design or test these accessories to Ford Motor Company engineering requirements. Contact an authorized Ford dealer for the accessory manufacturer's limited warranty details and request a copy of the Ford Licensed Accessories product limited warranty from the accessory manufacturer.

Accessories

For maximum vehicle performance, keep the following information in mind when adding accessories or equipment to your vehicle:

- When adding accessories, equipment, passengers and luggage to your vehicle, do not exceed the total weight capacity of the vehicle or of the front or rear axle (GVWR or GAWR as indicated on the Safety Compliance Certification label). Consult your authorized dealer for specific weight information.
- The Federal Communications Commission (FCC) and Canadian Radio Telecommunications Commission (CRTC) regulate the use of mobile communications systems — such as two-way radios, telephones and theft alarms - that are equipped with radio transmitters. Any such equipment installed in your vehicle should comply with Federal Communications Commission (FCC) and Canadian Radio Telecommunications Commission (CRTC) regulations and should be installed only by a qualified service technician.
- Mobile communications systems may harm the operation of your vehicle, particularly if they are not properly designed for automotive use.
- Any non-Ford electrical or electronic accessories or components that are added to the vehicle by the authorized dealer or the owner, may adversely affect battery performance and durability, and may also adversely affect the performance of other electrical systems in the vehicle.

Extended Service Plan (ESP)

PROTECT YOURSELF FROM THE RISING COST OF VEHICLE REPAIRS WITH FORD PROTECT.

Ford Protect (U.S. Only)

Ford Protect means peace of mind. It's the extended service plan backed by Ford Motor Company, and provides more protection beyond the New Vehicle Limited Warranty coverage.

Ford Protect Can Quickly Pay for Itself

One trip to the Service Center could easily exceed the price of your Ford Extended Service Plan. With Ford Protect you minimize your risk for unexpected repair bills and rising repair costs.

Up to 1,000+ Covered Vehicle Components

There are four core Ford Protect with different levels of coverage. Ask your authorized dealer for details.

1. PremiumCARE - Our most comprehensive coverage. With over 1,000 covered components, this plan is so complete it's probably easier to list what's not covered.
2. ExtraCARE - Covers 113 components, and includes many high-tech items.
3. BaseCARE - Covers 84 components.
4. PowertrainCARE - Covers 29 critical components.

Ford Protect is honored by all authorized Ford dealers in the U.S., Canada and Mexico.

That means you get:

- Reliable, quality service at any Ford or Lincoln dealership.
- Repairs performed by factory trained technicians, using genuine parts.

Rental Car Reimbursement

1st day Rental Benefit

If you bring your car into your dealer for service, we'll give you a loaner to use for the day.

Extended Rental Benefits

If your vehicle is kept overnight for covered repairs, you are eligible for rental car coverage, including bumper to bumper warranty repairs, and Field Service Actions.

Roadside Assistance

Exclusive 24/7 roadside assistance, including:

- Towing, flat-tire change and battery jump starts.
- Out of fuel and lock-out assistance.
- Travel expense reimbursement for lodging, meals and rental car.
- Assistance for taxi, shuttle, rental car coverage or other transportation.

Transferable Coverage

If you sell your vehicle before your Ford Protect plan coverage expires, you can transfer any remaining coverage to the new owner. Which should give you and your potential buyer a little more peace of mind.

Less Cost to Properly Maintain Your Vehicle

Ford Protect also offers a Premium Maintenance Plan that covers all scheduled maintenance, and selected wear items. The coverage is prepaid, so you never have to worry about the cost of your vehicle's maintenance.

Covered maintenance includes:

- Windshield wiper blades.
- Spark plugs.
- The clutch disc.

Extended Service Plan (ESP)

- Brake pads and linings.
- Shock absorbers.
- Struts.
- Engine Belts.
- Engine coolant hoses, clamps and o-rings.
- Diesel exhaust fluid replenishment.

Interest Free Finance Options

Just a 10% down payment will provide you with an affordable, no interest, no fee payment program allowing you all the security and benefits Ford ESP has to offer while paying over time. You are pre-approved with no credit check or hassles. To learn more, call our Ford Protect Extended Service Plan specialists at 800-367-3377.

Ford Protect Extended Service Plan
P.O. Box 321067
Detroit, MI 48232

EXTENDED SERVICE PLAN (CANADA ONLY)

You can get more protection for your vehicle by purchasing a Ford Extended Service Plan. Ford Extended Service Plan is the only service contract backed by Ford Motor Company of Canada, Limited. Depending on the plan you purchase, Ford Extended Service Plan provides benefits such as:

- Rental reimbursement.
- Coverage for certain maintenance and wear items.
- Protection against repair costs after your New Vehicle Limited Warranty Coverage expires.
- Roadside Assistance benefits.

There are several Ford Extended Service Plans available in various time, distance and deductible combinations. Each plan is tailored to fit your own driving needs, including reimbursement for towing and rental. When you purchase Ford Extended Service Plan, you receive added peace-of-mind protection throughout Canada, the United States and Mexico, provided by a network of participating authorized Ford Motor Company dealers.

Note: *Repairs performed outside of Canada, the United States and Mexico are not eligible for Ford Extended Service Plan coverage.*

This information is subject to change. For more information, visit your local Ford of Canada dealer or www.ford.ca to find the Ford Extended Service Plan that is right for you.

Scheduled Maintenance

GENERAL MAINTENANCE INFORMATION

Why Maintain Your Vehicle?

Carefully following the maintenance schedule helps protect against major repair expenses resulting from neglect or inadequate maintenance and may help to increase the value of your vehicle when you sell or trade it. Keep all receipts for completed maintenance with your vehicle.

We have established regular maintenance intervals for your vehicle based upon rigorous testing. It is important that you have your vehicle serviced at the proper times. These intervals serve two purposes; one is to maintain the reliability of your vehicle and the second is to keep your cost of owning your vehicle down.

It is your responsibility to have all scheduled maintenance performed and to make sure that the materials used meet the specifications identified in this owner's manual. See **Capacities and Specifications** (page 306).

Failure to perform scheduled maintenance invalidates warranty coverage on parts affected by the lack of maintenance.

Why Maintain Your Vehicle at Your Dealership?

Factory-Trained Technicians

Service technicians participate in extensive factory-sponsored certification training to help them become experts on the operation of your vehicle. Ask your dealership about the training and certification their technicians have received.

Genuine Ford and Motorcraft™ Replacement Parts

Dealerships stock Ford, Motorcraft and Ford-authorized branded re-manufactured replacement parts. These parts meet or exceed our specifications. Parts installed at your dealership carry a nationwide 24-month or unlimited mile (kilometer) parts and labor limited warranty.

If you do not use Ford authorized parts they may not meet our specifications and depending on the part, it could affect emissions compliance.

Convenience

Many dealerships have extended evening and Saturday hours to make your service visit more convenient and they offer one stop shopping. They can perform any services that are required on your vehicle, from general maintenance to collision repairs.

Note: *Not all dealers have extended hours or body shops. Please contact your dealer for details.*

Protecting Your Investment

Maintenance is an investment that pays dividends in the form of improved reliability, durability and resale value. To maintain the proper performance of your vehicle and its emission control systems, make sure you have scheduled maintenance performed at the designated intervals.

Your vehicle is very sophisticated and built with multiple, complex, performance systems. Every manufacturer develops these systems using different specifications and performance features. That is why it is important to rely upon your dealership to properly diagnose and repair your vehicle.

Scheduled Maintenance

Ford Motor Company has recommended maintenance intervals for various parts and component systems based upon engineering testing. Ford Motor Company relies upon this testing to determine the most appropriate mileage for replacement of oils and fluids to protect your vehicle at the lowest overall cost to you and recommends against maintenance schedules that deviate from the scheduled maintenance information.

We strongly recommend the use of only genuine Ford, Motorcraft or Ford-authorized re-manufactured replacement parts engineered for your vehicle.

Oil Change Indicator

Your vehicle is equipped with an information display, which indicates the proper oil change interval. This interval may be up to one year or 10000 miles (16000 kilometers).

A message appears in the information display when it is time for an oil change. Make sure you perform the oil change within two weeks or 500 miles (800 kilometers) of the message appearing. Make sure you reset the oil monitoring system after each oil change. See **Engine Oil Check** (page 255).

If your information display resets prematurely, becomes inoperative or the vehicle battery becomes discharged or disconnected, the oil monitoring system resets to 100% oil life. You should change your engine oil one year or 10000 miles (16000 kilometers) from the previous oil change. Never exceed one year or 10000 miles (16000 kilometers) between oil change intervals.

Intelligent Oil-Life Monitor (if equipped)

Your vehicle is equipped with the Intelligent Oil-Life Monitor system, which displays a message in the information display at the proper oil change interval. This interval may be up to two years or 20000 miles (32000 kilometers).

A message appears in the information display when it is time for an oil change. Make sure you perform the oil change within two weeks or 500 miles (800 kilometers) of the message appearing. Make sure you reset the Intelligent Oil-Life Monitor after each oil change. See **Engine Oil Check** (page 255).

If your information display resets prematurely or becomes inoperative, you should perform the oil change interval at six months or 5000 miles (8000 kilometers) from your last oil change. Never exceed two years or 20000 miles (32000 kilometers) between oil change intervals.

Additives and Chemicals

This owner's manual and the Ford Workshop Manual list the recommended additives and chemicals for your vehicle. We do not recommend using chemicals or additives not approved by us as part of your vehicle's normal maintenance. Please consult your warranty information.

Oils, Fluids and Flushing

In many cases, fluid discoloration is a normal operating characteristic and, by itself, does not necessarily indicate a concern or that the fluid needs to be changed. However, a qualified expert, such as the factory-trained technicians at your dealership, should inspect discolored fluids that also show signs of overheating or foreign material contamination immediately.

Scheduled Maintenance

Make sure to change your vehicle's oils and fluids at the specified intervals or in conjunction with a repair. Flushing is a viable way to change fluid for many vehicle sub-systems during scheduled maintenance. It is critical that systems are flushed only with new fluid that is the same as that required to fill and operate the

system or using a Ford-approved flushing chemical.

Owner Checks and Services

Make sure you perform the following basic maintenance checks and inspections every month or at six-month intervals.

Check every month
Engine oil level.
Function of all interior and exterior lights.
Tires (including spare) for wear and proper pressure.
Windshield washer fluid level.

Check every six months
Battery connections. Clean if necessary.
Body and door drain holes for obstructions. Clean if necessary.
Cooling system fluid level and coolant strength.
Door weatherstrips for wear. Lubricate if necessary.
Hinges, latches and outside locks for proper operation. Lubricate if necessary.
Parking brake for proper operation.
Safety belts and seat latches for wear and function.
Safety warning lamps (brake, ABS, airbag and safety belt) for operation.
Washer spray and wiper operation. Clean or replace blades as necessary.

Check Every 12 Months

Inspect the engine oil filter for signs of damage such as rust, paint blistering, scratches or dents. If any of these conditions are present, replace the filter. See **Normal Scheduled Maintenance** (page 469).

Scheduled Maintenance

Multi-point Inspection

In order to keep your vehicle running right, it is important to have the systems on your vehicle checked regularly. This can help identify potential issues and prevent major

problems. We recommend having the following multi-point inspection performed at every scheduled maintenance interval to help make sure your vehicle keeps running great.

Multi-point inspection	
Battery performance	Horn operation
Engine air filter	Radiator, cooler, heater and A/C hoses
Exhaust system	Suspension components for leaks or damage
Exterior lamps operation	Steering and linkage
Fluid levels*; fill if necessary	Tires for wear and proper pressure**
For oil and fluid leaks	Windshield for cracks, chips or pits
Half-shaft dust boots	Washer spray and wiper operation
Hazard warning system operation	

* Brake, coolant recovery reservoir, automatic transmission and window washer

**If your vehicle is equipped with a temporary mobility kit, check the tire sealant expiration Use By date on the canister. Replace as needed.

Be sure to ask your dealership service advisor or technician about the multi-point vehicle inspection. It is a comprehensive way to perform a thorough inspection of your vehicle. Your checklist gives you immediate feedback on the overall condition of your vehicle.

NORMAL SCHEDULED MAINTENANCE

Intelligent Oil-Life Monitor (if Equipped)

Your vehicle is equipped with an Intelligent Oil-Life Monitor that determines when you should change the engine oil based on how your vehicle is used. By using several important factors in its calculations, the monitor helps reduce the cost of owning your vehicle and reduces environmental waste at the same time.

Scheduled Maintenance

This means you do not have to remember to change the oil on a mileage-based schedule. Your vehicle lets you know when an oil change is due by displaying a message in the information display.

The following table provides examples of vehicle use and its impact on oil change intervals. It is a guideline only. Actual oil change intervals depend on several factors and generally decrease with severity of use.

When to expect the message prompting you to change your oil	
Interval	Vehicle use and example
7500-10000 miles (12000-16000 km)	Normal
	Normal commuting with highway driving No, or moderate, load or towing Flat to moderately hilly roads No extended idling
5000-7499 miles (8000-11999 km)	Severe
	Moderate to heavy load or towing Mountainous or off-road conditions Extended idling Extended hot or cold operation
3000-4999 miles (4800-7999 km)	Extreme
	Maximum load or towing Extreme hot or cold operation

Normal Maintenance Intervals

At every oil change interval as indicated by the information display.^{1,2}
Change engine oil and filter. ³
Inspect automatic transmission fluid level. Consult dealer for requirements.
Inspect brake pads, rotors, hoses and parking brake.
Inspect engine cooling system and motor/electronics cooling system strength and hoses.
Inspect exhaust system and heat shields.
Inspect half-shaft boots.

Scheduled Maintenance

At every oil change interval as indicated by the information display.^{1,2}

Inspect steering linkage, ball joints, suspension and tie-rod ends.

Inspect wheels and related components for abnormal noise, wear, looseness or drag.

¹ Do not exceed two years or 20000 miles (32000 kilometers) between service intervals.

² Perform multi-point inspection (recommended).

³ Reset the Intelligent Oil-Life Monitor system anytime you change the engine oil and filter. See **Engine Oil Check** (page 255).

Other maintenance items¹	
Every 10000 miles (16000 km)	Rotate tires, inspect tire wear and measure tread depth.
	Inspect engine oil filter for corrosion. ²
	Perform multi-point inspection (recommended).
Every 20000 miles (32000 km)	Replace cabin air filter.
Every 30000 miles (48000 km)	Replace engine air filter.
At 100000 miles (160000 km)	Change engine coolant and motor/electronics coolant. ³
Every 100000 miles (160000 km)	Replace spark plugs.
Every 150000 miles (240000 km)	Change automatic transmission fluid.

¹ Perform these maintenance items within 3000 miles (4800 kilometers) of the last engine oil and filter change. Do not exceed the designated distance for the interval.

² Inspect the engine oil filter for corrosion every one year or 10000 miles (16000 kilometers). If corrosion is present, change the filter then top-off the engine oil, if required. Do not reset the Intelligent Oil-Life Monitor.

³ Initial replacement at six years or 100000 miles (160000 kilometers), then every three years or 50000 miles (80000 kilometers).

Scheduled Maintenance

SPECIAL OPERATING CONDITIONS SCHEDULED MAINTENANCE

If you operate your vehicle **primarily** in any of the following conditions, you need to perform extra maintenance as indicated. If you operate your vehicle **occasionally** under any of these conditions, it is not necessary to perform the extra maintenance. For specific recommendations, see your dealership service advisor or technician.

Perform the services shown in the following tables when specified or within 3000 miles (4800 kilometers) of the message appearing in the information display prompting you to change your oil.

- **Example 1:** The message comes on at 28751 miles (46270 kilometers). Perform the 30000-mile (48000 kilometer) automatic transmission fluid replacement.
- **Example 2:** The message has **not** come on, but the odometer reads 30000 miles (48000 kilometers) (for example, the Intelligent Oil-Life Monitor was reset at 25000 miles [40000 kilometers]). Perform the engine air filter replacement.

Extensive idling or low-speed driving for long distances	
As required	Change engine oil and filter as indicated by information display and perform services listed in the Normal Scheduled Maintenance chart.*
Inspect frequently, service as required	Replace cabin air filter.
	Replace engine air filter.
Every 60000 miles (96000 km)	Replace spark plugs.

*Reset the Intelligent Oil-Life Monitor after engine oil and filter changes (if equipped). See **Engine Oil Check** (page 255).

Operating in dusty or sandy conditions (such as unpaved or dusty roads)	
Inspect frequently, service as required	Replace cabin air filter.
	Replace engine air filter.
Every 5000 miles (8000 km)	Inspect the wheels and related components for abnormal noise, wear, looseness or drag.
	Rotate tires, inspect tires for wear and measure tread depth.

Scheduled Maintenance

Operating in dusty or sandy conditions (such as unpaved or dusty roads)	
Every 5000 miles (8000 km) or six months	Change engine oil and filter.*
	Perform multi-point inspection.

*Reset the Intelligent Oil-Life Monitor after engine oil and filter changes (if equipped). See **Engine Oil Check** (page 255).

Exceptions

There are several exceptions to the Normal Schedule.

California Fuel Filter Replacement

If you register your vehicle in California, the California Air Resources Board has determined that the failure to perform this maintenance item does not nullify the emission warranty or limit recall liability before the completion of your vehicle's useful life. Ford Motor Company, however, urges you to have all recommended maintenance services performed at the specified intervals and to record all vehicle service.

Hot Climate Oil Change Intervals

Vehicles operating in the Middle East, North Africa, Sub-Saharan Africa or locations with similar climates using an American Petroleum Institute (API) Certified for Gasoline Engines (Certification mark) oil of SM or SN quality, the normal oil change interval is 3000 miles (5000 kilometers).

If the available API SM or SN oils are not available, then the oil change interval is 1800 miles (3000 kilometers).

Engine Air Filter and Cabin Air Filter Replacement

The life of the engine air filter and cabin air filter is dependent on exposure to dusty and dirty conditions. Vehicles operated in these conditions require frequent inspection and replacement of the engine air filter and cabin air filter.

Scheduled Maintenance

SCHEDULED MAINTENANCE RECORD

<input type="radio"/> Repair Order #:	<p>Dealer stamp</p>
<input type="radio"/> Distance:	
<input type="radio"/> Engine hours (optional):	
<input type="radio"/> Multi-point inspection (recommended): <input type="checkbox"/>	
<input type="radio"/> Signature:	

<input type="radio"/> Repair Order #:	<p>Dealer stamp</p>
<input type="radio"/> Distance:	
<input type="radio"/> Engine hours (optional):	
<input type="radio"/> Multi-point inspection (recommended): <input type="checkbox"/>	
<input type="radio"/> Signature:	

Scheduled Maintenance

<input type="radio"/> Repair Order #:	Dealer stamp
<input type="radio"/> Distance:	
<input type="radio"/> Engine hours (optional):	
<input type="radio"/> Multi-point inspection (recommended): <input type="checkbox"/>	
<input type="radio"/> Signature:	

<input type="radio"/> Repair Order #:	Dealer stamp
<input type="radio"/> Distance:	
<input type="radio"/> Engine hours (optional):	
<input type="radio"/> Multi-point inspection (recommended): <input type="checkbox"/>	
<input type="radio"/> Signature:	

Scheduled Maintenance

<input type="radio"/> Repair Order #:	<p>Dealer stamp</p>
<input type="radio"/> Distance:	
<input type="radio"/> Engine hours (optional):	
<input type="radio"/> Multi-point inspection (recommended): <input type="checkbox"/>	
<input type="radio"/> Signature:	

<input type="radio"/> Repair Order #:	<p>Dealer stamp</p>
<input type="radio"/> Distance:	
<input type="radio"/> Engine hours (optional):	
<input type="radio"/> Multi-point inspection (recommended): <input type="checkbox"/>	
<input type="radio"/> Signature:	

Scheduled Maintenance

<input type="radio"/> Repair Order #:	<p>Dealer stamp</p>
<input type="radio"/> Distance:	
<input type="radio"/> Engine hours (optional):	
<input type="radio"/> Multi-point inspection (recommended): <input type="checkbox"/>	
<input type="radio"/> Signature:	

<input type="radio"/> Repair Order #:	<p>Dealer stamp</p>
<input type="radio"/> Distance:	
<input type="radio"/> Engine hours (optional):	
<input type="radio"/> Multi-point inspection (recommended): <input type="checkbox"/>	
<input type="radio"/> Signature:	

Scheduled Maintenance

<input type="radio"/> Repair Order #:	<p>Dealer stamp</p>
<input type="radio"/> Distance:	
<input type="radio"/> Engine hours (optional):	
<input type="radio"/> Multi-point inspection (recommended): <input type="checkbox"/>	
<input type="radio"/> Signature:	

<input type="radio"/> Repair Order #:	<p>Dealer stamp</p>
<input type="radio"/> Distance:	
<input type="radio"/> Engine hours (optional):	
<input type="radio"/> Multi-point inspection (recommended): <input type="checkbox"/>	
<input type="radio"/> Signature:	

Scheduled Maintenance

<input type="radio"/> Repair Order #:	<p>Dealer stamp</p>
<input type="radio"/> Distance:	
<input type="radio"/> Engine hours (optional):	
<input type="radio"/> Multi-point inspection (recommended): <input type="checkbox"/>	
<input type="radio"/> Signature:	

<input type="radio"/> Repair Order #:	<p>Dealer stamp</p>
<input type="radio"/> Distance:	
<input type="radio"/> Engine hours (optional):	
<input type="radio"/> Multi-point inspection (recommended): <input type="checkbox"/>	
<input type="radio"/> Signature:	

Scheduled Maintenance

<input type="radio"/> Repair Order #:	<p>Dealer stamp</p>
<input type="radio"/> Distance:	
<input type="radio"/> Engine hours (optional):	
<input type="radio"/> Multi-point inspection (recommended): <input type="checkbox"/>	
<input type="radio"/> Signature:	

<input type="radio"/> Repair Order #:	<p>Dealer stamp</p>
<input type="radio"/> Distance:	
<input type="radio"/> Engine hours (optional):	
<input type="radio"/> Multi-point inspection (recommended): <input type="checkbox"/>	
<input type="radio"/> Signature:	

Scheduled Maintenance

<input type="radio"/> Repair Order #:	<p>Dealer stamp</p>
<input type="radio"/> Distance:	
<input type="radio"/> Engine hours (optional):	
<input type="radio"/> Multi-point inspection (recommended): <input type="checkbox"/>	
<input type="radio"/> Signature:	

<input type="radio"/> Repair Order #:	<p>Dealer stamp</p>
<input type="radio"/> Distance:	
<input type="radio"/> Engine hours (optional):	
<input type="radio"/> Multi-point inspection (recommended): <input type="checkbox"/>	
<input type="radio"/> Signature:	

Scheduled Maintenance

<input type="radio"/> Repair Order #:	Dealer stamp
<input type="radio"/> Distance:	
<input type="radio"/> Engine hours (optional):	
<input type="radio"/> Multi-point inspection (recommended): <input type="checkbox"/>	
<input type="radio"/> Signature:	

<input type="radio"/> Repair Order #:	Dealer stamp
<input type="radio"/> Distance:	
<input type="radio"/> Engine hours (optional):	
<input type="radio"/> Multi-point inspection (recommended): <input type="checkbox"/>	
<input type="radio"/> Signature:	

Scheduled Maintenance

<input type="radio"/> Repair Order #:	<p>Dealer stamp</p>
<input type="radio"/> Distance:	
<input type="radio"/> Engine hours (optional):	
<input type="radio"/> Multi-point inspection (recommended): <input type="checkbox"/>	
<input type="radio"/> Signature:	

<input type="radio"/> Repair Order #:	<p>Dealer stamp</p>
<input type="radio"/> Distance:	
<input type="radio"/> Engine hours (optional):	
<input type="radio"/> Multi-point inspection (recommended): <input type="checkbox"/>	
<input type="radio"/> Signature:	

Appendices

END USER LICENSE AGREEMENT

VEHICLE SOFTWARE END USER LICENSE AGREEMENT (EULA)

- You ("You" or "Your" as applicable) have acquired a vehicle having several devices, including SYNC ® and various control modules, ("DEVICES") that include software licensed or owned by Ford Motor Company and its affiliates ("FORD MOTOR COMPANY"). Those software products of FORD MOTOR COMPANY origin, as well as associated media, printed materials, and "online" or electronic documentation ("SOFTWARE") are protected by international intellectual property laws and treaties. The SOFTWARE is licensed, not sold. All rights reserved.
- The SOFTWARE may interface with and/or communicate with, or may be later upgraded to interface with and/or communicate with additional software and/or systems provided by FORD MOTOR COMPANY.

IF YOU DO NOT AGREE TO THIS END USER LICENSE AGREEMENT ("EULA") DO NOT USE THE DEVICES OR COPY THE SOFTWARE. ANY USE OF THE SOFTWARE, INCLUDING BUT NOT LIMITED TO USE ON THE DEVICES, WILL CONSTITUTE YOUR AGREEMENT TO THIS EULA (OR RATIFICATION OF ANY PREVIOUS CONSENT).

GRANT OF SOFTWARE LICENSE: This EULA grants you the following license:

- You may use the SOFTWARE as installed on the DEVICES and as otherwise interfacing with systems and/or services provide by or through FORD MOTOR COMPANY or its third party software and service providers.

Description of Other Rights and Limitations

- **Speech Recognition:** If the SOFTWARE includes speech recognition component(s), you should understand that speech recognition is an inherently statistical process and that recognition errors are inherent in the process. Neither FORD MOTOR COMPANY nor its suppliers shall be liable for any damages arising out of errors in the speech recognition process. It is your responsibility to monitor any speech recognition functions included in the system.
- **Limitations on Reverse Engineering, Decompilation and Disassembly:** You may not reverse engineer, decompile, translate, disassemble or attempt to discover any source code or underlying ideas or algorithms of the SOFTWARE nor permit others to reverse engineer, decompile or disassemble the SOFTWARE, except and only to the extent that such activity is expressly permitted by applicable law notwithstanding this limitation or to the extent as may be permitted by the licensing terms governing use of any open source components included with the SOFTWARE.
- **Limitations on Distributing, Copying, Modifying and Creating Derivative Works:** You may not distribute, copy, make modifications to or create derivative works based on the SOFTWARE, except and only to the extent that such activity is expressly permitted by applicable law notwithstanding this limitation or to the extent as may be permitted by the licensing terms governing use of any open source components included with the SOFTWARE.

Appendices

- **Single EULA:** The end user documentation for the DEVICES and related systems and services may contain multiple EULAs, such as multiple translations and/or multiple media versions (e.g., in the user documentation and in the software). Even if you receive multiple EULAs, you are licensed to use only one (1) copy of the SOFTWARE.
- **SOFTWARE Transfer:** You may permanently transfer your rights under this EULA only as part of a sale or transfer of the DEVICES, provided you retain no copies, you transfer all of the SOFTWARE (including all component parts, the media and printed materials, any upgrades, and, if applicable, the Certificate(s) of Authenticity), and the recipient agrees to the terms of this EULA. If the SOFTWARE is an upgrade, any transfer must include all prior versions of the SOFTWARE.
- **Termination:** Without prejudice to any other rights, FORD MOTOR COMPANY may terminate this EULA if you fail to comply with the terms and conditions of this EULA.
- **Internet-Based Services Components:** The SOFTWARE may contain components that enable and facilitate the use of certain Internet-based services. You acknowledge and agree that FORD MOTOR COMPANY, third party software and service suppliers, its affiliates and/or its designated agent may automatically check the version of the SOFTWARE and/or its components that you are utilizing and may provide upgrades or supplements to the SOFTWARE that may be automatically downloaded to your DEVICES.
- **Additional Software/Services:** The SOFTWARE may permit FORD MOTOR COMPANY, third party software and service suppliers, its affiliates and/or its designated agent to provide or make available to you SOFTWARE updates, supplements, add-on components, or Internet-based services components of the SOFTWARE after the date you obtain your initial copy of the SOFTWARE ("Supplemental Components".) SOFTWARE updates may cause you to incur additional charges from your wireless service provider. If FORD MOTOR COMPANY or third party software and services suppliers provide or make available to you Supplemental Components and no other EULA terms are provided along with the Supplemental Components, then the terms of this EULA shall apply. FORD MOTOR COMPANY, its affiliates and/or its designated agent reserve the right to discontinue without liability any Internet-based services provided to you or made available to you through the use of the SOFTWARE.

Appendices

- **Links to Third Party Sites:** The SOFTWARE may provide you with the ability to link to third party sites. The third party sites are not under the control of FORD MOTOR COMPANY, its affiliates and/or its designated agent. Neither FORD MOTOR COMPANY nor its affiliates nor its designated agent are responsible for (i) the contents of any third party sites, any links contained in third party sites, or any changes or updates to third party sites, or (ii) webcasting or any other form of transmission received from any third party sites. If the SOFTWARE provides links to third party sites, those links are provided to you only as a convenience, and the inclusion of any link does not imply an endorsement of the third party site by FORD MOTOR COMPANY, its affiliates and/or its designated agent.
- **Obligation to Drive Responsibly:** You recognize your obligation to drive responsibly and keep attention on the road. You will read and abide with the DEVICES operating instructions particularly as they pertain to safety and you agree to assume any risk associated with the use of the DEVICES.

UPGRADES AND RECOVERY MEDIA:

If the SOFTWARE is provided by FORD MOTOR COMPANY separate from the DEVICES on media such as a ROM chip, CD ROM disk(s) or via web download or other means, and is labeled "For Upgrade Purposes Only" or "For Recovery Purposes Only" you may install one (1) copy of such SOFTWARE onto the DEVICES as a replacement copy for the existing SOFTWARE, and use it in accordance with this EULA, including any additional EULA terms accompanying the upgrade SOFTWARE.

INTELLECTUAL PROPERTY RIGHTS:

All title and intellectual property rights in and to the SOFTWARE (including but not limited to any images, photographs, animations, video, audio, music, text and "applets" incorporated into the SOFTWARE), the accompanying printed materials, and any copies of the SOFTWARE, are owned by FORD MOTOR COMPANY, or its affiliates or suppliers. The SOFTWARE is licensed, not sold. You may not copy the printed materials accompanying the SOFTWARE. All title and intellectual property rights in and to the content which may be accessed through use of the SOFTWARE is the property of the respective content owner and may be protected by applicable copyright or other intellectual property laws and treaties. This EULA grants you no rights to use such content outside its intended use. All rights not specifically granted under this EULA are reserved by FORD MOTOR COMPANY, its affiliates, and third party software and service providers and suppliers. Use of any on-line services which may be accessed through the SOFTWARE may be governed by the respective terms of use relating to such services. If this SOFTWARE contains documentation that is provided only in electronic form, you may print one copy of such electronic documentation.

EXPORT RESTRICTIONS: You acknowledge that the SOFTWARE is subject to U.S. and European Union export jurisdiction. You agree to comply with all applicable international and national laws that apply to the SOFTWARE, including the U.S. Export Administration Regulations, as well as end-user, end-use and destination restrictions issued by U.S. and other governments.

Appendices

TRADEMARKS: This EULA does not grant you any rights in connection with any trademarks or service marks of FORD MOTOR COMPANY, its affiliates, and third party software and service providers.

PRODUCT SUPPORT: Please refer to FORD MOTOR COMPANY instructions provided in the documentation for the DEVICES product support, such as the vehicle owner guide.

Should you have any questions concerning this EULA, or if you desire to contact FORD MOTOR COMPANY for any other reason, please refer to the address provided in the documentation for the DEVICES.

No Liability for Certain Damages: EXCEPT AS PROHIBITED BY LAW, FORD MOTOR COMPANY, ANY THIRD PARTY SOFTWARE OR SERVICES SUPPLIERS, AND THEIR AFFILIATES SHALL HAVE NO LIABILITY FOR ANY INDIRECT, SPECIAL, CONSEQUENTIAL OR INCIDENTAL DAMAGES ARISING FROM OR IN CONNECTION WITH THE USE OR PERFORMANCE OF THE SOFTWARE. THIS LIMITATION SHALL APPLY EVEN IF ANY REMEDY FAILS OF ITS ESSENTIAL PURPOSE. THERE ARE NO WARRANTIES OTHER THAN THOSE THAT MAY BE EXPRESSLY PROVIDED FOR YOUR NEW VEHICLE.

SYNC® Automotive Important Safety Information Read and follow instructions:

- Before using your SYNC® system, read and follow all instructions and safety information provided in this end user manual ("Owner Guide".) Not following precautions found in the Owner Guide can lead to an accident or other serious injuries.

General Operation

- **Voice Command Control:** Certain functions within the SYNC® system may be accomplished using voice commands. Using voice commands while driving helps you to operate the system without removing your hands from the wheel or eyes from the road.
- **Prolonged Views of Screen:** Do not access any function requiring a prolonged view of the screen while you are driving. Pull over in a safe and legal manner before attempting to access a function of the system requiring prolonged attention.
- **Volume Setting:** Do not raise the volume excessively. Keep the volume at a level where you can still hear outside traffic and emergency signals while driving. Driving while unable to hear these sounds could cause an accident.
- **Navigation Features:** Any navigation features included in the system are intended to provide turn by turn instructions to get you to a desired destination. Please make certain all persons using this system carefully read and follow instructions and safety information fully.
- **Distraction Hazard:** Any navigation features may require manual (non-verbal) setup. Attempting to perform such set-up or insert data while driving can distract your attention and could cause an accident or other serious injury. Stop the vehicle in a safe and legal manner before attempting these operations.
- **Let Your Judgment Prevail:** Any navigation features are provided only as an aid. Make your driving decisions based on your observations of local conditions and existing traffic regulations. Any such feature is not a

Appendices

substitute for your personal judgment. Any route suggestions made by this system should never replace any local traffic regulations or your personal judgment or knowledge of safe driving practices.

- **Route Safety:** Do not follow the route suggestions if doing so would result in an unsafe or illegal maneuver, if you would be placed in an unsafe situation, or if you would be directed into an area that you consider unsafe. The driver is ultimately responsible for the safe operation of the vehicle and therefore, must evaluate whether it is safe to follow the suggested directions.
- **Potential Map Inaccuracy:** Maps used by this system may be inaccurate because of changes in roads, traffic controls or driving conditions. Always use good judgment and common sense when following the suggested routes.
- **Emergency Services:** Do not rely on any navigation features included in the system to route you to emergency services. Ask local authorities or an emergency services operator for these locations. Not all emergency services such as police, fire stations, hospitals and clinics are likely to be contained in the map database for such navigation features.

Your Responsibilities and Assumptions of Risk

- You agree to each of the following: (a) Any use of the SOFTWARE while driving an automobile or other vehicle in violation of applicable law or otherwise driving in an unsafe manner presents a significant risk of distracted driving and should not be attempted under any circumstances; (b) Use of the SOFTWARE at excessive volume poses a significant risk of hearing damage and should not be attempted under any circumstances; (c) The SOFTWARE may not be compatible with new or different versions of an operating system, third party software, or third party services, and the SOFTWARE may potentially cause a critical failure of an operating system, third party software, or third party service. (d) Any third party service accessed by or third party software used with the SOFTWARE (i) may charge an additional fee for access, (ii) may not work correctly, on an uninterrupted basis, or error free, (iii) may change streaming formats or discontinue operation, (iv) may contain adult, profane or offensive content; and (v) may contain inaccurate, false or misleading traffic, weather, financial or safety information or other content; and (e) Use of the SOFTWARE may cause you to incur additional charges from your wireless service provider (WSP) and any data or minute calculators that may be included in the software program are for reference only, are not warranted in any way and should not be relied upon in anyway.
- When using the SOFTWARE, you agree to be responsible for and assume the entire risk to the items set forth in Section (a) – (e) above.

Appendices

Disclaimer of Warranty

YOU EXPRESSLY ACKNOWLEDGE AND AGREE THAT USE OF THE DEVICES AND SOFTWARE IS AT YOUR SOLE RISK AND THAT THE ENTIRE RISK AS TO SATISFACTORY QUALITY, PERFORMANCE, COMPATIBILITY, ACCURACY AND EFFORT IS WITH YOU. TO THE MAXIMUM EXTENT PERMITTED BY APPLICABLE LAW, THE SOFTWARE AND ANY THIRD PARTY SOFTWARE OR THIRD-PARTY SERVICES ARE PROVIDED "AS IS" AND "AS AVAILABLE", WITH ALL FAULTS AND WITHOUT WARRANTY OF ANY KIND, AND FORD MOTOR COMPANY HEREBY DISCLAIMS ALL WARRANTIES AND CONDITIONS WITH RESPECT TO THE SOFTWARE, THIRD PARTY SOFTWARE, AND THIRD-PARTY SERVICES, EITHER EXPRESS, IMPLIED OR STATUTORY, INCLUDING, BUT NOT LIMITED TO, THE IMPLIED WARRANTIES AND/OR CONDITIONS OF MERCHANTABILITY, OF SATISFACTORY QUALITY, OF FITNESS FOR AN PARTICULAR PURPOSE, OF ACCURACY, OF QUIET ENJOYMENT, AND NON-INFRINGEMENT OF THIRD-PARTY RIGHTS. FORD MOTOR COMPANY DOES NOT WARRANT (a) AGAINST INTERFERENCE WITH YOUR ENJOYMENT OF THE SOFTWARE, THIRD PARTY SOFTWARE, OR THIRD-PARTY SERVICES, (b) THAT THE SOFTWARE, THIRD PARTY SOFTWARE, OR THIRD-PARTY SERVICES WILL MEET YOUR REQUIREMENTS, (c) THAT THE OPERATION OF THE SOFTWARE, THIRD PARTY SOFTWARE, OR THIRD-PARTY SERVICES WILL BE UNINTERRUPTED OR ERROR-FREE, (d) OR THAT DEFECTS IN THE SOFTWARE, THIRD PARTY SOFTWARE, OR THIRD-PARTY SERVICES WILL BE CORRECTED. NO ORAL OR WRITTEN INFORMATION OR ADVICE GIVEN BY FORD MOTOR COMPANY OR ITS AUTHORIZED REPRESENTATIVE SHALL

CREATE A WARRANTY. SHOULD THE SOFTWARE, THIRD PARTY SOFTWARE, OR THIRD-PARTY SERVICES PROVE DEFECTIVE, YOU ASSUME THE ENTIRE COST OF ALL NECESSARY SERVICING, REPAIR OR CORRECTION. SOME JURISDICTIONS DO NOT ALLOW THE DISCLAIMER OF IMPLIED WARRANTIES OR LIMITATIONS ON APPLICABLE STATUTORY RIGHTS OF A CONSUMER, SO THE ABOVE DISCLAIMER MAY NOT FULLY APPLY TO YOU. THE SOLE WARRANTY PROVIDED BY FORD MOTOR COMPANY SHALL BE FOUND IN THE WARRANTY INFORMATION INCLUDING WITH YOUR OWNER GUIDE. TO THE EXTENT THAT THERE IS ANY CONFLICT BETWEEN THE TERMS OF THIS SECTION AND THE WARRANTY BOOKLET, THE WARRANTY BOOKLET SHALL CONTROL.

Applicable Law, Venue, Jurisdiction

- The laws of the State of Michigan govern this EULA and Your use of the SOFTWARE. Your use of the SOFTWARE may also be subject to other local, state, national, or international laws. Any litigation arising out of or related to this EULA shall be brought and maintained exclusively in a court of the State of Michigan located in Wayne County or in the United States District Court for the Eastern District of Michigan. You hereby consent to submit to the personal jurisdiction of a court in the State of Michigan located in Wayne County and the United States District Court for the Eastern District of Michigan for any dispute arising out of or relating to this EULA.

Appendices

Binding Arbitration and Class Action Waiver

(a) Application. This Section applies to any dispute EXCEPT IT DOES NOT INCLUDE A DISPUTE RELATING TO COPYRIGHT INFRINGEMENT, OR TO THE ENFORCEMENT OR VALIDITY OF YOUR, FORD MOTOR COMPANY, OR ANY OF FORD MOTOR COMPANY'S LICENSORS' INTELLECTUAL PROPERTY RIGHTS. Dispute means any dispute, action, or other controversy between You and FORD MOTOR COMPANY, other than the exceptions listed above, concerning the SOFTWARE (including its price) or this EULA, whether in contract, warranty, tort, statute, regulation, ordinance, or any other legal or equitable basis.

(b) Notice of Dispute. In the event of a Dispute, You or FORD MOTOR COMPANY must give the other a "Notice of Dispute", which is a written statement of the name, address, and contact information of the party giving it, the facts giving rise to the dispute, and the relief requested. You and FORD MOTOR COMPANY will attempt to resolve any dispute through informal negotiation within 60 days from the date the Notice of Dispute is sent. After 60 days, You or FORD MOTOR COMPANY may commence arbitration.

(c) Small claims court. You may also litigate any dispute in small claims court in your county of residence or FORD MOTOR COMPANY'S principal place of business, if the dispute meets all requirements to be heard in the small claims court. You may litigate in small claims court whether or not You negotiated informally first.

(d) Binding arbitration. If You and FORD MOTOR COMPANY, do not resolve any dispute by informal negotiation or in small claims court, any other effort to resolve the dispute will be conducted exclusively by binding arbitration. You are giving up

the right to litigate (or participate in as a party or class member) all disputes in court before a judge or jury. Instead, all disputes will be resolved before a neutral arbitrator, whose decision will be final except for a limited right of appeal under the Federal Arbitration Act. Any court with jurisdiction over the parties may enforce the arbitrator's award.

(e) Class action waiver. Any proceedings to resolve or litigate any dispute in any forum will be conducted solely on an individual basis. Neither you nor FORD MOTOR COMPANY, will seek to have any dispute heard as a class action, as a private attorney general action, or in any other proceeding in which any party acts or proposes to act in a representative capacity. No arbitration or proceeding will be combined with another without the prior written consent of all parties to all affected arbitrations or proceedings.

(f) Arbitration procedure. Any arbitration will be conducted by the American Arbitration Association (the "AAA"), under its Commercial Arbitration Rules. If You are an individual and use the SOFTWARE for personal or vehicle use, or if the value of the dispute is \$75,000 or less whether or not You are an individual or how You use the SOFTWARE, the AAA Supplementary Procedures for Consumer-Related Disputes will also apply. To commence arbitration, submit a Commercial Arbitration Rules Demand for Arbitration form to the AAA. You may request a telephonic or in-person hearing by following the AAA rules. In a dispute involving \$10,000 or less, any hearing will be telephonic unless the arbitrator finds good cause to hold an in-person hearing instead. For more information, see adr.org or call 1-800-778-7879. You agree to commence arbitration only in your county of residence or FORD MOTOR COMPANY'S principal place of business. The arbitrator

Appendices

may award the same damages to You individually as a court could. The arbitrator may award declaratory or injunctive relief only to You individually, and only to the extent required to satisfy Your individual claim. **Arbitration fees and incentives.**

- i. Disputes involving \$75,000 or less. FORD MOTOR COMPANY will promptly reimburse your filing fees and pay the AAA's and arbitrator's fees and expenses. If you reject FORD MOTOR COMPANY'S last written settlement offer made before the arbitrator was appointed ("last written offer"), your dispute goes all the way to an arbitrator's decision (called an "award"), and the arbitrator awards you more than the last written offer, FORD MOTOR COMPANY will give you three incentives: (1) pay the greater of the award or \$1,000; (2) pay twice your reasonable attorney's fees, if any; and (3) reimburse any expenses (including expert witness fees and costs) that your attorney reasonably accrues for investigating, preparing, and pursuing your claim in arbitration. The arbitrator will determine the amounts.
- ii. Disputes involving more than \$75,000. The AAA rules will govern payment of filing fees and the AAA's and arbitrator's fees and expenses.
- iii. Disputes involving any amount. In any arbitration you commence, FORD MOTOR COMPANY will seek its AAA or arbitrator's fees and expenses, or Your filing fees if reimbursed, only if the arbitrator finds the arbitration frivolous or brought for an improper purpose. In any arbitration FORD MOTOR COMPANY commences, it will pay all filing, AAA, and arbitrator's fees and expenses. It will not seek its attorney's fees or expenses from you in any arbitration. Fees and expenses are not counted in determining how much a dispute involves.

(h) Claims or disputes must be filed within one year. To the extent permitted by law, any claim or dispute under this EULA to which this Section applies must be filed within one year in small claims court (Section c) or in arbitration (Section d). The one-year period begins when the claim or dispute first could be filed. If such a claim or dispute is not filed within one year, it is permanently barred.

(i) Severability. If the class action waiver (Section e) is found to be illegal or unenforceable as to all or some parts of a dispute, then that portion of Section e will not apply to those parts. Instead, those parts will be severed and proceed in a court of law, with the remaining parts proceeding in arbitration. If any other provision of that portion Section e is found to be illegal or unenforceable, that provision will be severed with the remainder of Section e remaining in full force and effect.

Telenav Software End User License Agreement

Please read these terms and conditions carefully before you use the TeleNav Software. Your use of the TeleNav Software indicates that you accept these terms and conditions. If you do not accept these terms and conditions, do not break the seal of the package, launch, or otherwise use the TeleNav Software. TeleNav may revise this Agreement and the privacy policy at any time, with or <http://www.telenav.com> from time to time to review the then current version of this Agreement and of the privacy policy.

1. Safe and Lawful Use

You acknowledge that devoting attention to the TeleNav Software may pose a risk of injury or death to you and others in situations that otherwise require your undivided attention, and you therefore agree to comply with the following when using the TeleNav Software:

Appendices

(a) observe all traffic laws and otherwise drive safely;

(b) use your own personal judgment while driving. If you feel that a route suggested by the TeleNav Software instructs you to perform an unsafe or illegal maneuver, places you in an unsafe situation, or directs you into an area that you consider to be unsafe, do not follow such instructions;

(c) do not input destinations, or otherwise manipulate the TeleNav Software, unless your vehicle is stationary and parked;

(d) do not use the TeleNav Software for any illegal, unauthorized, unintended, unsafe, hazardous, or unlawful purposes, or in any manner inconsistent with this Agreement;

(e) arrange all GPS and wireless devices and cables necessary for use of the TeleNav Software in a secure manner in your vehicle so that they will not interfere with your driving and will not prevent the operation of any safety device (such as an airbag).

You agree to indemnify and hold TeleNav harmless against all claims resulting from any dangerous or otherwise inappropriate use of the TeleNav Software in any moving vehicle, including as a result of your failure to comply with the directions above.

2. Account Information

You agree: (a) when registering the TeleNav Software, to provide TeleNav with true, accurate, current, and complete information about yourself, and (b) to inform TeleNav promptly of any changes to such information, and to keep it true, accurate, current and complete.

3. Software License

- Subject to your compliance with the terms of this Agreement, TeleNav hereby grants to you a personal, non-exclusive, non-transferable license (except as expressly permitted below in connection with your permanent transfer of the TeleNav Software license), without the right to sublicense, to use the TeleNav Software (in object code form only) in order to access and use the TeleNav Software. This license shall terminate upon any termination or expiration of this Agreement. You agree that you will use the TeleNav Software only for your personal business or leisure purposes, and not to provide commercial navigation services to other parties.

3.1 License Limitations

- **(a)** reverse engineer, decompile, disassemble, translate, modify, alter or otherwise change the TeleNav Software or any part thereof; **(b)** attempt to derive the source code, audio library or structure of the TeleNav Software without the prior express written consent of TeleNav; **(c)** remove from the TeleNav Software, or alter, any of TeleNav's or its suppliers' trademarks, trade names, logos, patent or copyright notices, or other notices or markings; **(d)** distribute, sublicense or otherwise transfer the TeleNav Software to others, except as part of your permanent transfer of the TeleNav Software; or **(e)** use the TeleNav Software in any manner that
 - i. infringes the intellectual property or proprietary rights, rights of publicity or privacy or other rights of any party,

Appendices

ii. violates any law, statute, ordinance or regulation, including but not limited to laws and regulations related to spamming, privacy, consumer and child protection, obscenity or defamation, or

iii. is harmful, threatening, abusive, harassing, tortuous, defamatory, vulgar, obscene, libelous, or otherwise objectionable; and (f) lease, rent out, or otherwise permit unauthorized access by third parties to the TeleNav Software without advanced written permission of TeleNav.

4. Disclaimers

- To the fullest extent permissible pursuant to applicable law, in no event will TeleNav, its licensors and suppliers, or agents or employees of any of the foregoing, be liable for any decision made or action taken by you or anyone else in reliance on the information provided by the TeleNav Software. TeleNav also does not warrant the accuracy of the map or other data used for the TeleNav Software. Such data may not always reflect reality due to, among other things, road closures, construction, weather, new roads and other changing conditions. You are responsible for the entire risk arising out of your use of the TeleNav Software. For example but without limitation, you agree not to rely on the TeleNav Software for critical navigation in areas where the well-being or survival of you or others

is dependent on the accuracy of navigation, as the maps or functionality of the TeleNav Software are not intended to support such high risk applications, especially in more remote geographical areas.

- TELENAV EXPRESSLY DISCLAIMS AND EXCLUDES ALL WARRANTIES IN CONNECTION WITH THE TELENAV SOFTWARE, WHETHER STATUTORY, EXPRESS OR IMPLIED, INCLUDING ALL WARRANTIES WHICH MAY ARISE FROM COURSE OF DEALING, CUSTOM OR TRADE AND INCLUDING, BUT NOT LIMITED TO, THE IMPLIED WARRANTIES OF MERCHANTABILITY, FITNESS FOR A PARTICULAR PURPOSE AND NON-INFRINGEMENT OF THIRD PARTY RIGHTS WITH RESPECT TO THE TELENAV SOFTWARE.
- Certain jurisdictions do not permit the disclaimer of certain warranties, so this limitation may not apply to you.

5. Limitation of Liability

- TO THE EXTENT PERMITTED UNDER APPLICABLE LAW, UNDER NO CIRCUMSTANCES SHALL TELENAV OR ITS LICENSORS AND SUPPLIERS BE LIABLE TO YOU OR TO ANY THIRD PARTY FOR ANY INDIRECT, INCIDENTAL, CONSEQUENTIAL, SPECIAL OR EXEMPLARY DAMAGES (INCLUDING IN EACH CASE, BUT NOT LIMITED TO, DAMAGES FOR THE INABILITY TO USE THE EQUIPMENT OR ACCESS DATA, LOSS OF DATA, LOSS OF BUSINESS, LOSS OF PROFITS, BUSINESS INTERRUPTION OR THE LIKE) ARISING OUT OF THE USE OF OR INABILITY TO USE THE TELENAV SOFTWARE, EVEN IF TELENAV HAS BEEN ADVISED OF THE POSSIBILITY OF SUCH DAMAGES. NOTWITHSTANDING ANY DAMAGES THAT YOU MIGHT INCUR FOR ANY

Appendices

REASON WHATSOEVER (INCLUDING, WITHOUT LIMITATION, ALL DAMAGES REFERENCED HEREIN AND ALL DIRECT OR GENERAL DAMAGES IN CONTRACT, TORT (INCLUDING NEGLIGENCE) OR OTHERWISE), THE ENTIRE LIABILITY OF TELENV AND OF ALL OF TELENV'S SUPPLIERS SHALL BE LIMITED TO THE AMOUNT ACTUALLY PAID BY YOU FOR THE TELENV SOFTWARE. SOME STATES AND/OR JURISDICTIONS DO NOT ALLOW THE EXCLUSION OR LIMITATION OF INCIDENTAL OR CONSEQUENTIAL DAMAGES, SO THE ABOVE LIMITATIONS OR EXCLUSIONS MAY NOT APPLY TO YOU.

6. Arbitration and Governing Law

- You agree that any dispute, claim or controversy arising out of or relating to this Agreement or the TeleNav Software shall be settled by independent arbitration involving a neutral arbitrator and administered by the American Arbitration Association in the County of Santa Clara, California. The arbitrator shall apply the Commercial Arbitration Rules of the American Arbitration Association, and the judgment upon the award rendered by the arbitrator may be entered by any court having jurisdiction. Note that there is no judge or jury in an arbitration proceeding and the decision of the arbitrator shall be binding upon both parties. You expressly agree to waive your right to a jury trial. This Agreement and performance hereunder will be governed by and construed in accordance with the laws of the State of California, without giving effect to its conflict of law provisions. To the extent judicial action is necessary in connection with the binding arbitration, both TeleNav and you agree to submit

to the exclusive jurisdiction of the courts of the County of Santa Clara, California. The United Nations Convention on Contracts for the International Sale of Goods shall not apply.

7. Assignment

- You may not resell, assign, or transfer this Agreement or any of your rights or obligations, except in totality, in connection with your permanent transfer of the TeleNav Software, and expressly conditioned upon the new user of the TeleNav Software agreeing to be bound by the terms and conditions of this Agreement. Any such sale, assignment or transfer that is not expressly permitted under this paragraph will result in immediate termination of this Agreement, without liability to TeleNav, in which case you and all other parties shall immediately cease all use of the TeleNav Software. Notwithstanding the foregoing, TeleNav may assign this Agreement to any other party at any time without notice, provided the assignee remains bound by this Agreement.

8. Miscellaneous

8.1

This Agreement constitutes the entire agreement between TeleNav and you with respect to the subject matter hereof.

8.2

Except for the limited licenses expressly granted in this Agreement, TeleNav retains all right, title and interest in and to the TeleNav Software, including without limitation all related intellectual property rights. No licenses or other rights which are not expressly granted in this Agreement are intended to, or shall be, granted or

Appendices

conferred by implication, statute, inducement, estoppel or otherwise, and TeleNav and its suppliers and licensors hereby reserve all of their respective rights other than the licenses explicitly granted in this Agreement.

8.3

By using the TeleNav Software, you consent to receive from TeleNav all communications, including notices, agreements, legally required disclosures or other information in connection with the TeleNav Software (collectively, "Notices") electronically. TeleNav may provide such Notices by posting them on TeleNav's Website or by downloading such Notices to your wireless device. If you desire to withdraw your consent to receive Notices electronically, you must discontinue your use of the TeleNav Software.

8.4

TeleNav's or your failure to require performance of any provision shall not affect that party's right to require performance at any time thereafter, nor shall a waiver of any breach or default of this Agreement constitute a waiver of any subsequent breach or default or a waiver of the provision itself.

8.5

If any provision herein is held unenforceable, then such provision will be modified to reflect the intention of the parties, and the remaining provisions of this Agreement will remain in full force and effect.

8.6

The headings in this Agreement are for convenience of reference only, will not be deemed to be a part of this Agreement, and will not be referred to in connection with the construction or interpretation of this Agreement. As used in this Agreement, the words "include" and "including" and variations thereof, will not be deemed to be terms of limitation, but rather will be deemed to be followed by the words "without limitation".

9. Other Vendors Terms and Conditions

- The Telenav Software utilizes map and other data licensed to Telenav by third party vendors for the benefit of you and other end users. This Agreement includes end-user terms applicable to these companies (included at the end of this Agreement), and thus your use of the Telenav Software is also subject to such terms. You agree to comply with the following additional terms and conditions, which are applicable to Telenav's third party vendor licensors::

9.1 End User Terms Required by HERE North America, LLC

The data ("Data") is provided for your personal, internal use only and not for resale. It is protected by copyright, and is subject to the following terms and conditions which are agreed to by you, on the one hand, and Telenav ("Telenav") and its licensors (including their licensors and suppliers) on the other hand.

© 2013 HERE. All rights reserved.

The Data for areas of Canada includes information taken with permission from Canadian authorities, including: © Her Majesty the Queen in Right of Canada, © Queen's Printer for Ontario, © Canada Post Corporation, GeoBase®, © Department of Natural Resources Canada.

Appendices

HERE holds a non-exclusive license from the United States Postal Service® to publish and sell ZIP+4® information.

©United States Postal Service® 2014. Prices are not established, controlled or approved by the United States Postal Service®. The following trademarks and registrations are owned by the USPS: United States Postal Service, USPS, and ZIP+4

The Data for Mexico includes certain data from Instituto Nacional de Estadística y Geografía.

Terms and Conditions

Permitted Use. You agree to use this Data together with the Telenav Software solely for the internal business and personal purposes for which you were licensed, and not for service bureau, time-sharing or other similar purposes. Accordingly, but subject to the restrictions set forth in the following paragraphs, you agree not to otherwise reproduce, copy, modify, decompile, disassemble, create any derivative works of, or reverse engineer any portion of this Data, and may not transfer or distribute it in any form, for any purpose, except to the extent permitted by mandatory laws.

Restrictions. Except where you have been specifically licensed to do so by Telenav, and without limiting the preceding paragraph, you may not use this Data (a) with any products, systems, or applications installed or otherwise connected to or in communication with vehicles, capable of vehicle navigation, positioning, dispatch, real time route guidance, fleet management or similar applications; or (b) with or in communication with any

positioning devices or any mobile or wireless-connected electronic or computer devices, including without limitation cellular phones, palmtop and handheld computers, pagers, and personal digital assistants or PDAs.

Warning. The Data may contain inaccurate or incomplete information due to the passage of time, changing circumstances, sources used and the nature of collecting comprehensive geographic data, any of which may lead to incorrect results.

No Warranty. This Data is provided to you “as is,” and you agree to use it at your own risk. Telenav and its licensors (and their licensors and suppliers) make no guarantees, representations or warranties of any kind, express or implied, arising by law or otherwise, including but not limited to, content, quality, accuracy, completeness, effectiveness, reliability, fitness for a particular purpose, usefulness, use or results to be obtained from this Data, or that the Data or server will be uninterrupted or error-free.

Disclaimer of Warranty: TELENAV AND ITS LICENSORS (INCLUDING THEIR LICENSORS AND SUPPLIERS) DISCLAIM ANY WARRANTIES, EXPRESS OR IMPLIED, OF QUALITY, PERFORMANCE, MERCHANTABILITY, FITNESS FOR A PARTICULAR PURPOSE OR NON-INFRINGEMENT. Some States, Territories and Countries do not allow certain warranty exclusions, so to that extent the above exclusion may not apply to you.

Disclaimer of Liability: TELENAV AND ITS LICENSORS (INCLUDING THEIR LICENSORS AND SUPPLIERS) SHALL NOT BE LIABLE TO YOU: IN RESPECT OF ANY CLAIM, DEMAND OR ACTION, IRRESPECTIVE OF THE NATURE OF THE CAUSE OF THE CLAIM, DEMAND OR ACTION ALLEGING ANY LOSS, INJURY OR

Appendices

DAMAGES, DIRECT OR INDIRECT, WHICH MAY RESULT FROM THE USE OR POSSESSION OF THE INFORMATION; OR FOR ANY LOSS OF PROFIT, REVENUE, CONTRACTS OR SAVINGS, OR ANY OTHER DIRECT, INDIRECT, INCIDENTAL, SPECIAL OR CONSEQUENTIAL DAMAGES ARISING OUT OF YOUR USE OF OR INABILITY TO USE THIS INFORMATION, ANY DEFECT IN THE INFORMATION, OR THE BREACH OF THESE TERMS OR CONDITIONS, WHETHER IN AN ACTION IN CONTRACT OR TORT OR BASED ON A WARRANTY, EVEN IF TELENAV OR ITS LICENSORS HAVE BEEN ADVISED OF THE POSSIBILITY OF SUCH DAMAGES. Some States, Territories and Countries do not allow certain liability exclusions or damages limitations, so to that extent the above may not apply to you.

Export Control. You shall not export from anywhere any part of the Data or any direct product thereof except in compliance with, and with all licenses and approvals required under, applicable export laws, rules and regulations, including but not limited to the laws, rules and regulations administered by the Office of Foreign Assets Control of the U.S. Department of Commerce and the Bureau of Industry and Security of the U.S. Department of Commerce. To the extent that any such export laws, rules or regulations prohibit HERE from complying with any of its obligations hereunder to deliver or distribute Data, such failure shall be excused and shall not constitute a breach of this Agreement.

Entire Agreement. These terms and conditions constitute the entire agreement between Telenav (and its licensors, including their licensors and suppliers) and you pertaining to the subject matter hereof, and supersedes in their entirety any and all written or oral agreements previously existing between us with respect to such subject matter.

Governing Law. The above terms and conditions shall be governed by the laws of the State of Illinois [insert “Netherlands” where European HERE Data is used], without giving effect to (i) its conflict of laws provisions, or (ii) the United Nations Convention for Contracts for the International Sale of Goods, which is explicitly excluded. You agree to submit to the jurisdiction of the State of Illinois [insert “The Netherlands” where European HERE Data is used] for any and all disputes, claims and actions arising from or in connection with the Data provided to you hereunder.

Government End Users. If the Data is being acquired by or on behalf of the United States government or any other entity seeking or applying rights similar to those customarily claimed by the United States government, this Data is a “commercial item” as that term is defined at 48 C.F.R. (“FAR”) 2.101, is licensed in accordance with these End-User Terms, and each copy of Data delivered or otherwise furnished shall be marked and embedded as appropriate with the following “Notice of Use,” and shall be treated in accordance with such Notice:

NOTICE OF USE
CONTRACTOR (MANUFACTURER/ SUPPLIER) NAME: HERE
CONTRACTOR (MANUFACTURER/ SUPPLIER) ADDRESS: c/o Nokia, 425 West Randolph Street, Chicago, Illinois 60606
This Data is a commercial item as defined in FAR 2.101 and is subject to these End-User Terms under which this Data was provided.
© 1987 – 2014 HERE – All rights reserved.

Appendices

If the Contracting Officer, federal government agency, or any federal official refuses to use the legend provided herein, the Contracting Officer, federal government agency, or any federal official must notify HERE prior to seeking additional or alternative rights in the Data.

Gracenote® Copyright

CD and music-related data from Gracenote, Inc., copyright©

2000-2007 Gracenote. Gracenote Software, copyright © 2000-2007 Gracenote. This product and service may practice one or more of the following U.S. Patents 5,987,525; 6,061,680; 6,154,773; 6,161,132; 6,230,192; 6,230,207; 6,240,459; 6,330,593 and other patents issued or pending. Some services supplied under license from Open Globe, Inc. for U.S. Patent 6,304,523.

Gracenote and CDDB are registered trademarks of Gracenote. The Gracenote logo and logotype, and the "Powered by Gracenote™" logo are trademarks of Gracenote.

Gracenote® End User License Agreement (EULA)

This device contains software from Gracenote, Inc. of 2000 Powell Street Emeryville, California 94608 ("Gracenote").

The software from Gracenote (the "Gracenote Software") enables this device to do disc and music file identification and obtain music-related information, including name, artist, track, and title information ("Gracenote Data") from online servers ("Gracenote Servers"), and to perform other functions. You may use Gracenote Data only by means of the intended End User functions of this device. This device may contain content belonging to Gracenote's providers. If so, all of the restrictions set forth herein with respect to

Gracenote Data shall also apply to such content and such content providers shall be entitled to all of the benefits and protections set forth herein that are available to Gracenote. You agree that you will use the content from Gracenote ("Gracenote Content"), Gracenote Data, the Gracenote Software, and Gracenote Servers for your own personal, non-commercial use only. You agree not to assign, copy, transfer or transmit the Gracenote Content, Gracenote Software or any Gracenote Data (except in a Tag associated with a music file) to any third party. YOU AGREE NOT TO USE OR EXPLOIT GRACENOTE CONTENT, GRACENOTE DATA, THE GRACENOTE SOFTWARE, OR GRACENOTE SERVERS, EXCEPT AS EXPRESSLY PERMITTED HEREIN.

You agree that your non-exclusive licenses to use the Gracenote Content, Gracenote Data, the Gracenote Software, and Gracenote Servers will terminate if you violate these restrictions. If your licenses terminate, you agree to cease any and all use of the Gracenote Content, Gracenote Data, the Gracenote Software, and Gracenote Servers.

Gracenote, respectively, reserve all rights in Gracenote Data, the Gracenote Software, and the Gracenote Servers and Gracenote Content, including all ownership rights. Under no circumstances will either Gracenote become liable for any payment to you for any information that you provide, including any copyrighted material or music file information. You agree that Gracenote may enforce its respective rights, collectively or separately, under this agreement against you, directly in each company's own name.

Appendices

Gracenote uses a unique identifier to track queries for statistical purposes. The purpose of a randomly assigned numeric identifier is to allow Gracenote to count queries without knowing anything about who you are. For more information, see the web page at www.gracenote.com for the Gracenote Privacy Policy.

THE GRACENOTE SOFTWARE, EACH ITEM OF GRACENOTE DATA AND THE GRACENOTE CONTENT ARE LICENSED TO YOU "AS IS". NEITHER GRACENOTE MAKES ANY REPRESENTATIONS OR WARRANTIES, EXPRESS OR IMPLIED, REGARDING THE ACCURACY OF ANY GRACENOTE DATA FROM THE GRACENOTE SERVERS OR GRACENOTE CONTENT. GRACENOTE COLLECTIVELY AND SEPARATELY RESERVE THE RIGHT TO DELETE DATA AND/OR CONTENT FROM THE COMPANIES' RESPECTIVE SERVERS OR, IN THE CASE OF GRACENOTE, CHANGE DATA CATEGORIES FOR ANY CAUSE THAT GRACENOTE DEEMS SUFFICIENT. NO WARRANTY IS MADE THAT EITHER GRACENOTE CONTENT OR THE GRACENOTE SOFTWARE OR GRACENOTE SERVERS ARE ERROR-FREE OR THAT THE FUNCTIONING OF THE GRACENOTE SOFTWARE OR GRACENOTE SERVERS WILL BE UNINTERRUPTED. GRACENOTE IS NOT OBLIGATED TO PROVIDE YOU WITH ANY ENHANCED OR ADDITIONAL DATA TYPES THAT GRACENOTE MAY CHOOSE TO PROVIDE IN THE FUTURE AND IS FREE TO DISCONTINUE ITS ONLINE SERVICES AT ANY TIME. GRACENOTE DISCLAIM ALL WARRANTIES EXPRESS OR IMPLIED, INCLUDING, BUT NOT LIMITED TO, IMPLIED WARRANTIES OF MERCHANTABILITY, FITNESS FOR A PARTICULAR PURPOSE, TITLE, AND NON-INFRINGEMENT. NEITHER GRACENOTE WARRANTS THE RESULTS THAT WILL BE OBTAINED BY YOUR USE

OF THE GRACENOTE SOFTWARE OR ANY GRACENOTE SERVER. IN NO CASE WILL GRACENOTE BE LIABLE FOR ANY CONSEQUENTIAL OR INCIDENTAL DAMAGES OR FOR ANY LOST PROFITS OR LOST REVENUES FOR ANY REASON WHATSOEVER. © Gracenote 2007.

FCC ID: ACJ-SYNCG3-L

IC: 216B-SYNCG3-L

This device complies with Part 15 of the FCC Rules and with RSS-210 of Industry Canada. Operation is subject to the following two conditions:

- (1)** This device may not cause harmful interference, and
- (2)** this device must accept any interference received, including interference that may cause undesired operation.

WARNING



Changes or modifications not expressly approved by the party responsible for compliance could void the user's authority to operate the equipment. The term "IC" before the radio certification number only signifies that Industry Canada technical specifications were met.

The antenna used for this transmitter must not be co-located or operating in conjunction with any other antenna or transmitter.

Appendices

TYPE APPROVALS

RF Certification Logos for Tire Pressure Monitoring Sensor(s)

Schrader AG2SZ4 Numero de Registro
CNC: H-13498

E207816

Argentina

TRA
REGISTERED NO:ER0130238/14
DEALER NO:DA0047074/10

E207817

Abu Dhabi, Dubai

 **ANATEL**
MODELO: AG2SZ3
2109-14-8001

(01)0789895330292

E197509



E202555

Brazil

Herby, Schrader Electronics UK Ltd., declares that this TPMS is in compliance with the essential requirements and other provisions of directive 1999/5/EC. The declaration of conformity may be consulted at emcteam@schrader.co.uk

E207818

European Union EU

Kingdom of Jordan Type approval for tyre pressure sensor.
Model: AG2SZ4
Manufacturer: Schrader Electronics
Type Approval Number: TRC/LPD/2014/56

E207819

Jordan

RAQP/33A/0514/S/(14-0847)

E207820

Malaysia

Appendices



E197811

Moldova

Complies with
IDA Standards
DA 00461

E207822

Singapore

AGREE PAR L'ANRT MAROC
Numéro d'agrément: MR9098
ANRT 2014
Date d'agrément: 14/03/2014

E207821

Morocco



TA-2014/064

Approved

E198002

South Africa



NTC

Type Approved

No:ESD-1408639C

E198001

Philippines



CCAM14LP0460T0

E203899

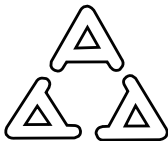

E197844

Serbia

Appendices



CCAM14LP0090T3

E203679

Taiwan



Schrader Electronics цім стверджує, що обладнання Радіопередавач моделі AG2S24 системи контролю тиску в шині автомобіля відповідає вимогам Технічного регламенту радіоблабднання і телекомунікаційного кінцевого (термінального) обладнання (Постанова КМУ № 679 від 24 червня 2009 р.) Декларація відповідності знаходиться на сайті Schrader

Electronics та надається за запитом на електронну адресу doc.request@schrader.co.uk

E198009

Ukraine

Index

A

- A/C
 - See: Climate Control.....116
- About This Manual.....7
- ABS
 - See: Brakes.....174
- ABS driving hints
 - See: Hints on Driving With Anti-Lock Brakes.....175
- Accessories.....462
 - Exterior Style.....462
 - Interior Style.....462
 - Lifestyle.....462
 - Peace of Mind.....462
- Accessories
 - See: Replacement Parts Recommendation.....12
- ACC
 - See: Using Adaptive Cruise Control.....196
- Active Park Assist.....186
 - Deactivating the Active Park Assist Feature.....190
 - Parallel Parking, Perpendicular Parking, Parallel Park Out Assist.....186
 - Troubleshooting the System.....190
- Adjusting the Headlamps.....264
 - Horizontal Aim Adjustment.....265
 - Vertical Aim Adjustment.....264
- Adjusting the Steering Wheel.....67
 - Power Tilt and Telescope Steering Column.....67
- Airbag Disposal.....47
- Air Conditioning
 - See: Climate Control.....116
- Air Filter
 - See: Changing the Engine Air Filter.....270
- Alarm
 - See: Anti-Theft Alarm.....66
- Ambient Lighting.....80
- Anti-Theft Alarm.....66
 - Arming the Alarm.....66
 - Disarming the Alarm.....66
- Appendices.....484
- Apps.....434
 - SiriusXM Traffic and Travel Link.....436
- Audible Warnings and Indicators.....93
 - Headlamps On Warning Chime.....93
 - Keyless Warning Alert.....93
 - Parking Brake On Warning Chime.....93
- Audio Control.....68
 - MODE.....69
 - Seek, Next or Previous.....69
- Audio System.....314
 - General Information.....314
- Audio Unit - Vehicles With: AM/FM/CD/SYNC/Satellite Radio.....317
- Audio Unit - Vehicles With: AM/FM/CD.....315
- Audio Unit - Vehicles With: Sony AM/FM/CD.....319
 - Menu Structure.....320
- Autolamps.....74
 - Windshield Wiper Activated Headlamps.....74
- Automatic Climate Control - Vehicles With: Sony Audio System.....117
- Automatic Climate Control - Vehicles Without: Sony Audio System.....116
- Automatic High Beam Control.....76
 - Activating the System.....77
 - Manually Overriding the System.....77
- Automatic Transmission.....170
 - Brake-Shift Interlock Override.....172
 - If Your Vehicle Gets Stuck In Mud or Snow.....172
 - Understanding the Shift Positions of Your Automatic Transmission.....170
- Automatic Transmission Fluid Check.....261
- Autowipers.....71
 - Autowipers Settings.....72
- Auxiliary Power Points.....137
 - 110 Volt AC Power Point.....137
 - 12 Volt DC Power Point.....137
 - Locations.....137

B

- Battery
 - See: Changing the 12V Battery.....261
- Blind Spot Information System.....208
 - Switching the System Off and On.....210
 - System Errors.....210

Index

Using the System.....	208	Cleaning the Alloy Wheels.....	275
Bonnet Lock		Cleaning the Engine.....	273
See: Opening and Closing the Hood.....	253	Cleaning the Exterior.....	271
Booster Seats.....	25	Exterior Chrome Parts.....	272
Types of Booster Seats.....	26	Exterior Plastic Parts.....	272
Brake Fluid Check.....	261	Stripes or Graphics.....	272
Brakes.....	174	Underbody.....	272
General Information.....	174	Under Hood.....	272
Breaking-In.....	224	Cleaning the Instrument Panel and	
Bulb Specification Chart.....	268	Instrument Cluster Lens.....	274
C		Cleaning the Interior.....	274
Cabin Air Filter.....	121	Cleaning the Windows and Wiper	
California Proposition 65.....	11	Blades.....	273
Capacities and Specifications.....	310	Clearing All MyKeys.....	56
Specifications.....	310	Climate.....	398
Car Wash		Climate Control.....	116
See: Cleaning the Exterior.....	271	Climate Controlled Seats.....	130
Center Console.....	139	Cooled Seats.....	130
Center Console with Rotary Control.....	139	Collision, Damage or Fire Event.....	231
Changing a Bulb.....	267	Guidance for Ford Motor Company Electric	
Headlamp.....	267	and Hybrid-Electric Vehicles Equipped	
LED Lamps.....	267	With High Voltage Batteries.....	231
License Plate Lamp.....	268	Coolant Check	
Reversing Lamp.....	267	See: Engine Coolant Check.....	256
Changing a Fuse.....	251	Crash Sensors and Airbag Indicator.....	46
Fuses.....	251	Creating a MyKey.....	55
Changing the 12V Battery.....	261	Programming or Changing Configurable	
Changing the Engine Air Filter.....	270	Settings.....	56
Changing the Wiper Blades.....	263	Cross Traffic Alert.....	210
Charging the High Voltage Battery.....	164	False Alerts.....	213
Energi Vehicles.....	164	Switching the System Off and On.....	213
Checking MyKey System Status.....	56	System Errors.....	213
MyKey Distance.....	56	System Lights, Messages and Audible	
Number of Admin Keys.....	56	Alerts.....	212
Number of MyKeys.....	56	System Limitations.....	212
Checking the Wiper Blades.....	263	Using the System.....	210
Child Restraint and Seatbelt		Cruise Control.....	69
Maintenance.....	37	Principle of Operation.....	195
Child Restraint Positioning.....	27	Type 1.....	69
Child Safety.....	16	Type 2.....	69
General Information.....	16	Cruise control	
Child Safety Locks.....	28	See: Using Cruise Control.....	195
Left-Hand Side.....	29	Customer Assistance.....	235
Right-Hand Side.....	29		
Cleaning Leather Seats.....	275	D	
Cleaning Products.....	271	Data Recording.....	9
		Event Data Recording.....	10

Index

Service Data Recording.....	9
Daytime Running Lamps.....	76
Type 1 - Conventional (Non-Configurable).....	76
Type 2 - Configurable.....	76
Digital Radio.....	323
HD Radio Reception and Station Troubleshooting.....	324
Direction Indicators.....	78
Driver Alert.....	203
PRINCIPLE OF OPERATION.....	203
USING DRIVER ALERT.....	203
Driver and Passenger Airbags.....	40
Children and Airbags.....	40
Proper Driver and Front Passenger Seating Adjustment.....	40
Driver and Passenger Knee Airbags.....	44
Driving Aids.....	203
Driving Hints.....	224
Driving Through Water.....	225
DRL See: Daytime Running Lamps.....	76
E	
Economical Driving.....	224
EcoSelect.....	150
Electric Parking Brake.....	175
Applying the Electric Parking brake.....	175
Battery With No Charge.....	177
Parking On a Hill (Vehicles With a Manual Transmission).....	175
Releasing the Electric Parking Brake.....	176
Electric Vehicle Information.....	414
Charge Settings (Energi Vehicles Only).....	416
Power.....	430
Emission Control System.....	159
On-Board Diagnostics (OBD-II).....	160
Readiness for Inspection and Maintenance (I/M) Testing.....	160
End User License Agreement.....	484
VEHICLE SOFTWARE END USER LICENSE AGREEMENT (EULA).....	484
Engine Block Heater.....	144
Using the Engine Block Heater.....	145
Engine Coolant Check.....	256
Adding Coolant.....	257
Coolant Change.....	259
Engine Coolant Temperature Management.....	260
Fail-Safe Cooling.....	259
Recycled Coolant.....	258
Severe Climates.....	258
Engine Immobilizer See: Passive Anti-Theft System.....	65
Engine Oil Check.....	255
Adding Engine Oil.....	255
Engine Oil Dipstick.....	255
Engine Specifications.....	306
Entertainment.....	388
AM/FM Radio.....	389
Apps.....	397
Bluetooth Stereo or USB.....	396
CD (If equipped).....	395
HD Radio™ Information (If Available).....	392
SIRIUS® Satellite Radio (If Activated).....	389
Sources.....	388
Supported Media Players, Formats and Metadata Information.....	397
USB Port.....	397
Environment.....	15
EPB See: Electric Parking Brake.....	175
Event Data Recording See: Data Recording.....	9
Export Unique Options.....	13
Extended Service Plan (ESP).....	464
EXTENDED SERVICE PLAN (CANADA ONLY).....	465
Ford Protect (U.S. Only).....	464
Exterior Mirrors.....	82
Auto-Dimming Feature.....	82
Blind Spot Monitor.....	83
Fold-Away Exterior Mirrors.....	82
Heated Exterior Mirrors.....	82
Integrated Blind Spot Mirrors.....	83
Memory Mirrors.....	82
Power Exterior Mirrors.....	82
Puddle Lamps.....	83
Signal Indicator Mirrors.....	83

Index

F

Fastening the Seatbelts.....	31
Rear Inflatable Seatbelt.....	33
Seatbelt Locking Modes.....	32
Using Seatbelts During Pregnancy.....	31
Flat Tire Inflation	
See: Tire Sealant and Inflator Kit.....	279
Floor Mats.....	225
Fog Lamps - Front	
See: Front Fog Lamps.....	78
Ford Credit.....	11
US Only.....	11
Front Fog Lamps.....	78
Front Parking Aid.....	183
Obstacle Distance Indicator.....	184
Front Passenger Sensing System.....	41
Fuel and Refueling.....	153
Fuel Consumption.....	158
Calculating Fuel Economy.....	159
Filling the Tank.....	158
Fuel Filler Funnel Location.....	155
Fuel Quality.....	154
Choosing the Right Fuel.....	154
Fuel Freshness Mode.....	154
Fuel Shutoff.....	228
Fuses.....	242
Fuse Specification Chart.....	242
Passenger Compartment Fuse	
Panel.....	249
Power Distribution Box.....	242

G

Garage Door Opener	
See: Universal Garage Door Opener.....	132
Gauges.....	86
Left Information Display.....	86
Right Information Display.....	88
General Information on Radio	
Frequencies.....	48
Intelligent Access.....	48
General Maintenance Information.....	466
Multi-point Inspection.....	469
Owner Checks and Services.....	468
Protecting Your Investment.....	466
Why Maintain Your Vehicle?.....	466

Why Maintain Your Vehicle at Your	
Dealership?.....	466
Getting Assistance Outside the U.S. and	
Canada.....	238
Getting the Services You Need.....	235
Away From Home.....	235
Global Opening and Closing.....	82
Closing the Windows.....	82
Opening the Windows.....	82

H

Hazard Warning Flashers.....	228
Headlamp Adjusting	
See: Adjusting the Headlamps.....	264
Headlamp Exit Delay.....	75
Headlamp Removal	
See: Removing a Headlamp.....	265
Head Restraints.....	122
Adjusting the Head Restraint.....	123
Tilting Head Restraints.....	123
Heated Seats.....	129
Heated Steering Wheel.....	70
Heated Windows and Mirrors.....	120
Heated Exterior Mirror.....	120
Heated Rear Window.....	120
Heating	
See: Climate Control.....	116
High Voltage Battery Cut-Off	
Switch.....	169
High Voltage Battery.....	162
General Information.....	162
Hill Start Assist.....	177
Switching the System On and Off.....	178
Using Hill Start Assist.....	178
Hints on Controlling the Interior	
Climate.....	119
Cooling the Interior Quickly.....	120
General Hints.....	119
Heating the Interior Quickly.....	120
Recommended Settings for Cooling.....	120
Recommended Settings for Heating.....	120
Side Window Defogging in Cold	
Weather.....	120
Hints on Driving With Anti-Lock	
Brakes.....	175
Home Screen.....	380

Index

Hood Lock	
See: Opening and Closing the Hood.....	253
Hybrid Vehicle Frequently Asked Questions.....	151
Hybrid Vehicle Operation.....	146
Battery.....	147
Braking.....	147
Driving.....	146
Driving to Optimize Fuel Economy.....	147
Engine.....	147
EV+ Mode.....	148
Starting.....	146
Stopping.....	146
Transmission Operation.....	146
I	
In California (U.S. Only).....	236
Information Display Control.....	70
Information Display Control Features.....	70
Information Displays.....	94
General Information.....	94
Information Messages.....	103
Active Park.....	103
Adaptive Cruise Control.....	104
AdvanceTrac™.....	104
Airbag.....	105
Alarm.....	105
Automatic Engine Shutdown.....	105
Battery and Charging System (12 volt).....	106
Battery and Charging System (High Voltage).....	106
Blind Spot Information and Cross Traffic Alert System.....	107
Doors and Locks.....	107
Driver Alert.....	108
Fuel.....	108
Hill Start Assist.....	109
Keys and Intelligent Access.....	109
Lane Keeping System.....	110
Maintenance.....	110
MyKey.....	111
Park Aid.....	112
Park Brake.....	112
Power Steering.....	113
Pre-Collision Assist.....	113
Remote Start.....	113
Seats.....	113
Starting System.....	114
Tire Pressure Monitoring System.....	114
Traction Control.....	114
Transmission.....	115
Installing Child Restraints.....	17
Child Seats.....	17
Using Lap and Shoulder Belts.....	18
Using Lower Anchors and Tethers for Children (LATCH).....	22
Using Tether Straps.....	24
Instrument Cluster.....	86
Instrument Lighting Dimmer.....	75
Vehicles With Front Fog Lamps.....	75
Vehicles Without Front Fog Lamps.....	75
Interior Lamps.....	78
Front Interior Lamp.....	78
Rear Interior Lamp.....	80
Interior Luggage Compartment Release.....	63
Interior Mirror.....	84
Auto-Dimming Mirror.....	84
Introduction.....	7
J	
Jump Starting the Vehicle.....	229
Connecting the Jumper Cables.....	229
Jump Starting.....	230
Preparing Your Vehicle.....	229
Removing the Jumper Cables.....	230
K	
Keyless Entry.....	61
SECURICODE™ Keyless Entry Keypad.....	61
Keyless Starting.....	141
Ignition Modes.....	141
Keys and Remote Controls.....	48
L	
Lane Keeping System.....	204
Switching the System On and Off.....	205
Lighting Control.....	73
Headlamp Flasher.....	74
High Beams.....	73

Index

Lighting.....	73
General Information.....	73
Load Carrying.....	218
Load Limit.....	218
Special Loading Instructions for Owners of Pick-up Trucks and Utility-type Vehicles.....	222
Vehicle Loading - with and without a Trailer.....	218
Locking and Unlocking.....	58
Activating Intelligent Access.....	59
Autolock.....	60
Autounlock.....	61
Battery Saver.....	61
Illuminated Entry.....	61
Illuminated Exit.....	61
Power Door Locks.....	58
Remote Control.....	58
Smart Unlocks for Intelligent Access Keys.....	60
Locks.....	58
M	
Maintenance.....	253
General Information.....	253
Manual Seats.....	124
Media Hub.....	328
Memory Function.....	126
Easy Entry and Exit Feature.....	128
Linking a PreSet Position to your Remote Control or Intelligent Access Key Fob.....	127
Saving a PreSet Position.....	127
Message Center See: Information Displays.....	94
Mirrors See: Heated Windows and Mirrors.....	120
See: Windows and Mirrors.....	81
Mobile Communications Equipment.....	13
Moonroof.....	84
Bounce-Back.....	85
Opening and Closing the Moonroof.....	85
Venting the Moonroof.....	85
Motorcraft Parts.....	307
MyKey Troubleshooting.....	57
MyKey™.....	54
Principle of Operation.....	54

N

Navigation.....	406
cityseeker.....	413
Destination Mode.....	408
Map Mode.....	406
Navigation Map Updates.....	414
Navigation Menu.....	411
SiriusXM Traffic and Travel Link.....	414
Waypoints.....	412
Normal Scheduled Maintenance.....	469
Intelligent Oil-Life Monitor.....	469
Normal Maintenance Intervals.....	470

O

Oil Change Indicator Reset.....	256
Oil Check See: Engine Oil Check.....	255
Opening and Closing the Hood.....	253
Closing the Hood.....	254
Opening the Hood.....	253
Ordering Additional Owner's Literature.....	239
Obtaining a French Owner's Manual.....	240
Overhead Console.....	140

P

Parking Aids.....	182
Principle of Operation.....	182
Passive Anti-Theft System.....	65
SecuriLock®.....	65
PATS See: Passive Anti-Theft System.....	65
Perchlorate.....	11
Personal Safety System™.....	38
How Does the Personal Safety System Work?.....	38
Phone.....	400
During a Phone Call.....	404
Making Calls.....	403
Pairing Your Cell Phone for the First Time.....	400
Phone Menu.....	401
Receiving Calls.....	404
Smartphone Connectivity.....	405
Text Messaging.....	405

Index

Plug-In Hybrid Vehicle Operation.....	148
ECO Cruise.....	150
EV Modes.....	148
Fuel Freshness.....	150
Low Engine Use.....	150
Plug-in Power Mode and Hybrid Mode.....	148
Post-Crash Alert System.....	233
Power Door Locks See: Locking and Unlocking.....	58
Power Seats.....	124
10-way power seat.....	126
6-way power seat.....	125
Power Lumbar.....	126
Power Windows.....	81
Accessory Delay.....	81
Bounce-Back.....	81
One-Touch Down.....	81
One-Touch Up.....	81
Window Lock.....	81
Pre-Collision Assist.....	214
Using the Pre-Collision Assist System.....	215
Protecting the Environment.....	15
R	
Rear Parking Aid.....	182
Obstacle Distance Indicator.....	183
Rear Seat Armrest.....	131
Rear Seats.....	128
Rear View Camera.....	191
Camera Guidelines.....	193
Manual Zoom.....	194
Obstacle Distance Indicator.....	194
Rear Camera Delay.....	194
Using the Rear View Camera System.....	192
Rear View Camera See: Rear View Camera.....	191
Refueling.....	156
Fuel Filler Door Manual Override Lever.....	158
System Warnings.....	158
Remote Control.....	48
Car Finder.....	51
Intelligent Access Key.....	48
Remote Start.....	51
Replacing the Battery.....	50
Sounding the Panic Alarm.....	51
Using the Key Blade.....	49
Remote Start.....	121
Automatic Settings.....	121
Removing a Headlamp.....	265
Repairing Minor Paint Damage.....	275
Replacement Parts Recommendation.....	12
Collision Repairs.....	12
Scheduled Maintenance and Mechanical Repairs.....	12
Warranty on Replacement Parts.....	12
Replacing a Lost Key or Remote Control.....	53
Reporting Safety Defects (Canada Only).....	240
Reporting Safety Defects (U.S. Only).....	240
Roadside Assistance.....	227
Vehicles Sold in Canada: Getting Roadside Assistance.....	227
Vehicles Sold in Canada: Roadside Assistance Program Coverage.....	228
Vehicles Sold in Canada: Using Roadside Assistance.....	228
Vehicles Sold in the United States: Getting Roadside Assistance.....	227
Vehicles Sold in the United States: Using Roadside Assistance.....	227
Roadside Emergencies.....	227
Running-In See: Breaking-In.....	224
Running Out of Fuel.....	155
Adding Fuel From a Portable Fuel Container.....	155
Filling a Portable Fuel Container.....	155
S	
Safety Canopy™.....	44
Safety Precautions.....	153
Satellite Radio.....	325
Satellite Radio Electronic Serial Number (ESN).....	326
Satellite Radio Reception Factors.....	326
SIRIUS® Satellite Radio Service.....	326
Troubleshooting.....	327
Scheduled Maintenance Record.....	474

Index

Scheduled Maintenance.....	466	Starting a Gasoline Engine.....	142
Seatbelt Extension.....	37	Automatic Engine Shutdown.....	143
Seatbelt Height Adjustment.....	34	Failure to Start.....	142
Seatbelt Reminder.....	35	Guarding Against Exhaust Fumes.....	144
Belt-Minder™.....	35	Important Ventilating Information.....	144
Seatbelts.....	30	Starting Your Vehicle.....	142
Principle of Operation.....	30	Stopping the Engine When Your Vehicle is Moving.....	143
Seatbelt Warning Lamp and Indicator		Stopping the Engine When Your Vehicle is Stationary.....	143
Chime.....	35	Starting and Stopping the Engine.....	141
Conditions of operation.....	35	General Information.....	141
Seats.....	122	Steering.....	213
Security.....	65	Electric Power Steering.....	213
Settings.....	437	Steering Wheel.....	67
911 Assist.....	442	Storage Compartments.....	139
Ambient Lighting.....	447	Sunroof	
Bluetooth.....	439	See: Moonroof.....	84
Clock.....	439	Sun Visors.....	84
Display.....	449	Illuminated Vanity Mirror.....	84
General.....	446	Supplementary Restraints System.....	39
Media Player.....	438	Principle of Operation.....	39
Mobile Apps.....	445	Symbols Glossary.....	7
Navigation.....	443	SYNC™ 3.....	367
Phone.....	439	General Information.....	367
Radio.....	442	SYNC™ 3 Troubleshooting.....	450
Sound.....	437	SYNC™ Applications and Services.....	345
Valet Mode.....	449	911 Assist.....	345
Vehicle.....	447	SYNC Mobile Apps.....	347
Voice Control.....	449	SYNC™.....	329
Wi-Fi.....	447	General Information.....	329
Side Airbags.....	43	SYNC™ Troubleshooting.....	359
Side Sensing System.....	184		
Obstacle Distance Indicator.....	185	T	
Sitting in the Correct Position.....	122	Technical Specifications	
Snow Chains		See: Capacities and Specifications.....	306
See: Using Snow Chains.....	300	The Better Business Bureau (BBB) Auto Line Program (U.S. Only).....	237
Special Notices.....	12	Tire Care.....	285
New Vehicle Limited Warranty.....	12	Glossary of Tire Terminology.....	287
On Board Diagnostics Data Link		Information About Uniform Tire Quality Grading.....	285
Connector.....	13	Information Contained on the Tire	
Special Instructions.....	12	Sidewall.....	288
Special Operating Conditions Scheduled		Temperature A B C.....	286
Maintenance.....	472	Traction AA A B C.....	286
Exceptions.....	473		
Speed Control			
See: Cruise Control.....	195		
Spinout Detection.....	233		
Stability Control.....	180		
Principle of Operation.....	180		

Index

Treadwear.....	286	USB Port.....	328
Tire Inflation When Punctured		Using Adaptive Cruise Control.....	196
See: Tire Sealant and Inflator Kit.....	279	Automatic Cancellation.....	200
Tire Pressure Monitoring System.....	301	Blocked Sensor.....	201
Changing Tires With a Tire Pressure		Canceling the Set Speed.....	200
Monitoring System.....	302	Changing the Set Speed.....	200
Understanding Your Tire Pressure		Detection Issues.....	201
Monitoring System	302	Following a Vehicle.....	198
Tire Repair Kit		Following a Vehicle to a Complete	
See: Tire Sealant and Inflator Kit.....	279	Stop.....	198
Tire Sealant and Inflator Kit.....	279	Hilly Condition Usage.....	200
First Stage: Reinflating the Tire with Sealing		Overriding the System.....	199
Compound and Air.....	281	Resuming the Set Speed.....	200
General Information.....	280	Setting the Adaptive Cruise Speed.....	197
Second Stage: Checking Tire		Setting the Adaptive Cruise Speed When	
Pressure.....	283	Your Vehicle is Stationary.....	197
Tips for Use of the Kit.....	280	Setting the Gap Distance.....	198
What to do after the Tire has been		Switching Adaptive Cruise Control	
Sealed.....	283	Off.....	200
What to do when a Tire Is Punctured.....	281	Switching Adaptive Cruise Control	
Tires		On.....	197
See: Wheels and Tires.....	279	Switching to Normal Cruise Control.....	202
Towing a Trailer.....	223	System Not Available.....	201
Towing Points.....	234	Using Cruise Control.....	195
Installing the Recovery Hook.....	234	Switching Cruise Control Off.....	196
Recovery Hook Location.....	234	Switching Cruise Control On.....	195
Towing the Vehicle on Four		Using MyKey With Remote Start	
Wheels.....	223	Systems.....	57
Emergency Towing.....	223	Using Snow Chains.....	300
Recreational Towing.....	223	Using Stability Control.....	181
Towing.....	223	Using Summer Tires.....	300
Traction Control.....	179	Using SYNC™ With Your Media	
Principle of Operation.....	179	Player.....	350
Transmission Code Designation.....	309	Accessing Your USB Song Library.....	354
Transmission.....	170	Bluetooth Devices and System	
Transmission.....	170	Settings.....	356
See: Transmission.....	170	Connecting Your Digital Media Player to the	
Transporting the Vehicle.....	233	USB Port.....	350
Type Approvals.....	500	Media Menu Features.....	354
RF Certification Logos for Tire Pressure		Media Voice Commands.....	351
Monitoring Sensor(s).....	500	USB 2.....	356
		Voice Commands for Audio Sources.....	357
U		Using SYNC™ With Your Phone.....	333
Under Hood Overview.....	254	Accessing Features through the Phone	
Unique Driving Characteristics.....	146	Menu.....	338
Universal Garage Door Opener.....	132	Accessing Your Phone Settings.....	341
HomeLink Wireless Control System.....	132	Bluetooth Devices.....	342
		Making Calls.....	336

Index

Pairing a Phone for the First Time.....	333
Pairing Subsequent Phones.....	334
Phone Options during an Active Call.....	337
Phone Voice Commands.....	335
Receiving Calls.....	337
System Settings.....	343
Text Messaging.....	339
Using Traction Control.....	179
Switching the System Off.....	179
System Indicator Lights and Messages.....	179
Using a Switch.....	179
Using the Information Display Controls.....	179
Using Voice Recognition.....	331
Audio Voice Commands.....	382
Climate Voice Commands.....	383
Initiating a Voice Session.....	331
Mobile App Voice Commands.....	386
Navigation Voice Commands.....	385
Phone Voice Commands.....	383
SiriusXM Traffic and Travel Link Voice Commands.....	386
System Interaction and Feedback.....	332
Voice Settings Commands.....	387
Utilizing the Mediation/Arbitration Program (Canada Only).....	238
V	
Vehicle Care.....	271
General Information.....	271
Vehicle Certification Label.....	309
Vehicle Identification Number.....	308
Vehicle Storage.....	276
12V Battery.....	277
Body.....	276
Brakes.....	277
Cooling System.....	277
Engine.....	276
Fuel System.....	277
General.....	276
Miscellaneous.....	277
Removing Vehicle From Storage.....	277
Tires.....	277
Ventilation	
See: Climate Control.....	116
VIN	
See: Vehicle Identification Number.....	308
Voice Control.....	69
W	
Warning Lamps and Indicators.....	89
Adaptive Cruise Control.....	90
Anti-Lock Braking System.....	90
Battery.....	90
Blind Spot Monitor.....	90
Brake System.....	90
Cruise Control.....	90
Direction Indicator.....	90
Door Ajar.....	90
EcoSelect.....	90
Electric Park Brake.....	91
Engine Oil.....	91
Engine or Motor Coolant Temperature.....	91
EV Later.....	91
EV Now.....	91
Fasten Seatbelt.....	91
Front Airbag.....	91
Front Fog Lamps.....	91
Grade Assist.....	91
Heads Up Display.....	91
High Beam.....	91
Hood Ajar.....	91
Lane Keeping Aid.....	91
Low Fuel Level.....	92
Low Tire Pressure Warning.....	92
Parking Lamps.....	92
Powertrain Fault.....	92
Ready to Drive.....	92
Service Engine Soon.....	92
Stability Control.....	93
Stability Control Off.....	93
Stop Safely.....	93
Trunk Ajar.....	93
Vehicle Plugged in.....	93
Washer Fluid Check.....	261
Washers	
See: Cleaning the Exterior.....	271
See: Wipers and Washers.....	71
Waxing.....	272
Wheels and Tires.....	279
Technical Specifications.....	304
Windows and Mirrors.....	81

Index

Windshield Washers.....	72
Windshield Wipers.....	71
Intermittent Wipe.....	71
Speed Dependent Wipers.....	71
Wiper Blades	
See: Checking the Wiper Blades.....	263
Wipers and Washers.....	71