

ACCORD

HONDA
The Power of Dreams

**2019 SEDAN
OWNER'S MANUAL**

WARNING

California Proposition 65 Warning

Operating, servicing and maintaining a passenger vehicle or off-highway motor vehicle can expose you to chemicals including engine exhaust, carbon monoxide, phthalates, and lead, which are known to the State of California to cause cancer and birth defects or other reproductive harm. To minimize exposure, avoid breathing exhaust, do not idle the engine except as necessary, service your vehicle in a well-ventilated area and wear gloves or wash your hands frequently when servicing your vehicle. For more information go to www.P65Warnings.ca.gov/passenger-vehicle.

Event Data Recorders

This vehicle is equipped with an event data recorder (EDR).

The main purpose of an EDR is to record, in certain crash or near crash-like situations, such as an air bag deployment or hitting a road obstacle, data that will assist in understanding how a vehicle's systems performed. **The EDR is designed to record data related to vehicle dynamics and safety systems for a short period of time, typically 30 seconds or less. The EDR in this vehicle is designed to record such data as:**

- **How various systems in your vehicle were operating;**
- **Whether or not the driver and passenger safety belts were buckled/fastened;**

- **How far (if at all) the driver was depressing the accelerator and/or brake pedal; and,**
- **How fast the vehicle was traveling.**

These data can help provide a better understanding of the circumstances in which crashes and injuries occur. NOTE: EDR data are recorded by your vehicle only if a non-trivial crash situation occurs; no data are recorded by the EDR under normal driving conditions and no personal data (e.g., name, gender, age, and crash location) are recorded. However, other parties, such as law enforcement, could combine the EDR data with the type of personally identifying data routinely acquired during a crash investigation.

To read data recorded by an EDR, special equipment is required, and access to the vehicle or the EDR is needed. In addition to the vehicle manufacturer, other parties, such as law enforcement, that have the special equipment, can read the information if they have access to the vehicle or the EDR.

The data belongs to the vehicle owner and may not be accessed by anyone else except as legally required or with the permission of the vehicle owner.

Service Diagnostic Recorders

This vehicle is equipped with service-related devices that record information about powertrain performance. The data can be used to verify emissions law requirements and/or help technicians diagnose and solve service problems. It may also be combined with data from other sources for research purposes, but it remains confidential. Some diagnostic and maintenance information is uploaded to Honda upon vehicle start up.

California Perchlorate Contamination Prevention Act

The airbags, seat belt tensioners, and CR type batteries in this vehicle may contain perchlorate materials - special handling may apply. See www.dtsc.ca.gov/hazardouswaste/perchlorate/

As you read this manual, you will find information that is preceded by a **NOTICE** symbol. This information is intended to help you avoid damage to your vehicle, other property, or the environment.

Software End User License Agreement

Your vehicle comes equipped with software, which is governed by the End User License Agreement in Owner's Manual, and which contains a binding arbitration clause. Please refer to the End User License Agreement for the terms and conditions governing your use of the installed software, as well as the applications, services, functions, and content provided through the software. Your use of the installed software will serve as your consent to the terms and conditions of the End User License Agreement.

You may opt out within 30 days of your initial use of the Software by sending a signed, written notice to HONDA at American Honda Motor Co., Inc. Honda Automobile Customer Services Mail Stop 100-5E-8A, 1919 Torrance Blvd. Torrance, CA 90501-2746.

Privacy Notice

This vehicle may share location and usage information. To manage this setting, visit www.hondalink.com/vehicle-data-choices.

A Few Words About Safety

Your safety, and the safety of others, is very important. And operating this vehicle safely is an important responsibility.

To help you make informed decisions about safety, we have provided operating procedures and other information on labels and in this manual. This information alerts you to potential hazards that could hurt you or others.

Of course, it is not practical or possible to warn you about all the hazards associated with operating or maintaining your vehicle. You must use your own good judgment.

You will find this important safety information in a variety of forms, including:

- **Safety Labels** - on the vehicle.
- **Safety Messages** - preceded by a safety alert symbol  and one of three signal words: **DANGER**, **WARNING**, or **CAUTION**. These signal words mean:

 **DANGER**

You WILL be KILLED or SERIOUSLY HURT if you don't follow instructions.

 **WARNING**

You CAN be KILLED or SERIOUSLY HURT if you don't follow instructions.

 **CAUTION**

You CAN be HURT if you don't follow instructions.

- **Safety Headings** - such as Important Safety Precautions.
- **Safety Section** - such as Safe Driving.
- **Instructions** - how to use this vehicle correctly and safely.

This entire book is filled with important safety information - please read it carefully.

This owner's manual should be considered a permanent part of the vehicle and should remain with the vehicle when it is sold.

This owner's manual covers all models of your vehicle. You may find descriptions of equipment and features that are not on your particular model.

Images throughout this owner's manual (including the front cover) represent features and equipment that are available on some, but not all, models. Your particular model may not have some of these features.

This owner's manual is for vehicles sold in the United States and Canada.

The information and specifications included in this publication were in effect at the time of approval for printing. Honda Motor Co., Ltd. reserves the right, however, to discontinue or change specifications or design at any time without notice and without incurring any obligation.

➤ **Safe Driving P. 33**

For Safe Driving P. 34 Seat Belts P. 38 Airbags P. 45

➤ **Instrument Panel P. 77**

Indicators P. 78 Gauges and Displays P. 137

➤ **Controls P. 163**

Clock P. 164 Locking and Unlocking the Doors P. 166
Opening and Closing the Moonroof* P. 189
Adjusting the Seats P. 210

➤ **Features P. 243**

Audio System P. 244 Audio System Basic Operation P. 252, 273
Customized Features P. 370, 381 HomeLink® Universal Transceiver* P. 400

➤ **Driving P. 453**

Before Driving P. 454 Towing a Trailer P. 459
Multi-View Rear Camera P. 594 Refueling P. 597

➤ **Maintenance P. 603**

Before Performing Maintenance P. 604 Maintenance Minder™ P. 607
Checking and Maintaining Wiper Blades P. 639
Climate Control System Maintenance P. 654

➤ **Handling the Unexpected P. 663**

Tools P. 664 If a Tire Goes Flat P. 665
Overheating P. 679 Indicator, Coming On/Blinking P. 681
When You Cannot Open the Trunk P. 695

➤ **Information P. 699**

Specifications P. 700 Identification Numbers P. 704
Emissions Testing P. 707 Warranty Coverages P. 709

Contents

Child Safety P. 61

Exhaust Gas Hazard P. 75

Safety Labels P. 76

Opening and Closing the Trunk P. 180

Security System P. 183

Opening and Closing the Windows P. 186

Operating the Switches Around the Steering Wheel P. 190

Adjusting the Mirrors P. 208

Interior Lights/Interior Convenience Items P. 221

Climate Control System P. 239

Audio Error Messages P. 343

General Information on the Audio System P. 348

Bluetooth® HandsFreeLink® P. 403, 427

Refuel Recommend P. 452

When Driving P. 465

Braking P. 571

Parking Your Vehicle P. 583

Fuel Economy and CO₂ Emissions P. 600

Turbo Engine Vehicle P. 601

Maintenance Under the Hood P. 614

Replacing Light Bulbs P. 631

Checking and Maintaining Tires P. 642

Battery P. 651

Remote Transmitter Care P. 653

Cleaning P. 655

Accessories and Modifications P. 660

Engine Does Not Start P. 671

Jump Starting P. 674

Shift Lever Does Not Move P. 677

Fuses P. 688

Emergency Towing P. 693

When You Cannot Unlock the Fuel Fill Door P. 694

Refueling P. 697

Devices that Emit Radio Waves P. 705

Reporting Safety Defects P. 706

Authorized Manuals P. 711

Customer Service Information P. 712

Quick Reference Guide P. 4

Safe Driving P. 33

Instrument Panel P. 77

Controls P. 163

Features P. 243

Driving P. 453

Maintenance P. 603

Handling the Unexpected P. 663

Information P. 699

Index P. 713

Visual Index

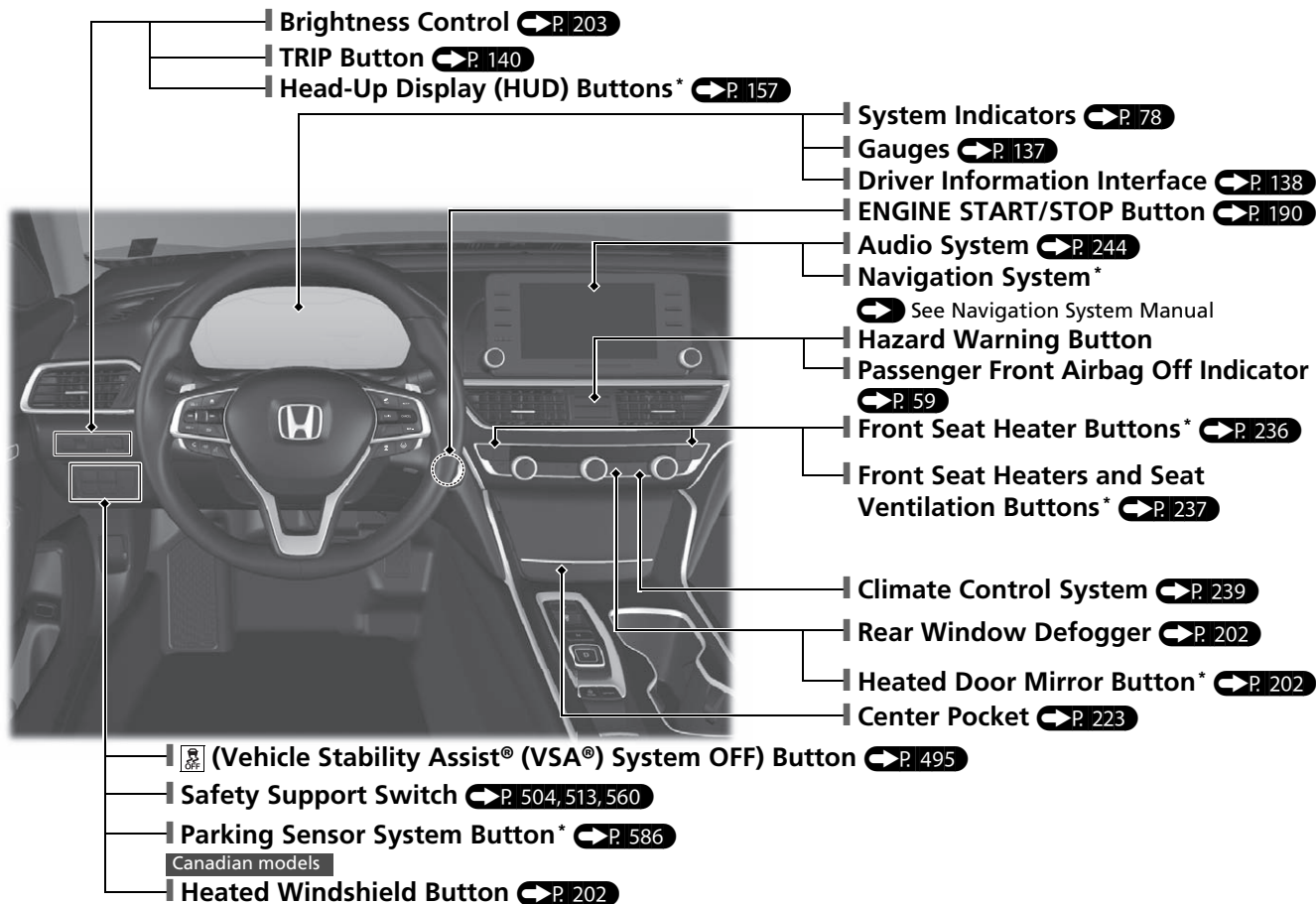

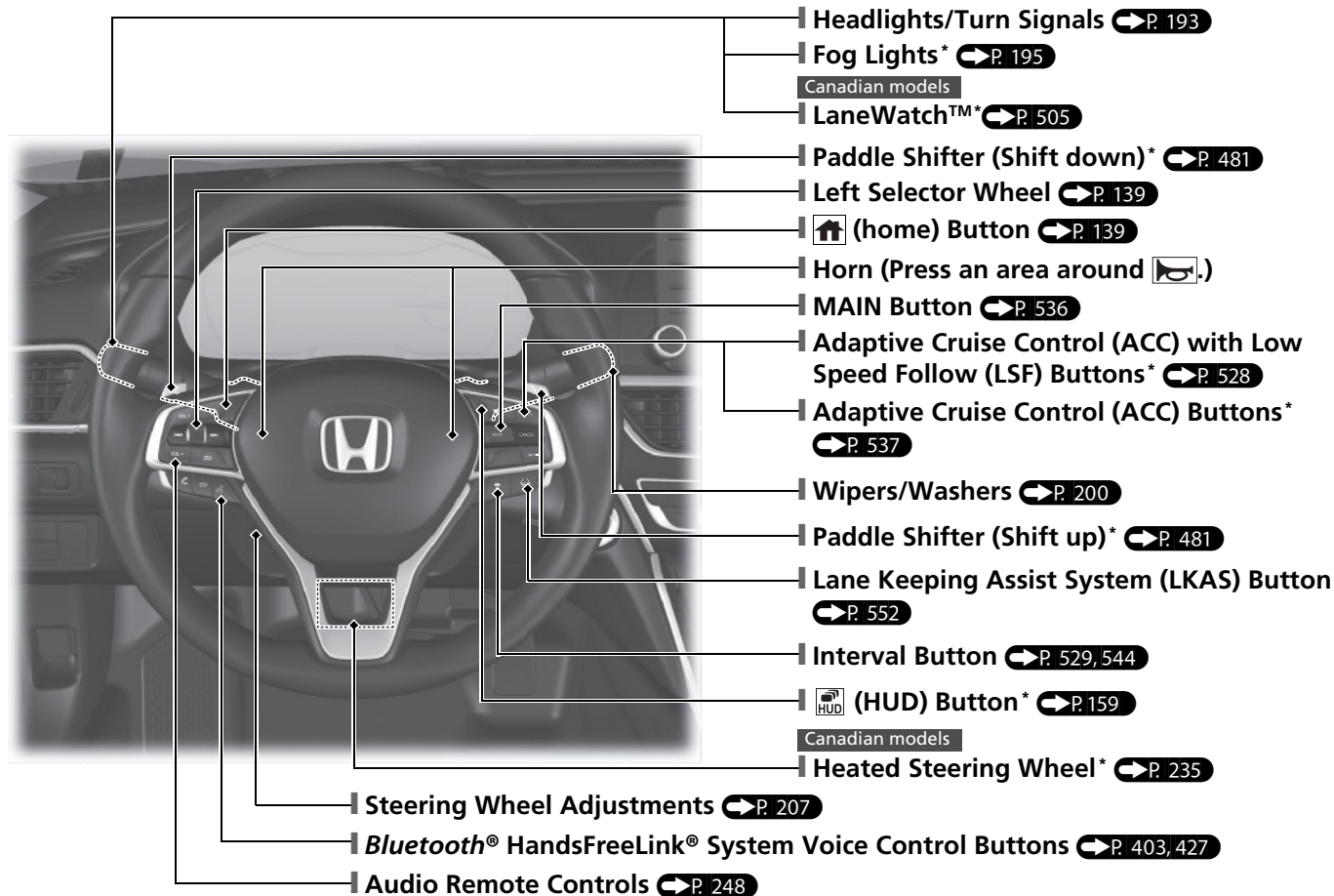

Visual Index

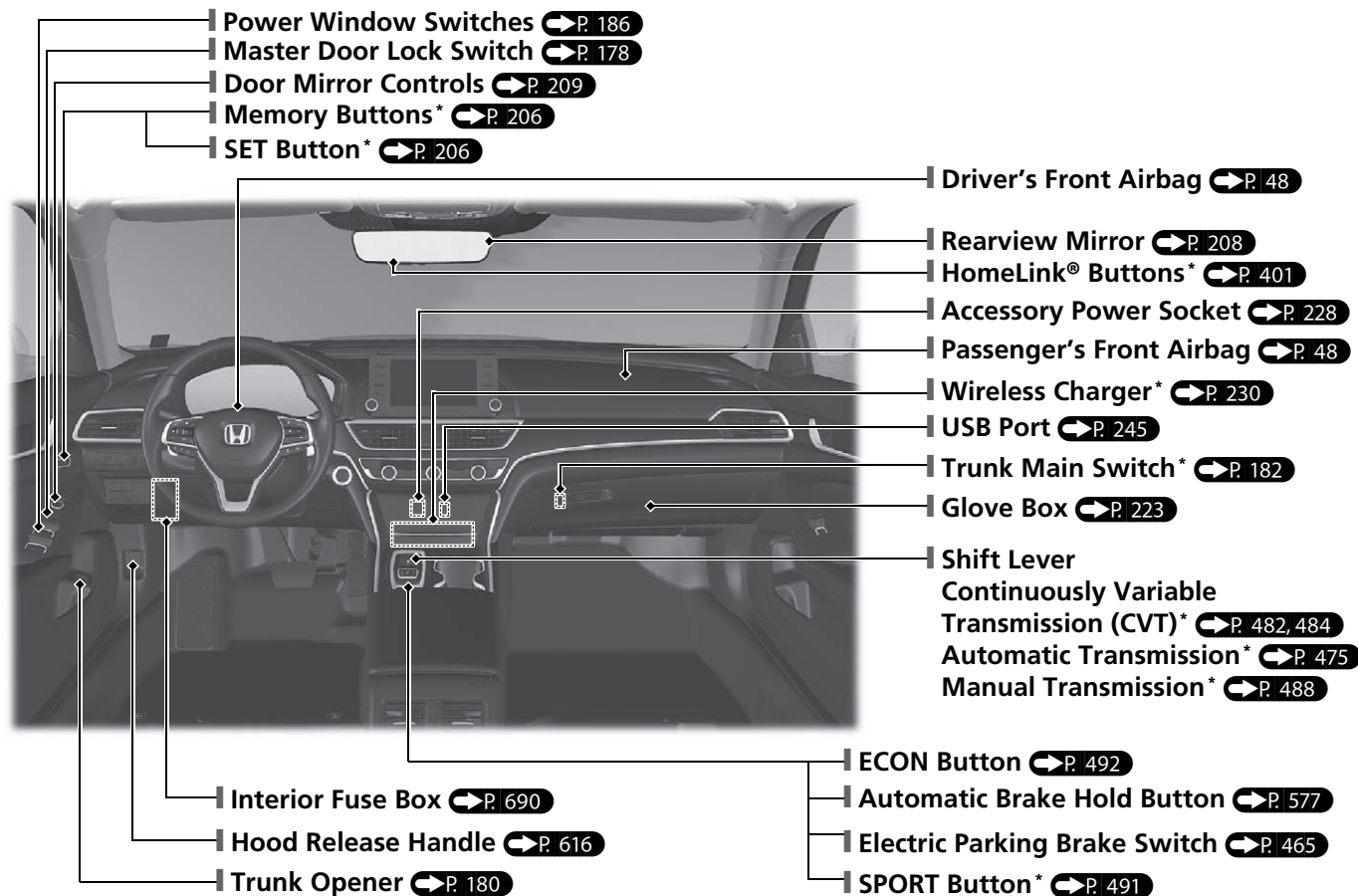

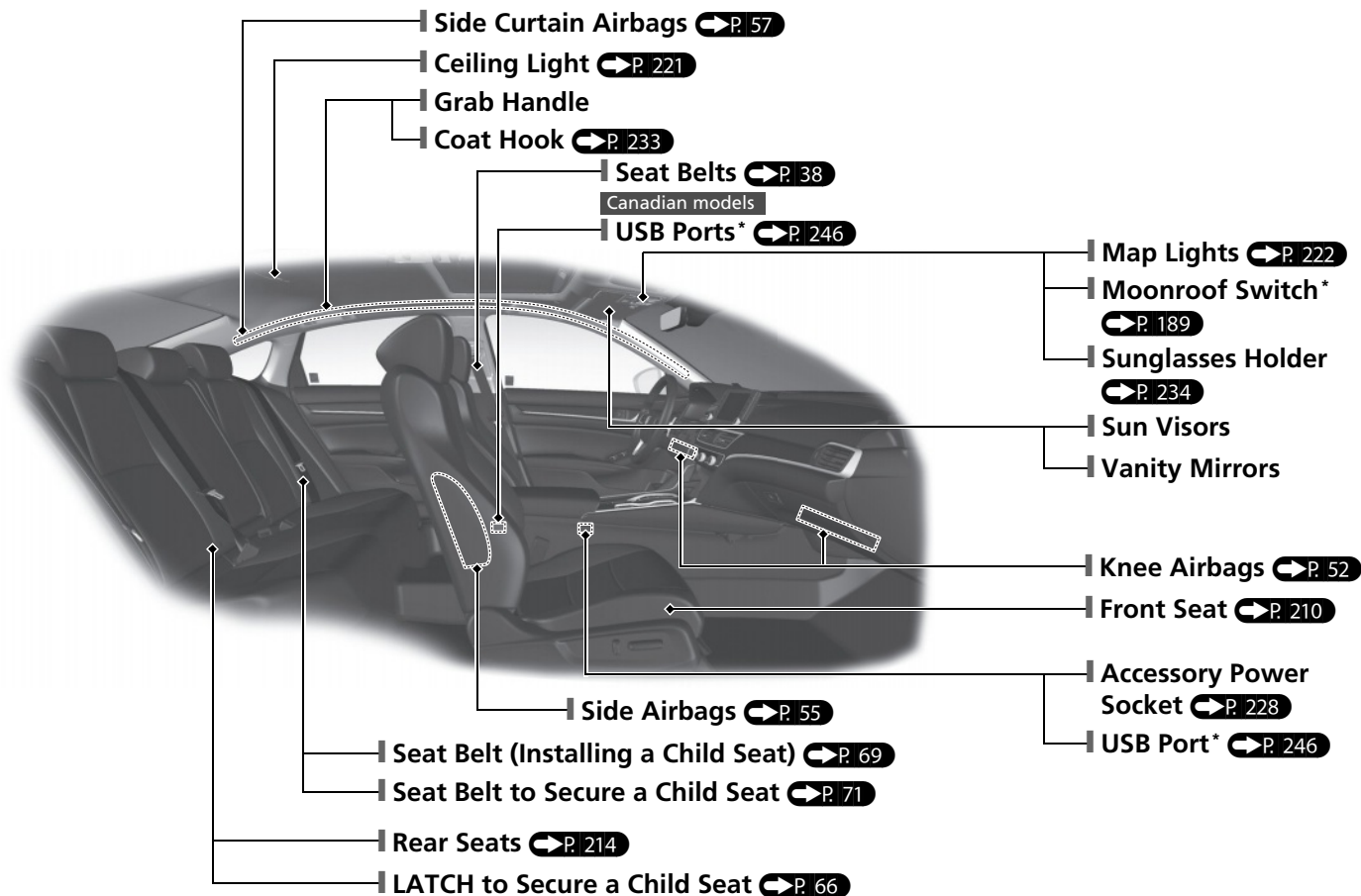

Visual Index

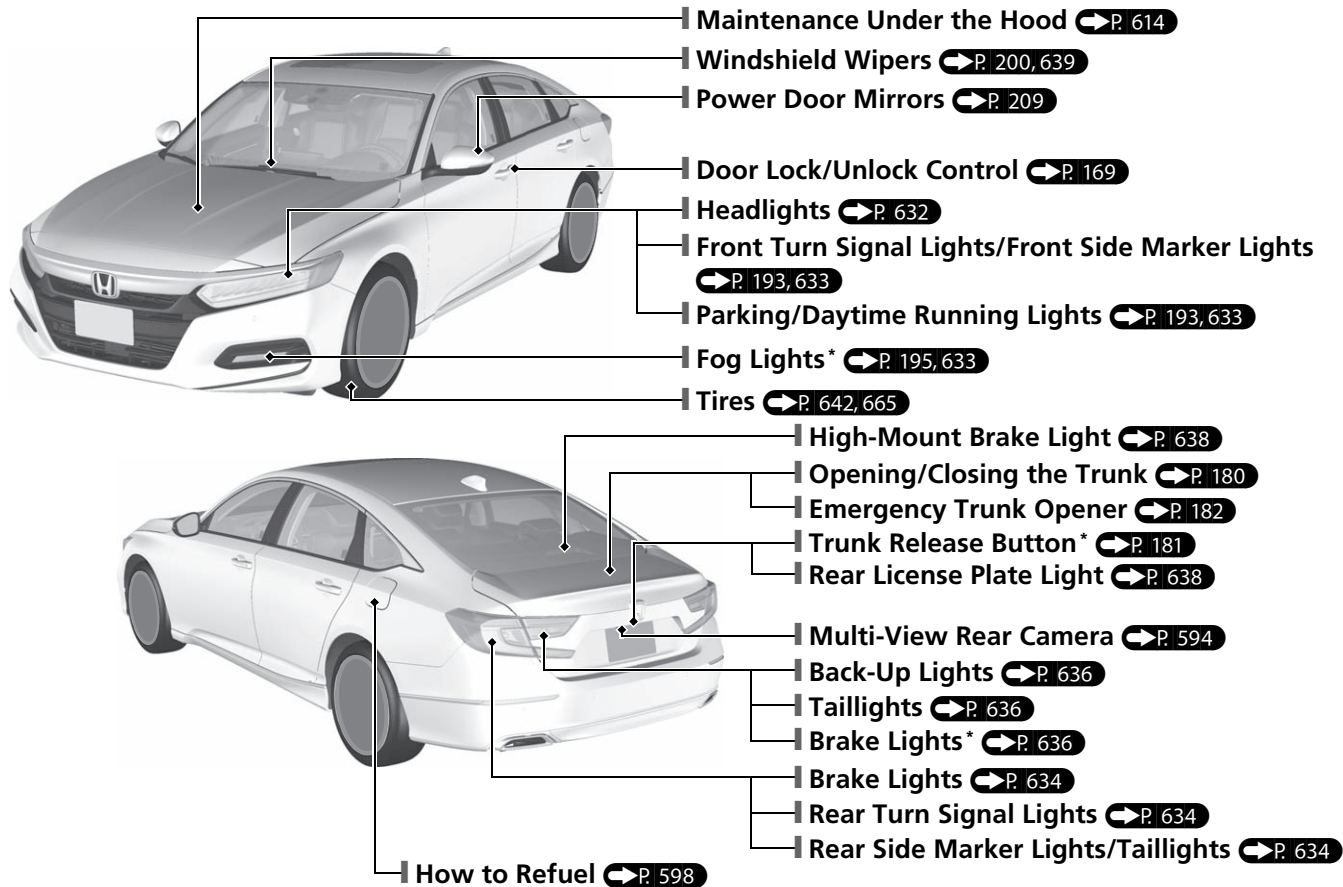

Eco Assist[®] System P. 492

Ambient Meter

Ambient Meter

- With SPORT mode* off, the color of the ambient meter changes to green to indicate that the vehicle is being driven in a fuel efficient manner.



The message is displayed for a few seconds when the **ECON** button is pressed.

- *1: Models without the adaptive damper system
- *2: Models with the adaptive damper system
- *3: Continuously variable transmission models without SPORT mode
- *4: Manual transmission models
- *5: Automatic transmission/Continuously variable transmission models with SPORT mode



ECON Mode Indicator P. 97

Comes on when the **ECON** button is pressed.

ECON Button P. 492

Helps maximize fuel economy.

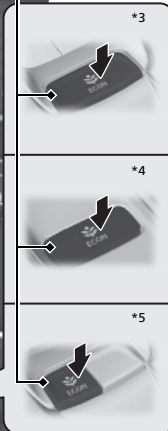
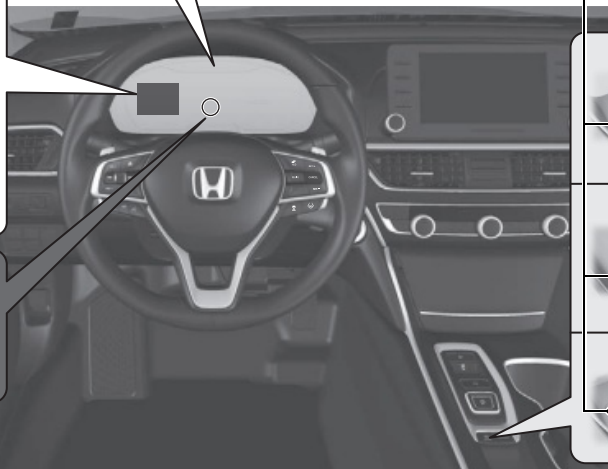

Safe Driving P. 33

Airbags P. 45

- Your vehicle is fitted with airbags to help protect you and your passengers during a moderate-to-severe collision.

Child Safety P. 61

- All children 12 and younger should be seated in the rear seat.
- Smaller children should be properly restrained in a forward-facing child seat.
- Infants must be properly restrained in a rear-facing child seat.

Exhaust Gas Hazard P. 75

- Your vehicle emits dangerous exhaust gases that contain carbon monoxide. Do not run the engine in confined spaces where carbon monoxide gas can accumulate.

Seat Belts P. 38

- Fasten your seat belt and sit upright well back in the seat.
- Check that your passengers are wearing their seat belts correctly.

Before Driving Checklist P. 37

- Before driving, check that the front seats, head restraints, steering wheel, and mirrors have been properly adjusted.

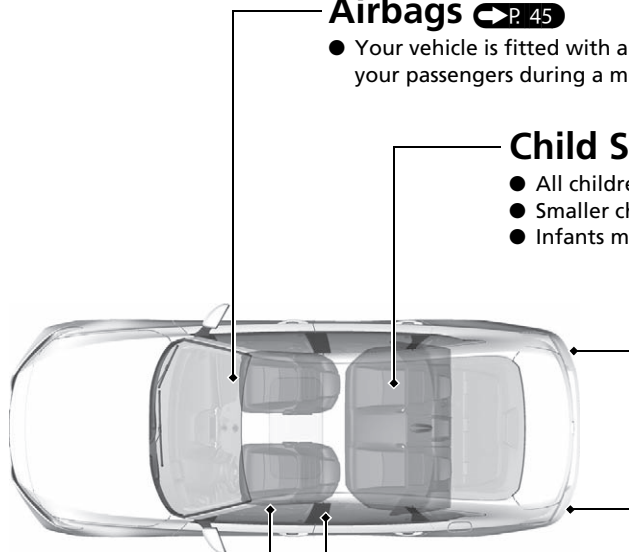

Fasten your lap belt as low as possible.

Instrument Panel P. 77

Indicators  P. 78 / Driver Information Interface  P. 138 / Gauges  P. 137 /
Head-Up Display*  P. 157

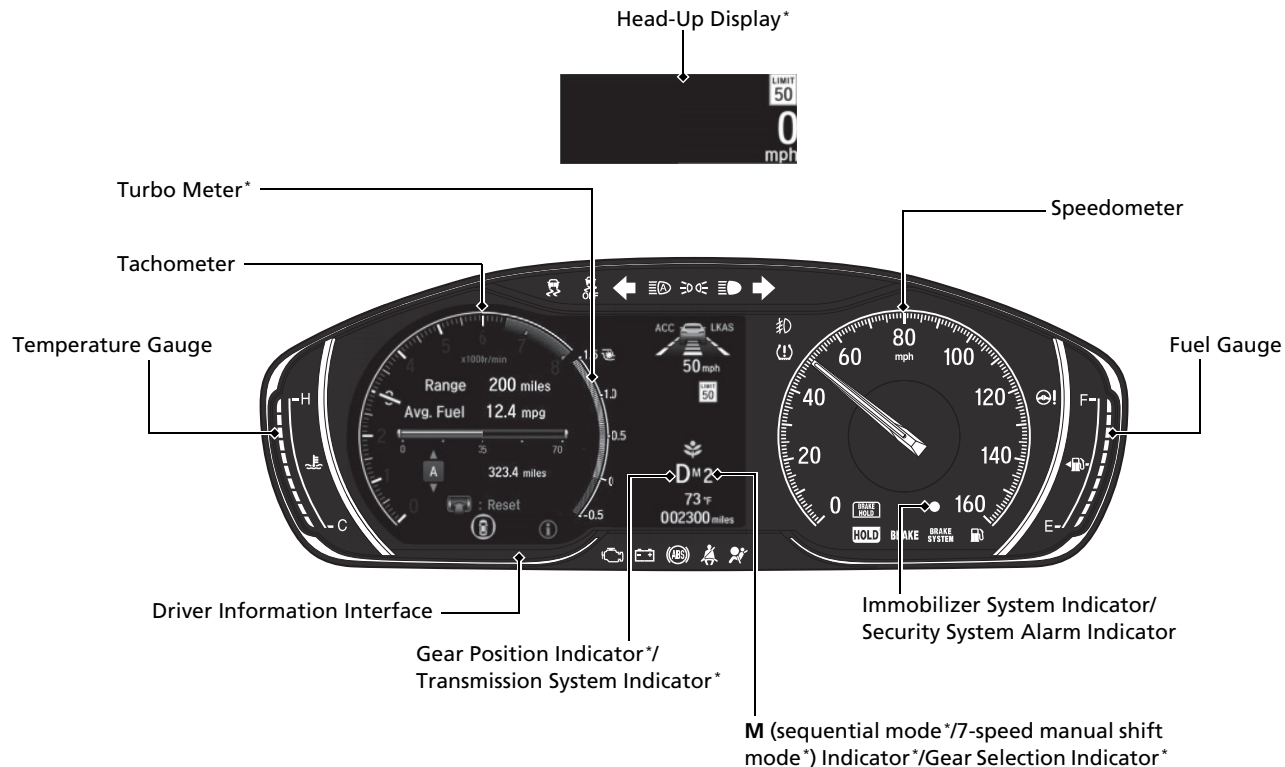





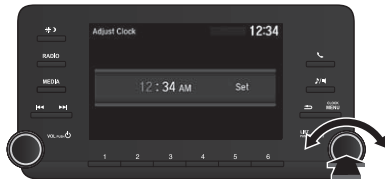

* Not available on all models

Controls P. 163

Clock P. 164



Models with color audio

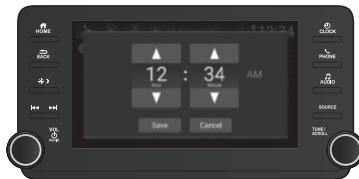

- 1 Press the **MENU/CLOCK** button.
- 2 Select **Adjust Clock**, then press .
- 3 Rotate  to adjust the hours.
- 4 Press  to switch to minute adjustment.
- 5 Rotate  to adjust the minutes.
- 6 Press  to switch to **Set**. **To adjust time**
- 7 Press  to complete clock adjustment.

Models with Display Audio



- 5 Select **Set Date** or **Set Time**.
- 6 Adjust the dates, hours and minutes by selecting /.
- 7 Select **Save** to set the date or time.

Models with navigation system

The navigation system receives signals from GPS satellites, updating the clock automatically.

ENGINE START/STOP Button P. 190

Press the button to change the vehicle's power mode.



Turn Signals P. 193

Turn Signal Control Lever



Lights P. 193

Light Control Switches

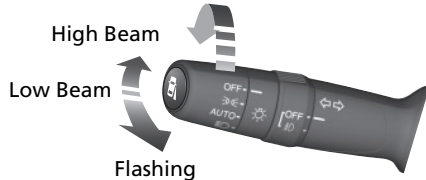





Wipers and Washers

 P. 200

Wiper/Washer Control Lever

Adjustment Ring

: Low Sensitivity*¹
: Lower speed, fewer sweeps*²

: High Sensitivity*¹
: Higher speed, more sweeps*²

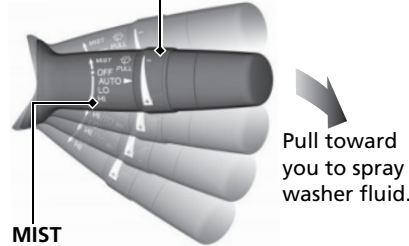

MIST
OFF

AUTO*¹: Wiper speed varies automatically

INT*²: Low speed with intermittent

LO: Low speed wipe

HI: High speed wipe

*1: Models with automatic intermittent wipers

*2: Models without automatic intermittent wipers

Models with automatic intermittent wipers

AUTO should always be turned **OFF** before the following situations in order to prevent severe damage to the wiper system:

- Cleaning the windshield
- Driving through a car wash
- No rain

Steering Wheel P. 207

- To adjust, push the adjustment lever down, adjust to the desired position, then lock the lever back in place.

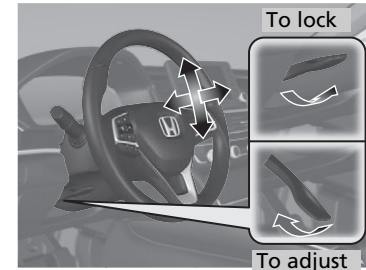

Unlocking the Front Doors from the Inside P. 176

- Pull either front door inner handle to unlock and open it at the same time.

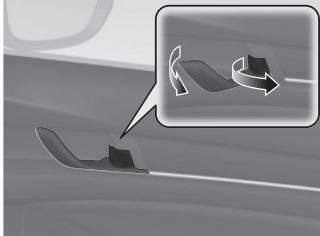

- Unlocking and opening the driver's door from the inner handle unlocks all the other doors.

Trunk P. 180

- Press the trunk opener on the driver's door to unlock and open the trunk.
- Press the trunk release button on the remote to unlock and open the trunk.
- Press the trunk release button* on the trunk lid to unlock and open the trunk.

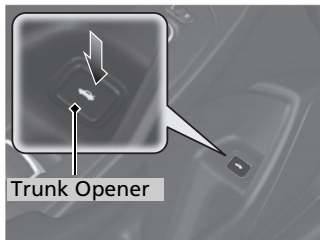

Power Door Mirrors P. 209

- With the power mode is ON, move the selector switch to L or R.
- Push the appropriate edge of the adjustment switch to adjust the mirror.

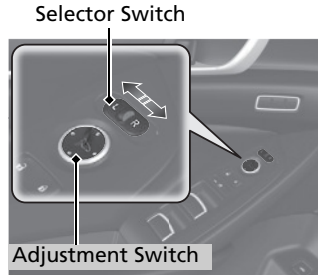

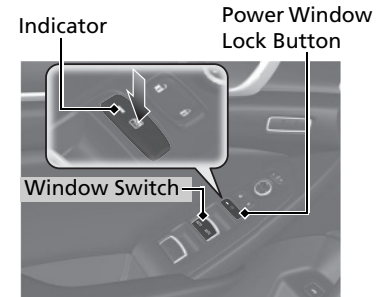

Power Windows P. 186

- With the power mode is ON, open and close the power windows.
- If the power window lock button is in the off position, each passenger's window can be opened and closed with its own switch.
- If the power window lock button is in the on position (indicator on), each passenger's window switch is disabled.



Climate Control System P. 239

- Press the **AUTO** button to activate the climate control system.
- Press the  button to turn the system on or off.
- Press the  button to defrost the windshield.

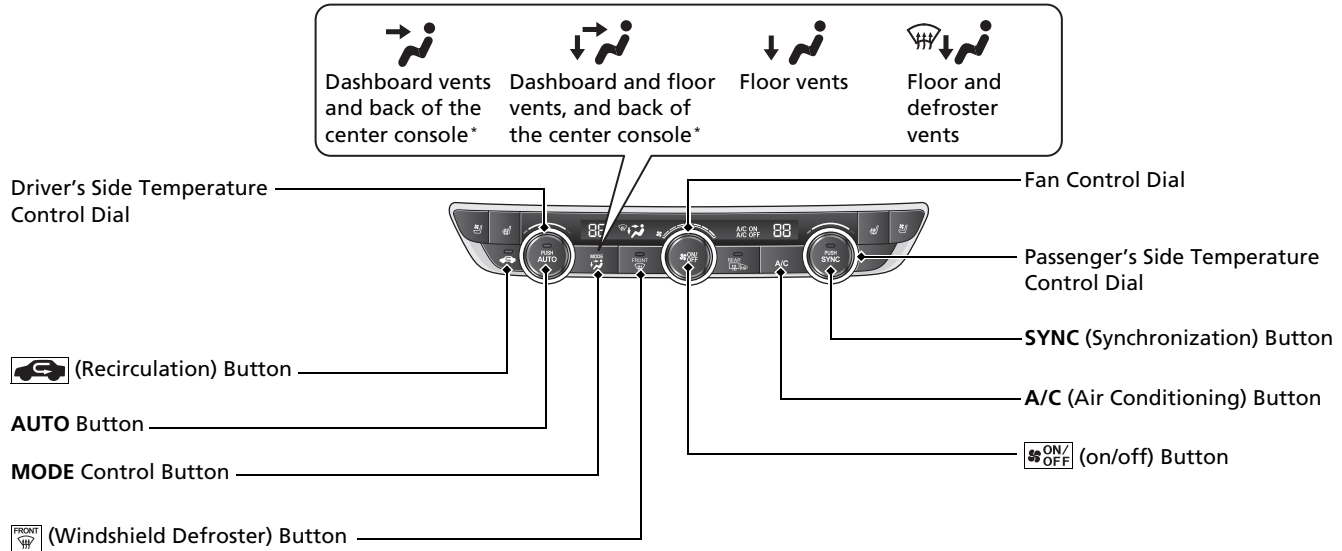

Features



Audio Remote Controls

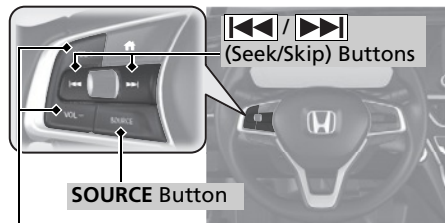

Models with color audio



VOL+/VOL- (Volume) Buttons

- VOL+/VOL- (Volume) Buttons
Press to adjust the volume up/down.
- SOURCE Button
Press to change the audio mode:
FM1→FM2→AM→USB/iPod→Pandora®→
Bluetooth® Audio.
-  (Seek/Skip) Buttons
Radio: Press  to change the preset station.
iPod, USB device, or Bluetooth® Audio:
Press  to skip to the beginning of the next song or return to the beginning of the current song.

USB device:

Press and hold  to change a folder.

Models with Display Audio

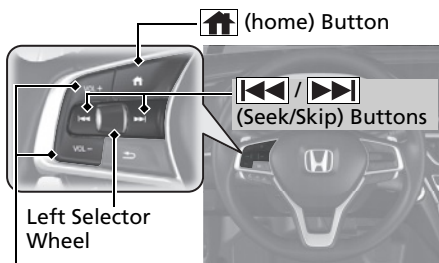





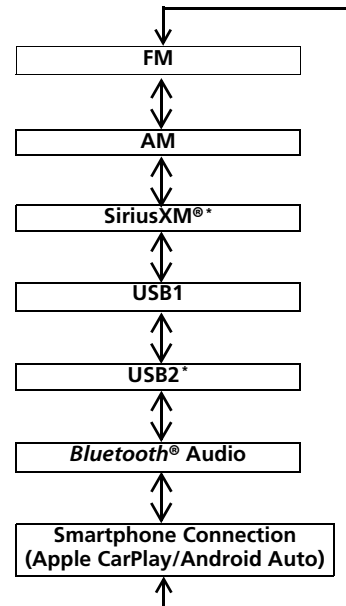

VOL+/VOL- (Volume) Buttons

- VOL+/VOL- (Volume) Buttons
Press to adjust the volume up/down.
- Left Selector Wheel
When selecting the audio mode
Press the  (home) button, then roll up or down to select **Audio** on the driver information interface, and then press the left selector wheel.

Roll up or down: To cycle through the audio modes, roll up or down and then press the left selector wheel:



-  (Seek/Skip) Buttons
 - Radio: Press  /  to change the preset station.
 - iPod, USB device, *Bluetooth*® Audio or Smartphone Connection:
 - Press  /  to skip to the beginning of the next song or return to the beginning of the current song.
 - USB device:
 - Press and hold  /  to change a folder.

Audio System ➔ P. 252, 273

Models with color audio

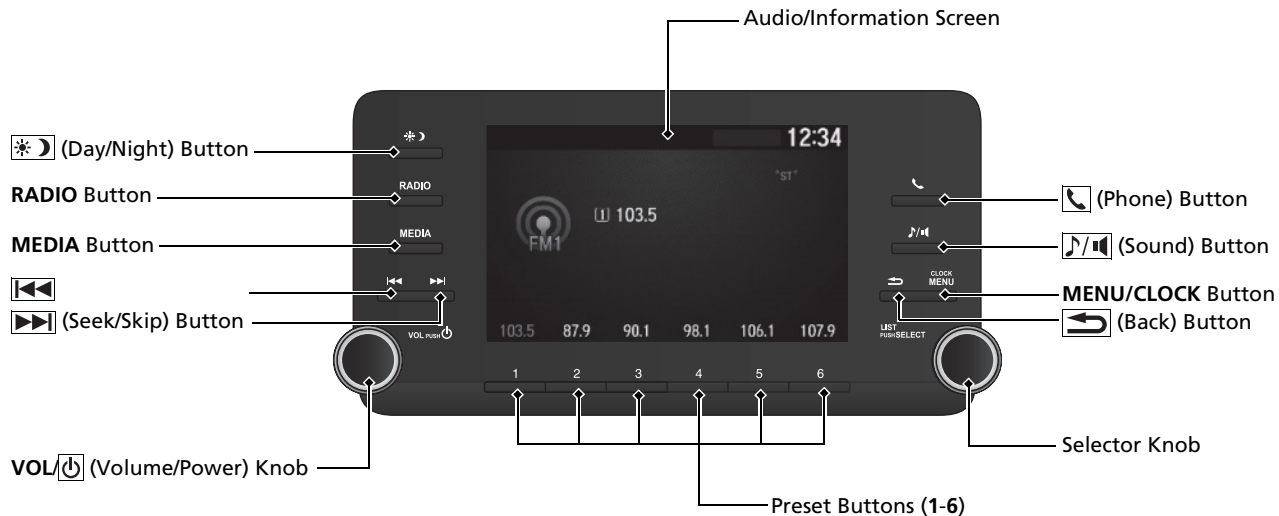

For navigation system operation See the Navigation System Manual



Driving P. 453

Manual Transmission* P. 488

Automatic Transmission* P. 475

- Always depress the brake pedal before selecting **P** or changing the gear position from **P**.
- Select **P** and depress the brake pedal when starting the engine.
- Gear selection

Gear Position Indicator

The gear position indicator and the shift button indicator indicate the current gear selection.



Gear Position Indicator

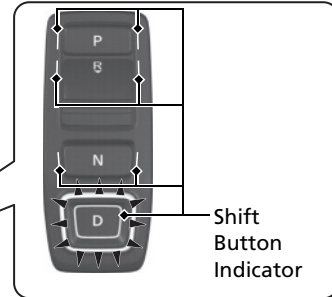

Shift Button Indicator

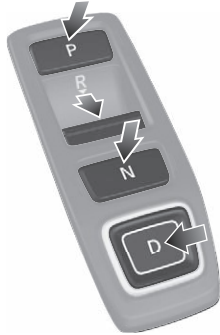

P

Park

Press the **P** button.

Used when parking or before turn off or start the engine.
Transmission is locked.

R

Reverse

Pull back the **R** button.

Used when reversing.

N

Neutral

Press the **N** button.

Transmission is not locked.

D

Drive

Press the **D** button.

- Normal driving (gears change between 1st and 10th automatically)
- Temporarily driving in the sequential mode
- Driving in the sequential mode (when driving in SPORT mode)

Paddle Shifters P.480

- Paddle shifters allow you to shift gears much like a manual transmission (1st through 10th). This is useful for engine braking.

Gear Position Indicator

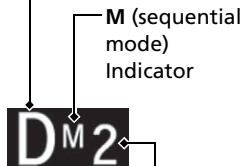

Gear Selection Indicator

Shift Down 
Paddle Shifter

Shift Up 
Paddle Shifter



When the transmission is in

D

- The transmission will shift back to automatic mode once the system detects that the vehicle is cruising.

When the transmission is in **D** with SPORT mode

- Holds the selected gear, and the **M** (sequential mode) indicator comes on.
- The gear selection is shown in the instrument panel.

Continuously Variable Transmission *

➔ P. 482, 484

- Shift to **P** and depress the brake pedal when starting the engine.
- **Shifting**

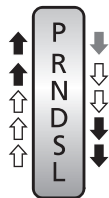

Models without paddle shifters

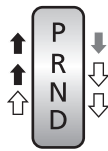

Models with paddle shifters

- Depress the brake pedal and press the shift lever release button to shift.
- Press the shift lever release button and shift.
- Shift without pressing the shift lever release button.

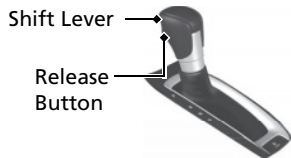

P **Park**
Used when parking or starting the engine.

R **Reverse**
Used when reversing.

N **Neutral**
Transmission is not locked.

D **Drive**

- Used for normal driving.
- On models with paddle shifters, 7-speed mode can be used temporarily.
- On models with paddle shifters, 7-speed manual shift mode can be used when driving in SPORT mode.

S **Drive (S)***

- Used for better acceleration.
- Used to increase engine braking.
- Used when going up or down hills.

L **Low***

- Used to further increase engine braking.
- Used when going up or down hills.

7-Speed Manual Shift Mode* ➔ P. 486

- Allows you to manually shift the transmission up or down without removing your hands from the steering wheel.

M Indicator



Gear Selection Indicator

Shift Down **-**
Paddle Shifter



Shift Up **+**
Paddle Shifter

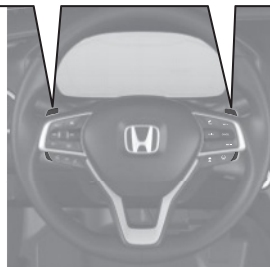

When the shift lever is in **D** with SPORT mode

- Pulling a paddle shifter changes the mode from continuously variable transmission to 7-speed manual shift mode.
- The **M** indicator and the selected speed number are displayed in the gear selection indicator.

When the shift lever is in **D**

- Pulling a paddle shifter temporarily changes the mode from continuously variable transmission to 7-speed manual shift mode. The selected speed number is displayed in the gear selection indicator.

* Not available on all models

VSA® On and Off P. 495

- The Vehicle Stability Assist® (VSA®) system helps stabilize the vehicle during cornering, and helps maintain traction while accelerating on loose or slippery road surfaces.
- VSA® comes on automatically every time you start the engine.
- To partially disable or fully restore VSA® function, press and hold the button until you hear a beep.

CMBS™ On and Off

 P. 513

- When a possible collision is likely unavoidable, the CMBS™ can help you to reduce the vehicle speed and the severity of the collision.
- The CMBS™ is turned on every time you start the engine.
- To turn the CMBS™ on or off, use the safety support switch.

Tire Pressure Monitoring System (TPMS) P. 497

- Detects a change in tire conditions and overall dimensions due to decrease in tire pressures.
- The TPMS is turned on automatically every time you start the engine.
- A calibration procedure must be performed when certain conditions arise.

Refueling P. 597

Fuel recommendation: Unleaded gasoline, pump octane number 87 or higher

Fuel tank capacity: 14.8 US gal (56 L)

- 1 Unlock the driver's door using the master door lock switch.

 **Using the Master Door Lock Switch**
 P. 178

- 2 Press on the edge of the fuel fill door to make it pop up slightly.



- 3 After refueling, wait for about five seconds before removing the filler nozzle.

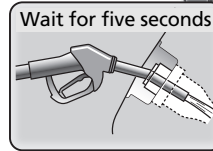

Honda Sensing®

➔ P. 507

Honda Sensing® is a driver support system which employs the use of two distinctly different kinds of sensors, a radar sensor located at the lower part of the front bumper and a front sensor camera mounted to the interior side of the windshield, behind the rear view mirror.

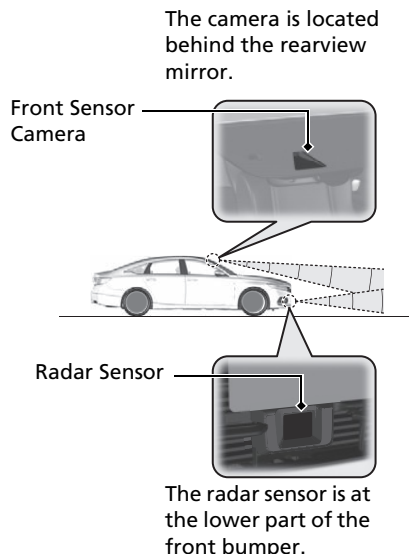

Collision Mitigation Braking System™ (CMBS™)

➔ P. 510

Can assist you when there is a possibility of your vehicle colliding with a vehicle or a pedestrian detected in front of yours. The CMBS™ is designed to alert you when a potential collision is determined, as well as to reduce your vehicle speed to help minimize collision severity when a collision is deemed unavoidable.

Adaptive Cruise Control (ACC) with Low Speed Follow (LSF) *

➔ P. 519

Helps maintain a constant vehicle speed and a set following interval behind a vehicle detected ahead of yours and, if the detected vehicle comes to a stop, can decelerate and stop your vehicle, without you having to keep your foot on the brake or the accelerator.

Adaptive Cruise Control (ACC) *

➔ P. 535

Helps maintain a constant vehicle speed and a set following interval behind a vehicle detected ahead of yours, without you having to keep your foot on the brake or the accelerator.

Lane Keeping Assist System (LKAS)

➔ P. 550

Provides steering input to help keep the vehicle in the middle of a detected lane and provides tactile and visual alerts if the vehicle is detected drifting out of its lane.

Road Departure Mitigation (RDM) System

➔ P. 558

Alerts and helps to assist you when the system detects a possibility of your vehicle unintentionally crossing over detected lane markings and/or leaving the roadway altogether.

Traffic Sign Recognition System ➔ P. 562

Reminds you of road sign information, such as the current speed limit, your vehicle has just passed through, showing it on the driver information interface and the head-up display*.

Maintenance P. 603

Under the Hood P. 614

- Check engine oil, engine coolant, and windshield washer fluid. Add when necessary.
- Check brake fluid and clutch* fluid.
- Check the battery condition monthly.

- 1 Pull the hood release handle under the corner of the dashboard.

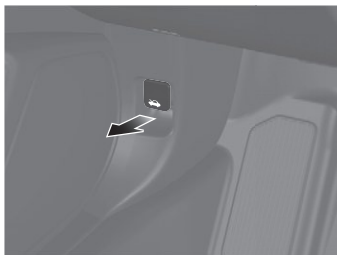

- 2 Locate the hood latch lever, push it to the side, and then raise the hood. Once you have raised the hood slightly, you can release the lever.

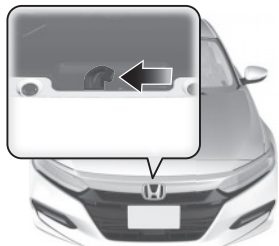

- 3 When finished, close the hood and make sure it is firmly locked in place.

Wiper Blades P. 639

- Replace blades if they leave streaks across the windshield.

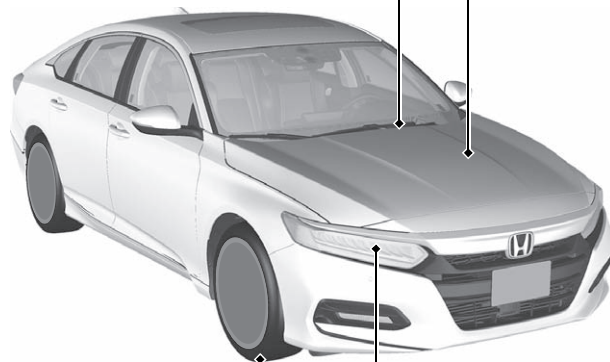

Tires P. 642

- Inspect tires and wheels regularly.
- Check tire pressures regularly.
- Install snow tires for winter driving.

Lights P. 631

- Inspect all lights regularly.

Handling the Unexpected P. 663

Flat Tire P. 665

- Park in a safe location and replace the flat tire with the compact spare tire in the trunk.



Engine Won't Start P. 671

- If the battery is dead, jump start using a booster battery.

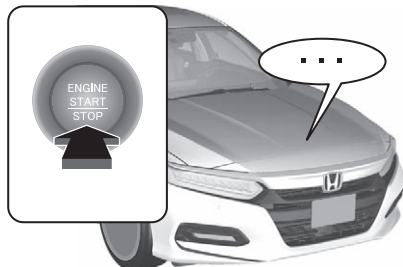

Overheating P. 679

- Park in a safe location. If you do not see steam under the hood, open the hood, and let the engine cool down.



Indicators Come On P. 681

- Identify the indicator and consult the owner's manual.



Blown Fuse P. 688

- Check for a blown fuse if an electrical device does not operate.

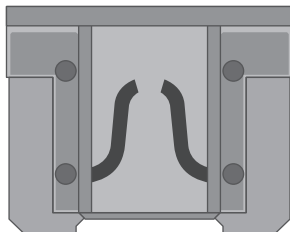

Emergency Towing P. 693

- Call a professional towing service if you need to tow your vehicle.



What to Do If

Q

Manual transmission models

Continuously variable transmission models for Canadian models

The power mode does not change from VEHICLE OFF to ACCESSORY. Why?

A

- The steering wheel may be locked.
- Move the steering wheel left and right after pressing the **ENGINE START/STOP** button.



Q

Continuously variable transmission models

The power mode does not change from ACCESSORY to VEHICLE OFF. Why?

A

The shift lever should be moved to **P**.



Q

Why does the brake pedal pulsate slightly when applying the brakes?

A

This can occur when the ABS activates and does not indicate a problem. Apply firm, steady pressure on the brake pedal. Never pump the brake pedal.

➤ Anti-lock Brake System (ABS) ➔ P. 581

Q The rear door cannot be opened from inside the vehicle. Why?

A Check if the childproof lock is in the lock position. If so, open the rear door with the outside door handle. To cancel this function, slide the lever up to the unlock position.

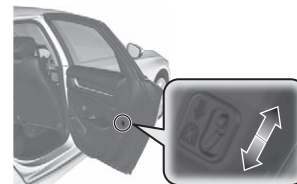

Q Why do the doors lock after I unlocked the doors?

A If you do not open the doors within 30 seconds, the doors are relocked automatically for security.

Q Why does the beeper sound when I open the driver's door?

A The beeper sounds when:

- The power mode is in ACCESSORY.
- The exterior lights are left on.

Q Why does a beeper sound when I walk away from the vehicle after I close the door?

A The beeper sounds if you move outside the walk away auto door lock operating range before the door completely closes.

➤ Locking the vehicle (Walk away auto lock®) ➔ P.171

Q Why does the beeper sound when I start driving?

A The beeper sounds when the driver and/or front passenger are not wearing their seat belts.

Q I'm seeing an amber indicator of a tire with an exclamation point. What is that?

A The Tire Pressure Monitoring System (TPMS) needs attention. If you recently inflated or changed a tire, you have to recalibrate the system.

➤ Tire Pressure Monitoring System (TPMS) ➔ P. 497

Q Pressing the electric parking brake switch does not release the parking brake. Why?

A Press the electric parking brake switch with the brake pedal depressed.

Q Depressing the accelerator pedal does not release the parking brake automatically. Why?

A

- Fasten the driver's seat belt.
- Check if the transmission is in **P*** or **N**. If so, select any other position.

Q **Models with electronic gear selector**
Why does the gear position automatically change to **P** when I open the driver's door to check for parking space lines when reversing?

A

- Fasten the driver's seat belt.
- Close the driver's door and manually change the gear position.

➤ When opening the driver's door ➔ P. 477

Q Why do I hear a screeching sound when I apply the brake pedal?

A The brake pads may need to be replaced. Have your vehicle inspected by a dealer.

Safe Driving

You can find many safety recommendations throughout this chapter, and throughout this manual.

For Safe Driving

Important Safety Precautions.....	34
Your Vehicle's Safety Features.....	36
Safety Checklist	37

Seat Belts

About Your Seat Belts.....	38
Fastening a Seat Belt.....	41
Seat Belt Inspection.....	44

Airbags

Airbag System Components.....	45
Types of Airbags.....	48
Front Airbags (SRS)	48

Knee Airbags.....	52
Side Airbags.....	55
Side Curtain Airbags.....	57
Airbag System Indicators.....	58
Airbag Care	60

Child Safety

Protecting Child Passengers	61
Safety of Infants and Small Children.....	63
Safety of Larger Children	73

Exhaust Gas Hazard

Carbon Monoxide Gas.....	75
--------------------------	----

Safety Labels

Label Locations.....	76
----------------------	----

The following pages explain your vehicle's safety features and how to use them properly. The safety precautions below are ones that we consider to be among the most important.

Important Safety Precautions

■ Always wear your seat belt

A seat belt is your best protection in all types of collisions. Airbags are designed to supplement seat belts, not replace them. So even though your vehicle is equipped with airbags, make sure you and your passengers always wear your seat belts, and wear them properly.

■ Restrain all children

Children ages 12 and under should ride properly restrained in a back seat, not the front seat. Infants and small children should be restrained in a child seat. Larger children should use a booster seat and a lap/shoulder seat belt until they can use the belt properly without a booster seat.

■ Be aware of airbag hazards

While airbags can save lives, they can cause serious or fatal injuries to occupants who sit too close to them, or are not properly restrained. Infants, young children, and short adults are at the greatest risk. Be sure to follow all instructions and warnings in this manual.

■ Don't drink and drive

Alcohol and driving don't mix. Even one drink can reduce your ability to respond to changing conditions, and your reaction time gets worse with every additional drink. So don't drink and drive, and don't let your friends drink and drive, either.

▣ Important Safety Precautions

Some states, provinces and territories prohibit the use of cell phones other than hands-free devices by the driver while driving.

■ Pay appropriate attention to the task of driving safely

Engaging in cell phone conversation or other activities that keep you from paying close attention to the road, other vehicles, and pedestrians could lead to a crash. Remember, situations can change quickly, and only you can decide when it is safe to divert some attention away from driving.

■ Control your speed

Excessive speed is a major factor in crash injuries and deaths. Generally, the higher the speed, the greater the risk, but serious injuries can also occur at lower speeds. Never drive faster than is safe for current conditions, regardless of the maximum speed posted.

■ Keep your vehicle in safe condition

Having a tire blowout or a mechanical failure can be extremely hazardous. To reduce the possibility of such problems, check your tire pressures and condition frequently, and perform all regularly scheduled maintenance.

■ Do not leave children unattended in the vehicle

Children, pets and people needing assistance left unattended in the vehicle may be injured if they activate one or more of the vehicle controls. They may also cause the vehicle to move, resulting in a crash in which they and/or another person(s) can be injured or killed. Also, depending on the ambient temperature, the temperature of the interior may reach extreme levels, which can result in harm or death. Even if the climate control system is on, never leave them in the vehicle unattended as the climate control system can shut off at any time.

Your Vehicle's Safety Features

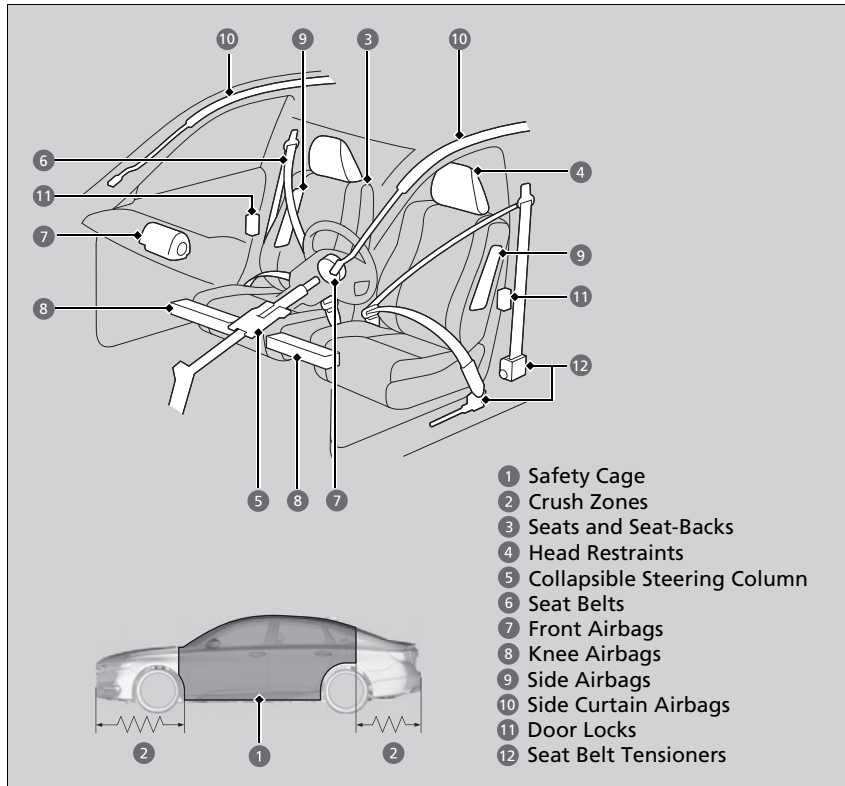

The following checklist will help you take an active role in protecting yourself and your passengers.

►► Your Vehicle's Safety Features

Your vehicle is equipped with many features that work together to help protect you and your passengers during a crash.

Some features do not require any action on your part. These include a strong steel framework that forms a safety cage around the passenger compartment, front and rear crush zones, a collapsible steering column, and tensioners that tighten the front seat belts in a sufficient crash.

However, you and your passengers cannot take full advantage of these features unless you remain seated in the correct position and always wear your seat belts. In fact, some safety features can contribute to injuries if they are not used properly.

Safety Checklist

For the safety of you and your passengers, make a habit of checking these items each time before you drive.

- After everyone has entered the vehicle, be sure all doors are closed and locked. Locking the doors helps prevent an occupant from being ejected and an outsider from unexpectedly opening a door.
 - **Locking/Unlocking the Doors from the Inside** P. 176
- Adjust your seat to a position suitable for driving. Be sure the front seats are adjusted as far to the rear as possible while allowing the driver to control the vehicle. Sitting too close to a front airbag can result in serious or fatal injury in a crash.
 - **Adjusting the Seats** P. 210
- Adjust head restraints to the proper position. Head restraints are most effective when the center of the head restraint aligns with the center of your head. Taller persons should adjust their head restraint to the highest position.
 - **Adjusting the Front and Rear Outer* Head Restraint Positions** P. 216
- Always wear your seat belt, and make sure you wear it properly. Confirm that any passengers are properly belted as well.
 - **Fastening a Seat Belt** P. 41
- Protect children by using seat belts or child seats according to a child's age, height and weight.
 - **Child Safety** P. 61

* Not available on all models

▶ Safety Checklist

If the door and/or trunk open message appears on the driver information interface, a door and/or the trunk is not completely closed. Close all doors and the trunk tightly until the message disappears.

➤ **Driver Information Interface Warning and Information Messages** P. 105

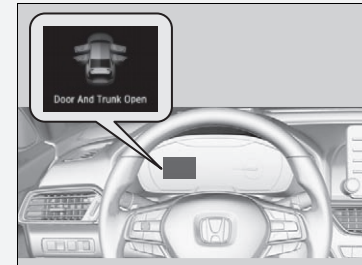

About Your Seat Belts

Seat belts are the single most effective safety device because they keep you connected to the vehicle so that you can take advantage of many built-in safety features. They also help keep you from being thrown against the inside of the vehicle, against any passengers, or out of the vehicle. When worn properly, seat belts also keep your body properly positioned in a crash so that you can take full advantage of the additional protection provided by the airbags.

In addition, seat belts help protect you in almost every type of crash, including:

- frontal impacts
- side impacts
- rear impacts
- rollovers

■ Lap/shoulder seat belts

All five seating positions are equipped with lap/shoulder seat belts with emergency locking retractors. In normal driving the retractor lets you move freely while keeping some tension on the belt. During a collision or sudden stop the retractor locks to restrain your body.

The front passenger's and rear seat belts also have a lockable retractor for use with child seats.

➤ **Installing a Child Seat with a Lap/Shoulder Seat Belt** P. 69

➤ About Your Seat Belts

WARNING

Not wearing a seat belt properly increases the chance of serious injury or death in a crash, even though your vehicle has airbags.

Be sure you and your passengers always wear seat belts and wear them properly.

If a rear seat passenger moves around and extends the seat belt, the lockable retractor may activate. If this happens, release the retractor by unfastening the seat belt and allow the belt to retract completely. Then refasten the belt.

If you extend the seat belt too quickly, it will lock in place. If this happens, slightly retract the seat belt, then extend it slowly.

Seat belts cannot completely protect you in every crash. But in most cases, seat belts can reduce your risk of serious injury.

■ Proper use of seat belts

Follow these guidelines for proper use:

- All occupants should sit upright, well back in the seat, and remain in that position for the duration of the trip. Slouching and leaning reduce the effectiveness of the belt and can increase the chance of serious injury in a crash.
- Never place the shoulder part of a lap/shoulder seat belt under your arm or behind your back. This could cause very serious injuries in a crash.
- Two people should never use the same seat belt. If they do, they could be very seriously injured in a crash.
- Do not put any accessories on the seat belts. Devices intended to improve comfort or reposition the shoulder part of a seat belt can reduce the protective capability and increase the chance of serious injury in a crash.

■ Seat Belt Reminder



The seat belt system includes an indicator on the instrument panel to remind the driver or a front passenger or both to fasten their seat belts.

If you set the power mode to ON and a seat belt is not fastened, a beeper will sound and the indicator will blink. After a few seconds, the beeper will stop and the indicator will come on and remain illuminated until the seat belt is fastened.

The beeper will periodically sound and the indicator will blink while the vehicle is moving until the seat belt is fastened.

▶▶ About Your Seat Belts

Most states and all Canadian provinces and territories require you to wear seat belts.

▶▶ Seat Belt Reminder

The indicator will also come on if a front passenger does not fasten their seat belt within six seconds after the power mode is set to ON.

When no one is sitting in the front passenger's seat, the indicator will not come on and the beeper will not sound.

The indicator also may not come on and the beeper may not sound when the occupant is not heavy enough to trigger the weight sensor. Such occupants (e.g., infants and smaller children) should be moved to the rear seat as a deploying front airbag likely will injure or kill them.

▶▶ **Protecting Child Passengers** P. 61

■ Automatic Seat Belt Tensioners

The front seats are equipped with automatic seat belt tensioners to enhance safety.

The tensioners automatically tighten the front seat belts during a moderate-to-severe frontal collision, sometimes even if the collision is not severe enough to inflate the front airbags or the knee airbags.

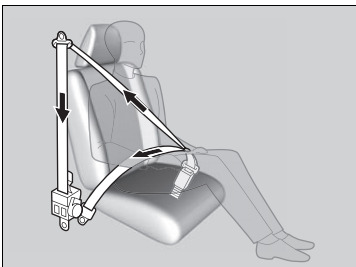

▶▶ Automatic Seat Belt Tensioners

The seat belt tensioners can only operate once. If a tensioner is activated, the SRS indicator will come on. Have a dealer replace the tensioner and thoroughly inspect the seat belt system as it may not offer protection in a subsequent crash.

During a moderate-to-severe side impact, the tensioner on that side of the vehicle also activates.

Fastening a Seat Belt

After adjusting a front seat to the proper position, and while sitting upright and well back in the seat:

▶ **Adjusting the Seats** P. 210

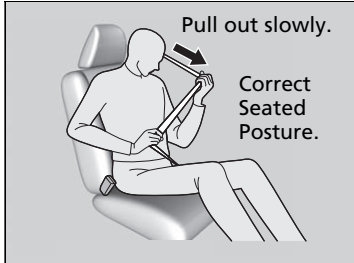

1. Pull the seat belt out slowly.

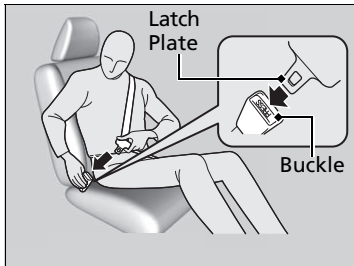

2. Insert the latch plate into the buckle, then tug on the belt to make sure the buckle is secure.

▶ Make sure that the belt is not twisted or caught on anything.

▶▶ Fastening a Seat Belt

No one should sit in a seat with an inoperative seat belt or one that does not appear to be working correctly. Using a seat belt that is not working properly may not protect the occupant in a crash. Have a dealer check the belt as soon as possible.



3. Position the lap part of the belt as low as possible across your hips, then pull up on the shoulder part of the belt so the lap part fits snugly. This lets your strong pelvic bones take the force of a crash and reduces the chance of internal injuries.
4. If necessary, pull up on the belt again to remove any slack, then check that the belt rests across the center of your chest and over your shoulder. This spreads the forces of a crash over the strongest bones in your upper body.

Adjusting the Shoulder Anchor

The front seats have adjustable shoulder anchors to accommodate taller and shorter occupants.

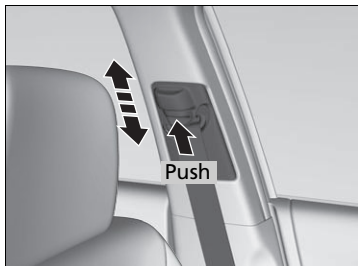

1. Move the anchor up and down while holding the release button.
2. Position the anchor so that the belt rests across the center of your chest and over your shoulder.

Fastening a Seat Belt

WARNING

Improperly positioning the seat belts can cause serious injury or death in a crash.

Make sure all seat belts are properly positioned before driving.

To release the belt, push the red **PRESS** button and then guide the belt by hand until it has retracted completely. When exiting the vehicle, be sure the belt is properly stowed so that it will not get caught in the closing door.

Never insert any foreign objects into the buckle or retractor mechanism.

Adjusting the Shoulder Anchor

After an adjustment, make sure that the shoulder anchor position is secure.

The shoulder anchor height can be adjusted to four levels. If the belt contacts your neck, lower the height one level at a time.

Advice for Pregnant Women

If you are pregnant, the best way to protect yourself and your unborn child when driving or riding in a vehicle is to always wear a seat belt and keep the lap part of the belt as low as possible across the hips.

Wear the shoulder belt across the chest avoiding the abdomen.



Wear the lap part of the belt as low as possible across the hips.

Advice for Pregnant Women

Each time you have a checkup, ask your doctor if it is okay for you to drive.

To reduce the risk of injuries to both you and your unborn child that can be caused by an inflating front airbag:

- When driving, sit upright and adjust the seat as far back as possible while allowing full control of the vehicle.
- When sitting in the front passenger's seat, adjust the seat as far back as possible.

Seat Belt Inspection

Regularly check the condition of your seat belts as follows:

- Pull each belt out fully, and look for frays, cuts, burns, and wear.
- Check that the latch plates and buckles work smoothly and the belts retract easily.
 - ▶ If a belt does not retract easily, cleaning the belt may correct the problem. Only use a mild soap and warm water. Do not use bleach or cleaning solvents. Make sure the belt is completely dry before allowing it to retract.

Any belt that is not in good condition or working properly will not provide proper protection and should be replaced as soon as possible.

A belt that has been worn during a crash may not provide the same level of protection in a subsequent crash. Have your seat belts inspected by a dealer after any collision.

▶▶ Seat Belt Inspection

WARNING

Not checking or maintaining seat belts can result in serious injury or death if the seat belts do not work properly when needed.

Check your seat belts regularly and have any problem corrected as soon as possible.

Airbag System Components

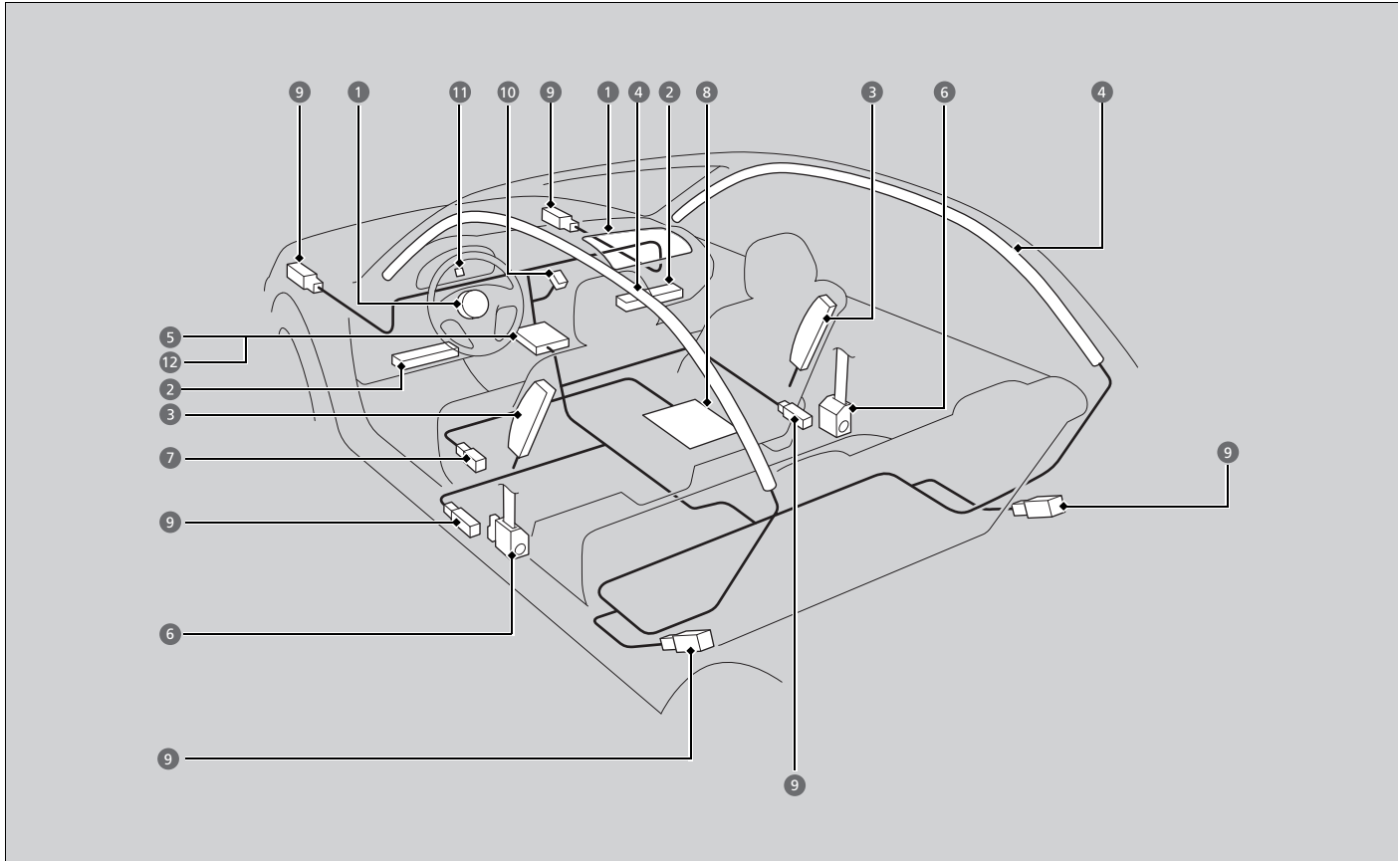

The front, front knee, front side, and side curtain airbags are deployed according to the direction and severity of impact. Both side curtain airbags are deployed in a rollover. The airbag system includes:

- 1 Two SRS (Supplemental Restraint System) front airbags. The driver's airbag is stored in the center of the steering wheel; the front passenger's airbag is stored in the dashboard. Both are marked **SRS AIRBAG**.
- 2 Two knee airbags. The driver's knee airbag is stored under the steering column; the front passenger's knee airbag is stored under the glove box. Both are marked **SRS AIRBAG**.
- 3 Two side airbags, one for the driver and one for a front passenger. The airbags are stored in the outer edges of the seat-backs. Both are marked **SIDE AIRBAG**.
- 4 Two side curtain airbags, one for each side of the vehicle. The airbags are stored in the ceiling, above the side windows. The front and rear pillars are marked **SIDE CURTAIN AIRBAG**.
- 5 An electronic control unit that, when the power mode is in ON, continually monitors information about the various impact sensors, seat and buckle sensors, rollover sensor, airbag activators, seat belt tensioners, and other vehicle information. During a crash event the unit can record such information.
- 6 Automatic front seat belt tensioners. In addition, the driver's and front passenger's seat belt buckles incorporate sensors that detect whether or not the belts are fastened.
- 7 A driver's seat position sensor. This sensor determines the optimal force at which the airbag will deploy in a crash.
- 8 Weight sensors in the front passenger's seat. The front passenger's airbag will be turned off if the weight on the seat is approximately 65 lbs (29 kg) or less (the weight of an infant or small child).
- 9 Impact sensors that can detect a moderate-to-severe front or side impact.
- 10 An indicator on the dashboard that alerts you that the front passenger's front airbag has been turned off.
- 11 An indicator on the instrument panel that alerts you to a possible problem with your airbag system or seat belt tensioners.
- 12 A rollover sensor that can detect if your vehicle is about to roll over and signal the control unit to deploy both side curtain airbags.

Important Facts About Your Airbags

Airbags can pose serious hazards. To do their job, airbags must inflate with tremendous force. So, while airbags help save lives, they can cause burns, bruises, and other minor injuries, sometimes even fatal ones if occupants are not wearing their seat belts properly and sitting correctly.

What you should do: Always wear your seat belt properly, and sit upright and as far back from the steering wheel as possible while allowing full control of the vehicle. A front passenger should move their seat as far back from the dashboard as possible.

Remember, however, that no safety system can prevent all injuries or deaths that can occur in a severe crash, even when seat belts are properly worn and the airbags deploy.

Do not place hard or sharp objects between yourself and a front airbag.

Carrying hard or sharp objects on your lap, or driving with a pipe or other sharp object in your mouth, can result in injuries if your front airbag inflates.

Do not attach or place objects on the front and front knee airbag covers.

Objects on the covers marked **SRS AIRBAG** could interfere with the proper operation of the airbags or be propelled inside the vehicle and hurt someone if the airbags inflate.

Important Facts About Your Airbags

Do not attempt to deactivate your airbags. Together, airbags and seat belts provide the best protection.

When driving, keep hands and arms out of the deployment path of the front airbag by holding each side of the steering wheel. Do not cross an arm over the airbag cover.

Types of Airbags

Your vehicle is equipped with four types of airbags:

- **Front airbags:** Airbags in front of the driver's and front passenger's seats.
- **Front knee airbags:** Airbags under the steering column and under the glove box.
- **Side airbags:** Airbags in the driver's and front passenger's seat-backs.
- **Side curtain airbags:** Airbags above the side windows.

Each is discussed in the following pages.

Front Airbags (SRS)

The front SRS airbags inflate in a moderate-to-severe frontal collision to help protect the head and chest of the driver and/or front passenger.

SRS (Supplemental Restraint System) indicates that the airbags are designed to supplement seat belts, not replace them. Seat belts are the occupant's primary restraint system.

Housing Locations

The front airbags are housed in the center of the steering wheel for the driver, and in the dashboard for the front passenger. Both airbags are marked **SRS AIRBAG**.

Types of Airbags

The airbags can inflate whenever the power mode is in ON.

After an airbag inflates in a crash, you may see a small amount of smoke. This is from the combustion process of the inflator material and is not harmful. People with respiratory problems may experience some temporary discomfort. If this occurs, get out of the vehicle as soon as it is safe to do so.

Front Airbags (SRS)

During a frontal crash severe enough to cause one or both front airbags to deploy, the airbags can inflate at different rates, depending on the severity of the crash, whether or not the seat belts are latched, and/or other factors. Frontal airbags are designed to supplement the seat belts to help reduce the likelihood of head and chest injuries in frontal crashes.

■ Operation

Front airbags are designed to inflate during moderate-to-severe frontal collisions. When the vehicle decelerates suddenly, the sensors send information to the control unit which signals one or both front airbags to inflate.

A frontal collision can be either head-on or angled between two vehicles, or when a vehicle crashes into a stationary object, such as a concrete wall.

■ How the Front Airbags Work

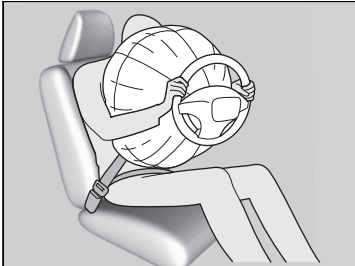

While your seat belt restrains your torso, the front airbag provides supplemental protection for your head and chest.

The front airbags deflate immediately so that they won't interfere with the driver's visibility or the ability to steer or operate other controls.

The total time for inflation and deflation is so fast that most occupants are not aware that the airbags deployed until they see them lying in front of them.

▣ How the Front Airbags Work

Although the driver's and front passenger's airbags normally inflate within a split second of each other, it is possible for only one airbag to deploy. This can happen if the severity of a collision is at the margin, or threshold, that determines whether or not the airbags will deploy. In such cases, the seat belt will provide sufficient protection, and the supplemental protection offered by the airbag would be minimal.

■ When front airbags should not deploy

Minor frontal crashes: Front airbags were designed to supplement seat belts and help to save lives, not to prevent minor scrapes, or even broken bones that might occur during a less than moderate-to-severe frontal crash.

Side impacts: Front airbags can provide protection when a sudden deceleration causes a driver or front passenger to move towards the front of the vehicle. Side airbags and side curtain airbags have been specifically designed to help to reduce the severity of injuries that can occur during a moderate-to-severe side impact which can cause the driver or passenger to move towards the side of the vehicle.

Rear impacts: Head restraints and seat belts are your best protection during a rear impact. Front airbags cannot provide any significant protection and are not designed to deploy in such collisions.

Rollovers: In a rollover, your best form of protection is a seat belt or, if your vehicle is equipped with a rollover sensor, both a seat belt and a side curtain airbag. Front airbags, however, are not designed to deploy in a rollover as they would provide little if any protection.

■ When front airbags deploy with little or no visible damage

Because the airbag system senses sudden deceleration, a strong impact to the vehicle framework or suspension might cause one or more of the airbags to deploy. Examples include running into a curb, the edge of a hole, or other low fixed object that causes a sudden deceleration in the vehicle chassis. Since the impact is underneath the vehicle, damage may not be readily apparent.

■ When front airbags may not deploy, even though exterior damage appears severe

Since crushable body parts absorb crash energy during an impact, the amount of visible damage does not always indicate proper airbag operation. In fact, some collisions can result in severe damage but no airbag deployment because the airbags would not have been needed or would not have provided protection even if they had deployed.

Advanced Airbags

The airbags have advanced features to help reduce the likelihood of airbag related injuries to smaller occupants.

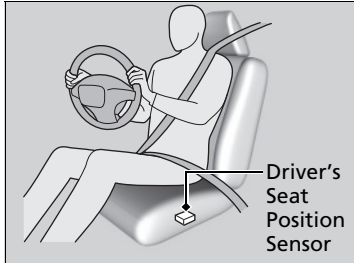

The driver's advanced airbag system includes a seat position sensor.

Based on information from this sensor and the severity of the impact, the advanced airbag system determines the optimal deployment of the driver's airbag.

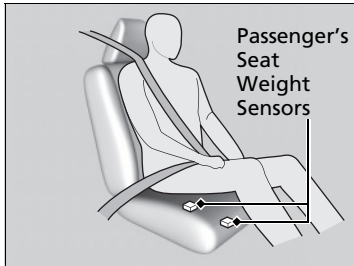

The front passenger's advanced airbag system has weight sensors.

We advise against allowing a child age 12 or under to ride in the front passenger's seat. However, **if you do allow a child age 12 or under to ride in the front passenger's seat**, note that the system will automatically turn off the front passenger's airbag if the sensors detect that the child is approximately 65 lbs (29 kg) or less.

Advanced Airbags

If there is a problem with the driver's seat position sensor, the SRS indicator will come on, and in the event of a crash, the airbag will deploy (regardless of the driver's seating position) with a force corresponding to the severity of the impact.

For the advanced airbags to work properly:

- Do not spill any liquid on or under the seats.
- Do not put any object under the passenger's seat.
- Make sure any objects are positioned properly on the floor. Improperly positioned objects can interfere with the advanced airbag sensors.
- All occupants should sit upright and wear their seat belts properly.
- Do not cover the passenger's side dashboard with a cloth, towel, cover, etc.

▶ **Passenger Front Airbag Off Indicator** P. 59

Knee Airbags

The knee SRS airbags inflates in a moderate-to-severe frontal collision to help keep the driver and/or front passenger in the proper position and to help maximize the benefit provided by the vehicle's other safety features.

SRS (Supplemental Restraint System) indicates that the airbags are designed to supplement seat belts, not replace them. Seat belts are the occupant's primary restraint system.

Housing Locations

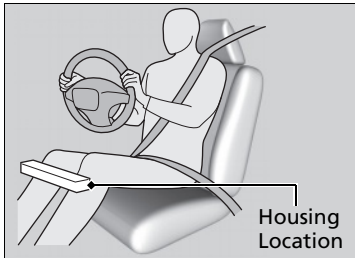

The driver's knee airbag is housed under the steering column.

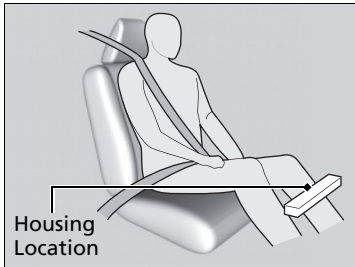

The front passenger's knee airbag is housed under the glove box.

Both are marked **SRS AIRBAG**.

⚠ Knee Airbags

Do not attach accessories on or near the knee airbags. They can interfere with the proper operation of the airbags, or hurt someone if an airbag inflates.

The driver and front passenger should not store any items under the seat or behind their feet. The items can interfere with proper airbag deployment in the event of a moderate to severe frontal collision and may result in inadequate protection.

Operation

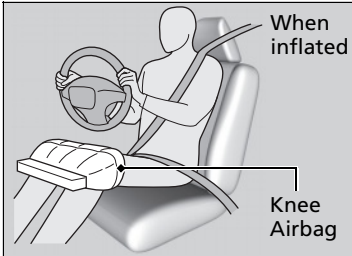

When the front airbags inflate, the knee airbags also inflate.

Even if the collision is not severe enough to deploy the front airbags, the knee airbags may inflate alone.

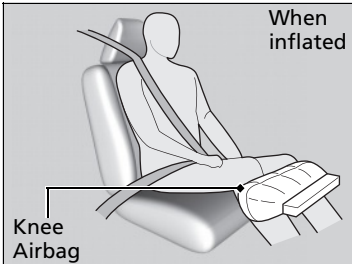

■ **When knee airbags deploy with little or no visible damage**

Because the airbag system senses sudden deceleration, a strong impact to the vehicle framework or suspension might cause one or more of the airbags to deploy. Examples include running into a curb, the edge of a hole, or other low fixed object that causes a sudden deceleration in the vehicle chassis. Since the impact is underneath the vehicle, damage may not be readily apparent.

■ **When knee airbags may not deploy, even though exterior damage appears severe**

Since crushable body parts absorb crash energy during an impact, the amount of visible damage does not always indicate proper airbag operation. In fact, some collisions can result in severe damage but no airbag deployment because the airbags would not have been needed or would not have provided protection even if they had deployed.

Side Airbags

The side airbags help protect the torso and pelvis of the driver or a front passenger during a moderate-to-severe side impact.

Housing Locations

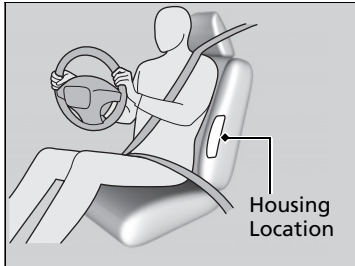

The side airbags are housed in the outside edge of the driver's and passenger's seat-backs.

Both are marked **SIDE AIRBAG**.

Operation

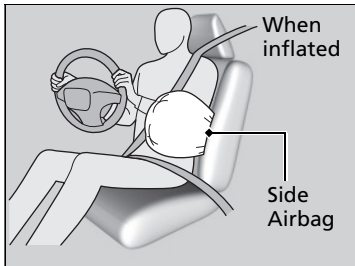

When the sensors detect a moderate-to-severe side impact, the control unit signals the side airbag on the impact side to immediately inflate.

Side Airbags

Make sure you and your front seat passenger always sit upright. Leaning into the path of a side airbag can prevent the airbag from deploying properly and increases your risk of serious injury.

Do not attach accessories on or near the side airbags. They can interfere with the proper operation of the airbags, or hurt someone if an airbag inflates.

Do not cover or replace the front seat-back covers without consulting a dealer. Improperly replacing or covering front seat-back covers can prevent your side airbags from properly deploying during a side impact.

■ **When a side airbag deploys with little or no visible damage**

Because the airbag system senses sudden acceleration, a strong impact to the side of the vehicle's framework can cause a side airbag to deploy. In such cases, there may be little or no damage, but the side impact sensors detected a severe enough impact to deploy the airbag.

■ **When a side airbag may not deploy, even though visible damage appears severe**

It is possible for a side airbag not to deploy during an impact that results in apparently severe damage. This can occur when the point of impact was toward the far front or rear of the vehicle, or when the vehicle's crushable body parts absorbed most of the crash energy. In either case, the side airbag would not have been needed nor provided protection even if it had deployed.

Side Curtain Airbags

The side curtain airbags help protect the heads of the driver and passengers in the outer seating positions during a moderate-to-severe side impact. The side curtain airbags equipped in this vehicle are also designed to help reduce the likelihood of partial and complete ejection of vehicle occupants through side windows in crashes, particularly rollover crashes.

Housing Locations

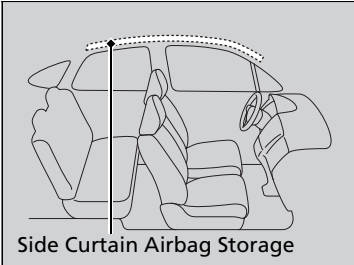

Side Curtain Airbag Storage

The side curtain airbags are located in the ceiling above the side windows on both sides of the vehicle.

Operation

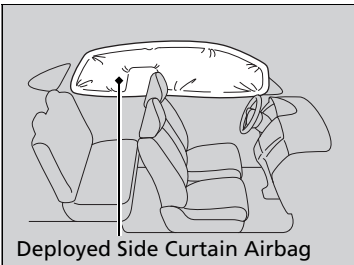

Deployed Side Curtain Airbag

The side curtain airbag is designed to deploy in a rollover or a moderate-to-severe side impact.

Side Curtain Airbags

To get the best protection from the side curtain airbags, occupants should wear their seat belts properly and sit upright and well back in their seats.

Do not attach any objects to the side windows or roof pillars as they can interfere with the proper operation of the side curtain airbags.

If the impact is on the passenger's side, the passenger's side curtain airbag deploys even if there are no occupants on that side of the vehicle.

If the SRS control unit senses that your vehicle is about to rollover, it immediately deploys both side curtain airbags and activates both front seat belt tensioners.

■ When side curtain airbags deploy in a frontal collision

One or both side curtain airbags may also inflate in a moderate-to-severe angled frontal collision.

Airbag System Indicators

If a problem occurs in the airbag system, the SRS indicator will come on and a message appears on the Driver information interface.

Supplemental Restraint System (SRS) Indicator



■ When the power mode is set to ON

The indicator comes on for a few seconds, then goes off. This tells you the system is working properly.

If the indicator comes on at any other time, or does not come on at all, have the system checked by a dealer as soon as possible. If you don't, your airbags and seat belt tensioners may not work properly when they are needed.

Supplemental Restraint System (SRS) Indicator

⚠ WARNING

Ignoring the SRS indicator can result in serious injury or death if the airbag systems or tensioners do not work properly.

Have your vehicle checked by a dealer as soon as possible if the SRS indicator alerts you to a possible problem.

Passenger Front Airbag Off Indicator

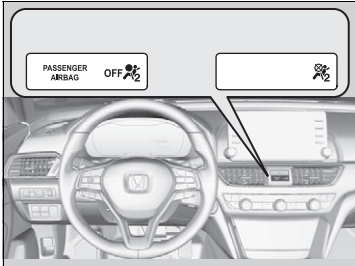

■ When the passenger airbag off indicator comes on

The indicator comes on to alert you that the passenger's front airbag has been turned off. This occurs when the weight sensors detect about 65 lbs (29 kg) or less, the weight of an infant or small child, on the seat.

Children age 12 or under should always ride properly restrained in a back seat.

🚗 **Child Safety** P. 61

If the front passenger's seat is empty, the indicator will come on and, in the event of a crash, the front passenger's airbag will not deploy. The front passenger's knee airbag will not deploy either.

⊠ Passenger Front Airbag Off Indicator

To ensure the passenger is detected properly, confirm that:

- There is no child seat or other object pressing against the rear of the seat-back.
- There is no rear passenger pushing or pulling on the back of the front passenger's seat.
- The front seat or seat-back is not forced back against an object on the seat or floor behind it.
- There is no object placed under or beside the front passenger's seat.
- The occupant is sitting in an upright position and the seat back is not excessively reclined.
- The occupant is not leaning against the door or center console.
- The occupant's feet are placed on the floor in front of them.
- There are no objects hanging from the front passenger's seat.
- Only small, lightweight objects are in the seat-back pocket.

The passenger airbag off indicator may come on and go off periodically if the total weight on the seat is near the airbag cutoff threshold.

Have your vehicle checked by a dealer as soon as possible if:

- All of the above conditions are met, and the indicator comes on with an adult seated in the front passenger seat.
- The seat is empty and the indicator is off.

Do not allow an adult passenger to ride in the front seat when the indicator is on.

Airbag Care

You do not need to, and should not, perform any maintenance on or replace any airbag system components yourself. However, you should have your vehicle inspected by a dealer in the following situations:

■ When the airbags have deployed

If an airbag has inflated, the control unit and other related parts must be replaced. Similarly, once an automatic seat belt tensioner has been activated, it must be replaced.

■ When the vehicle has been in a moderate-to-severe collision

Even if the airbags did not inflate, have your dealer inspect the following: the driver's seat position sensor, weight sensors in the passenger's seat, front seat belt tensioners, and each seat belt that was worn during the crash.

■ Do not remove or modify a front seat without consulting a dealer

This would likely disable or affect the proper operation of the driver's seat position sensor or the weight sensors in the passenger's seat. If it is necessary to remove or modify a front seat to accommodate a person with disabilities, contact a Honda dealer, or for U.S. vehicles, American Honda Automobile Customer Service at 1-800-999-1009 and for Canadian vehicles, Honda Canada Customer Relations at 1-888-9-HONDA-9.

▶▶ Airbag Care

We recommend against the use of salvaged airbag system components, including the airbag, tensioners, sensors, and control unit.

Protecting Child Passengers

Each year, many children are injured or killed in vehicle crashes because they are either unrestrained or not properly restrained. In fact, vehicle crashes are the number one cause of death of children ages 12 and under.

To reduce the number of child deaths and injuries, every state, Canadian province and territory requires that infants and children be properly restrained when they ride in a vehicle.

Children should sit properly restrained in a rear seat. This is because:

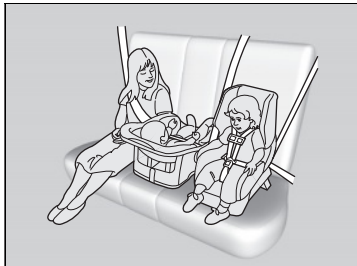

- An inflating front or side airbag can injure or kill a child sitting in the front seat.
- A child in the front seat is more likely to interfere with the driver's ability to safely control the vehicle.
- Statistics show that children of all sizes and ages are safer when they are properly restrained in a rear seat.

Protecting Child Passengers

⚠ WARNING

Children who are unrestrained or improperly restrained can be seriously injured or killed in a crash.

Any child too small for a seat belt should be properly restrained in a child seat. A larger child should be properly restrained with a seat belt, using a booster seat if necessary.

The National Highway Traffic Safety Administration and Transport Canada recommend that all children ages 12 and under be properly restrained in a rear seat. Some states or provinces/territories have laws restricting where children may ride.

Continued

- Never hold a child on your lap because it is impossible to protect them in the event of a collision.
- Never put a seat belt over yourself and a child. During a crash, the belt would likely press deep into the child and cause serious or fatal injuries.
- Never let two children use the same seat belt. Both children could be very seriously injured in a crash.
- Any child who is too small to wear a seat belt correctly must be restrained in an approved child seat that is properly secured to the vehicle using either the seat belt or the lower anchors of the LATCH system.
- Do not allow children to operate the doors, windows or seat adjustments.
- Do not leave children in the vehicle unattended, especially in hot weather when the inside of the vehicle can get hot enough to kill them. They could also activate vehicle controls causing it to move unexpectedly.

►► Protecting Child Passengers

⚠ WARNING

Allowing a child to play with a seat belt or wrap one around their neck can result in serious injury or death.

Instruct children not to play with any seat belt and make sure any unused seat belt a child can reach is buckled, fully retracted, and locked.

To deactivate a lockable retractor, release the buckle and allow the seat belt to wind up all the way.

To remind you of the passenger's front airbag hazards and child safety, your vehicle has warning labels on the dashboard (U.S. models) and on the front visors. Please read and follow the instructions on these labels.

📖 Safety Labels P. 76

Safety of Infants and Small Children

Protecting Infants

An infant must be properly restrained in a rear-facing, reclining child seat until the infant reaches the seat manufacturer's weight or height limit for the seat, and the infant is at least one year old.



Positioning a rear-facing child seat

Child seats must be placed and secured in a rear seating position.

When properly installed, a rear-facing child seat may prevent the driver or a front passenger from moving their seat all the way back, or from locking their seat-back in the desired position. Make sure that there is no contact between the child seat and the seat in front of it.

It can also interfere with proper operation of the passenger's advanced front airbag system.

➤ **Airbags** P. 45

If this occurs, we recommend that you install the child seat directly behind the front passenger's seat, move the seat as far forward as needed, and leave it unoccupied. Or, you may wish to get a smaller rear-facing child seat.

Protecting Infants

⚠ WARNING

Placing a rear-facing child seat in the front seat can result in serious injury or death during a crash.

Always place a rear-facing child seat in the rear seat, not the front.

Many experts recommend use of a rear-facing seat for a child up to two years old if the child's height and weight are appropriate for a rear-facing seat.

Rear-facing child seats should never be installed in a forward facing position.

Always refer to the child seat manufacturer's instructions before installation.

Do not allow a front seat to rest against a child seat installed in a rear seating position: The weight sensor in the front seat may not correctly detect the actual weight of the occupant.

■ Protecting Smaller Children

If a child is at least one year old and has exceeded the weight and height limitations of a rearward facing child seat, the child should be properly restrained in a firmly secured forward facing child seat until they exceed the weight and height limitations for the forward facing child seat.



■ Forward-facing child seat placement

We strongly recommend placing a forward-facing child seat in a rear seating position.

Placing a forward-facing child seat in the front seat can be hazardous, even with advanced front airbags that automatically turn the passenger's front airbag off. A rear seat is the safest place for a child.

▶▶ Protecting Smaller Children

⚠ WARNING

Placing a forward-facing child seat in the front seat can result in serious injury or death if the front airbag inflates.

If you must place a forward-facing child seat in front, move the vehicle seat as far back as possible, and properly restrain the child.

Educate yourself about the laws and regulations regarding child seat use where you are driving, and follow the child seat manufacturer's instructions.

■ Selecting a Child Seat

Most child seats are LATCH-compatible (Lower Anchors and Tethers for Children). Some have a rigid-type connector, while others have a flexible-type connector. Both are equally easy to use. Some existing and previously owned child seats can only be installed using the seat belt. Whichever type you choose, follow the child seat manufacturer's use and care instructions including recommended expiration dates as well as the instructions in this manual. Proper installation is key to maximizing your child's safety.

In seating positions and vehicles not equipped with LATCH, a LATCH-compatible child seat can be installed using the seat belt and a top tether for added security. This is because all child seats are required to be designed so that they can be secured with a lap belt or the lap part of a lap/shoulder belt. In addition, the child seat manufacturer may advise that a seat belt be used to attach a LATCH-compatible seat once a child reaches a specified weight. Please read the child seat owner's manual for proper installation instructions.

■ Important consideration when selecting a child seat

Make sure the child seat meets the following three requirements:

- The child seat is the correct type and size for the child.
- The child seat is the correct type for the seating position.
- The child seat is compliant with Federal Motor Vehicle Safety Standard 213 or Canadian Motor Vehicle Safety Standard 213.

▶▶ Selecting a Child Seat

Installation of a LATCH-compatible child seat is simple.

LATCH-compatible child seats have been developed to simplify the installation process and reduce the likelihood of injuries caused by incorrect installation.

■ Installing a LATCH-Compatible Child Seat

A LATCH-compatible child seat can be installed in either of the two outer rear seats. A child seat is attached to the lower anchors with either the rigid or flexible type of connectors.

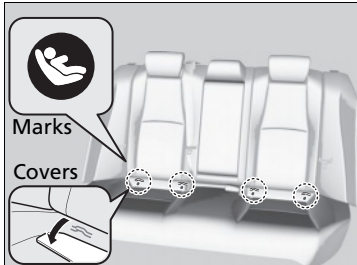

1. Locate the anchor marks affixed to the base of the seat cushion.
2. Pull out the anchor covers under the marks to expose the lower anchors.

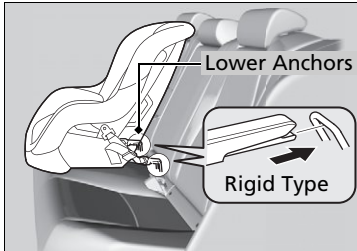

3. Place the child seat on the vehicle seat, then attach the child seat to the lower anchors according to the instructions that came with the child seat.

- ▶ When installing the child seat, make sure that the lower anchors are not obstructed by the seat belt or any other object.

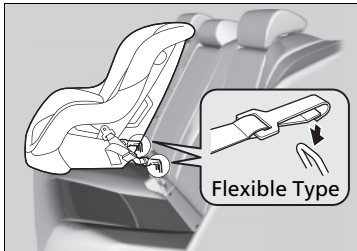

▶▶ Installing a LATCH-Compatible Child Seat

⚠ WARNING

Never attach two child seats to the same anchor. In a collision, one anchor may not be strong enough to hold two child seat attachments and may break, causing serious injury or death.

For your child's safety, when using a child seat installed using the LATCH system, make sure that the child seat is properly secured to the vehicle. A child seat that is not properly secured will not adequately protect a child in a crash and may cause injury to the child or other vehicle occupants.

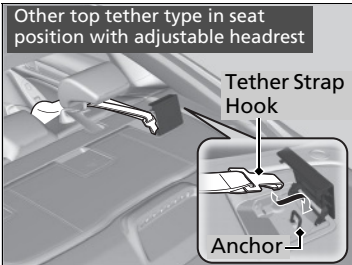
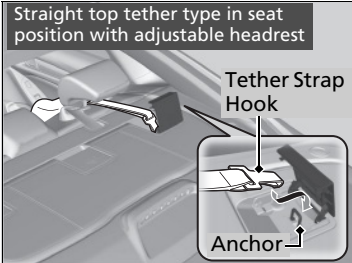

4. Open the tether anchor cover behind the head restraint.

Seat position with adjustable headrest

5. Raise the head restraint to its highest position, then route the tether strap between the head restraint legs, and secure the tether strap hook to the anchor.

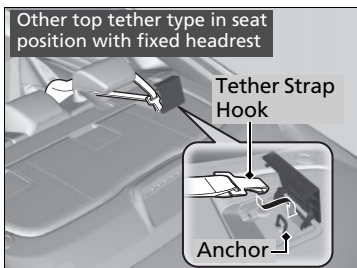
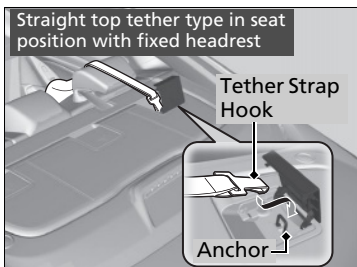

Straight top tether type in seat position with fixed headrest

5. Route the tether strap over the top of the head restraint and secure the tether strap hook to the anchor.

Other top tether type in seat position with fixed headrest

5. Route the tether strap over the side of the head restraint and secure the tether strap hook to the anchor.

All models

6. Tighten the tether strap as instructed by the child seat manufacturer.
7. Make sure the child seat is firmly secured by rocking it forward and back and side to side; little movement should be felt.
8. Make sure any unused seat belt that a child can reach is buckled, the lockable retractor is activated, and the belt is fully retracted and locked.

►► Installing a LATCH-Compatible Child Seat

⚠ WARNING

Do not use the lower inner anchors of the outer rear seats to secure a LATCH-compatible child seat to the rear center seat, unless the manufacturer's instructions for that system permit the use of inner anchors with the stated spacing.

Installing a LATCH-compatible child seat in the rear center seat

Each outer rear seat is equipped with a pair of lower anchors which are used to secure a LATCH-compatible child seat. The rear center seat, however, is not equipped with anchors of any kind. The inner and outer anchors are spaced apart at a standard distance of 11 inches (280 mm). The distance between the two inner anchors is 15.4 inches (390 mm).

LATCH-compatible restraint systems that are fitted with rigid-type attachments cannot be installed in the rear center seat. However, a system fitted with flexible-type attachments can be installed in the center seat, provided that the manufacturer's instructions for that system permit the use of the inner anchors with the stated spacing.

Before seating a child, make sure that the system is properly attached to both the lower anchors and tether anchors.

■ Installing a Child Seat with a Lap/Shoulder Seat Belt

A child seat can be installed with a lap/shoulder belt in any rear seat or, if absolutely necessary, the front passenger seat.

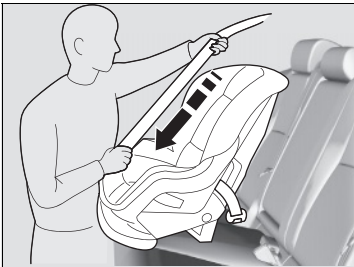

1. Place the child seat on the vehicle seat.
2. Route the seat belt through the child seat according to the seat manufacturer's instructions, and insert the latch plate into the buckle.
 - ▶ Insert the latch plate fully until it clicks.
3. Slowly pull the shoulder part of the belt all the way out until it stops. This activates the lockable retractor.
4. Let the seat belt retract a few inches and check that the retractor has switched modes by pulling on the webbing. It should not pull out again until it is reset by removing the latch plate from the buckle.
 - ▶ If you are able to pull the shoulder belt out, the lockable retractor is not activated. Slowly pull the seat belt all the way out, and repeat steps 3 – 4.

⊠ Installing a Child Seat with a Lap/Shoulder Seat Belt

A child seat that is not properly secured will not adequately protect a child in a crash and may cause injury to the child or other vehicle occupants.

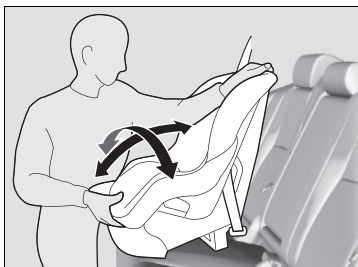

5. Grab the shoulder part of the seat belt near the buckle, and pull up to remove any slack from the lap part of the belt.

▶ When doing this, place your weight on the child seat and push it into the vehicle seat.

6. Make sure the child seat is firmly secured by rocking it forward and back and side to side; less than one inch of movement should occur near the seat belt.

7. Make sure any unused seat belt that a child can reach is buckled, the lockable retractor is activated, and the belt is fully retracted and locked.

▶▶ Installing a Child Seat with a Lap/Shoulder Seat Belt

To deactivate a lockable retractor, release the buckle and allow the seat belt to wind up all the way.

■ Adding Security with a Tether

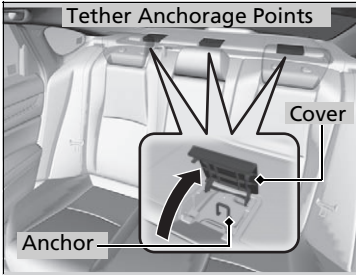

A tether anchorage point is provided behind each rear seating position. If you have a child seat that comes with a tether but can be installed with a seat belt, the tether may be used for additional security.

1. Locate the appropriate tether anchorage point and lift the cover.

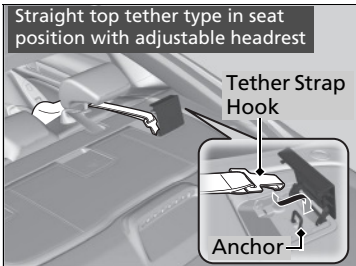

2. Route the tether strap over the head restraint. Make sure the strap is not twisted.

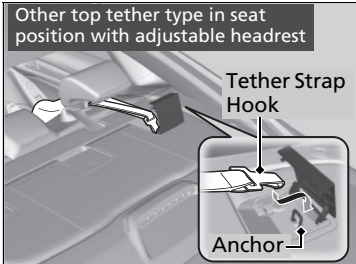

▣ Adding Security with a Tether

Always use a tether for forward facing child seats when using the seat belt or lower anchors.

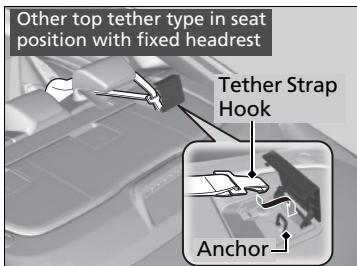
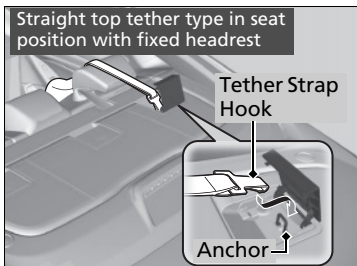

3. Secure the tether strap hook to the anchor.
4. Tighten the tether strap as instructed by the child seat manufacturer.

Safety of Larger Children

Protecting Larger Children

The following pages give instructions on how to check proper seat belt fit, what kind of booster seat to use if one is needed, and important precautions for a child who must sit in front.

Checking Seat Belt Fit

When a child is too big for a child seat, secure the child in a rear seat using the lap/shoulder seat belt. Have the child sit upright and all the way back, then answer the following questions.

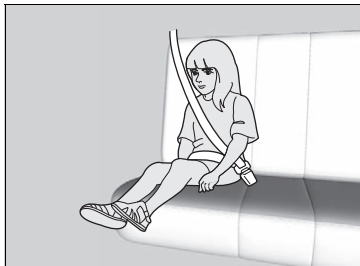

Checklist

- Do the child's knees bend comfortably over the edge of the seat?
- Does the shoulder belt cross between the child's neck and arm?
- Is the lap part of the seat belt as low as possible, touching the child's thighs?
- Will the child be able to stay seated like this for the whole trip?

If you answer yes to all these questions, the child is ready to wear the lap/shoulder seat belt correctly. If you answer no to any question, the child needs to ride on a booster seat until the seat belt fits properly without a booster seat.

▶ Safety of Larger Children

⚠ WARNING

Allowing a child age 12 or under to sit in front can result in injury or death if the passenger's front airbag inflates.

If a larger child must ride in front, move the vehicle seat as far to the rear as possible, have the child sit up properly and wear the seat belt properly, using a booster seat if needed.

■ Booster Seats

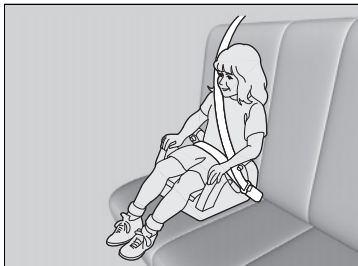

If a lap/shoulder seat belt cannot be used properly, position the child in a booster seat in the rear seat. For the child's safety, check that the child meets the booster seat manufacturer's recommendations.

■ Protecting Larger Children-Final Checks

Your vehicle has a rear seat where children can be properly restrained. If you ever have to carry a group of children, and a child must ride in front:

- Make sure you read and fully understand the instructions and safety information in this manual.
- Move the front passenger seat as far back as possible.
- Have the child sit upright and well back in the seat.
- Check that the seat belt is properly positioned so that the child is secure in the seat.

■ Monitoring child passengers

We strongly recommend that you keep an eye on child passengers. Even older, more mature children sometimes need to be reminded to fasten their seat belts and sit up properly.

▶▶ Booster Seats

When installing a booster seat, make sure to read the instructions that came with it, and install the seat accordingly.

There are high- and low-type booster seats. Choose a booster seat that allows the child to wear the seat belt correctly.

Some U.S. states and Canadian provinces and territories require children to use a booster seat until they reach a given age or weight (e.g. 6 years or 60 lbs). Be sure to check current laws in the state or province, or territory where you intend to drive.

Carbon Monoxide Gas

The engine exhaust from this vehicle contains carbon monoxide, a colorless, odorless, and highly toxic gas. As long as you properly maintain your vehicle, carbon monoxide gas will not get into the interior.

■ Have the exhaust system inspected for leaks whenever

- The exhaust system is making an unusual noise.
- The exhaust system may have been damaged.
- The vehicle is raised for an oil change.

When you operate a vehicle with the trunk open, airflow can pull exhaust gas into the interior and create a hazardous condition. If you must drive with the trunk open, open all the windows and set the climate control system as shown below.

1. Select the fresh air mode.
2. Select the  mode.
3. Set the fan speed to high.
4. Set the temperature control to a comfortable setting.

Adjust the climate control system in the same manner if you sit in your parked vehicle with the engine running.

Carbon Monoxide Gas

⚠ WARNING

Carbon monoxide gas is toxic.

Breathing it can cause unconsciousness and even kill you.

Avoid any enclosed areas or activities that expose you to carbon monoxide.

An enclosed area such as a garage can quickly fill up with carbon monoxide gas. Do not run the engine with the garage door closed. Even when the garage door is open, drive out of the garage immediately after starting the engine.

Label Locations

These labels are in the locations shown. They warn you of potential hazards that can cause serious injury or death. Read these labels carefully.

If a label comes off or becomes hard to read (except for the U.S. dashboard label which may be removed by the owner), contact a dealer for a replacement.

Sun Visor

U.S. models

WARNING
EVEN WITH ADVANCED AIR BAGS

Children can be killed or seriously injured by the air bag.
 ■ The back seat is the safest place for children.
 ■ Never put a rear-facing child seat in the front.
 ■ Always use seat belts and child restraints.
 ■ See owner's manual for more information about air bags.



Canadian models

WARNING	ATTENTION
<p>To avoid serious injury</p> <ul style="list-style-type: none"> ■ For maximum safety protection in all types of crashes, you must always wear your safety belt. ■ Do not install rearward-facing child seats in any front passenger seat position. ■ Do not sit or lean unnecessarily close to the air bag. ■ Do not place any objects over the air bag or between the air bag and yourself. ■ See the owner's manual for further information and explanations. 	<p>Pour éviter des blessures graves</p> <ul style="list-style-type: none"> ■ Pour profiter d'une protection maximale lors d'une collision boucliez toujours votre ceinture de sécurité. ■ N'installez jamais un siège pour enfants faisant face à l'arrière sur le siège du passager avant. ■ Ne vous appuyez pas et ne vous assoyez pas près du coussin gonflable. ■ Ne déposez aucun objet sur le coussin gonflable ou entre le coussin gonflable et vous. ■ Lisez le guide utilisateur pour de plus amples renseignements.

Dashboard U.S. models only

This Vehicle is Equipped with Advanced Air Bags

Even with Advanced Air Bags
 Children can be killed or seriously injured by the air bag.
 The back seat is the safest place for children.
 Never put a rear-facing child seat in the front.
 Always use seat belts and child restraints.
 See owner's manual for more information about air bags.

Labels removed by owner only.

DANGER
WARNING
危險
危險

NEVER OPEN WHEN HOT
 Hot coolant will scald you.
 WINDSHIELD PANS GUARD SHOULD
 NOT BE HEISSIM MOTOR OFFEN.
 風擋玻璃蓋請勿在引擎熱時打開。
 108kPa



Radiator Cap

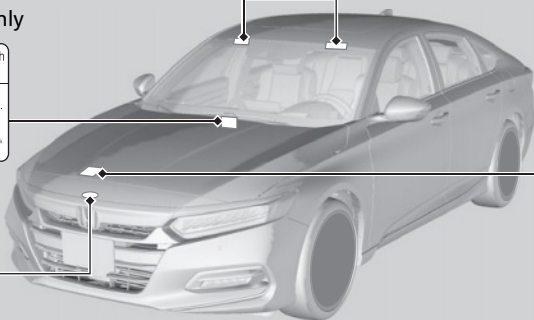

Air Conditioner System



U.S. models

WARNING

Flammable Refrigerant
 CAUTION SYSTEM CONTAINS REFRIGERANT
 R-1234yf UNDER HIGH PRESSURE.
 TO BE SERVICED ONLY BY QUALIFIED PERSONNEL.
 Follow Instructions in the service manual.

AIR CONDITIONER SYSTEM
 REFRIGERANT : R-1234yf (SAE J639 J2842 J2845)
 REC. CHARGE : MAX 0.445kg MIN 0.395kg
 OIL TYPE : ND-OIL14 (POE)

TVA Honda Motor Co., Ltd.

Canadian models

WARNING

Flammable Refrigerant
 CAUTION SYSTEM CONTAINS REFRIGERANT
 R-1234yf UNDER HIGH PRESSURE.
 TO BE SERVICED ONLY BY QUALIFIED PERSONNEL.
 Follow Instructions in the service manual.

R-1234yf



































Instrument Panel

This chapter describes the buttons, indicators, and gauges that are used while driving.













Indicators	78
Driver Information Interface Warning and Information Messages.....	105
Gauges and Displays	
Gauges.....	137
Driver Information Interface	138
Head-Up Display*	157



* Not available on all models

 *1 Canada	Parking Brake and Brake System Indicator (Red)	→ P. 79		Seat Belt Reminder Indicator	→ P. 89		Security System Alarm Indicator	→ P. 96
 *1 Canada	Parking Brake and Brake System Indicator (Amber)	→ P. 80		Low Fuel Indicator	→ P. 89		System Message Indicator	→ P. 96
 *1	Automatic Brake Hold System Indicator	→ P. 82	 *1	Anti-lock Brake System (ABS) Indicator	→ P. 90		ECON Mode Indicator	→ P. 97
 *1	Automatic Brake Hold Indicator	→ P. 82	 *1	Supplemental Restraint System Indicator	→ P. 90	SPORT	SPORT Mode Indicator*	→ P. 98
 Canada	Automatic Brake Hold Indicator	→ P. 82	 *1	Auto High-Beam Indicator	→ P. 90	ACC *1	Adaptive Cruise Control (ACC) with Low Speed Follow (LSF) Indicator (Amber)* / Adaptive Cruise Control (ACC) Indicator (Amber)*	→ P. 99
 *1	Malfunction Indicator Lamp	→ P. 83	 *1	Vehicle Stability Assist® (VSA®) System Indicator	→ P. 91	ACC	Adaptive Cruise Control (ACC) with Low Speed Follow (LSF) Indicator (Green)* / Adaptive Cruise Control (ACC) Indicator (Green)*	→ P. 100
 *1	Charging System Indicator	→ P. 84	 *1	Vehicle Stability Assist® (VSA®) OFF Indicator	→ P. 92	ACC	Adaptive Cruise Control (ACC) with Low Speed Follow (LSF) Indicator (Green)* / Adaptive Cruise Control (ACC) Indicator (Green)*	→ P. 100
 D	Gear Position Indicator*	→ P. 84	 *1	Electric Power Steering (EPS) System Indicator	→ P. 92	LKAS *1	Lane Keeping Assist System (LKAS) Indicator (Amber)	→ P. 100
 M 2	M (sequential mode* / 7-speed manual shift mode*) Indicator* / Gear Selection Indicator*	→ P. 84	 *1	Low Tire Pressure/TPMS Indicator	→ P. 93	LKAS	Lane Keeping Assist System (LKAS) Indicator (Green)	→ P. 100
	Transmission System Indicator*	→ P. 85, 87		Turn Signal and Hazard Warning Indicators	→ P. 94	LKAS	Lane Keeping Assist System (LKAS) Indicator (Green)	→ P. 100
	Shift Up Indicator*	→ P. 88		High Beam Indicator	→ P. 94	 *1	Safety Support Indicator (Amber)	→ P. 101
	Shift Down Indicator*	→ P. 88		Lights On Indicator	→ P. 94		Safety Support Indicator (Green/Gray)	→ P. 104
				Fog Light Indicator*	→ P. 94			
				Immobilizer System Indicator	→ P. 95			

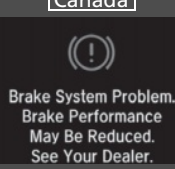

*1 : When you set the power mode to ON, these indicators come on to indicate that system checks are being performed. They go off a few seconds later or after the engine has started. If an indicator does not come on or turn off, there may be a malfunction in the corresponding system. To resolve the issue, follow the instructions in the owner's manual.



Indicator	Name	On/Blinking	Explanation	Message
<p>U.S. BRAKE</p> <p>Canada</p>  <p>(Red)</p>	<p>Parking Brake and Brake System Indicator (Red)</p>	<ul style="list-style-type: none"> • Comes on when the parking brake is applied, and goes off when it is released. • Comes on when the brake fluid level is low. • Comes on if there is a problem with the brake system. • The beeper sounds and the indicator comes on if you drive with the parking brake not fully released. • Comes on for about 30 seconds when you pull or push the electric parking brake switch when the power mode is in ACCESSORY or VEHICLE OFF. • Stays on for about 30 seconds when you set the power mode to VEHICLE OFF while the electric parking brake is set. 	<ul style="list-style-type: none"> • Comes on while driving - Make sure the parking brake is released. Check the brake fluid level. <ul style="list-style-type: none"> ➤ What to do when the indicator comes on while driving P. 683 • Comes on along with the brake system indicator (amber) - Immediately stop in a safe place. Contact a dealer for repair. The brake pedal becomes harder to operate. Depress the pedal further than you normally do. • Comes on along with the ABS indicator - Have your vehicle checked by a dealer. <ul style="list-style-type: none"> ➤ If the Brake System Indicator (Red) Comes On or Blinks P. 683 • Blinks and the brake system indicator (amber) comes on at the same time - There is a problem with the electric parking brake system. The parking brake may not be set. Avoid using the parking brake and have your vehicle checked by a dealer immediately. <ul style="list-style-type: none"> ➤ If the Brake System Indicator (Red) Comes On or Blinks at the Same Time When the Brake System Indicator (Amber) Comes On P. 684 	<div data-bbox="1292 386 1492 537">  <p>Release Parking Brake</p> </div> <div data-bbox="1292 543 1492 694">  <p>Brake Fluid Low. Do Not Drive. Check Fluid Level.</p> </div> <div data-bbox="1292 700 1492 851">  <p>Brake System Problem. Brake Performance May Be Reduced. See Your Dealer.</p> </div>



Indicator	Name	On/Blinking	Explanation	Message
 	Parking Brake and Brake System Indicator (Amber)	<ul style="list-style-type: none"> • Comes on if there is a problem with a system related to braking other than the conventional brake system. • Comes on if there is a problem with the electric parking brake system. 	<ul style="list-style-type: none"> • Stays on constantly - Have your vehicle checked by a dealer. • Comes on while driving - Avoid using the parking brake and have your vehicle checked by a dealer immediately. 	<div style="border: 1px solid black; padding: 5px; margin-bottom: 5px;">  </div> <div style="border: 1px solid black; padding: 5px; margin-bottom: 5px;">  </div> <div style="border: 1px solid black; padding: 5px; margin-bottom: 5px;">  </div> <div style="border: 1px solid black; padding: 5px;">  </div>

Indicator	Name	On/Blinking	Explanation	Message
<p>U.S.</p> <p>BRAKE SYSTEM</p> <p>Canada</p>  <p>(Amber)</p>	<p>Parking Brake and Brake System Indicator (Amber)</p>	<ul style="list-style-type: none"> Comes on if there is a problem with the automatic brake hold system. Comes on if there is a problem with the radar sensor. Indicator may come on temporarily when the Maximum Load Limit is exceeded. 	<p>➤ Automatic Brake Hold P. 577</p> <ul style="list-style-type: none"> Make sure the total load is within the Maximum Load Limit. ➤ Maximum Load Limit P. 457 Stays on constantly - Have your vehicle checked by a dealer. 	<p>U.S.</p> <p>BRAKE SYSTEM</p> <p>Brake Hold System Problem. Apply Brake When Stopped. See Your Dealer.</p> <p>Canada</p>  <p>Brake Hold System Problem. Apply Brake When Stopped. See Your Dealer.</p>



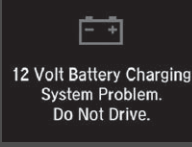

Instrument Panel

Indicator	Name	On/Blinking	Explanation	Message
	Automatic Brake Hold System Indicator	<ul style="list-style-type: none"> Comes on when the automatic brake hold system is on. 	<p>➔ Automatic Brake Hold P. 577</p>	 <p>Brake Hold System Standby</p>
	Automatic Brake Hold Indicator	<ul style="list-style-type: none"> Comes on when the automatic brake hold is activated. 	<p>➔ Automatic Brake Hold P. 577</p>	—



Indicator	Name	On/Blinking	Explanation	Message
	Malfunction Indicator Lamp	<ul style="list-style-type: none"> • After you have set the power mode to ON, the vehicle performs system checks. However, if the readiness codes have not been set by that time, this indicator will blink five times and then go off. • Comes on if there is a problem with the emissions control system. • Blinks when a misfire in the engine's cylinders is detected. 	<ul style="list-style-type: none"> • Readiness codes are part of the on board diagnostics for the emissions control systems. <ul style="list-style-type: none"> ▶ Testing of Readiness Codes P. 707 • Comes on while driving - Have your vehicle checked by a dealer. • Blinks while driving - Stop in a safe place where there are no flammable objects. Stop the engine for 10 minutes or more, and wait for it to cool down. Then, take your vehicle to a dealer. <ul style="list-style-type: none"> ▶ If the Malfunction Indicator Lamp Comes On or Blinks P. 682 	<div style="background-color: #333; color: white; padding: 5px; text-align: center;">  Emissions System Problem. Power May Be Reduced. See Your Dealer. </div> <div style="background-color: #333; color: white; padding: 5px; text-align: center; margin-top: 10px;">  Emission System Problem. Avoid Heavy Acceleration And High Speed. See Your Dealer. </div>

Indicator	Name	On/Blinking	Explanation	Message
	Charging System Indicator	<ul style="list-style-type: none"> Comes on when the battery is not charging. 	<ul style="list-style-type: none"> Stop in a safe place and have your vehicle checked by a dealer immediately. <ul style="list-style-type: none"> ➤ If the Charging System Indicator Comes On P. 681 	
	Gear Position Indicator*	<ul style="list-style-type: none"> Indicates the current gear selection. 	<ul style="list-style-type: none"> ➤ Shifting P. 475, 482, 484 	—
	M (sequential mode*/7-speed manual shift mode*) Indicator*/Gear Selection Indicator*	<ul style="list-style-type: none"> Comes on when the sequential mode*/7-speed manual shift mode* is applied. 	<ul style="list-style-type: none"> ➤ Sequential Mode P. 480 ➤ 7-Speed Manual Shift Mode P. 486 	—



Automatic transmission models

Indicator	Name	On/Blinking	Explanation	Message
	Transmission System Indicator	<ul style="list-style-type: none"> The current gear selection blinks if the transmission system has a problem. 	<ul style="list-style-type: none"> Blinks while driving - Avoid sudden starts and acceleration and have your vehicle checked by a dealer immediately. 	 <p>Transmission System Problem. Performance May Be Reduced. See Your Dealer.</p>
		<ul style="list-style-type: none"> The indicated current gear selection blinks if you cannot put the transmission into R due to a transmission system failure. 	<ul style="list-style-type: none"> Avoid sudden starts, sudden acceleration and high speed, and have your vehicle checked by a dealer immediately. 	 <p>Transmission System Problem. Reverse Gear Not Available. See Your Dealer.</p>
		<ul style="list-style-type: none"> The indicated current gear selection blinks if the transmission system has a problem and the performance of the vehicle is reduced. 	<ul style="list-style-type: none"> Avoid sudden starts, sudden acceleration and high speed, and have your vehicle checked by a dealer immediately. 	 <p>Transmission System Problem. Avoid Heavy Acceleration And High Speed. See Your Dealer.</p>
		<ul style="list-style-type: none"> The indicated current gear selection blinks if the transmission system has a problem and the paddle shifters cannot be used. 	<ul style="list-style-type: none"> Have your vehicle checked by a dealer immediately. 	 <p>Transmission System Problem. Paddle Shifters Not Available. See Your Dealer.</p>

Automatic transmission models





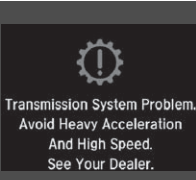
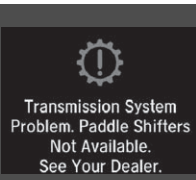

Indicator	Name	On/Blinking	Explanation	Message
	Transmission System Indicator	<ul style="list-style-type: none"> The current gear position or all the gear positions blink if there is a problem with the transmission and the vehicle is no longer able to run. 	<ul style="list-style-type: none"> Immediately park your car in a safe place. <ul style="list-style-type: none"> 🔧 Emergency Towing P. 693 Have your vehicle checked by a dealer. 	 <p>Stop Driving When Safe. Transmission Problem. See Manual</p>
		<ul style="list-style-type: none"> The current gear position or all the gear positions blink if there is a problem with the transmission and it is not possible to select P. 	<ul style="list-style-type: none"> Depending on the circumstances, you can set the power mode to ON as an emergency measure. <ul style="list-style-type: none"> 🔧 If the Transmission Indicator Blinks along with the Warning Message P. 687 While the vehicle is stopped, apply the parking brake. Have your vehicle checked by a dealer immediately. 	 <p>Transmission System Problem. Apply Parking Brake When Parked. See Your Dealer.</p>





Continuously variable transmission models





Indicator	Name	On/Blinking	Explanation	Message
	Transmission System Indicator	<ul style="list-style-type: none"> Blinks if the transmission system has a problem. 	<ul style="list-style-type: none"> Blinks while driving - Avoid sudden starts and acceleration and have your vehicle checked by a dealer immediately. 	
		<ul style="list-style-type: none"> Blinks if the transmission system has a problem and the performance of the vehicle is reduced. 	<ul style="list-style-type: none"> Avoid sudden starts, sudden acceleration and high speed, and have your vehicle checked by a dealer immediately. 	
		<p>Models with paddle shifters</p> <ul style="list-style-type: none"> Blinks if the transmission system has a problem and the paddle shifters cannot be used. 	<ul style="list-style-type: none"> Have your vehicle checked by a dealer immediately. 	





Manual transmission models





Indicator	Name	On/Blinking	Explanation	Message
	Shift Up Indicator	<ul style="list-style-type: none"> Comes on when shifting up is recommended. 	 Shift Up/Down Indicators P. 489	—
	Shift Down Indicator	<ul style="list-style-type: none"> Comes on when shifting down is recommended. 	 Shift Up/Down Indicators P. 489	—





Indicator	Name	On/Blinking	Explanation	Message
	Seat Belt Reminder Indicator	<ul style="list-style-type: none"> Blinks and the beeper sounds for a few seconds if you are not wearing a seat belt when you set the power mode to ON, then the indicator comes on. If the front passenger is not wearing a seat belt, the indicator comes on a few seconds later. Blinks while driving if either you and/or the front passenger has not fastened a seat belt. The beeper sounds and the indicator blinks at regular intervals. 	<ul style="list-style-type: none"> The beeper stops and the indicator goes off when you and the front passenger fasten their seat belts. Stays on after you and/or the front passenger has fastened the seat belt(s) - A detection error may have occurred in the sensor. Have your vehicle checked by a dealer.  Seat Belt Reminder P. 39 	<div data-bbox="1294 260 1489 412">  Fasten Seat Belt </div> <div data-bbox="1294 423 1489 574">  Fasten Passenger's Seat Belt </div>
	Low Fuel Indicator	<ul style="list-style-type: none"> Comes on when the fuel reserve is running low (approximately 2.2 U.S. gal./8.4 L left). Blinks if there is a problem with the fuel gauge. 	<ul style="list-style-type: none"> Comes on - Refuel your vehicle as soon as possible. Blinks - Have your vehicle checked by a dealer. 	<div data-bbox="1294 613 1489 781">  Fuel Low </div> <div data-bbox="1294 798 1489 955">  Fuel Gauge System Problem. Level Not Accurate. See Your Dealer. </div>





Indicator	Name	On/Blinking	Explanation	Message
	Anti-lock Brake System (ABS) Indicator	<ul style="list-style-type: none"> Comes on if there is a problem with the ABS. 	<ul style="list-style-type: none"> Stays on constantly - Have your vehicle checked by a dealer. With this indicator on, your vehicle still has normal braking ability but no anti-lock function. ➤ Anti-lock Brake System (ABS) P. 581 	 Anti-Lock Brake System Problem. Brake Performance May Be Reduced. See Your Dealer.
	Supplemental Restraint System Indicator	<ul style="list-style-type: none"> Comes on if a problem with any of the following is detected: <ul style="list-style-type: none"> - Supplemental restraint system - Knee airbag system - Side airbag system - Side curtain airbag system - Seat belt tensioner 	<ul style="list-style-type: none"> Stays on constantly - Have your vehicle checked by a dealer. 	 Supplemental Restraint System Problem. See Your Dealer.
	Auto High-Beam Indicator	<ul style="list-style-type: none"> Comes on when all the operating conditions of the auto high-beam are met. 	➤ Auto High-Beam P. 197	—

Indicator	Name	On/Blinking	Explanation	Message
	Vehicle Stability Assist® (VSA®) System Indicator	<ul style="list-style-type: none"> • Blinks when VSA® is active. • Comes on if there is a problem with the brake assist system, VSA® system or hill start assist system. 	<ul style="list-style-type: none"> • Stays on constantly - Have your vehicle checked by a dealer.  Vehicle Stability Assist® (VSA®), aka Electronic Stability Control (ESC), System P. 494 	 <p>Vehicle Stability Assist System Problem. Reduced Traction And Handling. See Your Dealer.</p>  <p>Hill Start Assist Problem. Vehicle May Roll Upon Brake Release. See Your Dealer.</p>
		<ul style="list-style-type: none"> • Comes on if the VSA® system is deactivated temporarily after the battery has been disconnected, then re-connected. 	<ul style="list-style-type: none"> • Drive a short distance at more than 12 mph (20 km/h). The indicator should go off. If it does not, have your vehicle checked by a dealer. 	 <p>Systems Initializing... Continue Driving.</p>





Indicator	Name	On/Blinking	Explanation	Message
	Vehicle Stability Assist® (VSA®) OFF Indicator	<ul style="list-style-type: none"> • Comes on when you partially disable VSA®. 	<p>► VSA® On and Off P. 495</p>	 <p>Vehicle Stability Assist (VSA) OFF</p>
		<ul style="list-style-type: none"> • Comes on if the VSA® system is deactivated temporarily after the battery has been disconnected, then re-connected. 	<ul style="list-style-type: none"> • Drive a short distance at more than 12 mph (20 km/h). The indicator should go off. If it does not, have your vehicle checked by a dealer. 	 <p>Systems Initializing... Continue Driving.</p>
	Electric Power Steering (EPS) System Indicator	<ul style="list-style-type: none"> • Comes on if there is a problem with the EPS system. 	<ul style="list-style-type: none"> • Stays on constantly - Have your vehicle checked by a dealer. ► If the Electric Power Steering (EPS) System Indicator Comes On P. 685 	 <p>Electric Power Steering System Problem. Steering Assist Reduced. See Your Dealer.</p>



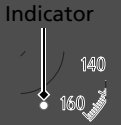

Indicator	Name	On/Blinking	Explanation	Message
	Low Tire Pressure/TPMS Indicator	<ul style="list-style-type: none"> • May come on briefly if the power mode is set to ON and the vehicle is not moved within 45 seconds, to indicate the calibration process is not yet complete. • Comes on and stays on when: <ul style="list-style-type: none"> - One or more tires' pressures are determined to be significantly low. - The system has not been calibrated. 	<ul style="list-style-type: none"> • Comes on while driving - Stop in a safe place, check tire pressures, and inflate the tire(s) if necessary. • Stays on after the tires are inflated to the recommended pressures - The system needs to be calibrated. <ul style="list-style-type: none"> ▶ TPMS Calibration P. 497 	 <p>Tire Pressures Low</p>
		<ul style="list-style-type: none"> • Blinks for about one minute, and then stays on if there is a problem with the TPMS, or when a compact spare tire is temporarily installed. 	<ul style="list-style-type: none"> • Blinks and remains on - Have your vehicle checked by a dealer. If the vehicle is fitted with a compact spare, get your regular tire repaired or replaced and put back on your vehicle as soon as you can. 	 <p>Tire Pressure Monitor System Problem. Check Tire Pressure. See Your Dealer.</p>
		<ul style="list-style-type: none"> • Comes on if the TPMS is deactivated temporarily after the battery has been disconnected, then re-connected. 	<ul style="list-style-type: none"> • Drive a short distance at more than 12 mph (20 km/h). The indicator should go off. If it does not, have your vehicle checked by a dealer. 	 <p>Systems Initializing... Continue Driving.</p>

Indicator	Name	On/Blinking	Explanation	Message
	Turn Signal and Hazard Warning Indicators	<ul style="list-style-type: none"> • Blinks when you operate the turn signal lever. • Blink along with all turn signals if you press the hazard warning button. 	<ul style="list-style-type: none"> • Does not blink or blinks rapidly - A turn signal light bulb has blown. Change the bulb immediately.  Replacing Light Bulbs P. 633, 634 	—
	High Beam Indicator	<ul style="list-style-type: none"> • Comes on when the high beam headlights are on. 	—	—
	Lights On Indicator	<ul style="list-style-type: none"> • Comes on whenever the light switch is on, or in AUTO when the exterior lights are on. 	<ul style="list-style-type: none"> • If you set the power mode to VEHICLE OFF while the lights are on, a chime sounds when the driver's door is opened. 	—
	Fog Light Indicator*	<ul style="list-style-type: none"> • Comes on when the fog lights are on. 	—	—

Indicator	Name	On/Blinking	Explanation	Message
 <p>Indicator</p>	<p>Immobilizer System Indicator</p>	<ul style="list-style-type: none"> Blinks if the immobilizer system cannot recognize the key information. 	<ul style="list-style-type: none"> Blinks - You cannot start the engine. Set the power mode to VEHICLE OFF*1, then select the ON mode again. Repeatedly blinks - The system may be malfunctioning. Have your vehicle checked by a dealer. Do not attempt to alter this system or add other devices to it. Electrical problems can occur. 	<div style="border: 1px solid gray; padding: 5px; margin-bottom: 5px;">  <p>To Start Engine: Fully Depress Brake + Push</p> <p style="text-align: right;">*2</p> </div> <div style="border: 1px solid gray; padding: 5px; margin-bottom: 5px;">  <p>Fully Release Brake + Push</p> <p style="text-align: right;">*2</p> </div> <div style="border: 1px solid gray; padding: 5px; margin-bottom: 5px;">  <p>To Start Engine: Fully Depress Brake + Clutch + Push</p> <p style="text-align: right;">*3</p> </div> <div style="border: 1px solid gray; padding: 5px;">  <p>Fully Release Clutch + Push</p> <p style="text-align: right;">*3</p> </div>



*1: Canadian models only: Apply and hold the brake pedal before selecting the ON mode.
 *2: Automatic transmission/Continuously variable transmission models for Canadian models
 *3: Manual transmission models for Canadian models

Indicator	Name	On/Blinking	Explanation	Message
	Security System Alarm Indicator	<ul style="list-style-type: none"> Blinks when the security system alarm has been set. 	<ul style="list-style-type: none">  Security System Alarm P. 184 	—
	System Message Indicator	<ul style="list-style-type: none"> Comes on along with a beep when a problem is detected. A system message on the driver information interface appears at the same time. 	<ul style="list-style-type: none"> While the indicator is on, press the  (home) button to see the message again. <ul style="list-style-type: none">  Accessing contents in the main display P. 138 Refer to the Indicators information in this chapter when a system message appears on the driver information interface. Take the appropriate action for the message. The driver information interface does not return to the normal screen unless the warning is canceled, or the left selector wheel is pressed. 	—

Indicator	Name	On/Blinking	Explanation	Message
	ECON Mode Indicator	<ul style="list-style-type: none"> Comes on when you press the ECON button. 	 ECON Button P. 492	<div style="text-align: right;">*1</div>  <div style="text-align: right;">*2</div> 

*1: Models without the adaptive damper system

*2: Models with the adaptive damper system

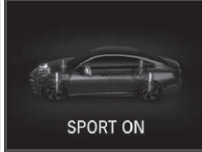
Indicator	Name	On/Blinking	Explanation	Message
	SPORT Mode Indicator*	<ul style="list-style-type: none"> • Comes on when you press the SPORT button. • The ambient meter remains lit up in red as long as SPORT mode is on. 	 SPORT Mode* P. 491	<div style="text-align: right;">*1</div>  <div style="text-align: right;">*2</div> 

*1: Models without the adaptive damper system





*2: Models with the adaptive damper system

Indicator	Name	On/Blinking	Explanation	Message
<div style="background-color: #333; color: white; padding: 5px; text-align: center; width: 40px; margin: auto;">ACC</div>	Adaptive Cruise Control (ACC) with Low Speed Follow (LSF) Indicator (Amber)* / Adaptive Cruise Control (ACC) Indicator (Amber)*	<ul style="list-style-type: none"> Comes on if there is a problem with ACC with LSF*/ACC*. 	<ul style="list-style-type: none"> Stays on constantly - Have your vehicle checked by a dealer. 	<div style="background-color: #333; color: white; padding: 10px; text-align: center;"> <p>ACC</p> <p>Adaptive Cruise Control System Problem. See Your Dealer.</p> </div>
		<ul style="list-style-type: none"> Comes on if the ACC with LSF*/ACC* is deactivated temporarily after the battery has been disconnected, then re-connected. 	<ul style="list-style-type: none"> Drive a short distance at more than 12 mph (20 km/h). The indicator should go off. If it does not, have your vehicle checked by a dealer. 	<div style="background-color: #333; color: white; padding: 10px; text-align: center;">  <p>Systems Initializing... Continue Driving.</p> </div>
		<ul style="list-style-type: none"> Indicator may come on temporarily when the Maximum Load Limit is exceeded. ACC with LSF*/ACC* has been automatically canceled. 	<ul style="list-style-type: none"> Make sure the total load is within the Maximum Load Limit. <ul style="list-style-type: none"> ➤ Maximum Load Limit P. 457 	<div style="background-color: #333; color: white; padding: 10px; text-align: center;"> <p>—</p> </div>

Instrument Panel



* Not available on all models







Indicator	Name	On/Blinking	Explanation	Message
ACC	Adaptive Cruise Control (ACC) with Low Speed Follow (LSF) Indicator (Green)*/ Adaptive Cruise Control (ACC) Indicator (Green)*	<ul style="list-style-type: none"> Comes on when you press the MAIN button. 	<ul style="list-style-type: none"> ➤ Adaptive Cruise Control (ACC) with Low Speed Follow (LSF)* P. 519 ➤ Adaptive Cruise Control (ACC)* P. 535 	—
LKAS	Lane Keeping Assist System (LKAS) Indicator (Amber)	<ul style="list-style-type: none"> Comes on if there is a problem with the LKAS. 	<ul style="list-style-type: none"> Stays on constantly - Have your vehicle checked by a dealer. 	<p>LKAS</p> <p>Lane Keeping Assist System Problem. See Your Dealer.</p>
LKAS	Lane Keeping Assist System (LKAS) Indicator (Green)	<ul style="list-style-type: none"> Comes on when you press the MAIN button. 	<ul style="list-style-type: none"> ➤ Lane Keeping Assist System (LKAS) P. 550 	—

Indicator	Name	On/Blinking	Explanation	Message
	Safety Support Indicator (Amber)	<ul style="list-style-type: none"> Comes on if there is a problem with RDM, CMBS™, or the blind spot information system*. 	<ul style="list-style-type: none"> Stays on constantly - Have your vehicle checked by a dealer. 	<div data-bbox="1289 236 1495 389">  <p>Road Departure Mitigation System Problem. See Your Dealer.</p> </div> <div data-bbox="1289 395 1495 548">  <p>Collision Mitigation Braking System Problem. See Your Dealer.</p> </div> <div data-bbox="1289 554 1495 707">  <p>Blind Spot Information System Problem. See Your Dealer.</p> </div>
		<ul style="list-style-type: none"> Comes on if the RDM and CMBS™ are deactivated temporarily after the battery has been disconnected and then re-connected. 	<ul style="list-style-type: none"> Drive a short distance at more than 12 mph (20 km/h). The indicator should go off. If it does not, have your vehicle checked by a dealer. 	<div data-bbox="1289 749 1495 907">  <p>Systems Initializing... Continue Driving.</p> </div>





Instrument Panel

* Not available on all models

Indicator	Name	On/Blinking	Explanation	Message
	Safety Support Indicator (Amber)	<ul style="list-style-type: none"> Comes on when RDM and/or CMBS™ shuts itself off. 	<ul style="list-style-type: none"> Indicator may come on temporarily when passing through an enclosed space, such as tunnel. The area around the radar sensor is blocked by dirt, mud, etc. Stop your vehicle in a safe place and wipe the debris off with a soft cloth. Have your vehicle checked by a dealer if the indicator does not go off even after you have cleaned the radar sensor. <ul style="list-style-type: none"> ➤ Collision Mitigation Braking System™ (CMBS™) P. 510 	 <p>Some Driver Assist Systems Cannot Operate: Radar Obstructed</p>
		<ul style="list-style-type: none"> Stays on - The temperature inside the camera is too high. Use the climate control system to cool down the camera. The system activates when the temperature inside the camera cools down. <ul style="list-style-type: none"> ➤ Front Sensor Camera P. 568 	 <p>Some Driver Assist Systems Cannot Operate: Camera Temperature Too High</p>	



Indicator	Name	On/Blinking	Explanation	Message
	Safety Support Indicator (Amber)	<ul style="list-style-type: none"> Comes on when RDM and/or CMBS™ shuts itself off. 	<ul style="list-style-type: none"> Stays on - The area around the camera is blocked by dirt, mud, etc. Stop your vehicle in a safe place and wipe the debris off with a soft cloth. Have your vehicle checked by a dealer if the indicator and message are still displayed even after you have cleaned the area around the camera.  Front Sensor Camera P. 568 	 <p>Some Driver Assist Systems Cannot Operate: Clean Front Windshield</p>
		<p>Models with the blind spot information system</p> <ul style="list-style-type: none"> Comes on when mud, snow, or ice has accumulated in the vicinity of the blind spot information system sensor. 	<ul style="list-style-type: none"> Comes on while driving - Something may be interfering with the blind spot information system sensor. Check the vicinity of the blind spot information system sensor and remove any obstacles.  Blind spot information System* P. 502 	 <p>Blind Spot Information System Not Available</p>
		<ul style="list-style-type: none"> Indicator may come on temporarily when the Maximum Load Limit is exceeded. 	<ul style="list-style-type: none"> Make sure the total load is within the Maximum Load Limit.  Maximum Load Limit P. 457 	<p>—</p>





* Not available on all models





Indicator	Name	On/Blinking	Explanation	Message
	Safety Support Indicator (Green/Gray)	<ul style="list-style-type: none"> • Lights up in green when RDM, CMBS™, and the blind spot information system* are on. • Lights up in green and gray when RDM, CMBS™, or the blind spot information system*, or any two of these systems are off. • Lights up in gray when RDM, CMBS™, and the blind spot information system* are off. 	<ul style="list-style-type: none"> ➤ RDM On and Off P. 560 ➤ CMBS™ On and Off P. 513 ➤ Blind spot information System On and Off P. 504 	<div data-bbox="1299 225 1498 385">  <p>Road Departure Mitigation: OFF</p> </div> <div data-bbox="1299 393 1498 553">  <p>Collision Mitigation Braking System OFF</p> </div> <div data-bbox="1299 561 1498 721">  <p>Blind Spot Info System OFF</p> </div>



Driver Information Interface Warning and Information Messages



The following messages appear only on the driver information interface. Press the  (home) button, select **Warnings**, then press the left selector wheel to see the message again with the system message indicator on.



Message	Condition	Explanation
 Critical Failure Detected. Stop Driving When Safe.	<ul style="list-style-type: none"> Appears when the vehicle is no longer able to run due to a malfunction. 	<ul style="list-style-type: none"> Immediately stop in a safe place. Have your vehicle checked by a dealer immediately.
 Depress Brake Pedal And Apply Parking Brake	<ul style="list-style-type: none"> Appears when there is a risk that the vehicle will move unexpectedly after you have stopped due to a malfunction with the vehicle. 	<ul style="list-style-type: none"> While the vehicle is stopped, apply the parking brake. Have your vehicle checked by a dealer.
 To Continue to Drive, Depress Brake Pedal And Push Switch	<p>Automatic transmission models</p> <ul style="list-style-type: none"> Appears when you set the power mode to ON again and the vehicle is able to run. 	<p>➤ Starting the Engine P. 465</p>



Message	Condition	Explanation
 <p>Door Open</p>  <p>Trunk Open</p>  <p>Door And Trunk Open</p>	<ul style="list-style-type: none"> • Appears if any door or the trunk is not completely closed. • Appears if any door or the trunk is opened while driving. The beeper sounds. 	<ul style="list-style-type: none"> • Disappears when all doors and the trunk are closed.
 <p>Engine Oil Pressure Low. Stop Engine. Do Not Drive.</p>	<ul style="list-style-type: none"> • Appears when the engine oil pressure is low. 	<ul style="list-style-type: none"> • Appears while driving - Immediately stop in a safe place. <ul style="list-style-type: none"> ☒ If the Low Oil Pressure Warning Appears P. 681



Message	Condition	Explanation
 Shutter Grille System Problem. Power May Be Reduced. See Your Dealer.	<p>Models with shutter grille</p> <ul style="list-style-type: none"> Appears if there is a problem with the shutter grille, and the radiator coolant temperature is too high. 	<ul style="list-style-type: none"> Power output will be reduced, so you may not be able to accelerate or maintain your current speed. Have your vehicle checked by a dealer.
 Washer Fluid Low	<p>Canadian models</p> <ul style="list-style-type: none"> Appears when the washer fluid is low. 	<ul style="list-style-type: none"> Refill the washer fluid. <ul style="list-style-type: none"> ➤ Refilling Window Washer Fluid P. 630
 Maintenance Due Soon	<ul style="list-style-type: none"> Appears when the scheduled maintenance is due soon. Consequently, Maintenance Due Now and Maintenance Past Due follow. 	<ul style="list-style-type: none"> ➤ Maintenance Minder Messages on the Driver Information Interface P. 609
 Charging System Problem	<ul style="list-style-type: none"> Appears when there is a problem with the sensor on the battery. Appears along with the battery charging system indicator when the battery is not charging. 	<ul style="list-style-type: none"> Have your vehicle checked by a dealer. <ul style="list-style-type: none"> ➤ Checking the Battery P. 651 Turn off the climate control system and rear defogger to reduce electricity consumption. <ul style="list-style-type: none"> ➤ If the Charging System Indicator Comes On P. 681





Message	Condition	Explanation
 <p>Engine Temperature Too Hot. Do Not Drive. Allow Engine To Cool.</p>	<ul style="list-style-type: none"> Appears when the engine coolant temperature gets abnormally high. 	<p>➤ Overheating P. 679</p>
<p>Automatic transmission/Continuously variable transmission models</p>  <p>Brake Hold Disabled. Apply Brake Pedal.</p> <p>Manual transmission models</p>  <p>Brake Hold Disabled. Apply Brake Pedal.</p>	<ul style="list-style-type: none"> Appears if the automatic brake hold is automatically canceled while it is in operation. 	<ul style="list-style-type: none"> Immediately depress the brake pedal.

Message	Condition	Explanation
 <p>Brake Hold System OFF</p>	<ul style="list-style-type: none"> • Appears when the automatic brake hold system is turned off. 	<p>➤ Automatic Brake Hold P. 577</p>
 <p>To Enable Brake Hold: Seat Belt + Push</p>	<ul style="list-style-type: none"> • Appears when the automatic brake hold button is pressed without wearing the driver's seat belt. 	<ul style="list-style-type: none"> • Fasten the driver's seat belt. <p>➤ Automatic Brake Hold P. 577</p>





Message	Condition	Explanation
<p data-bbox="108 228 306 295">Automatic transmission/ Continuously variable transmission models</p>  <p data-bbox="118 407 296 448">To Disable Brake Hold: Brake + Push</p> <p data-bbox="108 479 306 519">Manual transmission models</p>  <p data-bbox="118 642 296 683">To Disable Brake Hold: Brake + Push</p>	<ul style="list-style-type: none"> • Appears when the automatic brake hold button is pressed without depressing the brake pedal while the automatic brake hold is in operation. 	<ul style="list-style-type: none"> • Press the automatic brake hold button with the brake pedal depressed. <ul style="list-style-type: none"> ➤ Automatic Brake Hold P. 577
 <p data-bbox="118 826 296 844">Parking Brake Engaged</p>	<ul style="list-style-type: none"> • Appears when the parking brake is applied automatically while it is in operation. 	<ul style="list-style-type: none"> ➤ Automatic Brake Hold P. 577 ➤ Parking Brake P. 571

Message	Condition	Explanation
<div data-bbox="102 230 300 297">Automatic transmission/ Continuously variable transmission models</div> <div data-bbox="134 333 264 381"></div> <div data-bbox="102 395 300 434">To Release Parking Brake: Brake + Push</div> <div data-bbox="102 482 300 521">Manual transmission models</div> <div data-bbox="134 566 264 614"></div> <div data-bbox="102 628 300 667">To Release Parking Brake: Brake + Push</div>	<ul style="list-style-type: none"> • Appears when the electric parking brake switch is pressed without depressing the brake pedal while the electric parking brake is in operation. 	<ul style="list-style-type: none"> • Press the electric parking brake switch with the brake pedal depressed. <ul style="list-style-type: none"> ▶ Parking Brake P. 571



Message	Condition	Explanation
<p data-bbox="108 228 306 292">Automatic transmission/ Continuously variable transmission models</p>  <p data-bbox="150 385 263 423">To Start Engine: Brake + Push</p> <hr/> <p data-bbox="108 479 277 517">Manual transmission models</p>  <p data-bbox="150 617 263 655">To Start Engine: Clutch + Push</p>	<ul data-bbox="325 217 778 269" style="list-style-type: none"> • Appears after you set the power mode to ACCESSORY or ON. <p data-bbox="325 284 501 306">Canadian models</p> <ul data-bbox="325 314 836 367" style="list-style-type: none"> • Appears after you unlock and open the driver's door. 	<p data-bbox="948 445 1241 468">➤ Starting the Engine P. 465</p>
 <p data-bbox="140 815 272 853">To Unlock Wheel: Push + Rotate</p>	<p data-bbox="325 721 715 762">Continuously variable transmission models for Canadian models</p> <p data-bbox="325 781 612 804">Manual transmission models</p> <ul data-bbox="325 812 798 834" style="list-style-type: none"> • Appears when the steering wheel is locked. 	<ul data-bbox="895 721 1495 773" style="list-style-type: none"> • Move the steering wheel left and right while pressing the ENGINE START/STOP button.

Message	Condition	Explanation
 <p>Accessory Mode</p>	<ul style="list-style-type: none"> Appears when the power mode is in ACCESSORY. 	<p>—</p>
 <p>To Switch Vehicle OFF: Push Twice</p>	<ul style="list-style-type: none"> Appears after the driver's door is opened when the power mode is in ACCESSORY. 	<ul style="list-style-type: none"> Change the power mode to VEHICLE OFF. <ul style="list-style-type: none"> ▶ ENGINE START/STOP Button P. 190
 <p>Keyless Remote Not Detected</p>	<ul style="list-style-type: none"> Appears when you close the door with the power mode in ON without the remote inside the vehicle. 	<ul style="list-style-type: none"> Disappears when you bring the remote back inside the vehicle and close the door. <ul style="list-style-type: none"> ▶ Remote Reminder P. 192
 <p>Keyless Remote Battery Low</p>	<ul style="list-style-type: none"> Appears when the remote battery becomes weak. 	<ul style="list-style-type: none"> Replace the battery as soon as possible. <ul style="list-style-type: none"> ▶ Replacing the Button Battery P. 653

Message	Condition	Explanation
<p data-bbox="108 232 306 273">Automatic transmission models</p> <div data-bbox="177 322 236 344" style="border: 1px solid black; padding: 2px; text-align: center;">P</div> <p data-bbox="145 378 272 418">To Start Engine: Shift To Park</p> <p data-bbox="118 456 300 497">Continuously variable transmission models</p> <div data-bbox="156 527 256 583">  </div> <p data-bbox="145 602 272 642">To Start Engine: Shift To Park</p>	<p data-bbox="328 221 767 266">Automatic transmission/Continuously variable transmission models</p> <ul data-bbox="328 277 831 359" style="list-style-type: none"> • Appears if you try to start the engine when the transmission is in [N] and the parking brake is disengaged. 	<ul data-bbox="906 221 1477 303" style="list-style-type: none"> • Put the transmission into [P], then start the engine in the normal procedure. <ul data-bbox="959 277 1246 303" style="list-style-type: none"> ➤ Starting the Engine P. 465
<div data-bbox="177 721 236 766" style="border: 1px solid black; padding: 2px; text-align: center;">(P)</div> <p data-bbox="129 796 288 836">To Start Engine: Apply Parking Brake</p>	<p data-bbox="328 686 608 708">Manual transmission models</p> <ul data-bbox="328 720 887 771" style="list-style-type: none"> • Appears when the parking brake is disengaged while the power mode is in ON. 	<ul data-bbox="906 686 1445 796" style="list-style-type: none"> • Set the parking brake, then start the engine in the normal procedure. <ul data-bbox="959 745 1246 796" style="list-style-type: none"> ➤ Parking Brake P. 571 ➤ Starting the Engine P. 465

Message	Condition	Explanation
 <p>To Start, Hold Remote Near Start Button</p>	<ul style="list-style-type: none"> Appears if the remote battery is too weak to start the engine or the key is not within operating range to start the engine. A beeper sounds six times. 	<ul style="list-style-type: none"> Bring the remote in front of the ENGINE START/STOP button to be touched with. <ul style="list-style-type: none"> ➤ If the Remote Battery is Weak P. 672
<div style="border: 1px solid black; padding: 2px; width: fit-content; margin-bottom: 5px;">U.S.</div>  <p>Starter System Problem. Engine May Not Restart. See Your Dealer.</p> <div style="border: 1px solid black; padding: 2px; width: fit-content; margin-bottom: 5px;">Canada</div>  <p>Starter System Problem. Engine May Not Restart. See Your Dealer.</p>	<ul style="list-style-type: none"> Appears when the starter system has a problem. 	<ul style="list-style-type: none"> As a temporary measure, press and hold the ENGINE START/STOP button for up to 15 seconds while pressing the brake pedal and clutch pedal (manual transmission only), manually start the engine. Have your vehicle checked by a dealer.
 <p>Smart Entry System Problem. See Your Dealer.</p>	<ul style="list-style-type: none"> Appears as soon as a problem is detected in the smart entry system* or push button starting system. 	<ul style="list-style-type: none"> Have your vehicle checked by a dealer.

* Not available on all models

Message	Condition	Explanation
 <p>Pressing Button Again 2x Or Holding Will Cause Ignition OFF & Power Loss</p>	<ul style="list-style-type: none"> Appears if you press the ENGINE START/STOP button while the vehicle is moving. 	<ul style="list-style-type: none"> The message will disappear after six seconds or when the power mode is set to VEHICLE OFF.
 <p>Driver Attention Level Low</p>	<ul style="list-style-type: none"> Appears if the vehicle is being driven in a manner consistent with drowsy or inattentive driving. 	
 <p>Driver Attention Level Low. Time For A Break</p>		<p>➤ Driver Attention Monitor P. 152</p>



Automatic transmission models

Message	Condition	Explanation
 <p>Transmission Temperature Near Limit. Avoid Heavy Acceleration And High Speed.</p>	<ul style="list-style-type: none"> • Appears when the temperature of the transmission is starting to get too hot. • The performance of the vehicle may be reduced. 	<ul style="list-style-type: none"> • Until the message disappears, reduce your speed and allow the system to cool down.
<p>To Shift From Park; Engine Must Be Running</p>	<ul style="list-style-type: none"> • Appears when you attempt to change to another gear position with the transmission in P and the engine OFF. 	<ul style="list-style-type: none"> • To select another gear position while in P, the engine must be ON.
<p>Transmission System Problem. Park Not Available. See Your Dealer.</p>	<ul style="list-style-type: none"> • Appears when you set the power mode to OFF while driving. 	<ul style="list-style-type: none"> • Immediately stop in a safe place, set the parking brake, then restart the engine. If the message disappears, continue driving.

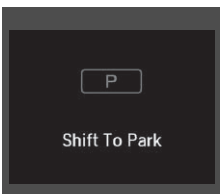
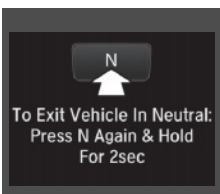
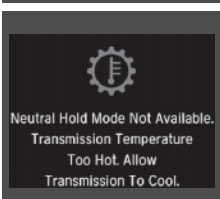

Automatic transmission models

Message	Condition	Explanation
	<ul style="list-style-type: none"> Appears if the vehicle is stopped and the driver's seat belt is unfastened, as there is a possibility that the vehicle may roll. 	<ul style="list-style-type: none"> When the vehicle is idling or when you are parking or exiting the vehicle, put the transmission into P before releasing the brake pedal. <ul style="list-style-type: none"> ➤ Shift Operation P. 476
	<ul style="list-style-type: none"> Appears when you put the transmission into N, then release the N button. 	<ul style="list-style-type: none"> ➤ If you want to keep the transmission in N position [car wash mode] P. 478
	<ul style="list-style-type: none"> Appears when car wash mode is not available due to the transmission being too hot. 	<ul style="list-style-type: none"> When the transmission is too hot, car wash mode may not be available. Let the engine idle until the transmission has cooled down. <ul style="list-style-type: none"> ➤ If you want to keep the transmission in N position [car wash mode] P. 478

Automatic transmission models

Message	Condition	Explanation
 <p>To Shift: Release Accelerator Pedal</p>	<ul style="list-style-type: none"> Appears when you try to change the gear position without releasing your foot off the accelerator pedal. 	<ul style="list-style-type: none"> Release your foot off the accelerator pedal, then select a shift button.
<p>To Shift: Vehicle Must Be Stopped</p>	<ul style="list-style-type: none"> Appears when the P button is pressed while the vehicle is moving. Appears if you put the transmission into R while the vehicle is moving forward, or into D while the vehicle is reversing. 	<ul style="list-style-type: none"> Make sure that the vehicle comes to a stop before operating the select button.
 <p>Fasten Seat Belt</p>	<ul style="list-style-type: none"> Appears when you set the power mode to ON without fastening the driver's seat belt. Appears when you change the gear position after P has been automatically selected with the driver's door open, the driver's seat belt unfastened, then the brake pedal is released. 	<ul style="list-style-type: none"> Fasten the seat belt properly before you start to drive. <ul style="list-style-type: none"> ► Shift Operation P. 476
 <p>To Shift: Apply Brake Pedal</p>	<ul style="list-style-type: none"> Appears when you try to change the gear position without depressing the brake pedal. 	<ul style="list-style-type: none"> Depress the brake pedal, then select a shift button.

Automatic transmission models



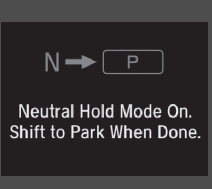

Message	Condition	Explanation
 <p data-bbox="135 340 280 400">Gear Position is N. Release Accelerator Pedal.</p>	<ul data-bbox="327 250 877 304" style="list-style-type: none"> • Appears if you depress the accelerator pedal when the transmission is in N. 	<ul data-bbox="904 250 1476 304" style="list-style-type: none"> • Release the accelerator pedal. After that, depress the brake pedal and change the transmission position.
 <p data-bbox="119 538 300 580">Gear Unavailable. Try Again After Awhile.</p>	<ul data-bbox="327 444 877 577" style="list-style-type: none"> • Appears when the shift is repeatedly changed between P and any other position. • Appears when you try to take the transmission out of P immediately after you start engine. 	<ul data-bbox="904 444 1412 549" style="list-style-type: none"> • Wait for a while then change the gear position. • Try to take the transmission out of P again.

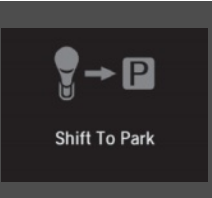

Automatic transmission models

Message	Condition	Explanation
 <p>Neutral Hold Mode On. Shift to Park When Done.</p>	<ul style="list-style-type: none"> Appears when you press and hold N button for more than two seconds. 	<ul style="list-style-type: none"> Disappears when you set the gear position to a gear other than N. <ul style="list-style-type: none"> ➤ If you want to keep the transmission in N position [car wash mode] P. 478

Continuously variable transmission models



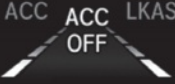

Message	Condition	Explanation
 <p>Shift To Park</p>	<ul style="list-style-type: none"> Appears if you press the ENGINE START/STOP button to turn the engine off without the shift lever in P. 	<p>U.S. models</p> <ul style="list-style-type: none"> Move the shift lever to P. The power mode changes to VEHICLE OFF. <p>Canadian models</p> <ul style="list-style-type: none"> Move the shift lever to P, then press the ENGINE START/STOP button twice.

Message	Condition	Explanation
 <p>Automatic Lighting Control System Problem. Manual Controls Available. See Your Dealer.</p>	<ul style="list-style-type: none"> Appears if there is a problem with the automatic lighting control system. 	<ul style="list-style-type: none"> Appears while driving - Manually turn the lights on, and have your vehicle checked by a dealer.
 <p>Headlight System Problem. Headlight Performance May Be Reduced. See Your Dealer.</p>	<ul style="list-style-type: none"> Appears if there is a problem with the headlights. 	<ul style="list-style-type: none"> Appears while driving - The headlights may not be on. When conditions allow you to drive safely, have your vehicle checked by a dealer as soon as possible.
 <p>Parking Sensor System Problem.</p>	<p>Models with parking sensor system</p> <ul style="list-style-type: none"> Appears if there is a problem with the parking sensor system. 	<ul style="list-style-type: none"> Check if the area around the sensor(s) is covered with mud, ice, snow, etc. If the indicator(s) stays on or the beeper does not stop even after you clean the area, have the system checked by a dealer.
 <p>WARNING: Approaching Object</p>	<p>Models with parking sensor system</p> <ul style="list-style-type: none"> Appears if there are obstacles around the sensors. 	<ul style="list-style-type: none"> Check for obstacles near your vehicle to make sure it is safe to park.



Message	Condition	Explanation
 <p>Auto High-Beam Problem. Manual Controls Available. See Your Dealer.</p>	<ul style="list-style-type: none"> • Appears if there is a problem with the auto high-beam. 	<ul style="list-style-type: none"> • Manually operate the headlight switch. • If you are driving with the high-beam headlights when this happens, the headlights are changed to low beams.
	<ul style="list-style-type: none"> • Appears when ACC with LSF*/ACC* has been automatically canceled. 	<ul style="list-style-type: none"> • You can resume the set speed after the condition that caused ACC with LSF*/ACC* to cancel improves. Press the RES/+ button. <ul style="list-style-type: none"> ➤ Adaptive Cruise Control (ACC) with Low Speed Follow (LSF)* P. 519 ➤ Adaptive Cruise Control (ACC)* P. 535
	<ul style="list-style-type: none"> • Flashes when the system senses a likely collision with a vehicle in front of you. 	<ul style="list-style-type: none"> • Take the appropriate means to prevent a collision (apply the brakes, change lanes, etc.) <ul style="list-style-type: none"> ➤ Collision Mitigation Braking System™ (CMBS™) P. 510 ➤ Adaptive Cruise Control (ACC) with Low Speed Follow (LSF)* P. 519 ➤ Adaptive Cruise Control (ACC)* P. 535



* Not available on all models

Message	Condition	Explanation
Cruise Cancelled: Speed Too High	<ul style="list-style-type: none"> Appears when ACC with LSF*/ACC* is canceled due to excessive high vehicle speed. 	<ul style="list-style-type: none"> Reduce the speed, then reset ACC with LSF*/ACC*. <ul style="list-style-type: none"> ➤ Adaptive Cruise Control (ACC) with Low Speed Follow (LSF)* P. 519 ➤ Adaptive Cruise Control (ACC)* P. 535
Cannot Set Cruise: Speed Too High	<ul style="list-style-type: none"> Appears when the speed of the vehicle is too high for you to set ACC with LSF*/ACC*. 	<ul style="list-style-type: none"> Reduce the speed, then set ACC with LSF*/ACC*. <ul style="list-style-type: none"> ➤ Adaptive Cruise Control (ACC) with Low Speed Follow (LSF)* P. 519 ➤ Adaptive Cruise Control (ACC)* P. 535
Cruise Cancelled: Speed Too Low	<p>Manual transmission models</p> <ul style="list-style-type: none"> Appears when ACC is canceled due to excessive low vehicle speed. 	<ul style="list-style-type: none"> Raise the speed, then reset ACC. <ul style="list-style-type: none"> ➤ Adaptive Cruise Control (ACC)* P. 535
Cannot Set Cruise: Speed Too Low	<p>Manual transmission models</p> <ul style="list-style-type: none"> Appears when the speed of the vehicle is too low for you to set ACC. 	<ul style="list-style-type: none"> Raise the speed, then set ACC. <ul style="list-style-type: none"> ➤ Adaptive Cruise Control (ACC)* P. 535

Message	Condition	Explanation
 <p>Cruise Cancelled: Too Close To Vehicle Ahead</p>	<ul style="list-style-type: none"> Appears when the distance between your vehicle and the vehicle ahead of you is too close while ACC with LSF*/ACC* is in operation. 	<ul style="list-style-type: none"> ACC with LSF*/ACC* has been automatically canceled. <ul style="list-style-type: none"> ➤ Adaptive Cruise Control (ACC) with Low Speed Follow (LSF)* P. 519 ➤ Adaptive Cruise Control (ACC)* P. 535
 <p>Cannot Set Cruise: Too Close To Vehicle Ahead</p>	<ul style="list-style-type: none"> Appears when pressing the SET/- button while the distance between your vehicle and the vehicle ahead of you is too close. 	<ul style="list-style-type: none"> ACC with LSF*/ACC* cannot be set. <ul style="list-style-type: none"> ➤ Adaptive Cruise Control (ACC) with Low Speed Follow (LSF)* P. 519 ➤ Adaptive Cruise Control (ACC)* P. 535
 <p>BRAKE</p> <p>Cruise Cancelled: Parking Brake Is Applied</p>	<ul style="list-style-type: none"> Appears when the parking brake is applied automatically while ACC with LSF*/ACC* is in operation. 	<ul style="list-style-type: none"> ACC with LSF*/ACC* has been automatically canceled. <ul style="list-style-type: none"> ➤ Adaptive Cruise Control (ACC) with Low Speed Follow (LSF)* P. 519 ➤ Adaptive Cruise Control (ACC)* P. 535 ➤ Parking Brake P. 571
 <p>BRAKE</p> <p>Cannot Set Cruise: Parking Brake Is Applied</p>	<ul style="list-style-type: none"> Appears when pressing the SET/- button while the parking brake is applied. 	<ul style="list-style-type: none"> ACC with LSF*/ACC* cannot be set. <ul style="list-style-type: none"> ➤ Adaptive Cruise Control (ACC) with Low Speed Follow (LSF)* P. 519 ➤ Adaptive Cruise Control (ACC)* P. 535 ➤ Parking Brake P. 571



* Not available on all models

Message	Condition	Explanation
<div data-bbox="118 232 300 322" style="border: 1px solid black; padding: 5px; margin-bottom: 5px;">Automatic transmission/ Continuously variable transmission models</div> <div data-bbox="172 344 242 400" style="text-align: center;">  </div> <div data-bbox="118 430 300 474" style="text-align: center;">Cannot Set Cruise: Brake Pedal Is Applied</div> <div data-bbox="118 508 300 553" style="border: 1px solid black; padding: 5px; margin-bottom: 5px;">Manual transmission models</div> <div data-bbox="172 580 242 636" style="text-align: center;">  </div> <div data-bbox="118 665 300 710" style="text-align: center;">Cannot Set Cruise: Brake Pedal Is Applied</div>	<ul style="list-style-type: none"> • Appears when pressing the SET/- button while the vehicle is moving and the brake pedal is depressed. 	<ul style="list-style-type: none"> • ACC with LSF*/ACC* cannot be set. <ul style="list-style-type: none"> ➤ Adaptive Cruise Control (ACC) with Low Speed Follow (LSF)* P. 519 ➤ Adaptive Cruise Control (ACC)* P. 535



Message	Condition	Explanation
 <p>Cruise Will Cancel Soon: Slope Too Steep</p>	<ul style="list-style-type: none"> • Appears just before the ACC with LSF*/ACC* is automatically canceled when you are descending a long hill etc (The following interval is automatically set to extra long). • Appears when the ACC with LSF*/ACC* has been automatically canceled. 	<ul style="list-style-type: none"> ➤ Adaptive Cruise Control (ACC) with Low Speed Follow (LSF)* P. 519 ➤ Adaptive Cruise Control (ACC)* P. 535
 <p>Cruise Cancelled: Slope Too Steep. Watch Downhill Speed</p>		
 <p>Cannot Set Cruise: Slope Too Steep</p>	<ul style="list-style-type: none"> • Appears when you are descending a long hill etc and you press the RES/+ or SET/- button. 	<ul style="list-style-type: none"> ➤ Adaptive Cruise Control (ACC) with Low Speed Follow (LSF)* P. 519 ➤ Adaptive Cruise Control (ACC)* P. 535

* Not available on all models

Models with ACC with LSF



Message	Condition	Explanation
 <p>Cruise Cancelled: Fasten Seat Belt</p>	<ul style="list-style-type: none"> Appears when the driver's seat belt is unfastened while your vehicle is automatically stopped by ACC with LSF. 	<ul style="list-style-type: none"> ACC with LSF has been automatically canceled. <ul style="list-style-type: none"> ➤ Adaptive Cruise Control (ACC) with Low Speed Follow (LSF)* P. 519
 <p>Cannot Set Cruise: Fasten Seat Belt</p>	<ul style="list-style-type: none"> Appears when pressing the SET/- button while the driver's seat belt is unfastened. 	<ul style="list-style-type: none"> ACC with LSF cannot be set. <ul style="list-style-type: none"> ➤ Adaptive Cruise Control (ACC) with Low Speed Follow (LSF)* P. 519

Models with ACC with LSF





Message	Condition	Explanation
<p data-bbox="102 262 295 303">Automatic transmission models</p>  <p data-bbox="129 423 268 464">Cruise Cancelled: Shift To Drive</p> <p data-bbox="102 493 277 535">Continuously variable transmission models</p>  <p data-bbox="129 650 268 692">Cruise Cancelled: Shift To Drive</p>	<ul style="list-style-type: none"> Appears when the transmission is put into any position other than D or S * while ACC with LSF is in operation. 	<ul style="list-style-type: none"> ACC with LSF has been automatically canceled. <ul style="list-style-type: none"> ► Adaptive Cruise Control (ACC) with Low Speed Follow (LSF)* P. 519

* Not available on all models

Models with ACC with LSF

Message	Condition	Explanation
<p>Automatic transmission models</p>  <p>Cannot Set Cruise: Shift To Drive</p> <p>Continuously variable transmission models</p>  <p>Cannot Set Cruise: Shift To Drive</p>	<ul style="list-style-type: none"> Appears when pressing the SET/- button while the transmission is in any position other than D or S*. 	<ul style="list-style-type: none"> ACC with LSF cannot be set. <ul style="list-style-type: none"> ➤ Adaptive Cruise Control (ACC) with Low Speed Follow (LSF)* P. 519

Models with ACC with LSF





Message	Condition	Explanation
 <p>Cruise Cancelled: Slope Too Steep</p>	<ul style="list-style-type: none"> Appears when the vehicle is stopped on a very steep slope while ACC with LSF is in operation. 	<ul style="list-style-type: none"> ACC with LSF has been automatically canceled. <ul style="list-style-type: none"> ▣ Adaptive Cruise Control (ACC) with Low Speed Follow (LSF)* P. 519
 <p>Cruise Cancelled: Slope Too Steep</p>		
 <p>Cannot Set Cruise: Slope Too Steep</p>	<ul style="list-style-type: none"> Appears when pressing the SET/- button while the vehicle is stopped on a very steep slope. 	<ul style="list-style-type: none"> ACC with LSF cannot be set. <ul style="list-style-type: none"> ▣ Adaptive Cruise Control (ACC) with Low Speed Follow (LSF)* P. 519
 <p>Cannot Set Cruise: Slope Too Steep</p>		



* Not available on all models



Models with ACC with LSF



Message	Condition	Explanation
 <p>Cruise Cancelled: Apply Brake Pedal</p>	<ul style="list-style-type: none"> Appears if ACC with LSF is canceled while your vehicle is automatically stopped by ACC with LSF. 	<ul style="list-style-type: none"> Immediately depress the brake pedal.

Manual transmission models

Message	Condition	Explanation
 <p>Cannot Set Cruise: Clutch Pedal Is Applied</p>	<ul style="list-style-type: none"> Appears when pressing the SET/- button while the vehicle is moving and the clutch pedal is depressed. 	<ul style="list-style-type: none"> ACC cannot be set.  Adaptive Cruise Control (ACC)* P. 535
 <p>Cruise Cancelled: Clutch Pedal Was Applied Too Long</p>	<ul style="list-style-type: none"> Appears when the clutch pedal is depressed while ACC is in operation. 	<ul style="list-style-type: none"> ACC has been automatically canceled.  Adaptive Cruise Control (ACC)* P. 535

Message	Condition	Explanation
 <p>Some Driver Assist Systems Cannot Operate: Radar Obstructed</p>	<ul style="list-style-type: none"> • Appears if anything covers the radar sensor cover and prevents the sensor from detecting a vehicle in front. • May appear when driving in bad weather (rain, snow, fog, etc.). 	<ul style="list-style-type: none"> • When the radar sensor gets dirty, stop your vehicle in a safe place, and wipe off dirt using a soft cloth. • Have your vehicle checked by a dealer if the message does not disappear even after you clean the sensor cover. <ul style="list-style-type: none"> ➤ Radar Sensor P. 570
 <p>Some Driver Assist Systems Cannot Operate: Camera Temperature Too High</p>	<ul style="list-style-type: none"> • Appears if the temperature inside the front sensor camera is too high and some driver assist systems and auto high-beam cannot be activated. 	<ul style="list-style-type: none"> • Use the climate control system to cool down the camera. • Disappears - The camera has been cooled down and the systems are activated normally. <ul style="list-style-type: none"> ➤ Front Sensor Camera P. 568 ➤ Auto High-Beam P. 197
 <p>Some Driver Assist Systems Cannot Operate: Clean Front Windshield</p>	<ul style="list-style-type: none"> • Appears if the area around the front sensor camera is blocked by dirt, mud, etc. and be prevented from detecting a vehicle in front. • May appear when driving in bad weather (rain, snow, fog, etc.). 	<ul style="list-style-type: none"> • When the front window gets dirty, stop your vehicle in a safe place, and wipe it off with a soft cloth. • Have your vehicle checked by a dealer if the message does not disappear even after you cleaned the area around the camera. <ul style="list-style-type: none"> ➤ Front Sensor Camera P. 568 ➤ Auto High-Beam P. 197

Message	Condition	Explanation
 <p>Lane Departure</p>	<p>Lane Keeping Assist System (LKAS)</p> <ul style="list-style-type: none"> • Appears when the vehicle is driving out of a detected lane. The steering wheel vibrates rapidly. <p>Road Departure Mitigation (RDM) System</p> <ul style="list-style-type: none"> • Appears when the vehicle is driving out of a detected lane. <p>When you selected Warning Only</p> <ul style="list-style-type: none"> - The steering wheel vibrates rapidly when the vehicle is drifting out of a detected lane. <p>When you selected Narrow, Normal or Wide</p> <ul style="list-style-type: none"> - The steering wheel vibrates rapidly when the vehicle is drifting out of a detected lane. The system also steers the vehicle to help you remain within your driving lane. 	<ul style="list-style-type: none"> • Keep the vehicle within the lane you are driving. <ul style="list-style-type: none"> ➤ Lane Keeping Assist System (LKAS) P. 550 • Keep the vehicle within the lane you are driving. <ul style="list-style-type: none"> ➤ Road Departure Mitigation (RDM) System P. 558 • You can change the setting for the road departure mitigation system. Narrow, Normal, Wide, and Warning Only can be selected. <ul style="list-style-type: none"> ➤ Customized Features P. 370, 381
 <p>Road Departure Mitigation Activated</p>	<p>Road Departure Mitigation (RDM) System</p> <p>When you selected Narrow</p> <ul style="list-style-type: none"> • Appears when the vehicle is likely to drive out of a detected lane. The RDM system also steers the vehicle to help you remain within your driving lane. 	<p>—</p>

Message	Condition	Explanation
 <p>Steering Required</p>	<ul style="list-style-type: none"> Blinks when you fail to steer the vehicle. The beeper sounds simultaneously. 	<ul style="list-style-type: none"> Operate the steering wheel to resume the LKAS.
 <p>Lane Keeping Assist Cannot Operate</p>	<ul style="list-style-type: none"> Appears when the LKAS is in operation, or the LKAS button is pressed, but there is a problem with a system related to the LKAS. The LKAS cancels automatically. The beeper sounds simultaneously if selected by customization. 	<ul style="list-style-type: none"> If any other system indicators come on, such as the VSA®, ABS and brake system, take appropriate action. <ul style="list-style-type: none"> ▶ Indicators P. 78
 <p>Adaptive Damper System Problem. See Your Dealer.</p>	<p>Models with adaptive damper system</p> <ul style="list-style-type: none"> Appears if there is a problem with the adaptive damper system. 	<ul style="list-style-type: none"> Have your vehicle checked by a dealer. Your vehicle will have normal damping ability without the adaptive damper feature.
<p>Drive Mode Change Unavailable</p>	<ul style="list-style-type: none"> Appears if the ECON mode or SPORT mode* cannot be changed due to certain situations, such as a system error or adverse driving conditions. 	<ul style="list-style-type: none"> ▶ ECON Button P. 492 ▶ SPORT Mode* P. 491

* Not available on all models

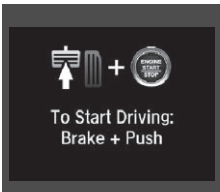
Message	Condition	Explanation
 <p>To Start Driving: Brake + Push</p>	<p>Models with remote engine starter</p> <ul style="list-style-type: none"> • Appears when you unlock and open the driver's door while the engine is running by remote engine start. 	<p>➤ Remote Engine Start with Vehicle Feedback* P. 469</p>

Gauges

Gauges include the speedometer, fuel gauge, and related indicators. They are displayed when the power mode is in ON.

Speedometer

Displays your driving speed in mph (U.S.) or km/h (Canada).

Fuel Gauge

Displays the amount of fuel left in the fuel tank.

Temperature Gauge

Displays the temperature of the engine coolant.

Speedometer

You can show another speed unit on the driver information interface and set the displayed measurements to read in either mph and km/h.

➔ **Tachometer** P. 149

Fuel Gauge

NOTICE

You should refuel when the reading approaches **E**. Running out of fuel can cause the engine to misfire, damaging the catalytic converter.

The actual amount of remaining fuel may differ from the fuel gauge reading.

Temperature Gauge

NOTICE

Driving with the temperature gauge pointer in the upper zone can cause serious engine damage. Pull safely to the side of the road and allow engine temperature to return to normal.

➔ **Overheating** P. 679

Driver Information Interface

The driver information interface shows the odometer, trip meter, outside temperature indicator, and other gauges.



It also displays important messages such as warnings and other helpful information.

■ Switching the Display

■ Accessing contents in the main display

Press the  (home) button, then roll the left selector wheel to scroll to the content you want to see. Press the left selector wheel to see detailed information.

» Switching the Display

To go back to the previous screen, press the ^{*1} (hang-up/back)/ ^{*2} (back) button.

Models with Display Audio

You can edit, add, or delete the meter contents using the audio/information screen.

➤ **Customizing the Meter** P. 285

*1: Models with color audio

*2: Models with Display Audio

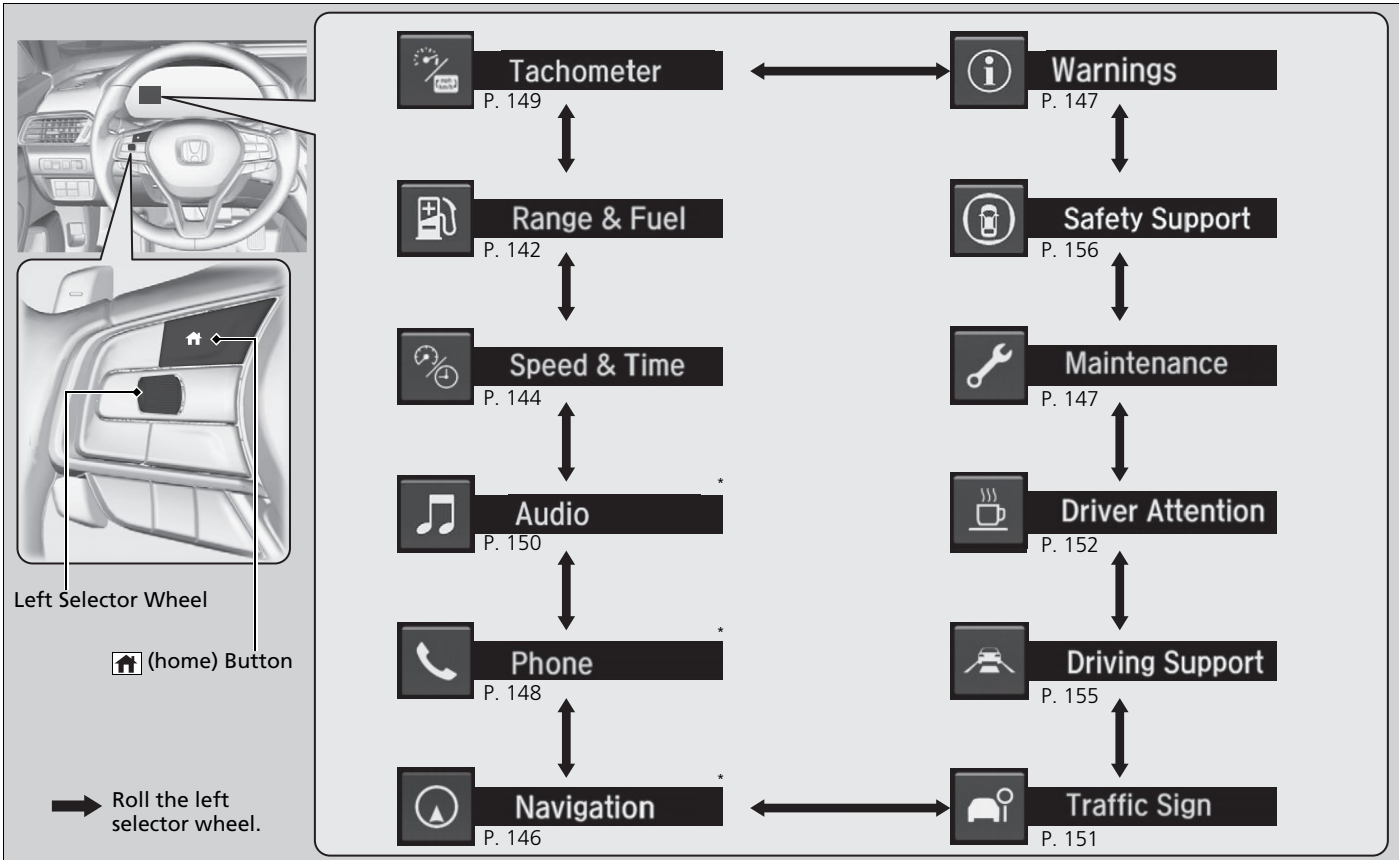

* Not available on all models

■ Sub display

Press the **TRIP** button to change the display.

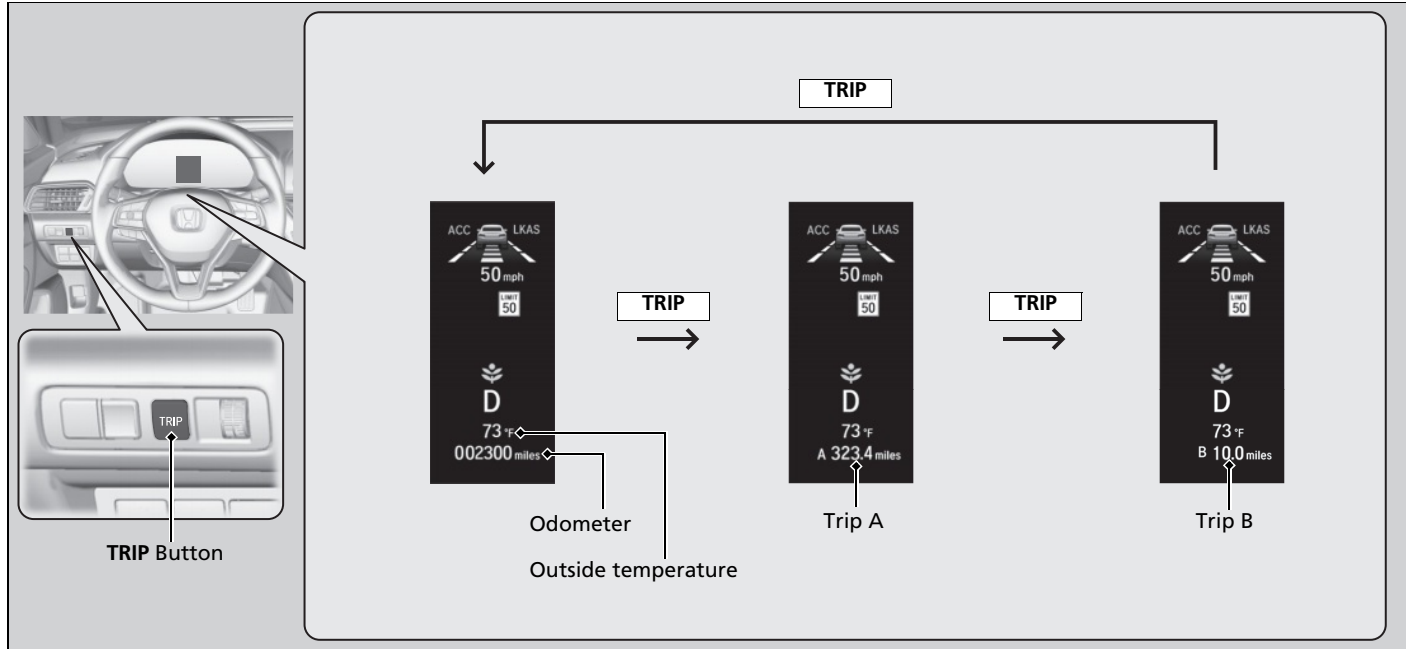

■ Odometer

Shows the total number of miles or kilometers that your vehicle has accumulated.

■ Trip Meter

Shows the total number of miles or kilometers driven since the last reset. Meters A and B can be used to measure two separate trips.

■ Resetting a trip meter

To reset a trip meter, display it, then press and hold the **TRIP** Button. The trip meter is reset to **0.0**.

■ Outside Temperature

Shows the outside temperature in Fahrenheit (U.S.) or Celsius (Canada).

■ Adjusting the outside temperature display

Adjust the temperature reading by up to $\pm 5^{\circ}\text{F}$ or $\pm 3^{\circ}\text{C}$ if the temperature reading seems incorrect.

Use the customized features in the audio/information screen to correct the temperature.

🔧 **Customized Features** P. 370, 381

☒ Trip Meter

Switch between trip meter A and trip meter B by pressing the **TRIP** Button.

☒ Outside Temperature

The temperature sensor is in the front bumper. Road heat and exhaust from another vehicle can affect the temperature reading when your vehicle speed is less than 19 mph (30 km/h).

It may take several minutes for the display to be updated after the temperature reading has stabilized.

■ Range & Fuel

Roll the left selector wheel to switch between trip computer A and trip computer B.

Instrument Panel

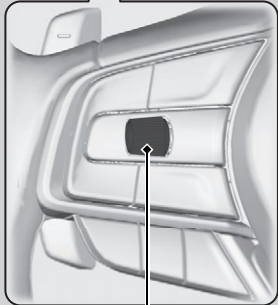
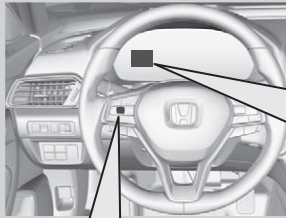

Left Selector Wheel

➔ Roll the left selector wheel.

Trip Computer A



- Range
- Average Fuel Economy
- Instant Fuel Economy
- Trip Meter



Trip Computer B

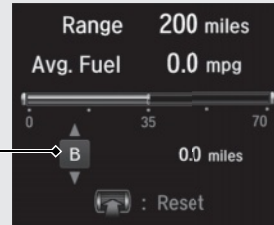

■ Trip meter

Shows the total number of miles or kilometers driven since the last reset. Meters A and B can be used to measure two separate trips.

Resetting a trip meter

To reset the trip meter, display it, press the left selector wheel and then select **Reset**.

- ▶ The trip meter is reset to **0.0**.

■ Average fuel economy (Avg. Fuel)

Shows the estimated average fuel economy of each trip meter in mpg or l/100 km. The display is updated at set intervals. When a trip meter is reset, the average fuel economy is also reset.

■ Instant fuel economy

Shows the instant fuel economy as a bar graph in mpg or l/100 km.

■ Range

Shows the estimated distance you can travel on the remaining fuel. This estimated distance is based on the vehicle's current fuel economy.

☒ Trip meter

Switch between trip meter A and trip meter B by rolling the left selector wheel.

Resetting the trip meter in the **Range & Fuel**, the trip meter in the sub display resets at the same time.

☒ Average fuel economy (Avg. Fuel)

You can change when the average fuel economy is reset.

- ☒ **Customized Features** P. 370, 381

■ Speed & Time

Roll the left selector wheel to switch between trip computer A and trip computer B.

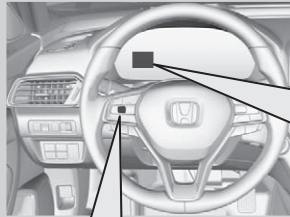

Left Selector Wheel

➔ Roll the left selector wheel.

Trip Computer A

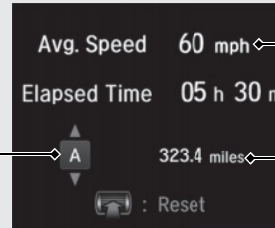

Average Speed

Elapsed Time

Trip Meter



Trip Computer B

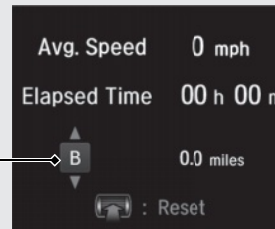

■ Trip meter

➤ **Trip meter** P. 143

■ Elapsed Time

Shows the time elapsed since the last time Trip A or Trip B was reset.

■ Average Speed (Avg. Speed)

Shows the average speed in mph or km/h since the last time Trip A or Trip B was reset.

⌘ Elapsed Time

You can change when to reset the elapsed time.

➤ **Customized Features** P. 370, 381

⌘ Average Speed (Avg. Speed)

You can change when to reset the average speed.

➤ **Customized Features** P. 370, 381

Navigation *



Turn-By-Turn Driving Directions



Compass

Models with Display Audio

Display Audio shows you turn-by-turn directions to your destination.

Models with navigation system

When the navigation system is not providing driving guidance, an image of a compass appears in the driver information interface.

➤ **Refer to the navigation system**

Navigation*

Models with Display Audio

Turn-by-turn directions will be shown on the driver information interface only when your android phone is connected to Android Auto™.

You can select whether to have the turn-by-turn display come on or not during the route guidance.

➤ **Customized Features** P. 381

■ Warnings

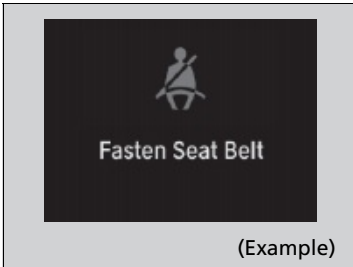

(Example)

➤ **Driver Information Interface Warning and Information Messages** P. 105

■ Maintenance

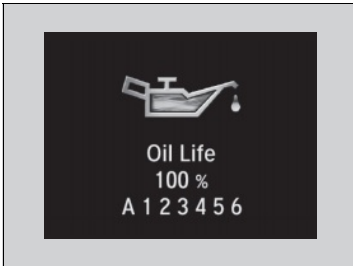

■ **Oil Life**
Shows the remaining oil life and Maintenance Minder™.

➤ **Maintenance Minder™** P. 607

⌘ Warnings

If there are no Warnings, **None** message appears on the driver information interface.

■ Phone*

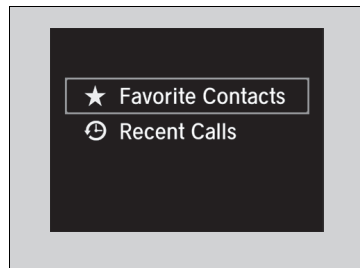

Shows the current phone information.

▶ **Bluetooth® HandsFreeLink®** P. 427

Tachometer



Shows the number of engine revolutions per minute.



■ Speed Unit

Enables you to show another speed unit on the driver information interface and set the displayed measurements to read in either mph and km/h.

Press and hold the left selector wheel when you select the **Tachometer** on the driver information interface. Each time you do this, the unit will change from mph to km/h or vice versa. After this, a confirmation screen will appear for a few seconds.

☒ Tachometer

You can turn on or off the tachometer display when you does not select the **Tachometer** on the driver information interface.

☒ **Customized Features** P. 370, 381

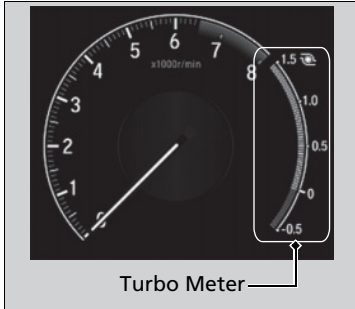

Models with SPORT mode

■ Turbo Meter

When the turbo charger is producing boost, this meter shows the boost pressure.

When the SPORT mode is turned on while the tachometer appears, the turbo meter appears on the driver information interface.

■ Audio*

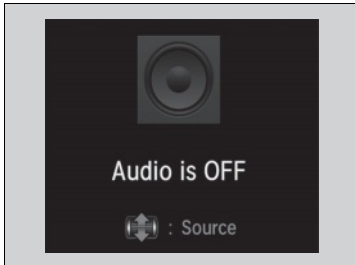

Shows the current audio information.

▶ **Audio System Basic Operation** P. 273

■ Traffic Sign Recognition System

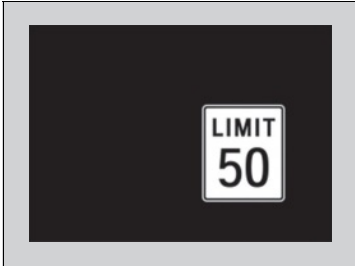

Shows the traffic sign recognition system.

▶ **Traffic Sign Recognition System** P. 562

■ Driver Attention Monitor

The Driver Attention Monitor analyzes steering inputs to determine if the vehicle is being driven in a manner consistent with drowsy or inattentive driving. If it determines that the vehicle is being driven in such a manner, it will display the degree of the driver's attention on the driver information interface.

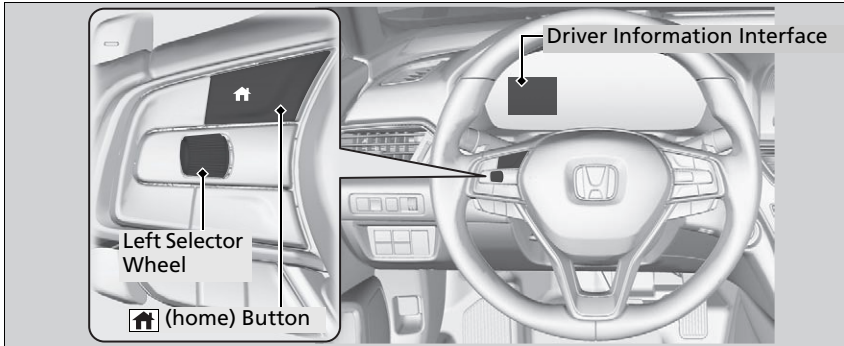

When you select **Driver Attention** on the driver information interface, bars on it light up in white to indicate the degree of the driver's attention.

▶ Accessing contents in the main display

P. 138

▶▶ Driver Attention Monitor

The Driver Attention Monitor cannot always detect if the driver is tired or inattentive. Regardless of the system's feedback, if you are feeling tired, stop in a safe location and rest for as long as needed.

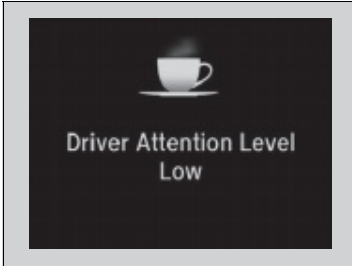

If two bars light up, the **Driver Attention Level Low** message will appear.

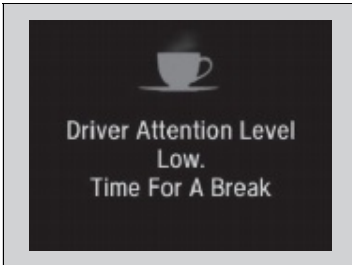

If one bar lights up, the **Driver Attention Level Low. Time For A Break** message will appear, a beep will sound, and the steering wheel will vibrate.

If this message appears, stop in a safe location and rest for as long as needed.

The message will disappear when the left selector wheel is pressed or when the system has determined that the driver is driving normally.

If the driver does not take a break and the monitor continues to detect that the driver is very tired, the message will appear again after approximately 15 minutes, accompanied by a beep and steering wheel vibrations.

The message does not appear when the traveling time is 30 minutes or less.

■ **The Driver Attention Monitor resets when:**

- The engine is turned off.
- The driver unfastens the seat belt and opens the door while the vehicle is stopped.

■ **For the Driver Attention Monitor to function:**

- The vehicle must be traveling above 25 mph (40 km/h).
- The electric power steering (EPS) system indicator must be off.

■ **Depending on driving conditions or other factors, the Driver Attention Monitor may not function in the following circumstances:**

- The steering assist function of the Lane Keeping Assist System (LKAS) is active.
 - **Lane Keeping Assist System (LKAS)** P. 550
- The condition of the road is poor, e.g. the surface is unpaved or bumpy.
- It is windy.
- The driver is frequently operating the vehicle in an assertive manner such as changing lanes or accelerating.

■ **Customizing**

You can change the Driver Attention Monitor settings. Select **Tactile and Audible Alert**^{*1}/**Tactile And Audible Alert**^{*2}, **Tactile Alert**, or **Off**^{*1}/**OFF**^{*2}.

➤ **Customized Features** P. 370, 381

➤ For the Driver Attention Monitor to function:

The bars on the driver information interface remain grayed out unless the Driver Attention Monitor is functioning.

*1 : Models with color audio

*2 : Models with Display Audio

Driving Support Information

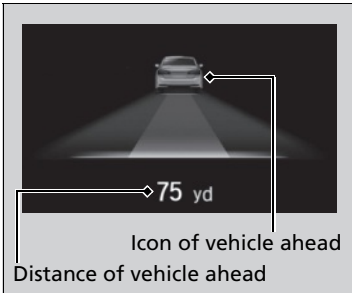

Shows the distance between your vehicle and the vehicle detected ahead.

Informs you whether ACC with LSF*/ACC* and/or LKAS is activated or not. If ACC with LSF*/ACC* is activated, the set following interval is displayed. If LKAS is activated, the displayed lane marks change to indicate that LKAS is activated.

- ▶ **Adaptive Cruise Control (ACC) with Low Speed Follow (LSF)*** P. 519
- ▶ **Adaptive Cruise Control (ACC)*** P. 535
- ▶ **Lane Keeping Assist System (LKAS)** P. 550

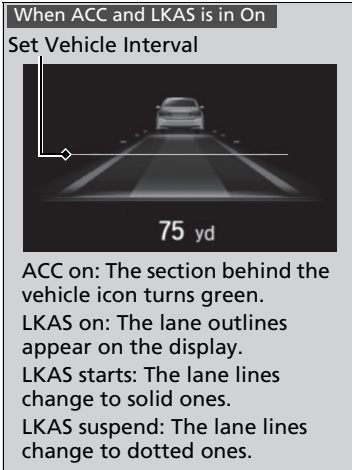

Driving Support Information

In case ACC with LSF*/ACC* is not activated, when the distance between your vehicle and the vehicle ahead becomes to small, the section behind the vehicle icon turns amber and alerts you.

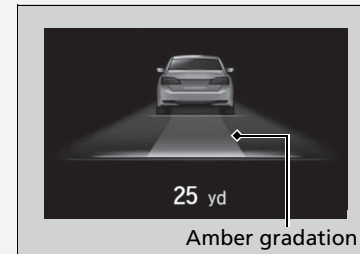

* Not available on all models

■ Safety Support

Indicates the state of RDM, CMBS™ and the blind spot information system*, such as On, Off, or Failure, by color and letters.

The following colors indicate the state of any of the above mentioned systems:

- Green: The system is on.
- Gray: The system is off.
- Amber: There is a problem with the system.

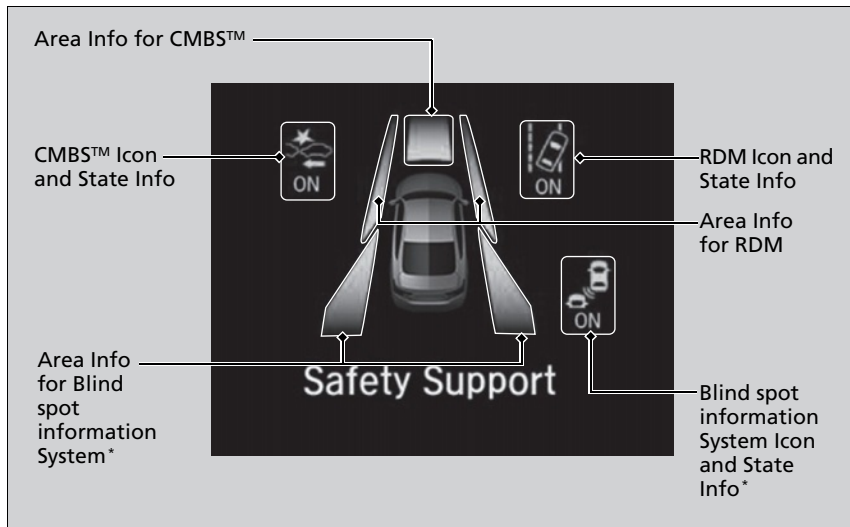

▶▶ Safety Support

If a system is indicated by the color amber, have your vehicle checked by a dealer immediately.

To turn on or off each system, first rotate the left selector wheel to switch displays. From the next display you can select which system to turn on or off.

- ▶▶ **RDM On and Off** P. 560
- ▶▶ **CMBS™ On and Off** P. 513
- ▶▶ **Blind spot information System On and Off** P. 504

You can also confirm the state of the each function by the color of the safety support indicator.



- ▶▶ **Safety Support Indicator (Amber)** P. 101
- ▶▶ **Safety Support Indicator (Green/Gray)** P. 104

Head-Up Display*

Shows the current mode for ACC with LSF, tachometer, traffic sign recognition system, gear position indicator, or turn-by-turn directions along with the vehicle speed. You can choose which item to be displayed using the  (HUD) button on the steering wheel. They are displayed when the power mode is in ON.

To turn the head-up display on and off: Press the **HUD** button on the driver side control panel.

The display can be moved up and down to come level with your eyes.

To raise or lower the head-up display: Press and hold the  or  button until the desired position is reached.

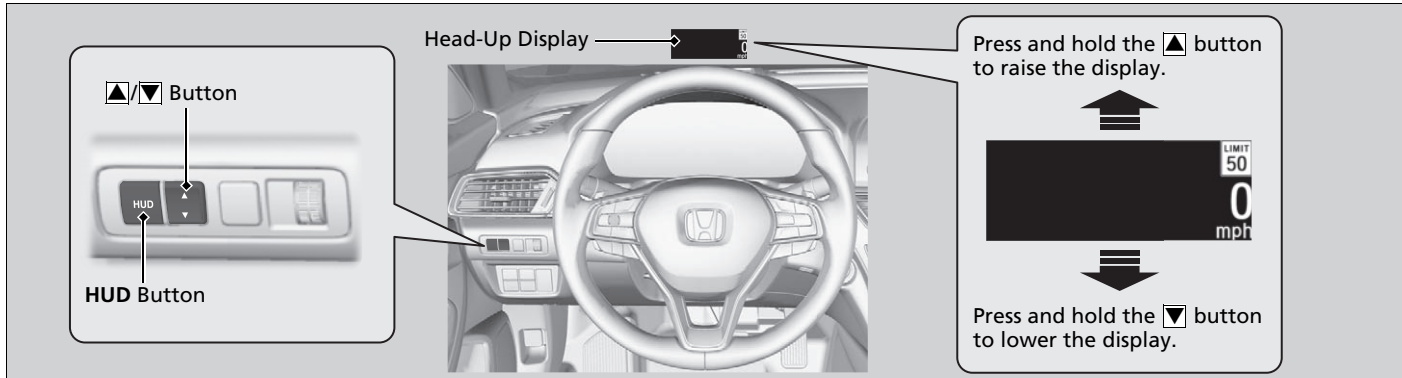

* Not available on all models

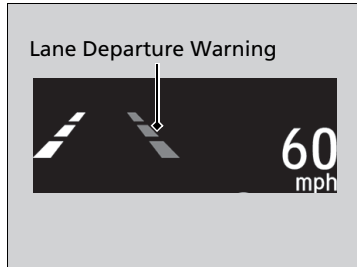

The display also shows the following warnings.

- **Lane Departure Warning:** When your vehicle is too close to the traffic lane lines, the lane departure warning appears.
 - ▶ **Lane Keeping Assist System (LKAS)**
P. 550
- **Head-up Warning Lights:** Flash when the **BRAKE** message appears on the driver information interface.
 - ▶ **Collision Mitigation Braking System™ (CMBS™)** P. 510
 - ▶ **Adaptive Cruise Control (ACC) with Low Speed Follow (LSF)*** P. 519

■ To Change Head-Up Display Content

Each time you press the  (HUD) button on the steering wheel, the head-up display content will change.

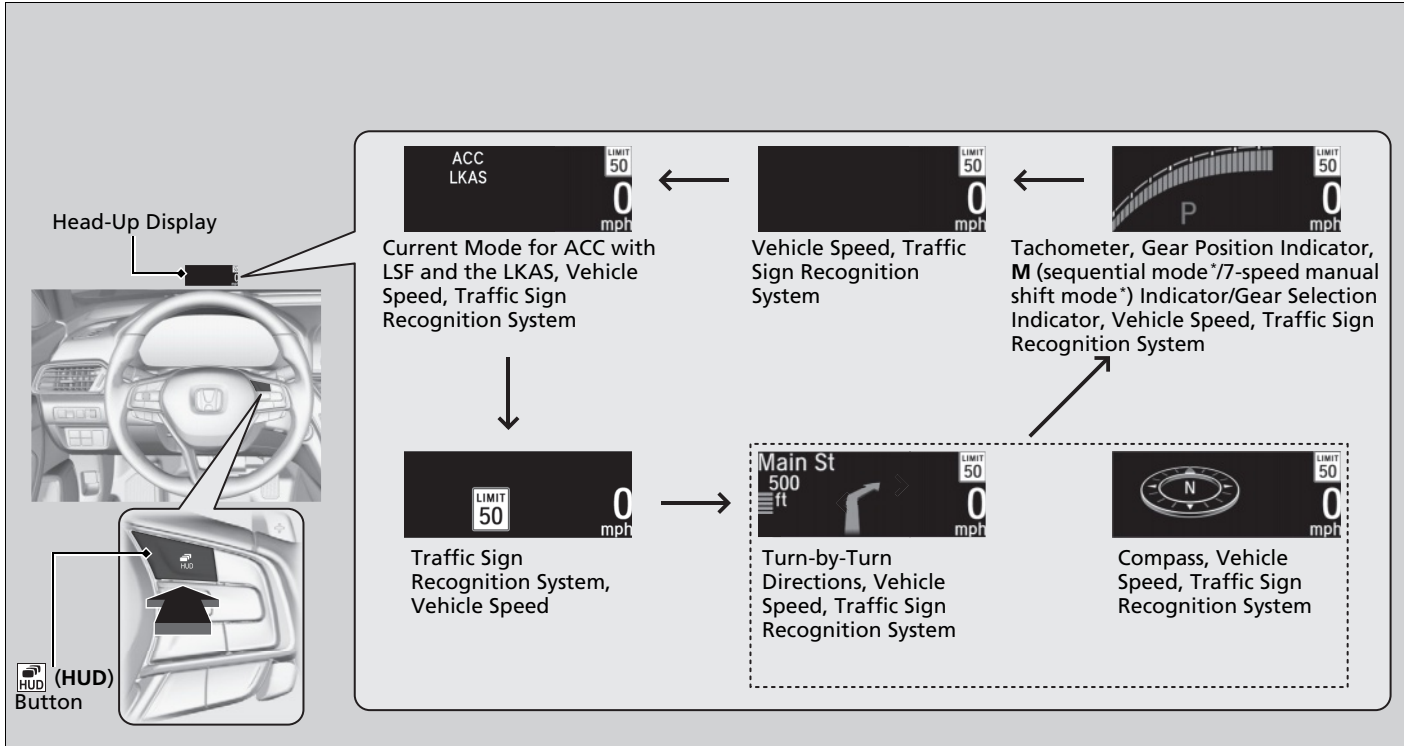

Instrument Panel

* Not available on all models

■ Vehicle Speed

Shows your driving speed in mph or km/h.

■ Tachometer

Shows the number of engine revolutions as a bar graph.

■ Gear Position Indicator

Shows the current gear selection.

■ M (sequential mode*/7-speed manual shift mode*) Indicator/Gear Selection Indicator

Shows the current mode for the sequential mode*/7-speed manual shift mode*.

■ Current Mode for ACC with LSF and the LKAS

Shows the current mode for ACC with LSF and the LKAS.

➤ **Adaptive Cruise Control (ACC) with Low Speed Follow (LSF)*** P. 519

➤ **Lane Keeping Assist System (LKAS)** P. 550

➤ Vehicle Speed

Switch between mph and km/h by using the driver information interface or customized features on the audio/information screen.

➤ **Speed Unit** P. 149

➤ **Customized Features** P. 381

■ Turn-by-Turn Directions

Shows you turn-by-turn driving directions to your destination linked with the navigation system.

➤ **Refer to the Navigation System Manual**

■ Traffic Sign Recognition System

Shows the traffic sign recognition system.

➤ **Traffic Sign Recognition System** P. 562

☒ Turn-by-Turn Directions

The head-up display shows a compass when the route guidance is not used.

You can select whether the turn-by-turn display comes on during the route guidance.

➤ **Customized Features** P. 381

Controls

This chapter explains how to operate the various controls necessary for driving.



Clock	164
Locking and Unlocking the Doors	
Key Types and Functions	166
Low Remote Signal Strength	168
Locking/Unlocking the Doors from the Outside	169
Locking/Unlocking the Doors from the Inside	176
Childproof Door Locks	178
Auto Door Locking/Unlocking	179
Opening and Closing the Trunk	180
Security System	
Immobilizer System	183
Security System Alarm.....	184
Opening and Closing the Windows	186

Opening and Closing the Moonroof*	189
Operating the Switches Around the Steering Wheel	
ENGINE START/STOP Button.....	190
Turn Signals	193
Light Switches.....	193
Fog Lights*	195
Daytime Running Lights	196
Auto High-Beam	197
Wipers and Washers	200
Rear Defogger/Heated Door Mirror* Button	202

Canadian models

Heated Windshield Button	202
Brightness Control	203
Driving Position Memory System*	205
Adjusting the Steering Wheel	207
Adjusting the Mirrors	
Interior Rearview Mirror	208
Power Door Mirrors	209
Adjusting the Seats	210
Interior Lights/Interior Convenience Items	221
Climate Control System	
Using Automatic Climate Control	239
Automatic Climate Control Sensors... ..	242

* Not available on all models





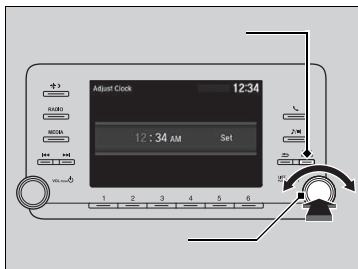

Adjusting the Clock

You can adjust the time manually in the audio/information screen, with the power mode in ON.

Adjusting the Time



Models with color audio

1. Press the **MENU/CLOCK** button.
2. Select **Adjust Clock**, then press .
3. Rotate  to adjust the hours.
4. Press  to switch to minute adjustment.
5. Rotate  to adjust the minutes.
6. Press  to switch to **Set**.
7. Press  to complete clock adjustment.

» Clock

Models with navigation system

The clock is automatically updated through the navigation system, so the time does not need to be adjusted.

Models with color audio

These indications are used to show how to operate the selector knob.

Rotate  to select.

Press  to enter.

You can customize the clock display to show the 12 hour clock or 24 hour clock.

➔ **Customized Features** P. 370

You can turn the clock display on and off.



➔ **Customized Features** P. 370





Models with Display Audio

1. Press the , then select **Settings**.
2. Select **System**.
3. Select **Day & Time**.
4. Select **Set Date & Time**.
5. Select **Automatic Date & Time**, then select **OFF**.

To adjust time:

6. Select **Set Time**.
7. Selecting /.
8. Select **Save** to set the time.

To adjust date:



6. Select **Set Date**.
7. Selecting /.
8. Select **Save** to set the date.



▶▶ Clock

Models with Display Audio

You can also adjust the clock by touching the clock displayed on the upper right corner of the display or the **Clock** icon on the home screen.

1. Touch the clock on the display.
The clock screen of the select face-type appears.
2. Select **Settings**.
3. Select **Day & Time**.
4. Select **Set Date & Time**.
5. Select **Automatic Date & Time**, then select **OFF**.
6. Select **Set Date** or **Set Time**.
7. Adjusting the dates, hours and minutes by selecting /.
8. Select **Save** to set the time.

You can customize the clock display to show the 12 hour clock or 24 hour clock.

 **Customized Features** P. 381

You can customize the date display to MM/DD/YYYY, DD/MM/YYYY or YYYY/MM/DD.

 **Customized Features** P. 381

Key Types and Functions

This vehicle comes with the following keys:

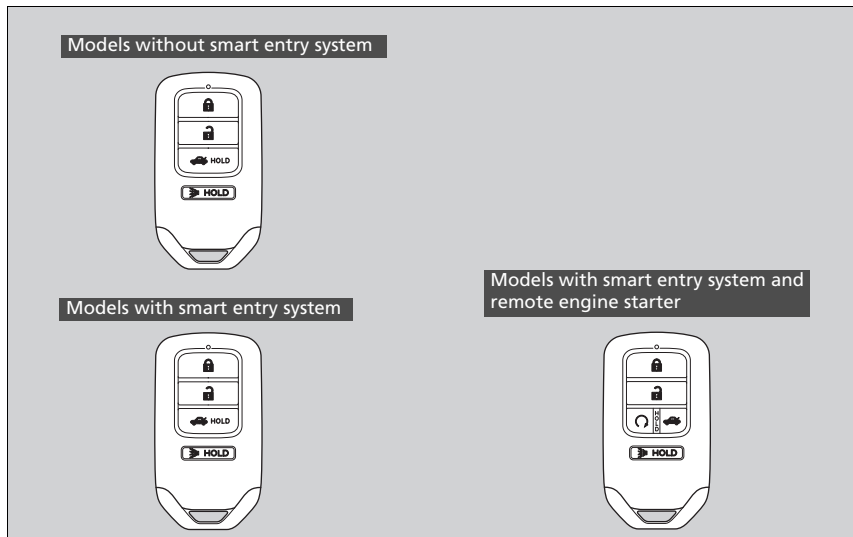

Use the key to start and stop the engine, and to lock and unlock all the doors, fuel fill door and to open the trunk.

You can also use the remote transmitter or smart entry system* to lock and unlock all the doors, fuel fill door and to open the trunk.

Key Types and Functions

All the keys have an immobilizer system. The immobilizer system helps to protect against vehicle theft.

➤ **Immobilizer System** P. 183

Follow the advice below to prevent damage to the keys:

- Do not leave the keys in direct sunlight, or in locations with high temperature or high humidity.
- Do not drop the keys or set heavy objects on them.
- Keep the keys away from liquids, dust and sand.
- Do not take the keys apart except for replacing the battery.

If the circuits in the keys are damaged, the engine may not start, and the remote transmitter may not work.

If the keys do not work properly, have them inspected by a dealer.

Models with remote engine starter

You can remotely start the engine using the remote.

➤ **Remote Engine Start with Vehicle Feedback*** P. 469

■ Built-in Key

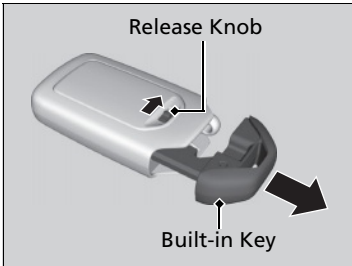

The built-in key can be used to lock/unlock the doors or open the trunk when the remote battery becomes weak and the power door lock/unlock operation is disabled.

To remove the built-in key, slide the release knob and then pull out the key. To reinstall the built-in key, push the built-in key into the remote until it clicks.

■ Key Number Tag

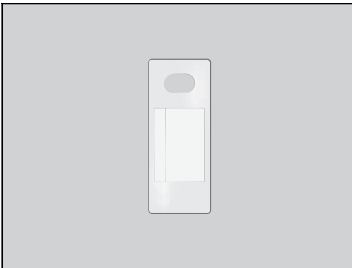

Contains a number that you will need if you purchase a replacement key.

▣ Key Number Tag

Keep the key number tag separate from the key in a safe place outside of your vehicle. If you wish to purchase an additional key, contact a dealer.

If you lose your key and you cannot start the engine, contact a dealer.

Low Remote Signal Strength

The vehicle transmits radio waves to locate the remote when locking/unlocking the doors*, and fuel fill door*, opening the trunk*, or to start the engine.

In the following cases, locking/unlocking the doors*, and fuel fill door*, opening the trunk*, or to start the engine may be inhibited or operation may be unstable:

- Strong radio waves are being transmitted by nearby equipment.
- You are carrying the remote together with telecommunications equipment, laptop computers, cell phones, or wireless devices.
- A metallic object is touching or covering the remote.

Low Remote Signal Strength

Communication between the remote and the vehicle consumes the remote's battery.

Battery life is about two years, but this varies depending on regularity of use.

The battery is consumed whenever the remote is receiving strong radio waves. Avoid placing it near electrical appliances such as televisions and personal computers.

Locking/Unlocking the Doors from the Outside

■ Using the Smart Entry with Push Button Start System *

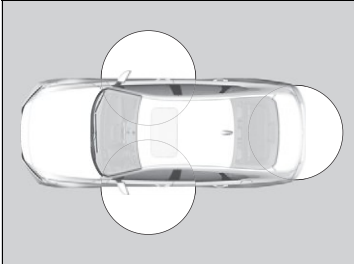

When you carry the remote, you can lock/unlock the doors, fuel fill door, and open the trunk.

You can lock/unlock the doors, fuel fill door within a radius of about 32 inches (80 cm) of the outside door handle. You can open the trunk within about 32 inches (80 cm) radius from the trunk release button.

■ Locking the doors

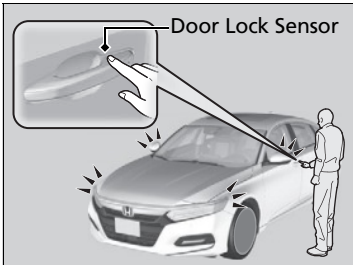

Touch the door lock sensor on the front door.

- ▶ Some exterior lights flash; the beeper sounds; all the doors and fuel fill door lock; and the security system sets.

☒ Locking/Unlocking the Doors from the Outside

If the interior light switch is in the door activated position, the interior light comes on when you unlock the doors.

No doors opened: The light fades out after 30 seconds.

Doors relocked: The light goes off immediately.

☒ **Interior Lights** P. 221

☒ Using the Smart Entry with Push Button Start System *

If you do not open a door within 30 seconds of unlocking the vehicle with the smart entry system, the doors and trunk will automatically relock.

You can lock or unlock doors using the smart entry system only when the power mode is in VEHICLE OFF.

- Do not leave the remote in the vehicle when you get out. Carry it with you.
- Even if you are not carrying the remote, you can lock/unlock the doors while someone else with the remote is within range.
- The door may be unlocked if the door handle is covered with water in heavy rain or in a car wash if the remote is within range.
- If you grip a front door handle wearing gloves, the door sensor may be slow to respond or may not respond by unlocking the doors.
- After locking the door, you have up to 2 seconds during which you can pull the door handle to confirm whether the door is locked.

* Not available on all models

■ Unlocking the doors and trunk

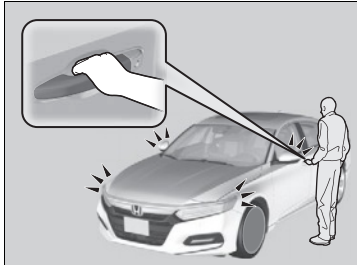

- Grab the driver's door handle:
- ▶ The driver's door and fuel fill door unlocks.
 - ▶ Some exterior lights flash twice and the beeper sounds twice.
- Grab the front passenger's door handle:
- ▶ All the doors and fuel fill door unlock.
 - ▶ Some exterior lights flash twice and the beeper sounds twice.

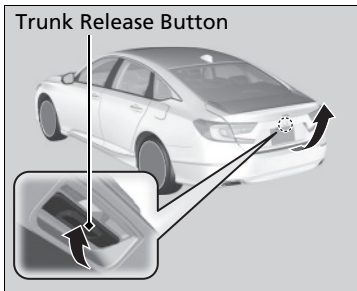

- Press the trunk release button:
- ▶ The trunk unlocks and opens.
 - ▶ A beeper will sound.
- **Using the Trunk Release Button*** P. 181

▶▶ Using the Smart Entry with Push Button Start System *

- If you need to unlock the door immediately after locking it, wait at least 2 seconds before gripping the handle, otherwise the door will not unlock.
- The door might not open if you pull it immediately after gripping the door handle. Grip the handle again and confirm that the door is unlocked before pulling the handle.
- Even within the 32 inches (80 cm) radius, you may not be able to lock/unlock the doors with the remote if it is above or below the outside handle.
- The remote may not operate if it is too close to the door and door glass.

The light flash, beep and door unlock mode settings can be customized using the audio/information screen.

➤ **Customized Features** P. 381

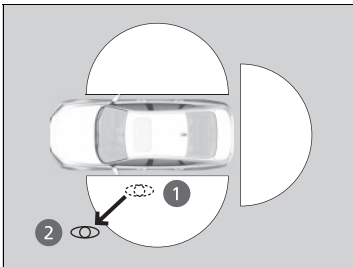
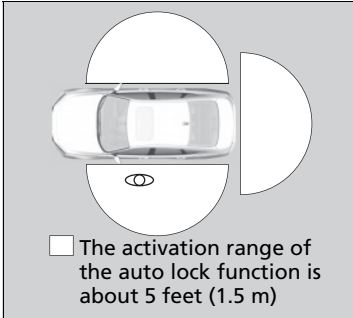

■ Locking the vehicle (Walk away auto lock®)

When you walk away from the vehicle while carrying the remote, the doors will automatically lock.

The auto lock function activates when all doors are closed, and the remote is within about 5 feet (1.5 m) radius of the outside door handle.

Exit vehicle while carrying remote and close door(s).

1. While within about 5 feet (1.5 m) radius of the vehicle.
 - ▶ The beeper sounds; the auto lock function will be activated.
2. Carry the remote beyond about 5 feet (1.5 m) from the vehicle and remain outside this range for 2 or more seconds.
 - ▶ Some exterior lights flash; the beeper sounds; all doors will then lock.

☒ Locking the vehicle (Walk away auto lock®)

The auto lock function is set to OFF as the factory default setting. The auto lock function can be set to ON using the audio/information screen.

If you set the auto lock function to ON using the audio/information screen, only the remote that was used to unlock the driver's door prior to the setting change can activate auto lock.

▶ **Customized Features** P. 381

After the auto lock function has been activated, when you stay within the locking/unlocking operation range, the indicator on the remote will continue to flash until the doors are locked.

When you stay beside the vehicle within the operation range, the doors will automatically lock approximately 30 seconds after the auto lock function activating beeper sounds.

When you open a door after the auto lock function activating beeper sounds, the auto lock function will be delayed until all doors are closed.

When all doors have been closed and the remote is inside the vehicle, or if the remote is not detected within about 5 feet (1.5 m) of the vehicle, auto lock function will not be activated.

If you press the unlock button on the remote within the operation range soon after the auto lock function activating beeper sounds, the auto lock function will be canceled.

To temporarily deactivate the function:

1. Set the power mode to OFF.
2. Open the driver's door.
3. Using the master door lock switch, operate the lock as follows:
Lock → Unlock → Lock → Unlock.
▶ The beeper sounds and the function is deactivated.

To restore the function:

- Set the power mode to ON.
- Lock the vehicle without using the auto lock function.
- Walk away at least more than about 5 feet (1.5 m) away from the vehicle while carrying the remote.
- Open any door.

▶▶ Locking the vehicle (Walk away auto lock®)

The auto lock function does not operate when any of the following conditions are met.

- The remote is inside the vehicle.
- A door or the hood is not closed.
- The power mode is set to any mode other than OFF.
- The remote is not located within a radius of about 5 feet (1.5 m) from the vehicle when you get out of the vehicle and close the doors.

Auto lock function operation stop beeper

After the auto lock function has been activated, the auto lock operation stop beeper sounds for approximately two seconds in the following cases.

- The remote is put inside the vehicle through a window.
- You are located too close to the vehicle.
- The remote is put inside the trunk.

If the warning beeper sounds, check that you are carrying the remote. Then, open/close a door and confirm the auto lock activation beeper sounds once.

In the case that the remote is out of operating range when you close a door or the trunk, a beeper will sound to indicate that the auto lock function has been canceled.

■ Using the Remote Transmitter

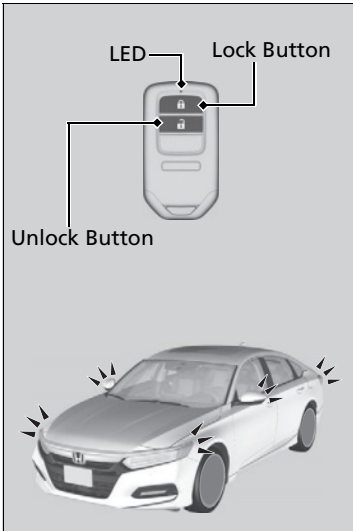

■ Locking the doors

Press the lock button.

Once:

- ▶ Some exterior lights flash, all the doors and fuel fill door lock, and the security system sets.

Twice (within five seconds after the first push):

- ▶ Some exterior lights flash, the beeper sounds and verifies the security system is set.

■ Unlocking the doors

Press the unlock button.

Once:

- ▶ Some exterior lights flash twice, and the driver's door, fuel fill door unlocks.

Twice:

- ▶ Some exterior lights flash twice, and the remaining doors unlock.

☒ Using the Remote Transmitter

If you do not open a door within 30 seconds of unlocking the vehicle with the remote transmitter, the doors will automatically relock.

You can change the relock timer setting.

☒ **Customized Features** P. 370, 381

You can lock or unlock doors using the remote transmitter only when the power mode in VEHICLE OFF.

The remote transmitter uses low-power signals, so the operating range may vary depending on the surroundings.

The remote will not lock the vehicle when a door is open.

If the distance at which the remote transmitter works varies, the battery is probably low.

If the LED does not come on when you press a button, the battery is dead.

☒ **Replacing the Button Battery** P. 653

You can customize the door unlock mode setting.

☒ **Customized Features** P. 370, 381

■ Locking/Unlocking the Doors Using a Key

If the lock or unlock button of the remote does not work, use the key instead.

Fully insert the key and turn it.

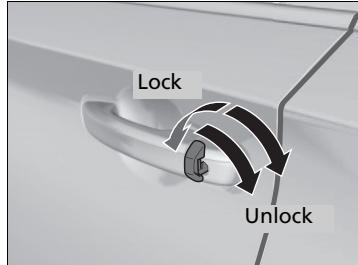

▶ Locking/Unlocking the Doors Using a Key

When you lock the driver's door with a key, all the other doors and the fuel fill door lock at the same time. When unlocking, the driver's door unlocks first. Turn the key a second time within a few seconds to unlock the remaining doors.

You can customize the door unlock mode setting.

▶ **Customized Features** P. 370, 381

■ Locking a Door Without Using a Key

If you do not have the key on you, or if for some reason you cannot lock a door using the key, you can lock the door without it.

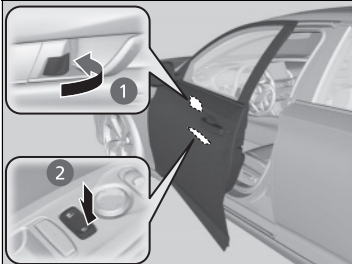

■ Locking the front doors

Push the lock tab forward ① or push the master door lock switch in the lock direction ②, and close the door.

■ Locking the rear doors

Push the lock tab forward and close the door.

■ Lockout prevention system

The doors cannot be locked when the remote is inside the vehicle.

☒ Locking a Door Without Using a Key

When you lock the driver's door or lock the passenger's door using the master door lock switch, all the other doors and the fuel fill door lock at the same time.

Before locking a door, make sure that the key is not inside the vehicle.

Locking/Unlocking the Doors from the Inside

■ Using the Lock Tab

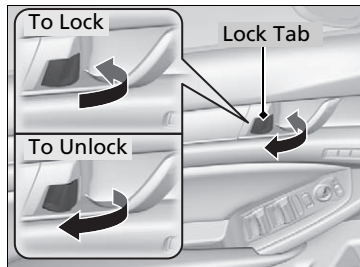

■ **Locking a door**
Push the lock tab forward.

■ **Unlocking a door**
Pull the lock tab rearward.

▶▶ Using the Lock Tab

When you lock the door using the lock tab on the driver's door, all the other doors and the fuel fill door lock at the same time.

When you unlock the door using the lock tab on the driver's door, only the driver's door will unlock.

■ Unlocking Using the Front Door Inner Handle

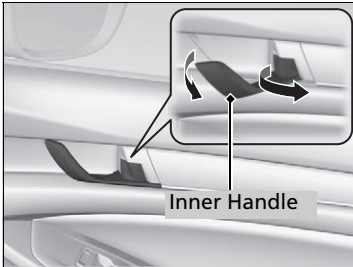

Pull the front door inner handle.

- ▶ The door unlocks and opens in one motion.

Unlocking and opening the driver's door from the inner handle unlocks all the other doors and the fuel fill door.

To avoid all the doors to be unlocked, use the lock tab on the driver's door to unlock, then lock again before opening the door.

- ▶ This setting works for one time only. If you do not want all the doors to be unlocked all the time, customize the **Auto Door Unlock** setting to **Off**^{*1}/**OFF**^{*2} using the audio/information screen.

▶ **Customized Features** P. 370, 381

*1: Models with color audio

*2: Models with Display Audio

⊠ Unlocking Using the Front Door Inner Handle

The front door inner handles are designed to allow front seat occupants to open the door in one motion. However, this feature requires that front seat occupants never pull a front door inner handle while the vehicle is in motion.

Children should always ride in a rear seat where childproof door locks are provided.

▶ **Childproof Door Locks** P. 178

■ Using the Master Door Lock Switch

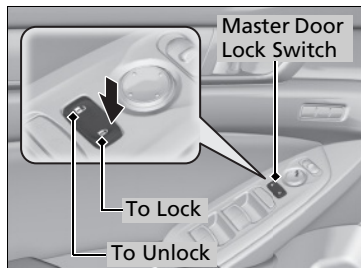

Press the master door lock switch in (as shown) to lock or unlock all the doors, fuel fill door.

Childproof Door Locks

The childproof door locks prevent the rear doors from being opened from the inside regardless of the position of the lock tab.

■ Setting the Childproof Door Locks

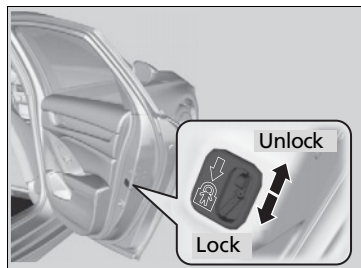

Slide the lever in the rear door to the lock position, and close the door.

■ When opening the door

Open the door using the outside door handle.

► Childproof Door Locks

To open the door from the inside when the childproof door lock is on, put the lock tab in the unlock position, lower the rear window, put your hand out of the window, and pull the outside door handle.

Auto Door Locking/Unlocking

Your vehicle locks or unlocks all doors automatically when a certain condition is met.

■ Auto Door Locking

■ Drive lock mode

All doors lock when the vehicle's speed reaches about 10 mph (15 km/h).

■ Auto Door Unlocking

■ Driver's door open mode

All doors unlock when the driver's door is opened.

☒ Auto Door Locking/Unlocking

You can turn off or change to another auto door locking/unlocking setting using the audio/information screen.

☒ **Customized Features** P. 370, 381

Precautions for Opening/Closing the Trunk

■ Opening the trunk

Opening the trunk all the way.

- ▶ If it is not fully opened, the trunk lid may begin to close under its own weight.

■ Closing the trunk

Keep the trunk lid closed while driving to:

- ▶ Avoid possible damage.
- ▶ Prevent exhaust gas from leaking into the vehicle.

☒ **Exhaust Gas Hazard** P. 75

Using the Trunk Opener

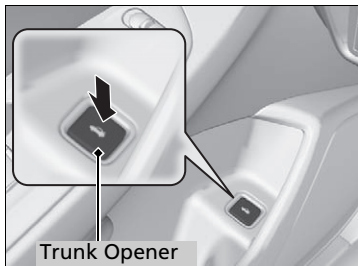

Press and hold the trunk opener on the driver's door to unlock and open the trunk.

☒ **When You Cannot Open the Trunk** P. 695

Using the Trunk Release Button*

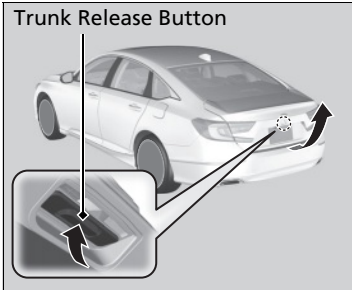

Push up the release button on the trunk lid after all the doors are unlocked.

🚫 **When You Cannot Open the Trunk** P. 695

Even if the trunk is locked, you can open the trunk if you carry the remote.

▶ Some exterior lights flash twice and the beeper sounds.

Using the Remote Transmitter

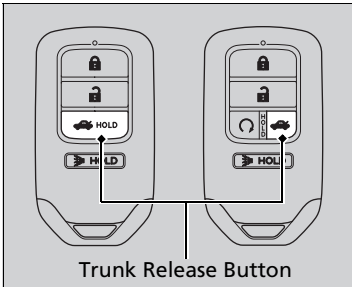

Press the trunk release button for approximately one second to unlock and open the trunk.

🔊 Using the Trunk Release Button*

- If you forget the remote inside, the beeper will sound and the trunk will not close.
- A person who is not carrying the remote can unlock the trunk if a person who is carrying it is within range.
- If the beeper sounds after you close the trunk, move the remote away from the trunk and close again.
- The remote may not operate if it is too close to the trunk.

* Not available on all models

Trunk Main Switch *

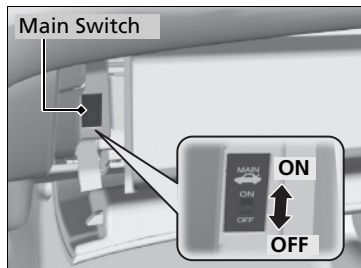

The trunk main switch disables the trunk release button on the remote transmitter and the trunk release button on the trunk lid and trunk opener on the driver's door to protect luggage in the trunk.

1. Make sure the rear seat-back is not folded down.
2. Turn off the trunk main switch in the glove box.
3. Lock the glove box.

Emergency Trunk Opener

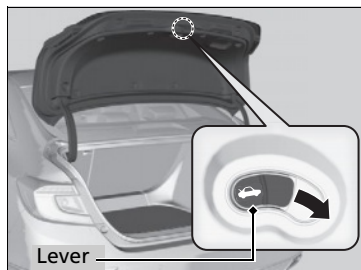

The trunk release lever allows you to open the trunk from inside for your safety.

Slide the release lever in the direction of the arrow.

▶▶ Trunk Main Switch *

If you need to give the key to someone else, remove the built-in key from the remote by sliding the release knob, and give the remote as a valet key.

▶▶ Emergency Trunk Opener

Parents should decide if their children should be shown how to use this feature.

Immobilizer System

The immobilizer system prevents a key that has not been pre-registered from starting the engine. Each key contains electronic transmitters that use electronic signals to verify the key.

Pay attention to the following when pressing the **ENGINE START/STOP** button:

- Do not allow objects that emit strong radio waves near the **ENGINE START/STOP** button.
- Make sure the key is not covered by or touching a metal object.
- Do not bring a key from another vehicle's immobilizer system near the **ENGINE START/STOP** button.
- Do not put the key near magnetic items. Electronic device, such as televisions and audio systems emit strong magnetic fields. Note that even a key chain can become magnetic.

Immobilizer System

NOTICE

Leaving the key in the vehicle can result in theft or accidental movement of the vehicle. Always take the key with you whenever you leave the vehicle unattended.

Do not alter the system or add other devices to it. Doing so may damage the system and make your vehicle inoperable.

Canadian models

Apply and hold the brake pedal before turning the vehicle on the first time after the battery has been disconnected.

Security System Alarm

The security system alarm activates when the trunk, hood or doors are forcibly opened. The alarm does not activate if the trunk or doors are opened with the key, remote transmitter, or smart entry with push button start system*. However, the alarm activates if a door is opened with the key and then the transmission is taken out of [P] (continuously variable transmission models) or the hood is opened before the power mode is in ON.

■ When the security system alarm activates

The horn sounds intermittently, and some the exterior lights flash.

■ To deactivate the security system alarm

Unlock the vehicle using the key, remote transmitter or smart entry with push button start system*. The system, along with the horn and flashing lights, is deactivated.

■ Setting the security system alarm

The security system alarm automatically sets when the following conditions have been met:

- The power mode is set to VEHICLE OFF.
- The hood and trunk are closed.
- All doors are locked from outside with the key, remote transmitter, or smart entry with push button start system*.

■ When the security system alarm sets

The security system alarm indicator in the instrument panel blinks and the blinking interval changes after about 15 seconds.

■ To cancel the security system alarm

The security system alarm is canceled when the vehicle is unlocked using the key*, remote transmitter or smart entry with push button start system*, or when the power mode is set to ON. The security system alarm indicator goes off at the same time.

* Not available on all models

► Security System Alarm

Do not alter the system or add other devices to it. Doing so may damage the system and make your vehicle inoperable.

The security alarm continues for a maximum of two minutes until the security system alarm deactivates.

Do not set the security system alarm when someone is in the vehicle or a window is open. The system can accidentally activate when:

- Unlocking the door with the lock tab.
- Opening the trunk with the trunk opener or the emergency trunk opener.
- Opening the hood with the hood release.

Continuously variable transmission models

- Taking the transmission out of [P].

If the battery goes dead after you have set the security system alarm, the security alarm may go off once the battery is recharged or replaced.

If this occurs, deactivate the security system alarm by unlocking a door using the key, remote transmitter, or smart entry with push button start system*.

■ Panic Mode

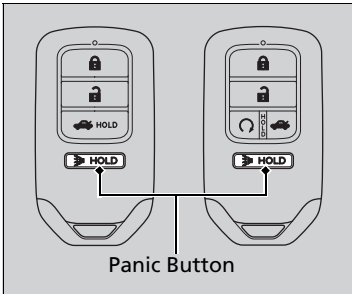

■ The panic button on the remote transmitter

If you press the panic button for approximately one second, the following will occur for about 30 seconds:

- The horn sounds.
- Some exterior lights flash.

■ Canceling panic mode

- Press any button on the remote transmitter.
- Set the power mode to ON.

Opening/Closing the Power Windows

The power windows can be opened and closed when the power mode is in ON, using the switches on the doors. The driver's side switches can be used to open and close all the windows.

The power window lock button on the driver's side must be switched off (indicator off) to open and close the windows from anywhere other than the driver's seat.

When the power window lock button is pressed, the indicator comes on and you can only operate the driver's window. Turn the power window lock button on (indicator on) if a child is in the vehicle.

Opening/Closing Windows with Auto-Open/Close Function

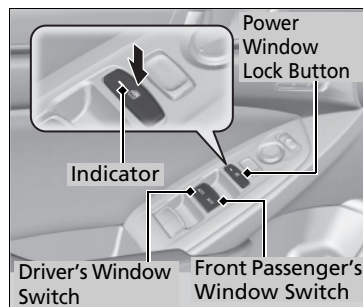

Manual operation

To open: Push the switch down lightly, and hold it until the desired position is reached.

To close: Pull the switch up lightly, and hold it until the desired position is reached.

Automatic operation

To open: Push the switch down firmly.

To close: Pull the switch up firmly.

The window opens or closes completely. To stop the window at any time, push or pull the switch briefly.

Opening/Closing the Power Windows

WARNING

Closing a power window on someone's hands or fingers can cause serious injury.

Make sure your passengers are away from the windows before closing them.

The power windows can be operated for up to 10 minutes after you set the power mode to VEHICLE OFF.

Opening either front door cancels this function.

Auto Reverse

If a power window senses resistance when closing automatically, it will stop closing and reverse direction.

The driver's window auto reverse function is disabled when you continuously pull up the switch.

The auto reverse function stops sensing when the window is almost closed to ensure that it fully closes.

■ Opening/Closing Windows without Auto-Open/Close Function

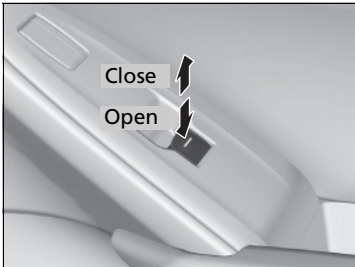

To open: Push the switch down.

To close: Pull the switch up.

Release the switch when the window reaches the desired position.

■ Opening Windows and Moonroof* with the Remote

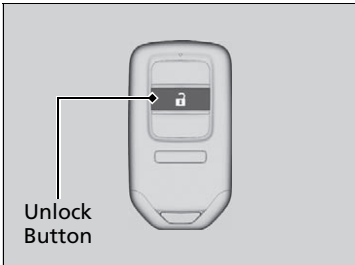

To open: Press the unlock button, and then within 10 seconds, press it again and hold it.

If the windows and moonroof* stop midway, repeat the procedure.

* Not available on all models

■ Opening/Closing the Windows and Moonroof* with the Key

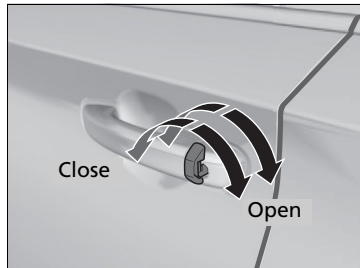

To open: Unlock the driver's door with the key. Within 10 seconds of returning the key to the central position, turn the key in the unlock direction and hold it there.

To close: Lock the driver's door with the key. Within 10 seconds of returning the key to the central position, turn the key in the lock direction and hold it there.

Release the key to stop the windows/moonroof* at the desired position. If you want further adjustment, repeat the same operation.

■ Opening/Closing the Moonroof

You can only operate the moonroof when the power mode is in ON. Use the switch in the front of the ceiling to open and close the moonroof.

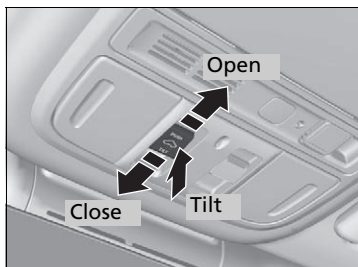

■ Automatic operation

To open: Pull the switch back firmly.

To close: Push the switch forward firmly.

The moonroof will automatically open or close all the way. To stop the moonroof midway, pull or push the switch briefly.

■ Manual operation

To open: Pull the switch back lightly, and hold it until the desired position is reached.

To close: Push the switch forward lightly, and hold it until the desired position is reached.

■ Tilting the moonroof up

To tilt: Push on the center of the moonroof switch.

To close: Push the switch forward firmly, then release.

☒ Opening/Closing the Moonroof

⚠ WARNING

Opening or closing the moonroof on someone's hands or fingers can cause serious injury.

Make sure all hands and fingers are clear of the moonroof before opening or closing it.

NOTICE

Opening the moonroof in below freezing temperature or when it is covered with snow or ice can damage the moonroof panel or motor.

The power moonroof can be operated for up to 10 minutes after you set the power mode to OFF. Opening either front door cancels this function.

When resistance is detected, the auto reverse function causes the moonroof to change directions, then stop. Auto reverse stops sensing when the moonroof is almost closed to ensure that it fully closes. Make sure that all objects, including fingers, are clear of the moonroof.

You can use the remote transmitter or the key to operate the moonroof.

☒ **Opening Windows and Moonroof* with the Remote** P. 187

☒ **Opening/Closing the Windows and Moonroof* with the Key** P. 188

* Not available on all models

Operating the Switches Around the Steering Wheel

ENGINE START/STOP Button

Changing the Power Mode

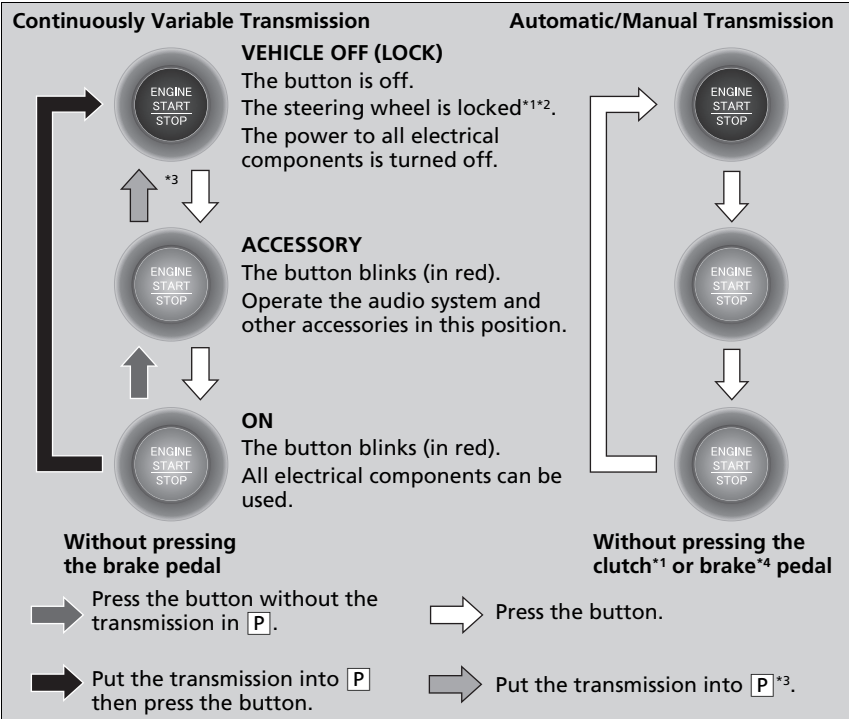

ENGINE START/STOP Button

ENGINE START/STOP Button Operating Range

You can start the engine when the remote is inside the vehicle.

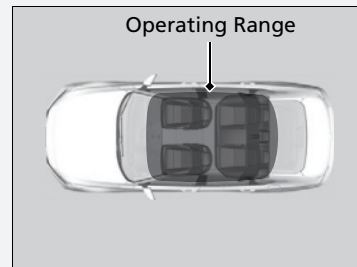

If the battery of the remote is getting low, the engine may not start when you push the **ENGINE START/STOP** button. If the engine does not start, refer to the following link.

▶ If the Remote Battery is Weak P. 672

The engine may also run if the remote is close to the door or window, even if it is outside the vehicle.

ON mode:

The **ENGINE START/STOP** button is red when the engine is running.

*1: Manual transmission models

*2: Continuously variable transmission models for Canadian models

*3: U.S. models

*4: Automatic transmission models

Automatic Power Off

If you leave the vehicle for 30 to 60 minutes with the transmission in **P***¹ and the power mode in ACCESSORY, the vehicle automatically goes into the mode similar to VEHICLE OFF (LOCK) to avoid draining the battery.

Manual transmission models

Continuously variable transmission models for Canadian models

When in this mode:

The steering wheel does not lock.

You cannot lock or unlock doors with the remote transmitter or the smart entry with push button start system*.

Press the **ENGINE START/STOP** button twice to switch the mode to VEHICLE OFF (LOCK).

Power Mode Reminder

If you open the driver's door when the power mode is set to ACCESSORY, a warning buzzer sounds.

*1: Automatic transmission/Continuously variable transmission models

* Not available on all models

Changing the Power Mode

Manual transmission models

Continuously variable transmission models for Canadian models

If the power mode does not change from VEHICLE OFF to ACCESSORY, press the **ENGINE START/STOP** button while moving the steering wheel left and right. The steering wheel will unlock, allowing the mode to change.

Do not leave the power mode in ACCESSORY or ON when you get out.

Remote Reminder

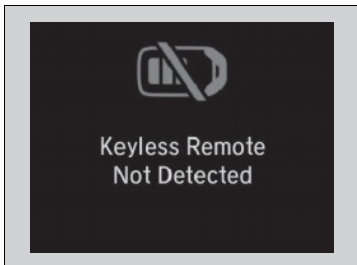

Warning buzzers may sound from inside and/or outside the vehicle to remind you that the remote is out of the vehicle. If the buzzer continues even after the remote is put back inside, place it to be within its operational range.

■ When the power mode is in ON

If the remote is taken out of the vehicle, and the driver's door is closed, a warning buzzer sounds from both inside and outside the vehicle. A warning message on the driver information interface notifies the driver inside that the remote is outside of the vehicle.

■ When the power mode is in ACCESSORY

If the remote is taken out of the vehicle, and all the doors are closed, a warning buzzer sounds from outside the vehicle.

Remote Reminder

When the remote is within the system's operational range, and the driver's door is closed, the warning function cancels.

If the remote is taken out of the vehicle after the engine has been started, you can no longer change the **ENGINE START/STOP** button mode or restart the engine. Always make sure if the remote is in your vehicle when you operate the **ENGINE START/STOP** button.

Removing the remote from the vehicle through a window does not activate the warning buzzer.

Do not put the remote on the dashboard or in the glove box. It may cause the warning buzzer to go off. Under some other conditions that can prevent the vehicle from locating the remote, the warning buzzer may also go off even if the remote is within the system's operational range.

Turn Signals

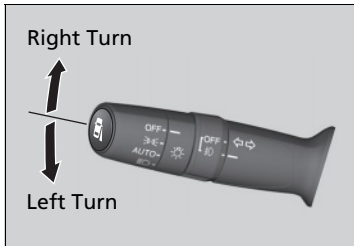

The turn signals can be used when the power mode is in ON.

■ One-touch turn signal

When you lightly push up or down and release the turn signal lever, the exterior turn signals and turn signal indicator blink three times. This feature can be used when signaling for a lane change.

Light Switches

■ Manual Operation

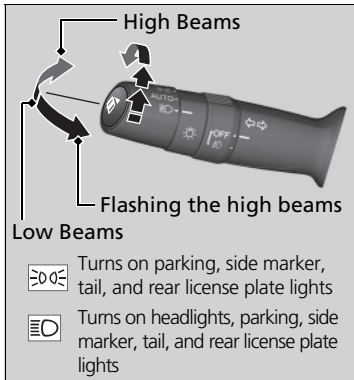

Rotating the light switch turns the lights on and off, regardless of the power mode setting.

■ High beams

Push the lever forward until you hear a click.

■ Low beams

When in high beams, pull the lever back to return to low beams.

■ Flashing the high beams

Pull the lever back, and release it.

▶ Light Switches

If you leave the power mode in VEHICLE OFF while the lights are on, a chime sounds when the driver's door is opened.

When the lights are on, the lights on indicator in the instrument panel will be on.

▶ **Lights On Indicator** P. 94

Do not leave the lights on when the engine is off because it will cause the battery to discharge.

If you sense that the level of the headlights is abnormal, have the vehicle inspected by a dealer.

■ Automatic Operation (automatic lighting control)

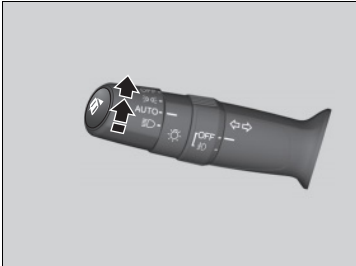

Automatic lighting control can be used when the power mode is in ON.

When you turn the light switch to **AUTO**, the headlights and other exterior lights will switch on and off automatically depending on the ambient brightness.

- ▶ You can change the auto light sensitivity setting.
 - ▣ **Customized Features** P. 370, 381

The headlights comes on when you unlock a door in dark areas with the headlight switch in **AUTO**.

- ▶ Once you lock the door, the headlights will go off.

▣ Automatic Operation (automatic lighting control)

We recommend that you turn on the lights manually when driving at night, in a dense fog, or in dark areas such as long tunnels or parking facilities.

The light sensor is in the location shown below. Do not cover this light sensor with anything; otherwise, the automatic lighting system may not work properly.

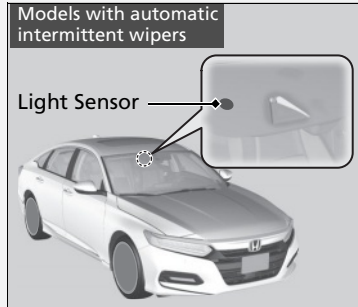
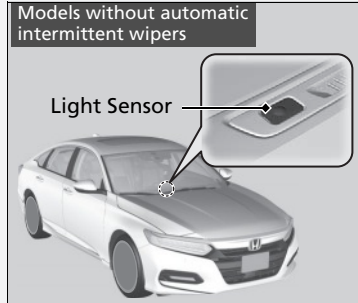

■ Headlight Integration with Wipers

The headlights automatically come on when the wipers are used several times within a certain number of intervals with the headlight switch in **AUTO**.
The headlights automatically go off a few minutes later if the wipers are stopped.

■ Automatic Lighting Off Feature

The headlights, all other exterior lights, and the instrument panel lights turn off 15 seconds after you set the power mode to VEHICLE OFF, take the remote with you, and close the driver's door.

If you set the power mode to VEHICLE OFF with the headlight switch on, but do not open the door, the lights turn off after 10 minutes (three minutes, if the switch is in the **AUTO** position).

The lights turn on again when you unlock or open the driver's door. If you unlock the door, but do not open it within 15 seconds, the lights go off. If you open the driver's door, you will hear a lights on reminder chime.

Fog Lights *



When the low beam headlights are on, turn the fog light switch on to use the fog lights.

* Not available on all models

⌘ Automatic Operation (automatic lighting control)

Adjust the auto light sensitivity as follows:

Setting	The exterior lights come on when the ambient light is at
MAX	Bright
HIGH	
MID	
LOW	
MIN	

⌘ Headlight Integration with Wipers

This feature activates while the headlights are off in **AUTO**.

The instrument panel brightness does not change when the headlights come on.

At dark ambient light levels, the automatic lighting control feature turns on the headlights, regardless of the number of wiper sweeps.

⌘ Automatic Lighting Off Feature

You can change the headlight auto off timer setting.

➤ **Customized Features** P. 370, 381

Daytime Running Lights

The parking/daytime running lights come on when the following conditions have been met:

- The power mode is in ON.
- The headlight switch is off, or in .
- The parking brake is released.

The lights remain on even if you set the parking brake. Setting the power mode to VEHICLE OFF will turn off the daytime running lights.

The daytime running lights are off once the headlight switch is turned on, or when the head light switch is in **AUTO** and it is getting darker outside.

▶▶ Daytime Running Lights

The parking lights serve as daytime running lights.

Auto High-Beam

Using a camera mounted to the inside of the windshield, this system detects light sources ahead of the vehicle. Depending on the light source, the system automatically switches the headlights to high beam for optimal visibility at night.

The system operates when:

- The headlight switch is in **AUTO**.
- The lever is in the low beam position.
- The low beams are on and the system recognizes that you are driving at night.
- The vehicle speed is above 25 mph (40 km/h).

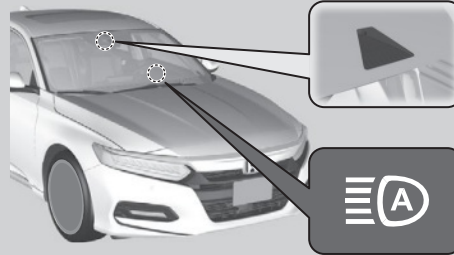

How it works

When the camera detects lights coming from a preceding or oncoming vehicle, the headlights remain in low beam.

When the camera detects no lights coming from a preceding or oncoming vehicle, the headlights change to high beam.

The view angle or distance that the camera can detect lights ahead differs depending on conditions, such as the brightness of the lights and the weather.

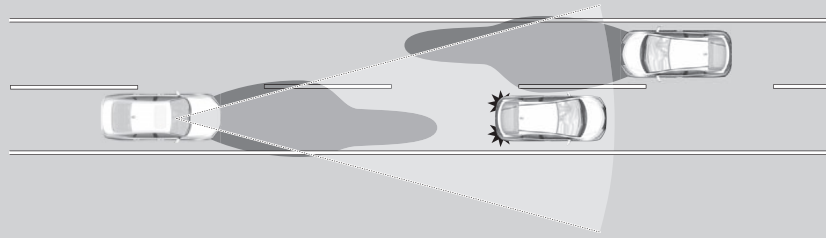

Auto High-Beam

The auto high-beam determines when to change the headlight beams by responding to the brightness of the lights ahead of your vehicle. In the following cases, the system may not respond to the lights properly:

- The brightness of the lights from the preceding or oncoming vehicle is intense or poor.
- Visibility is poor due to the weather (rain, snow, fog, windshield frost, etc.).
- Other light sources, such as streetlights and electric billboards are illuminating the road ahead.
- The brightness level of the road ahead constantly changes.
- The road is bumpy or with many curves.
- A vehicle cuts in front of you, or a vehicle in front of you is not in the preceding or oncoming direction.
- Your vehicle is tilted with heavy load in the rear.

If you find the timing of beam changes inconvenient for driving, change the headlight beams manually.

■ Operating the System

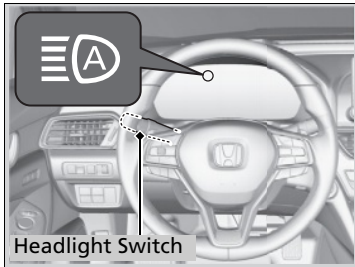

To activate the system, turn the headlight switch to **AUTO** and then set the headlights to low beam. The auto high-beam indicator will come on.

➔ **Light Switches** P. 193

The high beams remain on unless:

- You have been driving below 15 mph (24 km/h) for an extended amount of time.
- The speed of the vehicle drops below 6 mph (10 km/h).
- The windshield wipers have been running at a high speed for more than a few seconds.
- You enter a well lit location.

The high beams come back on once the condition that caused them to turn off no longer exists.

If needed, you can temporarily turn the high beams off manually. Turn on the high beams by pushing the lever forward until you hear a click, or flash the high beams once by pulling the lever toward you. To turn the high beams back on, repeat one of the procedures.

⌘ Operating the System

For the auto high-beam to work properly:

- Do not place an object that reflects light on the dashboard.
- Keep the windshield around the camera clean. When cleaning the windshield, be careful not to apply the windshield cleanser to the camera lens.
- Do not attach an object, sticker or film to the area around the camera.
- Do not touch the camera lens.

If you do not want the system to be activated at any time when the headlight switch is in **AUTO**, consult a dealer or disable the system.

➔ **Disabling or Re-enabling the System** P. 199

If the camera receives a strong impact, or repairing of the area near the camera is required, consult a dealer.

To help reduce the likelihood that high interior temperatures will cause the camera system to shut off, when parking, find a shady area or face the front of the vehicle away from the sun.

If you use a reflective sun shade, do not allow it to cover the camera housing. Covering the camera can concentrate heat on the camera.

If the  message appears:

- Park your vehicle in a safe place, and clean the windshield. If the message does not disappear after you have cleaned the windshield and driven for a while, have your vehicle checked by a dealer.

Disabling or Re-enabling the System

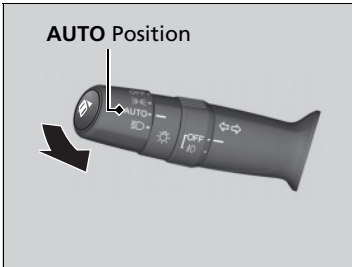

Disabling or re-enabling the system when the vehicle is parked with the power mode is in ON and the light switch is in the **AUTO** position.

Disabling the system: Pull the light switch lever towards you and hold it for 40 seconds. The indicator blinks twice.

Re-enabling the system: Pull the light switch lever towards you and hold it for 30 seconds. The indicator blinks once.

Disabling or Re-enabling the System

The auto high-beam is in the previously selected disabled or re-enabled setting each time you start the engine.

Wipers and Washers

■ Windshield Wiper/Washer

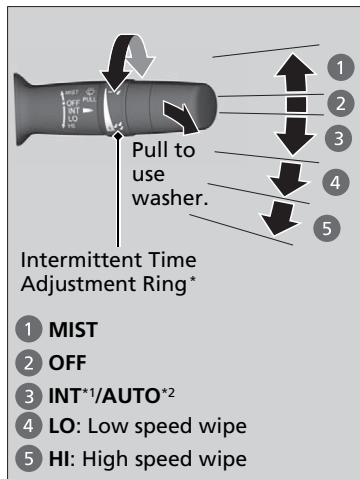

- 1 MIST
- 2 OFF
- 3 INT^{*1}/AUTO^{*2}
- 4 LO: Low speed wipe
- 5 HI: High speed wipe

The windshield wipers and washers can be used when the power mode is in ON.

■ MIST

The wipers run at high speed until you release the lever.

■ Wiper switch (OFF, INT^{*1}/AUTO^{*2}, LO, HI)

Move the lever up or down to change the wiper settings.

■ Adjusting wiper operation*

Turn the adjustment ring to adjust the wiper operation.

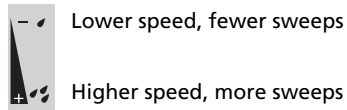

■ Washer

Sprays while you pull the lever toward you.

When you release the lever for more than one second, the spray stops, the wipers sweep two or three more times to clear the windshield, then stop.

*1: Models with manual intermittent operation
 *2: Models with automatic intermittent operation

* Not available on all models

» Wipers and Washers

NOTICE

Do not use the wipers when the windshield is dry. The windshield will get scratched, or the rubber blades will get damaged.

NOTICE

Turn the washers off if no washer fluid comes out. The pump may get damaged.

The wiper motor may stop motor operation temporarily to prevent an overload. Wiper operation will return to normal within a few minutes, once the circuit has returned to normal.

Models with intermittent time adjustment ring

If the vehicle speeds up while the wipers are operating intermittently, the length of the wipe interval shortens.

When the vehicle speeds up, the wiper operation's shortest delay setting (🕒) and the LO setting become the same.

NOTICE

In cold weather, the blades may freeze to the windshield.

Operating the wipers in this condition may damage the wipers. Use the defogger or heated windshield* to warm the windshield, then turn the wipers on.

Automatic Intermittent Wipers *

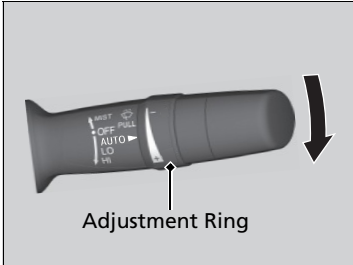

When you push the lever down to **AUTO**, the windshield wipers sweep once, and go into the automatic mode.

The wipers operate intermittently, at low speed, or at high speed and stops in accordance with the amount of rainfall the rainfall sensor detects.

■ AUTO sensitivity adjustment

When the wiper function is set to **AUTO**, you can adjust the sensitivity of the rain fall sensor (using the adjustment ring) so that wipers will operate in accordance with your preference.

Sensor sensitivity

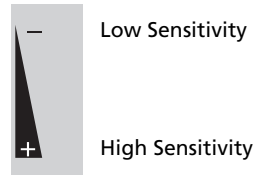

Wipers and Washers

If the wipers stop operating due to an obstacle such as the build-up of snow, park the vehicle in a safe place.

Rotate the wiper switch to **OFF**, and set the power mode to ACCESSORY or VEHICLE OFF, then remove the obstacle.

Automatic Intermittent Wipers *

The rainfall sensor is in the location shown below.

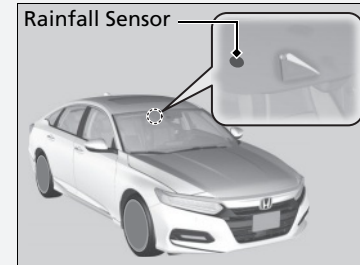

AUTO should always be turned **OFF** before the following situations in order to prevent severe damage to the wiper system:

- Cleaning the windshield
- Driving through a car wash
- No rain present

* Not available on all models

Rear Defogger/Heated Door Mirror* Button

Press the rear defogger and heated door mirror button to defog the rear window and mirrors when the power mode is in ON.

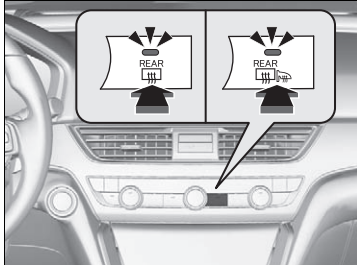

The rear defogger and heated door mirrors automatically switch off after 10-30 minutes depending on the outside temperature. However, if the outside temperature is 32°F (0°C) or below, it does not automatically switch off.

Canadian models

Heated Windshield Button

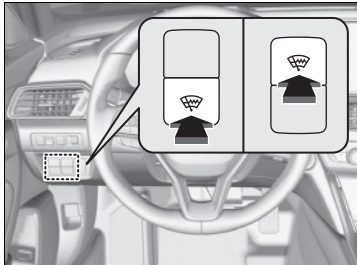

Press the heated windshield button to deice the windshield when the power mode is in ON.

▶▶ Rear Defogger/Heated Door Mirror* Button

NOTICE

When cleaning the inside of the rear window, be careful not to damage the heating wires. It is critical to wipe the window from side to side along the defogger heating wires.

This system consumes a lot of power, so turn it off when the window has been defogged or deiced. Also, do not use the system for a long time while the engine is idling. This may weaken the battery, making it difficult to start the engine.

When the outside temperature is below 41°F (5°C), the heated door mirror may activate automatically for 10 minutes when you set the power mode to ON.

▶▶ Heated Windshield Button

This system consumes a lot of power, so turn it off when the window has been defogged or deiced. Also, do not use the system for a long period when the engine is idling. This may weaken the battery, making it difficult to start the engine.

Brightness Control

■ Adjusting the Instrument Panel Brightness

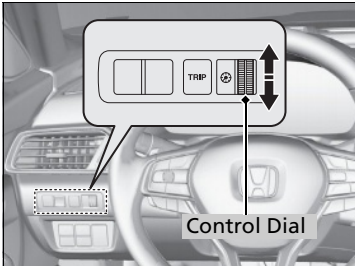

When the power mode is in ON, you can use the brightness control dial to adjust instrument panel brightness.

Brighten: Turn the dial up.

Dim: Turn the dial down.

You will hear a beeper when the brightness reaches minimum or maximum. Several seconds after you have adjusted the brightness, you will be returned to the previous screen.

■ Brightness level indicator

The brightness level is shown on the driver information interface while you are adjusting it.



☒ Brightness Control

Instrument panel brightness varies, depending on whether the exterior lights are on or off. The instrument panel dims to reduce glare when they are on.

To cancel the reduced instrument panel brightness when the exterior lights are on, turn the dial up until the brightness display is up to max, the beeper sounds.

The brightness can be set differently for when the exterior lights are on, and when they are off.

■ Adjusting the Head-Up Display Brightness*

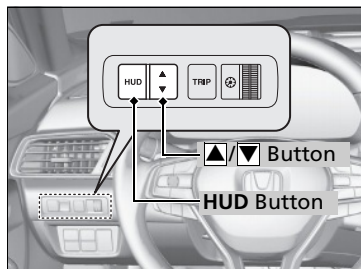

When the head-up display is on, press and hold the **HUD** button until its brightness level indicator on the driver information interface.

Brighten: Press the ▲ button.

Dim: Press the ▼ button.

Several seconds after you have adjusted the brightness, you will be returned to the previous screen.



■ Brightness level indicator

The brightness level is shown on the driver information interface while you are adjusting it.

Driving Position Memory System*

You can store two driver's seat positions (except for power lumbar) with the driving position memory system.

When you unlock and open the driver's door with a remote transmitter, or smart entry system to one of the two preset positions and the seat adjusts to retracted positions of one of the two preset positions automatically.

The seat will move to the stored position when you set the power mode to ACCESSORY.

When you enter the vehicle, the driver information interface briefly shows you which remote transmitter you used to unlock the vehicle.

- **DRIVER 1** transmitter is linked to memory button 1.
- **DRIVER 2** transmitter is linked to memory button 2.



The driver's seat moves rearward depending on the set seating position once you

- Stop the vehicle.
- Put the transmission into **P**.
- Turn the engine off.
- Then open the driver's door.

Once the power mode is in the ACCESSORY position, the driver's seat moves forward to the **DRIVER 1** or **2** preset position.

▶▶ Driving Position Memory System*

Using the audio/information screen you can disable the automatic seat adjustment function.

▶ **Customized Features** P. 381

The driver's seat easy exit feature can be turned ON/OFF.

▶ **Customized Features** P. 381

System Operation

The system will not operate if:

- The vehicle speed is above 2 mph (3 km/h).
- Either memory position button is pressed while the seat is in motion.
- The seat position is adjusted while in operation.
- The memory 1 or 2 position is set fully to the rear.

■ Storing a Position in Memory

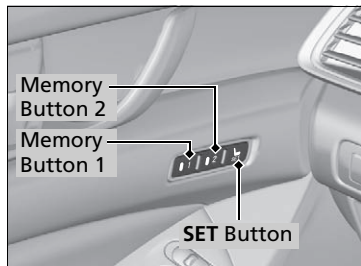

1. Set the power mode to ON. Adjust the driver's seat to the desired position.
2. Press the **SET** button.
 - ▶ You will hear the beeper, and the memory button indicator light will blink.
3. Press the memory button **1** or **2** within five seconds of pressing the **SET** button.
 - ▶ Once the seat position has been memorized, the indicator light on the button you pressed stays on and you will hear two beeps.

■ Recalling the Stored Position

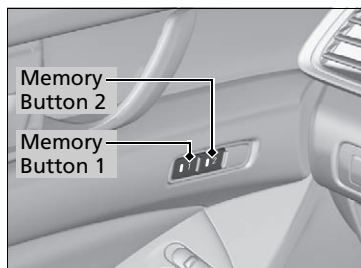

1. Put the transmission into **P**.
2. Apply the parking brake.
3. Press a memory button (**1** or **2**).
 - ▶ You will hear a beep, and the indicator light will blink.

The seat will automatically move to the memorized position. When it has finished moving, you will hear a beep, and the indicator light stays on.

▶▶ Storing a Position in Memory

After you press the **SET** button, the storing operation will be canceled when:

- You do not press the memory button within five seconds.
- You readjust the seat position before the two beeps.
- You set the power mode to any position except ON.

▶▶ Recalling the Stored Position

The seat will stop moving if:

- The vehicle speed is above 2 mph (3 km/h).
- You press the **SET** button or memory button **1** or **2**.
- You adjust the seat position.

Adjusting the Steering Wheel

The steering wheel height and distance from your body can be adjusted so that you can comfortably grip the steering wheel in an appropriate driving posture.

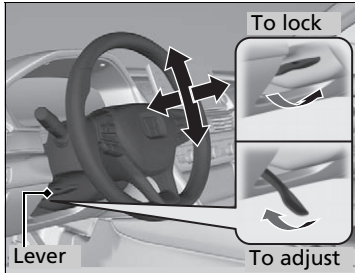

1. Push the steering wheel adjustment lever down.
 - ▶ The steering wheel adjustment lever is under the steering column.
2. Move the steering wheel up or down, and in or out.
 - ▶ Make sure you can see the instrument panel gauges and indicators.
3. Pull the steering wheel adjustment lever up to lock the steering wheel in position.
 - ▶ After adjusting the position, make sure you have securely locked the steering wheel in place by trying to move it up, down, in, and out.

Adjusting the Steering Wheel

⚠ WARNING

Adjusting the steering wheel position while driving may cause you to lose control of the vehicle and be seriously injured in a crash.

Adjust the steering wheel only when the vehicle is stopped.

Interior Rearview Mirror

Adjust the angle of the rearview mirror when you are sitting in the correct driving position.

Rearview Mirror with Day and Night Positions*

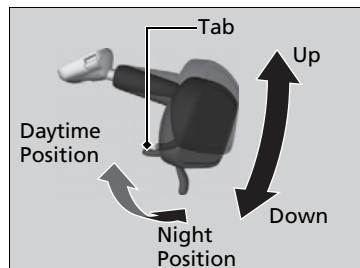

Flip the tab to switch the position. The night position will help to reduce the glare from headlights behind you when driving after dark.

Automatic Dimming Rearview Mirror*

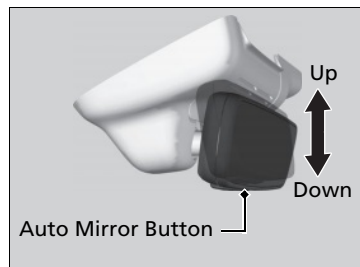

When you are driving after dark, the automatic dimming rearview mirror reduces the glare from headlights behind you. Press the auto mirror button to turn this function on and off. When activated, the auto indicator comes on.

Adjusting the Mirrors

Keep the inside and outside mirrors clean and adjusted for best visibility.

Adjust the mirrors before you start driving.

➤ **Adjusting the Seats** P. 210

Automatic Dimming Rearview Mirror*

The auto dimming function cancels when the transmission is in **R**.

Power Door Mirrors

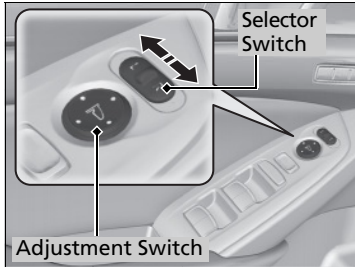

You can adjust the door mirrors when the power mode is in ON.

■ Mirror position adjustment

L/R selector switch: Select the left or right mirror. After adjusting the mirror, return the switch to the center position.

Mirror position adjustment switch: Press the switch left, right, up, or down to move the mirror.

■ Reverse Tilt Door Mirror*

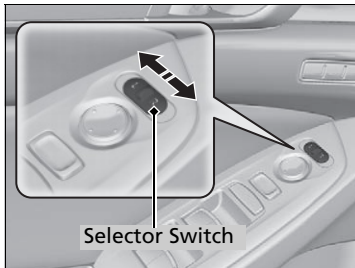

If activated, passenger's side door mirror automatically tilts downward when you put the transmission into **R**; this improves close-in visibility on the passenger's side of the vehicle when backing up. The mirror automatically returns to its original position when you take the transmission out of **R**.

To activate this feature, set the power mode to ON and slide the selector switch to the passenger's side.

* Not available on all models

Adjusting the Seats

Front Seats

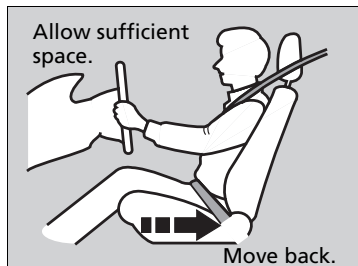

Adjust the driver's seat as far back as possible while allowing you to maintain full control of the vehicle. You should be able to sit upright, well back in the seat and be able to adequately press the pedals without leaning forward, and grip the steering wheel comfortably. The passenger's seat should be adjusted in a similar manner, so that it is as far back from the front airbag in the dashboard as possible.

Adjusting the Seats

⚠ WARNING

Sitting too close to a front airbag can result in serious injury or death if the front airbags inflate.

Always sit as far back from the front airbags as possible while maintaining control of the vehicle.

The National Highway Traffic Safety Administration and Transport Canada recommend that drivers allow at least 10 inches (25 cm) between the center of the steering wheel and the chest.

Always make seat adjustments before driving.

Adjusting the Seat Positions

Adjusting the front power seat(s)*

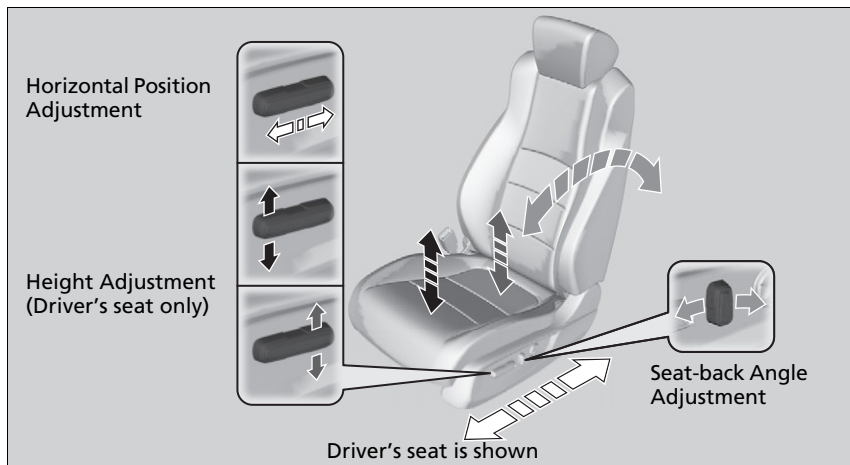

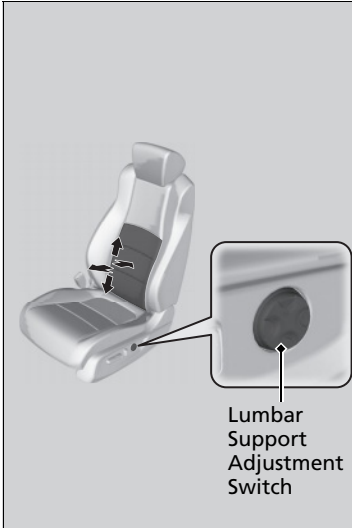

■ Lumbar Support Adjustment Switch*

Press the top: To move the lumbar support up.

Press the bottom: To move the lumbar support down.

Press the front: To increase the entire lumbar support.

Press the rear: To decrease the entire lumbar support.

■ Adjusting the front manual seat(s)*

►► Adjusting the front manual seat(s)*

Height Adjustment

(Driver side only)

Pull up or push down the lever to raise or lower the seat.

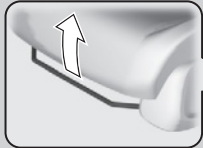
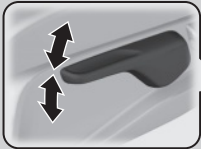

Horizontal Position Adjustment

Pull up on the bar to move the seat, then release the bar.

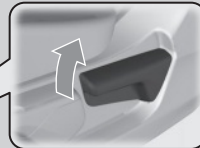

Seat-back Angle Adjustment

Pull up the lever to change the angle.

Driver's seat is shown.

Once a seat is adjusted correctly, rock it back and forth to make sure it is locked in position.

■ Adjusting the Seat-Backs

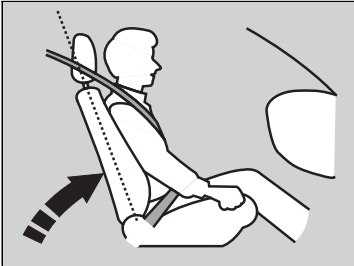

Adjust the driver's seat-back to a comfortable, upright position, leaving ample space between your chest and the airbag cover in the center of the steering wheel.

The front seat passenger should also adjust their seat-back to a comfortable, upright position.

Reclining a seat-back so that the shoulder part of the belt no longer rests against the occupant's chest reduces the protective capability of the belt. It also increases the chance of sliding under the belt in a crash and being seriously injured. The farther a seat-back is reclined, the greater the risk of injury.

▣ Adjusting the Seat-Backs

⚠ WARNING

Reclining the seat-back too far can result in serious injury or death in a crash.

Adjust the seat-back to an upright position, and sit well back in the seat.

Do not put a cushion, or other object, between the seat-back and your back.

Doing so may interfere with proper seat belt or airbag operation.

If you cannot get far enough away from the steering wheel and still reach the controls, we recommend that you investigate whether some type of adaptive equipment may help.

Rear Seats

Folding Down the Rear Seat(s)

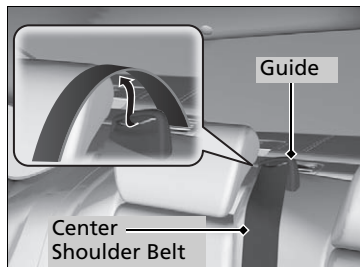

1. Remove the center shoulder belt from the guide.

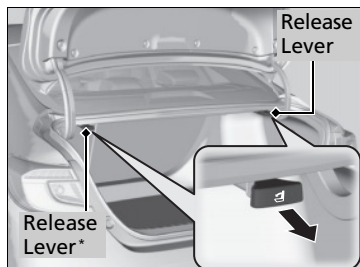

2. Pull the release lever in the trunk to release the lock.

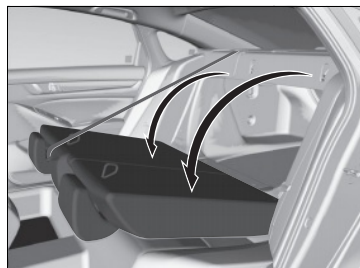

3. Fold the seat-back down.

Folding Down the Rear Seat(s)

The rear seat-back(s*) can be folded down to accommodate bulkier items in the trunk.

Never drive with the seat-back folded down and the trunk lid open.

Exhaust Gas Hazard P. 75

To lock a seat-back upright, push it backwards until it locks.

When returning the seat-back to its original position, push it firmly back. Also, make sure all rear shoulder belts are positioned in front of the seat-back, and the center shoulder belt is re-positioned in the guide.

Make sure that the folded seat-back does not press against the front passenger seat, as this can cause the weight sensors in the front passenger seat to work improperly.

Passenger Front Airbag Off Indicator P. 59

Make sure all items in the trunk or items extending through the opening into the rear seat is properly secured. Loose items can fly forward if you have to brake hard.

The front seat(s) must be far enough forward so they do not interfere with the rear seats as they fold down.

Maintain a Proper Sitting Position

After all occupants have adjusted their seats and head restraints, and put on their seat belts, it is very important that they continue to sit upright, well back in their seats, with their feet on the floor, until the vehicle is safely parked and the power mode is off.

Sitting improperly can increase the chance of injury during a crash. For example, if an occupant slouches, lies down, turns sideways, sits forward, leans forward or sideways, or puts one or both feet up, the chance of injury during a crash is greatly increased.

In addition, an occupant who is out of position in the front seat can be seriously or fatally injured in a crash by striking interior parts of the vehicle or being struck by an inflating front airbag.

▶▶ Maintain a Proper Sitting Position

⚠ WARNING

Sitting improperly or out of position can result in serious injury or death in a crash.

Always sit upright, well back in the seat, with your feet on the floor.

Head Restraints

Your vehicle is equipped with head restraints in all seating positions.

■ Adjusting the Front and Rear Outer* Head Restraint Positions

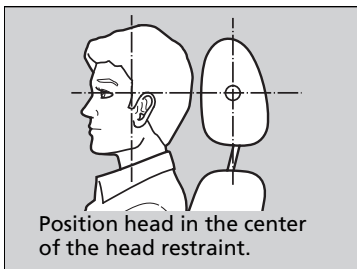

Head restraints are most effective for protection against whiplash and other rear-impact crash injuries when the center of the back of the occupant's head rests against the center of the restraint. The tops of the occupant's ears should be level with the center height of the restraint.

► Head Restraints

⚠ WARNING

Improperly positioning head restraints reduces their effectiveness and increases the likelihood of serious injury in a crash.

Make sure head restraints are in place and positioned properly before driving.

In order for the head restraint system to work properly:

- Do not hang any items on the head restraints, or from the restraint legs.
- Do not place any object between an occupant and the seat-back.
- Install each restraint in its proper location.

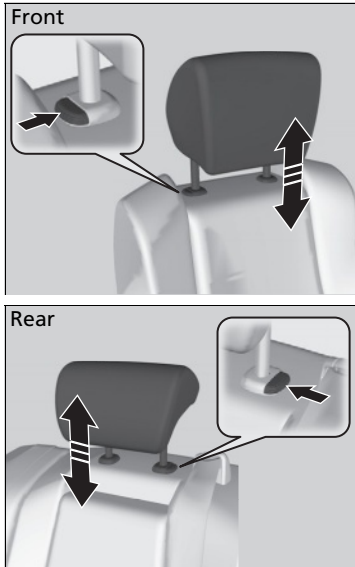

To raise the head restraint: Pull it upward.
To lower the head restraint: Push it down while pressing the release button.

■ Removing and Reinstalling the Head Restraints

Head restraints can be removed for cleaning or repair.

To remove a head restraint:

Pull the restraint up as far as it will go. Then push the release button, and pull the restraint up and out.

To reinstall a head restraint:

Insert the legs back in place, then adjust the head restraint to an appropriate height while pressing the release button. Pull up on the restraint to make sure it is locked in position.

⌘ Removing and Reinstalling the Head Restraints

WARNING

Failure to reinstall, or correctly reinstall, the head restraints can result in severe injury during a crash.

Always replace the head restraints before driving.

Armrest

■ Using the Front Seat Armrest

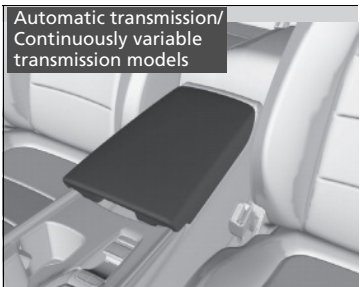

The console lid can be used as an armrest.

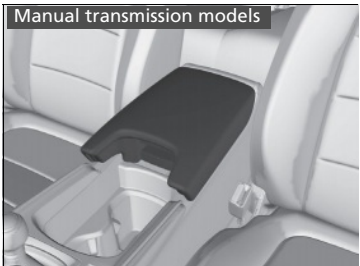

■ Using the Rear Seat Armrest

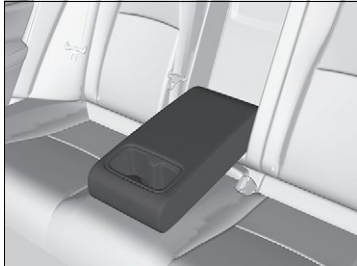

Pull down the armrest in the center backrest.

Interior Lights

Interior Light Switches

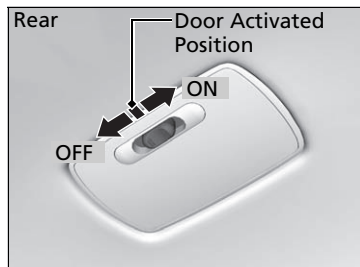
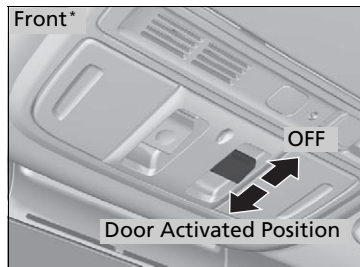

■ ON

The interior lights come on regardless of whether the doors are open or closed.

■ Door activated

The interior lights come on in the following situations:

- When any doors are opened.
- You unlock the driver's door.
- When the power mode is set to VEHICLE OFF.

■ OFF

The interior lights remain off regardless of whether the doors are open or closed.

Interior Light Switches

In the door activated position, the interior lights fade out and go off about 30 seconds after the doors are closed.

The lights go off after about 30 seconds in the following situations:

- When you unlock the driver's door but do not open it.
- When you set the power mode to VEHICLE OFF but do not open a door.

You can change the interior lights dimming time.

➤ **Customized Features** P. 370, 381

The interior lights go off immediately in the following situations:

- When you lock the driver's door.
- When you close the driver's door in ACCESSORY mode.
- When you set the power mode to ON.

To avoid draining the battery, do not leave the interior lights on for an extended length of time when the engine is off.

If you leave any of the doors open in VEHICLE OFF mode, the interior lights go off after about 15 minutes.

■ Map Lights

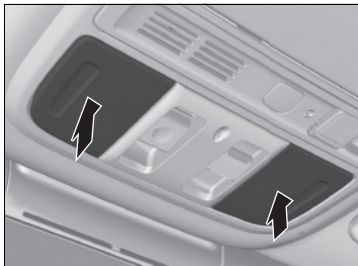

The map lights can be turned on and off by pressing the lenses.

■ Ambient Lights *

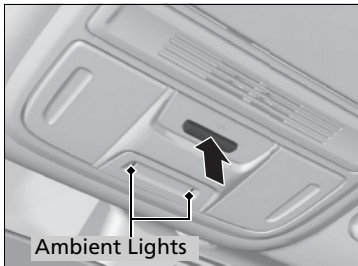

When the parking lights are on, push the ambient light switch to turn the ambient lights on.

»» Map Lights

Models with moonroof

When the interior light switch is in the door activated position and any door is open, the map light will not go off when you press the lens.

Interior Convenience Items

■ Glove Box

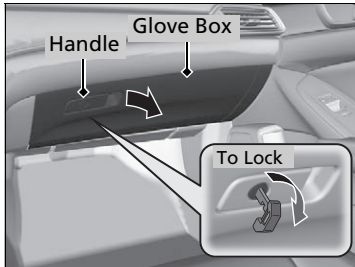

Pull the handle to open the glove box.

■ Models with trunk main switch

You can lock the glove box with the built-in key.

■ Center Pocket

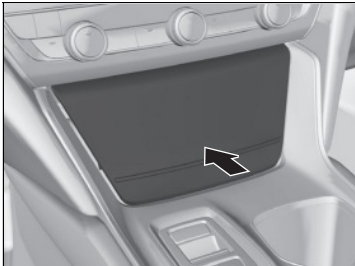

Push the cover to open the pocket.

☒ Glove Box

⚠ WARNING

An open glove box can cause serious injury to your passenger in a crash, even if the passenger is wearing the seat belt.

Always keep the glove box closed while driving.

■ Console Compartment

Automatic transmission/
Continuously variable
transmission models



Pull the handle to open the console compartment.

Manual transmission models



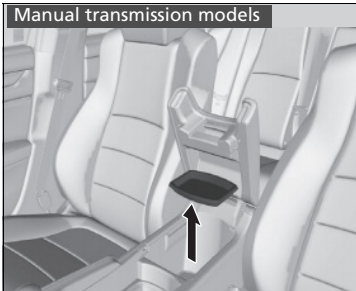
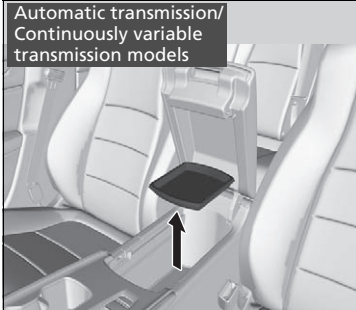

■ Removable tray

The tray in the console compartment is detachable. To remove the tray, simply pull it up.

■ Beverage Holders

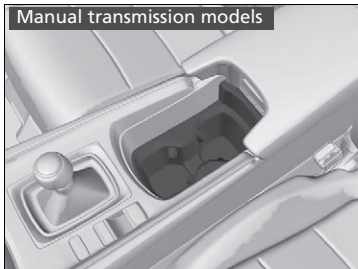
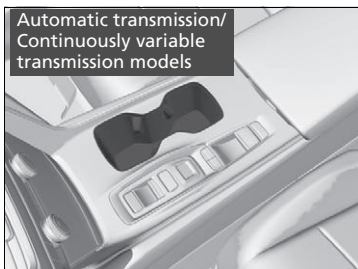

■ **Front seat beverage holders**
Are located in the console between the front seats.

» Beverage Holders

NOTICE

Spilled liquids damage the upholstery, carpeting, and electrical components in the interior.

Be careful when you are using the beverage holders. Hot liquid can scald you.

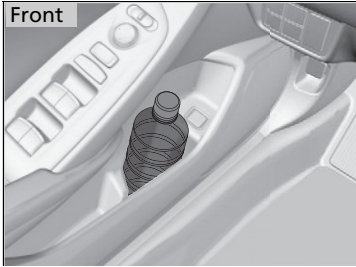

■ **Door side beverage holders**

Are located on the both of front and rear door side pockets.

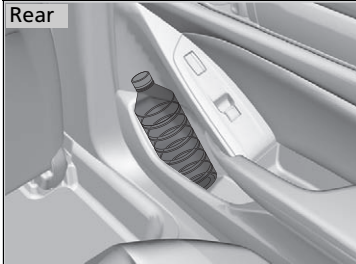

■ **Rear seat beverage holders**

Fold the armrest down to use the rear seat beverage holders.

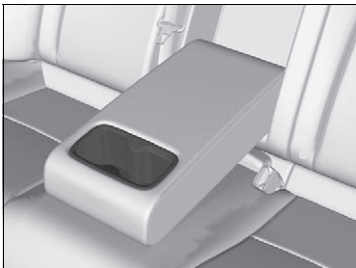

■ Accessory Power Sockets

The accessory power sockets can be used when the power mode is in ACCESSORY or ON.

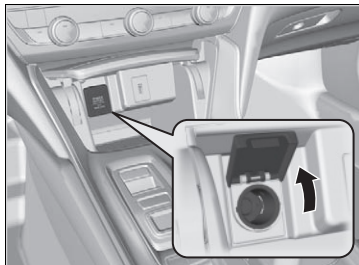

■ Accessory power socket (center pocket)

Open the center pocket and the cover to use it.

▶▶ Accessory Power Sockets

NOTICE

Do not insert an automotive type cigarette lighter element. The power socket can overheat.

The accessory power socket is designed to supply power for 12-volt DC accessories that are rated 180 watts (15 amps) or less.

To prevent battery drain, use the power socket only when the engine is running.

When both sockets are being used, the combined power rating of the accessories should not exceed 180 watts (15 amps).

Automatic transmission/
Continuously variable
transmission models

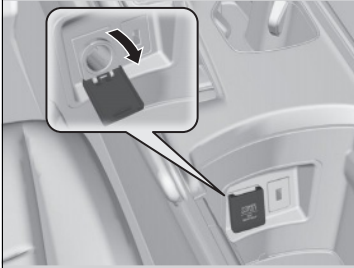

Manual transmission models

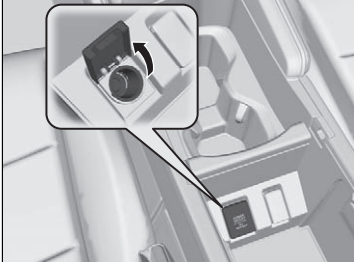



■ Accessory power socket (console compartment)

Open the console lid and the cover to use it.

■ Wireless Charger*

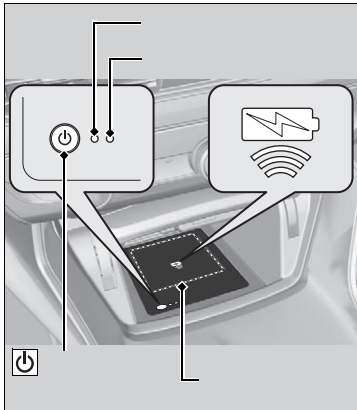
To use the wireless charger, the power mode must be in ACCESSORY or ON. Charge a compatible device on the area indicated by the  mark as follows:



1. To turn the system on and off, press and hold the  (power) button.
 - When the system is activated, the green indicator light comes on.
2. Place the device you want to charge on the charging area.
 - The system will automatically start charging the device, and the amber indicator light will come on.
 - Make sure that the device is compatible with the system, and placed with the chargeable side in the center of the charging area.
3. When charging is completed, the green indicator light will come on.
 - Depending on the device, the amber indicator light will stay on.

►► Wireless Charger*

FCC statement

This product complies with the appropriate requirements or the required standards of FCC (Federal Communication Commission), described below:

This device complies with Part 18 of the FCC rules. This equipment generates, uses, and can radiate radio frequency energy and, if not installed and used per the instructions, may cause harmful interference to radio communications.

In order to use safely:

- Remove any metal objects from the charge pad before charging a device.
- Do not open the charger case.
- Do not use the charger if it malfunctions. Contact your dealer.

If the charger interferes with radio communications, attempt to correct the interference:

- Press and hold the switch on the charger for a few seconds to turn off the charger.

 appears on the audio/information screen when the device is being charged by the wireless charger.

■ When charging does not start

Perform one of the solutions in the following table.

Indicator		Cause	Solution
Green & Amber	Blinking simultaneously	There is an obstacle(s) between the charging area and the device.	Remove the obstacle(s).
		The device is not within the charging area.	Move the device to the center of the charging area where  is located.
Amber	Blinking	The wireless charger is faulty.	Contact a dealer for repairs.

Wireless Charger*

⚠ CAUTION

Metal objects between the charge pad and the device to be charged will get hot and can burn you.

- Always remove foreign objects from the charge pad before charging the device.
- Be sure the surface is clear of dust and other debris before charging.
- Do not spill liquids (i. e. water, drinks, etc.) on the charger and the device.
- Do not use oil, grease, alcohol, benzine or thinner for cleaning the charge pad.
- Do not cover the system with towels, clothing, or other objects while charging etc.
- Avoid spraying aerosols which may come in contact with the charge pad surface.

This system consumes a lot of power. Do not use the system for a long time when the engine is not running. This may weaken the battery, making it difficult to start the engine.

When using the wireless charger, check the user's manual that came with the compatible device you want to charge.

* Not available on all models

Wireless Charger*

NOTICE

Do not place any magnetic recording media or precision machines within the charging area while charging. The data on your cards such as credit cards can be lost because of the magnetic effect. Also precision machines such as watches can go wrong.

“Qi” and  marks are the registered trademarks owned by Wireless Power Consortium (WPC).

In the following cases, charging may stop or not start:

- The device is already fully charged.
- The temperature of the device is extremely high while charging.
- You are at a place that emits strong electromagnetic waves or noises such as TV station, electric power plant, or gas station.

A device may not charge if the size or shape of its chargeable side is not appropriate for use with the charging area.

Not all devices are compatible with the system.

During the charging phase, it is normal for the charging area and device to heat up.

Charging may be briefly interrupted when:

- All the doors or the trunk are closed
 - to avoid interference with the proper functioning of the smart entry system.
- The position of the device is altered.

Do not charge more than one device at a time on a charging area.

■ Coat Hook



There is a coat hook on the rear left grab handle. Pull it down to use it.

■ Cargo Hooks

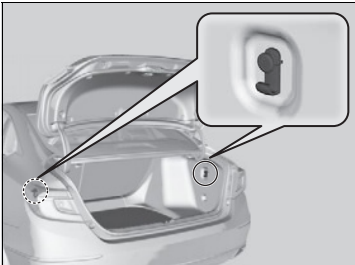

The cargo hooks in the trunk can be used to install a net for securing items.

☒ Coat Hook

The coat hook is not designed for large or heavy items.

☒ Cargo Hooks

Heavy objects may damage the hook. Make sure any items put on this hook weigh less than 6.6 lbs (3 kg).

Distribute cargo evenly on the floor of the trunk, placing the heaviest items on the bottom and as far forward as possible.

➤ **Maximum Load Limit** P. 457

■ Sunglasses Holder

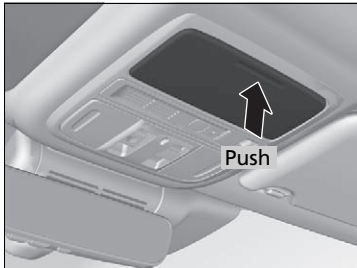

To open the sunglasses holder, push and release the indent. To close, push it again until it latches.

You can store eyeglasses and other small items in this holder.

►► Sunglasses Holder

Keep the holder closed while driving except when accessing stored items.

Canadian models

Heated Steering Wheel*



The power mode must be in ON to use the heated steering wheel.

Press the button on the lower side of the steering wheel.

When a comfortable temperature is reached, press the button again to turn it off.

The heated steering wheel is turned off every time you start the engine, even if you turned it on the last time you drove the vehicle.

Heated Steering Wheel*

Do not use the heated steering wheel continuously when the engine is off. Under such conditions, the battery may be weakened, making the engine difficult to start.

* Not available on all models

Continued

Front Seat Heaters *



The power mode must be in ON to use the seat heaters.

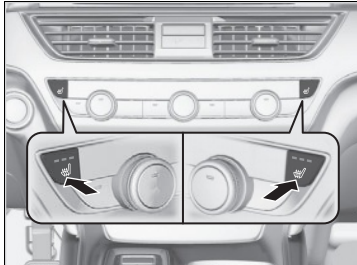

Press the seat heater button:

Once - The HI setting (three indicators on)

Twice - The MID setting (two indicators on)

Three times - The LO setting (one indicator on)

Four times - The OFF setting (no indicators on)

When the power mode is turned on after it is turned off, the previous setting of front seat heaters is maintained.

Front Seat Heaters *

WARNING

Heat induced burns are possible when using seat heaters.

Persons with a diminished ability to sense temperature (e.g., persons with diabetes, lower-limb nerve damage, or paralysis) or with sensitive skin should not use seat heaters.

Do not use the seat heaters even in LO when the engine is off. Under such conditions, the battery may be weakened, making the engine difficult to start.

After a certain period of time, the strength setting for the front seat heaters will automatically be reduced by one level at a time until the front seat heaters shuts off. The elapsed time varies according to the interior environment.

Front Seat Heaters and Seat Ventilation*

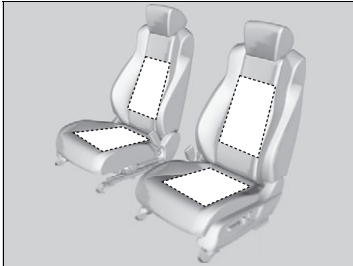

The power mode must be in ON to use the seat heaters or ventilation.

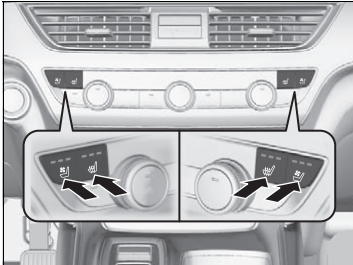

Press the seat heater or the seat ventilation button:

- Once - The HI setting (three indicators on)
- Twice - The MID setting (two indicators on)
- Three times - The LO setting (one indicator on)
- Four times - The OFF setting (no indicators on)

When the power mode is turned on after it is turned off, the previous setting of front seat heaters and ventilation is maintained.

Front Seat Heaters and Seat Ventilation*

⚠ WARNING

Heat induced burns are possible when using seat heaters.

Persons with a diminished ability to sense temperature (e.g., persons with diabetes, lower-limb nerve damage, or paralysis) or with sensitive skin should not use seat heaters.

Do not use the seat heaters and the seat ventilation even in LO when the engine is off. Under such conditions, the battery may be weakened, making the engine difficult to start.

After a certain period of time, the strength setting for the front seat heaters will automatically be reduced by one level at a time until the front seat heaters shuts off. The elapsed time varies according to the interior environment.

* Not available on all models

■ Rear Seat Heaters *

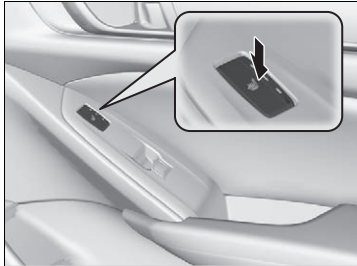

The power mode must be in ON to use the seat heaters.

There is no heater in the rear center seating position.

Press the seat heater button:

Once - The HI setting (three indicators on)

Twice - The MID setting (two indicators on)

Three times - The LO setting (one indicator on)

Four times - The OFF setting (no indicators on)

▣ Rear Seat Heaters *

⚠ WARNING

Heat induced burns are possible when using seat heaters.

Persons with a diminished ability to sense temperature (e.g., persons with diabetes, lower-limb nerve damage, or paralysis) or with sensitive skin should not use seat heaters.

Do not use the seat heaters even in LO when the engine is off. Under such conditions, the battery may be weakened, making the engine difficult to start.

After a certain period of time, the strength setting for the rear seat heaters will automatically be reduced by one level at a time until the rear seat heaters shuts off. The elapsed time varies according to the interior environment.

Using Automatic Climate Control

The automatic climate control system maintains the interior temperature you select. The system also selects the proper mix of heated or cooled air that raises or lowers the interior temperature to your preference as quickly as possible.

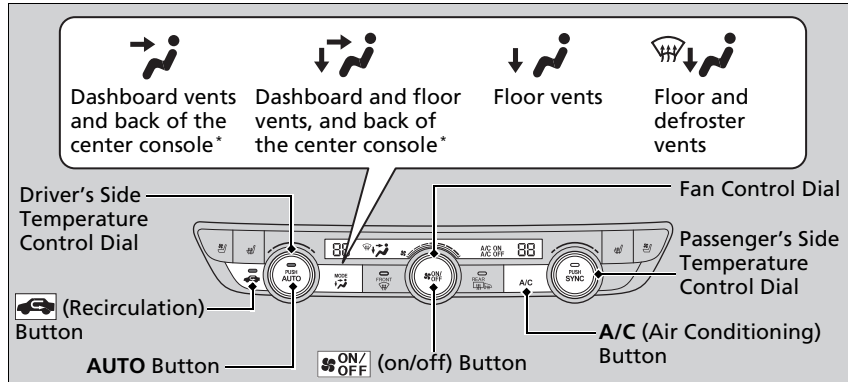

Use the system when the engine is running.

1. Press the **AUTO** button.
2. Adjust the interior temperature using the driver's side or passenger's side control dial.
3. Press the **ON/OFF** (on/off) button to cancel.

■ Switching between the recirculation and fresh air modes

Press the  (recirculation) button and switch the mode depending on environmental conditions.

Recirculation mode (indicator on): Recirculates air from the vehicle's interior through the system.

Fresh air mode (indicator off): Maintains outside ventilation. Keep the system in fresh air mode in normal situations.

* Not available on all models

Using Automatic Climate Control

If any buttons are pressed while using the climate control system in auto, the function of the button that was pressed will take priority.

The **AUTO** indicator will go off, but functions unrelated to the button that was pressed will be controlled automatically.

To prevent cold air from blowing in from outside, the fan may not start immediately when the **AUTO** button is pressed.

If the interior is very warm, you can cool it down more rapidly by partially opening the windows, turning the system on auto, and setting the temperature to low. Change the fresh mode to recirculation mode until the temperature cools down.

When you set the temperature to the lower or upper limit, **Lo** or **Hi** is displayed.

Pressing the **ON/OFF** button switches the climate control system between on and off. When turned on, the system returns to your last selection.

While ECON mode is active, the climate control system may have reduced cooling performance.

■ Defrosting the Windshield and Windows

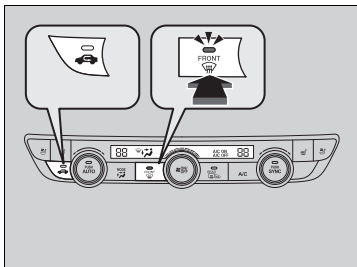

Pressing the  button turns the air conditioning system on and automatically switches the system to fresh air mode.

Press the  button again to turn off, the system returns to the previous settings.

■ To rapidly defrost the windows

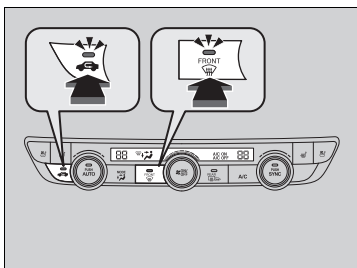

1. Press the  button.
2. Press the  button.

►► Defrosting the Windshield and Windows

For your safety, make sure you have a clear view through all the windows before driving.

Do not set the temperature near the upper or lower limit.

When cold air hits the windshield, the outside of the windshield may fog up.

If the side windows fog up, adjust the vents so that the air hits the side windows.

Synchronization Mode

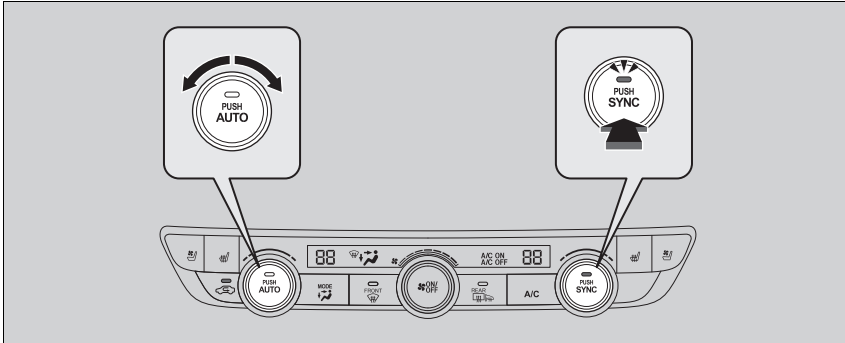

You can set the temperature synchronously for the driver side and the passenger side in synchronization mode.

1. Press the **SYNC** button.
▶ The system will switch to the synchronization mode.
2. Adjust the temperature using driver's side temperature control dial.

Press the **SYNC** button or adjust the interior temperature using the passenger's side control dial to return to dual mode.

☒ Synchronization Mode

When you press the **FRONT OFF** button, the system changes to synchronization mode.

When the system is in dual mode, the driver side temperature and the passenger side temperature can be set separately.

Models with navigation system

The system adjusts each temperature based on the information of the sunlight sensor and the sun position updated by the navigation system.

Automatic Climate Control Sensors

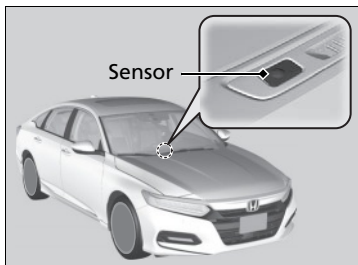

The automatic climate control system is equipped with sensors. Do not cover or spill any liquid on them.

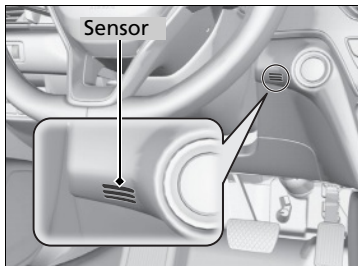

Features

This chapter describes how to operate technology features.

Audio System		
About Your Audio System	244	
USB Port(s)	245	
Audio System Theft Protection	247	
Audio Remote Controls	248	
Models with color audio		
Audio System Basic Operation	252	
Audio/Information Screen	253	
Adjusting the Sound	257	
Display Setup	258	
Playing AM/FM Radio	259	
Playing an iPod	261	
Playing Pandora®	264	
Playing a USB Flash Drive	266	
Playing <i>Bluetooth</i> ® Audio	269	
Siri® Eyes Free	272	
Models with Display Audio		
Audio System Basic Operation	273	
Audio/Information Screen	274	
System Updates	286	
Adjusting the Sound	292	
Display Setup	293	
Voice Control Operation	295	
Playing AM/FM Radio	298	
Playing SiriusXM® Radio*	302	
Playing an iPod	313	
Playing a USB Flash Drive	316	
Playing <i>Bluetooth</i> ® Audio	319	
HondaLink®	321	
HondaLink® Service*	325	
Wi-Fi Connection	330	
Near Field Communication (NFC)*	332	
Siri® Eyes Free	335	
Apple CarPlay®	336	
Android Auto™	339	
Audio Error Messages	343	
General Information on the Audio System	348	
Customized Features	370, 381	
HomeLink® Universal Transceiver*	400	
Bluetooth® HandsFreeLink®	403, 427	
Refuel Recommend	452	

* Not available on all models

About Your Audio System

The audio system features AM/FM radio and SiriusXM® Radio* service. It can also play USB flash drives, and iPod, iPhone and *Bluetooth*® devices.

You can operate the audio system from the buttons and knobs on the panel, the remote controls on the steering wheel, or the icons on the touchscreen interface*.

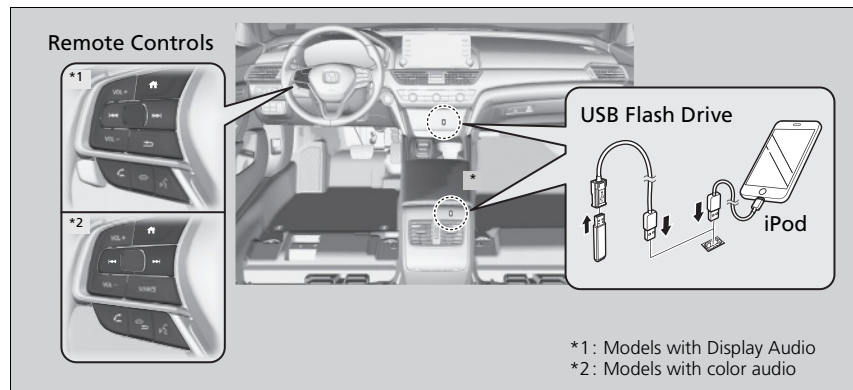

About Your Audio System

iPod, iPhone and iTunes are trademarks of Apple Inc.

State or local laws may prohibit the operation of handheld electronic devices while operating a vehicle.

SiriusXM® Radio* is available on a subscription basis only. For more information on SiriusXM® Radio*, contact a dealer.

General Information on the Audio System P. 348

SiriusXM® Radio* is available in the United States and Canada, except Hawaii, Alaska, and Puerto Rico.

SiriusXM®* is a registered trademark of SiriusXM Radio*, Inc.

USB Port(s)

Install the iPod USB connector or the USB flash drive to the USB port.

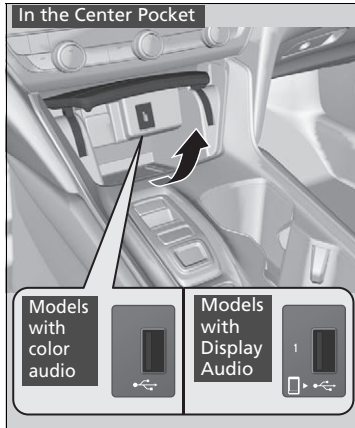

■ In the Center Pocket

Models with color audio

The USB port (1.0A) is for playing audio files on a USB flash drive, connecting a cellular phone and charging devices.

Models with Display Audio

The USB port (2.5A) is for charging devices, playing audio files and connecting compatible phones with Apple CarPlay or Android Auto.

⌘ USB Port(s)

- Do not leave the iPod or USB flash drive in the vehicle. Direct sunlight and high temperatures may damage it.
- We recommend using an extension cable with the USB port.
- Do not connect the iPod or USB flash drive using a hub.
- Do not use a device such as a card reader or hard disk drive, as the device or your files may be damaged.
- We recommend backing up your data before using the device in your vehicle.
- Displayed messages may vary depending on the device model and software version.

If the audio system does not recognize the iPod, try reconnecting it a few times or reboot the device. To reboot, follow the manufacturer's instructions provided with the iPod or visit www.apple.com/ipod.

USB charge

The USB port can supply up to 1.0A/2.5A of power. It does not output 1.0A/2.5A unless the device requests.

For amperage details, read the operating manual of the device that needs to be charged.

Set the power mode to ACCESSORY or ON first.

Under certain conditions, a device connected to the port may generate noise in the radio you are listening to.

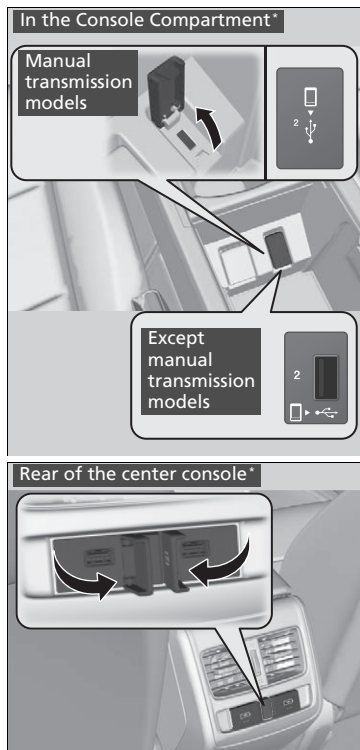

■ **In the console compartment***

The USB port (2.5A) is for charging devices, playing audio files and connecting compatible phones with Apple CarPlay or Android Auto.

■ **Rear of the center console***

The USB ports (2.5A) are only for charging devices.

» USB Port(s)

Rear of the center console*

These ports are for battery charge only. You cannot play music even if you have connected music players to them.

Under certain conditions, a device connected to the port may generate noise in the radio you are listening to.

Audio System Theft Protection

The audio system is disabled when it is disconnected from the power source, such as when the battery is disconnected or goes dead. In certain conditions, the system may display a code entry screen. If this occurs, reactivate the audio system.

■ Reactivating the audio system

1. Set the power mode to ON.
2. Turn on the audio system.
3. Press and hold the audio system power knob for more than two seconds.
 - ▶ The audio system is reactivated when the audio control unit establishes a connection with the vehicle control unit. If the control unit fails to recognize the audio unit, you must go to a dealer and have the audio unit checked.

Audio Remote Controls

Models with color audio

Allow you to operate the audio system while driving.

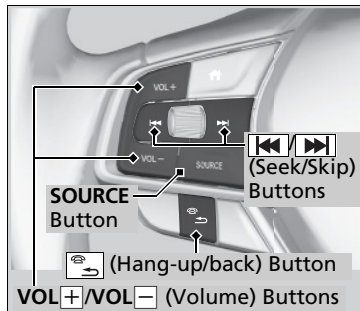

SOURCE Button

Cycles through the audio modes as follows:
 FM1 → FM2 → AM → USB/iPod →
 Pandora® → Bluetooth® Audio

VOL+ / VOL- (Volume) Buttons

Press VOL+: To increase the volume.
Press VOL-: To decrease the volume.

Seek/Skip Buttons

- When listening to the radio
 - Press** : To select the next preset radio station.
 - Press** : To select the previous preset radio station.
 - Press and hold** : To select the next strong station.
 - Press and hold** : To select the previous strong station.
- When listening to an iPod, USB flash drive, or Bluetooth® Audio
 - Press** : To skip to the next song.
 - Press** : To go back to the beginning of the current or previous song.
- When listening to a USB flash drive
 - Press and hold** : To skip to the next folder.
 - Press and hold** : To go back to the previous folder.

Audio Remote Controls

Some modes appear only when an appropriate device or medium is used.

Depending on the Bluetooth® device you connect, some functions may not be operated.

Models with color audio

Press the (Hang-up/back) button to go back to the previous command or cancel a command.

Models with Display Audio

Allow you to operate the audio system while driving. The information is shown on the driver information interface or head-up display*.

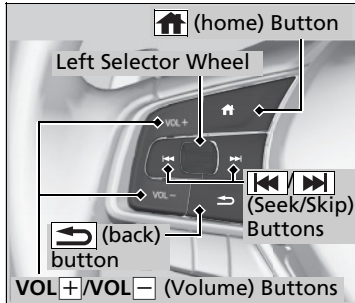
**Left Selector Wheel**

- When selecting the audio mode
Press the  (home) button, then roll up or down to select **Audio** on the driver information interface, and then press the left selector wheel.

VOL+ /VOL- (Volume) Buttons

Press VOL+: To increase the volume.

Press VOL-: To decrease the volume.

▶▶ Audio Remote Controls**Models with Display Audio**

Press the  (back) button for the driver information interface to go back to the previous screen or cancel a command.

Press the  (home) button to go back to the home screen of the driver information interface.







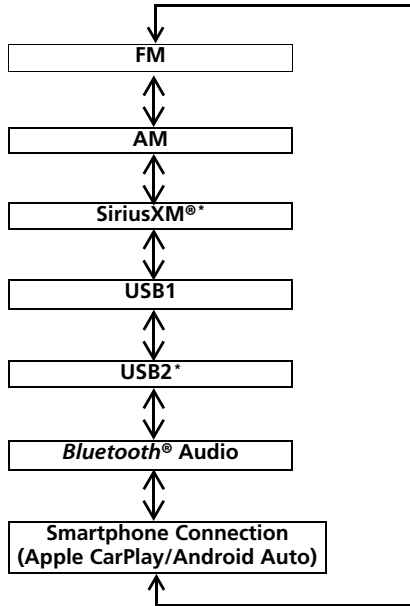

* Not available on all models

Roll up or down:

To cycle through the audio modes, roll up or down and then press the left selector wheel:



(Seek/Skip) Buttons

- When listening to the radio
 - Press** : To select the next preset radio station.
 - Press** : To select the previous preset radio station.
 - Press and hold** : To select the next strong station.
 - Press and hold** : To select the previous strong station.
- When listening to an iPod, USB flash drive, or *Bluetooth*® Audio, or Smartphone Connection
 - Press** : To skip to the next song.
 - Press** : To go back to the beginning of the current or previous song.
- When listening to a USB flash drive
 - Press and hold** : To skip to the next folder.
 - Press and hold** : To go back to the previous folder.

Models with color audio

To use the audio system function, the power mode must be in ACCESSORY or ON.

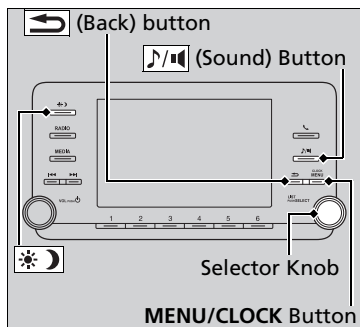

Use the selector knob or **MENU/CLOCK** button to access some audio functions.

Press to switch between the normal and extended display for some functions.

Selector knob: Rotate left or right to scroll through the available choices. Press to set your selection.

MENU/CLOCK button: Press to select any mode.

The available mode includes the wallpaper, display, clock, language setup, and play modes. Play modes can be also selected from scan, random, repeat, and so on.

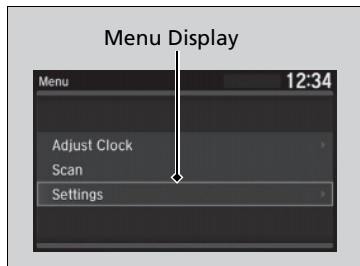

(Back) button: Press to go back to the previous display.

(Sound) button: Press to select the sound setting mode.

(Day/Night) button: Press to change the audio/information screen brightness.

Press , then adjust the brightness using .

- ▶ Each time you press , the mode switches between the daytime mode, nighttime mode and OFF mode.

Audio System Basic Operation

These indications are used to show how to operate the selector knob.

Rotate to select.

Press to enter.

Menu Items

- ▶ **Adjust Clock** P. 164
- ▶ **Wallpaper Setup** P. 255
- ▶ **Display Setup** P. 258
- ▶ **Scan** P. 300
- ▶ **Play Mode** P. 263
- ▶ **RDS Settings** P. 260
- ▶ **Bluetooth** P. 269

Press the **SOURCE**, **VOL+**/**VOL-**, or button on the steering wheel to change any audio setting.

- ▶ **Audio Remote Controls** P. 248

Audio/Information Screen

Displays the audio status and wallpaper. From this screen, you can go to various setup options.

Switching the Display

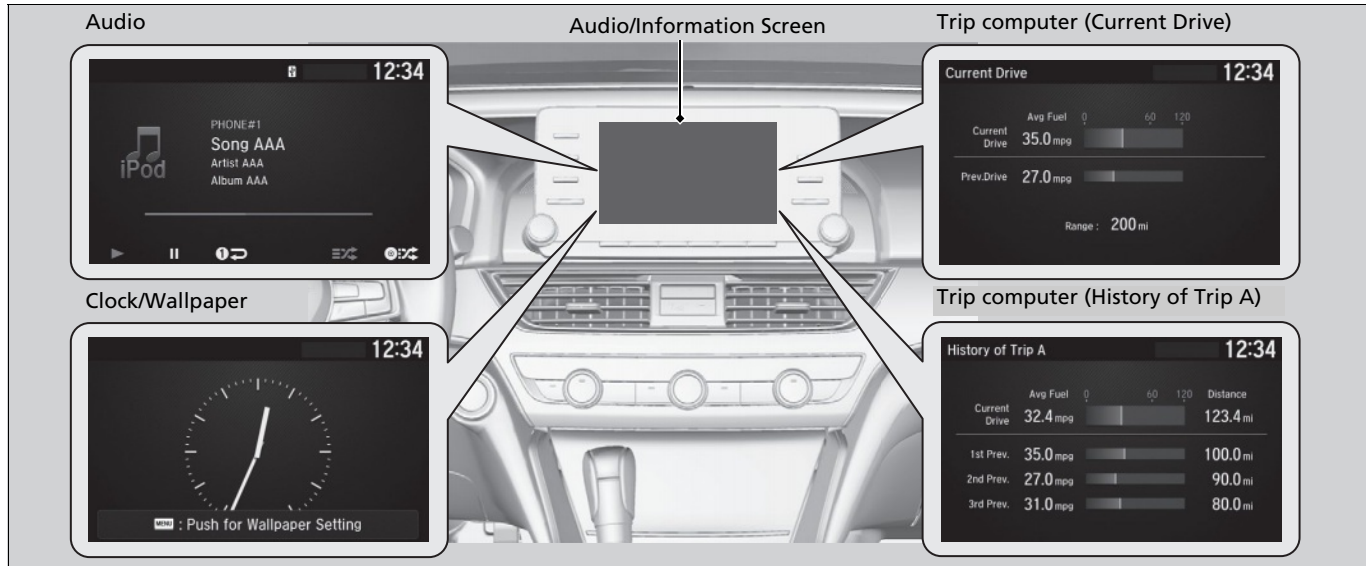

■ Audio

Shows the current audio information.

■ Trip computer (Current Drive)

Shows the range, and instant and average fuel economy of the current trip, as well as the average fuel economy from your last trip.

■ Trip computer (History of Trip A)







Shows the average fuel economy and distance traveled for the current trip, as well as the average fuel economy and distances traveled during the last three driving cycles.

Each time you reset the trip meter A, the information on the display updates. The history of the previous three driving cycles is kept.

■ Clock/Wallpaper

Shows a clock screen or an image you import.

■ Change display

1. Press the **MENU/CLOCK** button.
2. Rotate  to select **Settings**, then press .
3. Rotate  to select **Display Change**, then press .
4. Rotate  to select **Clock/Wallpaper**, then press .
 - ▶ If you want to return to the audio display, select **Audio**.

Wallpaper Setup

You can change, store, and delete the wallpaper on the audio/information screen.

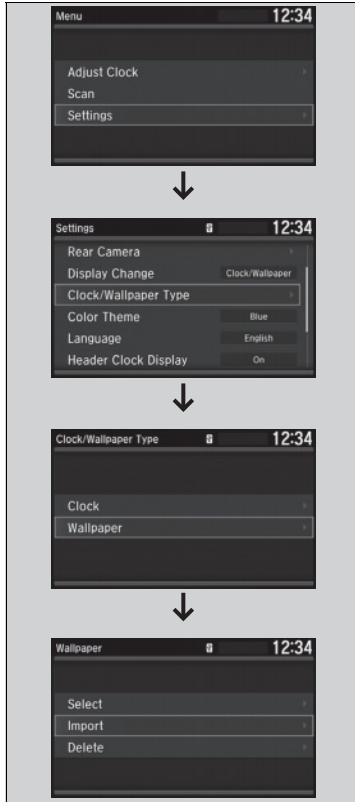

■ Import wallpaper

You can import up to three images, one at a time, for wallpaper from a USB flash drive.











1. Connect the USB flash drive to the USB port.
 - ▶ **USB Port(s)** P. 245
2. Press the **MENU/CLOCK** button.
3. Rotate to select **Settings**, then press .
4. Rotate to select **Clock/Wallpaper Type**, then press .
5. Rotate to select **Wallpaper**, then press .
6. Rotate to select **Import**, then press .
 - ▶ The picture name is displayed on the list.
7. Rotate to select a desired picture, then press .
 - ▶ The selected picture is displayed.
8. Press to save the picture.
9. Press to select **OK**.
10. Rotate to select a location to save the picture, then press .
 - ▶ The display will return to the wallpaper setting screen.

⌘ Wallpaper Setup





- When importing wallpaper files, the image must be in the USB flash drive's root directory. Images in a folder cannot be imported.
- The file name must be fewer than 32 characters.
- The file format of the image that can be imported is BMP (bmp) or JPEG (jpg).
- The individual file size limit is 2 MB.
- The maximum image size is 1,920 x 936 pixels. If the size of the image is small, it will be enlarged, with the aspect ratio remaining the same.
- Up to 255 files can be selected.
- If the USB flash drive does not have any pictures, the **Unable to load image** message appears.
- The wallpaper setup is limited while driving.

Continued











■ Select wallpaper

1. Press the **MENU/CLOCK** button.
2. Rotate  to select **Settings**, then press .
3. Rotate  to select **Clock/Wallpaper Type**, then press .
4. Rotate  to select **Wallpaper**, then press .
5. Rotate  to select **Select**, then press 
 - ▶ The screen changes to the wallpaper list.
6. Rotate  to select a desired wallpaper, then press .

■ To view wallpaper once it is set

1. Press the **MENU/CLOCK** button.
2. Rotate  to select **Settings**, then press .
3. Rotate  to select **Display Change**, then press .
4. Rotate  to select **Clock/Wallpaper**, then press .
5. Press the  (Back) button until the top screen is displayed.

■ Delete wallpaper

1. Press the **MENU/CLOCK** button.
2. Rotate  to select **Settings**, then press .
3. Rotate  to select **Clock/Wallpaper Type**, then press .
4. Rotate  to select **Wallpaper**, then press .
5. Rotate  to select **Delete**, then press 
 - ▶ The screen changes to the wallpaper list.
6. Rotate  to select a wallpaper that you want to delete, then press .
7. Rotate to select **Yes**, then press 
 - ▶ The display will return to the wallpaper setting screen.

▶▶ Wallpaper Setup

To go back to the previous screen, press the  (Back) button.

When the file size is large, it takes a while to be previewed.

Adjusting the Sound

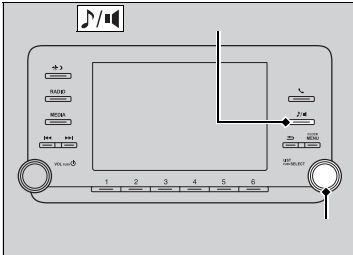

Press the (sound) button, and rotate to scroll through the following choices:

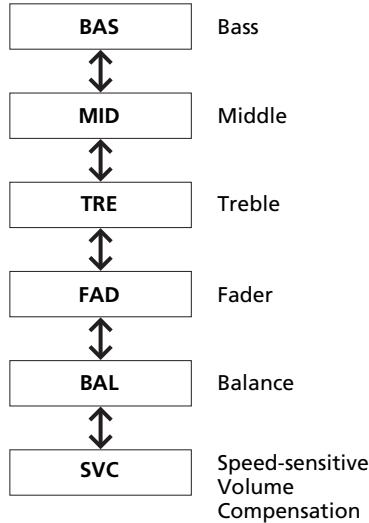

Rotate to adjust the sound setting, then press .

Adjusting the Sound









The SVC has four modes: **Off**, **Low**, **Mid**, and **High**. SVC adjusts the volume level based on the vehicle speed. As you go faster, audio volume increases. As you slow down, audio volume decreases.

Display Setup

You can change the brightness or color theme of the audio/information screen.







■ Changing the Screen Brightness

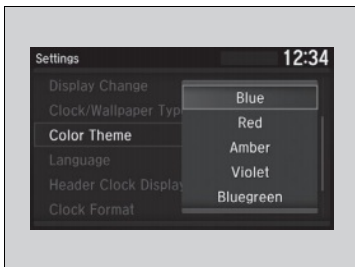

1. Press the **MENU/CLOCK** button.
2. Rotate  to select **Settings**, then press .
3. Rotate  to select **Display Adjustment**, then press .
4. Rotate  to select **Brightness**, then press .
5. Rotate  to adjust the setting, then press .

■ Changing the Screen's Color Theme



1. Press the **MENU/CLOCK** button.
2. Rotate  to select **Settings**, then press .
3. Rotate  to select **Color Theme**, then press .
4. Rotate  to select the setting you want, then press .

▶▶ Changing the Screen Brightness

You can change the **Contrast** and **Black Level** settings in the same manner.

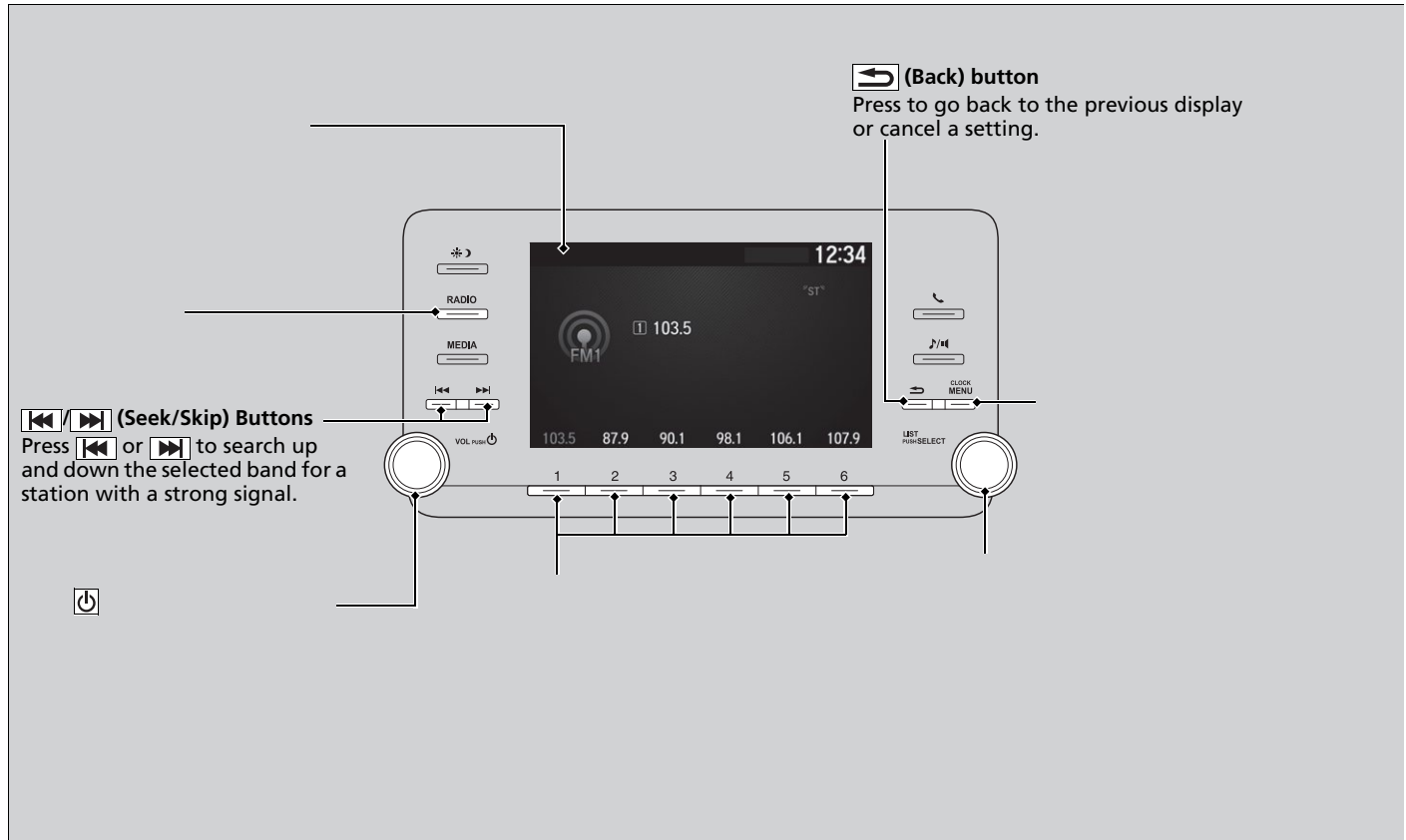

Playing AM/FM Radio



Radio Data System (RDS)



Provides text data information related to your selected RDS-capable FM station.

To find an RDS station from Station List

1. Press  while listening to an FM station.
2. Rotate  to select the station, then press .





Update List

Updates your available station list at any time.

1. Press  while listening to an FM station.
2. Rotate  to select **Update List**, then press .

Radio text

Displays the radio text information of the selected RDS station.

1. Press the **MENU/CLOCK** button.
2. Rotate  to select **Settings**, then press .
3. Rotate  to select **RDS Settings**, then press .
4. Rotate  to select **Radio Text**, then press .

Scan

Samples each of the strongest stations on the selected band for 10 seconds.

1. Press the **MENU/CLOCK** button.
2. Rotate  to select **Scan**, then press .

To turn off scan, press .

▶▶ Playing AM/FM Radio

The **ST** indicator appears on the display indicating stereo FM broadcasts. Stereo reproduction in AM is not available.

Switching the Audio Mode

Press the **SOURCE** button on the steering wheel.

 **Audio Remote Controls** P. 248

You can store 6 AM stations and 12 FM stations into the preset memory. FM1 and FM2 let you store 6 stations each.

▶▶ Radio Data System (RDS)

When you select an RDS-capable FM station, the RDS automatically turns on, and the frequency display changes to the station name. However, when the signals of that station become weak, the display changes from the station name to the frequency.

Playing an iPod

Connect the iPod using your dock connector to the USB Port, then press the **MEDIA** button.

 **USB Port(s)** P. 245

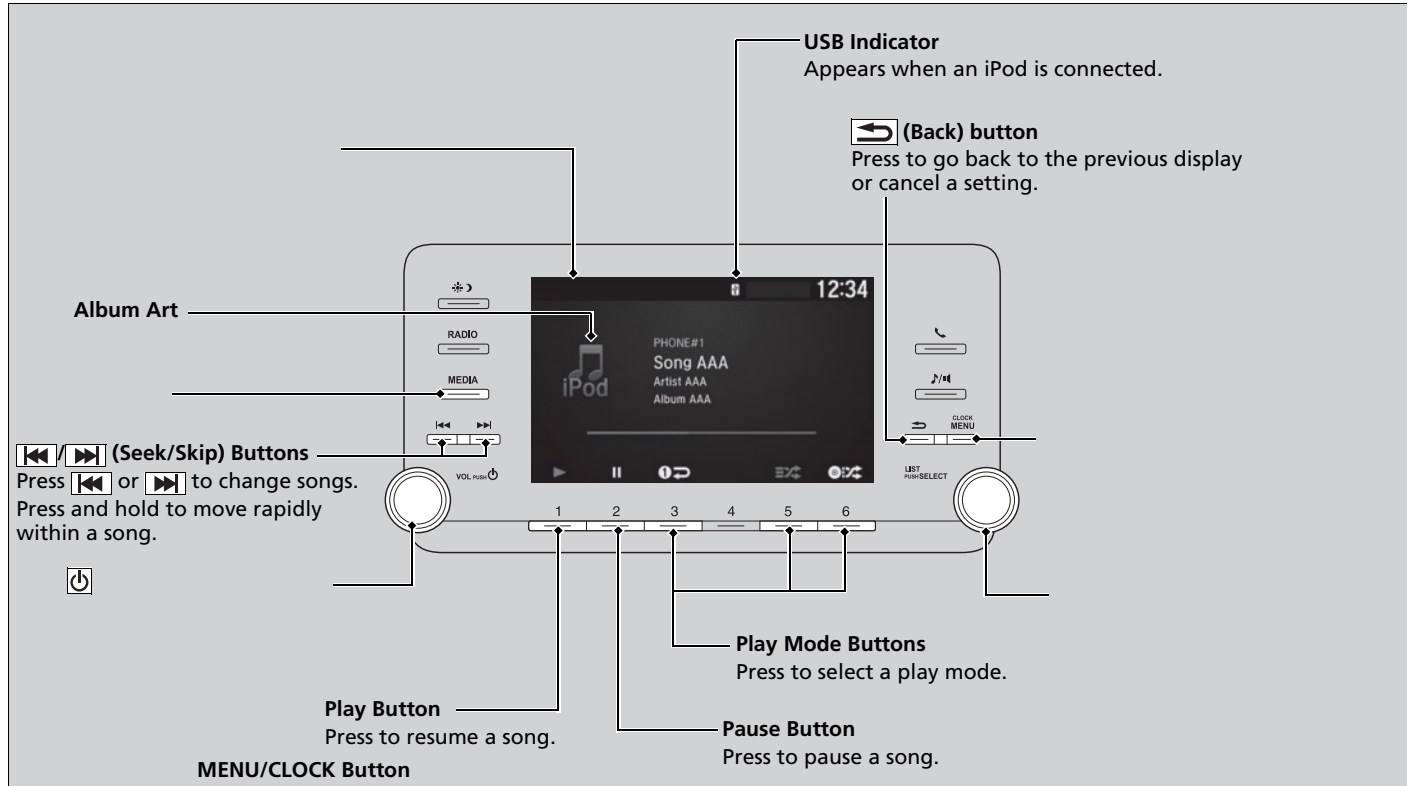

Features

How to Select a Song from the iPod Music List with the Selector Knob

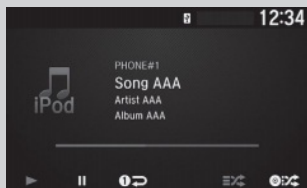

Category Selection



Item Selection



1. Press to display the iPod music list.

2. Rotate to select a category.

3. Press to display a list of items in the category.

4. Rotate to select an item, then press .
▶ Press and rotate repeatedly until a desired item you want to listen is displayed.

▶▶ Playing an iPod

Available operating functions vary on models or versions. Some functions may not be available on the vehicle's audio system.

If there is a problem, you may see an error message on the audio/information screen.

iPod/USB Flash Drive P. 343

How to Select a Play Mode

You can select repeat and shuffle modes when playing a song.



Available mode icons appear above the play mode buttons.

Press the button corresponding to the mode you want to select.

To turn off a play mode

Press the selected button.

How to Select a Play Mode

Play Mode Menu Items



 **Shuffle Albums:** Plays all available albums in a selected category (playlists, artists, albums, songs, genres, or composers) in random order.



 **Shuffle All:** Plays all available songs in a selected category (playlists, artists, albums, songs, genres, or composers) in random order.

 **Repeat One Track:** Repeats the current song.

You can also select a play mode by pressing the **MENU/CLOCK** button.

Rotate  to select **Play Mode**, then press .

Rotate  to select a mode, then press .

To turn it off, rotate  to select **Normal Play**, then press .

Playing Pandora®

Your audio system allows you to listen to music from the Pandora® app on a compatible smartphone.

This function is available when the phone is paired and connected to the vehicle's *Bluetooth®* HandsFreeLink® (HFL) system, or with an iPhone, you can connect using your USB cable to the USB port.

▶ **Phone Setup** P. 409

▶ **USB Port(s)** P. 245

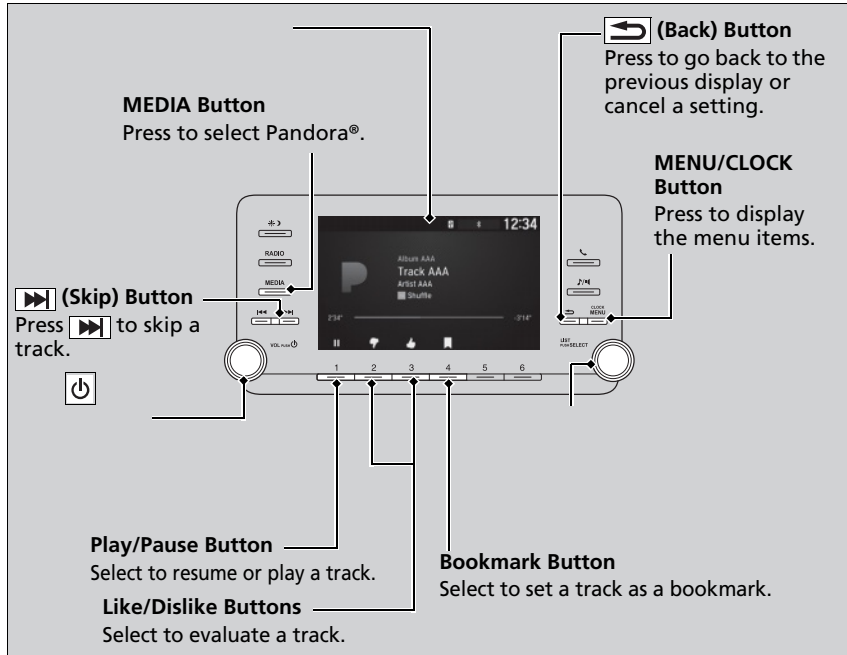

▶▶ Playing Pandora®

Pandora®, the Pandora logo, and the Pandora trade dress are trademarks or registered trademarks of Pandora Media, Inc., used with permission. Pandora is only available in certain countries. Visit the Pandora website for more information.

To find out if your phone is compatible with this feature, visit automobiles.honda.com/handsfreelink/ or call 1-888-528-7876.

To use this service in your vehicle, the Pandora® app must first be installed on your phone. Visit www.pandora.com for more information.

Find the music you love and let the music you love find you. Pandora® gives you a personalized music experience that continually evolves with your tastes. Create personalized stations from songs, artists or genres. Not sure where to start? Use our voice search to easily find stations that match your mood or activity.



If you cannot operate Pandora® through the audio system, it may be streaming through *Bluetooth®* Audio. Make sure Pandora® mode on your audio system is selected.

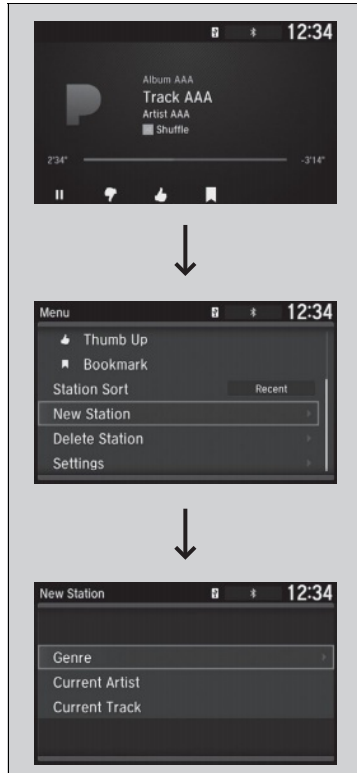

How to Create a Station

You can create a station when playing Pandora®.



1. Press the **MENU/CLOCK** button.

2. Rotate  to select **New Station**, then press .

3. Rotate  to select an item, then press .
▶ You can select **Genre**, **Current Artist**, or **Current Track**.



How to Create a Station

Available operating functions vary on software versions. Some functions may not be available on the vehicle's audio system.

If there is a problem, you may see an error message on the audio/information screen.

 Pandora® P. 345

Pandora® may limit the total number of skips allowed on the service. If you dislike a track after the skip limit has been reached, your feedback will be saved but the current track will continue to play.

To change stations, press  on the main Pandora® screen, and rotate  to select **Station List**, and then select a new station.

Playing a USB Flash Drive

Your audio system reads and plays sound files on a USB flash drive in either MP3, WMA or AAC*1 format.

Connect your USB flash drive to the USB port, then press the **MEDIA** button.

➤ **USB Port(s)** P. 245

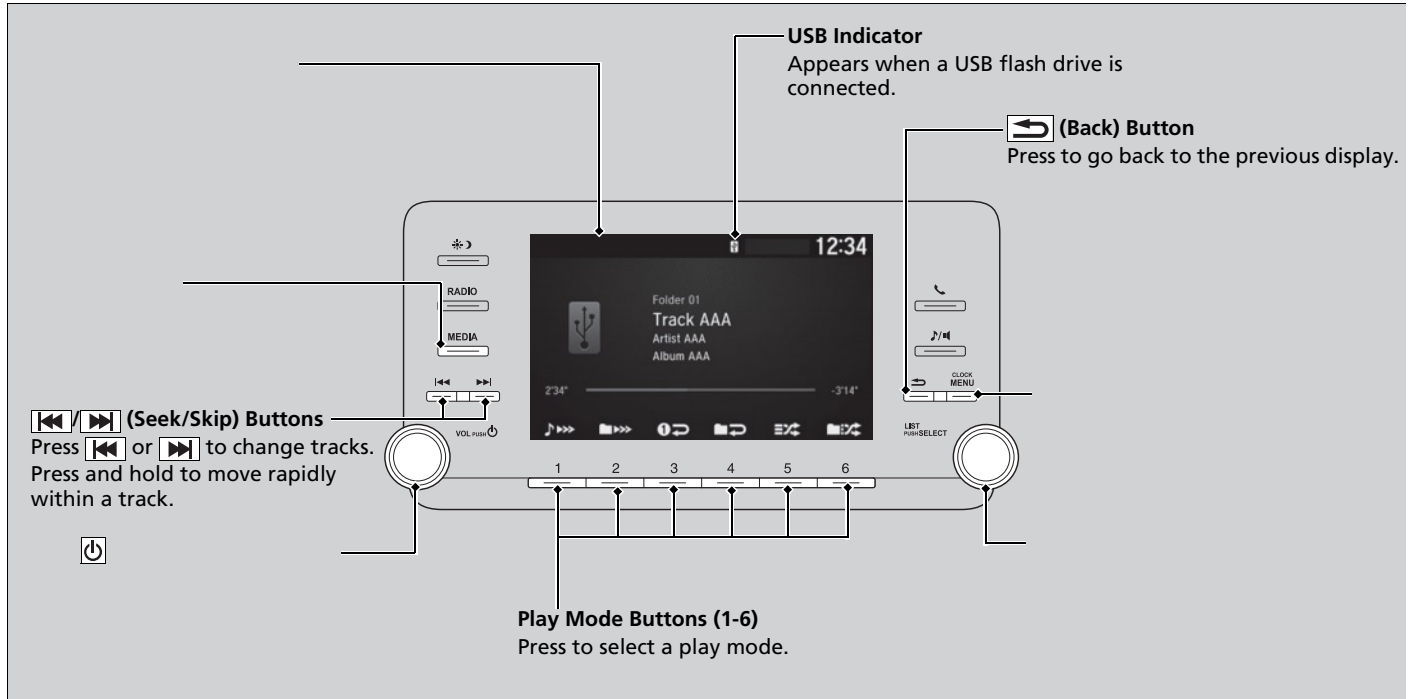

*1: Only AAC format files recorded with iTunes are playable on this unit.

How to Select a File from a Folder with the Selector Knob

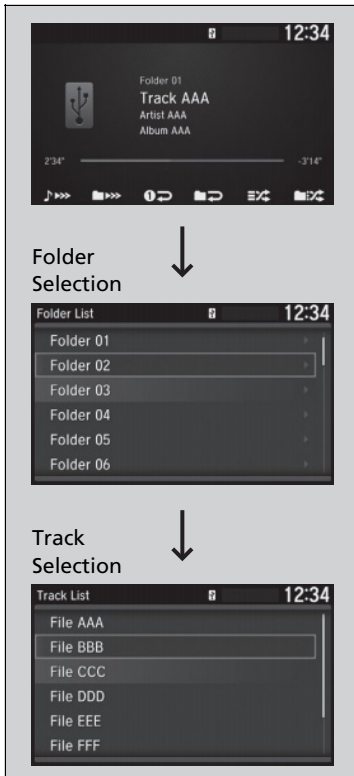

1. Press to display a folder list.
2. Rotate to select a folder.
3. Press to display a list of files in that folder.
4. Rotate to select a file, then press .

▶▶ Playing a USB Flash Drive

Use the recommended USB flash drives.

▶ **General Information on the Audio System**
P. 348

Files in WMA format protected by digital rights management (DRM) cannot be played.

The audio system displays **Unplayable File**, and then skips to the next file.

If there is a problem, you may see an error message on the audio/information screen.

▶ **iPod/USB Flash Drive** P. 343

Continued

■ How to Select a Play Mode

You can select repeat, random, and scan modes when playing a file.



Available mode icons appear above the play mode buttons.

Press the button corresponding to the mode you want to select.

■ To turn off a play mode

Press the selected button.

▶▶ How to Select a Play Mode

Play Mode Menu Items

Repeat

Repeat One Folder: Repeats all files in the current folder.

Repeat One Track: Repeats the current file.

Random

Random in Folder: Plays all files in the current folder in random order.

Random All: Plays all files in random order.

Scan

Scan Folders: Provides 10-second sampling of the first file in each of the main folders.

Scan Tracks: Provides 10-second sampling of all files in the current folder.

You can also select a play mode by pressing the **MENU/CLOCK** button.

Rotate to select **Play Mode**, then press .

Rotate to select a mode, then press .

To turn it off, rotate to select **Normal Play**, then press .

Playing *Bluetooth*® Audio

Your audio system allows you to listen to music from your *Bluetooth*-compatible phone.

This function is available when the phone is paired and connected to the vehicle's *Bluetooth*® HandsFreeLink® (HFL) system.

📱 **Phone Setup** P. 432

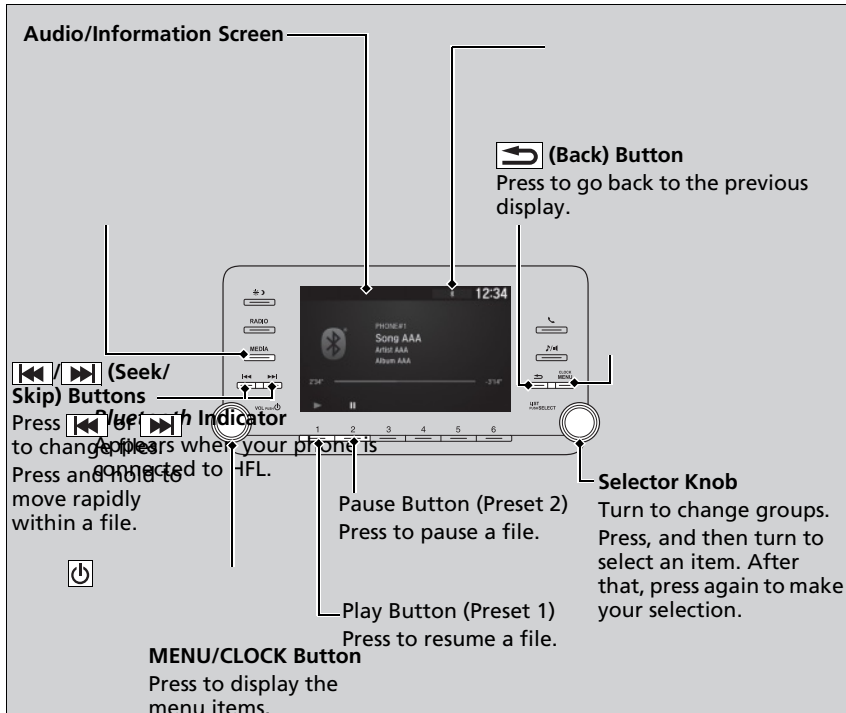

▶▶ Playing *Bluetooth*® Audio

Not all *Bluetooth*-enabled phones with streaming audio capabilities are compatible with the system.

For a list of compatible phones:

- U.S.: Visit automobiles.honda.com/handsfreelink/, or call 1-888-528-7876.
- Canada: For more information on smartphone compatibility, call 1-888-528-7876.

In some states, it may be illegal to perform some data device functions while driving.

Only one phone can be used with HFL at a time. When there are more than two paired phones in the vehicle, the first paired phone the system finds is automatically connected.

If more than one phone is paired to the HFL system, there will be a delay before the system begins to play.

In some cases, the name of the artist, album, or track may not appear correctly.

Some functions may not be available on some devices.

■ To Play *Bluetooth*® Audio Files

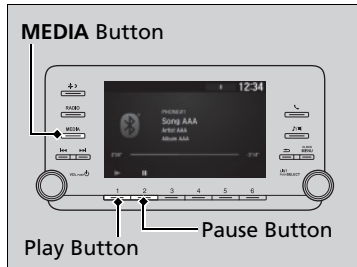

1. Make sure that your phone is paired and connected to HFL.
2. Press the **MEDIA** button until the *Bluetooth*® Audio mode is selected.

If the phone is not recognized, another HFL-compatible phone, which is not compatible for *Bluetooth*® Audio, may already be connected.

■ To pause or resume a file

Press the play or pause button to select a mode.

▶▶ To Play *Bluetooth*® Audio Files

To play the audio files, you may need to operate your phone. If so, follow the phone maker's operating instructions.

The pause function may not be available on some phones.

If any audio device is connected to the USB port, you may need to press the **MEDIA** button repeatedly to select the *Bluetooth*® Audio system.

Switching to another mode pauses the music playing from your phone.

How to Select a Song from the Music Search List with the Selector Knob

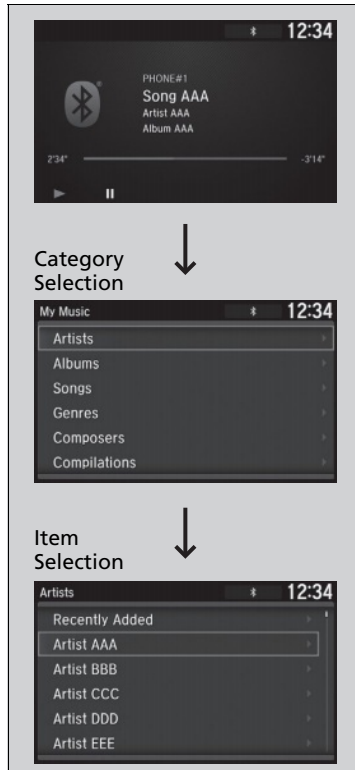

1. Press to display the music search list.

2. Rotate to select a category.

3. Press to display a list of items in the category.

4. Rotate to select an item, then press .
▶ Press and rotate repeatedly until a desired item you want to listen is displayed.

How to Select a Song from the Music Search List with the Selector Knob

Depending on the *Bluetooth*® device you connect, some or all of the categories may not be displayed.

Siri® Eyes Free

You can talk to Siri using the  (Talk) button on the steering wheel when your iPhone is paired to the *Bluetooth*® HandsFreeLink® (HFL) system.

➤ **Phone Setup** P. 409

▶▶ Siri® Eyes Free

Siri is a trademark of Apple Inc.

Check Apple Inc. website for features available for Siri.

We recommend against using Siri other than in Siri® Eyes Free while operating a vehicle.

▶▶ Using Siri® Eyes Free

Some commands work only on specific phone features or apps.

Siri® Eyes Free can be used only to play music from an iPod.

■ Using Siri® Eyes Free

(Hang-up/back) Button

Press to deactivate Siri® Eyes Free.

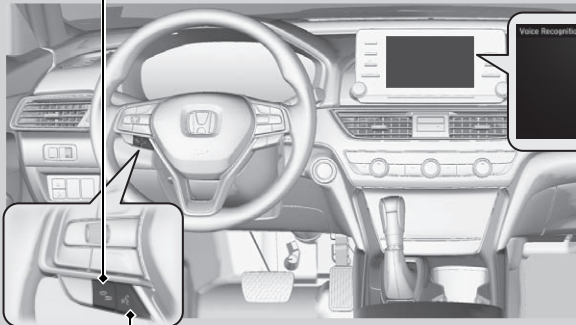

Appears when Siri is activated in Siri® Eyes Free

While in Siri® Eyes Free:

The display remains the same. No feedback or commands appear.

(Talk) Button

Press and hold until the display changes as shown.

Audio System Basic Operation

Models with Display Audio

To use the audio system function, the power mode must be in ACCESSORY or ON.

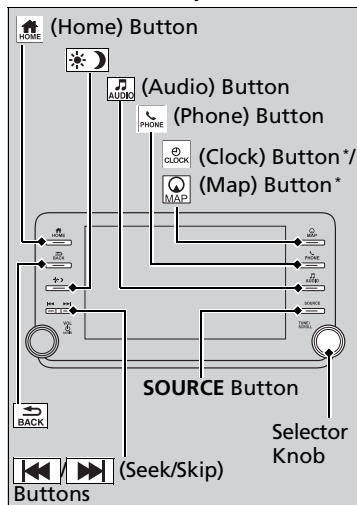

(Home) Button: Press to go to the home screen.

Switching the Display P. 138

(Back) Button: Press to go back to the previous display when it is displayed.

(Seek/Skip) Buttons: Press to change songs.

(Clock) Button*: Press to display the clock screen.



(Map) Button*: Press to display the map screen.

(Phone) Button: Press to display the phone screen.

(Audio) Button: Press to display the current audio information.

SOURCE Button: Press to display the source select screen.

Selector Knob: Rotate left or right to scroll through the available choices. Press  to set your selection.

(Day/Night) Button: Press to change the audio/information screen brightness. Press  once and select  or  to make an adjustment.

► Each time you press , the mode switches among the daytime mode, nighttime mode and off mode.

Audio System Basic Operation

These indications are used to show how to operate the Selector Knob.

Rotate  to select.

Press  to enter.

Selector Knob

When the list is not displayed, songs, frequency, etc. can be changed.

While connected to Apple CarPlay, it changes as follows:

- Pressing the Phone Button, display the Apple CarPlay phone screen.
- Pressing the Audio Button, display the Apple CarPlay audio screen.

* Not available on all models

Audio/Information Screen

Displays the audio status and wallpaper. From this display, you can go to various setup options.

■ Switching the Display

■ Using the audio/information screen

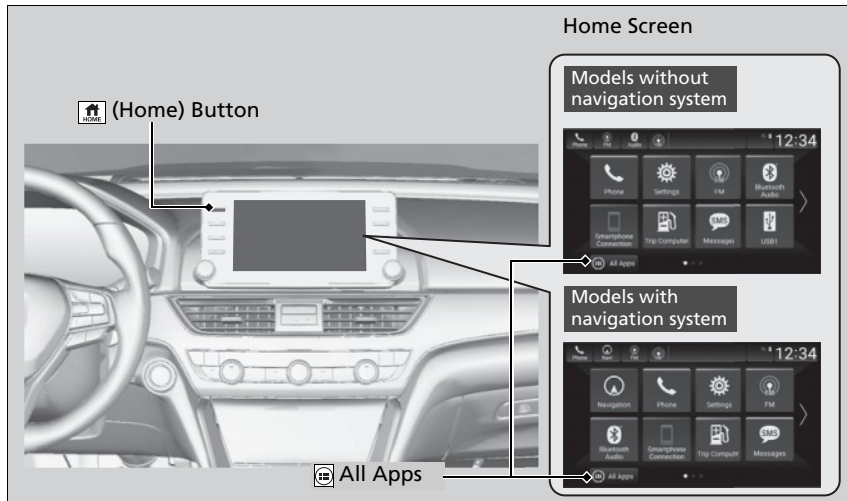

Press the  button to go to the home screen.

Select the following icons on the home screen or after selecting  **All Apps**.

■ Phone

Displays the HFL information.

▶ **Bluetooth® HandsFreeLink®** P. 427

▶▶ Audio/Information Screen

Touchscreen Operation

- Use simple gestures - including touching, swiping, and scrolling - to operate certain audio functions.
- Some items may be grayed out during driving to reduce the potential for distraction.
- You can select them when the vehicle is stopped or use voice commands.
- Wearing gloves may limit or prevent touchscreen response.

You can change the touchscreen sensitivity setting.

▶ **Customized Features** P. 381

■ Trip Computer

Displays the trip computer information.

- **Current Drive** tab: Displays the current trip information.
- **Trip A/Trip B** tab: Displays information for the current and three previous drives.
The information is stored every time you reset Trip A/B.
To reset the Trip A/B, select **Settings**, then select **Delete Trip History**.
To change the setting of how to reset Trip A/B, select **OK**.

■ Clock

Displays the clock.

■ System Updates

Updates the software version of the audio system.

📖 **System Updates** P. 286

■ FM/AM/SiriusXM*/USB1/USB2*/Bluetooth Audio/Smartphone Connection

Displays the each audio information.

■ Settings

Enters the customizing menu screen.

📖 **Customized Features** P. 381

■ Navigation*

Displays the navigation screen.

📖 **Refer to the Navigation System Manual**

■ **HondaLink**

Displays the HondaLink screen.

➤ **HondaLink**® P. 321

■ **Apple CarPlay/Android Auto**

Displays the **Apple CarPlay** or **Android Auto** screen.

➤ **Apple CarPlay**® P. 336

➤ **Android Auto**™ P. 339

■ **Messages**

Displays the text message screen.

➤ **Bluetooth**® **HandsFreeLink**® P. 427

■ **AT&T Hotspot***

Displays the AT&T Hotspot screen.

■ **NFC Manager***

Displays the Near Field Communication (NFC) manager screen.

➤ **Near Field Communication (NFC)*** P. 332

■ **Compass***

Displays the compass screen.

Wallpaper Setup

You can change, store, and delete the wallpaper on the audio/information screen.

Import wallpaper

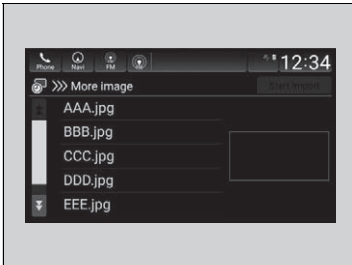

1. Connect the USB flash drive to the USB port in the center pocket or console compartment*.

▶ **USB Port(s)** P. 245

2. Select **Clock**.
3. Select **Settings**.
4. Select **Clock Faces**.
5. Select **Add New Wallpaper**.
 - ▶ The **Searching...** screen is displayed.
6. Import a desired picture.
 - ▶ Multiple pictures can be imported at the same time.
7. Select **Start Import**.
 - ▶ The display will return to the **Clock Faces** screen.

Wallpaper Setup

The wallpaper you set up on **Clock Faces** cannot be displayed on the driver information interface.

- The file name must be fewer than 255 characters.
- The file format of the image that can be imported is BMP (bmp) or JPEG (jpg).
- If the USB flash drive does not have any pictures, the **No files detected** message appears.
- Up to five pictures can be imported.
- The maximum image size is 1,920 × 936 pixels. If the image size is less the image is displayed in the middle of the screen with the extra area appearing in black.

* Not available on all models

■ Select wallpaper

1. Select **Clock**.
2. Select **Settings**.
3. Select **Clock Faces**.
4. Select a desired wallpaper.
5. Select **Set**.
 - ▶ The display will return to the **Clock Faces** screen.

■ To view wallpaper once it is set

1. Press the  button.
2. Select **Clock**.

■ Delete wallpaper

1. Select **Clock**.
2. Select **Settings**.
3. Select **Clock Faces**.
4. Select a desired wallpaper.
5. Select **Delete**.
6. Select **Yes**.
 - ▶ The display will return to the **Clock Faces** screen.



▶▶ Wallpaper Setup

You cannot delete the initial imported wallpapers.

Home Screen

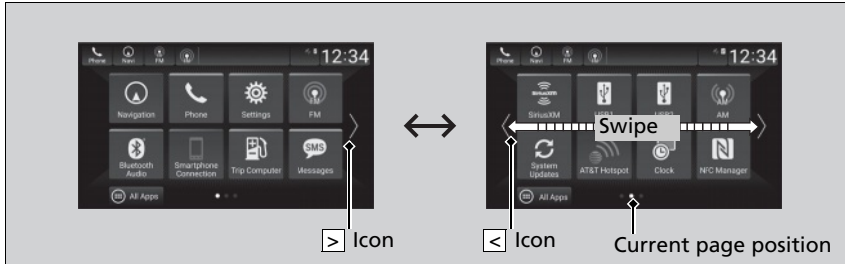
■ To change to a next screen



Selecting  or , or swiping the screen left or right changes to the next screen.

Home Screen

The home screen has 2 or 3 pages. You can add up to 7 pages.

Press the  button to go directly back to the first page of the home screen from any page.

■ To add app icons on the home screen

App icons can be added on the home screen.



1. Press the  button.
2. Select and hold the home screen.
3. Select **Add**.
4. Drag and drop the icon to where you want it to be.
5. Select **Done**.
 - ▶ The screen will return to the home screen.

▶▶ To add app icons on the home screen

You can add app icons by the following procedure.

1. Press the  button.
2. Select **All Apps**.
3. Select **Customize**.
4. Select **Add**.
5. Drag and drop the icon to where you want it to be.
6. Select **Done**.
 - ▶ The screen will return to the home screen.

Pre-installed apps may not start up normally. If this occurs, you need to reset the system.

▶ **Defaulting All the Settings** P. 399

If you perform **Factory Data Reset**, it may reset all the settings to their factory default.

▶ **Defaulting All the Settings** P. 399

In case those apps still do not startup normally even after **Factory Data Reset**, contact your dealer.

There is a possibility that a browser is shut down in the situation of the use. In that situation, the screen will return to before the browser startup.

■ To move icons on the home screen

You can change location on the home screen.

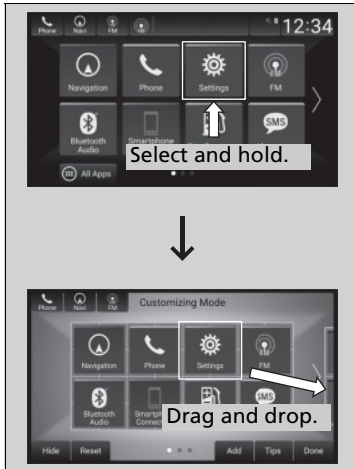

1. Select and hold an icon.
 - ▶ The screen switches to the customization screen.
2. Drag and drop the icon to where you want it to be.
3. Select **Done**.
 - ▶ The screen will return to the home screen.

☒ To move icons on the home screen

Select **Tips** to show tips. To hide them, select it again.

■ To remove icons on the home screen

You can delete the icons on the home screen.

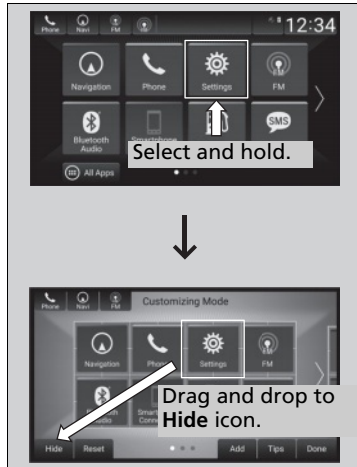

1. Select and hold an icon.
 - ▶ The screen switches to the customization screen.
2. Drag and drop the icon you want to remove to the **Hide** icon.
 - ▶ The icon is removed from the home screen.
3. Select **Done**.
 - ▶ The screen will return to the home screen.

▶▶ To remove icons on the home screen

Apps will not be deleted by deleting the icon on the home screen.

Select **Tips** to show tips. To hide them, select it again.

■ To shortcut icons on the home screen

You can store up to three icons on the upper left of the home screen.

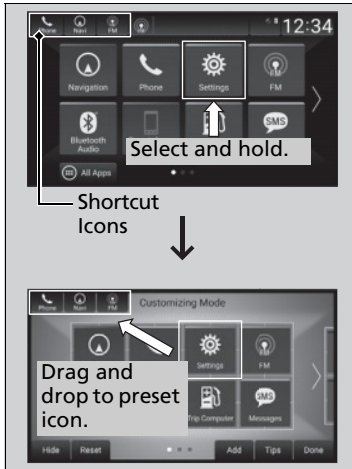

1. Select and hold an icon.
 - ▶ The screen switches to the customization screen.
2. Drag and drop the icon you want to store to the upper left of the home screen.
 - ▶ The icon is shortcut.
3. Select **Done**.
 - ▶ The screen will return to the home screen.

▶▶ To shortcut icons on the home screen

Select **Tips** to show tips. To hide them, select it again.

Status Area



1. Select the system status icon.
 - ▶ The status area appears.
2. Select an item to see the details.
3. Press the **BACK** button or the system status icon to close the area.

■ Customizing the Meter

You can edit, show, or hide the meter contents on the driver information interface.

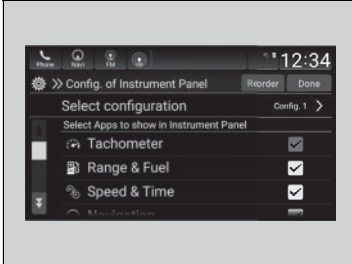

1. Press the  button.
2. Select **Settings**.
3. Select **System**.
4. Select **Config. of Instrument Panel**.
5. Select and hold the content you wish to show or hide.
 - ▶ The checked items are displayed on the driver information interface.

■ Editing order

To change the order of the contents on the driver information interface, first select:

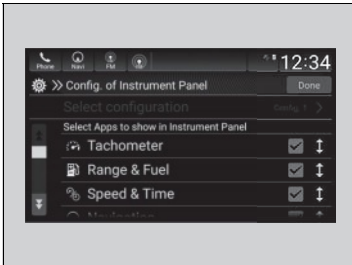

1. Press the  button.
2. Select **Settings**.
3. Select **System**.
4. Select **Config. of Instrument Panel**.
5. Select **Reorder**.
6. Select and hold the contents you want to move.
7. Drag and drop the contents to where you want it to be.
8. Select **Done**.

☒ Customizing the Meter

You can store up to three customized configurations. To select or customize a configuration, select **Select configuration..** When you select **Select configuration.** during customization, the settings you changed will be saved.

System Updates

The audio system's firmware can be updated with a Wi-Fi connection, or with a USB device.

■ How to Update Wirelessly

■ Wireless connection mode setup

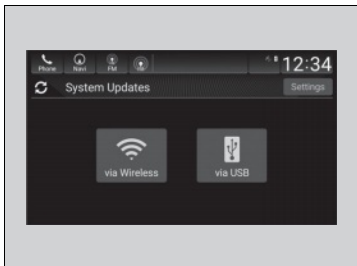

1. Press the  button.
2. Select **System Updates**.
3. Select **Settings**.
4. Select **Connection Setup**.
5. Select **Wi-Fi**.

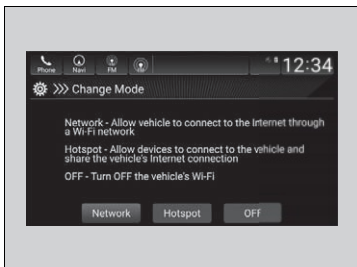

6. Select **Change Mode**.
7. Select **Network**, then **Confirm**.
 - ▶ The display returns to the network list.
8. Select an access point from the network list, then **Save**.
 - ▶ If the audio system requires a password, enter a password.

▶▶ Wireless connection mode setup

If your vehicle has a telematics control unit (TCU), you do not need the wireless connection mode setup.

■ How to update

When the audio system update is available, the notification is shown on the audio/information screen. Use the following procedure to update the system.



1. Press the  button.
2. Select **System Updates**.

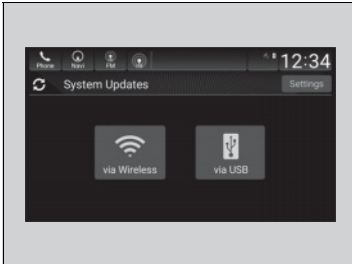

3. Select **via Wireless**.
 - ▶ If a notification is displayed on the screen, the screen of step 5 will be displayed.
4. Select **Download Now**.
 - ▶ A notification appears on the screen.

☒ How to update

You can update the system via Wi-Fi, but cannot use the captive portal that require login or agreement the terms of use on the browser.

Your download will be canceled if:

- Your Wi-Fi connection is severed.
- You turn off the ignition when the battery is low on power.

Your download will recommence the next time a Wi-Fi connection is established.

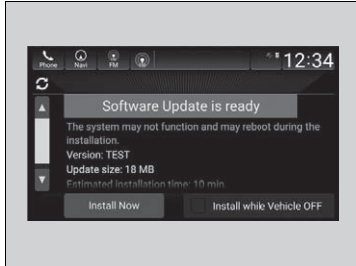

5. Select **Install Now** or **Install while Vehicle OFF**.

- ▶ A notification appears on the screen if the update is successful.

▶▶ How to update

For battery protection, **Install while Vehicle OFF** cannot be selected when the battery is low on power. If you want to install the updated data, recharge the battery or select **Install Now**.

■ Automatic download settings

Use the following procedure to change to the automatic download setting.

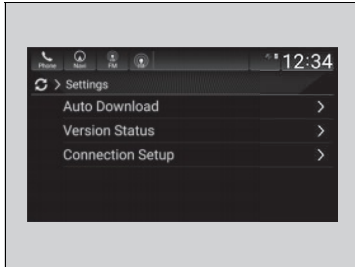

1. Press the  button.
2. Select **System Updates**.
3. Select **Settings**.
4. Select **Auto Download**.
5. Select the access point, then **Yes**.

■ View a version and update status



Use the following procedure to confirm the version and update status.

1. Press the  button.
2. Select **System Updates**.
3. Select **Settings**.
4. Select **Version Status**.

■ How to Update with a USB Device

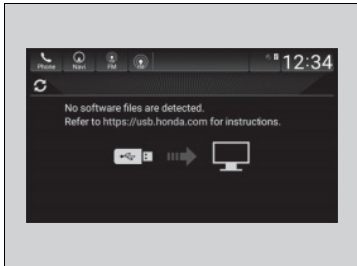
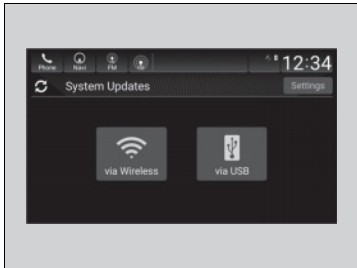
■ Download the update files from the server



1. Press the  button.
2. Select **System Updates**.
3. Select **via USB**.
 - ▶ A notification appears on the screen.
4. Connect a USB device into the USB port in the center pocket or console compartment*.
 - ▶ The inventory data is copied into the USB device.
 - ▶  **USB Port(s)** P. 245
5. Remove the USB device from the USB port.
6. Connect the USB device into your computer, and then download the update files.
 - ▶ Follow the link to download the required software update files. Refer to <https://usb.honda.com> for instructions.

▶▶ How to Update with a USB Device

A USB device with a minimum of 8 GB of free space or more is recommended.

Be sure to delete any previous inventory or update files from the USB before starting the USB update process.

■ Update the audio system

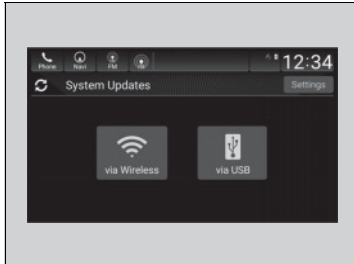

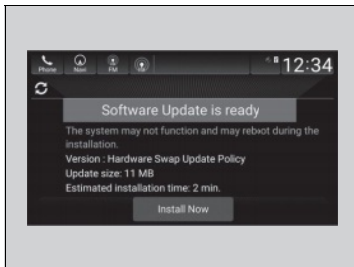

1. Press the  button.
2. Select **System Updates**.
3. Select **via USB**.
 - ▶ A notification appears on the screen.
4. Connect the USB device with the update files into the USB port.
 - ▶ A notification appears on the screen.
 - ▶ **USB Port(s)** P. 245

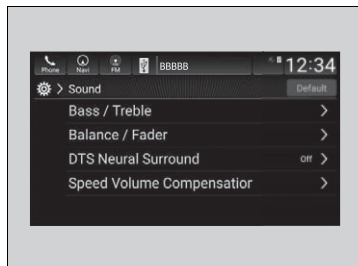
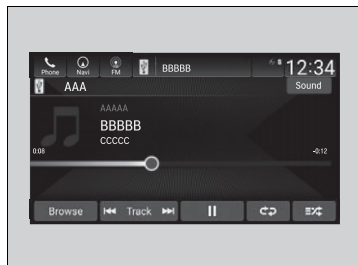

5. Select **Install Now**.
 - ▶ A notification appears on the screen if the update is successful.

Adjusting the Sound



1. Press the  button.
2. Select an audio source icon.
3. Select **Sound**.
4. Select the setting you want.
5. Select **Save**.

Select an item from the following choices:

- **Bass / Treble:** Treble, Midrange, Bass
- **Balance / Fader:** Balance, Fader
- **DTS Neural Surround*:** DTS Neural Surround™
- **Speed Volume Compensation:** Speed Volume Compensation (SVC)

▶▶ Adjusting the Sound

The SVC adjusts the volume level based on the vehicle speed. As you go faster, audio volume increases. As you slow down, audio volume decreases.

You can also adjust the sound the following procedure.

1. Press the  button.
2. Select **Settings**.
3. Select **Sound**.

To reset each setting for **Bass / Treble**, **Balance / Fader**, **DTS Neural Surround*** and **Speed Volume Compensation** select **Default**.

Display Setup

You can change the brightness of the audio/information screen.

Changing the Screen Brightness



1. Press the  button.
2. Select **Settings**.
3. Select **Display**.
4. Select **Day Mode** or **Night Mode**.
5. Select the setting you want.
6. Select **Save**.

Changing the Screen Brightness

You can change the **Contrast** and **Black Level** settings in the same manner.

To reset the settings, select **Default**.

Continued

■ Selecting an Audio Source

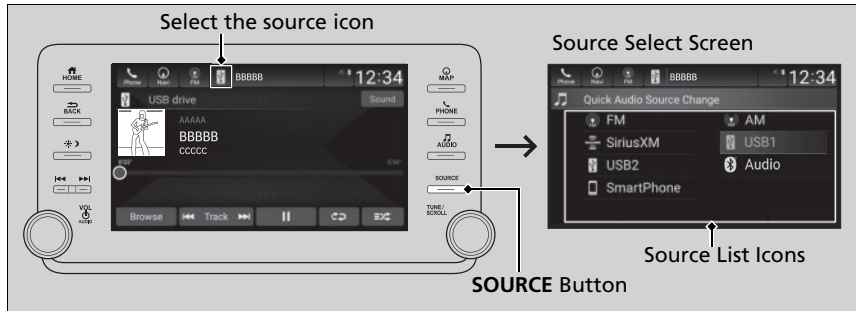



Select the current source icon, then select an icon on the source list or use the **SOURCE** button to switch the audio source.

■ Limitations for Manual Operation *

Certain manual functions are disabled or inoperable while the vehicle is in motion. You cannot select a grayed-out option until the vehicle is stopped.

Voice Control Operation

Your vehicle has a voice control system that allows hands-free operation.

The voice control system uses the  (talk) and  (back) buttons on the steering wheel and a microphone near the map lights on the ceiling.

Voice Recognition

To achieve optimum voice recognition when using the voice control system:

- Make sure the correct screen is displayed for the voice command that you are using.



The system recognizes only certain commands.

Available voice commands.

 **Voice Portal Screen** P. 296

- Close the windows and moonroof*.
- Adjust the dashboard and side vents so air does not blow onto the microphone on the ceiling.
- Speak clearly in a clear, natural speaking voice without pausing between words.
- Reduce any background noise if possible. The system may misinterpret your command if more than one person is speaking at the same time.

Voice Control Operation

When you press the  button, a helpful prompt asks what you would like to do. Press and release the  button again to bypass this prompt and give a command.

* Not available on all models

Voice Portal Screen

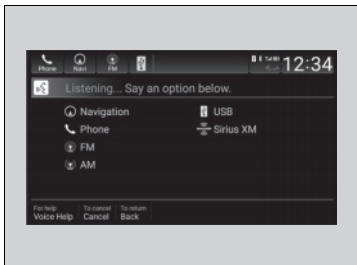

When the  (talk) button is pressed, available voice commands appear on the screen.

For a complete list of commands, say "Voice Help" after the beep.

The system only recognizes the commands on the following pages, at certain screens. Free form voice commands are not recognized.

*1: Models with navigation system

Phone Commands

This can be only used when the phone is connected. When the system recognizes the Phone command, the screen will change the dedicated screen for the voice recognition of the phone.

Phone Commands

- *Phone*
- *Call <Your Contact Name>*
- *Call <Phone Number>*

The system recognize an only contact name in the stored phonebook of your phone. If full name is registered in first name field, the system will recognize the first name and last name as one contact name.

Phone commands are not available if using Apple CarPlay.

Audio Commands

When the system recognizes the Audio command, the screen will change the dedicated screen for the voice recognition of the audio.

FM Commands

- *FM*
- *Tune to <87.7-107.9> FM*

AM Commands

- *AM*
- *Tune to <530-1710> AM*

Sirius XM Commands

- *Sirius XM*
- *Channel <1-999>*
- *Channel <station name>*

USB Commands

- *USB*
- *Play genre <Genre name>*
- *Play Artist <Artist name>*
- *Play Album <Album name>*
- *Play Playlist <Playlist name>*
- *Play Song <Song name>*
- *Play Music*
- *List Genre <Genre name>*
- *List Artist <Artist name>*
- *List Album <Album name>*
- *List Playlist <Playlist name>*

■ Navigation Commands*1

The system accepts navigation command on the dedicated screen for the voice recognition of the navigation.

☒ **Refer to the Navigation System Manual**

■ Standard Commands

- *Voice Help*
- *Cancel*
- *Back*

Voice Help are readout voice guidance for Help on current screen.

Playing AM/FM Radio

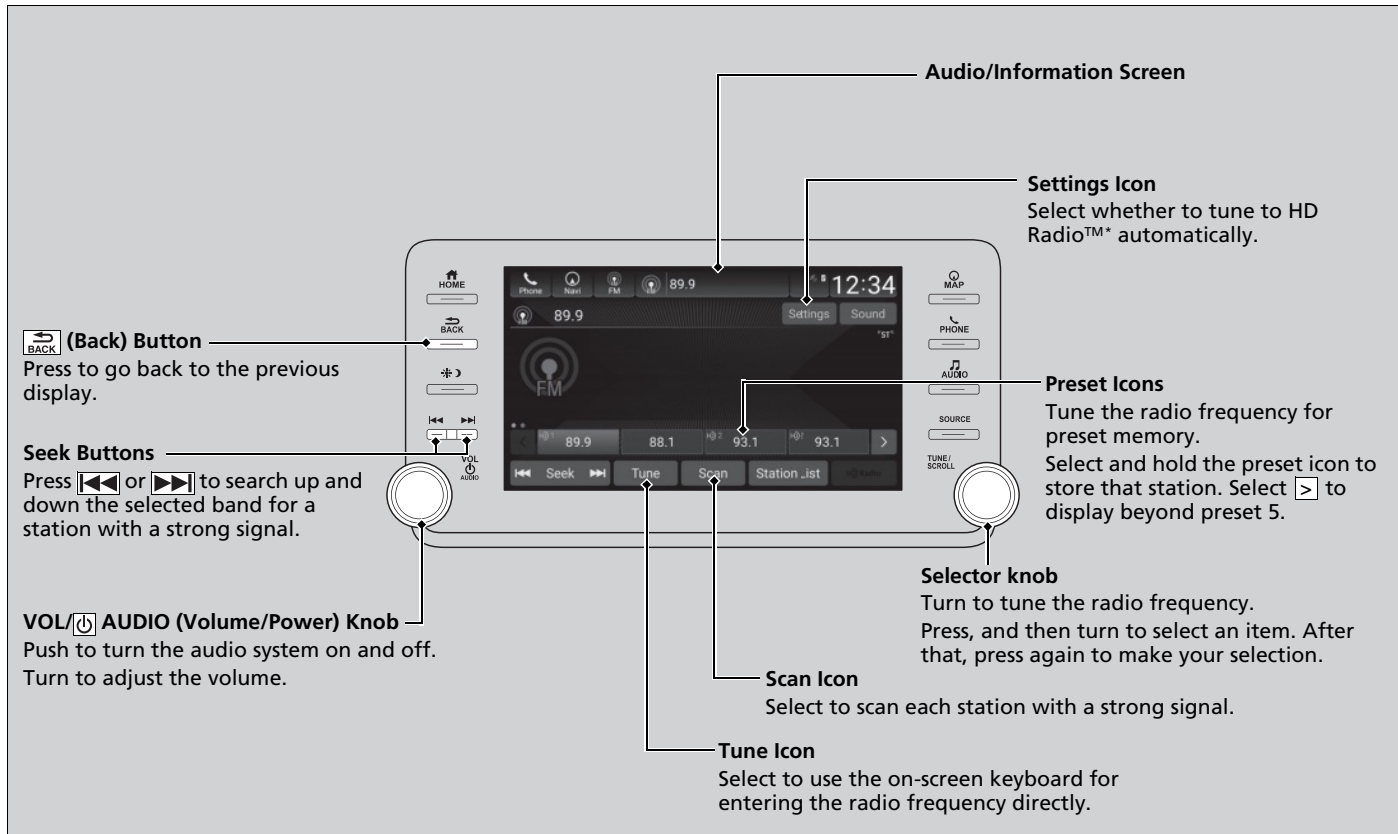

■ Preset Memory

To store a station:

1. Tune to the selected station.
2. Select and hold the preset number for the station you want to store.

■ Station List

Lists the strongest stations on the selected band.

1. Select **Station List** to display a list.
2. Select the station.

■ Manual update

Updates your available station list at any time.

1. Select **Station List** to display a list.
2. Select **Refresh**.

▶▶ Preset Memory

The **ST** indicator appears on the display indicating stereo FM broadcasts. Stereo reproduction in AM is not available.

Switching the Audio Mode

Roll the left selector wheel or select the audio source icon on the screen.

▶▶ **Audio Remote Controls** P. 248

You can store 12 AM/FM stations into preset memory.

Models with HD Radio™ feature

HD Radio Technology manufactured under license from iBiquity Digital Corporation. U.S. and Foreign Patents. HD Radio™ and the HD, HD Radio, and "Arc" logos are proprietary trademarks of iBiquity Digital Corp.



■ Scan

Samples each of the strongest stations on the selected band for 10 seconds. To turn off scan, select **Stop** or .

■ Radio Data System (RDS)

Provides text data information related to your selected RDS-capable FM station.

■ To find an RDS station from Station List

1. Select **Station List** to display a list while listening to an FM station.
2. Select the station.

■ Manual update

Updates your available station list at any time.

1. Select **Station List** to display a list while listening to an FM station.
2. Select **Refresh**.

■ Scan

Samples each of the strongest stations on the selected band for 10 seconds. To turn off scan, select **Stop** or .

▶▶ Radio Data System (RDS)

When you select an RDS-capable FM station, the RDS automatically turns on, and the frequency display changes to the station name. However, when the signals of that station become weak, the display changes from the station name to the frequency.

Models with HD Radio™ feature

■ HD Subchannel

Displays the subchannel list when an HD Radio™ station is selected while listening to an FM station.

1. Select **HD Radio Channels**.
2. Select the channel number.

■ AM/FM Settings

Change the AM/FM settings.

1. Select **Settings**.
 2. Select an option.
- **HD Radio:** Automatically choose a digital or an analog channel, or listen to analog only.
 - **Artwork:** Turns the artwork display on and off.

Playing SiriusXM® Radio *

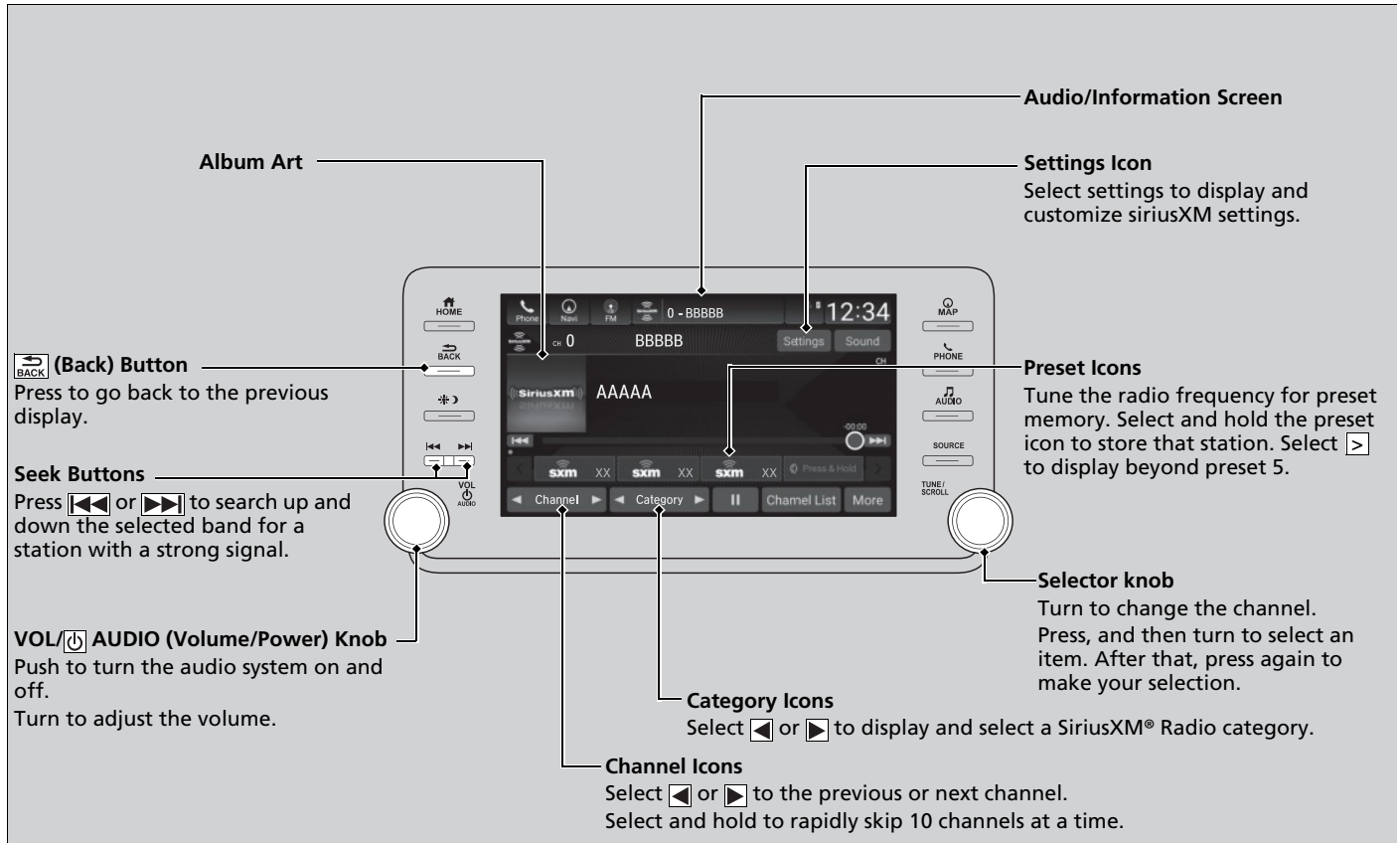

■ To Change the Tune Mode

1. Select **Settings**.
2. Select **Tune Mode**.
3. Select **Channel** or **Category**.

▶▶ Playing SiriusXM® Radio*

In the channel mode, all available channels are selectable. In the category mode, you can select a channel within a category (Jazz, Rock, Classical, etc.).

There may be instances when SiriusXM® Radio does not broadcast all the data fields (artist name, title). This does not indicate a problem with your audio system.

SiriusXM® Radio stations load in ascending order, which can take about a minute. Once they have loaded you will be able to scroll up or down to make your selections.

Switching the Audio Mode

Roll up or down to select **Audio** on the left selector wheel or select the audio source icon on the screen.

▶▶ **Audio Remote Controls** P. 248

Tune Start:

When you change to a preset channel, a song being played on that channel restarts from the beginning with this function. This can be turned on or off by the following procedure.

1. Select **Settings**.
2. Select **Tune Start**.
3. Select **ON** or **OFF**.

To change a category, select **Category** icons, or select **More** and then select **Category List**.

■ Preset Memory

To store a channel:

1. Tune to the selected channel.
2. Select and hold the preset number for the station you want to store.

■ Multi-channel preset (for music channels only)

You can store up to 10 of your preferred music channels per preset.

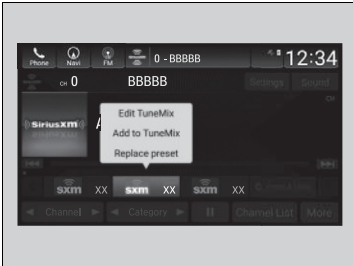

1. Tune a station.
2. Select and hold the preset number you want to add a music channel.
3. Select **Add to TuneMix** or **Create TuneMix**.
 - ▶ A message appears if there are no available presets.

▶▶ Preset Memory

You can store 12 SiriusXM® channels into the preset memory.

▶▶ Multi-channel preset (for music channels only)

TuneMix:

The multi-channel preset function can be turned on or off by the following procedure.

1. Select **Settings**.
2. Select **TuneMix**.
3. Select **ON** or **OFF**.

When you want to replace the channel, select **Replace preset**.

If you want to delete a channel, select **Edit TuneMix**, and then select the channel you want to delete.

■ Listening to Featured Channels

Suggested channel listing received from SiriusXM® can be displayed and selected.

1. Select **Category List**.
2. Select **Featured Favorite**.

☒ Listening to Featured Channels

Up to ten featured channels by SiriusXM® can be displayed.



Featured channel lists are at the top of the channel list.

To switch the sorting method, select **Number** or **Name** on the upper right of the screen.

Select **Keypad** to use the on-screen keyboard for entering the channel number directly.

■ Replay Function

The system can record up to the last 60 minutes broadcast of your currently tuned channel as well as the last 30 minutes broadcast of preset channels, starting from the moment you turn the vehicle on. If you tuned to preset channel, the system records up to 60 minutes of a broadcast instead of up to 30 minutes. You can rewind and replay the last 30 or 60 minutes of a broadcast.

Move the position you want to replay by selecting  or .

To play or pause on playback mode, select the play/pause icon.

■ Returning to real-time broadcast

Select and hold .

▶▶ Replay Function

The system starts storing broadcast in memory when the power mode is turned ON. You can go back to the program from that point.

You can no longer replay any program once the power mode is turned off as it erases memory. You can check how long the program has been stored in memory from the audio/information screen.

After 30 or 60 minutes of recording the system will automatically start deleting the oldest data.

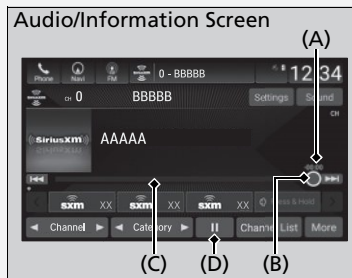

- (A): Shows how much time the replayed segment is behind the real-time broadcast
- (B): Replayed segment
- (C): Length stored in memory
- (D): Play/Pause icon

■ Live Sports Alert

While listening to other channel, you can receive sports alerts such as scores from your favorite teams.

■ To set up a favorite team

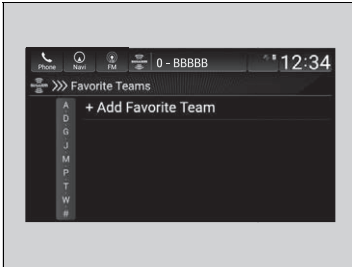

1. Select **Settings**.
2. Select **Sports Notifications Setup**.
3. Select **Favorite Teams**.
4. Select **+ Add Favorite Team**.
5. Select a team.

■ To set up an alert message

1. Select **Settings**.
2. Select **Sports Notifications Setup**.
3. Select **Notifications**.
4. Select **Game Notifications** or **SportsFlash Game Play Notifications**.
5. Select **Notifications**.
6. Select **ON**.
7. Select a favorite team.

▶▶ Live Sports Alert

The Pop-up appears and notifies you of a sports alert function.

▶▶ To set up a favorite team

Sports alerts cut in only when SiriusXM® mode is on.

■ Traffic and Weather Information

You can receive traffic and weather information.

1. Select **Settings**.
2. Select **Traffic & Weather Now Setup**.
3. Select **Selected City**.
4. Select the region.

☒ Traffic and Weather Information

When traffic and weather information is received, a notification is displayed in the header area.

☒ **Status Area** P. 284

Channel Schedule

You can view a channel schedule or receive a alert when your favorite program is about to start.

To view a channel schedule

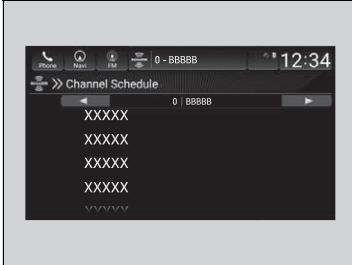

1. Select **More**.
2. Select **Channel Schedule**.

To set up an alert message

1. Select **More**.
2. Select **Channel Schedule**.
3. Select a program.
4. Select **Set Program Alert**.
5. Select **Just Once** or **Everytime**.

Channel Schedule

Select **Keypad** to use the on-screen keyboard for entering the channel number directly.

To set up an alert message

The Pop-up appears and notifies you of an alert function.

Selecting **Just Once** disables the alert feature next time you turn the power mode to ON.

If you want to delete the alert, select **Remove Alert**.

To enable an alert message, change settings for the alert function.

▶ **To enable the alert function** P. 310

■ Manage Program Alert

You can change settings for the alert function.

■ To enable the alert function

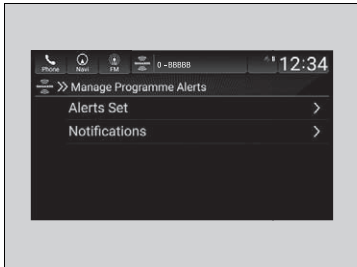

1. Select **Settings**.
2. Select **Manage Program Alerts**.
3. Select **Notifications**.
4. Select **ON** or **OFF**.

■ To remove an alert

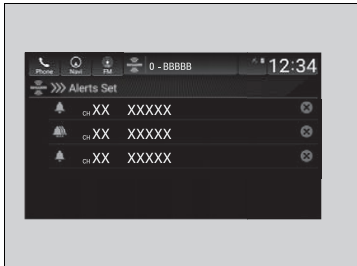

1. Select **Settings**.
2. Select **Manage Program Alerts**.
3. Select **Alerts Set**.
4. Select  on the alert you want to delete.
 - ▶ A confirmation message appears on the screen. Select **Yes**.

■ Scan

Sample each channel on the selected mode for 10 seconds.

1. Select **More**.
2. Select **Scan**.

You can change a scan mode by the following procedure.

1. Select **Settings**.
2. Select **Scan Mode**.
3. Select **Channel** or **Preset**.

To turn off scan, select **Stop**.

☒ Scan

The "Scan Songs in Presets" function is based on TuneScan™ technology of SiriusXM®.

The "Featured Channels" function is based on Featured Favorites™ technology of SiriusXM®.

TuneScan™ and Featured Favorites™ are registered trademarks of SiriusXM® Radio, Inc.

■ SiriusXM Settings

Change the SiriusXM settings.

1. Select **Settings**.

2. Select an option.

- **Tune Mix:** Turns multiple channel mix preset on and off.
- **Tune Mode:** Choose whether to group by category or channel number when changing channels.
- **Scan Mode:** Select the scan mode from all channels or presets.
- **Tune Start:** Start the currently playing song at the beginning when you switch to a music channel preset.
- **Sports Notifications Setup:** Set to receive sports alerts such as scores from your favorite teams.
 - ▶ **Live Sports Alert** P. 307
- **Traffic & Weather Now Setup:** Set to receive traffic and weather information.
 - ▶ **Traffic and Weather Information** P. 308
- **Manage Program Alerts:** Change settings for the alert function.
 - ▶ **Manage Program Alert** P. 310

Playing an iPod

Using your USB connector, connect the iPod to the USB port(s), then select the USB mode.

▶ **USB Port(s)** P. 245

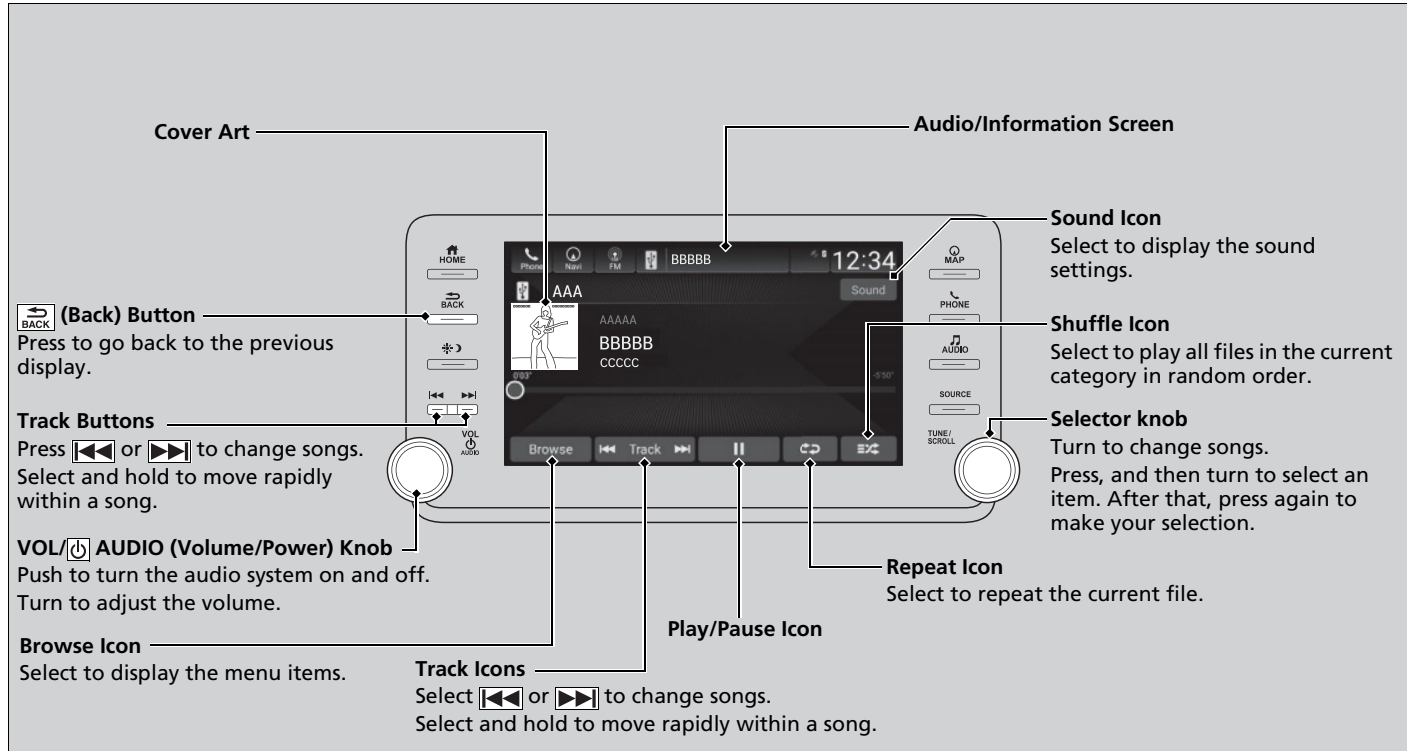

How to Select a Song from the Music Search List

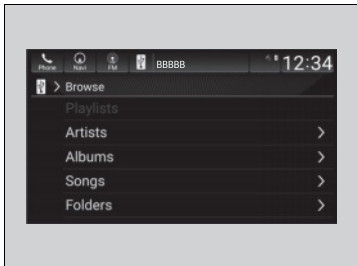

1. Select **Browse**.
2. Select a search category (e.g., Artists, Albums, etc.).
3. Continue making selections until you find the song of your choice.

▶▶ Playing an iPod

Available operating functions vary on models or versions. Some functions may not be available on the vehicle's audio system.

If there is a problem, you may see an error message on the audio/information screen.

▶ **iPod/USB Flash Drive** P. 343

If you operate the music app on your iPhone/iPod while the phone is connected to the audio system, you may no longer be able to operate the same app on the audio/information screen. Reconnect the device if necessary.

If an iPhone is connected via Apple CarPlay, the iPod/USB source will be unavailable and audio files on the phone will be playable only within Apple CarPlay.

How to Select a Play Mode

You can select shuffle and repeat modes when playing a file.

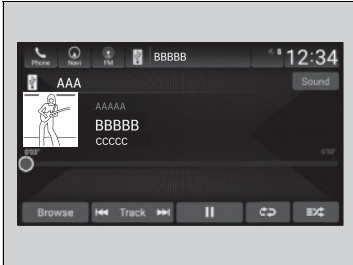

■ Shuffle/Repeat

Select Shuffle or repeat icon repeatedly until a desired mode.

■ To turn off a play mode

Select the mode you want to turn off.

▶▶ How to Select a Play Mode

Play Mode Menu Items

Shuffle

 **Shuffle off:** Shuffle mode to off.

 **Shuffle All Songs:** Plays all available songs in a selected list (playlists, artists, albums, songs, genres, or composers) in random order.

 **Shuffle in Folder:** Plays all files in the current folder in random order.

Repeat

 **Repeat off:** Repeat mode to off.

 **Repeat Song:** Repeats the current song.

 **Repeat all:** Repeats the all songs.

Playing a USB Flash Drive

Your audio system reads and plays audio files on a USB flash drive in either MP3, WMA, or AAC*1 format.

Connect your USB flash drive to the USB port(s), then select the USB mode.

➔ **USB Port(s)** P. 245

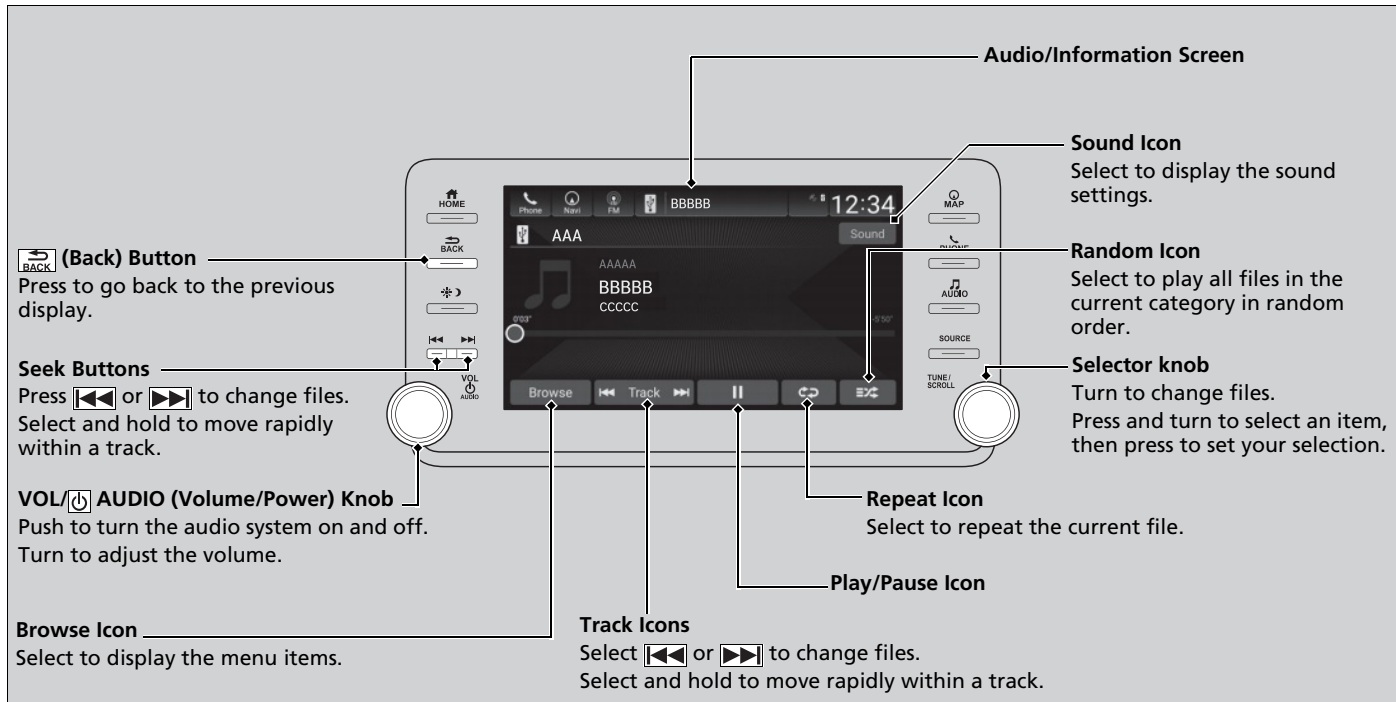

*1: Only AAC format files recorded with iTunes are playable on this unit.

How to Select a File from the Music Search List

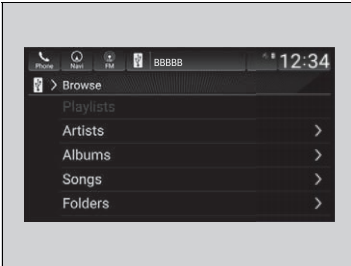

1. Select **Browse**.
2. Select a search category (e.g., Artists, Albums, etc.).
3. Continue making selections until you find the song of your choice.

▶▶ Playing a USB Flash Drive

Use the recommended USB flash drives.

▶ **General Information on the Audio System**
P. 348

WMA files protected by digital rights management (DRM) cannot be played.

The audio system displays **The selected file cannot be played**, then skips to the next file.

If there is a problem, you may see an error message on the audio/information screen.

▶ **iPod/USB Flash Drive** P. 343

■ How to Select a Play Mode

You can select repeat and random modes when playing a file.

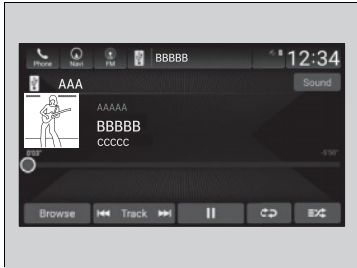

■ Random/Repeat

Select Random or repeat icon repeatedly until a desired mode.

■ To turn off a play mode

Select the mode you want to turn off.

▶▶ How to Select a Play Mode

Play Mode Menu Items

Random

- Random off:** Random mode to off.
- Random All Tracks:** Plays all files in random order.
- Random in Folder:** Plays all files in the current folder in random order.

Repeat

- Repeat off:** Repeat mode to off.
- Repeat track:** Repeats the current folder.
- Repeat all:** Repeats the all songs.

Playing *Bluetooth*® Audio

Your audio system allows you to listen to music from your *Bluetooth*-compatible phone.

This function is available when the phone is paired and connected to the vehicle's *Bluetooth*® HandsFreeLink® (HFL) system.

📌 **Phone Setup** P. 432

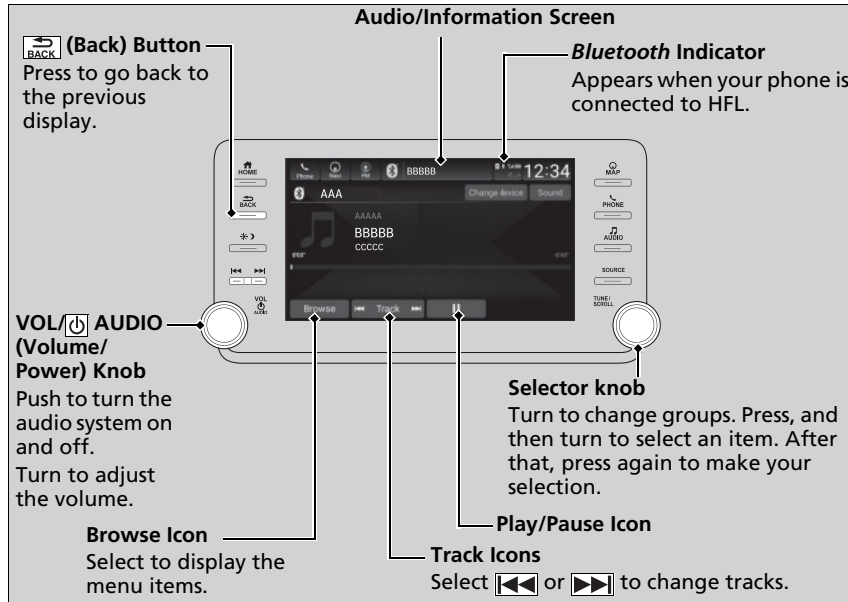

▶▶ Playing *Bluetooth*® Audio

Not all *Bluetooth*-enabled phones with streaming audio capabilities are compatible with the system. For a list of compatible phones:

- U.S.: Visit automobiles.honda.com/handsfreelink or call 1-888-528-7876.
- Canada: For more information on smartphone compatibility, call 1-888-528-7876.

It may be illegal to perform some data device functions while driving.

Only one phone can be used with HFL at a time. When there are more than two paired phones in the vehicle, the first paired phone the system finds is automatically connected.

The connected phone for *Bluetooth*® Audio can be different.

If more than one phone is paired to the HFL system, there may be a delay before the system begins to play.

In some cases, the name of the artist, album, or track may not appear correctly.

Some functions may not be available on some devices.

If a phone is currently connected via Apple CarPlay or Android Auto, *Bluetooth*® Audio from that phone will be unavailable. However, you can have a second previously paired phone stream *Bluetooth*® Audio by selecting  from the *Bluetooth*® device list.

📌 **Phone Setup** P. 432

Continued

■ To Play *Bluetooth*® Audio Files

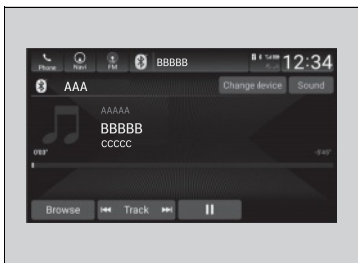

1. Make sure that your phone is paired and connected to the system.
 ▶ **Phone Setup** P. 432
2. Select the *Bluetooth*® Audio mode.

If the phone is not recognized, another HFL-compatible phone, which is not compatible for *Bluetooth*® Audio, may already be connected.

■ To pause or resume a file

Select the play/pause icon.

■ Searching for Music

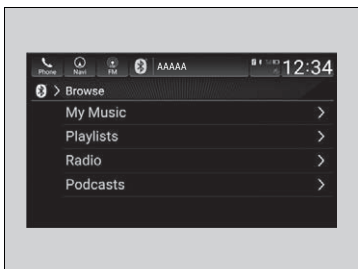

1. Select **Browse**.
2. Select a search category (e.g., Albums).
3. Select an item.
 ▶ The selection begins playing.

▶▶ To Play *Bluetooth*® Audio Files

To play the audio files, you may need to operate your phone. If so, follow the phone maker's operating instructions.

Switching to another mode pauses the music playing from your phone.

You can change the connected phone by selecting **Change Devices**.

▶ **Phone Setup** P. 432

▶▶ Searching for Music

Depending on the *Bluetooth*® device you connect, some or all of the lists may not be displayed.

HondaLink®

HondaLink® connects you to the latest information from Honda. You can connect your phone wirelessly through Wi-Fi or *Bluetooth*®.

📶 **Wi-Fi Connection** P. 330

📶 **Phone Setup** P. 432

To Connect to HondaLink®

Use the following procedure to connect to HondaLink®.

■ To enable the HondaLink®

You need to allow the consent of the location service to enable the HondaLink®.

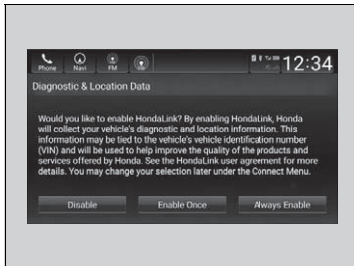

Disable: Does not allow this consent.

Enable Once: Allows only one time. (Shows again next time.)

Always Enable: Allows anytime. (Never show again.)

▶▶ HondaLink®

If your vehicle has a telematics control unit (TCU), you can use HondaLink® without connecting the phone.

The HondaLink® connect app is compatible with most iPhone and Android phones.

If the system is connected to the HondaLink® connect app through *Bluetooth*® and another *Bluetooth*® audio device is connected, the *Bluetooth*® connection to the HondaLink® connect app will be severed.

Some cell phone carriers charge for tethering and smartphone data use. Check your phone's data subscription package.

Continued

■ To link with HondaLink®

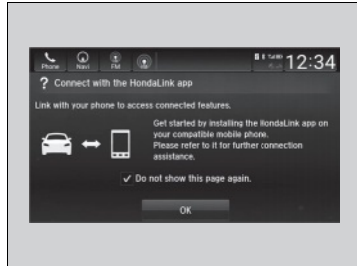

You may see the connection guide screen after launching HondaLink® when there is no connection available.

■ HondaLink® Menu

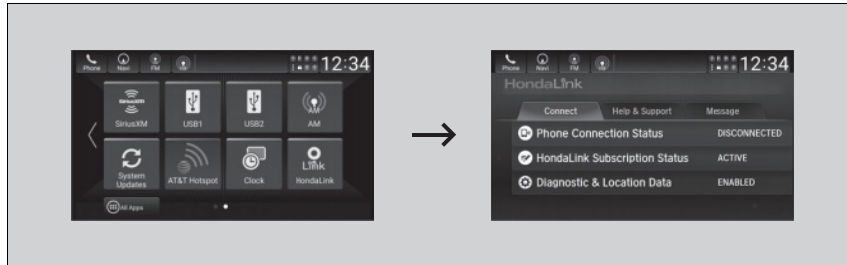

■ Connect

Displays instruction messages when the vehicle needs service.

■ Help & Support

Displays tips for vehicle usage, and get support via road side or customer service center.

■ Message

Displays helpful and important information from Honda.

■ Vehicle Information and Message from Honda Tips

You can check the messages that are received quickly in the shortcut operation.

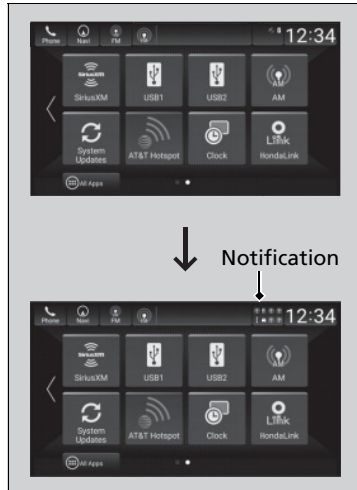

1. A notification appears and notifies you of a new message on the header area.

2. A notification is continuously displayed in the header area until the new message is read.



3. Select the system status icon to see the messages.

4. Select a new message to open.
▶ If you have selected the update option for HondaLink®, follow the directions on the screen to complete the process.

▶▶ Vehicle Information and Message from Honda Tips

When you update HondaLink®, you must keep the engine running and maintain a constant connection with HondaLink®.

If the update is interrupted, the system will automatically resume the process. If, however, a week has elapsed since the process was first interrupted, you must repeat the process from the beginning.

You can update HondaLink® by selecting **Message from Honda** on the HondaLink® menu.

HondaLink® Service*

Is a subscription-based service that provides convenient features such as voice communication in case of emergency, online security, and one-on-one operator assistance.

In Case of Emergency

Automatic collision notification



If your vehicle's airbags deploy or if the unit detects that the vehicle is severely impacted, your vehicle automatically will attempt to connect to the HondaLink® operator. If connected, information about your vehicle, its location, and its condition can be sent to the operator*¹; you also can speak to the operator when connected.

IMPORTANT: In a crash, HondaLink® will attempt to notify emergency services but NEITHER HONDA NOR ITS SERVICE PROVIDERS GUARANTEE THAT SUCH NOTIFICATION WILL OCCUR.

Honda reserves the right to terminate HondaLink® services at any time or for any reason, and in the future may not be able to provide services due to changes in, or obsolescence of, technology integral to the service or changes in governmental regulation.

*1: Depending on your phone and adequate cellular coverage, your vehicle's location may not be sent to the operator.

* Not available on all models

Continued

▶▶ HondaLink® Service*

HondaLink® also provides services you can operate from the Internet or your smartphone.

To subscribe to HondaLink®, or to get more information about all of its features, contact an Honda dealer, or visit hondalink.honda.com

▶▶ In Case of Emergency

Your vehicle may not be able to connect to the operator if the battery level is low, the line is disconnected, or you do not have adequate cellular coverage.

You cannot use this emergency services when:

- You travel outside the HondaLink® service coverage areas.
- There is a problem with the connecting devices, such as the microphones, speakers, or the unit itself.

You cannot operate other phone-related functions using the screen while talking to the operator. Only the operator can terminate the connection to your vehicle.

▶▶ Automatic collision notification

If the unit fails to connect to the operator, it repeatedly tries until it succeeds.

■ Manual operator connection

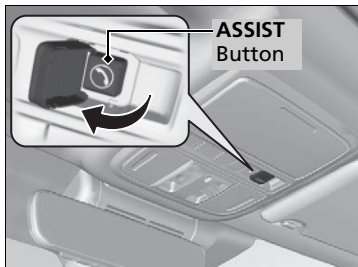

If you need to talk to the HondaLink® operator in a situation where no airbag has deployed, you can manually connect to them by pressing the **ASSIST** button with the power mode in ACCESSORY or ON.

1. Open the cover attached to the ceiling console.
2. Press the **ASSIST** button.
 - ▶ You are connected to the HondaLink® operator.

▶▶ Manual operator connection

Do not press the button while driving. When you need to contact the operator, park the vehicle in a safe place.

If the unit fails to connect to the operator, it automatically cancels the action after three minutes.

If necessary, the cover can be broken to access the **ASSIST** button.

■ Security Features

Your subscribed telematics service provider can track your vehicle's location, remotely lock or unlock doors, and help you find your vehicle. To use these features, you need your user ID and personal identification number (PIN).

■ Stolen vehicle tracking

This feature searches and tracks down your vehicle position even if it is on the move. If you believe that your vehicle has been stolen, contact the police as well as the provider.

■ Remote door lock/unlock

The provider can remotely lock or unlock doors upon your request.

■ Vehicle finder

This feature is convenient to use when trying to locate your vehicle in large areas, such as a crowded parking lot. If you cannot locate your vehicle after using the remote transmitter's answerback function, you can contact the provider which can then flash your vehicle's exterior lights and sound the horn, and sends vehicle location via web/Smartphone.

■ Security alarm notification

If the security system in your vehicle detects an abnormal condition, such as someone tampering with the lock on your vehicle, the provider notifies you by email.

☒ Security Features

The contact information of your provider, your user ID and PIN will be given when you subscribe to HondaLink®. If you forget any of the above, contact a Honda dealer, or go to hondalink.honda.com.

You can also activate the remote door lock/unlock and vehicle finder features from the Internet or using your smartphone app. Ask a dealer, or visit hondalink.honda.com.

☒ Vehicle finder

The lights will stop flashing and horn will stop sounding under the following:

- When conditions 30 seconds have elapsed.
- You unlock the doors using the remote transmitter.
- You unlock the doors using the smart entry system.
- You unlock the doors using the built-in key.
- The power mode is set to ACCESSORY or ON.

■ Operator Assistance

Connect to the HondaLink® operator when trying to find a destination or for roadside assistance.

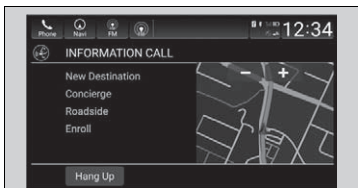
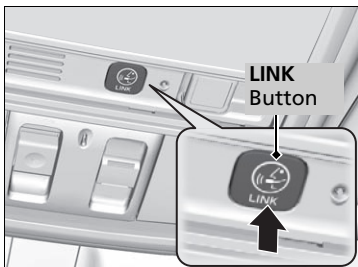

Audio/information screen when connected to the HondaLink® operator.

1. Press the **LINK** button.
 - ▶ Connection to the operator begins.
2. Talk to the operator.
 - ▶ To disconnect, select **Hang Up** on the audio/information screen or press the  button on the steering wheel.

▶▶ Operator Assistance

Remain attentive to road conditions and driving during operator assistance.

If you want to add or renew a subscription, call the Operator Assistance.

1. Press the  button.
2. Select **HondaLink**.
3. Select **HondaLink Subscription Status**.

■ Convenient Features

Your subscribed telematics service provider can check your vehicle's condition.

■ Virtual Dashboard

You can remotely check the mileage, fuel range, and oil life in your app.

■ Remote Start and stop the engine

You can remotely start and stop engine using your app as same as the smart entry key.

■ Geofence Alert

You can receive a notification anytime your vehicle enters or leaves a region set by you.

■ Speed Alert

You can receive a notification when your vehicle has exceeded a speed limit set by you.

■ Personal Data Wipe

You can reset your audio and navigation system settings to factory defaults with the app.

■ Wi-Fi hotspot

Vehicle provides 4G LTE network environment as Wi-Fi router to use tablet or smartphone in your vehicle.

☒ Convenient Features



The contact information of your provider, your user ID and PIN will be given when you subscribe to HondaLink®. If you forget any of the above, contact a Honda dealer, or go to hondalink.honda.com.

Wi-Fi Connection

You can connect the audio system to the Internet using Wi-Fi on the audio/information screen. If your phone has wireless hotspot capabilities, the system can be tethered to the phone. Use the following steps to setup.

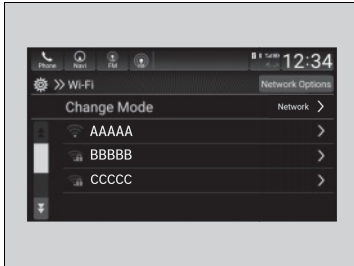
Wi-Fi mode (setting for the first time)



1. Press the  button.
2. Select **Settings**.
3. Select **Connections**.
4. Select **Wi-Fi**.
5. Select **Change Mode**.
6. Select **Network** or **Hotspot**, then **Confirm**.
 - ▶ To change the Wi-Fi settings, select **Network Options** or **HotSpot Options**.
 - ▶ Select the access point you want to connect to the system.
7. Select **Connect**.
 - ▶ Enter a password for the access point, and select **Done**.
 - ▶ When the connection is successful, the  icon is displayed on the list.
8. Press the  button to go back to the home screen.

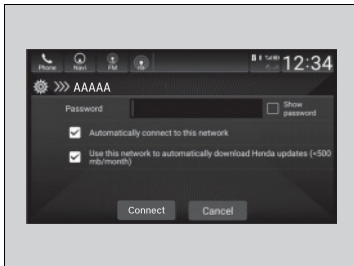

Wi-Fi Connection

Wi-Fi and Wi-Fi Direct a registered trademark of Wi-Fi Alliance®.



Wi-Fi mode (setting for the first time)

You cannot go through the setting procedure while a vehicle is moving. Park in a safe place to set the audio system in Wi-Fi mode.

Some cell phone carriers charge for tethering and smartphone data use. Check your phone's data subscription package.

Check your phone manual to find out if the phone has Wi-Fi connectivity.

You can confirm whether Wi-Fi connection is on or off with the  icon on the Wi-Fi network list. Transmission speed and others will not be displayed on this screen.

In case of Wi-Fi connection with your phone, make sure your phone's Wi-Fi setting is in access point (tethering) mode.

■ Wi-Fi mode (after the initial setting has been made)

Make sure your phone's Wi-Fi setting is in access point (tethering) mode.

▶▶ Wi-Fi mode (after the initial setting has been made)

iPhone users

You may need to go through an initial setup for Wi-Fi connection again after you boot your phone.

Near Field Communication (NFC)*

Android phone only

Near Field Communication (NFC) allows you to connect your phone to the audio system easily via *Bluetooth*®.

NFC enables two devices to communicate in close proximity, within about 0.6 inch (15 mm).

The following features are available:

- *Bluetooth*® setup
- Image transfer for wallpaper

NFC Setup

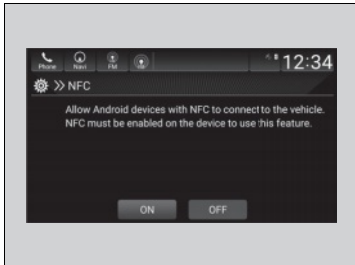

1. Press the  button.
2. Select **Settings**.
3. Select **Connections**.
4. Select **NFC**, then **ON**.
5. Select **Android Beam**, then **ON**.

▶▶ Near Field Communication (NFC)*

To use the NFC function, your Android phone first must be NFC compatible.

Check with the manual that came with your Android phone to find out if your phone is NFC compatible. The N-Mark is a trademark or registered trademark of NFC Forum, Inc. in the United States and in other countries.



Bluetooth® Setup

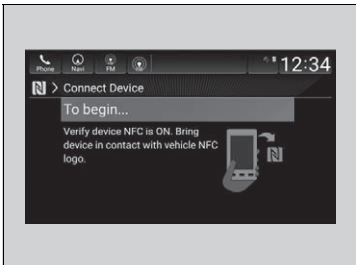
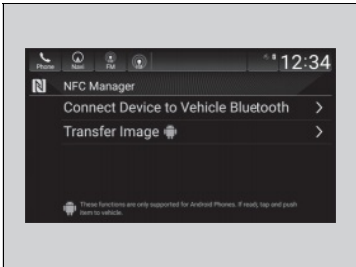
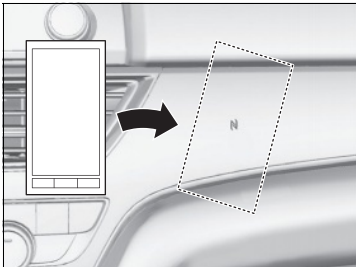

1. Press the  button then select **NFC Manager**. Or touch the NFC logo near the glove box with the NFC tag of your phone.
 - ▶ The **NFC Manager** screen is displayed.

2. Select **Connect Device to Vehicle Bluetooth**.

3. Touch the NFC logo near the glove box with the NFC tag of your phone.
4. A notification appears on the screen if pairing is successful.
 - ▶ Confirm if the pairing code on the screen and your phone match. This may vary by phone.

Bluetooth® Setup

To use the NFC function, you first need to set up your Android phone to enable this function. For instructions on how to use NFC with your Android phone, refer to the manual that came with your phone.

Image Transfer for the Wallpaper

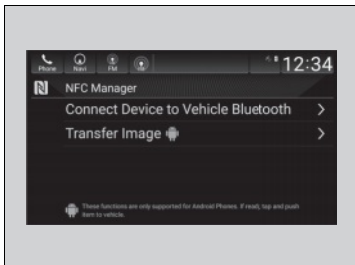

1. Press the  button.
2. Select **NFC Manager** or touch the NFC logo near the glove box with the NFC tag of your phone.
3. Select **Transfer Image**.

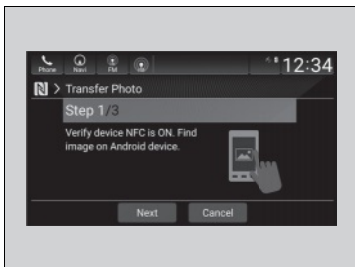

4. Open the photo you want to transfer on your phone, then select **Next**.
5. Touch the NFC logo near the glove box with the NFC tag of your phone.
6. Select the photo on your phone.



7. A confirmation message appears on the screen. Select **Wallpaper**.

Image Transfer for the Wallpaper

The wallpaper you set up on Clock Faces cannot be displayed on the driver information interface.

- The file name must be fewer than 255 characters.
- The file format of the image that can be imported is BMP (bmp) or JPEG (jpg).
- If the USB flash drive does not have any pictures, the **No files detected** message appears.
- Up to five pictures can be imported.
- The maximum image size is 1,920 × 936 pixels. If the image size is less the image is displayed in the middle of the screen with the extra area appearing in black.

Siri® Eyes Free

You can talk to Siri using to press and hold the  (Talk) button on the steering wheel when your iPhone is paired to the *Bluetooth*® HandsFreeLink® (HFL) system.

📄 **Phone Setup** P. 432

Using Siri® Eyes Free

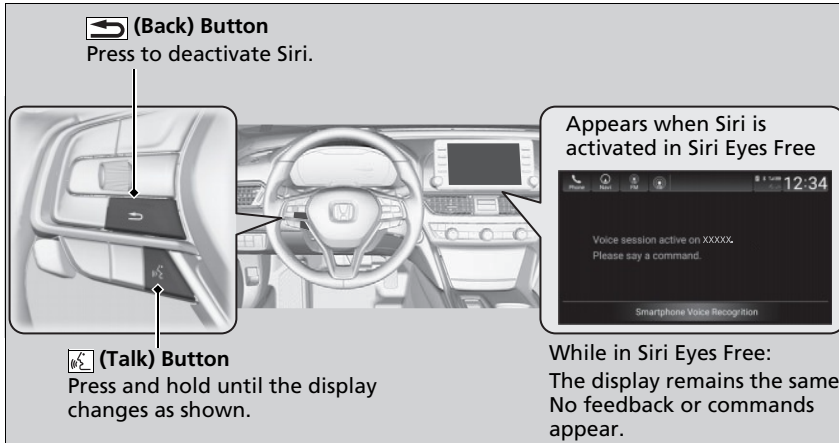

▶ Siri® Eyes Free

Siri is a trademark of Apple Inc.

Check Apple Inc. website for features available for Siri.

While driving we recommend only using Siri through the  button on the steering wheel (Siri Eyes Free).

▶ Using Siri® Eyes Free

Some commands work only on specific phone features or apps.

Apple CarPlay®

If you connect an Apple CarPlay-compatible iPhone to the system via the USB port in the center pocket or console compartment*, you can use the audio/information screen, instead of the iPhone display, to make a phone call, listen to music, view maps (navigation), and access messages.

➤ **USB Port(s)** P. 245

Apple CarPlay Menu

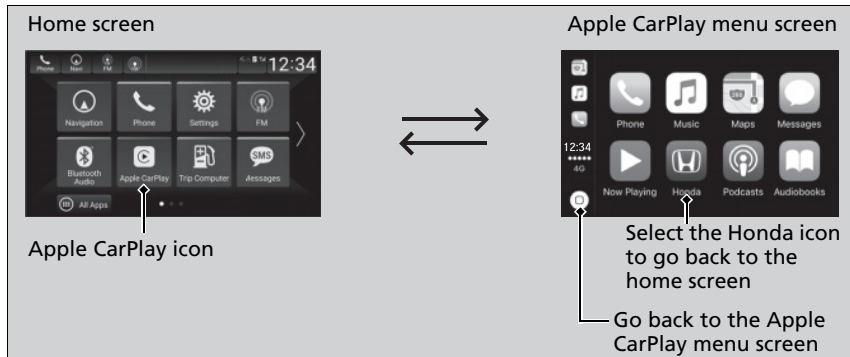

■ Phone

Access the contact list, make phone calls, or listen to voice mail.

■ Messages

Check and reply to text messages, or have messages read to you.

■ Music

Play music stored on your iPhone.

▶▶ Apple CarPlay®

Only iPhone 5 or newer versions with iOS 8.4 or later are compatible with Apple CarPlay.

Park in a safe place before connecting your iPhone to Apple CarPlay and when launching any compatible apps.

To use Apple CarPlay, connect the USB cable to the USB port located in the center pocket or console compartment*.

The USB ports located on the rear of the center console* are used only for charging.

➤ **USB Port(s)** P. 245

While connected to Apple CarPlay, calls are only made through Apple CarPlay. If you want to make a call with HandsFreeLink®, turn Apple CarPlay OFF or detach the USB cable from your iPhone.

➤ **Setting Up Apple CarPlay** P. 337

When your iPhone is connected to Apple CarPlay, it is not possible to use the *Bluetooth*® Audio or *Bluetooth*® HandsFreeLink®. However, other previously paired phones can stream audio via *Bluetooth*® while Apple CarPlay is connected.

➤ **Phone Setup** P. 432

For details on countries and regions where Apple CarPlay is available, as well as information pertaining to function, refer to the Apple homepage.

■ Maps

Display Apple Maps and use the navigation function just as you would on your iPhone.

Models with navigation system

Only one navigation system (pre-installed navigation or Apple CarPlay) can give directions at a time. When you are using one system, directions to any prior destination set on the other system will be canceled, and the system you are currently using will direct you to your destination.

■ Setting Up Apple CarPlay

After you have connected your iPhone to the system via the front USB port, use the following procedure to set up Apple CarPlay. Use of Apple CarPlay will result in the transmission of certain user and vehicle information (such as vehicle location, speed, and status) to your iPhone to enhance the Apple CarPlay experience. You will need to consent to the sharing of this information on the audio/information screen.

■ Enabling Apple CarPlay

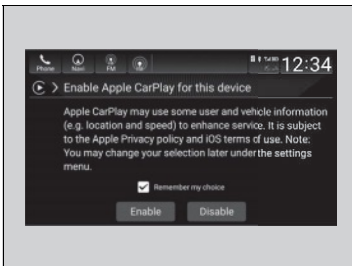

Check the checkbox.

Enable: Allows this consent.

Disable: Does not allow this consent.

You may change the consent settings under the **Connections** settings menu.

▶▶ Apple CarPlay®

Apple CarPlay Operating Requirements & Limitations

Apple CarPlay requires a compatible iPhone with an active cellular connection and data plan. Your carrier's rate plans will apply.

Changes in operating systems, hardware, software, and other technology integral to providing Apple CarPlay functionality, as well as new or revised governmental regulations, may result in a decrease or cessation of Apple CarPlay functionality and services. Honda cannot and does not provide any warranty or guarantee of future Apple CarPlay performance or functionality.

It is possible to use 3rd party apps if they are compatible with Apple CarPlay. Refer to the Apple homepage for information on compatible apps.

▶▶ Setting Up Apple CarPlay

You can also use the method below to set up Apple CarPlay:

Select HOME → Settings → Connections → Smartphone Connection → Apple CarPlay → Select device → Edit Device Permissions

Use of user and vehicle information

The use and handling of user and vehicle information transmitted to/from your iPhone by Apple CarPlay is governed by the Apple iOS terms and conditions and Apple's Privacy Policy.

■ Operating Apple CarPlay with Siri

Press and hold the talk button to activate Siri.

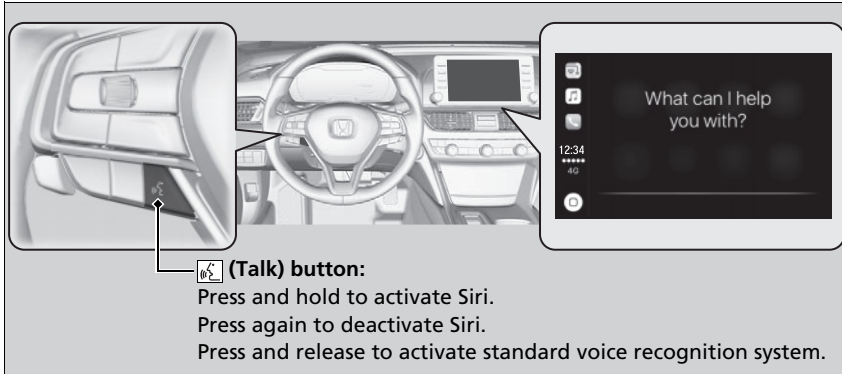

▣ Operating Apple CarPlay with Siri

Below are examples of questions and commands for Siri:

- What movies are playing today?
- Call dad at work.
- What song is this?
- How's the weather tomorrow?
- Read my latest email.
- Find a table for four tonight in Chicago.

For more information, please visit www.apple.com/ios/siri.

Android Auto™

When you connect an Android phone to the audio system via the front USB port, Android Auto is automatically initiated. When connected via Android Auto, you can use the audio/information screen to access the Phone, Google Maps (Navigation), Google Play Music, and Google Now functions. When you first use Android Auto, a tutorial will appear on the screen.

We recommend that you complete this tutorial while safely parked before using Android Auto.

➤ **USB Port(s)** P. 245

➤ **Auto Pairing Connection** P. 341

Android Auto™

To use Android Auto, you need to download the Android Auto app from Google Play to your smartphone.

Only Android 5.0 (Lollipop) or later versions are compatible with Android Auto.

Bluetooth A2DP cannot be used with Android Auto phone.

Park in a safe place before connecting your Android phone to Android Auto and when launching any compatible apps.

To use Android Auto, connect the USB cable to the USB port(s) located in the center pocket or the console compartment*. The USB ports located on the rear of the center console* will not enable Android Auto operation.

➤ **USB Port(s)** P. 245

To directly access the Android Auto phone function, press **Phone** on the home screen.

➤ **Auto Pairing Connection** P. 341

When your Android phone is connected to Android Auto, it is not possible to use the *Bluetooth®* Audio. However, other previously paired phones can stream audio via *Bluetooth®* while Android Auto is connected.

➤ **Phone Setup** P. 432

* Not available on all models

Android Auto Menu

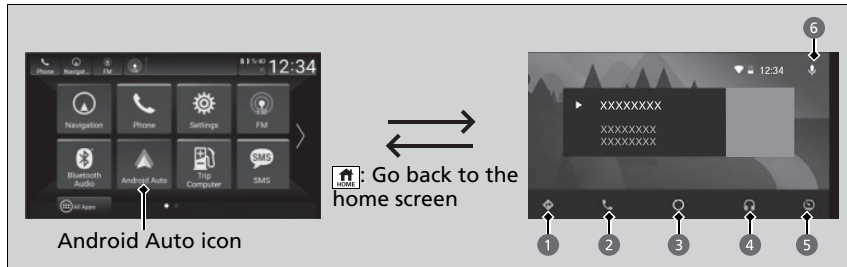

1 Maps (Navigation)

Display Google Maps and use the navigation function just as you would with your Android phone. When the vehicle is in motion, it is not possible to make keyboard entries. Stop the vehicle in a safe location to undertake a search or provide other inputs.

Models with navigation system

Only one navigation system (pre-installed navigation or Android Auto) can give directions at a time. When you are using one system, directions to any prior destination set on the other system will be canceled, and the system you are currently using will direct you to your destination.

The audio/Information screen shows you turn-by-turn driving directions to your destination.

2 Phone (Communication)

Make and receive phone calls as well as listen to voicemail.

3 Google Now (Home screen)

Display useful information organized by Android Auto into simple cards that appear just when they're needed.

Android Auto™

For details on countries and regions where Android Auto is available, as well as information pertaining to function, refer to the Android Auto homepage.

Android Auto Operating Requirements & Limitations

Android Auto requires a compatible Android phone with an active cellular connection and data plan. Your carrier's rate plans will apply.

Changes in operating systems, hardware, software, and other technology integral to providing Android Auto functionality, as well as new or revised governmental regulations, may result in a decrease or cessation of Android Auto functionality and services. Honda cannot and does not provide any warranty or guarantee of future Android Auto performance or functionality.

It is possible to use 3rd party apps if they are compatible with Android Auto. Refer to the Android Auto homepage for information on compatible apps.

4 Music and audio

Play Google Play Music and music apps that are compatible with Android Auto. To switch between music apps, press this icon.

5 Go back to the Home Screen.

6 Voice

Operate Android Auto with your voice.

Auto Pairing Connection

When you connect an Android phone to the unit via the front USB port, Android Auto is automatically initiated.

Enabling Android Auto

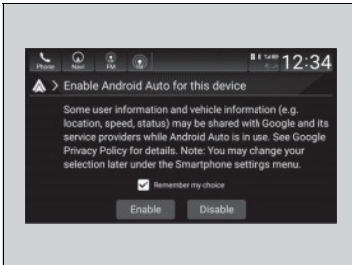

Check the checkbox.

Enable: Allows this consent.

Disable: Does not allow this consent.

You may change the consent settings under the **Connections** settings menu.

Enabling Android Auto

Only initialize Android Auto when you safely parked. When Android Auto first detects your phone, you will need to set up your phone so that auto pairing is possible. Refer to the instruction manual that came with your phone.

You can use the method below to change Android Auto settings after you have completed the initial setup:

Select HOME → Settings → Connections → Smartphone Connection → Android Auto → Select device → Edit Device Permissions

Use of user and vehicle information

The use and handling of user and vehicle information transmitted to/from your phone by Android Auto is governed by the Google's Privacy Policy.

Continued

■ Operating Android Auto with Voice Recognition

Press and hold the talk button to operate Android Auto with your voice.



 **(Talk) button:**

Press and hold to operate Android Auto with your voice.

Press and release to activate standard voice recognition system.

🗨️ Operating Android Auto with Voice Recognition

Below are examples of commands you can give with voice recognition:

- Reply to text.
- Call my wife.
- Navigate to Honda.
- Play my music.
- Send a text message to my wife.
- Call flower shop.

For more information, please refer to the Android Auto homepage.

You can also activate the voice recognition function by pressing the  icon in the upper-right corner of the screen.

iPod/USB Flash Drive

If an error occurs while playing an iPod or USB flash drive, you may see the following error messages. If you cannot clear the error message, contact a dealer.

Error Message	Solution
USB Error Please check owners manual ^{*1}	Appears when an incompatible device is connected. Disconnect the device. Then turn the audio system off, and turn it on again. Do not reconnect the device that caused the error.
Unsupported Ver ^{*1}	Appears when an unsupported iPod is connected. If it appears when a supported iPod is connected, update the iPod software to the newer version.
Connect Retry ^{*1, *2}	Appears when the system does not acknowledge the iPod. Reconnect the iPod.
Unplayable File ^{*1, *2}	Appears when the files in the USB flash drive are copyright protected or an unsupported format. This error message appears for about three seconds, then plays the next song.
No Song ^{*1} No Data ^{*2}	<p>iPod Appears when the iPod is empty.</p> <p>USB flash drive Appears when the USB flash drive is empty.</p> <p>iPod and USB flash drive Check that compatible files are stored on the device.</p>
Unsupported ^{*1, *2}	Appears when an unsupported device is connected. If it appears when a supported device is connected, reconnect the device. Appears when unsupported formats are in the device. Check that compatible files are stored on the device.

*1:Models with color audio

*2:Models with Display Audio

Error Message	Solution
Device No Response ^{*1, *2}	Appears when the system does not communicate with a connected device. If it appears when a device is connected, contact your place of device purchase.
HUB Unsupported ^{*1} USB hub not supported ^{*2}	Appears when only a HUB is connected. If it appears, connect a USB flash drive to the HUB.

*1:Models with color audio

*2:Models with Display Audio

Models with color audio

Pandora®

If an error occurs while playing Pandora®, you may see the following error messages. If you cannot clear the error message, contact a dealer.

Error Message	Solution
No Device Connected	Appears when no device is connected. Check the <i>Bluetooth</i> ® and USB connection.
No Data	Appears when no data is available with Pandora® activated. Reboot the app and reconnect the device.
To begin listening, select a station from the stations list.	Appears when any station is not selected. Select a station from the station list on the device.
PANDORA ver unsupported.	Appears when Pandora® version is not supported. Update Pandora® to the latest version.
No station list on device. Use device to create station.	Appears when there is no station list on the device. Use the device to create a station.
PANDORA system maintenance.	Appears when the Pandora® server is in maintenance. Try again later.
Unable to play PANDORA. When stopped, log-in to PANDORA.	Appears you do not log in to Pandora®. Log in to Pandora®.
No network connectivity.	Appears when the network is deteriorated. Move the vehicle and check the reception of the signal.
Unable to play PANDORA. Please try again later.	Appears when the sending the data is failed for ten times and the device may have a malfunction. Try again later. Move the vehicle and check the reception of the signal.

Error Message	Solution
Unable to play PANDORA. Music licensing restricts play in this area.	Appears when the vehicle is in the restricted area to listen the music. Move the vehicle and check the reception of the signal.
USB Error Please check owners manual	Appears when an incompatible device is connected. If there is any problem with the connected device itself, the audio system may not be able to detect it. Contact a dealer.

Models with Display Audio

Android/Apps

If an error occurs while using the audio system or apps, you may see the following error messages. If you cannot clear the error message, contact a dealer.

Error Message	Solution
Unfortunately, **** has stopped.* ¹	Error has occurred within app, select OK on the screen to close the app.
**** is not responding. Would you like to close it?*	App is not responding. Select Wait if you can wait for a response from app a little longer. If it does not respond even if you keep waiting, select OK to close the app and start it up. If the error message continues, perform Factory Data Reset .  Defaulting All the Settings P. 399

*1:****part is variable characters, and will change depending upon where an error occurs.

General Information on the Audio System

Models with Display Audio

SiriusXM® Radio Service*

■ Subscribing to SiriusXM® Radio

1. You need your radio ID ready before registering for subscription. To see the ID in the screen, select **Channel** to 0.
2. Have your radio ID ready, and either call or visit the SiriusXM® website to subscribe.

■ Receiving SiriusXM® Radio

Switch to the SiriusXM® mode by using the audio remote controls on the steering wheel, or through the audio/information screen, and stay in this mode for about 30 minutes until the service is activated. Make sure your vehicle is in an open area with good reception.

■ SiriusXM® Radio Display Messages

Channel ** is not subscribed. Call SiriusXM to subscribe.*¹**

You are not subscribed to the channel selected.

Subscription updated:

SiriusXM® radio is receiving information update from the network.

Channel Not Available:

No such channel exists, or the artist or title information is unavailable.

No Signal:

The signal is too weak in the current location.

Check Tuner:

There is a problem with the SiriusXM® tuner. Contact a dealer.

Check Antenna:

There is a problem with the SiriusXM® antenna. Contact a dealer.

*1: ****part is variable characters, and will change depending upon where an subscribe.

* Not available on all models

▶▶ Subscribing to SiriusXM® Radio

Contact Information for SiriusXM® Radio:

- US: SiriusXM® Radio at
www.siriusxm.com/subscribe-now or 1-855-236-9236
- Canada: SiriusXM® Canada at
www.siriusxm.ca/subscribe-now, or 1-877-209-0079

▶▶ Receiving SiriusXM® Radio

The SiriusXM® satellites are in orbit over the equator; therefore, objects south of the vehicle may cause satellite reception interruptions. Satellite signals are more likely to be blocked by tall buildings and mountains the farther north you travel from the equator.

You may experience reception problems under the following circumstances:

- In a location with an obstruction to the south of your vehicle.
- In tunnels
- On the lower level of a multi-tiered road
- Large items carried on the roof rack

Compatible iPod, iPhone, and USB Flash Drives

iPod, and iPhone Model Compatibility

Models with color audio

Model
iPod (5th generation)
iPod classic 80GB/160GB (launch in 2007)
iPod classic 120GB (launch in 2008)
iPod classic 160GB (launch in 2009)
iPod nano (1st to 7th generation) released between 2005 and 2012
iPod touch (1st to 5th generation) released between 2007 and 2012
iPhone/iPhone 3G/iPhone 3GS/iPhone 4/iPhone 4s/iPhone 5/iPhone 5c/iPhone 5s/iPhone 6/iPhone 6 Plus

Models with Display Audio

Model
iPod touch (5th to 6th generation) released between 2012 and 2015
iPhone 4s/iPhone 5/iPhone 5s/iPhone 5c/iPhone 6/iPhone 6 Plus/iPhone 6S/iPhone 6S Plus/iPhone SE/iPhone 7/iPhone 7 Plus

USB Flash Drives

- A USB flash drive of 256 MB or higher is recommended.
- Some digital audio players may not be compatible.
- Some USB flash drives (e.g., a device with security lockout) may not work.
- Some software files may not allow for audio play or text data display.
- Some versions of MP3, WMA, or AAC formats may be unsupported.

⌘ iPod, and iPhone Model Compatibility

This system may not work with all software versions of these devices.

⌘ USB Flash Drives

Files on the USB flash drive are played in their stored order. This order may be different from the order displayed on your PC or device.

Honda App License Agreement

■ END USER LICENSE AGREEMENT

PLEASE CAREFULLY READ THIS END USER LICENSE AGREEMENT (THIS "AGREEMENT") WHICH GOVERNS YOUR USE OF THE SOFTWARE INSTALLED ON YOUR HONDA OR ACURA VEHICLE (YOUR "VEHICLE") AS WELL AS THE APPLICATIONS, SERVICES, FUNCTIONS, AND CONTENT PROVIDED THROUGH THE SOFTWARE (COLLECTIVELY, THE "SERVICES"). YOUR USE OF THE SOFTWARE OR SERVICES WILL SERVE AS YOUR CONSENT TO THE TERMS OF THIS AGREEMENT. THE SOFTWARE IS OWNED (OR LICENSED), PROVIDED, AND/OR OPERATED BY AMERICAN HONDA MOTOR CO. INC., ("HONDA," "US," "WE," OR "OUR"), WITH ITS BUSINESS ADDRESS AT 1919 TORRANCE BLVD., TORRANCE, CA 90501. REFERENCE TO "HONDA" IN THIS AGREEMENT INCLUDES HONDA'S PARENT COMPANY AND ITS AFFILIATES AND DESIGNATED AGENTS. THE SERVICES ARE OWNED (OR LICENSED), PROVIDED, AND/OR OPERATED BY HONDA OR A THIRD-PARTY SERVICE PROVIDER (A "PROVIDER"). REFERENCE TO A "PROVIDER" IN THIS AGREEMENT INCLUDES SUCH PROVIDER'S PARENT COMPANY, AFFILIATES, AND DESIGNATED AGENTS.

A. Description of the Software. The SOFTWARE includes the software, firmware and the like, installed and executing on your VEHICLE during manufacture, and thereafter updated from time to time by HONDA, you or an authorized HONDA dealer (a "DEALER"). The SOFTWARE allows you to access and use a variety of SERVICES, including but not limited to: (a) HONDA applications, services, and content provided through the SOFTWARE (together, "HONDA SERVICES"); and (b) PROVIDER applications, services, and content provided through the SOFTWARE (together, "PROVIDER SERVICES"), each of which may provide access to various information, media, content, and services.

B. SOFTWARE Licensing and Intellectual Property.

1. SOFTWARE. This AGREEMENT grants you a non-exclusive, limited, and revocable license to use the SOFTWARE and SERVICES solely (a) as installed on your VEHICLE by HONDA, (b) as updated on your Vehicle by HONDA, you (but only as and when directed by HONDA), or a DEALER and (c) as permitted under the terms of this AGREEMENT.

2. HONDA Services. The SOFTWARE may provide you with access to various HONDA SERVICES. Installation, activation, or use of HONDA SERVICES may require your consent to additional terms, conditions, and privacy policies applicable to those HONDA SERVICES (the "HONDA TERMS"). You acknowledge and agree that any collection, use, sharing of data generated by your VEHICLE or your use of your VEHICLE, and your use of the HONDA SERVICES shall be subject to this AGREEMENT and any additional HONDA TERMS that may be specifically applicable to such HONDA SERVICES or data generation. The HONDA SERVICES may collect, use, and share such data while you are using the SOFTWARE.

3. Open-Source Software. The SOFTWARE and SERVICES may incorporate software licensed to HONDA under free or open-source licenses which govern HONDA's distribution and your use of such software. HONDA and the third-party authors, licensors, and distributors of such software disclaim all warranties and all liability arising from any and all use or distribution of the software. To the extent such software is provided under terms that differ from the applicable free or open-source licenses, those terms are offered by HONDA alone. Additional information regarding free and open-source software incorporated in the SOFTWARE and SERVICES is available in this manual or within the SOFTWARE.

4. Provider Services. The SOFTWARE may provide you with access to various PROVIDER SERVICES. Installation or use of such PROVIDER SERVICES may require your consent to additional terms, conditions, and privacy policies of the applicable PROVIDER (the "PROVIDER TERMS"). This AGREEMENT restricts the manner in which you can install and use PROVIDER SERVICES but does not grant you a license or permission to use such PROVIDER SERVICES. Your permission to use PROVIDER SERVICES is limited and subject to any license grants, conditions, and limitations included in the PROVIDER TERMS. You acknowledge that any collection, use, sharing of your information, targeted advertising practices by PROVIDERS, and your use of the PROVIDER SERVICES shall be subject to both this AGREEMENT and any applicable PROVIDER TERMS. The PROVIDER SERVICES may collect, use, and share such information while you are using the SOFTWARE.

5. License Limitations and Restrictions on Use.

(a) Limited License. You understand and agree that the SOFTWARE and SERVICES are licensed, not sold, to you solely for use in accordance with this AGREEMENT and any applicable PROVIDER TERMS, and any documentation for the VEHICLE made available to you by HONDA (any "DOCUMENTATION"). HONDA and its licensors reserve all rights in the SOFTWARE and HONDA SERVICES not expressly granted to you under this AGREEMENT. PROVIDERS and their licensors reserve all rights in the PROVIDER SERVICES not expressly granted to you under the applicable PROVIDER TERMS.

(b) Restrictions on Use. The licenses granted under this AGREEMENT do not permit you to use the SOFTWARE or SERVICES on a device other than your VEHICLE. As a condition of using the SOFTWARE and SERVICES, you agree that you may not and will not:

- (1) copy, download, distribute, modify, publish, sell, rent, lease, lend, license, sublicense, reuse, or create derivative works of the SOFTWARE or SERVICES or any of the content or other material within the SOFTWARE or SERVICES, including without limitation, HONDA or PROVIDER names, logos, or any other trademarks of HONDA or PROVIDERS or used in association with the SOFTWARE or any SERVICES, except as required to use the SOFTWARE or SERVICES in accordance with this AGREEMENT, any applicable PROVIDER TERMS, and the DOCUMENTATION;
- (2) access or use the SOFTWARE or SERVICES in any manner intended to damage or impair the operation of the SOFTWARE or SERVICES or interfere with anyone else's use and enjoyment of the SOFTWARE or SERVICES;
- (3) access or attempt to access any system or server on which the SOFTWARE or SERVICES is hosted or modify or alter the SOFTWARE or SERVICES in any way;
- (4) use the SOFTWARE or SERVICES for any unlawful purpose, or in violation of any third party rights;
- (5) use the SOFTWARE or SERVICES in violation of any applicable traffic regulations, rules or laws, including but not limited to any driver distraction laws, rules or regulations;
- (6) violate the terms of this AGREEMENT, any HONDA TERMS, any PROVIDER TERMS or other applicable third-party terms, conditions, and privacy policies; or
- (7) reverse engineer, decompile, disassemble, attempt to derive the source code of, nor permit others to reverse engineer, decompile, or disassemble, or attempt to derive the source code of the SOFTWARE or SERVICES, except and only to the extent that such activity is expressly permitted (a) by applicable law notwithstanding this limitation or (b) the terms of applicable free or opensource software licenses.

6. Intellectual Property Rights. All title and intellectual property rights in and to the SOFTWARE and SERVICES, the accompanying DOCUMENTATION, and all copies of the SOFTWARE or SERVICES are owned by HONDA, PROVIDERS, or their suppliers or licensors. This AGREEMENT does not grant you any rights in connection with any trademarks or service marks of HONDA, PROVIDERS, or their licensors, affiliates, or suppliers.

7. Export Restrictions: You acknowledge that the SOFTWARE and SERVICES are subject to U.S., European Union, and other export jurisdictions. You agree to comply with all applicable international and national laws that apply to the SOFTWARE and SERVICES, including the U.S. Export Administration Regulations, as well as end-user, end-use, and destination restrictions issued by the U.S. and other governments.

C. SOFTWARE Operation

- 1.** HONDA reserves the right to suspend or terminate your access to and use of the SOFTWARE or SERVICES if you are found to be in violation of this AGREEMENT or as reasonably deemed necessary by HONDA.
- 2. Eligibility/Registration/Activation.** The SOFTWARE is intended for and available to individuals who (a) are of legal age of majority in their jurisdiction of residence (and at least 18 years of age), or are younger than 18 years of age and possess a valid driver's license issued by their jurisdiction of residence, and (b) own or have permissive access to a compatible VEHICLE. We do not knowingly collect any information, including personal information, from children under 13. If we learn or are notified that we have collected personal information of a child under 13, we will immediately take steps to delete such information.
- 3. Use of PROVIDER SERVICES through the SOFTWARE.** Certain PROVIDER SERVICES made available through the SOFTWARE may require that you register or otherwise have an account with the PROVIDER and agree to PROVIDER TERMS. Any use of any of such PROVIDER SERVICES within the SOFTWARE is subject to this AGREEMENT and the applicable PROVIDER TERMS. HONDA does not exercise control over such PROVIDER SERVICES and is not responsible or liable for the availability, security, or content of such PROVIDER SERVICES, and the inclusion of any PROVIDER SERVICES does not imply a referral from, the approval of, or the endorsement by HONDA of such PROVIDER SERVICES. HONDA is not responsible or liable, directly or indirectly, for any damage relating to or resulting from your use of the PROVIDER SERVICES.
- 4. Links to Third Party Sites:** The SOFTWARE may provide you with the ability to access third-party sites and content through the use of the SOFTWARE or SERVICES. The third-party sites and content are not under the control of HONDA. HONDA is not responsible or liable, directly or indirectly, for such third-party websites and their content or for any damage relating to or resulting from your access or use of such websites and content.

5. Unauthorized Use and Abuse. You are responsible for ensuring your (and any authorized third parties') use of the SOFTWARE and SERVICES remains in compliance with this AGREEMENT and all other applicable HONDA TERMS and PROVIDER TERMS. You acknowledge and agree that any use of the SOFTWARE or SERVICES occurring through your VEHICLE will be deemed your actions and that HONDA and PROVIDERS may rely upon such actions. You agree to immediately notify us if you suspect fraudulent or abusive activity involving the SOFTWARE or SERVICES. If you so notify us or if we otherwise suspect fraudulent or abusive activity, you agree to cooperate with us in any fraud investigation and to use any fraud prevention measures we prescribe. Your failure to immediately notify us or cooperate to use such measures will result in your liability for all fraudulent usage or abusive activity associated with your VEHICLE.

6. SOFTWARE Updates. The SOFTWARE and SERVICES may be updated when your VEHICLE is serviced by a DEALER or remotely, over-the-air, by HONDA from time to time; such updates may occur with or without further notice or your future consent. The SOFTWARE may be updated at HONDA's discretion and for any purpose including, without limitation, to patch or otherwise improve the SOFTWARE or SERVICES functionality, security, or stability. All updates to the SOFTWARE and SERVICES are subject to this AGREEMENT and any other applicable HONDA TERMS and PROVIDER TERMS.

7. Uninstalling, Removing, and Replacing the SOFTWARE. Replacing SOFTWARE or HONDA SERVICES with software or firmware not provided and installed by HONDA or a DEALER will render all representations and warranties for the SOFTWARE, HONDA SERVICES, and VEHICLE functionality reliant upon the SOFTWARE or HONDA SERVICES null and void.

D. SOFTWARE Operational Notices and Warnings

1. Vehicle Geolocation Information. You acknowledge that your VEHICLE may be equipped with certain traffic and map features. The traffic feature will automatically collect and transmit, through GPS technology, your Vehicle's current location (longitude and latitude), travel direction and speed ("VEHICLE GEOLOCATION INFORMATION") to HONDA and PROVIDERS. The VEHICLE GEOLOCATION INFORMATION is used by HONDA and PROVIDERS to provide traffic and navigation-related information to you, but may also be used to provide other SERVICES or offers to you. HONDA will not use such VEHICLE GEOLOCATION INFORMATION for its own marketing efforts, or provide such information to unaffiliated third parties for their own purposes, without your express consent.

2. Potential Map Inaccuracy and Route Safety. Maps used by this system may be inaccurate because of changes in roads, traffic controls, routing, or driving conditions. Always use good judgment and common sense when following suggested routes. Do not follow the route suggestions if doing so would result in an unsafe or illegal driving maneuver, if you would be placed in an unsafe situation, or if you would be directed into an area that you consider unsafe. Do not rely on any navigation features included in the system to route you to emergency services. Not all emergency services such as police, fire stations, hospitals, or clinics are likely to be contained in the map database for such navigation features. Ask local authorities or an emergency services operator for such locations and routes. The driver is ultimately responsible for the safe operation of the vehicle and therefore, must evaluate whether it is safe to follow the suggested directions. Any navigation features are provided only as an aid. Make your driving decisions based on your observations of local conditions and existing traffic regulations. Navigation features are not a substitute for your personal judgment. Any route suggestions made by the SOFTWARE or SERVICES should never replace any local traffic regulations or your personal judgment or knowledge of safe driving practices.

3. Speech Recognition: You acknowledge and understand that HONDA and PROVIDERS may record, retain, and use voices commands when you use the speech recognition components of the SOFTWARE or SERVICES. You and all VEHICLE operators and passengers (a) consent to the recording and retention of voice commands in support of providing speech recognition components and (b) release HONDA and PROVIDERS from all claims, liabilities, and losses that may result from any use of such recorded voice commands. Recognition errors are inherent in speech recognition. It is your responsibility to monitor any speech recognition functions included in the system and address any errors. Neither HONDA nor PROVIDERS will be liable for any damages arising out of errors in the speech recognition process.

4. Distraction Hazards. Navigation features may require manual (non-verbal) input or setup. Attempting to perform such set-up or insert data while driving can seriously distract your attention and could cause a crash or other serious consequences; the ability to undertake such interactions may also be limited by state or local law, which laws you are responsible to know and follow. Even occasional short scans of the screen may be hazardous if your attention has been diverted away from your driving at a critical time. Pull over and stop the vehicle in a safe and legal manner before attempting to access a function of the system requiring prolonged attention. Do not raise the volume excessively. Keep the volume at a level where you can still hear outside traffic and emergency signals while driving. Driving while unable to hear these sounds could result in a crash.

E. Information Collection and Storage

1. Information Collection, Use, Transmission and Storage of Data. Consent to Use of Data: You agree that HONDA and PROVIDERS may collect and use your information gathered in any manner as part of product support services related to the SOFTWARE or related services. HONDA may share such information with third parties, including, without limitation, PROVIDERS, third party software and services suppliers, their affiliates and/or their designated agents, solely to improve their products or to provide services or technologies to you. HONDA, third party software and systems suppliers, their affiliates and/or their designated agent may disclose this information to others, but not in a form that personally identifies you.

2. Information Storage. Depending on the type of multimedia system you have in your VEHICLE, certain information may be stored for ease of use of the SOFTWARE including, without limitation, search history, location history in certain applications, previous and saved destinations, map locations within certain applications, and device numbers and contact information.

(a) Vehicle Health Information. Your VEHICLE may remotely transmit information regarding the status and health of your VEHICLE (“VEHICLE INFORMATION”) to HONDA without notification to you. VEHICLE INFORMATION may contain VEHICLE maintenance and malfunction status that is derived from VEHICLE diagnostic data and includes, but is not limited to, status of powered doors and windows, battery life data, battery charging data, VEHICLE speed, coolant temperature, air compressor revolution, output power, warning codes, diagnostic trouble codes, fuel injection volume, and engine rotations per minute. VEHICLE HEALTH INFORMATION may be used by HONDA for research and development, to deliver HONDA SERVICES and information to you, and to contact you, and is retained only for a period of time necessary to fulfill these goals.

(b) VEHICLE Geolocation Data (non-navigation/map based). If you opt-in to geolocation-based SERVICES, your vehicle’s geolocation data (latitude and longitude) will be automatically sent from your VEHICLE to HONDA and PROVIDERS.

(c) You understand that the inputting or uploading of information to your VEHICLE’s multimedia system or the SOFTWARE or SERVICES is at your own risk and that HONDA is not responsible for unauthorized access to or use of any personal or other information. All information uploaded to the SOFTWARE and SERVICES may be stored on your VEHICLES’s multimedia system and you understand that the security and safety of your VEHICLE’s multimedia system is your sole responsibility.

F. NO WARRANTY. You understand and agree that your use of the SOFTWARE and SERVICES are solely at your own risk and that you will be solely responsible for any damage to your VEHICLE's multimedia system or any other equipment or any loss of data that may result from your use of the SOFTWARE or SERVICES. THE SOFTWARE AND SERVICES ARE PROVIDED ON AN "AS IS" AND "AS AVAILABLE" BASIS WITHOUT ANY WARRANTY OF ANY KIND, EXPRESSED, IMPLIED OR STATUTORY. WE SPECIFICALLY DISCLAIM ANY IMPLIED WARRANTIES OF MERCHANTABILITY, FITNESS FOR A PARTICULAR PURPOSE, AND NON-INFRINGEMENT. HONDA makes no warranties that the SOFTWARE or SERVICES will meet your requirements, or that the SOFTWARE or SERVICES will be uninterrupted, timely, secure, non-infringing or error free. You understand and agree that you are responsible for any and all charges, costs or expenses associated with your use of the SOFTWARE or SERVICES. Advice or information, whether oral or written, obtained by you from us or through the SOFTWARE or SERVICES are provided for informational purposes only and will not create any warranty not expressly made herein. You should not rely on any such information or advice. We assume no liability or responsibility for any errors or omissions in the SOFTWARE or SERVICES. We do not make any warranty or representation that your use of the material displayed on, or obtained through, the SOFTWARE or SERVICES is non-infringing of any rights of any third party. Any decision or action taken by you on the basis of information or content provided via the application is at your sole discretion and risk. HONDA and PROVIDERS are not responsible or liable for any such decision, or for the accuracy, completeness, usefulness, or availability of any content or information displayed, transmitted, or otherwise made available via the SOFTWARE or SERVICES. To the extent jurisdictions do not allow the exclusion of certain warranties, some of the above exclusions may not apply to you.

G. LIMITATIONS ON LIABILITY. You and HONDA are each waiving important rights.

1. Limitations on YOUR liability. HONDA cannot recover from you any consequential, indirect, incidental, or special damages, or attorney's fees in connection with your use of the SOFTWARE or HONDA SERVICES. HONDA WAIVES TO THE FULLEST EXTENT ALLOWED BY LAW ANY CLAIM FOR DAMAGES OTHER THAN DIRECT, COMPENSATORY DAMAGES AS LIMITED IN THIS AGREEMENT.

2. Limitation on HONDA and PROVIDER liability. Neither HONDA nor PROVIDERS will be liable to you or any other party for consequential, indirect, incidental, special, or punitive damages (including without limitation lost profits) in connection with your use of the SOFTWARE or SERVICES, even if HONDA or PROVIDERS are aware of the possibility of such damages. These limitations apply to all claims, including, without limitation, claims in contract and tort (such as negligence, product liability and strict liability). To the extent that a jurisdiction does not permit the exclusion or limitation of liability as set forth herein our liability is limited to the maximum extent permitted by law in such states. If HONDA or PROVIDERS are found liable to you for any reason, you agree that the aggregate liability of all these parties to you for any claim is limited to ten U.S. dollars (US \$10.00). Neither HONDA nor any PROVIDER would have agreed to provide the SOFTWARE or SERVICES to you if you did not agree to this limitation. This amount is the sole and exclusive liability of HONDA and PROVIDERS to you, and is payable as liquidated damages and not as a penalty. Except where prohibited by law, you may not bring any claim against HONDA or any third-party beneficiary more than two (2) years after the claim arises. We do not have any liability for SOFTWARE or SERVICES interruptions of any length.

(a) **Release of HONDA and PROVIDERS** For yourself and anyone else claiming under you, you agree to release and discharge HONDA, PROVIDERS, their respective officers, directors, and employees, and each third-party beneficiary from all claims, liabilities and losses in connection with the SOFTWARE or SERVICES, including, but not limited to claims for personal injury or property damage arising from the total or partial failure of performance of the SOFTWARE or SERVICES, even if caused by or based upon the negligence, gross negligence, strict products liability, Deceptive Trade Practices Act violations, bad faith, or breach of warranty of us or the malfunction of the SOFTWARE or SOFTWARE SERVICES. YOU AGREE TO WAIVE TO THE FULLEST EXTENT ALLOWED BY LAW, ANY CLAIM FOR DAMAGES OTHER THAN DIRECT, COMPENSATORY DAMAGES AS LIMITED IN THIS AGREEMENT. YOU HEREBY RELEASE AND DISCHARGE HONDA AND ITS LICENSORS AND CONTRACTORS (INCLUDING ANY THIRD PARTIES PROVIDING ALL OR PART OF THE SOFTWARE OR SERVICES) FROM AND AGAINST ANY CLAIMS, DAMAGES, EXPENSES AND LIABILITY ARISING FROM OR RELATED TO ANY INJURIES, DAMAGES, OR LOSSES TO ANY PERSON (INCLUDING DEATH) OR PROPERTY OF ANY KIND RESULTING IN WHOLE OR PART, DIRECTLY OR INDIRECTLY, FROM YOUR USE OF THE SOFTWARE OR SERVICES.

H. Survival. You agree that the limitations of liability and indemnities in this AGREEMENT will survive even after the AGREEMENT has ended. These limitations of liability apply not only to you, but to anyone using the SOFTWARE or SERVICES via your VEHICLE, to anyone making a claim on your behalf, and to any claims made by your family, employees, customers, or others arising out of or relating to your VEHICLE, the SOFTWARE, or SERVICES.

I. Availability/Interruption. The SOFTWARE and certain SERVICES are made available through your VEHICLE's compatible multimedia system when the VEHICLE is turned on. Certain SERVICES may be available only through your compatible mobile device when it is within the operating range of the VEHICLE and a wireless carrier. The availability of the SOFTWARE and SERVICES may be subject to transmission limitation or interruption, including but not limited to technical obsolescence or sunset of the hardware, software or firmware, inside of or external to the Vehicle, required for data transmission or receipt. HONDA does not guarantee that the SOFTWARE, SERVICES, or any portion thereof will be available at all times or in all areas. You acknowledge and agree that HONDA is not responsible for performance degradation, interruption or delays. You acknowledge that HONDA shall not be liable to you if the SOFTWARE or SERVICES in a given location are not available. If the SOFTWARE or SERVICES are not available within your intended location, you agree that your sole remedy shall be to cease using the SOFTWARE and SERVICES.

J. PRODUCT SUPPORT: Product support for the SOFTWARE is provided by HONDA. For product support, please refer to HONDA instructions provided in the DOCUMENTATION. Should you have any questions concerning this AGREEMENT, or if you desire to contact HONDA for any other reason, please refer to the HONDA contact information provided in the DOCUMENTATION.

K. Termination and Transfer.

1. Termination. This AGREEMENT is effective until terminated by you or US. WE may terminate this AGREEMENT for any or no reason, and with or without notice to you. Your rights under this AGREEMENT will terminate automatically without notice from US if you fail to comply with any term of this AGREEMENT. Upon termination of this AGREEMENT, you shall cease all use of the SOFTWARE and SERVICES.

2. Transfer: You may permanently transfer your rights under this AGREEMENT only as part of a sale or transfer of the VEHICLE, provided you retain no copies, you transfer all of the SOFTWARE and HONDA SERVICES (including all component parts, the media and printed materials, and any upgrades), and the recipient agrees to the terms of this AGREEMENT. You agree to notify HONDA upon the sale or transfer of the VEHICLE. To contact HONDA, please refer to the HONDA contact information provided in the DOCUMENTATION.

L. Changes to the SOFTWARE or SERVICES. WE may change, modify, or update the SOFTWARE or SERVICES from time to time. Unless explicitly stated otherwise, any new features or services that augment or enhance the SOFTWARE or SERVICES in the future shall respectively be considered part of the SOFTWARE or SERVICES and subject to this AGREEMENT. WE reserve the right at any time and from time to time to interrupt, restrict, modify, suspend, discontinue, temporarily or permanently, the SOFTWARE or SERVICES (or any portion thereof), with or without notice to you, and you agree that HONDA shall not be liable to you or to any third party for any modification, suspension or discontinuance of the SOFTWARE or SERVICES.

M. ARBITRATION:

PLEASE READ THIS ARBITRATION PROVISION CAREFULLY TO UNDERSTAND YOUR RIGHTS. YOU AGREE THAT ANY CLAIM THAT YOU MAY HAVE IN THE FUTURE MUST BE RESOLVED THROUGH BINDING ARBITRATION. YOU WAIVE THE RIGHT TO HAVE YOUR DISPUTE HEARD IN COURT AND WAIVE THE RIGHT TO BRING CLASS CLAIMS. YOU UNDERSTAND THAT DISCOVERY AND APPEAL RIGHTS ARE MORE LIMITED IN ARBITRATION.

Arbitration is a method of resolving a claim, dispute or controversy without filing a lawsuit. By agreeing to arbitrate, the right to go to court is waived and instead claims, disputes or controversies are submitted to binding arbitration. This provision sets forth the terms and conditions of our agreement. YOU and HONDA agree and acknowledge that this Agreement affects interstate commerce and the Federal Arbitration Act ("FAA") applies. By using the Software, Vehicle, or Services, YOU elect to have disputes resolved by arbitration. YOU, HONDA or any involved third party may pursue a Claim. "Claim" means any dispute between YOU, HONDA, or any involved third party relating to your use of the Software, the Vehicle, or the Services, this Agreement, or our relationship, including any representations, omissions or warranties. "Claim" does not include personal injury or wrongful death claims. YOU or HONDA may seek remedies in small claims court or provisional judicial remedies without arbitrating. In addition, notwithstanding anything herein to the contrary, YOU or HONDA may seek equitable relief in a court of competent jurisdiction.

YOU or HONDA may select arbitration with American Arbitration Association, JAMS or National Arbitration and Mediation. Contact these sponsors for their rules. The hearing will be in the federal district where YOU reside. If agreed, it may be by telephone or written submissions. Filing and arbitrator fees to be paid per the sponsor rules. You may contact the sponsor for a fee waiver. If no fee waivers, HONDA will pay filing and arbitrator fees up to \$5,000, unless law requires more. Each party is responsible for other fees. Arbitrator may award costs or fees to prevailing party, if permitted by law. HONDA will not seek fees, unless the claims are frivolous.

Arbitrator shall be an attorney or current or retired judge familiar with automotive or consumer software. The arbitrator shall follow substantive law, statute of limitations and decide all issues relating to the interpretation, construction, enforceability and applicability of this provision. The arbitrator may order relief permitted by law. This provision is governed and enforceable by the FAA. An award shall include a written opinion and be final, subject to appeal by the FAA.

This provision survives termination of this Agreement or relationship, bankruptcy, assignment or transfer. If part of this provision is unenforceable, the remainder remains in effect. If unenforceability allows arbitration as a class action, then this provision is entirely unenforceable. YOU may opt out within 30 days of your initial use of the Software by sending a signed, written notice to HONDA at Honda Financial Services, P.O. Box 165007, Irving, TX 75016. HONDA reserves the right to make changes to this provision after providing written notice and an opportunity to opt out.

N. Miscellaneous: You may not assign this AGREEMENT without HONDA's prior written consent. This AGREEMENT and any additional HONDA TERMS and PROVIDER TERMS represents the entire agreement between you and US. HONDA may amend the terms of this AGREEMENT by providing you with notices of such updated terms. If you do not consent to be bound by the updated terms, your sole remedy will be to cease using the SOFTWARE and SERVICES. If any part of this AGREEMENT is found invalid, void, or unenforceable, the balance of the AGREEMENT will remain valid and enforceable according to its terms. To the fullest extent permitted by law, and except as explicitly provided otherwise, this AGREEMENT and any disputes arising out of or relating to it will be governed by the laws of the State of California, except that California laws concerning choice of law or conflicts shall not apply if they would cause the substantive law of another jurisdiction to apply. Notwithstanding the foregoing, Section M shall be governed by the Federal Arbitration Act and the laws of the State of California, as applicable, as set forth therein. The failure to enforce any term of this AGREEMENT on one occasion shall not prevent enforcement on any other occasion or the enforcement of any other term. Headings and captions shall not be considered included for purposes of interpretation or application hereof, but are for convenience only.

Models with Display Audio

Legal Information on Apple CarPlay/Android Auto

OWNER'S MANUAL LICENSE/LIABILITY STATEMENTS

USE OF APPLE CARPLAY IS SUBJECT TO YOUR AGREEMENT TO THE CARPLAY TERMS OF USE, WHICH ARE INCLUDED AS PART OF THE APPLE iOS TERMS OF USE. IN SUMMARY, THE CARPLAY TERMS OF USE DISCLAIM APPLE AND ITS SERVICE PROVIDERS' LIABILITY IF THE SERVICES FAIL TO PERFORM CORRECTLY OR ARE DISCONTINUED, STRICTLY LIMIT APPLE AND ITS SERVICE PROVIDERS' OTHER LIABILITIES, DESCRIBE THE KINDS OF USER INFORMATION (INCLUDING, FOR EXAMPLE, VEHICLE LOCATION, VEHICLE SPEED, AND VEHICLE STATUS) BEING GATHERED AND STORED BY APPLE AND ITS SERVICE PROVIDERS, AND DISCLOSE CERTAIN POSSIBLE RISKS ASSOCIATED WITH THE USE OF CARPLAY, INCLUDING THE POTENTIAL FOR DRIVER DISTRACTION. SEE APPLE'S PRIVACY POLICY FOR DETAILS REGARDING APPLE'S USE AND HANDLING OF DATA UPLOADED BY CARPLAY.

USE OF ANDROID AUTO IS SUBJECT TO YOUR AGREEMENT TO THE ANDROID AUTO TERMS OF USE WHICH MUST BE AGREED TO WHEN THE ANDROID AUTO APPLICATION IS DOWNLOADED TO YOUR ANDROID PHONE. IN SUMMARY, THE ANDROID AUTO TERMS OF USE DISCLAIM GOOGLE AND ITS SERVICE PROVIDERS' LIABILITY IF THE SERVICES FAIL TO PERFORM CORRECTLY OR ARE DISCONTINUED, STRICTLY LIMIT GOOGLE AND ITS SERVICE PROVIDERS' OTHER LIABILITIES, DESCRIBE THE KINDS OF USER INFORMATION (INCLUDING, FOR EXAMPLE, VEHICLE LOCATION, VEHICLE SPEED, AND VEHICLE STATUS) BEING GATHERED AND STORED BY GOOGLE AND ITS SERVICE PROVIDERS, AND DISCLOSE CERTAIN POSSIBLE RISKS ASSOCIATED WITH THE USE OF ANDROID AUTO, INCLUDING THE POTENTIAL FOR DRIVER DISTRACTION. SEE GOOGLE'S PRIVACY POLICY FOR DETAILS REGARDING GOOGLE'S USE AND HANDLING OF DATA UPLOADED BY ANDROID AUTO.

DISCLAIMER OF WARRANTIES; LIMITATION ON LIABILITY





YOU EXPRESSLY ACKNOWLEDGE AND AGREE THAT USE OF APPLE CARPLAY OR ANDROID AUTO (“THE APPLICATIONS”) IS AT YOUR SOLE RISK AND THAT THE ENTIRE RISK AS TO SATISFACTORY QUALITY, PERFORMANCE, ACCURACY AND EFFORT IS WITH YOU TO THE MAXIMUM EXTENT PERMITTED BY APPLICABLE LAW, AND THAT THE APPLICATIONS AND INFORMATION ON THE APPLICATIONS IS PROVIDED “AS IS” AND “AS AVAILABLE,” WITH ALL FAULTS AND WITHOUT WARRANTY OF ANY KIND, AND HONDA HEREBY DISCLAIMS ALL WARRANTIES AND CONDITIONS WITH RESPECT TO THE APPLICATIONS AND INFORMATION ON THE APPLICATIONS, EITHER EXPRESS, IMPLIED OR STATUTORY, INCLUDING, BUT NOT LIMITED TO, THE IMPLIED WARRANTIES AND/OR CONDITIONS OF MERCHANTABILITY, SATISFACTORY QUALITY, FITNESS FOR A PARTICULAR PURPOSE, ACCURACY, QUIET ENJOYMENT, AND NON-INFRINGEMENT OF THIRD PARTY RIGHTS. NO ORAL OR WRITTEN INFORMATION OR ADVICE GIVEN BY HONDA OR AN AUTHORIZED REPRESENTATIVE SHALL CREATE A WARRANTY. AS EXAMPLES, AND WITHOUT LIMITATION, HONDA DISCLAIMS ANY WARRANTY REGARDING THE ACCURACY OF DATA PROVIDED BY THE APPLICATIONS, SUCH AS THE ACCURACY OF DIRECTIONS, ESTIMATED TRAVEL TIME, SPEED LIMITS, ROAD CONDITIONS, NEWS, WEATHER, TRAFFIC, OR OTHER CONTENT PROVIDED BY APPLE, GOOGLE, THEIR AFFILIATES, OR THIRD PARTY PROVIDERS; HONDA DOES NOT GUARANTEE AGAINST LOSS OF APPLICATION DATA, WHICH MAY BE LOST AT ANY TIME; HONDA DOES NOT GUARANTEE THAT THE APPLICATIONS OR ANY SERVICES PROVIDED THROUGH THEM WILL BE PROVIDED AT ALL TIMES OR THAT ANY OR ALL SERVICES WILL BE AVAILABLE AT ANY PARTICULAR TIME OR LOCATION. FOR EXAMPLE, SERVICES MAY BE SUSPENDED OR INTERRUPTED WITHOUT NOTICE FOR REPAIR, MAINTENANCE, SECURITY FIXES, UPDATES, ETC., SERVICES MAY BE UNAVAILABLE IN YOUR AREA OR LOCATION, ETC. IN ADDITION, YOU UNDERSTAND THAT CHANGES IN THIRD PARTY TECHNOLOGY OR GOVERNMENT REGULATION MAY RENDER THE SERVICES AND/OR APPLICATIONS OBSOLETE AND/OR UNUSABLE.

TO THE EXTENT NOT PROHIBITED BY LAW, IN NO EVENT SHALL HONDA OR ITS AFFILIATES BE LIABLE FOR PERSONAL INJURY, OR ANY INCIDENTAL, SPECIAL, INDIRECT OR CONSEQUENTIAL DAMAGES WHATSOEVER, INCLUDING, WITHOUT LIMITATION, DAMAGES FOR LOSS OF PROFITS, CORRUPTION OR LOSS OF DATA, FAILURE TO TRANSMIT OR RECEIVE ANY DATA, BUSINESS INTERRUPTION OR ANY OTHER COMMERCIAL DAMAGES OR LOSSES, ARISING OUT OF OR RELATED TO THE APPLICATIONS OR YOUR USE OF OR INABILITY TO USE THE APPLICATIONS OR INFORMATION ON THE APPLICATIONS, HOWEVER CAUSED, REGARDLESS OF THE THEORY OF LIABILITY (CONTRACT, TORT OR OTHERWISE) AND EVEN IF HONDA WERE ADVISED OF THE POSSIBILITY OF SUCH DAMAGES. SOME STATES AND JURISDICTIONS DISALLOW THE EXCLUSION OR LIMITATION OF LIABILITY FOR DAMAGES, SO THESE LIMITATIONS AND EXCLUSIONS MAY NOT APPLY TO YOU. IN NO EVENT SHALL HONDA’S TOTAL LIABILITY TO YOU FOR ALL DAMAGES (OTHER THAN AS MAY BE REQUIRED BY APPLICABLE LAW IN CASES INVOLVING PERSONAL INJURY) EXCEED THE AMOUNT OF FIVE DOLLARS (\$5.00). THE FOREGOING LIMITATIONS WILL APPLY EVEN IF THE ABOVE STATED REMEDY FAILS OF ITS ESSENTIAL PURPOSE.

About Open Source Licenses

To see the open source license information, follow these steps.

Models with color audio

1. Press the **MENU/CLOCK** button.
2. Rotate  to select **Settings**, then press .
3. Rotate  to select **License**, then press .

Models with Display Audio

1. Press the  button.
2. Select **Settings**.
3. Select **System**.
4. Select **About**.
5. Select **Legal Information**.
6. Select **License**.

▶▶ About Open Source Licenses

Models with Telematics Control Unit

Free/Open Source Software Information

This product contains Free/Open Source Software(FOSS).

The license information and/or the source code of such FOSS can be found at the following URL.

<https://www.denso.com/global/en/opensource/tcu/honda/>

License Information*

DOLBY DIGITAL

Manufactured under license from Dolby Laboratories. Dolby, Dolby Audio, Pro Logic, and the double-D symbol are trademarks of Dolby Laboratories.



DTS

For DTS patents, see <http://patents.dts.com>. Manufactured under license from DTS Licensing Limited. DTS, DTS-HD, the Symbol, & DTS and the Symbol together are registered trademarks of DTS, Inc. ©DTS, Inc. All Rights Reserved.



■ Bluetooth

The *Bluetooth*® word mark and logos are registered trademarks owned by Bluetooth SIG, Inc. and any use of such marks by PANASONIC CORPORATION is under license. Other trademarks and trade names are those of their respective owners.



■ Windows Media

This product is protected by certain intellectual property rights of Microsoft. Use or distribution of such technology outside of this product is prohibited without a license from Microsoft.

■ Apple

“Made for iPod,” and “Made for iPhone,” mean that an electronic accessory has been designed to connect specifically to iPod, or iPhone, respectively, and has been certified by the developer to meet Apple performance standards. Apple is not responsible for the operation of this device or its compliance with safety and regulatory standards. Please note that the use of this accessory with iPod, or iPhone, may affect wireless performance.

Apple, the Apple Logo, iPod touch are trademarks of Apple Inc., registered in the U.S. and other countries. Apple CarPlay, and Lightning are trademarks of Apple Inc. App Store is a service mark of Apple Inc.



■ MPEG

Mpeg4 Visual

THIS PRODUCT IS LICENSED UNDER THE MPEG-4 VISUAL PATENT PORTFOLIO LICENSE FOR THE PERSONAL AND NON-COMMERCIAL USE OF A CONSUMER FOR (i) ENCODING VIDEO IN COMPLIANCE WITH THE MPEG-4 VISUAL STANDARD ("MPEG-4 VIDEO") AND/OR (ii) DECODING MPEG-4 VIDEO THAT WAS ENCODED BY A CONSUMER ENGAGED IN A PERSONAL AND NONCOMMERCIAL ACTIVITY AND/OR WAS OBTAINED FROM A VIDEO PROVIDER LICENSED BY MPEG LA TO PROVIDE MPEG-4 VIDEO. NO LICENSE IS GRANTED OR SHALL BE IMPLIED FOR ANY OTHER USE. ADDITIONAL INFORMATION INCLUDING THAT RELATING TO PROMOTIONAL, INTERNAL AND COMMERCIAL USES AND LICENSING MAY BE OBTAINED FROM MPEG LA, LLC. SEE [HTTP://WWW.MPEGLA.COM](http://www.mpegla.com).

VC-1

THIS PRODUCT IS LICENSED UNDER THE VC-1 PATENT PORTFOLIO LICENSE FOR THE PERSONAL AND NON-COMMERCIAL USE OF A CONSUMER TO (i) ENCODE VIDEO IN COMPLIANCE WITH THE VC-1 STANDARD ("VC-1 VIDEO") AND/OR (ii) DECODE VC-1 VIDEO THAT WAS ENCODED BY A CONSUMER ENGAGED IN A PERSONAL AND NON-COMMERCIAL ACTIVITY AND/OR WAS OBTAINED FROM A VIDEO PROVIDER LICENSED TO PROVIDE VC-1 VIDEO. NO LICENSE IS GRANTED OR SHALL BE IMPLIED FOR ANY OTHER USE. ADDITIONAL INFORMATION MAY BE OBTAINED FROM MPEG LA, L.L.C. SEE [HTTP://WWW.MPEGLA.COM](http://www.mpegla.com).

AVC/H.264

THIS PRODUCT IS LICENSED UNDER THE AVC PATENT PORTFOLIO LICENSE FOR THE PERSONAL AND NONCOMMERCIAL USE OF A CONSUMER TO (i) ENCODE VIDEO IN COMPLIANCE WITH THE AVC STANDARD (“AVC VIDEO”) AND/OR (ii) DECODE AVC VIDEO THAT WAS ENCODED BY A CONSUMER ENGAGED IN A PERSONAL AND NON-COMMERCIAL ACTIVITY AND/OR WAS OBTAINED FROM A VIDEO PROVIDER LICENSED TO PROVIDE AVC VIDEO. NO LICENSE IS GRANTED OR SHALL BE IMPLIED FOR ANY OTHER USE.

ADDITIONAL INFORMATION MAY BE OBTAINED FROM MPEG LA, L.L.C. SEE [HTTP://WWW.MPEGLA.COM](http://www.mpegla.com).

■ SDHC Memory Card

microSDHC Logo is a trademark of SD-3C, LLC.

Models with color audio

Use the audio/information screen to customize certain features.

■ How to customize

While the vehicle is at a complete stop with the power mode in ON, press the **MENU/CLOCK** button, then select **Settings**. To customize the phone settings, press the  button, then select **Phone Setup**.

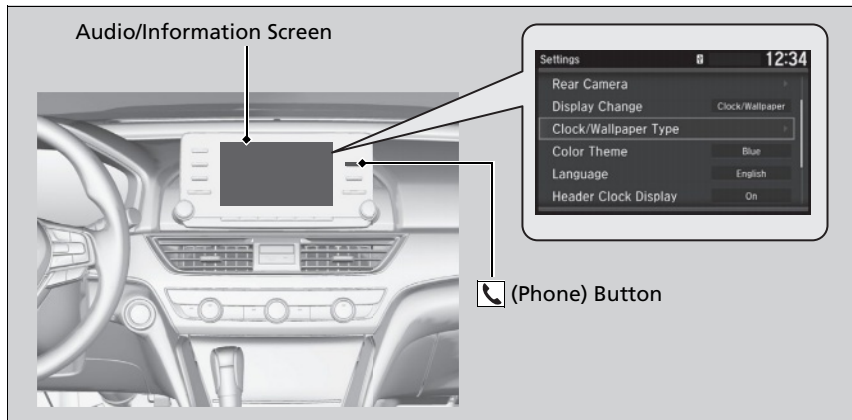

» Customized Features

When you customize settings:



- Make sure that the vehicle is at a complete stop.
- Shift to **P**.

» How to customize

These indications are used to show how to operate the selector knob.

Rotate  to select.

Press  to enter.

To customize other features, select **Settings**, rotate , and press .

➤ **List of customizable options** P. 388

■ Customization Flow

Press the MENU/CLOCK button.

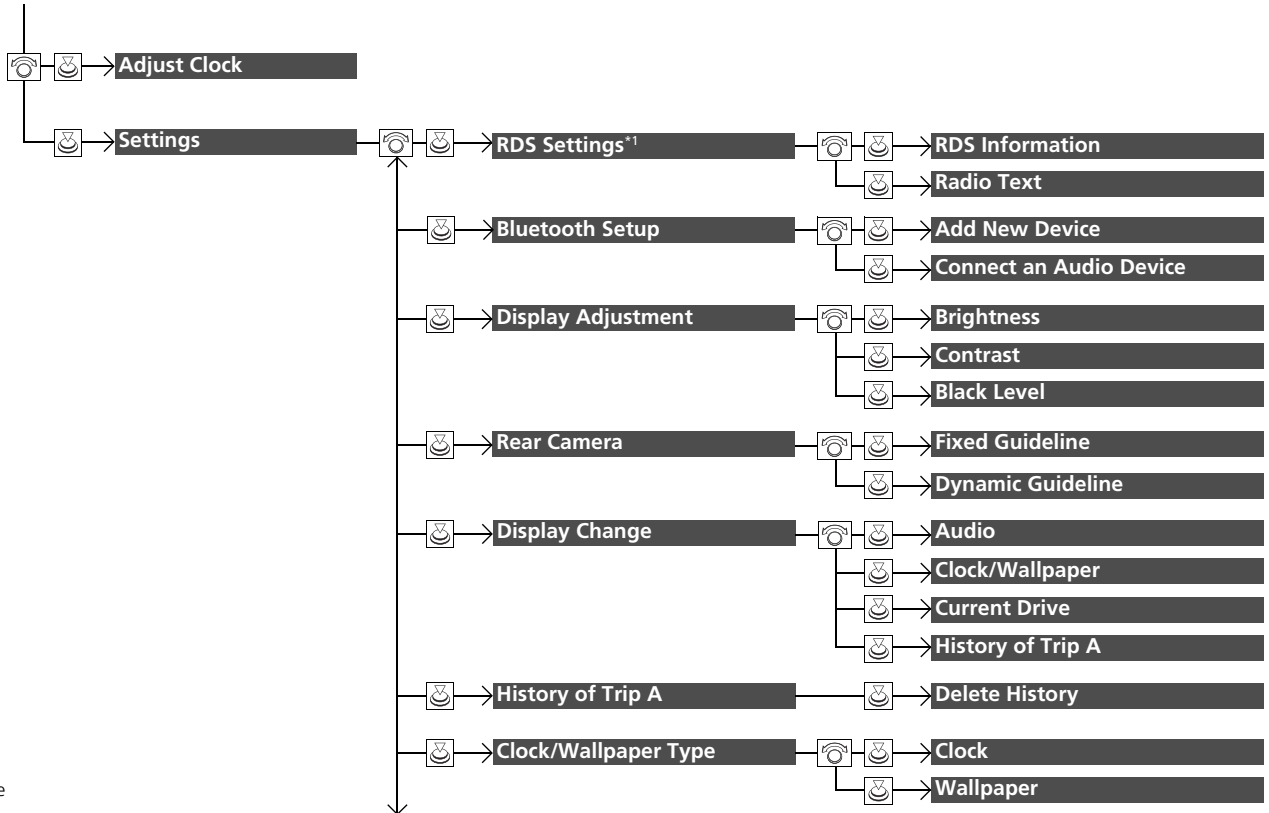

*1: FM mode

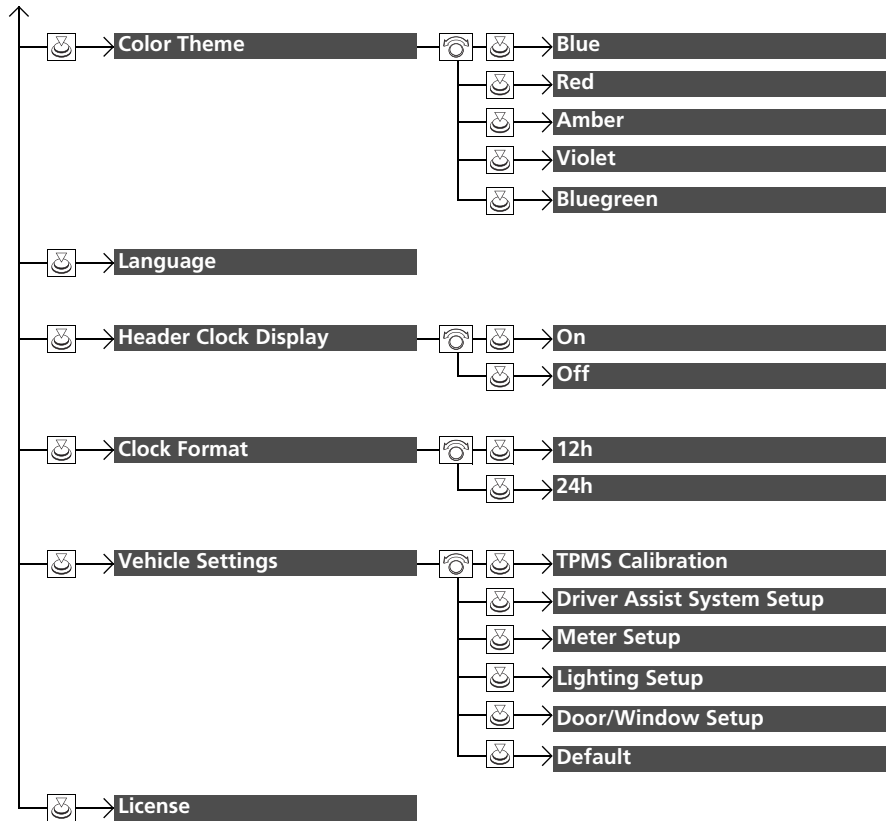

Press the  button and rotate  to select **Phone Setup**, then press .

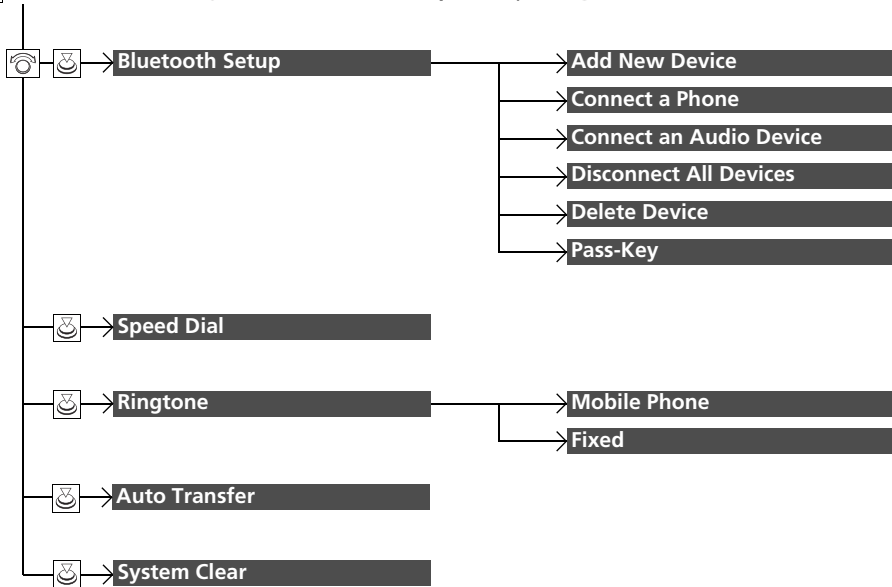

■ List of customizable options

Setup Group	Customizable Features	Description	Selectable Settings	
Settings	Adjust Clock	Adjust Clock. ▶ Clock P. 164	—	
	FM mode	RDS Information	Selects whether the RDS information comes on.	On* ¹ /Off
	RDS Settings	Radio Text	Displays the radio text information of the selected RDS station.	—
	Bluetooth Setup	Add New Device	Pairs a new phone to HFL, edits and deletes a paired phone, and create a code for a paired phone. ▶ Phone Setup P. 409	—
		Connect an Audio Device	Connects, disconnects or pairs a <i>Bluetooth</i> ® Audio device to HFL.	—
	Display Adjustment	Brightness	Changes the brightness of the audio/information screen.	—
		Contrast	Changes the contrast of the audio/information screen.	—
		Black Level	Changes the black level of the audio/information screen.	—
	Rear Camera	Fixed Guideline	Selects whether the fixed guidelines come on the audio/information screen.	On* ¹ /Off
		Dynamic Guideline	Selects whether the dynamic guidelines come on the audio/information screen.	On* ¹ /Off

*1:Default Setting

Setup Group	Customizable Features	Description	Selectable Settings		
Settings	Display Change	Changes the display type.	Audio^{*1}/Clock/Wallpaper/Current Drive/History of Trip A		
	History of Trip A	Delete History	Resets the trip meter.	Yes/No	
		Clock	Changes the clock display type.	Analog^{*1}/Off	
	Clock/Wallpaper Type	Select	Changes the wallpaper type.	Blank^{*1}/Image 1/Image 2/Image 3	
		Wallpaper	Import	Imports an image file for a new wallpaper. 📁 Wallpaper Setup P. 255	—
			Delete	Deletes an image file for a wallpaper.	Image 1/Image 2/Image 3
		Color Theme	Changes the background color of the audio/information screen.	Blue^{*1}/Red/Amber/Violet/Bluegreen	
		Language	Changes the display language.	English^{*1}/Français/Español	
		Header Clock Display	Selects whether the header clock display comes on.	On^{*1}/Off	
		Clock Format	Selects the digital clock display from 12H to 24H.	12h^{*1}/24h	

*1:Default Setting

Setup Group	Customizable Features		Description	Selectable Settings
Settings	Vehicle Settings	TPMS Calibration	Cancels/Calibrates the tire pressure monitoring system (TPMS).	Cancel*¹/Calibrate
		Forward Collision Warning Distance	Changes CMBS™ alert distance.	Long/Normal*¹/Short
		ACC Forward Vehicle Detect Beep	Causes the system to beep when the system detects a vehicle, or when the vehicle goes out of the ACC with LSF range.	On/Off*¹
		Road Departure Mitigation Setting	Changes the setting for the road departure mitigation system.	Normal*¹/Wide/Warning Only/Narrow
		Lane Keeping Assist Suspend Beep	Causes the system to beep when LKAS is suspended.	On/Off*¹
		Traffic Sign Recognition System	Displays traffic sign icon on the driver information interface.	Small Icon On*¹/Small Icon Off
		Driver Attention Monitor	Changes the setting for the driver attention monitor.	Tactile and Audible Alert*¹/Tactile Alert/Off

*1: Default Setting

Setup Group	Customizable Features		Description	Selectable Settings	
Settings	Vehicle Settings	Meter Setup	Language Selection	Changes the displayed language.	English^{*1}/Français/Español
			Adjust Outside Temp. Display	Adjusts the temperature reading by a few degrees.	-5°F ~ ±0°F^{*1} ~ +5°F
			"Trip A" Reset Timing	Changes the setting of how to reset trip meter A and average fuel economy A.	When Fully Refueled/IGN Off/Manually Reset^{*1}
			"Trip B" Reset Timing	Changes the setting of how to reset trip meter B and average fuel economy B.	When Fully Refueled/IGN Off/Manually Reset^{*1}
			Adjust Alarm Volume	Changes the alarm volume, such as buzzers, warnings, turn signal sound, and so on.	High/Mid^{*1}/Low
			Fuel Efficiency Backlight	Turns the ambient meter feature on and off.	On^{*1}/Off
			Speed/Distance Units	Selects the trip computer units.	mph · miles^{*1}/km/h · km
			Tachometer	Selects whether the tachometer come on the driver information interface.	On/Off^{*1}

*1:Default Setting

Setup Group	Customizable Features		Description	Selectable Settings	
Settings	Vehicle Settings	Lighting Setup	Interior Light Dimming Time	Changes the length of time the interior lights stay on after you close the doors.	60seconds/30seconds*¹/15seconds
			Headlight Auto OFF Timer	Changes the length of time the exterior lights stay on after you close the driver's door.	60seconds/30seconds/15seconds*¹/0seconds
			Auto Light Sensitivity	Changes the timing for the headlights to come on.	Max/High/Mid*¹/Low/Min
			Auto Interior Illumination Sensitivity	Changes the sensitivity of the brightness of the instrument panel when the headlight switch is in the AUTO position.	Min/Low/Mid*¹/High/Max
			Headlight Integration Wiper	Changes the settings for the wiper operation when the headlights automatically come on while the headlight switch is in the AUTO position.	On*¹/Off

*1:Default Setting

Setup Group	Customizable Features		Description	Selectable Settings	
Settings	Vehicle Settings	Door/ Window Setup	Auto Door Lock	Used to change the setting for when the doors automatically lock.	With Vehicle Speed*¹/Shift from P/Off
			Auto Door Unlock	Changes the setting for when the doors unlock automatically.	All Doors When Driver's Door Opens*¹/All Doors When Shifted to Park/All Doors When Ignition Switched Off/Off
			Key and Remote Unlock Mode	Sets up the driver's door or all the doors to unlock on the first push of the remote.	Driver Door*¹/All Doors
			Keyless Lock Answer Back	LOCK/UNLOCK- The exterior lights flash. LOCK (2nd push)- The beeper sounds.	On*¹/Off
			Security Relock Timer	Changes the time it takes for the doors to relock and the security system to set after you unlock the vehicle without opening any door.	90seconds/60seconds/ 30seconds*¹
			Default	Resets the vehicle settings to the factory defaults.	Yes/No
	License		Shows the legal information.	—	

*1:Default Setting

Setup Group	Customizable Features	Description	Selectable Settings
Phone Setup	Add New Device	Pairs a new phone to HFL. ➤ Phone Setup P. 409	—
	Connect a Phone	Pairs a new phone or connects a paired phone to HFL. ➤ Phone Setup P. 409	—
	Bluetooth Setup		
	Connect an Audio Device	Connects a <i>Bluetooth</i> ® Audio device to HFL.	—
	Disconnect All Devices	Disconnects a paired phone from HFL.	—
	Delete Device	Deletes a paired phone.	—
	Pass-Key	Inputs and changes a code for a paired phone.	—
	Speed Dial	Edits, adds or deletes a speed dial entry. ➤ Speed Dial P. 418	—
	Ringtone	Selects the ring tone.	Mobile Phone *1/ Fixed
Auto Transfer	Set calls to automatically transfer from your phone to HFL when you enter the vehicle.	On *1/ Off	
System Clear	Cancels/Resets all customized items in the Phone Setup group as default.	—	

*1:Default Setting

Customized Features

Models with Display Audio

Use the audio/information screen to customize certain features.

■ How to customize

With the power mode in ON, select **Settings**, then select a setting item.

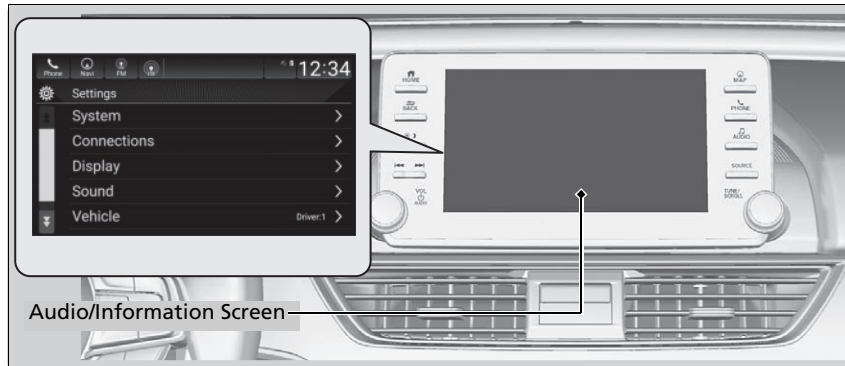

Customized Features

When you customize settings:

- Make sure that the vehicle is at a complete stop.

Automatic transmission/Continuously variable transmission models

- Shift to **P**.

Manual transmission models

- Set the parking brake.

To customize other features, select **Settings**.

➔ **List of customizable options** P. 388

■ Customization flow

Press the  button.

Select **Settings**.

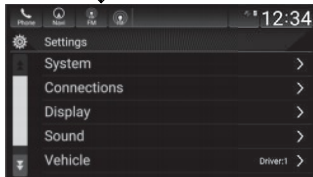

Features

System

Language

Touch Panel Sensitivity

System Volumes

System Volumes

Reading/Warning

Verbal Reminder

Config. of Instrument Panel

Select configuration

Security

Password

Unknown sources

Day & Time

Set Date & Time

Automatic Date & Time

Set Date

Set Time

Time Zone

Automatic Time Zone*

(Select time zone)

Auto Daylight Saving Time

Date Format

Time Format

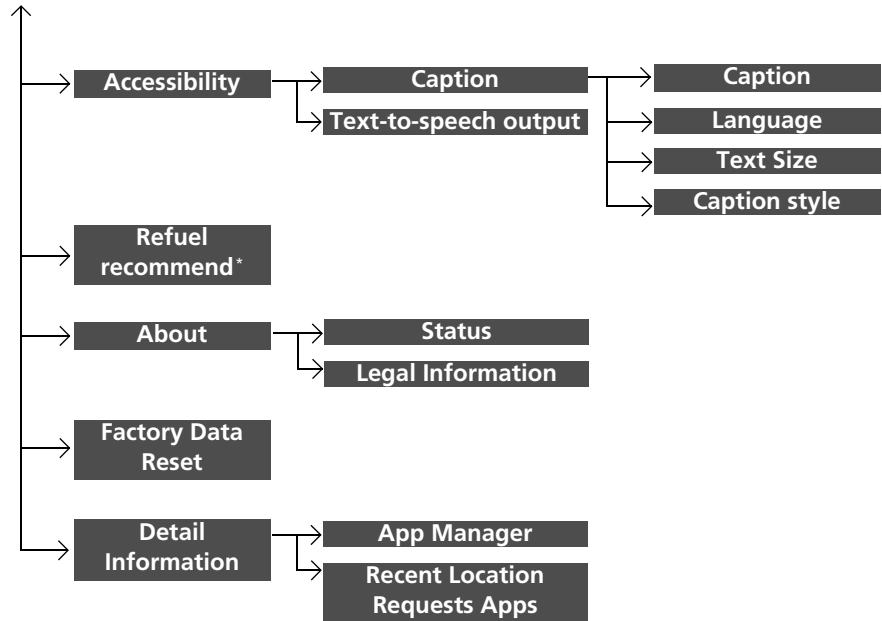

* Not available on all models

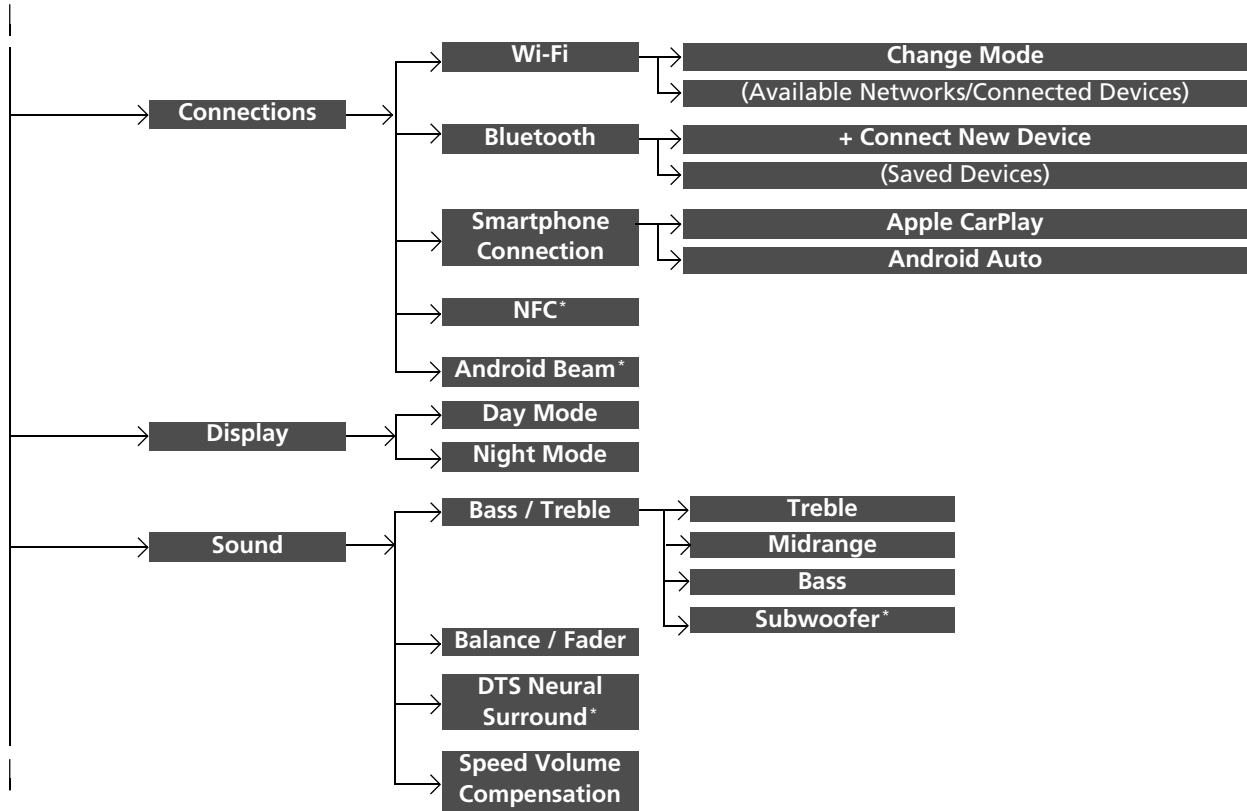

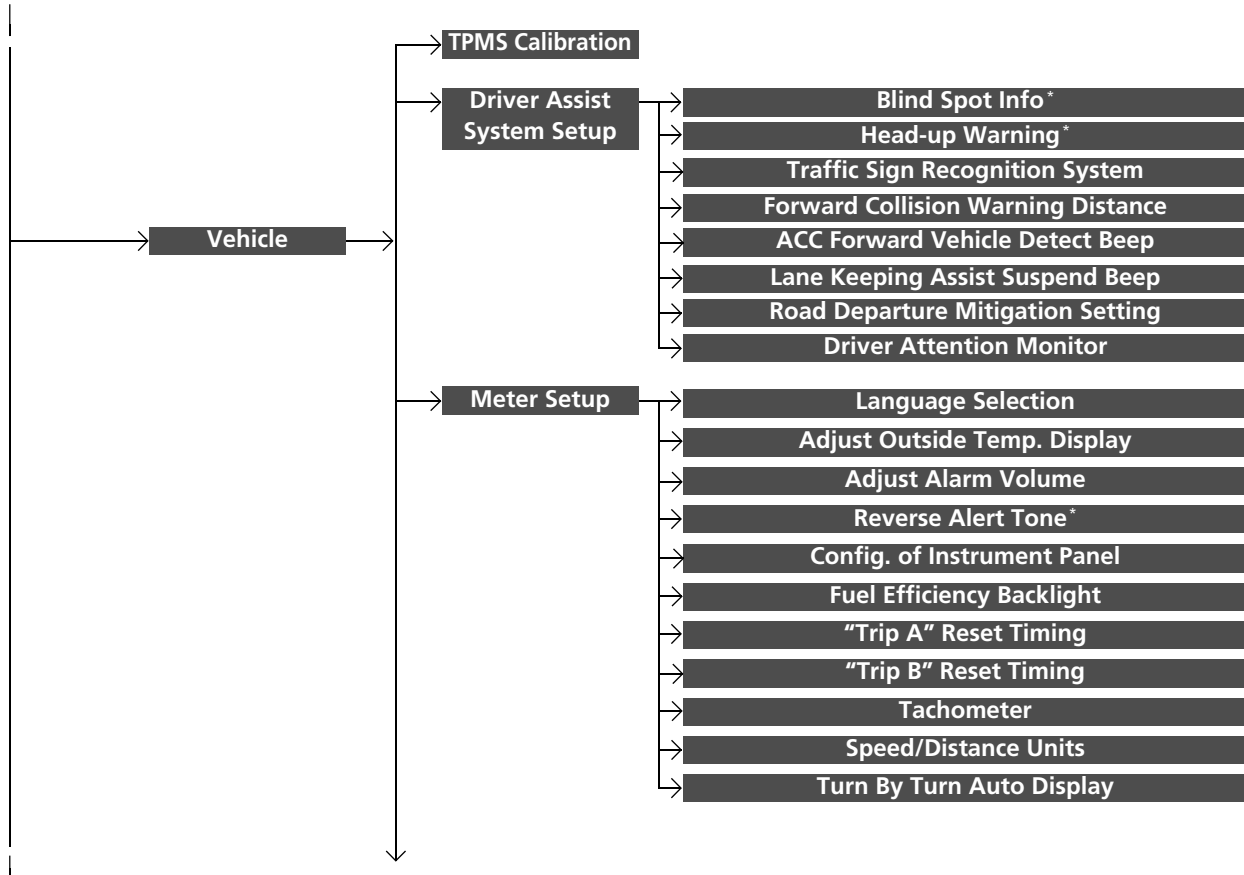

* Not available on all models

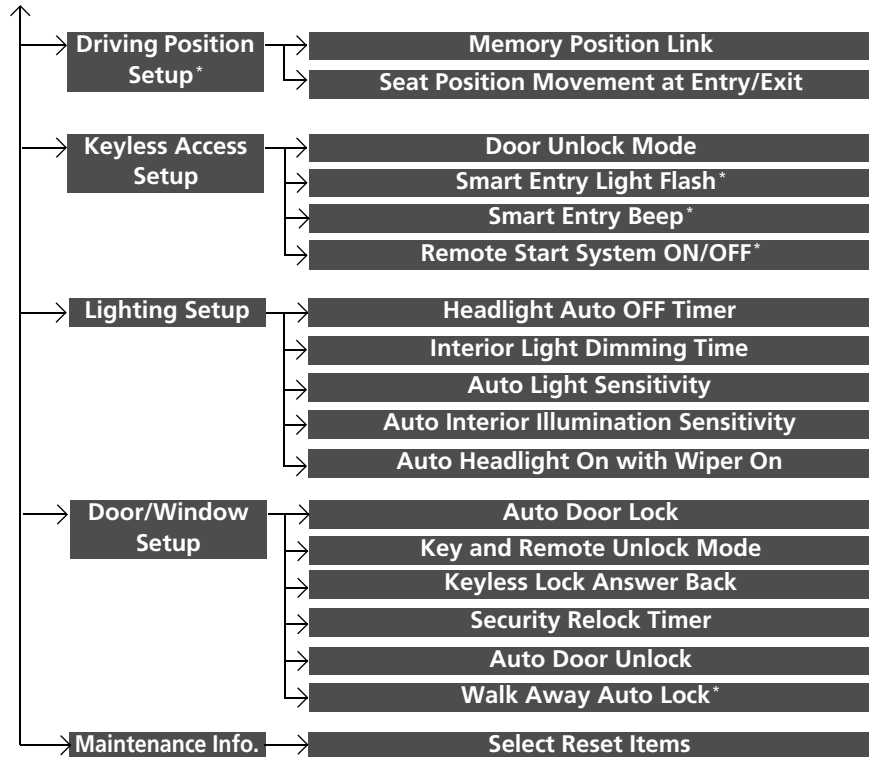

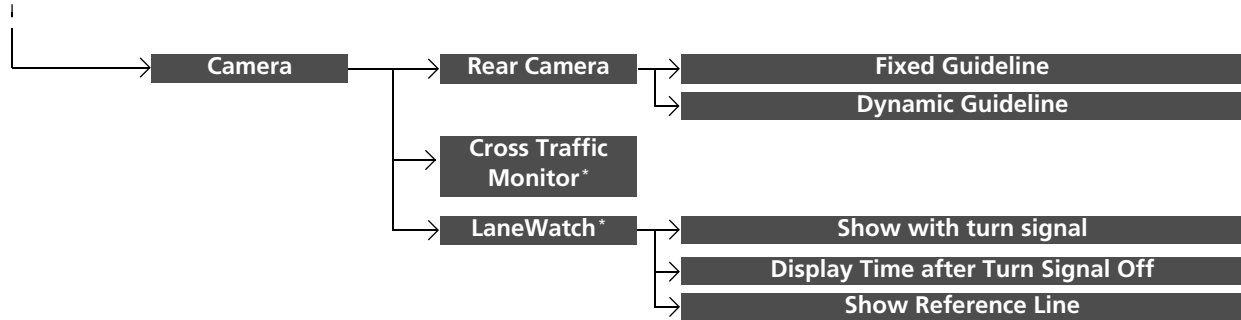

* Not available on all models

■ List of customizable options

Setup Group	Customizable Features	Description	Selectable Settings	
System	Day & Time	Automatic Date & Time	Selects ON to have the GPS automatically adjust the clock. Select OFF to cancel this function.	ON*¹/OFF
		Set Date & Time	Adjusts date. <input checked="" type="checkbox"/> Adjusting the Clock P. 164	—
		Set Time	Adjusts clock. <input checked="" type="checkbox"/> Adjusting the Clock P. 164	—
	Time Zone	Automatic Time Zone*	Sets the navigation system to automatically adjust the clock when driving through different time zones.	ON*¹/OFF
		(Select time zone)	Changes the time zone manually.	—
	Auto Daylight Saving Time	Select ON to have the GPS automatically adjust the clock to daylight savings time. Select OFF to cancel this function.	ON*¹/OFF	
	Date Format	Sets the date format.	MM/DD/YYYY*¹/ DD/MM/YYYY/ YYYY/MM/DD	
	Time Format	Selects the digital clock display from 12H to 24H .	12H*¹/24H	

*1:Default Setting



* Not available on all models

Setup Group	Customizable Features	Description	Selectable Settings	
System	Language	Changes the display language.	English (United States)^{*1}/Spanish/ French/	
	Touch Panel Sensitivity	Sets the sensitivity of the touch panel screen.	High/Normal^{*1}	
	System Volumes	System Volumes	Changes the system sounds volume.	—
		Reading/Warning Verbal Reminder	Turns the verbal reminders on and off.	ON^{*1}/OFF
	Config. of Instrument Panel	Select configuration	Selects whether the apps display comes on or not on the driver information interface.	Config.1^{*1}/Config.2/ Config.3
	Security	Password	Set the value of password display.	ON^{*1}/OFF
Unknown sources		—	ON/OFF^{*1}	

*1:Default Setting

Setup Group	Customizable Features		Description	Selectable Settings	
System	Accessibility	Caption	Turns the subtitles on and off.	ON/OFF^{*1}	
		Language	Change the subtitle language.	Default^{*1}/English (United States)/ Spanish/French	
		Text Size	Change the subtitle Text Size.	Very small/Small/ Normal^{*1}/Large	
		Caption style	Change the subtitle Caption style.	Use app defaults^{*1}/ White on black/ Black on white/ Yellow on black/ Yellow on blue/ Custom	
		Text-to-speech output	Current TTS engine TtsService	—	—
		Refuel recommend[*]		Turns the refuel recommend function on and off. ▶ Refuel Recommend P. 452	ON^{*1}/OFF
	About	Status		Displays the Android setting items.	—
	Legal Information				

*1:Default Setting

Setup Group	Customizable Features	Description	Selectable Settings	
System	Factory Data Reset	Resets all the settings to their factory default.  Defaulting All the Settings P. 399	Continue/Cancel	
	Detail Information	App Manager	Displays the Android system memory and apps information.	—
		Recent Location Requests Apps	Displays the recent location requests from apps.	—
	Wi-Fi	Change Mode	Changes the Wi-Fi mode.	Network^{*1}/Hotspot/ OFF
(Available Networks/ Connected Devices)		Displays the available network(s) or current connected device(s).	—	
Connections	Bluetooth	+ Connect New Device	Pairs a new phone to HFL.  Phone Setup P. 432	—
		(Saved Devices)	Connects, disconnects, or deletes a paired phone.  Phone Setup P. 432	—
	Smartphone Connection	Apple CarPlay	Sets up the Apple CarPlay connection.	—
		Android Auto	Sets up the Android Auto connection.	—
NFC*		Turns the NFC function on and off.	ON^{*1}/OFF	
Android Beam*		Turns the NFC connection on and off.	ON^{*1}/OFF	

*1:Default Setting

* Not available on all models

Setup Group	Customizable Features	Description	Selectable Settings
Display	Day Mode	Adjusts the settings of the audio/information screen. ▶ Display Setup P. 258	—
	Night Mode		
Sound	Treble	Adjusts the settings of the audio speakers' sound. ▶ Adjusting the Sound P. 292	—
	Midrange		
	Bass / Treble		
	Bass		
	Subwoofer*		
	Balance / Fader		
	DTS Neural Surround*		
	Speed Volume Compensation		
Vehicle	TPMS Calibration	Cancels/Calibrates the tire pressure monitoring system (TPMS).	Calibrate/Cancel
	Blind Spot Info*	Changes the setting for the blind spot information.	Audible And Visual Alert*¹/Visual Alert
	Head-up Warning*	Turns the head-up warning on and off.	ON*¹/OFF
	Traffic Sign Recognition System	Select On/Off to indicate small displaying traffic sign icon on the driver information interface and the head-up display*.	Small Icons ON*¹/ Small Icons OFF

*1:Default Setting

* Not available on all models

Setup Group	Customizable Features	Description	Selectable Settings
Vehicle	Forward Collision Warning Distance	Changes Collision Mitigation Braking System (CMBS™) alert distance.	Normal^{*1}/Short/Long
	ACC Forward Vehicle Detect Beep	Causes the system to beep when the system detects a vehicle, or when the vehicle goes out of the ACC with LSF*/ACC* range.	ON/OFF^{*1}
	Lane Keeping Assist Suspend Beep	Causes the system to beep when Lane Keeping Assist System (LKAS) is suspended.	ON/OFF^{*1}
	Road Departure Mitigation Setting	Changes the setting for the road departure mitigation system.	Normal^{*1}/Wide/Warning Only/Narrow
	Driver Attention Monitor	Changes the setting for the driver attention monitor.	OFF/Tactile Alert/Tactile And Audible Alert^{*1}
	Language Selection	Changes the display language.	English^{*1}/Français/Español
	Meter Setup	Adjust Outside Temp. Display	Adjusts the temperature reading by a few degrees.
	Adjust Alarm Volume	Changes the alarm volume, such as the buzzers, warnings, turn signal sound, and so on.	High/Mid^{*1}/Low
	Reverse Alert Tone*	Turns the reverse alert tone on and off.	ON^{*1}/OFF

*1:Default Setting

* Not available on all models

Features

Setup Group	Customizable Features	Description	Selectable Settings
Vehicle	Meter Setup		
	Config. of Instrument Panel	Selects whether the apps display comes on or not on the driver information interface.	Config.1^{*1}/Config.2/ Config.3
	Fuel Efficiency Backlight	Turns the ambient meter feature on and off.	ON^{*1}/OFF
	“Trip A” Reset Timing	Changes the setting of how to reset trip meter A and average fuel economy A.	When Fully Refueled/Manually Reset^{*1}/IGN OFF
	“Trip B” Reset Timing	Changes the setting of how to reset trip meter B and average fuel economy B.	When Fully Refueled/Manually Reset^{*1}/IGN OFF
	Tachometer	Selects whether the tachometer come on the driver information interface.	ON/OFF^{*1}
	Speed/Distance Units	Selects the trip computer units.	km/h · km/mph · miles^{*1} (U.S.) km/h · km^{*1}/mph · miles (Canada)
Turn By Turn Auto Display	Selects whether the turn-by-turn display comes on during the route guidance.	ON^{*1}/OFF	

*1:Default Setting

Setup Group	Customizable Features	Description	Selectable Settings	
Vehicle	Driving Position Setup*	Memory Position Link	Turns the driving position memory system on and off.	ON*¹/OFF
		Seat Position Movement at Entry/Exit	Moves the seat rearward when you get in/get out of the vehicle. Changes the setting for this feature.	ON*¹/OFF
	Keyless Access Setup	Door Unlock Mode	Changes which doors unlock when you grab the driver's door handle.	Driver Door Only*¹/ All Doors
		Smart Entry Light Flash*	Causes some exterior lights to flash when you unlock/lock the doors.	ON*¹/OFF
		Smart Entry Beep*	Causes the beeper to sound when you unlock/lock the doors.	ON*¹/OFF
	Remote Start System ON/OFF*	Turns the remote engine start feature on and off.	ON*¹/OFF	

*1:Default Setting

Setup Group	Customizable Features	Description	Selectable Settings	
Vehicle	Lighting Setup	Headlight Auto OFF Timer	Changes the length of time the exterior lights stay on after you close the driver's door.	0 sec/15 sec^{*1}/30 sec/60 sec
		Interior Light Dimming Time	Changes the length of time the interior lights stay on after you close the doors.	15 sec/30 sec^{*1}/60 sec
		Auto Light Sensitivity	Changes the timing for the headlights to come on.	Min/Low/Mid^{*1}/High/Max
		Auto Interior Illumination Sensitivity	Changes the sensitivity of the brightness of the instrument panel when the headlight switch is in AUTO .	Min/Low/Mid^{*1}/High/Max
		Auto Headlight On with Wiper On	Used to automatically come on the headlights when the wipers are used several times within a certain number of intervals with the headlight switch is in AUTO .	ON^{*1}/OFF

*1:Default Setting

Setup Group	Customizable Features	Description	Selectable Settings	
Vehicle	Auto Door Lock	Changes the setting for the automatic locking feature.	OFF/With Vehicle Speed^{*1}/Shift From P	
	Key and Remote Unlock Mode	Sets up either the driver's door or all doors to unlock on the first push of the remote or built-in key.	Driver Door Only^{*1}/All Doors	
	Keyless Lock Answer Back	LOCK/UNLOCK- The exterior lights flash. LOCK (2nd push)- The beeper sounds.	ON^{*1}/OFF	
	Door/Window Setup	Security Relock Timer	Changes the time it takes for the doors to relock and the security system to set after you unlock the vehicle without opening any door.	30sec^{*1}/60sec/90sec
		Auto Door Unlock	Changes the setting for when the doors unlock automatically.	OFF/All Doors When Driver's Door Opens^{*1}/All Doors When Shifted to Park^{*2}/All Doors With IGN OFF
		Walk Away Auto Lock*	Changes the settings for the auto lock function when you walk away from the vehicle.	ON/OFF^{*1}
Maintenance Info.	Select Reset Items	Resets the engine oil life display when you have performed the maintenance service.	—	

*1:Default Setting

*2:Except Manual transmission models

* Not available on all models

Setup Group	Customizable Features	Description	Selectable Settings	
Camera	Rear Camera	Fixed Guideline Selects whether the guidelines come on the rear camera monitor. ► Multi-View Rear Camera P. 594	ON^{*1}/OFF	
		Dynamic Guideline Selects whether the guidelines come on the rear camera monitor. ► Multi-View Rear Camera P. 594	ON^{*1}/OFF	
	Cross Traffic Monitor[*]	Turns the cross traffic monitor on and off.	ON^{*1}/OFF	
	LaneWatch [*]	Show with turn signal	Selects whether the LaneWatch display comes on when you move the turn signal lever to indicate a right turn.	ON^{*1}/OFF
		Display Time after Turn Signal Off	Changes the length of time the LaneWatch display stays on after the turn signal lever returns to the center.	0 second^{*1}/2 seconds
		Show Reference Line	Selects whether the reference lines come on the LaneWatch monitor.	ON^{*1}/OFF

*1: Default Setting

Models with Display Audio

Defaulting All the Settings

Reset all the menu and customized settings as the factory defaults.

Defaulting System Settings

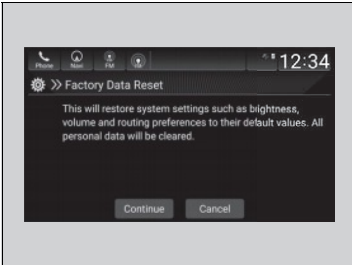

1. Press the button.
2. Select **Settings**.
3. Select **System**.
4. Select **Factory Data Reset**.
 - ▶ A confirmation message appears on the screen.
5. Select **Continue** to reset the settings.
6. Select **Continue** again to reset the settings.
 - ▶ The system will reboot.

Defaulting Vehicle Settings

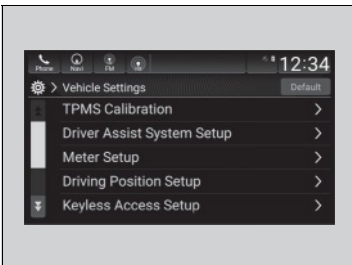

1. Press the button.
2. Select **Settings**.
3. Select **Vehicle**.
4. Select **Default**.
5. Select **Yes**.

Defaulting All the Settings

When you transfer the vehicle to a third party, reset all settings to default and delete all personal data.

If you perform **Factory Data Reset**, it will reset the preinstalled apps to their factory default.

If you perform **Factory Data Reset**, you cannot use the HondaLink® because it becomes off line.

HondaLink® P. 321

The HomeLink® Universal Transceiver can be programmed to operate up to three remote controlled devices around your home, such as garage doors, lighting, or home security systems.

■ Important Safety Precautions

Refer to the safety information that came with your garage door opener to test that the safety features are functioning properly. If you do not have the safety information, contact the manufacturer.

Before programming HomeLink, make sure that people and objects are out of the way of the garage or gate to prevent potential injury or damage.

When programming a garage door opener, park just outside the garage door's path.

⌘ HomeLink® Universal Transceiver*

Before programming HomeLink to operate a garage door opener, confirm that the opener has an external entrapment protection system, such as an "electronic eye," or other safety and reverse stop features. If it does not, HomeLink may not be able to operate it.

Training HomeLink

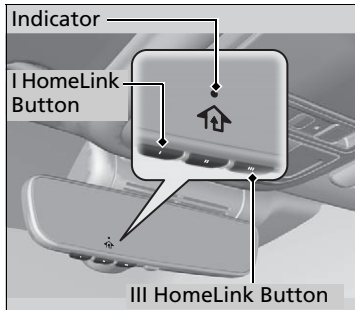

If it is necessary to erase a previously entered learned code:

- Press and hold the I and III HomeLink buttons for about 10 seconds, until the green indicator blinks. Release the buttons, and proceed to step 1.
- If you are training the second or third button, go directly to step 1.

The instructions on the next page should work for most gate or garage openers, but may not work for all. For detailed instructions about your specific remote opener, visit <http://www.homelink.com> or call (800) 355-3515.

■ Programming a Button

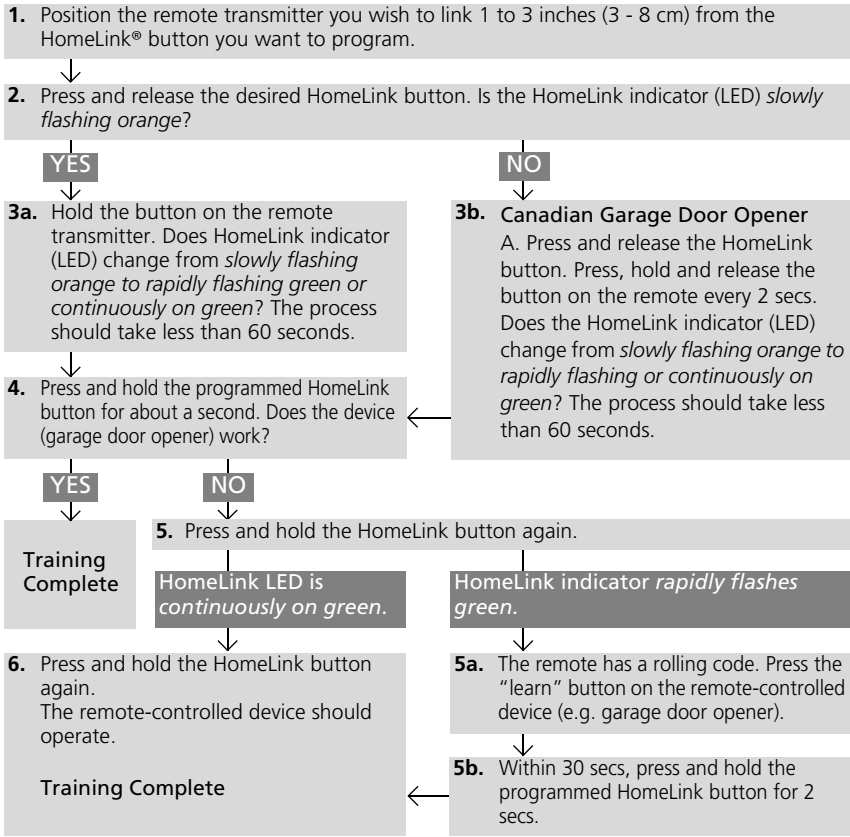

▶▶ Training HomeLink

Reprogramming a Button

If you want to retrain a programmed button for a new device, you do not have to erase all button memory. You can replace the existing memory code using this procedure:

1. Press and hold the desired HomeLink button until the HomeLink indicator begins to *slowly flash orange*. This should take about 20 seconds.
2. Release the HomeLink button and position the remote transmitter you wish to link 1 - 3 inches (3 - 8 cm) from the HomeLink button you want to program, then follow steps 3 - 6 under "programming a button."

Erasing Button Memory

To erase programming from the buttons, press and hold the two outside HomeLink buttons until the HomeLink indicator changes from *orange to rapidly flashing green*. This should take about 10 seconds. You should erase all programming before selling the vehicle.

Operating

To operate, simply press and release the programmed HomeLink button. Activation will now occur for the trained device.

Questions

For questions or comments, visit www.HomeLink.com, www.youtube.com/HomeLinkGentex, or by calling the HomeLink Hotline (North America only) at (800) 355-3515.

HomeLink® is a registered trademark of Gentex Corporation.

Models with color audio

Bluetooth® HandsFreeLink® (HFL) allows you to place and receive phone calls using your vehicle's audio system, without handling your cell phone.

Using HFL

HFL Buttons

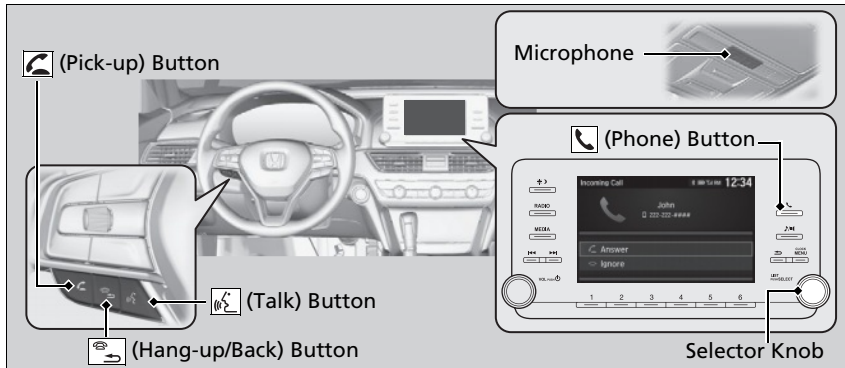

(Pick-up) button: Press to go directly to the phone screen or to answer an incoming call.

(Hang-up/back) button: Press to end a call or to cancel a command.

(Talk) button: Press to call a number with a stored voice tag.

(Phone) button: Press to go directly to the phone screen.

Selector knob: Rotate to select an item on the screen, then press.

Bluetooth® HandsFreeLink®

Place your phone where you can get good reception.

To use HFL, you need a Bluetooth-compatible cell phone. For a list of compatible phones, pairing procedures, and special feature capabilities:

- U.S.: Visit automobiles.honda.com/handsfreelink/ or call 1-888-528-7876.
- Canada: For more information on smartphone compatibility, call 1-888-528-7876.

Voice control tips

- Aim the vents away from the ceiling and close the windows, as noise coming from them may interfere with the microphone.
- Press and release the  button when you want to call a number using a stored voice tag. Speak clearly and naturally after a beep.
- If the microphone picks up voices other than yours, the command may be misinterpreted.
- To change the volume level, use the audio system's volume knob or the remote audio controls on the steering wheel.

State or local laws may prohibit the operation of handheld electronic devices while operating a vehicle.

If you receive a call while using the audio system, the system resumes its operation after ending the call.

Up to 20 speed dial entries can be stored. If there is no entry in the system, Speed Dial is disabled.

 **Speed Dial** P. 418

Up to 20 call histories can be stored. If there is no call history, Call History is disabled.

HFL Status Display

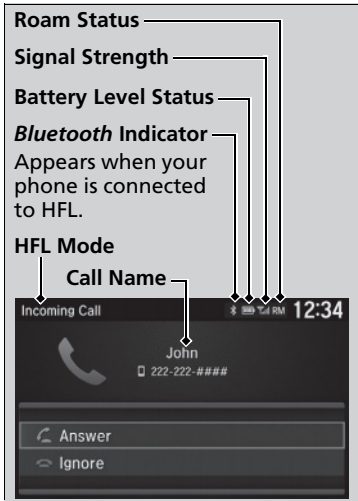

The audio/information screen notifies you when there is an incoming call.

Limitations for Manual Operation

Certain manual functions are disabled or inoperable while the vehicle is in motion. You cannot select a grayed-out option until the vehicle is stopped.

Only previously stored speed dial entries can be called using voice commands while the vehicle is in motion.

▶ **Speed Dial** P. 418

Bluetooth® HandsFreeLink®

Bluetooth® Wireless Technology
The *Bluetooth®* word mark and logos are registered trademarks owned by *Bluetooth SIG, Inc.*, and any use of such marks by Honda Motor Co., Ltd., is under license. Other trademarks and trade names are those of their respective owners.

HFL Limitations
An incoming call on HFL will interrupt the audio system when it is playing. It will resume when the call is ended.

HFL Status Display

The information that appears on the audio/information screen varies between phone models.

You can change the system language to English, French, or Spanish.

▶ **Customized Features** P. 370

HFL Menu

The power mode must be in ACCESSORY or ON to use HFL.

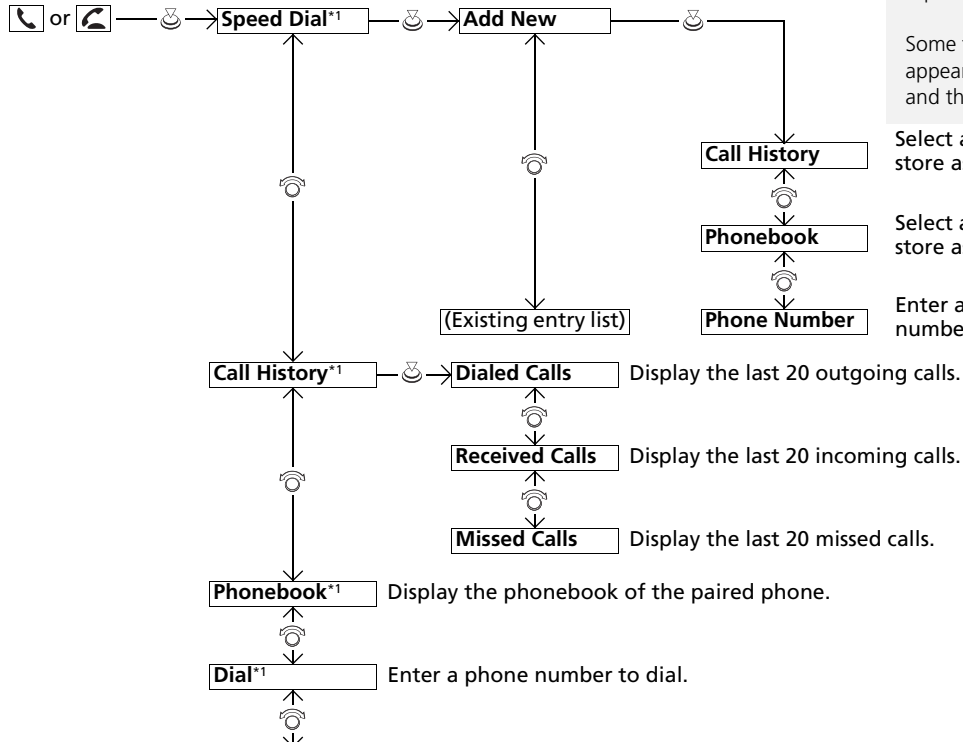

*1: Appears only when a phone is connected to HFL.

HFL Menu

To use HFL, you must first pair your *Bluetooth*-compatible cell phone to the system while the vehicle is parked.

Some functions are limited while driving. A message appears on the screen when the vehicle is moving and the operation is canceled.

Select a phone number from the call history to store as a speed dial number.

Select a phone number from the phonebook to store as a speed dial number.

Enter a phone number to store as a speed dial number.

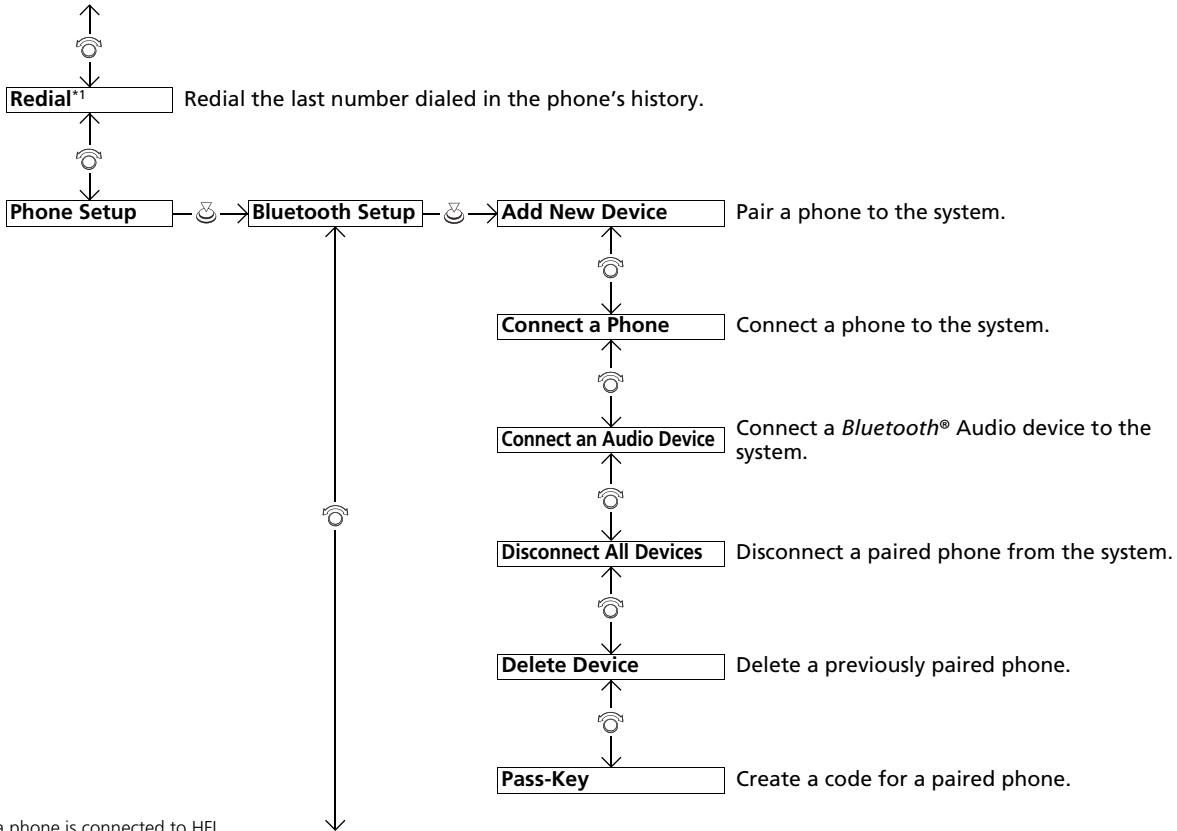

*1: Appears only when a phone is connected to HFL.

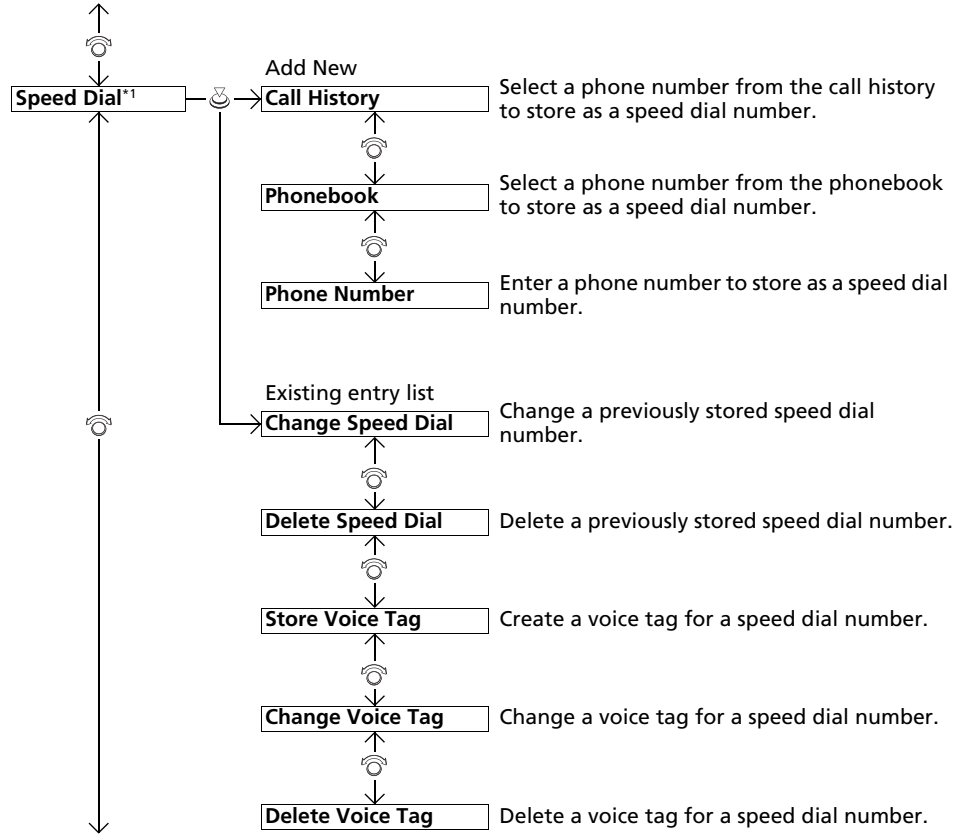

*1: Appears only when a phone is connected to HFL.

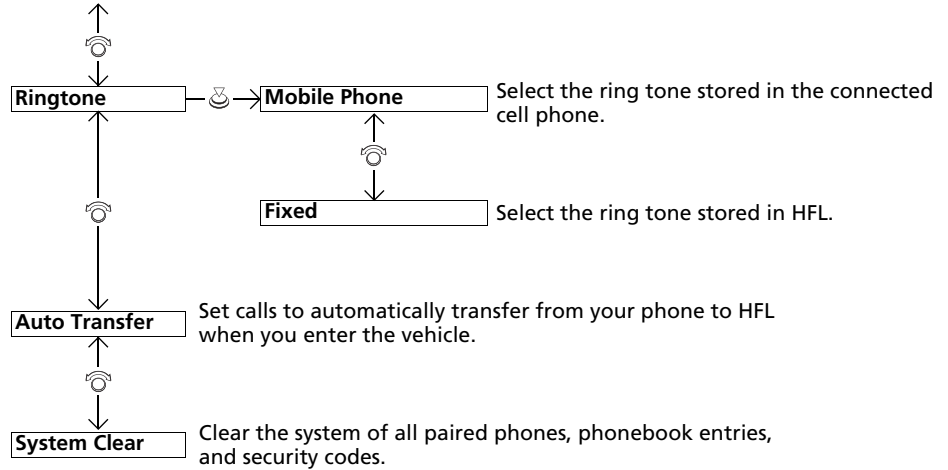

Phone Setup



■ To pair a cell phone (No phone has been paired to the system)

1. Press the button or the button.
2. Rotate to select **Yes**, then press .
3. Make sure your phone is in search or discoverable mode, then press .
 - ▶ HFL automatically searches for a *Bluetooth*® device.
4. When your phone appears on the list, select it by pressing .
 - ▶ If your phone doesn't appear, select **Phone Not Found?** and search for *Bluetooth*® devices using your phone. From your phone, select **HandsFreeLink**.
5. The system gives you a pairing code on the audio/information screen.
 - ▶ Confirm if the pairing code on the screen and your phone match. This may vary by phone.
6. A notification appears on the screen if pairing is successful.

☒ Phone Setup

Your *Bluetooth*-compatible phone must be paired to HFL before you can make and receive hands-free calls.

Phone Pairing Tips:

- You cannot pair your phone while the vehicle is moving.
- Up to six phones can be paired.
- Your phone's battery may drain faster when it is paired to HFL.
- If your phone is not ready for pairing or not found by the system within three minutes, the system will time out and return to idle.

Once you have paired a phone, you can see it displayed on the screen with one or two icons on the right side.

These icons indicate the following:

: The phone can be used with HFL.

: The phone is compatible with *Bluetooth*® Audio.



■ **To pair a cell phone (when a phone has already been paired to the system)**

1. Press the button or the button.
 - ▶ If a prompt appears asking to connect to a phone, select **No** and proceed with step 2.
 2. Rotate to select **Phone Setup**, then press .
 3. Rotate to select **Bluetooth Setup**, then press .
 4. Rotate to select **Add New Device**, then press .
- ▶ The screen changes to device list.

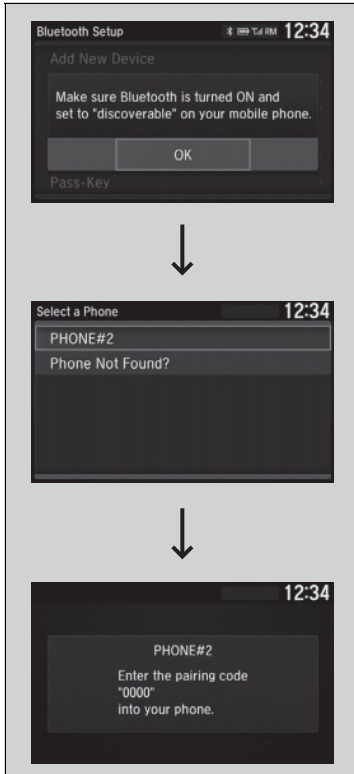

5. Make sure your phone is in search or discoverable mode, then press .
 - ▶ HFL automatically searches for a *Bluetooth*® device.
6. When your phone appears on the list, select it by pressing .
 - ▶ If your phone does not appear, select **Phone Not Found?** and search for *Bluetooth*® devices using your phone. From your phone, select **HandsFreeLink**.
7. The system gives you a pairing code on the audio/information screen.
 - ▶ Confirm if the pairing code on the screen and your phone match. This may vary by a phone.

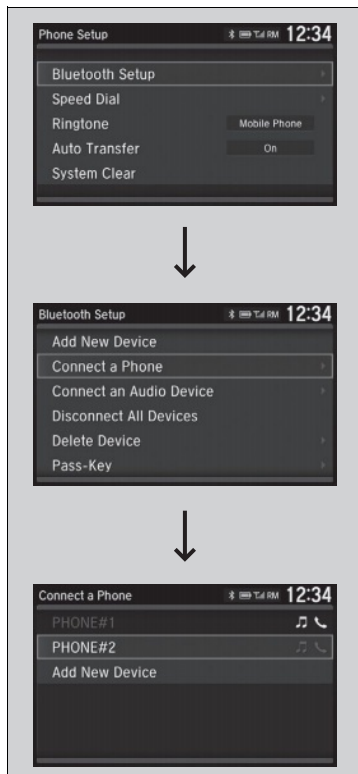

■ **To change the currently paired phone**

1. Press the button or the button.
2. Rotate to select **Phone Setup**, then press .
3. Rotate to select **Bluetooth Setup**, then press .
4. Rotate to select **Connect a Phone**, then press .
 - ▶ The screen changes to a device list.
5. Rotate to select a desired device name, then press .
 - ▶ HFL disconnects the connected phone and starts searching for another paired phone.



■ **To change the pairing code setting**

1. Press the button or the button.
2. Rotate to select **Phone Setup**, then press .
3. Rotate to select **Bluetooth Setup**, then press .
4. Rotate to select **Pass-Key**, then press .
5. Input a new pairing code, then press .

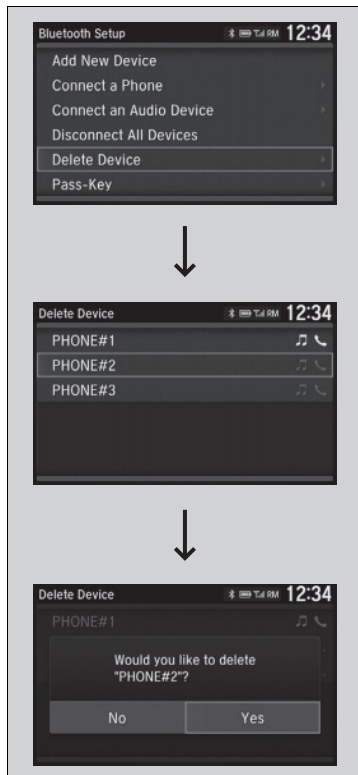

■ **To delete a paired phone**

1. Press the button or the button.
2. Rotate to select **Phone Setup**, then press .
3. Rotate to select **Bluetooth Setup**, then press .
4. Rotate to select **Delete Device**, then press .
 - ▶ The screen changes to a device list.
5. Rotate to select a phone you want to delete, then press .
6. A confirmation message appears on the screen. Rotate to select **Yes**, then press .

Ring Tone

You can change the ring tone setting.



1. Press the button or the button.
2. Rotate to select **Phone Setup**, then press .
3. Rotate to select **Ringtone**, then press .
4. Rotate to select **Mobile Phone** or **Fixed**, then press .

Automatic Transferring

If you get into the vehicle while you are on the phone, the call can be automatically transferred to HFL.

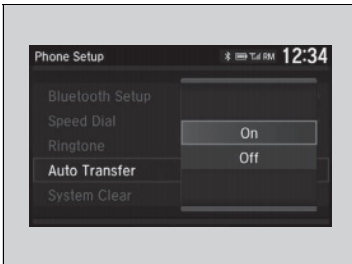

1. Press the button or the button.
2. Rotate to select **Phone Setup**, then press .
3. Rotate to select **Auto Transfer**, then press .
4. Rotate to select **On** or **Off**, then press .

Ring Tone

Mobile Phone: For certain connected phones, the ring tone stored in the phone sounds from the speakers.

Fixed: The fixed ring tone sounds from the speakers.

■ To Clear the System

Pairing codes, paired phones, all stored voice tags, all speed dial entries, all call history data, and all imported phonebook data are erased.

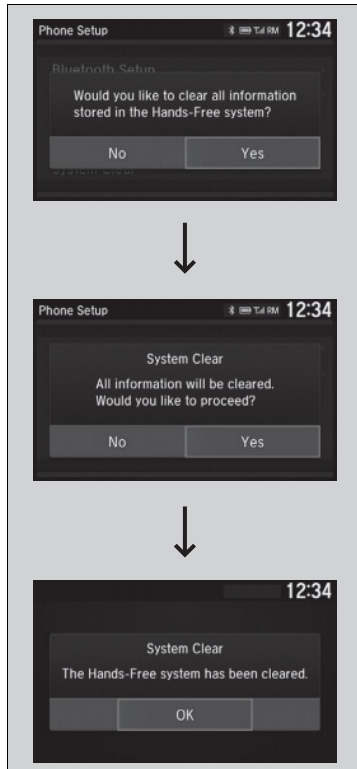

1. Press the button or the button.
2. Rotate to select **Phone Setup**, then press .
3. Rotate to select **System Clear**, then press .
4. Rotate to select **Yes**, then press .
5. A confirmation message appears on the screen. Rotate to select **Yes**, then press .
6. A notification appears on the screen. Press .

Automatic Import of Cellular Phonebook and Call History

When your phone is paired, the contents of its phonebook and call history are automatically imported to HFL.

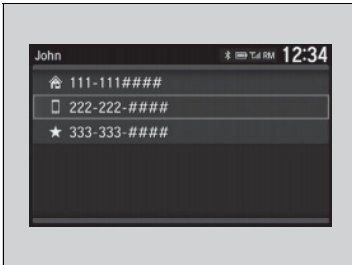

Automatic Import of Cellular Phonebook and Call History

When you select a person from the list in the cellular phonebook, you can see up to three category icons. The icons indicate what types of numbers are stored for that name.

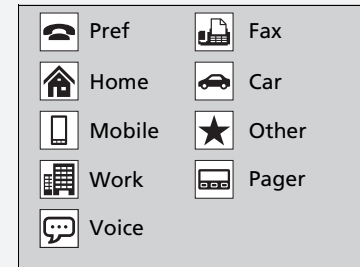

If a name has four or more numbers, ... appears instead of category icons.

On some phones, it may not be possible to import the category icons to HFL.

The phonebook is updated after every connection. Call history is updated after every connection or call.

■ Speed Dial

Up to 20 speed dial numbers can be stored per phone.

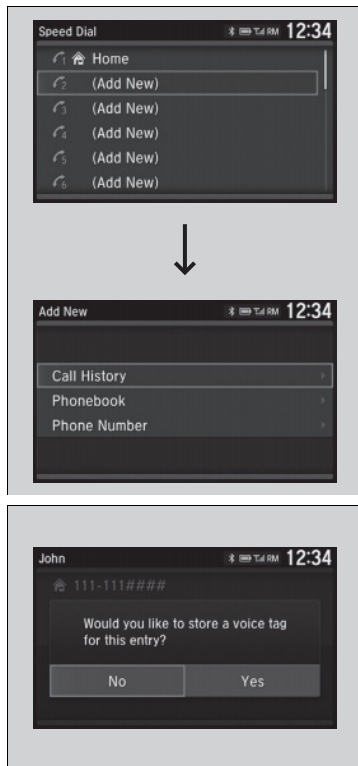

To store a speed dial number:

1. Press the button or the button.
2. Rotate to select **Speed Dial**, then press .
3. Rotate to select **Add New**, then press .
4. Rotate to select a place to choose a number from, then press .
 - From **Call History**:
 - ▶ Select a number from the call history.
 - From **Phonebook**:
 - ▶ Select a number from the connected cell phone's imported phonebook.
 - From **Phone Number**:
 - ▶ Input the number manually.
5. When the speed dial is successfully stored, you are asked to create a voice tag for the number. Rotate to select **Yes** or **No**, then press .
6. Using the button, follow the prompts to say the name for the speed dial entry.

▶▶ Speed Dial

When a voice tag is stored, you can press the button and call the number using voice commands.

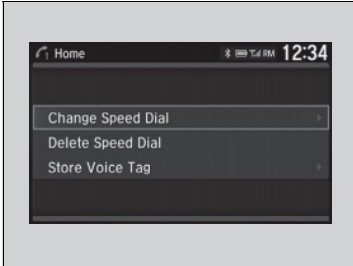

■ To edit a speed dial

1. Press the button or the button.
2. Rotate to select **Phone Setup**, then press .
3. Rotate to select **Speed Dial**, then press .
4. Select an existing speed dial entry.
5. Rotate to select **Change Speed Dial**, then press .
6. Select a new speed dial number, then press .

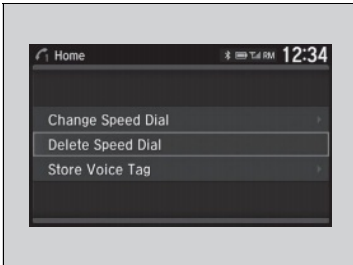

■ To delete a speed dial number

1. Press the button or the button.
2. Rotate to select **Phone Setup**, then press .
3. Rotate to select **Speed Dial**, then press .
4. Select an existing speed dial entry.
5. Rotate to select **Delete Speed Dial**, then press .
 - ▶ A confirmation message appears on the screen. Rotate to select **Yes**, then press .

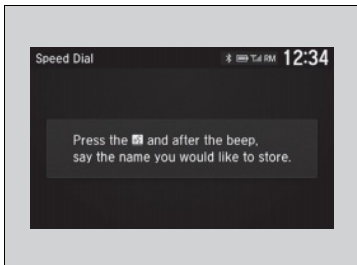
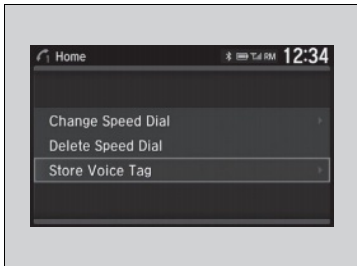

■ **To add a voice tag to a stored speed dial number**

1. Press the button or the button.
2. Rotate to select **Phone Setup**, then press .
3. Rotate to select **Speed Dial**, then press .
4. Select an existing speed dial entry.
5. Rotate to select **Store Voice Tag**, then press .
6. Using the button, follow the prompts to complete the voice tag.

■ **To change a voice tag**

1. Press the button or the button.
2. Rotate to select **Phone Setup**, then press .
3. Rotate to select **Speed Dial**, then press .
4. Select an existing speed dial entry.
5. Rotate to select **Change Voice Tag**, then press .
6. Using the button, follow the prompts to complete the voice tag.

▶▶ Speed Dial

Avoid using duplicate voice tags.
 Avoid using "home" as a voice tag.
 It is easier for HFL to recognize a longer name. For example, use "John Smith" instead of "John."

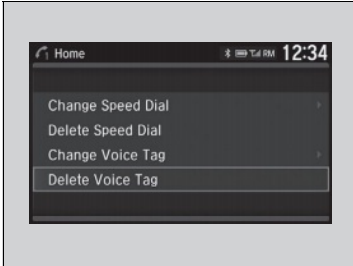

■ To delete a voice tag

1. Press the button or the button.
2. Rotate to select **Phone Setup**, then press .
3. Rotate to select **Speed Dial**, then press .
4. Select an existing speed dial entry.
5. Rotate to select **Delete Voice Tag**, then press .
 - ▶ A confirmation message appears on the screen. Rotate to select **Yes**, then press .

■ Making a Call

You can make calls by inputting any phone number, or by using the imported phonebook, call history, speed dial entries, or redial.

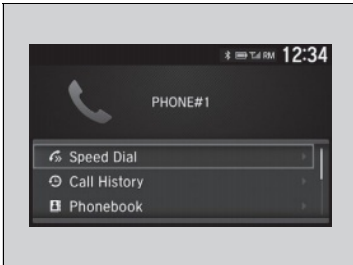

▣ Making a Call

Any voice-tagged speed dial entry can be dialed by voice from any screen.

Press the button and follow the prompts.

Once a call is connected, you can hear the voice of the person you are calling through the audio speakers.



■ To make a call using the imported phonebook

When your phone is paired, the contents of its phonebook are automatically imported to HFL.

1. Press the button or the button.
 2. Rotate to select **Phonebook**, then press .
 3. The phonebook is stored alphabetically. Rotate to select the initial, then press .
 4. Rotate to select a name, then press .
 5. Rotate to select a number, then press .
- ▶ Dialing starts automatically.

■ To make a call using a phone number

1. Press the button or the button.
 2. Rotate to select **Dial**, then press .
 3. Rotate to select a number, then press .
 4. Rotate to select , then press .
- ▶ Dialing starts automatically.

▶▶ To make a call using the imported phonebook

This function is disabled while the vehicle is moving. However, you can call a stored voice-tagged speed dial number using voice commands.

- ▶ **Limitations for Manual Operation** P. 404
- ▶ **Speed Dial** P. 418

▶▶ To make a call using a phone number

This function is disabled while the vehicle is moving. However, you can call a stored voice-tagged speed dial number using voice commands.

- ▶ **Limitations for Manual Operation** P. 404
- ▶ **Speed Dial** P. 418

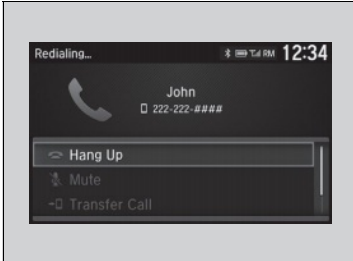

■ **To make a call using redial**

1. Press the button or the button.
 2. Rotate to select **Redial**, then press .
- ▶ Dialing starts automatically.



■ **To make a call using the call history**

Call history is stored by **Dialed Calls**, **Received Calls**, and **Missed Calls**.

1. Press the button or the button.
 2. Rotate to select **Call History**, then press .
 3. Rotate to select **Dialed Calls**, **Received Calls**, or **Missed Calls**, then press .
 4. Rotate to select a number, then press .
- ▶ Dialing starts automatically.

▶▶ To make a call using redial

Press and hold the button to redial the last number dialed in your phone's call history.

▶▶ To make a call using the call history

The call history appears only when a phone is connected to HFL, and displays the last 20 dialed, received, or missed calls.



■ To make a call using a speed dial entry

1. Press the button or the button.
2. Rotate to select **Speed Dial**, then press .
3. Rotate to select a number, then press .
 - ▶ Dialing starts automatically.

▶▶ To make a call using a speed dial entry

Select **Others** to view another paired phone's speed dial list.

When a voice tag is stored, press the button and call the number using voice commands.

▶ **Speed Dial** P. 418

Any voice-tagged speed dial entry can be dialed by voice from any screen. Press the button and follow the prompts.

Receiving a Call

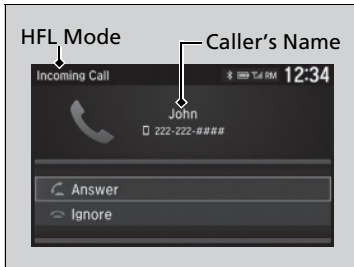

When there is an incoming call, an audible notification sounds and the **Incoming Call** screen appears.

Press the  button to answer the call.

Press the  button to decline or end the call.

Receiving a Call





Call Waiting

Press the  button to put the current call on hold to answer the incoming call.

Press the  button again to return to the current call.

Select **Ignore** to ignore the incoming call if you do not want to answer it.

Press the  button if you want to hang up the current call.

You can select the icons on the audio/information screen instead of the  and  buttons. Rotate  to select the icon, then press .

Options During a Call

The following options are available during a call.



Swap Call: Put the current call on hold to answer the incoming call.

Mute: Mute your voice.

Transfer Call: Transfer a call from HFL to your phone.

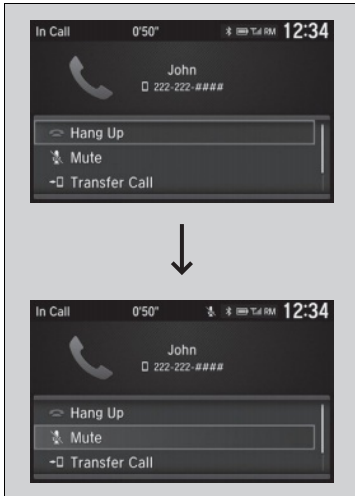
Dial Tones: Send numbers during a call. This is useful when you call a menu-driven phone system.



1. To view the available options, press the  button.
2. Rotate  to select the option, then press .
 - ▶ The check box is checked when **Mute** is selected. Select **Mute** again to turn it off.

Options During a Call

Dial Tones: Available on some phones.

Models with Display Audio

Bluetooth® HandsFreeLink® (HFL) allows you to place and receive phone calls using your vehicle's audio system, without handling your cell phone.

Using HFL

HFL Buttons

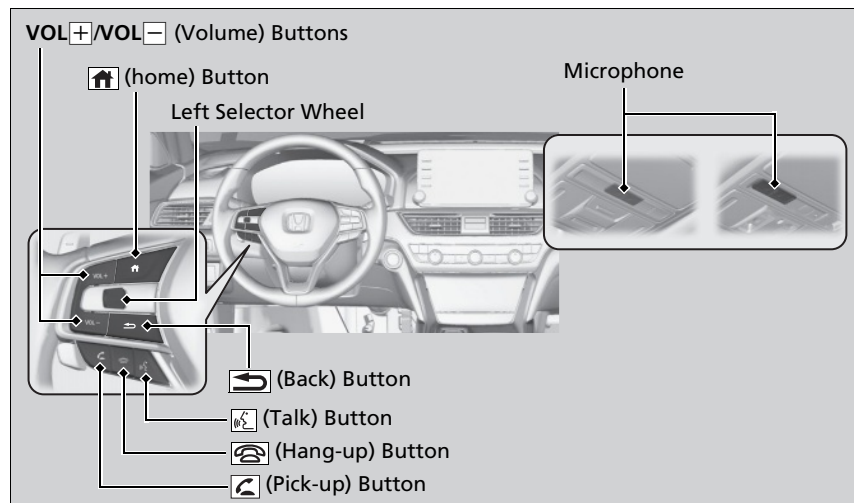

Bluetooth® HandsFreeLink®

Place your phone where you can get good reception.

To use HFL, you need a *Bluetooth*-compatible cell phone. For a list of compatible phones, pairing procedures, and special feature capabilities:

- U.S.: Visit automobiles.honda.com/handsfreelink/, or call 1-888-528-7876.
- Canada: For more information on smartphone compatibility, call 1-888-528-7876.

To use the system, the **Bluetooth** setting must be **ON**.

➤ **Phone Setup** P. 432

Voice control tips

- Aim the vents away from the ceiling and close the windows, as noise coming from them may interfere with the microphones.
- Press the **[OK]** button when you want to call a number using a phonebook name or a number. Speak clearly and naturally after a beep.
- If the microphones pick up voices other than yours, the command may be misinterpreted.
- To change the volume level, select the audio system's **VOL** (Volume) or use the remote audio controls on the steering wheel.

If there is no Favorite Contact entry in the system, the pop-up notification appears on the screen.

➤ **Favorite Contacts** P. 437

 **(Pick-up) button:** Press to go directly to the phone menu on the driver information interface, or to answer an incoming call.

 **(Hang-up) button:** Press to end a call.

 **(Back) button:** Press to go back to the previous screen, or cancel a command.

 **(Talk) button:** Press to access Voice Portal.

Left Selector Wheel: Press the  (home) button, then roll up or down to select **Phone** on the driver information interface, and then press the left selector wheel.

 **(home) button:** Press to go back to the home screen of the driver information interface.

To go to the phone screen of the driver information interface:

1. Press the  (home) button on the steering wheel.

2. Select **Phone**.

▶ You can select **Favorite Contacts** or **Recent Calls**.

Bluetooth® HandsFreeLink®

Bluetooth® Wireless Technology

The *Bluetooth®* word mark and logos are registered trademarks owned by *Bluetooth* SIG, Inc., and any use of such marks by Honda Motor Co., Ltd., is under license. Other trademarks and trade names are those of their respective owners.

HFL Limitations

An incoming call on HFL will interrupt the audio system when it is playing. It will resume when the call is ended.

HFL Status Display

The audio/information screen notifies you when there is an incoming call.



Limitations for Manual Operation *

Certain manual functions are disabled or inoperable while the vehicle is in motion. You cannot select a grayed-out option until the vehicle is stopped.

Only previously stored phonebook names or numbers can be called using voice commands while the vehicle is in motion.

▶ **Favorite Contacts** P. 437

HFL Status Display

The information that appears on the audio/information screen varies between phone models.

* Not available on all models

HFL Menu

The power mode must be in ACCESSORY or ON to use the system.

■ Phone settings screen

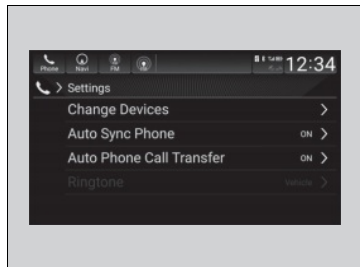

1. Press the  button.
2. Select **Phone**.
3. Select **Settings**.

▶▶ HFL Menu

To use HFL, you must first pair your *Bluetooth*-compatible cell phone to the system while the vehicle is parked.

Some functions are limited while driving.

Features

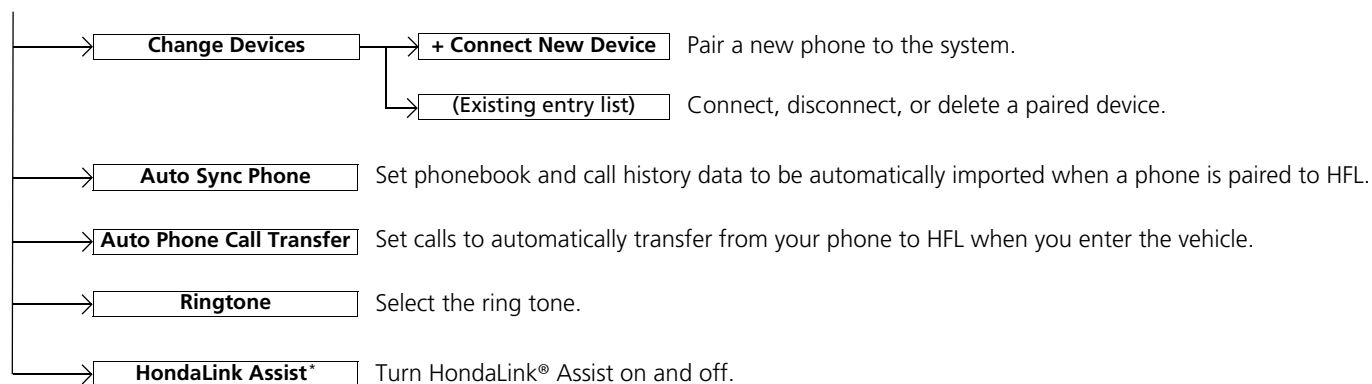

■ Phone menu screen

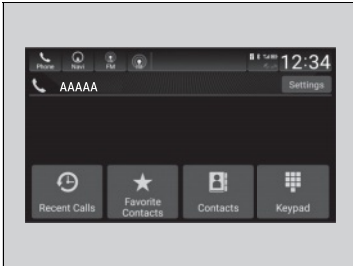

1. Press the  button.
2. Select **Phone**.

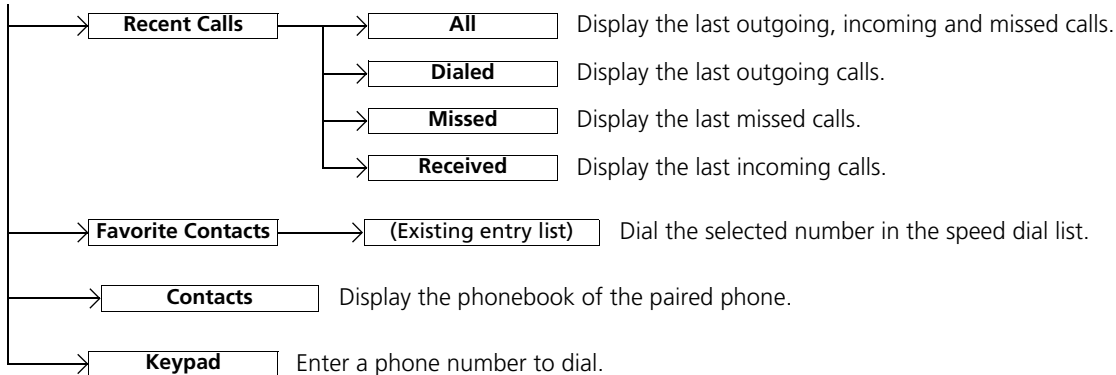

Phone Setup

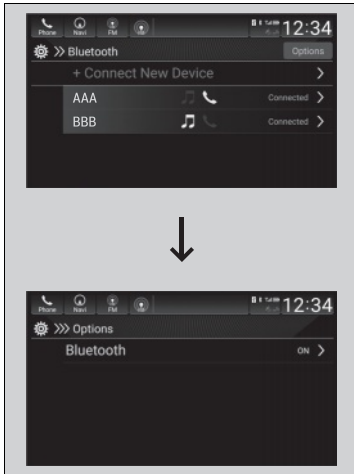

■ Bluetooth® setup

You can turn *Bluetooth*® function on and off.

1. Press the  button.
2. Select **Settings**.
3. Select **Connections**.
4. Select **Bluetooth**.
5. Select **Options**.
6. Select **Bluetooth**, then **ON**.



■ **To pair a cell phone (when there is no phone paired to the system)**

1. Press the  button.
2. Select **Phone**.
3. Select **Connect Phone**.
4. Make sure your phone is in search or discoverable mode, then select **+ Connect New Device**.
 - ▶ HFL automatically searches for a *Bluetooth*® device.
5. Select your phone when it appears on the list.
 - ▶ If your phone still does not appear, search for *Bluetooth*® devices using your phone.

From your phone, search for **HandsFree Link**.
6. The system gives you a pairing code on the audio/information screen.
 - ▶ Confirm if the pairing code on the screen and your phone match.

This may vary by phone.
7. Select desired functions and then select **Save**.

☒ Phone Setup



Your *Bluetooth*-compatible phone must be paired to the system before you can make and receive hands-free calls.

Phone Pairing Tips:

- You cannot pair your phone while the vehicle is moving.
- Up to six phones can be paired.
- Your phone's battery may drain faster when it is paired to the system.

Once you have paired a phone, you can see it displayed on the screen with one or more icons on the right side.



These icons indicate the following:

- : The phone is compatible with *Bluetooth*® Audio.
- : The phone can be used with HFL.

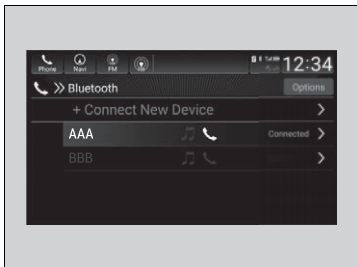
If there is an active connection to Apple CarPlay pairing of additional Bluetooth compatible devices is unavailable.



■ **To change the currently paired phone**

1. Go to the phone settings screen.
 - ▶ **Phone settings screen** P. 430
2. Select **Change Devices**.
3. Select a phone to connect.
 - ▶ HFL disconnects the connected phone and starts searching for another paired phone.
4. Select  or .
5. Select **Save**.



■ **To delete a paired phone**

1. Go to the phone settings screen.
 - ▶ **Phone settings screen** P. 430
2. Select **Change Devices**.
3. Select a phone you want to delete.

4. Select **Delete**.
5. A confirmation message appears on the screen. Select **Yes**.

▶▶ **To change the currently paired phone**

If no other phones are found or paired when trying to switch to another phone, HFL will inform you that the original phone is connected again.

To pair other phones, select **+ Connect New Device** from the **Bluetooth** screen.

Ring Tone

You can change the ring tone setting.



1. Go to the phone settings screen.
 ▶ **Phone settings screen** P. 430
2. Select **Ringtone**.
3. Select **Vehicle** or **Phone**.

Automatic Transferring

If you get into the vehicle while you are on the phone, the call can be automatically transferred to HFL.

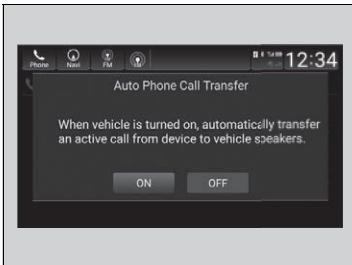

1. Go to the phone settings screen.
 ▶ **Phone settings screen** P. 430
2. Select **Auto Phone Call Transfer**.
3. Select **ON** or **OFF**.

Ring Tone

Vehicle: The fixed ring tone sounds from the speakers.

Phone: Depending on the make and model of the mobile phone, the ring tone stored in the phone will sound if the phone is connected.

■ Automatic Import of Cellular Phonebook and Call History

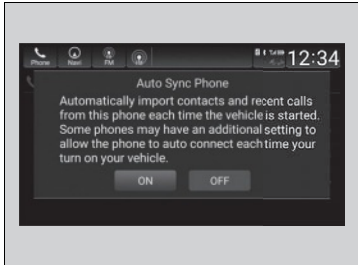
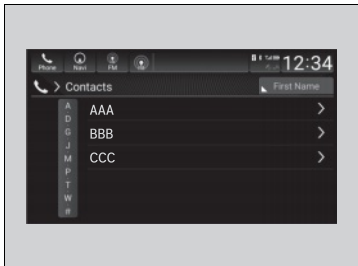

■ When Automatic Phone Sync is set to On:

When your phone is paired, the contents of its phonebook and call history are automatically imported to the system.

■ Changing the Automatic Phone Sync setting

1. Go to the phone settings screen.
 - ▶ Phone settings screen P. 430
2. Select **Auto Sync Phone**.
3. Select **ON** or **OFF**.

▶▶ Automatic Import of Cellular Phonebook and Call History

On some phones, it is necessary to set up it enabled to be imported the cellular phonebook.

When you select a name from the list in the cellular phonebook, you can see a category icon. The icons indicate what types of numbers are stored for that name.



On some phones, it may not be possible to import the category icons to the system.

The phonebook is updated after every connection. Call history is updated after every connection or call.

Favorite Contacts

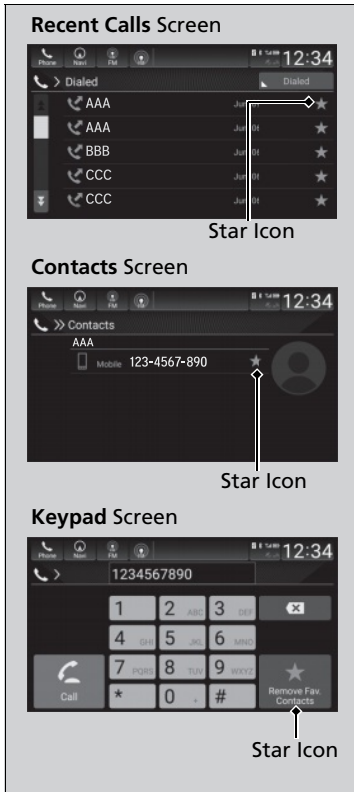

To store a speed dial number:

1. Go to the phone menu screen.
 - ▶ **Phone menu screen** P. 431
2. Select the **Recent Calls, Contacts,** or **Keypad** screen.
3. Select the star icon.
 - ▶ A notification appears on the screen if the Favorite Contact is successfully stored.
 - ▶ To remove the Favorite Contact, select the star icon again.

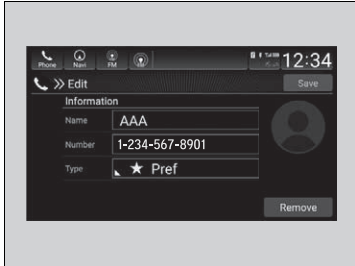

■ To edit a Favorite Contact

1. Go to the phone menu screen.
 - ▶ **Phone menu screen** P. 431
2. Select **Favorite Contacts**.
3. Select **Edit** on the speed dial entry you want to edit.
4. Select a setting you want.
5. Select **Save**.

■ To delete a speed dial

1. Go to the phone menu screen.
 - ▶ **Phone menu screen** P. 431
2. Select **Favorite Contacts**.
3. Select **Edit** on the speed dial entry you want to delete.
4. Select **Remove**.
5. A confirmation message appears on the screen. Select **Yes**.

Making a Call

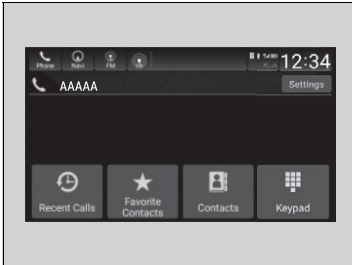

You can make calls by inputting any phone number, or by using the imported phonebook, call history, or Favorite Contact entries.

▶▶ Making a Call

Once a call is connected, you can hear the voice of the person you are calling through the audio speakers.

While there is an active connection with Apple CarPlay, phone calls cannot be made with HandsFreeLink® and are only made from Apple CarPlay.

Continued

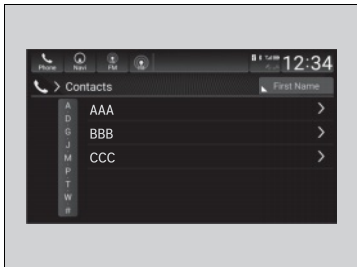

■ **To make a call using the imported phonebook**

1. Go to the phone menu screen.
 - ▶ **Phone menu screen** P. 431
2. Select **Contacts**.
3. Select a name.
 - ▶ You can sort by **First Name** or **Last Name**. Select the icon on the upper right of the screen.
4. Select a number.
 - ▶ Dialing starts automatically.

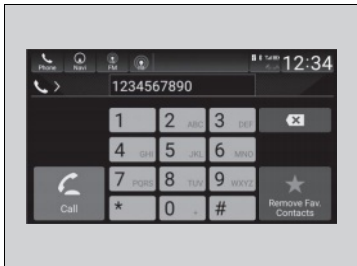

■ **To make a call using a phone number**

1. Go to the phone menu screen.
 - ▶ **Phone menu screen** P. 431
2. Select **Keypad**.
3. Select a number.
 - ▶ Use the keyboard on the touch screen for entering numbers.
4. Select **Call**.
 - ▶ Dialing starts automatically.

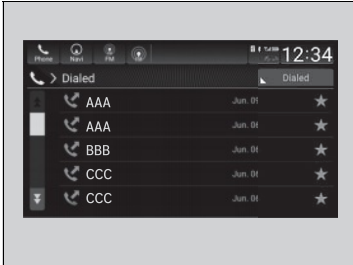

■ To make a call using the call history

Call history is stored by **All**, **Dialed**, **Missed**, and **Received**.

1. Go to the phone menu screen.

▶ **Phone menu screen** P. 431

2. Select **Recent Calls**.

▶ You can sort by **All**, **Dialed**, **Missed**, or **Received**. Select the icon on the upper right of the screen.

3. Select a number.

▶ Dialing starts automatically.

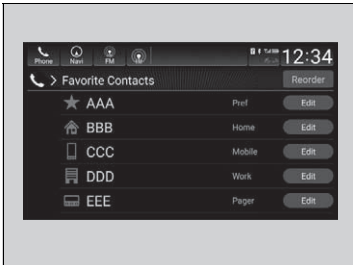

■ To make a call using a Favorite Contact entry

1. Go to the phone menu screen.

▶ **Phone menu screen** P. 431

2. Select **Favorite Contacts**.

▶ You can change the order of Favorite Contact entries by selecting **Reorder**.

3. Select a number.

▶ Dialing starts automatically.



☒ To make a call using the call history

The call history appears only when a phone is connected to the system.

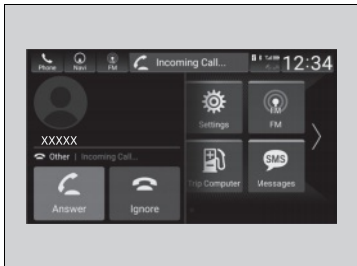
■ Receiving a Call



When there is an incoming call, an audible notification sounds (if activated) and the **Incoming Call...** screen appears.

Press the  button to answer the call.
Press the  button to decline or end the call.

■ Options During a Call

The following options are available during a call.

Mute: Mute your voice.

Use Handheld: Transfer a call from the system to your phone.

Keypad: Send numbers during a call. This is useful when you call a menu-driven phone system.



The available options are shown on the lower half of the screen.

Select the option.

- ▶ The mute icon appears when **Mute** is selected. Select **Mute** again to turn it off.

▶▶ Receiving a Call



Call Waiting

Press the  button to put the current call on hold to answer the incoming call.

Press the  button again to return to the current call.

Select **Ignore** to ignore the incoming call if you do not want to answer it.

Press the  button if you want to hang up the current call.

You can select the icons on the audio/information screen instead of the  and  buttons.

▶▶ Options During a Call

You can select the icons on the audio/information screen.

To Set Up Text Message Options

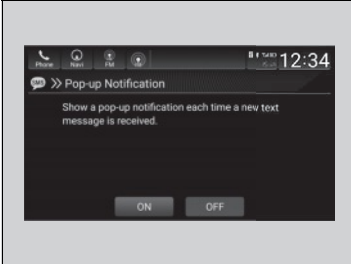

■ To turn on or off the text message notice

1. Press the  button.
2. Select **Messages**.
3. Select **Settings**.
4. Select **Pop-up Notification**.
5. Select **ON** or **OFF**.

☒ To Set Up Text Message Options

To use the text message function, it may be necessary to set up on your phone.

☒ To turn on or off the text message notice

ON: A pop-up notification comes on every time you receive a new message.

OFF: The message you receive is stored in the system without notification.

Continued

Receiving a Text Message

HFL can display newly received text messages as well as the last 20 messages received on a linked cell phone. Each received message can be read aloud and replied to using a fixed common phrase.

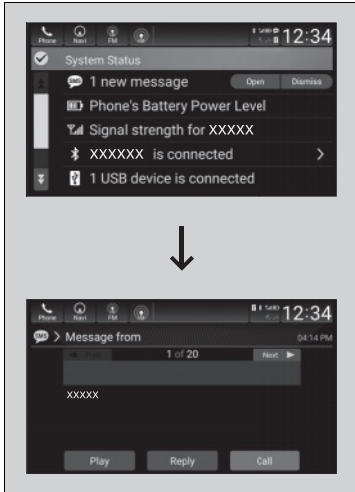

1. Select the system status icon.
 - ▶ The status area appears.
2. A pop-up appears and notifies you of a new text message.
3. Select **Open** to display the message.
 - ▶ The text message is displayed.
4. Select **Play** to listen to the message. To discontinue the message read-out, select **Stop**.

Receiving a Text Message

Some mobile phones might not be able to read the transmission log of data sent and data received.

The system does not display any received messages while you are driving. You can only hear them read aloud.

The system can only receive messages that are sent a text (SMS) messages. The message sent using the data services will not be displayed in the list.

With some phones, you may be able to display up to 20 of the last text messages received.

State or local laws may limit your use of the HFL text message feature. Only use the text message feature when conditions allow you to do so safely.

Selecting a Phone

You can select one from the *Bluetooth*® device list to be active and receive notifications.

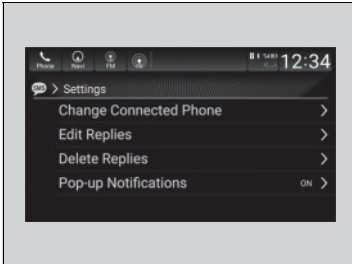

1. Press the  button.
2. Select **Messages**.
3. Select **Settings**.
4. Select **Change Connected Phone**.
5. Change a desired phone.
 - **To change the currently paired phone**
P. 434

Selecting a Phone

You can only receive notifications from one phone at a time.

■ Displaying Messages

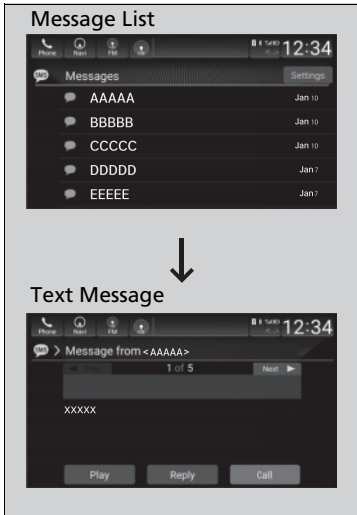



1. Press the  button.
2. Select **Messages**.
 - ▶ Select a phone if necessary.
3. Select a message.
 - ▶ The text message is displayed.

▶▶ Displaying Messages

The  (blue) icon appears next to an unread message.

If you delete a message on the phone, the message will also be deleted from the system. If you send a message from the system, the message goes to your phone's outbox.

To see the previous or next message, select  **Prev** or **Next**  on the message screen.

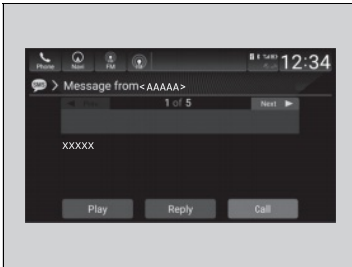

■ Read or Stop reading a message

1. Go to the text message screen.
2. Select **Play**.
 - ▶ The system starts reading the message aloud.
3. Select **Stop** to stop reading. Select **Play** again to start reading the message.

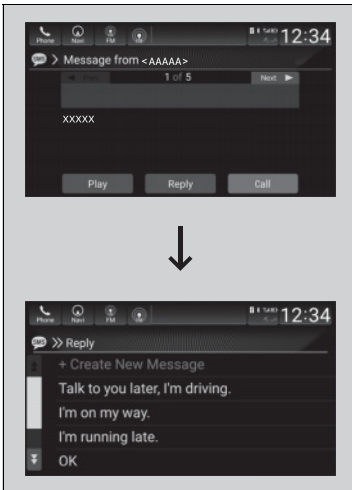

■ Reply to a message

1. Go to the text message screen.
2. Select **Reply**.
3. Select the reply message.
 - ▶ The pop-up menu appears on the screen.
4. Select **Send** to send the message.
 - ▶ **Message sent** appears on the screen when the reply message was successfully sent.

☒ Reply to a message

The available reply messages are as follows:

- **Talk to you later, I'm driving.**
- **I'm on my way.**
- **I'm running late.**
- **OK**
- **Yes**
- **No**

The default reply messages are displayed only in English. If you want to use reply messages in languages other than English, please edit them.

☒ **To edit a reply message** P. 448

You can add a reply message by selecting **+ Create New Message**.

☒ **To edit a reply message** P. 448

Only certain phones receive and send messages when paired and connected. For a list of compatible phones:

- U.S.: Visit automobiles.honda.com/handsfreelink/, or call 1-888-528-7876.
- Canada: For more information on smartphone compatibility, call 1-888-528-7876.

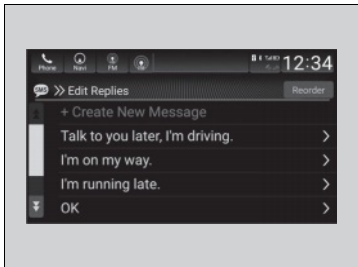

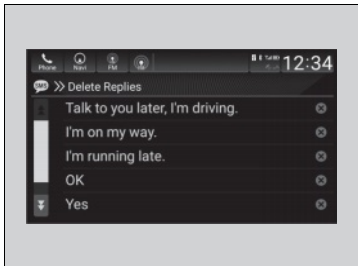

■ To edit a reply message

1. Press the  button.
2. Select **Messages**.
3. Select **Settings**.
4. Select **Edit Replies**.
5. Select the reply message you want to edit or **+ Create New Message**.
 - ▶ The on-screen keyboard screen is displayed.
6. Enter a reply message, and then select **Save**.



■ To delete a reply message

1. Press the  button.
2. Select **Messages**.
3. Select **Settings**.
4. Select **Delete Replies**.
5. Select  on the reply message you want to delete.
 - ▶ The pop-up menu appears on the screen.
6. Select **Yes**.

▶▶ To edit a reply message

You can change the order of reply messages by selecting **Reorder**.

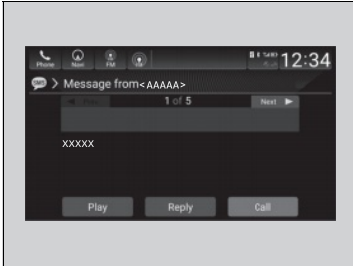

■ Making a call to a sender

1. Go to the text message screen.
2. Select **Call**.

HondaLink® Assist*

In Case of Emergency

Automatic collision notification

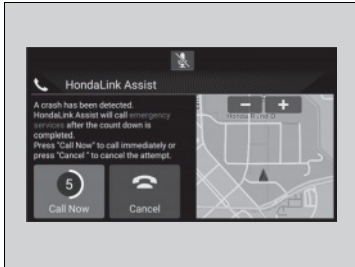

If your vehicle's airbags deploy or if the unit detects that the vehicle is severely impacted, your vehicle automatically will attempt to connect to the HondaLink® operator. If connected, information about your vehicle, its location, and its condition can be sent to the operator*1; you also can speak to the operator when connected.

IMPORTANT: For vehicles equipped with HondaLink® Assist, owner activation constitutes authorization for Honda to collect information from your vehicle needed to provide the service, and agreement to the Terms of Use at www.hondalink.com/TermsAndConditions. In a crash, HondaLink® Assist will attempt to notify emergency services but NEITHER HONDA NOR ITS SERVICE PROVIDERS GUARANTEE THAT SUCH NOTIFICATION WILL OCCUR.

Honda reserves the right to terminate HondaLink® Assist services at any time or for any reason, and in the future may not be able to provide services due to changes in, or obsolescence of, technology integral to the service or changes in governmental regulation.

*1: Depending on your phone and adequate cellular coverage, your vehicle's location may not be sent to the operator.

HondaLink® Assist*

HondaLink® Assist also provides services you can operate from the Internet or your smartphone.

To subscribe to HondaLink® Assist, or to get more information about all of its features, contact an Honda dealer, or visit hondalink.honda.com

In Case of Emergency

Your vehicle may not be able to connect to the operator if the battery level is low, the line is disconnected, or you do not have adequate cellular coverage.

You cannot use this emergency services when:

- You travel outside the HondaLink® service coverage areas.
- There is a problem with the connecting devices, such as the microphones, speakers, or the unit itself.
- **HondaLink Assist** is not enabled.

▶ **To enable notification** P. 451

You cannot operate other phone-related functions using the screen while talking to the operator.

Only the operator can terminate the connection to your vehicle.

Automatic collision notification

If the unit fails to connect to the operator, it repeatedly tries until it succeeds.

■ To enable notification

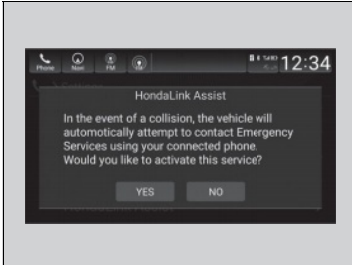

1. Go to the phone settings screen.
▶ **Phone settings screen** P. 430
2. Select **HondaLink Assist**.
3. Select **YES** or **NO**.

☒ To enable notification

Setting options:

- **YES**: Notification is available.
- **NO**: Disable the feature.

Refuel Recommend

Models with navigation system

Your vehicle is equipped with a feature that recommends refueling at a timing of your preference. Once the system is programmed, this feature will notify you when refueling is recommended as well as enable you to search for gas stations that are located in the vicinity of your vehicle.



1. When it is time to refuel the vehicle, a notification is displayed and a notification icon is displayed in the header.
2. Touch the box that contains the icon.

3. Select **Find Gas Station Now**.

4. Choose a gas station from the search screen of the navigation system.
 - ▶ For instructions on how to use the navigation system, refer to the navigation system manual.

Refuel Recommend

You can change the setting for **Refuel Recommend** by selecting: **Settings**→**System**→**Refuel recommend**

When you turn off this feature, the timing that you programmed for refueling will be deleted.

This feature can only be used when the gas tank fuel level is below 30 percent.

If you select **Find Gas Station Now** or put more than 5 liters of gasoline into the gas tank, the notification for refueling will disappear. If you prefer not to be notified, select OFF in the settings for Refuel Recommend.

When you drive on a rough road or ascend or descend a hill for an extended period of time, the notification may disappear or may not be displayed at all.



Driving

This chapter discusses driving and refueling.

Before Driving	454
Towing a Trailer	459
When Driving	
Starting the Engine	465
Precautions While Driving.....	473
Automatic Transmission*/Continuously Variable Transmission*	474
Shifting	475, 482, 484, 488
SPORT Mode*	491
ECON Button	492
Adaptive Damper System*	493
Vehicle Stability Assist® (VSA®), aka Electronic Stability Control (ESC), System.....	494

Agile Handling Assist	496
Tire Pressure Monitoring System (TPMS)....	497
Tire Pressure Monitoring System (TPMS) - Required Federal Explanation	500
Blind spot information System*	502
LaneWatch™*	505
Honda Sensing®	507
Collision Mitigation Braking System™ (CMBS™)	510
Adaptive Cruise Control (ACC) with Low Speed Follow (LSF)*	519
Adaptive Cruise Control (ACC)*	535
Lane Keeping Assist System (LKAS)....	550

Road Departure Mitigation (RDM) System.....	558
Traffic Sign Recognition System	562
Front Sensor Camera	568
Radar Sensor	570
Braking	
Brake System	571
Anti-lock Brake System (ABS)	581
Brake Assist System	582
Parking Your Vehicle	583
Multi-View Rear Camera	594
Refueling	597
Fuel Economy and CO₂ Emissions	600
Turbo Engine Vehicle	601

* Not available on all models

Driving Preparation

Check the following items before you start driving.

Exterior Checks

- Make sure there are no obstructions on the windows, door mirrors, exterior lights, or other parts of the vehicle.
 - ▶ Remove any frost, snow, or ice.
 - ▶ Remove any snow on the roof, as this can slip down and obstruct your field of vision while driving. If frozen solid, remove ice once it has softened.
 - ▶ When removing ice from around the wheels, be sure not to damage the wheel or wheel components.
- Make sure the hood is securely closed.
 - ▶ If the hood opens while driving, your front view will be blocked.
- Make sure the tires are in good condition.
 - ▶ Check air pressure, check for damage and excessive wear.
 - ✎ **Checking and Maintaining Tires** P. 642
- Make sure there are no people or objects behind or around the vehicle.
 - ▶ There are blind spots from the inside.

Exterior Checks

NOTICE

When doors are frozen shut, use warm water around the door edges to melt any ice. Do not try to force them open, as this can damage the rubber trim around the doors. When done, wipe dry to avoid further freezing.

Do not pour warm water into the key cylinder. You will be unable to insert the key if the water freezes in the hole.

Heat from the engine and exhaust can ignite flammable materials left under the hood, causing a fire. If you've parked your vehicle for an extended period, inspect and remove any debris that may have collected, such as dried grass and leaves that have fallen or have been carried in for use as a nest by a small animal. Also check under the hood for leftover flammable materials after you or someone else has performed maintenance on your vehicle.

Interior Checks

- Store or secure all items on board properly.
 - ▶ Carrying too much cargo, or improperly storing it, can affect your vehicle's handling, stability, stopping distance, and tires, and make it unsafe.
 - ✦ **Maximum Load Limit** P. 457
- Do not pile items higher than the seat height.
 - ▶ They can block your view and may be thrown forward in the event of sudden braking.
- Do not place anything in the front seat footwells. Make sure to secure the floor mat.
 - ▶ An object or unsecured floor mat can interfere with your brake and accelerator pedal operation while driving.
- If you have any animals on board, do not let them move around in the vehicle.
 - ▶ They may interfere with driving and a crash could occur.
- Securely close and lock all doors and the trunk.
 - ✦ **Locking/Unlocking the Doors from the Inside** P. 176
- Adjust your seating position properly.
 - ▶ Adjust the head restraint, too.
 - ✦ **Adjusting the Seats** P. 210
 - ✦ **Adjusting the Front and Rear Outer* Head Restraint Positions** P. 216
- Adjust the mirrors and steering wheel properly for your driving.
 - ▶ Adjust them while sitting in the proper driving position.
 - ✦ **Adjusting the Mirrors** P. 208
 - ✦ **Adjusting the Steering Wheel** P. 207

Interior Checks

The headlight aim is set by the factory, and does not need to be adjusted. However, if you regularly carry heavy items in the trunk or tow a trailer*, have the aiming readjusted at a dealer or by a qualified technician.

* Not available on all models

- Be sure items placed on the floor behind the front seats cannot roll under the seats.
 - ▶ They can interfere with the driver's ability to operate the pedals, the operation of the seats, or the operation of the sensors under the seats.
- Everyone in the vehicle must fasten their seat belt.
 - ▶ **Fastening a Seat Belt** P. 41
- Make sure that the indicators in the instrument panel come on when you start the vehicle, and go off soon after.
 - ▶ Always have a dealer check the vehicle if a problem is indicated.
 - ▶ **Indicators** P. 78

Maximum Load Limit

The maximum load for your vehicle is 850 lbs (385 kg). See the Tire and Loading Information label attached to the driver's doorjamb.

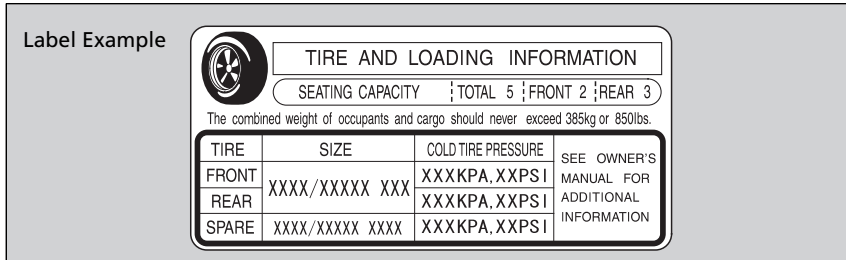

This figure includes the total weight of all occupants, cargo, and accessories, and the tongue load if you are towing a trailer*.

Steps for Determining Correct Load Limit -

- (1)** Locate the statement "The combined weight of occupants and cargo should never exceed XXX kg or XXX lbs." on your vehicle's placard.
- (2)** Determine the combined weight of the driver and passengers that will be riding in your vehicle.
- (3)** Subtract the combined weight of the driver and passengers from XXX kg or XXX lbs.
- (4)** The resulting figure equals the available amount of cargo and luggage load capacity. For example, if the "XXX" amount equals 1,400 lbs. and there will be five 150 lb. passengers in your vehicle, the amount of available cargo and luggage load capacity is 650 lbs. (1,400 - 750 (5 x 150) = 650 lbs.)

* Not available on all models

Continued

Maximum Load Limit

⚠ WARNING

Overloading or improper loading can affect handling and stability and cause a crash in which you can be hurt or killed.

Follow all load limits and other loading guidelines in this manual.

Gross Vehicle Weight Rating (GVWR):

The maximum allowable weight of the vehicle, all occupants, all accessories, all cargo, and the tongue load*.

📖 **Specifications** P. 700, 702

Gross Axle Weight Rating (GAWR):

The maximum allowable weight of the vehicle axle.

📖 **Specifications** P. 700, 702

- (5) Determine the combined weight of luggage and cargo being loaded on the vehicle. That weight may not safely exceed the available cargo and luggage load capacity calculated in step 4.
- (6) If your vehicle will be towing a trailer, load from your trailer will be transferred to your vehicle. Consult this manual to determine how this reduces the available cargo and luggage load capacity of your vehicle.

In addition, the total weight of the vehicle, all occupants, accessories, cargo, and trailer tongue load must not exceed the Gross Vehicle Weight Rating (GVWR) or the Gross Axle Weight Rating (GAWR). Both are on a label on the driver's doorjamb.

▶▶ Maximum Load Limit

Towing a Trailer:

See Towing a Trailer to determine whether your vehicle is designed to tow a trailer.

▶▶ **Towing a Trailer** P. 459

Load Limits Example

Example1



Max Load
850 lbs
(385 kg)



Passenger Weight
150 lbs x 2 = 300 lbs
(68 kg x 2 = 136 kg)



Cargo Weight
550 lbs
(249 kg)

Example2



Max Load
850 lbs
(385 kg)



Passenger Weight
150 lbs x 5 = 750 lbs
(68 kg x 5 = 340 kg)



Cargo Weight
100 lbs
(45 kg)

Towing a Trailer

1.5 L engine models

Your vehicle is not designed to tow a trailer. Attempting to do so can void your warranties.

2.0 L engine models

Towing Preparation

Towing Load Limits

Your vehicle can tow a trailer if you carefully observe the load limits, use the proper equipment, and follow the towing guidelines. Check the load limits before driving.

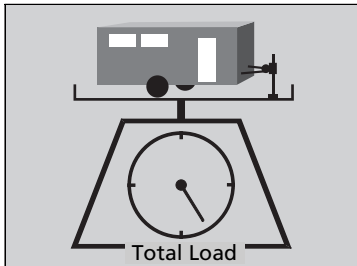

■ Total trailer weight

Maximum allowable weight of the trailer, cargo, and everything in or on it must not exceed 1,000 lbs (450 kg). Towing loads in excess of this can seriously affect vehicle handling and performance and can damage the engine and drivetrain.

☒ Towing Load Limits

⚠ WARNING

Exceeding any load limit or improperly loading your vehicle and trailer can cause a crash in which you can be seriously hurt or killed.

Check the loading of your vehicle and trailer carefully before starting to drive.

Check if all loads are within limits at a public scale. If a public scale is not available, add the estimated weight of your cargo load to the weight of your trailer (as quoted by the manufacturer), and the tongue load.

Break-in Period.

Avoid towing a trailer during your vehicle's first 600 miles (1,000 km).

Never exceed the gross weight ratings.

Gross weight information

☒ **Vehicle Specifications** P. 702

Continued

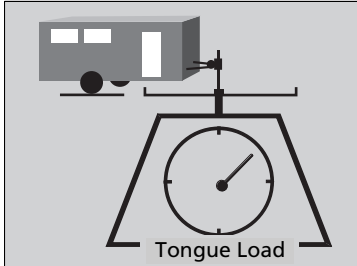

■ Tongue load

The weight of the tongue with a fully loaded trailer on the hitch should be approximately 10% of the total trailer weight.

- Excessive tongue load reduces front tire traction and steering control. Too little tongue load can make the trailer unstable and cause it to sway.
- To achieve a proper tongue load, start by loading 60% of the load toward the front of the trailer and 40% toward the rear. Readjust the load as needed.

■ Towing Equipment and Accessories

Towing equipment varies by the size of your trailer, how much load you are towing, and where you are towing.

■ Hitches

The hitch must be of an approved type and properly bolted to the underbody.

■ Safety chains

Always use safety chains when you tow a trailer. Leave enough slack to allow the trailer to turn corners easily, but do not allow the chains to drag on the ground.

■ Trailer brakes

There are two common types of trailer brakes: surge and electric. Surge brakes are common for boat trailers, since the brakes will get wet. If you choose electric brakes, be sure they are electronically actuated. Do not attempt to attach trailer brakes to your vehicle's hydraulic system, as it will lower braking effectiveness and create a potential hazard.

■ Additional towing equipment

Many states and provinces/territories require special outside mirrors when towing a trailer. Even if mirrors are not required in your locale, you should install special mirrors if visibility is restricted in any way.

■ Trailer light

Trailer lights and equipment must comply with federal, state, province/territory, and local regulations. Check with your local trailer sales or rental agency for the requirements in the area where you plan to tow.

▣ Towing Equipment and Accessories

Make sure that all equipment is properly installed and maintained, and that it meets federal, state, province/territory, and local regulations.

Consult your trailer maker for proper installation and setup of the equipment. Improper installation and setup can affect the handling, stability, and braking performance of your vehicle.

Consult your trailer sales or rental agency if any other items are recommended or required for your towing situation.

The lighting and wiring of trailers can vary by type and brand. If a connector is required, it should only be installed by a qualified technician.

2.0 L engine models

Driving Safely with a Trailer

■ Things You Need To Know Before Towing a Trailer

- Have the trailer properly serviced and keep it in good condition.
- Make sure that all the weights and load in the vehicle and trailer are within limits.
 - ✎ **Towing Load Limits** P. 459
- Securely attach the hitch, safety chains, and other necessary parts to the trailer.
- Securely store all the items in and on the trailer so that they do not shift while driving.
- Check if the lights and brakes on the trailer are working properly.
- Check the pressure of the trailer tires, including the spare.

■ Towing Speeds and Gears

- Drive slower than normal.
- Obey posted speed limits for vehicles with trailers.

Automatic transmission models

- Use the  position when towing a trailer on level roads.

■ Turning and Braking

- Turn more slowly and with a wider turning arc than normal.
- Allow more time and distance for braking.
- Do not brake or turn suddenly.

■ Driving in Hilly Terrain

- Monitor your temperature gauge. If it nears the red (Hot) mark, turn off the climate control system and reduce speed. Pull to the side of the road safely to cool down the engine if necessary.

►► Driving Safely with a Trailer

Operating speed when towing a trailer must not exceed 62 mph (100 km/h).

Parking

In addition to the normal precautions, place wheel chocks at each of the trailer's tires.

Towing Your Vehicle

Automatic transmission/Continuously variable transmission models

Your vehicle is not designed to be towed behind a motorhome. If your vehicle needs to be towed in an emergency, refer to the emergency towing information.

🔧 **Emergency Towing** P. 693

Manual transmission models

Your vehicle can be towed behind a motorhome.

Manual transmission models

When Your Vehicle is Towed Behind a Motorhome

Perform the following procedure before towing your vehicle.

1. Put the transmission into neutral.
2. Release the parking brake.
3. Set the power mode to ACCESSORY.
 - ▶ Make sure the steering wheel does not lock.
4. Turn off all the electric devices. Do not use any accessory power sockets.
 - ▶ This can prevent the battery from running down.

Extended towing

If you tow more than eight hours in one day, you should repeat the “When Your Vehicle is Towed Behind a Motorhome” at least every eight hours.

You also need to perform the following procedure to prevent the battery from running down.

▶▶ Towing Your Vehicle

Manual transmission models

Do not exceed 65 mph (100 km/h).

Consult your towing parts sales or rental agency if any other items are recommended or required for your towing situation.

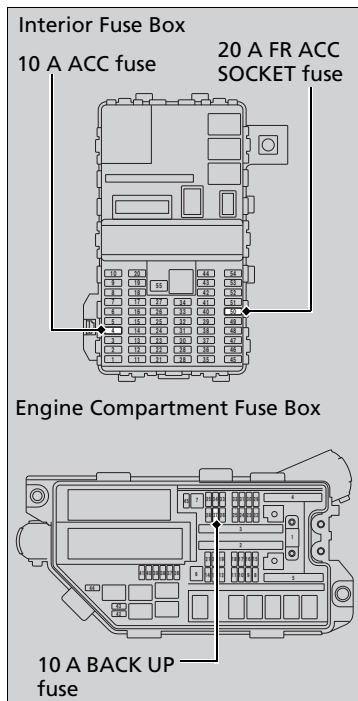

1. Remove the 20 A FR ACC SOCKET and 10 A ACC fuses. These fuses are located in the interior fuse box.

▶ **Interior Fuse Box** P. 690

2. Remove the 10 A BACK UP fuse. This fuse is located in the engine compartment fuse box.

▶ **Engine Compartment Fuse Box** P. 688

3. Store the fuses in a safe place so you do not lose them.

▶ Make sure to reinstall the fuses before you start driving your vehicle.

4. Push the **ENGINE START/STOP** button without depressing the clutch pedal.

▶ The **ENGINE START/STOP** button blinks.

5. Touch the center of the **ENGINE START/STOP** button with the **H** logo on the remote while the **ENGINE START/STOP** button is blinking.

▶ The **ENGINE START/STOP** button stop blinking, then stays on.

6. Put the transmission into neutral.

7. Push the **ENGINE START/STOP** button once without depressing the clutch pedal.

▶ Make sure the steering wheel does not lock.

▶▶ Towing Your Vehicle

Make sure to reinstall the fuses before you start driving your vehicle.

Starting the Engine

Automatic transmission models

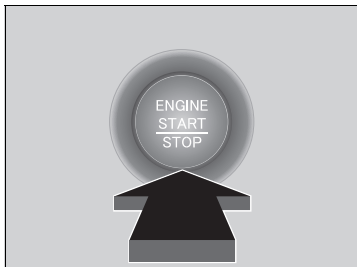
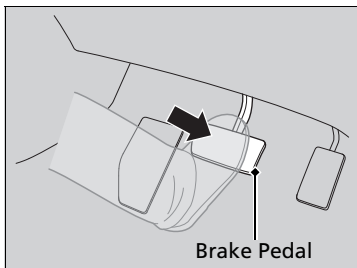

1. Make sure the parking brake is applied.
 - ▶ The parking brake indicator (red) comes on for 30 seconds when you pull up the electric parking brake switch.
 - ▶ The parking brake must be applied to start the engine.
2. Depress the brake pedal.
 - ▶ Although it is possible to start the vehicle in **N** with the parking brake applied, it is safer to start it in **P**.
3. Press the **ENGINE START/STOP** button without depressing the accelerator pedal.

Starting the Engine

Keep your foot firmly on the brake pedal when starting the engine.

The engine is harder to start in cold weather and in thinner air found at altitudes above 8,000 feet (2,400 meters).

When starting the engine in cold weather, turn off all electrical accessories such as the lights, climate control system and rear defogger in order to reduce battery drain.

If you live in a region where winter is extremely cold, an engine block heater will improve starting and warming of the engine. Consult a dealer for details.

If the exhaust system sounds abnormal or you can smell exhaust gas inside the vehicle, have your vehicle checked by a dealer. There may be a problem with the engine or exhaust system.

The immobilizer system protects your vehicle from theft.

If an improperly coded device is used, the engine's fuel system is disabled.

▶ **Immobilizer System** P. 183

Continuously variable transmission models

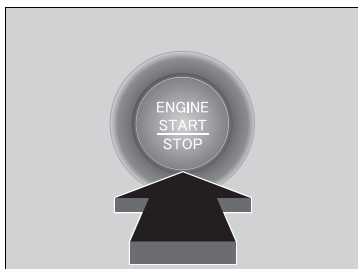
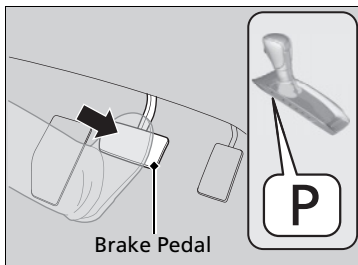
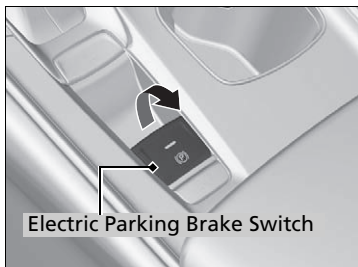

1. Make sure the parking brake is applied.
 - ▶ The parking brake indicator (red) comes on for 30 seconds when you pull up the electric parking brake switch.
 - ▶ The parking brake must be applied to start the engine.
2. Check that the transmission is in **P**, then depress the brake pedal.
 - ▶ Although it is possible to start the vehicle in **N** with the parking brake applied, it is safer to start it in **P**.
3. Press the **ENGINE START/STOP** button without depressing the accelerator pedal.

▶▶ Starting the Engine

Bring the remote close to the **ENGINE START/STOP** button if the battery in the remote is weak.

❏ **If the Remote Battery is Weak** P. 672

The engine may not start if the remote is subjected to strong radio waves.

Do not hold the **ENGINE START/STOP** button to start the engine.

If the engine does not start, wait at least 30 seconds before trying again.

Manual transmission models

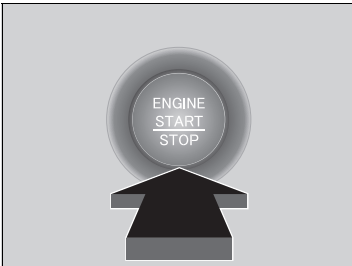
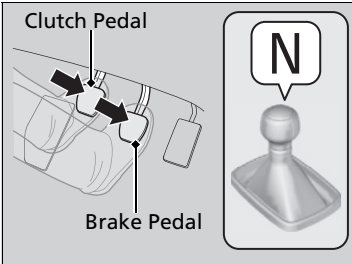

1. Make sure the parking brake is applied.
 - ▶ The parking brake indicator (red) comes on for 30 seconds when you pull up the electric parking brake switch.
 - ▶ The parking brake must be applied to start the engine.

2. Check that the transmission is in neutral. Then depress the brake pedal with your right foot, and the clutch pedal with your left foot.
 - ▶ The clutch pedal must be fully depressed to start the engine.

3. Press the **ENGINE START/STOP** button without depressing the accelerator pedal.

▶▶ Starting the Engine

Manual transmission models

If the vehicle stalls on a slope, the electric parking brake system may automatically engage. If it does not, engage it manually, then start the engine again.

■ Stopping the Engine

You can turn the engine off when the vehicle is completely stopped.

Automatic transmission/Continuously variable transmission models

1. Put the transmission into **P**.
2. Press the **ENGINE START/STOP** button.

Manual transmission models

- If the transmission is in neutral, press the **ENGINE START/STOP** button.
- If the transmission is in any gear other than neutral, depress the clutch pedal, then press the **ENGINE START/STOP** button.



Remote Engine Start with Vehicle Feedback*

You can remotely start the engine using the  button on the remote.

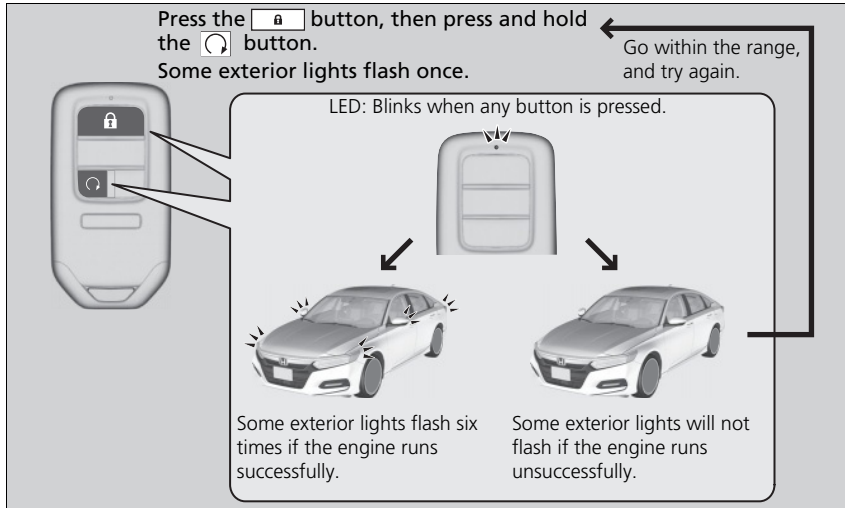
To start the engine



When started remotely, the engine automatically shuts off after 10 minutes of idling and/or the brake pedal and **ENGINE START/STOP** button have not been pressed simultaneously.

To extend the run time for another 10 minutes during the first run, press the  button, then press and hold the  button.

- ▶ Some exterior lights flash six times if a 10-minute extension request was transmitted successfully.

* Not available on all models

Remote Engine Start with Vehicle Feedback*

⚠ WARNING

Engine exhaust contains toxic carbon monoxide.

Breathing carbon monoxide can kill you or cause unconsciousness.

Never use the remote engine starter when the vehicle is parked in a garage or other area with limited ventilation.

The remote engine start may violate local laws. Before using the remote engine start, check your local laws.

If there are buildings and obstacles between your vehicle and the remote, the range will be reduced. The range may be less when the vehicle is running. This distance may vary by external electrical interference.

The engine may not start by the remote engine start if:

- You have disabled a remote engine start setting using the audio/information screen.
- The power mode is not in VEHICLE OFF.
- The transmission is in a position other than **P**.
- The hood is open, or any door or the trunk is unlocked.

Continued

■ To stop the engine

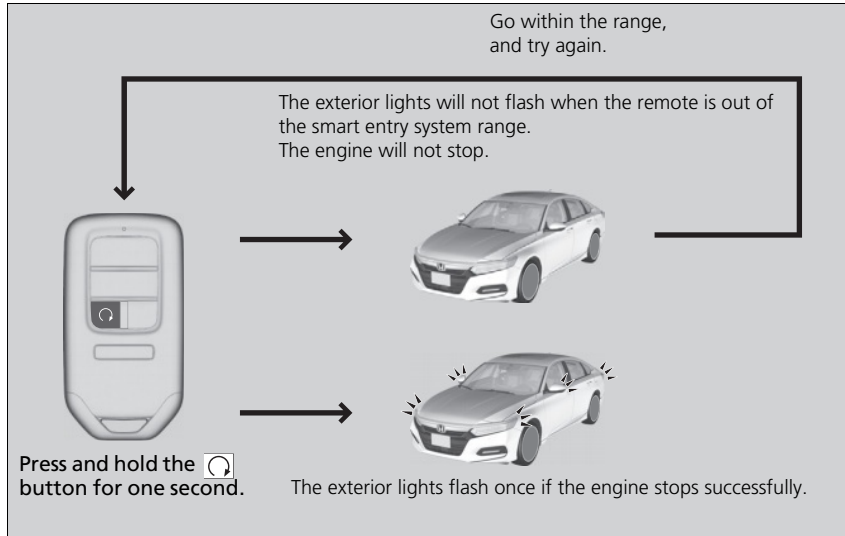

▶▶ Remote Engine Start with Vehicle Feedback*

- You have already used the remote twice to start the engine.
- Another registered remote is in the vehicle.
- There is an antenna failure.
- The door is unlocked with the built-in key.
- The engine oil pressure is low.
- The engine coolant temperature is extremely high.
- The security system alarm is not set.

The engine may stop while it is running if:

- You do not start the vehicle within 10 minutes of starting the engine with the remote.
- The engine is stopped by using the remote.
- The security system alarm is activated.
- The door is unlocked with the built-in key.
- The hood is open.
- The engine coolant temperature is extremely high.
- The battery is low.
- The engine oil pressure is low.
- The malfunction indicator lamp (MIL) comes on if there is a problem with the emissions control systems.
- You press the **ENGINE START/STOP** button without depressing the brake pedal.

Automatic transmission models

- The transmission is in a position other than **P**.

Continuously variable transmission models

- You press the shift lever release button.

▶▶ Remote Engine Start with Vehicle Feedback*

While the engine is running, the vehicle will automatically precondition inside the vehicle.

When it is warm outside:

- The climate control system is activated in auto mode.

When it is cold outside:

- The defroster is activated at a moderately warm temperature.
- The rear defogger and door mirror heaters are activated.
- The seat heaters* and heated steering wheel* are activated.

▶ **Heated Steering Wheel*** P. 235

▶ **Front Seat Heaters*** P. 236

▶ **Front Seat Heaters and Seat Ventilation***
P. 237

* Not available on all models

Starting to Drive

Automatic transmission/Continuously variable transmission models

When the engine was started using the  button on the remote

1. While depressing the brake pedal, press the **ENGINE START/STOP** button.

When the engine was started in any case

2. Keeping your right foot on the brake pedal, put the transmission into **D**. Select **R** when reversing.
3. With the parking brake applied, release the brake pedal and gently depress the accelerator pedal.
 - ▶ Make sure the parking brake indicator (red) goes off.

Hill start assist system

Hill start assist keeps the brake engaged briefly to help prevent the vehicle from rolling on inclines as you move your foot from the brake pedal to the accelerator.

Automatic transmission/Continuously variable transmission models

Put the transmission into **D**, **S*** or **L*** when facing uphill, or **R** when facing downhill, then release the brake pedal.

Manual transmission models

Depress the clutch pedal, and put the transmission into **1** when facing uphill, or **R** when facing downhill, then release the brake pedal.

Starting to Drive

When the engine was started using the  button on the remote

The engine stops when the transmission is taken out of **P** before the **ENGINE START/STOP** button is pressed. Follow the step 1 when starting to drive.

You can also release the parking brake by pressing the electric parking brake switch while depressing the brake pedal.

When facing downhill, you can start your vehicle more smoothly by manually releasing it with the electric parking brake switch than by releasing it with the accelerator pedal.

Hill start assist system

Hill start assist may not prevent the vehicle from rolling downhill on a very steep or slippery slope, and does not operate on small inclines.

Hill start assist is not a replacement for the parking brake.

Hill start assist will operate even when VSA® is switched off.

Precautions While Driving

In Rain

Avoid driving in deep water and on flooded roads. This can damage the engine or driveline, or cause electrical component failure.

Other Precautions

If there is a strong impact with something under the vehicle, stop in a safe location. Check the underside of the vehicle for damage or any fluid leaks.

Precautions While Driving

NOTICE

Do not change the transmission while pressing the accelerator pedal. You could damage the transmission.

NOTICE

If you repeatedly turn the steering wheel at an extremely low speed, or hold the steering wheel in the full left or right position for a while, the electric power steering (EPS) system heats up. The system goes into a protective mode, and limits its performance. The steering wheel becomes harder and harder to operate. Once the system cools down, the EPS system is restored. Repeated operation under these conditions can eventually damage the system.

If the power mode is set to ACCESSORY while driving, the engine will shut down and all steering and brake power assist functions will stop, making it difficult to control the vehicle.

Do not put the transmission into **N**, as you will lose engine braking (and acceleration) performance.

During the first 600 miles (1,000 km) of operation, avoid sudden acceleration or full throttle operation so as not to damage the engine or powertrain.

Avoid hard braking for the first 200 miles (300 km). You should also follow this when the brake pads are replaced.

Automatic Transmission*/Continuously Variable Transmission*

■ Creeping

The engine runs at a higher idle speed and creeping increases. Keep the brake pedal firmly depressed when stopped.

■ Kickdown

Quickly depressing the accelerator pedal while driving uphill may cause the transmission to drop to a lower gear, unexpectedly increasing vehicle speed. Depress the accelerator pedal carefully, especially on slippery roads and curves.

Automatic transmission models

Shifting

Change the gear position in accordance with your driving needs.

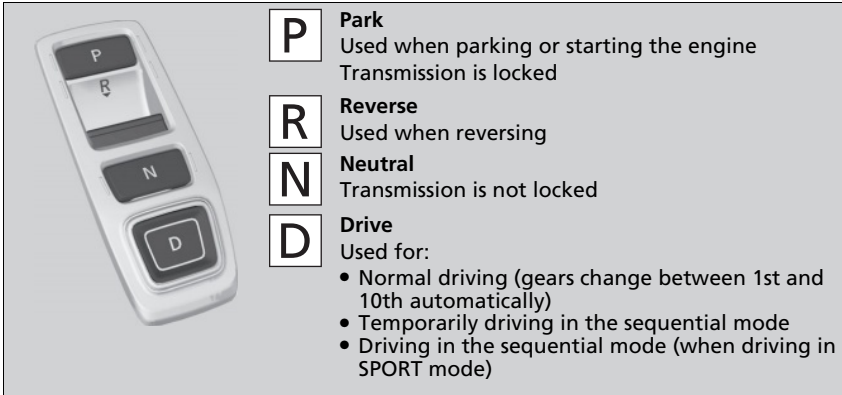
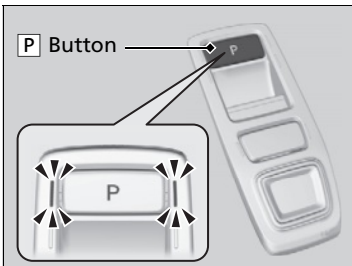
■ Shift button positions**■ P (park) button**

Park your vehicle in a safe place with the power mode in ON, then apply the brakes and press the **P** button to put the transmission in Park.

The indicators on the sides of the **P** button come on.

Shifting

⚠ WARNING

The vehicle can roll away if left unattended without confirming that Park is engaged.

A vehicle that rolls away could cause a crash resulting in serious injury or death.

Always keep your foot on the brake pedal until you have confirmed that **P** is shown on the gear position indicator.

To prevent malfunction and unintended engagement:

- Do not spill any liquids on or around shift buttons.
- Do not place or drop any objects on or around shift buttons.
- Do not let passengers or children operate the shift buttons.

The beeper sounds and a message appears on the driver information interface when you depress the accelerator pedal with the transmission in **N**. Put the transmission into **D** or **R** with the brake pedal depressed.

When shifting gears in extremely low temperatures (–22°F/–30°C), there may be a short delay before the shift is indicated in the display. Always confirm you are in the correct gear before driving.

■ Shift Operation

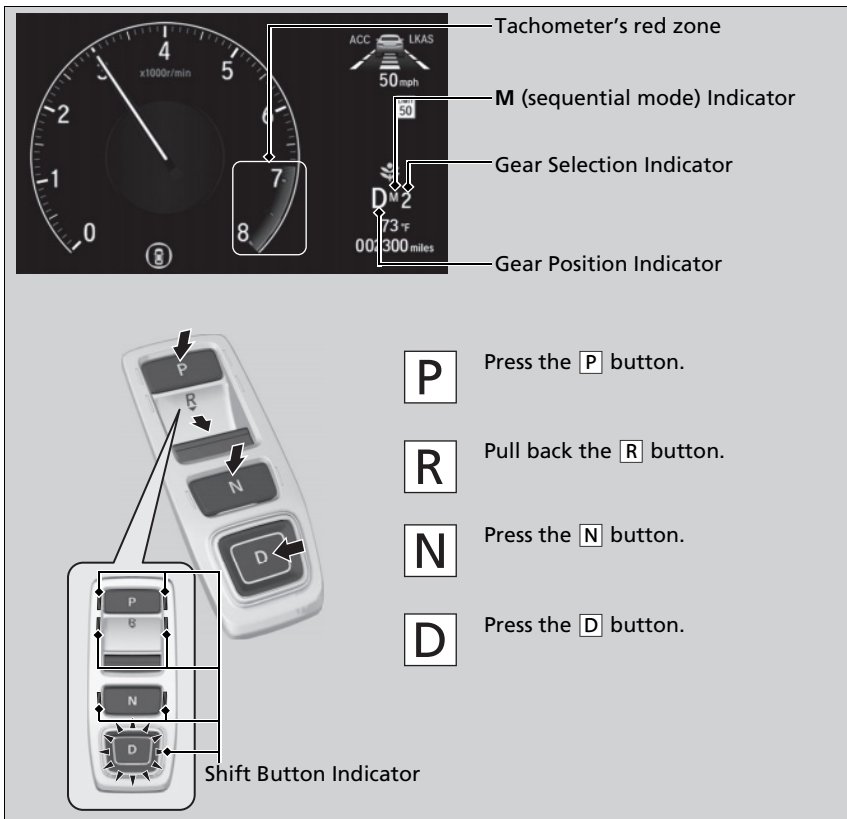

- P** Press the **P** button.
- R** Pull back the **R** button.
- N** Press the **N** button.
- D** Press the **D** button.

▶▶ Shift Operation

NOTICE

When you change **D** to **R** and visa versa, depress the brake pedal to come to a complete stop, then select the intended gear position while maintaining brake pressure.

Use the gear position indicator and the shift button indicator to check the gear position before selecting a shift button.

If the indicator of the currently selected gear position, or all the gear position indicators are blinking simultaneously, there is a problem with the transmission.

Avoid sudden acceleration and have the transmission checked by a dealer as soon as possible.

The fuel supply may be cut off if you drive at engine speeds in or over the tachometer's red zone (engine speed limit). If this happens, you may experience a slight jolt.

When the engine speed is increased while the transmission is in **N**, **P** or **R**, the fuel supply may be cut off even without the engine speed entering the tachometer's red zone.

The beeper sounds once when you change to **R**.

▶ **Customized Features** P. 381

■ When opening the driver's door

If you open the driver's door under the following conditions, the transmission automatically puts into **P**;

- The vehicle is stationary with the engine running, or moving at 1 mph (2 km/h) or slower.
- The transmission is in other than **P**.
- You have unfastened the driver side seat belt.
 - ▶ If you manually put the transmission from **P** with the brake pedal depressed, the transmission will automatically return to **P** once you release the brake pedal.

■ When turning off the power mode

If you turn the engine off while the vehicle is stationary, and the transmission is in other than **P**, the transmission automatically puts into **P**.

⚠ When opening the driver's door

You should always put the transmission into **P** before opening the driver's door. Make sure to park the vehicle in a safe place.

➤ When Stopped P. 583

If you want to drive the vehicle after the transmission has automatically put into **P** under the described conditions, close the door, fasten the seat belt, depress the brake pedal, then change the gear position.

If you leave the vehicle, turn off the engine and lock the doors.

■ **If you want to keep the transmission in [N] position [car wash mode]**

With the engine running:

1. Press and hold the brake pedal.
2. Press and release the [N] button.
 - ▶ [N] (Neutral) hold mode will appear on the driver information interface.
3. Press the [N] button again and hold it for two seconds.
 - ▶ The vehicle will enter car wash mode, which must be used when your vehicle is pulled through a conveyor type automatic car wash where you or an attendant do not remain in the vehicle.

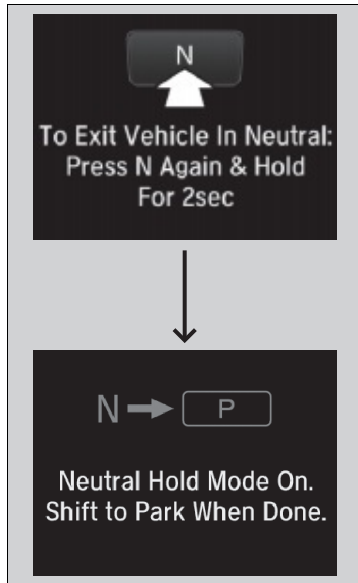

If the **ENGINE STOP/START** button is pressed after car wash mode has been activated, the power mode will change to ACCESSORY and a message will be displayed on the driver information interface.

- ▶ For 15 minutes the transmission remains in [N] with the power mode will remain in ACCESSORY. After that, the transmission automatically changes to [P] and the power mode changes to OFF.
- ▶ Manually changing to [P] cancels ACCESSORY mode. The [P] indicator comes on and the power mode changes to OFF. You must always put the transmission into [P] when car wash mode is no longer needed.

▶▶ If you want to keep the transmission in [N] position [car wash mode]

NOTICE

When transmission is too hot, carwash mode may not be available. Let the engine idle and cool down transmission.

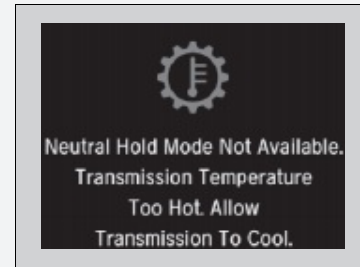

To keep the vehicle in [N] position, you can also follow this procedure:

While the power mode is on, select [N], and then within five seconds, press the **ENGINE STOP/START** button.

Note that the transmission may not stay in [N] position while any of the following indicators is on:

- Transmission system indicator.
- Malfunction indicator lamp.
- Charging system indicator.

■ Restriction on selecting a gear position

You cannot select a transmission under certain circumstances that may lead to a crash.

When the transmission is in:	1. Under the circumstances of that:	2. You cannot select:	3. The transmission remains in/changes to:	How to change the transmission	
P	The brake pedal is not depressed.	Other transmission	P	Release the accelerator pedal and depress the brake pedal.	
	The accelerator pedal is depressed.				
N	The vehicle is moving at low speed without the brake pedal depressed.		N		N
	The vehicle is moving at low speed with the accelerator pedal depressed.				
N or D	The vehicle is moving forward.	R	N	Stop your vehicle in a safe place, depress the brake pedal, and select the appropriate transmission.	
R or N	The vehicle is moving backward.	D			
R , N or D	The vehicle is moving.	P			

■ Sequential Mode

Use the paddle shifters to change between 1st and 10th gears without removing your hands from the steering wheel. The transmission will switch to the sequential mode.

■ When the transmission is in **D**:

The vehicle will go into the sequential mode momentarily, and the gear selection indicator will come on.

When the vehicle goes into the sequential mode by **-** paddle shifter and the lower gear is available, the transmission properly selects single or double gear change.

Once you start traveling at a constant speed, the sequential mode will automatically switch off, and the gear selection indicator will go off.

Hold the **+** paddle shifter for two seconds to return to normal drive.

■ When the transmission is in **D** with **SPORT** mode:

The vehicle will go into the sequential mode, and the **M** (sequential mode) indicator and gear selection indicator will come on.

If the vehicle speed increases and the engine speed reaches near the tachometer's red zone, the transmission automatically shifts up to the next gear.

You can cancel this mode by holding the **+** paddle shifter for two seconds. When the sequential mode is canceled, the sequential mode indicator and gear selection indicator go off.

Sequential Mode Operation

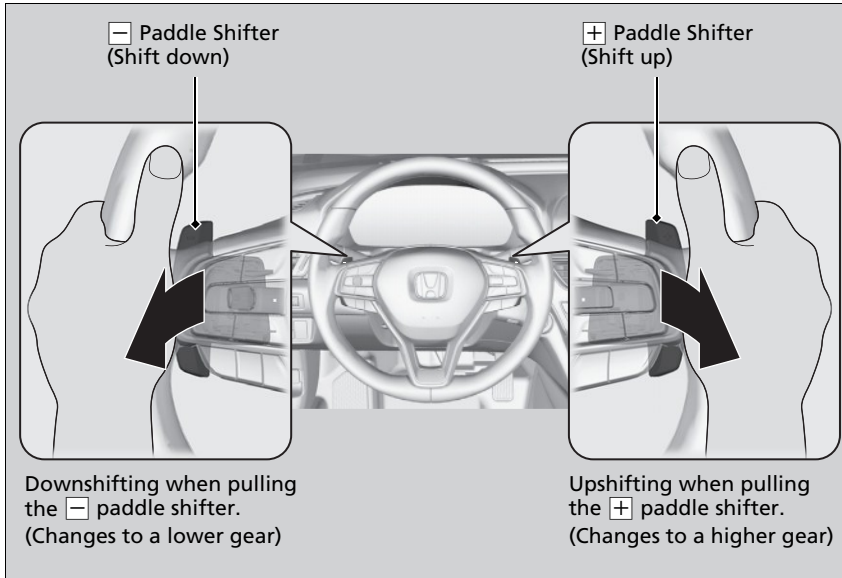

Sequential Mode Operation

Each paddle shift operation makes a single gear change.

To change gears continuously, release the paddle shifter before pulling it again for the next gear.

If the gear selection indicator blinks when you try to shift up or down, this means your vehicle speed is not in its allowable gear range or the protection of transmission system is necessary.

Slightly accelerate to shift up and decelerate to shift down while the indicator is blinking.

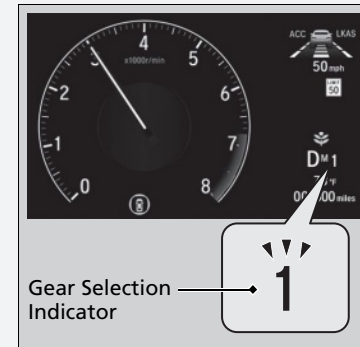

Continuously variable transmission models without paddle shifters

Shifting

Change the shift position in accordance with your driving needs.

■ Shift lever positions

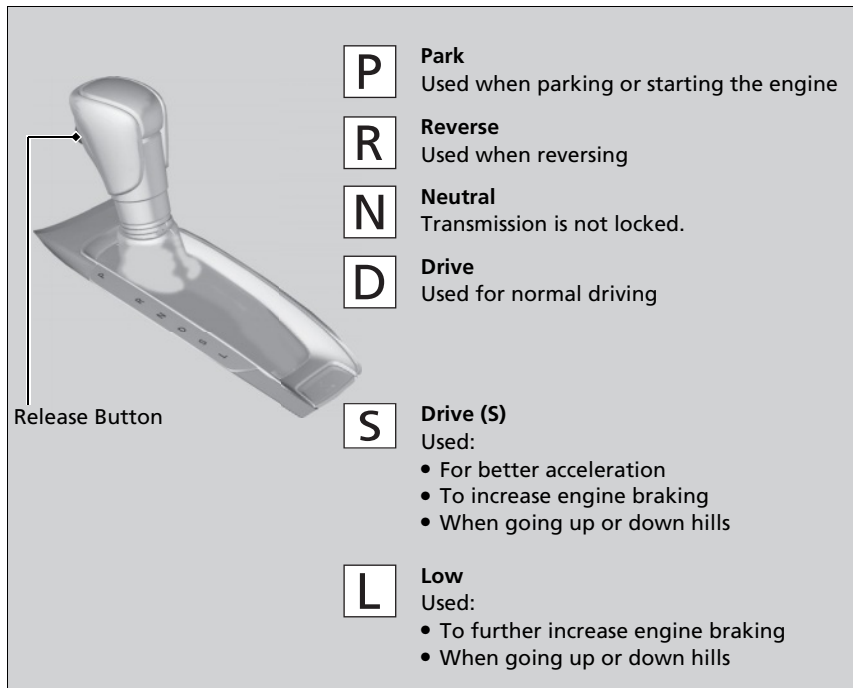

▶▶ Shifting

You cannot change the power mode from ON to VEHICLE OFF unless the shift lever is in **P**.

The vehicle may move very slightly even in **N** while the engine is cold.

Depress the brake pedal firmly and, when necessary, apply the parking brake.

Shift Lever Operation

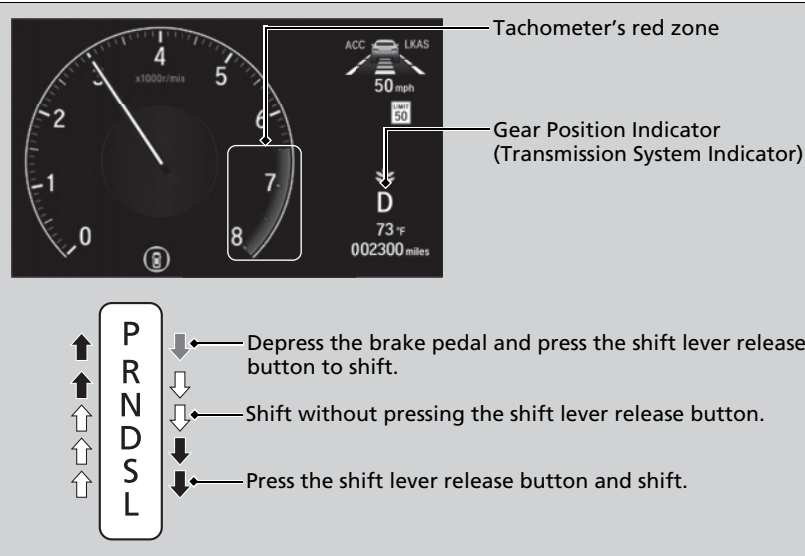

Shift Lever Operation

NOTICE

When you change the shift lever from **D** to **R** and vice versa, come to a complete stop and keep the brake pedal depressed. Operating the shift lever before the vehicle has come to a complete standstill can damage the transmission.

Use the gear position indicator to check the lever position before pulling away.

If the transmission system indicator blinks when driving, in any shift position, there is a problem with the transmission. Avoid sudden acceleration and have the transmission checked by a dealer as soon as possible.

The fuel supply may be cut off if you drive at engine speeds in or over the tachometer's red zone (engine speed limit). If this happens, you may experience a slight jolt.

It may not be possible to operate the shift lever if the brake pedal is applied while the shift lever release button is held down. Depress the brake pedal first.

When shifting positions in extremely low temperatures (-22°F/-30°C), there may be a short delay before the shift position is displayed. Always confirm you are in the correct shift position before driving.

Continuously variable transmission models with paddle shifters

Shifting

Change the shift position in accordance with your driving needs.

■ Shift lever positions

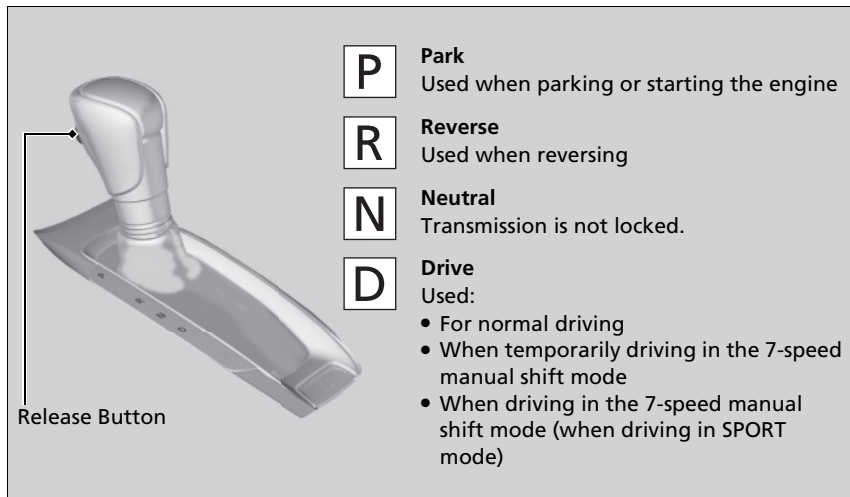

▶▶ Shifting

You cannot change the power mode from ON to VEHICLE OFF unless the shift lever is in **P**.

The vehicle may move very slightly even in **N** while the engine is cold.

Depress the brake pedal firmly and, when necessary, apply the parking brake.

Shift Lever Operation

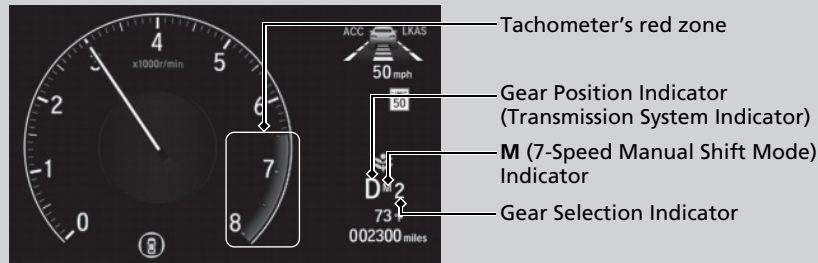

Tachometer's red zone

Gear Position Indicator
(Transmission System Indicator)

M (7-Speed Manual Shift Mode)
Indicator

Gear Selection Indicator

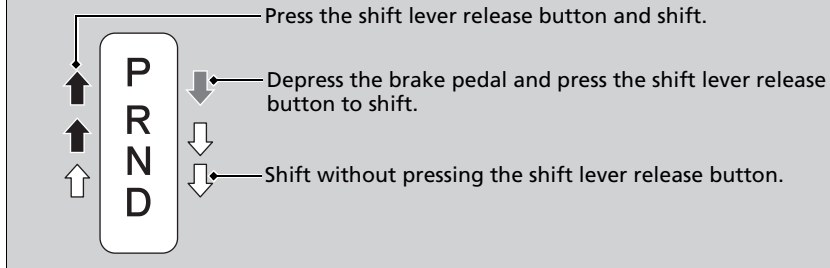

Shift Lever Operation

NOTICE

When you change the shift lever from **D** to **R** and vice versa, come to a complete stop and keep the brake pedal depressed.

Operating the shift lever before the vehicle has come to a complete standstill can damage the transmission.

Use the gear position indicator to check the lever position before pulling away.

If the transmission system indicator blinks when driving, in any shift position, there is a problem with the transmission.

Avoid sudden acceleration and have the transmission checked by a dealer as soon as possible.

The fuel supply may be cut off if you drive at engine speeds in or over the tachometer's red zone (engine speed limit). If this happens, you may experience a slight jolt.

It may not be possible to operate the shift lever if the brake pedal is applied while the shift lever release button is held down.

Depress the brake pedal first.

When shifting positions in extremely low temperatures (-22°F/-30°C), there may be a short delay before the shift position is displayed. Always confirm you are in the correct shift position before driving.

■ 7-Speed Manual Shift Mode

Use the paddle shifters to change between 1st and 7th speeds without releasing your hands from the steering wheel. The transmission switches to the 7-speed manual shift mode when you pull a paddle shifter while driving. This mode is useful when engine braking is needed.

■ When the shift lever is in **D**:

The shift mode goes into the 7-speed manual shift mode temporarily, and the number is displayed in the gear selection indicator.

The 7-speed manual shift mode is canceled automatically if you drive at constant speed or accelerate, and the number in the gear selection indicator goes off.

You can cancel this mode by pulling the **+** paddle shifter for a few seconds.

The 7-speed manual shift mode is especially useful when reducing the vehicle speed temporarily before making a turn.

■ When the shift lever is in **D** with **SPORT** mode:

The shift mode goes into the 7-speed manual shift mode. The **M** indicator and the speed number are displayed in the gear selection indicator. As the vehicle speed slows down, the transmission automatically shifts down accordingly. When the vehicle comes to a stop, it automatically shifts down into 1st.

If the vehicle speed increases and the engine speed reaches near the tachometer's red zone, the transmission automatically shifts up.

You can only pull away in 1st speed.

When canceling the 7-speed manual shift mode, pressing the **SPORT** button. When the 7-speed manual shift mode is canceled, the **M** indicator and gear selection indicator go off.

⌘ 7-Speed Manual Shift Mode

In the 7-speed manual shift mode, the transmission shifts up or down by operating either paddle shifter under the following conditions:

Shift Up: The engine speed reaches the lowest threshold of the higher speed position.

Shift Down: The engine speed reaches the highest threshold of the lower speed position.

When the engine speed reaches near the tachometer's red zone, the transmission shifts up automatically.

When the engine speed reaches the lowest threshold of the selected speed position, the transmission shifts down automatically.

Operating the paddle shifters on slippery surfaces may cause the tires to lock up. In this case, the 7-speed manual shift mode is canceled and goes back to the normal D driving mode.

7-Speed Manual Shift Mode Operation

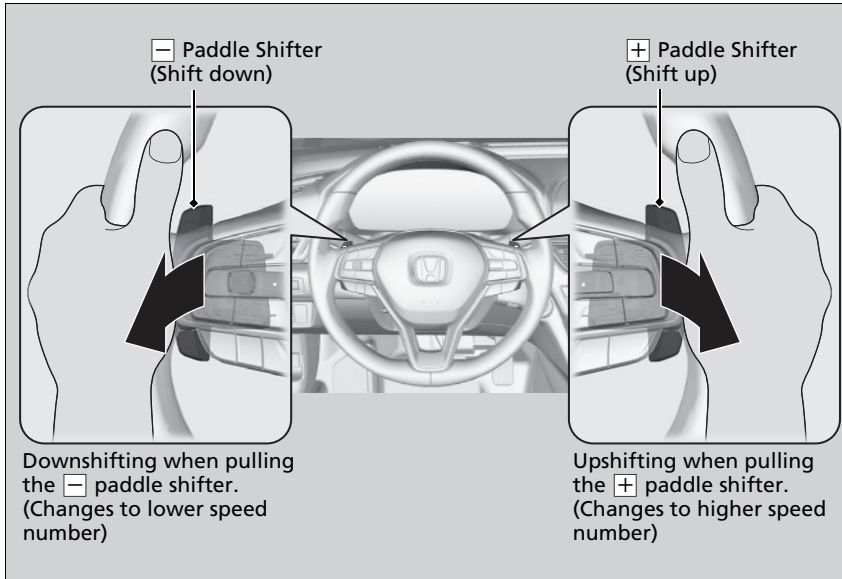

7-Speed Manual Shift Mode Operation

Each paddle shift operation makes a single speed change.

To change continuously, release the paddle shifter before pulling it again for the next speed.

The gear selection indicator blinks when you cannot shift up or down. It indicates that your vehicle speed is not in its allowable shifting range. Slightly accelerate to shift up and decelerate to shift down while the indicator is blinking.

Manual transmission models

Shifting

■ Shift Lever Operation

Fully depress the clutch pedal to operate the shift lever and change gears, then slowly release the pedal.

Depress the clutch pedal, and pause for a few seconds before shifting into **[R]**, or shift into one of the forward gears for a moment. This stops the gears so they do not “grind.”

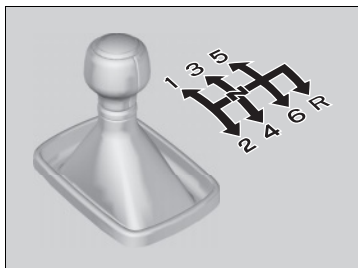

When you are not shifting, do not rest your foot on the clutch pedal. This can cause your clutch to wear out faster.

» Shifting

NOTICE

Do not shift to **[R]** before the vehicle comes to a complete stop. Shifting to **[R]** before stopping can damage the transmission.

NOTICE

Before downshifting, make sure the engine will not go into the tachometer’s red zone. Should this occur, it can severely damage your engine.

There is a metallic part on the shift lever. If you leave the vehicle parked outside for a long time on a hot day, be careful before moving the shift lever. Because of heat, the shift lever may be extremely hot. If the outside temperature is low, the shift lever may feel cold.

If you exceed the maximum speed for the gear you are in, the engine speed will enter into the tachometer’s red zone. When this happens, you may experience a slight jolt.

Shift Up/Down Indicators



Come on to inform you that upshifting or downshifting is necessary to prevent the engine from over revving or stalling.

The shift up indicator:
Comes on when upshifting is recommended.

The shift down indicator:
Comes on when downshifting is recommended.

Shift Up/Down Indicators

This indicator will not prompt you to downshift to increase engine braking. It is up to you to downshift to increase engine braking when driving downhill.

Always shift down at the appropriate vehicle speed.

The shift down indicator does not come on when downshifting from **2** to **1**.

Road and traffic conditions may require you to shift at times other than those indicated.

■ Reverse Lockout

The manual transmission has a lockout mechanism that stops you from accidentally shifting into **R** from a forward gear while the vehicle is moving above a certain speed.

If you cannot shift to **R** when the vehicle is stopped, do the following:

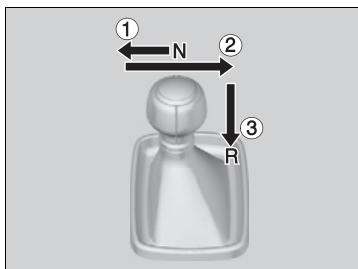

1. Depress the clutch pedal, move the shift lever all the way to the left, and shift to **R**.
2. If you still cannot shift into **R**, apply the parking brake, and set the power mode to ACCESSORY or VEHICLE OFF.
3. Depress the clutch pedal and shift into **R**.
4. Keep depressing the clutch pedal and start the engine.

Have the vehicle checked by a dealer if you have to go through this procedure repeatedly.

SPORT Mode*

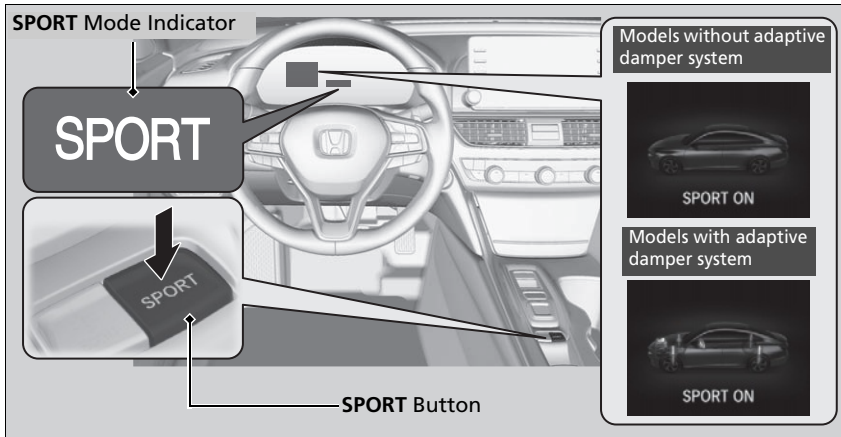

To turn the SPORT mode on and off, press the **SPORT** button.

The SPORT mode increases engine performance, transmission and handling*. This mode is suitable for driving on hills or through curves on mountain roads.

The SPORT mode is turned off every time you start the engine, even if you turned it on the last time you drove the vehicle.

The ambient meter color changes to a constant red and the turbo meter appears on the driver information interface.

* Not available on all models

ECON Button

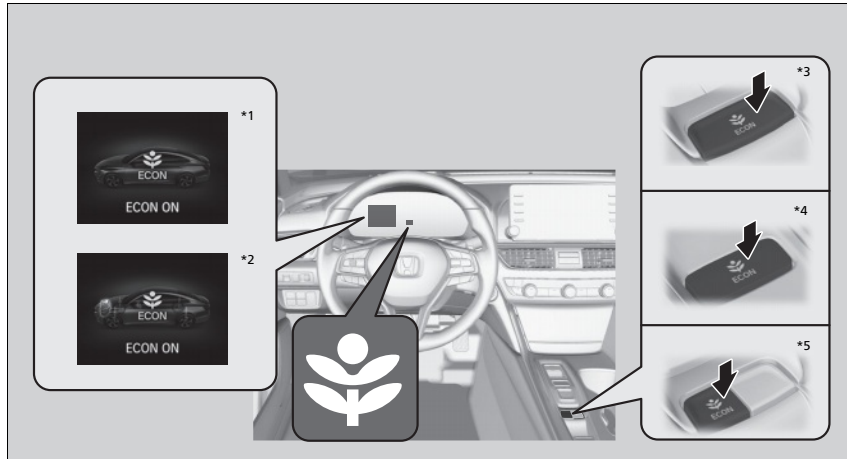

The **ECON** button turns the ECON mode on and off. The ECON mode helps you improve your fuel economy by adjusting the performance of the engine, transmission and climate control system.

▶▶ ECON Button

While in ECON mode, the climate control system has greater temperature fluctuations.

- *1 : Models without the adaptive damper system
- *2 : Models with the adaptive damper system
- *3 : Continuously variable transmission models without SPORT mode
- *4 : Manual transmission models
- *5 : Automatic transmission/Continuously variable transmission models with SPORT mode

Adaptive Damper System*

Constantly controls your vehicle's front and rear dampers according to current road conditions, vehicle speed and steering operation.

You can change handling response by turning the SPORT mode on.

🗨 **SPORT Mode*** P. 491

Vehicle Stability Assist® (VSA®), aka Electronic Stability Control (ESC), System

VSA® helps to stabilize the vehicle during cornering if the vehicle turns more or less than what was intended. It also assists in maintaining traction on slippery surfaces. It does so by regulating engine output and selectively applying the brakes.

▶▶ Vehicle Stability Assist® (VSA®), aka Electronic Stability Control (ESC), System

The VSA® may not function properly if tire type and size are mixed. Make sure to use the same size and type of tire, and the air pressures as specified.

When the VSA® system indicator comes on and stays on while driving, there may be a problem with the system. While this may not interfere with normal driving, have your vehicle checked by a dealer immediately.

VSA® cannot enhance stability in all driving situations and does not control the entire braking system. You still need to drive and corner at speeds appropriate for the conditions and always leave a sufficient margin of safety.

The main function of the VSA® system is generally known as Electronic Stability Control (ESC). The system also includes a traction control function.

The Vehicle Stability Assist® (VSA®) system, Vehicle Stability Assist® (VSA®) OFF, adaptive cruise control (ACC) with low speed follow (LSF)*, adaptive cruise control (ACC)*, safety support and low tire pressure/TPMS indicators may come on in amber along with a message in the driver information interface when you set the power mode to ON after re-connecting a battery.

Drive a short distance at more than 12 mph (20 km/h). Each indicator should go off. If any do not, have your vehicle checked by a dealer.

■ VSA® Operation

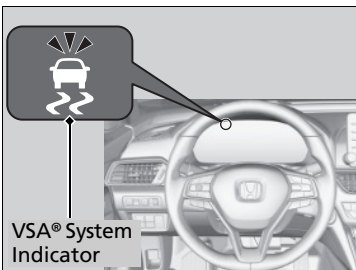

When VSA® activates, you may notice that the engine does not respond to the accelerator. You may also notice some noise from the hydraulic system. You will also see the indicator blink.

VSA® On and Off

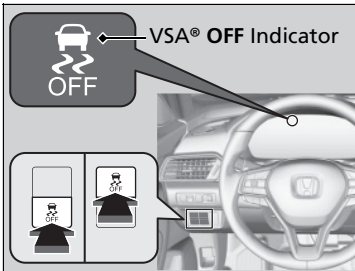

This button is on the driver side control panel. To partially disable VSA® functionality/features, press and hold it until you hear a beep.

Your vehicle will have normal braking and cornering ability, but traction control function will be less effective.

To restore VSA® functionality/features, press the  (VSA® **OFF**) button until you hear a beep.

VSA® is turned on every time you start the engine, even if you turned it off the last time you drove the vehicle.

Vehicle Stability Assist® (VSA®), aka Electronic Stability Control (ESC), System

In certain unusual conditions when your vehicle gets stuck in shallow mud or fresh snow, it may be easier to free it with the VSA® temporarily switched off.

When the  button is pressed, the traction control function becomes less effective. This allows for the wheels to spin more freely at low speed. You should only attempt to free your vehicle with the VSA® off if you are not able to free it when the VSA® is on.

Immediately after freeing your vehicle, be sure to switch VSA® on again. We do not recommend driving your vehicle with the VSA® system switched off.

You may hear a motor sound coming from the engine compartment while system checks are being performed immediately after starting the engine or while driving. This is normal.

Agile Handling Assist

Lightly brakes the front wheels, as needed, when you turn the steering wheel, and helps support the vehicle's stability and performance during cornering.

Agile Handling Assist

The agile handling assist cannot enhance stability in all driving situations. You still need to drive and corner at speeds appropriate for the conditions and always leave a sufficient margin of safety.

When the VSA® system indicator comes on and stays on while driving, the agile handling assist does not activate.

You may hear a sound coming from the engine compartment while the agile handling assist is activated. This is normal.

Tire Pressure Monitoring System (TPMS)

Instead of directly measuring the pressure in each tire, the TPMS on this vehicle monitors and compares the rolling radius and rotational characteristics of each wheel and tire while you are driving to determine if one or more tires are significantly under-inflated. This will cause the low tire pressure/TPMS indicator to come on and a message to appear on the driver information interface.

TPMS Calibration

You must start TPMS calibration every time you:

- Adjust the pressure in one or more tires.
- Rotate the tires.
- Replace one or more tires.

Before calibrating the TPMS:

- Set the cold tire pressure in all four tires.
 - **Checking Tires** P. 642

Make sure:

- The vehicle is at a complete stop.

Manual transmission models

- The transmission is in neutral.

Automatic transmission/Continuously variable transmission models

- The transmission is in **P**.

All models

- The power mode is in ON.

⚠ Tire Pressure Monitoring System (TPMS)

The system does not monitor the tires when driving at low speed.

Conditions such as low ambient temperature and altitude change directly affect tire pressure and can trigger the low tire pressure/TPMS indicator to come on.

Tire pressure checked and inflated in:

- Warm weather can become under-inflated in colder weather.
- Cold weather can become over-inflated in warmer weather.

The low tire pressure/TPMS indicator will not come on as a result of over inflation.

The TPMS may not function properly if tire type and size are mixed. Make sure to use the same size and type of tire.

➤ **Checking and Maintaining Tires** P. 642

The low tire pressure/TPMS indicator may come on with a delay or may not come on at all when:

- You rapidly accelerate, decelerate, or turn the steering wheel.
- You drive on snowy or slippery roads.
- Snow chains* are used.

* Not available on all models

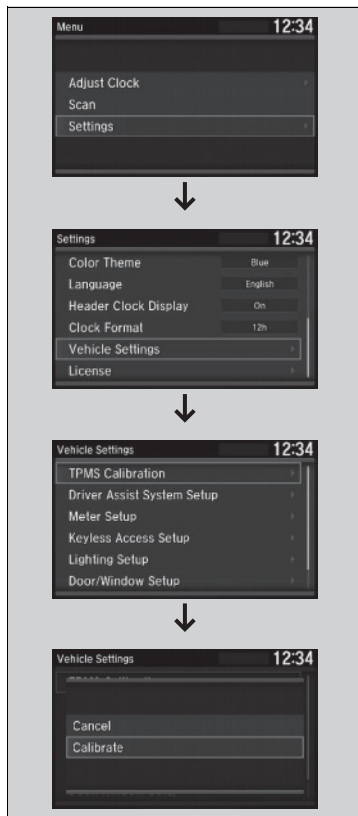

Models with color audio

You can calibrate the system from the customized feature on the audio/information screen.

▶ **Audio System Basic Operation** P. 252

1. Set the power mode to ON.
 2. Press the **MENU/CLOCK** button.
 3. Rotate to select **Settings**, then press .
 4. Rotate to select **Vehicle Settings**, then press .
 5. Rotate to select **TPMS Calibration**, then press .
 6. Rotate to select **Calibrate**, then press .
- If the **Calibration failed to start.** message appears, repeat steps 5-6.
 - The calibration process finishes automatically.

▶▶ Tire Pressure Monitoring System (TPMS)

The low tire pressure/TPMS indicator may come on under the following conditions:

- A compact spare tire is used.
- There is a heavier and uneven load on the tires, such as when towing a trailer*, than the condition at calibration.
- Snow chains* are used.

The Vehicle Stability Assist® (VSA®) system, Vehicle Stability Assist® (VSA®) OFF, adaptive cruise control (ACC) with low speed follow (LSF)*, adaptive cruise control (ACC)*, safety support and low tire pressure/TPMS indicators may come on in amber along with a message in the driver information interface when you set the power mode to ON after re-connecting a battery.

Drive a short distance at more than 12 mph (20 km/h). Each indicator should go off. If any do not, have your vehicle checked by a dealer.

▶▶ TPMS Calibration

TPMS cannot be calibrated if a compact spare tire is installed.

The calibration process requires approximately 30 minutes of cumulative driving at speeds between 30-60 mph (48-97 km/h).

During this period, if the power mode is set to ON and the vehicle is not moved within 45 seconds, you may notice the low tire pressure/TPMS indicator comes on briefly. This is normal and indicates that the calibration process is not yet complete.

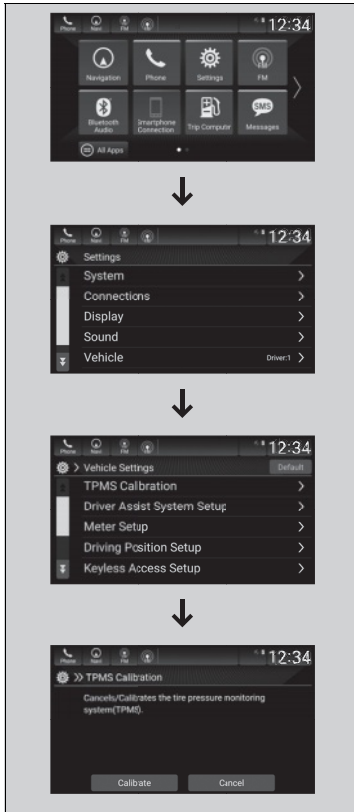

Models with Display Audio

You can calibrate the system from the customized feature on the audio/information screen.

▶ Audio System Basic Operation P. 273

1. Set the power mode to ON.
2. Press the button.
3. Select **Settings**.
4. Select **Vehicle**.
5. Select **TPMS Calibration**.
6. Select **Calibrate**.

- If the **Calibration Failed To Start** message appears, repeat steps 5-6.
- The calibration process finishes automatically.

▶▶ TPMS Calibration

If the snow chains* are installed, remove them before calibrating the TPMS.

If the low tire pressure/TPMS indicator comes on even when the properly inflated specified regular tires are installed, have your vehicle checked by a dealer.

We recommend that the tires be replaced with the same brand, model, and size as the originals. Ask a dealer for details.

* Not available on all models

U.S. models

Tire Pressure Monitoring System (TPMS) - Required Federal Explanation

Each tire, including the spare (if provided), should be checked monthly when cold and inflated to the inflation pressure recommended by the vehicle manufacturer on the vehicle placard or tire inflation pressure label.

(If your vehicle has tires of a different size than the size indicated on the vehicle placard or tire inflation pressure label, you should determine the proper tire inflation pressure for those tires.)

As an added safety feature, your vehicle has been equipped with a tire pressure monitoring system (TPMS) that illuminates a low tire pressure telltale



when one or more of your tires is significantly under-inflated.

Accordingly, when the low tire pressure telltale illuminates, you should stop and check your tires as soon as possible, and inflate them to the proper pressure.

Driving on a significantly under-inflated tire causes the tire to overheat and can lead to tire failure. Under-inflation also reduces fuel efficiency and tire tread life, and may affect the vehicle's handling and stopping ability.

Please note that the TPMS is not a substitute for proper tire maintenance, and it is the driver's responsibility to maintain correct tire pressure, even if under-inflation has not reached the level to trigger illumination of the TPMS low tire pressure telltale.

Your vehicle has also been equipped with a TPMS malfunction indicator to indicate when the system is not operating properly. The TPMS malfunction indicator is combined with the low tire pressure telltale. When the system detects a malfunction, the telltale will flash for approximately one minute and then remain continuously illuminated. This sequence will continue upon subsequent vehicle start-ups as long as the malfunction exists.

When the malfunction indicator is illuminated, the system may not be able to detect or signal low tire pressure as intended.

TPMS malfunctions may occur for a variety of reasons, including the installation of replacement or alternate tires or wheels on the vehicle that prevent the TPMS from functioning properly.

Always check the TPMS malfunction telltale after replacing one or more tires or wheels on your vehicle to ensure that the replacement or alternate tires and wheels allow the TPMS to continue to function properly.

Blind spot information System*

Is designed to detect vehicles in specified alert zones adjacent to your vehicle, particularly in harder to see areas commonly known as "blind spots."

When the system detects vehicles approaching from behind in adjacent lanes, the appropriate indicator comes on for a few seconds, providing assistance when you change lanes.

■ How the system works

- Your vehicle speed is between 20 mph (32 km/h) and 100 mph (160 km/h).

Automatic transmission/
Continuously variable
transmission models

- The transmission is in **D**.

Alert zone range

- A: Approx. 1.6 ft. (0.5 m)
- B: Approx. 10 ft. (3 m)
- C: Approx. 10 ft. (3 m)

Radar Sensors:
underneath the
rear bumper
corners

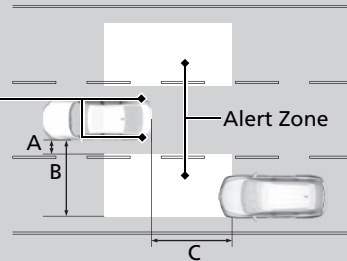

▶▶ Blind spot information System*

⚠ WARNING

Failure to visually confirm that it is safe to change lanes before doing so may result in a crash and serious injury or death. Do not rely only on the blind spot information system when changing lanes.

Always look in your mirrors, to either side of your vehicle, and behind you for other vehicles before changing lanes.

Important Safety Reminder

Like all assistance systems, the blind spot information system has limitations. Over reliance on the blind spot information system may result in a collision.

The blind spot information system alert indicator may not come on under the following conditions:

- A vehicle does not stay in the alert zone for more than two seconds.
- A vehicle is parked in a side lane.
- The speed difference between your vehicle and the vehicle you are passing is greater than 6 mph (10 km/h).
- An object not detected by the radar sensors approaches or passes your vehicle.
- A vehicle running in the adjacent lane is a motorcycle or other small vehicle.

■ When the system detects a vehicle

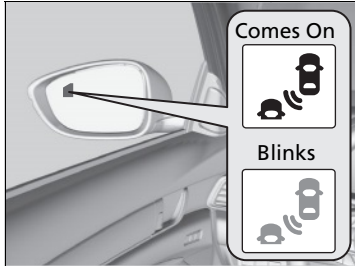

Blind spot information System Alert Indicator:
Located on the outside rearview mirror on both sides.

Comes on when:

- A vehicle enters the alert zone from behind to overtake you with a speed difference of no more than 31 mph (50 km/h) from your vehicle.
- You pass a vehicle with a speed difference of no more than 12 mph (20 km/h).

Blinks and a beeper sounds when:

You move the turn signal lever in the direction of the detected vehicle. The beeper sounds three times.

⊗ Blind spot information System*

The system is for your convenience only. Even if an object is within the alert zone, the following situations may occur.

- The blind spot information system alert indicator may not come on due to obstruction (splashes, etc.) even without the **Blind Spot Information System Not Available** driver information interface appearing.
- The blind spot information system alert indicator may come on even with the message appearing.

You can change the setting for the blind spot information system.

➔ **Customized Features** P. 381

Automatic transmission/Continuously variable transmission models

The system does not operate when in **R**.

2.0 L engine models

Turn the system off when towing a trailer.

The system may not work properly for the following reasons:

- The added mass tilts the vehicle and changes the radar coverage.
- The trailer itself can be detected by the radar sensors, causing the blind spot information system alert indicators to come on.

■ Blind spot information System On and Off

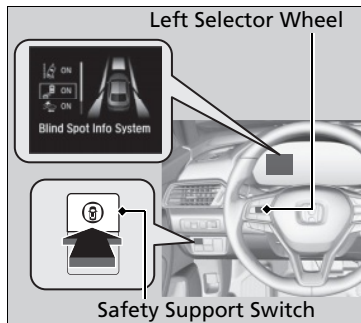

When you turn the blind spot information system on and off, do the following.

1. Press the safety support switch.
2. Roll the left selector wheel to the  symbol and push it.

The blind spot information system is in the previously selected **ON** or **OFF** setting each time you start the engine.

▶▶ Blind spot information System*

The blind spot information system may be adversely affected when:

- Objects (guard rails, poles, trees, etc..) are detected.
- An object that does not reflect radio waves well, such as a motorcycle, is in the alert zone.
- Driving on a curved road.
- A vehicle is moving from a far lane to the adjacent lane.
- The system picks up external electrical interference.
- The rear bumper or the sensors have been improperly repaired or the rear bumper has been deformed.
- The orientation of the sensors has been changed.
- In bad weather (Heavy rain, snow, and fog).
- Making a turn at an intersection.
- Driving on a bumpy road.
- Making a short turn that slightly tilts the vehicle.

For proper the blind spot information system operation:

- Always keep the rear bumper corner area clean.
- Do not cover the rear bumper corner area with labels or stickers of any kind.
- Take your vehicle to a dealer if you need the rear bumper corner area or the radar sensors to be repaired, or the rear bumper corner area is strongly impacted.

Canadian models

LaneWatch™*

LaneWatch is an assistance system that allows you to check the passenger side rear areas displayed on the audio/information screen when the turn signal is activated to the passenger's side. A camera in the passenger side door mirror monitors these areas and allows you to check for vehicles, in addition to your visual check and use of the passenger door mirror. You can also keep the system on for your convenience while driving.

1 The system activates when you:

Move the turn signal lever to the passenger side. Press the LaneWatch button.



The system deactivates when you:

Pull the turn signal lever back. Press the LaneWatch button again.

2

The passenger side view display appears on the audio/information screen.



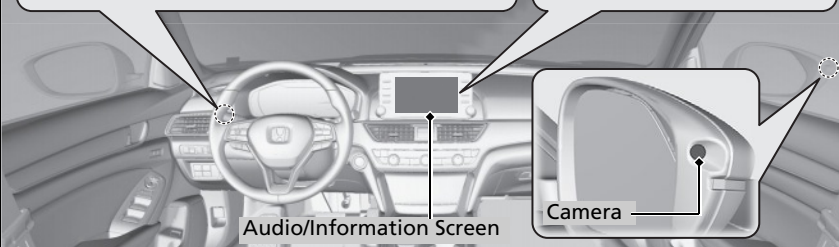

Audio/Information Screen Camera

LaneWatch™*

⚠ WARNING

Failure to visually confirm that it is safe to change lanes before doing so may result in a crash and serious injury or death.

Do not rely only on LaneWatch while driving.

Always look in your mirrors, to either side of your vehicle, and behind you for other vehicles before changing lanes.

Important Safety Reminder

Like all assistance systems, LaneWatch has limitations. Over reliance on LaneWatch may result in a collision.

The LaneWatch function can be affected by weather, lighting (including headlights and low sun angle), ambient darkness, camera condition, and loading.

The LaneWatch may not provide the intended display of traffic to the side and rear under the following conditions:

- Your vehicle's suspension has been altered, changing the height of the vehicle.
- Your tires are over or under inflated.
- Your tires or wheels are of varied size or construction.

* Not available on all models

Continued

■ Customizing the LaneWatch settings

You can customize the following items using the audio/information screen.

- **Show with turn signal:** Selects whether LaneWatch monitor comes on when you operate the turn signal light lever.
- **Show Reference Line:** Selects whether the reference lines appear on the LaneWatch monitor.
- **Display Time after Turn Signal Off:** Changes the remaining LaneWatch display time after you pull the turn signal lever back.
- **Display:** Adjusts display settings.
 - ▶ Customized Features P. 381
 - ▶ Audio Remote Controls P. 248

■ Reference Lines

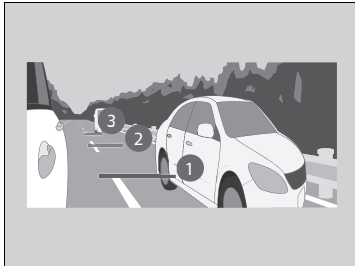

Three lines that appear on the screen can give an idea of how far the vehicles or objects on the screen are from your vehicle, respectively. If an object is near line 1 (in red), it indicates that it is close to your vehicle whereas an object near line 3 is farther away.

▶ LaneWatch™*

The LaneWatch camera view is restricted. Its unique lens makes objects on the screen slightly look different from what they are.

For proper LaneWatch operation:

- The camera is located in the passenger side door mirror. Always keep this area clean. If the camera lens is covered with dirt or moisture, use a soft, moist cloth to keep the lens clean and free of debris.
- Do not cover the camera lens with labels or stickers of any kind.
- Do not touch the camera lens.

Automatic transmission/Continuously variable transmission models

LaneWatch display does not come on when the transmission is in **[R]**.

▶ Reference Lines

The area around the reference line 1 (red) is very close to your vehicle. As always, make sure to visually confirm the safety of a lane change before changing lanes.

The distance between your vehicle and lines 1, 2 and 3 on the screen vary depending on road conditions and vehicle loading. For example, the reference lines on the screen may seem to appear closer than the actual distances when the rear of your vehicle is more heavily loaded.

Consult a dealer if:

- The passenger side door mirror, or area around it is severely impacted, resulting in changing the camera angle.
- The LaneWatch display does not come on at all.

Honda Sensing® is a driver support system which employs the use of two distinctly different kinds of sensors: a radar sensor located in the front lower grille and a front sensor camera mounted to the interior side of the windshield, behind the rearview mirror.

Honda Sensing® has following functions.

■ The functions which do not require switch operations to activate

- Collision Mitigation Braking System™ (CMBS™) 📄 P. 510
- Road Departure Mitigation (RDM) System 📄 P. 558
- Traffic Sign Recognition System 📄 P. 562

■ The functions which require switch operations to activate

- Adaptive Cruise Control (ACC) with Low Speed Follow (LSF)* 📄 P. 519
- Adaptive Cruise Control (ACC)* 📄 P. 535
- Lane Keeping Assist System (LKAS) 📄 P. 550

■ Operation Switches for the ACC with LSF*/ACC*/LKAS

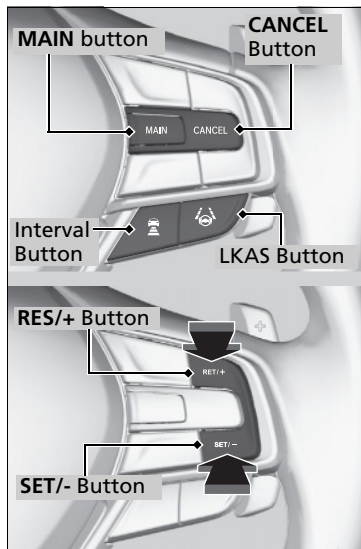

■ MAIN Button

Press to activate standby mode for ACC with LSF*/ACC* and LKAS. Or press to cancel these systems.

■ LKAS Button

Press to activate or cancel the LKAS.

■ RES/+ and SET/- Button

Press **RES/+** button to resume the ACC with LSF*/ACC* or increase the vehicle speed. Press **SET/-** button to set the ACC with LSF*/ACC* or decrease the vehicle speed.

■ Interval Button

Press the  (interval) button to change the ACC with LSF*/ACC* following interval.

■ CANCEL Button

Press to cancel ACC with LSF*/ACC*.

Driver Information Interface Content

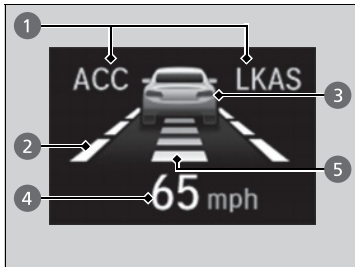

You can see the current state of ACC with LSF*/ACC* and LKAS.

- ① Indicates that ACC with LSF*/ACC*, and LKAS are ready to be activated.
- ② Indicates that LKAS is activated and whether or not traffic lane lines are detected.
- ③ Indicates whether or not a vehicle is detected ahead.
- ④ Shows the set vehicle speed.
- ⑤ Shows the set vehicle interval.

Models with head-up display

You can have the head-up display show you the current state of each function.

🗨 **Head-Up Display*** P. 157

* Not available on all models

Collision Mitigation Braking System™ (CMBS™)

Can assist you when there is a possibility of your vehicle colliding with a vehicle or a pedestrian detected in front of yours. The CMBS™ is designed to alert you when a potential collision is determined, as well as to reduce your vehicle speed to help minimize collision severity when a collision is deemed unavoidable.

■ How the system works

When to use

The camera is located behind the rearview mirror.

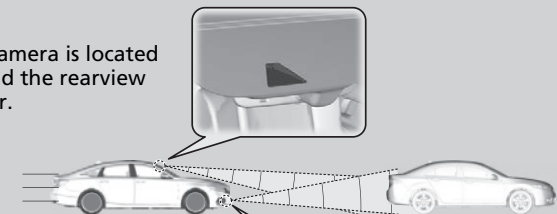

The radar sensor is at the lower part of the front bumper.

The system starts monitoring the roadway ahead when your vehicle speed is about 3 mph (5 km/h) and there is a vehicle in front of you.

The CMBS™ activates when:

- The speed difference between your vehicle and a vehicle or pedestrian detected in front of you becomes about 3 mph (5 km/h) and over with a chance of a collision.
- Your vehicle speed is about 62 mph (100 km/h) or less and the system determines there is a chance of a collision with:
 - Vehicles detected in front of you that are stationary, oncoming, or traveling in your same direction.
 - A pedestrian who is detected in front of you.
- Your vehicle speed is above 62 mph (100 km/h), and the system determines there is a chance of a collision with a vehicle detected in front of you traveling in your same direction.

▶▶ Collision Mitigation Braking System™ (CMBS™)

Important Safety Reminder

The CMBS™ is designed to reduce the severity of an unavoidable collision. It does not prevent a collision nor stop the vehicle automatically. It is still your responsibility to operate the brake pedal and steering wheel appropriately according to the driving conditions.

The CMBS™ may not activate or may not detect a vehicle in front of your vehicle under certain conditions:

▶ **CMBS™ Conditions and Limitations** P. 514

You can read about handling information for the camera equipped with this system.

▶ **Front Sensor Camera** P. 568

For directions on the proper handling of the radar sensor, refer to the following page.

▶ **Radar Sensor** P. 570

When the CMBS™ activates, it may automatically apply the brake. It will be canceled when your vehicle stops or a potential collision is not determined.

■ When the system activates

The system provides visual and audible alerts of a possible collision, and stops if the collision is avoided.

- ▶ Take appropriate action to prevent a collision (apply the brakes, change lanes, etc.).

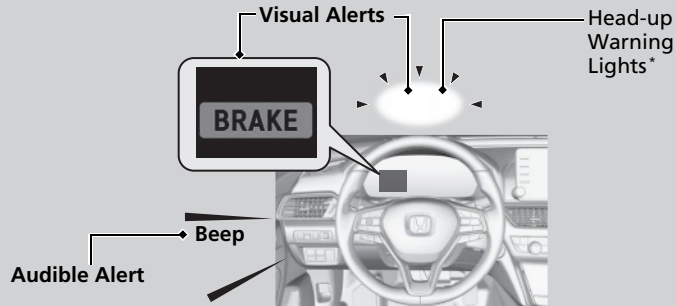

At system's earliest collision alert stage, you can change the distance (**Long/Normal/Short**) between vehicles at which alerts will come on through audio/information screen setting options.

- ▶ **Customized Features** P. 370, 381

▶ Collision Mitigation Braking System™ (CMBS™)

The camera in the CMBS™ is also designed to detect pedestrians.

However, this pedestrian detection feature may not activate or may not detect a pedestrian in front of your vehicle under certain conditions. Refer to the ones indicating the pedestrian detection limitations from the list.

- ▶ **CMBS™ Conditions and Limitations** P. 514

Models with head-up display

The head-up warning uses a lens located at the front end of the dashboard.

Do not cover the lens or spill any liquid on it.

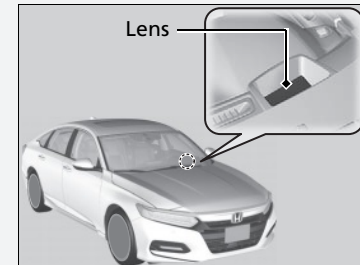

■ Collision Alert Stages

The system has three alert stages for a possible collision. However, depending on circumstances, the CMBS™ may not go through all of the stages before initiating the last stage.

Distance between vehicles		CMBS™		
		The radar sensor detects a vehicle	Audible & Visual WARNINGS	Braking
Stage one		There is a risk of a collision with the vehicle ahead of you.	When in Long , visual and audible alerts come on at a longer distance from a vehicle ahead than in Normal setting, and in Short , at a shorter distance than in Normal .	—
Stage two		The risk of a collision has increased, time to respond is reduced.	Visual and audible alerts.	Lightly applied
Stage three		The CMBS™ determines that a collision is unavoidable.		Forcefully applied

CMBS™ On and Off

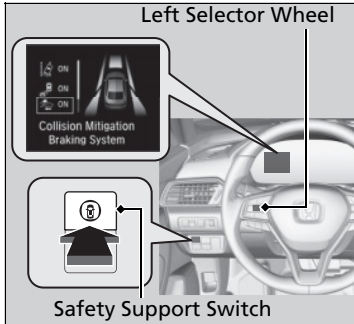

When you turn the CMBS™ on and off, do the following.

1. Press the safety support switch.
2. Roll the left selector wheel to the  symbol and push it.
 - ▶ The message appears on the driver information interface when the system becomes on or off.

The CMBS™ is turned on every time you start the engine, even if you turned it off the last time you drove the vehicle.

Collision Mitigation Braking System™ (CMBS™)

The CMBS™ may automatically shut off, and the safety support indicator (amber) will come and stay on under certain conditions:

▶ **CMBS™ Conditions and Limitations** P. 514

When the CMBS™ is activated, it will continue to operate even if the accelerator pedal is partially depressed. However, it will be canceled if the accelerator pedal is deeply depressed.

The Vehicle Stability Assist® (VSA®) system, Vehicle Stability Assist® (VSA®) OFF, adaptive cruise control (ACC) with low speed follow (LSF)*, adaptive cruise control (ACC)*, safety support and low tire pressure/TPMS indicators may come on in amber along with a message in the driver information interface when you set the power mode to ON after re-connecting a battery. Drive a short distance at more than 12 mph (20 km/h). Each indicator should go off. If any do not, have your vehicle checked by a dealer.

* Not available on all models

■ CMBS™ Conditions and Limitations

The system may automatically shut off and the safety support indicator (amber) will come on under certain conditions. Some examples of these conditions are listed below. Other conditions may reduce some of the CMBS™ functions.

📷 **Front Sensor Camera** P. 568

■ Environmental conditions

- Driving in bad weather (rain, fog, snow, etc.).
- Sudden changes between light and dark, such as an entrance or exit of a tunnel.
- There is little contrast between objects and the background.
- Driving into low sunlight (e.g., at dawn or dusk).
- Strong light is reflected onto the roadway.
- Driving in the shadows of trees, buildings, etc.
- Roadway objects or structures are misinterpreted as vehicles and pedestrians.
- Reflections on the interior of the windshield.
- Driving at night or in a dark condition such as a tunnel.

■ Roadway conditions

- Driving on a snowy or wet roadway (obscured lane marking, vehicle tracks, reflected lights, road spray, high contrast).
- Driving on curvy, winding, or undulating roads.
- The road is hilly or the vehicle is approaching the crest of a hill.

📷 Collision Mitigation Braking System™ (CMBS™)

Have your vehicle checked by a dealer if you find any unusual behavior of the system (e.g., the warning message appears too frequently).

■ Vehicle conditions

- Headlight lenses are dirty or the headlights are not properly adjusted.
- The outside of the windshield is blocked by dirt, mud, leaves, wet snow, etc.
- The inside of the windshield is fogged.
- An abnormal tire or wheel condition (wrong sized, varied size or construction, improperly inflated, compact spare tire, etc.).
- When tire chains* are installed.
- The vehicle is tilted due to a heavy load or suspension modifications.
- The camera temperature gets too high.
- Driving with the parking brake applied.
- When the radar sensor at the lower part of the front bumper gets dirty.
- The vehicle is towing a trailer*.

■ Detection limitations

- A vehicle or pedestrian suddenly crosses in front of you.
- The distance between your vehicle and the vehicle or pedestrian ahead of you is too short.
- A vehicle cuts in front of you at a slow speed, and it brakes suddenly.
- When you accelerate rapidly and approach the vehicle or pedestrian ahead of you at high speed.
- The vehicle ahead of you is a motorcycle, bicycle, mobility scooter or other small vehicle.
- When there are animals in front of your vehicle.
- When you drive on a curved, winding or undulating road that makes it difficult for the sensor to properly detect a vehicle in front of you.
- The speed difference between your vehicle and a vehicle or pedestrian in front of you is significantly large.
- An oncoming vehicle suddenly comes in front of you.
- Another vehicle suddenly comes in front of you at an intersection, etc.
- Your vehicle abruptly crosses over in front of an oncoming vehicle.
- When driving through a narrow iron bridge.
- When the lead vehicle suddenly slows down.

* Not available on all models

Limitations applicable to pedestrian detection only

- When there is a group of people in front of your vehicle walking together side by side.
- Surrounding conditions or belongings of the pedestrian alter the pedestrian's shape, preventing the system from recognizing that the person is a pedestrian.
- When the pedestrian is shorter than about 3.3 feet (1 meter) or taller than about 6.6 feet (2 meters) in height.
- When a pedestrian blends in with the background.
- When a pedestrian is bent over or squatting, or when their hands are raised or they are running.
- When several pedestrians are walking ahead in a group.
- When the camera cannot correctly identify that a pedestrian is present due to an unusual shape (holding luggage, body position, size).

■ Automatic shutoff

The CMBS™ may automatically shut itself off and the safety support indicator (amber) comes and stays on when:

- The temperature inside the system is high.
- You drive off-road or on a mountain road, or curved and winding road for an extended period.
- An abnormal tire condition is detected (wrong tire size, flat tire, etc.).
- The camera behind the rearview mirror, or the area around the camera, including the windshield, gets dirty.

Once the conditions that caused the CMBS™ to shut off improve or are addressed (e.g., cleaning), the system comes back on.

■ With Little Chance of a Collision

The CMBS™ may activate even when you are aware of a vehicle ahead of you, or when there is no vehicle ahead. Some examples of this are:

■ When Passing

Your vehicle approaches another vehicle ahead of you and you change lanes to pass.

■ At an intersection

Your vehicle approaches or passes another vehicle that is making a left or right turn.

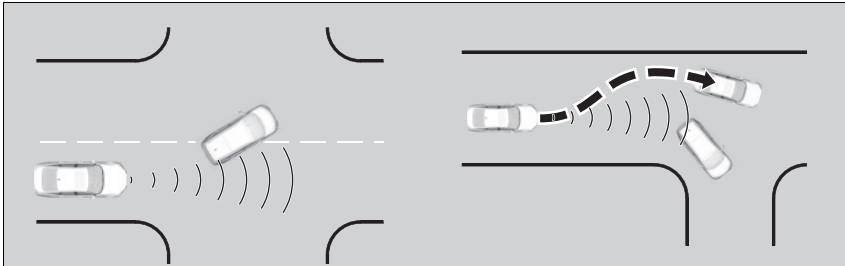

■ **On a curve**

When driving through curves, your vehicle comes to a point where an oncoming vehicle is right in front of you.

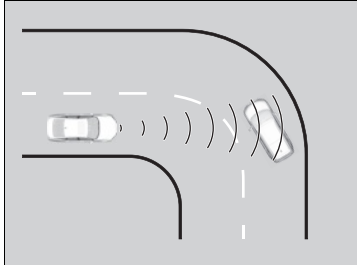

■ **Through a low bridge at high speed**

You drive under a low or narrow bridge at high speed.

■ **Speed bumps, road work sites, train tracks, roadside objects, etc.**

You drive over speed bumps, steel road plates, etc., or your vehicle approaches train tracks or roadside objects (such as a traffic sign and guard rail) on a curve or, when parking, stationary vehicles and walls.

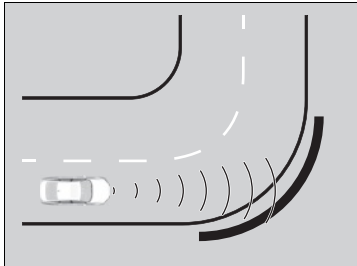

Adaptive Cruise Control (ACC) with Low Speed Follow (LSF)*

Helps maintain a constant vehicle speed and a set following interval behind a vehicle detected ahead of yours and, if the detected vehicle comes to a stop, can decelerate and stop your vehicle, without you having to keep your foot on the brake or the accelerator.

When ACC with LSF slows your vehicle by applying the brakes, your vehicle's brake lights will illuminate.

When to use

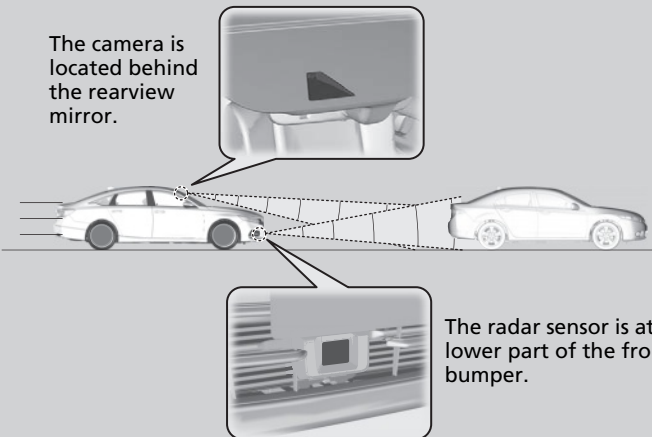

The camera is located behind the rearview mirror.

The radar sensor is at the lower part of the front bumper.

- Vehicle speed for ACC with LSF: **A vehicle is detected ahead within ACC with LSF range** – ACC with LSF operates at speeds up to 90 mph (145 km/h).
- **No vehicle is detected within ACC with LSF range** – ACC with LSF operates at the speed of 25 mph (40 km/h) or above.
- Gear position for ACC with LSF: In **D** or **S***.

⚠ Adaptive Cruise Control (ACC) with Low Speed Follow (LSF)*

⚠ WARNING

Improper use of ACC with LSF can lead to a crash.

Use ACC with LSF only when driving on expressways or freeways and in good weather conditions.

⚠ WARNING

ACC with LSF has limited braking capability and may not stop your vehicle in time to avoid a collision with a vehicle that quickly stops in front of you.

Always be prepared to apply the brake pedal if the conditions require.

Important Reminder

As with any system, there are limits to ACC with LSF. Use the brake pedal whenever necessary, and always keep a safe interval between your vehicle and other vehicles.

* Not available on all models

■ How to activate the system

How to use

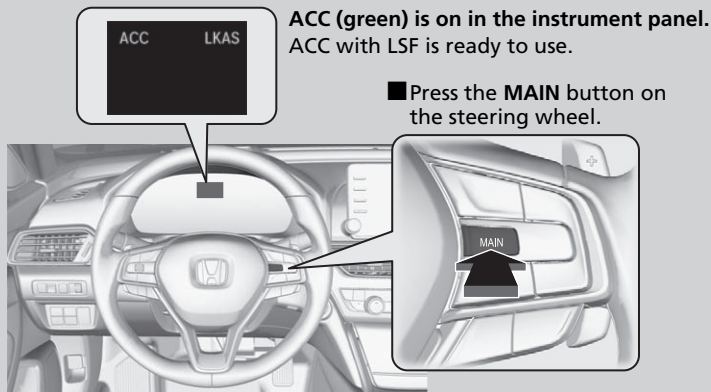

ACC (green) is on in the instrument panel.
ACC with LSF is ready to use.

■ Press the **MAIN** button on the steering wheel.

▶ Adaptive Cruise Control (ACC) with Low Speed Follow (LSF)*

When the **MAIN** button is pressed, both ACC with LSF and the Lane Keeping Assist System (LKAS) are either turned on or off.

ACC with LSF may not work properly under certain conditions.

▶ **ACC with LSF Conditions and Limitations**
P. 525

When not using ACC with LSF: Turn off adaptive cruise by pressing the **MAIN** button. This also will turn off the Lane Keeping Assist System (LKAS).

Do not use ACC with LSF under the following conditions:

- On roads with heavy traffic or while driving in continuous stop and go traffic.
- On roads with sharp turns.
- On roads with steep downhill sections, as the set vehicle speed can be exceeded by coasting. In such cases, ACC with LSF will not apply the brakes to maintain the set speed.
- On roads with toll collection facilities or other objects between lanes of traffic, or in parking areas, or facilities with drive through access.

■ To Set the Vehicle Speed

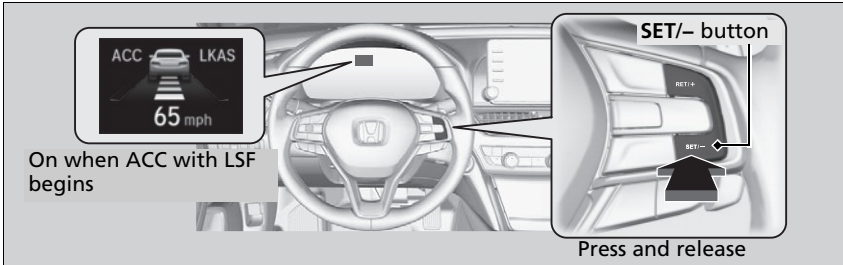

When driving at about 25 mph (40 km/h) or above: Take your foot off the pedal and press the **SET/-** button when you reach the desired speed. The moment you release the button, the set speed is fixed, and ACC with LSF begins.

When driving slower than about 25 mph (40 km/h): If the vehicle is moving and the brake pedal is not depressed, pressing the button fixes the set speed to about 25 mph (40 km/h) regardless of current vehicle speed. If the vehicle is stationary, you can set the vehicle speed even with the brake pedal depressed.

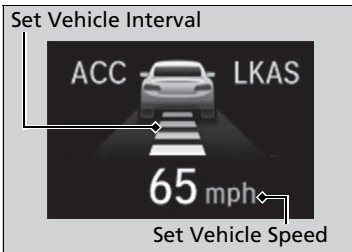

When ACC with LSF starts operating, the vehicle icon, interval bars and set speed appear on the driver information interface.

When you use ACC with LSF, Straight Driving Assist (a feature of the Electric Power Steering system) is activated.

By enabling the steering system to automatically compensate for natural steering pull, Straight Driving Assist makes it easier for you to keep your vehicle in a straight line.

Continued

▣ To Set the Vehicle Speed

You can switch the displayed set speed measurements on the driver information interface or audio/information screen between mph and km/h.

➤ **Speed Unit** P. 149

➤ **Customized Features** P. 370, 381

The Vehicle Stability Assist® (VSA®) system, Vehicle Stability Assist® (VSA®) OFF, adaptive cruise control (ACC) with low speed follow (LSF), safety support and low tire pressure/TPMS indicators may come on in amber along with a message in the driver information interface when you set the power mode to ON after re-connecting a battery.

Drive a short distance at more than 12 mph (20 km/h). Each indicator should go off. If any do not, have your vehicle checked by a dealer.

■ When in Operation

■ There is a vehicle ahead

ACC with LSF monitors if a vehicle ahead of you enters the ACC with LSF range. If a vehicle is detected doing so, the ACC with LSF system maintains or decelerates your vehicle's set speed in order to keep the vehicle's set following interval from the vehicle ahead.

➤ **To Set or Change Following Interval** P. 529

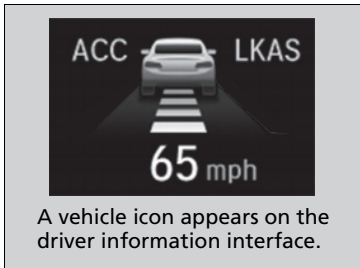
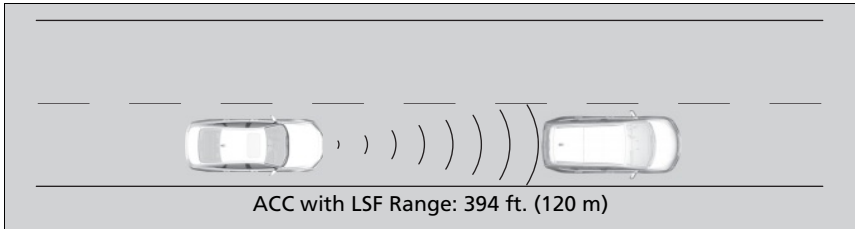

When a vehicle whose speed is slower than your set speed is detected in front of you, your vehicle starts to slow down.

▶▶ When in Operation

If the vehicle ahead of you slows down abruptly, or if another vehicle cuts in front of you, the beeper sounds, a message appears on the driver information interface, and the head-up warning lights* flash.

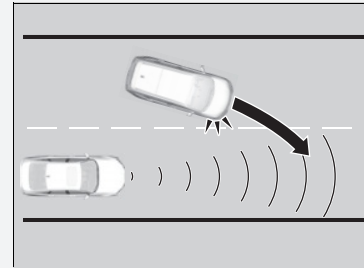

Depress the brake pedal, and keep an appropriate interval from the vehicle ahead.



■ There is no vehicle ahead



A vehicle icon with dotted-line contour appears on the driver information interface.

Your vehicle maintains the set speed without having to keep your foot on the brake or accelerator pedal.

If there previously was a vehicle detected ahead that kept your vehicle from traveling at the set speed, ACC with LSF accelerates your vehicle to the set speed, and then maintains it.

■ When you depress the accelerator pedal

You can temporarily increase the vehicle speed. In this case, there is no audible or visual alert even if a vehicle is in the ACC with LSF range.

ACC with LSF stays on unless you cancel it. Once you release the accelerator pedal, the system resumes an appropriate speed for keeping the following interval while a vehicle ahead is within the ACC with LSF range.

⌘ When in Operation

Even if the interval between your vehicle and the vehicle detected ahead is short, ACC with LSF may start accelerating your vehicle under the following circumstances:

- The vehicle ahead of you is going at almost the same speed as, or faster than, your vehicle.
- A vehicle that cuts in front of you is going faster than your vehicle, gradually increasing the interval between the vehicles.

You can also set the system to beep when a vehicle in front of you comes in and goes out of the ACC with LSF detecting range. Change the **ACC Forward Vehicle Detect Beep** setting.

➤ **Customized Features** P. 370, 381

Limitations

You may need to use the brake to maintain a safe interval when using ACC with LSF. Additionally, ACC with LSF may not work properly under certain conditions.

➤ **ACC with LSF Conditions and Limitations**
P. 525

⌘ When you depress the accelerator pedal

While the accelerator pedal is depressed, the system does not apply the brakes to keep the following interval, as well as the **BRAKE** message on the driver information interface display does not appear.

➤ **When in Operation** P. 522

■ A vehicle detected ahead is within ACC with LSF range and slows to a stop

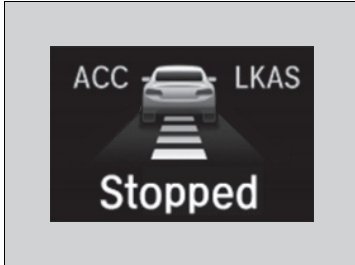

Your vehicle also stops, automatically. The **Stopped** message appears on the driver information interface.

When the vehicle ahead of you starts again, the vehicle icon on the driver information interface blinks. If you press the **RES/+** or **SET/-** button, or depress the accelerator pedal, ACC with LSF operates again within the prior set speed.

If no vehicle is ahead of you before you resume driving, depress the accelerator pedal and ACC with LSF will operate again within the prior set speed.

▶▶ A vehicle detected ahead is within ACC with LSF range and slows to a stop

⚠ WARNING

Exiting a vehicle that has been stopped while the ACC with LSF system is operating can result in the vehicle moving without operator control.

A vehicle that moves without operator control can cause a crash, resulting in serious injury or death.

Never exit a vehicle when the vehicle is stopped by ACC with LSF.

ACC with LSF Conditions and Limitations

The system may automatically shut off and the **ACC** with LSF indicator will come on under certain conditions. Some examples of these conditions are listed below. Other conditions may reduce some of the ACC with LSF functions.

■ Environmental conditions

- Driving in bad weather (rain, fog, snow, etc.).

■ Roadway conditions

- Driving on a snowy or wet roadway (obscured lane marking, vehicle tracks, reflected lights, road spray, high contrast).

■ Vehicle conditions

- The outside of the windshield is blocked by dirt, mud, leaves, wet snow, etc.
- An abnormal tire or wheel condition (Wrong sized, varied size or construction, improperly inflated, compact spare tire, etc.).
- The camera temperature gets too high.
- The parking brake is applied.
- When the radar sensor cover is dirty.
- The vehicle is tilted due to a heavy load or suspension modifications.
- When tire chains* are installed.

* Not available on all models

▣ ACC with LSF Conditions and Limitations

For directions on the proper handling of the radar sensor, refer to the following page.

▣ **Radar Sensor** P. 570

You can read about handling information for the camera equipped with this system.

▣ **Front Sensor Camera** P. 568

Always keep the radar sensor cover clean.

Never use chemical solvents or polishing powder for cleaning the radar sensor cover. Clean it with water or a mild detergent.

Do not put a sticker on the radar sensor cover or replace the radar sensor cover.

If you need the radar sensor to be repaired, or removed, or the radar sensor cover is strongly impacted, turn off the system by pressing the **MAIN** button and take your vehicle to a dealer.

Have your vehicle checked by a dealer if you find any unusual behavior of the system (e.g., the warning message appears too frequently).

If the front of the vehicle is impacted in any of the following situations, the radar sensor may not work properly. Have your vehicle checked by a dealer:

- The vehicle mounted onto a bump, curb, chock, embankment, etc.
- You drive the vehicle where the water is deep.
- Your vehicle has a frontal collision.

■ Detection limitations

- A vehicle suddenly crosses in front of you.
- The interval between your vehicle and the vehicle ahead of you is too short.
- A vehicle cuts in front of you at a slow speed, and it brakes suddenly.
- When you accelerate rapidly and approach the vehicle ahead of you at high speed.
- The vehicle ahead of you is a motorcycle, bicycle, mobility scooter, or other small vehicle.
- When there are animals in front of your vehicle.
- When you drive on a curved or winding or undulating road that makes it difficult for the sensor to properly detect a vehicle in front of you.

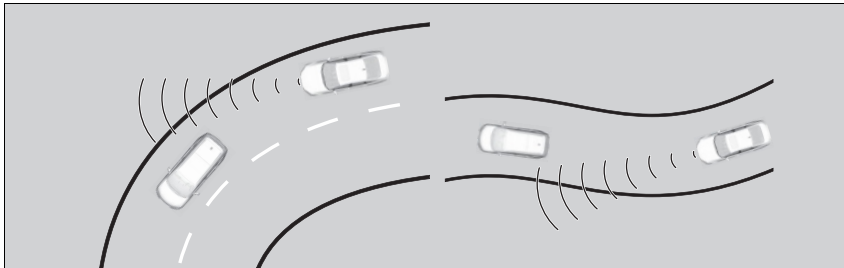

- The speed difference between your vehicle and a vehicle in front of you is significantly large.
- An oncoming vehicle suddenly comes in front of you.
- Your vehicle abruptly crosses over in front of an oncoming vehicle.

- When driving through a narrow iron bridge.



- When the vehicle ahead of you brakes suddenly.
- When the vehicle ahead of you has a unique shape.

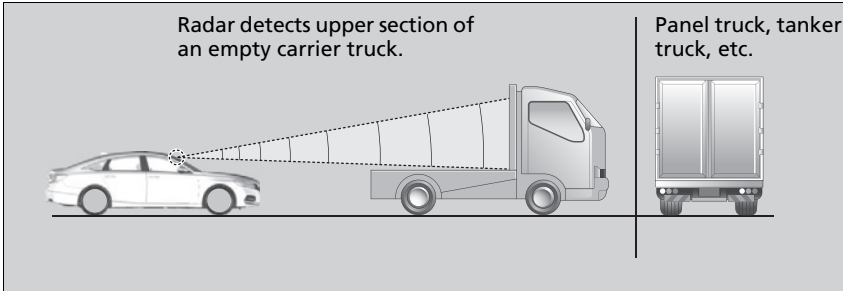

- When your vehicle or the vehicle ahead of you is driving on one edge of the lane.

■ To Adjust the Vehicle Speed

Increase or decrease the vehicle speed using the **RES/+** or **SET/-** button on the steering wheel.

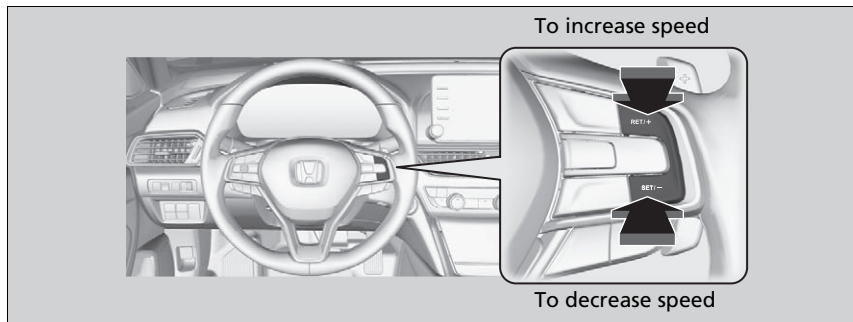

- Each time you press the **RES/+** or **SET/-** button, the vehicle speed is increased or decreased by about 1 mph or 1 km/h accordingly.
- If you keep pressing the **RES/+** or **SET/-** button, the vehicle speed increases or decreases by about 5 mph or 5 km/h accordingly.

▶▶ To Adjust the Vehicle Speed

If a vehicle detected ahead is going at a speed slower than your increased set speed, ACC with LSF may not accelerate your vehicle. This is to maintain the set interval between your vehicle and the vehicle ahead.

When you depress the accelerator pedal and then push and release the **SET/-** button, the current speed of the vehicle is set.



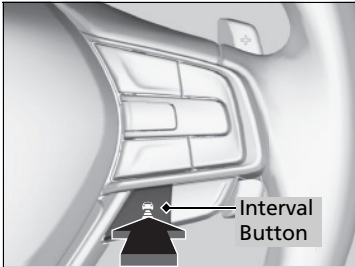

■ To Set or Change Following Interval



Press the  (Interval) button to change the ACC with LSF following interval. Each time you press the button, the following interval (the interval behind a vehicle detected ahead of you) setting cycles through extra long, long, middle, and short following intervals.

Determine the most appropriate following interval setting based on your specific driving conditions. Be sure to adhere to any following interval requirements set by local regulation.

The higher your vehicle's following speed is, the longer the short, middle, long or extra long following interval becomes. See the following examples for your reference.

Following Interval		When the Set Speed is:	
		50 mph (80 km/h)	65 mph (104 km/h)
Short		83 feet 25 meters 1.1 sec	100 feet 31 meters 1.1 sec
Middle		110 feet 33 meters 1.5 sec	137 feet 42 meters 1.5 sec
Long		154 feet 47 meters 2.1 sec	200 feet 61 meters 2.1 sec
Extra Long		207 feet 63 meters 2.9 sec	272 feet 83 meters 2.9 sec

When your vehicle stops automatically because a vehicle detected ahead of you has stopped, the interval between the two vehicles will vary based on the ACC with LSF interval setting.

To Cancel

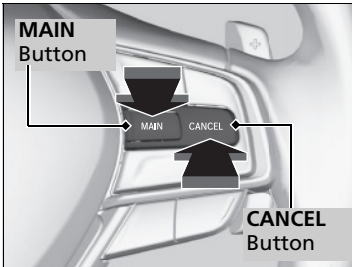

To cancel ACC with LSF, do any of the following:

- Press the **CANCEL** button.
- Press the **MAIN** button.
 - ▶ The **ACC** with LSF indicator (green) goes off.
- Depress the brake pedal.
 - ▶ When the LSF function has stopped the vehicle, you cannot cancel ACC with LSF by depressing the brake pedal.

▶▶ To Cancel

Resuming the prior set speed: After you have canceled ACC with LSF, you can resume the prior set speed while it is still displayed. Press the **RES/+** button.

The set speed cannot be set or resumed when ACC with LSF has been turned off using the **MAIN** button. Press the **MAIN** button to activate the system, then set the desired speed.

■ Automatic cancellation

The beeper sounds and a message appears on the driver information interface when ACC with LSF is automatically canceled. Any of these conditions may cause the ACC with LSF to automatically cancel:

- Bad weather (rain, fog, snow, etc.)
- When the radar sensor at the lower part of the front bumper gets dirty.
- The vehicle ahead of you cannot be detected.
- An abnormal tire condition is detected, or the tires are skidding.
- Driving on a mountainous road, or driving off road for extended periods.
- Abrupt steering wheel movement.
- When the ABS, VSA® or CMBS™ is activated.
- When the ABS or VSA® system indicator comes on.
- When the vehicle is stopped on a very steep slope.
- When you manually apply the parking brake.
- When the detected vehicle within the ACC with LSF range is too close to your vehicle.
- The camera behind the rearview mirror, or the area around the camera, including the windshield, gets dirty.
- When the Maximum Load Limit is exceeded.
- When passing through an enclosed space, such as tunnel.

In the following cases, a buzzer sounds, ACC with LSF is deactivated, and the **Cruise Cancelled: Slope Too Steep. Watch Downhill Speed** message appears in the driver information interface.

- The vehicle has repeatedly applied the brakes to maintain the set speed (for example, you are descending a long slope).

The ACC with LSF automatic cancellation can be also triggered by the following causes. In these cases, the parking brake will be automatically applied.

- The driver's seat belt is unfastened when the vehicle is stationary.
- The vehicle stops for more than 10 minutes.
- The engine is turned off.

▶ Automatic cancellation

Even though ACC with LSF has been automatically canceled, you can still resume the prior set speed. Wait until the condition that caused ACC with LSF to cancel improves, then press the **SET/-** button.

■ To Switch ACC with LSF to Cruise Control

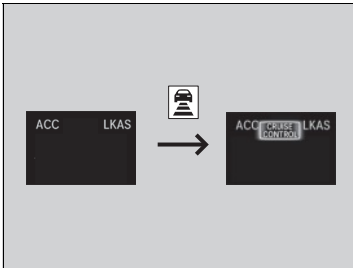

Press and hold the  (interval) button for one second. **Cruise Mode Selected** appears on the driver information interface for two seconds, and then the mode switches to Cruise.

To switch back to ACC with LSF, press and hold the  button again for one second.

■ When to use

Desired speed in a range above roughly 25 mph (40 km/h) ~.

■ To Set the Vehicle Speed

Take your foot off the pedal and press the **SET/–** button when you reach the desired speed.

The moment you release the **SET/–** button, the set speed is fixed, and cruise control begins. The **CRUISE CONTROL** indicator comes on.

When you use cruise control, Straight Driving Assist (a feature of the Electric Power Steering system) is activated.

By enabling the steering system to automatically compensate for natural steering pull, Straight Driving Assist makes it easier for you to keep your vehicle in a straight line.

▶ To Switch ACC with LSF to Cruise Control

Always be aware which mode you are in. When you are driving in Cruise mode, the system will not assist you to maintain a following interval from a vehicle ahead of you.

You can switch the displayed set speed measurements on the driver information interface or audio/information screen between mph and km/h.

▶ **Speed Unit** P. 149

▶ **Customized Features** P. 370, 381

■ To Adjust the Vehicle Speed

Each time you press the **RES/+** or **SET/-** button, the vehicle speed is increased or decreased by about 1 mph (1.6 km/h).

If you keep pressing the **RES/+** or **SET/-** button, the vehicle speed increases or decreases until you release it. This speed is then set.

■ To Cancel

To cancel cruise control, do any of the following:

- Press the **CANCEL** button.
- Press the **MAIN** button.
- Depress the brake pedal.

The **CRUISE CONTROL** indicator goes off.

▶▶ To Cancel

Resuming the prior set speed:

After cruise control has been canceled, you can still resume the prior set speed by pressing the **RES/+** button while driving at a speed of at least 25 mph (40 km/h) or more.

You cannot set or resume in the following situations:

- When vehicle speed is less than 25 mph (40 km/h)
- When the **MAIN** button is turned off.

At vehicle speeds of 22 mph (35 km/h) or less, cruise control canceled automatically.

Adaptive Cruise Control (ACC)*

Helps maintain a constant vehicle speed and a set following interval behind a vehicle detected ahead of yours, without you having to keep your foot on the brake or the accelerator.

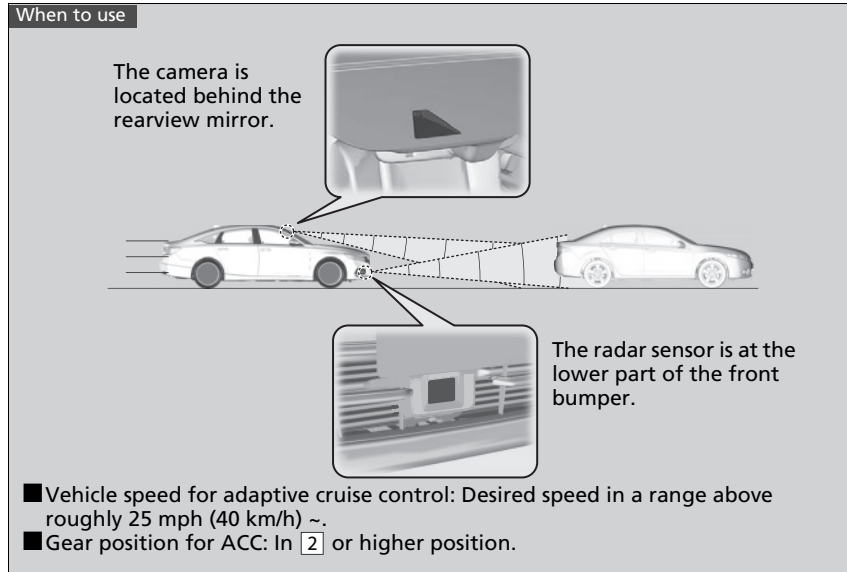

Adaptive Cruise Control (ACC)*

⚠ WARNING

Improper use of ACC can lead to a crash.

Use ACC only when driving on expressways or freeways in good weather conditions.

⚠ WARNING

ACC has limited braking capability.

When your vehicle speed drops below 25 mph (40 km/h), ACC will automatically cancel and no longer will apply your vehicle's brakes.

Always be prepared to apply the brake pedal when conditions require.

Important Reminder

As with any system, there are limits to ACC. Use the brake pedal whenever necessary, and always keep a safe interval between your vehicle and other vehicles.

* Not available on all models

■ How to activate the system

How to use

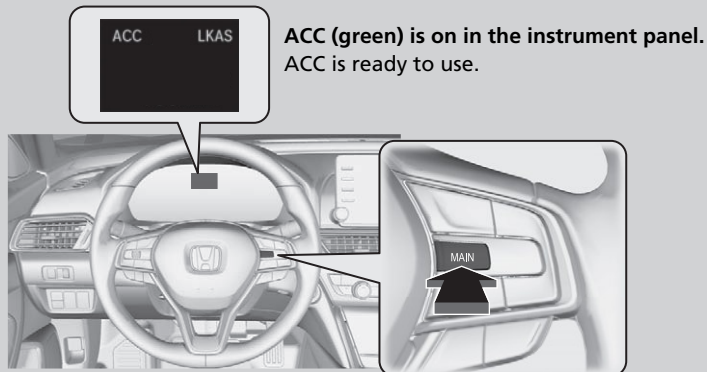

ACC (green) is on in the instrument panel. ACC is ready to use.

■ Press the **MAIN** button on the steering wheel.

▶ Adaptive Cruise Control (ACC)*

When the **MAIN** button is pressed, ACC and Lane Keeping Assist System (LKAS) are both turned on or off.

ACC may not work properly under certain conditions.

▶ **ACC Conditions and Limitations** P. 540

When not using ACC: Turn off adaptive cruise by pressing the **MAIN** button. This also will turn off the Lane Keeping Assist System (LKAS).

Do not use ACC under the following conditions:

- On roads with heavy traffic or while driving in continuous stop and go traffic.
- On roads with sharp turns.
- On roads with steep downhill sections, as the set vehicle speed can be exceeded by coasting. In such cases, ACC will not apply the brakes to maintain the set speed.
- On roads with toll collection facilities or other objects between lanes of traffic, or in parking areas, or facilities with drive through access.

When the engine speed slows down, try to downshift.

When the engine speed goes up, try to upshift. You can maintain the set speed if you change gear within five seconds.

■ To Set the Vehicle Speed

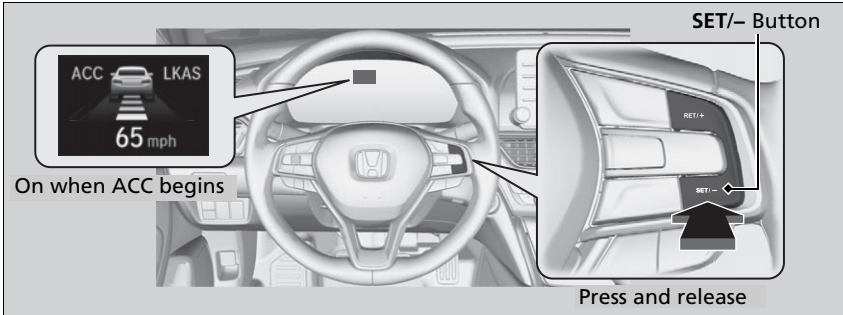

Take your foot off the pedal and press down the **SET/-** button when you reach the desired speed. The moment you release the button, the set speed is fixed, and ACC begins.

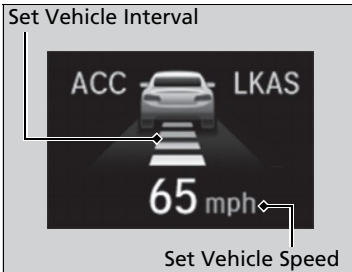

When ACC starts operating, the vehicle icon, interval bars and set speed appear on the driver information interface.

When you use ACC, Straight Driving Assist (a feature of the Electric Power Steering system) is activated.

By enabling the steering system to automatically compensate for natural steering pull, Straight Driving Assist makes it easier for you to keep your vehicle in a straight line.

☒ To Set the Vehicle Speed

You can switch the displayed set speed measurements on the driver information interface or audio/information screen between mph and km/h.

➤ **Speed Unit** P. 149

➤ **Customized Features** P. 381

The Vehicle Stability Assist® (VSA®) system, Vehicle Stability Assist® (VSA®) OFF, adaptive cruise control (ACC), safety support and low tire pressure/TPMS indicators may come on in amber along with a message in the driver information interface when you set the power mode to ON after re-connecting a battery.

Drive a short distance at more than 12 mph (20 km/h). Each indicator should go off. If any do not, have your vehicle checked by a dealer.

■ When in Operation

■ There is a vehicle ahead

ACC monitors if a vehicle ahead of you enters the ACC range. If a vehicle is detected doing so, the ACC system maintains or decelerates your vehicle's set speed in order to keep the vehicle's set following interval from the vehicle ahead.

➔ **To Set or Change Following Interval** P. 544

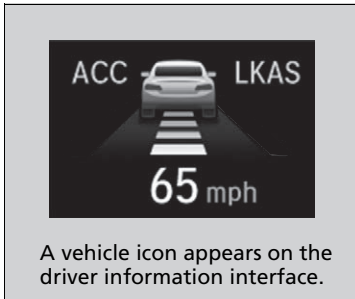
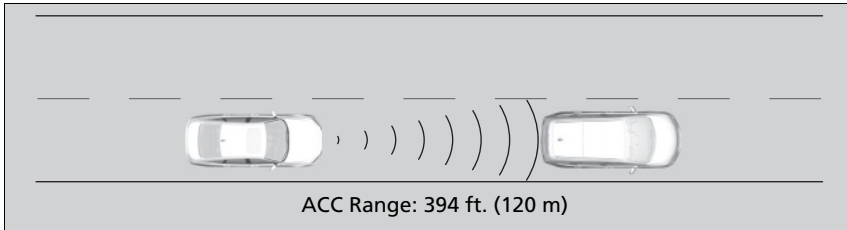

When a vehicle whose speed is slower than your set speed is detected in front of you, your vehicle starts to slow down.

⌘ When in Operation

If the vehicle detected ahead of you slows down abruptly, or if another vehicle is detected cutting in front of you, the beeper sounds and a message appears on the driver information interface.

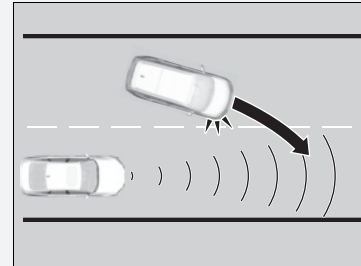

Depress the brake pedal, and keep an appropriate interval from the vehicle ahead.

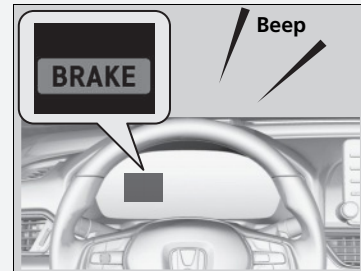

■ **There is no vehicle ahead**



A vehicle icon with dotted-line contour appears on the driver information interface.

Your vehicle maintains the set speed without having to keep your foot on the brake or accelerator pedal.

If there previously was a vehicle detected ahead that kept your vehicle from traveling at the set speed, ACC accelerates your vehicle to the set speed, and then maintains it.

■ **When you depress the accelerator pedal**

You can temporarily increase the vehicle speed. In this case, there is no audible or visual alert even if a vehicle is in the ACC range.

ACC stays on unless you cancel it. Once you release the accelerator pedal, the system resumes an appropriate speed for keeping the following interval while a vehicle ahead is within the ACC range.

⌘ **When in Operation**

Even if the interval between your vehicle and the vehicle detected ahead is short, ACC may start accelerating your vehicle under the following circumstances:

- The vehicle ahead of you is going at almost the same speed as, or faster than, your vehicle.
- A vehicle that cuts in front of you is going faster than your vehicle, gradually increasing the interval between the vehicles.

You can also set the system to beep when a vehicle in front of you comes in and goes out of the ACC detecting range. Change the **ACC Forward Vehicle Detect Beep** setting.

⌘ **Customized Features** P. 381

Limitations

You may need to use the brake to maintain a safe interval when using ACC. Additionally, ACC may not work properly under certain conditions.

⌘ **ACC Conditions and Limitations** P. 540

⌘ **When you depress the accelerator pedal**

While the accelerator pedal is depressed, the system does not apply the brakes to keep the following interval, as well as the **BRAKE** message on the driver information interface does not appear.

⌘ **When in Operation** P. 538

ACC Conditions and Limitations

The system may automatically shut off and the **ACC** indicator will come on under certain conditions. Some examples of these conditions are listed below. Other conditions may reduce some of the ACC functions.

Environmental conditions

- Driving in bad weather (rain, fog, snow, etc.).

Roadway conditions

- Driving on a snowy or wet roadway (obscured lane marking, vehicle tracks, reflected lights, road spray, high contrast).

Vehicle conditions

- The outside of the windshield is blocked by dirt, mud, leaves, wet snow, etc.
- An abnormal tire or wheel condition (Wrong sized, varied size or construction, improperly inflated, compact spare tire, etc.).
- The camera temperature gets too high.
- The parking brake is applied.
- When the radar sensor cover is dirty.
- When the front of the vehicle tilts up due to heavy cargo in the trunk or rear seats.
- When tire chains* are installed.

ACC Conditions and Limitations

For directions on the proper handling of the radar sensor, refer to the following page.

▶ **Radar Sensor** P. 570

You can read about handling information for the camera equipped with this system.

▶ **Front Sensor Camera** P. 568

Always keep the radar sensor cover clean.

Never use chemical solvents or polishing powder for cleaning the sensor cover. Clean it with water or a mild detergent.

Do not put a sticker on the radar sensor cover or replace the radar sensor cover.

If you need the radar sensor to be repaired, or removed, or the radar sensor cover is strongly impacted, turn off the system by pressing the **MAIN** button and take your vehicle to a dealer.

Have your vehicle checked by a dealer if you find any unusual behavior of the system (e.g., the warning message appears too frequently).

If the front of the vehicle is impacted in any of the following situations, the radar sensor may not work properly. Have your vehicle checked by a dealer:

- The vehicle mounted onto a bump, curb, chock, embankment, etc.
- You drive the vehicle where the water is deep.
- Your vehicle has a frontal collision.

■ Detection limitations

- A vehicle suddenly crosses in front of you.
- The interval between your vehicle and the vehicle ahead of you is too short.
- A vehicle cuts in front of you at a slow speed, and it brakes suddenly.
- When you accelerate rapidly and approach the vehicle ahead of you at high speed.
- The vehicle ahead of you is a motorcycle, bicycle, mobility scooter, or other small vehicle.
- When there are animals in front of your vehicle.
- When you drive on a curved or winding or undulating road that makes it difficult for the sensor to properly detect a vehicle in front of you.

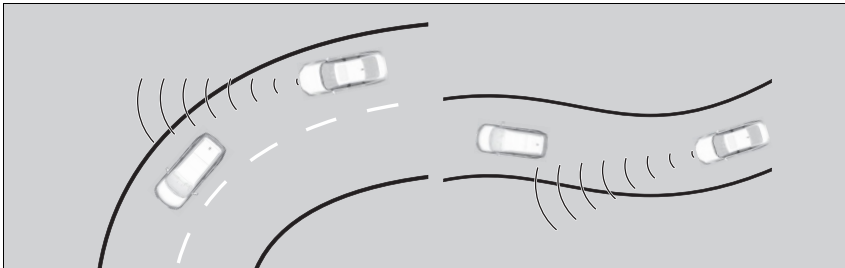

- The speed difference between your vehicle and a vehicle in front of you is significantly large.
- An oncoming vehicle suddenly comes in front of you.
- Your vehicle abruptly crosses over in front of an oncoming vehicle.

- When driving through a narrow iron bridge.



- When the vehicle ahead of you brakes suddenly.
- When the vehicle ahead of you has a unique shape.

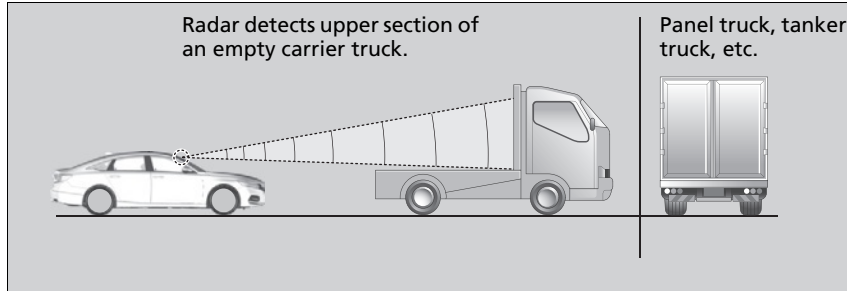

- When your vehicle or the vehicle ahead of you is driving on one edge of the lane.

■ To Adjust the Vehicle Speed

Increase or decrease the vehicle speed using the **RES/+** or **SET/-** button on the steering wheel.

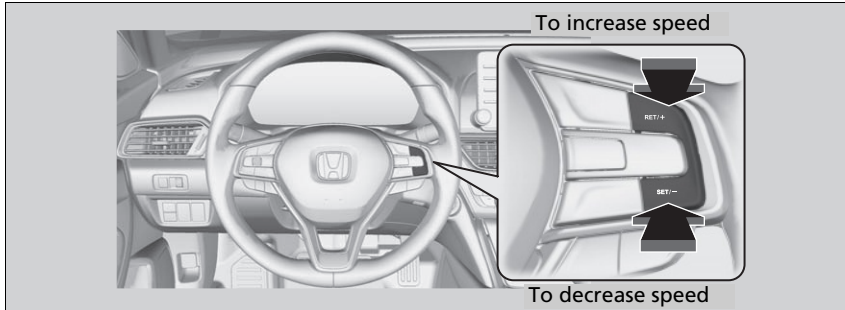

- Each time you press the **RES/+** or **SET/-** button, the vehicle speed is increased or decreased by about 1 mph or 1 km/h accordingly.
- If you keep pressing the **RES/+** or **SET/-** button, the vehicle speed increases or decreases by about 5 mph or 5 km/h accordingly.

☒ To Adjust the Vehicle Speed

If a vehicle detected ahead is going at a speed slower than your increased set speed, ACC may not accelerate your vehicle. This is to maintain the set interval between your vehicle and the vehicle ahead.

When you depress the accelerator pedal and then push and release the **SET/-** button, the current speed of the vehicle is set.

Continued

■ To Set or Change Following Interval

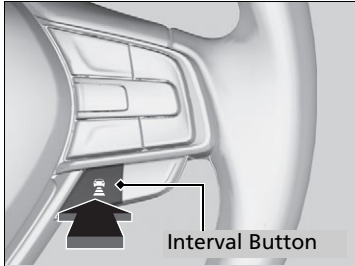





Press the  (interval) button to change the ACC following interval.

Each time you press the button, the following interval (the interval behind a vehicle detected ahead of you) setting cycles through extra long, long, middle, and short following intervals.

Determine the most appropriate following interval setting based on your specific driving conditions. Be sure to adhere to any following interval requirements set by local regulation.

The higher your vehicle's following speed is, the longer the short, middle, long or extra long following interval becomes. See the following examples for your reference.

Following Interval		When the Set Speed is:	
		50 mph (80 km/h)	65 mph (104 km/h)
Short		84 feet 26 meters 1.1 sec	102 feet 31 meters 1.1 sec
Middle		111 feet 34 meters 1.5 sec	139 feet 43 meters 1.5 sec
Long		155 feet 48 meters 2.1 sec	202 feet 62 meters 2.1 sec
Extra Long		215 feet 66 meters 3.0 sec	282 feet 86 meters 3.0 sec

■ To Cancel

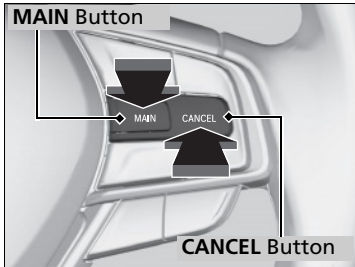

To cancel ACC, do any of the following:

- Press the **CANCEL** button.
- Press the **MAIN** button.
 - ▶ The **ACC** indicator (green) goes off.
- Depress the brake pedal.
- Depress the clutch pedal for five seconds or more.

▶▶ To Cancel

Resuming the prior set speed: After you have canceled ACC, you can resume the prior set speed while it is still displayed. Press the **RES/+** button when driving at a speed of at least 25 mph (40 km/h) or more.

The set speed cannot be set or resumed when ACC has been turned off using the **MAIN** button. Press the **MAIN** button to activate the system, then set the desired speed.

■ Automatic cancellation

The beeper sounds and a message appears on the driver information interface when ACC is automatically canceled. Any of these conditions may cause the ACC to automatically cancel:

- Bad weather (rain, fog, snow, etc.)
- When the radar sensor at the lower part of the front bumper gets dirty.
- The vehicle ahead of you cannot be detected.
- An abnormal tire condition is detected, or the tires are skidding.
- Driving on a mountainous road, or driving off road for extended periods.
- Abrupt steering wheel movement.
- When the ABS, VSA® or CMBS™ is activated.
- When the ABS or VSA® system indicator comes on.
- When you manually apply the parking brake.
- When the detected vehicle within the ACC range is too close to your vehicle.
- The camera behind the rearview mirror, or the area around the camera, including the windshield, gets dirty.
- When the Maximum Load Limit is exceeded.
- When passing through an enclosed space, such as tunnel.
- Ignoring shift down indication shown in the tachometer display will cancel the ACC after about 10 seconds.
- The engine speed goes into the tachometer's red zone.
- The engine speed goes to below 1,000 rpm.
- You shift into neutral temporarily when shifting into a higher or lower gear.

In the following cases, a buzzer sounds, ACC is deactivated, and the **Cruise Cancelled: Slope Too Steep. Watch Downhill Speed** message appears in the driver information interface.

- The vehicle has repeatedly applied the brakes to maintain the set speed (for example, you are descending a long slope).

⌘ Automatic cancellation

Even though ACC has been automatically canceled, you can still resume the prior set speed. Wait until the condition that caused ACC to cancel improves, then press the **SET/-** button.

■ To Switch ACC to Cruise Control

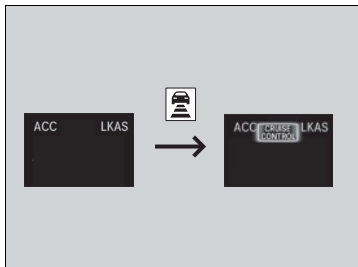

Press and hold the  (interval) button for one second. **Cruise Mode Selected** appears on the driver information interface for two seconds, and then the mode switches to Cruise.

To switch back to ACC, press and hold the  button again for one second.

■ When to use

Desired speed in a range above roughly 25 mph (40 km/h) ~.

■ To Set the Vehicle Speed

Take your foot off the pedal and press the **SET/-** button when you reach the desired speed.

The moment you release the **SET/-** button, the set speed is fixed, and cruise control begins. The **CRUISE CONTROL** indicator comes on.

When you use cruise control, Straight Driving Assist (a feature of the Electric Power Steering system) is activated.

By enabling the steering system to automatically compensate for natural steering pull, Straight Driving Assist makes it easier for you to keep your vehicle in a straight line.

▶▶ To Switch ACC to Cruise Control

Always be aware which mode you are in. When you are driving in Cruise mode, the system will not assist you to maintain a following interval from a vehicle ahead of you.

You can switch the displayed set speed measurements on the driver information interface or audio/information screen between mph and km/h.

▶ **Speed Unit** P. 149

▶ **Customized Features** P. 381

To Adjust the Vehicle Speed

- Each time you press the **RES/+** or **SET/-** button, the vehicle speed is increased or decreased by about 1 mph (1.6 km/h).
- If you keep the **RES/+** or **SET/-** button pressed, the vehicle speed increases or decreases until you release it. This speed is then set.

To Cancel

To cancel cruise control, do any of the following:

- Press the **CANCEL** button.
- Press the **MAIN** button.
- Depress the brake pedal.
- Depress the clutch pedal for five seconds or more.

The **CRUISE CONTROL** indicator goes off.

☒ To Cancel

Resuming the prior set speed:

After cruise control has been canceled, you can still resume the prior set speed by pressing the **RES/+** button while driving at a speed of at least 25 mph (40 km/h) or more.

You cannot set or resume in the following situations:

- When vehicle speed is less than 25 mph (40 km/h)
- When the **MAIN** button is turned off.

At vehicle speeds of 22 mph (35 km/h) or less, cruise control canceled automatically.

Lane Keeping Assist System (LKAS)

Provides steering input to help keep the vehicle in the middle of a detected lane and provides tactile and visual alerts if the vehicle is detected drifting out of its lane.

■ Steering input assist

The system applies torque to the steering to keep the vehicle between the left and right lane lines. The applied torque becomes stronger as the vehicle gets closer to either of the lane lines.



■ Front Sensor Camera
Monitors the lane lines.

■ Tactile and visual alerts

Rapid vibrations on the steering wheel and a warning display alert you that the vehicle is drifting out of a detected lane.

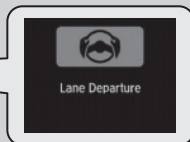

When you operate the turn signals to change lanes, the system is suspended, and resumes after the signals are off.

If you make a lane change without operating the turn signals, the LKAS alerts activate, and torque is applied to the steering.

▶ Lane Keeping Assist System (LKAS)

Important Safety Reminders

The LKAS is for your convenience only. It is not a substitute for your vehicle control. The system does not work if you take your hands off the steering wheel or fail to steer the vehicle.

▶ Driver Information Interface Warning and Information Messages P. 105

Do not place objects on the instrument panel. Objects may reflect on the windshield and prevent correct detection of the traffic lanes.

The LKAS only alerts you when lane drift is detected without a turn signal in use. The LKAS may not detect all lane markings or lane departures; accuracy will vary based on weather, speed, and lane marker condition.

It is always your responsibility to safely operate the vehicle and avoid collisions.

The LKAS is convenient when it is used on freeways.

The LKAS may not work properly or may work improperly under the certain conditions:

▶ LKAS Conditions and Limitations P. 555

You can read about handling information for the camera equipped with this system.

▶ Front Sensor Camera P. 568

■ Lane Keep Support Function

Provides assistance to keep the vehicle in the center of the lane. When the vehicle nears a white or yellow line, steering force of the electric power steering will become stronger.

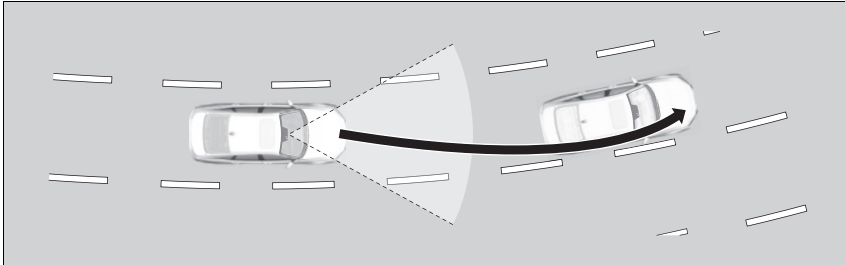

■ Lane Departure Warning Function

When the vehicle enters the warning area, the LKAS alerts you with slight steering wheel vibration as well as a warning display.

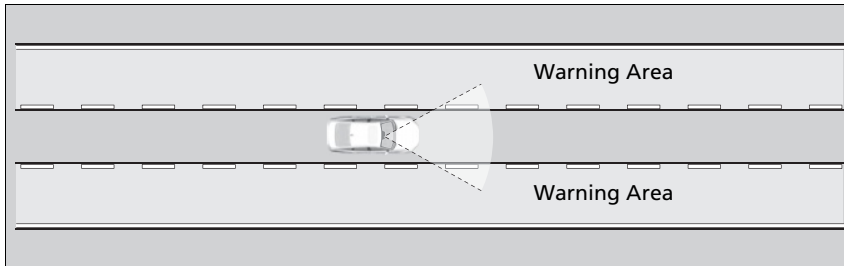

☒ Lane Keeping Assist System (LKAS)

The LKAS may not function as designed while driving in frequent stop and go traffic, or on roads with sharp curves.

When it fails to detect lanes, the system will temporarily be canceled. When a lane is detected, the system will recover automatically.

■ When the System can be Used

The system can be used when the following conditions are met.

- The lane in which you are driving has detectable lane markers on both sides, and your vehicle is in the center of the lane.
- The vehicle speed is between 45 and 90 mph (72 and 145 km/h).
- You are driving on a straight or slightly curved road.
- The turn signals are off.
- The brake pedal is not depressed.
- The wipers are not in high speed operation.

■ How to activate the system

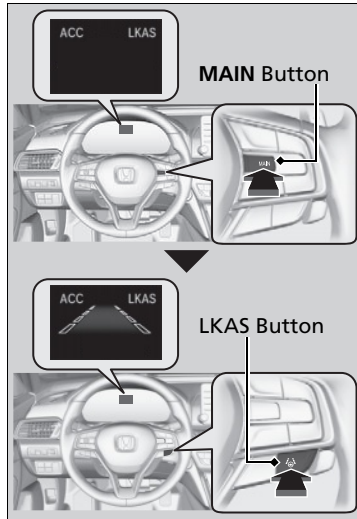

1. Press the **MAIN** button.
 - ▶ The LKAS is on in the driver information interface.
The system is ready to use.
2. Press the LKAS button.
 - ▶ Lane outlines appear on the driver information interface.
The system is activated.

▶▶ When the System can be Used

If the vehicle drifts toward either left or right lane line due to the system applying torque, turn off the LKAS and have your vehicle checked by a dealer.

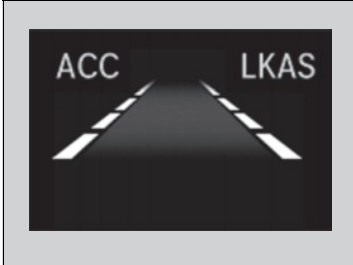

3. Keep your vehicle near the center of the lane while driving.
 - ▶ The dotted outer lines change to solid ones once the system starts operating after detecting the left and right lane markings.

To cancel

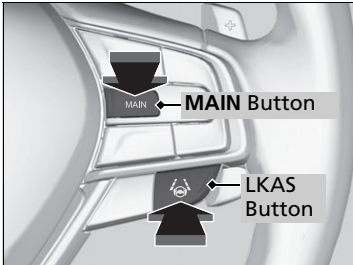

To cancel the LKAS:
Press the **MAIN** or LKAS button.

The LKAS is turned off every time you stop the engine, even if you turned it on the last time you drove the vehicle.

▶▶ To cancel

Models with ACC with LSF

Pressing the **MAIN** button also turns ACC with LSF on and off.

Models with ACC

Pressing the **MAIN** button also turns ACC on and off.

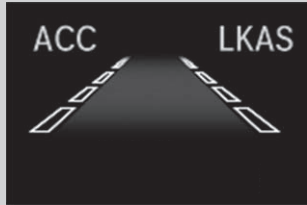

When the LKAS is suspended, the lane lines on the driver information interface change to contour lines, and the beeper sounds (if activated).

■ **The system operation is suspended if you:**

- Set the wipers to **HI**.
 - ▶ Turning the wipers off or setting it to **LO** resumes the LKAS.
- Decrease the vehicle speed to about 40 mph (64 km/h) or less.
 - ▶ Increasing the vehicle speed to about 45 mph (72 km/h) or more resumes the LKAS.
- Depress the brake pedal.
 - ▶ The LKAS resumes and starts detecting the lane lines again once you release the brake pedal.

Models with automatic intermittent wipers

- Set the wiper switch to **AUTO** and the wipers operate at high speed.
 - ▶ The LKAS resumes when the wipers stop or operate at low speed.

■ **The LKAS may automatically be suspended when:**

- The system fails to detect lane lines.
 - The steering wheel is quickly turned.
 - You fail to steer the vehicle.
 - Driving through a sharp curve.
 - Driving at a speed in excess of approximately 90 mph (145 km/h).
- Once these conditions no longer exist, the LKAS automatically resumes.

■ The LKAS may automatically be canceled when:

- The camera temperature gets extremely high or low.
- The camera behind the rearview mirror, or the area around the camera, including the windshield, gets dirty.
- The ABS or VSA® system engages.

The beeper sounds if the LKAS is automatically canceled.

LKAS Conditions and Limitations

The system may not detect lane markings and therefore may not keep the vehicle in the middle of a lane under certain conditions, including the following:

■ Environmental conditions

- Driving in bad weather (rain, fog, snow, etc.).
- Sudden changes between light and dark, such as an entrance or exit of a tunnel.
- There is little contrast between lane lines and the roadway surface.
- Driving into low sunlight (e.g., at dawn or dusk).
- Strong light is reflected onto the roadway.
- Driving in the shadows of trees, buildings, etc.
- Shadows of adjacent objects are parallel to lane markings.
- Roadway objects or structures are misinterpreted as lane markers.
- Reflections on the interior of the windshield.
- Driving at night or in a dark condition such as a tunnel.

■ Roadway conditions

- Driving on a snowy or wet roadway (obscured lane marking, vehicle tracks, reflected lights, road spray, high contrast).
- Driving on a road with temporary lane markings.
- Faint, multiple, or varied lane markings are visible on the roadway due to road repairs or old lane markings.

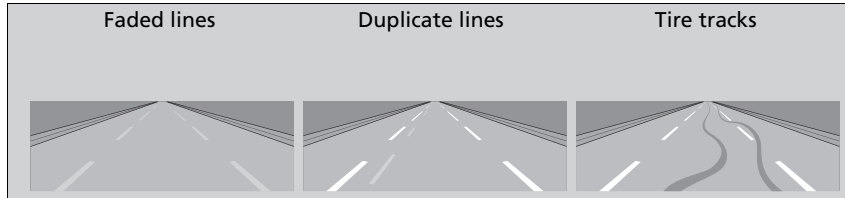

- The roadway has merging, split, or crossing lines (e.g., such as at an intersection or crosswalk).
- The lane markings are extremely narrow, wide, or changing.

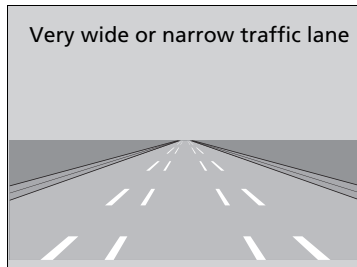

- The vehicle in front of you is driving near the lane lines.
- The road is hilly or the vehicle is approaching the crest of a hill.
- Driving on rough or unpaved roads, or over bumpy surfaces.

- When objects on the road (curb, guard rail, pylons, etc.) are recognized as white lines (or yellow lines).
- Driving on roads with double lines.

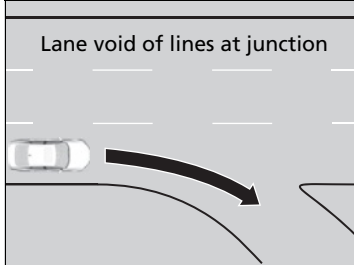

■ Vehicle conditions

- Headlight lenses are dirty or the headlights are not properly adjusted.
- The outside of the windshield is streaked or blocked by dirt, mud, leaves, wet snow, etc.
- The inside of the windshield is fogged.
- The camera temperature gets too high.
- An abnormal tire or wheel condition (wrong sized, varied size or construction, improperly inflated, compact spare tire, etc.).
- The vehicle is tilted due to a heavy load or suspension modifications.
- The vehicle is towing a trailer*.

* Not available on all models

Road Departure Mitigation (RDM) System

Alerts and helps to assist you when the system determines a possibility of your vehicle unintentionally crossing over detected lane markings and/or leaving the roadway altogether.

■ How the System Works

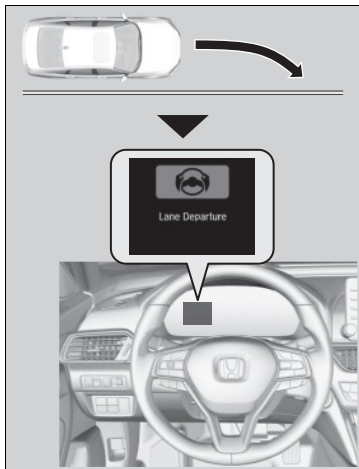

The front camera behind the rearview mirror monitors left and right lane markings (in white or yellow). If your vehicle is getting too close to detected lane markings without a turn signal activated, the system, in addition to a visual alert, applies steering torque and alerts you with rapid vibrations on the steering wheel, to help you remain within the detected lane.

▶ **Customized Features** P. 370, 381

As a visual alert, the **Lane Departure** message appears on the driver information interface.

If the system determines that its steering input is insufficient to keep your vehicle on the roadway, it may apply braking.

▶ Braking is applied only when the lane markings are solid continuous lines.

The system cancels assisting operations when you turn the steering wheel to avoid crossing over detected lane markings.

If the system operates several times without detecting driver response, the system beeps to alert you.

* Not available on all models

▶▶ Road Departure Mitigation (RDM) System

Important Safety Reminder

Like all assistance systems, the RDM system has limitations.

Over-reliance on the RDM system may result in a collision. It is always your responsibility to keep the vehicle within your driving lane.

The RDM system only alerts you when lane drift is detected without a turn signal in use. The RDM system may not detect all lane markings or lane or roadway departures; accuracy will vary based on weather, speed and lane marker condition. It is always your responsibility to safely operate the vehicle and avoid collisions.

You can read about handling information for the camera equipped with this system.

▶ **Front Sensor Camera** P. 568

The RDM system may not work properly or may work improperly under the certain conditions:

▶ **RDM Conditions and Limitations** P. 560

There are times when you may not notice RDM functions due to your operation of the vehicle, or road surface conditions.

In the following case, a beeper sounds, a message related to the ACC with LSF*/ACC* appears on the driver information interface, and the braking function controlled by the RDM system is canceled.

- The vehicle has repeatedly applied the brakes to maintain the set speed (for example, you are descending a long slope).

How the System Activates

The system becomes ready to start searching for lane markings when all the following conditions are met:

- The vehicle is traveling between about 45 and 90 mph (72 and 145 km/h).
- The vehicle is on a straight or slightly curved road.
- The turn signals are off.
- The brake pedal is not depressed.
- The wipers are not in high speed operation.
- The vehicle is not accelerating or braking, and the steering wheel is not being turned.
- The system makes a determination that the driver is not actively accelerating, braking or steering.

⌘ Road Departure Mitigation (RDM) System

If LKAS is off and you have selected **Narrow** from the customized options using the audio/information screen, the message below will appear in case the system determines a possibility of your vehicle crossing over detected lane markings.

⌘ **Customized Features** P. 370, 381



⌘ How the System Activates

The RDM system may automatically shut off and the safety support indicator (amber) comes and stays on.

⌘ **Indicators** P. 78

RDM system function can be impacted when the vehicle is:

- Not driven within a traffic lane.
- Driven on the inside edge of a curve, or outside of a lane.
- Driven in a narrow lane.

RDM On and Off

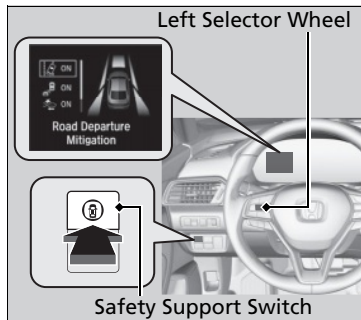

When you turn the RDM on and off, do the following.

1. Press the safety support switch.
2. Roll the left selector wheel to the  symbol and push it.
 - ▶ The message appears on the driver information interface when the system becomes on or off.

The RDM is in the previously selected **ON** or **OFF** setting each time you start the engine.

RDM Conditions and Limitations

The system may not properly detect lane markings and the position of your vehicle under certain conditions. Some examples of these conditions are listed below.

Environmental conditions

- Driving in bad weather (rain, fog, snow, etc.).
- Sudden changes between light and dark, such as an entrance or exit of a tunnel.
- There is little contrast between lane lines and the roadway surface.
- Driving into low sunlight (e.g., at dawn or dusk).
- Strong light is reflected onto the roadway.
- Driving in the shadows of trees, buildings, etc.
- Shadows of adjacent objects are parallel to lane markings.
- Roadway objects or structures are misinterpreted as lane markers.
- Reflections on the interior of the windshield.
- Driving at night or in a dark condition such as a tunnel.

* Not available on all models

RDM On and Off

When you have selected **Warning Only** from the customized options using the audio/information screen, the system does not operate the steering wheel and braking.

▶ **Customized Features** P. 370, 381

The Vehicle Stability Assist® (VSA®) system, Vehicle Stability Assist® (VSA®) OFF, adaptive cruise control (ACC) with low speed follow (LSF)*, adaptive cruise control (ACC)*, safety support and low tire pressure/TPMS indicators may come on in amber along with a message in the driver information interface when you set the power mode to ON after re-connecting a battery.

Drive a short distance at more than 12 mph (20 km/h). Each indicator should go off. If any do not, have your vehicle checked by a dealer.

■ Roadway conditions

- Driving on a snowy or wet roadway (obscured lane marking, vehicle tracks, reflected lights, road spray, high contrast).
- Driving on a road with temporary lane markings.
- Faint, multiple, or varied lane markings are visible on the roadway due to road repairs or old lane markings.
- The roadway has merging, split, or crossing lines (e.g., such as at an intersection or crosswalk).
- The lane markings are extremely narrow, wide, or changing.
- The vehicle in front of you is driving near the lane lines.
- The road is hilly or the vehicle is approaching the crest of a hill.
- Driving on rough or unpaved roads, or over bumpy surfaces.
- When objects on the road (curb, guard rail, pylons, etc.) are recognized as white lines (or yellow lines).
- Driving on roads with double lines.

■ Vehicle conditions

- Headlight lenses are dirty or the headlights are not properly adjusted.
- The outside of the windshield is streaked or blocked by dirt, mud, leaves, wet snow, etc.
- The inside of the windshield is fogged.
- The camera temperature gets too high.
- An abnormal tire or wheel condition (wrong sized, varied size or construction, improperly inflated, compact spare tire, etc.).
- The vehicle is tilted due to a heavy load or suspension modifications.
- When tire chains* are installed.
- The vehicle is towing a trailer*.

* Not available on all models

Traffic Sign Recognition System

Reminds you of road sign information, such as the current speed limit, your vehicle has just passed through, showing it on the driver information interface and the head-up display*.

How the System Works

When the camera located behind the rearview mirror captures traffic signs while driving, the system displays the ones that are recognized as designated for your vehicle. The sign icon will be displayed until the vehicle reaches a predetermined time and distance.

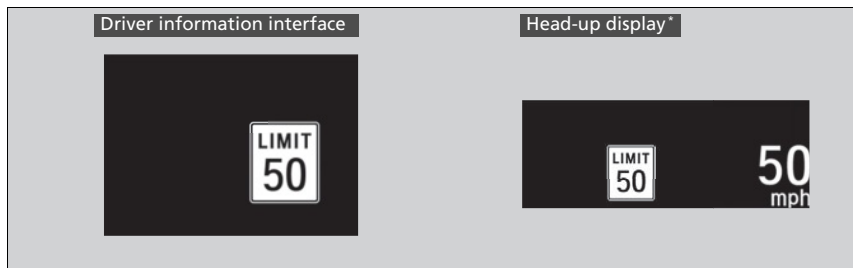

The sign icon also may switch to another one or disappear when:

- The other designated limit is detected.
- You make a turn with a turn signal at an intersection.

Traffic Sign Recognition System

Not all signs may be displayed, but any signs posted on roadsides should not be ignored. The system does not work on the designated traffic signs of all the countries you travel, nor in all situations. Do not rely too much on the system. Always drive at speeds appropriate for the road conditions.

Never apply a film or attach any objects to the windshield that could obstruct the camera's field of vision and cause the system to operate abnormally. Scratches, nicks, and other damage to the windshield within the camera's field of vision can cause the system to operate abnormally. If this occurs, we recommend that you replace the windshield with a genuine Honda replacement windshield. Making even minor repairs within the camera's field of vision or installing an aftermarket replacement windshield may also cause the system to operate abnormally. After replacing the windshield, have a dealer recalibrate the camera. Proper calibration of the camera is necessary for the system to operate properly.

If the system does not detect any traffic signs while you are driving, the image below may appear.

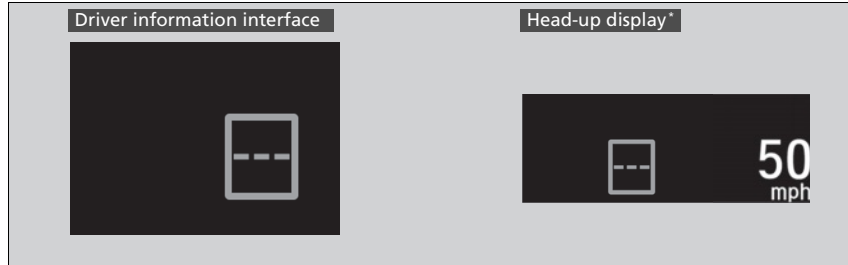

☒ Traffic Sign Recognition System

To help reduce the likelihood that high interior temperatures will cause the camera's sensing system to shut off, when parking, find a shady area or face the front of the vehicle away from the sun. If you use a reflective sun shade, do not allow it to cover the camera housing. Covering the camera can concentrate heat on it.

If the **Some Driver Assist Systems Cannot Operate: Camera Temperature Too High** message appears, the traffic sign recognition system does not work, and ☒ will be displayed.

- Use the climate control system to cool down the interior and, if necessary, also use defroster mode with the air flow directed towards the camera.
- Start driving the vehicle to lower the windshield temperature, which cools down the area around the camera.

If the **Some Driver Assist Systems Cannot Operate: Clean Front Windshield** message appears, the traffic sign recognition system does not work, and ☒ will be displayed.

Park your vehicle in a safe place, and clean the windshield. If the message does not disappear after you have cleaned the windshield and driven for a while, have your vehicle checked by a dealer.

■ Traffic Sign Recognition System Conditions and Limitations

The traffic sign recognition system may not be able to recognize the traffic sign in the following cases.

■ Vehicle conditions

- Headlight lenses are dirty or the headlights are not properly adjusted.
- The outside of the windshield is blocked by dirt, mud, leaves, wet snow, etc.
- The inside of the windshield is fogged.
- There are portions remaining to be wiped.
- An abnormal tire or wheel condition (wrong sized, varied size or construction, improperly inflated, compact spare tire, etc.).
- The vehicle is tilted due to a heavy load or suspension modifications.

■ Environmental conditions

- Driving into low sunlight (e.g., at dawn or dusk).
- Strong light is reflected onto the roadway.
- Sudden changes between light and dark, such as an entrance or exit of a tunnel.
- When you drive in the shadows of trees, buildings, etc.
- Driving at night, in dark areas such as long tunnels.
- Driving in bad weather (rain, fog, snow, etc.).
- A vehicle in front of you is travelling flying up spray or snow.

▶▶ Traffic Sign Recognition System Conditions and Limitations

When the traffic sign recognition system malfunctions,  appears on the driver information interface. If this message does not disappear, have your vehicle checked by a dealer.

Driver information interface



Head-up display*



■ The position or the condition of the traffic sign

- A sign is hard to be found since it is in a complicated area.
- A sign is located far away from your vehicle.
- A sign is located where the beam of the headlight is hard to reach.
- A sign is on a corner or bend in the road.
- Faded or bent signs.
- Rotated or damaged signs.
- A sign is covered with mud, snow, or frost.
- A part of the sign is hidden by the trees, or the sign itself is hidden by a vehicle and others.
- Light (a streetlight) or a shadow is reflected on the surface of the sign.
- A sign is too bright or too dark (an electric sign).
- A sign of a small size.

■ Other conditions

- When you are driving at a high speed.

The traffic sign recognition system may not operate correctly, such as displaying a sign that does not follow the actual regulation for the roadway or does not exist at all in the following cases.

- ▶ Regarding the speed limit sign, it may display higher or lower speed than the actual speed limit.
- There is a supplementary sign with further information such as weather, time, vehicle type, school zone, etc.
- Figures on the sign are hard to read (electric sign, numbers on the sign are blurred).
- A sign is in the vicinity of the lane you are driving even though it is not for the lane (speed limit sign situated at the junction between the side road and the main road, etc.).
- There are things that look similar to the color or shape of the recognition object (similar sign, electric sign, signboard, structure, etc.).
- A lorry and others stuck with the sticker of the speed limit sign on the back are travelling in front of you.

■ Signs Displayed on the Driver information interface and Head-Up Display*

The speed limit sign icon is displayed on the right half of the screen.

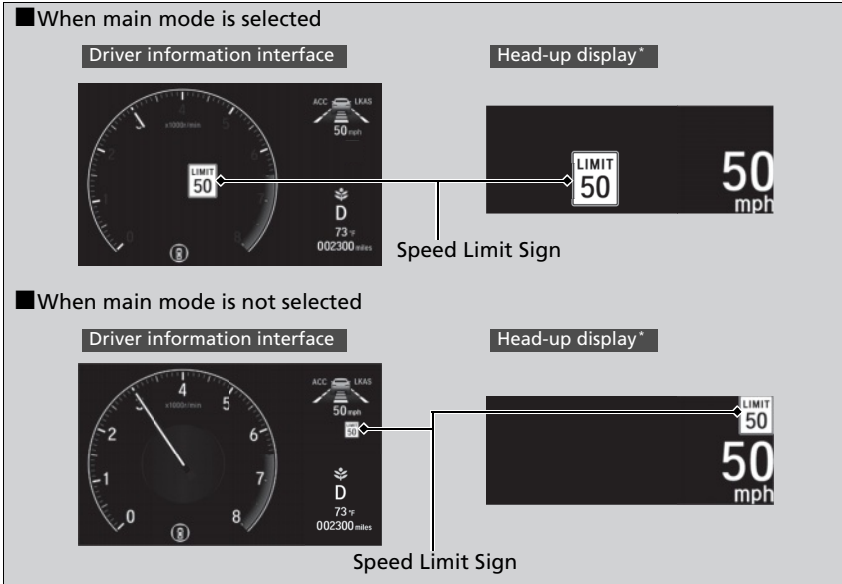

■ Selecting to display traffic signs when main mode is off

You can continue displaying reduced-size traffic sign icon on the driver information interface and head-up display* even while the main mode is not selected.

➤ **Customized Features** P. 370, 381

* Not available on all models

Front Sensor Camera

The camera, used in systems such as LKAS, RDM, ACC*, ACC with LSF*, CMBS™ and traffic sign recognition system, is designed to detect an object that triggers any of the systems to operate its functions.

■ Camera Location and Handling Tips

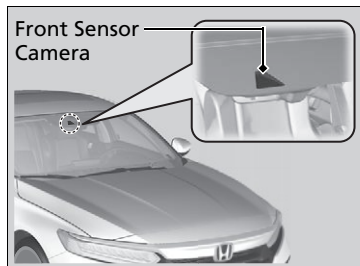

This camera is located behind the rearview mirror.

To help reduce the likelihood that high interior temperatures will cause the camera's sensing system to shut off, when parking, find a shady area or face the front of the vehicle away from the sun. If you use a reflective sun shade, do not allow it to cover the camera housing. Covering the camera can concentrate heat on it.

▣ Front Sensor Camera

Never apply a film or attach any objects to the windshield, the hood, or the front grille that could obstruct the camera's field of vision and cause the system to operate abnormally. Scratches, nicks, and other damage to the windshield within the camera's field of vision can cause the system to operate abnormally. If this occurs, we recommend that you replace the windshield with a genuine Honda replacement windshield. Making even minor repairs within the camera's field of vision or installing an aftermarket replacement windshield may also cause the system to operate abnormally. After replacing the windshield, have a dealer recalibrate the camera. Proper calibration of the camera is necessary for the system to operate properly.

Do not place an object on the top of the instrument panel. It may reflect onto the windshield and prevent the system from detecting lane lines properly.

▶ Front Sensor Camera

If the **Some Driver Assist Systems Cannot Operate: Camera Temperature Too High** message appears:

- Use the climate control system to cool down the interior and, if necessary, also use defroster mode with the airflow directed towards the camera.
- Start driving the vehicle to lower the windshield temperature, which cools down the area around the camera.

If the **Some Driver Assist Systems Cannot Operate: Clean Front Windshield** message appears:

- Park your vehicle in a safe place, and clean the windshield. If the message does not disappear after you have cleaned the windshield and driven for a while, have your vehicle checked by a dealer.

Radar Sensor

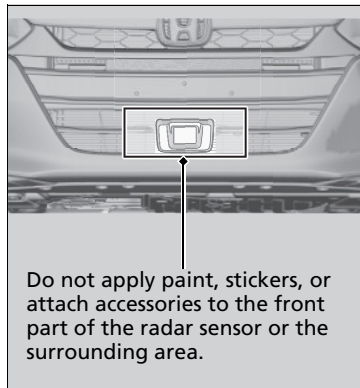
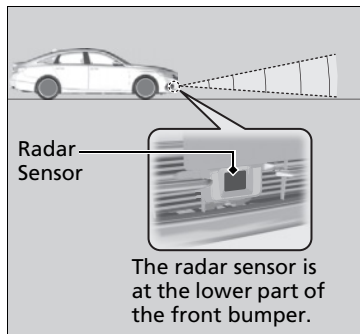

The radar sensor is at the lower part of the front bumper.

- Do not change the position of the radar sensor or any of the surrounding parts.
- Do not apply paint, stickers, or attach non-genuine accessories to the front part of the radar sensor or the surrounding area. Be particularly careful that any custom license plate frame or other accessory does not block any part of the radar beam path (see adjacent illustration).

▶▶ Radar Sensor

Avoid strong impacts to the radar sensor cover.

For the CMBS™ to work properly:

- Always keep the radar sensor cover clean.
- Never use chemical solvents or polishing powder for cleaning the sensor cover. Clean it with water or a mild detergent.
- Do not put a sticker on the radar sensor cover or replace the radar sensor cover.

If you need the radar sensor to be repaired, or removed, or the radar sensor cover is strongly impacted, turn off the system by using the safety support switch and take your vehicle to a dealer.

▶▶ **CMBS™ On and Off** P. 513

If the vehicle is involved in any of the following situations, the radar sensor may not work properly. Have your vehicle checked by a dealer:

- Your vehicle is involved in a frontal collision.
- Your vehicle drives through deep water or is submerged in deep water.
- Your vehicle strongly strikes a bump, curb, chock, or embankment that could jar the radar sensor.

Brake System

Parking Brake

Use the parking brake to keep the vehicle stationary when parked. When the parking brake is applied, you can manually or automatically release it.

Automatic transmission/Continuously variable transmission models



■ To apply

The electric parking brake can be applied any time the vehicle has battery, no matter which position the power mode is in.

Pull the electric parking brake switch up gently and securely.

- ▶ The indicator in the switch comes on.
- ▶ The parking brake indicator (red) comes on.

Manual transmission models



⊞ Braking

When you depress the brake pedal, you may hear a whirring sound from the engine compartment. This is because the brake system is in operation, and it is normal.

⊞ Parking Brake

You may hear the electric parking brake system motor operating from the rear wheel area when you apply or release the parking brake. This is normal.

The brake pedal may slightly move due to the electric parking brake system operation when you apply or release the parking brake. This is normal.

You cannot apply or release the parking brake if the battery goes dead.

➤ **Jump Starting** P. 674

If you pull up and hold the electric parking brake switch while driving, the brakes on all four wheels are applied by the VSA® system until the vehicle comes to a stop. The electric parking brake then applies, and the switch should be released.

Manual transmission models

The engine will not start unless the electric parking brake is engaged. If the vehicle stalls on a slope, the electric parking brake system may automatically engage. If it does not, engage it manually, then start the engine again.

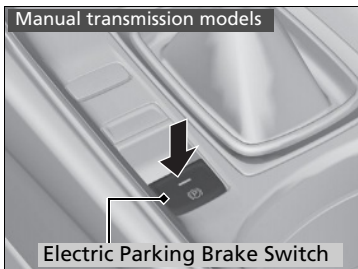
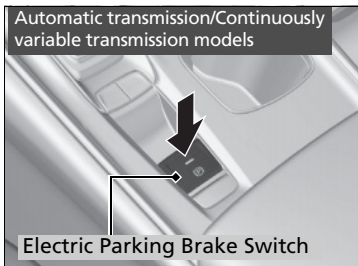

■ To release

The power mode must be in ON in order to release the electric parking brake.

1. Depress the brake pedal.
2. Press the electric parking brake switch.
 - ▶ The indicator in the switch goes off.
 - ▶ The parking brake indicator (red) goes off.

Manually releasing the parking brake using the switch helps your vehicle start slowly and smoothly when facing down hill on steep hills.

▶▶ Parking Brake

In the following situations, the parking brake automatically operates.

- When the vehicle stops with the automatic brake hold system activated for more than 10 minutes.
- When the driver's seat belt is unfastened while your vehicle is stopped and the automatic brake hold system is applied.
- When the engine is turned off while the automatic brake hold system is applied.
- When there is a problem with the automatic brake hold system while brake hold is applied.

Models with ACC with LSF

- When the vehicle is stops more than 10 minutes while ACC with LSF is activated.
- When the driver's seat belt is unfastened while your vehicle is stopped automatically by ACC with LSF.
- When the engine is turned off while ACC with LSF is activated.

Manual transmission models

- When there is a problem with the electric parking brake switch, after you set the power mode to VEHICLE OFF.

Automatic transmission/Continuously variable transmission models

Automatic parking brake feature operation

If the automatic parking brake feature has been activated:

- The parking brake is applied automatically when you set the power mode to VEHICLE OFF.
- To confirm that the parking brake is applied, check if the parking brake indicator (red) is on.
 - ➔ P. 575

To release automatically

Automatic transmission/Continuously variable transmission models

Depressing the accelerator pedal releases the parking brake.

Manual transmission models

Depress the accelerator pedal while releasing the clutch pedal releases the parking brake.

All models

Use the accelerator pedal to release the parking brake when you are starting the vehicle facing uphill, or in a traffic jam.

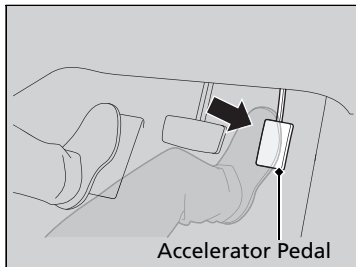

Automatic transmission/Continuously variable transmission models

Gently depress the accelerator pedal.

When on a hill, it may require more accelerator input to release.

- ▶ The indicator in the switch goes off.
- ▶ The parking brake indicator (red) goes off.

▶▶ Parking Brake

If the parking brake cannot be released automatically, release it manually.

When the vehicle is travelling uphill, the accelerator pedal may need to be pressed farther to automatically release the electric parking brake.

The parking brake cannot be released automatically while the following indicators are on:

- Malfunction indicator lamp
- Transmission indicator

The parking brake may not be released automatically while the following indicators are on:

- Brake system indicator
- VSA® system indicator
- **ABS** indicator
- Supplemental restraint system indicator

Manual transmission models

The clutch pedal is fully depressed before gently depress the accelerator pedal and release the clutch pedal.

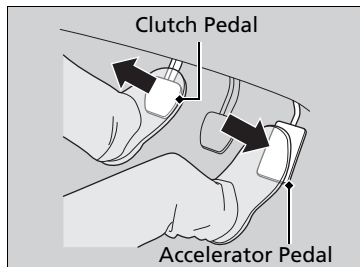

Manual transmission models

Gently depress the accelerator pedal and release the clutch pedal.

- The indicator in the switch goes off.
- The parking brake indicator (red) goes off.

The parking brake automatically releases as you depress the accelerator pedal when:

- You are wearing the driver's seat belt.
- The engine is running.

Automatic transmission/Continuously variable transmission models

- The transmission is not in **P** or **N**.

Manual transmission models

- The transmission is not in neutral.

Automatic transmission/Continuously variable transmission models**■ Activating and deactivating the automatic parking brake feature**

With the power mode is in ON, carry out the following steps to either activate or deactivate the automatic parking brake feature.

1. Put the transmission into **P**.
2. Without depressing the brake pedal, pull up and release the parking brake switch.
 - ▶ Check that the parking brake indicator (red) has come on.
3. Pull up and hold the parking brake switch. When you hear a beeping sound, release the switch and within 3 seconds pull up and hold the switch again.
4. When you hear a sound indicating that the procedure is completed, release the switch.
 - ▶ Two beeps indicates that the feature has been activated.
 - ▶ One beep indicates that the feature has been deactivated.
 - ▶ When you have completed activating the feature, the parking brake will remain applied after you turn off the engine.
 - ▶ To confirm that the parking brake is applied, check if the parking brake indicator (red) is on.

Automatic transmission models

If you need to temporarily deactivate the feature for when putting your vehicle through a conveyor type car wash, you can follow the procedure explained below.

1. Depress the brake pedal and bring the vehicle to a stop.
2. Set the power mode to VEHICLE OFF and then within 2 seconds push down the parking brake switch.
 - ▶ Activation and deactivation settings for the feature will not be affected.
 - ▶ Before temporarily deactivating the feature, make sure to first turn off both ACC with LSF and the automatic brake hold system.
 - ▶ To confirm that the parking brake is applied, check if the parking brake indicator (red) is on.

▶▶ Parking Brake

In cold climates, the parking brake may freeze in place if applied.

When parking the vehicle, chock the wheels and make sure the automatic parking brake feature is deactivated.

Also, when putting your vehicle through a conveyor-type car wash or when having your vehicle towed, deactivate the automatic parking brake feature and leave the parking brake released.

■ Foot Brake

Your vehicle is equipped with disc brakes at all four wheels. The brake assist system increases the stopping force when you depress the brake pedal hard in an emergency situation. The anti-lock brake system (ABS) helps you retain steering control when braking very hard.

➤ **Brake Assist System** P. 582

➤ **Anti-lock Brake System (ABS)** P. 581

▣ Foot Brake

Check the brakes after driving through deep water, or if there is a buildup of road surface water. If necessary, dry the brakes by lightly depressing the pedal several times.

If you hear a continuous metallic friction sound when applying the brakes, this is caused by the brake wear indicator rubbing on the brake disk and indicates that the brake pads need to be replaced. Have the vehicle checked by a dealer. If you hear only an occasional squeak or squeal when you initially apply the brake pedal, this may be normal and caused by high frequency vibration of the brake pads against the rotating brake disc.

Constantly using the brake pedal while going down a long hill builds up heat, which reduces the brake effectiveness. Apply engine braking by taking your foot off the accelerator pedal and downshifting to a lower gear/speed position. With manual transmission* use a lower gear for greater engine braking.

Do not rest your foot on the brake pedal while driving, as it will lightly apply the brakes and cause them to lose effectiveness over time and reduce pad life. It will also confuse drivers behind you.

Whenever the brakes are activated by CMBS™ or another system that automatically controls braking, the brake pedal is depressed and released in accordance with braking function.

Automatic Brake Hold

Automatic transmission/Continuously variable transmission models

Keeps the brake applied after releasing the brake pedal until the accelerator pedal is pressed. You can use this system while the vehicle is temporarily stopped, like at traffic lights and in heavy traffic.

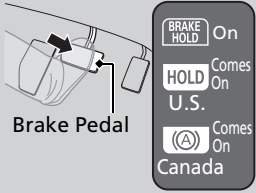
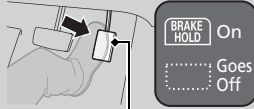
<p>■ Turning on the system</p>  <p>Automatic Brake Hold Button</p> <p>Fasten your seat belt properly, then start the engine. Press the automatic brake hold button.</p> <ul style="list-style-type: none"> • The automatic brake hold system indicator comes on. The system is turned on. 	<p>■ Activating the system</p>  <p>Brake Pedal</p> <p>Depress the brake pedal to come to a complete stop. The transmission must be in D, N, S* or L*.</p> <ul style="list-style-type: none"> • The automatic brake hold indicator comes on. Braking is kept for up to 10 minutes. • Release the brake pedal after the automatic brake hold indicator comes on. 	<p>■ Canceling the system</p>  <p>Accelerator Pedal</p> <p>Depress the accelerator pedal while the transmission must be in D, R, S* or L*. The system is canceled and the vehicle starts to move.</p> <ul style="list-style-type: none"> • The automatic brake hold indicator goes off. The system continues to be on.
--	--	---

Automatic Brake Hold

⚠ WARNING

Activating the automatic brake hold system on steep hills or slippery roads may still allow the vehicle to move if you remove your foot from the brake pedal.

If a vehicle unexpectedly moves, it may cause a crash resulting in serious injury or death.

Never activate the automatic brake hold system or rely on it to keep a vehicle from moving when stopped on a steep hill or slippery roads.

⚠ WARNING

Using the automatic brake hold system to park the vehicle may result in the vehicle unexpectedly moving.

If a vehicle moves unexpectedly, it may cause a crash, resulting in serious injury or death.

Never leave the vehicle when braking is temporarily kept by automatic brake hold and always park the vehicle by putting the transmission in **P*** and applying the parking brake.

* Not available on all models

Manual transmission models

Keeps the brake applied after releasing the brake pedal until you change a gear to a position other than neutral and:

- Release the clutch pedal on a level road or when facing downhill.
- Release the clutch pedal and depress the accelerator pedal when facing uphill.

You can use this system while the vehicle is temporarily stopped, like at traffic lights and in heavy traffic.

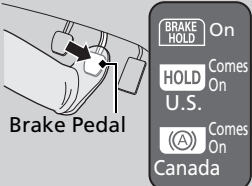
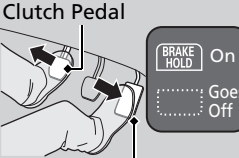
■ Turning on the system	■ Activating the system	■ Canceling the system
 <p data-bbox="119 565 295 610">Automatic Brake Hold Button</p>	 <p data-bbox="406 565 526 588">Brake Pedal</p>	 <p data-bbox="694 453 821 476">Clutch Pedal</p> <p data-bbox="734 610 917 632">Accelerator Pedal</p>
<p data-bbox="108 649 359 767">Fasten your seat belt properly, then start the engine. Press the automatic brake hold button.</p> <ul data-bbox="108 772 359 879" style="list-style-type: none"> • The automatic brake hold system indicator comes on. The system is turned on. 	<p data-bbox="402 649 654 722">Depress the brake pedal to come to a complete stop.</p> <ul data-bbox="402 728 654 935" style="list-style-type: none"> • The automatic brake hold indicator comes on. Braking is kept for up to 10 minutes. • Release the brake pedal after the automatic brake hold indicator comes on. 	<p data-bbox="694 649 933 711">Shift into one of the gears other than neutral and:</p> <ul data-bbox="694 716 933 890" style="list-style-type: none"> • Release the clutch pedal on a level road or when facing downhill. • Release the clutch pedal and depress the accelerator pedal when facing uphill. <p data-bbox="694 896 933 957">The system is canceled and the vehicle starts to move.</p> <ul data-bbox="694 963 933 1041" style="list-style-type: none"> • The automatic brake hold indicator goes off. The system releases the brake automatically.

■ The system automatically cancels when:

- You engage the parking brake.

Automatic transmission/Continuously variable transmission models

- You depress the brake pedal and put the transmission into **P** or **R**.

All models

■ The system automatically cancels and the parking brake is applied when:

- Braking is kept for more than 10 minutes.
- The driver's seat belt is unfastened.
- The engine is turned off.
- **Brake Hold System Problem. Apply Brake When Stopped. See Your Dealer.** appears on the driver information interface.
- There is a problem with automatic brake hold system.

Manual transmission models

- The engine stalls.

Automatic Brake Hold

While the system is activated, you can turn off the engine or park the vehicle through the same procedure as you normally do.

When Stopped P. 583

Whether the system is on, or the system is activated, the automatic brake hold turns off once the engine is off.

Manual transmission models

The system turns off if the engine stalls while automatic brake hold is active or the system is on.

■ Turning off the automatic brake hold system

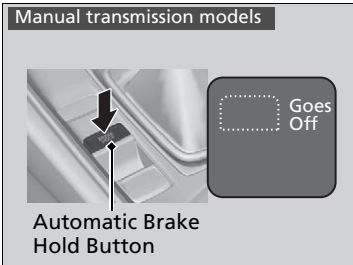
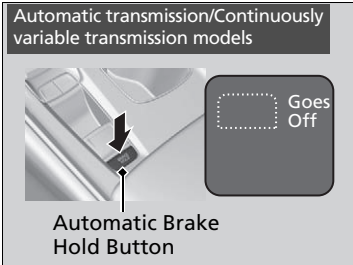

While the system is on, press the automatic brake hold button again.

- The automatic brake hold system indicator goes off.

If you want to turn off automatic brake hold while the system is in operation, press the automatic brake hold button with the brake pedal depressed.

►► Turning on the system

Make sure to turn off the automatic brake hold system before using an automated car wash.

You may hear an operating noise if the vehicle moves while the automatic brake hold system is in operation.

Anti-lock Brake System (ABS)

■ ABS

Helps prevent the wheels from locking up, and helps you retain steering control by pumping the brakes rapidly, much faster than you.

The electronic brake distribution (EBD) system, which is part of the ABS, also balances the front-to-rear braking distribution according to vehicle loading.

You should never pump the brake pedal. Let the ABS work for you by always keeping firm, steady pressure on the brake pedal. This is sometimes referred to as “stomp and steer.”

■ ABS operation

The brake pedal may pulsate slightly when the ABS is working. Keep holding the pedal firmly down. On dry pavement, you will need to press on the brake pedal very hard before the ABS activates. However, you may feel the ABS activate immediately if you are trying to stop on snow or ice.

ABS may activate when you depress the brake pedal when driving on:

- Wet or snow covered roads.
- Roads paved with stone.
- Roads with uneven surfaces, such as potholes, cracks, manholes, etc.

When the vehicle speed goes under 6 mph (10 km/h), the ABS stops.

* Not available on all models

ⓘ Anti-lock Brake System (ABS)

NOTICE

The ABS may not function correctly if you use a tire of the wrong size or type.

If the **ABS** indicator comes on while driving, there may be a problem with the system. While normal braking will not be affected, there is a possibility that the ABS will not be operating. Have your vehicle checked by a dealer immediately.

The ABS is not designed for the purpose of reducing the time or distance it takes for a vehicle to stop: It is designed to limit brake lockup which can lead to skidding and loss of steering control.

In the following cases, your vehicle may need more distance to stop than a vehicle without the ABS:

- You are driving on rough or uneven road surfaces, such as gravel or snow.
- The tires are equipped with snow chains*.

The following may be observed with the ABS system:

- Motor sounds coming from the engine compartment when the brakes are applied, or when system checks are being performed after the engine has been started and while the vehicle accelerates.
- Brake pedal and/or the vehicle body vibration when ABS activates.

These vibrations and sounds are normal to ABS systems and are no cause for concern.

Brake Assist System

■ Brake Assist System

Designed to assist the driver by generating greater braking force when you depress the brake pedal hard during emergency braking.

■ Brake assist system operation

Press the brake pedal firmly for more powerful braking.

When brake assist operates, the pedal may wiggle slightly and an operating noise may be heard. This is normal. Keep holding the brake pedal firmly down.

When Stopped

1. Depress the brake pedal firmly.
2. With the brake pedal depressed, pull up the electric parking brake switch slowly, but fully.

Automatic transmission/Continuously variable transmission models

3. Put the transmission into **P**.

Manual transmission models

3. Put the transmission into **R** or **1**.

All models

4. Turn off the engine.
 - ▶ The parking brake indicator (red) goes off in about 30 seconds.

Always confirm the electric parking brake is set, in particular if you are parked on an incline.

» Parking Your Vehicle

Automatic transmission/Continuously variable transmission models

⚠ WARNING

The vehicle can roll away if left unattended without confirming that Park is engaged.

A vehicle that rolls away could cause a crash resulting in serious injury or death.

Always keep your foot on the brake pedal until you have confirmed that **P** is shown on the gear position indicator.

Do not park your vehicle near flammable objects, such as dry grass, oil, or timber. Heat from the exhaust can cause a fire.

»» When Stopped

Automatic transmission/Continuously variable transmission models

NOTICE

The following can damage the transmission:

- Depressing the accelerator and brake pedals simultaneously.
- Holding the vehicle in place when facing uphill by depressing the accelerator pedal.
- Putting the transmission into **P** before the vehicle stops completely.

In extremely cold temperatures, the parking brake may freeze up if applied. If such temperatures are expected, do not apply the parking brake but, if parking on a slope, either turn the front wheels so they will contact the curb if the vehicle rolls down the slope or block the wheels to keep the vehicle from moving. If you do not take either precaution, the vehicle may roll unexpectedly, leading to a crash.

Parking Sensor System*

The corner and center sensors monitor obstacles around your vehicle, and the beeper, driver information interface and audio/information screen let you know the approximate distance between your vehicle and the obstacle.

■ The sensor location and range

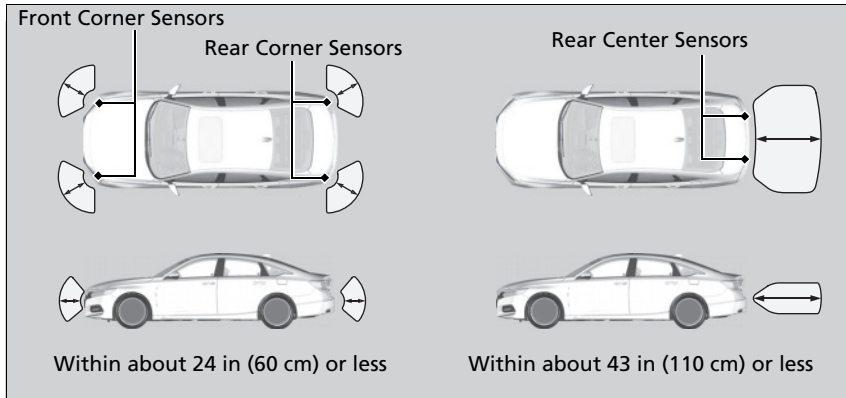

⊠ Parking Sensor System*

Even when the system is on, always confirm if there is no obstacle near your vehicle before parking.

The system may not work properly when:

- The sensors are covered with snow, ice, mud or dirt.
- The vehicle is on uneven surface, such as grass, bumps, or a hill.
- The vehicle has been out in hot or cold weather.
- The system is affected by devices that emit ultrasonic waves.
- Driving in bad weather.

The system may not sense:

- Thin or low objects.
- Sonic-absorptive materials, such as snow, cotton, or sponge.
- Objects directly under the bumper.

Do not put any accessories on or around the sensors.

* Not available on all models

■ Parking sensor system on and off

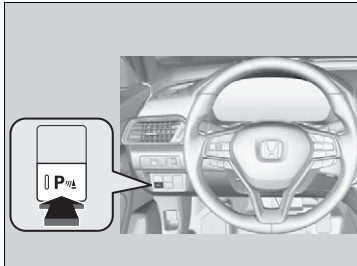

With the power mode in ON, press the parking sensor system button to turn on or off the system. The indicator in the button comes on when the system is on.

The front corner, rear corner and rear center sensors start to detect an obstacle when the transmission is in **[R]**, and the vehicle speed is less than 5 mph (8 km/h).

The front corner sensors start to detect an obstacle when the transmission is in any position other than **[P]**, and the vehicle speed is less than 5 mph (8 km/h).

▶▶ Parking Sensor System *

When you set the power mode to ON, the system will be in the previously selected condition.

■ Screen Operation

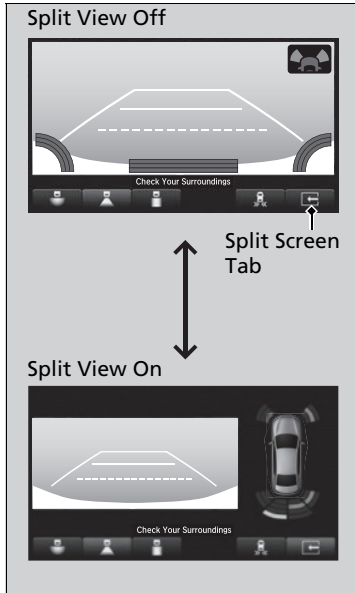



You can switch between split view off and split view on by touching the split screen tab.

☒ Screen Operation

The split screen tab disappears, and the split view returns to the last camera view mode under the following conditions:

- If the parking sensor system is turned off.
- If there is a malfunction in the system.

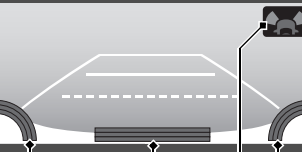
■ When the distance between your vehicle and obstacles behind becomes shorter

Length of the intermittent beep	Distance between the Bumper and Obstacle		Indicator	Audio/Information Screen
	Corner Sensors	Center Sensors		
Moderate	—	Rear: About 43-24 in (110-60 cm)	Comes on in Yellow*1	
Short	About 24-18 in (60-45 cm)	About 24-18 in (60-45 cm)	Comes on in Amber	
Very short	About 18-14 in (45-35 cm)	About 18-14 in (45-35 cm)		
Continuous	About 14 in (35 cm) or less	About 14 in (35 cm) or less	Comes on in Red	 

*1: At this stage, only the center sensors detect obstacles.

■ Turning off All Rear Sensors

1. Make sure that the parking sensor system is not activated. Set the power mode to VEHICLE OFF.
2. Press and hold the parking sensor system button, and set the power mode to ON.
3. Keep pressing the button for ten seconds. Release the button when the indicator in the button blinks.
 - ▶ The beeper sounds once.
4. Press the button again. The indicator in the button goes off.
 - ▶ The beeper sounds twice. The rear sensors are now turned off.

To turn the rear sensors on again, follow the above procedure. The beeper sounds three times when the rear sensors come back on.

☒ Turning off All Rear Sensors

When you put the transmission into [R], the indicator in the parking sensor system button blinks as a reminder that the rear sensors have been turned off.

Cross Traffic Monitor*

Monitors the rear corner areas using the radar sensors when reversing, and alerts you if a vehicle approaching from a rear corner is detected.

The system is convenient when you are backing out of a parking space.

ⓘ Cross Traffic Monitor*

CAUTION

Cross Traffic Monitor cannot detect all approaching vehicles and may not detect an approaching vehicle at all.

Failure to visually confirm that it is safe to back up the vehicle before doing so may result in a collision.

Do not solely rely on the system when reversing; always also use your mirrors, and look behind and to the sides of your vehicle before reversing.

Models with parking sensor system

The parking sensor system's alerting buzzer overrides the Cross Traffic Monitor buzzer when the sensors are detecting obstacles at the closest range.

How the System Works

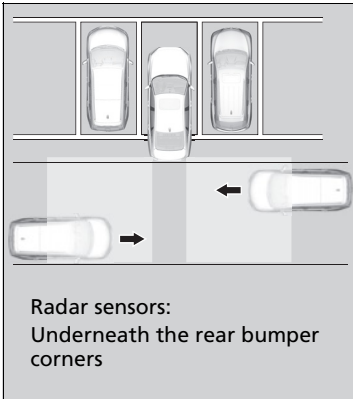

The system activates when:

- The power mode is in ON.
- The Cross Traffic Monitor system is turned on.
 - ▶ **Cross Traffic Monitor On and Off** P. 593
- The transmission is in **R**.
- Your vehicle is moving at 3 mph (5 km/h) or lower.

When a vehicle is detected approaching from a rear corner, Cross Traffic Monitor alerts you with a buzzer and a displayed warning.

The system will not detect a vehicle that approaches from directly behind your vehicle, nor will it provide alerts about a detected vehicle when it moves directly behind your vehicle.

The system does not provide alerts for a vehicle that is moving away from your vehicle, and it may alert for pedestrians, bicycles, or stationary objects.

⊠ Cross Traffic Monitor*

Cross Traffic Monitor may not detect or may delay alerting an approaching vehicle, or may alert without an approaching vehicle under the following conditions:

- An obstacle, such as another vehicle and a wall, near your vehicle's rear bumper, is blocking the radar sensor's scope.
- Your vehicle is moving at the speed of about 3 mph (5 km/h) or higher.
- A vehicle is approaching at the speed other than between about 6 mph (10 km/h) and 16 mph (25 km/h).
- The system picks up external interference such as other radar sensors from another vehicle or strong radio wave transmitted from a facility nearby.
- Either corner of the rear bumper is covered with snow, ice, mud or dirt.
- When there is bad weather.
- Your vehicle is on an incline.
- Your vehicle is tilted due to a heavy load in the rear.
- Your vehicle is reversing towards a wall, a pole, a vehicle, and so on.

The rear bumper or the sensors have been improperly repaired or the rear bumper has been deformed. Have your vehicle checked by a dealer.

For proper operation, always keep the rear bumper corner area clean. Do not cover the rear bumper corner area with labels or stickers of any kind.

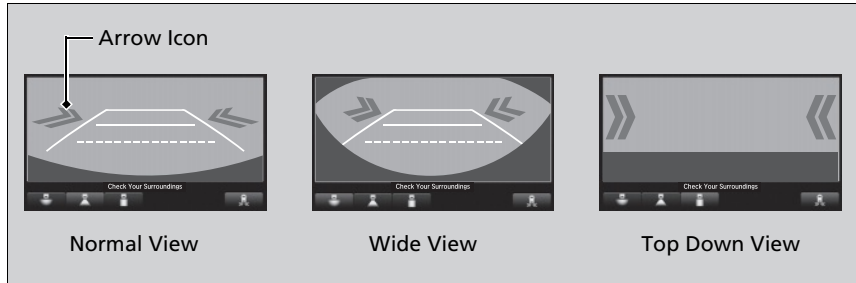

* Not available on all models

■ When the System Detects a Vehicle



An arrow icon appears on the side a vehicle is approaching on the audio/information screen.

▶▶ When the System Detects a Vehicle

If the  on the lower right changes to  in amber when the transmission is in **R**, mud snow or ice may have accumulated in the vicinity of the sensor. The system is temporarily canceled. Check the bumper corners for any obstructions, and thoroughly clean the area if necessary.

If the  comes on when the transmission is in **R**, there may be a problem with the Cross Traffic Monitor system. Do not use the system and have your vehicle checked by a dealer.

If the display remains the same with the transmission in **R**, there may be a problem with the rear camera system and the Cross Traffic Monitor system. Do not use the system and have your vehicle checked by a dealer.

■ Cross Traffic Monitor On and Off

You can switch on and off the system using the audio/information screen.

1. Press the  button.
2. Select **Settings**.
3. Select **Camera**.
4. Select **Cross Traffic Monitor**.
5. Select **ON** or **OFF**, then select **Save**.

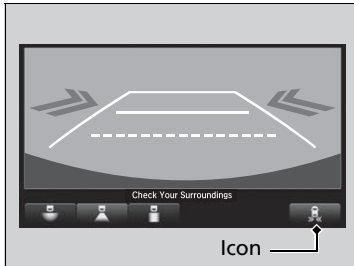

The system can also be turned on and off on the audio/information screen by pressing the CTM icon.

About Your Multi-View Rear Camera

The audio/information screen can display your vehicle's rear view. The display automatically changes to the rear view when the transmission is put into **R**.

Multi-View Rear Camera Display Area

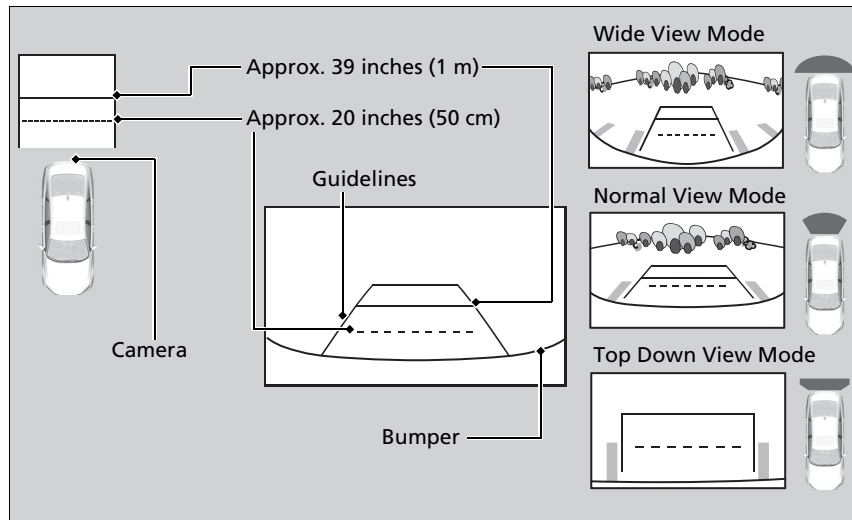

*1 : Models with color audio
*2 : Models with Display Audio

About Your Multi-View Rear Camera

The rear camera view is restricted. You cannot see the corner ends of the bumper or what is underneath the bumper. Its unique lens also makes objects appear closer or farther than they actually are.

Visually confirm that it is safe to drive before backing up. Certain conditions (such as weather, lighting, and high temperatures) may also restrict the rear view. Do not rely on the rearview display which does not give you all information about conditions at the back of your vehicle.

If the camera lens is covered with dirt or moisture, use a soft, moist cloth to keep the lens clean and free of debris.

You can change the **Fixed Guideline** and **Dynamic Guideline** settings.

Customized Features P. 370, 381

Fixed Guideline

On^{*1}/**ON**^{*2}: Guidelines appear when you put the transmission into **R**.

Off^{*1}/**OFF**^{*2}: Guidelines do not appear.

Dynamic Guideline



On^{*1}/**ON**^{*2}: Guidelines move according to the steering wheel direction.

Off^{*1}/**OFF**^{*2}: Guidelines do not move.

You can view three different camera modes on the audio/information screen.



Models with color audio

Press the preset button(1-3) under the appropriate icon to switch the mode.

- : Wide view mode
- : Normal view mode
- : Top down view mode

Models with Display Audio

Touch the appropriate icon to switch the mode.

- : Wide view mode
- : Normal view mode
- : Top down view mode

Models with color audio

- If you were last using Wide view mode or Normal view mode, the same view mode will be activated the next time you put the transmission into **R**.
- If you were using Top down view mode before you turned off the engine, Wide view mode will be activated the next time you set the power mode to ON and put the transmission into **R**.
- If you were using Top down view mode and 10 seconds elapsed after you took the transmission out of **R**, Wide view mode will be activated the next time you put the transmission into **R**.

Models with Display Audio

- If you were last using Wide view mode or Normal view mode, the same view mode will be activated the next time you put the transmission into **[R]**.
- If you were using Top down view mode before turning off the engine, the next time you set the power mode to ON and put the transmission into **[R]**, the view mode you were using just before using Top down view mode (Wide view mode or Normal view mode) will be activated.
- If you were using Top down view mode and 10 seconds elapsed after you took the transmission out of **[R]**, the view mode you were using just before selecting Top down view mode (Wide view mode or Normal view mode) will be activated the next time you put the transmission into **[R]**.

Fuel Information

■ Fuel recommendation

Unleaded gasoline, pump octane number 87 or higher

Use of a lower octane gasoline can cause a persistent, heavy metallic knocking noise that can lead to engine damage.

■ Top tier detergent gasoline

Because the level of detergency and additives in gasoline vary in the market, Honda endorses the use of “TOP TIER Detergent Gasoline” where available to help maintain the performance and reliability of your vehicle. TOP TIER Detergent Gasoline meets a new gasoline standard jointly established by leading automotive manufacturers to meet the needs of today’s advanced engines.

Qualifying gasoline retailers will, in most cases, identify their gasoline as having met “TOP TIER Detergent Gasoline” standards at the retail location. This fuel is guaranteed to contain the proper level of detergent additives and be free of metallic additives. The proper level of detergent additives, and absence of harmful metallic additives in gasoline, help avoid build-up of deposits in your engine and emission control system.

For further important fuel-related information for your vehicle, or on information on gasoline that does not contain MMT, visit www.hondacars.com. In Canada, visit www.honda.ca for additional information on gasoline. For more information on top tier gasoline, visit www.toptiergas.com.

■ Fuel tank capacity: 14.8 US gal (56 L)

⌘ Fuel Information

NOTICE

We recommend quality gasoline containing detergent additives that help prevent fuel system and engine deposits. In addition, in order to maintain good performance, fuel economy, and emissions control, we strongly recommend the use of gasoline that does NOT contain harmful manganese-based fuel additives such as MMT, if such gasoline is available.

Use of gasoline with these additives may adversely affect performance, and cause the malfunction indicator lamp on your instrument panel to come on. If this happens, contact a dealer for service. Some gasoline today is blended with oxygenates such as ethanol. Your vehicle is designed to operate on oxygenated gasoline containing up to 15% ethanol by volume. Do not use gasoline containing methanol. If you notice any undesirable operating symptoms, try another service station or switch to another brand of gasoline.

How to Refuel

Your fuel tank is not equipped with a fuel filler cap. You can insert the filler nozzle directly into the filler neck. The tank seals itself again when you pull out the filler nozzle.

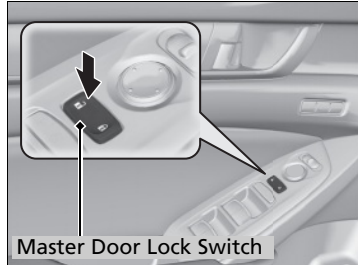

1. Stop your vehicle with the service station pump on the left side of the vehicle in the rear.
2. Turn off the engine.
3. Unlock the driver's door using the master door lock switch.
 - ▶ The fuel fill door on the outer side of the vehicle will unlock.

🔓 Using the Master Door Lock Switch

P. 178

4. Press the area indicated by the arrow to release the fuel fill door. You will hear a click.

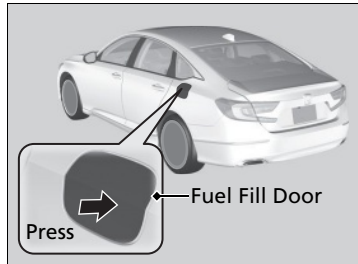

🔓 How to Refuel

⚠️ WARNING

Gasoline is highly flammable and explosive. You can be burned or seriously injured when handling fuel.

- Stop the engine, and keep heat, sparks, and flame away.
- Handle fuel only outdoors.
- Wipe up spills immediately.

The fuel filler opening is designed to accept only service station filler nozzles for refueling. Use of smaller diameter tubes (e.g., those used to siphon fuel for other uses) or other non-service station devices can damage the area in and around the filler opening.

Use the master door lock switch to unlock the fuel fill door.

The vehicle doors and fuel fill door automatically relock if the remote unlock function is used. This can be deactivated by briefly opening then closing the driver's door.

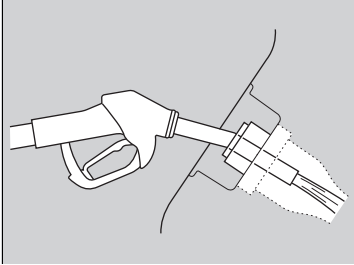

5. Place the end of the filler nozzle on the lower part of filler opening, then insert it slowly and fully.
 - ▶ Make sure that the end of the filler nozzle goes down along with the filler pipe.
 - ▶ Keep the filler nozzle level.
 - ▶ When the tank is full, the filler nozzle will click off automatically.
 - ▶ After filling, wait about five seconds before removing the filler nozzle.
6. Shut the fuel fill door by hand.

How to Refuel

The filler nozzle automatically stops to leave space in the fuel tank so that fuel does not overflow as a result of changes in air temperature.

If the filler nozzle keeps turning off when the tank is not full, there may be a problem with the pump's fuel vapor recovery system. Try filling at another pump. If this does not fix the problem, consult a dealer.

Do not continue to add fuel after the filler nozzle has automatically stopped. Additional fuel can exceed the full tank capacity.

If you have to refuel your vehicle from a portable container, use the funnel provided with your vehicle.

▶ Refueling From a Portable Fuel Container
P. 697

Improving Fuel Economy and Reducing CO₂ Emissions

Achieving fuel economy and reducing CO₂ emissions is dependent on several factors, including driving conditions, load weight, idling time, driving habits, and vehicle condition. Depending on these and other factors, you may not achieve the rated fuel economy of this vehicle.

Maintenance and Fuel Economy

You can optimize your fuel economy with proper maintenance of your vehicle. Always maintain your vehicle in accordance with the messages displayed on the driver information interface.

- Use the recommended viscosity engine oil, displaying the API Certification Seal.
- Maintain the specified tire pressure.
- Do not load the vehicle with excess cargo.
- Keep your vehicle clean. A buildup of snow or mud on your vehicle's underside adds weight and increases wind resistance.

Improving Fuel Economy and Reducing CO₂ Emissions

Direct calculation is the recommended method to determine actual fuel consumed while driving.

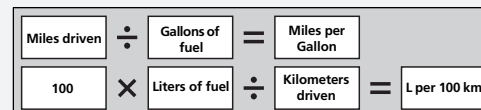

In Canada, posted fuel economy numbers are established following a simulated test. For more information on how this test is performed, please visit <http://oee.nrcan.gc.ca/>

Handling Precautions

The turbocharger is a high-precision device to obtain greater horsepower by delivering a large volume of compressed air into the engine using a turbine driven by the engine's exhaust gas pressure.

- When the engine is cold just after starting, avoid revving the engine or sudden acceleration.
- Always replace the engine oil and engine oil filter according to the Maintenance Minder. The turbine rotates at very high speeds over 100,000 rpm and its temperature reaches over 1,292°F (700°C). It is lubricated and cooled by engine oil. If you fail to replace the engine oil and filter at the scheduled distance or interval, deteriorated engine oil may cause failure such as sticking and abnormal noise of the turbine bearing.

☒ Turbo Engine Vehicle

The scheduled maintenance intervals for replacing the filter is indicated on the driver information interface. Follow the information of when to replace them.

☒ **Maintenance Minder™** P. 607

The temperature gauge pointer is at the **H** mark when you restart the engine after driving under high load conditions such as at high speed or in hilly terrain. This is normal. The gauge goes down after you idle or drive the vehicle for about one minute.

Maintenance

This chapter discusses basic maintenance.



Before Performing Maintenance

Inspection and Maintenance	604
Safety When Performing Maintenance.....	605
Parts and Fluids Used in Maintenance	
Service	606

Maintenance Minder™

607

Maintenance Under the Hood

Maintenance Items Under the Hood.....	614
Opening the Hood	616
Recommended Engine Oil	617
Oil Check	618
Adding Engine Oil	620
Changing the Engine Oil and Oil Filter	621

Engine Coolant	625
Transmission Fluid	627
Brake/Clutch* Fluid	629
Refilling Window Washer Fluid.....	630
Replacing Light Bulbs	631
Checking and Maintaining Wiper	
Blades	639
Checking and Maintaining Tires	
Checking Tires	642
Tire and Loading Information Label.....	643
Tire Labeling	643
DOT Tire Quality Grading (U.S. Vehicles).....	645
Wear Indicators.....	647

Tire Service Life	647
Tire and Wheel Replacement	648
Tire Rotation	649
Winter Tires	650
Battery	651
Remote Transmitter Care	
Replacing the Button Battery	653
Climate Control System Maintenance	654
Cleaning	
Interior Care	655
Exterior Care.....	657
Accessories and Modifications	660

* Not available on all models

Inspection and Maintenance

For your safety, perform all listed inspections and maintenance to keep your vehicle in good condition. If you become aware of any abnormality (noise, smell, insufficient brake fluid, oil residue on the ground, etc.), have your vehicle inspected by a dealer. (Note, however, that service at a dealer is not mandatory to keep your warranties in effect.)

Types of Inspection and Maintenance

■ Daily inspections

Perform inspections before long distance trips, when washing the vehicle, or when refueling.

■ Periodic inspections

- Check the brake fluid level monthly.
 - **Brake/Clutch* Fluid** P. 629
- Check the tire pressure monthly. Examine the tread for wear and foreign objects.
 - **Checking and Maintaining Tires** P. 642
- Check the operation of the exterior lights monthly.
 - **Replacing Light Bulbs** P. 631
- Check the condition of the wiper blades at least every six months.
 - **Checking and Maintaining Wiper Blades** P. 639

» Inspection and Maintenance

U.S. models

Maintenance, replacement, or repair of emissions control devices and systems may be done by any automotive repair establishment or individuals using parts that are “certified” to EPA standards.

According to state and federal regulations, failure to perform maintenance on the maintenance main items marked with # will not void your emissions warranties. However, all maintenance services should be performed in accordance with the intervals indicated by the driver information interface.

➤ **Maintenance Service Items** P. 611

If you want to perform complex maintenance tasks that require more skills and tools, you can purchase a subscription to the Service Express website at www.techinfo.honda.com.

➤ **Authorized Manuals** P. 711

If you want to perform maintenance yourself, make sure that you have the necessary tools and skills first. After performing maintenance, update the records in the separate maintenance booklet.

Safety When Performing Maintenance

Some of the most important safety precautions are given here.

However, we cannot warn you of every conceivable hazard that can arise in performing maintenance. Only you can decide whether you should perform a given task.

Maintenance Safety

- To reduce the possibility of fire or explosion, keep cigarettes, sparks, and flames away from the battery and all fuel related parts.
- Never leave rags, towels, or other flammable objects under the hood.
 - ▶ Heat from the engine and exhaust can ignite them, causing a fire.
- To clean parts, use a commercially available degreaser or parts cleaner, not gasoline.
- Wear eye protection and protective clothing when working with the battery or compressed air.
- Engine exhaust contains carbon monoxide, which is poisonous and can kill you.
 - ▶ Only operate the engine if there is sufficient ventilation.

Vehicle Safety

- The vehicle must be in a stationary condition.
 - ▶ Make sure your vehicle is parked on level ground, the parking brake is set, and the engine is off.
- Be aware that hot parts can burn you.
 - ▶ Make sure to let the engine and exhaust system cool thoroughly before touching vehicle parts.
- Be aware that moving parts can injure you.
 - ▶ Do not start the engine unless instructed, and keep your hands and limbs away from moving parts.

⚠ Safety When Performing Maintenance

⚠ WARNING

Improperly maintaining this vehicle or failing to correct a problem before driving can cause a crash in which you can be seriously hurt or killed.

Always follow the inspection and maintenance recommendations according to the schedules in this owner's manual.

⚠ WARNING

Failure to properly follow maintenance instructions and precautions can cause you to be seriously hurt or killed.

Always follow the procedures and precautions in this owner's manual.

Parts and Fluids Used in Maintenance Service

The use of Honda genuine parts and fluids is recommended when maintaining and servicing your vehicle. Honda genuine parts are manufactured according to the same high quality standards used in Honda vehicles.

▶▶ Parts and Fluids Used in Maintenance Service

2.0 L engine models

Do not press the engine cover forcibly. This may damage the engine cover and component parts.



If the engine oil life is less than 15%, you will see the Maintenance Minder messages appear on the driver information interface every time you set the power mode to ON. The messages notify you when to change the engine oil, or when to bring your vehicle to a dealer for indicated maintenance services.

To Use Maintenance Minder™

■ Displaying the Maintenance Minder Information

Maintenance items, which should be serviced at the same time that you replace the engine oil, appear on the driver information interface.

You can view them on the engine oil life screen at any time.

1. Set the power mode to ON.
2. Press the  (home) button.
3. Roll the left selector wheel until  is displayed.
4. Press the left selector wheel to go to the **Maintenance Minder** screen. The engine oil life appears on the driver information interface along with maintenance items due soon.

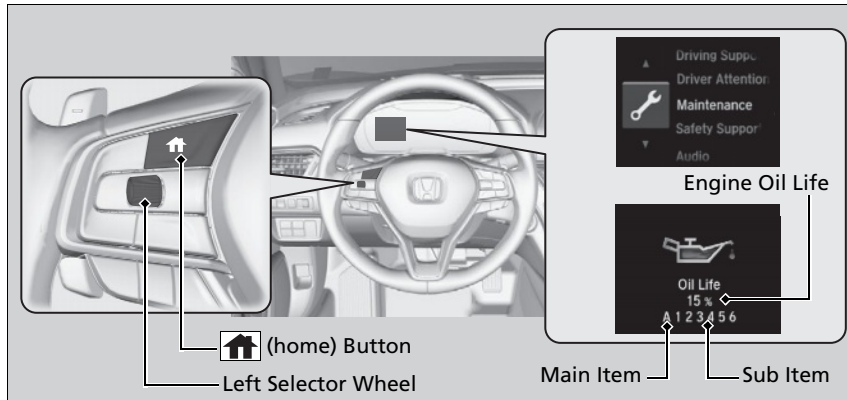

►► Displaying the Maintenance Minder Information



Based on the engine operating conditions, the remaining engine oil life is calculated and displayed as a percentage.





Displayed Engine Oil Life (%)	Calculated Engine Oil Life (%)
100	100 to 91
90	90 to 81
80	80 to 71
70	70 to 61
60	60 to 51
50	50 to 41
40	40 to 31
30	30 to 21
20	20 to 16
15	15 to 11
10	10 to 6
5	5 to 1
0	0

There is a list of maintenance main and sub items you can view on the driver information interface.

► **Maintenance Service Items** P. 611

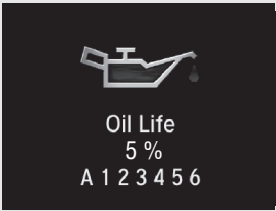
Maintenance Minder Messages on the Driver Information Interface

Maintenance Message	Oil Life Display	Explanation	Information
-	 <p>Oil Life 100 % A 1 2 3 4 5 6</p>	When you select the Maintenance Minder screen, it displays codes for maintenance items due at the next engine oil change, along with the percentage of engine oil life remaining.	-
Maintenance Due Soon 	15 %  <p>Oil Life 15 % A 1 2 3 4 5 6</p>	The engine oil life indicator starts to appear along with other due-soon maintenance item codes when the remaining oil life drops to 15 percent.	The engine oil is approaching the end of its service life.

Maintenance Message	Oil Life Display	Explanation	Information
Maintenance Due Now  Maintenance Due Now	5 % 	The remaining engine oil life is 5 to 1 percent. Press the  (home) button to switch to another display.	The engine oil has almost reached the end of its service life, and the maintenance items should be inspected and serviced as soon as possible.
Maintenance Past Due  10 miles Maintenance Past Due A 1 2 3 4 5	Negative Distance 	The engine oil has passed its service life, and a negative distance appears after driving over 10 miles (U.S. models) or 10 km (Canadian models). The negative distance on the display blinks.	The engine oil life has passed. The maintenance items must be inspected and serviced immediately.

The system message indicator (④) comes on along with the Maintenance Minder message.

Maintenance Service Items

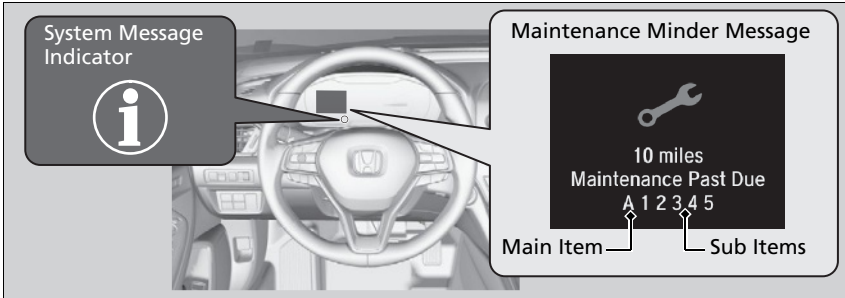

⊞ Maintenance Service Items

- Adjust the valves during services A, B, 1, 2, or 3 if they are noisy.

U.S. models

CODE	Maintenance Main Items
A	<ul style="list-style-type: none"> • Replace engine oil*1
B	<ul style="list-style-type: none"> • Replace engine oil*1 and oil filter • Inspect front and rear brakes • Inspect tie rod ends, steering gearbox, and boots • Inspect suspension components • Inspect driveshaft boots • Inspect brake hoses and lines (Including ABS/VA®) • Inspect all fluid levels and condition of fluids • Inspect exhaust system# • Inspect fuel lines and connections#

*1: If a Maintenance Minder message does not appear more than 12 months after the display is reset, change the engine oil every year.

#: See information on maintenance and emissions warranty in the first column on page 709.

*2: If you drive in dusty conditions, replace the air cleaner element every 15,000 miles (24,000 km).

*3: If you drive primarily in urban areas that have high concentrations of soot in the air from industry and from diesel-powered vehicles, replace the dust and pollen filter every 15,000 miles (24,000 km).

CODE	Maintenance Sub Items
1	<ul style="list-style-type: none"> • Rotate tires
2	<ul style="list-style-type: none"> • Replace air cleaner element*2 • Replace dust and pollen filter*3 • Inspect drive belt
3	<ul style="list-style-type: none"> • Replace transmission fluid*4
4	<ul style="list-style-type: none"> • Replace spark plugs • Inspect valve clearance
5	<ul style="list-style-type: none"> • Replace engine coolant
7	<ul style="list-style-type: none"> • Replace brake fluid*6

*4: Continuously variable transmission models

Driving in mountainous areas at very low vehicle speeds results in higher transmission temperatures. This requires transmission fluid changes more frequently than recommended by the Maintenance Minder. If you regularly drive your vehicle under these conditions, have the transmission fluid changed every 25,000 miles (40,000 km).

*5: If a Maintenance Minder message does not appear more than 36 months after the display for item 7 is reset, change the brake fluid every 3 years.

Continued

►► Maintenance Service Items

- Adjust the valves during services A, 0, 9, 1, 2, or 3 if they are noisy.

Canadian models

CODE	Maintenance Main Items
A	• Replace engine oil* ¹
0	• Replace engine oil* ¹ and oil filter



- *1: If a Maintenance Minder Message does not appear more than 12 months after the display is reset, change the engine oil every year.
- *2: If you drive in dusty conditions, replace the air cleaner element every 15,000 miles (24,000 km).
- *3: If you drive primarily in urban areas that have high concentrations of soot in the air from industry and from diesel-powered vehicles, replace the dust and pollen filter every 15,000 miles (24,000 km).
- *4: **Continuously variable transmission models**
Driving in mountainous areas at very low vehicle speeds results in higher transmission temperatures. This requires transmission fluid changes more frequently than recommended by the Maintenance Minder. If you regularly drive your vehicle under these conditions, have the transmission fluid changed every 25,000 miles (40,000 km).
- *5: If a Maintenance Minder Message does not appear more than 36 months after the display for item 7 is reset, change the brake fluid every 3 years.
- #: See information on maintenance and emissions warranty in the first column on page 709.

CODE	Maintenance Sub Items
1	• Rotate tires
2	• Replace air cleaner element* ² • Replace dust and pollen filter* ³ • Inspect drive belt
3	• Replace transmission fluid* ⁴
4	• Replace spark plugs • Inspect valve clearance
5	• Replace engine coolant
7	• Replace brake fluid* ⁶
9	• Service front and rear brakes • Inspect tie rod ends, steering gear box, and boots • Inspect suspension components • Inspect driveshaft boots • Inspect brake hoses and lines (including ABS/VSA®) • Inspect all fluid levels and condition of fluids • Inspect exhaust system # • Inspect fuel lines and connections #

Resetting the Display

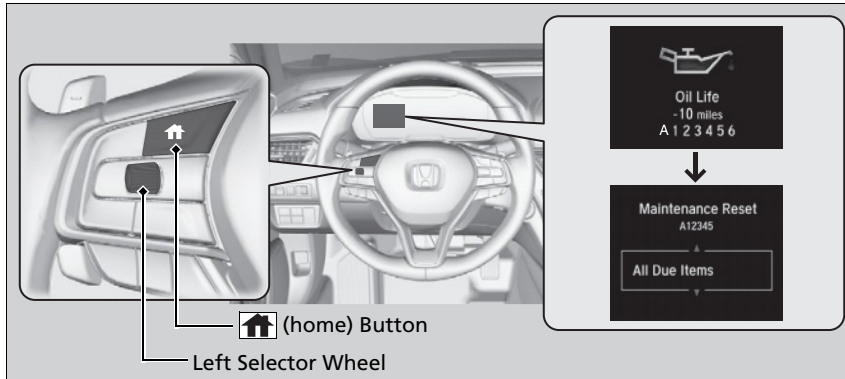
Reset the maintenance minder information display if you have performed the maintenance service.



1. Set the power mode to ON.
2. Press the  (home) button.
3. Roll the left selector wheel until  is displayed.
4. Press the left selector wheel to go to the **Maintenance Minder** screen.
5. Press the left selector wheel to enter the reset mode.
6. Roll the left selector wheel select a maintenance item to reset, or to select **All Due Items** (You can also select **Cancel** to end the process).
7. Press the left selector wheel to reset the selected item.
8. Repeat from step 5 for other items you wish to reset.

Resetting the Display

NOTICE

Failure to reset the Maintenance Minder™ display after a maintenance service results in the system showing incorrect maintenance intervals, which can lead to serious mechanical problems.

The dealer will reset the Maintenance Minder™ display after completing the required maintenance service. If someone other than a dealer performs maintenance service, reset the Maintenance Minder™ display yourself.

Models with Display Audio

You can reset the Maintenance Minder™ display using the audio/information screen.

▶ **Customized Features** P. 381

Maintenance Items Under the Hood

1.5 L engine models

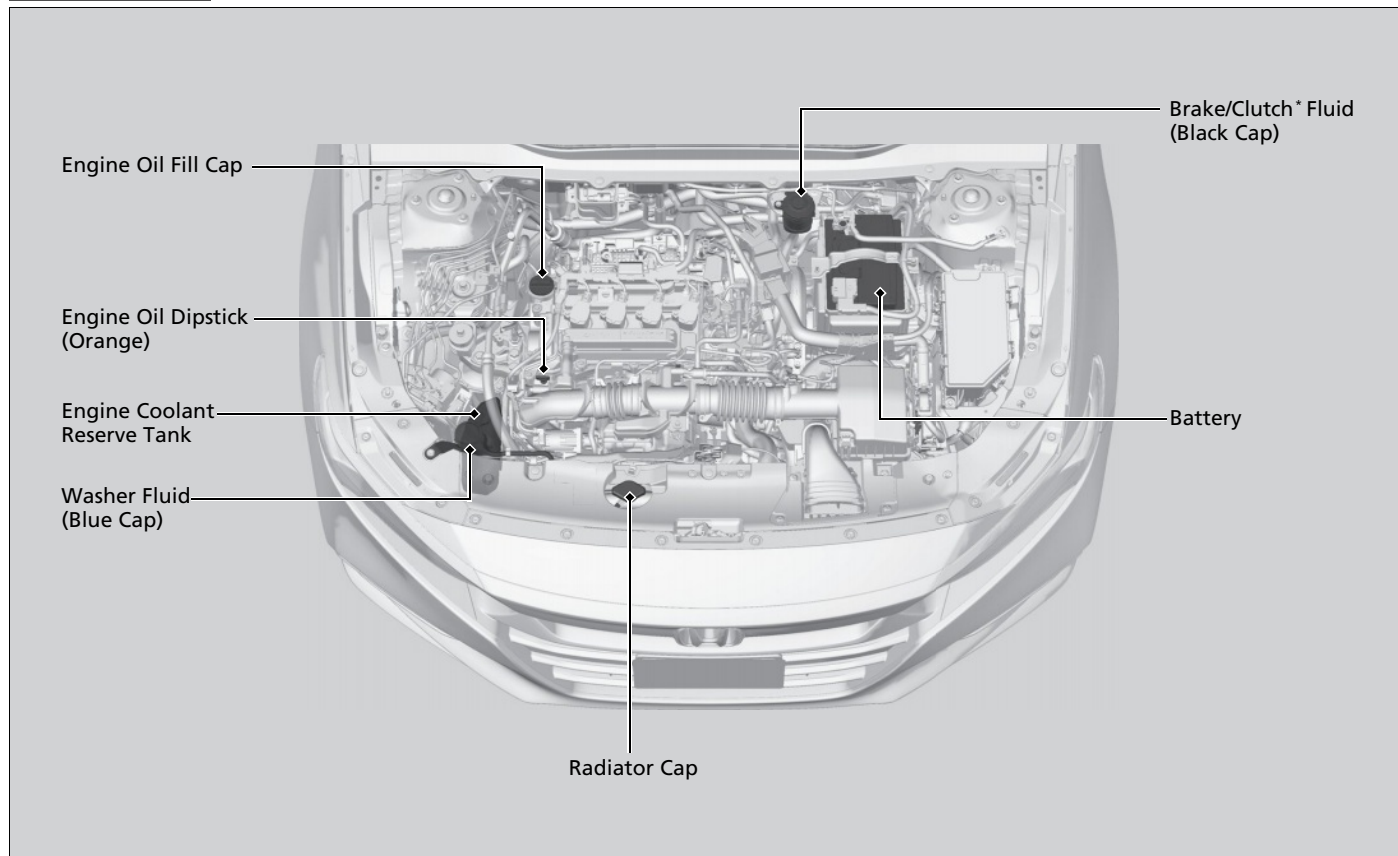

2.0 L engine models

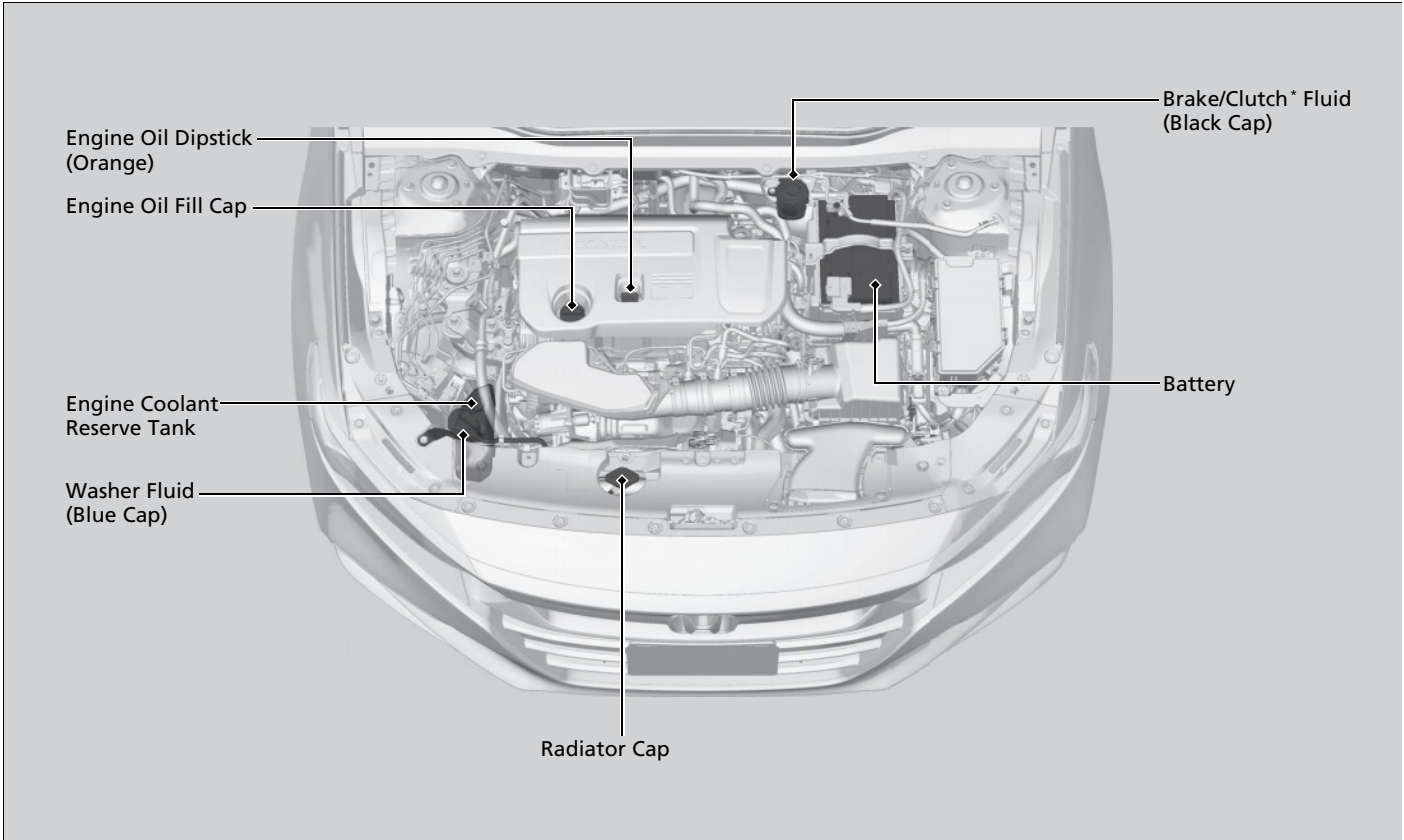

* Not available on all models

Opening the Hood

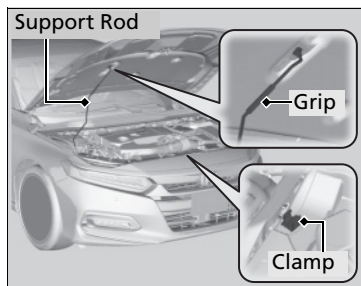
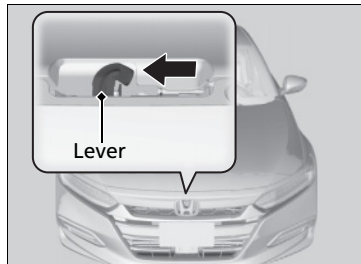
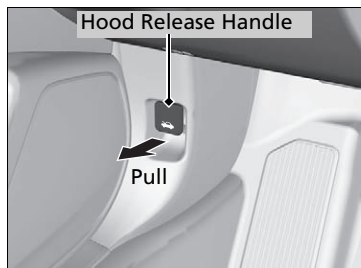

1. Park the vehicle on a level surface, and set the parking brake.
2. Pull the hood release handle under the driver's side lower corner of the dashboard.
 - The hood will pop up slightly.
3. Push the hood latch lever (located under the front edge of the hood to the center) and raise the hood. Once you have raised the hood slightly, you can release the lever.

4. Remove the support rod from the clamp using the grip. Mount the support rod in the hood.

When closing, remove the support rod, and stow it in the clamp, then gently lower the hood. Remove your hand at a height of approximately 12 inches (30 cm) and let the hood close.

►► Opening the Hood

NOTICE

Do not open the hood when the wiper arms are raised. The hood will strike the wipers, resulting in damage to the hood and/or the wipers.

When closing the hood, check that the hood is securely latched.

2.0 L engine models

Do not press the engine cover forcibly. This may damage the engine cover and component parts.

If the hood latch lever moves stiffly, or if you can open the hood without lifting the lever, the latch mechanism should be cleaned and lubricated.

Recommended Engine Oil

- **Genuine Honda Motor Oil**
- **Premium-grade 0W-20 detergent oil with an API Certification Seal on the container.**



Oil is a major contributor to your engine's performance and longevity. If you drive the vehicle with insufficient or deteriorated oil, the engine may fail or be damaged.

This seal indicates the oil is energy conserving and that it meets the American Petroleum Institute's latest requirements.

Use a Genuine Honda Motor Oil or another commercial engine oil of suitable viscosity for the ambient temperature as shown.

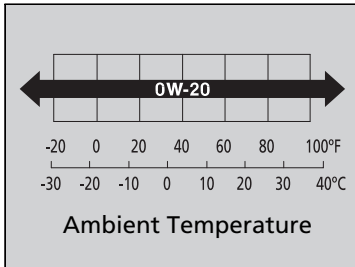

■ Synthetic oil

You may also use synthetic motor oil if it is labeled with the API Certification Seal and is the specified viscosity grade.

►► Recommended Engine Oil

Engine Oil Additives

Your vehicle does not require oil additives. In fact, they may adversely affect the engine performance and durability.

Oil Check

We recommend that you check the engine oil level every time you refuel.

Park the vehicle on level ground.

Wait approximately three minutes after turning the engine off before you check the oil.

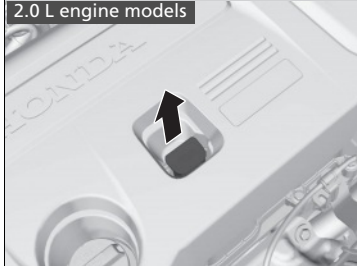
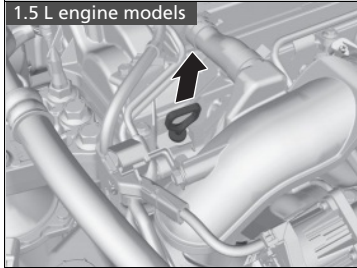

1. Remove the dipstick (orange).
2. Wipe the dipstick with a clean cloth or paper towel.
3. Insert the dipstick back all the way into its hole.

Oil Check

If the oil level is near or below the lower mark, slowly add oil being careful not to overfill.

1.5 L engine models

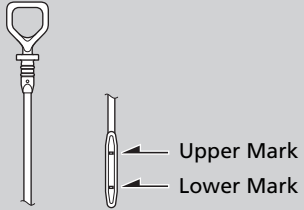

4. Remove the dipstick again, and check the level. It should be between the upper and lower marks. Add oil if necessary.

2.0 L engine models

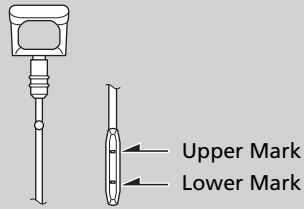

Adding Engine Oil

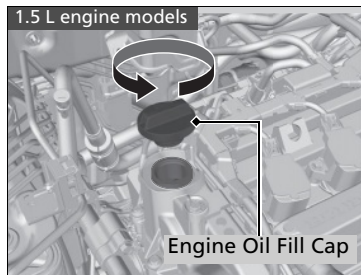

1. Unscrew and remove the engine oil fill cap.
2. Add oil slowly.
3. Reinstall the engine oil fill cap, and tighten it securely.
4. Wait for three minutes and recheck the engine oil dipstick.

►► Adding Engine Oil

NOTICE

Do not fill the engine oil above the upper mark. Overfilling the engine oil can result in leaks and engine damage.

If any oil spills, wipe it away immediately. Spilled oil may damage the engine compartment components.

Changing the Engine Oil and Oil Filter

You must change the engine oil and oil filter regularly in order to maintain the engine's lubrication. The engine may be damaged if they are not changed regularly.

Change the oil and filter in accordance with the maintenance message on the driver information interface.

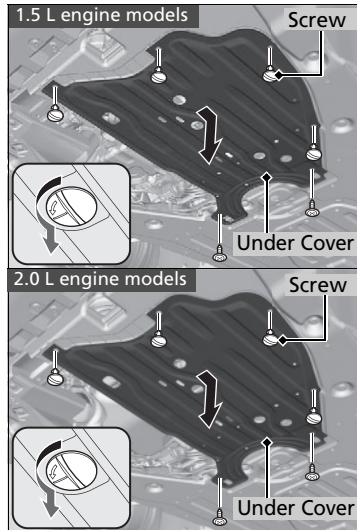

1. Run the engine until it reaches normal operating temperature, and then turn the engine off.
2. Open the hood and remove the engine oil fill cap.
3. Remove the Phillips-head and slotted head screws by turning 90° counterclockwise on the undercarriage.

Changing the Engine Oil and Oil Filter

NOTICE

You may damage the environment if you do not dispose of the oil in a suitable way. If you are changing the oil by yourself, appropriately dispose of the used oil. Put the oil in a sealed container and take it to a recycling center. Do not throw the oil away into a garbage can or onto the ground.

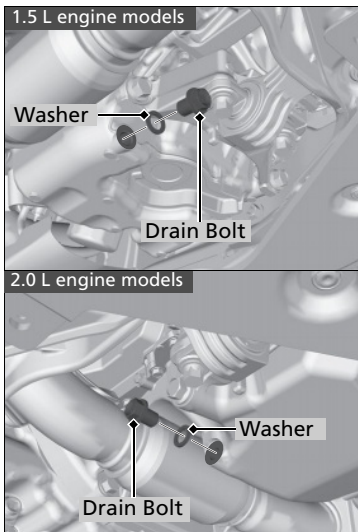

4. Remove the drain bolt and washer from the bottom of the engine, and drain the oil into a suitable container.

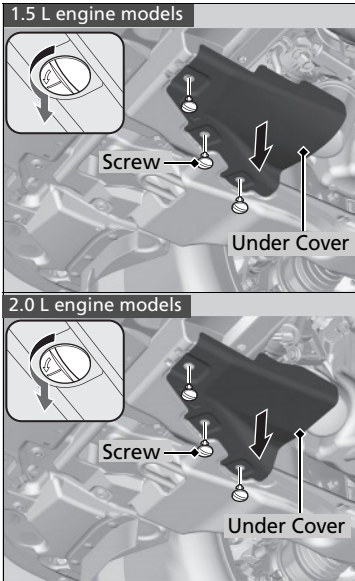

5. Remove the slotted head screws by turning 90° counterclockwise on the undercarriage and remove the under cover.

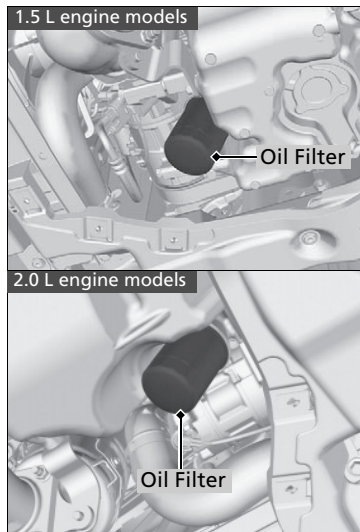

6. Remove the oil filter and dispose of the remaining oil.
7. Check that the filter gasket is not stuck to the engine contact surface.
 - If it is stuck, you must detach it.
8. Wipe away dirt and dust adhering to the contact surface of the engine block, and install a new oil filter.
 - Apply a light coat of new engine oil to the filter gasket.
9. Put a new washer on the drain bolt, then reinstall the drain bolt.
 - Tightening torque:
30 lbf·ft (40 N·m, 4.0 kgf·m)
10. Pour the recommended engine oil into the engine.
 - Engine oil change capacity (including filter):
 - 1.5 L engine models**
3.7 US qt (3.5 L)
 - 2.0 L engine models**
5.0 US qt (4.8 L)
11. Reinstall the engine oil fill cap securely and start the engine.
12. Run the engine for a few minutes, and then check that there is no leak from the drain bolt or oil filter.
13. Stop the engine, wait for three minutes, and then check the oil level on the dipstick.
 - If necessary, add more engine oil.

►► Changing the Engine Oil and Oil Filter

You will need a special wrench to replace the oil filter. You can buy this wrench from a dealer.

When installing the new oil filter, follow the instructions supplied with the oil filter.

Reinstall the engine oil fill cap. Start the engine. The low oil pressure indicator should go off within five seconds. If it does not, turn off the engine, and check your work.

Engine Coolant

Specified coolant: Honda Long Life Antifreeze/Coolant Type 2

This coolant is premixed with 50% antifreeze and 50% water. Do not add any straight antifreeze or water.

We recommend you check the engine coolant level every time you refuel. Check the reserve tank first. If it is completely empty, also check the coolant level in the radiator. Add the engine coolant accordingly.

Reserve Tank

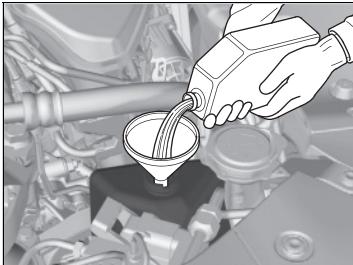
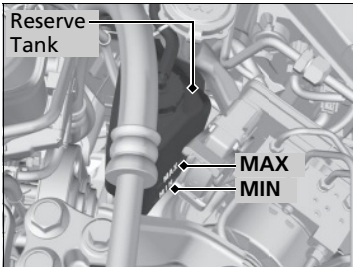

1. **Make sure the engine and radiator are cool.**
2. Check the amount of coolant in the reserve tank.
 - If the coolant level is below the **MIN** mark, add the specified coolant until it reaches the **MAX** mark.
3. Inspect the cooling system for leaks.

Engine Coolant

⚠ WARNING

Removing the radiator cap while the engine is hot can cause the coolant to spray out, seriously scalding you.

Always let the engine and radiator cool down before removing the radiator cap.

NOTICE

Genuine Honda engine coolant is a 50/50 mixture of antifreeze and water that can withstand freezing at temperatures as low as about -31°F (-35°C). If your vehicle is consistently subjected to temperatures below this, the concentration of antifreeze in the coolant should be increased. Consult a dealer for details.

If Honda antifreeze/coolant is not available, you may use another major brand of non-silicate coolant as a temporary replacement. Check that it is a high quality coolant recommended for aluminum engines. Continued use of any non-Honda coolant can result in corrosion, causing the cooling system to malfunction or fail. Have the cooling system flushed and refilled with Honda antifreeze/coolant as soon as possible.

Do not add rust inhibitors or other additives to your vehicle's cooling system. They may not be compatible with the coolant or with the engine components.

Continued

Radiator

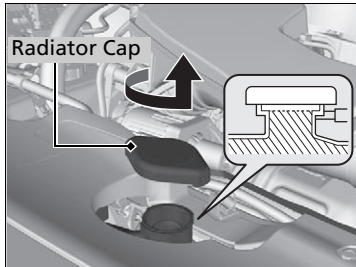

- 1. Make sure the engine and radiator are cool.**
2. Turn the radiator cap 1/8 turn counterclockwise and relieve any pressure in the cooling system.
3. Push down and turn the radiator cap counterclockwise to remove it.
4. The coolant level should be up to the base of the filler neck. Add coolant if it is low.
5. Put the radiator cap back on, and tighten it fully.

Radiator

NOTICE

Pour the fluid slowly and carefully so you do not spill any. Clean up any spills immediately; they can damage components in the engine compartment.

Transmission Fluid

Continuously Variable Transmission (CVT) Fluid *

Specified fluid: Honda HCF-2 Transmission Fluid

Have a dealer check the fluid level and replace if necessary.

Do not attempt to check or change the automatic transmission fluid yourself.

Manual Transmission Fluid *

Specified fluid: Honda Manual Transmission Fluid (MTF)

Have a dealer check the fluid level and replace if necessary.

Do not attempt to check or change the automatic transmission fluid yourself.

⌘ Continuously Variable Transmission (CVT) Fluid *

NOTICE

Do not mix HCF-2 with other transmission fluids.

Using a transmission fluid other than HCF-2 may adversely affect the operation and durability of your vehicle's transmission, and damage the transmission. Any damage caused by using a transmission fluid that is not equivalent to HCF-2 is not covered by Honda's new vehicle limited warranty.

⌘ Manual Transmission Fluid *

NOTICE

If Honda MTF is not available, you may use the API certified SAE 0 W-20 or 5 W-20 viscosity motor oil as a temporary measure.

Replace with MTF as soon as possible. Motor oil does not contain the proper additives for the transmission and continued use can cause decreased shifting performance and lead to transmission damage.

* Not available on all models

■ Automatic Transmission Fluid*

Specified fluid: Honda Automatic Transmission Fluid ATF-Type 2.0

Have a dealer check the fluid level and replace if necessary.

Do not attempt to check or change the automatic transmission fluid yourself.

▶▶ Automatic Transmission Fluid*

NOTICE

Do not mix Honda ATF-Type 2.0 with other transmission fluids.

Using a transmission fluid other than Honda ATF-Type 2.0 may adversely affect the operation and durability of your vehicle's transmission, and damage the transmission.

Any damage caused by using a transmission fluid that is not equivalent to Honda ATF-Type 2.0 is not covered by Honda's new vehicle limited warranty.

Brake/Clutch* Fluid

Specified fluid: Honda Heavy Duty Brake Fluid DOT 3

Use the same fluid for both the brakes and clutch.

Checking the Brake Fluid

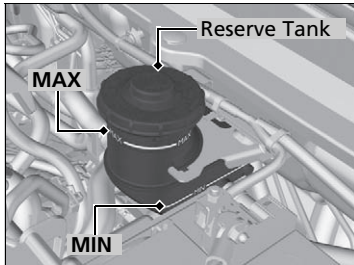

The fluid level should be between the **MIN** and **MAX** marks on the side of the reserve tank.

Manual transmission models

The brake fluid reserve tank is also used for your vehicle's clutch fluid. As long as you keep the brake fluid level as instructed above, there is no need for checking the clutch fluid level.

Brake/Clutch* Fluid

NOTICE

Brake fluid marked DOT 5 is not compatible with your vehicle's braking system and can cause extensive damage.

If the specified brake fluid is not available, you should use only DOT 3 or DOT 4 fluid from a sealed container as a temporary replacement.

Using any non-Honda brake fluid can cause corrosion and decrease the longevity of the system. Have the brake system flushed and refilled with Honda Heavy Duty Brake Fluid DOT 3 as soon as possible.

If the brake fluid level is at or below the **MIN** mark, have a dealer inspect the vehicle for leaks or worn brake pads as soon as possible.

* Not available on all models

Refilling Window Washer Fluid

Check the amount of window washer fluid.



If the level is low, fill the washer reservoir.

Canadian models

If the washer fluid is low, a message appears on the driver information interface.

All models

Pour the washer fluid carefully. Do not overflow the reservoir.

►► Refilling Window Washer Fluid

NOTICE

Do not use engine antifreeze or a vinegar/water solution in the windshield washer reservoir. Antifreeze can damage your vehicle's paint. A vinegar/water solution can damage the windshield washer pump. Use only commercially available windshield washer fluid. Avoid prolonged use of hard water to prevent lime scale build up.

Headlight Bulbs

When replacing, use the following bulbs.

High beam headlight: LED type*

High beam headlight: 60 W (HB3 for halogen bulb type)*

Low beam headlight: LED type

Headlight Bulbs

Models with halogen high beam headlights

NOTICE

Halogen bulbs get very hot when lit. Oil, perspiration, or a scratch on the glass can cause the bulb to overheat and shatter.

All models

The headlight aim is set by the factory, and does not need to be adjusted. However, if you regularly carry heavy items in the trunk or tow a trailer*, have the aiming readjusted at a dealer or by a qualified technician.

Models with halogen high beam headlights

When replacing a halogen bulb, handle it by its base, and protect the glass from contact with your skin or hard objects. If you touch the glass, clean it with denatured alcohol and a clean cloth.

* Not available on all models

High Beam Headlights

Models with halogen high beam headlights

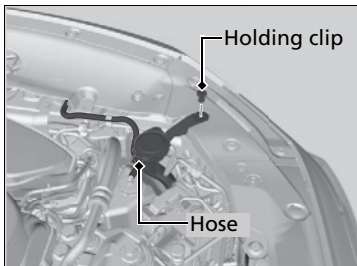

Passenger side

1. Remove the hose and the holding clip using a flat-tip screwdriver, then remove the upper part of the window washer reserve tank.
 - ▶ Check the amount of window washer fluid is below the upper part of the window washer reserve tank and remove it.

Both sides

2. Push the tab to remove the coupler.
3. Rotate the old bulb counter-clockwise to remove.
4. Insert a new bulb into the headlight assembly and turn it clockwise.
5. Insert the coupler into the connector of the bulb.

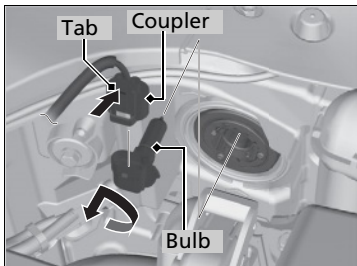

Low Beam Headlights

Low beam headlights are LED type. Have an authorized Honda dealer inspect and replace the light assembly.

High Beam Headlights

Models with LED high beam headlights

High beam headlights are LED type. Have an authorized Honda dealer inspect and replace the light assembly.

When removing the clip, insert a flat-tip screwdriver, then lift and remove the clip.

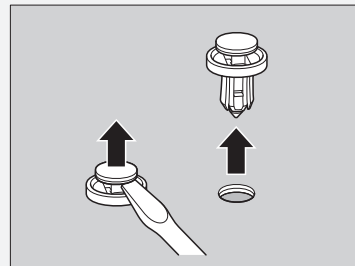

Insert the clip with the pin raised, and push until it is flat.

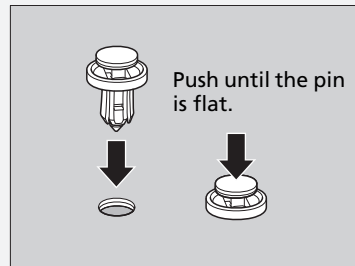

Fog Lights*

Fog lights are LED type. Have an authorized Honda dealer inspect and replace the light assembly.

Parking/Daytime Running Lights

Parking/daytime running lights are LED type. Have an authorized Honda dealer inspect and replace the light assembly.

Front Turn Signal Lights

Front turn signal lights are LED type. Have an authorized Honda dealer inspect and replace the light assembly.

Front Side Marker Lights

Front side marker lights are LED type. Have an authorized Honda dealer inspect and replace the light assembly.

Side Turn Signal/Emergency Indicator Lights*

Door mirror side turn lights are LED type. Have an authorized Honda dealer inspect and replace the light assembly.

* Not available on all models

Brake, Taillight, Rear Side Marker Lights and Rear Turn Signal Light Bulbs

When replacing, use the following bulbs.

Brake Light: LED
Taillight: LED
Rear Side Marker Light: LED
Rear Turn Signal Light: 21 W (Amber)

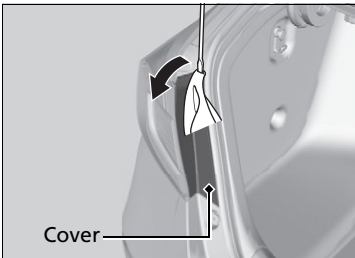

1. Pry on the edge of the cover using a flat-tip screwdriver to remove the covers.
 - ▶ Wrap the flat-tip screwdriver with a cloth to prevent scratches.
2. Remove the bolts.
3. Pull the light assembly out of the rear pillar.

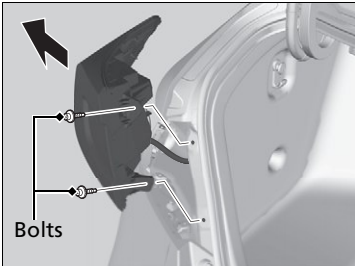

▶▶ Brake, Taillight, Rear Side Marker Lights and Rear Turn Signal Light Bulbs

Brake and rear side marker/taillights are LED type. Have an authorized Honda dealer inspect and replace the light assembly.

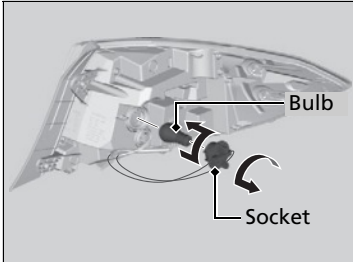

4. Turn the socket counter-clockwise and remove it.
5. Push and turn the old bulb clockwise and remove it, and insert a new bulb.

Taillight, Brake Light* and Back-Up Light Bulbs

When replacing, use the following bulbs.

Taillight: LED
Brake Light*: LED
Back-Up Light: 16 W

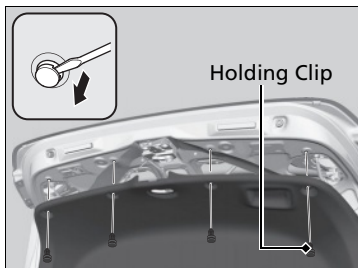

1. Remove the holding clips using a flat-tip screwdriver, then pull the lining back.

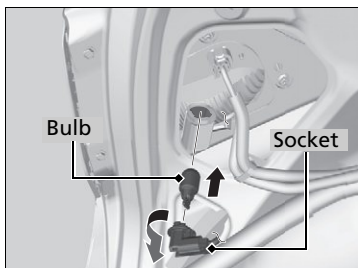

Driver side

2. Turn the socket counter-clockwise and remove it.
3. Remove the old bulb and insert a new bulb.

▶▶ Taillight, Brake Light* and Back-Up Light Bulbs

Taillights and brake lights* are LED type. Have an authorized Honda dealer inspect and replace the light assembly.

When removing the clip, insert a flat-tip screwdriver, then lift and remove the clip.

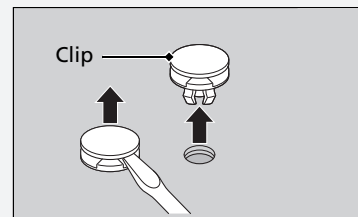

Insert the clip with the pin raised, and push until it is flat.

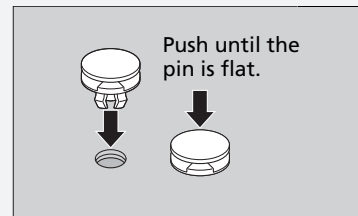

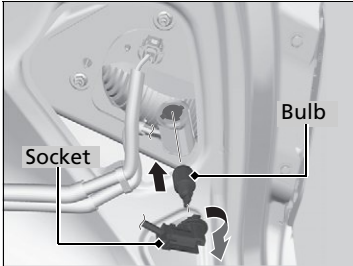

Passenger side

2. Turn the socket clockwise and remove it.
3. Remove the old bulb and insert a new bulb.

Rear License Plate Light

Rear license plate light is LED type. Have an authorized Honda dealer inspect and replace the light assembly.

High-Mount Brake Light

High-mount brake light is LED type. Have an authorized Honda dealer inspect and replace the light assembly.

Checking Wiper Blades

If the wiper blade rubber has deteriorated, it will leave streaks and the hard surfaces of the blade may scratch the window glass.

Changing the Wiper Blade Rubber

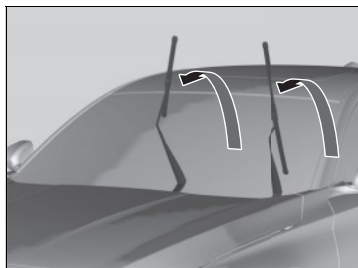
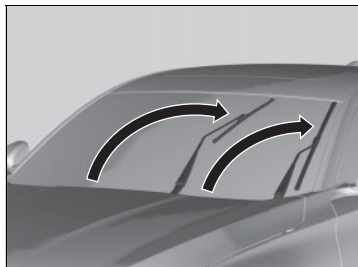

1. Set the power mode to VEHICLE OFF.
2. While holding the wiper switch in the **MIST** position, set the power mode to ON, then to VEHICLE OFF.
 - ▶ Both wiper arms are set to the maintenance position as shown in the image.
3. Lift the driver side wiper arm first, then the passenger side.

Changing the Wiper Blade Rubber

NOTICE

Avoid dropping the wiper arm onto the windshield, it may damage the wiper arm and/or the windshield.

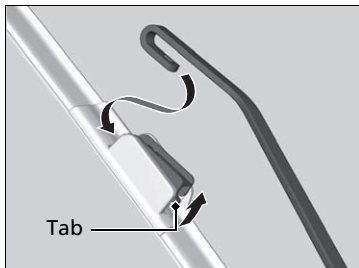

4. Press and hold the tab, then slide the holder off the wiper arm.

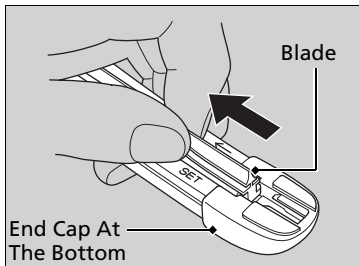

5. Pull the end of the wiper blade in the direction of the arrow in the image until it is out of the holder's end cap.

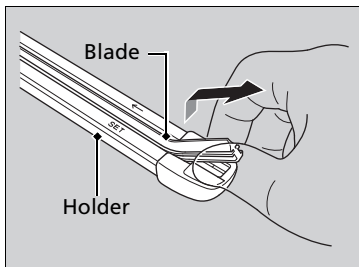

6. Pull the wiper blade in the opposite direction to slide it out of its holder.

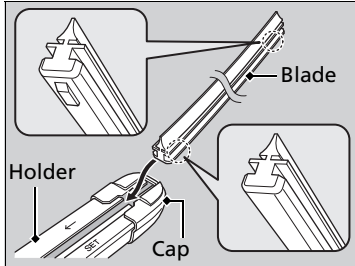

7. Insert the flat side of the new wiper blade onto the bottom part of the holder. Insert the blade all the way.
8. Install the end of the wiper blade into the cap.
9. Slide the holder onto the wiper arm until it locks.
10. Lower the passenger side wiper arm first, then the driver side.
11. Set the power mode to ON and hold the wiper switch in the **MIST** position until both wiper arms return to the standard position.

Checking Tires

To safely operate your vehicle, your tires must be of the proper type and size, in good condition with adequate tread, and properly inflated.

■ Inflation guidelines

Properly inflated tires provide the best combination of handling, tread life, and comfort. Refer to the driver's doorjamb label or specifications page for the specified pressure.

Under inflated tires wear unevenly, adversely affect handling and fuel economy, and are more likely to fail from overheating.

Overinflated tires make your vehicle ride harshly, are more prone to road hazards, and wear unevenly.

Every day before you drive, look at each of the tires. If one looks lower than the others, check the pressure with a tire gauge.

At least once a month or before long trips, use a gauge to measure the pressure in all tires, including the spare. Even tires in good condition can lose 1–2 psi (10–20 kPa, 0.1–0.2 kgf/cm²) per month.

■ Inspection guidelines

Every time you check inflation, also examine the tires and valve stems.

Look for:

- Bumps or bulges on the side or in the tread. Replace the tire if you find any cuts, splits, or cracks in the side of the tire. Replace it if you see fabric or cord.
- Remove any foreign objects and inspect for air leaks.
- Uneven tread wear. Have a dealer check the wheel alignment.
- Excessive tread wear.

➤ **Wear Indicators** P. 647

- Cracks or other damage around valve stem.

🔧 Checking Tires

⚠️ WARNING

Using tires that are excessively worn or improperly inflated can cause a crash in which you can be seriously hurt or killed.

Follow all instructions in this owner's manual regarding tire inflation and maintenance.

Measure the air pressure when tires are cold. This means the vehicle has been parked for at least three hours, or driven less than 1 mile (1.6 km). If necessary, add or release air until the specified pressure is reached.

If checked when hot, tire pressure can be as much as 4–6 psi (30–40 kPa, 0.3–0.4 kgf/cm²) higher than if checked when cold.

Whenever tire pressure is adjusted, you must calibrate the TPMS.

➤ **TPMS Calibration** P. 497

Have a dealer check the tires if you feel a consistent vibration while driving. New tires and any that have been removed and reinstalled should be properly balanced.

Check the spare tire pressure once a month or before long trips.

Tire and Loading Information Label

The label attached to the driver's doorjamb provides necessary tire and loading information.

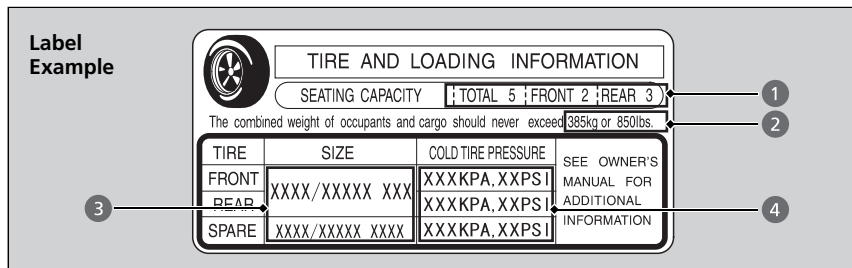

Tire and Loading Information Label

The tire and loading information label attached to the driver's doorjamb contains:

- 1 The number of people your vehicle can carry.
- 2 The total weight your vehicle can carry. Do not exceed this weight.
- 3 The original tire sizes for front, rear, and spare.
- 4 The proper cold tire pressure for front, rear, and spare.

Tire Labeling

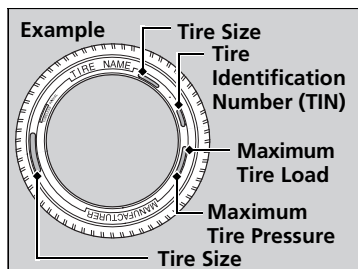

The tires that came on your vehicle have a number of markings. Those you should be aware of are described as shown.

Tire Sizes

Following is an example of tire size with an explanation of what each component means.

P235/60 R18 102T

P: Vehicle type (P indicates passenger vehicle).

235: Tire width in millimeters.

60: Aspect ratio (the tire's section height as a percentage of its width).

R: Tire construction code (R indicates radial).

18: Rim diameter in inches.

102: Load index (a numerical code associated with the maximum load the tire can carry).

T: Speed symbol (an alphabetical code indicating the maximum speed rating).

Tire Sizes

Whenever tires are replaced, they should be replaced with tires of the same size.

Continued

■ Tire Identification Number (TIN)

The tire identification number (TIN) is a group of numbers and letters that look like the example in the side column. TIN is located on the sidewall of the tire.

■ Glossary of Tire Terminology

Cold Tire Pressure – The tire air pressure when the vehicle has been parked for at least three hours or driven less than 1 mile (1.6 km).

Load Rating – Means the maximum load that a tire is rated to carry for a given inflation pressure.

Maximum Inflation Pressure – The maximum tire air pressure that the tire can hold.

Maximum Load Rating – Means the load rating for a tire at the maximum permissible inflation pressure for that tire.

Recommended Inflation Pressure – The cold tire inflation pressure recommended by the manufacturer.

Treadwear Indicators (TWI) – Means the projections within the principal grooves designed to give a visual indication of the degrees of wear of the tread.

► Tire Identification Number (TIN)

DOT B97R FW6X 2209

DOT: This indicates that the tire meets all requirements of the U.S. Department of Transportation.

B97R: Manufacturer's identification mark.

FW6X: Tire type code.

22 09: Date of manufacture.

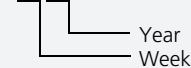

DOT Tire Quality Grading (U.S. Vehicles)

The tires on your vehicle meet all U.S. Federal Safety Requirements. All tires are also graded for treadwear, traction, and temperature performance according to Department of Transportation (DOT) standards. The following explains these gradings.

Uniform Tire Quality Grading

Quality grades can be found where applicable on the tire sidewall between tread shoulder and maximum section width.

Treadwear

The treadwear grade is a comparative rating based on the wear rate of the tire when tested under controlled conditions on a specified government test course. For example, a tire graded 150 would wear one and one-half (1 1/2) times as well on the government course as a tire graded 100. The relative performance of tires depends upon the actual conditions of their use, however, and may depart significantly from the norm due to variations in driving habits, service practices and differences in road characteristics and climate.

Uniform Tire Quality Grading

For example:
Treadwear 200
Traction AA
Temperature A

All passenger car tires must conform to Federal Safety Requirements in addition to these grades.

■ Traction

The traction grades, from highest to lowest, are AA, A, B, and C. Those grades represent the tire's ability to stop on wet pavement as measured under controlled conditions on specified government test surfaces of asphalt and concrete. A tire marked C may have poor traction performance.

■ Temperature

The temperature grades are A (the highest), B, and C, representing the tire's resistance to the generation of heat and its ability to dissipate heat when tested under controlled conditions on a specified indoor laboratory test wheel. Sustained high temperature can cause the material of the tire to degenerate and reduce tire life, and excessive temperature can lead to sudden tire failure. The grade C corresponds to a level of performance which all passenger car tires must meet under the Federal Motor Vehicle Safety Standard No. 109. Grades B and A represent higher levels of performance on the laboratory test wheel than the minimum required by law.

▶▶ Traction

Warning: The traction grade assigned to this tire is based on straight-ahead braking traction tests, and does not include acceleration, cornering, hydroplaning, or peak traction characteristics.

▶▶ Temperature

Warning: The temperature grade for this tire is established for a tire that is properly inflated and not overloaded. Excessive speed, underinflation, or excessive loading, either separately or in combination, can cause heat buildup and possible tire failure.

Wear Indicators

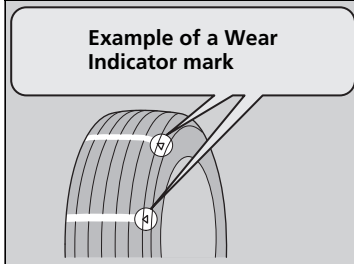

The groove where the wear indicator is located is 1/16 inch (1.6 mm) shallower than elsewhere on the tire. If the tread has worn so that the indicator is exposed, replace the tire.

Worn out tires have poor traction on wet roads.

Tire Service Life

The life of your tires is dependent on many factors, including driving habits, road conditions, vehicle loading, inflation pressure, maintenance history, speed, and environmental conditions (even when the tires are not in use).

In addition to regular inspections and inflation pressure maintenance, it is recommended that you have annual inspections performed once the tires reach five years old. All tires, including the spare, should be removed from service after 10 years from the date of manufacture, regardless of their condition or state of wear.

Checking Tires

High speed driving

We recommend that you do not drive faster than the posted speed limits and conditions allow. If you drive at sustained high speeds (over 99 mph or 160 km/h), adjust the cold tire pressures as shown below to avoid excessive heat build up and sudden tire failure.

Models with 225/50R17 tires

Tire Size	225/50R17 94V
Pressure	Front: 35 psi (240 kPa, 2.4 kgf/cm ²) Rear: 33 psi (230 kPa, 2.3 kgf/cm ²)

Models with 235/40R19 tires

Tire Size	235/40R19 96V
Pressure	Front: 36 psi (250 kPa, 2.5 kgf/cm ²) Rear: 36 psi (250 kPa, 2.5 kgf/cm ²)

Tire and Wheel Replacement

Replace your tires with radials of the same size, load range, speed rating, and maximum cold tire pressure rating (as shown on the tire's sidewall). Using tires of a different size or construction can cause certain vehicle systems such as the ABS and Vehicle Stability Assist® (VSA®) system to work incorrectly.

It is best to replace all four tires at the same time. If that isn't possible, replace the front or rear tires in pairs.

Make sure that the wheel's specifications match those of the original wheels.

▶▶ Tire and Wheel Replacement

WARNING

Installing improper tires on your vehicle can affect handling and stability. This can cause a crash in which you can be seriously hurt or killed.

Always use the size and type of tires recommended in this owner's manual.

Tire Rotation

Rotating tires according to the maintenance messages on the driver information interface helps to distribute wear more evenly and increase tire life.

■ Tires without rotation marks

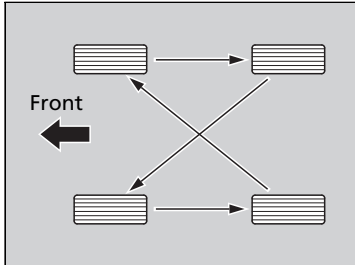

Rotate the tires as shown here.

■ Tires with rotation marks

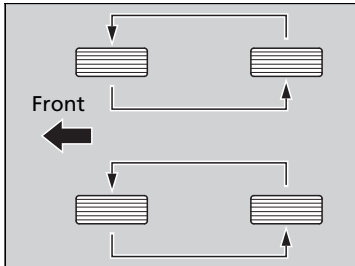

Rotate the tires as shown here.

☒ Tire Rotation

Tires with directional tread patterns should only be rotated front to back (not from one side to the other). Directional tires should be mounted with the rotation indication mark facing forward, as shown below.

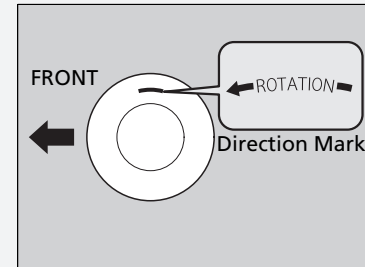

Whenever tires are rotated, you must calibrate the TPMS.

☒ **TPMS Calibration** P. 497

Winter Tires

If driving on snowy or frozen roads, mount all season marked **M+S** tires, snow tires, or tire chains; reduce speed; and maintain sufficient distance between vehicles when driving.

Be particularly careful when operating the steering wheel or brakes to prevent skidding.

Use tire chains, snow tires, or all season tires when necessary or according to the law.

When mounting, refer to the following points.

For winter tires:

- Select the size and load ranges that are the same as the original tires.
- Mount the tires to all four wheels.

For tire chains:

- Install them on the front tires only.
- Because your vehicle has limited tire clearance, we strongly recommend using the chains listed below:

Models with 225/50R17 tires

Cable-type: SCC Radial Chain SC1036

Models with 235/40R19 tires

Not recommended to use any type of chains

- Follow the chain manufacturer's instruction when installing. Mount them as tightly as you can.
- Check that the chains do not touch the brake lines or suspension.
- Drive slowly.

Winter Tires

WARNING

Using the wrong chains, or not properly installing chains, can damage the brake lines and cause a crash in which you can be seriously injured or killed.

Follow all instructions in this owner's manual regarding the selection and use of tire chains.

NOTICE

Traction devices that are the wrong size or improperly installed can damage your vehicle's brake lines, suspension, body, and wheels. Stop driving if they are hitting any part of the vehicle.

When tire chains are mounted, follow the chain manufacturer's instructions regarding vehicle operational limits.

If your vehicle is equipped with summer tires, be aware that these tires are not designed for winter driving conditions. For more information, contact a dealer.

Checking the Battery

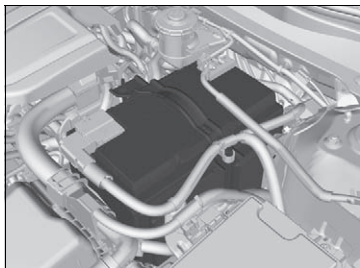

The condition of the battery is monitored by a sensor located on the negative terminal of the battery. If there is a problem with this sensor, the driver information interface will display a warning message. If this happens, have your vehicle inspected by a dealer.

Check the battery terminals for corrosion monthly.

If your vehicle's battery is disconnected or goes dead:

- The audio system is disabled.
 - **Reactivating the audio system** P. 247
- The clock resets.
 - **Clock** P. 164

Canadian models

- The immobilizer system needs to be reset.
 - **Immobilizer System Indicator** P. 95

Battery

⚠ WARNING

The battery gives off explosive hydrogen gas during normal operation.

A spark or flame can cause the battery to explode with enough force to kill or seriously hurt you.

When conducting any battery maintenance, wear protective clothing and a face shield, or have a skilled technician do it.

WARNING: Battery post, terminals, and related accessories contain lead and lead compounds.

Wash your hands after handling.

When you find corrosion, clean the battery terminals by applying a baking powder and water solution. Clean the terminals with a damp towel. Cloth/towel dry the battery. Coat the terminals with grease to help prevent future corrosion.

Charging the Battery

Disconnect both battery cables to prevent damaging your vehicle's electrical system. Always disconnect the negative (–) cable first, and reconnect it last.

⚠ Charging the Battery

When replacing the battery, the replacement must be of the same specifications. Consult a dealer for more information.

The Vehicle Stability Assist® (VSA®) system, Vehicle Stability Assist® (VSA®) OFF, adaptive cruise control (ACC) with low speed follow (LSF)*, adaptive cruise control (ACC)*, safety support and low tire pressure/TPMS indicators may come on in amber along with a message in the driver information interface when you set the power mode to ON after re-connecting a battery.

Drive a short distance at more than 12 mph (20 km/h). Each indicator should go off. If any do not, have your vehicle checked by a dealer.

Replacing the Button Battery

If the indicator does not come on when the button is pressed, replace the battery.

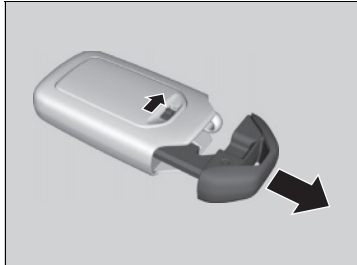

Battery type: CR2032

1. Remove the built-in key.
2. Remove the upper half of the cover by carefully prying on the edge with a coin.
 - ▶ Wrap a coin with a cloth to prevent scratching the remote.
 - ▶ Remove carefully to avoid losing the buttons.
3. Make sure to replace the battery with the correct polarity.

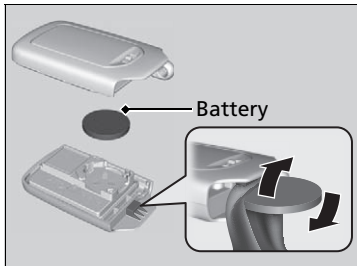

Replacing the Button Battery

⚠ WARNING

CHEMICAL BURN HAZARD

The battery that powers the remote can cause severe internal burns and can even lead to death if swallowed.

Keep new and used batteries away from children.

If you suspect that a child has swallowed the battery, seek medical attention immediately.

NOTICE

An improperly disposed of battery can damage the environment. Always confirm local regulations for battery disposal.

Replacement batteries are commercially available or at a dealer.

Air Conditioning

To ensure proper and safe operation, the Society of Automotive Engineers (SAE J2845) recommends that the refrigerant system only be serviced by trained and certified technicians.

Never repair or replace the air conditioning evaporator (cooling coil) with one removed from a used or salvaged vehicle.

New replacement mobile air conditioning evaporators must be certified (and labeled) as meeting SAE Standard J2842.

» Air Conditioning

NOTICE

Vented refrigerant is harmful to the environment. To avoid refrigerant from venting, never replace the evaporator with one removed from a used or salvaged vehicle.

Refrigerant in your vehicle's air conditioning system is flammable and can be ignited during servicing if proper procedures are not followed.

The air conditioner label is found under the hood:

➔ **Safety Labels** P. 76

➔ **Specifications** P. 700, 702

Canadian models

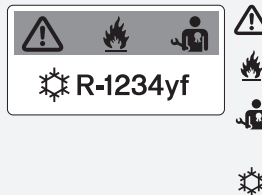

Dust and Pollen Filter

The climate control system is equipped with a dust and pollen filter that collects pollen, dust, and other debris in the air. The Maintenance Minder™ messages will let you know when to replace the filter.

We recommend that you replace the dust and pollen filter sooner when using your vehicle in areas with high concentrations of dust.

Interior Care

Use a damp cloth with a mixture of mild detergent and warm water to remove dirt. Use a clean cloth to remove detergent residue.

Cleaning Seat Belts

Use a soft brush with a mixture of mild soap and warm water to clean the seat belts. Let the belts air dry. Wipe the openings of the seat belt anchors using a clean cloth.

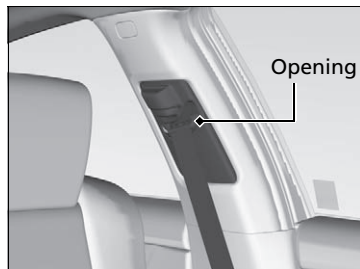

Cleaning the Window

Wipe using a glass cleaner.

Interior Care

Do not spill liquids inside the vehicle. Electrical devices and systems may malfunction if liquids are splashed on them.

Do not use silicone based sprays on electrical devices such as audio devices and switches. Doing so may cause the items to malfunction or cause a fire inside the vehicle. If a silicone based spray is inadvertently used on electrical devices, consult a dealer.

Depending on their composition, chemicals and liquid aromatics may cause discoloration, wrinkles, and cracking to resin-based parts and textiles. Do not use alkali solvents or organic solvents such as benzene or gasoline.

After using chemicals, make sure to gently wipe them away using a dry cloth. Do not place used cloths on top of resin based parts or textiles for long periods of time without washing.

Cleaning the Window

Wires are mounted to the inside of the rear window. Wipe along the same direction as the wires with a soft cloth so as not to damage them.

Be careful not to spill fluids, such as water or glass cleaner, on or around the cover of both the front sensor camera and the rainfall/light sensor*.

* Not available on all models

Floor Mats

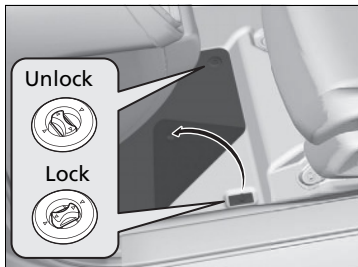

The driver's floor mat hooks over floor anchors, which keep them from sliding forward. To remove a mat for cleaning, turn the anchor knobs to the unlock position. When reinstalling the mat after cleaning, turn the knobs to the lock position.

Do not put additional floor mats on top of the anchored mats.

Maintaining Genuine Leather*

To properly clean leather:

1. Use a vacuum or soft dry cloth first to remove any dirt or dust.
2. Clean the leather with a soft cloth dampened with a solution comprised of 90% water and 10% neutral soap.
3. Wipe away any soap residue with a clean damp cloth.
4. Wipe away residual water and allow leather to air dry in the shade.

Floor Mats

If you use any floor mats that were not originally provided with your vehicle, make sure they are designed for your specific vehicle, fit correctly, and are securely anchored by the floor anchors. Position the rear seat floor mats properly. If they are not properly positioned, the floor mats can interfere with the front seat functions.

Maintaining Genuine Leather*

It is important to clean or wipe away dirt or dust as soon as possible. Spills can soak into leather resulting in stains. Dirt or dust can cause abrasions in the leather. In addition, please note that some dark colored clothing can rub onto the leather seats resulting in discoloration or stains.

Exterior Care

Dust off the vehicle body after you drive.

Regularly inspect your vehicle for scratches on painted surfaces. A scratch on a painted surface can result in body rust. If you find a scratch, promptly repair it.

Washing the Vehicle

Wash the vehicle regularly. Wash more frequently when driving in the following conditions:

- If driving on roads with road salt.
- If driving in coastal areas.
- If tar, soot, bird droppings, insects, or tree sap are stuck to painted surfaces.

Using an Automated Car Wash

- Make sure to follow the instructions indicated on the automated car wash.
- Fold in the door mirrors.
- Automatic intermittent wiper equipment vehicles, wipers switch to OFF.

Using High Pressure Cleaners

- Keep sufficient distance between the cleaning nozzle and the vehicle body.
- Take particular care around the windows. Standing too close may cause water to enter the vehicle interior.
- Do not spray high pressure water directly into the engine compartment. Instead, use low pressure water and a mild detergent.

Washing the Vehicle

Do not spray water into the air intake vents. It can cause a malfunction.

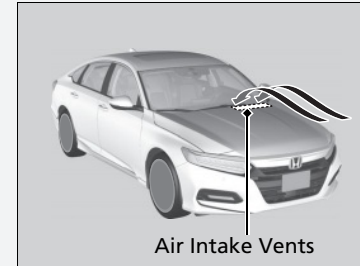

Do not spray water onto the fuel fill door directly. A high-pressure spray may cause it to open.

Do not spray water onto the capless unit when the fuel fill door is open. It can cause damage to the fuel system or engine.

If you need to lift the wiper arms away from the windshield, first set the wiper arms to the maintenance position.

➤ **Changing the Wiper Blade Rubber** P. 639

Using an Automated Car Wash

Automatic transmission models

When using an automated car wash that pulls the vehicle through with a conveyor, make sure vehicle is in car wash mode.

➤ **If you want to keep the transmission in **N** position [car wash mode]** P. 478

■ Applying Wax

A good coat of automotive body wax helps protect your vehicle's paint from the elements. Wax will wear off over time and expose your vehicle's paint to the elements, so reapply as necessary.

■ Maintaining the Bumpers and Other Resin Coated Parts

If you get gasoline, oil, engine coolant, or battery fluid on resin coated parts, they may be stained or the coating may peel. Promptly wipe it away using a soft cloth and clean water.

■ Cleaning the Window

Wipe using a glass cleaner.

■ Maintaining Aluminum Wheels

Aluminum is susceptible to deterioration caused by salt and other road contaminants. When necessary, as early as possible use a sponge and mild detergent to wipe away these contaminants. Do not use a stiff brush or harsh chemicals (including some commercial wheel cleaners). These can damage the protective finish on aluminum alloy wheels, resulting in corrosion. Depending on the type of finish, the wheels also may lose their luster or appear burnished. To avoid water stains, wipe the wheels dry with a cloth while they are still wet.

►► Applying Wax

NOTICE

Chemical solvents and strong cleaners can damage the paint, metal, and plastic on your vehicle. Wipe away spills immediately.

►► Maintaining the Bumpers and Other Resin Coated Parts

Ask a dealer about the correct coating material when you want to repair the painted surface of the parts made of resin.

■ Fogged Exterior Light Lenses

The inside lenses of exterior lights (headlights, brake lights, etc.) may fog temporarily if you have driven in the rain, or after the vehicle has been run through a car wash. Dew condensation also may build up inside the lenses when there is a significant enough difference between the ambient and inside lens temperatures (similar to vehicle windows fogging up in rainy conditions). These conditions are natural processes, not structural design problems in the exterior lights.

Lens design characteristics may result in moisture developing on the light lens frame surfaces. This also is not a malfunction.

However, if you see large amounts of water accumulation, or large water drops building up inside the lenses, have your vehicle inspected by a dealer.

Accessories

When installing accessories, check the following:

- Do not install accessories on the windshield. They can obstruct your view and delay your reaction to driving conditions.
- Do not install any accessories over areas marked **SRS AIRBAG**, on the sides or backs of the front seats, on front or side pillars, or near the side windows. Accessories installed in these areas may interfere with proper operation of the vehicle's airbags or may be propelled into you or another occupant if the airbags deploy.
- Be sure electronic accessories do not overload electrical circuits or interfere with proper operation of your vehicle.
 - ▣ **Fuses** P. 688
- Before installing any electronic accessory, have the installer contact a dealer for assistance. If possible, have a dealer inspect the final installation.

» Accessories and Modifications

WARNING

Improper accessories or modifications can affect your vehicle's handling, stability, and performance, and cause a crash in which you can be seriously hurt or killed.

Follow all instructions in this owner's manual regarding accessories and modifications.

Honda Genuine accessories are recommended to ensure proper operation on your vehicle.

Modifications

Do not modify your vehicle in a manner that may affect its handling, stability, or reliability, or install non-genuine Honda parts or accessories that may have a similar effect.

Even minor modifications to vehicle systems can affect overall vehicle performance. Always make sure all equipment is properly installed and maintained, and do not make any modification to your vehicle or its systems that might cause your vehicle to no longer meet federal, state, province, territory, and local regulations.

The on-board diagnostic port (OBD-II/SAE J1962 connector) installed on this vehicle is intended to be used with automobile system diagnostic devices or with other devices that Honda has approved. Use of any other type of device may adversely affect the vehicle's electronic systems or allow them to be compromised, possibly resulting in a system malfunction, drained battery, or other unexpected problems.

Do not modify or attempt to repair any of the electrical components.

Handling the Unexpected

This chapter explains how to handle unexpected troubles.

Tools	
Types of Tools	664
If a Tire Goes Flat	
Changing a Flat Tire	665
Engine Does Not Start	
Checking the Engine	671
If the Remote Battery is Weak	672
Emergency Engine Stop	673
Jump Starting	674
Shift Lever Does Not Move	677
Overheating	
How to Handle Overheating	679

Indicator, Coming On/Blinking	
If the Low Oil Pressure Warning Appears ...	681
If the Charging System Indicator Comes On	681
If the Malfunction Indicator Lamp Comes On or Blinks	682
If the Brake System Indicator (Red) Comes On or Blinks	683
If the Brake System Indicator (Red) Comes On or Blinks at the Same Time When the Brake System Indicator (Amber) Comes On....	684
If the Electric Power Steering (EPS) System Indicator Comes On	685

If the Low Tire Pressure/TPMS Indicator Comes On or Blinks	686
If the Transmission Indicator Blinks along with the Warning Message	687
Fuses	
Fuse Locations	688
Inspecting and Changing Fuses	692
Emergency Towing	693
When You Cannot Unlock the Fuel Fill Door	694
When You Cannot Open the Trunk ...	695
Refueling	697

Types of Tools

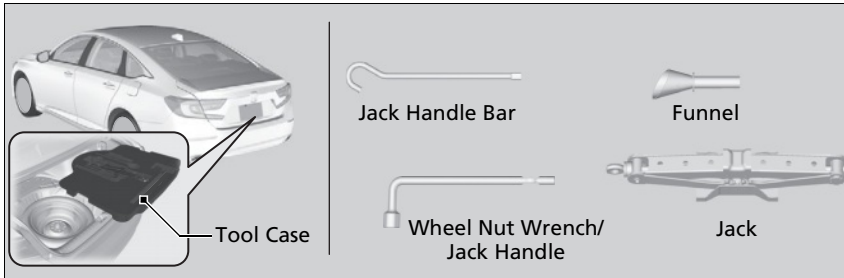

Types of Tools

The tools are stored in the trunk.

Changing a Flat Tire

If a tire goes flat while driving, grasp the steering wheel firmly, and brake gradually to reduce speed. Then, stop in a safe place. Replace the flat tire with a compact spare tire. Go to a dealer as soon as possible to have the full-size tire repaired or replaced.

1. Park the vehicle on a firm, level, and non-slippery surface, and apply the parking brake.

Automatic transmission/Continuously variable transmission models

2. Put the transmission into **P**.

Manual transmission models

2. Move the shift lever to **R**.

All models

3. Turn on the hazard warning lights and set the power mode to VEHICLE OFF.

Changing a Flat Tire

Follow these compact spare precautions:
Periodically check the tire pressure of the compact spare. It should be set to the specified pressure.
Specified Pressure: 60 psi (420 kPa, 4.2 kgf/cm²)

When driving with the compact spare tire, keep the vehicle speed under 50 mph (80 km/h). Replace with a full-size tire as soon as possible.

The compact spare tire and wheel in your vehicle are specifically for this model. Do not use them with another vehicle. Do not use another type of compact spare tire or wheel with your vehicle.

Do not mount tire chains on a compact spare tire. If a chain-mounted front tire goes flat, remove one of the full-size rear tires and replace it with the compact spare tire. Remove the flat front tire and replace it with the full-size tire that was removed from the rear. Mount the tire chains on the front tire.

NOTICE

Do not use the jack if it doesn't work properly. Call your dealer or a professional towing service.

Do not mount the compact spare on the front. If either front tire goes flat, remove the rear tire on the same side, and mount the compact spare on the rear and the rear tire on the front.

■ Getting Ready to Replace the Flat Tire

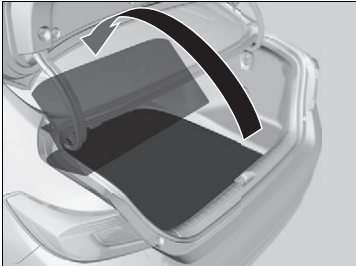

1. Open the trunk floor lid.

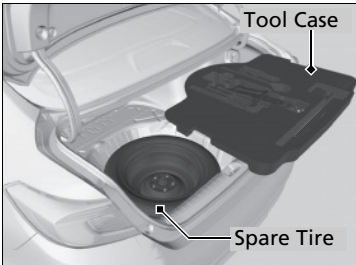

- 2. Take the tool case out of the trunk.
- 3. Take the jack, wheel nut wrench and jack handle bar out of the tool case.
- 4. Unscrew the wing bolt, and remove the spacer cone. Then, remove the spare tire.

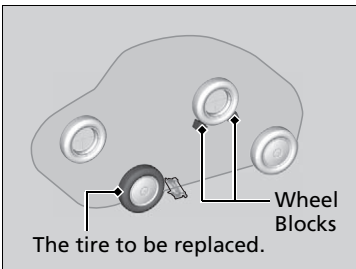

5. Place a wheel block or rock in the front and rear of the wheel diagonal to the flat tire.



6. Place the compact spare tire (wheel side up) under the vehicle body, near the tire that needs to be replaced.



7. Loosen each wheel nut about one turn using the wheel nut wrench.

■ How to Set Up the Jack

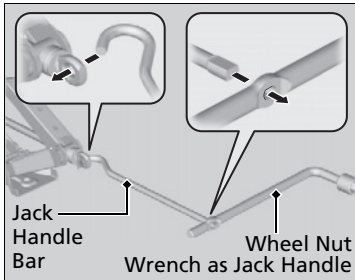
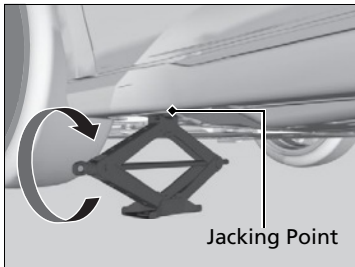
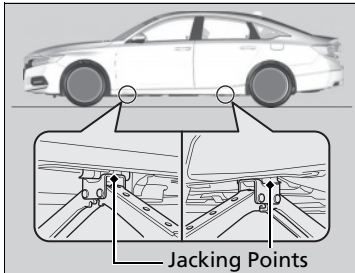

1. Place the jack under the jacking point closest to the tire to be changed.
2. Turn the end bracket clockwise (as shown in the image) until the top of the jack contacts the jacking point.
 - ▶ Make sure that the jacking point tab is resting in the jack notch.
3. Raise the vehicle, using the jack handle bar and the jack handle, until the tire is off the ground.

▶▶ How to Set Up the Jack

⚠ WARNING

The vehicle can easily roll off the jack, seriously injuring anyone underneath.

Follow the directions for changing a tire exactly, and never get under the vehicle when it is supported only by the jack.

Do not use the jack with people or luggage in the vehicle.

Use the jack provided in your vehicle. Other jacks may not support the weight ("load") or may not fit the jacking point.

The following instructions must be followed to use the jack safely:

- Do not use while the engine is running.
- Use only where the ground is firm and level.
- Use only at the jacking points.
- Do not get in the vehicle while using the jack.
- Do not put anything on top of or underneath the jack.

Replacing the Flat Tire



1. Remove the wheel nuts and flat tire.

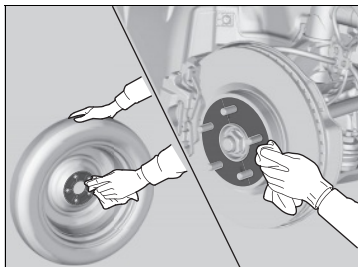

2. Wipe the mounting surfaces of the wheel with a clean cloth.

3. Mount the compact spare tire.

4. Screw the wheel nuts until they touch the lips around the mounting holes, then stop rotating.

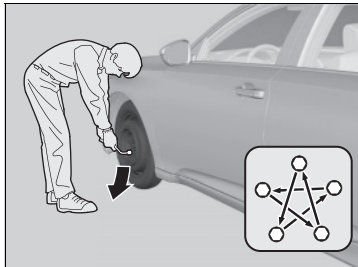

5. Lower the vehicle and remove the jack. Tighten the wheel nuts in the order indicated in the image. Go around, tightening the nuts, two to three times in this order.

Wheel nut torque:

80 lbf-ft (108 N-m, 11 kgf-m)

Replacing the Flat Tire

Do not over tighten the wheel nuts by applying extra torque using your foot or a pipe.

■ Storing the Flat Tire

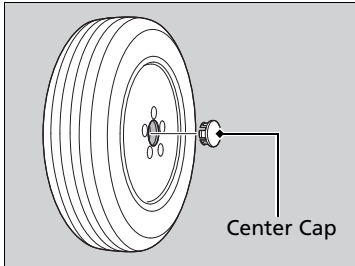

1. Remove the center cap.

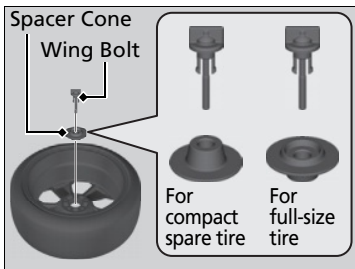

2. Place the flat tire face down in the spare tire well.

3. Remove the spacer cone from the wing bolt, flip it over, and insert it back on the bolt. Secure the flat tire with the wing bolt.

4. Securely put the jack and wheel nut wrench back in the tool case. Store the case in the trunk.

■ TPMS and the Compact Spare Tire

If you replace a flat tire with the spare tire, the low tire pressure/TPMS indicator comes on while you are driving. After driving for a few miles (kilometers), **Tire Pressure Monitor System Problem. Check Tire Pressure. See Your Dealer.** will appear on the driver information interface and the indicator will start blinking for a short time and then stay on; however, this is normal and is no cause for concern.

Calibrate the TPMS when you replace the tire with a specified regular tire.

▶ **TPMS Calibration** P. 497

▶▶ Storing the Flat Tire

⚠ WARNING

Loose items can fly around the interior in a crash and can seriously injure the occupants.

Store the wheel, jack, and tools securely before driving.

Checking the Engine

If the engine does not start, check the starter.

☒ Checking the Engine

If you must start the vehicle immediately, use an assisting vehicle or booster battery to jump start it.

☒ **Jump Starting** P. 674

Starter condition	Checklist
<p>Starter doesn't turn or turns over slowly.</p> <p>The battery may be dead. Check each of the items on the right and respond accordingly.</p>	<p>Check for a message on the driver information interface.</p> <ul style="list-style-type: none">• If the To Start, Hold Remote Near Start Button message appears<ul style="list-style-type: none">☒ If the Remote Battery is Weak P. 672▶ Make sure the remote is in its operating range.<ul style="list-style-type: none">☒ ENGINE START/STOP Button Operating Range P. 190
<p>The starter turns over normally but the engine doesn't start.</p> <p>There may be a problem with a fuse. Check each of the items on the right and respond accordingly.</p>	<p>Check brightness of the interior lights.</p> <p>Turn on the interior lights and check the brightness.</p> <ul style="list-style-type: none">• If the interior lights are dim or do not come on at all<ul style="list-style-type: none">☒ Battery P. 651• If the interior lights come on normally<ul style="list-style-type: none">☒ Inspecting and Changing Fuses P. 692
<p>The starter turns over normally but the engine doesn't start.</p> <p>There may be a problem with a fuse. Check each of the items on the right and respond accordingly.</p>	<p>Review the engine start procedure.</p> <p>Follow its instructions, and try to start the engine again. ☒ Starting the Engine P. 465, 466, 467</p> <p>Check the immobilizer system indicator.</p> <p>When the immobilizer system indicator is blinking, the engine cannot be started.</p> <ul style="list-style-type: none">☒ Immobilizer System P. 183
<p>The starter turns over normally but the engine doesn't start.</p> <p>There may be a problem with a fuse. Check each of the items on the right and respond accordingly.</p>	<p>Check the fuel level.</p> <p>There should be enough fuel in the tank. ☒ Fuel Gauge P. 137</p>
<p>The starter turns over normally but the engine doesn't start.</p> <p>There may be a problem with a fuse. Check each of the items on the right and respond accordingly.</p>	<p>Check the fuses.</p> <p>Check all fuses, or have the vehicle checked by a dealer.</p> <ul style="list-style-type: none">☒ Inspecting and Changing Fuses P. 692
<p>The starter turns over normally but the engine doesn't start.</p> <p>There may be a problem with a fuse. Check each of the items on the right and respond accordingly.</p>	<p>If the problem continues:</p> <ul style="list-style-type: none">☒ Emergency Towing P. 693

If the Remote Battery is Weak

If the beeper sounds, the **To Start, Hold Remote Near Start Button** message appears on the driver information interface, and the **ENGINE START/STOP** button flashes, and the engine won't start, start the engine as follows:

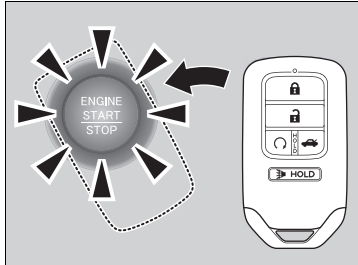

1. Touch the center of the **ENGINE START/STOP** button with the **H** logo on the remote while the **ENGINE START/STOP** button is flashing. The buttons on the remote should be facing you.

▶ The **ENGINE START/STOP** button flashes for about 30 seconds.

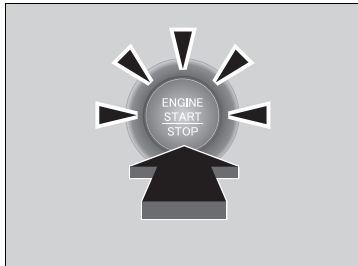

2. Depress the brake pedal (automatic transmission/continuously variable transmission) or clutch pedal (manual transmission) and press the **ENGINE START/STOP** button within 10 seconds after the beeper sounds and the **ENGINE START/STOP** button changes from flashing to on.

▶ If you don't depress the pedal, the mode will change to **ACCESSORY**.

Emergency Engine Stop

The **ENGINE START/STOP** button may be used to stop the engine due to an emergency situation even while driving. If you must stop the engine, do either of the following operations:

- Press and hold the **ENGINE START/STOP** button for about two seconds.
- Firmly press the **ENGINE START/STOP** button three times.

The steering wheel will not lock. However, because turning off the engine disables the power assist the engine provides to the steering and braking systems, it will require significantly more physical effort and time to steer and slow the vehicle. Use both feet on the brake pedal to slow down the vehicle and stop immediately in a safe place. With manual transmission models you can also downshift the transmission to utilize engine braking.

Automatic transmission models

The transmission automatically changes to **P** after the vehicle comes to a complete stop. Then, the power mode changes to VEHICLE OFF.

Continuously variable transmission models

The power mode is in ACCESSORY when the engine is stopped. To change the mode to VEHICLE OFF, put the transmission into **P** after the vehicle comes to a complete stop.

Continuously variable transmission models for Canadian models

Then press the **ENGINE START/STOP** button twice without depressing the brake pedal.

Manual transmission models

The power mode changes to VEHICLE OFF.

⚠ Emergency Engine Stop

Do not press the button while driving unless it is absolutely necessary for the engine to be turned off.

Jump Starting Procedure

Turn off the power to electric devices, such as audio and lights. Turn off the engine, then open the hood.

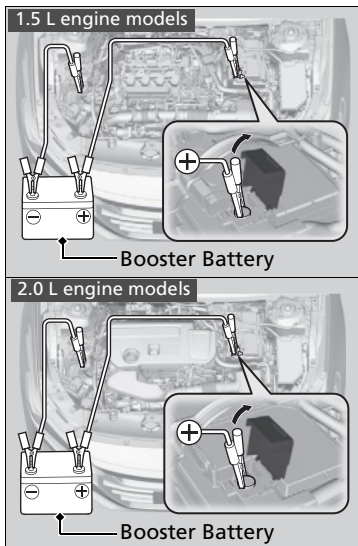

1. Open the cover on the positive \oplus terminal.
2. Connect the first jumper cable to your vehicle's battery \oplus terminal.
3. Connect the other end of the first jumper cable to the booster battery \oplus terminal.
 - ▶ Use a 12-volt booster battery only.
 - ▶ When using an automotive battery charger to boost your 12-volt battery, select a lower charging voltage than 15-volt. Check the charger manual for the proper setting.
4. Connect the second jumper cable to the booster battery \ominus terminal.

Jump Starting

⚠ WARNING

A battery can explode if you do not follow the correct procedure, seriously injuring anyone nearby.

Keep all sparks, open flames, and smoking materials away from the battery.

Securely attach the jumper cables clips so that they do not come off when the engine vibrates. Also be careful not to tangle the jumper cables or allow the cable ends to touch each other while attaching or detaching the jumper cables.

1.5 L engine models

Engine Mounting Bolt

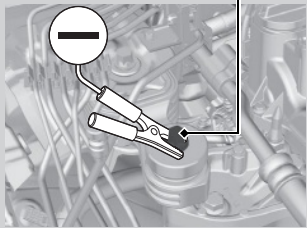

2.0 L engine models

Engine Mounting Bolt

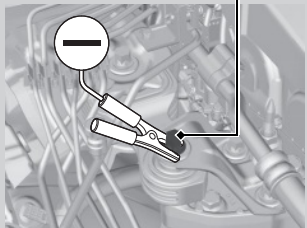

5. Connect the other end of the second jumper cable to the engine mounting bolt as shown. Do not connect this jumper cable to any other part.
6. If your vehicle is connected to another vehicle, start the assisting vehicle's engine and increase its rpm slightly.
7. Attempt to start your vehicle's engine. If it turns over slowly, check that the jumper cables have good metal-to-metal contact.

▶▶ Jump Starting

Battery performance degrades in cold conditions and may prevent the engine from starting.

Continued

■ What to Do After the Engine Starts

Once your vehicle's engine has started, remove the jumper cables in the following order.

1. Disconnect the jumper cable from your vehicle's ground.
2. Disconnect the other end of the jumper cable from the booster battery ⊖ terminal.
3. Disconnect the jumper cable from your vehicle's battery ⊕ terminal.
4. Disconnect the other end of the jumper cable from the booster battery ⊕ terminal.

Have your vehicle inspected by a nearby service station or a dealer.

▣ What to Do After the Engine Starts

The Vehicle Stability Assist® (VSA®) system, Vehicle Stability Assist® (VSA®) OFF, adaptive cruise control (ACC) with low speed follow (LSF)*, adaptive cruise control (ACC)*, safety support and low tire pressure/TPMS indicators may come on in amber along with a message in the driver information interface when you set the power mode to ON after re-connecting a battery. Drive a short distance at more than 12 mph (20 km/h). Each indicator should go off. If any do not, have your vehicle checked by a dealer.

Shift Lever Does Not Move

Continuously variable transmission models

Follow the procedure below if you cannot move the shift lever out of the **P** position.

Releasing the Lock

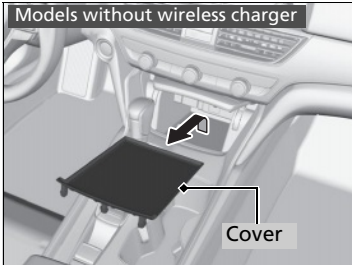

1. Set the parking brake.
2. Remove the built-in key from the remote.
3. Open the center pocket.
➤ **Center Pocket** P. 223

Models without wireless charger

4. Remove the cover in the center pocket.

All models

5. Wrap a cloth around the tip of the built-in key. Put it into the shift lock release slot (as shown in the image) and remove the cover.

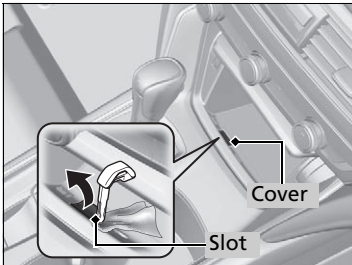

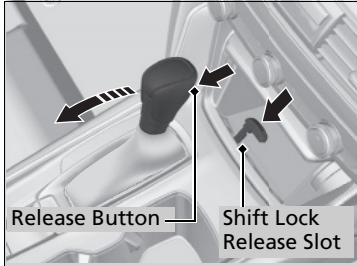

6. Insert the key into the shift lock release slot.
7. While pushing the key down, press the shift lever release button, and place the shift lever into **N**.
 - ▶ The lock is now released. Have the shift lever checked by a dealer as soon as possible.

How to Handle Overheating

Overheating symptoms are as follows:

- The temperature gauge pointer is at the **H** mark or the engine suddenly loses power.
- **Engine Temperature Too Hot. Do Not Drive. Allow Engine To Cool.** message appears on the driver information interface.
- Steam or spray comes out of the engine compartment.

■ First thing to do

1. Immediately park the vehicle in a safe place.
2. Turn off all accessories and turn on the hazard warning lights.
 - ▶ **No steam or spray present:** Keep the engine running and open the hood.
 - ▶ **Steam or spray is present:** Turn off the engine and wait until it subsides. Then open the hood.

☞ How to Handle Overheating

⚠ WARNING

Steam and spray from an overheated engine can seriously scald you.

Do not open the hood if steam is coming out.

NOTICE

Continuing to drive with the temperature gauge pointer at the **H** mark may damage the engine.

Continued

■ Next thing to do

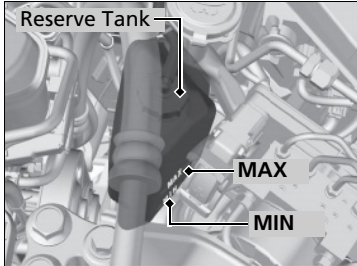

1. Check that the cooling fan is operating and stop the engine once the temperature gauge pointer comes down.
 - If the cooling fan is not operating, immediately stop the engine.
2. Once the engine has cooled down, inspect the coolant level and check the cooling system components for leaks.
 - If the coolant level in the reserve tank is low, add coolant until it reaches the **MAX** mark.
 - If there is no coolant in the reserve tank, check that the radiator is cool. Cover the radiator cap with a heavy cloth and open the cap. If necessary, add coolant up to the base of the filler neck, and put the cap back on.

■ Last thing to do

Once the engine has cooled sufficiently, restart it and check the temperature gauge. If the temperature gauge pointer has come down, resume driving. If it has not come down, contact a dealer for repairs.

►► How to Handle Overheating

⚠ WARNING

Removing the radiator cap while the engine is hot can cause the coolant to spray out, seriously scalding you.

Always let the engine and radiator cool down before removing the radiator cap.

If the coolant is leaking, contact a dealer for repairs.

Use water as an emergency/temporary measure only. Have a dealer flush the system with proper antifreeze as soon as possible.

If the Low Oil Pressure Warning Appears

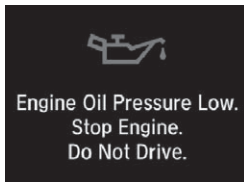

■ Reasons for the warning to appear

Appears when the engine oil pressure is low.

■ What to do as soon as the warning appears

1. Immediately park the vehicle in a safe place.
2. If necessary, turn the hazard warning lights on.

■ What to do after parking the vehicle

1. Stop the engine and let it sit for approximately three minutes.
2. Open the hood and check the oil level.
 🔧 **Oil Check** P. 618
3. Start the engine and check the low oil pressure warning.
 - ▶ The warning disappears: Start driving again.
 - ▶ The warning does not disappear: Immediately stop the engine and contact a dealer for repairs.

If the Charging System Indicator Comes On



■ Reasons for the indicator to come on

Comes on when the battery is not being charged.

■ What to do when the indicator comes on

Stop in a safe place and have your vehicle checked by a dealer immediately.

🔧 If the Low Oil Pressure Warning Appears

NOTICE

Running the engine with low oil pressure can cause serious mechanical damage almost immediately.

🔧 If the Charging System Indicator Comes On

If you need to stop temporarily, do not turn off the engine. Restarting the engine may rapidly discharge the battery.

If the Malfunction Indicator Lamp Comes On or Blinks



■ Reasons for the indicator lamp to come on or blink

- Comes on if there is a problem with the engine emissions control system.
- Blinks when engine misfiring is detected.

■ What to do when the indicator lamp comes on

Avoid high speeds and immediately get your vehicle inspected at a dealer.

■ What to do when the indicator lamp blinks

Park the vehicle in a safe place with no flammable items and wait at least 10 minutes with the engine stopped until it cools.

▶▶ If the Malfunction Indicator Lamp Comes On or Blinks

NOTICE

If you drive with the malfunction indicator lamp on, the emissions control system and the engine could be damaged.

If the malfunction indicator lamp blinks again when restarting the engine, drive to the nearest dealer at 31 mph (50 km/h) or less. Have your vehicle inspected.

If the Brake System Indicator (Red) Comes On or Blinks



■ Reasons for the indicator to come on

- The brake fluid is low.
- There is a malfunction in the brake system.

■ What to do when the indicator comes on while driving

Depress the brake pedal lightly to check pedal pressure.

- If normal, check the brake fluid level the next time you stop.
- If abnormal, take immediate action. If necessary, downshift the transmission to slow the vehicle using engine braking.

■ Reason for the indicator to blink

- There is a problem with the electric parking brake system.

■ What to do when the indicator blinks

Avoid using the parking brake and have your vehicle checked by a dealer immediately.

▶▶ If the Brake System Indicator (Red) Comes On or Blinks

Have your vehicle repaired immediately.

It is dangerous to drive with low brake fluid. If there is no resistance from the brake pedal, stop immediately in a safe place. If necessary, downshift the gears.

If the brake system indicator and **ABS** indicator come on simultaneously, the electronic brake distribution system is not working. This can result in vehicle instability during sudden braking. Have your vehicle inspected by a dealer immediately.

If the brake system indicator (red) blinks at the same time when the brake system indicator (amber) comes on, the parking brake may not work. Avoid using the parking brake and have your vehicle checked by a dealer immediately.

▶▶ If the Brake System Indicator (Red) Comes On or Blinks at the Same Time When the Brake System Indicator (Amber) Comes On P. 684

If you repeatedly operate the electric parking brake in a short period of time, the brake stops operating to prevent heating of the system and the indicator blinks.

It returns to its original state in approximately 1 minute.

If the Brake System Indicator (Red) Comes On or Blinks at the Same Time When the Brake System Indicator (Amber) Comes On



■ If the brake system indicator (red) comes on or blinks at the same time when the brake system indicator (amber) comes on, release the parking brake manually or automatically.

▶ Parking Brake P. 571

- If the brake system indicator (red) continuously comes on or blinks at the same time when the brake system indicator (amber) comes on, stop the vehicle in a safe place and have it inspected by a dealer immediately.

▶ Preventing the vehicle from moving

Automatic transmission/Continuously variable transmission models

Put the transmission into **P**.

Manual transmission models

Move to shift lever to **1** or **R**.

- If only the brake system indicator (red) is turned off, avoid using the parking brake and have your vehicle checked by a dealer immediately.

▶ If the Brake System Indicator (Red) Comes On or Blinks at the Same Time When the Brake System Indicator (Amber) Comes On

If you apply the parking brake, you may not be able to release it.

If the brake system indicator (red) and the brake system indicator (amber) come on at the same time, the parking brake is working.

If the brake system indicator (red) blinks at the same time when the brake system indicator (amber) comes on, the parking brake may not work because it is checking the system.

If the Electric Power Steering (EPS) System Indicator Comes On



■ Reasons for the indicator to come on

- Comes on when there is a problem with the EPS system.
- If you depress the accelerator pedal repeatedly to increase the engine speed while the engine is idling, the indicator comes on, and sometimes the steering wheel becomes harder to operate.

■ What to do when the indicator comes on

- Stop the vehicle in a safe place and restart the engine.
If the indicator comes on and stays on, immediately have your vehicle inspected by a dealer.

If the Low Tire Pressure/TPMS Indicator Comes On or Blinks



■ Reasons for the indicator to come on or blink

A tire pressure is significantly low, or the TPMS has not been calibrated. If there is a problem with the TPMS, the indicator blinks for about one minute, and then stays on.

If the compact spare tire is installed, the indicator will either come on or it will first blink for about one minute, then stay on.

■ What to do when the indicator comes on

Drive carefully and avoid abrupt cornering and hard braking.

Stop your vehicle in a safe place. Check the tire pressure and adjust the pressure to the specified level. The specified tire pressure is on a label on the driver side doorjamb.

▶ Calibrate the TPMS after the tire pressure is adjusted.

➤ **TPMS Calibration** P. 497

If the compact spare tire causes the indicator to come on, change the tire to a full-size tire. The indicator goes off after calibrating the TPMS.

■ What to do when the indicator blinks, then remains on

Have the tire inspected by a dealer as soon as possible. If the compact spare tire causes the indicator to first blink, and then stay on, change the tire to a full-size tire. The indicator goes off after calibrating the TPMS.

➤ **TPMS Calibration** P. 497

▶▶ If the Low Tire Pressure/TPMS Indicator Comes On or Blinks

NOTICE

Driving on an extremely underinflated tire can cause it to overheat. An overheated tire can fail. Always inflate your tires to the prescribed level.

Automatic transmission models

If the Transmission Indicator Blinks along with the Warning Message

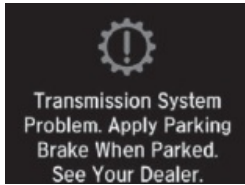

■ Reasons for the indicator to blink

The transmission is malfunctioning.

■ What to do when the indicator blinks

- Immediately have your vehicle inspected by a dealer.
- Put the transmission into **N** after starting the engine.
 - ▶ Check if the **N** position on the driver information interface and the indicator on the **N** button light/blink.
 - **Starting the Engine** P. 465

▶▶ If the Transmission Indicator Blinks along with the Warning Message

You may not be able to start the engine.

Make sure to set the parking brake when parking your vehicle.

Call a professional towing service if you need to tow your vehicle.

➤ **Emergency Towing** P. 693

Fuse Locations

If any electrical devices are not working, set the power mode to VEHICLE OFF and check to see if any applicable fuse is blown.

■ Engine Compartment Fuse Box

Located near the battery. Push the tabs to open the box.

Fuse locations are shown on the fuse box cover. Locate the fuse in question by the fuse number and box cover number.

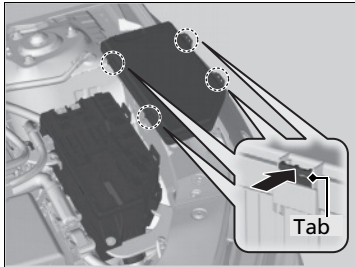

■ **Circuit protected and fuse rating**

	Circuit Protected	Amps
1	BATTERY	125 A
	–	(70 A)
	EPS	70 A
2	–	(30 A)
	FUSE BOX MAIN 2	60 A
	EBB	40 A
	ABS/VSA FSR	40 A
	–	(30 A)
3	IG MAIN1	30 A
	REAR DEFROSTER	40 A
	FUSE BOX MAIN 1	60 A
	–	(30 A)
	HEATER MOTOR	40 A
	–	(40 A)
	ST MG	30 A
	SUB FAN MOTOR	30 A
	–	(30 A)
	–	(30 A)
4	FUSE BOX OP 2*	(70 A)
	–	(40 A)
	FUSE BOX OP 1	60 A

	Circuit Protected	Amps
5	–	(40 A)
	MAIN FAN MOTOR	30 A
	SPM2	30 A
	ABS/VSA MOTOR	40 A
	IG MAIN2	30 A
	WIPER MOTOR	30 A
6	SRM1	30 A
7	–	–
8	–	–
9	STOP LIGHT	10 A
10	TCU*	(15 A)
11	INJ	20 A
12	TCU2*	(10 A)
13	IGP	15 A
14	TCU3*	(10 A)
15	FI ECU	10 A
16	BATT SNSR	7.5 A
17	DBW	15 A
18	IG COIL	15 A
19	HAZARD	15 A
20	–	–
21	–	–
22	H/STRG*	(10 A)
23	–	–
24	AUDIO	15 A
25	REAR H/SEAT*	(20 A)
26	FR WIPER DEICER*	(15 A)

	Circuit Protected	Amps
27	BACK UP	10 A
28	HORN	10 A
29	FR FOG LIGHT*	(10 A)
30	SHUTTER GRILLE*	(7.5 A)
31	MG CLUTCH	10 A
32	WASHER MOTOR	15 A
33	–	–
34	–	(10 A)
35	AUDIO SUB*	(7.5 A)
36	IGPS	7.5 A
37	IGPS (LAF)	7.5 A
38	VB ACT	7.5 A
39	IG1 TCU*	(10 A)
40	IG1 FUEL PUMP	20 A
41	IG1 ABS/VSA	7.5 A
42	IG1 ACG	10 A
43	IG1 ST MOTOR	10 A
44	IG1 MONITOR	7.5 A
45	–	–

* Not available on all models

■ Interior Fuse Box

Located under the dashboard.

Fuse locations are shown on the label on the side panel.

Locate the fuse in question by the fuse number and label number.

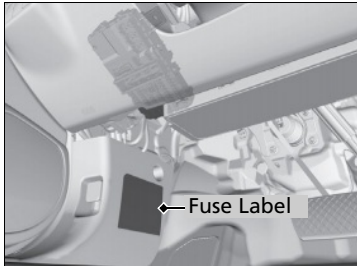

■ Circuit protected and fuse rating

	Circuit Protected	Amps
1	–	–
2	L SIDE DOOR UNLOCK	10 A
3	R SIDE DOOR UNLOCK	10 A
4	ACC	10 A
5	ACC KEY LOCK	7.5 A
6	SRS	10 A
7	–	–
8	IG HOLD2*	(10 A)
9	SMART	10 A
10	–	–
11	L SIDE DOOR LOCK	10 A
12	DR DOOR LOCK	(10 A)
13	R SIDE DOOR LOCK	10 A
14	OPTION	10 A
15	DRL	10 A
16	CTR ACC SOCKET	(20 A)
17	MOON ROOF*	(20 A)
18	–	–
19	–	–
20	SBW ECU*	(10 A)
21	DR DOOR UNLOCK	(10 A)
22	–	–
23	–	–
24	PREMIUM AMP*	(20 A)
25	–	–

	Circuit Protected	Amps
26	–	–
27	–	–
28	–	–
29	–	–
30	–	–
31	–	–
32	IG HOLD3*	(15 A)
33	DR P/SEAT SLI*	(20 A)
34	AS P/SEAT SLI*	(20 A)
35	OPTION2	10 A
36	METER	10 A
37	OPTION1	10 A
38	DR P/SEAT REC *	(20 A)
39	AS P/SEAT REC *	(20 A)
40	DR P/LUMBAR*	(10 A)
41	–	–
42	AVS*	(20 A)
43	OPTION	10 A
44	ADS*	(20 A)
45	–	–
46	SRS	10 A
47	–	–
48	HUD*	(10 A)
49	DOOR LOCK	20 A
50	FR ACC SOCKET	20 A
51	RR R P/W	20 A
52	RR L P/W	20 A

	Circuit Protected	Amps
53	AS P/W	20 A
54	DR P/W	20 A
55	–	–

* Not available on all models

Inspecting and Changing Fuses

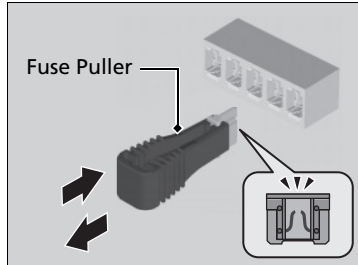
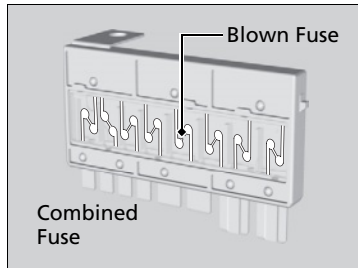

1. Set the power mode to VEHICLE OFF. Turn headlights and all accessories off.
2. Open the fuse box cover in the engine compartment.
3. Check the large fuse in the engine compartment.
 - If the fuse is blown, use a Phillips-head screwdriver to remove the screw and replace it with a new one.
4. Inspect the small fuses in the engine compartment and the vehicle interior.
 - If there is a blown fuse, remove it with the fuse puller and replace it with a new one.

► Inspecting and Changing Fuses

NOTICE

Replacing a fuse with one that has a higher rating greatly increases the chances of damaging the electrical system.

Replace fuse with a spare fuse of the same specified amperage.

Use the charts to locate the fuse in question and confirm the specified amperage on the fuse label.

► **Fuse Locations** P. 688

There is a fuse puller on the back of the engine compartment fuse box cover.

Call a professional towing service if you need to tow your vehicle.

■ Flat bed equipment

The operator loads your vehicle on the back of a truck.

This is the best way to transport your vehicle.

■ Wheel lift equipment

The tow truck uses two pivoting arms that go under the front tires and lift them off the ground. The rear tires remain on the ground. **This is an acceptable way to tow your vehicle.**

» Emergency Towing

NOTICE

Trying to lift or tow your vehicle by the bumpers will cause serious damage. The bumpers are not designed to support the vehicle's weight.

Make sure the parking brake is released. If you cannot release the parking brake, your vehicle must be transported by the flat bed equipment.

➤ **Parking Brake** P. 571

NOTICE

Improper towing such as towing behind a motorhome or other motor vehicle can damage the transmission.

Never tow your vehicle with just a rope or chain. It is very dangerous, since ropes or chains may shift from side to side or break.

When You Cannot Unlock the Fuel Fill Door

What to Do When Unable to Unlock the Fuel Fill Door

If you cannot unlock the fuel fill door, use the following procedure.

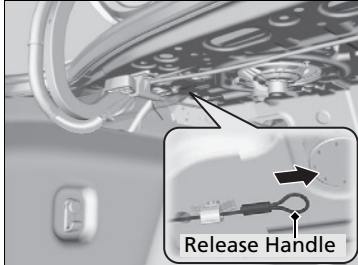

1. Open the trunk.
 2. Pull the release handle toward you.
 - ▶ The fuel fill door unlocks.
 3. Open the fuel fill door.
- **How to Refuel** P. 598

When You Cannot Unlock the Fuel Fill Door

After taking these steps, contact a dealer to have the vehicle checked.

What to Do When Unable to Open the Trunk

If you cannot open the trunk, use the following procedure.

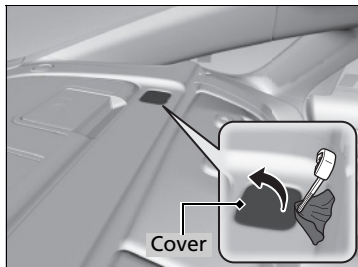

Models with adjustable headrest

1. Remove the driver side rear outer head restraint.

➤ Removing and Reinstalling the Head Restraints P. 218

All models

2. Remove the built-in key from the remote.
3. Wrap a cloth around the tip of the built-in key. Put it into the cover (as shown in the image) and remove the cover.

Models with the cylinder in the cover

4. Insert the key into the cylinder and turn the key to the right.

▶ The trunk unlocks and opens.

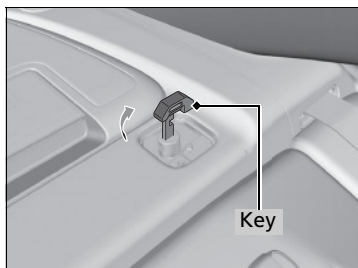

When You Cannot Open the Trunk

Following up:

After taking these steps, contact a dealer to have the vehicle checked.

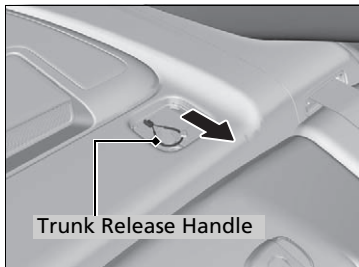

Models without the cylinder in the cover

- 4.** Pull the trunk release handle up in the direction of the arrow in the image.
 - ▶ The trunk unlocks and opens.

Refueling From a Portable Fuel Container

If you have run out of fuel and need to refuel your vehicle from a portable fuel container, use the funnel provided with your vehicle.

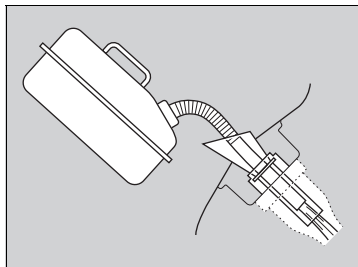
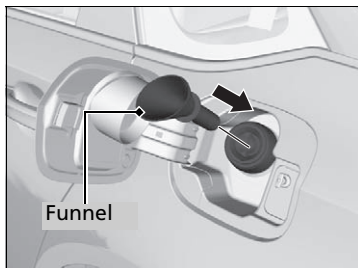

1. Turn off the engine.
2. Press on the edge of the fuel fill door until you hear a click when the driver's door is unlocked.
 - ▶ The fuel fill door opens.
3. Take the funnel out of the tool case in the trunk.
 - ▶ **Types of Tools** P. 664
4. Place the end of the funnel on the lower part of filler opening, then insert it slowly and fully.
 - ▶ Make sure that the end of the funnel goes down along with the filler pipe.
5. Fill the tank with fuel from the portable fuel container.
 - ▶ Pour fuel carefully so you do not spill any.
6. Remove the funnel from the filler neck.
 - ▶ Wipe up any fuel from the funnel before storing it.
7. Shut the fuel fill door by hand.

▶▶ Refueling From a Portable Fuel Container

⚠ WARNING

Gasoline is highly flammable and explosive. You can be burned or seriously injured when handling fuel.

- Stop the engine, and keep heat, sparks, and flame away.
- Handle fuel only outdoors.
- Wipe up spills immediately.

NOTICE

Do not insert the nozzle of a portable fuel container or any funnel other than the one provided with your vehicle. Doing so can damage the fuel system. Do not try to pry open or push open the sealed fuel tank with foreign objects. This can damage the fuel system and its seal.

Make sure the fuel in the portable fuel container is gasoline before you refuel.

Information

This chapter includes your vehicle's specifications, locations of identification numbers, and other information required by regulation.

Specifications	700
Identification Numbers	
Vehicle Identification Number (VIN), Engine Number, and Transmission Number	704
Devices that Emit Radio Waves	705
Reporting Safety Defects	706
Emissions Testing	
Testing of Readiness Codes.....	707
Warranty Coverages	709
Authorized Manuals	711

1.5 L engine models

Vehicle Specifications

Model	ACCORD
No. of Passengers:	
Front	2
Rear	3
Total	5
Weights:	
Gross Vehicle Weight Rating	See the certification label on the driver's doorjamb
Gross Axle Weight Rating (Front)	See the certification label on the driver's doorjamb
Gross Axle Weight Rating (Rear)	See the certification label on the driver's doorjamb

Air Conditioning

Refrigerant Type	HFO-1234yf (R-1234yf)
Charge Quantity	13.9 – 15.7 oz (395 – 445 g)
Lubricant Type	ND-OIL 14
Quantity	5.6 – 6.5 cu-in (92 – 107 cm ³)

Engine Specifications

Displacement	91.38 cu-in (1,498 cm ³)
Spark Plugs	NGK DILKAR8P8SY

Fuel

Type	Unleaded gasoline, Pump octane number of 87 or higher
Fuel Tank Capacity	14.8 US gal (56 L)

Washer Fluid

Tank Capacity	U.S.: 2.6 US qt (2.5 L) Canada: 4.8 US qt (4.5 L)
---------------	--

Light Bulbs

Headlights (Low Beam)	LED
Headlights (High Beam)	60W (HB3)* ¹ LED* ²
Fog Lights*	LED
Parking/Daytime Running Lights	LED
Front Turn Signal Lights	LED
Front Side Marker Lights	LED
Side Turn Signal Lights (on Door Mirrors)*	LED
Brake Lights	LED
Rear Turn Signal Lights	21W (Amber)
Rear Side Marker Lights	LED
Taillights	LED
Back-Up Lights	16W
High-Mount Brake Light	LED
Rear License Plate Light	LED
Interior Lights	
Map Lights	8W
Ceiling Light	8W
Ambient Lights	LED
Vanity Mirror Lights	1.4W
Center Pocket Light	LED
Door Courtesy Lights*	2CP (3.8W)
Door Inner Handle Lights*	LED
Trunk Light	5W
Console Compartment Light*	LED

*1: Models with halogen high beam headlights

*2: Models with LED high beam headlights

■ Brake/Clutch* Fluid

Specified	Honda Heavy Duty Brake Fluid DOT 3
-----------	------------------------------------

■ Continuously Variable Transmission Fluid*

Specified	Honda HCF-2 Transmission Fluid
Capacity	Change 3.9 US qt (3.7 L)

■ Manual Transmission Fluid*

Specified	Honda Manual Transmission Fluid (MTF)
Capacity	Change 2.0 US qt (1.9 L)

■ Engine Oil

Recommended	·Genuine Honda Motor Oil 0W-20	
	·API Premium-grade 0W-20 detergent oil	
Capacity	Change	3.4 US qt (3.2 L)
	Change including filter	3.7 US qt (3.5 L)

■ Engine Coolant

Specified	Honda Long-Life Antifreeze/Coolant Type2
Ratio	50/50 with distilled water
Capacity	1.59 US gal (6.03 L)*1
	1.56 US gal (5.90 L) *2
	(change including the remaining 0.17 US gal (0.66 L) in the reserve tank)

*1: Continuously variable transmission models
 *2: Manual transmission models

■ Tire

Regular	Size	225/50R17 94V*1 235/40R19 96V*2
	Pressure psi (kPa [kgf/cm ²])	
	Front	32 (220 [2.2])*1 33 (225 [2.25])*2
	Rear	32 (220 [2.2])*1 33 (225 [2.25])*2
Compact Spare	Size	T135/90D16 102M*1 T135/80D17 103M*2
	Pressure psi (kPa [kgf/cm ²])	60 (420 [4.2])
Wheel Size	Regular	17 x 7 1/2J*1 19 x 8 1/2J*2
	Compact Spare	16 x 4T*1 17 x 4T*2

*1: U.S. LX, EX, EX-L, EX-LN models and Canadian LX, SE, EX-L models

*2: U.S. Sport, Touring models and Canadian Sport, Touring models

* Not available on all models

2.0 L engine models

Vehicle Specifications

Model	ACCORD
No. of Passengers:	
Front	2
Rear	3
Total	5
Weights:	
Gross Vehicle Weight Rating	See the certification label on the driver's doorjamb
Gross Axle Weight Rating (Front)	See the certification label on the driver's doorjamb
Gross Axle Weight Rating (Rear)	See the certification label on the driver's doorjamb

Air Conditioning

Refrigerant Type	HFO-1234yf (R-1234yf)
Charge Quantity	13.9 – 15.7 oz (395 – 445 g)
Lubricant Type	ND-OIL 14
Quantity	5.6 – 6.5 cu-in (92 – 107 cm ³)

Engine Specifications

Displacement	121.76 cu-in (1,996 cm ³)
Spark Plugs	NGK DILKAR8P8SY

Fuel

Type	Unleaded gasoline, Pump octane number of 87 or higher
Fuel Tank Capacity	14.8 US gal (56 L)

Washer Fluid

Tank Capacity	U.S.: 2.6 US qt (2.5 L) Canada: 4.8 US qt (4.5 L)
---------------	--

Light Bulbs

Headlights (Low Beam)	LED
Headlights (High Beam)	60W (HB3)* ¹ LED* ²
Fog Lights	LED
Parking/Daytime Running Lights	LED
Front Turn Signal Lights	LED
Front Side Marker Lights	LED
Side Turn Signal Lights (on Door Mirrors)	LED
Brake Lights	LED
Rear Turn Signal Lights	21W (Amber)
Rear Side Marker Lights	LED
Taillights	LED
Back-Up Lights	16W
High-Mount Brake Light	LED
Rear License Plate Light	LED
Interior Lights	
Map Lights	8W
Ceiling Light	8W
Ambient Lights	LED
Vanity Mirror Lights	1.4W
Center Pocket Light	LED
Door Courtesy Lights* ¹	2CP (3.8W)
Door Inner Handle Lights* ¹	LED
Trunk Light	5W
Console Compartment Light* ¹	LED

*1: Models with halogen high beam headlights

*2: Models with LED high beam headlights

■ Brake/Clutch* Fluid

Specified	Honda Heavy Duty Brake Fluid DOT 3
-----------	------------------------------------

■ Automatic Transmission Fluid*

Specified	Honda Automatic Transmission Fluid ATF-type 2.0
Capacity	Change 4.5 US qt (4.3 L)

■ Manual Transmission Fluid*

Specified	Honda Manual Transmission Fluid (MTF)
Capacity	Change 2.27 US qt (2.15 L)

■ Engine Oil

Recommended	·Genuine Honda Motor Oil 0W-20 ·API Premium-grade 0W-20 detergent oil
Change	4.6 US qt (4.4 L)
Capacity	Change including filter 5.0 US qt (4.8 L)

■ Engine Coolant

Specified	Honda Long-Life Antifreeze/Coolant Type2
Ratio	50/50 with distilled water
Capacity	1.34 US gal (5.06 L) (change including the remaining 0.17 US gal (0.66 L) in the reserve tank)

■ Tire

Regular	Size	225/50R17 94V* ¹ 235/40R19 96V* ²
	Pressure	
	psi (kPa [kgf/cm ²])	32 (220 [2.2])* ¹ 33 (225 [2.25])* ²
Compact Spare	Size	T135/80D17 103M
	Pressure	
Wheel Size	psi (kPa [kgf/cm ²])	60 (420 [4.2])
	Regular	17 x 7 1/2J* ¹ 19 x 8 1/2J* ²
	Compact Spare	17 x 4T

*1: U.S. EX-L, EX-LN models

*2: U.S. Sport, Touring models and Canadian Sport, Touring models

* Not available on all models

Vehicle Identification Number (VIN), Engine Number, and Transmission Number

Your vehicle has a 17-digit vehicle identification number (VIN) used to register your vehicle for warranty purposes, and for licensing and insuring your vehicle.

The locations of your vehicle's VIN, engine number, and transmission number are shown as follows.

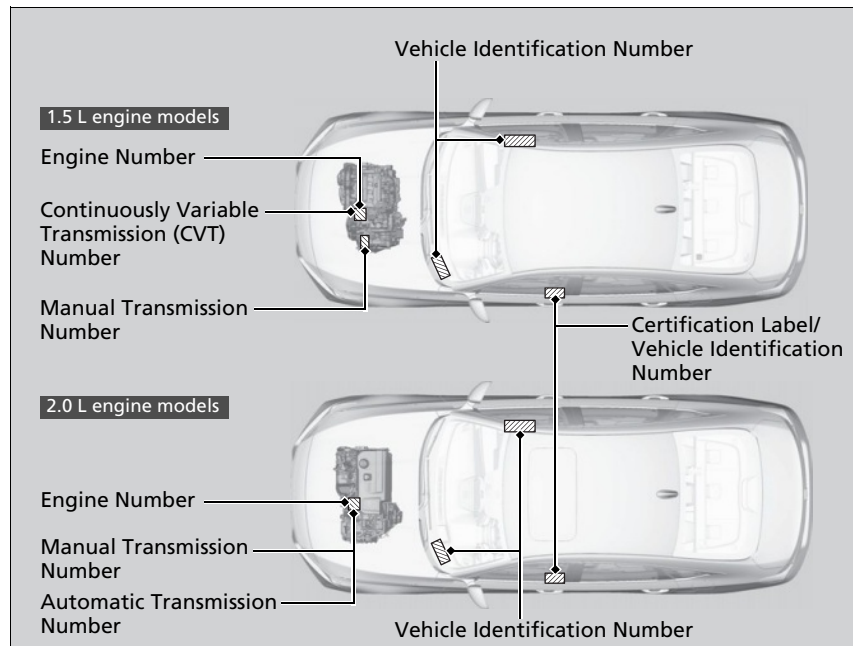

Vehicle Identification Number (VIN), Engine Number, and Transmission Number

The interior vehicle identification number (VIN) is located under the cover.

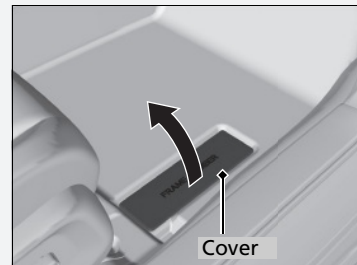

Each radio frequency device installed in the vehicle conforms to the requirements and standards of the regulation listed below:

As required by the FCC:

This device complies with Part 15 of the FCC rules. Operation is subject to the following two conditions: (1) This device may not cause harmful interference, and (2) this device must accept any interference received, including interference that may cause undesired operation.

Changes or modifications not expressly approved by the party responsible for compliance could void the user's authority to operate the equipment.

This device complies with Industry Canada licence-exempt RSS standard(s).

Operation is subject to the following two conditions: (1) this device may not cause interference, and (2) this device must accept any interference, including interference that may cause undesired operation of the device.

In the U.S.

If you believe that your vehicle has a defect which could cause a crash or could cause injury or death, you should immediately inform the National Highway Traffic Safety Administration (NHTSA) in addition to notifying American Honda Motor Co., Inc.

If NHTSA receives similar complaints, it may open an investigation, and if it finds that a safety defect exists in a group of vehicles, it may order a recall and remedy campaign. However, NHTSA cannot become involved in individual problems between you, your dealer, or American Honda Motor Co., Inc.

To contact NHTSA, you may call the Vehicle Safety Hotline toll-free at 1-888-327-4236 (TTY: 1-800-424-9153); go to <http://www.safercar.gov>; or write to: Administrator, NHTSA, 1200 New Jersey Avenue, SE., Washington, DC 20590. You can also obtain other information about motor vehicle safety from <http://www.safercar.gov>.

In Canada

If you believe that your vehicle has a defect which could cause a crash or could cause injury or death, you should immediately inform Honda Canada Inc. and you may also inform Transport Canada.

If Transport Canada receives similar complaints, it may open an investigation, and if it finds that a safety defect exists in a group of vehicles, it may lead to a recall and remedy campaign. However, Transport Canada cannot become involved in individual problems between you, your dealer, or Honda Canada Inc.

To contact Transport Canada's Defect Investigations and Recalls Division, you may call 1-800-333-0510. For more information on reporting safety defects or about motor vehicle safety, go to <http://www.tc.gc.ca/roadsafety>.

Testing of Readiness Codes

Your vehicle has readiness codes as part of the onboard self diagnostic system. Some States use these codes for testing to verify whether your vehicle's emissions components are working properly. The codes may not be read properly if testing is performed just after the battery has gone dead or been disconnected.

To check if they are set, set the power mode to ON, without starting the engine. The malfunction indicator lamp will come on for several seconds. If it then goes off, the readiness codes are set. If it blinks five times, the readiness codes are not set.

If you are required to have your vehicle tested before the readiness codes are ready, prepare the vehicle for retesting by doing the following:

1. Fill the gas tank to approximately 3/4 full.
2. Park the vehicle and leave the engine off for 6 hours or more.
3. Make sure the ambient temperature is between 40°F and 95°F (4°C and 35°C).
4. Start the engine without touching the accelerator pedal, and let it idle for 20 seconds.
5. Keep the vehicle in **P** (automatic transmission/continuously variable transmission) or neutral (manual transmission). Increase the engine speed to 2,000 rpm, and hold it there for about 3 minutes.
6. Let the engine idle with your foot off the accelerator for 20 seconds.

Testing of Readiness Codes

The readiness codes are erased when the battery is disconnected, and set again only after several days of driving under a variety of conditions.

If a testing facility determines that the readiness codes are not set, you may be requested to return at a later date to complete the test.

If the testing facility determines the readiness codes are still not set, see a dealer.

7. Select a nearby, lightly traveled major highway where you can maintain a speed of 50 to 60 mph (80 to 97 km/h) for at least 20 minutes. Drive on the highway in **D** (automatic transmission/continuously variable transmission) or 5th (manual transmission). Do not use cruise control. When traffic allows, drive for 90 seconds without moving the accelerator pedal. (Vehicle speed may vary slightly; this is okay.) If you cannot do this for a continuous 90 seconds because of traffic conditions, drive for at least 30 seconds, then repeat it two more times (for a total of 90 seconds).
8. Drive in city or suburban traffic for at least 10 minutes. When traffic conditions allow, let the vehicle coast for several seconds without using the accelerator pedal or the brake pedal.
9. Park the vehicle and leave the engine off for 30 minutes.

■ U.S. Owners

Your new vehicle is covered by these warranties:

New Vehicle Limited Warranty – covers your new vehicle, except for the emissions control systems and accessories, against defects in materials and workmanship.

Emissions Control Systems Defects Warranty and Emissions Performance Warranty – these two warranties cover your vehicle's emissions control systems. Time, mileage, and coverage are conditional. Please read your warranty booklet for exact information.

Seat Belt Limited Warranty – a seat belt that fails to function properly is covered by a limited warranty. Please read your warranty booklet for details.

Rust Perforation Limited Warranty – all exterior body panels are covered for rust-through from the inside for the specified time period with no mileage limit.

Accessory Limited Warranty – Honda accessories are covered under this warranty. Time and mileage limits depend on the type of accessory and other factors. Please read your warranty booklet for details.

Replacement Parts Limited Warranty – covers all Honda replacement parts against defects in materials and workmanship.

Replacement Battery Limited Warranty – provides prorated coverage for a replacement battery purchased from a dealer.

Replacement Muffler Lifetime Limited Warranty – provides coverage for as long as the purchaser of the muffler owns the vehicle.

Restrictions and exclusions apply to all these warranties. Please read the Honda warranty information booklet that came with your vehicle for precise information on warranty coverages. Your vehicle's original tires are covered by their manufacturer. Tire warranty information is in a separate booklet.

■ **Canadian Owners**

Please refer to the warranty manual that came with your vehicle.

■ **EPA Contact Information**

An owner may obtain further information concerning emission warranties or report violations of the terms of the emission warranties by contacting:

U.S. Environmental Protection Agency
Office of Transportation and Air Quality
Compliance Division, Light-Duty Vehicle Group
Attn: Warranty Complaints
2000 Traverwood Drive
Ann Arbor, MI 48105
Email: complianceinfo@epa.gov

■ Service Express

For electronic copies of service publications, you can purchase a subscription to Service Express. Visit www.techinfo.honda.com for pricing and options.

■ For U.S. Owners

Manuals can be purchased from Helm Incorporated. You can order a manual by phone at 1(800) 782-4356 (credit card orders only), or online at www.helminc.com.

■ For Canadian Owners

Please contact a dealer to order any manuals that you may require.

Honda dealership personnel are trained professionals who should be able to deal with any problems you may encounter with your vehicle. If, however, you are faced with a problem that they cannot resolve to your satisfaction, contact Honda Customer Services.

U.S. Owners

American Honda Motor Co., Inc.
Honda Automobile Customer Services
Mail Stop 100-5E-8A
1919 Torrance Blvd.
Torrance, CA 90501-2746
Tel: 1 (800) 999-1009

Canadian Owners

Honda Canada Inc.
Customer Relations
180 Honda Boulevard
Markham, ON
L6C 0H9
Tel: 1-888-9-HONDA-9
Fax: 1-877-939-0909
E-mail: Honda_cr@ch.honda.com

In Puerto Rico and the U.S. Virgin Islands

Bella International
P.O. Box 190816
San Juan, PR 00919-0816
Tel: 1 (787) 620-7546

Customer Service Information

When you call or write, please give us the following information:

- Vehicle Identification Number
 - ▣ **Vehicle Identification Number (VIN), Engine Number, and Transmission Number** P. 704
- Date of purchase
- Odometer reading of your vehicle
- Your name, address, and telephone number
- A detailed description of the problem
- Name of the dealer who sold the vehicle to you

Numbers

7-Speed Manual Shift Mode	486
Operation	487

A

ABS (Anti-lock Brake System)	581
Accessories and Modifications	660
Accessory Power Sockets	228
Adaptive Cruise Control (ACC) .. 99, 100,	535
Adaptive Cruise Control (ACC) with Low	
Speed Follow (LSF)	99, 100, 519
Adaptive Damper System	493
Additives	
Coolant	625
Engine Oil	617
Washer	630
Additives, Engine Oil	617
Adjusting	
Armrest	219
Front Seats	210
Head Restraints	216
Mirrors	208
Rear Seats	214
Steering Wheel	207
Agile Handling Assist	496
Air Conditioning System	
(Climate Control System)	239
Changing the Mode	239
Defrosting the Windshield and	
Windows	240

Dust and Pollen Filter	654
Recirculation/Fresh Air Mode	239
Sensors	242
Synchronized Mode	241
Using Automatic Climate Control	239
Air Pressure	643, 701, 703
Airbags	45
Advanced Airbags	51
After a Collision	48
Airbag Care	60
Event Data Recorder	0
Front Airbags (SRS)	48
Indicator	58, 90
Knee Airbags	52
Passenger Front Airbag Off Indicator	59
Sensors	45
Side Airbags	55
Side Curtain Airbags	57
AM/FM Radio	259, 298
Ambient Lights	222
Android Auto™	339
Anti-lock Brake System (ABS)	581
Indicator	90
Apple CarPlay®	336
Armrest	219
Audio Remote Controls	248
Audio System	244
Adjusting the Sound	257, 292
Audio/Information Screen	253, 274
Display Setup	258, 293
Error Messages	343

General Information	348
Home Screen	279
How to Update Wirelessly	286
How to Update with a USB Device	290
How to use Siri® Eyes Free	272, 335
iPod	261, 313
Limitations for Manual Operation	294
MP3/WMA/AAC	266, 316
Near Field Communication (NFC)	332
Pandora®	264
Reactivating	247
Remote Controls	248
Security Code	247
Selecting an Audio Source	294
Status Area	284
System Updates	286
Theft Protection	247
USB Flash Drives	266, 316, 349
USB Ports	245
Wallpaper Setup	255, 277
Audio/Information Screen	253, 274
Authorized Manuals	711
Auto Door Locking/Unlocking	179
Customize	379, 397
Auto High-Beam	197
Indicator	90
Automatic Brake Hold	577
Indicator	82, 577
Automatic Brake Hold System	
Indicator	82, 577
Automatic Intermittent Wipers	201

Automatic Lighting	194
Automatic Transmission	
Creeping	474
Fluid	628
Kickdown	474
Shift Operation	476
Shifting.....	475
Average Fuel Economy.....	143
Average Speed.....	145

B

Battery	651
Charging System Indicator.....	84, 681
Jump Starting.....	674
Maintenance (Checking the Battery).....	651
Maintenance (Replacing).....	653
Belts (Seat)	38
Beverage Holders.....	226
Blind spot information System	502
Bluetooth® Audio	269, 319
Bluetooth® HandsFreeLink®	403, 427
Booster Seats (For Children).....	74
Brake System.....	571
Anti-lock Brake System (ABS).....	581
Automatic Brake Hold.....	577
Brake Assist System	582
Fluid	629
Foot Brake.....	576
Indicator.....	79, 80, 683, 684
Parking Brake	571

Brightness Control (Instrument Panel)....	203
Bulb Replacement	631
Brake, Taillight, Rear Side Marker Lights and Rear Turn Signal Light.....	634
Fog Lights	633
Front Side Marker Lights.....	633
Front Turn Signal Lights.....	633
Headlights.....	631
High-Mount Brake Light.....	638
Parking/Daytime Running Lights	633
Rear License Plate Lights.....	638
Side Turn Signal/Emergency Indicator Lights	633
Taillight, Brake Light and Back-Up Light...	636
Bulb Specifications	700, 702

C

Carbon Monoxide Gas	75
Cargo Hooks	233
Carrying Cargo	455, 457
Center Pocket	223
Certification Label.....	704
Changing Bulbs	631
Charging System Indicator.....	84, 681
Child Safety.....	61
Childproof Door Locks.....	178
Emergency Trunk Opener	182
Child Seat.....	61
Booster Seats	74
Child Seat for Infants.....	63

Child Seat for Small Children	64
Installing a Child Seat with a Lap/ Shoulder Seat Belt.....	69
Larger Children	73
Rear-facing Child Seat.....	63
Selecting a Child Seat	65
Using a Tether	71
Childproof Door Locks.....	178
Cleaning the Exterior.....	657
Cleaning the Interior	655
Climate Control System	239
Changing the Mode.....	239
Defrosting the Windshield and Windows	240
Dust and Pollen Filter	654
Recirculation and Fresh Air Mode.....	239
Sensors	242
Synchronized Mode	241
Using Automatic Climate Control.....	239
Clock	164
CMBS™ (Collision Mitigation Braking System™)	510
Coat Hook	233
Collision Mitigation Braking System™ (CMBS™)	510
Compact Spare Tire.....	665, 701, 703
Console Compartment.....	224
Continuously Variable Transmission	
Creeping.....	474
Fluid	627
Kickdown	474

Operating the Shift Lever	23, 483, 485
Shift Lever Does Not Move.....	677
Shifting.....	482, 484
Controls	163
Coolant (Engine)	625
Adding to the Engine Coolant Reserve	
Tank	625
Adding to the Radiator	626
Overheating.....	679
Creeping (Automatic Transmission/ Continuously Variable Transmission)	474
Cross Traffic Monitor	590
Cup Holders	226
Customer Service Information	712
Customized Features	370, 381

D

Daytime Running Lights	196
Dead Battery	674
Defaulting All the Settings	399
Defrosting the Windshield and Windows	240
Devices that Emit Radio Waves	705
Dimming	
Headlights	193
Rearview Mirror	208
Dipstick (Engine Oil)	618
Directional Signals (Turn Signal)	193
Door Mirrors	209

Doors	166
Auto Door Locking	179
Auto Door Unlocking.....	179
Door and Trunk Open Message	37
Keys	166
Locking/Unlocking the Doors	
from the Inside	176
Locking/Unlocking the Doors	
from the Outside	169
Lockout Prevention System	175
DOT Tire Quality Grading	645
Driver Attention Monitor	152
Driver Information Interface	138
Switching the Display	138
Warning and Information Messages	105
Driving	453
Automatic Transmission/ Continuously Variable Transmission	474
Braking.....	571
Shifting Gear	475, 488
Shifting Position	482, 484
Starting the Engine	465
Driving Position Memory System	205
Driving Support Information	155
Dust and Pollen Filter	654

E

Eco Assist® System	9
ECON Button	492

Econ Mode	
Indicator.....	97
Elapsed Time	145
Electric Power Steering (EPS) System	
Indicator.....	92, 685
Electronic Stability Control (ESC)	494
Emergency	693
Emergency Engine Stop	673
Emergency Trunk Opener	182
Emissions Testing (Readiness Codes)	707
Engine	704
Coolant.....	625
Jump Starting.....	674
Oil.....	617
Starting.....	465
Engine Coolant	625
Adding to the Engine Coolant Reserve	
Tank.....	625
Adding to the Radiator.....	626
Overheating	679
Temperature Gauge	137
Engine Oil	617
Adding.....	620
Checking.....	618
Displaying Oil Life.....	608
Low Oil Pressure Warning.....	681
Recommended Engine Oil	617
ENGINE START/STOP Button	190
EPS (Electric Power Steering) System	685
Exhaust Gas Hazard (Carbon Monoxide)	75

Exterior Care (Cleaning)	657
Exterior Mirrors.....	209

F

Features.....	243
Filters	
Dust and Pollen	654
Oil	621
Flat Tire	665
Floor Mats.....	656
Fluids	
Automatic Transmission.....	628
Brake/Clutch.....	629
Continuously Variable Transmission	627
Engine Coolant.....	625
Manual Transmission	627
Windshield Washer.....	630
FM/AM Radio	259, 298
Fog Lights.....	195
Indicator.....	94
Folding Down the Rear Seat.....	214
Foot Brake.....	576
Front Airbags (SRS).....	48
Front Seat Heaters.....	236
Front Seat Heaters and Seat Ventilation	237
Front Seats	
Adjusting.....	210
Front Sensor Camera	568
Fuel.....	24, 597

Economy.....	600
Gauge.....	137
Instant Fuel Economy	143
Low Fuel Indicator	89
Range	143
Recommendation	597
Refueling.....	597
Fuel Economy and CO₂ Emissions	600
Fuel Fill Door	24, 598
Unable to Unlock	694
Fuses	688
Inspecting and Changing.....	692
Locations.....	688, 690

G

Gasoline (Fuel)	
Economy.....	600
Gauge.....	137
Information	597
Instant Fuel Economy	143
Low Fuel Indicator	89
Refueling.....	597
Gauges	137
Gear Position Indicator	84
Gear Shift Lever Positions	
Continuously Variable Transmission.....	482, 484
Manual Transmission.....	488
Glass (care)	655, 658
Glove Box	223

H

Halogen Bulbs	631
Handling the Unexpected	663
HandsFreeLink® (HFL)	403, 427
Automatic Import of Cellular Phonebook and Call History	417, 436
Automatic Transferring	415, 435
Displaying Messages	446
Favorite Contacts.....	437
HFL Buttons	403, 427
HFL Menus.....	405, 430
HFL Status Display.....	404, 429
In Case of Emergency	325, 450
Limitations for Manual Operation....	404, 429
Making a Call	421, 439
Options During a Call.....	426, 442
Phone Setup	409, 432
Receiving a Call.....	425, 442
Receiving a Text Message.....	444
Ring Tone	415, 435
Selecting a Phone	445
Speed Dial	418
To Clear the System	416
To Set Up a Text Message Options	443
Hazard Warning Button	4
HD Radio™	301
Head Restraints	216

Headlights	193	Adaptive Cruise Control (ACC) with Low Speed Follow (LSF) (Green) /Adaptive Cruise Control (ACC) (Green)	100, 520, 536	Safety Support (Green)	104
Aiming	631	Anti-lock Brake System (ABS)	90	Seat Belt Reminder	39, 89
Auto High-Beam	197	Auto High-Beam	90	Security System Alarm	96
Automatic Operation	194	Automatic Brake Hold	82, 577, 578	Shift Down	88
Dimming	193, 196	Automatic Brake Hold System	82, 577, 578	Shift Up	88
Operating	193	Charging System	84, 681	SPORT Mode	98, 491
Head-Up Display	157	ECON Mode	97, 492	Supplemental Restraint System	58, 90
Heated Steering Wheel	235	Electric Power Steering (EPS) System	92, 685	System Message	96
Heated Windshield Button	202	Fog Light	94	Transmission System	85, 87
Heaters (Seat)	236, 237, 238	Gear Position	84	Turn Signal and Hazard Warning	94
HFL (HandsFreeLink®)	403, 427	High Beam	94	Vehicle Stability Assist® (VSA®) OFF	92, 495
High Beam Indicator	94	Immobilizer System	95	Vehicle Stability Assist® (VSA®) System	91, 494
Hill Start Assist System	472	Lane Keeping Assist System (LKAS) (Amber)	100	Information	699
HomeLink® Universal Transceiver	400	Lane Keeping Assist System (LKAS) (Green)	100, 552	Instant Fuel Economy	143
Honda App License Agreement	350	Lights On	94	Instrument Panel	77
Honda Sensing®	25, 507	Low Fuel	89	Brightness Control	203
HondaLink®	321	Low Tire Pressure/TPMS	93, 497, 500	Interior Lights	221
I		M (sequential mode/7-speed manual shift mode) Indicator/Gear Selection Indicator	84	Interior Rearview Mirror	208
Identification Numbers		Malfunction Indicator Lamp	83, 682	iPad	349
Engine and Transmission	704	Parking Brake and Brake System (Amber)	80, 684	iPhone	349
Vehicle Identification	704	Parking Brake and Brake System (Red)	79, 683, 684	iPod	261, 313, 349
Illumination Control		Safety Support (Amber)	101	J	
Dial	203			Jack (Wheel Nut Wrench)	668
Immobilizer System	183			Jump Starting	674
Indicator	95				
Indicators	78				
Adaptive Cruise Control (ACC) with Low Speed Follow (LSF) (Amber) /Adaptive Cruise Control (ACC) (Amber)	99				

K

Key Number Tag	167
Keyless Lockout Prevention	175
Keys	166
Lockout Prevention	175
Number Tag	167
Rear Door Won't Open	178
Remote Transmitter	173
Types and Functions	166
Valet Key	182
Kickdown (Automatic Transmission/ Continuously Variable Transmission).....	474
Knee Airbags.....	52

L

Lane Keeping Assist System (LKAS)	550
LaneWatch™.....	505
Language (HFL).....	404, 429
LATCH (Child Seats)	66
Lights	193, 631
Auto High-Beam.....	197
Automatic	194
Bulb Replacement.....	631
Daytime Running Lights	196
Fog Lights.....	195
High Beam Indicator	94
Interior	221
Light Switches	193
Lights On Indicator	94
Turn Signals.....	193

Load Limits.....	457
Locking/Unlocking.....	166
Auto Door Locking/Unlocking.....	179
Childproof Door Locks.....	178
From Inside	176
From Outside	169
Keys	166
Using a Key	174
Lockout Prevention System	175
Low Battery Charge	681
Low Fuel Indicator.....	89
Low Oil Pressure Warning	681
Low Remote Signal Strength.....	168
Lower Anchors.....	66
Lubricant Specifications Chart.....	700, 702
Luggage (Maximum Load Limit)	457
Lumbar Support Adjustment Switch.....	211

M

Maintenance.....	147, 603
Battery	651
Brake/Clutch Fluid	629
Cleaning	655
Climate Control System.....	654
Coolant.....	625
Maintenance Minder™	607
Oil.....	618
Precautions	604
Radiator	626
Remote Transmitter.....	653

Replacing Light Bulbs	631
Safety	605
Service Items.....	611
Tires.....	642
Transmission Fluid.....	627
Under the Hood.....	614
Malfunction Indicator Lamp	83, 682
Manual Transmission	488
Map Lights.....	222
Maximum Load Limit.....	457
Meters, Gauges	137
Mirrors	208
Adjusting	208
Door	209
Exterior	209
Interior Rearview	208
Modifications (and Accessories)	660
Moonroof	189
MP3.....	266, 316
MP3/WMA/AAC.....	266, 316
Multi-View Rear Camera	594

N

Navigation.....	146
Near Field Communication (NFC).....	332
Numbers (Identification)	704

O

Odometer	140
Oil (Engine)	617
Adding	620
Checking	618
Displaying Oil Life	608
Low Oil Pressure Warning	681
Oil Life	147
Recommended Engine Oil	617
Viscosity	617
Open Source Licenses	364
Opening	
Trunk	695
Opening/Closing	
Hood	616
Moonroof	189
Power Windows	186
Trunk	180
Outside Temperature Display	141
Overheating	679

P

Paddle Shifters	
(7-Speed Manual Shift Mode)	486
Pandora®	264
Panic Mode	185
Parking	583
Parking Brake	571
Parking Brake and Brake System Indicator (Amber)	80

Parking Brake and Brake System Indicator (Red)	79, 683, 684
Parking Sensor System	585
Passenger Front Airbag Off Indicator	59
Passing Indicators	193
Phone	148
Playing <i>Bluetooth</i> ® Audio	269, 319
Power Windows	186
Precautions While Driving	473
Rain	473
Pregnant Women	43
Puncture (Tire)	665

R

Radiator	626
Radio (AM/FM)	259, 298
Radio (SiriusXM®)	302
Radio Data System (RDS)	260, 300
Range	143
RDS (Radio Data System)	260, 300
Readiness Codes (Emissions Testing)	707
Rear Defogger/Heated Door Mirror	
Button	202
Rear Seat (Folding Down)	214
Rear Seat Heaters	238
Rearview Mirror	208
Refueling	597
Fuel Gauge	137
Gasoline	597, 700, 702
Low Fuel Indicator	89

Regulations	500, 645, 705
Remote Engine Start with Vehicle	
Feedback	469
Remote Transmitter	173
Replacement	
Battery	653
Bulbs	631
Fuses	688, 690
Tires	648
Wiper Blade Rubber	639
Reporting Safety Defects	706
Resetting a Trip Meter	141, 143
Road Departure Mitigation (RDM)	558
On and Off	560

S

Safe Driving	33
Safety Check	37
Safety Labels	76
Safety Message	1
Safety Support	156
Seat Belts	38
Adjusting the Shoulder Anchor	42
Automatic Seat Belt Tensioners	40
Checking	44
Fastening	41
Installing a Child Seat with a Lap/ Shoulder Seat Belt	69
Pregnant Women	43
Reminder	39

Warning Indicator.....	39, 89	Specifications.....	700	Tires.....	642
Seat Heaters.....	236, 237, 238	Specified Fuel.....	597, 700, 702	Air Pressure.....	643, 701, 703
Seat Ventilation.....	237	Speedometer.....	137	Checking and Maintaining.....	642
Seats.....	210	SPORT Mode.....	491	Inspection.....	642
Adjusting.....	210	Indicator.....	98	Labeling.....	643
Front Seats.....	210	SRS Airbags (Airbags).....	48	Puncture (Flat Tire).....	665
Rear Seats.....	214	Starting the Engine.....	465	Regulations.....	645
Seat Heaters.....	236, 237, 238	Does Not Start.....	671	Rotation.....	649
Seat Ventilation.....	237	Jump Starting.....	674	Spare Tire.....	665, 701, 703
Security System.....	183	Steering Wheel.....		Summer.....	650
Immobilizer System Indicator.....	95	Adjusting.....	207	Tire Chains.....	650
Security System Alarm Indicator.....	96	Stopping.....	583	Wear Indicators.....	647
Select Buttons.....	20, 475	Summer Tires.....	650	Winter.....	650
Operation.....	476	Sunglasses Holder.....	234	Tools.....	664
Selecting a Child Seat.....	65	Supplemental Restraint System (SRS).....	48	Towing a Trailer.....	459
Selector Knob (Audio).....	252	Switches.....		Equipment and Accessories.....	461
Shift Lever.....	23, 482, 484, 488	(Around the Steering Wheel).....	4, 5, 190	Load Limits.....	459
Operation.....	23, 483, 485, 488	System Message Indicator.....	96	Towing Your Vehicle.....	463
Releasing.....	677	System Updates.....	286	Emergency.....	693
Won't Move.....	677	T		TPMS	
Shifting (Transmission).....	475, 482, 484, 488	Tachometer.....	149	(Tire Pressure Monitoring System).....	497
Shoulder Anchor.....	42	Temperature.....		Indicator.....	93, 686
Side Airbags.....	55	Gauge.....	137	Traffic Sign Recognition System.....	562
Side Curtain Airbags.....	57	Outside Temperature Display.....	141	Transmission.....	475, 482, 484, 488
Siri® Eyes Free.....	272, 335	Temperature Sensor.....	141, 242	Automatic.....	475
SiriusXM® Radio.....	302	Time (Adjusting).....	164	Continuously Variable.....	482, 484
Smart Entry with Push Button Start		Tire Pressure Monitoring System		Fluid.....	627, 628
System.....	169	(TPMS).....	497	Gear Position Indicator.....	84
Snow Tires.....	650	Indicator.....	93, 686	Manual.....	488
Spare Tire.....	665, 701, 703			Number.....	704
Spark Plugs.....	700, 702				

Transmission System

Indicator	85
TRIP Button	140
Trip Computer	142, 144
Trip Meter	141, 143, 145
Troubleshooting	663
Blown Fuse	688, 690
Brake Pedal Vibrates	29
Buzzer Sounds When Opening Door	30
Emergency Towing	693
Engine Won't Start	671
Noise When Braking	31
Overheating	679
Puncture/Flat Tire	665
Rear Door Won't Open	30, 178
Shift Lever Won't Move	677
Warning Indicators	78
Trunk	180
Lid	180
Light Bulb	700, 702
Main Switch	182
Unable to Open	695
Turbo Engine Vehicle	601
Turn Signals	193
Indicators (Instrument Panel)	94
Turn-by-Turn Directions	161

U

Unlocking the Doors	169
Unlocking the Front Doors from the Inside	14
USB Flash Drives	266, 316, 349
USB Ports	245
Using the Smart Entry with Push Button Start System	169

V

Valet Key	182
Vanity Mirrors	7
Vehicle Identification Number	704
Vehicle Speed	160
Vehicle Stability Assist® (VSA®)	494
Off Button	495
Off Indicator	92
System Indicator	91
Ventilation	237
Viscosity (Oil)	617, 701, 703
Voice Control Operation	295
Voice Portal Screen	296
Voice Recognition	295
VSA® (Vehicle Stability Assist®)	494

W

Wallpaper	255, 277
Warning and Information Messages	105
Warning Indicator On/Blinking	681
Warning Labels	76
Warnings	147
Warranties (Warranty Manual provided separately)	709
Watts	700, 702
Wear Indicators (Tire)	647
Wheel Nut Wrench (Jack Handle) ...	664, 668
Wi-Fi Connection	330
Window Washers	200
Adding/Refilling Fluid	630
Switch	200
Windows (Opening and Closing)	186
Windshield	
Cleaning	655, 658
Defrosting/Defogging	240
Washer Fluid	630
Wiper Blades	639
Wipers and Washers	200
Winter Tires	
Snow Tires	650
Tire Chains	650
Wipers and Washers	200
Automatic Intermittent Wipers	201
Checking and Replacing Wiper Blades	639
Wireless Charger	230
WMA	266, 316
Worn Tires	642



31TVA610
OM-08295
00X31-TVA-6100

owners.honda.com (U.S.)
myhonda.ca (Canada)

2019 Honda Accord Sedan Owner's Manual
©2018 Honda Motor Co., Ltd. — All Rights Reserved

Printed in U.S.A.