

CLARITY

HONDA
The Power of Dreams

**2018 PLUG-IN HYBRID
OWNER'S MANUAL**

WARNING

California Proposition 65 Warning

Operating, servicing and maintaining a passenger vehicle or off-road vehicle can expose you to chemicals including engine exhaust, carbon monoxide, phthalates, and lead, which are known to the State of California to cause cancer and birth defects or other reproductive harm. To minimize exposure, avoid breathing exhaust, do not idle the engine except as necessary, service your vehicle in a well-ventilated area and wear gloves or wash your hands frequently when servicing your vehicle. For more information go to www.P65Warnings.ca.gov/passenger-vehicle.

Event Data Recorders

This vehicle is equipped with an event data recorder (EDR).

The main purpose of an EDR is to record, in certain crash or near crash-like situations, such as an air bag deployment or hitting a road obstacle, data that will assist in understanding how a vehicle's systems performed. **The EDR is designed to record data related to vehicle dynamics and safety systems for a short period of time, typically 30 seconds or less. The EDR in this vehicle is designed to record such data as:**

- **How various systems in your vehicle were operating;**
- **Whether or not the driver and passenger safety belts were buckled/fastened;**

- **How far (if at all) the driver was depressing the accelerator and/or brake pedal; and,**
- **How fast the vehicle was traveling.**

These data can help provide a better understanding of the circumstances in which crashes and injuries occur. NOTE: EDR data are recorded by your vehicle only if a non-trivial crash situation occurs; no data are recorded by the EDR under normal driving conditions and no personal data (e.g., name, gender, age, and crash location) are recorded. However, other parties, such as law enforcement, could combine the EDR data with the type of personally identifying data routinely acquired during a crash investigation.

To read data recorded by an EDR, special equipment is required, and access to the vehicle or the EDR is needed. In addition to the vehicle manufacturer, other parties, such as law enforcement, that have the special equipment, can read the information if they have access to the vehicle or the EDR.

The data belongs to the vehicle owner and may not be accessed by anyone else except as legally required or with the permission of the vehicle owner.

Service Diagnostic Recorders

This vehicle is equipped with service-related devices that record information about powertrain performance. The data can be used to verify emissions law requirements and/or help technicians diagnose and solve service problems. It may also be combined with data from other sources for research purposes, but it remains confidential. Some diagnostic and maintenance information is uploaded to Honda upon vehicle start up.

California Perchlorate Contamination Prevention Act

The airbags, seat belt tensioners, and CR type batteries in this vehicle may contain perchlorate materials - special handling may apply. See www.dtsc.ca.gov/hazardouswaste/perchlorate/

As you read this manual, you will find information that is preceded by a **NOTICE** symbol. This information is intended to help you avoid damage to your vehicle, other property, or the environment.

Software End User License Agreement

Your vehicle comes equipped with software, which is governed by the End User License Agreement in Owner's Manual, and which contains a binding arbitration clause. Please refer to the End User License Agreement for the terms and conditions governing your use of the installed software, as well as the applications, services, functions, and content provided through the software. Your use of the installed software will serve as your consent to the terms and conditions of the End User License Agreement.

You may opt out within 30 days of your initial use of the Software by sending a signed, written notice to HONDA at American Honda Motor Co., Inc. Honda Automobile Customer Services Mail Stop 100-5E-8A, 1919 Torrance Blvd. Torrance, CA 90501-2746.

Privacy Notice

This vehicle may share location and usage information. To manage this setting, visit www.hondalink.com/vehicle-data-choices.

High-Voltage Battery Monitoring System

This vehicle is equipped with a monitoring system that compiles data about your vehicle and driving conditions and transmits that data to Honda at regular intervals as determined at the discretion of Honda. This data includes information on but not limited to the following:

- Vehicle location, distance driven, warning indicators and messages, and vehicle speed
- High-Voltage Battery system control and power generation

The system does not record audio or images.

Data collected is used for the sole purposes of technical diagnoses, preventive maintenance, research and vehicle development.

Neither Honda nor any third party receiving data will use the data for any other purpose without first obtaining customer authorization.

A Few Words About Safety

Your safety, and the safety of others, is very important. And operating this vehicle safely is an important responsibility.

To help you make informed decisions about safety, we have provided operating procedures and other information on labels and in this manual. This information alerts you to potential hazards that could hurt you or others.

Of course, it is not practical or possible to warn you about all the hazards associated with operating or maintaining your vehicle. You must use your own good judgment.

You will find this important safety information in a variety of forms, including:

- **Safety Labels** - on the vehicle.
- **Safety Messages** - preceded by a safety alert symbol  and one of three signal words: **DANGER**, **WARNING**, or **CAUTION**. These signal words mean:

 **DANGER**

You **WILL** be **KILLED** or **SERIOUSLY HURT** if you don't follow instructions.

 **WARNING**

You **CAN** be **KILLED** or **SERIOUSLY HURT** if you don't follow instructions.

 **CAUTION**

You **CAN** be **HURT** if you don't follow instructions.

- **Safety Headings** - such as Important Safety Precautions.
- **Safety Section** - such as Safe Driving.
- **Instructions** - how to use this vehicle correctly and safely.

This entire book is filled with important safety information - please read it carefully.

This owner's manual should be considered a permanent part of the vehicle and should remain with the vehicle when it is sold.

This owner's manual covers all models of your vehicle. You may find descriptions of equipment and features that are not on your particular model.

Images throughout this owner's manual (including the front cover) represent features and equipment that are available on some, but not all, models. Your particular model may not have some of these features.

This owner's manual is for vehicles sold in the United States and Canada.

The information and specifications included in this publication were in effect at the time of approval for printing. Honda Motor Co., Ltd. reserves the right, however, to discontinue or change specifications or design at any time without notice and without incurring any obligation.

➤ Safe Driving P. 41

For Safe Driving P. 42 Seat Belts P. 47 Airbags P. 54

➤ Instrument Panel P. 85

Indicators P. 86 Gauges and Driver Information Interface P. 121

➤ Controls P. 135

Clock P. 136 Locking and Unlocking the Doors P. 137
Operating the Switches Around the Steering Wheel P. 158
Interior Lights/Interior Convenience Items P. 183

➤ Features P. 203

Audio System P. 204 Audio System Basic Operation P. 210
Customized Features P. 306 HomeLink® Universal Transceiver* P. 332

➤ Driving P. 369

Before Driving P. 370 Towing a Trailer P. 375
Multi-View Rear Camera P. 449 Refueling P. 451

➤ Maintenance P. 471

Before Performing Maintenance P. 472 Maintenance Minder™ P. 475
Checking and Maintaining Wiper Blades P. 496
Climate Control System Maintenance P. 511 Cleaning P. 513

➤ Handling the Unexpected P. 521

If a Tire Goes Flat P. 522 Handling of the Jack P. 534
Indicator, Coming On/Blinking P. 545
When You Cannot Unlock the Fuel Fill Door P. 562

➤ Information P. 565

Specifications P. 566 Identification Numbers P. 568
Emissions Testing P. 572 Warranty Coverages P. 573

Contents

Child Safety P. 69

Safety Labels P. 83

Opening and Closing the Trunk P. 150
Adjusting the Mirrors P. 173
Climate Control System P. 193

Security System P. 153
Adjusting the Seats P. 175

Opening and Closing the Windows P. 156

Audio Error Messages P. 284
Bluetooth® HandsFreeLink® P. 335

General Information on the Audio System P. 288

When Driving P. 376
Charging P. 454

Braking P. 431
Fuel Economy and CO₂ Emissions P. 469

Parking Your Vehicle P. 447

Maintenance Under the Hood P. 480
Checking and Maintaining Tires P. 499
Accessories and Modifications P. 519

Replacing Light Bulbs P. 494
12-Volt Battery P. 508

Remote Transmitter Care P. 510

Power System Won't Start P. 535
Fuses P. 553
When You Cannot Open the Charge Lid P. 563

Jump Starting P. 539
Emergency Towing P. 561

Overheating P. 542

When You Cannot Open the Trunk P. 564

Devices that Emit Radio Waves P. 569
Authorized Manuals P. 576

Reporting Safety Defects P. 571
Customer Service Information P. 577

Quick Reference Guide P. 6

Safe Driving P. 41

Instrument Panel P. 85

Controls P. 135

Features P. 203

Driving P. 369

Maintenance P. 471

Handling the Unexpected P. 521

Information P. 565

Index P. 579

Visual Index

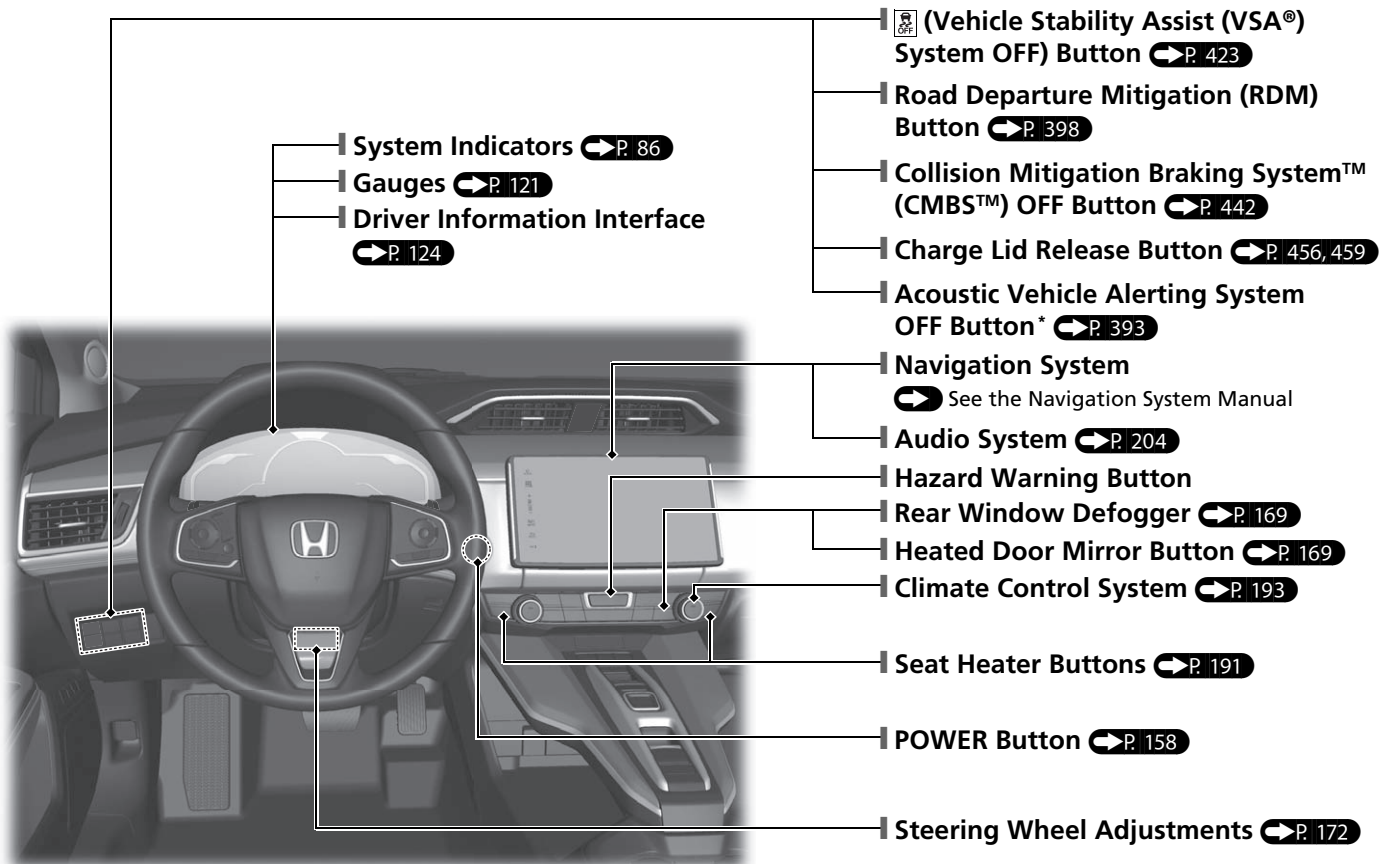

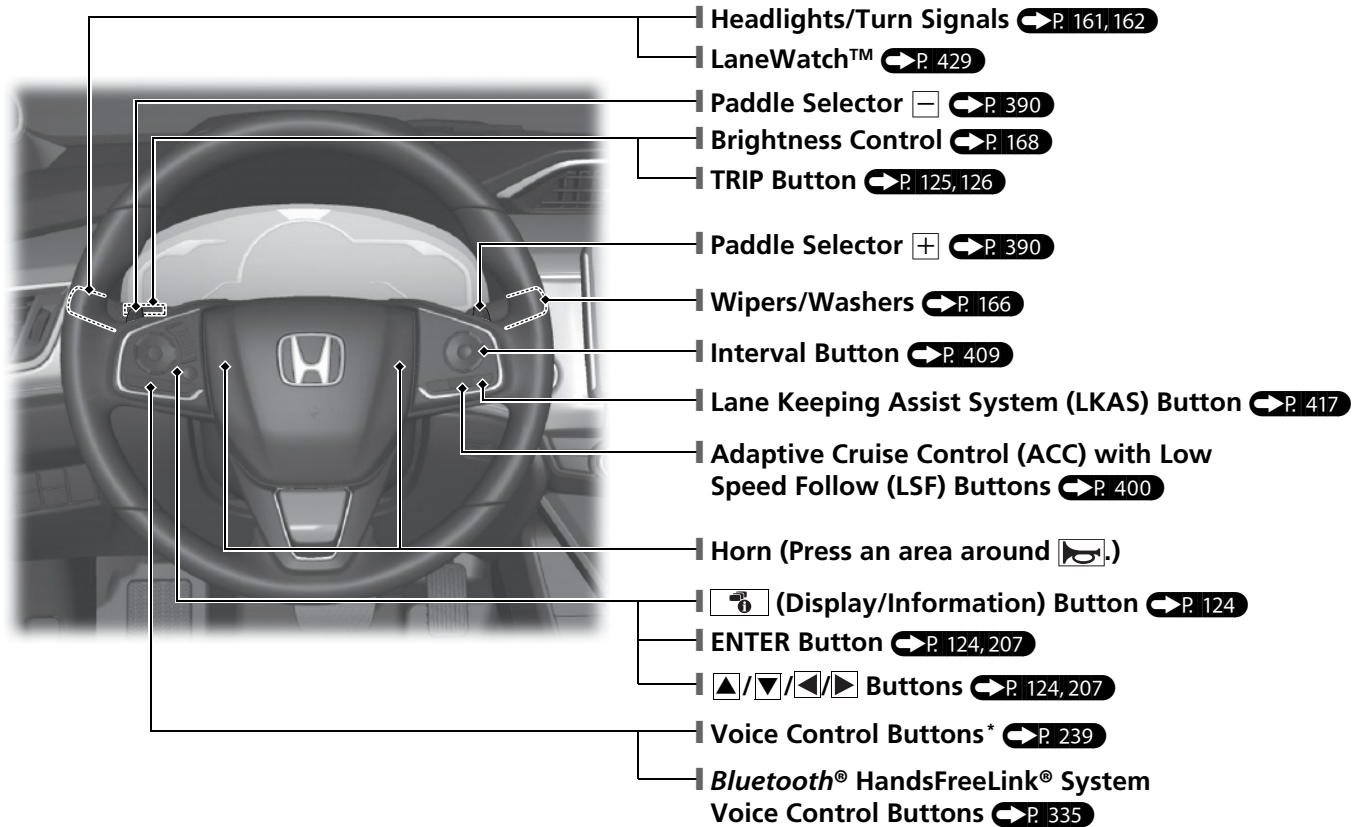

Visual Index

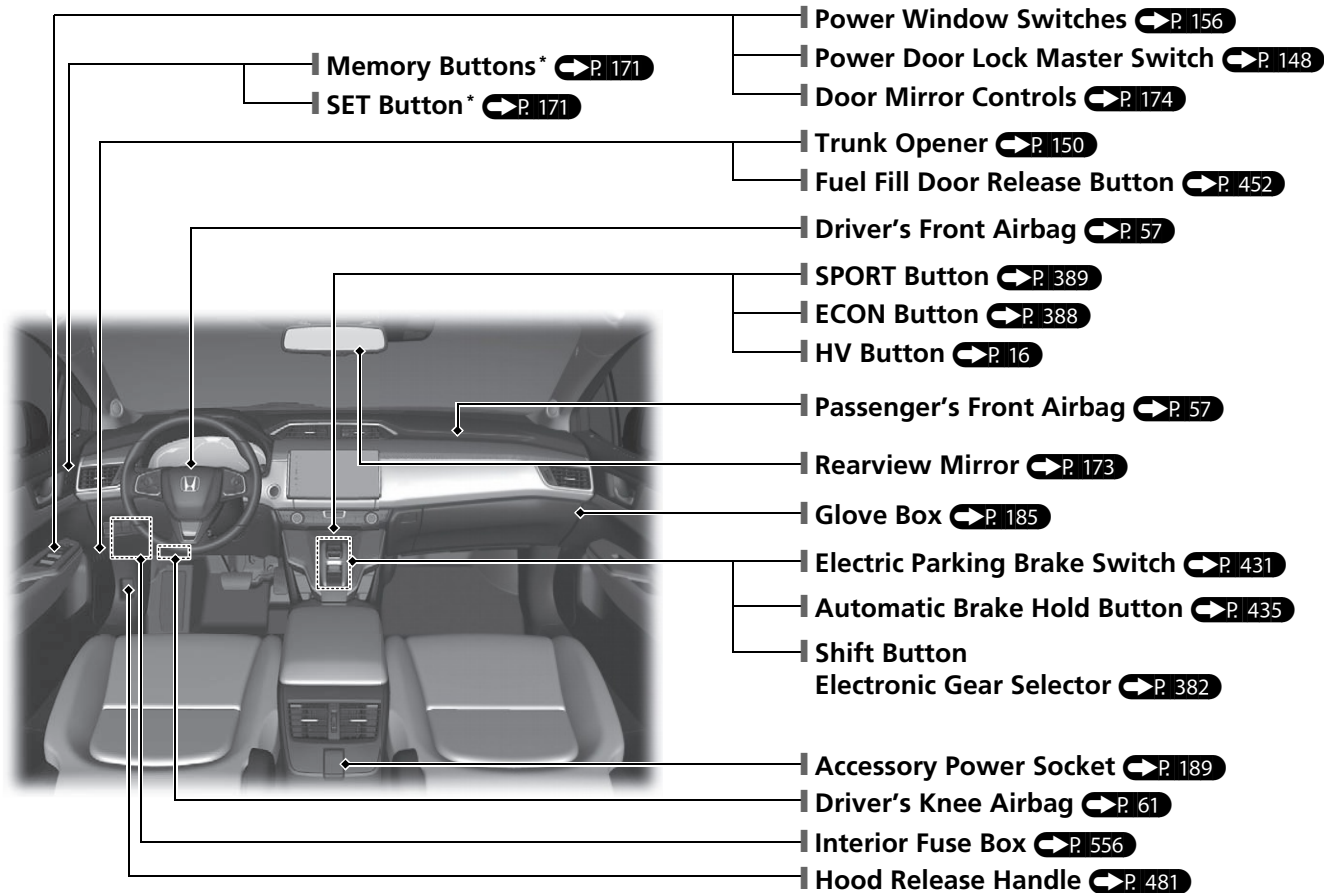

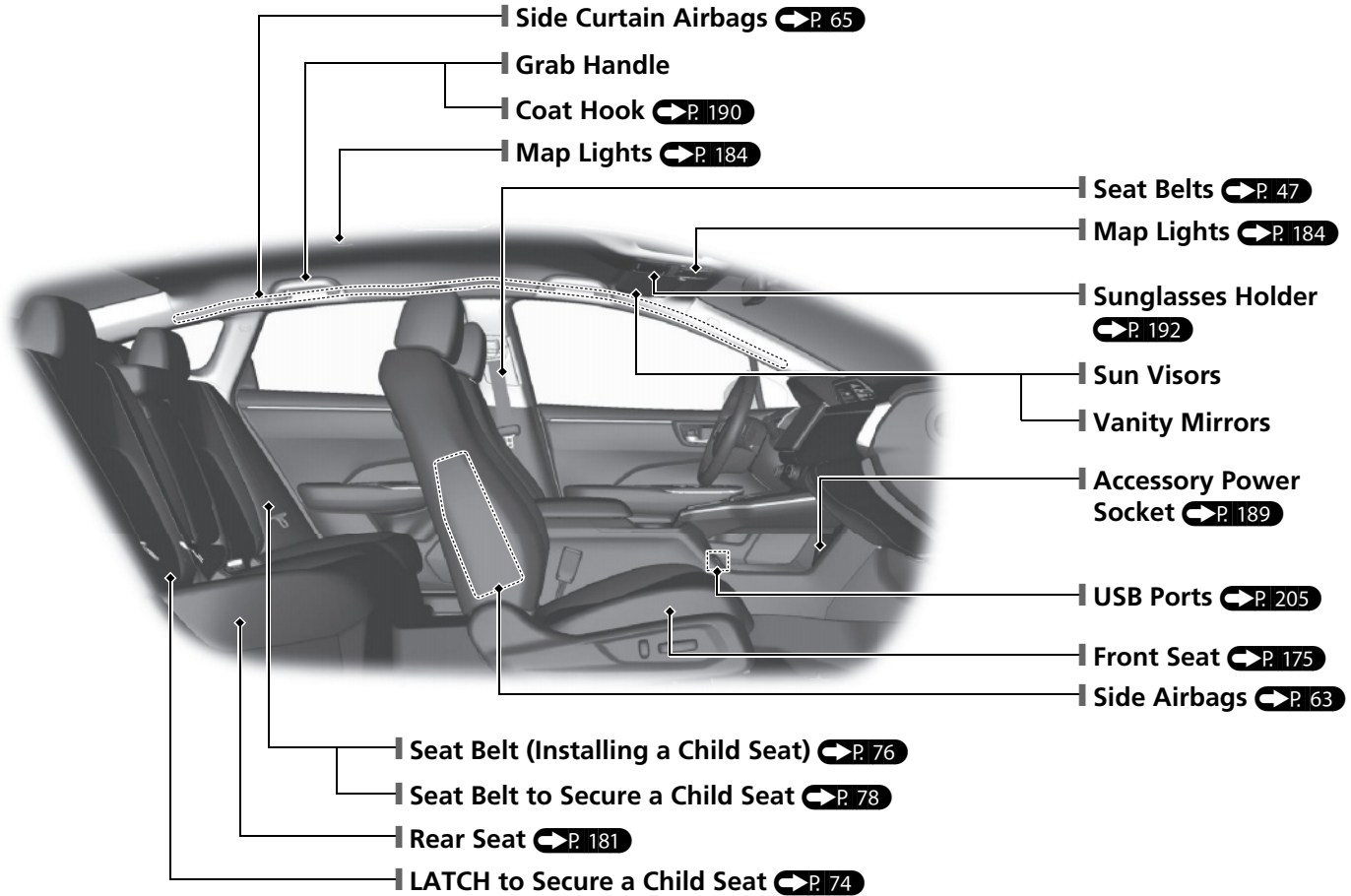

Visual Index

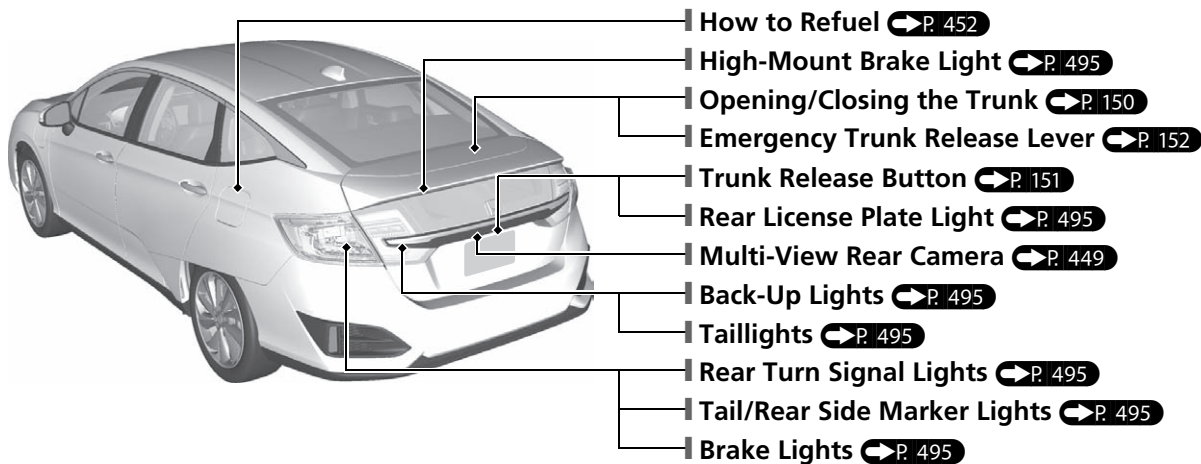
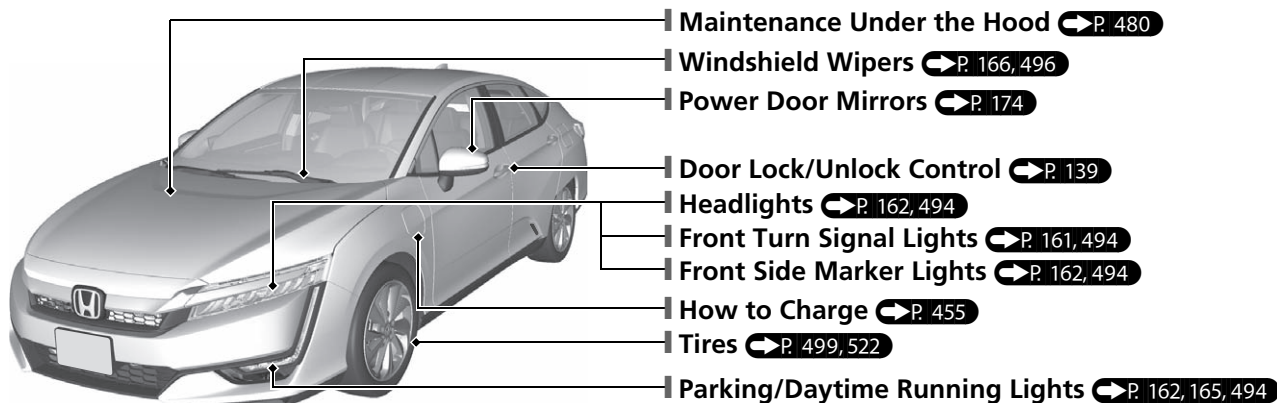

SPORT HYBRID i-MMD Plug-in (Intelligent Multi-mode Drive Plug-in)

Your Honda SPORT HYBRID i-MMD Plug-in vehicle uses both an electric motor and a gasoline engine as propulsion sources, with the electric motor receiving electricity from an internal High Voltage battery or internal generator.

When the High Voltage battery has sufficient charge levels, the vehicle is propelled solely by the power supplied by the High Voltage battery (Electric) or by a combination of power supplied by both the High Voltage battery and the generator which is driven by the engine.

When the High Voltage battery charge drops to low levels, the vehicle is propelled by power supplied by the engine-driven generator.

The system offers three different propulsion sources: You can drive with the electric motor, the gasoline engine, or both the electric motor and the gasoline engine (hybrid). Under most driving conditions, the system automatically selects an appropriate propulsion source based on the current driving needs.

You may also choose to use the propulsion sources as follows:

- EV - While driving in city traffic or at slow speed.
- HV - During highway driving at high speeds.
- HV Charge - To charge the High Voltage battery while driving.

The High Voltage battery can be charged while the vehicle is running or while it is plugged in.

 **Power Source and Charging**  **P.15**

There are three drive modes: ECON, NORMAL, and SPORT

Regardless of the drive mode that is activated, when the accelerator pedal is depressed past a certain point, the engine starts. When this occurs, electrical power generated by the engine combines with electrical power from the battery to provide greater driving force. If you select ECON mode, the threshold for the engine to provide additional power is higher than it is when the vehicle operates under either of the two sources. Note that if the accelerator pedal is depressed past the point at which you feel a click, the engine will start in the ECON mode with the HV indicator off.

➔ HV Button  P. 16

To maintain fuel efficiency, keep steady pressure on the accelerator pedal and avoid aggressive acceleration and deceleration.

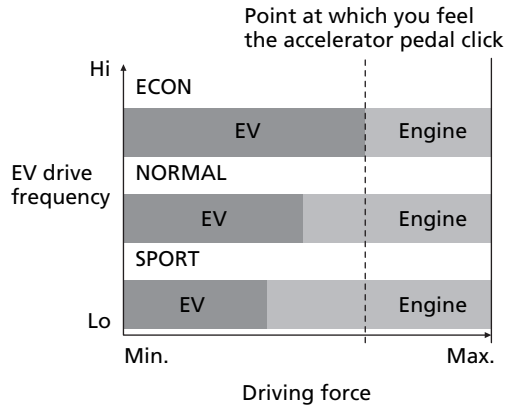

SPORT Mode Indicator

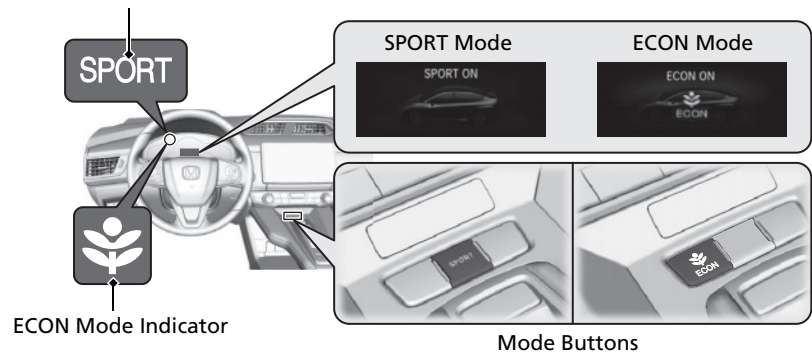

The indicator for the mode that you have selected comes on.

Auto Engine Stop/Start

The car will select the appropriate source of power depending on the drive mode you select.

As a result, the engine will automatically start or stop as needed to either charge the battery or provide supplemental power.

Under certain circumstances, the engine may turn on or, if it is already on, it may not turn off.

- You are going uphill or accelerating aggressively.
- The climate control system is in heavy use.
- The Ambient temperature is too hot or too cold.
- The High Voltage Battery state of charge is very low.
- The vehicle is running a system check.







System Check

When the engine initially starts (between the time the **POWER** button is turned on and turned off), the vehicle conducts a system check.

- While the check is being conducted, the engine may periodically turn on and off. This, however, is normal.
- The curved blue line in the **POWER/CHARGE** Gauge will not appear during the system check (**EV** indicator may still turn on).
- Once the engine starts, it will continue to run until the system reaches operating temperature.

The curved blue line in the **POWER/CHARGE** Gauge will reappear once the system check is completed.

➤ **POWER/CHARGE** Gauge ➡ P.122

Power Source	Electric	Hybrid	Engine
EV indicator	 Comes on		 Goes off
POWER/CHARGE Gauge	The readings on the blue bar		The readings on the white bar
Driving state	<p>Light to mid acceleration or cruise</p> <ul style="list-style-type: none"> Only the electric motor provides propulsion to the wheels. 	<p>Mild to heavy acceleration</p> <ul style="list-style-type: none"> The electric motor provides propulsion to the wheels. The engine drives the generator, supplying electricity to the electric motor for added power or to the High Voltage battery for charging. 	<p>The vehicle is cruising at a higher speed.</p> <ul style="list-style-type: none"> Propulsion is provided by the engine, coupled through the gears to the transmission. This is indicated by the gear icon  in the display.
Energy flow			

Power Source and Charging

Electric Source

When the High Voltage battery is sufficiently charged, the vehicle is propelled solely by the electric motor. When the remaining power of the High Voltage battery drops to a certain level, the vehicle switches to HV.

- ▶ To maintain charge levels, you can, at any time, use the **HV** button to switch the vehicle to HV.

➤ **Switching to HV** ➔ P.16

- ▶ If the High Voltage battery charge drops below levels that are necessary for the vehicle to run in Electric, you can enable charging of the battery by pressing and holding the **HV** button.

➤ **Switching to HV CHARGE** ➔ P.17

Hybrid Source

In hybrid, the electric motor receives power either from the High Voltage battery or from the generator which is driven by the engine, or from both the High Voltage battery and generator.

Engine Source

When the vehicle is driving under light load within a certain speed range, the engine provides direct power to the wheels.

Charging the High Voltage Battery ➔ P.455

There are a number of ways to charge the High Voltage battery. You can:

- Use the Level 2 240V charger, or the portable charging cable located in the trunk.
- Use a public charging station.
- Enable HV Charge and let the battery charge while the vehicle is being driven.

When charging from an external source, you can schedule the start and end time for charging.

➔ P.467

Regenerative Energy and Regenerative Braking

When the vehicle is decelerating or descending a hill, the electric motor acts as a generator that recovers a portion of the energy that was used to accelerate the vehicle.

The regenerative force that the electric motor applies to the wheels when it is in regenerative mode helps to slow the vehicle down in a manner similar to engine braking which is used on conventional vehicles. If you want to slow the vehicle down at a faster rate without using the brakes, you can use the deceleration paddle selector to increase the resistive force.



HV Button

You can enable HV or HV Charge by pressing the **HV** button. The **HV** indicator comes on regardless of which source you have enabled. If you press the **HV** button again, or set the power mode to **VEHICLE OFF** or **ACCESSORY**, the source you have selected will be cancelled.

- **HV**

To enable HV, press the **HV** button. In HV, the engine may run at times to drive the generator so that battery charge levels can be maintained.

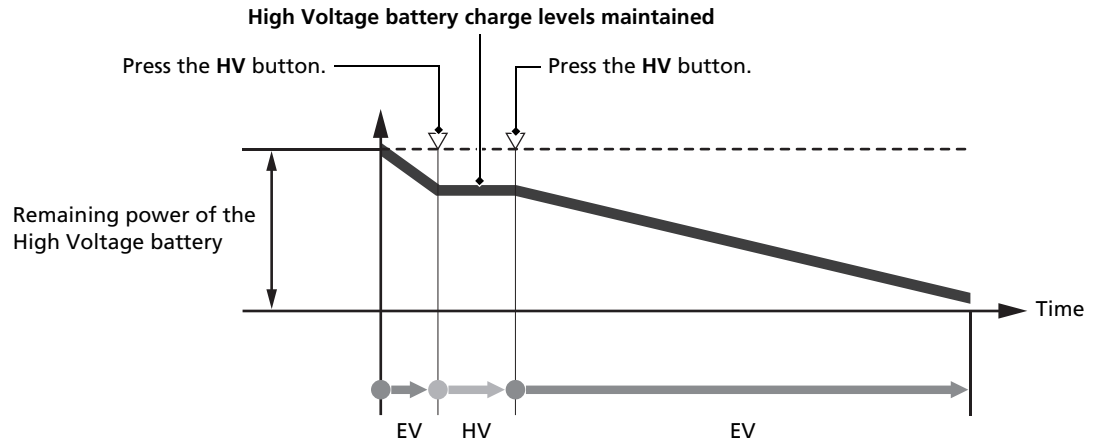
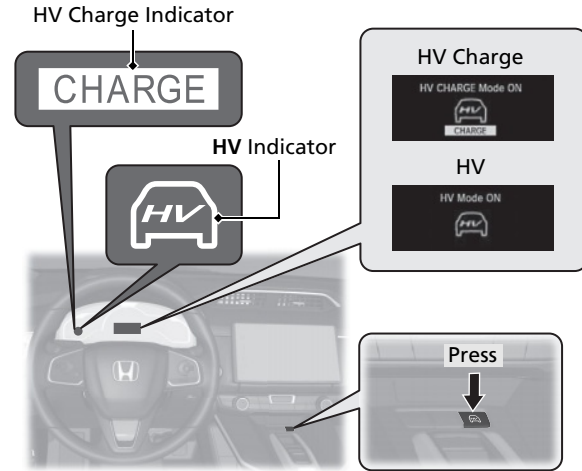

HV Charge

To **enable HV Charge**, press the **HV** button until the HV Charge indicator turns on.

While the vehicle is in HV Charge, the High Voltage battery will continue to charge until the battery charge level display reaches 12 segments. Once the battery reaches this level, the vehicle switches to HV. You can cancel HV Charge before the battery reaches 12 segments by pressing the **HV** button.

When the vehicle is in HV Charge, priority is given to the charging of the High Voltage battery. While the battery is being charged, the engine may run at a higher RPM than usual. The time it takes for the battery to be charged to 12 segments varies depending on driving conditions.

The high voltage battery can be charged to 12 segments in after about 1 hour of high-speed driving. HV Charge is not recommended for city driving or other driving situations when you need to stop frequently or drive slowly. In these situations, press the **HV** button again to disable HV Charge. If you are in HV and approaching a destination where the vehicle can be charged, you can turn off HV and use the remaining battery power to drive.

- Any time the **HV** button is pressed while in HV or HV Charge, the system returns to EV operation.

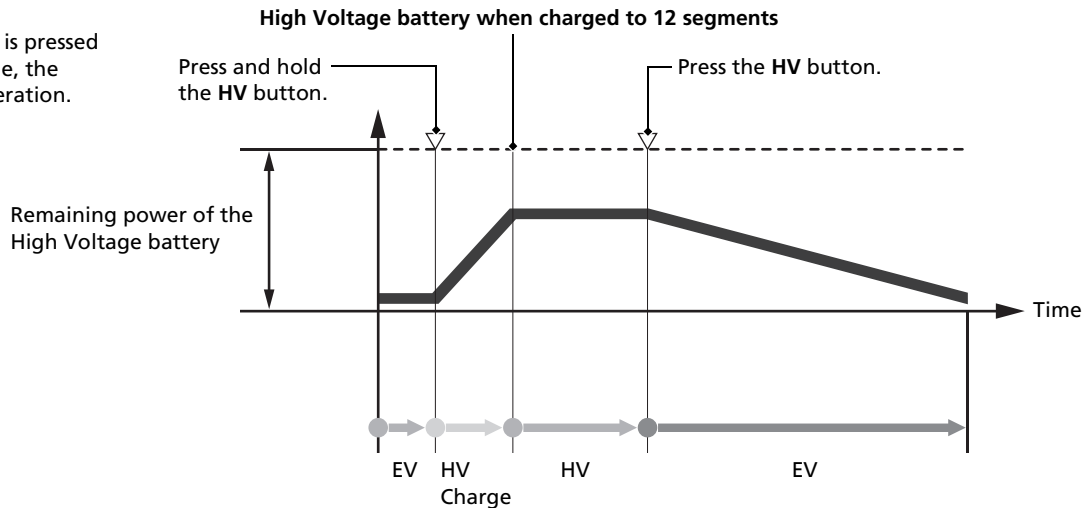

Energy Efficiency

As with a gasoline powered vehicle, the fuel efficiency and the range of this vehicle is most impacted by the driver's driving style. Aggressive acceleration and high-speed driving can easily trigger the system to switch the propulsion source to the gasoline-powered engine. Climate control system usage also has a strong impact with heavy usage negatively affecting the vehicle's range.

Battery Type

There are two types of batteries used in this vehicle, a standard 12-volt battery that powers the airbags, the interior and exterior lights, and other standard 12-volt systems, and a high voltage battery that is used to power the propulsion motor and recharge the 12-volt battery.

Hybrid Vehicles

High voltage parts and high voltage wires in this vehicle are sheathed in electromagnetic shielding material; therefore, the amount of electromagnetic waves emitted is no more greater than those emitted by household appliances or the electrical parts in conventional vehicles.

Sounds Unique to the Honda Plug-In System

When you first start driving this vehicle, you likely will hear some unfamiliar sounds, particularly when you first turn on the power system, while driving, and just after parking. Some of these sounds are unique to this vehicle's powertrain, fuel, and climate control systems; others are similar to sounds generated by conventional automobiles that typically are masked by louder noises absent from a vehicle of this design. These sounds are not a cause for concern, and you will soon recognize them as normal and thus be able to detect any new or unusual noise should one develop.

Safety Precautions



Do not touch the High Voltage system

Attempting to take a system component apart or disconnect one of its wires can cause severe electrical shock. If the High Voltage system is in need of maintenance or repair, make sure that the maintenance or repair is carried out by an authorized Honda Clarity Plug-In Hybrid dealer.

If a crash occurs

- Be careful of electric shock hazard.
 - ▶ If a severe crash damages your vehicle's High Voltage system, there is a possibility of electrical shock due to exposed High Voltage components or wires. If this happens, do not touch any of the High Voltage system components or any of its orange wires.
- Avoid contact with High Voltage battery fluid.
 - ▶ The High Voltage battery contains a flammable electrolyte that can leak as a result of a severe crash. Avoid any skin or eye contact with the electrolyte as it is corrosive. If you accidentally come into contact with the electrolyte, rinse the exposed skin or flush your eyes with copious amounts of water for at least five minutes, then seek medical attention immediately.
- Use a fire extinguisher for an electrical fire.
 - ▶ Attempting to extinguish an electrical fire with a small quantity of water can be dangerous.
- Anytime the vehicle is damaged in an accident, have it repaired by an authorized Honda Clarity Plug-In Hybrid dealer.

Emergency Shutdown System for the High Voltage System

If the vehicle is involved in a crash, the emergency shutdown system will activate depending on the severity of the impact. When the system activates, the High Voltage system automatically shuts down, and the vehicle can no longer move under its own power. To return the High Voltage system back to normal operation, consult an authorized Honda Clarity Plug-In Hybrid dealer.

Honda collects and recycles High Voltage batteries used in its vehicles. Consult an authorized Honda Clarity Plug-In Hybrid dealer for more information.

Eco Assist® System

Ambient Meter

- Changes color to reflect how fuel-efficiently you are driving.
 - Green: Slow acceleration or deceleration (good fuel economy)
 - White-green: Moderate acceleration or deceleration (moderate fuel economy)
 - White: Aggressive acceleration or deceleration (poor fuel economy)
- The indicator remains red as long as **SPORT** mode is activated.

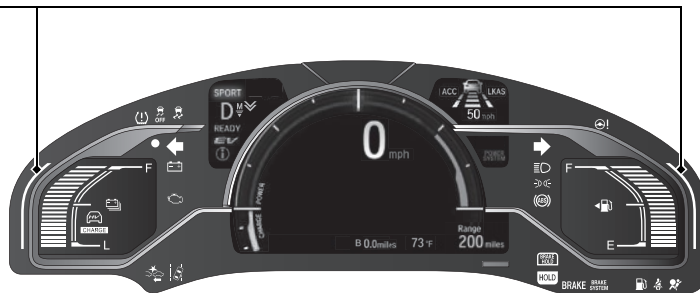

ECON Mode Indicator → P. 98
Comes on when the **ECON** button is pressed.



The message is displayed for a few seconds when the **ECON** button is pressed.



ECON Button → P. 388
Helps maximize fuel economy.

Drive Cycle Score/Lifetime Points

- Appears when the power mode is in VEHICLE OFF (LOCK).



Eco Drive Display [P. 130](#)

The vehicle icon in the display moves forward and back.

- When you accelerate and decelerate, the icon moves forward and back respectively. The greater the acceleration or deceleration, the greater the icon moves.
- You can maintain better fuel efficiency by keeping the icon in the center.

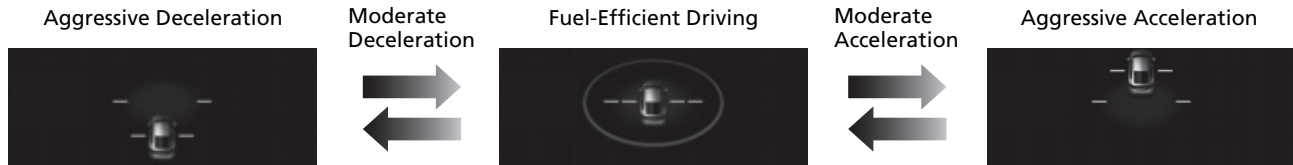

Safe Driving P. 41

Airbags P. 54

- Your vehicle is fitted with airbags to help protect you and your passengers during a moderate-to-severe collision.

Child Safety P. 69

- All children 12 and younger should be seated in the rear seat.
- Smaller children should be properly restrained in a forward-facing child seat.
- Infants must be properly restrained in a rear-facing child seat.

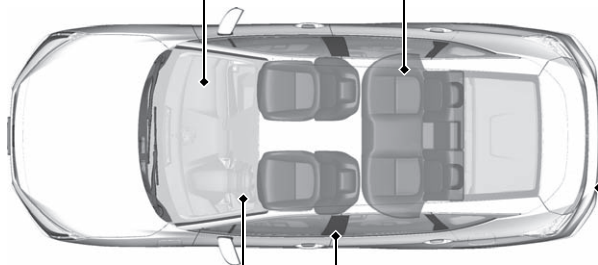

Exhaust Gas Hazard P. 82

- Your vehicle emits dangerous exhaust gases that contain carbon monoxide. Do not run the engine in confined spaces where carbon monoxide gas can accumulate.

Seat Belts P. 47

- Fasten your seat belt and sit upright well back in the seat.
- Check that your passengers are wearing their seat belts correctly.

Before Driving Checklist P. 46

- Before driving, check that the front seats, head restraints, steering wheel, and mirrors have been properly adjusted.



Fasten your lap belt as low as possible.

Instrument Panel P. 85

Gauges  P. 121 / Driver Information Interface  P. 124 /

System Indicators  P. 86

System Indicators

SPORT SPORT Mode Indicator

READY READY Indicator

 Vehicle Stability Assist (VSA®) System Indicator

 VSA® OFF Indicator

 Low Tire Pressure/TPMS Indicator

 System Message Indicator

 12-Volt Battery Charging System Indicator

 HV Indicator

CHARGE HV Charge Indicator

 Malfunction Indicator Lamp

 Road Departure Mitigation (RDM) Indicator

 Collision Mitigation Brake System™ (CMBS™) Indicator

Immobilizer System Indicator/
Security System Alarm Indicator

Deceleration Paddle Selector Indicator

Gear Position Indicator

Speedometer

High Voltage Battery Charge Level Gauge

POWER/CHARGE Gauge

Driver Information Interface

Fuel Gauge

System Indicators

 ECON Mode Indicator

EV EV Indicator

 Automatic Brake Hold System Indicator

HOLD U.S. Automatic Brake Hold Indicator

 Canada

System Indicators

ACC Adaptive Cruise Control (ACC) with Low Speed Follow (LSF) Indicator

LKAS Lane Keeping Assist System (LKAS) Indicator

System Indicators

 Electric Power Steering (EPS) System Indicator

 Lights On Indicator

 High Beam Indicator

 Turn Signal and Hazard Warning Indicators

 Supplemental Restraint System Indicator

 Anti-lock Brake System (ABS) Indicator

BRAKE U.S. Parking Brake and Brake System Indicator (Red)

Canada

BRAKE SYSTEM U.S. Parking Brake and Brake System Indicator (Amber)

 Canada
Seat Belt Reminder Indicator



POWER SYSTEM
POWER SYSTEM Indicator

 Low Fuel Indicator

Controls P. 135

Clock P. 136



- 1 Select the  (Home) icon, then select **Settings**.
- 2 Select **Clock**, then **Clock Adjustment**.
- 3 Touch the respective / icon to adjust the hours or minutes up or down.
- 4 Select **OK**.

Models with navigation system

The navigation system receives signals from GPS satellites, updating the clock automatically.

POWER Button P. 158

Press the button to change the vehicle's power mode.

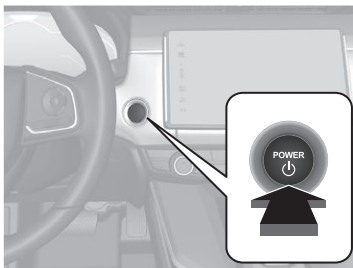

Turn Signals P. 161

Turn Signal Control Lever

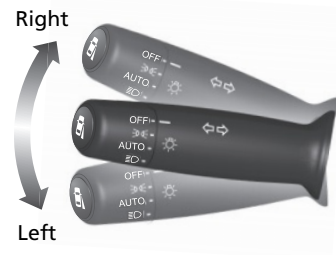

Lights P. 162

Light Control Switches

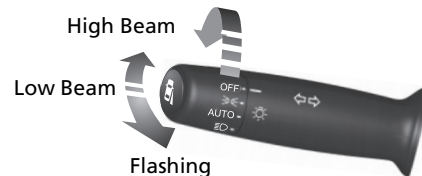

Wipers and Washers

➔ P. 166

Wiper/Washer Control Lever

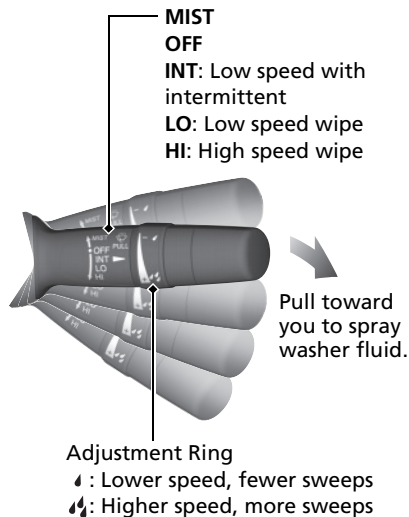

Steering Wheel ➔ P. 172

- To adjust, push the adjustment lever down, adjust to the desired position, then lock the lever back in place.

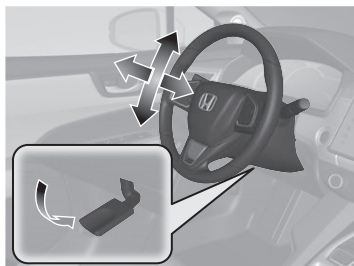

Unlocking the Front Doors from the Inside

➔ P. 147

- Pull either front door inner handle to unlock and open it in one motion.

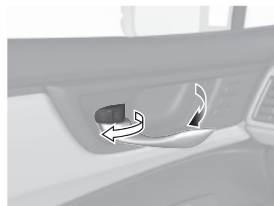

- Unlocking and opening the driver's door from the inner handle unlocks all the other doors.

Trunk ➔ P. 150

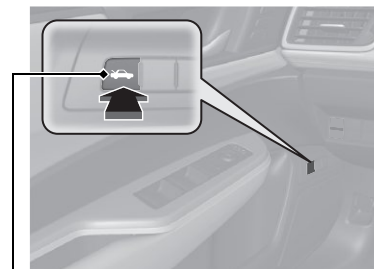

Trunk Opener

- To unlock and open the trunk:
 - Press the trunk opener on the driver's door.
 - Press the trunk release button on the smart entry remote.
 - Press the trunk release button on the trunk lid.

Power Door Mirrors

➔ P. 174

- With the power mode in ON, move the selector switch to **L** or **R**.
- Push the appropriate edge of the adjustment switch to adjust the mirror.

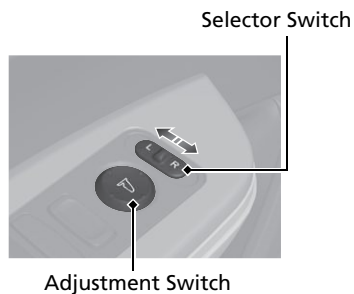

Power Windows ➔ P. 156

- With the power mode in ON, open and close the power windows.
- If the power window lock button is in the off position, each passenger's window can be opened and closed with its own switch.
- If the power window lock button is in the on position (indicator on), each passenger's window switch is disabled.

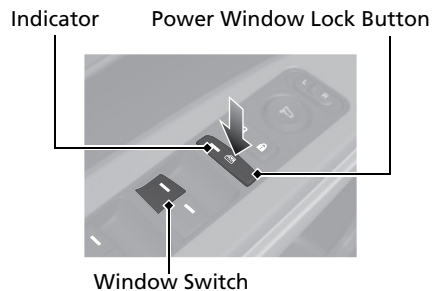

Climate Control System P. 193

- Press the **AUTO** button to activate the climate control system.
- Press the **ON/OFF** button to turn the system on or off.
- Press the **FRONT WINDSHIELD DEFROSTER** button to defrost the windshield.

The climate control system is voice operable* P. 239

A/C (Air Conditioning) Icon —

MODE Control Icon
(Air flows from dashboard vents and back of the center console)

MODE Control Icon
(Air flows from floor and dashboard vents, and back of the center console)

Fan Control Icon —

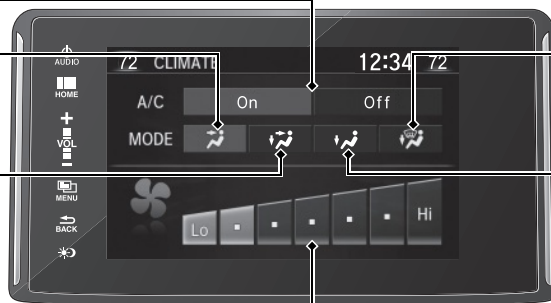

MODE Control Icon
(Air flows from floor and windshield defroster vents)

MODE Control Icon
(Air flows from floor vents)

(Fan Control) Buttons —

Driver's Side Temperature Control Dial —

AUTO Button —

(Recirculation) Button —

(Fresh Air) Button —

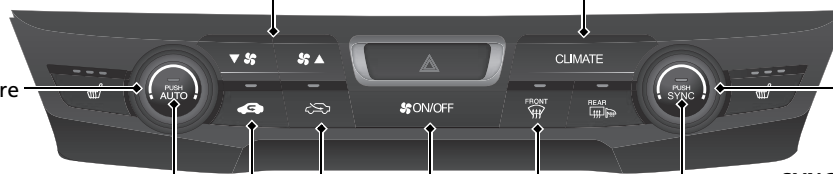

CLIMATE Button

Passenger's Side Temperature Control Dial

SYNC (Synchronization) Button

(Windshield Defroster) Button

(ON/OFF) Button

* Not available on all models

Features P. 203

Audio Remote Controls

 P. 207

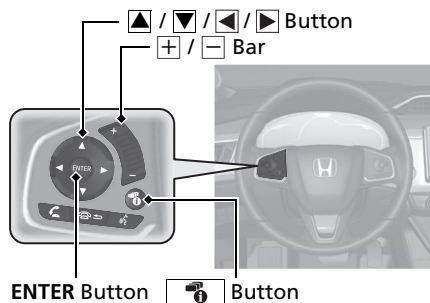

- **+ / - Bar**
Press to adjust the volume up/down.
- **▲ / ▼ Button**
Press **▲** or **▼** to cycle through the audio mode as follows:
FM→AM→SiriusXM®*→USB→iPod→
Bluetooth® Audio→Pandora®*→Apple
CarPlay/Android Auto

- **ENTER Button**
- When listening to the radio and SiriusXM®*

- 1 Press **ENTER** to switch the display to a preset list you stored in the preset buttons.
- 2 Press **▲** or **▼** to select a preset, then press **ENTER**.

- When listening to a USB flash drive

- 1 Press **ENTER** to display the folder list.
- 2 Press **▲** or **▼** to select a folder.
- 3 Press **ENTER** to display a list of tracks in that folder.
- 4 Press **▲** or **▼** to select a track, then press **ENTER**.

- When listening to an iPod

- 1 Press **ENTER** to display the iPod music list.
- 2 Press **▲** or **▼** to select a category.
- 3 Press **ENTER** to display a list of items in the category.
- 4 Press **▲** or **▼** to select an item, then press **ENTER**.
▶ Press **ENTER** and press **▲** or **▼** repeatedly until a desired item you want to listen is displayed.

- When listening to Pandora®*

- 1 Press **ENTER** to display the station list.
- 2 Press **▲** or **▼** to select an item, then press **ENTER**.

- When listening to *Bluetooth*® Audio

- 1 Press **ENTER** to display the track list.
- 2 Press **▲** or **▼** to select a track, then press **ENTER**.

-  /  Button

Radio: Press to change the preset station.
Press and hold to select the next or previous strong station.

USB device:

Press to skip to the beginning of the next song or return to the beginning of the current song.
Press and hold to change a folder.



Button:

Press to change contents.

 **Driver Information Interface** 

Audio System P. 204

For navigation system operation  See the Navigation System Manual

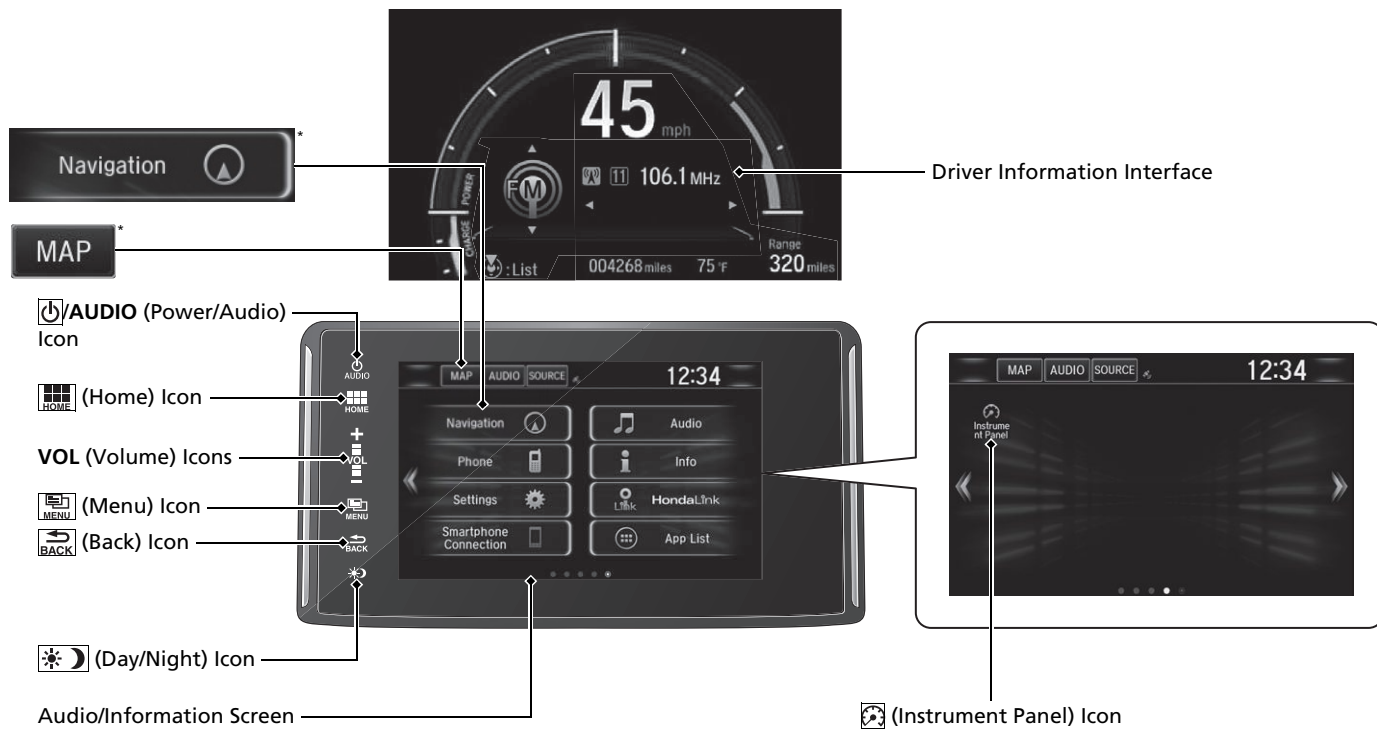

Driving P. 369

Electronic Gear Selector P. 382

- Select **P** and depress the brake pedal when turning on the power.
- Gear selection

Gear Position Indicator
The gear position indicator and the shift button indicator indicate the current gear selection.



Gear Position Indicator

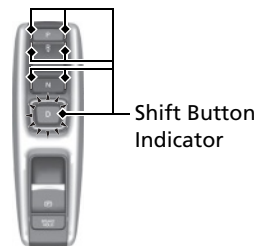

Shift Button Indicator

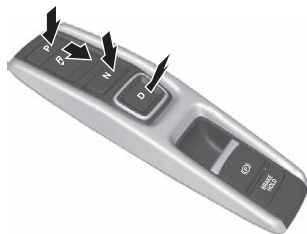

- P Park**
Press the **P** button.
Used when parking or before turning the power on or off.
Transmission is locked.
- R Reverse**
Press back the **R** button.
Used when reversing.
- N Neutral**
Press the **N** button.
Transmission is not locked.
- D Drive**
Press the **D** button.
Used for normal driving.

Deceleration Paddle Selector **P. 390**

When you release the accelerator pedal, you can control the rate of deceleration without releasing your hands from the steering wheel. Using the deceleration paddle selector situated on the steering wheel, you can sequentially shift through four stages of deceleration.

Pull the selector for a few seconds when you want to cancel the deceleration paddle selector.

- **When SPORT mode is OFF**

If you pull back the paddle selector, the rate of deceleration will change temporarily, and the stage will appear in the instrument panel.

- **When SPORT mode is ON**

If you pull back the paddle selector, the rate of deceleration will change and the stage along with **M** will appear in the instrument panel.



Paddle Selector



Paddle Selector

When SPORT mode is OFF, the deceleration stage appears.



Deceleration stage

When SPORT mode is ON, The deceleration stage and **M** appear.

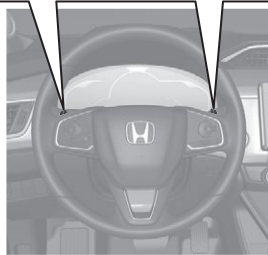
**VSA® On and Off** **P. 423**

- The vehicle stability assist (VSA®) system helps stabilize the vehicle during cornering and helps maintain traction while accelerating on loose or slippery road surfaces.
- VSA® comes on automatically every time you turn on the power system.
- To partially disable or fully restore VSA® function, press and hold the button until you hear a beep.

CMBS™ On and Off

P. 442

- When a possible collision is likely unavoidable, the CMBS™ can help you to reduce the vehicle speed and the severity of the collision.
- The CMBS™ is turned on every time you start the engine.
- To turn the CMBS™ on or off, press and hold the button until you hear a beep.

Tire Pressure Monitoring System (TPMS) **P. 425**

- Detects a change in tire conditions and overall dimensions due to decrease in tire pressures.
- The TPMS is turned on automatically every time you turn on the power system.
- A calibration procedure must be performed when certain conditions arise.

Refueling P. 451

Fuel recommendation: Unleaded gasoline, pump octane number 87 or higher required

Fuel tank capacity: 7.0 US gal (26.5 L)

- 1** Press the fuel fill door release button.
▶ **Please Wait** appears for a few seconds on the driver information interface.
- 2** When the message changes to **Ready**, the fuel fill door automatically opens.
- 3** Turn the fuel fill cap slowly to remove the cap.
- 4** Place the cap in the holder on the fuel fill door.
- 5** After refueling, screw the cap back on until it clicks at least once.

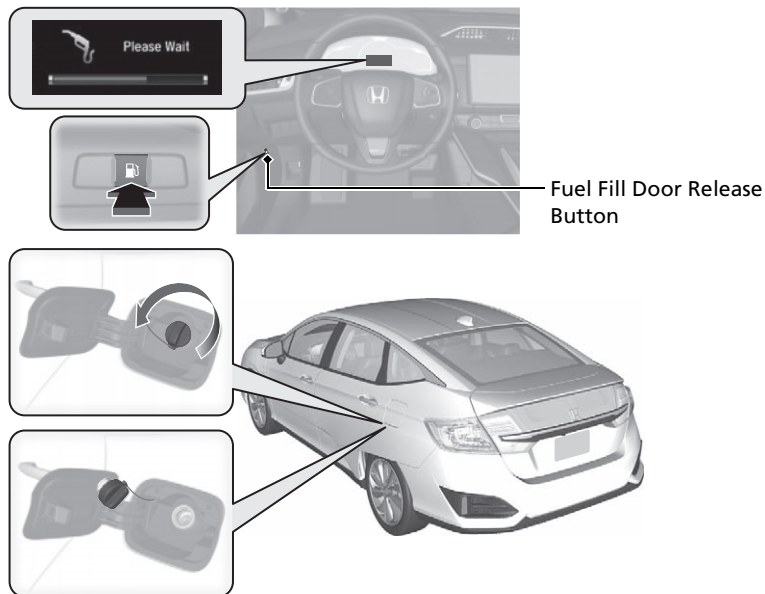

Honda Sensing™

Honda Sensing™ is a driver support system which employs the use of two distinctly different kinds of sensors, a radar sensor located in the front grille and a front sensor camera mounted to the interior side of the windshield, behind the rear view mirror.

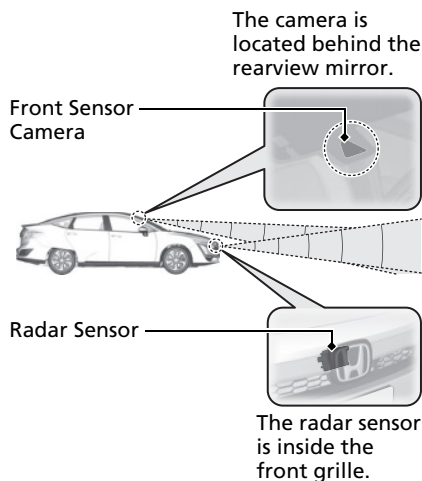

Adaptive Cruise Control (ACC) with Low Speed Follow (LSF) P. 400

Helps maintain a constant vehicle speed and a set following-interval behind a vehicle detected ahead of yours and, if the detected vehicle comes to a stop, can decelerate and stop your vehicle, without you having to keep your foot on the brake or the accelerator.

Road Departure Mitigation (RDM) System P. 396

Alerts and helps to assist you when the system detects a possibility of your vehicle unintentionally crossing over detected lane markings and/or leaving the roadway altogether.

Lane Keeping Assist System (LKAS) P. 415

Provides steering input to help keep the vehicle in the middle of a detected lane and provides tactile and visual alerts if the vehicle is detected drifting out of its lane.

Collision Mitigation Braking System™ (CMBS™) P. 439

Can assist you when there is a possibility of your vehicle colliding with a vehicle or a pedestrian detected in front of yours. The CMBS™ is designed to alert you when a potential collision is determined, as well as to reduce your vehicle speed to help minimize collision severity when a collision is deemed unavoidable.

Maintenance ↔ P. 471

Under the Hood ↔ P. 480

- Check engine oil, coolants and windshield washer fluid. Add when necessary.
- Check brake fluid.
- Check the 12-volt battery condition monthly.

- 1** Pull the hood release handle under the corner of the dashboard.



- 2** Locate the hood latch lever, push it to the side, and then raise the hood. Once you have raised the hood slightly, you can release the lever.

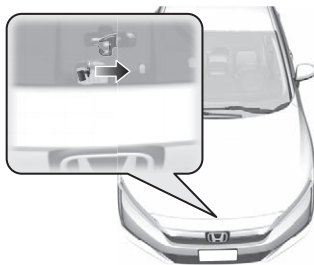

- 3** When finished, close the hood and make sure it is firmly locked in place.

Wiper Blades ↔ P. 496

- Replace blades if they leave streaks across the windshield.

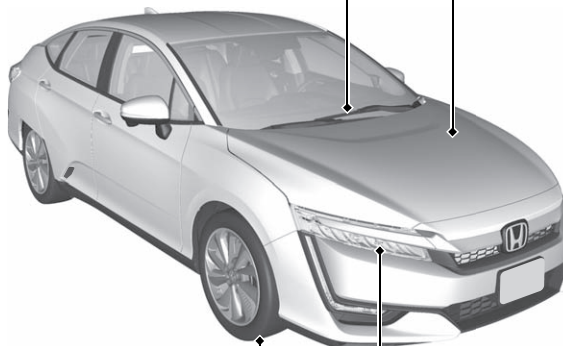

Tires ↔ P. 499

- Inspect tires and wheels regularly.
- Check tire pressures regularly.
- Install snow tires for winter driving.

Lights ↔ P. 494

- Inspect all lights regularly.

Handling the Unexpected P. 521

Flat Tire P. 522

- Park in a safe location and repair the flat tire using the temporary tire repair kit.



Power System Won't Start P. 535

- If the 12-volt battery is dead, jump start using a booster battery.

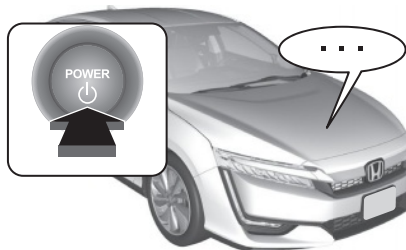

Overheating P. 542

- Park in a safe location. If you do not see steam under the hood, open the hood, and let the power system cool down.



Indicators Come On P. 545

- Identify the indicator and consult the owner's manual.

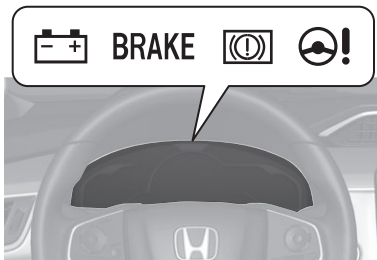

Blown Fuse P. 553

- Check for a blown fuse if an electrical device does not operate.

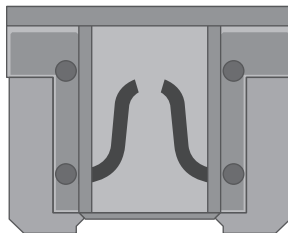

Emergency Towing P. 561

- Call a professional towing service if you need to tow your vehicle.

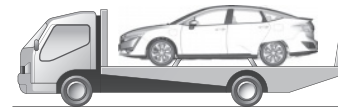

What to Do If

Q Why do I hear an operating noise when applying the brakes?

A This can occur when the ABS activates and does not indicate a problem. Apply firm, steady pressure on the brake pedal. Never pump the brake pedal.

➤ Anti-lock Brake System (ABS) ➔ P.437

Q The rear door cannot be opened from inside the vehicle. Why?

A Check if the childproof lock is in the lock position. If so, open the rear door with the outside door handle.

To cancel this function, slide the lever up to the unlock position.

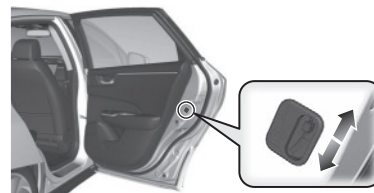

Q Why do the doors lock after I unlocked the doors?

A If you do not open the doors within 30 seconds, the doors are relocked automatically for security.

Q Why does the beeper sound when I open the driver's door?

A The beeper sounds when:

- The power mode is in ACCESSORY.
- The exterior lights are left on.

Q Why doesn't the curved blue line in the meter appear even when the EV indicator is on?

A The vehicle is performing a system check.
➤ Auto Engine Stop/Start P. 13

Q Why does the beeper sound when I start driving?

A The beeper sounds when the driver and/or front passenger are not wearing their seat belts.

Q Why does a beeper sound when I walk away from the vehicle after I close the door?

A The beeper sounds if you move outside the walk away auto lock operating range before the door completely closes.
➤ Locking the doors and trunk (Walk away auto lock) P. 140

Q Pressing the electric parking brake switch does not release the parking brake. Why?

A Press the electric parking brake switch with the brake pedal depressed.

Q Depressing the accelerator pedal does not release the parking brake automatically. Why?

A

- Fasten the driver's seat belt.
- Check if the transmission is in **P** or **N**. If so, select any other position.

Q Why does the gear position automatically change to **P** when I open the driver's door to check for parking space lines when reversing?

A

- Fasten the driver's seat belt.
- Close the driver's door and manually change the gear position.

▶ When opening the driver's door ➔ **P. 385**

Q Why do I hear a screeching sound when I apply the brake pedal?

A The brake pads may need to be replaced. Have your vehicle inspected by an authorized Honda Clarity Plug-In Hybrid dealer.

Q I'm seeing an amber indicator of a tire with an exclamation point. What is that?

A The Tire Pressure Monitoring System (TPMS) needs attention. If you recently inflated or changed a tire, you have to recalibrate the system.

▶ TPMS Calibration ➔ **P. 425**

Safe Driving

You can find many safety recommendations throughout this chapter, and throughout this manual.

For Safe Driving

Important Safety Precautions.....	42
Your Vehicle's Safety Features.....	45
Safety Checklist	46

Seat Belts

About Your Seat Belts.....	47
Fastening a Seat Belt.....	50
Seat Belt Inspection.....	53

Airbags

Airbag System Components.....	54
Types of Airbags.....	57
Front Airbags (SRS)	57

Driver's Knee Airbag.....	61
Side Airbags.....	63
Side Curtain Airbags.....	65
Airbag System Indicators.....	66
Airbag Care	68

Child Safety

Protecting Child Passengers	69
Safety of Infants and Small Children...	71
Safety of Larger Children	80

Exhaust Gas Hazard

Carbon Monoxide Gas.....	82
--------------------------	----

Safety Labels

Label Locations	83
-----------------------	----

The following pages explain your vehicle's safety features and how to use them properly. The safety precautions below are ones that we consider to be among the most important.

Important Safety Precautions

■ Always wear your seat belt

A seat belt is your best protection in all types of collisions. Airbags are designed to supplement seat belts, not replace them. So even though your vehicle is equipped with airbags, make sure you and your passengers always wear your seat belts, and wear them properly.

■ Restrain all children

Children ages 12 and under should ride properly restrained in a back seat, not the front seat. Infants and small children should be restrained in a child seat. Larger children should use a booster seat and a lap/shoulder seat belt until they can use the belt properly without a booster seat.

■ Be aware of airbag hazards

While airbags can save lives, they can cause serious or fatal injuries to occupants who sit too close to them, or are not properly restrained. Infants, young children, and short adults are at the greatest risk. Be sure to follow all instructions and warnings in this manual.

■ Don't drink and drive

Alcohol and driving don't mix. Even one drink can reduce your ability to respond to changing conditions, and your reaction time gets worse with every additional drink. So don't drink and drive, and don't let your friends drink and drive, either.

▣ Important Safety Precautions

Some states, provinces and territories prohibit the use of cell phones other than hands-free devices by the driver while driving.

■ Pay appropriate attention to the task of driving safely

Engaging in cell phone conversation or other activities that keep you from paying close attention to the road, other vehicles, and pedestrians could lead to a crash. Remember, situations can change quickly, and only you can decide when it is safe to divert some attention away from driving.

■ Control your speed

Excessive speed is a major factor in crash injuries and deaths. Generally, the higher the speed, the greater the risk, but serious injuries can also occur at lower speeds. Never drive faster than is safe for current conditions, regardless of the maximum speed posted.

■ Keep your vehicle in safe condition

Having a tire blowout or a mechanical failure can be extremely hazardous. To reduce the possibility of such problems, check your tire pressures and condition frequently, and perform all regularly scheduled maintenance.

■ Do not leave children unattended in the vehicle

Children left unattended in the vehicle may be injured if they activate one or more of the vehicle controls. They may also cause the vehicle to move, resulting in a crash in which the children and/or another person(s) can be injured or killed. Also, depending on the ambient temperature, the temperature of the interior may reach extreme levels, which can result in injury or death.

Even if the climate control system is on, never leave children in the vehicle unattended as the climate control system can shut off at any time.

■ **Handle high-voltage with care**

Familiarize yourself with the charging instructions and warnings supplied in this manual and on the quick reference card. If using a public charger, also observe the charging station manufacturer's instructions.

Your Vehicle's Safety Features

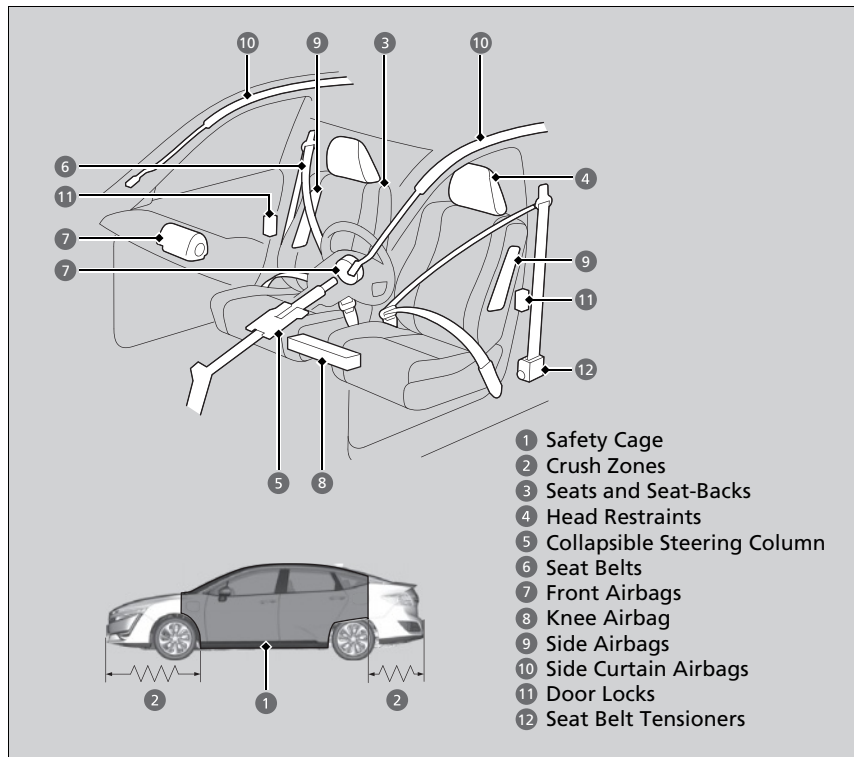

The following checklist will help you take an active role in protecting yourself and your passengers.

▣ Your Vehicle's Safety Features

Your vehicle is equipped with many features that work together to help protect you and your passengers during a crash.

Some features do not require any action on your part. These include a strong steel framework that forms a safety cage around the passenger compartment, front and rear crush zones, a collapsible steering column, and tensioners that tighten the front seat belts in a sufficient crash.

However, you and your passengers cannot take full advantage of these features unless you remain seated in the correct position and always wear your seat belts. In fact, some safety features can contribute to injuries if they are not used properly.

Safety Checklist

For the safety of you and your passengers, make a habit of checking these items each time before you drive. Check if the charging cable is connected to the vehicle and disconnect it if it is. The vehicle will not operate with the cable connected.

- After everyone has entered the vehicle, be sure all doors are closed and locked. Locking the doors helps prevent an occupant from being ejected and an outsider from unexpectedly opening a door.
 - ✦ **Locking/Unlocking the Doors from the Inside** P. 146
- Adjust your seat to a position suitable for driving. Be sure the front seats are adjusted as far to the rear as possible while allowing the driver to control the vehicle. Sitting too close to a front airbag can result in serious or fatal injury in a crash.
 - ✦ **Adjusting the Seats** P. 175
- Adjust head restraints to the proper position. Head restraints are most effective when the center of the head restraint aligns with the center of your head. Taller persons should adjust their head restraint to the highest position.
 - ✦ **Adjusting the Front Head Restraints Positions** P. 178
- Always wear your seat belt, and make sure you wear it properly. Confirm that any passengers are properly belted as well.
 - ✦ **Fastening a Seat Belt** P. 50
- Protect children by using seat belts or child seats according to a child's age, height and weight.
 - ✦ **Child Safety** P. 69

✦ Safety Checklist

If the door and/or trunk open message appears on the driver information interface, a door and/or the trunk is not completely closed. Close all doors and the trunk tightly until the message disappears.

✦ **Driver Information Interface Warning and Information Messages** P. 113



About Your Seat Belts

Seat belts are the single most effective safety device because they keep you connected to the vehicle so that you can take advantage of many built-in safety features. They also help keep you from being thrown against the inside of the vehicle, against any passengers, or out of the vehicle. When worn properly, seat belts also keep your body properly positioned in a crash so that you can take full advantage of the additional protection provided by the airbags.

In addition, seat belts help protect you in almost every type of crash, including:

- frontal impacts
- side impacts
- rear impacts
- rollovers

■ Lap/shoulder seat belts

All five seating positions are equipped with lap/shoulder seat belts with emergency locking retractors. In normal driving the retractor lets you move freely while keeping some tension on the belt. During a collision or sudden stop the retractor locks to restrain your body.

The front passenger's and rear seat belts also have a lockable retractor for use with child seats.

➤ **Installing a Child Seat with a Lap/Shoulder Seat Belt** P. 76

ⓘ About Your Seat Belts

⚠ WARNING

Not wearing a seat belt properly increases the chance of serious injury or death in a crash, even though your vehicle has airbags.

Be sure you and your passengers always wear seat belts and wear them properly.

Seat belts cannot completely protect you in every crash. But in most cases, seat belts can reduce your risk of serious injury.

Most states and all Canadian provinces and territories require you to wear seat belts.

If you extend the seat belt too quickly, it will lock in place. If this happens, slightly retract the seat belt, then extend it slowly.

■ Proper use of seat belts

Follow these guidelines for proper use:

- All occupants should sit upright, well back in the seat, and remain in that position for the duration of the trip. Slouching and leaning reduce the effectiveness of the belt and can increase the chance of serious injury in a crash.
- Never place the shoulder part of a lap/shoulder seat belt under your arm or behind your back. This could cause very serious injuries in a crash.
- Two people should never use the same seat belt. If they do, they could be very seriously injured in a crash.
- Do not put any accessories on the seat belts. Devices intended to improve comfort or reposition the shoulder part of a seat belt can reduce the protective capability and increase the chance of serious injury in a crash.

⌘ About Your Seat Belts

If a rear seat passenger moves around and extends the seat belt, the lockable retractor may activate. If this happens, release the retractor by unfastening the seat belt and allow the belt to retract completely. Then refasten the belt.

Seat Belt Reminder

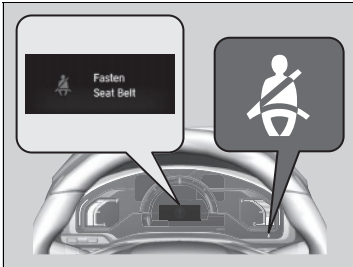

The seat belt system includes an indicator on the instrument panel to remind the driver or a front passenger to fasten their seat belts.

If you set the power mode to ON and a seat belt is not fastened, a beeper will sound and the indicator will blink. After a few seconds, the beeper will stop and the indicator will come on and remain illuminated until the seat belt is fastened.

The beeper will periodically sound and the indicator will blink while the vehicle is moving until the seat belt is fastened.

⌘ Seat Belt Reminder

The indicator will also come on if a front passenger does not fasten their seat belt within six seconds after the power mode is set to ON.

When no one is sitting in the front passenger's seat, the indicator will not come on and the beeper will not sound.

The indicator also may not come on and the beeper may not sound when the occupant is not heavy enough to trigger the weight sensor. Such occupants (e.g., infants and smaller children) should be moved to the rear seat as a deploying front airbag likely will injure or kill them.

➔ **Protecting Child Passengers** P. 69

Automatic Seat Belt Tensioners

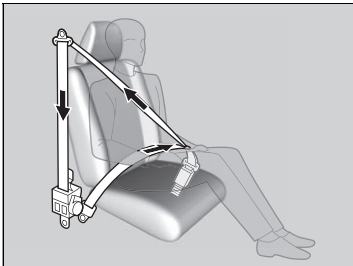

The front seats are equipped with automatic seat belt tensioners to enhance safety.

The tensioners automatically tighten the front seat belts during a moderate-to-severe frontal collision, sometimes even if the collision is not severe enough to inflate the front airbags or the driver's knee airbag.

⌘ Automatic Seat Belt Tensioners

The seat belt tensioners can only operate once. If a tensioner is activated, the SRS indicator will come on. Have an authorized Honda Clarity Plug-In Hybrid dealer replace the tensioner and thoroughly inspect the seat belt system as it may not offer protection in a subsequent crash.

During a moderate-to-severe side impact, the tensioner on that side of the vehicle also activates.

Fastening a Seat Belt

After adjusting a front seat to the proper position, and while sitting upright and well back in the seat:

➤ **Adjusting the Seats** P. 175

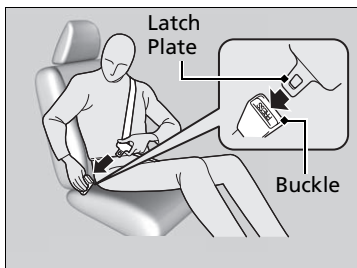
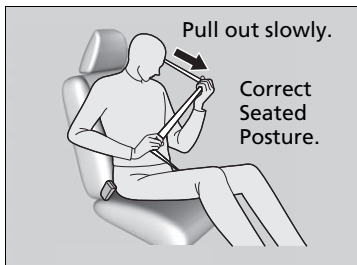

1. Pull the seat belt out slowly.

2. Insert the latch plate into the buckle, then tug on the belt to make sure the buckle is secure.

▶ Make sure that the belt is not twisted or caught on anything.

Fastening a Seat Belt

No one should sit in a seat with an inoperative seat belt or one that does not appear to be working correctly. Using a seat belt that is not working properly may not protect the occupant in a crash. Have an authorized Honda Clarity Plug-In Hybrid dealer check the belt as soon as possible.

Never insert any foreign objects into the buckle or retractor mechanism.

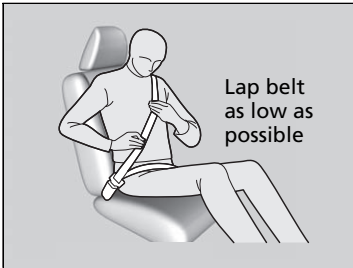

3. Position the lap part of the belt as low as possible across your hips, then pull up on the shoulder part of the belt so the lap part fits snugly. This lets your strong pelvic bones take the force of a crash and reduces the chance of internal injuries.
4. If necessary, pull up on the belt again to remove any slack, then check that the belt rests across the center of your chest and over your shoulder. This spreads the forces of a crash over the strongest bones in your upper body.

Adjusting the Shoulder Anchor

The front seats have adjustable shoulder anchors to accommodate taller and shorter occupants.

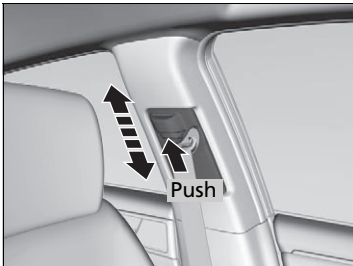

1. Move the anchor up and down while holding the release button.
2. Position the anchor so that the belt rests across the center of your chest and over your shoulder.

Fastening a Seat Belt

⚠ WARNING

Improperly positioning the seat belts can cause serious injury or death in a crash.

Make sure all seat belts are properly positioned before driving.

To release the belt, push the red **PRESS** button and then guide the belt by hand until it has retracted completely.

When exiting the vehicle, be sure the belt is properly stowed so that it will not get caught in the closing door.

Adjusting the Shoulder Anchor

The shoulder anchor height can be adjusted to four levels. If the belt contacts your neck, lower the height one level at a time.

After an adjustment, make sure that the shoulder anchor position is secure.

■ Advice for Pregnant Women

If you are pregnant, the best way to protect yourself and your unborn child when driving or riding in a vehicle is to always wear a seat belt and keep the lap part of the belt as low as possible across the hips.



▣ Advice for Pregnant Women

Each time you have a checkup, ask your doctor if it is okay for you to drive.

To reduce the risk of injuries to both you and your unborn child that can be caused by an inflating front airbag:

- When driving, sit upright and adjust the seat as far back as possible while allowing full control of the vehicle.
- When sitting in the front passenger's seat, adjust the seat as far back as possible.

Seat Belt Inspection

Regularly check the condition of your seat belts as follows:

- Pull each belt out fully, and look for frays, cuts, burns, and wear.
- Check that the latch plates and buckles work smoothly and the belts retract easily.
 - ▶ If a belt does not retract easily, cleaning the belt may correct the problem. Only use a mild soap and warm water. Do not use bleach or cleaning solvents. Make sure the belt is completely dry before allowing it to retract.

Any belt that is not in good condition or working properly will not provide proper protection and should be replaced as soon as possible.

A belt that has been worn during a crash may not provide the same level of protection in a subsequent crash. Have your seat belts inspected by an authorized Honda Clarity Plug-In Hybrid dealer after any collision.

Seat Belt Inspection

⚠ WARNING

Not checking or maintaining seat belts can result in serious injury or death if the seat belts do not work properly when needed.

Check your seat belts regularly and have any problem corrected as soon as possible.

Airbag System Components

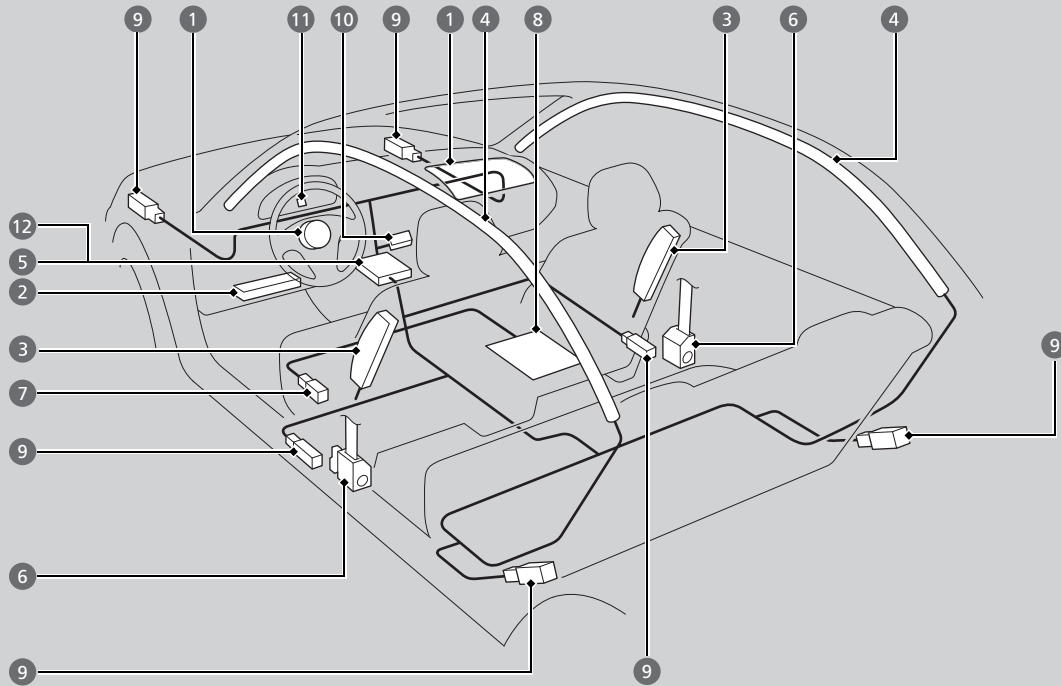

The front, driver's knee, front side, and side curtain airbags are deployed according to the direction and severity of impact. Both side curtain airbags are deployed in a rollover. The airbag system includes:

- 1 Two SRS (Supplemental Restraint System) front airbags. The driver's airbag is stored in the center of the steering wheel; the front passenger's airbag is stored in the dashboard. Both are marked **SRS AIRBAG**.
- 2 Driver's knee airbag. The knee airbag is stored under the steering column. It is marked **SRS AIRBAG**.
- 3 Two side airbags, one for the driver and one for a front passenger. The airbags are stored in the outer edges of the seat-backs. Both are marked **SIDE AIRBAG**.
- 4 Two side curtain airbags, one for each side of the vehicle. The airbags are stored in the ceiling, above the side windows. The front and rear pillars are marked **SIDE CURTAIN AIRBAG**.
- 5 An electronic control unit that, when the vehicle is on, continually monitors information about the various impact sensors, seat and buckle sensors, rollover sensor, airbag activators, seat belt tensioners, seat weight sensor, seat position sensor, passenger airbag OFF indicator, and other vehicle information. During a crash event the unit can record such information.
- 6 Automatic front seat belt tensioners. In addition, the driver's and front passenger's seat belt buckles incorporate sensors that detect whether or not the belts are fastened.
- 7 A driver's seat position sensor. This sensor determines the optimal force at which the airbag will deploy in a crash.
- 8 Weight sensors in the front passenger's seat. The front passenger's airbag will be turned off if the weight on the seat is approximately 65 lbs (29 kg) or less (the weight of an infant or small child).
- 9 Impact sensors that can detect a moderate-to-severe front or side impact.
- 10 An indicator on the dashboard that alerts you that the front passenger's front airbag has been turned off.
- 11 An indicator on the instrument panel that alerts you to a possible problem with your airbag system or seat belt tensioners.
- 12 A rollover sensor that can detect if your vehicle is about to roll over and signal the control unit to deploy both side curtain airbags.

■ Important Facts About Your Airbags

Airbags can pose serious hazards. To do their job, airbags must inflate with tremendous force. So, while airbags help save lives, they can cause burns, bruises, and other minor injuries, sometimes even fatal ones if occupants are not wearing their seat belts properly and sitting correctly.

What you should do: Always wear your seat belt properly, and sit upright and as far back from the steering wheel as possible while allowing full control of the vehicle. A front passenger should move their seat as far back from the dashboard as possible.

Remember, however, that no safety system can prevent all injuries or deaths that can occur in a severe crash, even when seat belts are properly worn and the airbags deploy.

Do not place hard or sharp objects between yourself and a front airbag.

Carrying hard or sharp objects on your lap, or driving with a pipe or other sharp object in your mouth, can result in injuries if your front airbag inflates.

Do not attach or place objects on the front and driver's knee airbag covers.

Objects on the covers marked **SRS AIRBAG** could interfere with the proper operation of the airbags or be propelled inside the vehicle and hurt someone if the airbags inflate.

▣ Important Facts About Your Airbags

Do not attempt to deactivate your airbags. Together, airbags and seat belts provide the best protection.

When driving, keep hands and arms out of the deployment path of the front airbag by holding each side of the steering wheel. Do not cross an arm over the airbag cover.

Types of Airbags

Your vehicle is equipped with four types of airbags:

- **Front airbags:** Airbags in front of the driver's and front passenger's seats.
- **Driver's knee airbag:** Airbag under the steering column.
- **Side airbags:** Airbags in the driver's and front passenger's seat-backs.
- **Side curtain airbags:** Airbags above the side windows.

Each is discussed in the following pages.

Front Airbags (SRS)

The front SRS airbags inflate in a moderate-to-severe frontal collision to help protect the head and chest of the driver and/or front passenger.

SRS (Supplemental Restraint System) indicates that the airbags are designed to supplement seat belts, not replace them. Seat belts are the occupant's primary restraint system.

Housing Locations

The front airbags are housed in the center of the steering wheel for the driver, and in the dashboard for the front passenger. Both airbags are marked **SRS AIRBAG**.

Types of Airbags

The airbags can inflate whenever the power mode is in ON.

After an airbag inflates in a crash, you may see a small amount of smoke. This is from the combustion process of the inflator material and is not harmful. People with respiratory problems may experience some temporary discomfort. If this occurs, get out of the vehicle as soon as it is safe to do so.

Front Airbags (SRS)

During a frontal crash severe enough to cause one or both front airbags to deploy, the airbags can inflate at different rates, depending on the severity of the crash, whether or not the seat belts are latched, and/or other factors. Frontal airbags are designed to supplement the seat belts to help reduce the likelihood of head and chest injuries in frontal crashes.

■ Operation

Front airbags are designed to inflate during moderate-to-severe frontal collisions. When the vehicle decelerates suddenly, the sensors send information to the control unit which signals one or both front airbags to inflate.

A frontal collision can be either head-on or angled between two vehicles, or when a vehicle crashes into a stationary object, such as a concrete wall.

■ How the Front Airbags Work

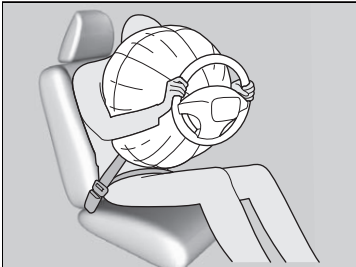

While your seat belt restrains your torso, the front airbag provides supplemental protection for your head and chest.

The front airbags deflate immediately so that they won't interfere with the driver's visibility or the ability to steer or operate other controls.

The total time for inflation and deflation is so fast that most occupants are not aware that the airbags deployed until they see them lying in front of them.

☒ How the Front Airbags Work

Although the driver's and front passenger's airbags normally inflate within a split second of each other, it is possible for only one airbag to deploy. This can happen if the severity of a collision is at the margin, or threshold that determines whether or not the airbags will deploy. In such cases, the seat belt will provide sufficient protection, and the supplemental protection offered by the airbag would be minimal.

■ When front airbags should not deploy

Minor frontal crashes: Front airbags were designed to supplement seat belts and help save lives, not to prevent minor scrapes, or even broken bones that might occur during a less than moderate-to-severe frontal crash.

Side impacts: Front airbags can provide protection when a sudden deceleration causes a driver or front passenger to move towards the front of the vehicle. Side airbags and side curtain airbags have been specifically designed to help reduce the severity of injuries that can occur during a moderate-to-severe side impact which can cause the driver or passenger to move towards the side of the vehicle.

Rear impacts: Head restraints and seat belts are your best protection during a rear impact. Front airbags cannot provide any significant protection and are not designed to deploy in such collisions.

Rollovers: In a rollover, your best form of protection is a seat belt or, if your vehicle is equipped with a rollover sensor, both a seat belt and a side curtain airbag. Front airbags, however, are not designed to deploy in a rollover as they would provide little if any protection.

■ When front airbags deploy with little or no visible damage

Because the airbag system senses sudden deceleration, a strong impact to the vehicle framework or suspension might cause one or more of the airbags to deploy. Examples include running into a curb, the edge of a hole, or other low fixed object that causes a sudden deceleration in the vehicle chassis. Since the impact is underneath the vehicle, damage may not be readily apparent.

■ When front airbags may not deploy, even though exterior damage appears severe

Since crushable body parts absorb crash energy during an impact, the amount of visible damage does not always indicate proper airbag operation. In fact, some collisions can result in severe damage but no airbag deployment because the airbags would not have been needed or would not have provided protection even if they had deployed.

Advanced Airbags

The airbags have advanced features to help reduce the likelihood of airbag related injuries to smaller occupants.

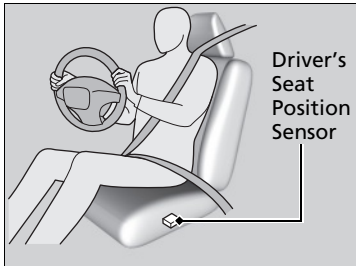

The driver's advanced airbag system includes a seat position sensor.

Based on information from this sensor and the severity of the impact, the advanced airbag system determines the optimal deployment of the driver's airbag.

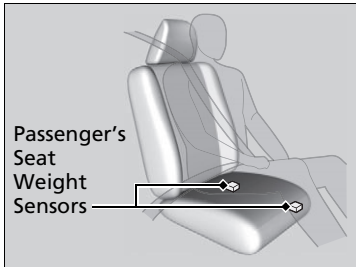

The front passenger's advanced airbag system has weight sensors.

We advise against allowing a child age 12 or under to ride in the front passenger's seat. However, ***if you do allow a child age 12 or under to ride in the front passenger's seat***, note that the system will automatically turn off the front passenger's airbag if the sensors detect that the child is approximately 65 lbs (29 kg) or less.

Advanced Airbags

If there is a problem with the driver's seat position sensor, the SRS indicator will come on, and in the event of a crash, the airbag will deploy (regardless of the driver's seating position) with a force corresponding to the severity of the impact.

For the advanced airbags to work properly:

- Do not spill any liquid on or under the seats.
- Do not put any object under the passenger's seat.
- Make sure any objects are positioned properly on the floor. Improperly positioned objects can interfere with the advanced airbag sensors.
- All occupants should sit upright and wear their seat belts properly.
- Do not cover the passenger's side dashboard with a cloth, towel, cover, etc.

▶ **Passenger Front Airbag Off Indicator** P. 67

Make sure the floor mat behind the front passenger's seat is hooked to the floor mat anchor. An improperly placed mat can interfere with the advanced airbag sensors.

▶ **Floor Mats** P. 514

Driver's Knee Airbag

The driver's knee SRS airbag inflates in a moderate-to-severe frontal collision to help keep the driver in the proper position and to help maximize the benefit provided by the vehicle's other safety features.

SRS (Supplemental Restraint System) indicates that the airbag is designed to supplement seat belts, not replace them. Seat belts are the occupant's primary restraint system.

Housing Locations

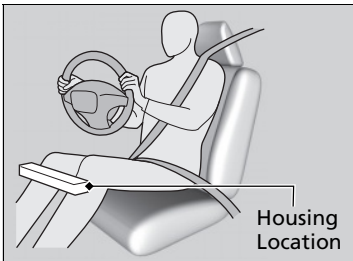

The driver's knee airbag is housed under the steering column.

The airbag is marked **SRS AIRBAG**.

Operation

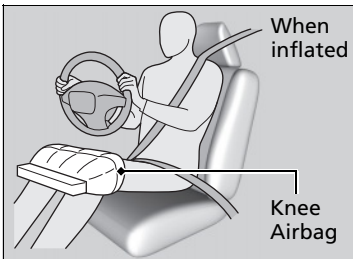

When the driver's front airbag inflates, the driver's knee airbag also inflates.

Even if the collision is not severe enough to deploy the front airbag, the knee airbag may inflate alone.

Driver's Knee Airbag

Do not attach accessories on or near the driver's knee airbag. They can interfere with the proper operation of the airbag, or hurt someone if an airbag inflates.

The driver should not store any items under the seat or behind their feet. The items can interfere with proper airbag deployment in the event of a moderate to severe frontal collision and may result in inadequate protection.

■ **When driver's knee airbag deploys with little or no visible damage**

Because the airbag system senses sudden deceleration, a strong impact to the vehicle framework or suspension might cause one or more of the airbags to deploy. Examples include running into a curb, the edge of a hole, or other low fixed object that causes a sudden deceleration in the vehicle chassis. Since the impact is underneath the vehicle, damage may not be readily apparent.

■ **When driver's knee airbag may not deploy, even though exterior damage appears severe**

Since crushable body parts absorb crash energy during an impact, the amount of visible damage does not always indicate proper airbag operation. In fact, some collisions can result in severe damage but no airbag deployment because the airbags would not have been needed or would not have provided protection even if they had deployed.

Side Airbags

The side airbags help protect the torso and pelvis of the driver or a front passenger during a moderate-to-severe side impact.

Housing Locations

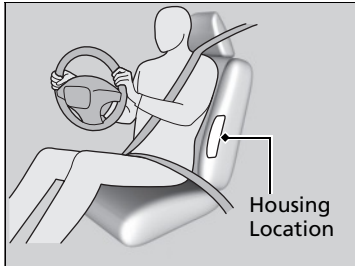

The side airbags are housed in the outside edge of the driver's and passenger's seat-backs.

Both are marked **SIDE AIRBAG**.

Operation

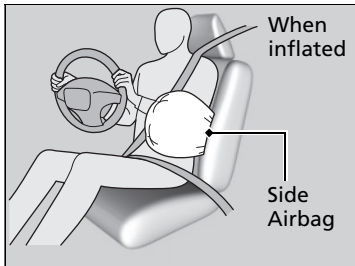

When the sensors detect a moderate-to-severe side impact, the control unit signals the side airbag on the impact side to immediately inflate.

Side Airbags

Make sure you and your front seat passenger always sit upright. Leaning into the path of a side airbag can prevent the airbag from deploying properly and increases your risk of serious injury.

Do not attach accessories on or near the side airbags. They can interfere with the proper operation of the airbags, or hurt someone if an airbag inflates.

Do not cover or replace the front seat-back covers without consulting an authorized Honda Clarity Plug-In Hybrid dealer. Improperly replacing or covering front seat-back covers can prevent your side airbags from properly deploying during a side impact.

■ **When a side airbag deploys with little or no visible damage**

Because the airbag system senses sudden acceleration, a strong impact to the side of the vehicle's framework can cause a side airbag to deploy. In such cases, there may be little or no damage, but the side impact sensors detected a severe enough impact to deploy the airbag.

■ **When a side airbag may not deploy, even though visible damage appears severe**

It is possible for a side airbag to not deploy during an impact that results in apparently severe damage. This can occur when the point of impact was toward the far front or rear of the vehicle, or when the vehicle's crushable body parts absorbed most of the crash energy. In either case, the side airbag would not have been needed nor provided protection even if it had deployed.

Side Curtain Airbags

The side curtain airbags help protect the heads of the driver and passengers in the outer seating positions during a moderate-to-severe side impact. The side curtain airbags equipped in this vehicle are also designed to help reduce the likelihood of partial and complete ejection of vehicle occupants through side windows in crashes, particularly rollover crashes.

Housing Locations

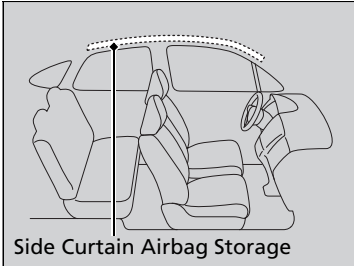

Side Curtain Airbag Storage

The side curtain airbags are located in the ceiling above the side windows on both sides of the vehicle.

Operation

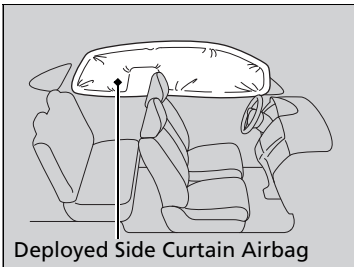

Deployed Side Curtain Airbag

The side curtain airbag is designed to deploy in a rollover or a moderate-to-severe side impact.

Side Curtain Airbags

If the SRS control unit senses that your vehicle is about to rollover, it immediately deploys both side curtain airbags and activates both front seat belt tensioners.

If the impact is on the passenger's side, the passenger's side curtain airbag deploys even if there are no occupants on that side of the vehicle.

To get the best protection from the side curtain airbags, occupants should wear their seat belts properly and sit upright and well back in their seats.

Do not attach any objects to the side windows or roof pillars as they can interfere with the proper operation of the side curtain airbags.

■ **When side curtain airbags deploy in a frontal collision**

One or both side curtain airbags may also inflate in a moderate-to-severe angled frontal collision.

Airbag System Indicators

If a problem occurs in the airbag system, the SRS indicator will come on and a message appears on the driver information interface.

■ Supplemental Restraint System (SRS) Indicator

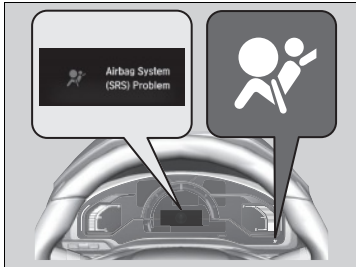

■ **When the power mode is set to ON**

The indicator comes on for a few seconds, then goes off. This tells you the system is working properly.

If the indicator comes on at any other time, or does not come on at all, have the system checked by an authorized Honda Clarity Plug-In Hybrid dealer as soon as possible. If you don't, your airbags and seat belt tensioners may not work properly when they are needed.

⌘ Supplemental Restraint System (SRS) Indicator

⚠ WARNING

Ignoring the SRS indicator can result in serious injury or death if the airbag systems or tensioners do not work properly.

Have your vehicle checked by an authorized Honda Clarity Plug-In Hybrid dealer as soon as possible if the SRS indicator alerts you to a possible problem.

Passenger Front Airbag Off Indicator

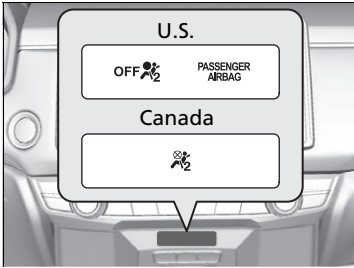

When the passenger front airbag off indicator comes on

The indicator comes on to alert you that the passenger's front airbag has been turned off.

This occurs when the weight sensors detect about 65 lbs (29 kg) or less, the weight of an infant or small child, on the seat.

Children age 12 or under should always ride properly restrained in a back seat.

📄 **Child Safety** P. 69

If the front passenger's seat is empty, the passenger's front airbag will not deploy and the indicator will come on.

Passenger Front Airbag Off Indicator

To ensure the passenger is detected properly, confirm that:

- There is no child seat or other object pressing against the rear of the seat-back.
- There is no rear passenger pushing or pulling on the back of the front passenger's seat.
- The front seat or seat-back is not forced back against an object on the seat or floor behind it.
- There is no object placed under or beside the front passenger's seat.
- The occupant is sitting in an upright position and the seat back is not excessively reclined.
- The occupant is not leaning against the door or center console.
- The occupant's feet are placed on the floor in front of them.
- There are no objects hanging from the front passenger's seat.
- Only small, lightweight objects are in the seat-back pocket.

The passenger front airbag off indicator may come on and go off periodically if the total weight on the seat is near the airbag cutoff threshold.

Have your vehicle checked by an authorized Honda Clarity Plug-In Hybrid dealer as soon as possible if:

- All of the above conditions are met, and the indicator comes on with an adult seated in the front passenger seat.
- The seat is empty and the indicator is off.

Do not allow an adult passenger to ride in the front seat when the indicator is on.

Airbag Care

You do not need to, and should not, perform any maintenance on or replace any airbag system components yourself. However, you should have your vehicle inspected by an authorized Honda Clarity Plug-In Hybrid dealer in the following situations:

■ When the airbags have deployed

If an airbag has inflated, the control unit and other related parts must be replaced. Similarly, once an automatic seat belt tensioner has been activated, it must be replaced.

■ When the vehicle has been in a moderate-to-severe collision

Even if the airbags did not inflate, have your authorized Honda Clarity Plug-In Hybrid dealer inspect the following: the driver's seat position sensor, weight sensors in the passenger's seat, front seat belt tensioners, and each seat belt that was worn during the crash.

■ Do not remove or modify a front seat without consulting an authorized Honda Clarity Plug-In Hybrid dealer

This would likely disable or affect the proper operation of the driver's seat position sensor or the weight sensors in the passenger's seat. If it is necessary to remove or modify a front seat to accommodate a person with disabilities, contact an authorized Honda Clarity Plug-In Hybrid dealer, or for U.S. vehicles, American Honda Automobile Customer Service at 1-800-999-1009 and for Canadian vehicles, Honda Canada Customer Relations at 1-888-9-HONDA-9.

✎ Airbag Care

We recommend against the use of salvaged airbag system components, including the airbag, tensioners, sensors, and control unit.

Protecting Child Passengers

Each year, many children are injured or killed in vehicle crashes because they are either unrestrained or not properly restrained. In fact, vehicle crashes are the number one cause of death of children ages 12 and under.

To reduce the number of child deaths and injuries, every state, Canadian province and territory requires that infants and children be properly restrained when they ride in a vehicle.

Children should sit properly restrained in a rear seat. This is because:

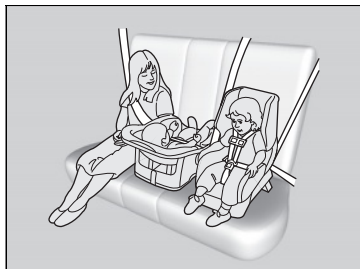

- An inflating front or side airbag can injure or kill a child sitting in the front seat.
- A child in the front seat is more likely to interfere with the driver's ability to safely control the vehicle.
- Statistics show that children of all sizes and ages are safer when they are properly restrained in a rear seat.

Protecting Child Passengers

⚠ WARNING

Children who are unrestrained or improperly restrained can be seriously injured or killed in a crash.

Any child too small for a seat belt should be properly restrained in a child seat. A larger child should be properly restrained with a seat belt, using a booster seat if necessary.

The National Highway Traffic Safety Administration and Transport Canada recommend that all children ages 12 and under be properly restrained in a rear seat. Some states or provinces/territories have laws restricting where children may ride.

- Any child who is too small to wear a seat belt correctly must be restrained in an approved child seat that is properly secured to the vehicle using either the seat belt or the lower anchors of the LATCH system.
- Never hold a child on your lap because it is impossible to protect them in the event of a collision.
- Never put a seat belt over yourself and a child. During a crash, the belt would likely press deep into the child and cause serious or fatal injuries.
- Never let two children use the same seat belt. Both children could be very seriously injured in a crash.
- Do not allow children to operate the doors, windows or seat adjustments.
- Do not leave children in the vehicle unattended, especially in hot weather when the inside of the vehicle can get hot enough to kill them. They could also activate vehicle controls causing it to move unexpectedly.

► Protecting Child Passengers

⚠ WARNING

Allowing a child to play with a seat belt or wrap one around their neck can result in serious injury or death.

Instruct children not to play with any seat belt and make sure any unused seat belt a child can reach is buckled, fully retracted, and locked.

To deactivate a lockable retractor, release the buckle and allow the seat belt to wind up all the way.

To remind you of the passenger's front airbag hazards and child safety, your vehicle has warning labels on the dashboard (U.S. models) and on the front visors. Please read and follow the instructions on these labels.

► **Safety Labels** P. 83

Safety of Infants and Small Children

■ Protecting Infants

An infant must be properly restrained in a rear-facing, reclining child seat until the infant reaches the seat manufacturer's weight or height limit for the seat, and the infant is at least one year old.

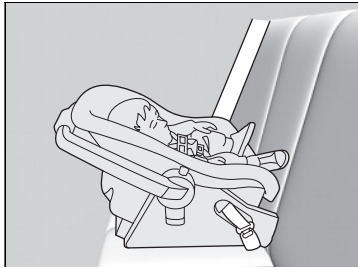

■ Positioning a rear-facing child seat

Child seats must be placed and secured in a rear seating position.

When properly installed, a rear-facing child seat may prevent the driver or a front passenger from moving their seat all the way back, or from locking their seat-back in the desired position. Make sure that there is no contact between the child seat and the seat in front of it.

It can also interfere with proper operation of the passenger's advanced front airbag system.

▶ **Airbags** P. 54

If this occurs, we recommend that you install the child seat directly behind the front passenger's seat, move the seat as far forward as needed, and leave it unoccupied. Or, you may wish to get a smaller rear-facing child seat.

▶▶ Protecting Infants

⚠ WARNING

Placing a rear-facing child seat in the front seat can result in serious injury or death during a crash.

Always place a rear-facing child seat in the rear seat, not the front.

Many experts recommend use of a rear-facing seat for a child up to two years old if the child's height and weight are appropriate for a rear-facing seat.

Rear-facing child seats should never be installed in a forward facing position.

Always refer to the child seat manufacturer's instructions before installation.

Do not allow a front seat to rest against a child seat installed in a rear seating position: The weight sensor in the front seat may not correctly detect the actual weight of the occupant.

■ Protecting Smaller Children

If a child is at least one year old and has exceeded the weight and height limitations of a rearward facing child seat, the child should be properly restrained in a firmly secured forward facing child seat until they exceed the weight and height limitations for the forward facing child seat.

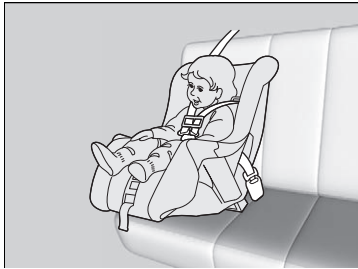

■ Forward-facing child seat placement

We strongly recommend placing a forward-facing child seat in a rear seating position.

Placing a forward-facing child seat in the front seat can be hazardous, even with advanced front airbags that automatically turn the passenger's front airbag off. A rear seat is the safest place for a child.

►► Protecting Smaller Children

⚠ WARNING

Placing a forward-facing child seat in the front seat can result in serious injury or death if the front airbag inflates.

If you must place a forward-facing child seat in front, move the vehicle seat as far back as possible, and properly restrain the child.

Educate yourself about the laws and regulations regarding child seat use where you are driving, and follow the child seat manufacturer's instructions.

■ Selecting a Child Seat

Most child seats are LATCH-compatible (Lower Anchors and Tethers for CHildren). Some have a rigid-type connector while others have a flexible-type connector. Both are equally easy to use. Some existing and previously owned child seats can only be installed using the seat belt. Whichever type you choose, follow the child seat manufacturer's use and care instructions including recommended expiration dates as well as the instructions in this manual. Proper installation is key to maximizing your child's safety.

In seating positions and vehicles not equipped with LATCH, a LATCH-compatible child seat can be installed using the seat belt and a top tether for added security. This is because all child seats are required to be designed so that they can be secured with a lap belt or the lap part of a lap/shoulder belt. In addition, the child seat manufacturer may advise that a seat belt be used to attach a LATCH-compatible seat once a child reaches a specified weight. Please read the child seat owner's manual for proper installation instructions.

■ Important consideration when selecting a child seat

Make sure the child seat meets the following three requirements:

- The child seat is the correct type and size for the child.
- The child seat is the correct type for the seating position.
- The child seat is compliant with Federal Motor Vehicle Safety Standard 213 or Canadian Motor Vehicle Safety Standard 213.

☒ Selecting a Child Seat

Installation of a LATCH-compatible child seat is simple.

LATCH-compatible child seats have been developed to simplify the installation process and reduce the likelihood of injuries caused by incorrect installation.

■ Installing a LATCH-Compatible Child Seat

A LATCH-compatible child seat can be installed in either of the two outer rear seats. A child seat is attached to the lower anchors with either the rigid or flexible type of connectors.

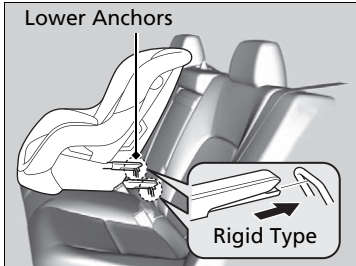
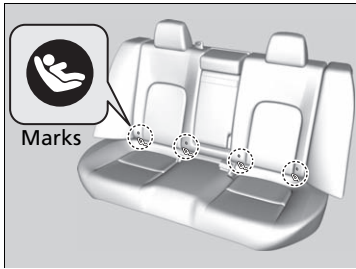

1. Locate the lower anchors under the marks.

2. Place the child seat on the vehicle seat, then attach the child seat to the lower anchors according to the instructions that came with the child seat.

► When installing the child seat, make sure that the lower anchors are not obstructed by the seat belt or any other object.

► Installing a LATCH-Compatible Child Seat

⚠ WARNING

Never attach two child seats to the same anchor. In a collision, one anchor may not be strong enough to hold two child seat attachments and may break, causing serious injury or death.

For your child's safety, when using a child seat installed using the LATCH system, make sure that the child seat is properly secured to the vehicle. A child seat that is not properly secured will not adequately protect a child in a crash and may cause injury to the child or other vehicle occupants.

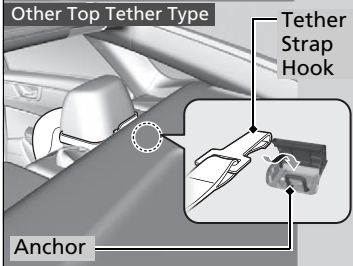
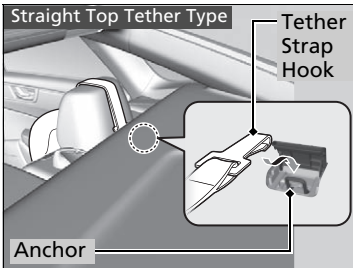
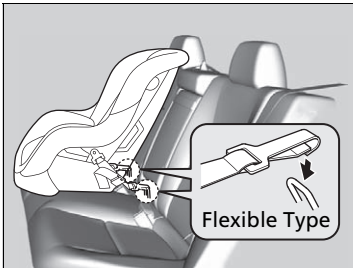

3. Open the tether anchor cover behind the head restraint.

4. Straight Top Tether Type

Route the tether strap over the top of the head restraint and secure the tether strap hook to the anchor.

Other Top Tether Type

Route the tether strap around the head restraint and secure the tether strap hook to the anchor.

5. Tighten the tether strap as instructed by the child seat manufacturer.

6. Make sure the child seat is firmly secured by rocking it forward and back and side to side; little movement should be felt.

7. Make sure any unused seat belt that a child can reach is buckled, the lockable retractor is activated, and the belt is fully retracted and locked.

▶▶ Installing a LATCH-Compatible Child Seat

⚠ WARNING

Do not use the lower inner anchors of the outer rear seats to secure a LATCH-compatible child seat to the rear center seat, unless the manufacturer's instructions for that system permit the use of inner anchors with the stated spacing.

Installing a LATCH-compatible child seat in the rear center seat

Each outer rear seat is equipped with a pair of lower anchors which are used to secure a LATCH-compatible child seat. The rear center seat, however, is not equipped with anchors of any kind.

The inner and outer anchors are spaced apart at a standard distance of 11 inches (280 mm). The distance between the two inner anchors is 15.7 inches (400 mm).

LATCH-compatible restraint systems that are fitted with rigid-type attachments cannot be installed in the rear center seat. However, a system fitted with flexible-type attachments can be installed in the center seat, provided that the manufacturer's instructions for that system permit the use of the inner anchors with the stated spacing.

Before seating a child, make sure that the system is properly attached to both the lower anchors and tether anchors.

■ Installing a Child Seat with a Lap/Shoulder Seat Belt

A child seat can be installed with a lap/shoulder belt in any rear seat or, if absolutely necessary, the front passenger seat.

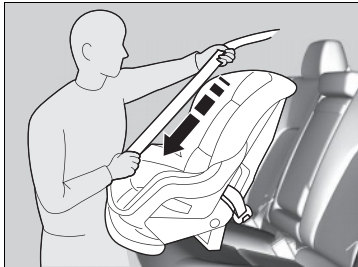
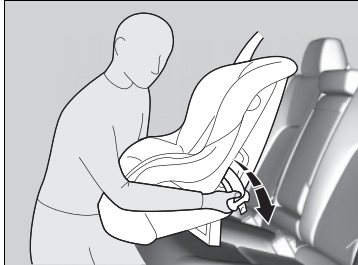

1. Place the child seat on the vehicle seat.
2. Route the seat belt through the child seat according to the seat manufacturer's instructions, and insert the latch plate into the buckle.
 - Insert the latch plate fully until it clicks.
3. Slowly pull the shoulder part of the belt all the way out until it stops. This activates the lockable retractor.
4. Let the seat belt retract a few inches and check that the retractor has switched modes by pulling on the webbing. It should not pull out again until it is reset by removing the latch plate from the buckle.
 - If you are able to pull the shoulder belt out, the lockable retractor is not activated. Slowly pull the seat belt all the way out, and repeat steps 3 – 4.

▣ Installing a Child Seat with a Lap/Shoulder Seat Belt

A child seat that is not properly secured will not adequately protect a child in a crash and may cause injury to the child or other vehicle occupants.



5. Grab the shoulder part of the seat belt near the buckle, and pull up to remove any slack from the lap part of the belt.

▶ When doing this, place your weight on the child seat and push it into the vehicle seat.

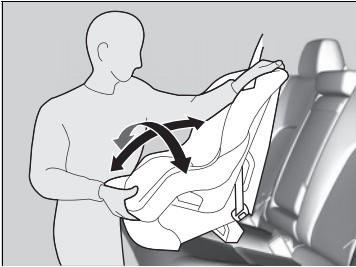

6. Make sure the child seat is firmly secured by rocking it forward and back and side to side; less than one inch of movement should occur near the seat belt.

7. Make sure any unused seat belt that a child can reach is buckled, the lockable retractor is activated, and the belt is fully retracted and locked.

▶▶ Installing a Child Seat with a Lap/Shoulder Seat Belt

To deactivate a lockable retractor, release the buckle and allow the seat belt to wind up all the way.

■ Adding Security with a Tether

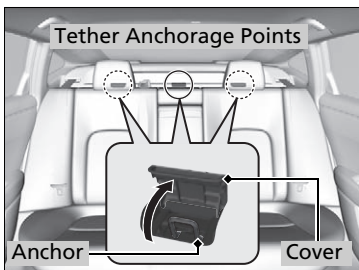

A tether anchorage point is provided behind each rear seating position. If you have a child restraint system that comes with a tether but can be installed with a seat belt, the tether may be used for additional security.

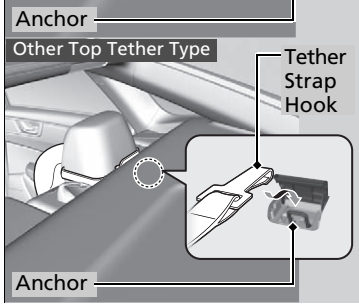
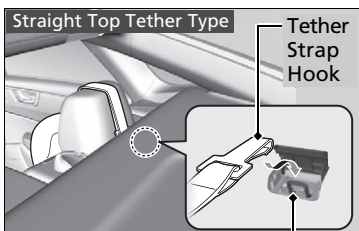

■ Using an outer anchor

1. Locate the appropriate tether anchorage point and lift the cover.
2. **Straight Top Tether Type**
Route the tether strap over the head restraint. Make sure the strap is not twisted.
- Other Top Tether Type**
Route the tether strap around the head restraint. Make sure the strap is not twisted.
3. Secure the tether strap hook to the anchor.
4. Tighten the tether strap as instructed by the child seat manufacturer.

►► Adding Security with a Tether

Always use a tether for forward facing child seats when using the seat belt or lower anchors.

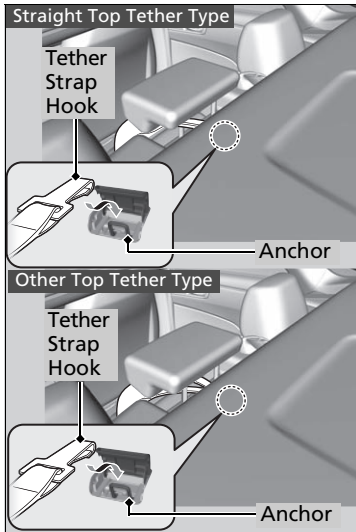

■ Using the center anchor

1. Locate the appropriate tether anchorage point and lift the cover.
2. Raise the head restraint to its highest position, then route the tether strap through the head restraint legs. Make sure the strap is not twisted.
3. Secure the tether strap hook to the anchor.
4. Tighten the tether strap as instructed by the child seat manufacturer.

Safety of Larger Children

■ Protecting Larger Children

The following pages give instructions on how to check proper seat belt fit, what kind of booster seat to use if one is needed, and important precautions for a child who must sit in front.

■ Checking Seat Belt Fit

When a child is too big for a child seat, secure the child in a rear seat using the lap/shoulder seat belt. Have the child sit upright and all the way back, then answer the following questions.



■ Checklist

- Do the child's knees bend comfortably over the edge of the seat?
- Does the shoulder belt cross between the child's neck and arm?
- Is the lap part of the seat belt as low as possible, touching the child's thighs?
- Will the child be able to stay seated like this for the whole trip?

If you answer yes to all these questions, the child is ready to wear the lap/shoulder seat belt correctly. If you answer no to any question, the child needs to ride on a booster seat until the seat belt fits properly without a booster seat.

▶ Safety of Larger Children

⚠ WARNING

Allowing a child age 12 or under to sit in front can result in injury or death if the passenger's front airbag inflates.

If a larger child must ride in front, move the vehicle seat as far to the rear as possible, have the child sit up properly and wear the seat belt properly, using a booster seat if needed.

Booster Seats



If a lap/shoulder seat belt cannot be used properly, position the child in a booster seat in the rear seat. For the child's safety, check that the child meets the booster seat manufacturer's recommendations.

Protecting Larger Children-Final Checks

Your vehicle has a rear seat where children can be properly restrained. If you ever have to carry a group of children, and a child must ride in front:

- Make sure you read and fully understand the instructions and safety information in this manual.
- Move the front passenger seat as far back as possible.
- Have the child sit upright and well back in the seat.
- Check that the seat belt is properly positioned so that the child is secure in the seat.

Monitoring child passengers

We strongly recommend that you keep an eye on child passengers. Even older, more mature children sometimes need to be reminded to fasten their seat belts and sit up properly.

Booster Seats

When installing a booster seat, make sure to read the instructions that came with it, and install the seat accordingly.

There are high- and low-type booster seats. Choose a booster seat that allows the child to wear the seat belt correctly.

Some U.S. states, and Canadian provinces and territories require children to use a booster seat until they reach a given age or weight (e.g. 6 years or 60 lbs). Be sure to check current laws in the state or province, or territory where you intend to drive.

Carbon Monoxide Gas

The engine exhaust from this vehicle contains carbon monoxide, a colorless, odorless, and highly toxic gas. As long as you properly maintain your vehicle, carbon monoxide gas will not get into the interior.

■ Have the exhaust system inspected for leaks whenever

- The exhaust system is making an unusual noise.
- The exhaust system may have been damaged.
- The vehicle is raised for an oil change.

When you operate a vehicle with the trunk open, airflow can pull exhaust gas into the interior and create a hazardous condition. If you must drive with the trunk open, open all the windows and set the climate control system as shown below.

1. Select the fresh air mode.
2. Select the  mode.
3. Set the fan speed to high.
4. Set the temperature control to a comfortable setting.

Adjust the climate control system in the same manner if you sit in your parked vehicle with the engine running.

Carbon Monoxide Gas

WARNING

Carbon monoxide gas is toxic.

Breathing it can cause unconsciousness and even kill you.

Avoid any enclosed areas or activities that expose you to carbon monoxide.

An enclosed area such as a garage can quickly fill up with carbon monoxide gas. Do not run the engine with the garage door closed. Even when the garage door is open, drive out of the garage immediately after starting the engine.

Label Locations

These labels are in the locations shown. They warn you of potential hazards that can cause serious injury or death. Read these labels carefully.

If a label comes off or becomes hard to read (except for the U.S. dashboard label which may be removed by the owner), contact an authorized Honda Clarity Plug-In Hybrid dealer for a replacement.

Sun Visor

U.S. models

WARNING

EVEN WITH ADVANCED AIR BAGS

Always wear your seat belt. Do not drink and drive. Do not use alcohol or drugs. Do not use prescription or over-the-counter medications. Do not use any illegal drugs. Do not use any recreational drugs. Do not use any prescription or over-the-counter medications. Do not use any illegal drugs. Do not use any recreational drugs.

Canadian models

WARNING

To avoid serious injury or death, always wear your seat belt. Do not drink and drive. Do not use alcohol or drugs. Do not use prescription or over-the-counter medications. Do not use any illegal drugs. Do not use any recreational drugs.

ATTENTION

Do not drink and drive. Do not use alcohol or drugs. Do not use prescription or over-the-counter medications. Do not use any illegal drugs. Do not use any recreational drugs.

Motor Coolant Reserve Tank Cap

DANGER WARNING

NEVER OPEN WHEN HOT. Hot coolant will scald you. **N'OUVREZ PAS QUAND CHAUD.** **N'ÛT BEHESSEMOTOR OPENEN.**

108kPa

Actuator Lid

U.S. models

WARNING

FIRE RISK

Always use the correct fuel. Do not use gasoline. Do not use any other fuels.

Canadian models

WARNING

AVERTISSEMENT

RISQUE D'INCENDIE

Utilisez toujours le bon carburant. Ne pas utiliser d'essence. Ne pas utiliser d'autres carburants.

Charging Lid

U.S. models

WARNING

FIRE RISK

Always use the correct fuel. Do not use gasoline. Do not use any other fuels.

Canadian models

WARNING

AVERTISSEMENT

RISQUE D'INCENDIE

Utilisez toujours le bon carburant. Ne pas utiliser d'essence. Ne pas utiliser d'autres carburants.

PCU

U.S. models

WARNING

HIGH VOLTAGE

Do not touch the PCU. Do not disconnect, open, or touch parts.

Canadian models

WARNING

ATTENTION

When you remove and attach the PCU, conduct maintenance according to the service manual. **Lorsque vous retirez et attachez le PCU, effectuez l'entretien selon le manuel de service.**

High Voltage Battery System

DANGER WARNING

NEVER OPEN WHEN HOT. Hot coolant will scald you. **N'OUVREZ PAS QUAND CHAUD.** **N'ÛT BEHESSEMOTOR OPENEN.**

48kPa

Radiator Cap

DANGER WARNING

NEVER OPEN WHEN HOT. Hot coolant will scald you. **N'OUVREZ PAS QUAND CHAUD.** **N'ÛT BEHESSEMOTOR OPENEN.**

108kPa

Air Conditioner System

U.S. models

WARNING

CAUTION: SYSTEM CONTAINS REFRIGERANT (A-CARRIER) REPAIRS SHOULD BE PERFORMED ONLY BY QUALIFIED PERSONNEL. (See instructions in the service manual.)

AIR CONDITIONER SYSTEM

REFRIGERANT: R-1234yf (A/C) (R1234yf)

REC. CHARGE: MAX 0.445kg (MIN 0.369kg)

OIL TYPE: SE-A2 (POE)

TRT Honda Motor Co., Ltd.

Canadian models

WARNING

R-1234yf

Dashboard

U.S. models only

This Vehicle is Equipped with Advanced Air Bags





Even with Advanced Air Bags, children and passengers under the age of 18 are not to be seated in the front passenger seat. Always use the proper seat belt technique. Do not use alcohol or drugs. Do not use prescription or over-the-counter medications. Do not use any illegal drugs. Do not use any recreational drugs.





Instrument Panel

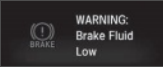
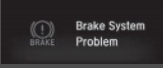

This chapter describes the buttons, indicators, and gauges that are used while driving.



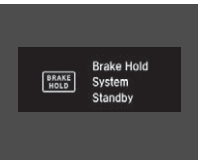



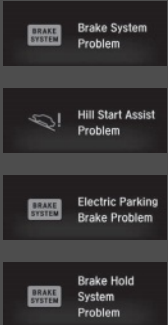

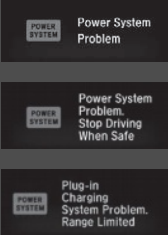





Indicators	86
Driver Information Interface Warning and Information Messages	103
Gauges and Driver Information Interface	121
Gauges	121
Driver Information Interface	124

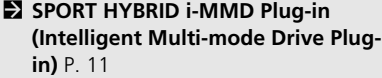



Indicator	Name	On/Blinking	Explanation	Message
 <p>U.S. BRAKE Canada  (Red)</p>	Parking Brake and Brake System Indicator (Red)	<ul style="list-style-type: none"> • Comes on for a few seconds when you set the power mode to ON, then goes off if the parking brake has been released. • Comes on when the parking brake is applied, and goes off when it is released. • Comes on when the brake fluid level is low. • Comes on if there is a problem with the brake system. • The beeper sounds and the indicator comes on if you drive with the parking brake not fully released. 	<ul style="list-style-type: none"> • Comes on while driving - Make sure the parking brake is released. Check the brake fluid level. <ul style="list-style-type: none"> ➤ What to do when the indicator comes on while driving P. 548 • Comes on along with the parking brake and brake system indicator (amber) - Immediately stop in a safe place. Contact an authorized Honda Clarity Plug-In Hybrid dealer for repair. The brake pedal becomes harder to operate. Depress the pedal further than you normally do. • Comes on along with the ABS indicator - Have your vehicle checked by an authorized Honda Clarity Plug-In Hybrid dealer. <ul style="list-style-type: none"> ➤ If the Brake System Indicator (Red) Comes On or Blinks P. 548 	  

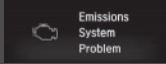

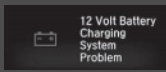
Indicator	Name	On/Blinking	Explanation	Message
	Parking Brake and Brake System Indicator (Red)	<ul style="list-style-type: none"> • Comes on for about 15 seconds when you push the electric parking brake switch while the power mode is in VEHICLE OFF. • Stays on for about 15 seconds when you set the power mode to VEHICLE OFF while the electric parking brake is set. 	<ul style="list-style-type: none"> • Blinks and the parking brake and brake system indicator (amber) comes on at the same time - There is a problem with the electric parking brake system. The parking brake may not be set. Avoid using the parking brake and have your vehicle checked by an authorized Honda Clarity Plug-In Hybrid dealer immediately. ➤ If the Brake System Indicator (Red) Comes On or Blinks at the Same Time When the Brake System Indicator (Amber) Comes On P. 550 	
	Automatic Brake Hold System Indicator	<ul style="list-style-type: none"> • Comes on for a few seconds when you set the power mode to ON, then goes off. • Comes on when the automatic brake hold system is on. 	<ul style="list-style-type: none"> ➤ Automatic Brake Hold P. 435 	
	Automatic Brake Hold Indicator	<ul style="list-style-type: none"> • Comes on for a few seconds when you set the power mode to ON, then goes off. • Comes on when the automatic brake hold is activated. 	<ul style="list-style-type: none"> ➤ Automatic Brake Hold P. 435 	

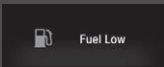

Indicator	Name	On/Blinking	Explanation	Message
	<p>Parking Brake and Brake System Indicator (Amber)</p>	<ul style="list-style-type: none"> • Comes on for a few seconds when you set the power mode to ON, then goes off. • Comes on if there is a problem with a system related to braking other than the conventional brake system. • Comes on if there is a problem with the cooperative control with regenerative braking, the electric servo brake system, or the hill start assist system. • Comes on if there is a problem with the electric parking brake system or the automatic brake hold system. 	<ul style="list-style-type: none"> • Comes on while driving - Avoid using the parking brake and have your vehicle checked by an authorized Honda Clarity Plug-In Hybrid dealer immediately. • Stays on constantly - Avoid high speeds and sudden braking. Take the vehicle to an authorized Honda Clarity Plug-In Hybrid dealer immediately. • With this indicator on, your vehicle still has normal braking ability. 	
	<p>POWER SYSTEM Indicator</p>	<ul style="list-style-type: none"> • Comes on for a few seconds when you set the power mode to ON, then goes off. • Comes on if there is a problem with the electric vehicle system or plug-in charging system. 	<ul style="list-style-type: none"> • Have your vehicle checked by an authorized Honda Clarity Plug-In Hybrid dealer. 	

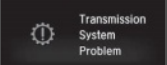

Indicator	Name	On/Blinking	Explanation	Message
	EV Indicator	<ul style="list-style-type: none"> Comes on for a few seconds when you set the power mode to ON, then goes off. Comes on when the vehicle is moved by the motor, and the engine is not operating. 	—	—
	HV Indicator	<ul style="list-style-type: none"> Comes on for a few seconds when you set the power mode to ON, then goes off. 	—	—
		<ul style="list-style-type: none"> Comes on when the vehicle is in HV. 		
		<ul style="list-style-type: none"> Comes on when the vehicle is in HV charge. 		
	HV Charge Indicator	<ul style="list-style-type: none"> Comes on for a few seconds when you set the power mode to ON, then goes off. 	—	—
		<ul style="list-style-type: none"> Comes along with the HV indicator when the vehicle is in HV charge. 		



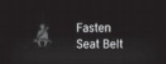

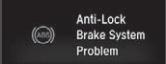
Indicator	Name	On/Blinking	Explanation	Message
	READY Indicator	<ul style="list-style-type: none"> Comes on when the vehicle is ready to drive. 	<ul style="list-style-type: none"> May go off if the POWER SYSTEM or transmission system indicator comes on. <ul style="list-style-type: none"> ► Turning on the Power P. 376 	
	Malfunction Indicator Lamp	<ul style="list-style-type: none"> Comes on when you set the power mode to ON, and goes off either when the power system is on or after several seconds if the vehicle did not start. If “readiness codes” have not been set, it blinks five times before it goes off. Comes on if there is a problem with the emissions control system. Blinks when a misfire in the engine’s cylinders is detected. 	<ul style="list-style-type: none"> Readiness codes are part of the on board diagnostics for the emissions control systems. <ul style="list-style-type: none"> ► Testing of Readiness Codes P. 572 Comes on while driving - Have your vehicle checked by an authorized Honda Clarity Plug-In Hybrid dealer. Blinks while driving - Stop in a safe place where there are no flammable objects. Stop the power system for 10 minutes or more, and wait for the engine to cool down. Then, take the vehicle to an authorized Honda Clarity Plug-In Hybrid dealer. <ul style="list-style-type: none"> ► If the Malfunction Indicator Lamp Comes On or Blinks P. 547 	
	12-Volt Battery Charging System Indicator	<ul style="list-style-type: none"> Comes on when you set the power mode to ON, and goes off when the power system is on. Comes on when the 12-volt battery is not charging. 	<ul style="list-style-type: none"> Comes on while driving - Turn off the climate control system and rear defogger in order to reduce electricity consumption. <ul style="list-style-type: none"> ► If the 12-Volt Battery Charging System Indicator Comes On P. 546 	

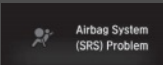
Indicator	Name	On/Blinking	Explanation	Message
	Low Fuel Indicator	<ul style="list-style-type: none"> • Comes on when the fuel reserve is running low (approximately 1.1 U.S. gal./4.0 Liter left). • Blinks if there is a problem with the fuel gauge. 	<ul style="list-style-type: none"> • Comes on - Refuel your vehicle as soon as possible. • Blinks - Have your vehicle checked by an authorized Honda Clarity Plug-In Hybrid dealer. 	 
	Gear Position Indicator	<ul style="list-style-type: none"> • Indicates the current gear selection. 	<p>➤ Shifting P. 382</p>	<p>—</p>
	Deceleration Paddle Selector Indicator	<ul style="list-style-type: none"> • Comes on when the paddle selector is pulled. • Blinks when deceleration does not occur while pulling the paddle selector. • Comes on with M when SPORT mode is selected and pulling the paddle selector. 	<p>➤ Deceleration Paddle Selector P. 390</p>	<p>—</p>

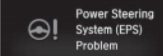

Indicator	Name	On/Blinking	Explanation	Message
	Transmission System Indicator	<ul style="list-style-type: none"> All the gear positions may light for several seconds, and go off. 	<ul style="list-style-type: none"> When all the gear positions illuminate, immediately stop your vehicle in a safe place. Indicators go off if there is no problem. However, even if they go off, take your vehicle to an authorized Honda Clarity Plug-In Hybrid dealer for inspection. 	
		<ul style="list-style-type: none"> The indicated current gear selection blinks if there is a problem with the transmission system. 	<ul style="list-style-type: none"> Avoid sudden start and acceleration, and stop in a safe place immediately. Have your vehicle checked by an authorized Honda Clarity Plug-In Hybrid dealer. 	
		<ul style="list-style-type: none"> The indicated current gear selection or all the gear positions blink if you cannot select P due to a transmission system failure. 	<ul style="list-style-type: none"> The engine can be activated as a temporary measure. <ul style="list-style-type: none"> ► If the Transmission System Indicator Blinks along with the Warning Message P. 552 Set the parking brake when parking. Have your vehicle checked by an authorized Honda Clarity Plug-In Hybrid dealer immediately. 	

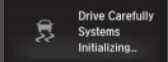

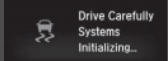

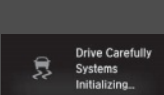

Indicator	Name	On/Blinking	Explanation	Message
	Seat Belt Reminder Indicator	<ul style="list-style-type: none"> • Comes on and the beeper sounds if you are not wearing a seat belt when you set the power mode to ON. • If the front passenger is not wearing a seat belt, the indicator comes on a few seconds later. • Blinks while driving if either you and/or the front passenger has not fastened a seat belt. The beeper sounds and the indicator blinks at regular intervals. 	<ul style="list-style-type: none"> • The beeper stops and the indicator goes off when you and the front passenger fasten their seat belts. • Stays on after you and/or the front passenger has fastened the seat belt(s) - A detection error may have occurred in the sensor. Have your vehicle checked by an authorized Honda Clarity Plug-In Hybrid dealer. <ul style="list-style-type: none"> ▶ Seat Belt Reminder P. 49 	 
	Anti-lock Brake System (ABS) Indicator	<ul style="list-style-type: none"> • Comes on for a few seconds when you set the power mode to ON, then goes off. • If it comes on at any other time, there is a problem with the ABS. 	<ul style="list-style-type: none"> • Stays on constantly - Have your vehicle checked by an authorized Honda Clarity Plug-In Hybrid dealer. With this indicator on, your vehicle still has normal braking ability but no anti-lock function. <ul style="list-style-type: none"> ▶ Anti-lock Brake System (ABS) P. 437 	

Indicator	Name	On/Blinking	Explanation	Message
	Supplemental Restraint System Indicator	<ul style="list-style-type: none"> • Comes on for a few seconds when you set the power mode to ON, then goes off. • Comes on if a problem with any of the following is detected: <ul style="list-style-type: none"> - Supplemental restraint system - Side airbag system - Side curtain airbag system - Seat belt tensioner 	<ul style="list-style-type: none"> • Stays on constantly or does not come on at all - Have your vehicle checked by an authorized Honda Clarity Plug-In Hybrid dealer. 	
	Electric Power Steering (EPS) System Indicator	<ul style="list-style-type: none"> • Comes on when you set the power mode to ON, and goes off when the power system is on. • Comes on if there is a problem with the EPS system. 	<ul style="list-style-type: none"> • Stays on constantly or does not come on at all - Have your vehicle checked by an authorized Honda Clarity Plug-In Hybrid dealer. <ul style="list-style-type: none"> ▣ If the Electric Power Steering (EPS) System Indicator Comes On P. 549 	







Indicator	Name	On/Blinking	Explanation	Message
	Vehicle Stability Assist (VSA®) System Indicator	<ul style="list-style-type: none"> • Comes on for a few seconds when you set the power mode to ON, then goes off. • Blinks when VSA® is active. • Comes on if there is a problem with the VSA® system. 	<ul style="list-style-type: none"> • Stays on constantly - Have your vehicle checked by an authorized Honda Clarity Plug-In Hybrid dealer. <ul style="list-style-type: none"> ➤ Vehicle Stability Assist (VSA®), aka Electronic Stability Control (ESC), System P. 422 	
		<ul style="list-style-type: none"> • Comes on if the VSA® system is deactivated temporarily after the battery has been disconnected, then re-connected. 	<ul style="list-style-type: none"> • Drive a short distance at more than 12 mph (20 km/h). The indicator should go off. If it does not, have your vehicle checked by an authorized Honda Clarity Plug-In Hybrid dealer. 	
	Vehicle Stability Assist (VSA®) OFF Indicator	<ul style="list-style-type: none"> • Comes on for a few seconds when you set the power mode to ON, then goes off. • Comes on when you deactivate VSA®. 	<ul style="list-style-type: none"> • ➤ VSA® On and Off P. 423 	
		<ul style="list-style-type: none"> • Comes on if the VSA® system is deactivated temporarily after the battery has been disconnected, then re-connected. 	<ul style="list-style-type: none"> • Drive a short distance at more than 12 mph (20 km/h). The indicator should go off. If it does not, have your vehicle checked by an authorized Honda Clarity Plug-In Hybrid dealer. 	





Instrument Panel



Indicator	Name	On/Blinking	Explanation	Message
	Low Tire Pressure/TPMS Indicator	<ul style="list-style-type: none"> • Comes on for a few seconds when you set the power mode to ON. • May come on briefly if the power mode is set to ON and the vehicle is not moved within 45 seconds, to indicate the calibration process is not yet complete. • Comes on and stays on when: <ul style="list-style-type: none"> - One or more tires' pressures are determined to be significantly low. - The system has not been calibrated. 	<ul style="list-style-type: none"> • Comes on while driving - Stop in a safe place, check tire pressures, and inflate the tire(s) if necessary. • Stays on after the tires are inflated to the recommended pressures - The system needs to be calibrated. <ul style="list-style-type: none"> ▶ TPMS Calibration P. 425 	
		<ul style="list-style-type: none"> • Blinks for about one minute, and then stays on if there is a problem with the TPMS. 	<ul style="list-style-type: none"> • Blinks and remains on - Have your vehicle checked by an authorized Honda Clarity Plug-In Hybrid dealer. 	
		<ul style="list-style-type: none"> • Comes on if the TPMS is deactivated temporarily after the battery has been disconnected, then re-connected. 	<ul style="list-style-type: none"> • Drive a short distance at more than 12 mph (20 km/h). The indicator should go off. If it does not, have your vehicle checked by an authorized Honda Clarity Plug-In Hybrid dealer. 	





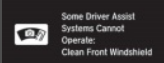

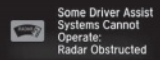

Indicator	Name	On/Blinking	Explanation	Message
	Turn Signal and Hazard Warning Indicators	<ul style="list-style-type: none"> Blinks when you operate the turn signal lever. Blinks along with all turn signals when you press the hazard warning button. 	<ul style="list-style-type: none"> Does not blink or blinks rapidly - Have your vehicle checked by an authorized Honda Clarity Plug-In Hybrid dealer immediately. 	—
	High Beam Indicator	<ul style="list-style-type: none"> Comes on when the high beam headlights are on. 	—	—
	Lights On Indicator	<ul style="list-style-type: none"> Comes on when the light switch in a position other than OFF or when the switch is set to AUTO and the exterior lights come on. 	<ul style="list-style-type: none"> If you set the power mode to ACCESSORY or VEHICLE OFF while the exterior lights are on, a chime sounds when the driver's door is opened. 	—
 Indicator	Immobilizer System Indicator	<ul style="list-style-type: none"> Blinks if the immobilizer system cannot recognize the key information. 	<ul style="list-style-type: none"> Blinks - You cannot start the power system. Set the power mode to VEHICLE OFF*1, then select the ON mode again. Repeatedly blinks - The system may be malfunctioning. Have your vehicle checked by an authorized Honda Clarity Plug-In Hybrid dealer. Do not attempt to alter this system or add other devices to it. Electrical problems can occur. 	<div style="border: 1px solid black; padding: 5px; margin-bottom: 10px;">Canadian models</div> <div style="background-color: #333; color: white; padding: 10px; margin-bottom: 10px;">  <p>To Start Engine: Fully Depress Brake + Push</p> </div> <div style="background-color: #333; color: white; padding: 10px;">  <p>Fully Release Brake + Push</p> </div>







*1:Canadian models only: Apply and hold the brake pedal before selecting the ON mode.

Indicator	Name	On/Blinking	Explanation	Message
	System Message Indicator	<ul style="list-style-type: none"> Comes on along with a beep when a problem is detected. A system message on the driver information interface appears at the same time. 	<ul style="list-style-type: none"> While the indicator is on, press the  (display/information) button to see the message again. Refer to the Indicators information in this chapter when a system message appears on the driver information interface. Take the appropriate action for the message. The driver information interface does not return to the normal screen unless the warning is canceled, or the  button is pressed. 	—
 <p>Indicator</p>	Security System Alarm Indicator	<ul style="list-style-type: none"> Blinks when the security system alarm has been set. 	<p>➤ Security System Alarm P. 153</p>	—
<p>SPORT</p>	SPORT Mode Indicator	<ul style="list-style-type: none"> Comes on when you press the SPORT button. The ambient meter remains lit up in red as long as sport mode is on. 	<p>➤ SPORT Mode P. 389</p>	
	ECON Mode Indicator	<ul style="list-style-type: none"> Comes on when ECON mode is on. 	<p>➤ ECON Mode P. 388</p>	

Indicator	Name	On/Blinking	Explanation	Message
	Road Departure Mitigation (RDM) Indicator	<ul style="list-style-type: none"> • Comes on for a few seconds when you set the power mode to ON, then goes off. • Comes on if there is a problem with the RDM system. 	<ul style="list-style-type: none"> • Stays on constantly - Have your vehicle checked by an authorized Honda Clarity Plug-In Hybrid dealer. 	
		<ul style="list-style-type: none"> • Comes on when the RDM system shuts itself off. 	<ul style="list-style-type: none"> • Stays on - The temperature inside the camera is too high. Use the climate control system to cool down the camera. The system activates when the temperature inside the camera cools down sufficiently.  Front Sensor Camera P. 394 	
			<ul style="list-style-type: none"> • Stays on - The area around the camera is blocked by dirt, mud, etc. Stop your vehicle in a safe place, and wipe it off with a soft cloth. • Have your vehicle checked by an authorized Honda Clarity Plug-In Hybrid dealer if the indicator and message come back on after you cleaned the area around the camera.  Front Sensor Camera P. 394 	

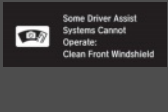

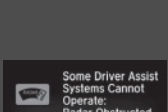

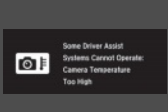
Indicator	Name	On/Blinking	Explanation	Message
<div style="background-color: #333; color: white; padding: 5px; text-align: center; font-weight: bold; font-size: 1.2em;">ACC</div>	Adaptive Cruise Control (ACC) with Low Speed Follow (LSF) Indicator (Amber)	<ul style="list-style-type: none"> • Comes on for a few seconds when you set the power mode to ON, then goes off. • Comes on if there is a problem with ACC with LSF. 	<ul style="list-style-type: none"> • Comes on while driving - Have your vehicle checked by an authorized Honda Clarity Plug-In Hybrid dealer. 	
		<ul style="list-style-type: none"> • Comes on if anything covers the radar sensor cover and prevents the sensor from detecting a vehicle in front. • May come on when driving in bad weather (rain, snow, fog, etc.) • ACC with LSF has been automatically canceled. 	<ul style="list-style-type: none"> • When the radar sensor gets dirty, stop your vehicle in a safe place, and then clean the sensor using a soft cloth. • Have your vehicle checked by an authorized Honda Clarity Plug-In Hybrid dealer if the indicator does not disappear, even after you clean the sensor cover. 	
<div style="background-color: #333; color: white; padding: 5px; text-align: center; font-weight: bold; font-size: 1.2em;">ACC</div>	Adaptive Cruise Control (ACC) with Low Speed Follow (LSF) Indicator (Green)	<ul style="list-style-type: none"> • Comes on when you press the MAIN button. 	<p>➤ Adaptive Cruise Control (ACC) with Low Speed Follow (LSF) P. 400</p>	



Indicator	Name	On/Blinking	Explanation	Message
	Lane Keeping Assist System (LKAS) Indicator (Amber)	<ul style="list-style-type: none"> • Comes on for a few seconds when you set the power mode to ON, then goes off. • Comes on if there is a problem with the LKAS. 	<ul style="list-style-type: none"> • Stays on constantly - Have your vehicle checked by an authorized Honda Clarity Plug-In Hybrid dealer. 	
	Lane Keeping Assist System (LKAS) Indicator (Green)	<ul style="list-style-type: none"> • Comes on when you press the MAIN button. 	<p>➤ Lane Keeping Assist System (LKAS) P. 415</p>	
	Collision Mitigation Braking System™ (CMBS™) Indicator	<ul style="list-style-type: none"> • Comes on for a few seconds when you set the power mode to ON, then goes off. • Comes on when you deactivate the CMBS™. • Comes on if there is a problem with the CMBS™. • Comes on if the CMBS is deactivated temporarily after the battery has been disconnected, then re-connected. 	<ul style="list-style-type: none"> • Stays on constantly without the CMBS™ off - Have your vehicle checked by an authorized Honda Clarity Plug-In Hybrid dealer. • ➤ Collision Mitigation Braking System™ (CMBS™) P. 439 • Drive a short distance at more than 12 mph (20 km/h). The indicator should go off. If it does not, have your vehicle checked by an authorized Honda Clarity Plug-In Hybrid dealer. 	  

Indicator	Name	On/Blinking	Explanation	Message
	Collision Mitigation Braking System™ (CMBS™) Indicator	<ul style="list-style-type: none"> Comes on when the CMBS™ system shuts itself off. 	<ul style="list-style-type: none"> Stays on - The area around the camera is blocked by dirt, mud, etc. Stop your vehicle in a safe place, and wipe it off with a soft cloth.  Front Sensor Camera P. 394 	
		<ul style="list-style-type: none"> When the radar sensor gets dirty, stop your vehicle in a safe place, and then clean the sensor using a soft cloth. Have your vehicle checked by an authorized Honda Clarity Plug-In Hybrid dealer if the message does not disappear even after you clean the sensor cover.  Collision Mitigation Braking System™ (CMBS™) P. 439 		
		<ul style="list-style-type: none"> Stays on - The temperature inside the camera is too high. Use the climate control system to cool down the camera. The system activates when the temperature inside the camera cools down sufficiently.  Front Sensor Camera P. 394 		

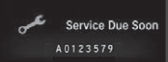

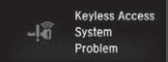
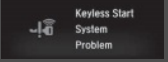

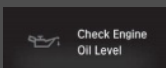

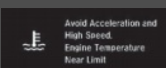
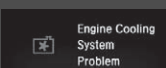
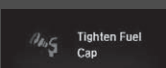
Driver Information Interface Warning and Information Messages



The following messages appear only on the driver information interface. Press the  (display/information) button to see the message again with the system message indicator on.



Message	Condition	Explanation
	<ul style="list-style-type: none"> Appears when the vehicle cannot be driven. 	<ul style="list-style-type: none"> Immediately stop in a safe place.
<div style="border: 1px solid black; padding: 2px; display: inline-block;">Canadian models</div> 	<ul style="list-style-type: none"> Appears when the washer fluid gets low. 	<ul style="list-style-type: none"> Refill the washer fluid.  Refilling Window Washer Fluid P. 493
	<ul style="list-style-type: none"> Appears when the scheduled maintenance is due soon. Consequently, Service Due Now and Service Past Due follow. 	<ul style="list-style-type: none">  Warning Message and Maintenance Minder Information on the Driver Information Interface P. 476
 	<ul style="list-style-type: none"> Appears as soon as a problem is detected in the smart entry system or push button starting system. 	<ul style="list-style-type: none"> Appears constantly - Have your vehicle checked by an authorized Honda Clarity Plug-In Hybrid dealer.

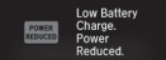
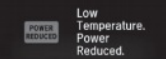

Message	Condition	Explanation
 <p>Charging System Problem</p>	<ul style="list-style-type: none"> • Appears when there is a problem with the sensor on the 12-volt battery. 	<ul style="list-style-type: none"> • Have your vehicle checked by an authorized Honda Clarity Plug-In Hybrid dealer. <ul style="list-style-type: none"> ➤ Checking the 12-Volt Battery P. 508
	<ul style="list-style-type: none"> • Appears along with the battery charging system indicator when the battery is not charging. 	<ul style="list-style-type: none"> • Turn off the climate control system and rear defogger to reduce electricity consumption. <ul style="list-style-type: none"> ➤ If the 12-Volt Battery Charging System Indicator Comes On P. 546
 <p>Check Engine Oil Level</p>	<ul style="list-style-type: none"> • Appears when the engine oil pressure is low. 	<ul style="list-style-type: none"> • Appears while driving - Immediately stop in a safe place. <ul style="list-style-type: none"> ➤ If the Low Oil Pressure Warning Appears P. 545
 <p>Stop Driving When Safe. Engine Temperature Too Hot</p>	<ul style="list-style-type: none"> • Appears when the engine coolant temperature gets abnormally high. 	<ul style="list-style-type: none"> ➤ Overheating P. 542
 <p>Avoid Acceleration and High Speed. Engine Temperature Near Limit</p>	<ul style="list-style-type: none"> • Appears when the engine coolant temperature is near its upper limit. 	<ul style="list-style-type: none"> • Drive slowly to prevent overheating.
 <p>Engine Cooling System Problem</p>	<ul style="list-style-type: none"> • Appears if there is a problem with the cooling system. 	<ul style="list-style-type: none"> • Drive slowly to prevent overheating and have your vehicle checked by an authorized Honda Clarity Plug-In Hybrid dealer as soon as possible.
 <p>Tighten Fuel Cap</p>	<ul style="list-style-type: none"> • Appears when the fuel fill cap is loose or is not installed. 	<ul style="list-style-type: none"> ➤ Tighten Fuel Cap Message P. 547



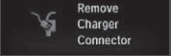
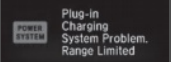

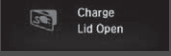
Message	Condition	Explanation
	<ul style="list-style-type: none"> • Appears if the vehicle's speed reaches about 10 mph (15 km/h) with the fuel fill door opened. • Appears when the fuel fill door has been open for 30 minutes. 	<ul style="list-style-type: none"> • Stop the vehicle and close the fuel fill door. • Turn off the power system, reinstall the fuel cap, and close the fuel fill door. <ul style="list-style-type: none"> - If you still want to refuel, press the fuel fill door release button to reopen the door.

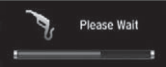
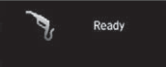
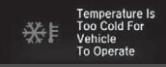

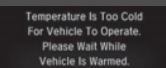

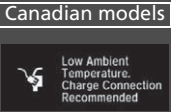
Message	Condition	Explanation
 To Switch Vehicle OFF: Push Twice	<ul style="list-style-type: none"> Appears after the driver's door is opened when the power mode is in ACCESSORY. 	<ul style="list-style-type: none"> Press the POWER button twice with your foot off the brake pedal to change the power mode to VEHICLE OFF.
 Accessory Mode	<ul style="list-style-type: none"> Appears when the power mode is in ACCESSORY. 	—
 Keyless Remote Not Detected	<ul style="list-style-type: none"> Appears when you close the door with the power mode in ON without the smart entry remote inside the vehicle. 	<ul style="list-style-type: none"> Disappears when you bring the smart entry remote back inside the vehicle and close the door. <ul style="list-style-type: none"> ➤ Smart Entry Remote Reminder P. 160
 Keyless Remote Battery Low	<ul style="list-style-type: none"> Appears when the smart entry remote battery becomes weak. 	<ul style="list-style-type: none"> Replace the battery as soon as possible. <ul style="list-style-type: none"> ➤ Replacing the Button Battery P. 510
 To Start, Hold Remote Near Start Button	<ul style="list-style-type: none"> Appears if the smart entry remote's battery is too weak to turn on the power system or the key is not within operating range to turn on the power system. A beeper sounds six times. 	<ul style="list-style-type: none"> Bring the back of the smart entry remote into contact with the POWER button. <ul style="list-style-type: none"> ➤ If the Smart Entry Remote Battery is Weak P. 537
 To Start Vehicle: Brake + Push	<ul style="list-style-type: none"> Appears when you set the power mode to ACCESSORY or ON. <p>Canadian models</p> <ul style="list-style-type: none"> Appears after you unlock and open the driver's door. 	<ul style="list-style-type: none"> ➤ Turning on the Power P. 376
 Pressing Button Again 2x Or Holding Will Cause Ignition OFF & Power Loss	<ul style="list-style-type: none"> Appears when the POWER button is pressed while driving. 	<ul style="list-style-type: none"> ➤ Emergency Power System Off P. 538

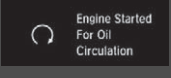
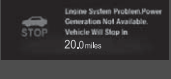

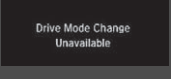
Message	Condition	Explanation
	<ul style="list-style-type: none"> • Appears when the high voltage battery charge level is extremely low. 	<ul style="list-style-type: none"> • Caused by the low battery charge level - Immediately charge the high voltage battery.
	<ul style="list-style-type: none"> • Appears when the power system temperature is low. 	<ul style="list-style-type: none"> • Your vehicle has less ability to accelerate and may be harder to start on an incline. <ul style="list-style-type: none"> U.S. models • In extremely cold climates, keep the vehicle stored in a garage. Canadian models • In extremely cold climates, keep the vehicle stored in a garage and connect the charging connector.
	<ul style="list-style-type: none"> • Appears when the power system temperature is high. 	<ul style="list-style-type: none"> • Your vehicle has less ability to accelerate and may be harder to start on an incline. • Park in a safe place, and cool the system down. <ul style="list-style-type: none"> ➤ Overheating P. 542
	<ul style="list-style-type: none"> • Appears if the power system is in diagnostic mode. 	<ul style="list-style-type: none"> • You may notice a decrease in available power. Have your vehicle checked by an authorized Honda Clarity Plug-In Hybrid dealer immediately. • As a result of diagnostics, the POWER SYSTEM indicator may come on. <ul style="list-style-type: none"> ➤ POWER SYSTEM Indicator P. 88

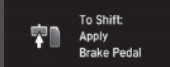
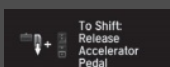

Message	Condition	Explanation
 <p>Remove Charger Connector</p>	<ul style="list-style-type: none"> Appears when the charging connector is connected to the inlet. 	<ul style="list-style-type: none"> The vehicle does not move while the charging connector is plugged into the inlet.
 <p>Plug-in Charging System Problem, Range Limited</p>	<ul style="list-style-type: none"> Appears when there is a problem with the standard plug-in charging system or the charging station outlet. 	<ul style="list-style-type: none"> This message only - There may be a problem with the charging station outlet. Refer to the instructions provided at the station or consult a qualified technician. If the outlet works properly, have the vehicle checked by an authorized Honda Clarity Plug-In Hybrid dealer. Comes on with the POWER SYSTEM indicator - Have your vehicle checked by an authorized Honda Clarity Plug-In Hybrid dealer.
 <p>Acoustic Vehicle Alerting System Problem</p>	<ul style="list-style-type: none"> Appears if there is a problem with the acoustic vehicle alerting system. 	<ul style="list-style-type: none"> Have your vehicle checked by an authorized Honda Clarity Plug-In Hybrid dealer immediately.
 <p>Charge Lid Open</p>	<ul style="list-style-type: none"> Appears when the charge lid is open. 	<ul style="list-style-type: none"> Close the charge lid. <ul style="list-style-type: none"> ➤ Charging P. 454

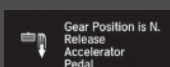
Message	Condition	Explanation
	<ul style="list-style-type: none"> Appears when you press the fuel fill door release button. 	<ul style="list-style-type: none"> The display changes to Ready when the fuel vapor pressure inside the fuel tank is released. You can start refueling once Ready appears. <ul style="list-style-type: none"> ➤ Refueling P. 451
	<ul style="list-style-type: none"> Appears when the vehicle is ready to be refueled. 	
	<ul style="list-style-type: none"> Appears when the high voltage battery and other system control temperatures are too low to operate (approx. -22°F [-30°C] or below). 	<ul style="list-style-type: none"> You must wait for an increase in the ambient temperature or move the vehicle to a warmer location. Consult an authorized Honda Clarity Plug-In Hybrid dealer. <p>U.S. models</p> <ul style="list-style-type: none"> In extremely cold climates, keep the vehicle stored in a garage. <p>Canadian models</p> <ul style="list-style-type: none"> In extremely cold climates, keep the vehicle stored in a garage and connect the charging connector.
	<ul style="list-style-type: none"> Appears when the charging connector is disconnected while the power mode is in ON with the charging connector connected. 	<ul style="list-style-type: none"> Set the power mode to OFF, then set it back to ON if you drive again. <ul style="list-style-type: none"> ➤ Turning on the Power P. 376
<p>Canadian models</p> 	<ul style="list-style-type: none"> Appears when the high voltage battery temperature is too low to operate (approx. -22°F [-30°C]). 	<ul style="list-style-type: none"> You can start the engine and use the climate control system to warm up the interior. You must wait for an increase in the high voltage battery temperature to drive.

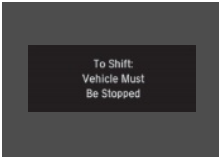

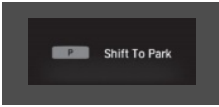
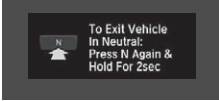
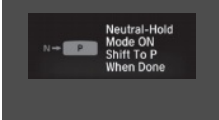
Message	Condition	Explanation
 <p>Canadian models Low Ambient Temperature. Charge Connection Recommended</p>	<ul style="list-style-type: none"> Appears when the outside temperature is low. 	<ul style="list-style-type: none"> In extremely cold climates, keep the vehicle stored in a garage or connect the charging connector.  Charging P. 454
 <p>Engine Started For Oil Circulation</p>	<ul style="list-style-type: none"> Appears when the engine starts automatically when the engine has not started for a long time. 	—
 <p>Engine System Problem Power Generation Not Available. Vehicle Will Stop in 20.0miles</p>	<ul style="list-style-type: none"> Appears when the vehicle can run only in EV because the failure that cannot generate power by the engine failure or generator failure etc occurs. The estimated distance you can travel on the remaining power is displayed. 	<ul style="list-style-type: none"> Have your vehicle checked by an authorized Honda Clarity Plug-In Hybrid dealer.
 <p>HV Charge Mode At Maximum Limit. Plug-in To Complete Charge.</p>	<ul style="list-style-type: none"> Appears when you are unable to select the HV Charge because the High Voltage battery charge level is at maximum limit (12 segments) of the HV Charge. 	 SPORT HYBRID i-MMD Plug-in (Intelligent Multi-mode Drive Plug-in) P. 11
 <p>Drive Mode Change Unavailable</p>	<ul style="list-style-type: none"> Appears if the drive mode cannot be changed due to certain situations, such as a system error or adverse driving conditions. 	—

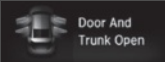
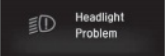
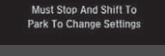

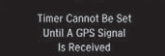

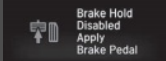
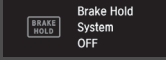
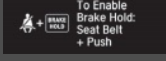
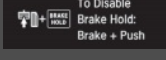
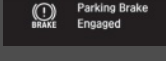
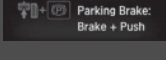
Message	Condition	Explanation
 <p>Fasten Seat Belt</p>	<ul style="list-style-type: none"> • Appears when you set the power mode to ON without fastening the driver's seat belt. • Appears if the gear position has been automatically changed to P and the driver attempts to take the vehicle out of P but does not have his or her seatbelt fastened. 	<ul style="list-style-type: none"> • Fasten the seat belt properly before you start to drive.  Shift Operation P. 384
 <p>To Shift: Apply Brake Pedal</p>	<ul style="list-style-type: none"> • Appears when you try to change the gear position without depressing the brake pedal while the transmission is in P or N. 	<ul style="list-style-type: none"> • Depress the brake pedal, then select a shift button.
 <p>To Shift: Release Accelerator Pedal</p>	<ul style="list-style-type: none"> • Appears when you try to change the gear position without releasing your foot off the accelerator pedal while the transmission is in P or N. 	<ul style="list-style-type: none"> • Release your foot off the accelerator pedal, then select a shift button.
 <p>Gear Unavailable. Try Again After Awhile</p>	<ul style="list-style-type: none"> • Appears when the transmission system temperature is too high. 	<ul style="list-style-type: none"> • Park in a safe place, and allow the system to cool down sufficiently.
 <p>Gear Position is N. Release Accelerator Pedal</p>	<ul style="list-style-type: none"> • Appears when you depress the accelerator pedal while the transmission is in N. 	<ul style="list-style-type: none"> • Release the accelerator pedal. • Depress the brake pedal, then select a shift button to start driving.

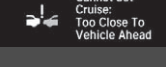
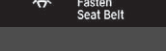

Message	Condition	Explanation
	<ul style="list-style-type: none"> • Appears when the parking button is pressed while the vehicle is moving. • Appears if you change the gear position to R while the vehicle is moving forward, or to D while the vehicle is reversing. 	<ul style="list-style-type: none"> • Make sure that the vehicle comes to a stop before operating the select button.
	<ul style="list-style-type: none"> • Appears if there is a problem with the electric system. • Appears when you set the power mode to OFF while driving. 	<ul style="list-style-type: none"> • Immediately stop in a safe place and set the parking brake. • Resume driving if the message disappears. • If there is a problem with the transmission system, the transmission system indicator comes on. <ul style="list-style-type: none"> ➤ Transmission System Indicator P. 92
	<ul style="list-style-type: none"> • Appears when the vehicle is stopped with the driver's seat belt unfastened and there is a chance that the vehicle may roll unintentionally. 	<ul style="list-style-type: none"> • Press the P button before releasing the brake pedal when idling, parking, or exiting the vehicle. <ul style="list-style-type: none"> ➤ Shift Operation P. 384
	<ul style="list-style-type: none"> • Appears for a few seconds if you have not pressed the N button long enough to initiate Neutral-Hold mode. 	<ul style="list-style-type: none"> ➤ If you want to keep the transmission in N position [car wash mode] P. 386
	<ul style="list-style-type: none"> • Appears when you press and hold N button for more than 2 seconds. 	<ul style="list-style-type: none"> • Disappears when you set the gear position to other than N. <ul style="list-style-type: none"> ➤ If you want to keep the transmission in N position [car wash mode] P. 386

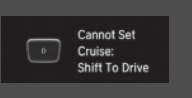
Message	Condition	Explanation
	<ul style="list-style-type: none"> • Appears if any door or the trunk is not completely closed. • Appears if any door or the trunk is opened while driving. The beeper sounds. 	<ul style="list-style-type: none"> • Goes off when all doors and the trunk are closed.
	<ul style="list-style-type: none"> • Appears when there is a problem with the headlights. 	<ul style="list-style-type: none"> • Appears while driving - The headlights may not be on. When conditions allow you to drive safely, have your vehicle checked by an authorized Honda Clarity Plug-In Hybrid dealer as soon as possible.
	<ul style="list-style-type: none"> • Appears while you are customizing the settings and the shift lever is moved out of P. 	<p>➤ Customized Features P. 306</p>
	<ul style="list-style-type: none"> • Appears if you try to go to vehicle settings from the driver information interface while the audio/information screen shows the same menu. 	<ul style="list-style-type: none"> • Select either display to customize a setting. You cannot have vehicle settings displayed on the driver information interface and audio/information screen simultaneously. <p>➤ Customized Features P. 306</p>
	<ul style="list-style-type: none"> • Appears if you try to go to Charge Timer Setup while the time is incorrect. 	<p>➤ Customized Features P. 306</p>

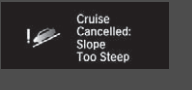

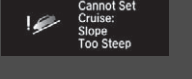
Message	Condition	Explanation
 <p>Brake Hold Disabled Apply Brake Pedal</p>	<ul style="list-style-type: none"> • Appears if the automatic brake hold is automatically canceled while it is in operation. • The beeper may sound. 	<ul style="list-style-type: none"> • Immediately depress the brake pedal.
 <p>Brake Hold System OFF</p>	<ul style="list-style-type: none"> • Appears when the automatic brake hold system is turned off. 	<p>➤ Automatic Brake Hold P. 435</p>
 <p>To Enable Brake Hold: Seat Belt + Push</p>	<ul style="list-style-type: none"> • Appears when the automatic brake hold button is pressed without wearing the driver's seat belt. 	<ul style="list-style-type: none"> • Fasten the driver's seat belt. ➤ Automatic Brake Hold P. 435
 <p>To Disable Brake Hold: Brake + Push</p>	<ul style="list-style-type: none"> • Appears when the automatic brake hold button is pressed without depressing the brake pedal while the automatic brake hold is in operation. 	<ul style="list-style-type: none"> • Press the automatic brake hold button with the brake pedal depressed. ➤ Automatic Brake Hold P. 435
 <p>Parking Brake Engaged</p>	<ul style="list-style-type: none"> • Appears when the parking brake is applied automatically while it is in operation. 	<p>➤ Automatic Brake Hold P. 435 ➤ Parking Brake P. 431</p>
 <p>To Release Parking Brake: Brake + Push</p>	<ul style="list-style-type: none"> • Appears when the electric parking brake switch is pressed without depressing the brake pedal while the electric parking brake is in operation. 	<ul style="list-style-type: none"> • Appears while driving - Press the electric parking brake switch with the brake pedal depressed. ➤ Parking Brake P. 431

Message	Condition	Explanation
	<ul style="list-style-type: none"> Flashes when the system senses a likely collision with a vehicle in front of you. 	<ul style="list-style-type: none"> Take the appropriate means to prevent a collision (apply the brakes, change lanes, etc.) <ul style="list-style-type: none"> ► Collision Mitigation Braking System™ (CMBS™) P. 439 ► Adaptive Cruise Control (ACC) with Low Speed Follow (LSF) P. 400
	<ul style="list-style-type: none"> Appears when ACC with LSF has been automatically canceled. 	<ul style="list-style-type: none"> You can resume the set speed after the condition that caused ACC with LSF to cancel improves. Press the RES/+ or -/SET switch up. <ul style="list-style-type: none"> ► Adaptive Cruise Control (ACC) with Low Speed Follow (LSF) P. 400
	<ul style="list-style-type: none"> Appears when the distance between your vehicle and the vehicle ahead of you is too close while ACC with LSF is in operation. 	<ul style="list-style-type: none"> ACC with LSF has been automatically canceled. <ul style="list-style-type: none"> ► Adaptive Cruise Control (ACC) with Low Speed Follow (LSF) P. 400
	<ul style="list-style-type: none"> Appears when pressing the RES/+ or -/SET switch down while the distance between your vehicle and the vehicle ahead of you is too close. 	<ul style="list-style-type: none"> ACC with LSF cannot be set. <ul style="list-style-type: none"> ► Adaptive Cruise Control (ACC) with Low Speed Follow (LSF) P. 400
	<ul style="list-style-type: none"> Appears when pressing the RES/+ or -/SET switch down while the driver's seat belt is unfastened. 	<ul style="list-style-type: none"> ACC with LSF cannot be set. <ul style="list-style-type: none"> ► Adaptive Cruise Control (ACC) with Low Speed Follow (LSF) P. 400

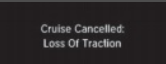
Message	Condition	Explanation
 <p>Cannot Set Cruise: Shift To Drive</p>	<ul style="list-style-type: none"> Appears when pressing the RES/+ or -/SET switch down while the transmission is not in D. 	<ul style="list-style-type: none"> ACC with LSF cannot be set. <ul style="list-style-type: none"> ➤ Adaptive Cruise Control (ACC) with Low Speed Follow (LSF) P. 400
 <p>Cruise Cancelled: Slope Too Steep</p>  <p>Cruise Cancelled: Slope Too Steep</p>	<ul style="list-style-type: none"> Appears when the vehicle is stopped on a very steep slope while ACC with LSF is in operation. 	<ul style="list-style-type: none"> ACC with LSF has been automatically canceled. <ul style="list-style-type: none"> ➤ Adaptive Cruise Control (ACC) with Low Speed Follow (LSF) P. 400
 <p>Cannot Set Cruise: Slope Too Steep</p>  <p>Cannot Set Cruise: Slope Too Steep</p>	<ul style="list-style-type: none"> Appears when pressing the RES/+ or -/SET switch down while the vehicle is stopped on a very steep slope. 	<ul style="list-style-type: none"> ACC with LSF cannot be set. <ul style="list-style-type: none"> ➤ Adaptive Cruise Control (ACC) with Low Speed Follow (LSF) P. 400

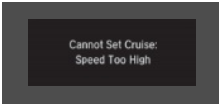
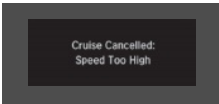
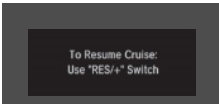
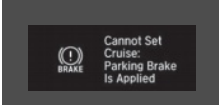
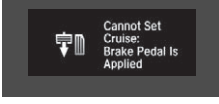
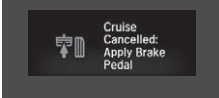
Message	Condition	Explanation
 	<ul style="list-style-type: none"> • Appears just before the ACC with LSF is automatically canceled when you are descending a long hill etc (The following interval is automatically set to extra long). • Appears when the ACC with LSF has been automatically canceled. 	<ul style="list-style-type: none"> ▶ Adaptive Cruise Control (ACC) with Low Speed Follow (LSF) P. 400
	<ul style="list-style-type: none"> • Appears when you are descending a long hill etc and you press the RES/+ or -/SET switch. 	<ul style="list-style-type: none"> ▶ Adaptive Cruise Control (ACC) with Low Speed Follow (LSF) P. 400
	<ul style="list-style-type: none"> • Appears if the VSA® or traction control function operates while ACC is in operation. 	<ul style="list-style-type: none"> • ACC has been automatically canceled. ▶ Adaptive Cruise Control (ACC) with Low Speed Follow (LSF) P. 400

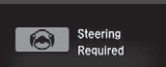
Message	Condition	Explanation
	<ul style="list-style-type: none"> Appears when the speed of the vehicle is too high for you to set ACC with LSF. 	<ul style="list-style-type: none"> Reduce the speed, then set ACC with LSF. <ul style="list-style-type: none"> ➤ Adaptive Cruise Control (ACC) with Low Speed Follow (LSF) P. 400
	<ul style="list-style-type: none"> Appears when ACC with LSF is cancelled due to excessive vehicle speed. 	<ul style="list-style-type: none"> Reduce the speed, then reset ACC with LSF. <ul style="list-style-type: none"> ➤ Adaptive Cruise Control (ACC) with Low Speed Follow (LSF) P. 400
	<ul style="list-style-type: none"> Appears when the vehicle ahead of you resumes driving, after your vehicle has been stopped automatically by ACC with LSF. 	<ul style="list-style-type: none"> Press the RES/+ or -/SET switch or depress the accelerator pedal to resume. <ul style="list-style-type: none"> ➤ Adaptive Cruise Control (ACC) with Low Speed Follow (LSF) P. 400
	<ul style="list-style-type: none"> Appears when pressing the RES/+ or -/SET switch down while the parking brake is applied. 	<ul style="list-style-type: none"> ACC with LSF cannot be set. <ul style="list-style-type: none"> ➤ Adaptive Cruise Control (ACC) with Low Speed Follow (LSF) P. 400 ➤ Parking Brake P. 431
	<ul style="list-style-type: none"> Appears when pressing the RES/+ or -/SET switch down while the vehicle is moving and the brake pedal is depressed. 	<ul style="list-style-type: none"> ACC with LSF cannot be set. <ul style="list-style-type: none"> ➤ Adaptive Cruise Control (ACC) with Low Speed Follow (LSF) P. 400
	<ul style="list-style-type: none"> Appears if ACC with LSF is canceled while your vehicle is automatically stopped by ACC with LSF. 	<ul style="list-style-type: none"> Immediately depress the brake pedal.

Message	Condition	Explanation
	<p>Lane Keeping Assist System (LKAS)</p> <ul style="list-style-type: none"> • Appears when the vehicle is driving out of a detected lane. The steering wheel vibrates rapidly. <p>Road Departure Mitigation (RDM) System</p> <ul style="list-style-type: none"> • Appears when the vehicle is driving out of a detected lane. <p>When you selected Warning Only</p> <ul style="list-style-type: none"> - The steering wheel vibrates rapidly when the vehicle is drifting out of a detected lane. <p>When you selected Narrow, Normal or Wide</p> <ul style="list-style-type: none"> - The steering wheel vibrates rapidly when the vehicle is drifting out of a detected lane. The system also steers the vehicle to help you remain within your driving lane. 	<ul style="list-style-type: none"> • Keep the vehicle within the lane you are driving. <ul style="list-style-type: none"> ▶ Road Departure Mitigation (RDM) System P. 396 ▶ Lane Keeping Assist System (LKAS) P. 415 • You can change the setting for the road departure mitigation system. Narrow, Normal, Wide, and Warning Only can be selected. <ul style="list-style-type: none"> ▶ Customized Features P. 306
	<ul style="list-style-type: none"> • Blinks when you fail to steer the vehicle. The beeper sounds simultaneously. 	<ul style="list-style-type: none"> • Operate the steering wheel to resume the LKAS.
	<p>Road Departure Mitigation System</p> <p>When you selected Narrow</p> <ul style="list-style-type: none"> • Appears when the vehicle is likely to drive out of a detected lane. - The system steers the vehicle to help you remain within your driving lane. 	<p>—</p>

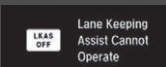
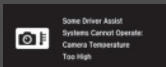
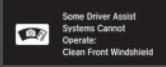
Message	Condition	Explanation
 <p>Lane Keeping Assist Cannot Operate</p>	<ul style="list-style-type: none"> Appears when the LKAS is in operation, or the LKAS button is pressed, but there is a problem with a system related to the LKAS. The LKAS cancels automatically. The beeper sounds simultaneously. 	<ul style="list-style-type: none"> If the VSA®, ABS, or brake system indicator or another indicator comes on, take appropriate action. <ul style="list-style-type: none"> ➤ Indicators P. 86
 <p>Some Driver Assist Systems Cannot Operate: Camera Temperature Too High</p>	<ul style="list-style-type: none"> Appears when the temperature inside the camera is too high. 	<ul style="list-style-type: none"> Use the climate control system to cool down the camera. Goes off - The camera has been cooled down. Pressing the LKAS button can resume the system. <ul style="list-style-type: none"> ➤ Adaptive Cruise Control (ACC) with Low Speed Follow (LSF) P. 400 ➤ Lane Keeping Assist System (LKAS) P. 415 ➤ Front Sensor Camera P. 394
 <p>Some Driver Assist Systems Cannot Operate: Clean Front Windshield</p>	<ul style="list-style-type: none"> Appears when the area around the camera is blocked by dirt, mud, etc. Stop your vehicle in a safe place, and wipe it off with a soft cloth. May appear when driving in bad weather (rain, snow, fog, etc.). 	<ul style="list-style-type: none"> Have your vehicle checked by an authorized Honda Clarity Plug-In Hybrid dealer if the message does not disappear, even after you clean the area around the camera. <ul style="list-style-type: none"> ➤ Adaptive Cruise Control (ACC) with Low Speed Follow (LSF) P. 400 ➤ Lane Keeping Assist System (LKAS) P. 415 ➤ Front Sensor Camera P. 394

Gauges

Gauges include the speedometer, fuel gauge, **POWER/CHARGE** gauge, high voltage battery charge level gauge, and related indicators. They are displayed when the power mode is in ON.

Speedometer

Displays your driving speed in mph or km/h.

Fuel Gauge



Displays the approximate amount of fuel left in the fuel tank.

Range



Shows the estimated distance you can travel on the remaining power and fuel. This estimate is based on the fuel economy and energy consumption of your previous trips and the remaining high voltage battery charge level.

Gauges

Press the  (display/information) button repeatedly until the  icon is shown on the driver information interface. Press **ENTER**, then press and hold it again. The speedometer reading and the displayed measurements will switch between mph and km/h.

Fuel Gauge

NOTICE

You should refuel when the needle approaches .

Running out of fuel can cause the engine to misfire, damaging the catalytic converter.

The actual amount of remaining fuel may differ from the fuel gauge reading.

■ POWER/CHARGE Gauge

■ Electric motor

The degree to which the electric motor is being powered is displayed by the readings on the **POWER** side.

When you depress the accelerator pedal, the white needle on the gauge moves. The curved blue line on the gauge shows the range within which only the electric motor provides propulsion to the wheels. The length of this line varies depending on the drive mode and the remaining power of the High Voltage battery. When the white needle exceeds the curved blue line, the engine starts and the curved blue line turns white.

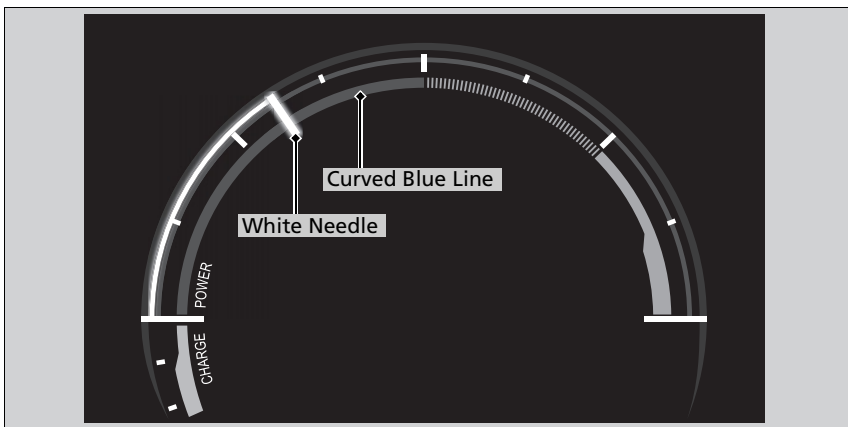

■ Battery charge in progress

The degree to which the High Voltage battery is being charged is displayed by the readings on the **CHARGE** side when coasting or during deceleration.

⊠ Electric motor

The power output of the electric motor is restricted when the high voltage battery charge level is running low (one segment on the gauge).

If you accelerate aggressively, the engine may start even though the white needle has not exceeded the curved blue line.

■ High Voltage Battery Charge Level Gauge

Shows the remaining high voltage battery charge level.

⌘ High Voltage Battery Charge Level Gauge

When the number of bars displayed on the High Voltage Battery Charge Level Gauge becomes one, assist by the high-voltage battery is limited and the vehicle output is lowered.

The high voltage battery charge level may decrease under the following conditions:

- When the 12-volt battery has been replaced.
- When the 12-volt battery has been disconnected.
- When the high voltage battery control system corrects its reading.



The charge level reading will be corrected automatically while driving.

Changes in the temperature of the high voltage battery can increase or decrease the battery's charging capacity. If temperature changes cause the battery's capacity to change, the number of indicators in the battery charge level gauge may also change, even if the amount of charge remains the same.

Driver Information Interface

The driver information interface shows the odometer, trip meter, outside temperature indicator, and other gauges. It also displays important messages such as warnings and other helpful information.

Switching the Display

Press the  (display/information) button and press  or  to change the display. Press **ENTER** to see detailed information.

Switching the Display

You can edit, add, or delete the meter contents using the audio/information screen.

 **Customizing the Meter** P. 219

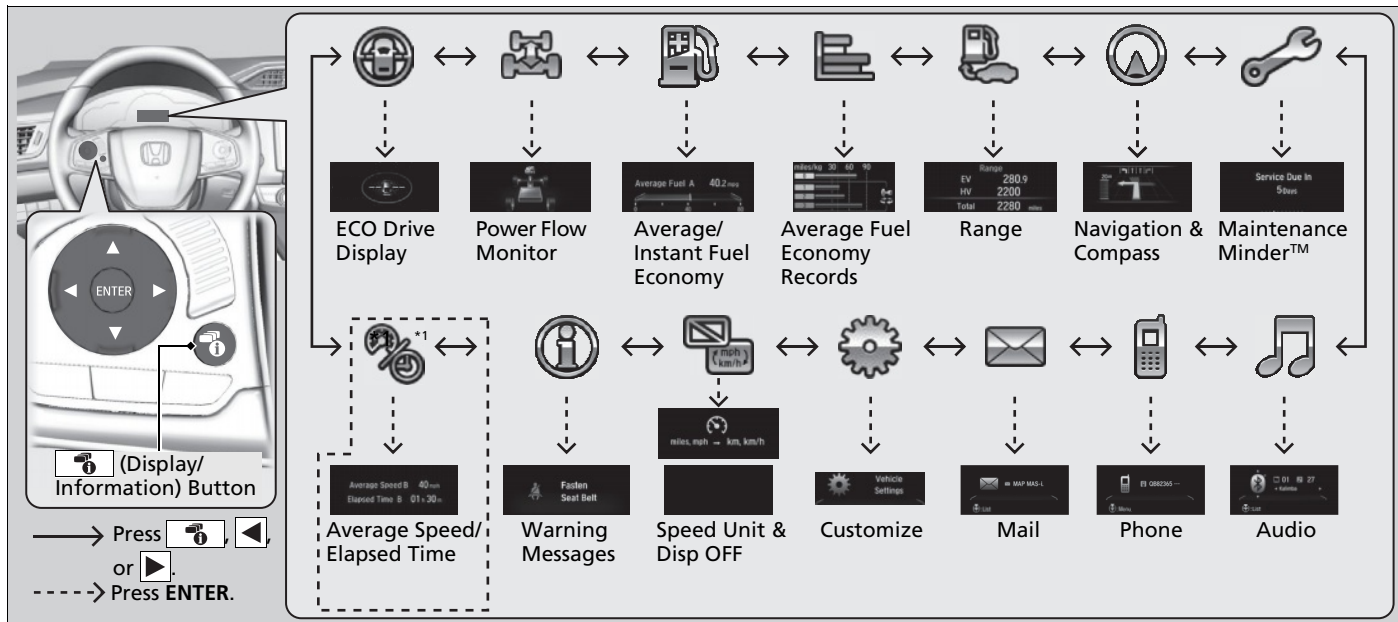

*1: You can add the content using the audio/information screen.

Press the **TRIP** button to change the display.

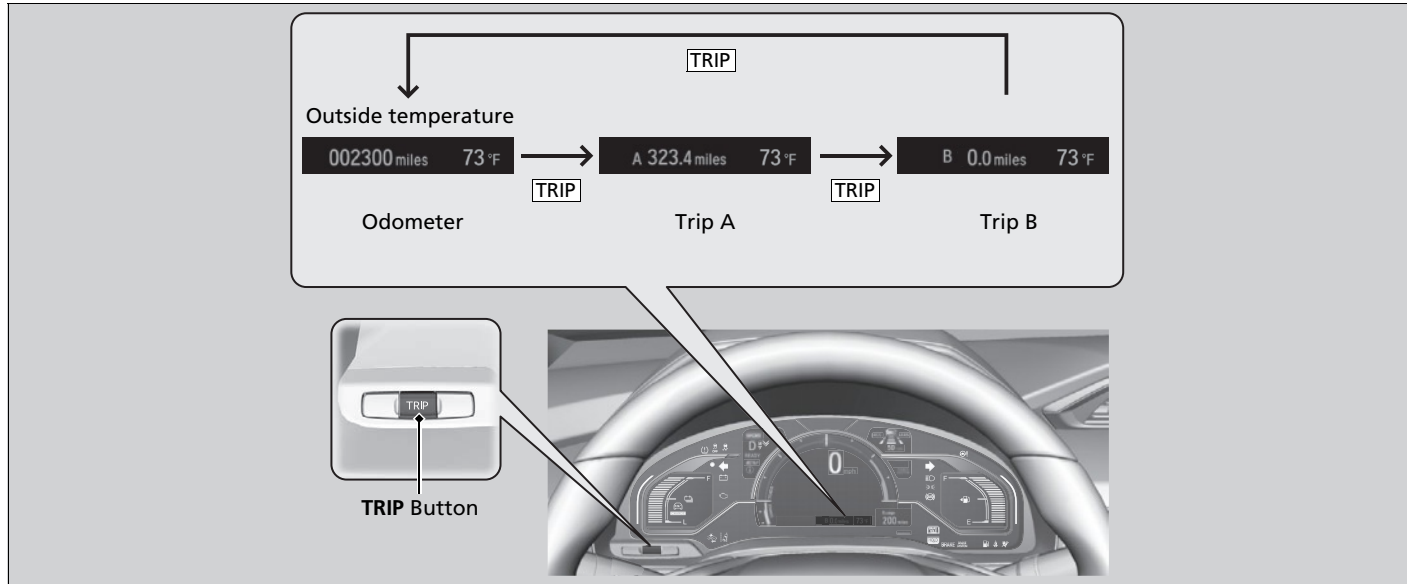

■ Odometer

Shows the total number of miles or kilometers that your vehicle has accumulated.

■ Trip Meter

Shows the total number of miles or kilometers driven since the last reset. Meters A and B can be used to measure two separate trips.

■ Resetting a trip meter

To reset a trip meter, display it, then press and hold the **TRIP** button. The trip meter is reset to **0.0**.

■ Outside Temperature

Shows the outside temperature in Fahrenheit (U.S.) or Celsius (Canada).

■ Adjusting the outside temperature display

Adjust the temperature reading up to $\pm 5^{\circ}\text{F}$ or 3°C if the temperature reading seems incorrect.

■ Average Fuel Economy

Shows the estimated average fuel economy of each trip meter in mpg or l/100 km. The display is updated at set intervals. When a trip meter is reset, the average fuel economy is also reset.

☞ Trip Meter

Switch between trip meter A and trip meter B by pressing the **TRIP** button.

☞ Outside Temperature

The temperature sensor is in the front bumper. Road heat and exhaust from another vehicle can affect the temperature reading when your vehicle speed is less than 19 mph (30 km/h).

It may take several minutes for the display to be updated after the temperature reading has stabilized.

Use the audio/information screen's customized features to correct the temperature.

☞ **Customized Features** P. 306

☞ Average Fuel Economy

You can change when to reset the average fuel economy.

☞ **Customized Features** P. 306

■ Instant Fuel Economy

Shows the instant fuel economy as a bar graph in mpg or l/100 km.

■ Elapsed Time

Shows the time elapsed since Trip A or Trip B was reset.

■ Average Speed

Shows the average speed in mph or km/h since Trip A or Trip B was reset.

■ Turn-by-Turn Directions

Shows you turn-by-turn driving directions to your destination linked with the navigation system.

➤ **Refer to the Navigation System Manual**

⌘ Elapsed Time

You can change when to reset the elapsed time.

➤ **Customized Features** P. 306

⌘ Average Speed

You can change when to reset the average speed.

➤ **Customized Features** P. 306

⌘ Turn-by-Turn Directions

The driver information interface shows a compass when the route guidance is not used.

You can select whether the turn-by-turn display comes on or not during the route guidance.

➤ **Customized Features** P. 306

■ Maintenance Minder™

Shows the Maintenance Minder™.

➤ **Maintenance Minder™** P. 475

■ Audio

Shows the current audio information.

➤ **Audio System Basic Operation** P. 210

■ Mail

Shows the current mail information.

➤ **Bluetooth® HandsFreeLink®** P. 335

■ Phone

Shows the current phone information.

➤ **Bluetooth® HandsFreeLink®** P. 335

Range

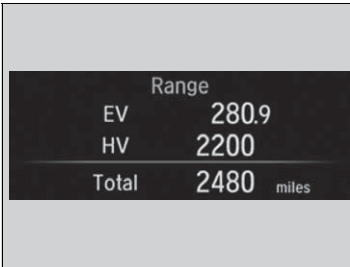

Shows the estimated distance you can travel on the remaining power and fuel. This estimate is based on the fuel economy and energy consumption of your previous trips and the remaining high voltage battery charge level.

Range

The displayed range may change even when the vehicle is stationary.

Average Fuel Economy Records

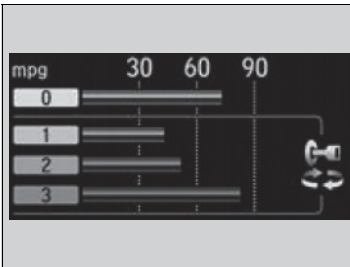

Shows the average fuel economy for the last three driving cycles (1 – 3), and the current driving cycle (0) in mpg or l/100 km.

Each time you set the power mode to ON, the display is updated, and the oldest record is deleted.

■ Eco Drive Display/Drive Cycle Score/Lifetime Points

■ Eco Drive Display

The vehicle icon on the display moves forward or backward while driving.

The more aggressive the acceleration is, the further the icon moves forward.

The more aggressive the deceleration is, the further the icon moves backward.

Keep the icon near the center of the circle for better fuel economy while driving.

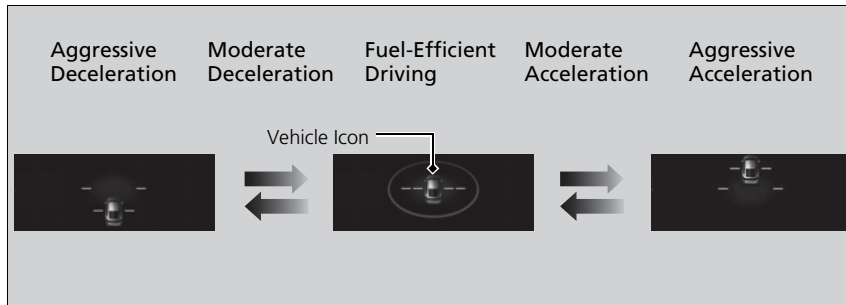

■ Drive Cycle Score/Lifetime Points

Appear for a few seconds when you set the power mode to VEHICLE OFF (LOCK). Each has three stages. Depending on your driving style, the leaf icon(s) and the gauge increase or decrease to indicate that you have reached a different stage of fuel economy.

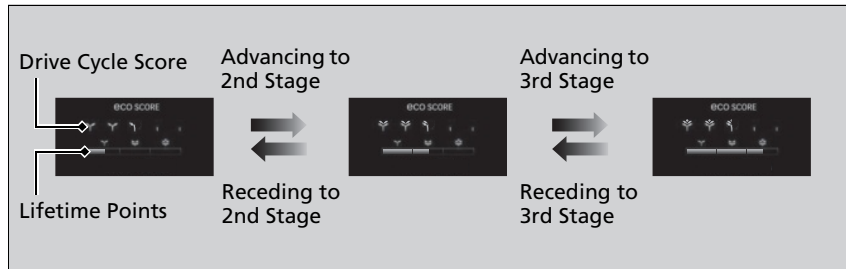

■ Resetting the Drive Cycle Score

1. Make sure the transmission is in **[P]**. Turn the power mode to ON.
2. If ECON mode is on, press the **ECON** button to turn it off.
3. Turn the power mode to VEHICLE OFF (LOCK).
4. Turn the power mode to ON again.
 - ▶ Make sure to complete steps from 4 through 6 within 30 seconds.
5. Depress the brake pedal twice.
 - ▶ The color of the ambient meter will change from white to green.
 - ▶ When the **Fuel Efficiency Backlight** setting on the audio/information display is off, the color stays white.
6. Press the **ECON** button twice.
 - ▶ The color of the ambient meter will turn to monochrome.
7. Turn the power mode to VEHICLE OFF (LOCK).

Power Flow Monitor

Displays the power flow of the motor and engine, indicating the vehicle's power source and whether the battery is being charged.

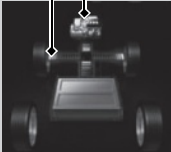

Hybrid (HV)
Power is supplied by the motor and the engine.



Electric Vehicle (EV)
Power is supplied by the motor.



Engine (Direct Drive)
Power is being supplied to charge the HV battery and supply power to the wheels.



Regeneration
The motor is charging the High Voltage battery.



Power is being supplied by only the engine.



The engine is running and the motor is charging the High Voltage battery.



Engine ON



Engine OFF

Power Flow Monitor

While the vehicle is stationary with the engine running, the following may appear on the driver Information Interface.

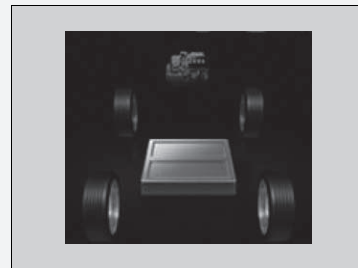

■ Customized Features

- Shows the customized feature (charge timer).
 - **Using a Timer** P. 467
- Use the audio/information screen to customize certain features.
 - **Customized Features** P. 306

■ Telematics Control Unit

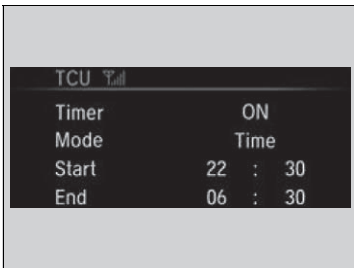

Sends and receives information between your vehicle and smartphones.

When you set the power mode to VEHICLE OFF, the telematics control unit signal strength and high voltage battery charge timer setting appear on the driver information interface.

➤ Telematics Control Unit

If you are planning to use a smartphone, check the telematics control unit signal strength before leaving the vehicle.

Controls

This chapter explains how to operate the various controls necessary for driving.

Clock	136	Security System Alarm.....	153	Adjusting the Steering Wheel	172
Locking and Unlocking the Doors		Opening and Closing the Windows ...	156	Adjusting the Mirrors	173
Key Types and Functions	137	Operating the Switches Around the		Interior Rearview Mirror	173
Low Smart Entry Remote Signal Strength..	138	Steering Wheel		Power Door Mirrors	174
Locking/Unlocking the Doors from the		POWER Button.....	158	Adjusting the Seats	175
Outside	139	Turn Signals.....	161	Front Seats	175
Locking/Unlocking the Doors from the		Light Switches.....	162	Interior Lights/Interior Convenience	
Inside	146	Daytime Running Lights	165	Items	183
Childproof Door Locks	148	Wipers and Washers	166	Interior Lights	183
Auto Door Locking/Unlocking	149	Brightness Control	168	Interior Convenience Items	185
Opening and Closing the Trunk	150	Rear Defogger/Heated Door Mirror		Climate Control System	193
Security System	153	Button.....	169	Using Automatic Climate Control	193
Immobilizer System	153	Driving Position Memory System*	170	Automatic Climate Control Sensors...	201

* Not available on all models

Adjusting the Clock

Models without navigation system

You can adjust the time manually in the audio/information screen, with the power mode in ON.

Adjusting the Time

Using the Settings menu on the audio/information screen

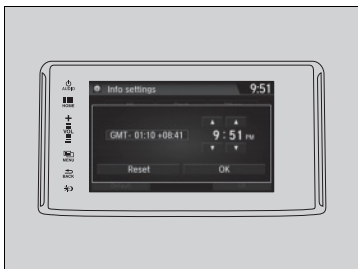

1. Select **Settings**.
2. Select **Clock**.
3. Select **Clock Adjustment**.
4. Select or to change hour.
5. Select or to change minute, then select **OK**.

Adjusting the Clock

You can customize the clock display to show the 12 hour clock or 24 hour clock.

➤ **Customized Features** P. 306

You can turn the clock display in the audio/information screen on and off.

➤ **Customized Features** P. 306

You cannot adjust the time while the vehicle is moving.

You can also adjust the clock by touching the clock displayed on the upper right corner of the display.

1. Touch the clock on the display.
2. Select **Clock Adjustment**.
3. Select or to change hour.
4. Select or to change minute, then select **OK**.

Models with navigation system

The clock is automatically updated through the navigation system, so the time does not need to be adjusted.

Key Types and Functions

This vehicle comes with the following keys:



Use the keys to turn on and off the power system, and to lock and unlock the doors and to open the trunk. You can also use the remote transmitter to lock and unlock the doors and trunk, and open the charge lid.

Built-in Key

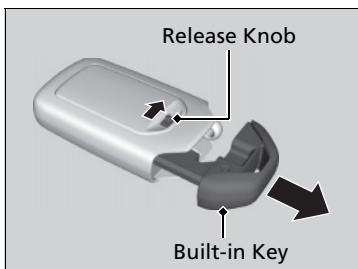

The built-in key can be used to lock/unlock the doors when the smart entry remote battery becomes weak and the power door lock/unlock operation is disabled.

To remove the built-in key, slide the release knob and then pull out the key. To reinstall the built-in key, push the built-in key into the smart entry remote until it clicks.

Key Types and Functions

All the keys have an immobilizer system. The immobilizer system helps to protect against vehicle theft.

Immobilizer System P. 153

Follow the advice below to prevent damage to the keys:

- Do not leave the keys in direct sunlight, or in locations with high temperature or high humidity.
- Do not drop the keys or set heavy objects on them.
- Keep the keys away from liquids, dust and sand.
- Do not take the keys apart except for replacing the battery.

If the circuits in the keys are damaged, the power system may not activate, and the remote transmitter may not work.

If the keys do not work properly, have them inspected by an authorized Honda Clarity Plug-In Hybrid dealer.

■ Key Number Tag

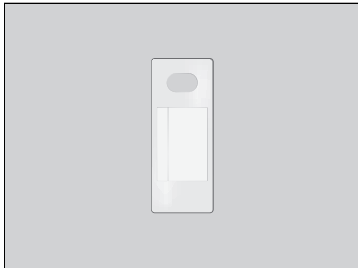

Contains a number that you will need if you purchase a replacement key.

Low Smart Entry Remote Signal Strength

The vehicle transmits radio waves to locate the smart entry remote when locking/unlocking the doors, opening the trunk, or to activate the power system.

In the following cases, locking/unlocking the doors, opening the trunk, or activating the power system may be inhibited or operation may be unstable:

- Strong radio waves are being transmitted by nearby equipment.
- You are carrying the smart entry remote together with telecommunications equipment, laptop computers, cell phones, or wireless devices.
- A metallic object is touching or covering the smart entry remote.

☒ Key Number Tag

Keep the key number tag separate from the key in a safe place outside of your vehicle. If you wish to purchase an additional key, contact an authorized Honda Clarity Plug-In Hybrid dealer.

If you lose your key and you cannot activate the power system, contact an authorized Honda Clarity Plug-In Hybrid dealer.

☒ Low Smart Entry Remote Signal Strength

Communication between the smart entry remote and the vehicle consumes the smart entry remote's battery.

Battery life is about two years, but this varies depending on regularity of use.

The battery is consumed whenever the smart entry remote is receiving strong radio waves. Avoid placing it near electrical appliances such as televisions and personal computers.

Locking/Unlocking the Doors from the Outside

■ Using the Smart Entry with Push Button Start System

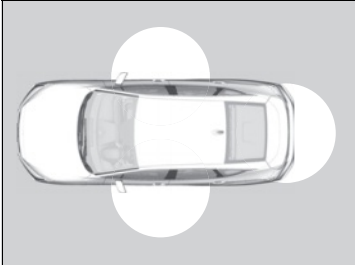

When you carry the smart entry remote, you can lock/unlock the doors and open the trunk. You can lock/unlock the doors within a radius of about 32 inches (80 cm) of the outside door handle or trunk release button.

■ Locking the doors and trunk

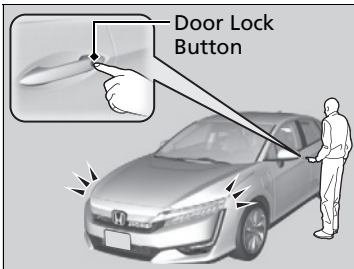

Press the door lock button on the front door.

- ▶ Some exterior lights flash; the beeper sounds; all the doors lock; and the security system sets.

☒ Locking/Unlocking the Doors from the Outside

If the interior light switch is in the door activated position, the interior light comes on when you unlock the doors.

No doors opened: The light fades out after 30 seconds.

Doors relocked: The light goes off immediately.

➤ **Interior Lights** P. 183

☒ Using the Smart Entry with Push Button Start System

If you do not open a door within 30 seconds of unlocking the vehicle with the smart entry system, the doors will automatically relock.

You can lock or unlock doors using the smart entry system only when the power mode is in VEHICLE OFF.

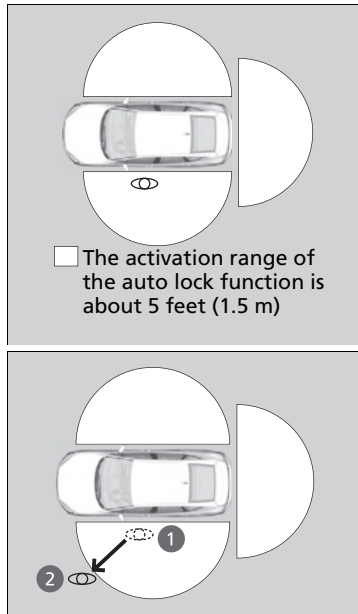

■ Locking the doors and trunk (Walk away auto lock)

When you walk away from the vehicle while carrying the smart entry remote, the doors will automatically lock.

The auto lock function activates when all doors are closed, and the smart entry remote is within about 5 feet (1.5 m) radius of the outside door handle.

Exit vehicle while carrying smart entry remote and close door(s).

1. While within about 5 feet (1.5 m) radius of the vehicle.
 - ▶ The beeper sounds; the auto lock function will be activated.
2. Carry the smart entry remote beyond about 5 feet (1.5 m) from the vehicle and remain outside this range for 2 or more seconds.
 - ▶ Some exterior lights flash; the beeper sounds; all doors will then lock.

▣ Locking the doors and trunk (Walk away auto lock)

The auto lock function is set to OFF as the factory default setting. The auto lock function can be set to ON using the audio/information screen.

If you set the auto lock function to ON using the audio/information screen, only the remote transmitter that was used to unlock the driver's door prior to the setting change can activate auto lock.

▶ **Customized Features** P. 306

After the auto lock function has been activated, when you stay within the locking/unlocking operation range, the indicator on the smart entry remote will continue to flash until the doors are locked.

When you stay beside the vehicle within the operation range, the doors will automatically lock approximately 30 seconds after the auto lock function activating beeper sounds.

When you open a door after the auto lock function activating beeper sounds, the auto lock function will be delayed until all doors are closed.

When all doors have been closed and the smart entry remote is inside the vehicle, or if the smart entry remote is not detected within about 5 feet (1.5 m) of the vehicle, auto lock function will not be activated.

To temporarily deactivate the function:

1. Set the power mode to OFF.
2. Open the driver's door.
3. Using the master door lock switch, operate the lock as follows:
Lock → Unlock → Lock → Unlock.
▶ The beeper sounds and the function is deactivated.

To restore the function:

- Set the power mode to ON.
- Lock the vehicle without using the auto lock function.
- With the smart entry remote on you, move out of the auto lock function operation range.
- Open any door.

⊗ Locking the doors and trunk (Walk away auto lock)

The auto lock function does not operate when any of the following conditions are met.

- The smart entry remote is inside the vehicle.
- A door or the hood is not closed.
- The power mode is set to any mode other than OFF.
- The smart entry remote is not located within a radius of about 5 feet (1.5 m) from the vehicle when you get out of the vehicle and close the doors.

Auto lock function operation stop beeper

After the auto lock function has been activated, the auto lock operation stop beeper sounds for approximately two seconds in the following cases.

- The smart entry remote is put inside the vehicle through a window.
- You are located too close to the vehicle.
- The smart entry remote is put inside the trunk.

If the warning beeper sounds, check that you are carrying the smart entry remote. Then, open/close a door and confirm the auto lock activation beeper sounds once.

■ Unlocking the doors and trunk

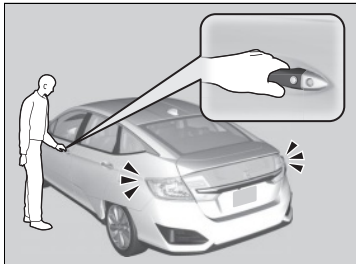

- Grab the driver's door handle:
- ▶ The driver's door unlocks.
 - ▶ Some exterior lights flash twice and the beeper sounds twice.

- Grab the front passenger's door handle:
- ▶ All doors unlock.
 - ▶ Some exterior lights flash twice and the beeper sounds twice.

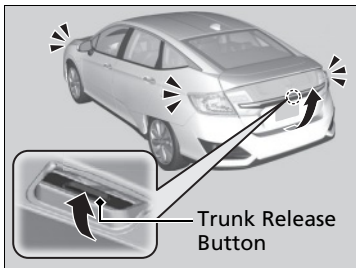

- Press the trunk release button:
- ▶ The trunk unlocks and opens.
 - ▶ Some exterior lights flash and the beeper sounds.

➤ **Using the Trunk Release Button** P. 151

➤ Using the Smart Entry with Push Button Start System

- Do not leave the smart entry remote in the vehicle when you get out. Carry it with you.
- Even if you are not carrying the smart entry remote, you can lock/unlock the doors while someone else with the remote is within range.
- The door may be unlocked if the door handle is covered with water in heavy rain or in a car wash if the smart entry remote is within range.
- If you grip a front door handle wearing gloves, the door sensor may be slow to respond or may not respond by unlocking the doors.
- After locking the door, you have up to two seconds during which you can pull the door handle to confirm whether the door is locked. If you need to unlock the door immediately after locking it, wait at least two seconds before gripping the handle, otherwise the door will not unlock.
- The door might not open if you pull it immediately after gripping the door handle. Grip the handle again and confirm that the door is unlocked before pulling the handle.
- Even within the 32 inches (80 cm) radius, you may not be able to lock/unlock the doors with the smart entry remote if it is above or below the outside handle.
- The smart entry remote may not operate if it is too close to the door and door glass.

The light flash, beep and door unlock mode settings can be customized using the audio/information screen.

➤ **Customized Features** P. 306

■ Using the Remote Transmitter

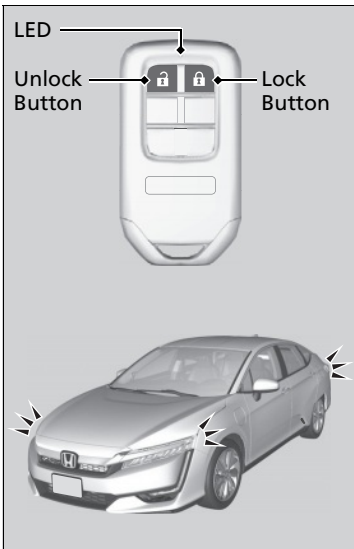

■ Locking the doors

Press the lock button.

Once:

- ▶ Some exterior lights flash, all the doors lock, and the security system sets.

Twice (within five seconds after the first push):

- ▶ The beeper sounds and verifies the security system is set.

■ Unlocking the doors

Press the unlock button.

Once:

- ▶ Some exterior lights flash twice, and the driver's door unlocks.

Twice:

- ▶ The remaining doors unlock.

▣ Using the Remote Transmitter

If you do not open a door within 30 seconds of unlocking the vehicle with the remote transmitter, the doors will automatically relock.

You can change the relock timer setting.

▣ **Customized Features** P. 306

You can lock or unlock doors using the remote transmitter only when the power mode is in VEHICLE OFF.

The remote transmitter uses low-power signals, so the operating range may vary depending on the surroundings.

The remote will not lock the vehicle when a door is open.

If the distance at which the remote transmitter works varies, the battery is probably low.

If the LED does not come on when you press a button, the battery is dead.

▣ **Replacing the Button Battery** P. 510

You can customize the door unlock mode setting.

▣ **Customized Features** P. 306

■ Locking/Unlocking the Doors Using a Key

If the lock or unlock button of the smart entry remote does not work, use the key instead.

➤ **Replacing the Button Battery** P. 510

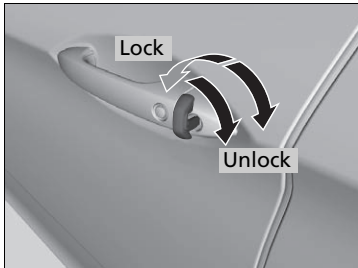

Fully insert the key and turn it.

☒ Locking/Unlocking the Doors Using a Key

When you lock the driver's door with a key, all the other doors lock at the same time. When unlocking, the driver's door unlocks first. Turn the key a second time within a few seconds to unlock the remaining doors.

You can customize the door unlock mode setting.

➤ **Customized Features** P. 306

■ Locking a Door Without Using a Key

If you do not have the key on you, or if for some reason you cannot lock a door using the key, you can lock the door without it.

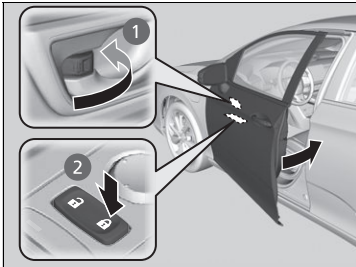

■ Locking the front doors

Push the lock tab forward **1** or push the master door lock switch in the lock direction **2**, and close the door.

■ Locking the rear doors

Push the lock tab forward and close the door.

■ Lockout prevention system

The doors cannot be locked when the smart entry remote is inside the vehicle.

⌘ Locking a Door Without Using a Key

When you lock the driver's door, all the other doors lock at the same time.
Before locking a door, make sure that the key is not inside the vehicle.

Locking/Unlocking the Doors from the Inside

■ Using the Lock Tab

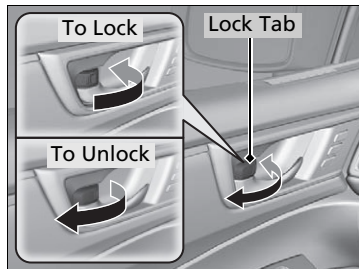

■ Locking a door

Push the lock tab forward.

■ Unlocking a door

Pull the lock tab rearward.

⌘ Using the Lock Tab

When you lock the door using the lock tab on the driver's door, all of the other doors lock at the same time.

When you unlock the door using the lock tab on the driver's door, only the driver's door will unlock.

■ Unlocking Using the Front Door Inner Handle

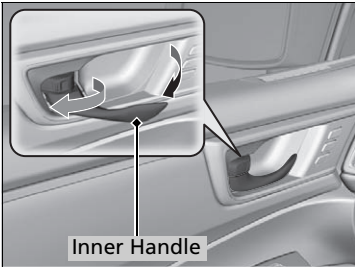

Pull the front door inner handle.

- ▶ The door unlocks and opens in one motion.

Unlocking and opening the driver's door from the inner handle unlocks all the other doors.

To avoid all the doors to be unlocked, use the lock tab on the driver's door to unlock, then lock again before opening the door.

- ▶ This setting works for one time only. If you do not want all the doors to be unlocked all the time, customize the **Auto Door Unlock** setting to **Off** using the audio/information screen.

▣ Unlocking Using the Front Door Inner Handle

The front door inner handles are designed to allow front seat occupants to open the door in one motion. However, this feature requires that front seat occupants never pull a front door inner handle while the vehicle is in motion.

Children should always ride in a rear seat where childproof door locks are provided.

▶ **Childproof Door Locks** P. 148

■ Using the Master Door Lock Switch

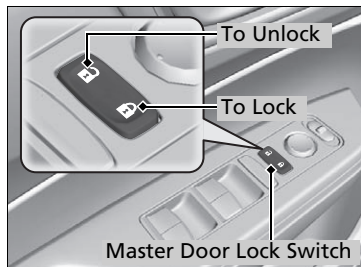

Press the master door lock switch in as shown to lock or unlock all the doors.

Childproof Door Locks

The childproof door locks prevent the rear doors from being opened from the inside regardless of the position of the lock tab.

■ Setting the Childproof Door Locks

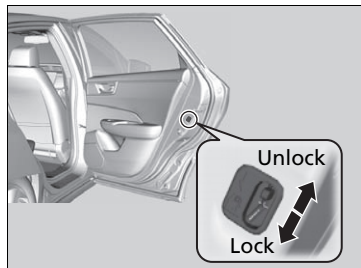

Slide the lever in the rear door to the lock position, and close the door.

■ When opening the door

Open the door using the outside door handle.

☒ Using the Master Door Lock Switch

When you lock/unlock either front door using the master door lock switch, all the other doors lock/unlock at the same time.

☒ Childproof Door Locks

To open the door from the inside when the childproof door lock is on, put the lock tab in the unlock position, lower the rear window, put your hand out of the window, and pull the outside door handle.

Auto Door Locking/Unlocking

Your vehicle locks or unlocks all doors automatically when a certain condition is met.

■ Auto Door Locking

■ Drive lock mode

All doors lock when the vehicle's speed reaches about 10 mph (15 km/h).

■ Auto Door Unlocking

■ Driver's door open mode

All doors unlock when the driver's door is opened.

☒ Auto Door Locking/Unlocking

You can turn off or change to another auto door locking/unlocking setting using the audio/information screen.

☒ **Customized Features** P. 306

Precautions for Opening/Closing the Trunk

■ Opening the trunk

Open the trunk all the way.

- ▶ If it is not fully opened, the trunk lid may begin to close under its own weight.

■ Closing the trunk

Keep the trunk lid closed while driving to:

- ▶ Avoid possible damage.
- ▶ Prevent exhaust gas from leaking into the vehicle.

➤ **Exhaust Gas Hazard** P. 82

Using the Trunk Opener

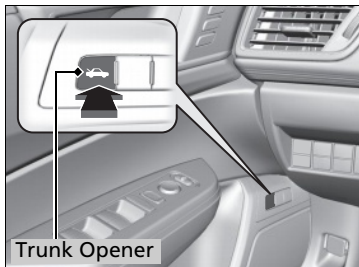

Pressing the trunk opener on the driver's door unlocks and opens the trunk.

➤ **When You Cannot Open the Trunk** P. 564

Using the Trunk Release Button

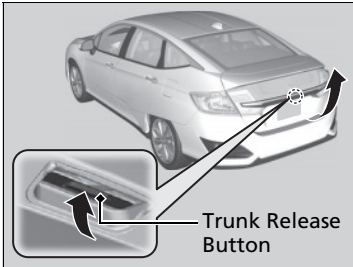

Push up the release button on the trunk lid after the doors are unlocked.

🚫 **When You Cannot Open the Trunk** P. 564

Even if the trunk is locked, you can open the trunk if you carry the smart entry remote.

▶ Some exterior lights flash and the beeper sounds.

Using the Remote Transmitter

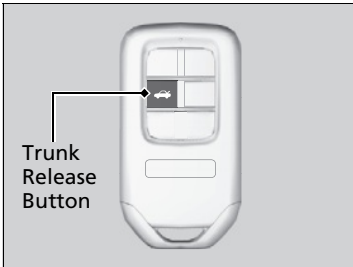

Press the trunk release button for approximately one second to unlock and open the trunk.

🚫 Using the Trunk Release Button

- If you forget the remote inside, the beeper will sound and the trunk will not close.
- A person who is not carrying the smart entry remote can unlock the trunk if a person who is carrying it is within range.
- If the beeper sounds after you close the trunk, move the smart entry remote away from the trunk and close again.
- The smart entry remote may not operate if it is too close to the trunk.

🚫 Using the Remote Transmitter

If the driver's door is locked, the trunk will automatically lock when you close it. Otherwise, you will have to lock it manually.

Emergency Trunk Opener

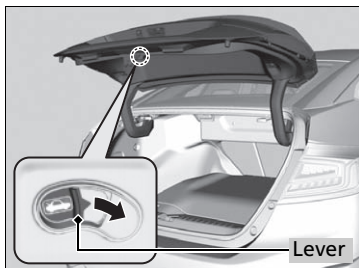

The trunk release lever allows you to open the trunk from inside for your safety.

Slide the release lever in the direction of the arrow.

Emergency Trunk Opener

Parents should decide if their children should be shown how to use this feature.

Immobilizer System

The immobilizer system prevents a key that has not been pre-registered from starting the power system. Each key contains electronic transmitters that use electronic signals to verify the key.

Pay attention to the following when pressing the **POWER** button:

- Do not allow objects that emit strong radio waves near the **POWER** button.
- Make sure the key is not covered by or touching a metal object.
- Do not bring a key from another vehicle's immobilizer system near the **POWER** button.
- Do not put the key near magnetic items. Electronic devices, such as televisions and audio systems emit strong magnetic fields. Note that even a key chain can become magnetic.

Security System Alarm

The security system alarm activates when the trunk, hood or doors are forcibly opened. The alarm does not activate if the trunk or doors are opened with the key, remote transmitter or smart entry system.

However, the alarm activates if a door is opened with the key and then the hood is opened before the power mode is set to ON.

■ When the security system alarm activates

The horn sounds intermittently and some exterior lights flash.

■ To deactivate the security system alarm

Unlock the vehicle using the key, remote transmitter or smart entry system. The system, along with the horn and flashing lights, is deactivated.

Immobilizer System

NOTICE

Leaving the key in the vehicle can result in theft or accidental movement of the vehicle. Always take the key with you whenever you leave the vehicle unattended.

Do not alter the system or add other devices to it. Doing so may damage the system and make your vehicle inoperable.

Canadian models only: Apply and hold the brake pedal before turning the vehicle on the first time after the 12-volt battery has been disconnected.

Security System Alarm

Do not alter the system or add other devices to it. Doing so may damage the system and make your vehicle inoperable.

The security alarm continues for a maximum of two minutes until the security system alarm deactivates.

■ Setting the security system alarm

The security system alarm automatically sets when the following conditions have been met:

- The power mode is set to VEHICLE OFF (LOCK).
- The hood is closed.
- All doors and the trunk are locked from outside with the key, remote transmitter or smart entry system.

■ When the security system alarm sets

The security system alarm indicator in the instrument panel blinks. When the blinking interval changes after about 15 seconds, the security system alarm is set.

■ To cancel the security system alarm

The security system alarm is canceled when the vehicle is unlocked using the remote transmitter, smart entry system, or the power mode is set to ON. The security system alarm indicator goes off at the same time.

☒ Security System Alarm

Do not set the security system alarm when someone is in the vehicle or a window is open. The system can accidentally activate when:

- Unlocking the door with the lock tab.
- Opening the trunk with the trunk opener or the emergency trunk opener.
- Opening the hood with the hood release.

If the 12-volt battery goes dead after you have set the security system alarm, the security alarm may go off once the 12-volt battery is recharged or replaced. If this occurs, deactivate the security system alarm by unlocking a door using the key, remote transmitter or smart entry system.

■ Panic Mode

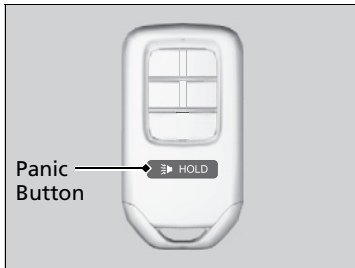

■ The panic button on the remote transmitter

If you press the panic button for approximately one second, the following will occur for about 30 seconds:

- The horn sounds.
- Some exterior lights flash.

■ Canceling panic mode

Press any button on the remote transmitter, or set the power mode to ON.

Opening/Closing the Power Windows

The power windows can be opened and closed when the power mode is in ON, using the switches on the doors.

The driver's side switches can be used to open and close all the windows. The power window lock button on the driver's side must be switched off (indicator off) to open and close the windows from anywhere other than the driver's seat.

When the power window lock button is pressed, the indicator comes on and you can only operate the driver's window. Turn the power window lock button on if a child is in the vehicle.

Opening/Closing Windows with Auto-Open/Close Function

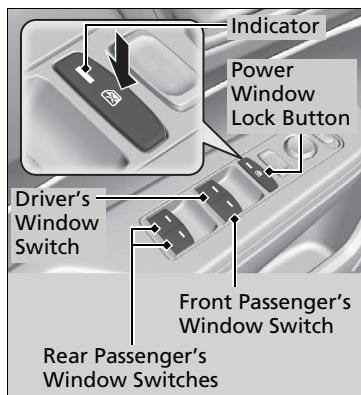

Manual operation

To open: Push the switch down lightly, and hold it until the desired position is reached.

To close: Pull the switch up lightly, and hold it until the desired position is reached.

Automatic operation

To open: Push the switch down firmly.

To close: Pull the switch up firmly.

The window opens or closes completely. To stop the window at any time, push or pull the switch briefly.

Opening/Closing the Power Windows

WARNING

Closing a power window on someone's hands or fingers can cause serious injury.

Make sure your passengers are away from the windows before closing them.

The power windows can be operated for up to 10 minutes after you set the power mode to VEHICLE OFF (LOCK).
Opening either front door cancels this function.

Auto Reverse

If a power window senses resistance when closing automatically, it will stop closing and reverse direction.

The driver's window auto reverse function is disabled when you continuously pull up the switch.

The auto reverse function stops sensing when the window is almost closed to ensure that it fully closes.

■ Opening the Windows with the Remote

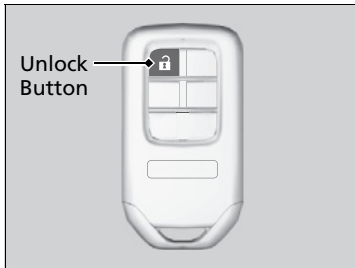

To open: Press the unlock button, and then within 10 seconds, press it again and hold it.

If the windows stop midway, repeat the procedure.

■ Opening/Closing the Windows with the Key

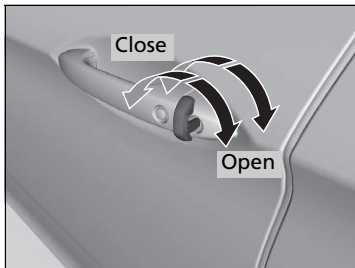

To open: Unlock the driver's door with the key. Within 10 seconds of returning the key to the central position, turn the key in the unlock direction and hold it there.

To close: Lock the driver's door with the key. Within 10 seconds of returning the key to the central position, turn the key in the lock direction and hold it there.

Release the key to stop the windows at the desired position. If you want further adjustment, repeat the same operation.

POWER Button

Changing the Power Mode

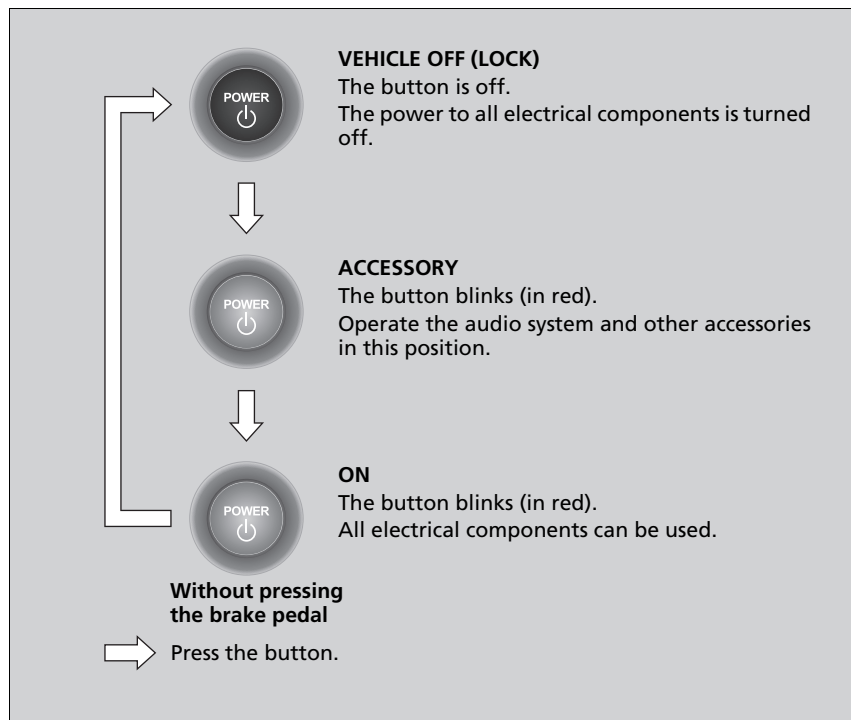

POWER Button

POWER Button Operating Range

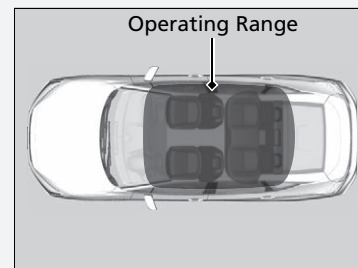

You can start the power system when the smart entry remote is inside the vehicle.

The power system may also start if the smart entry remote is close to the door or window, even if it is outside the vehicle.

ON mode:

The **POWER** button is on (in red), if the power system is on.

If the battery of the smart entry remote is getting low, the power system may not start when you press the **POWER** button. If the power system does not start, refer to the following link.

🔗 If the Smart Entry Remote Battery is Weak
P. 537

Do not leave the power mode in ACCESSORY or ON when you get out.

■ Automatic Power Off

If you leave the vehicle for 30 to 60 minutes with the transmission in **P** and the power mode in ACCESSORY, the vehicle automatically goes into the mode to VEHICLE OFF (LOCK) to avoid draining the 12-volt battery.

■ Power Mode Reminder

If you open the driver's door when the power mode is set to ACCESSORY, a warning beep sounds.

■ Smart Entry Remote Reminder

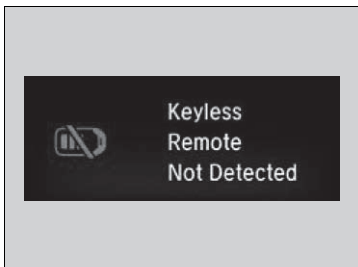

Warning buzzers may sound from inside and/or outside the vehicle to remind you that the smart entry remote is out of the vehicle. If the buzzer continues even after the remote is put back inside, place it to be within its operational range.

■ When the power mode is in ON

If the smart entry remote is taken out of the vehicle, and the driver's door is closed, a warning buzzer sounds from both inside and outside the vehicle. A warning message on the driver information interface notifies the driver inside that the remote outside of the vehicle.

■ When the power mode is in ACCESSORY

If the smart entry remote is taken out of the vehicle, and the driver's door is closed, a warning buzzer sounds from outside the vehicle.

▶ Smart Entry Remote Reminder

When the smart entry remote is within the system's operational range, and the driver's door is closed, the warning function cancels.

If the smart entry remote is taken out of the vehicle after the power system has been turned on, you can turn the power system off, but you can no longer use ACCESSORY mode or restart the vehicle. Always make sure if the remote is in your vehicle when you operate the **POWER** button.

Removing the smart entry remote from the vehicle through a window does not activate the warning buzzer.

Do not put the smart entry remote on the dashboard or in the glove box. It may cause the warning buzzer to go off. Under some other conditions that can prevent the vehicle from locating the remote, the warning buzzer may also go off even if the remote is within the system's operational range.

Turn Signals

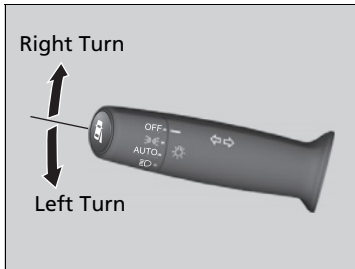

The turn signals can be used when the power mode is in ON.

■ One-touch turn signal

When you lightly push up or down and release the turn signal lever, the exterior turn signals and turn signal indicator blink three times.

This feature can be used when signaling for a lane change.

Light Switches

Manual Operation

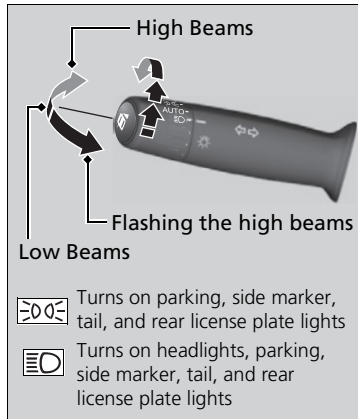

Rotating the light switch turns the lights on and off, regardless of the power mode setting.

High beams

Push the lever forward until you hear a click.

Low beams

When in high beams, pull the lever back to return to low beams.

Flashing the high beams

Pull the lever back, and release it.

Light Switches

If you leave the power mode in VEHICLE OFF (LOCK) while the lights are on, a chime sounds when the driver's door is opened.

When the lights are on, the lights on indicator in the instrument panel will be on.

▶ **Lights On Indicator** P. 97

Do not leave the lights on when the power system is off because it will cause the 12-volt battery to discharge.

If you sense that the level of the headlights is abnormal, have the vehicle inspected by an authorized Honda Clarity Plug-In Hybrid dealer.

Automatic Operation (automatic lighting control)



Automatic lighting control can be used when the power mode is in ON.

When you turn the light switch to **AUTO**, the headlights and other exterior lights will switch on and off automatically depending on the ambient brightness.

You can change the auto light sensitivity setting.

▶ **Customized Features** P. 306

The headlights comes on when you unlock a door in dark areas with the headlight switch in **AUTO**.

- ▶ Once you lock the door, the headlights will go off.

Automatic Operation (automatic lighting control)

We recommend that you turn on the lights manually when driving at night, in a dense fog, or in dark areas such as long tunnels or parking facilities.

The light sensor is in the location shown below. Do not cover this light sensor with anything; otherwise, the automatic lighting system may not work properly.

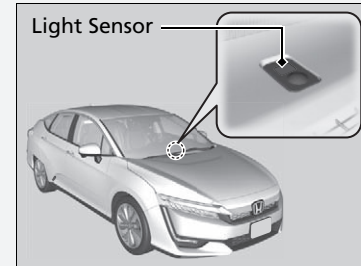

Adjust the auto light sensitivity as follows:

Setting	The exterior lights come on when the ambient light is at	
Max		Bright
High		
Mid		
Low		
Min		Dark

■ Headlight Integration with Wipers

The headlights automatically come on when the wipers are used several times within a certain number of intervals with the headlight switch in **AUTO**. The headlights automatically go off a few minutes later if the wipers are stopped.

■ Automatic Lighting Off Feature

The headlights, all other exterior lights, and the instrument panel lights turn off 15 seconds after you set the power mode to VEHICLE OFF (LOCK), take the remote with you, and close the driver's door.

If you set the power mode to VEHICLE OFF (LOCK) with the headlight switch on, but do not open the door, the lights turn off after 10 minutes (3 minutes, if the switch is in the **AUTO** position).

The lights turn on again when you unlock or open the driver's door. If you unlock the door, but do not open it within 15 seconds, the lights go off. If you open the driver's door, you will hear a lights on reminder chime.

⌘ Headlight Integration with Wipers

This feature activates while the headlights are off in **AUTO**.

The instrument panel brightness does not change when the headlights come on.

At dark ambient light levels, the automatic lighting control feature turns on the headlights, regardless of the number of wiper sweeps.

You can turn the headlight integration with wipers function on and off.

➤ **Customized Features** P. 306

⌘ Automatic Lighting Off Feature

You can change the headlight auto off timer setting.

➤ **Customized Features** P. 306

Daytime Running Lights

The daytime running lights come on when the following conditions have been met:

- The power mode is in ON.
- The headlight switch is **AUTO**, or **OFF**.
- The parking brake is released.

The lights remain on even if you set the parking brake.

Setting the power mode to VEHICLE OFF (LOCK) will turn off the daytime running lights.

The daytime running lights are off once the headlight switch is turned on, or when the headlight switch is in **AUTO** and it is getting darker outside.

Wipers and Washers

■ Windshield Wipers/Washers

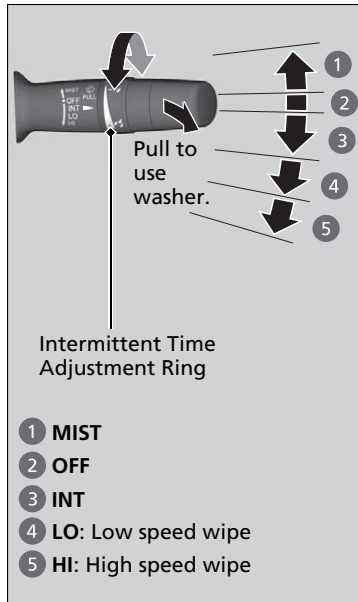

The windshield wipers and washers can be used when the power mode is in ON.

■ MIST

The wipers run at high speed until you release the lever.

■ Wiper switch (OFF, INT, LO, HI)

Move the lever up or down to change the wiper settings.

■ Adjusting wiper operation

Turn the adjustment ring to adjust the wiper operation.

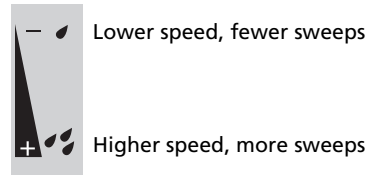

■ Washer

Sprays while you pull the lever toward you. When you release the lever for more than one second, the spray stops, the wipers sweep two or three more times to clear the windshield, then stop.

▶▶ Wipers and Washers

NOTICE

Do not use the wipers when the windshield is dry. The windshield will get scratched, or the rubber blades will get damaged.

Turn the washers off if no washer fluid comes out. The pump may get damaged.

When the wiper motor is kept running under heavy load for extended periods of time, this protection feature is activated, and the wiper speed may decrease or motor operation may stop temporarily. This function will be canceled within a few minutes once the load has been reduced; the wiper operation returns to normal.

If the vehicle speeds up while the wipers are operating intermittently, the length of the wipe interval shortens. When the vehicle speeds up, the wiper operation's shortest delay setting (🔊) and the LO setting become the same.

NOTICE

In cold weather, the blades may freeze to the windshield. Operating the wipers in this condition may damage the wipers. Use the defroster to warm the windshield, then turn the wipers on.

▶▶ Wipers and Washers

If the wipers stop operating due to an obstacle such as the build-up of snow, park the vehicle in a safe place.

Rotate the wiper switch to **OFF**, and set the power mode to ACCESSORY or VEHICLE OFF (LOCK), then remove the obstacle.

The washer jets are in the location shown below.

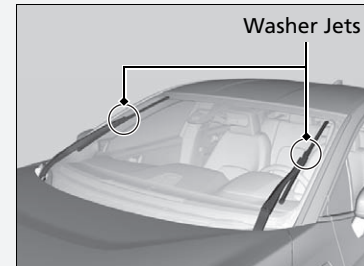

Brightness Control

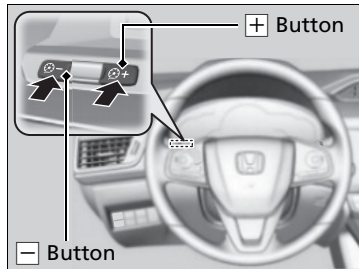

When the power mode is in ON, you can use the **+** or **-** button to adjust instrument panel brightness.

Brighten: Press the **+** button.

Dim: Press the **-** button.

You will hear a beep when the brightness reaches minimum or maximum. Several seconds after adjusting the brightness, you will be returned to the previous display.

■ Brightness level indicator

The brightness level is shown on the display while you are adjusting it.

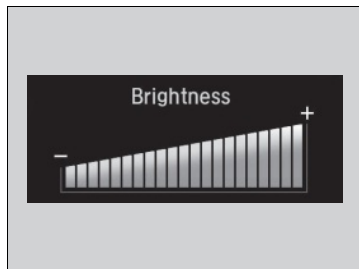

▶▶ Brightness Control

Instrument panel brightness varies, depending on whether the exterior lights are on or off. The instrument panel dims to reduce glare when they are on.

When it is bright outside and the headlight integration with the wiper is activated, the instrument panel brightness does not change.

To cancel the reduced instrument panel brightness when the exterior lights are on, press the **+** button until the brightness display is up to max, the beeper sounds.

The brightness can be set differently for when the exterior lights are on, and when they are off.

Rear Defogger/Heated Door Mirror Button

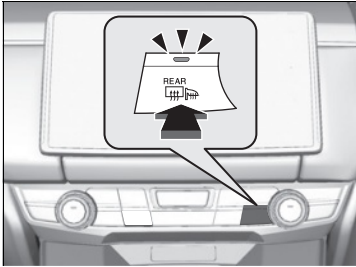

Press the rear defogger and heated door mirror button to defog the rear window and mirrors when the power mode is in ON.

The rear defogger and heated door mirrors automatically switch off after 10-30 minutes depending on the outside temperature.

However, if the outside temperature is 32°F (0°C) or below, it does not automatically switch off.

⊗ Rear Defogger/Heated Door Mirror Button

NOTICE

When cleaning the inside of the rear window, be careful not to damage the heating wires. It is critical to wipe the window from side to side along the defogger heating wires.

This system consumes a lot of power, so turn it off when the window has been defogged. Also, do not use the system for a long time while the power system is stopped. This may weaken the 12-volt battery, making it difficult to turn the power system on.

When the outside temperature is below 41°F (5°C), the heated door mirror may activate automatically for 10 minutes when you set the power mode to ON.

Driving Position Memory System*

You can store two driver's seat with the driving position memory system.

When you unlock and open the driver's door with a remote transmitter, or smart entry system, the seat adjusts automatically to one of the two preset positions.

- **DRIVER 1** transmitter is linked to memory button 1.
- **DRIVER 2** transmitter is linked to memory button 2.



▶▶ Driving Position Memory System*

Using the audio/information screen, you can disable the automatic seat adjustment function.

▶ **Customized Features** P. 306

■ Storing a Position in Memory

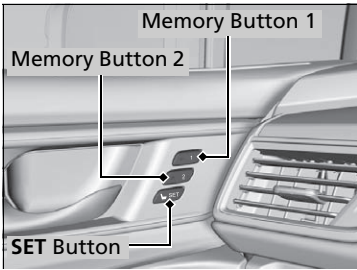

1. Set the power mode to ON. Adjust the driver's seat to the desired position.
2. Press the **SET** button.
 - ▶ You will hear the beeper, and the memory button indicator light will blink.
3. Press and hold memory button **1** or **2** within five seconds of pressing the **SET** button.
 - ▶ Once the seat position has been memorized, the indicator light on the button you pressed stays on and you will hear the double-beep.

■ Recalling the Stored Position

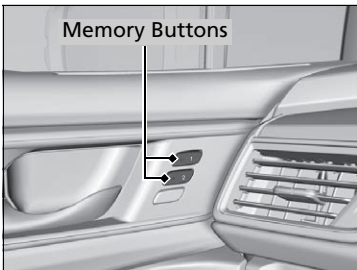

1. Put the transmission into **P**.
2. Apply the parking brake.
3. Press a memory button (**1** or **2**).
 - ▶ You will hear the beeper, and the indicator light will blink.

The seat will automatically move to the memorized position. When it has finished moving, you will hear the beeper, and the indicator light stays on.

☒ Storing a Position in Memory

After you press the **SET** button, the storing operation will be canceled when:

- You do not press the memory button within five seconds.
- You readjust the seat position before the double-beep.
- You set the power mode to any position except ON.

☒ Recalling the Stored Position

The seat will stop moving if you:

- Press the **SET** button or memory button **1** or **2**.
- Adjust the seat position.
- Put the transmission into a position other than **P**.

Adjusting the Steering Wheel

The steering wheel height and distance from your body can be adjusted so that you can comfortably grip the steering wheel in an appropriate driving posture.

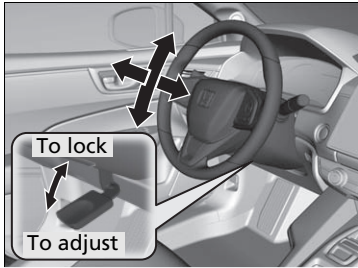

1. Push the steering wheel adjustment lever down.
 - ▶ The steering wheel adjustment lever is under the steering column.
2. Move the steering wheel up or down, and in or out.
 - ▶ Make sure you can see the instrument panel gauges and indicators.
3. Pull the steering wheel adjustment lever up to lock the steering wheel in position.
 - ▶ After adjusting the position, make sure you have securely locked the steering wheel in place by trying to move it up, down, in, and out.

Adjusting the Steering Wheel

⚠ WARNING

Adjusting the steering wheel position while driving may cause you to lose control of the vehicle and be seriously injured in a crash.

Adjust the steering wheel only when the vehicle is stopped.

Interior Rearview Mirror

Adjust the angle of the rearview mirror when you are sitting in the correct driving position.

Automatic Dimming Rearview Mirror

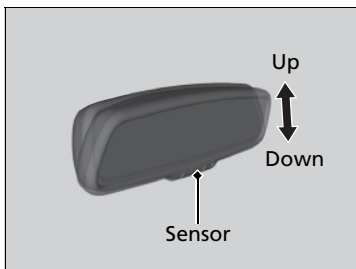

When you are driving after dark, the automatic dimming rearview mirror reduces the glare from headlights behind you, based on inputs from the mirror sensor. This feature is always active.

Adjusting the Mirrors

Keep the inside and outside mirrors clean and adjusted for best visibility.

Adjust the mirrors before you start driving.

➤ **Front Seats** P. 175

Automatic Dimming Rearview Mirror

The auto dimming function cancels when the transmission is in **R**.

Power Door Mirrors

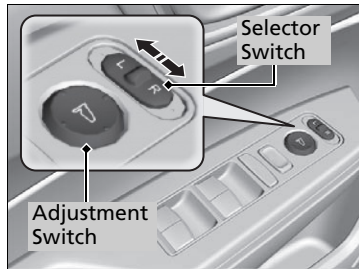

You can adjust the door mirrors when the power mode is in ON.

■ Mirror position adjustment

L/R selector switch: Select the left or right mirror. After adjusting the mirror, return the switch to the center position.

Mirror position adjustment switch: Press the switch left, right, up, or down to move the mirror.

■ Expanded View Driver's Mirror

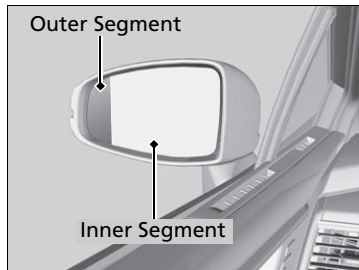

The driver's side door mirror has outer and inner segments. The outer segment is slightly curved to provide a wider angle view than a standard flat mirror. This wider view may help you check areas that are not visible using a standard door mirror.

⌘ Expanded View Driver's Mirror

Objects visible in the outer segment of the driver's side door mirror appear smaller than objects in the rest of the mirror. But in fact, they are closer than they appear.

Do not rely on your mirrors. Always look to the side and behind your vehicle before changing lanes.

Adjusting the Seats

Front Seats

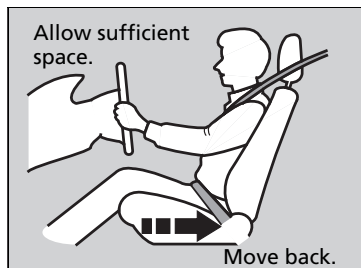

Adjust the driver's seat as far back as possible while allowing you to maintain full control of the vehicle. You should be able to sit upright, well back in the seat and be able to adequately press the pedals without leaning forward, and grip the steering wheel comfortably. The passenger's seat should be adjusted in a similar manner, so that it is as far back from the front airbag in the dashboard as possible.

Adjusting the Seats

⚠ WARNING

Sitting too close to a front airbag can result in serious injury or death if the front airbags inflate.

Always sit as far back from the front airbags as possible while maintaining control of the vehicle.

The National Highway Traffic Safety Administration and Transport Canada recommend that drivers allow at least 10 inches (25 cm) between the center of the steering wheel and the chest.

Always make seat adjustments before driving.

Adjusting the Seat Positions

Adjusting the front power seats*

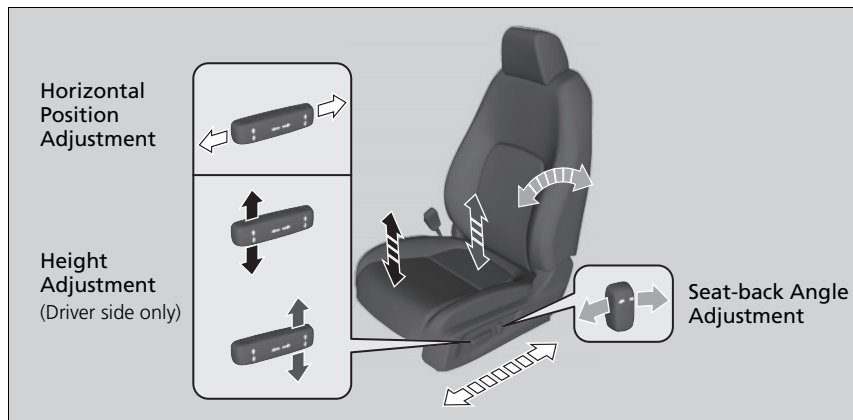

* Not available on all models

Continued

■ Adjusting the front manual seats*

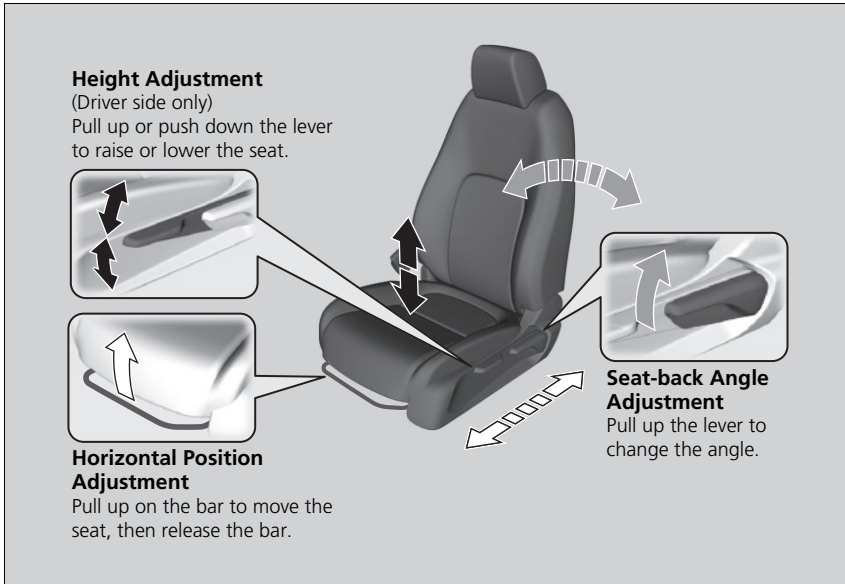

► Adjusting the front manual seats*

Once a seat is adjusted correctly, rock it back and forth to make sure it is locked in position.

■ Adjusting the Seat-Backs

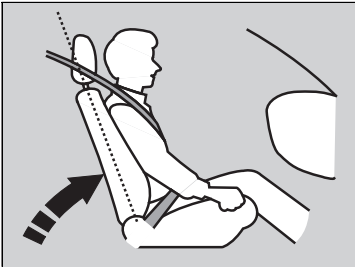

Adjust the driver's seat-back to a comfortable, upright position, leaving ample space between your chest and the airbag cover in the center of the steering wheel.

The front seat passenger should also adjust their seat-back to a comfortable, upright position.

Reclining a seat-back so that the shoulder part of the belt no longer rests against the occupant's chest reduces the protective capability of the belt. It also increases the chance of sliding under the belt in a crash and being seriously injured. The farther a seat-back is reclined, the greater the risk of injury.

⌘ Adjusting the Seat-Backs

⚠ WARNING

Reclining the seat-back too far can result in serious injury or death in a crash.

Adjust the seat-back to an upright position, and sit well back in the seat.

Do not put a cushion, or other object, between the seat-back and your back. Doing so may interfere with proper seat belt or airbag operation.

If you cannot get far enough away from the steering wheel and still reach the controls, we recommend that you investigate whether some type of adaptive equipment may help.

Head Restraints

Your vehicle is equipped with head restraints in all seating positions.

■ Adjusting the Front Head Restraints Positions

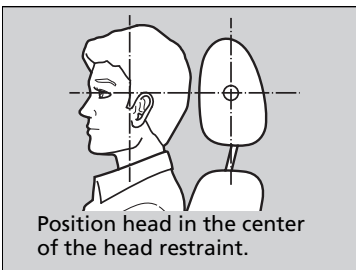

Head restraints are most effective for protection against whiplash and other rear-impact crash injuries when the center of the back of the occupant's head rests against the center of the restraint. The tops of the occupant's ears should be level with the center height of the restraint.

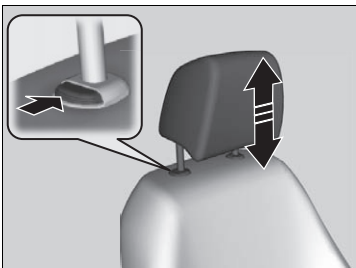

To raise the head restraint:

Pull it upward.

To lower the head restraint:

Push it down while pressing the release button.

Head Restraints

⚠ WARNING

Improperly positioning head restraints reduces their effectiveness and increases the likelihood of serious injury in a crash.

Make sure head restraints are in place and positioned properly before driving.

In order for the head restraint system to work properly:

- Do not hang any items on the head restraints, or from the restraint legs.
- Do not place any objects between an occupant and the seat-back.
- Install each restraint in its proper location.

■ Changing the Rear Center Seat Head Restraint Positions

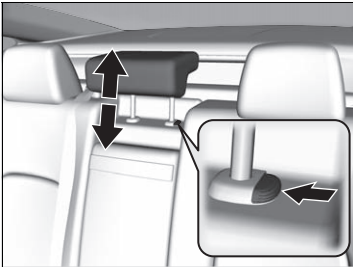

A passenger sitting in the center back seating position should adjust the height of their head restraint to an appropriate position before the vehicle begins moving.

To raise the head restraint:

Pull it upward.

To lower the head restraint:

Push it down while pressing the release button.

■ Front and rear center head restraints

■ Removing and Reinstalling the Head Restraints

Head restraints can be removed for cleaning or repair.

To remove a head restraint:

Pull the restraint up as far as it will go. Then push the release button, and pull the restraint up and out.

To reinstall a head restraint:

Insert the legs back in place, then adjust the head restraint to an appropriate height while pressing the release button. Pull up on the restraint to make sure it is locked in position.

⌘ Removing and Reinstalling the Head Restraints

⚠ WARNING

Failure to reinstall, or correctly reinstall, the head restraints can result in severe injury during a crash.

Always replace the head restraints before driving.

Maintain a Proper Sitting Position

After all occupants have adjusted their seats and head restraints, and put on their seat belts, it is very important that they continue to sit upright, well back in their seats, with their feet on the floor, until the vehicle is safely parked and the power system is off.

Sitting improperly can increase the chance of injury during a crash. For example, if an occupant slouches, lies down, turns sideways, sits forward, leans forward or sideways, or puts one or both feet up, the chance of injury during a crash is greatly increased.

In addition, an occupant who is out of position in the front seat can be seriously or fatally injured in a crash by striking interior parts of the vehicle or being struck by an inflating front airbag.

⚠ Maintain a Proper Sitting Position

WARNING

Sitting improperly or out of position can result in serious injury or death in a crash.

Always sit upright, well back in the seat, with your feet on the floor.

Rear Seats

60/40 Split Folding Down the Rear Seats

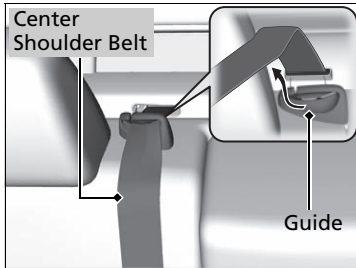

1. Remove the center shoulder belt from the guide.

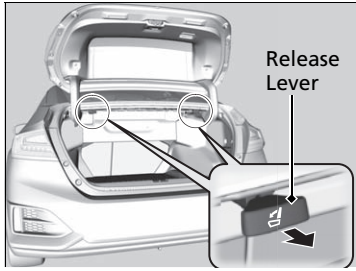

2. Pull the release lever in the trunk to release the lock.



3. Fold the seat-back down.

60/40 Split Folding Down the Rear Seats

The rear seat-back(s) can be folded down to accommodate bulkier items in the trunk.

Never drive with a seat-back folded down and the trunk lid open.

⚠ **Exhaust Gas Hazard** P. 82

To lock the seat-back upright, push it backwards until it locks.

When returning a seat-back to its original position, push it firmly back. Also, make sure all rear shoulder belts are positioned in front of the seat-back, and the center shoulder belt is re-positioned in the guide.

Make sure that the folded seat-back does not press against the front passenger seat, as this can cause the weight sensors in the front passenger seat to work improperly.

⚠ **Passenger Front Airbag Off Indicator** P. 67

Also make sure all items in the trunk or items extending through the opening into the rear seats are properly secured. Loose items can fly forward if you have to brake hard.

The front seat(s) must be far enough forward so they do not interfere with the rear seats as they fold down.

Armrest

■ Using the Front Seat Armrest

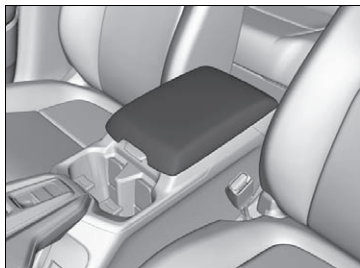

The console lid can be used as an armrest.

■ Using the Rear Seat Armrest



Pull down the armrest in the center backrest.

Interior Lights

Interior Light Switches

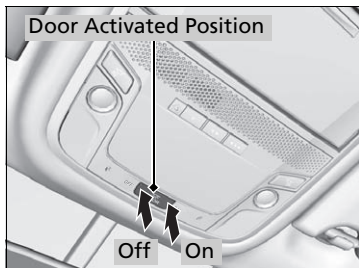

■ ON

The interior lights come on regardless of whether the doors are open or closed.

■ Door activated

The interior lights come on in the following situations:

- When any of the doors are opened.
- You unlock the driver's door.
- When the power mode is set to VEHICLE OFF (LOCK).

■ OFF

The interior lights remain off regardless of whether the doors are open or closed.

Interior Light Switches

In the door activated position, the interior lights fade out and go off about 30 seconds after the doors are closed.

The lights go off after about 30 seconds in the following situations:

- When you unlock the driver's door but do not open it.
- When you set the power mode to VEHICLE OFF (LOCK) but do not open a door.

You can change the interior lights dimming time.

➤ **Customized Features** P. 306

The interior lights go off immediately in the following situations:

- When you lock the driver's door.
- When you close the driver's door in ACCESSORY mode.
- When you set the power mode to ON.

To avoid draining the 12-volt battery, do not leave the interior light on for an extended length of time when the power system is off.

If you leave any of the doors open in VEHICLE OFF (LOCK) mode, the interior lights go off after about 15 minutes.

■ Map Lights

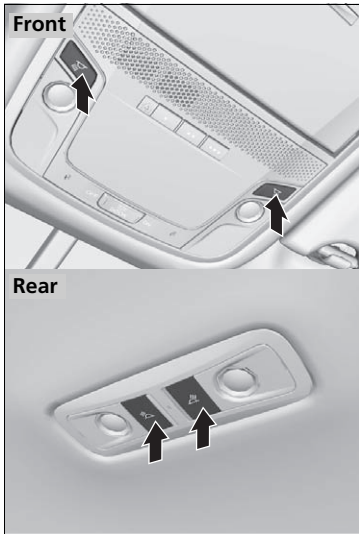

The map lights can be turned on and off by pressing the  (map light) button.

▣ Map Lights

When the interior light switch is in the door activated position and any door is open, the rear map light will not go off when you press the  (map light) button.

Interior Convenience Items

■ Glove Box

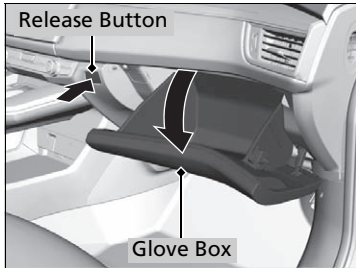

Press the release button to open the glove box.

☒ Glove Box

⚠ WARNING

An open glove box can cause serious injury to your passenger in a crash, even if the passenger is wearing the seat belt.

Always keep the glove box closed while driving.

The glove box light comes on when the parking lights are on.

■ Console Compartment

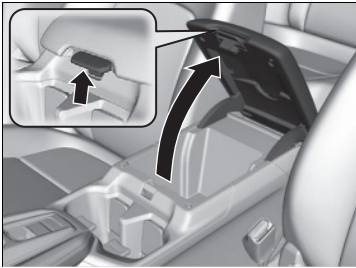

Pull the handle to open the console compartment.

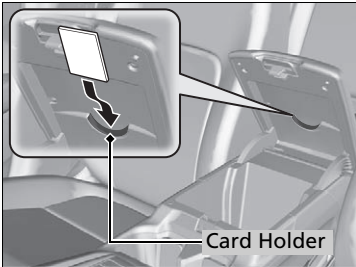

You can use the card holder located in the console compartment lid.

■ Beverage Holders

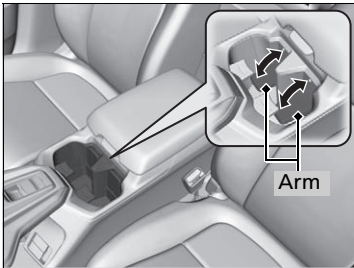

■ Front seat beverage holders

The beverage holders have two bases, an adjustable upper base and a fixed lower base.

For short cups, flip the upper base into position by lowering the arm. For tall cups, reverse the procedure.

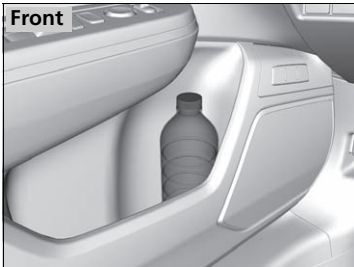

■ Door side beverage holders

Are located on the both of the front and rear door side pockets.

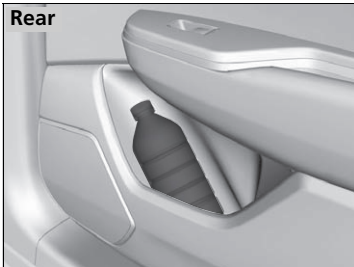

» Beverage Holders

NOTICE

Spilled liquids can damage the upholstery, carpeting, and electrical components in the interior.

Be careful when you are using the beverage holders. Hot liquid can scald you.

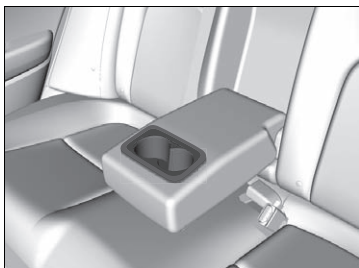
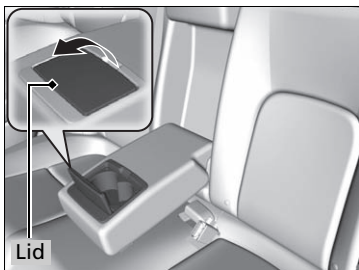

■ Rear seat beverage holders

Except Canadian models

Pull down the armrest in the center backrest and open the lid to use it.

Canadian models

Fold the armrest down to use the rear seat beverage holders.

■ Accessory Power Sockets

The accessory power sockets can be used when the power mode is in ACCESSORY or ON.

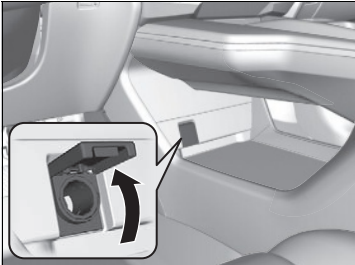

■ Accessory power socket (console panel)

Open the cover to use it.

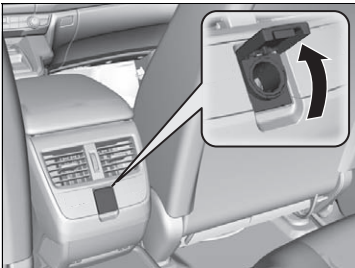

■ Accessory power socket (back of the console compartment)

Open the cover to use it.

» Accessory Power Sockets

NOTICE

Do not insert an automotive type cigarette lighter element. This can overheat the power socket.

The accessory power sockets are designed to supply power for 12-volt DC accessories that are rated 180 watts (15 amps) or less.

To prevent 12-volt battery drain, only use the power socket with the power system on.

■ Coat Hook

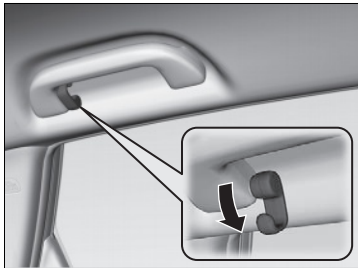

There is a coat hook on the rear left grab handle. Pull it down to use it.

■ Under-Floor Storage Area

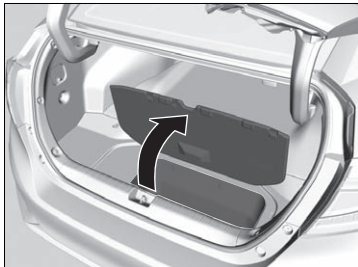

Pull up the cargo area floor lid.

☒ Coat Hook

The coat hook is not designed for large or heavy items.

Seat Heaters

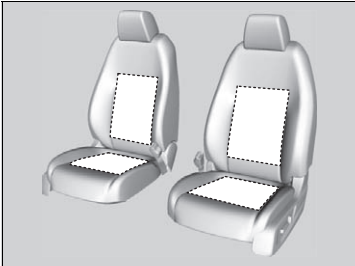

The power mode must be in ON to use the seat heaters.

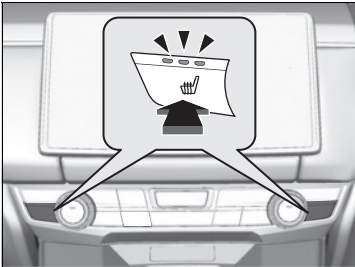

Press the seat heater button:

- Once - The HI setting (three indicators on)
- Twice - The MID setting (two indicators on)
- Three times - The LO setting (one indicator on)
- Four times - The OFF setting (no indicators on)

Seat Heaters

⚠ WARNING

Heat induced burns are possible when using seat heaters.

Persons with a diminished ability to sense temperature (e.g., persons with diabetes, lower-limb nerve damage, or paralysis) or with sensitive skin should not use seat heaters.

Avoid using seat heaters when the 12-volt battery charge is low. The vehicle may be difficult to start.

After a certain period of time, the strength setting for the seat heaters will automatically be reduced by one level at a time until the seat heaters shuts off. The elapsed time varies according to the interior environment.

When the ECON mode is active, the driver's side seat heater functions according to the status of the climate control system. If you want to use only the climate control system, press the seat heater button to OFF.

■ Sunglasses Holder



To open the sunglasses holder, press and release the indent. To close, press it again until it latches.

You can store eyeglasses and other small items in this holder.

☞ Sunglasses Holder

Keep the holder closed while driving except when accessing stored items.

Using Automatic Climate Control

The automatic climate control system maintains the interior temperature you select. The system also selects the proper mix of heated or cooled air that raises or lowers the interior temperature to your preference as quickly as possible.

Using Automatic Climate Control

Press the **CLIMATE** button to display **A/C, MODE**, fan control information on the audio/information screen to operate manually. Select icon to turn on or off **A/C**, change the vent mode, or change the fan speed.

If any buttons/icons are pressed while using the climate control system in auto, the function of the button/icon that was pressed will take priority. The **AUTO** indicator will go off, but functions unrelated to the button/icon that was pressed will be controlled automatically.

To prevent cold air from blowing in from outside, the fan may operate at low speed for a while after the **AUTO** button has been pressed.

If the interior is very warm, you can cool it down more rapidly by partially opening the windows, turning the system on auto, and setting the temperature to low. Change the fresh air mode to recirculation mode until the temperature cools down.

When you set the temperature to the lower or upper limit, **Lo** or **Hi** is displayed.

Pressing the  button switches the climate control system between on and off. When turned on, the system returns to your last selection.

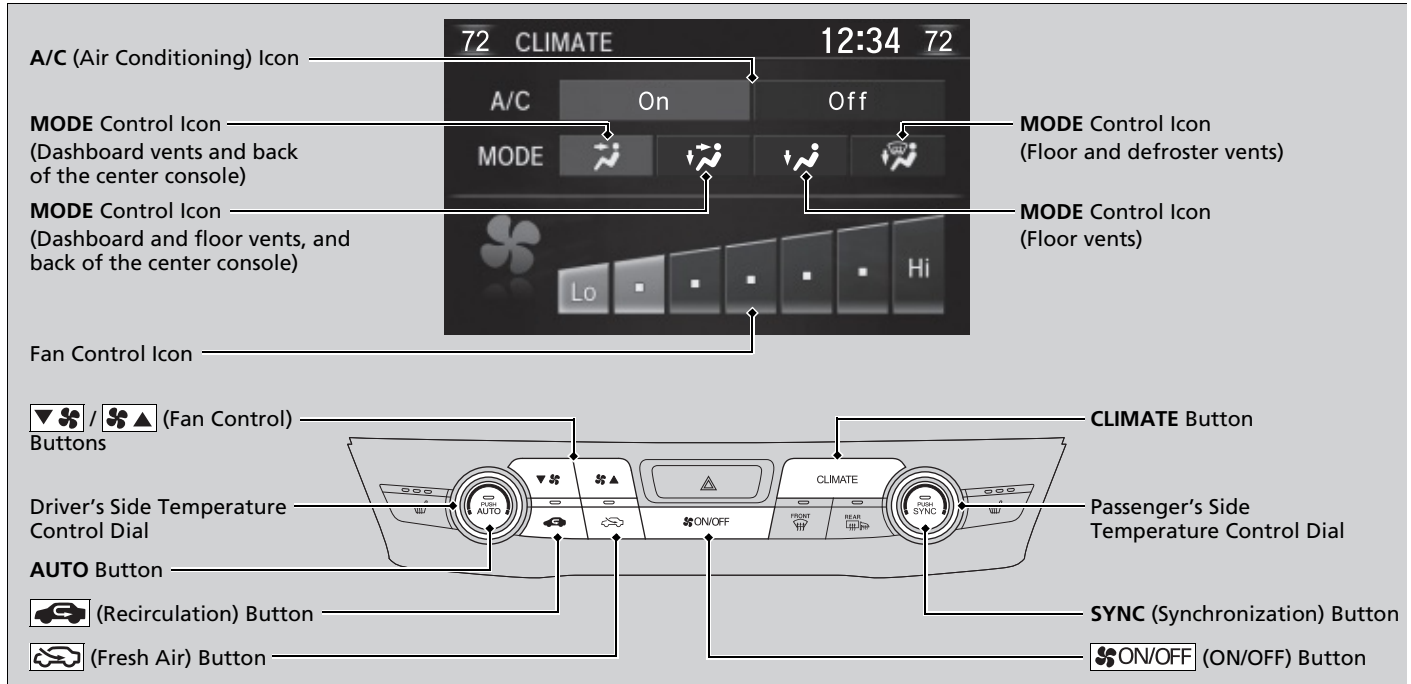

- Use the system when the power system is on.
1. Press the **AUTO** button.
 2. Adjust the interior temperature using the driver's side or passenger's side temperature control dial.
 3. Press the **ON/OFF** (ON/OFF) button to cancel.

■ Switching the vent mode

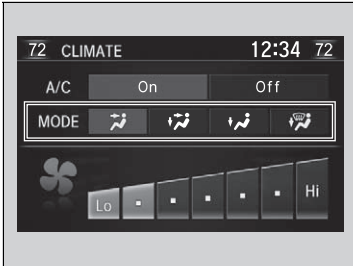

1. Press the **CLIMATE** button.
2. Select a desired vent mode icon.

■ A/C on and off

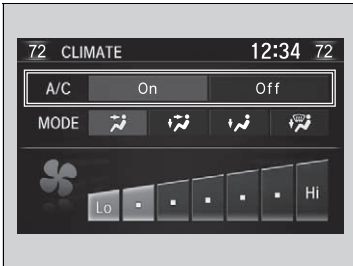

1. Press the **CLIMATE** button.
2. Select **On** or **Off**.

▶▶ Using Automatic Climate Control

Models with driving position memory system

When you unlock the doors with your remote, the driver's ID (**DRIVER 1** or **DRIVER 2**) is detected, and the climate control settings are turned to the respective mode automatically when you set the power mode to ON.

All models



If any icons are not selected within several seconds after the display is switched, it returns to the previous screen. In this case, press the **CLIMATE** button again.

You can change the length of time the climate control display stays on.

▶ **Customized Features** P. 306

While ECON mode is active, the climate control system may have reduced cooling performance.

■ Switching between the recirculation and fresh air modes

Press the  (recirculation) or  (fresh air) button to switch the mode depending on environmental conditions.

 Recirculation mode (indicator on): Recirculates air from the vehicle's interior through the system.

 Fresh air mode (indicator on): Maintains outside ventilation. Keep the system in fresh air mode in normal situations.

Defrosting the Windshield and Windows

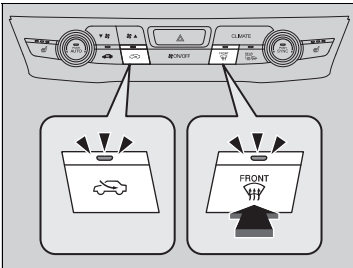

Pressing the  button turns the air conditioning system on and automatically switches the system to fresh air mode.

Press the  button again to turn off, the system returns to the previous settings.

To rapidly defrost the windows

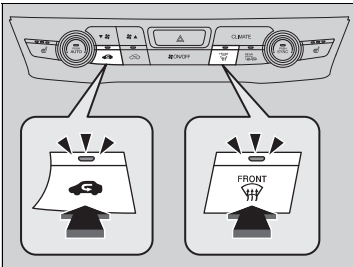

1. Press the  button.
2. Press the  button.

Defrosting the Windshield and Windows

For your safety, make sure you have a clear view through all the windows before driving.

Do not set the temperature near the upper or lower limit.

When cold air hits the windshield, the outside of the windshield may fog up.

If the side windows fog up, adjust the vents so that the air hits the side windows.

To rapidly defrost the windows

After defrosting the windows, switch over to fresh air mode.

If you keep the system in recirculation mode, the windows may fog up from humidity. This impedes visibility.

■ Synchronization Mode

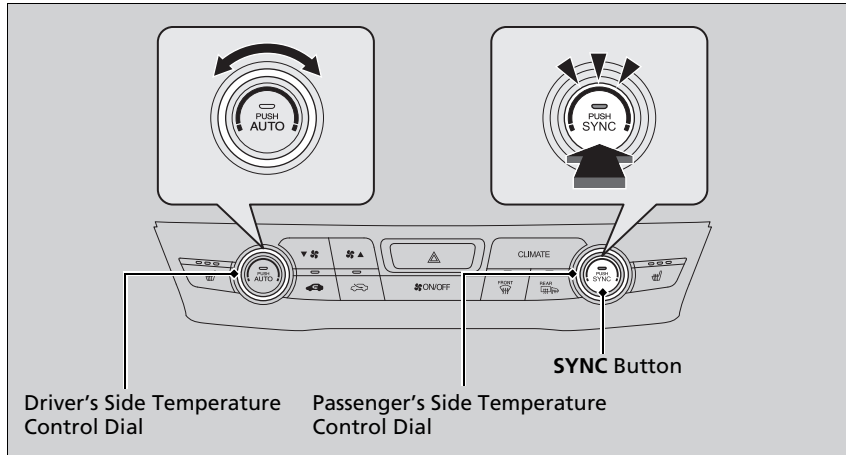

You can set the temperature synchronously for the driver's side and the passenger's side in synchronization mode.

1. Press the **SYNC** button.
 - The system switches to synchronization mode.
2. Adjust the temperature using the driver's side temperature control dial.

To return to dual mode, you can either press the **SYNC** button again or turn the dial of the passenger's side temperature control unit.

☒ Synchronization Mode

When you press the  button, the system changes to synchronization mode.

When the system is in dual mode, the driver's side temperature and the passenger's side temperature can be set separately.

■ Turning the Climate Control System On and Off with the Remote

You can operate the climate control system from outside the vehicle.

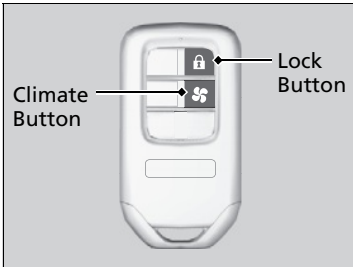

■ To turn on the system

1. Press the lock button.
 - ▶ Some exterior lights flash.
2. Within about five seconds, press and hold the climate button.
 - ▶ Some exterior lights flash.
 - ▶ After a few seconds, some exterior lights flash six times and the climate control system is turned on.

■ To turn off the system

Press and hold the climate button.

- ▶ Some exterior lights flash and the climate control system is turned off.

☒ Turning the Climate Control System On and Off with the Remote

⚠ WARNING

Make sure that no one is inside the vehicle when you use the remote climate control system. After a certain period of time has elapsed, the system shuts off temporarily. During this time, the interior of the vehicle may heat up or cool down depending on ambient temperatures. If a child is left inside the vehicle, extreme temperature exposure can result in death or serious injury of the child.

The climate control system does not operate when any of the following conditions are met.

- A door or the hood is not closed.
- The power mode is set to any mode other than OFF.
- The brake pedal is being depressed.
- The High Voltage battery level is low.

When you use the climate control system while the vehicle is charging, it is recommended that you set the charging level to 240 volt charge.

☒ Turning the Climate Control System On and Off with the Remote

The climate control system automatically turned off when any of the following conditions are met.

- The system has been operated for more than 30 minutes.
- The High Voltage battery level becomes low.
- A door or the hood is opened.
- The power mode is set to any mode other than OFF.
- The brake pedal is being depressed.

If the charging connector is unplugged, the High Voltage battery is used to power the climate control system.

Automatic Climate Control Sensors

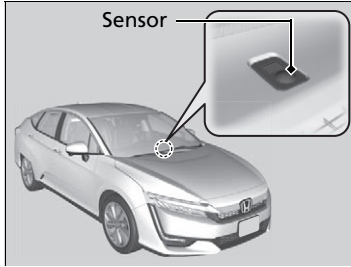

The automatic climate control system is equipped with sensors. Do not cover or spill any liquid on them.

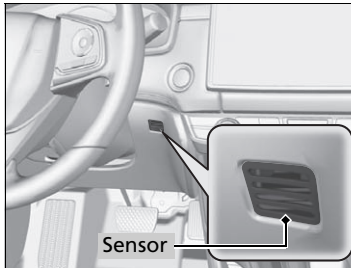

Features

This chapter describes how to operate technology features.

Audio System

About Your Audio System	204
USB Ports	205
Audio System Theft Protection	206
Audio Remote Controls	207
Audio System Basic Operation	210
Audio/Information Screen	211
Adjusting the Sound	236
Display Setup	237
Voice Control Operation	239
Playing AM/FM Radio	243
Playing SiriusXM® Radio*	247

Playing an iPod	255
Song By Voice™ (SBV)	258
Playing Pandora®*1	262
Playing a USB Flash Drive	264
Playing <i>Bluetooth</i> ® Audio	267
HondaLink®	269
Wi-Fi Connection	274
Siri Eyes Free	276
Apple CarPlay	277
Android Auto	280
Audio Error Messages	284

General Information on the Audio

System	288
Customized Features	306
HomeLink® Universal Transceiver*	332
Bluetooth® HandsFreeLink®	335

*1: Available only on U.S. models.

* Not available on all models

About Your Audio System

The audio system features AM/FM radio and SiriusXM® Radio service*. It can also play USB flash drives, and iPod, iPhone and *Bluetooth*® devices.

You can operate the audio system from the buttons and switches on the panel, the remote controls on the steering wheel, or the icons on the touchscreen interface.

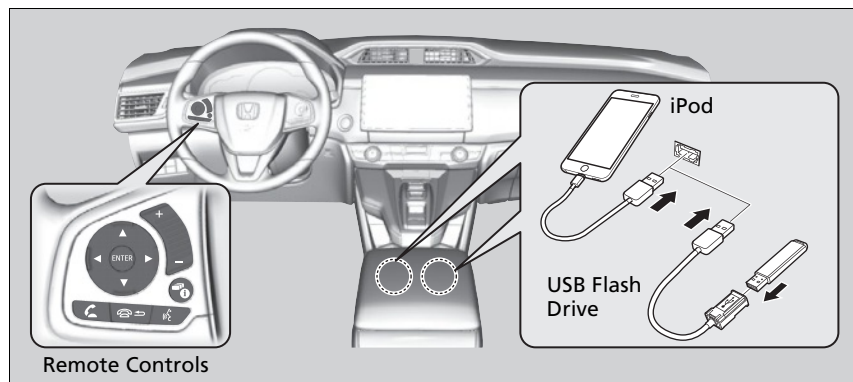

About Your Audio System

SiriusXM® Radio* is available on a subscription basis only. For more information on SiriusXM® Radio*, contact an authorized Honda Clarity Plug-In Hybrid dealer.

General Information on the Audio System P. 288

SiriusXM® Radio* is available in the United States and Canada, except Hawaii, Alaska, and Puerto Rico.

SiriusXM®* is a registered trademark of SiriusXM Radio, Inc.

iPod, iPhone and iTunes are trademarks of Apple Inc.

State or local laws may prohibit the operation of handheld electronic devices while operating a vehicle.

USB Ports

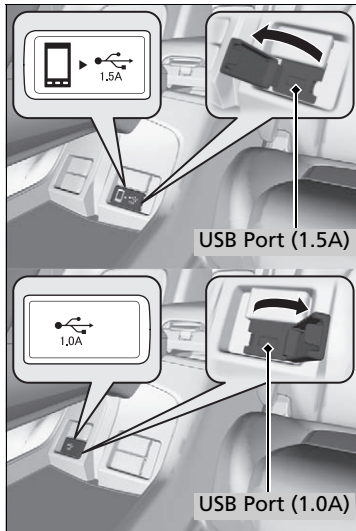

Install the device USB connector or the USB flash drive to the USB port.

- ▶ The USB port (1.5A) is for charging devices, playing audio files and connecting compatible phones with Apple CarPlay or Android Auto.
- ▶ The USB port (1.0A) is for playing audio files on the USB flash drive and connecting a cellular phone and charging device.

USB Ports

- Do not leave the iPod or USB flash drive in the vehicle. Direct sunlight and high temperatures may damage it.
- We recommend using an extension cable with the USB port.
- Do not connect the iPod or USB flash drive using a hub.
- Do not use a device such as a card reader or hard disk drive, as the device or your files may be damaged.
- We recommend backing up your data before using the device in your vehicle.
- Displayed messages may vary depending on the device model and software version.

If the audio system does not recognize the iPod, try reconnecting it a few times or reboot the device. To reboot, follow the manufacturer's instructions provided with the iPod or visit www.apple.com/ipod.

USB charge

The USB port can supply up to 1.0A or 1.5A of power. It does not output 1.0A or 1.5A unless requested by the device.

For amperage details, read the operating manual of the device that needs to be charged.

Turn the power mode to ACCESSORY or ON first.

Under certain conditions, a device connected to the port may generate noise in the radio you are listening to.

Audio System Theft Protection

The audio system is disabled when it is disconnected from the power source, such as when the 12-volt battery is disconnected or goes dead. In certain conditions, the system may display a code entry screen. If this occurs, reactivate the audio system.

■ Reactivating the audio system

1. Set the power mode to ON.
2. Turn on the audio system.
3. Select and hold the audio system power icon for more than two seconds.
 - ▶ The audio system is reactivated when the audio control unit establishes a connection with the vehicle control unit. If the control unit fails to recognize the audio unit, you must go to an authorized Honda Clarity Plug-In Hybrid dealer and have the audio unit checked.

Audio Remote Controls

Allow you to operate the audio system while driving. The information is shown on the driver information interface.

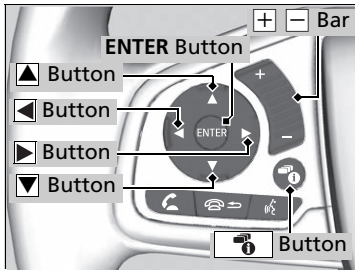

▲ ▼ Buttons

Press ▲ or ▼ to cycle through the audio mode as follows:

FM→AM→SiriusXM®*→USB→iPod
→Bluetooth® Audio→Pandora®*→Apple
CarPlay/Android Auto

ENTER Button

- When listening to the radio and SiriusXM®*
 1. Press **ENTER** to switch the display to a preset list you stored in the preset buttons.
 2. Press ▲ or ▼ to select a preset, then press **ENTER**.
- When listening to a USB flash drive
 1. Press **ENTER** to display the folder list.
 2. Press ▲ or ▼ to select a folder.
 3. Press **ENTER** to display a list of tracks in that folder.
 4. Press ▲ or ▼ to select a track, then press **ENTER**.

* Not available on all models

Continued

Audio Remote Controls











Some modes appear only when an appropriate device or medium is used.

Depending on the Bluetooth® device you connect, some functions may not be available.

Press the  (Hang-up/back) button to go back to the previous command or cancel a command.

Press the  button to switch display.

▶ **Switching the Display** P. 211

- When listening to an iPod
 1. Press **ENTER** to display the iPod music list.
 2. Press  or  to select a category.
 3. Press **ENTER** to display a list of items in the category.
 4. Press  or  to select an item, then press **ENTER**.
 - ▶ Press **ENTER** and press  or  repeatedly until the desired mode you want to listen to is displayed.
- When listening to Pandora®*
 1. Press **ENTER** to display the station list.
 2. Press  or  to select an item, then press **ENTER**.
- When listening to *Bluetooth*® Audio
 1. Press **ENTER** to display the track list.
 2. Press  or  to select a track, then press **ENTER**.

+ - (Volume) Bar

Press : To increase the volume.

Press : To decrease the volume.

◀ ▶ Buttons

- When listening to the radio

Press : To select the next preset radio station.

Press : To select the previous preset radio station.

Press and hold : To select the next strong station.

Press and hold : To select the previous strong station.

- When listening to an iPod, USB flash drive, or *Bluetooth*® Audio

Press : To skip to the next song.

Press : To go back to the beginning of the current or previous song.

- When listening to a USB flash drive

Press and hold : To skip to the next folder.

Press and hold : To go back to the previous folder.

- When listening to Pandora®*

Press : To skip to the next track.

Press and hold : To select the next station.

Press and hold : To select the previous station.

* Not available on all models

To use the audio system function, the power mode must be in ACCESSORY or ON.

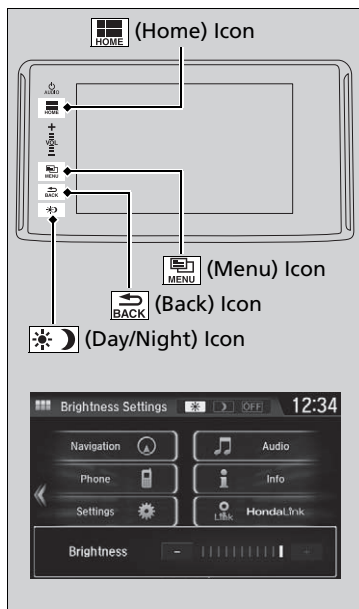

Select to go to the home screen.

➤ Using the audio/information screen

P. 212







Select to display available options including **Sound**, **View Radio Text**, **Music Search**, and playback modes.



Select to go back to the previous screen when the icon is illuminated.



(Day/Night): Select to change the audio/information screen brightness. Select  once and select  or  to make an adjustment.

- ▶ Each time you select , the mode switches among the daytime mode, nighttime mode and off mode.

➤ Audio System Basic Operation

Audio Menu Items

- **Station List** P. 244, 245
- **Music Search List** P. 256, 265
- **Scan** P. 245, 246, 254, 266
- **Play Mode** P. 257, 266

Audio/Information Screen

Displays the audio status and wallpaper. From this display, you can go to various setup options.

Switching the Display

Using the button

Press the  (display) button to change the display.

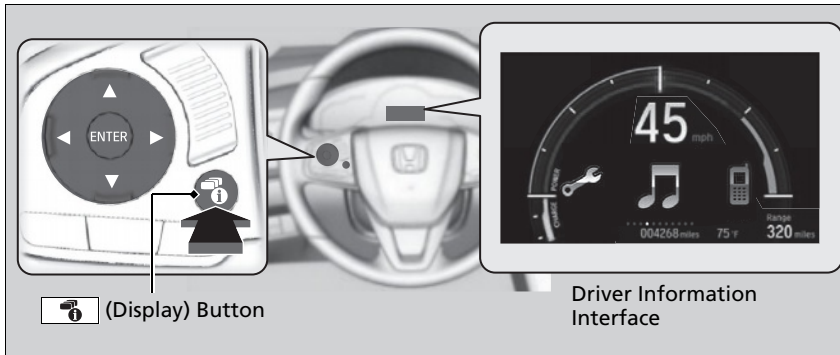



Using the button

You can edit, add, and delete the contents shown on the driver information interface.

Customizing the Meter P. 219

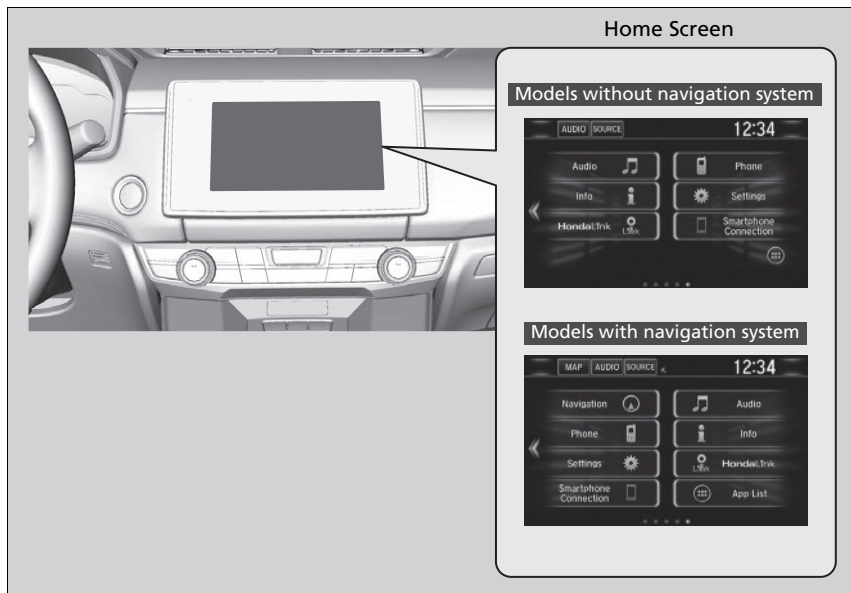
■ Using the audio/information screen



Select  to go to the home screen.

Select **Phone**, **Info**, **Audio**, **Settings**, **Navigation***, **HondaLink**, **Smartphone Connection (Apple CarPlay, Android Auto)**, **App List** () , or **Instrument Panel**.

■ Phone

Displays the HFL information.

 **Bluetooth® HandsFreeLink®** P. 335

■ Info

Displays **Trip Computer** or **Clock/Wallpaper**. Select  on the **Info Menu** screen to see all available options: **Trip Computer**, **Voice Info**, **Clock/Wallpaper**, **System/Device Information** and **Vehicle energy**.

Trip Computer:

- **Current Drive** tab: Displays the current trip information.
- **History of Trip A** tab: Displays information for the three previous drives. The information is stored every time you reset Trip A.
To delete the history manually, select **Delete history** on the **History of Trip A** tab. The confirmation message appears on the screen, then select **Yes**.

Voice Info: Displays a list of all voice commands.

Clock/Wallpaper: Displays the clock and wallpaper.

System/Device Information:

- **System Info:** Displays the software version of the audio system.
- **USB Info:** Displays the memory usage of the USB device.

Vehicle energy:

Displays the energy flow screen.

 **Energy flow screen** P. 215

■ Audio

Displays the current audio information.

 Audio/Information Screen**Touchscreen operation**

- Use simple gestures - including touching, swiping and scrolling - to operate certain audio functions.
- Some items may be grayed out during driving to reduce the potential for distraction.
- You can select them when the vehicle is stopped or use voice commands.
- Wearing gloves may limit or prevent touchscreen response.

You can change the touchscreen sensitivity setting.

 **Customized Features** P. 306

■ Settings*

Enters the customizing menu screen.

➤ **Customized Features** P. 306

■ Navigation*

Displays the navigation screen.

➤ **Refer to the Navigation System Manual**

■ HondaLink®

Displays the Hondalink® screen.

➤ **HondaLink®** P. 269

■ Smartphone Connection

Connects with your smartphone*¹ and allows some apps on your smartphone to be used on the audio system.

➤ **Apple CarPlay** P. 277

➤ **Android Auto** P. 280

■ App List

Adds or removes apps or widgets on the Home screen.

➤ **Home Screen** P. 225

■ Instrument Panel

Selects from three customizable settings for the driver information interface.

■ Energy flow screen

The energy flow screen shows the vehicle's power flow, and range.

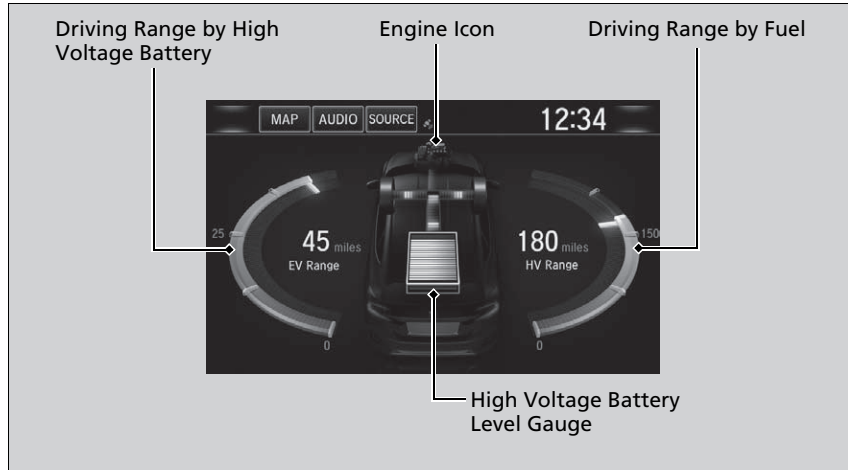

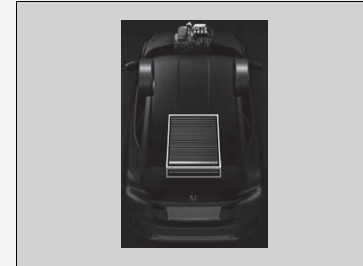

⌘ Energy flow screen

While the vehicle is stationary with the engine running, the following may appear on the display.







Shows the engine and High Voltage battery power flow, indicating what is supplying power to the vehicle and/or charging the battery.

- ▶ The indicator for the power transmission appears in blue, and for the battery charging operation, in green.

Display	Color of indicators	Vehicle's Condition
	Blue	While Driving: Power is being supplied by the engine.
	Blue	While Driving: Power is being supplied by the High Voltage battery.
	Blue	While Driving: Power is being supplied by the High Voltage battery and engine.

▶▶ Energy flow screen

While the engine provides propulsion directly to the wheels, the  icon appears in the power flow monitor on the screen.

Display	Color of indicators	Vehicle's Condition
	Green	While Decelerating: High Voltage battery is being charged by regenerative braking and engine.
	Green	While Decelerating: High Voltage battery is being charged by regenerative braking. When the engine is running, the engine icon is turned on.
	Blue and Green	While Driving: Power is being supplied and the High Voltage battery is being charged by the engine.

Display	Color of indicators	Vehicle's Condition
	Green	When Stopped: The vehicle is idle and the High Voltage battery is being charged by the engine.

Changing the Home Screen Icon Layout

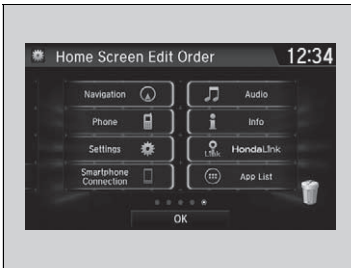

1. Select .
2. Select and hold an icon.
 - ▶ The screen switches to the customization screen.
3. Drag and drop the icon to where you want it to be.
4. Select **OK**.
 - ▶ The screen will return to the home screen.

Customizing the Meter

You can edit, add, or delete the meter contents on the driver information interface.

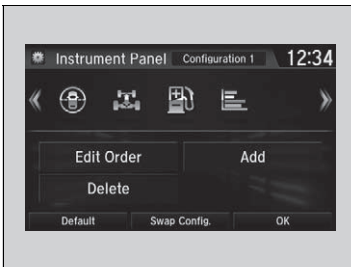

1. .
2. **Settings**
3. **System**
4. **Configuration of Instrument Panel**

Customizing the Meter

You can store up to three customized configurations. To select or customize a configuration, press **Swap Config.**

When you select **Swap Config.** during customization, the settings you changed will be saved.

When you select  during customization, the settings you changed will not be saved and you will be returned to the **Configuration of Instrument Panel** screen.

■ Editing order

To change the order of the icons on the driver information interface, first select:

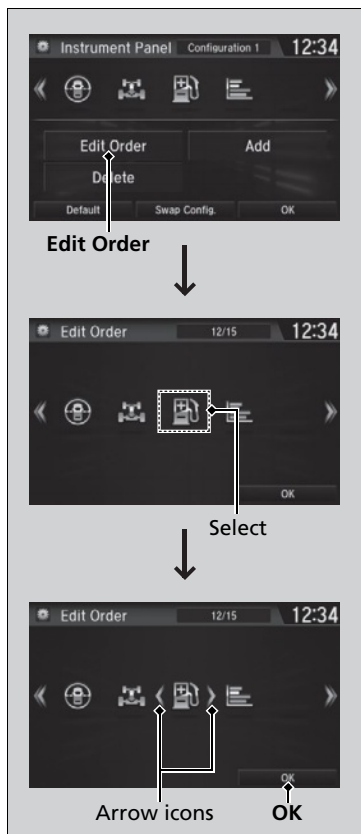

1. Edit Order

2. Select the icon you want to move.

- ▶ You will see arrows on both sides of the selected icon.

3. Select the left or right arrow repeatedly to move the icon to your desired position.

4. Select **OK**.

- ▶ The screen will return to the **Configuration of Instrument Panel** screen.

▶▶ Editing order

You can use an alternative method to change the order of the icons. First select:

1. **Edit Order**

2. Select and hold the icon you want to move.

3. Drag and drop the icon to where you want it to be.

4. Select **OK**.

- ▶ The screen will return to the **Configuration of Instrument Panel** screen.

■ Adding contents

You can add icons to the driver information interface. To add icons, first select:

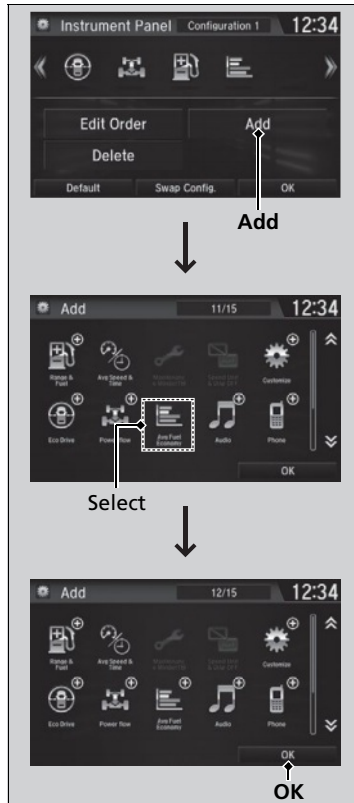

1. Add

2. Select an icon you want to add.

- ▶ You will see a plus mark on the upper right hand corner of the selected icon.

3. Select **OK**.

- ▶ The screen will return to the **Configuration of Instrument Panel** screen.

▶▶ Adding contents

Icons that are grayed out cannot be selected.

If an icon has a plus mark in the upper-right corner, it means that the icon has already been added.

■ Deleting contents

To delete contents on the driver information interface, first select:

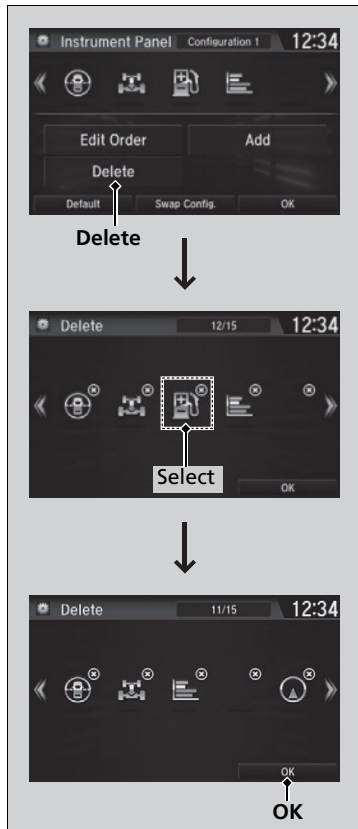

1. Delete

2. Select an icon you want to delete.

- ▶ The icon with an **X** on the upper right hand corner can be deleted.

3. Select **OK**.

- ▶ The screen will return to the **Configuration of Instrument Panel** screen.

▶▶ Deleting contents

You can also delete contents by selecting:

1. **Delete** or **Edit Order**

2. Select and hold an icon you want to delete.
3. Drag and drop the icon to the trash icon.
4. Select **OK**.

- ▶ The screen will return to the **Configuration of Instrument Panel** screen.

Wallpaper Setup

You can change, store, and delete the wallpaper on the audio/information screen.

Import wallpaper

You can import up to five images, one at a time, for wallpaper from a USB flash drive.

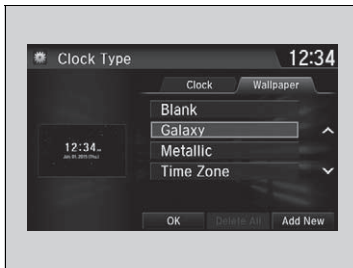

1. Connect the USB flash drive to the USB port.
 ▶ **USB Ports** P. 205
2. Select **Settings**.
3. Select **Clock**.
4. Select **Clock/Wallpaper Type**, then open the **Wallpaper** tab.
5. Select **Add New**.
 ▶ The picture name is displayed on the list.
6. Select a desired picture.
 ▶ The preview is displayed on the left side on the screen.
7. Select **Start Import** to save the data.
 ▶ The display will return to the wallpaper list.

Wallpaper Setup

The wallpaper you set up on **Clock Wallpaper/Type** cannot be displayed on the driver information interface.

- When importing wallpaper files, the image must be in the USB flash drive's root directory. Images in a folder cannot be imported.
- The file name must be fewer than 64 characters.
- The file format of the image that can be imported is BMP (bmp) or JPEG (jpg).
- The individual file size limit is 5 MB.
- The maximum image size is 4,096 × 4,096 pixels. If the image size is less than 800 × 480 pixels, the image is displayed in the middle of the screen with the extra area appearing in black.
- If the USB flash drive does not have any pictures, the **No files detected** message appears.

After changing the screen interface design, you can change the wallpaper by following procedure.

1. Select .
2. Select and hold empty space on the home screen. The pop-up menu appears on the screen.
3. Select **Change wallpaper**.
4. Select **Gallery**, **Live wallpapers**, or **Wallpapers**.

■ Select wallpaper

1. Select **Settings**.
2. Select **Clock**.
3. Select **Clock/Wallpaper Type**, then open the **Wallpaper** tab.
 - ▶ The screen changes to the wallpaper list.
4. Select a desired wallpaper.
 - ▶ The preview is displayed on the left side on the screen.
 - ▶ The pop-up menu appears on the screen.
5. Select **Set**.
 - ▶ The display will return to the wallpaper list.

■ To view wallpaper once it is set

1. Select .
2. Select **Info**.
3. Select .
4. Select **Clock/Wallpaper**.

■ Delete wallpaper

1. Select **Settings**.
2. Select **Clock**.
3. Select **Clock/Wallpaper Type**, then open the **Wallpaper** tab.
 - ▶ The screen changes to the wallpaper list.
4. Select a wallpaper that you want to delete.
 - ▶ The preview is displayed on the left side on the screen.
 - ▶ The pop-up menu appears on the screen.
5. Select **Delete**.
 - ▶ A confirmation message appears on the screen.
6. Select **Yes** to delete completely.
 - ▶ The display will return to the wallpaper list.

⌘ Wallpaper Setup

From the pop-up menu, select **Preview** to see a preview at full-size screen.

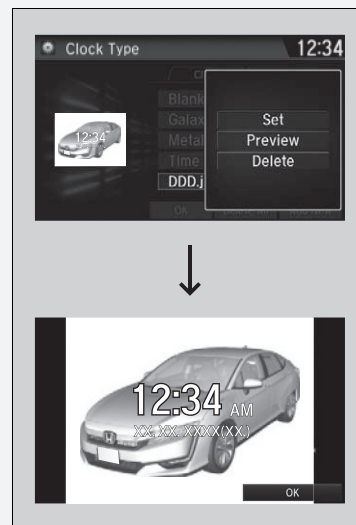

To go back to the previous screen, select **OK**, or select .



When the file size is large, it takes a while to be previewed.

To delete all wallpapers you add, select **Delete All**, then **Yes**.

Home Screen

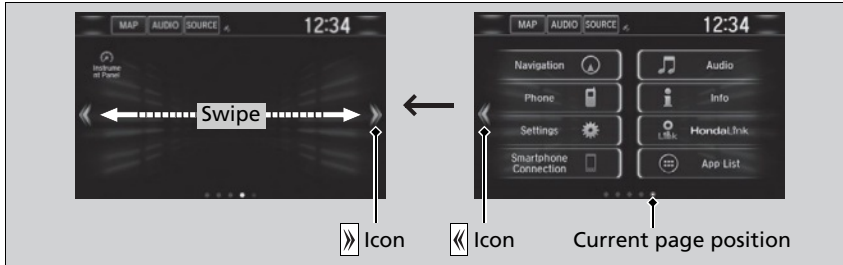
■ To change to a next screen



Selecting  or , or swiping the screen left or right changes to the next screen.

Home Screen

The home screen has 5 pages (fixed). You cannot add any more pages.

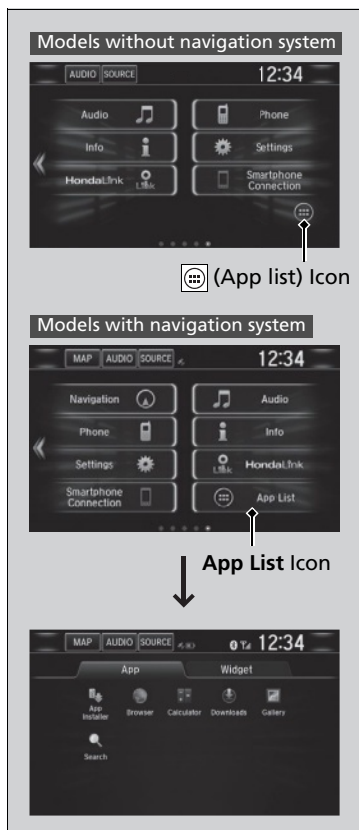

Select  to go directly back to the first page of the home screen from any page.

■ To use apps or widgets



(App list) Icon

App List Icon

1. Select .
2. Select **App List** or  icon.
▶ The **App** screen appears.
3. Select the app or widget you want to use.

Preinstall app list:

- **Browser:** Displays the web browser utilized by smartphone and Wi-Fi connection.
- **Calculator:** Displays Calculator.
- **Gallery:** Displays images.
- **Downloads:** Displays the data downloaded from the web browser and so on.
- **App Installer:** Check with a Honda dealer for apps that are available for installation.
- **Search:** Displays various retrieval screen.

▶▶ To use apps or widgets

Select and hold a selected app or widget to add that app's or widget's shortcut on the home screen.

Pre-installed apps may not start up normally. If this occurs, you need to reset the system.

▶▶ **Defaulting All the Settings** P. 331

If you perform **Factory Data Reset**, it may reset all the settings to their factory default.

▶▶ **Defaulting All the Settings** P. 331

In case those apps still do not startup normally even after **Factory Data Reset**, contact an authorized Honda Clarity Plug-In Hybrid dealer.

There is a possibility that a browser is shut down in the situation of the use. In that situation, the screen will return to before the browser startup.

Do not install apps other than those confirmed by a Honda dealer. Installation of unauthorized apps may introduce data corruption risks to your vehicle's information and your privacy.

You can delete user installed apps by the following procedure.

1. Select .
2. Select **Settings**.
3. Select **System**.
4. Select the **Others** tab.
5. Select **Detail Information**.
6. Select **Apps**.
7. Select an app that you want to delete.
8. Select **Delete**.

Pre-installed apps cannot be deleted.

■ To add app or widget icons on the home screen

App or widget icons can be added on the home screen.

1. Select .
2. Select .
3. Select and hold empty space on the home screen.
 - ▶ The pop-up menu appears on the screen.
4. Select **Add App** or **Add Widget**.
 - ▶ The **App/Widget** screen appears.

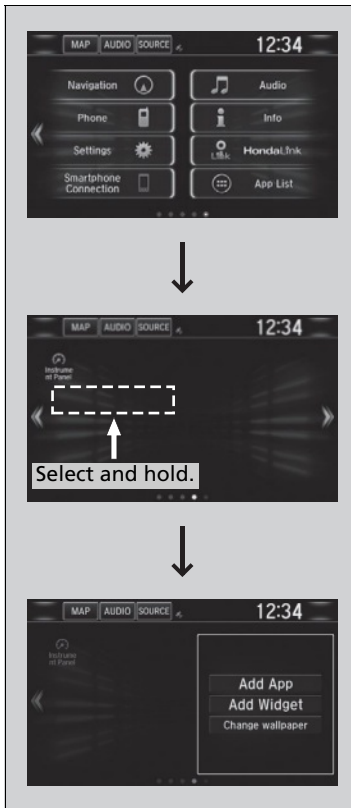

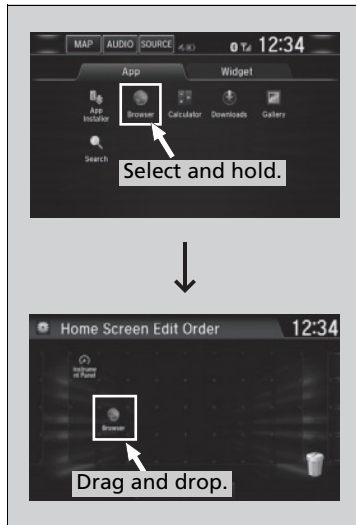

5. Select and hold an app or widget icon you want to add.
 - ▶ The screen switches to the customization screen.
6. Drag and drop the icon to where you want it to be.
7. Select **OK**.
 - ▶ The screen will return to the home screen.

■ To move icons on the home screen

You can change location on the home screen.

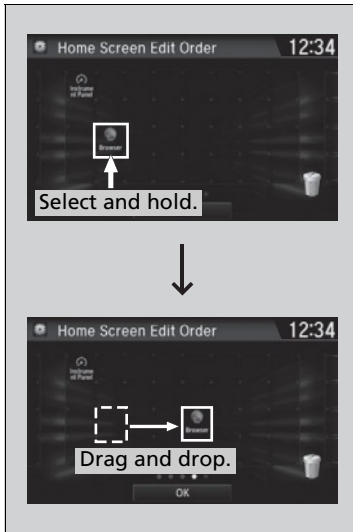

1. Select and hold an icon.
 - ▶ The screen switches to the customization screen.
2. Drag and drop the icon to where you want it to be.
3. Select **OK**.
 - ▶ The screen will return to the home screen.

☒ To move icons on the home screen

You can also move the **Phone, Info, Audio, Settings, Navigation***, **HondaLink, Smartphone Connection, App List** (☒), and **Instrument Panel** icons in the same manner.

* Not available on all models

■ To remove icons on the home screen

You can delete the icons on the home screen.

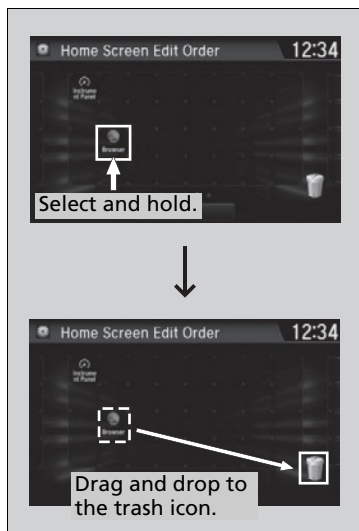

1. Select and hold an icon.
 - ▶ The screen switches to the customization screen.
2. Drag and drop the icon you want to remove to the trash icon.
 - ▶ The icon is removed from the home screen.
3. Select **OK**.
 - ▶ The screen will return to the home screen.

✎ To remove icons on the home screen

You cannot delete the **Phone, Info, Audio, Settings, Navigation*, HondaLink, Smartphone Connection, App List** (☰), and **Instrument Panel** icons.

Apps or widgets will not be deleted by deleting the icon on the home screen.

■ To change the home screen wallpaper

You can change a wallpaper of the home screen.

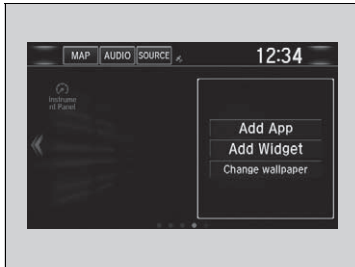

1. Select and hold empty space on the home screen.
 - ▶ The pop-up menu appears on the screen.
2. Select **Change wallpaper**.
 - ▶ The pop-up menu appears on the screen.

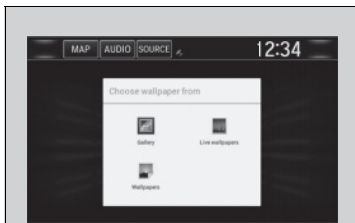

3. Select an app for selecting wallpapers.
4. Select the wallpaper you want to change.
5. Select **Set wallpaper**.
 - ▶ The wallpaper is changed, then the screen will return to the home screen.



Continued

Status Area

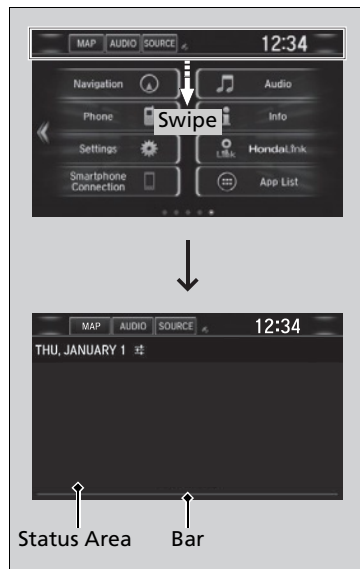

1. Swipe the upper area of the screen.
 - ▶ The status area appears.
2. Select an item to see the details.
3. Select **BACK** or swipe up the bottom bar to close the area.

Changing the Screen Interface

You can change the screen interface design.

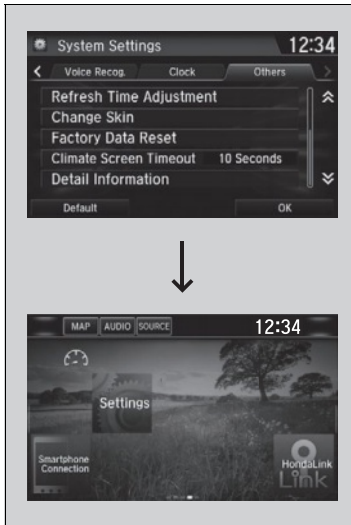

1. Select .
2. Select **Settings**.
3. Select **System**.
4. Select the **Others** tab.
5. Select **Change Skin**.
6. A confirmation message appears on the screen. Select **Yes**.

Changing the Screen Interface

After changing the screen interface design, you can change the wallpaper by following procedure.

1. Select .
2. Select and hold empty space on the home screen. The pop-up menu appears on the screen.
3. Select **Change wallpaper**.
4. Select **Gallery**, **Live wallpapers**, or **Wallpapers**.

If you change the screen interface, some of the setting items will change.

➤ **Customized Features** P. 306

Menu Customize

You can change menu icons on the right side of **Audio**, **Phone**, and **Info** screen.

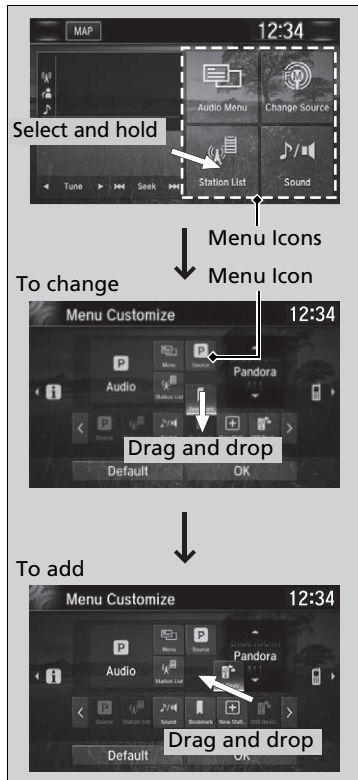

1. Select and hold menu icon.

2. Select ◀ or ▶ icon, then **Audio**, **Phone**, or **Info** from **Menu Customize**.

3. Select and hold the menu icon you want to change, then drag and drop the icon to the bottom.

4. Select and hold the menu icon you want to add, then drag and drop the icon to above.

5. Select **OK**.

Menu Customize

You can also use the method below to change menu icon:

Select **Settings**→**System**→**Home tab**→**Menu Icon Position**

■ Closing Apps

You can close specific apps running in the background on the system.

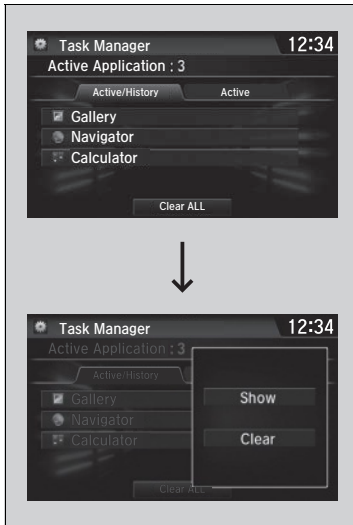

1. Select and hold .
2. Select the **Active** tab.
 - ▶ If you select the **Active/History** tab, you can close the apps that are currently running and delete the app activity history simultaneously.
3. Select an app you want to close.
4. Select **Clear**.
 - ▶ The display will return to the app list.

⌘ Closing Apps

If you have a number of apps running in the background and something goes wrong with the audio system, some of those apps may not work properly. If this happens, close all the apps and re-launch the app/apps that you want to use.

To close all apps on the system, select **Clear All**, then **Yes**.

You cannot close the HondaLink® and Garmin* apps.

* Not available on all models

Adjusting the Sound

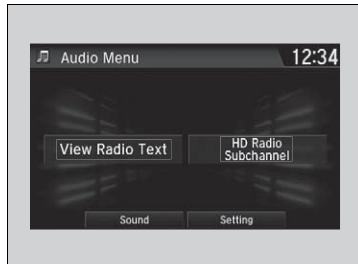

1. Select .
2. Select **Audio**.
3. Select .
4. Select **Sound**.

Select a tab from the following choices:

- **BAS-MID-TRE:** Bass, Middle, Treble
- **FAD-BAL:** Fader, Balance
- **SVC:** Speed Volume Compensation

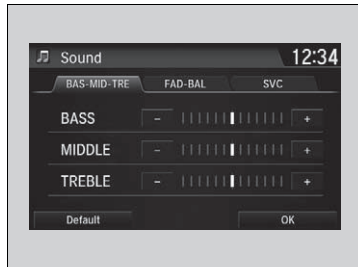

▶▶ Adjusting the Sound

The SVC has four modes: **Off**, **Low**, **Mid**, and **High**. SVC adjusts the volume level based on the vehicle speed. As you go faster, audio volume increases. As you slow down, audio volume decreases.

Display Setup

You can change the brightness or color theme of the audio/information screen.

Changing the Screen Brightness

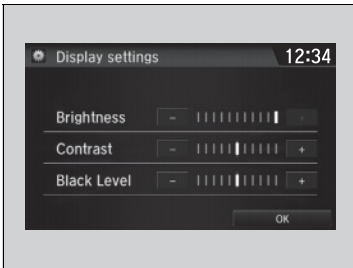

1. Select .
2. Select **Settings**.
3. Select **System**.
4. Select the **Display** tab.
5. Select **Display Settings**.
6. Select the setting you want.
7. Select **OK**.

Changing the Screen's Color Theme



1. Select .
2. Select **Settings**.
3. Select **System**.
4. Select the **Display** tab.
5. Select **Background Color**.
6. Select the setting you want.
7. Select **OK**.

Changing the Screen Brightness

You can change the **Contrast** and **Black Level** settings in the same manner.

■ Selecting an Audio Source

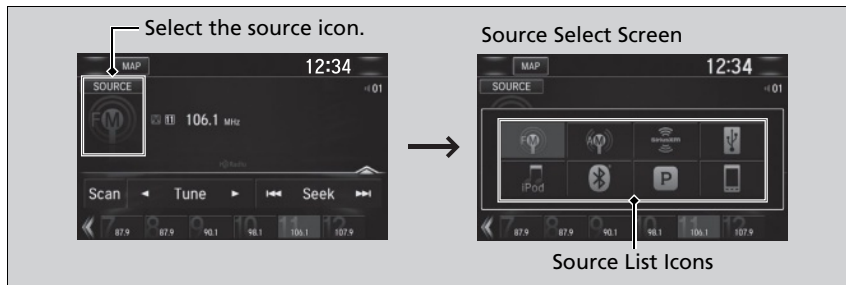



Select the current source icon, then select an icon on the source list to switch the audio source.

■ Limitations for Manual Operation

Certain manual functions are disabled or inoperable while the vehicle is in motion. You cannot select a grayed-out option until the vehicle is stopped.

Voice Control Operation

Your vehicle has a voice control system that allows hands-free operation.



The voice control system uses the  (Talk) and  (hang-up/back) buttons on the steering wheel and a microphone near the map lights in the ceiling.

Voice Recognition

To achieve optimum voice recognition when using the voice control system:

- Make sure the correct screen is displayed for the voice command that you are using.
The system recognizes only certain commands.
Available voice command P. 240
- Close the windows.
- Adjust the dashboard and side vents so air does not blow onto the microphone in the ceiling.
- Speak clearly in a natural speaking voice without pausing between words.
- Reduce any background noise if possible. The system may misinterpret your command if more than one person is speaking at the same time.

☒ Voice Control Operation

When you press the  button, a helpful prompt asks what you would like to do. Press and release the  button again to bypass this prompt and give a command.

☒ Voice Recognition

The voice control system can only be used from the driver's seat because the microphone unit removes noises from the front passenger's side.

Continued

■ Voice Portal Screen

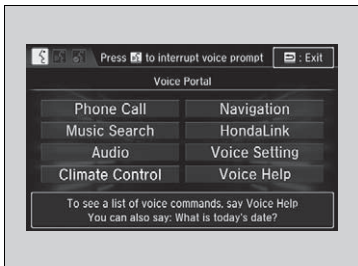

When the  (Talk) button is pressed, available voice commands appear on the screen.

For a complete list of commands, say "Voice Help" after the beep or select **Voice Help**.

You can see the list of commands in **Voice Info** on the **Info Menu** screen. Select **Info**, then select .

The system only recognizes the commands on the following pages, at certain screens. Free form voice commands are not recognized.

*1: Models with navigation system

* Not available on all models

■ Phone Call

This can be only used when the phone is connected. When the system recognizes the *Phone call* command, the screen will change to the voice recognition screen for phone commands.

- *Dial by Number*
- *Call History*
- *Redial*
- *Call <Your contact Name>*
- *Call <Phone Number>*
- *Call Police*
- *Call 911*

Phone Call commands are not available if using Apple CarPlay.

■ Music Search

This can be only used when the iPod or USB device is connected.

■ Climate Control*1

When the system recognizes the *Climate Control* command, the screen will change the dedicated screen to the climate control voice recognition screen.

➤ **Climate Control Commands*1** P. 242

■ Audio*1

When the system recognizes the *Audio* command, the screen will change to the audio voice recognition screen.

- *Audio On*2*
- *Audio Off*2*
- *Radio FM*
- *Radio AM*
- *Radio SXM*
- *PANDORA**
- *iPod*
- *USB*
- *Other Sources*

Pandora®* cannot be used while Android Auto is active.

■ Navigation*1

The screen changes to the navigation screen.

➤ **Refer to the Navigation System Manual**

■ HondaLink®

This can be only used when the phone is connected.

*2: These commands toggle the function on and off, so the command may not match your intended action.

■ Voice Setting

The screen changes to the **Voice Recog.** tab on the **System Settings** screen.

■ Voice Help

You can see a list of the available commands on the screen.

- *Useful Commands**¹
- *Phone Commands*
- *Audio Commands**¹
- *On Screen Commands*
- *Music Search Commands*
- *General Commands**¹
- *Climate Control Commands**¹

■ Useful Commands*¹

The system accepts these commands on the voice portal top screen.

- *Call <Phone Number>*
- *Call <Your contact Name>*
- *What time is it?*
- *What is today's date?*

*¹: Models with navigation system

* Not available on all models

■ Phone Commands

The system accepts these commands on the dedicated screen for the voice recognition of the phone.

- *Call by number*
- *Call by name*
- *Call <Phone Number>*
- *Call <Your contact Name>*

■ Audio Commands*¹

The system accepts these commands on the dedicated screen for the voice recognition of the audio.

■ Radio FM Commands

- *Radio tune to <87.7-107.9> FM*
- *Radio tune to <87.7 -107.9> HD <1-8> FM*
- *Preset <1-12>*

■ Radio AM Commands

- *Radio tune to <530-1710> AM*
- *Preset <1-6>*

■ Radio SXM Commands

- *SXM channel <1-999>*
- *SXM channel <channel name, category name, traffic and weather city name, sports team name>*
- *SXM preset <1-12>*

■ Pandora Commands*

- *PANDORA play*

■ iPod Commands

- *iPod play*
- *iPod play track <1-30>*
- *Music Search*
- *What album is this?*
- *What am I listening to?*

■ USB Commands

- *USB play*
- *USB play track <1-30>*
- *Music Search*
- *What album is this?*
- *What am I listening to?*

■ Bluetooth® audio Commands

- *Bluetooth® audio play*

NOTE:

Bluetooth® Audio commands may not work on some phones or *Bluetooth®* Audio devices.

■ On Screen Commands

When **On Screen Commands** is selected, the explanation screen is displayed.

■ Music Search Commands

The system accepts these commands on the **Music Search** screen.

■ Using Song By Voice

Song By Voice™ is a feature that allows you to select music from your iPod or USB device using Voice Commands. To activate this mode, you must push the talk switch and say: "Music search".

■ Song By Voice Commands

- *What am I listening to?*
- *Who am I listening to?*
- *Who is this?*
- *What's playing?*
- *Who's playing?*
- *What album is this?*

■ Play Commands

- *Play artist <Name>*
- *Play track/song <Name>*
- *Play album <Name>*
- *Play genre/category <Name>*
- *Play playlist <Name>*
- *Play composer <Name>*

■ List Commands

- *List artist <Name>*
- *List album <Name>*
- *List genre/category <Name>*
- *List playlist <Name>*
- *List composer <Name>*

■ General Commands*1

- *What time is it?*
- *What is today's date?*

■ Climate Control Commands*1

- *Climate Control On*^{*2}
- *Climate Control Off*^{*2}
- *Fan speed <1-7>*
- *Temperature max heat*
- *Temperature max cool*
- *Temperature <57-87> degrees*^{*3}
- *Temperature <18-32> degrees*^{*4}
- *Defrost On*^{*2}
- *Defrost Off*^{*2}
- *Air conditioner On*^{*2}
- *Air conditioner Off*^{*2}
- *More*
- *Climate Control Automatic*
- *Vent*
- *Dash and floor*
- *Fan speed up*
- *Fan speed down*
- *Floor vents*
- *Floor and Defrost*
- *Temperature up*
- *Temperature down*

*2: These commands toggle the function on and off, so the command may not match your intended action.

*3: U.S. models

*4: Canadian models

*1: Models with navigation system

Playing AM/FM Radio

The diagram illustrates the controls for playing AM/FM radio. It features two main displays: the Driver Information Interface (top) and the Audio/Information Screen (bottom). The Driver Information Interface shows a speedometer at 45 mph, a radio frequency of 106.1 MHz, and a range of 320 miles. The Audio/Information Screen shows the time 12:34, the source FM, and the frequency 106.1 MHz. A control panel on the left side of the Audio/Information Screen includes buttons for AUDIO, HOME, VOL, MENU, BACK, and Scan. The Audio/Information Screen also has buttons for Open/Close, Preset, and Seek.

Driver Information Interface

Audio/Information Screen

Power/Audio Icon
Select to turn the audio system on and off.

VOL (Volume) Icons
Select to adjust the volume.

(Menu) Icon
Select to display the menu items.

(Back) Icon
Select to go back to the previous display.

Scan Icon
Select to scan each station with a strong signal.

Tune Icons
Select ◀ or ▶ to tune the radio frequency.

Open/Close Icon^{*1}
Displays/hides the detailed information.

Preset Icons
Tune the preset radio frequency. Select and hold the preset icon to store that station. Select >> to display preset 7 onwards.

Seek Icons
Select ▶▶ or ◀◀ to search the selected band up or down for a station with a strong signal.

*1: Some or all of the lists may not be displayed.

■ Preset Memory

To store a station:

1. Tune to the selected station.
2. Select and hold the preset number for the station you want to store.

You can also store a preset station by the following procedure.

1. Tune to the selected station.
2. Select the open/close icon to display a list.
3. Select the **Preset** tab.
4. Select and hold the preset number for the station you want to store.

■ Station List

Lists the strongest stations on the selected band.

1. Select the open/close icon to display a list.
2. Select the **Station List** tab.
3. Select the station.

■ Manual update



Updates your available station list at any time.

1. Select the open/close icon to display a list.
2. Select the **Station List** tab.
3. Select **Refresh**.

▶▶ Playing AM/FM Radio

The **ST** indicator appears on the display indicating stereo FM broadcasts. Stereo reproduction in AM is not available.

Switching the Audio Mode

Press the  or  button on the steering wheel or select **SOURCE** on the screen.

 **Audio Remote Controls** P. 207

You can store 6 AM stations and 12 FM stations into preset memory.

Models with HD Radio™ feature

HD Radio Technology manufactured under license from iBiquity Digital Corporation. U.S. and Foreign Patents. HD Radio™ and the HD, HD Radio, and “Arc” logos are proprietary trademarks of iBiquity Digital Corp.



HD Radio™ stations not available in all locations in Canada.

■ Scan

Samples each of the strongest stations on the selected band for 10 seconds. To turn off scan, select **Cancel** or .

Models with HD Radio™ feature

■ HD Subchannel

Displays the subchannel list when an HD Radio™ station is selected while listening to an FM station.

1. Select .
2. Select **HD Radio Subchannel**.
3. Select the channel number.

■ Radio Data System (RDS)

Provides text data information related to your selected RDS-capable FM station.

■ To find an RDS station from Station List

1. Select the open/close icon to display a list while listening to an FM station.
2. Select the **Station List** tab.
3. Select the station.

■ Manual update

Updates your available station list at any time.

1. Select the open/close icon to display a list while listening to an FM station.
2. Select the **Station List** tab.
3. Select **Refresh**.

⌘ Radio Data System (RDS)

When you select an RDS-capable FM station, the RDS automatically turns on, and the frequency display changes to the station name. However, when the signals of that station become weak, the display changes from the station name to the frequency.

■ Radio text

Displays the radio text information of the selected RDS station.

1. Select .
2. Select **View Radio Text**.

■ Scan

Samples each of the strongest stations on the selected band for 10 seconds.

To turn off scan, select **Cancel** or .

Playing SiriusXM® Radio*

Channel Icons
 Select or to the previous or next channel.
 Select and hold to rapidly skip 10 channels at a time.

Driver Information Interface

Album Art

Audio/Information Screen

Station Art

Open/Close Icon^{*1}
 Displays/hides the detailed information.

Preset Icons
 Tune the preset radio station. Select and hold the preset icon to store that station. Select to display preset 7 onwards.

Skip Icons
 Select or to change section in the channel.
 Select and hold to move rapidly within the section.

AUDIO (Power/Audio) Icon
 Press to turn the audio system on and off.

VOL (Volume) Icons
 Select to adjust the volume.

(Menu) Icon
 Select to display the menu items.

(Back) Icon
 Select to go back to the previous display.

Scan Icon
 Select to scan each channel.

Category Icons
 Select or to display and select a SiriusXM® Radio category.

*1:Some or all of the lists may not be displayed.

* Not available on all models

■ To Change the Tune Mode

1. Select .
2. Select **Tune Mode**.
3. Select **Channel Mode** or **Category Mode**.



▶▶ Playing SiriusXM® Radio*

In the channel mode, all available channels are selectable. In the category mode, you can select a channel within a category (Jazz, Rock, Classical, etc.).

There may be instances when SiriusXM® Radio does not broadcast all the data fields (artist name, title). This does not indicate a problem with your audio system.

SiriusXM® Radio stations load in ascending order, which can take about a minute. Once they have loaded you will be able to scroll up or down to make your selections.

Switching the Audio Mode

Press the  or  button on the steering wheel or select **SOURCE** on the screen.

 **Audio Remote Controls** P. 207

Tune Start:

When you change to a preset channel, a song being played on that channel restarts from the beginning with this function. This can be turned on or off from the **Audio settings** screen.

 **Customized Features** P. 306

■ Preset Memory

To store a channel:

1. Tune to the selected channel.
2. Press and hold the preset number for the station you want to store.
 - ▶ If **Multiple Channel Mix Preset** setting to **On**, then select **Replace**.

You can also store a channel by the following procedure.

1. Tune to the selected channel.
2. Select the open/close icon to display a list.
3. Select the **Preset** tab.
4. Select and hold the preset number for the station you want to store.

■ Multi-channel preset (for music channels only)

You can store up to five of your preferred music channels to preset numbers.



1. Tune a station.
2. Select the open/close icon to display a list.
3. Select the **Preset** tab.
4. Select and hold the preset number you want to add a music channel.
 - ▶ A message appears if there are no available presets.
5. Select **Combine**.

▶▶ Playing SiriusXM® Radio*

You can store 12 SiriusXM® channels into the preset memory.

▶▶ Multi-channel preset (for music channels only)

To store a multi-channel preset, you need to setup the **Multiple Channel Mix Preset** setting to **On**.

▶ **Customized Features** P. 306

■ Listening to Featured Channels

Suggested channel listing received from SiriusXM® can be displayed and selected.

1. Select the open/close icon to display a channel list.
2. Select the **Channel** tab.
3. Select the featured channel list title you want to listen to.
 - ▶ The selected channel list of the title is displayed.
4. Select the channel.

▶▶ Listening to Featured Channels

Up to three featured channels by SiriusXM® can be displayed.

Featured channel lists are at the top of the channel list.

Replay Function

The system can record up to the last 60 minutes of your currently tuned channel's broadcast, as well as the last 30 minutes of your preset channel's broadcast, starting from the moment you turn the vehicle on. If you tuned to a preset channel, the system records up to 60 minutes of a broadcast instead of up to 30 minutes. You can rewind and replay the last 30 or 60 minutes of a broadcast.

1. Select .
2. Select **Playback**.
3. Move the time marker to the position you want to replay.

The following items are available on the pop-up screen:

 (Skip Down): Skips to the previously stored channel. Select and hold to fast-rewind the current selection.

 (Skip Up): Skips to the next channel. Select and hold to fast-forward the current selection.

 (15sec Back): Select to skip back 15 seconds in the current selection. Select and hold to fast-rewind the current selection.

 (15sec Skip): Select to skip forward 15 seconds in the current selection. Select and hold to fast-forward the current selection.

- ▶ Select **OK** to close the pop-up menu. Replay in playback mode continues.

To play or pause on playback mode:

1. Select .
2. Select **Play/Pause**.

Replay Function

The system starts storing broadcast in memory when the power mode is turned ON. You can go back to the program from that point.

You can no longer replay any program once the power mode is turned off as it erases memory. You can check how long the program has been stored in memory from the audio/information screen.

After 30 or 60 minutes of recording the system will automatically start deleting the oldest data.

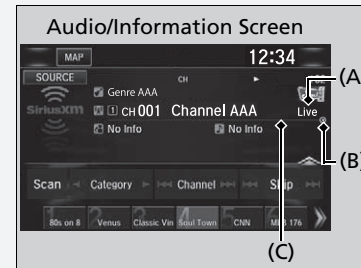

(A): Shows how much time the replayed segment is behind the real-time broadcast

(B): Replayed segment

(C): Length stored in memory

When you listen a multi-channel preset while at the playback mode, the replayed segment is not displayed.

■ Returning to real-time broadcast

1. Select .
2. Select **Go to Live**.

■ Live Sports Alert

While listening to other channels, you can receive sports alerts such as scores from the games of your favorite teams.

■ To set up a favorite team

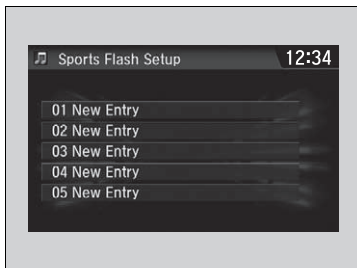

1. Select .
2. Select **Settings**.
3. Select **Audio**.
4. Select **SportsFlash Setup**.
5. Select **Favorite Team**.
6. Select a team.

■ To set up an alert message

1. Select .
2. Select **Settings**.
3. Select **Audio**.
4. Select **SportsFlash Setup**.
5. Select **Interrupt**.
6. Select **On(One Time)** or **On(Continue)**.

▶▶ Live Sports Alert

The sports alert function is available in SiriusXM® mode only.

▶▶ To set up a favorite team

Sports alerts cut in only when SiriusXM® mode is on. Selecting **On(One Time)** from the customized settings disables the alert feature next time you turn the power mode to ON.

▶▶ **Customized Features** P. 306

You can also set up a favorite team by the following procedure.

1. Select **Audio**.
2. Select .
3. Select **Setting**.
4. Select **SportsFlash Setup**.

■ To set up an alert beep

1. Select .
2. Select **Settings**.
3. Select **Audio**.
4. Select **SportsFlash Setup**.
5. Select **Interrupt Beep**.
6. Select **On**.

■ Receiving a sports alert

1. A pop-up appears and notifies you of a sports alert.
2. Select **Listen**.
 - ▶ You can use the same items as the playback mode pop-up screen.
 - **Replay Function** P. 251

To go back to the previous screen, select **Back**.

■ Listening to a missed sports alert

If you have missed a sports alert:

1. Select .
2. Select **SportsFlash List**.
3. Select alert.

☒ To set up an alert beep

You can also set up an alert beep by the following procedure.

1. Select **Audio**.
2. Select .
3. Select **Setting**.
4. Select **SportsFlash Setup**.

Continued

■ Traffic and Weather Information

You can receive traffic and weather information.

■ To set up a traffic & weather information

1. Select .
2. Select **Settings**.
3. Select **Audio**.
4. Select **Traffic & Weather Setup**.
5. Select the region.
 - ▶ When you do not want to receive the information, select **Unregistered**.

■ Listening a traffic and weather information

1. Select .
2. Select **Traffic & Weather**.
 - ▶ Play mode can also use the any items same as playback mode.
 - ▶ **Replay Function** P. 251
 - To go back to the previous screen, select **OK**.

■ Scan

Sample each channel on the selected mode for 10 seconds.

1. Select **Scan**.
2. Select **Scan Channels**.
 - ▶ You can select the desired channel by songs using **Scan Song in Preset**.

To turn off scan, select **Cancel**.

☞ Traffic and Weather Information

The traffic and weather information function at SiriusXM® mode only.

You can also set up the traffic and weather information by the following procedure.

1. Select **Audio**.
2. Select .
3. Select **Setting**.
4. Select **Traffic & Weather Setup**.

Traffic & Weather Now are registered trademarks of SiriusXM® Radio, Inc.

☞ Scan

The “Scan Songs in Preset” function is based on TuneScan™ technology of SiriusXM®.

The “Featured Channels” function is based on Featured Favorites™ technology of SiriusXM®.

TuneScan™ and Featured Favorites™ are registered trademarks of SiriusXM® Radio, Inc.

Playing an iPod

Connect the iPod using your USB connector to the USB port, then select the iPod mode.

 **USB Ports** P. 205

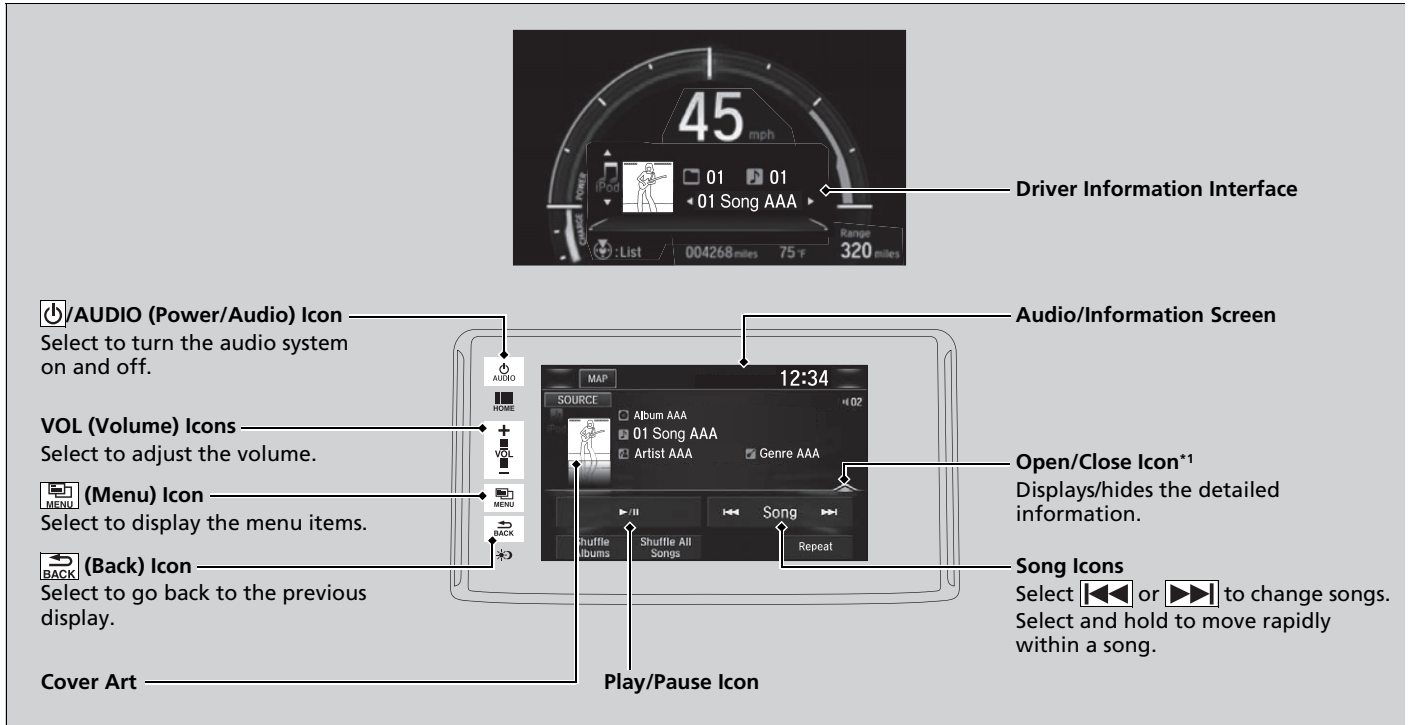

Driver Information Interface

Audio/Information Screen

Power/Audio (Power/Audio) Icon
Select to turn the audio system on and off.

VOL (Volume) Icons
Select to adjust the volume.



(Menu) Icon
Select to display the menu items.

(Back) Icon
Select to go back to the previous display.

Cover Art

Play/Pause Icon

Open/Close Icon*1
Displays/hides the detailed information.

Song Icons
Select  or  to change songs. Select and hold to move rapidly within a song.

*1: Some or all of the lists may not be displayed.

How to Select a Song from the Music Search List

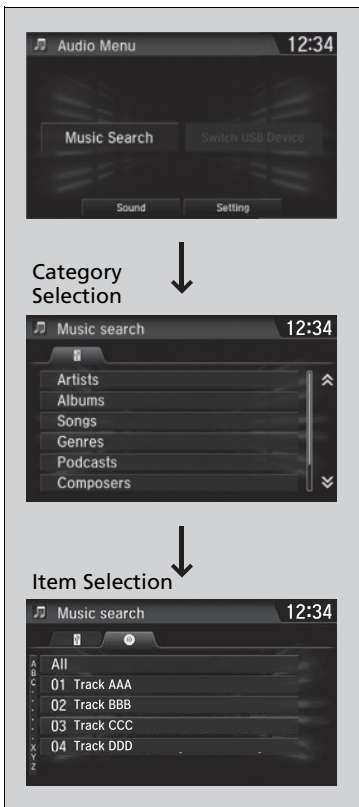

1. Select  and select **Music Search**.

2. Select the items on that menu.

▶▶ Playing an iPod

Available operating functions vary on models or versions. Some functions may not be available on the vehicle's audio system.

If there is a problem, you may see an error message on the audio/information screen.

 **iPod/USB Flash Drive** P. 284

If you operate any music app on your iPhone/iPod while the phone is connected to the audio system, you may no longer be able to operate the same app on the audio/information screen. Reconnect the device if necessary.

How to Select a Play Mode

You can select shuffle and repeat modes when playing a file.

Select a play mode.

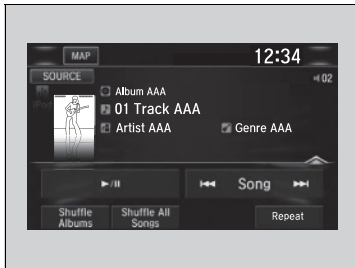

To turn off a play mode

Select the mode you want to turn off.

How to Select a Play Mode

Play Mode Menu Items

Shuffle Albums: Plays all available albums in a selected list (playlists, artists, albums, songs, podcasts, genres, composers, or audiobooks) in random order.

Shuffle All Songs: Plays all available files in a selected list (playlists, artists, albums, songs, podcasts, genres, composers, or audiobooks) in random order.

Repeat: Repeats the current track.

Song By Voice™ (SBV)

Use SBV to search for and play music from your USB flash drive or iPod using voice commands.

■ To enable SBV

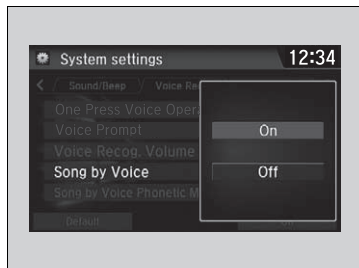

1. Select .
2. Select **Settings**.
3. Select **System**.
4. Select the **Voice Recog.** tab.
5. Select **Song by Voice**.
6. Select **On** or **Off**.



▶▶ Song By Voice™ (SBV)

Setting options:

- **On** (factory default): Song By Voice™ commands are available.
- **Off**: Disable the feature.

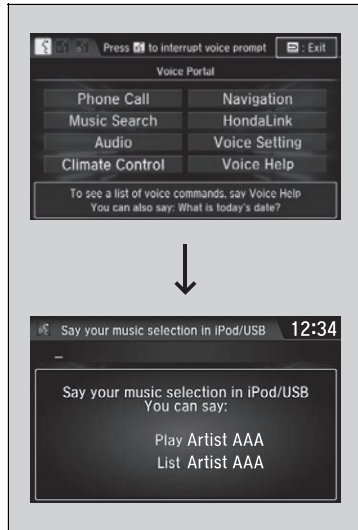
■ Searching for music using SBV



1. Set the **Song by Voice** setting to **On**.
2. Press the  (Talk) button and say "Music Search" to activate the SBV feature for the USB flash drive and iPod.
3. Then, say a next command.
 - ▶ Example 1: Say "(List) 'Artist A'" to view a list of songs by that artist. Select the desired song to start playing.
 - ▶ Example 2: Say "Play 'Artist A'" to start playing songs by that artist.
4. To cancel SBV, press the  (hang-up/back) button on the steering wheel. The selected song continues playing.

Once you have canceled this mode, you need to press the  button and say "Music Search" again to re-activate this mode.

▶▶ Searching for music using SBV

Song By Voice™ Commands List

▶ **Song By Voice Commands** P. 242

NOTE:

Song By Voice™ commands are available for tracks stored on the USB flash drive or iPod.

You can add phonetic modifications of difficult words so that it is easier for SBV to recognize artists, songs, albums, and composers in voice commands.

▶ **Phonetic Modification** P. 260

Phonetic Modification

Add phonetic modifications of difficult or foreign words so that it is easier for SBV to recognize artists, songs, albums, and composers in voice commands when searching for music on the USB flash drive or iPod.





1. Select **[HOME]**.
2. Select **Settings**.
3. Select **System**.
4. Select the **Voice Recog.** tab.
5. Select **Song by Voice Phonetic Modification**.
6. Select **New Modification**.
7. Select **USB** or **iPod**.

Phonetic Modification

Song by Voice Phonetic Modification function is not available when **Song by Voice** is set to **Off**.

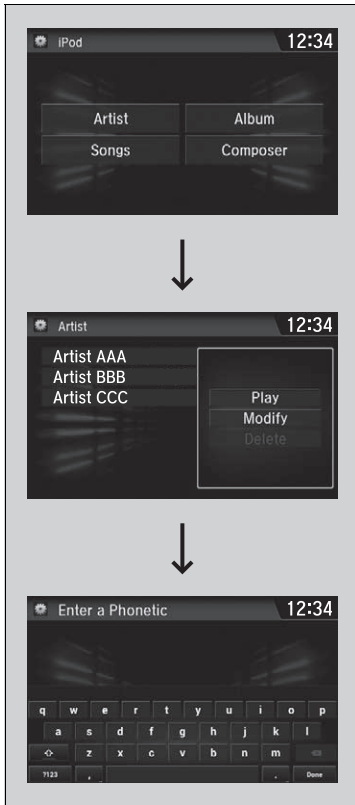
You can store up to 2,000 phonetic modification items.



8. Select the item to modify (e.g., **Artist**).
 - ▶ The list of the selected item appears on the screen.
9. Select an entry to modify.
 - ▶ The pop-up menu appears on the screen.
 - ▶ To listen to the current phonetic modification, select **Play**.
 - ▶ To delete the current phonetic modification, select **Delete**.
10. Select **Modify**.
11. Select the phonetic spelling you want to use (e.g., "Artist A") when prompted.
12. Select **OK**.
 - ▶ The artist "No Name" is phonetically modified to "Artist A." When in the SBV mode, you can press the  (Talk) button and use the voice command "Play 'Artist A'" to play songs by the artist "No Name."

Playing Pandora®*1

Your audio system allows you to listen to music from the Pandora® app on a compatible smartphone.

This function is available when the phone is paired and connected to the vehicle's *Bluetooth*® HandsFreeLink® (HFL) system, or with an iPhone, you can connect using your USB cable to the USB port.

▶ **Phone Setup** P. 343

▶ **USB Ports** P. 205

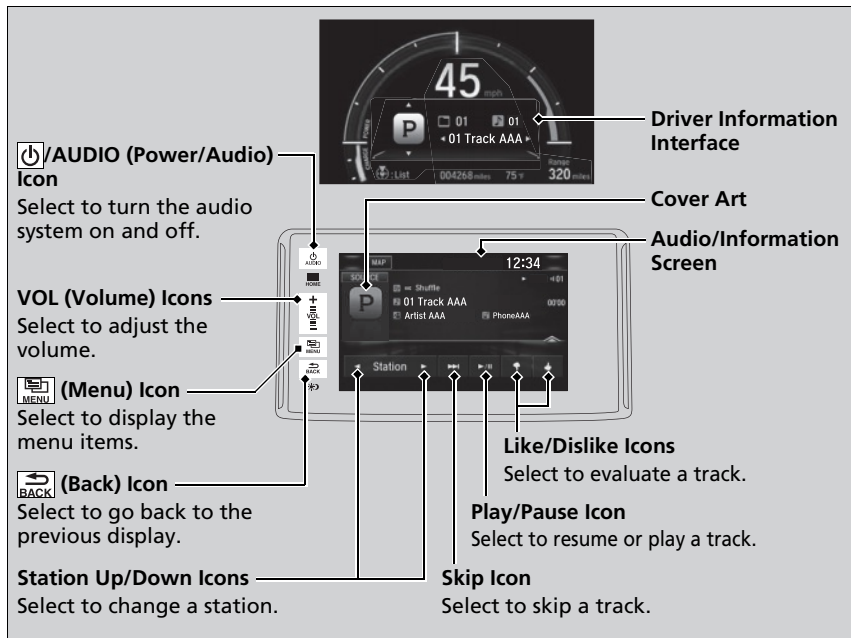

*1: Available only on U.S. models.

▶▶ Playing Pandora®*1

Pandora®, the Pandora logo, and the Pandora trade dress are trademarks or registered trademarks of Pandora Media, Inc., used with permission. Pandora is only available in certain countries. Visit the Pandora website for more information.

To find out if your phone is compatible with this feature, visit automobiles.honda.com/handsfreelink/, or call 1-888-528-7876.

To use this service in your vehicle, the Pandora® app must first be installed on your phone. Visit www.pandora.com for more information.

Pandora® is free, personalized radio that plays music and comedy you'll love. Just start with the name of one of your favorite artists, tracks, comedians or composers and Pandora® will create a custom station that plays similar tracks. Pandora® also features hundreds of genre stations ranging from Dubstep to Smooth Jazz to Power Workout.

If you cannot operate Pandora® through the audio system, it may be streaming through *Bluetooth*® Audio. Make sure Pandora® mode on your audio system is selected.

If your phone is connected to Android Auto, Pandora® is only available through the Android Auto interface. Visit the Android Auto website to check compatibility.

Pandora® Menu

You can operate some of the Pandora® menu items from your vehicle's audio system. The available items are:

- **Bookmark**
- **Station List**
- **New Station**
- **Switch USB device**
- **Sound**
- **Setting**

■ Operating a menu item

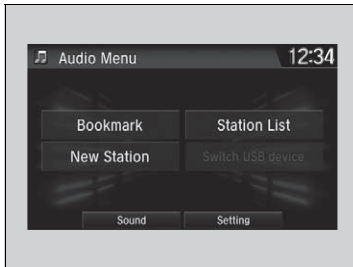

1. Select .
2. Select an item.

▶▶ Pandora® Menu

Available operating functions vary on software versions. Some functions may not be available on the vehicle's audio system.

If there is a problem, you may see an error message on the audio/information screen.

▶ **Pandora®** P. 286

Pandora® may limit the total number of skips allowed on the service. If you dislike a track after the skip limit has been reached, your feedback will be saved but the current track will continue to play.

To change stations, activate the Pandora® menu, select **Station List**, and then select a new station. It also changes stations on the main Pandora® screen.

Playing a USB Flash Drive

Your audio system reads and plays sound files on a USB flash drive in either MP3, WMA, or AAC*1 format.

Connect your USB flash drive to the USB port, then select the USB mode.

➤ **USB Ports** P. 205

The diagram shows two screens from the audio system. The top screen is the **Driver Information Interface**, which displays a speedometer showing 45 mph, a USB icon, track information (02 Album AAA, 01 Track AAA), and range information (004268 miles, 75°F, 320 miles). The bottom screen is the **Audio/Information Screen**, which displays a menu with options like SOURCE, MAP, and 12:34. It shows track information (02 Album AAA, 01 Track AAA, Artist AAA, Album AAA) and playback controls (Folder, Track, Random in Folder, Random All Tracks, Repeat Folder, Repeat Track). Callouts point to various icons and controls on both screens.

Driver Information Interface

Audio/Information Screen

Power/AUDIO (Power/Audio) Icon
Select to turn the audio system on and off.

VOL (Volume) Icons
Select to adjust the volume.

(Menu) Icon
Select to display the menu items.

(Back) Icon
Select to go back to the previous display.

Folder Icons
Select to skip to the next folder, and to skip to the beginning of the previous folder.

Open/Close Icon*2
Displays/hides the detailed information.

Track Icons
Select or to change files.
Select and hold to move rapidly within a track.

*1: Only AAC format files recorded with iTunes are playable on this unit.

*2: Some or all of the lists may not be displayed.

How to Select a File from the Music Search List

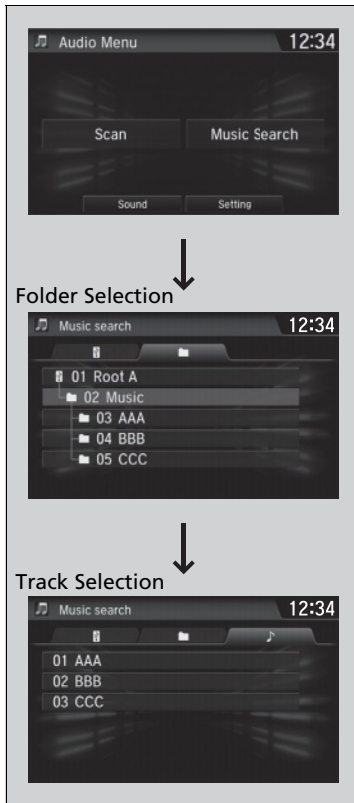

1. Select  and select **Music Search**.
2. Select **Music**.

3. Select a folder.

4. Select a track.

▶▶ Playing a USB Flash Drive

Use the recommended USB flash drives.

▶ **General Information on the Audio System**
P. 288

WMA files protected by digital rights management (DRM) cannot be played.

The audio system displays **Unplayable File**, then skips to the next file.

If there is a problem, you may see an error message on the audio/information screen.

▶ **iPod/USB Flash Drive** P. 284

■ How to Select a Play Mode

You can select scan, repeat, and random modes when playing a file.

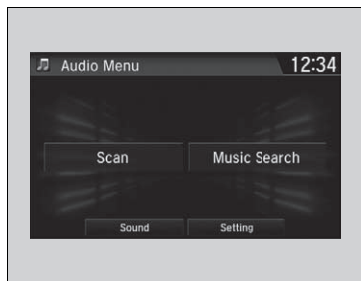

■ Scan

1. Select .
2. Select **Scan**.
3. Select a play mode.

■ Random/Repeat

Select a play mode.

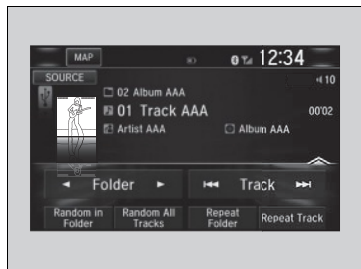

■ To turn off a play mode

To turn off Scan, select  or **Cancel**.

To turn off **Random/Repeat**, select the mode again.

▶▶ How to Select a Play Mode

Play Mode Menu Items

Scan

Scan Folders: Provides 10-second sampling of the first file in each of the main folders.

Scan Tracks: Provides 10-second sampling of all files in the current folder.

Random/Repeat

Random in Folder: Plays all files in the current folder in random order.

Random All Tracks: Plays all files in random order.

Repeat Folder: Repeats all files in the current folder.

Repeat Track: Repeats the current file.

Playing *Bluetooth*® Audio

Your audio system allows you to listen to music from your *Bluetooth*-compatible phone.

This function is available when the phone is paired and connected to the vehicle's *Bluetooth*® HandsFreeLink® (HFL) system.

🔧 **Phone Setup** P. 343

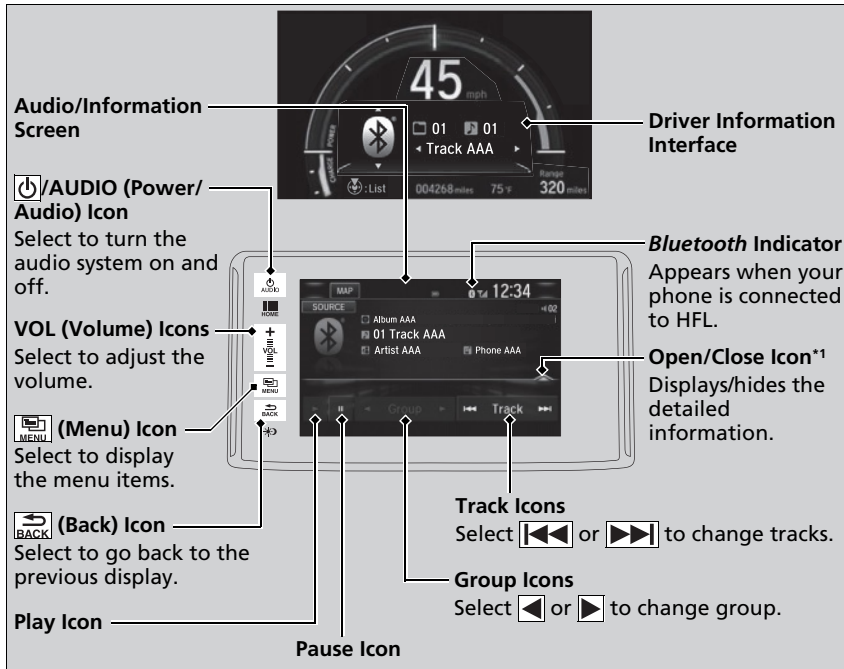

*1: Depending on the *Bluetooth*® device you connect, some or all of the lists may not be displayed.

▶▶ Playing *Bluetooth*® Audio

Not all *Bluetooth*-enabled phones with streaming audio capabilities are compatible.

To check if your phone is compatible, visit automobiles.honda.com/handsfreelink/.

It may be illegal to perform some data device functions while driving.

Only one phone can be used with HFL at a time. When there are more than two paired phones in the vehicle, the first paired phone the system finds is automatically connected.

The connected phone for *Bluetooth*® Audio can be different.

If more than one phone is paired to the HFL system, there may be a delay before the system begins to play.

In some cases, the name of the artist, album, or track may not appear correctly.

Some functions may not be available on some devices.

If a phone is currently connected via Apple CarPlay or Android Auto, *Bluetooth*® Audio from that phone is unavailable. However, a second previously paired phone can stream *Bluetooth*® Audio by selecting **Connect** from the **Bluetooth Device List**.

🔧 **Phone Setup** P. 343

■ To Play *Bluetooth*® Audio Files

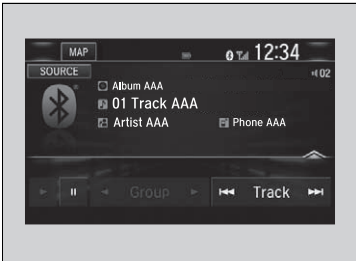



1. Make sure that your phone is paired and connected to the system.
▶ **Phone Setup** P. 343
2. Select the *Bluetooth*® Audio mode.

If the phone is not recognized, another HFL-compatible phone, which is not compatible for *Bluetooth*® Audio, may already be connected.

- ### ■ To pause or resume a file
- Select the play icon or pause icon.

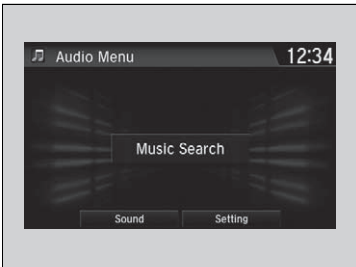
■ Searching for Music



1. Select .
2. Select **Music Search**.
3. Select a search category (e.g., Albums).
4. Select an item.
▶ The selection begins playing.

▶▶ To Play *Bluetooth*® Audio Files

To play the audio files, you may need to operate your phone. If so, follow the phone maker's operating instructions.

Switching to another mode pauses the music playing from your phone.

You can change the connected phone in the *Bluetooth*® settings on the **Audio Menu** screen by the following procedure.

1. Select .
2. Select **Setting**.

▶▶ Searching for Music

Depending on the *Bluetooth*® device you connect, some or all of the lists may not be displayed.

HondaLink®

HondaLink® connects you to the latest information from Honda. You can connect your phone wirelessly through Wi-Fi or *Bluetooth®*.

➤ **Wi-Fi Connection** P. 274

➤ **Phone Setup** P. 343

HondaLink® Menu

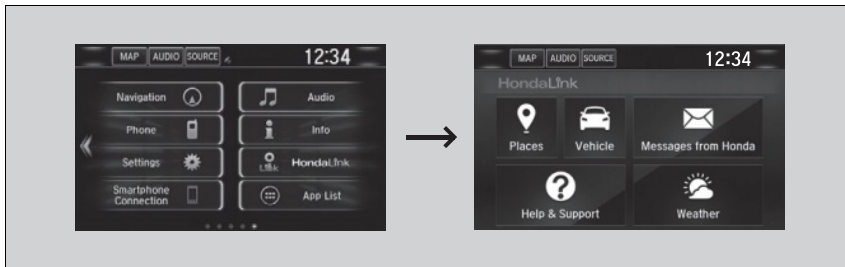

■ Places*

Displays restaurants, gas stations, Honda dealer, and so on. You can also navigate to the found locations via the navigation.

■ Vehicle

Displays instruction messages when the vehicle needs service.

■ Help & Support

Displays tips for vehicle usage, and get support via road side or customer service center.

▶▶ HondaLink®

The HondaLink® connect app is compatible with most iPhone and Android phones.

Some cell phone carriers charge for tethering and smartphone data use. Check your phone's data subscription package.

When Apple CarPlay or Android Auto is connected to the audio system, HondaLink® can be accessed even without a Wi-Fi connection.

* Not available on all models

■ Messages from Honda

Displays helpful and important information from Honda.

■ Weather*

Displays a weekly five-day weather forecast for any location you want. You can change the ZIP Code at any time.

■ To Set Up to Connect HondaLink® Service

Use the following procedure to connect to HondaLink® service.

■ To enable the HondaLink® service

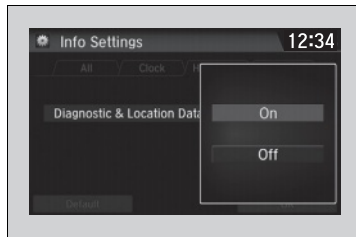

1. Select .
2. Select **Settings**.
3. Select **Info**.
4. Select the **HondaLink** tab.
5. Select **Diagnostic & Location Data**.
6. Select **On**.

You need to allow the consent of the location service to enable the HondaLink® service.

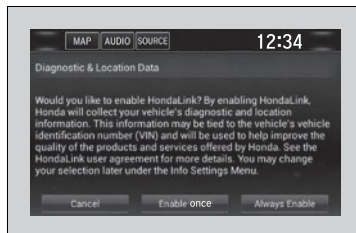

Enable once: Allows only one time. (Prompt shows again next time.)

Always Enable: Allows anytime. (Prompt does not show again.)

Cancel: Does not allow this consent.

■ To link with HondaLink®

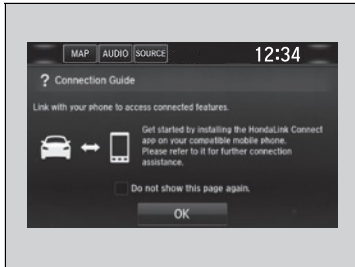

You can see the **Connection Guide** screen after launching HondaLink®. If you do not need this guide, select check-box and select **OK**.

■ Vehicle Information and Message from Honda Tips

You can check the messages that are received quickly in the shortcut operation.



1. A message appears and notifies you of a new message on the header area.
 - ▶ When the message is received, a notification ring can be heard.

2. A message icon is continuously displayed in the header area until the new message is read.



3. From the top of the screen, swipe down to see the messages.

4. Select a new message to open.

Wi-Fi Connection



You can connect the Display Audio to the Internet using Wi-Fi and browse websites or use online services on the audio/information screen. If your phone has wireless hotspot capabilities, the system can be tethered to the phone. Use the following steps to setup.

Wi-Fi mode (setting for the first time)



1. Select .
2. Select **Settings**.
3. Select **Bluetooth/Wi-Fi**.
4. Select the **Wi-Fi** tab.
5. Select **Wi-Fi On/Off Status**, then **On**.
6. Select **Wi-Fi Device List**.
 - ▶ Make sure your phone's Wi-Fi setting is in access point (tethering) mode.
 - ▶ Select the phone you want to connect to the system.
 - ▶ If you do not find the phone you want to connect in the list, select **Scan**.



7. Select **Connect**.
 - ▶ If needed, enter a password for your phone and select **OK**.
 - ▶ When the connection is successful, the  icon is displayed on the top of the screen.
8. Select  to go back to the home screen.

Wi-Fi mode (setting for the first time)

You cannot go through the setting procedure while a vehicle is moving. Park in a safe place to setup the Wi-Fi connection.

Some cell phone carriers charge for tethering and smartphone data use. Check your phone's data subscription package.

Check your phone manual to find out if the phone has Wi-Fi connectivity.

You can confirm whether Wi-Fi connection is on or off with the  icon on **Wi-Fi Device List**. Network speed will not be displayed on this screen.

■ Wi-Fi mode (after the initial setting has been made)

Make sure your phone's Wi-Fi setting is in access point (tethering) mode.

☒ Wi-Fi mode (after the initial setting has been made)

iPhone users

You may need to go through an initial setup for Wi-Fi connection again after you boot your phone.

Siri Eyes Free

You can talk to Siri using the  (Talk) button on the steering wheel when your iPhone is paired to the *Bluetooth*® HandsFreeLink® (HFL) system.

➔ **Phone Setup** P. 343

❏ Siri Eyes Free

Siri is a trademark of Apple Inc.

Check Apple Inc. website for features available for Siri.

We recommend against using Siri other than in Siri Eyes Free while operating a vehicle.

❏ Using Siri Eyes Free

Some commands work only on specific phone features or apps.

■ Using Siri Eyes Free

 **(Hang-up/back) Button**
Press to deactivate Siri Eyes Free.

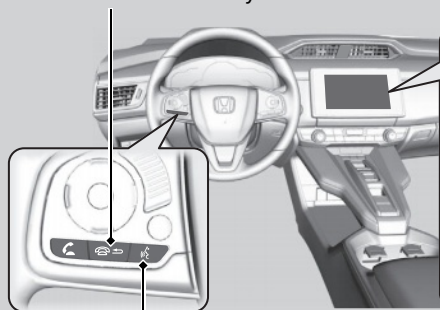

 **(Talk) Button**
Press and hold until the display changes as shown.

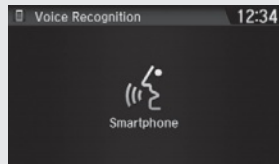

Appears when Siri is activated in Siri Eyes Free

While in Siri Eyes Free:
The display remains the same.
No feedback or commands appear.

Apple CarPlay

If you connect an Apple CarPlay-compatible iPhone to the system via the 1.5A USB port, you can use the audio/information screen, instead of the iPhone display, to make a phone call, listen to music, view maps (navigation), and access messages.

📖 **USB Ports** P. 205

Apple CarPlay Menu

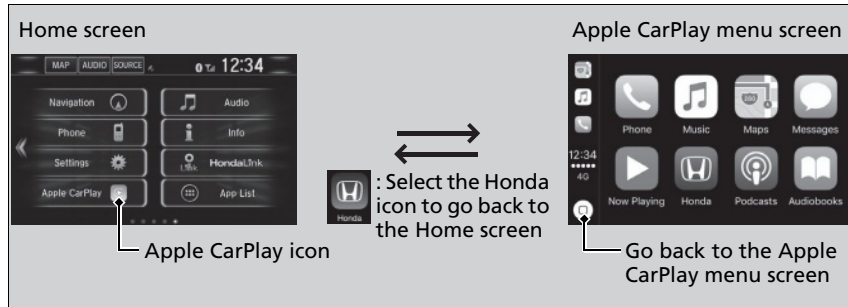

Phone

Access the contact list, make phone calls, or listen to voice mail.

Messages

Check and reply to text messages, or have messages read to you.

Music

Play music stored on your iPhone.

Apple CarPlay

Only iPhone 5 or newer versions with iOS 8.4 or later are compatible with Apple CarPlay.

Park in a safe place before connecting your iPhone to Apple CarPlay and when launching any compatible apps.

To use Apple CarPlay, connect the USB cable to the USB port (1.5A). The USB port (1.0A) will not enable Apple CarPlay operation.

📖 **USB Ports** P. 205

To directly access the Apple CarPlay phone function, press **Phone** on the home screen. While connected to Apple CarPlay, calls are only made through Apple CarPlay. If you want to make a call with *Bluetooth*® HandsFreeLink®, turn Apple CarPlay OFF or detach the USB cable from your iPhone.

📖 **Setting Up Apple CarPlay** P. 278

When your iPhone is connected to Apple CarPlay, it is not possible to use the *Bluetooth*® Audio or *Bluetooth*® HandsFreeLink®. However, other previously paired phones can stream audio via *Bluetooth*® while Apple CarPlay is connected.

📖 **Phone Setup** P. 343

For details on countries and regions where Apple CarPlay is available, as well as information pertaining to function, refer to the Apple homepage.

■ Maps

Display Apple Maps and use the navigation function just as you would on your iPhone.

Models with navigation system

Only one navigation system (pre-installed navigation or Apple CarPlay) can give directions at a time. When you are using one system, directions to any prior destination set on the other system will be canceled, and the system you are currently using will direct you to your destination.

■ Setting Up Apple CarPlay

After you have connected your iPhone to the system via the 1.5A USB port, use the following procedure to set up Apple CarPlay. Use of Apple CarPlay will result in the transmission of certain user and vehicle information (such as vehicle location, speed, and status) to your iPhone to enhance the Apple CarPlay experience. You will need to consent to the sharing of this information on the Display Audio Screen.

■ Enabling Apple CarPlay

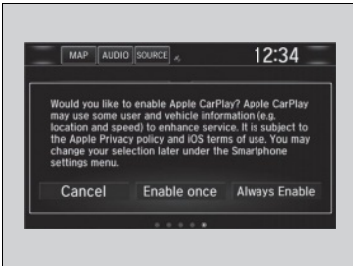

Enable once: Allows only once. (Prompt shows again next time.)

Always Enable: Allows anytime. (Prompt does not show again.)

Cancel: Does not allow this consent.

You may change the consent settings under the **Smartphone** settings menu.

▶▶ Apple CarPlay

Apple CarPlay Operating Requirements & Limitations

Apple CarPlay requires a compatible iPhone with an active cellular connection and data plan. Your carrier's rate plans will apply.

Changes in operating systems, hardware, software, and other technology integral to providing Apple CarPlay functionality, as well as new or revised governmental regulations, may result in a decrease or cessation of Apple CarPlay functionality and services. Honda cannot and does not provide any warranty or guarantee of future Apple CarPlay performance or functionality.

It is possible to use 3rd party apps if they are compatible with Apple CarPlay. Refer to the Apple homepage for information on compatible apps.

▶▶ Setting Up Apple CarPlay

You can also use the method below to set up Apple CarPlay:
Select HOME→Settings→Smartphone→Apple CarPlay

Use of user and vehicle information

The use and handling of user and vehicle information transmitted to /from your iPhone by Apple CarPlay is governed by the Apple iOS terms and conditions and Apple's Privacy Policy.

■ Operating Apple CarPlay with Siri

Press and hold the talk button to activate Siri.

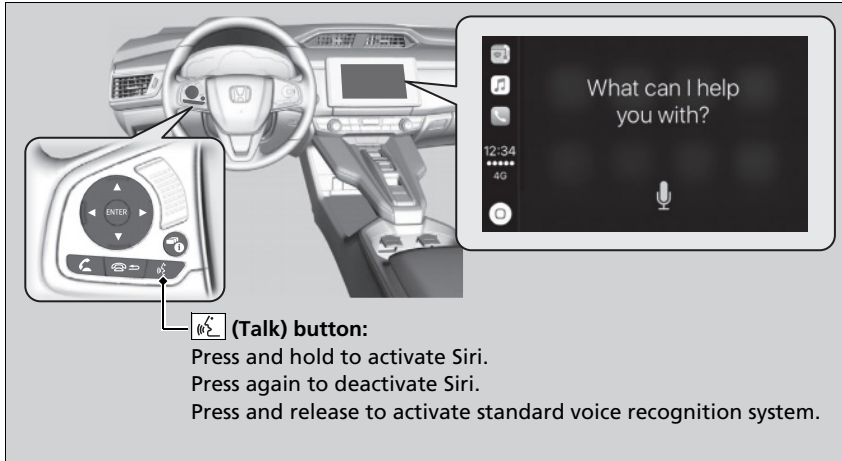

▣ Operating Apple CarPlay with Siri

Below are examples of questions and commands for Siri.

- What movies are playing today?
- Call dad at work.
- What song is this?
- How's the weather tomorrow?
- Read my latest email.
- Find a table for four tonight in Chicago.

For more information, please visit www.apple.com/ios/siri.

Android Auto

When you connect an Android phone to the Display Audio system via the 1.5A USB port, Android Auto is automatically initiated. When connected via Android Auto, you can use the audio/information screen to access the Phone, Google Maps (Navigation), Google Play Music, and Google Now functions. When you first use Android Auto, a tutorial will appear on the screen.

We recommend that you complete this tutorial while safely parked before using Android Auto.

- **USB Ports** P. 205
- **Auto Pairing Connection** P. 282

Android Auto

To use Android Auto, you need to download the Android Auto app from Google Play to your smartphone.

Only Android 5.0 (Lollipop) or later versions are compatible with Android Auto. Bluetooth A2DP cannot be used with Android Auto phone.

Park in a safe place before connecting your Android phone to Android Auto and when launching any compatible apps.

To use Android Auto, connect the USB cable to the USB port (1.5A). The USB port (1.0A) will not enable Android Auto operation.

- **USB Ports** P. 205

When your Android phone is connected to Android Auto, it is not possible to use the *Bluetooth*® Audio. However, other previously paired phones can stream audio via *Bluetooth*® while Android Auto is connected.

- **Phone Setup** P. 343

Android Auto Menu

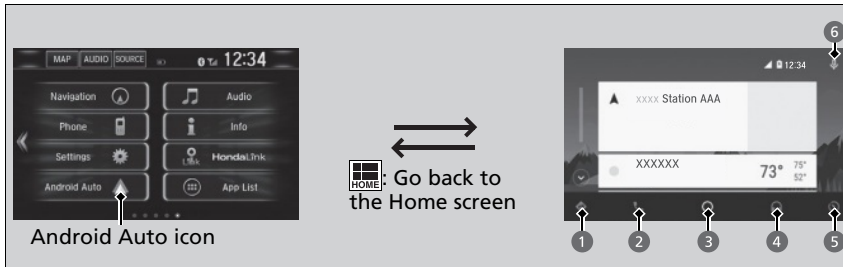

1 Maps (Navigation)

Display Google Maps and use the navigation function just as you would with your Android phone. When the vehicle is in motion, it is not possible to make keyboard entries. Stop the vehicle in a safe location to undertake a search or provide other inputs.

Models with navigation system

Only one navigation system (pre-installed navigation or Android Auto) can give directions at a time. When you are using one system, directions to any prior destination set on the other system will be canceled, and the system you are currently using will direct you to your destination.

The audio/information screen shows you turn-by-turn driving directions to your destination.

2 Phone (Communication)

Make and receive phone calls as well as listen to voicemail.

3 Google Now (Home screen)

Display useful information organized by Android Auto into simple cards that appear just when they're needed.

Android Auto

For details on countries and regions where Android Auto is available, as well as information pertaining to function, refer to the Android Auto homepage.

Android Auto Operating Requirements & Limitations

Android Auto requires a compatible Android phone with an active cellular connection and data plan. Your carrier's rate plans will apply.

Changes in operating systems, hardware, software, and other technology integral to providing Android Auto functionality, as well as new or revised governmental regulations, may result in a decrease or cessation of Android Auto functionality and services. Honda cannot and does not provide any warranty or guarantee of future Android Auto performance or functionality.

It is possible to use 3rd party apps if they are compatible with Android Auto. Refer to the Android Auto homepage for information on compatible apps.

4 Music and audio

Play Google Play Music and music apps that are compatible with Android Auto. To switch between music apps, press this icon.

5 Go back to the Home Screen.

6 Voice

Operate Android Auto with your voice.

Auto Pairing Connection

When you connect an Android phone to the unit via the 1.5A USB port, Android Auto is automatically initiated.

Enabling Android Auto

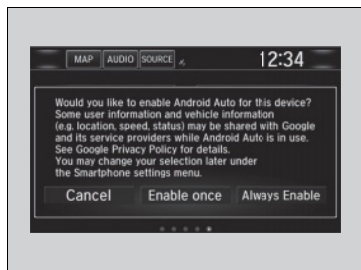

Enable once: Allows only once. (Prompt shows again next time.)

Always Enable: Allows anytime. (Prompt does not show again.)

Cancel: Does not allow this consent.

You may change the consent settings under the **Smartphone** settings menu.

Enabling Android Auto

Only initialize Android Auto when you safely parked. When Android Auto first detects your phone, you will need to set up your phone so that auto pairing is possible. Refer to the instruction manual that came with your phone.

You can use the method below to change Android Auto settings after you have completed the initial setup:
Select HOME→Settings→Smartphone→Android Auto

Use of user and vehicle information

The use and handling of user and vehicle information transmitted to /from your phone by Android Auto is governed by the Google's Privacy Policy.

■ Operating Android Auto with Voice Recognition

Press and hold the talk button to operate Android Auto with your voice.



▣ Operating Android Auto with Voice Recognition

Below are examples of commands you can give with voice recognition:

- Reply to text.
- Call my wife.
- Navigate to Honda.
- Play my music.
- Send a text message to my wife.
- Call flower shop.

For more information, please refer to the Android Auto homepage.

You can also activate the voice recognition function by pressing the  icon in the upper-right corner of the screen.

iPod/USB Flash Drive

If an error occurs while playing an iPod or USB flash drive, you may see the following error messages. If you cannot clear the error message, contact an authorized Honda Clarity Plug-In Hybrid dealer.

Error Message	Solution
USB Error	Appears when there is a problem with the audio system. Check if the device is compatible with the audio system.
A charging error has occurred with the connected USB device. When safe please check the compatibility of the device and USB cable and try again.	Appears when an incompatible device is connected. Disconnect the device. Then turn the audio system off, and turn it on again. Do not reconnect the device that caused the error.
Unsupported Version	Appears when an unsupported iPod is connected. If it appears when a supported iPod is connected, update the iPod software to the newer version.
Connect Retry	Appears when the system does not acknowledge the iPod. Reconnect the iPod.
Unplayable File	Appears when the files in the USB flash drive are copyright protected or an unsupported format. This error message appears for about three seconds, then plays the next song.

Error Message	Solution
No Data	<p>iPod Appears when the iPod is empty.</p> <p>USB flash drive Appears when the USB flash drive is empty or there are no MP3, WMA, or AAC files in the USB flash drive.</p> <p>iPod and USB flash drive Check that compatible files are stored on the device.</p>
Unsupported	Appears when an unsupported device is connected. If it appears when a supported device is connected, reconnect the device.

U.S. models

Pandora®

If an error occurs while playing Pandora®, you may see the following error messages.

If you cannot clear the error message, contact an authorized Honda Clarity Plug-In Hybrid dealer.

Error Message	Solution
To begin listening, select a station from the Stations list.	Appears when there is no station list on the device. Use the device to create a station.
The maximum number of tracks that can be skipped has been reached.	Appears when you try to skip a track or select Like/Dislike over the predetermined number of times in an hour.
Unable to play PANDORA. Please try again later. Unable to rate track. Please try again. Unable to save bookmark.	Appears when the commanded operation fails. Try again later.
No Data	Appears when no data is available with Pandora® activated. Reboot the app and reconnect the device.
PANDORA App version is not supported.	Appears when Pandora® version is not supported. Update Pandora® to the latest version.
PANDORA system maintenance.	Appears when the Pandora® server is in maintenance. Try again later.
Unable to connect to PANDORA. When stopped, check your mobile phone.	Appears when Pandora® is unable to play music. Check your device.
Unable to connect to PANDORA. When stopped, check your mobile phone.	Appears when Pandora® app is not installed on your device. Install Pandora® app to your device.

Android/Apps

If an error occurs while using the audio system or apps, you may see the following error messages. If you cannot clear the error message, contact an authorized Honda Clarity Plug-In Hybrid dealer.

Error Message*1	Solution
Unfortunately, **** has stopped.	Error has occurred within app, select OK on the screen to close the app.
**** is not responding. Would you like to close it?	App is not responding. Select Wait if you can wait for a response from app a little longer. If it does not respond even if you keep waiting, select OK to close the app and restart it. If the error message continues, perform Factory Data Reset . ➤ Defaulting All the Settings P. 331

*1:****part is variable characters, and will change depending upon where an error occurs.

SiriusXM® Radio Service*

■ Subscribing to SiriusXM® Radio

1. You need your radio ID ready before registering for subscription. To see the ID on the screen, select **Channel 0**.
2. Have your radio ID ready, and either call SiriusXM® or visit the SiriusXM® website to subscribe.

■ Receiving SiriusXM® Radio

Switch to the SiriusXM® mode by using the ▲ or ▼ button on the steering wheel, or through the audio/information screen, and stay in this mode for about 30 minutes until the service is activated. Make sure your vehicle is in an open area with good reception.

☒ Subscribing to SiriusXM® Radio

Contact Information for SiriusXM® Radio:

- U.S.: SiriusXM® Radio at www.siriusxm.com/subscribe-now, or 1-866-635-2349
- Canada: SiriusXM® Canada at www.siriusxm.ca/subscribe-now, or 1-877-209-0079

☒ Receiving SiriusXM® Radio

The SiriusXM® satellites are in orbit over the equator; therefore, objects south of the vehicle may cause satellite reception interruptions. Satellite signals are more likely to be blocked by tall buildings and mountains the farther north you travel from the equator.

You may experience reception problems under the following circumstances:

- In a location with an obstruction to the south of your vehicle.
- In tunnels
- On the lower level of a multi-tiered road
- Large items carried on the roof rack

■ SiriusXM® Radio Display Messages

Requested Channel Not Subscribed:

You are not subscribed to the channel selected.

Channel Off Air:

The channel is not currently broadcasting.

Channel unauthorized:

SiriusXM® is loading the audio or program information.

Subscription Updated.:

SiriusXM® radio is receiving information update from the network.

Channel Not Available:

No such channel exists, or the artist or title information is unavailable.

No Signal:

The signal is too weak in the current location.

Check Antenna:

There is a problem with the SiriusXM® antenna. Contact an authorized Honda Clarity Plug-In Hybrid dealer.

Check Tuner:

There is a problem with the SiriusXM® tuner. Contact an authorized Honda Clarity Plug-In Hybrid dealer.

Compatible iPod, iPhone, and USB Flash Drives

■ iPod and iPhone Model Compatibility

Model
iPod (5th generation)
iPod classic 80GB/160GB (launch in 2007)
iPod classic 120GB (launch in 2008)
iPod classic 160GB (launch in 2009)
iPod nano (1st to 7th generation) released between 2005 and 2012
iPod touch (1st to 6th generation) released between 2007 and 2012
iPhone 3G/iPhone 3GS/iPhone 4/iPhone 4s/iPhone 5/iPhone 5c/iPhone 5s/iPhone 6/ iPhone 6 Plus/iPhone 6s/iPhone 6s Plus/iPhone SE/iPhone 7/iPhone 7 Plus

■ USB Flash Drives

- A USB flash drive of 256 MB or higher is recommended.
- Some digital audio players may not be compatible.
- Some USB flash drives (e.g., a device with security lockout) may not work.
- Some software files may not allow for audio play or text data display.
- Some versions of MP3, WMA, or AAC formats may be unsupported.

⌘ iPod and iPhone Model Compatibility

This system may not work with all software versions of these devices.

⌘ USB Flash Drives

Files on the USB flash drive are played in their stored order. This order may be different from the order displayed on your PC or device.

Honda App License Agreement

END USER LICENSE AGREEMENT

PLEASE CAREFULLY READ THIS END USER LICENSE AGREEMENT (THIS "AGREEMENT") WHICH GOVERNS YOUR USE OF THE SOFTWARE INSTALLED ON YOUR HONDA OR ACURA VEHICLE (YOUR "VEHICLE") AS WELL AS THE APPLICATIONS, SERVICES, FUNCTIONS, AND CONTENT PROVIDED THROUGH THE SOFTWARE (COLLECTIVELY, THE "SERVICES"). YOUR USE OF THE SOFTWARE OR SERVICES WILL SERVE AS YOUR CONSENT TO THE TERMS OF THIS AGREEMENT. THE SOFTWARE IS OWNED (OR LICENSED), PROVIDED, AND/OR OPERATED BY AMERICAN HONDA MOTOR CO. INC., ("HONDA," "US," "WE," OR "OUR"), WITH ITS BUSINESS ADDRESS AT 1919 TORRANCE BLVD., TORRANCE, CA 90501. REFERENCE TO "HONDA" IN THIS AGREEMENT INCLUDES HONDA'S PARENT COMPANY AND ITS AFFILIATES AND DESIGNATED AGENTS. THE SERVICES ARE OWNED (OR LICENSED), PROVIDED, AND/OR OPERATED BY HONDA OR A THIRD-PARTY SERVICE PROVIDER (A "PROVIDER"). REFERENCE TO A "PROVIDER" IN THIS AGREEMENT INCLUDES SUCH PROVIDER'S PARENT COMPANY, AFFILIATES, AND DESIGNATED AGENTS.

A. Description of the Software. The SOFTWARE includes the software, firmware and the like, installed and executing on your VEHICLE during manufacture, and thereafter updated from time to time by HONDA, you or an authorized HONDA dealer (a "DEALER"). The SOFTWARE allows you to access and use a variety of SERVICES, including but not limited to: (a) HONDA applications, services, and content provided through the SOFTWARE (together, "HONDA SERVICES"); and (b) PROVIDER applications, services, and content provided through the SOFTWARE (together, "PROVIDER SERVICES"), each of which may provide access to various information, media, content, and services.

B. SOFTWARE Licensing and Intellectual Property.

1. SOFTWARE. This AGREEMENT grants you a non-exclusive, limited, and revocable license to use the SOFTWARE and SERVICES solely (a) as installed on your VEHICLE by HONDA, (b) as updated on your Vehicle by HONDA, you (but only as and when directed by HONDA), or a DEALER and (c) as permitted under the terms of this AGREEMENT

2. HONDA Services. The SOFTWARE may provide you with access to various HONDA SERVICES. Installation, activation, or use of HONDA SERVICES may require your consent to additional terms, conditions, and privacy policies applicable to those HONDA SERVICES (the "HONDA TERMS"). You acknowledge and agree that any collection, use, sharing of data generated by your VEHICLE or your use of your VEHICLE, and your use of the HONDA SERVICES shall be subject to this AGREEMENT and any additional HONDA TERMS that may be specifically applicable to such HONDA SERVICES or data generation. The HONDA SERVICES may collect, use, and share such data while you are using the SOFTWARE.

3. Open-Source Software. The SOFTWARE and SERVICES may incorporate software licensed to HONDA under free or open-source licenses which govern HONDA's distribution and your use of such software. HONDA and the third-party authors, licensors, and distributors of such software disclaim all warranties and all liability arising from any and all use or distribution of the software. To the extent such software is provided under terms that differ from the applicable free or open-source licenses, those terms are offered by HONDA alone. Additional information regarding free and open-source software incorporated in the SOFTWARE and SERVICES is available in this manual or within the SOFTWARE.

4. Provider Services. The SOFTWARE may provide you with access to various PROVIDER SERVICES. Installation or use of such PROVIDER SERVICES may require your consent to additional terms, conditions, and privacy policies of the applicable PROVIDER (the "PROVIDER TERMS"). This AGREEMENT restricts the manner in which you can install and use PROVIDER SERVICES but does not grant you a license or permission to use such PROVIDER SERVICES. Your permission to use PROVIDER SERVICES is limited and subject to any license grants, conditions, and limitations included in the PROVIDER TERMS. You acknowledge that any collection, use, sharing of your information, targeted advertising practices by PROVIDERS, and your use of the PROVIDER SERVICES shall be subject to both this AGREEMENT and any applicable PROVIDER TERMS. The PROVIDER SERVICES may collect, use, and share such information while you are using the SOFTWARE.

5. License Limitations and Restrictions on Use.

(a) Limited License. You understand and agree that the SOFTWARE and SERVICES are licensed, not sold, to you solely for use in accordance with this AGREEMENT and any applicable PROVIDER TERMS, and any documentation for the VEHICLE made available to you by HONDA (any "DOCUMENTATION"). HONDA and its licensors reserve all rights in the SOFTWARE and HONDA SERVICES not expressly granted to you under this AGREEMENT. PROVIDERS and their licensors reserve all rights in the PROVIDER SERVICES not expressly granted to you under the applicable PROVIDER TERMS.

(b) Restrictions on Use. The licenses granted under this AGREEMENT do not permit you to use the SOFTWARE or SERVICES on a device other than your VEHICLE. As a condition of using the SOFTWARE and SERVICES, you agree that you may not and will not:

- (1) copy, download, distribute, modify, publish, sell, rent, lease, lend, license, sublicense, reuse, or create derivative works of the SOFTWARE or SERVICES or any of the content or other material within the SOFTWARE or SERVICES, including without limitation, HONDA or PROVIDER names, logos, or any other trademarks of HONDA or PROVIDERS or used in association with the SOFTWARE or any SERVICES, except as required to use the SOFTWARE or SERVICES in accordance with this AGREEMENT, any applicable PROVIDER TERMS, and the DOCUMENTATION;
- (2) access or use the SOFTWARE or SERVICES in any manner intended to damage or impair the operation of the SOFTWARE or SERVICES or interfere with anyone else's use and enjoyment of the SOFTWARE or SERVICES;
- (3) access or attempt to access any system or server on which the SOFTWARE or SERVICES is hosted or modify or alter the SOFTWARE or SERVICES in any way;
- (4) use the SOFTWARE or SERVICES for any unlawful purpose, or in violation of any third party rights;
- (5) use the SOFTWARE or SERVICES in violation of any applicable traffic regulations, rules or laws, including but not limited to any driver distraction laws, rules or regulations;
- (6) violate the terms of this AGREEMENT, any HONDA TERMS, any PROVIDER TERMS or other applicable third-party terms, conditions, and privacy policies; or
- (7) reverse engineer, decompile, disassemble, attempt to derive the source code of, nor permit others to reverse engineer, decompile, or disassemble, or attempt to derive the source code of the SOFTWARE or SERVICES, except and only to the extent that such activity is expressly permitted (a) by applicable law notwithstanding this limitation or (b) the terms of applicable free or opensource software licenses.

6. Intellectual Property Rights. All title and intellectual property rights in and to the SOFTWARE and SERVICES, the accompanying DOCUMENTATION, and all copies of the SOFTWARE or SERVICES are owned by HONDA, PROVIDERS, or their suppliers or licensors. This AGREEMENT does not grant you any rights in connection with any trademarks or service marks of HONDA, PROVIDERS, or their licensors, affiliates, or suppliers.

7. Export Restrictions: You acknowledge that the SOFTWARE and SERVICES are subject to U.S., European Union, and other export jurisdictions. You agree to comply with all applicable international and national laws that apply to the SOFTWARE and SERVICES, including the U.S. Export Administration Regulations, as well as end-user, end-use, and destination restrictions issued by the U.S. and other governments.

C. SOFTWARE Operation

1. HONDA reserves the right to suspend or terminate your access to and use of the SOFTWARE or SERVICES if you are found to be in violation of this AGREEMENT or as reasonably deemed necessary by HONDA.

2. Eligibility/Registration/Activation. The SOFTWARE is intended for and available to individuals who (a) are of legal age of majority in their jurisdiction of residence (and at least 18 years of age), or are younger than 18 years of age and possess a valid driver's license issued by their jurisdiction of residence, and (b) own or have permissive access to a compatible VEHICLE. We do not knowingly collect any information, including personal information, from children under 13. If we learn or are notified that we have collected personal information of a child under 13, we will immediately take steps to delete such information.

3. Use of PROVIDER SERVICES through the SOFTWARE. Certain PROVIDER SERVICES made available through the SOFTWARE may require that you register or otherwise have an account with the PROVIDER and agree to PROVIDER TERMS. Any use of any of such PROVIDER SERVICES within the SOFTWARE is subject to this AGREEMENT and the applicable PROVIDER TERMS. HONDA does not exercise control over such PROVIDER SERVICES and is not responsible or liable for the availability, security, or content of such PROVIDER SERVICES, and the inclusion of any PROVIDER SERVICES does not imply a referral from, the approval of, or the endorsement by HONDA of such PROVIDER SERVICES. HONDA is not responsible or liable, directly or indirectly, for any damage relating to or resulting from your use of the PROVIDER SERVICES.

4. Links to Third Party Sites: The SOFTWARE may provide you with the ability to access third-party sites and content through the use of the SOFTWARE or SERVICES. The third-party sites and content are not under the control of HONDA. HONDA is not responsible or liable, directly or indirectly, for such third-party websites and their content or for any damage relating to or resulting from your access or use of such websites and content.

5. Unauthorized Use and Abuse. You are responsible for ensuring your (and any authorized third parties') use of the SOFTWARE and SERVICES remains in compliance with this AGREEMENT and all other applicable HONDA TERMS and PROVIDER TERMS. You acknowledge and agree that any use of the SOFTWARE or SERVICES occurring through your VEHICLE will be deemed your actions and that HONDA and PROVIDERS may rely upon such actions. You agree to immediately notify us if you suspect fraudulent or abusive activity involving the SOFTWARE or SERVICES. If you so notify us or if we otherwise suspect fraudulent or abusive activity, you agree to cooperate with us in any fraud investigation and to use any fraud prevention measures we prescribe. Your failure to immediately notify us or cooperate to use such measures will result in your liability for all fraudulent usage or abusive activity associated with your VEHICLE.

6. SOFTWARE Updates. The SOFTWARE and SERVICES may be updated when your VEHICLE is serviced by a DEALER or remotely, over-the-air, by HONDA from time to time; such updates may occur with or without further notice or your future consent. The SOFTWARE may be updated at HONDA's discretion and for any purpose including, without limitation, to patch or otherwise improve the SOFTWARE or SERVICES functionality, security, or stability. All updates to the SOFTWARE and SERVICES are subject to this AGREEMENT and any other applicable HONDA TERMS and PROVIDER TERMS.

7. Uninstalling, Removing, and Replacing the SOFTWARE. Replacing SOFTWARE or HONDA SERVICES with software or firmware not provided and installed by HONDA or a DEALER will render all representations and warranties for the SOFTWARE, HONDA SERVICES, and VEHICLE functionality reliant upon the SOFTWARE or HONDA SERVICES null and void.

D. SOFTWARE Operational Notices and Warnings

1. Vehicle Geolocation Information. You acknowledge that your VEHICLE may be equipped with certain traffic and map features. The traffic feature will automatically collect and transmit, through GPS technology, your Vehicle's current location (longitude and latitude), travel direction and speed ("VEHICLE GEOLOCATION INFORMATION") to HONDA and PROVIDERS. The VEHICLE GEOLOCATION INFORMATION is used by HONDA and PROVIDERS to provide traffic and navigation-related information to you, but may also be used to provide other SERVICES or offers to you. HONDA will not use such VEHICLE GEOLOCATION INFORMATION for its own marketing efforts, or provide such information to unaffiliated third parties for their own purposes, without your express consent.

2. Potential Map Inaccuracy and Route Safety. Maps used by this system may be inaccurate because of changes in roads, traffic controls, routing, or driving conditions. Always use good judgment and common sense when following suggested routes. Do not follow the route suggestions if doing so would result in an unsafe or illegal driving maneuver, if you would be placed in an unsafe situation, or if you would be directed into an area that you consider unsafe. Do not rely on any navigation features included in the system to route you to emergency services. Not all emergency services such as police, fire stations, hospitals, or clinics are likely to be contained in the map database for such navigation features. Ask local authorities or an emergency services operator for such locations and routes. The driver is ultimately responsible for the safe operation of the vehicle and therefore, must evaluate whether it is safe to follow the suggested directions. Any navigation features are provided only as an aid. Make your driving decisions based on your observations of local conditions and existing traffic regulations. Navigation features are not a substitute for your personal judgment. Any route suggestions made by the SOFTWARE or SERVICES should never replace any local traffic regulations or your personal judgment or knowledge of safe driving practices.

3. Speech Recognition: You acknowledge and understand that HONDA and PROVIDERS may record, retain, and use voices commands when you use the speech recognition components of the SOFTWARE or SERVICES. You and all VEHICLE operators and passengers (a) consent to the recording and retention of voice commands in support of providing speech recognition components and (b) release HONDA and PROVIDERS from all claims, liabilities, and losses that may result from any use of such recorded voice commands. Recognition errors are inherent in speech recognition. It is your responsibility to monitor any speech recognition functions included in the system and address any errors. Neither HONDA nor PROVIDERS will be liable for any damages arising out of errors in the speech recognition process.

4. Distraction Hazards. Navigation features may require manual (non-verbal) input or setup. Attempting to perform such set-up or insert data while driving can seriously distract your attention and could cause a crash or other serious consequences; the ability to undertake such interactions may also be limited by state or local law, which laws you are responsible to know and follow. Even occasional short scans of the screen may be hazardous if your attention has been diverted away from your driving at a critical time. Pull over and stop the vehicle in a safe and legal manner before attempting to access a function of the system requiring prolonged attention. Do not raise the volume excessively. Keep the volume at a level where you can still hear outside traffic and emergency signals while driving. Driving while unable to hear these sounds could result in a crash.

E. Information Collection and Storage

1. Information Collection, Use, Transmission and Storage of Data. Consent to Use of Data: You agree that HONDA and PROVIDERS may collect and use your information gathered in any manner as part of product support services related to the SOFTWARE or related services. HONDA may share such information with third parties, including, without limitation, PROVIDERS, third party software and services suppliers, their affiliates and/or their designated agents, solely to improve their products or to provide services or technologies to you. HONDA, third party software and systems suppliers, their affiliates and/or their designated agent may disclose this information to others, but not in a form that personally identifies you.

2. Information Storage. Depending on the type of multimedia system you have in your VEHICLE, certain information may be stored for ease of use of the SOFTWARE including, without limitation, search history, location history in certain applications, previous and saved destinations, map locations within certain applications, and device numbers and contact information.

(a) Vehicle Health Information. Your VEHICLE may remotely transmit information regarding the status and health of your VEHICLE (“VEHICLE INFORMATION”) to HONDA without notification to you. VEHICLE INFORMATION may contain VEHICLE maintenance and malfunction status that is derived from VEHICLE diagnostic data and includes, but is not limited to, status of powered doors and windows, battery life data, battery charging data, VEHICLE speed, coolant temperature, air compressor revolution, output power, warning codes, diagnostic trouble codes, fuel injection volume, and engine rotations per minute. VEHICLE HEALTH INFORMATION may be used by HONDA for research and development, to deliver HONDA SERVICES and information to you, and to contact you, and is retained only for a period of time necessary to fulfill these goals.

(b) VEHICLE Geolocation Data (non-navigation/map based). If you opt-in to geolocation-based SERVICES, your vehicle’s geolocation data (latitude and longitude) will be automatically sent from your VEHICLE to HONDA and PROVIDERS.

(c) You understand that the inputting or uploading of information to your VEHICLE’s multimedia system or the SOFTWARE or SERVICES is at your own risk and that HONDA is not responsible for unauthorized access to or use of any personal or other information. All information uploaded to the SOFTWARE and SERVICES may be stored on your VEHICLES’s multimedia system and you understand that the security and safety of your VEHICLE’s multimedia system is your sole responsibility.

F. NO WARRANTY. You understand and agree that your use of the SOFTWARE and SERVICES are solely at your own risk and that you will be solely responsible for any damage to your VEHICLE's multimedia system or any other equipment or any loss of data that may result from your use of the SOFTWARE or SERVICES. THE SOFTWARE AND SERVICES ARE PROVIDED ON AN "AS IS" AND "AS AVAILABLE" BASIS WITHOUT ANY WARRANTY OF ANY KIND, EXPRESSED, IMPLIED OR STATUTORY. WE SPECIFICALLY DISCLAIM ANY IMPLIED WARRANTIES OF MERCHANTABILITY, FITNESS FOR A PARTICULAR PURPOSE, AND NON-INFRINGEMENT. HONDA makes no warranties that the SOFTWARE or SERVICES will meet your requirements, or that the SOFTWARE or SERVICES will be uninterrupted, timely, secure, non-infringing or error free. You understand and agree that you are responsible for any and all charges, costs or expenses associated with your use of the SOFTWARE or SERVICES. Advice or information, whether oral or written, obtained by you from us or through the SOFTWARE or SERVICES are provided for informational purposes only and will not create any warranty not expressly made herein. You should not rely on any such information or advice. We assume no liability or responsibility for any errors or omissions in the SOFTWARE or SERVICES. We do not make any warranty or representation that your use of the material displayed on, or obtained through, the SOFTWARE or SERVICES is non-infringing of any rights of any third party. Any decision or action taken by you on the basis of information or content provided via the application is at your sole discretion and risk. HONDA and PROVIDERS are not responsible or liable for any such decision, or for the accuracy, completeness, usefulness, or availability of any content or information displayed, transmitted, or otherwise made available via the SOFTWARE or SERVICES. To the extent jurisdictions do not allow the exclusion of certain warranties, some of the above exclusions may not apply to you.

G. LIMITATIONS ON LIABILITY. You and HONDA are each waiving important rights.

1. Limitations on YOUR liability. HONDA cannot recover from you any consequential, indirect, incidental, or special damages, or attorney's fees in connection with your use of the SOFTWARE or HONDA SERVICES. HONDA WAIVES TO THE FULLEST EXTENT ALLOWED BY LAW ANY CLAIM FOR DAMAGES OTHER THAN DIRECT, COMPENSATORY DAMAGES AS LIMITED IN THIS AGREEMENT.

2. Limitation on HONDA and PROVIDER liability. Neither HONDA nor PROVIDERS will be liable to you or any other party for consequential, indirect, incidental, special, or punitive damages (including without limitation lost profits) in connection with your use of the SOFTWARE or SERVICES, even if HONDA or PROVIDERS are aware of the possibility of such damages. These limitations apply to all claims, including, without limitation, claims in contract and tort (such as negligence, product liability and strict liability). To the extent that a jurisdiction does not permit the exclusion or limitation of liability as set forth herein our liability is limited to the maximum extent permitted by law in such states. If HONDA or PROVIDERS are found liable to you for any reason, you agree that the aggregate liability of all these parties to you for any claim is limited to ten U.S. dollars (US \$10.00). Neither HONDA nor any PROVIDER would have agreed to provide the SOFTWARE or SERVICES to you if you did not agree to this limitation. This amount is the sole and exclusive liability of HONDA and PROVIDERS to you, and is payable as liquidated damages and not as a penalty. Except where prohibited by law, you may not bring any claim against HONDA or any third-party beneficiary more than two (2) years after the claim arises. We do not have any liability for SOFTWARE or SERVICES interruptions of any length.

(a) **Release of HONDA and PROVIDERS** For yourself and anyone else claiming under you, you agree to release and discharge HONDA, PROVIDERS, their respective officers, directors, and employees, and each third-party beneficiary from all claims, liabilities and losses in connection with the SOFTWARE or SERVICES, including, but not limited to claims for personal injury or property damage arising from the total or partial failure of performance of the SOFTWARE or SERVICES, even if caused by or based upon the negligence, gross negligence, strict products liability, Deceptive Trade Practices Act violations, bad faith, or breach of warranty of us or the malfunction of the SOFTWARE or SOFTWARE SERVICES. YOU AGREE TO WAIVE TO THE FULLEST EXTENT ALLOWED BY LAW, ANY CLAIM FOR DAMAGES OTHER THAN DIRECT, COMPENSATORY DAMAGES AS LIMITED IN THIS AGREEMENT. YOU HEREBY RELEASE AND DISCHARGE HONDA AND ITS LICENSORS AND CONTRACTORS (INCLUDING ANY THIRD PARTIES PROVIDING ALL OR PART OF THE SOFTWARE OR SERVICES) FROM AND AGAINST ANY CLAIMS, DAMAGES, EXPENSES AND LIABILITY ARISING FROM OR RELATED TO ANY INJURIES, DAMAGES, OR LOSSES TO ANY PERSON (INCLUDING DEATH) OR PROPERTY OF ANY KIND RESULTING IN WHOLE OR PART, DIRECTLY OR INDIRECTLY, FROM YOUR USE OF THE SOFTWARE OR SERVICES.

H. Survival. You agree that the limitations of liability and indemnities in this AGREEMENT will survive even after the AGREEMENT has ended. These limitations of liability apply not only to you, but to anyone using the SOFTWARE or SERVICES via your VEHICLE, to anyone making a claim on your behalf, and to any claims made by your family, employees, customers, or others arising out of or relating to your VEHICLE, the SOFTWARE, or SERVICES.

I. Availability/Interruption. The SOFTWARE and certain SERVICES are made available through your VEHICLE's compatible multimedia system when the VEHICLE is turned on. Certain SERVICES may be available only through your compatible mobile device when it is within the operating range of the VEHICLE and a wireless carrier. The availability of the SOFTWARE and SERVICES may be subject to transmission limitation or interruption, including but not limited to technical obsolescence or sunset of the hardware, software or firmware, inside of or external to the Vehicle, required for data transmission or receipt. HONDA does not guarantee that the SOFTWARE, SERVICES, or any portion thereof will be available at all times or in all areas. You acknowledge and agree that HONDA is not responsible for performance degradation, interruption or delays. You acknowledge that HONDA shall not be liable to you if the SOFTWARE or SERVICES in a given location are not available. If the SOFTWARE or SERVICES are not available within your intended location, you agree that your sole remedy shall be to cease using the SOFTWARE and SERVICES.

J. PRODUCT SUPPORT: Product support for the SOFTWARE is provided by HONDA. For product support, please refer to HONDA instructions provided in the DOCUMENTATION. Should you have any questions concerning this AGREEMENT, or if you desire to contact HONDA for any other reason, please refer to the HONDA contact information provided in the DOCUMENTATION.

K. Termination and Transfer.

1. Termination. This AGREEMENT is effective until terminated by you or US. WE may terminate this AGREEMENT for any or no reason, and with or without notice to you. Your rights under this AGREEMENT will terminate automatically without notice from US if you fail to comply with any term of this AGREEMENT. Upon termination of this AGREEMENT, you shall cease all use of the SOFTWARE and SERVICES.

2. Transfer: You may permanently transfer your rights under this AGREEMENT only as part of a sale or transfer of the VEHICLE, provided you retain no copies, you transfer all of the SOFTWARE and HONDA SERVICES (including all component parts, the media and printed materials, and any upgrades), and the recipient agrees to the terms of this AGREEMENT. You agree to notify HONDA upon the sale or transfer of the VEHICLE. To contact HONDA, please refer to the HONDA contact information provided in the DOCUMENTATION.

L. Changes to the SOFTWARE or SERVICES. WE may change, modify, or update the SOFTWARE or SERVICES from time to time. Unless explicitly stated otherwise, any new features or services that augment or enhance the SOFTWARE or SERVICES in the future shall respectively be considered part of the SOFTWARE or SERVICES and subject to this AGREEMENT. WE reserve the right at any time and from time to time to interrupt, restrict, modify, suspend, discontinue, temporarily or permanently, the SOFTWARE or SERVICES (or any portion thereof), with or without notice to you, and you agree that HONDA shall not be liable to you or to any third party for any modification, suspension or discontinuance of the SOFTWARE or SERVICES.

M. ARBITRATION:

PLEASE READ THIS ARBITRATION PROVISION CAREFULLY TO UNDERSTAND YOUR RIGHTS. YOU AGREE THAT ANY CLAIM THAT YOU MAY HAVE IN THE FUTURE MUST BE RESOLVED THROUGH BINDING ARBITRATION. YOU WAIVE THE RIGHT TO HAVE YOUR DISPUTE HEARD IN COURT AND WAIVE THE RIGHT TO BRING CLASS CLAIMS. YOU UNDERSTAND THAT DISCOVERY AND APPEAL RIGHTS ARE MORE LIMITED IN ARBITRATION.

Arbitration is a method of resolving a claim, dispute or controversy without filing a lawsuit. By agreeing to arbitrate, the right to go to court is waived and instead claims, disputes or controversies are submitted to binding arbitration. This provision sets forth the terms and conditions of our agreement. YOU and HONDA agree and acknowledge that this Agreement affects interstate commerce and the Federal Arbitration Act ("FAA") applies. By using the Software, Vehicle, or Services, YOU elect to have disputes resolved by arbitration. YOU, HONDA or any involved third party may pursue a Claim. "Claim" means any dispute between YOU, HONDA, or any involved third party relating to your use of the Software, the Vehicle, or the Services, this Agreement, or our relationship, including any representations, omissions or warranties. "Claim" does not include personal injury or wrongful death claims. YOU or HONDA may seek remedies in small claims court or provisional judicial remedies without arbitrating. In addition, notwithstanding anything herein to the contrary, YOU or HONDA may seek equitable relief in a court of competent jurisdiction..

YOU or HONDA may select arbitration with American Arbitration Association, JAMS or National Arbitration and Mediation. Contact these sponsors for their rules. The hearing will be in the federal district where YOU reside. If agreed, it may be by telephone or written submissions. Filing and arbitrator fees to be paid per the sponsor rules. You may contact the sponsor for a fee waiver. If no fee waivers, HONDA will pay filing and arbitrator fees up to \$5,000, unless law requires more. Each party is responsible for other fees. Arbitrator may award costs or fees to prevailing party, if permitted by law. HONDA will not seek fees, unless the claims are frivolous.

Arbitrator shall be an attorney or current or retired judge familiar with automotive or consumer software. The arbitrator shall follow substantive law, statute of limitations and decide all issues relating to the interpretation, construction, enforceability and applicability of this provision. The arbitrator may order relief permitted by law. This provision is governed and enforceable by the FAA. An award shall include a written opinion and be final, subject to appeal by the FAA.

This provision survives termination of this Agreement or relationship, bankruptcy, assignment or transfer. If part of this provision is unenforceable, the remainder remains in effect. If unenforceability allows arbitration as a class action, then this provision is entirely unenforceable. YOU may opt out within 30 days of your initial use of the Software by sending a signed, written notice to HONDA at Honda Financial Services, P.O. Box 165007, Irving, TX 75016. HONDA reserves the right to make changes to this provision after providing written notice and an opportunity to opt out.

N. Miscellaneous: You may not assign this AGREEMENT without HONDA's prior written consent. This AGREEMENT and any additional HONDA TERMS and PROVIDER TERMS represents the entire agreement between you and US. HONDA may amend the terms of this AGREEMENT by providing you with notices of such updated terms. If you do not consent to be bound by the updated terms, your sole remedy will be to cease using the SOFTWARE and SERVICES. If any part of this AGREEMENT is found invalid, void, or unenforceable, the balance of the AGREEMENT will remain valid and enforceable according to its terms. To the fullest extent permitted by law, and except as explicitly provided otherwise, this AGREEMENT and any disputes arising out of or relating to it will be governed by the laws of the State of California, except that California laws concerning choice of law or conflicts shall not apply if they would cause the substantive law of another jurisdiction to apply. Notwithstanding the foregoing, Section M shall be governed by the Federal Arbitration Act and the laws of the State of California, as applicable, as set forth therein. The failure to enforce any term of this AGREEMENT on one occasion shall not prevent enforcement on any other occasion or the enforcement of any other term. Headings and captions shall not be considered included for purposes of interpretation or application hereof, but are for convenience only.

Legal Information on Apple CarPlay/Android Auto

■ OWNER'S MANUAL LICENSE/LIABILITY STATEMENTS

USE OF APPLE CARPLAY IS SUBJECT TO YOUR AGREEMENT TO THE CARPLAY TERMS OF USE, WHICH ARE INCLUDED AS PART OF THE APPLE iOS TERMS OF USE. IN SUMMARY, THE CARPLAY TERMS OF USE DISCLAIM APPLE AND ITS SERVICE PROVIDERS' LIABILITY IF THE SERVICES FAIL TO PERFORM CORRECTLY OR ARE DISCONTINUED, STRICTLY LIMIT APPLE AND ITS SERVICE PROVIDERS' OTHER LIABILITIES, DESCRIBE THE KINDS OF USER INFORMATION (INCLUDING, FOR EXAMPLE, VEHICLE LOCATION, VEHICLE SPEED, AND VEHICLE STATUS) BEING GATHERED AND STORED BY APPLE AND ITS SERVICE PROVIDERS, AND DISCLOSE CERTAIN POSSIBLE RISKS ASSOCIATED WITH THE USE OF CARPLAY, INCLUDING THE POTENTIAL FOR DRIVER DISTRACTION. SEE APPLE'S PRIVACY POLICY FOR DETAILS REGARDING APPLE'S USE AND HANDLING OF DATA UPLOADED BY CARPLAY.

USE OF ANDROID AUTO IS SUBJECT TO YOUR AGREEMENT TO THE ANDROID AUTO TERMS OF USE WHICH MUST BE AGREED TO WHEN THE ANDROID AUTO APPLICATION IS DOWNLOADED TO YOUR ANDROID PHONE. IN SUMMARY, THE ANDROID AUTO TERMS OF USE DISCLAIM GOOGLE AND ITS SERVICE PROVIDERS' LIABILITY IF THE SERVICES FAIL TO PERFORM CORRECTLY OR ARE DISCONTINUED, STRICTLY LIMIT GOOGLE AND ITS SERVICE PROVIDERS' OTHER LIABILITIES, DESCRIBE THE KINDS OF USER INFORMATION (INCLUDING, FOR EXAMPLE, VEHICLE LOCATION, VEHICLE SPEED, AND VEHICLE STATUS) BEING GATHERED AND STORED BY GOOGLE AND ITS SERVICE PROVIDERS, AND DISCLOSE CERTAIN POSSIBLE RISKS ASSOCIATED WITH THE USE OF ANDROID AUTO, INCLUDING THE POTENTIAL FOR DRIVER DISTRACTION. SEE GOOGLE'S PRIVACY POLICY FOR DETAILS REGARDING GOOGLE'S USE AND HANDLING OF DATA UPLOADED BY ANDROID AUTO.

DISCLAIMER OF WARRANTIES; LIMITATION ON LIABILITY

YOU EXPRESSLY ACKNOWLEDGE AND AGREE THAT USE OF APPLE CARPLAY OR ANDROID AUTO (“THE APPLICATIONS”) IS AT YOUR SOLE RISK AND THAT THE ENTIRE RISK AS TO SATISFACTORY QUALITY, PERFORMANCE, ACCURACY AND EFFORT IS WITH YOU TO THE MAXIMUM EXTENT PERMITTED BY APPLICABLE LAW, AND THAT THE APPLICATIONS AND INFORMATION ON THE APPLICATIONS IS PROVIDED “AS IS” AND “AS AVAILABLE,” WITH ALL FAULTS AND WITHOUT WARRANTY OF ANY KIND, AND HONDA HEREBY DISCLAIMS ALL WARRANTIES AND CONDITIONS WITH RESPECT TO THE APPLICATIONS AND INFORMATION ON THE APPLICATIONS, EITHER EXPRESS, IMPLIED OR STATUTORY, INCLUDING, BUT NOT LIMITED TO, THE IMPLIED WARRANTIES AND/OR CONDITIONS OF MERCHANTABILITY, SATISFACTORY QUALITY, FITNESS FOR A PARTICULAR PURPOSE, ACCURACY, QUIET ENJOYMENT, AND NON-INFRINGEMENT OF THIRD PARTY RIGHTS. NO ORAL OR WRITTEN INFORMATION OR ADVICE GIVEN BY HONDA OR AN AUTHORIZED REPRESENTATIVE SHALL CREATE A WARRANTY. AS EXAMPLES, AND WITHOUT LIMITATION, HONDA DISCLAIMS ANY WARRANTY REGARDING THE ACCURACY OF DATA PROVIDED BY THE APPLICATIONS, SUCH AS THE ACCURACY OF DIRECTIONS, ESTIMATED TRAVEL TIME, SPEED LIMITS, ROAD CONDITIONS, NEWS, WEATHER, TRAFFIC, OR OTHER CONTENT PROVIDED BY APPLE, GOOGLE, THEIR AFFILIATES, OR THIRD PARTY PROVIDERS; HONDA DOES NOT GUARANTEE AGAINST LOSS OF APPLICATION DATA, WHICH MAY BE LOST AT ANY TIME; HONDA DOES NOT GUARANTEE THAT THE APPLICATIONS OR ANY SERVICES PROVIDED THROUGH THEM WILL BE PROVIDED AT ALL TIMES OR THAT ANY OR ALL SERVICES WILL BE AVAILABLE AT ANY PARTICULAR TIME OR LOCATION. FOR EXAMPLE, SERVICES MAY BE SUSPENDED OR INTERRUPTED WITHOUT NOTICE FOR REPAIR, MAINTENANCE, SECURITY FIXES, UPDATES, ETC., SERVICES MAY BE UNAVAILABLE IN YOUR AREA OR LOCATION, ETC. IN ADDITION, YOU UNDERSTAND THAT CHANGES IN THIRD PARTY TECHNOLOGY OR GOVERNMENT REGULATION MAY RENDER THE SERVICES AND/OR APPLICATIONS OBSOLETE AND/OR UNUSABLE.

TO THE EXTENT NOT PROHIBITED BY LAW, IN NO EVENT SHALL HONDA OR ITS AFFILIATES BE LIABLE FOR PERSONAL INJURY, OR ANY INCIDENTAL, SPECIAL, INDIRECT OR CONSEQUENTIAL DAMAGES WHATSOEVER, INCLUDING, WITHOUT LIMITATION, DAMAGES FOR LOSS OF PROFITS, CORRUPTION OR LOSS OF DATA, FAILURE TO TRANSMIT OR RECEIVE ANY DATA, BUSINESS INTERRUPTION OR ANY OTHER COMMERCIAL DAMAGES OR LOSSES, ARISING OUT OF OR RELATED TO THE APPLICATIONS OR YOUR USE OF OR INABILITY TO USE THE APPLICATIONS OR INFORMATION ON THE APPLICATIONS, HOWEVER CAUSED, REGARDLESS OF THE THEORY OF LIABILITY (CONTRACT, TORT OR OTHERWISE) AND EVEN IF HONDA WERE ADVISED OF THE POSSIBILITY OF SUCH DAMAGES. SOME STATES AND JURISDICTIONS DISALLOW THE EXCLUSION OR LIMITATION OF LIABILITY FOR DAMAGES, SO THESE LIMITATIONS AND EXCLUSIONS MAY NOT APPLY TO YOU. IN NO EVENT SHALL HONDA’S TOTAL LIABILITY TO YOU FOR ALL DAMAGES (OTHER THAN AS MAY BE REQUIRED BY APPLICABLE LAW IN CASES INVOLVING PERSONAL INJURY) EXCEED THE AMOUNT OF FIVE DOLLARS (\$5.00). THE FOREGOING LIMITATIONS WILL APPLY EVEN IF THE ABOVE STATED REMEDY FAILS OF ITS ESSENTIAL PURPOSE.

About Open Source Licenses

To see the open source license information, follow these steps.

1. Select .
2. Select **Settings**.
3. Select **System**.
4. Select the **Others** tab.
5. Select **Detail Information**.
6. Select **About device**.
7. Select **Legal information**.
8. Select **Open source licenses**.

Use the audio/information screen to customize certain features.

■ How to customize

While the vehicle is at a complete stop with the power mode in ON, select , and **Settings**, then select a setting item.

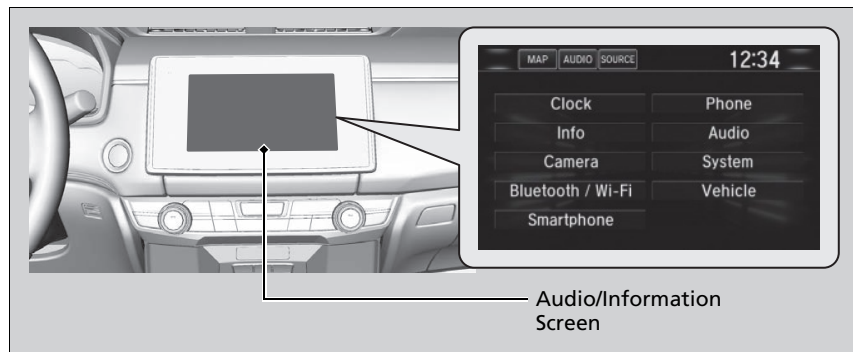

» Customized Features

When you customize setting, make sure that the vehicle is at a complete stop and **P** is selected.

To customize other features, select **Settings**.

➤ **List of customizable options** P. 314

■ Customization flow

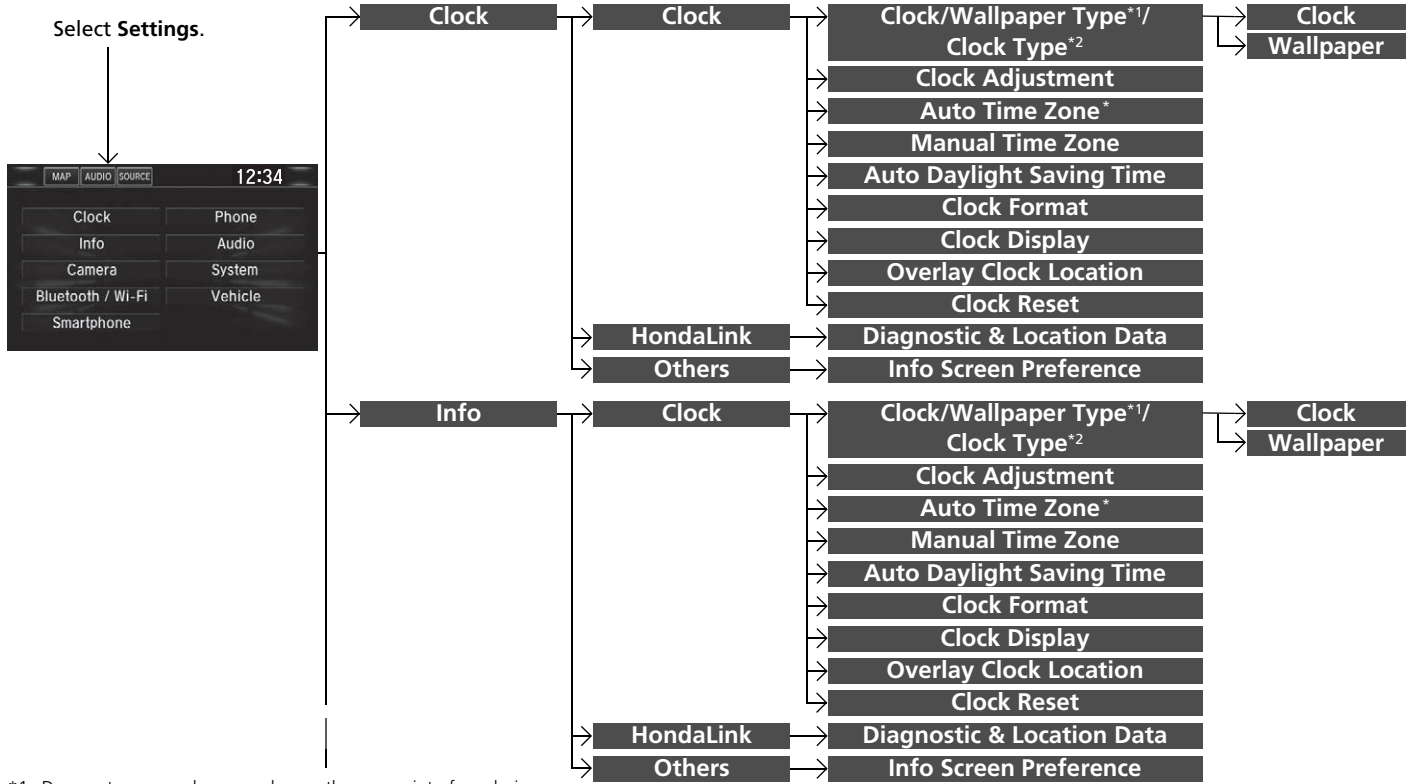

*1: Does not appear when you change the screen interface design.

*2: Appears only when you change the screen interface design.

* Not available on all models

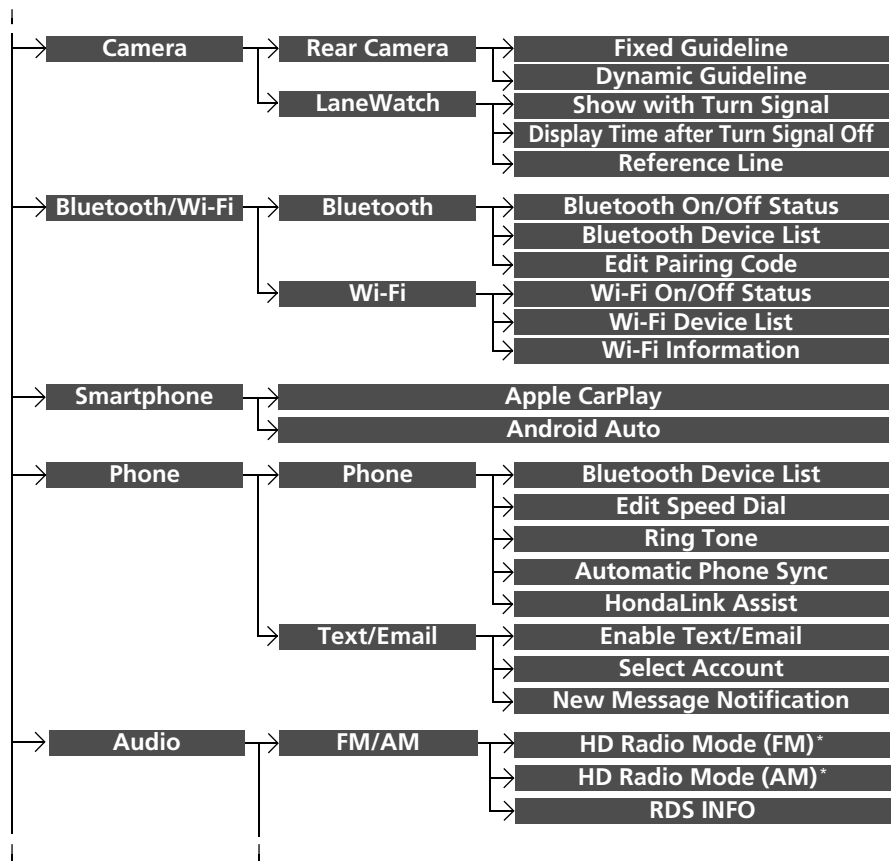

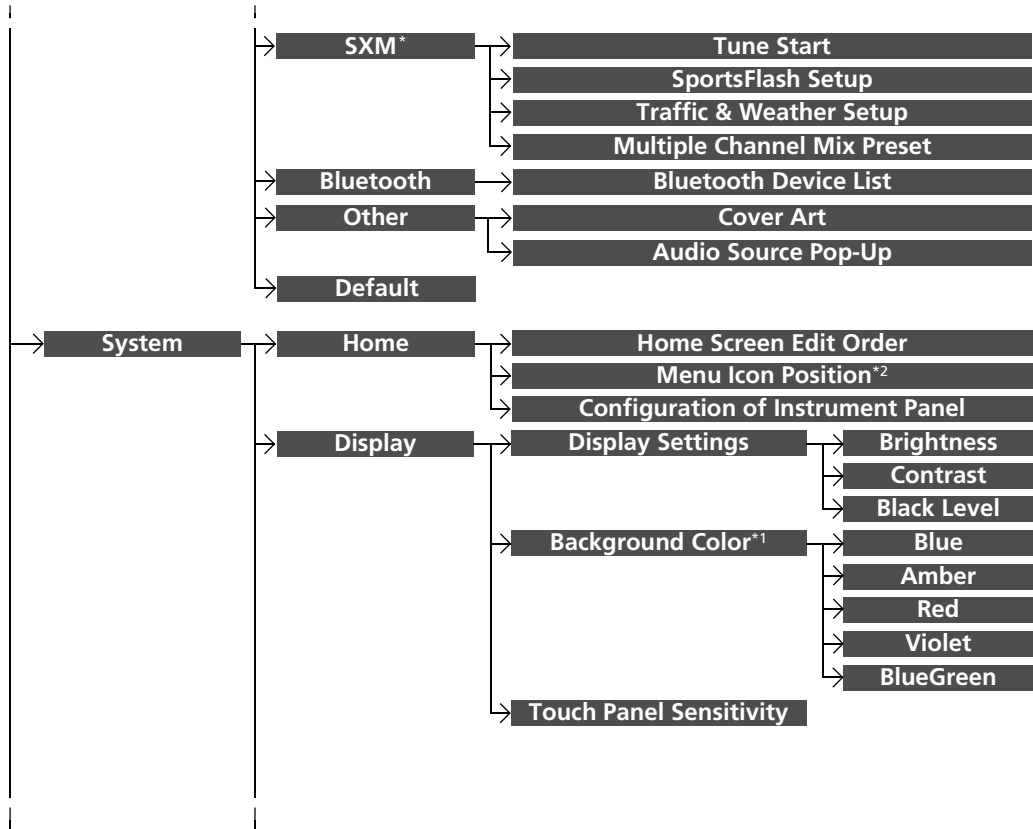

*1: Does not appear when you change the screen interface design.

*2: Appears only when you change the screen interface design.

* Not available on all models

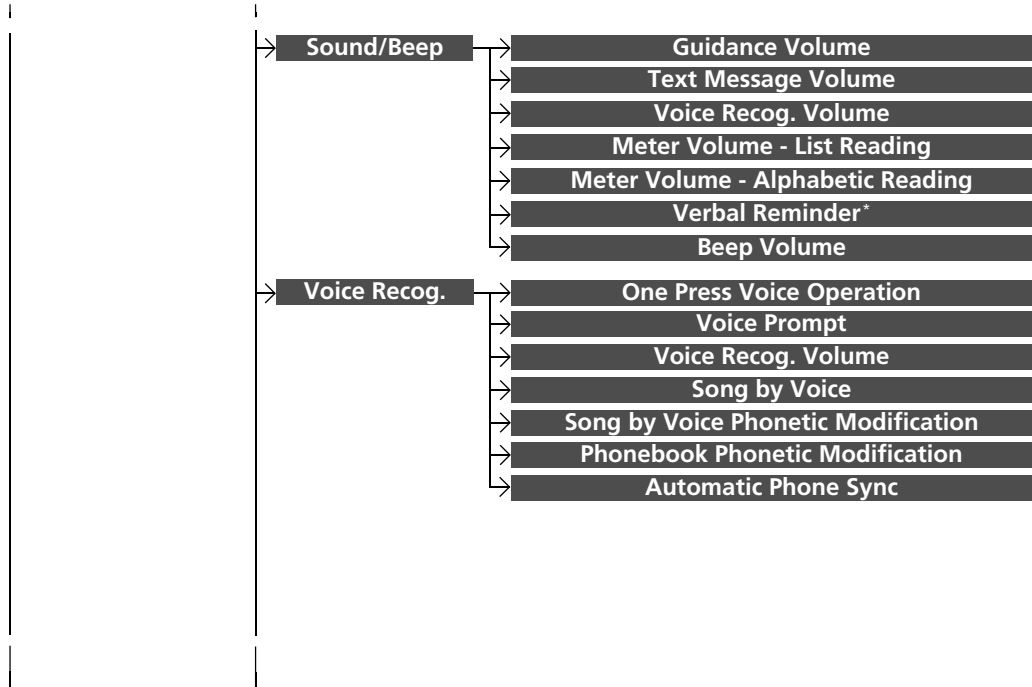

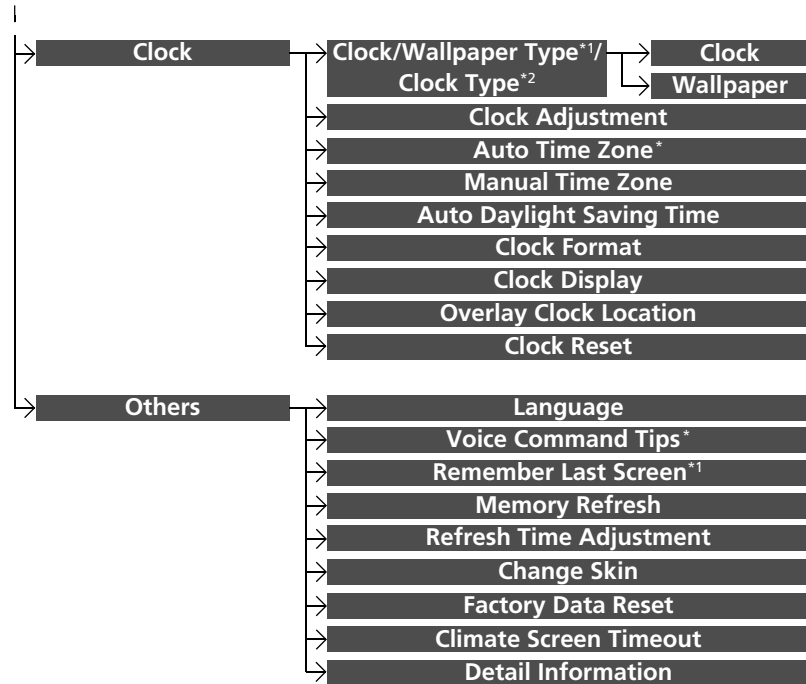

*1: Does not appear when you change the screen interface design.

*2: Appears only when you change the screen interface design.

* Not available on all models

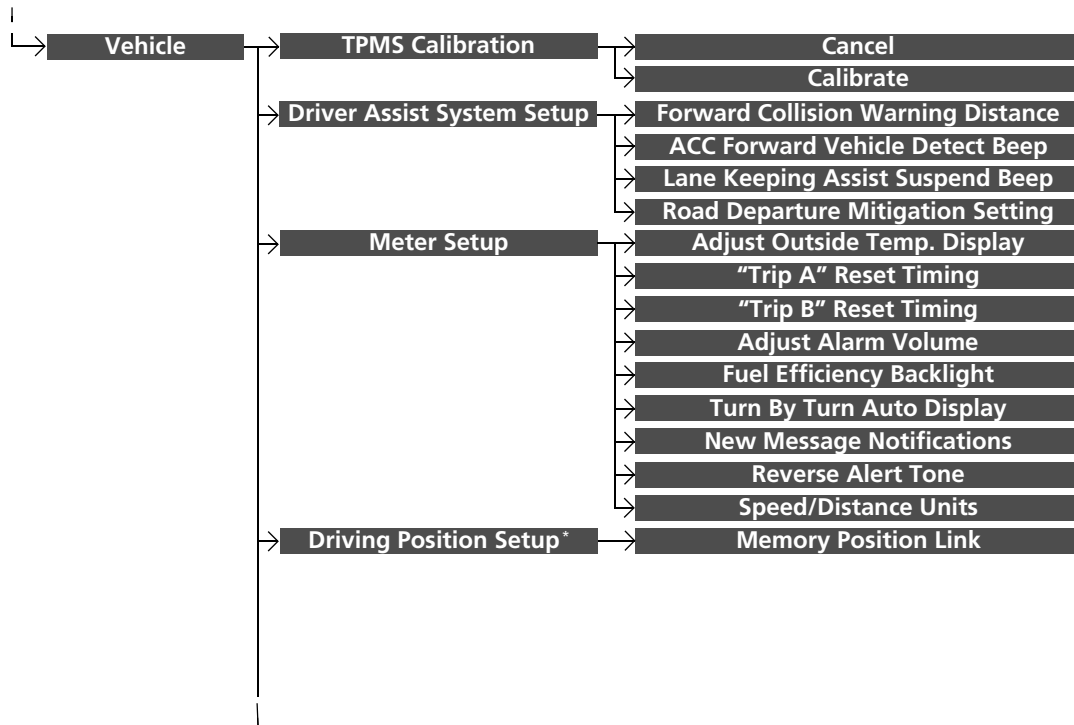

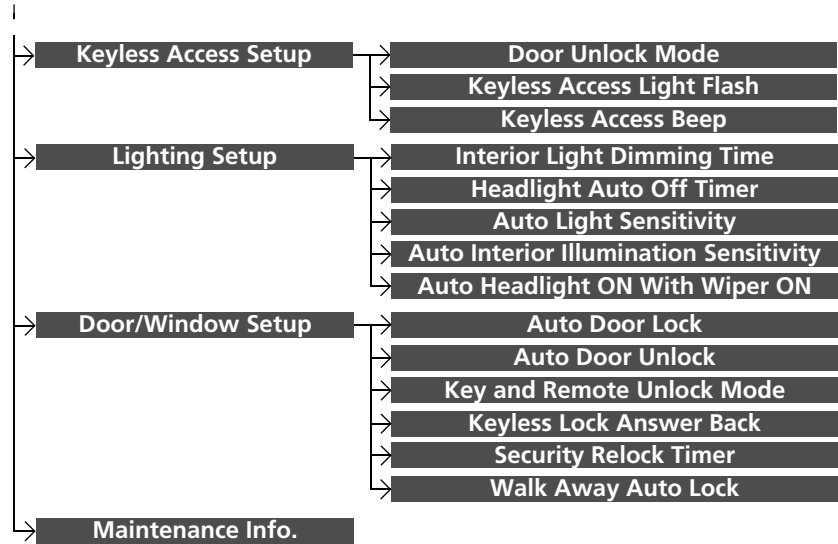

■ List of customizable options

Setup Group	Customizable Features	Description	Selectable Settings
Clock	Clock/ Wallpaper Type* ¹ / Clock Type* ²	Clock Wallpaper	
	Clock Adjustment		
	Auto Time Zone*		
	Manual Time Zone		
	Auto Daylight Saving Time		See Info on P. 315
	Clock Format		
	Clock Display		
	Overlay Clock Location		
	Clock Reset		
	HondaLink	Diagnostic & Location Data	
Others	Info Screen Preference		

*1: Does not appear when you change the screen interface design.

*2: Appears only when you change the screen interface design.

Setup Group	Customizable Features	Description	Selectable Settings	
Info	Clock	Clock/ Wallpaper Type^{*2/}	Clock Changes the clock display type.	Analog/Digital^{*1/} Small Digital/Off
		Clock Type^{*3}	Wallpaper <ul style="list-style-type: none"> • Changes the wallpaper type. • Imports an image file for a new wallpaper. • Deletes an image file for a wallpaper. 	Blank/Galaxy^{*1/} Metallic/Time Zone[*]
		Clock Adjustment	Adjusts Clock.	—
		Auto Time Zone[*]	Automatically adjusts the clock when driving through different time zones.	On^{*1/}Off
		Manual Time Zone	Changes the time zone manually.	—
		Auto Daylight Saving Time	Select On to have the GPS automatically adjust the clock to daylight savings time. Select Off to cancel this function.	On^{*1/}Off
		Clock Format	Selects the digital clock display from 12H to 24H.	12H^{*1/}24H
		Clock Display	Selects whether the clock display comes on.	On^{*1/}Off
		Overlay Clock Location	Changes the clock display layout.	Upper Right^{*1/}Upper Left/Lower Right/ Lower Left/Off
		Clock Reset	Resets the clock settings to the factory default.	Yes/No

*1:Default Setting

*2:Does not appear when you change the screen interface design.

*3:Appears only when you change the screen interface design.

* Not available on all models

Setup Group	Customizable Features		Description	Selectable Settings
Info	HondaLink	Diagnostic & Location Data	Turns HondaLink® on and off.	On^{*1}/Off
	Others	Info Screen Preference	Selects the top menu when the Info is selected. <ul style="list-style-type: none"> • Info Top- A brief menu pops up. • Info Menu- A full menu pops up. • Off- A menu does not pop up. 	Info Top/Info Menu^{*1}/Off

*1:Default Setting

Setup Group	Customizable Features	Description	Selectable Settings
Camera	Rear Camera	Fixed Guideline Selects whether the fixed guidelines come on the rear camera monitor. ▶ Multi-View Rear Camera P. 449	On^{*1}/Off
		Dynamic Guideline Selects whether the guidelines adjust to the movement of the steering wheel. ▶ Multi-View Rear Camera P. 449	On^{*1}/Off
		Default Cancels/Resets all customized items in the Rear Camera setting group as default.	Yes/No
	LaneWatch	Show with Turn Signal Selects whether the LaneWatch display comes on when you move the turn signal lever to indicate a right turn.	On^{*1}/Off
		Display Time after Turn Signal Off Changes the length of time the LaneWatch display stays on after the turn signal lever returns to the center.	0 second^{*1}/2 seconds
		Reference Line Selects whether the reference lines come on the LaneWatch monitor.	On^{*1}/Off
		Default Cancels/Resets all customized items in the LaneWatch group as default.	Yes/No

*1:Default Setting

Setup Group	Customizable Features	Description	Selectable Settings	
Bluetooth/ Wi-Fi	Bluetooth On/Off Status	Changes the <i>Bluetooth</i> ® status.	On*¹/Off	
	Bluetooth	<p>Pairs a new phone to HFL, edits or deletes a paired phone.</p> <p>☑ Phone Setup P. 343</p>	—	
	Edit Pairing Code	<p>Edits a pairing code.</p> <p>☑ To change the pairing code setting P. 344</p>	Random/Fixed*¹	
	Wi-Fi	Wi-Fi On/Off Status	Changes the Wi-Fi mode.	On/Off*¹
		Wi-Fi Device List	Connects, disconnects, or deletes the Wi-Fi device.	—
		Wi-Fi Information	Shows the Wi-Fi information of the head unit.	—
	Default	Cancels/Resets all customized items in the Bluetooth/Wi-Fi group as default.	Yes/No	
Smartphone	Apple CarPlay	Sets up the Apple CarPlay connection.	—	
	Android Auto	Sets up the Android Auto connection.	—	
	Default	Cancels/Resets all customized items in the Smartphone group as default.	Yes/No	

*1:Default Setting

Setup Group	Customizable Features	Description	Selectable Settings
Phone	Bluetooth Device List	Pairs a new phone to HFL, connects or disconnects a paired phone. ▶ Phone Setup P. 343	—
	Edit Speed Dial	Edits, adds or deletes a speed dial entry. ▶ Speed Dial P. 349	—
	Ring Tone	Selects the ring tone.	Fixed/Mobile Phone *1
	Automatic Phone Sync	Sets a phonebook and call history data to be automatically imported when a phone is paired to HFL.	On *1/ Off
	HondaLink Assist	Turns HondaLink Assist on and off.	On/Off *1
	Enable Text/Email	Turns the text/e-mail message function on and off.	On *1/ Off
	Select Account	Selects a text or e-mail message account.	—
	New Message Notification	Selects whether a pop-up alert comes on the screen when HFL receives a new text/e-mail message.	On/Off
Default	Cancels/Resets all customized items in the Phone settings group as default.	Yes/No	

*1:Default Setting

Setup Group	Customizable Features	Description	Selectable Settings	
Audio	FM/AM mode FM/AM	HD Radio Mode*	Selects whether the audio system automatically switches to the digital radio waves or receives the analog waves only.	Auto*¹/Analog Only
		RDS INFO	Turns on and off the RDS information.	On*¹/Off
		Tune Start	Turns on and off, starts the song from the beginning as you change preset stations.	On*¹/Off
		Interrupt	Turns on and off the sports alert function.	Off/On(One Time)/On(Continue)*¹
	SiriusXM® mode SXM*	SportsFlash Setup	Favorite Team Selects your favorite sports teams. 📡 Live Sports Alert P. 252	—
		Interrupt Beep	Causes the system to beep when the sports alert is notified.	On*¹/Off
		Traffic & Weather Setup	Selects the region you want to receive the information.	—
		Multiple Channel Mix Preset	Turns multiple channel mix preset on and off.	On/Off*¹

*1:Default Setting

Setup Group	Customizable Features	Description	Selectable Settings
Audio	Bluetooth <i>Bluetooth® mode</i>	Bluetooth Device List Pairs a new phone to HFL, edits or deletes a paired phone. ▶ Phone Setup P. 343	—
	Other	<i>iPod or USB mode</i> [Your selected media] Cover Art	Turns the cover art display on and off. On*/Off
		Audio Source Pop-Up	Selects whether the list of selectable audio source comes on when Audio is selected on the home screen. On/Off*1
	Default	Cancels/Resets all customized items in the Audio settings group as default. Yes/No	
System	Home	Home Screen Edit Order	Changes the HOME screen icon layout. —
		Menu Icon Position*2	Changes the position of the menu icons on the Audio , Phone , and Info screen. —
		Configuration of Instrument Panel	Changes the Instrument Panel screen icon layout. —



*1:Default Setting

*2:Appears only when you change the screen interface design.

Setup Group	Customizable Features	Description	Selectable Settings		
System	Display	Brightness	Changes the brightness of the audio/information screen.	—	
		Display Settings	Contrast	Changes the contrast of the audio/information screen.	—
			Black Level	Changes the black level of the audio/information screen.	—
	Background Color ^{*2}	Changes the background color of the audio/information screen.	Blue ^{*1} / Amber/Red/Violet/BlueGreen		
	Touch Panel Sensitivity	Sets the sensitivity of the touch panel screen.	High/Low ^{*1}		
	Sound/Beep	Guidance Volume	Changes the sound volume. Adjusts the guidance volume of the navigation system.	00~06 ^{*1} ~ 11	
Text Message Volume		Changes the text/e-mail message reading volume.	01~06 ^{*1} ~ 11		

*1:Default Setting

*2:Does not appear when you change the screen interface design.

Setup Group	Customizable Features	Description	Selectable Settings	
Sound/ Beep	Voice Recog. Volume	Changes the volume of the voice prompt.	01~06*1~11	
	Meter Volume - List Reading	Changes the list reading volume.	01~06*1~11	
	Meter Volume - Alphabetic Reading	Changes the alphabetic reading volume.	01~06*1~11	
	Verbal Reminder*	Turns the verbal reminders on and off.	On*1/Off	
	Beep Volume	Changes the beep volume.	Off/1/2*1/3	
System	One Press Voice Operation	Changes the setting of the  (Talk) button operation when using the voice operation.	On*1/Off	
	Voice Prompt	Turns the voice prompt on and off.	On*1/Off	
	Voice Recog. Volume	Changes the volume of the voice prompt.	01~06*1~11	
	Song by Voice	Turns the Song By Voice™ on and off.	On*1/Off	
	Voice Recog.	Song by Voice Phonetic Modification	Modifies a voice command for music stored in the USB flash drive or an iPod/iPhone.  Phonetic Modification P. 260	—
		Phonebook Phonetic Modification	Modifies a voice command for the phonebook.  Phonebook Phonetic Modification P. 352	—
		Automatic Phone Sync	Sets phonebook and call history data to be automatically imported when a phone is paired to HFL.	On/Off

*1:Default Setting

* Not available on all models

Setup Group	Customizable Features	Description	Selectable Settings
System	Clock/ Wallpaper Type*²/ Clock Type*³	Clock <hr/> Wallpaper	
	Clock Adjustment		
	Auto Time Zone*		
	Manual Time Zone	See Info on P. 315	
	Auto Daylight Saving Time		
	Clock Format		
	Clock Display		
	Overlay Clock Location		
	Clock Reset		
	Others	Language	Change the display language.

*1:Default Setting

*2:Does not appear when you change the screen interface design.

*3:Appears only when you change the screen interface design.

Setup Group	Customizable Features	Description	Selectable Settings
System Others	Voice Command Tips [*]	Alerts you when manual control of the system is disabled to prevent distraction while driving. Only voice commands are available.	On ^{*1} / Off
	Remember Last Screen ^{*2}	Selects whether the device remembers the last screen.	On/Off ^{*1}
	Memory Refresh	Turns on the audio system automatically and restores the fragmentation of a memory when the power mode is in VEHICLE OFF.	On ^{*1} / Off
	Refresh Time Adjustment	Sets the time for Memory Refresh .	—
	Change Skin	Changes the screen interface design.	Yes/No
	Factory Data Reset	Resets all the settings to their factory default. <input checked="" type="checkbox"/> Defaulting All the Settings P. 331	Yes/No

*1:Default Setting

*2:Does not appear when you change the screen interface design.

Setup Group	Customizable Features	Description	Selectable Settings	
System	Others	Climate Screen Timeout	Changes the length of time the climate control display stays on when you press the CLIMATE button.	Never/5 Seconds/10 Seconds*¹/20 Seconds
		Detail Information	Displays the details of the head unit and operating system information.	
	Default		Cancels /Resets all customized items in the System group as default.	Yes/No
Vehicle		TPMS Calibration	Cancels/Calibrates the TPMS.	Cancel/Calibrate
	Driver Assist System Setup	Forward Collision Warning Distance	Changes the distance at which CMBS™ alerts.	Long/Normal*¹/Short
		ACC Forward Vehicle Detect Beep	Causes the system to beep when the system detects a vehicle, or when the vehicle goes out of the ACC with LSF range.	On/Off*¹
		Lane Keeping Assist Suspend Beep	Causes the system to beep when LKAS is suspended.	On/Off*¹
		Road Departure Mitigation Setting	Changes the setting for the road departure mitigation system.	Normal*¹/Wide/Warning Only/Narrow

*1:Default Setting

Setup Group	Customizable Features	Description	Selectable Settings
Vehicle Meter Setup	Adjust Outside Temp. Display	Adjusts the temperature reading by a few degrees.	-5°F ~ ±0°F^{*1} ~ +5°F (U.S.) -3°C ~ ±0°C^{*1} ~ +3°C (Canada)
	"Trip A" Reset Timing	Changes the setting of how to reset trip meter A, average fuel economy A, average speed A, and elapsed time A.	When Refueled/ When Charged/IGN Off/Manually Reset^{*1}
	"Trip B" Reset Timing	Changes the setting of how to reset trip meter B, average fuel economy B, average speed B, and elapsed time B.	When Refueled/ When Charged/IGN Off/Manually Reset^{*1}
	Adjust Alarm Volume	Changes the alarm volume, such as buzzers, warnings, turn signal sound, and so on.	High/Mid^{*1}/Low
	Fuel Efficiency Backlight	Turns the ambient meter feature on and off.	On^{*1}/Off
	Turn By Turn Auto Display	Selects whether the turn-by-turn display comes on during the route guidance.	On^{*1}/Off
	New Message Notifications	Used to select whether a pop-up alert comes on the screen when HFL receives a new text/e-mail message.	On^{*1}/Off

*1:Default Setting

Setup Group	Customizable Features	Description	Selectable Settings
Vehicle	Reverse Alert Tone	Causes the beeper to sound once when the transmission is put into R .	On^{*1}/Off
	Meter Setup		km/h·km/ mph·miles^{*1} (U.S.) km/h·km^{*1}/ mph·miles (Canada)
	Speed/Distance Units	Selects the trip computer units.	
	Driving Position Setup[*]		
	Memory Position Link	Turns the driving position memory system on and off.	On^{*1}/Off
	Keyless Access Setup		
	Door Unlock Mode	Changes which doors unlock when you grab the driver's door handle.	Driver Door Only^{*1}/ All Doors
	Keyless Access Light Flash	Causes some exterior lights to flash when you unlock/lock the doors.	On^{*1}/Off
	Keyless Access Beep	Causes the beeper to sound when you unlock/lock the doors.	On^{*1}/Off

*1: Default Setting

Setup Group	Customizable Features	Description	Selectable Settings	
Vehicle	Lighting Setup	Interior Light Dimming Time	Changes the length of time the interior lights stay on after you close the doors.	15seconds/ 30seconds*¹/ 60seconds
		Headlight Auto Off Timer	Changes the length of time the exterior lights stay on after you close the driver's door.	0seconds/ 15seconds*¹/ 30seconds/ 60seconds
		Auto Light Sensitivity	Changes the timing for the headlights to come on.	Max/High/Mid*¹/ Low/Min
		Auto Interior Illumination Sensitivity	Changes the sensitivity of the brightness of the instrument panel when the headlight switch is in the AUTO position.	Max/High/Mid*¹/ Low/Min
		Auto Headlight ON With Wiper ON	Changes the settings for the wiper operation when the headlights automatically come on while the headlight switch is in the AUTO position.	On*¹/Off

*1:Default Setting

Setup Group	Customizable Features	Description	Selectable Settings	
Vehicle	Door/ Window Setup	Auto Door Lock	Used to change the setting for when the doors automatically lock.	With Vehicle Speed^{*1}/Shift from P/Off
		Auto Door Unlock	Changes the setting for when the doors unlock automatically.	All Doors When Driver's Door Opens^{*1}/All Doors When Shifted to Park/All Doors When Ignition Switched Off/Off
		Key and Remote Unlock Mode	Sets up the driver's door or all the doors to unlock on the first push of the remote.	Driver Door^{*1}/All Doors
		Keyless Lock Answer Back	LOCK/UNLOCK- The exterior lights flash. LOCK (2nd push)- The beeper sounds.	On^{*1}/Off
		Security Relock Timer	Changes the time it takes for the doors to relock and the security system to set after you unlock the vehicle without opening any door.	90seconds/ 60seconds/ 30seconds^{*1}
		Walk Away Auto Lock	Changes the settings for the auto lock function when you walk away from the vehicle.	On/Off^{*1}
		Maintenance Info.	Resets the Maintenance Minder™ display when you have performed the maintenance service.	—

*1:Default Setting

Defaulting All the Settings

Reset all the menu and customized settings as the factory defaults.

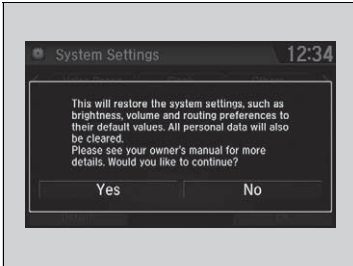

1. Select .
2. Select **Settings**.
3. Select **System**.
4. Select the **Others** tab.
5. Select **Factory Data Reset**.
 - ▶ A confirmation message appears on the screen.
6. Select **Yes** to reset the settings.
7. Select **Yes** again to reset the settings.
 - ▶ A confirmation message appears on the screen. Select **OK**.
 - ▶ After selecting **OK**, the system will reboot.

Defaulting All the Settings

When you transfer the vehicle to a third party, reset all settings to default and delete all personal data.

If you perform **Factory Data Reset**, it will reset the preinstalled apps to their factory default.

If you perform **Factory Data Reset**, you cannot use the HondaLink® because it becomes off line.

 **HondaLink®** P. 269

The HomeLink® Universal Transceiver can be programmed to operate up to three remote controlled devices around your home, such as garage doors, lighting, or home security systems.

■ Important Safety Precautions

Refer to the safety information that came with your garage door opener to test that the safety features are functioning properly. If you do not have the safety information, contact the manufacturer.

Before programming HomeLink, make sure that people and objects are out of the way of the garage or gate to prevent potential injury or damage.

When programming a garage door opener, park just outside the garage door's path.

⌘ HomeLink® Universal Transceiver*

Before programming HomeLink to operate a garage door opener, confirm that the opener has an external entrapment protection system, such as an "electronic eye," or other safety and reverse stop features. If it does not, HomeLink may not be able to operate it.

Training HomeLink

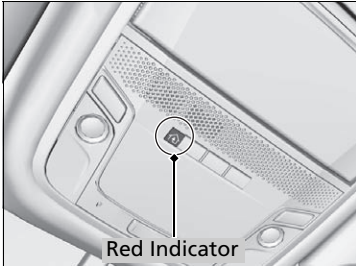

If it is necessary to erase a previously entered learned code:

- Press and hold the two outside buttons for about 20 seconds, until the red indicator blinks. Release the buttons, and proceed to step 1.
- If you are training the second or third button, go directly to step 1.

The instructions on the next page should work for most gate or garage openers, but may not work for all. For detailed instructions about your specific remote opener, visit <http://www.homelink.com> or call (800) 355-3515.

■ Training a Button

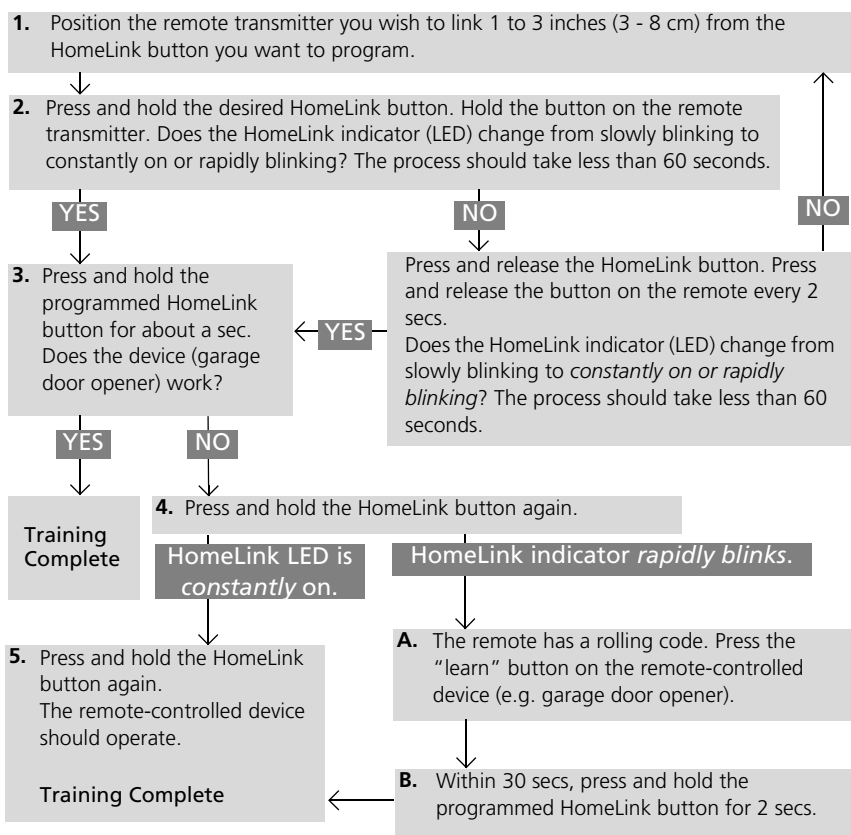

▶▶ Training HomeLink

Retraining a Button
 If you want to retrain a programmed button for a new device, you do not have to erase all button memory. You can replace the existing memory code using this procedure:

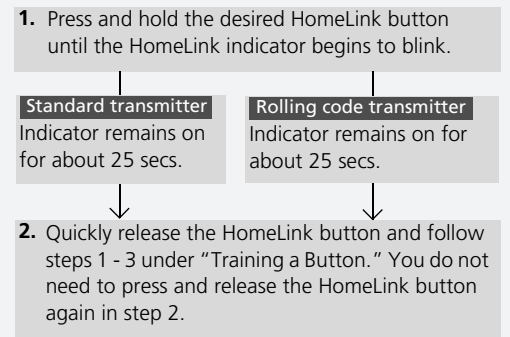

Erasing Codes
 To erase all the codes, press and hold the two outside buttons until the HomeLink indicator begins to blink (about 10 to 20 secs). You should erase all codes before selling the vehicle.

If you have any problems, see the device's instructions, visit www.homelink.com, or call HomeLink at (800) 355-3515.

HomeLink® is a registered trademark of Gentex Corporation.

Bluetooth® HandsFreeLink® (HFL) allows you to place and receive phone calls using your vehicle's audio system, without handling your cell phone.

Using HFL

HFL Buttons

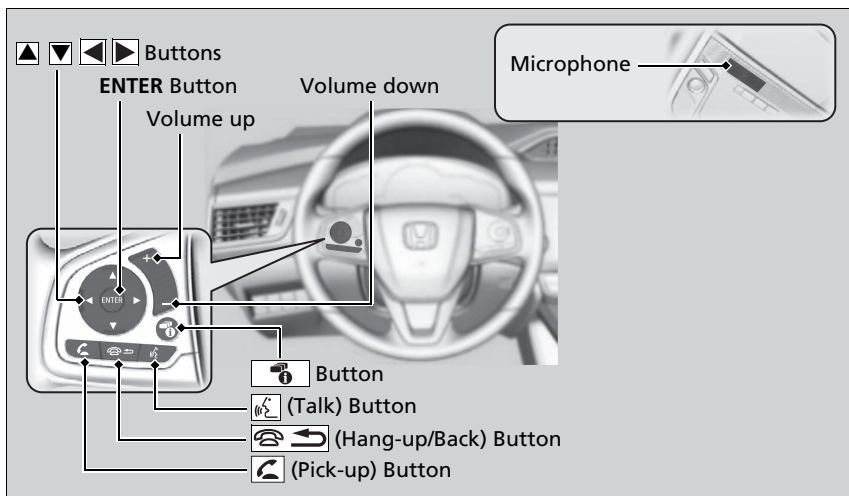

Bluetooth® HandsFreeLink®

Place your phone where you can get good reception.

To use HFL, you need a *Bluetooth*-compatible cell phone. For a list of compatible phones, pairing procedures, and special feature capabilities:

- U.S.: Visit automobiles.honda.com/handsfreelink/, or call 1-888-528-7876.
- Canada: For more information on smartphone compatibility, call 1-888-528-7876.

To use the system, the **Bluetooth On/Off Status** setting must be **On**. If there is an active connection to Apple CarPlay, HFL is unavailable.

➤ **How to customize** P. 306

Voice control tips

- Aim the vents away from the ceiling and close the windows, as noise coming from them may interfere with the microphone.
- Press the  button when you want to call a number using a stored voice tag. Speak clearly and naturally after a beep.
- If the microphone picks up voices other than yours, the command may be misinterpreted.
- To change the volume level, select the audio system's **VOL** (Volume) or use the remote audio controls on the steering wheel.



Up to five speed dial entries can be displayed among a total of 20 that can be entered.

➤ **Speed Dial** P. 349



 **(Pick-up) button:** Press to go directly to the phone menu on the driver information interface, or to answer an incoming call.

 **(Hang-up/back) button:** Press to end a call, go back to the previous command, or cancel a command.



 **(Talk) button:** Press to access Voice Portal.

  **buttons:** Press to select an item displayed on the phone menu in the driver information interface.

ENTER button: Press to call a number listed in the selected item on the phone menu in the driver information interface.

 **button:** Select  and press **ENTER** to display **Speed Dial**, **Call History**, or **Phonebook** on the phone menu in the driver information interface.

To go to the **Phone Menu** screen:

1. Select .
2. Select **Phone** to switch the display to the phone screen.
3. Select .

Bluetooth® HandsFreeLink®

Up to five previous calls can be displayed at a time among a total of 20 that can be entered. If there is no call history, Call History is disabled.

Bluetooth® Wireless Technology

The *Bluetooth®* word mark and logos are registered trademarks owned by Bluetooth SIG, Inc., and any use of such marks by Honda Motor Co., Ltd., is under license. Other trademarks and trade names are those of their respective owners.

HFL Limitations

An incoming call on HFL will interrupt the audio system when it is playing. It will resume when the call is ended.

HFL Status Display

The audio/information screen notifies you when there is an incoming call.

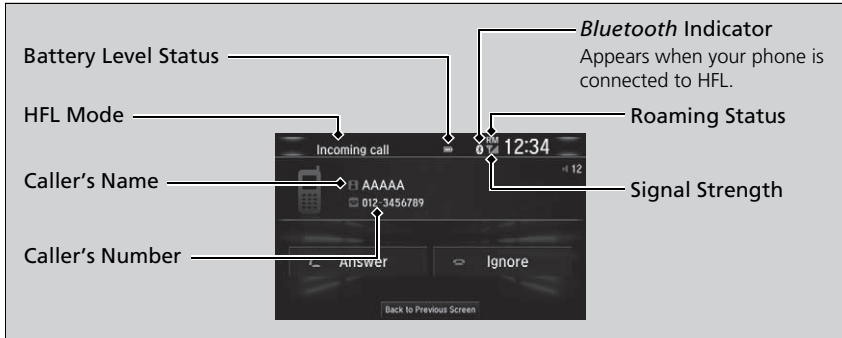

Limitations for Manual Operation

Certain manual functions are disabled or inoperable while the vehicle is in motion. You cannot select a grayed-out option until the vehicle is stopped.

Only previously stored speed dial entries with voice tags, phonebook names, or numbers can be called using voice commands while the vehicle is in motion.

▶ **Speed Dial** P. 349

HFL Status Display

The information that appears on the audio/information screen varies between phone models.

You can change the system language.

▶ **How to customize** P. 306

HFL Menu

The power mode must be in ACCESSORY or ON to use HFL.

■ Phone Settings screen



1. Select .
2. Select **Settings**.
3. Select **Phone**.

▶▶ HFL Menu

To use HFL, you must first pair your *Bluetooth*-compatible cell phone to the system while the vehicle is parked.

Some functions are limited while driving.

Features

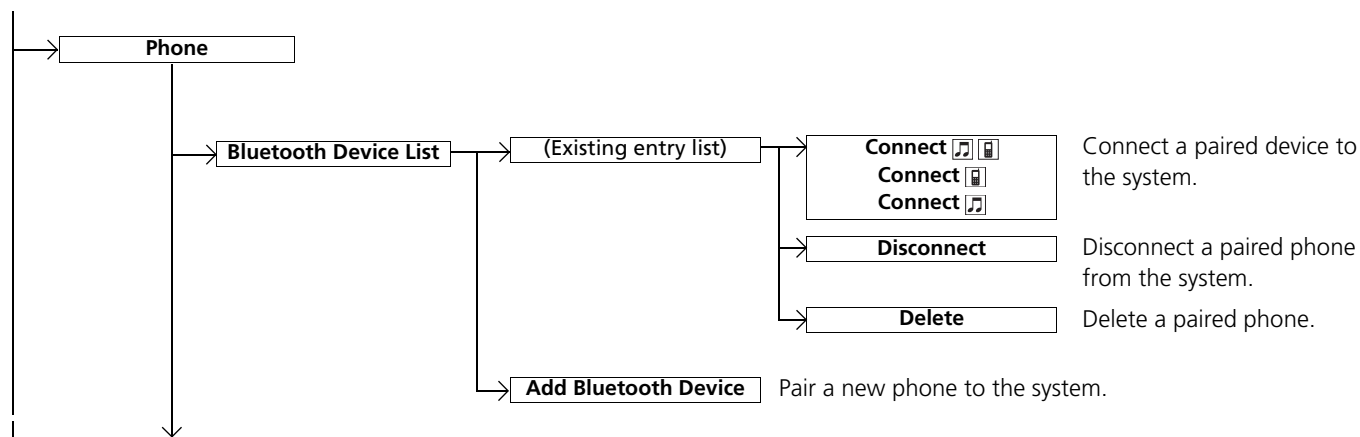

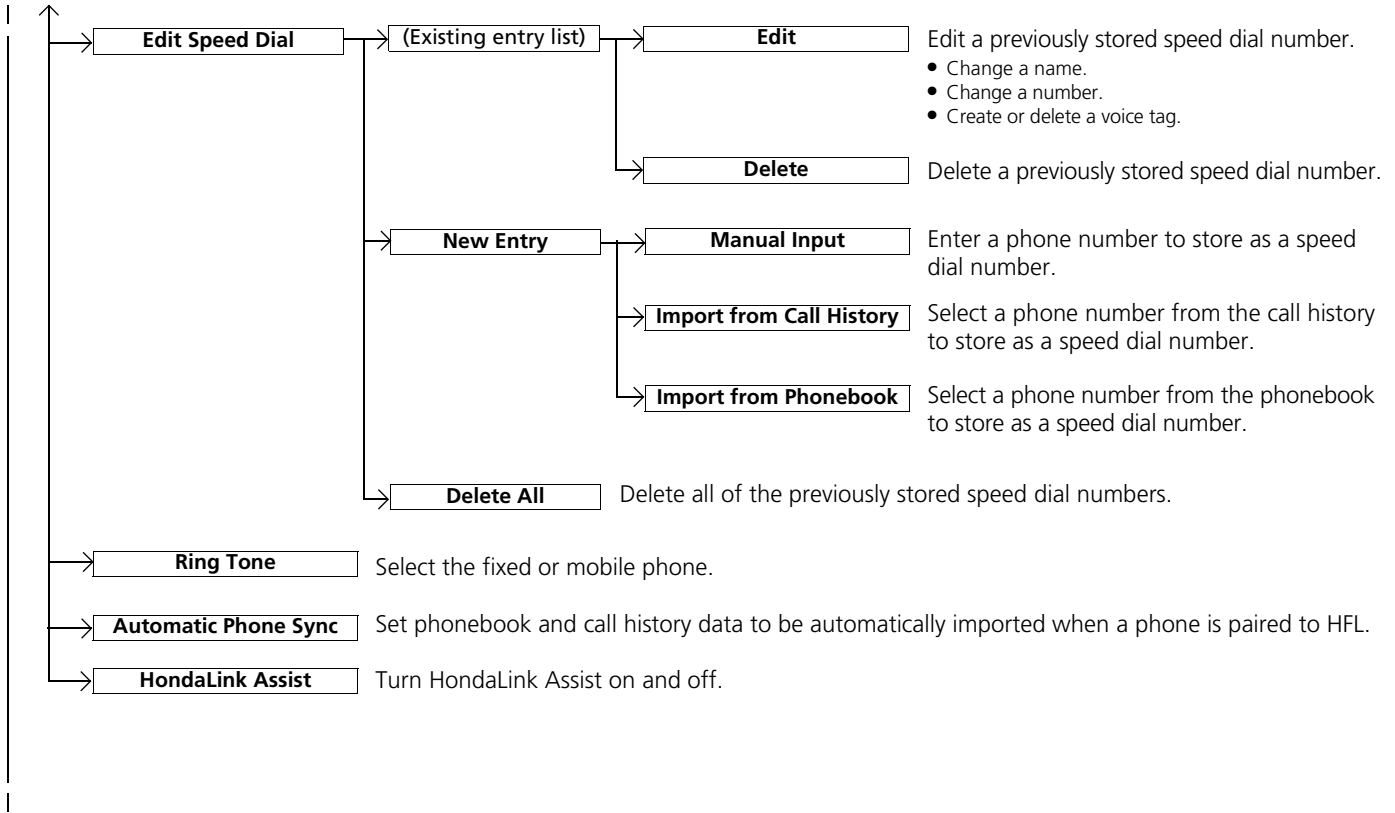

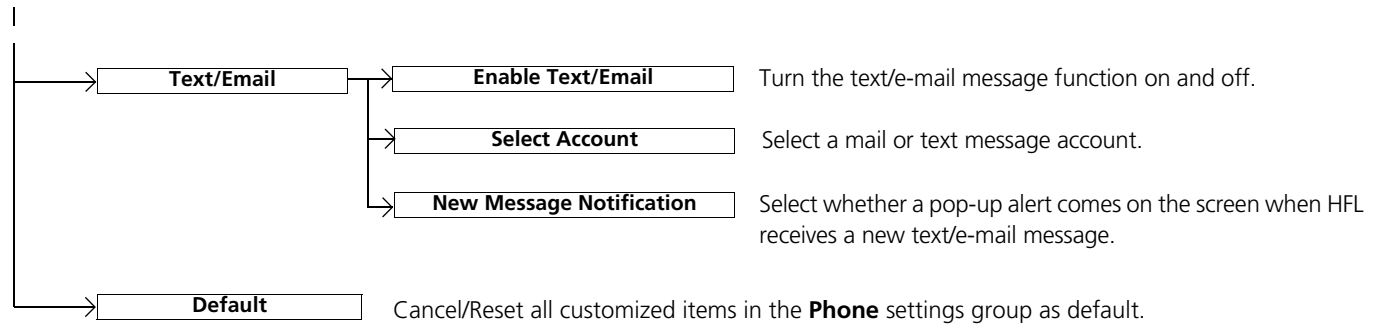

■ Phone Menu screen



1. Select .
2. Select **Phone**.
3. Select .

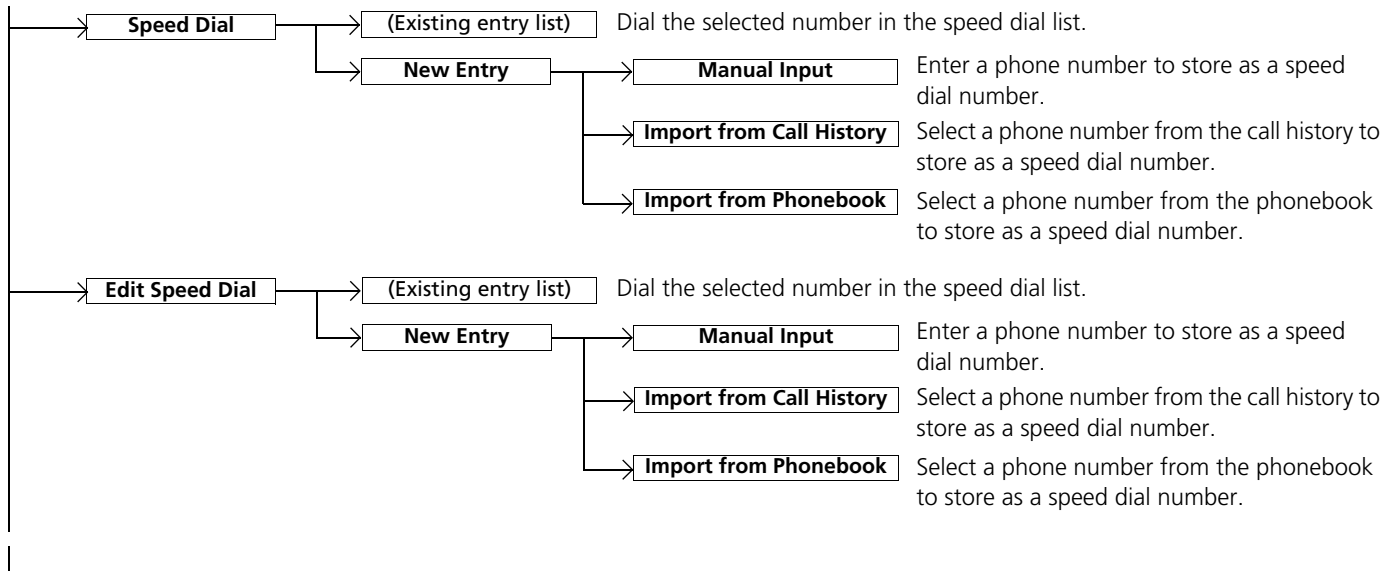

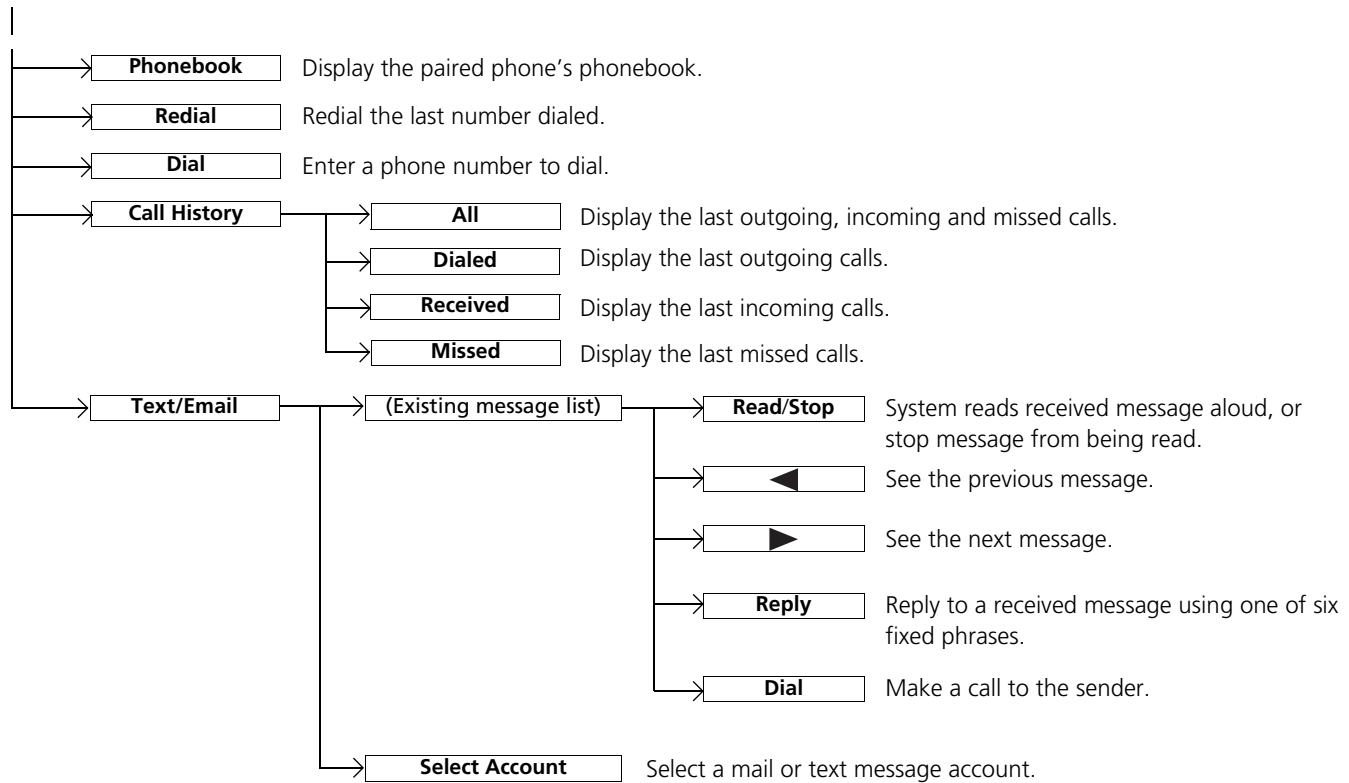

Phone Setup

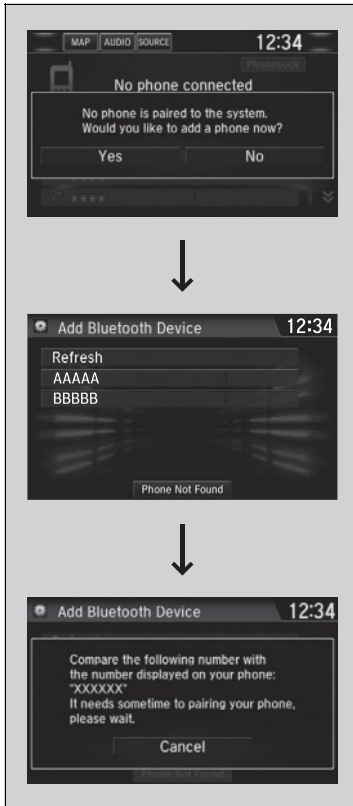

■ To pair a cell phone (when there is no phone paired to the system)

1. Select **Phone**.
2. Select **Yes**.
3. Make sure your phone is in search or discoverable mode, then select **Continue**.
 - ▶ HFL automatically searches for a *Bluetooth*® device.
4. Select your phone when it appears on the list.
 - ▶ If your phone does not appear, you can select **Refresh** to search again.
 - ▶ If your phone still does not appear, select **Phone Not Found** and search for *Bluetooth*® devices using your phone. From your phone, search for **HandsFreeLink**.
5. The system gives you a pairing code on the audio/information screen.
 - ▶ Confirm if the pairing code on the screen and your phone match. This may vary by phone.

☒ Phone Setup



Your *Bluetooth*-compatible phone must be paired to the system before you can make and receive hands-free calls.

Phone Pairing Tips:

- You cannot pair your phone while the vehicle is moving.
- Up to six phones can be paired.
- Your phone's battery may drain faster when it is paired to the system.
- If your phone is not ready for pairing or not found by the system within three minutes, the system will time out and return to idle.

Once you have paired a phone, you can see it displayed on the screen with one or two icons on the right side.



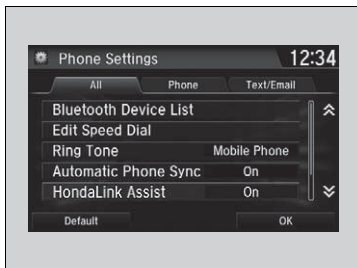

These icons indicate the following:

- : The phone can be used with HFL.
- : The phone is compatible with *Bluetooth*® Audio.

If there is an active connection to Apple CarPlay, pairing of additional *Bluetooth*-compatible devices is unavailable and **Add Bluetooth Device** is grayed out from the **Bluetooth Device List** screen.



■ **To change the currently paired phone**

1. Go to the **Phone Settings** screen.
 - ▶ **Phone Settings screen** P. 338
2. Select **Bluetooth Device List**.
3. Select a phone to connect.
 - ▶ HFL disconnects the connected phone and starts searching for another paired phone.
4. Select **Connect**  , **Connect** , or **Connect** .

■ **To change the pairing code setting**

1. Select .
2. Select **Settings**.
3. Select **Bluetooth/Wi-Fi**.
4. Select the **Bluetooth** tab.
5. Select **Edit Pairing Code**.

6. Select **Random** or **Fixed**.

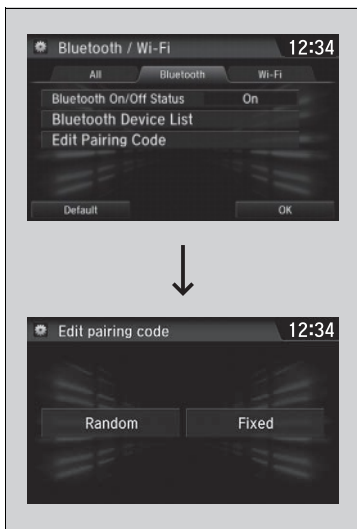

▶▶ To change the currently paired phone

If no other phones are found or paired when trying to switch to another phone, HFL will inform you that the original phone is connected again.

To pair other phones, select **Add Bluetooth Device** from the **Bluetooth Device List** screen.

▶▶ To change the pairing code setting

The default pairing code is **0000** until you change the setting. To create your own, select **Fixed**, and delete the current code, then enter a new one.

For a randomly generated pairing code each time you pair a phone, select **Random**.

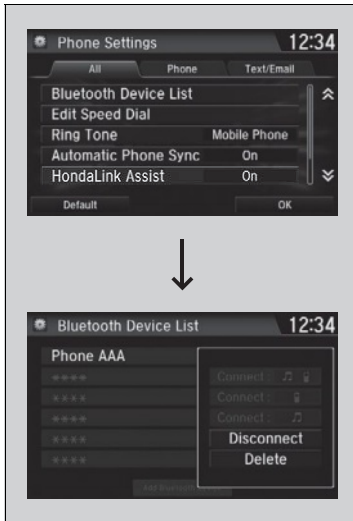

■ To delete a paired phone

1. Go to the **Phone Settings** screen.
 - ▶ **Phone Settings** screen P. 338
2. Select **Bluetooth Device List**.
3. Select a phone you want to delete.
4. Select **Delete**.
5. A confirmation message appears on the screen. Select **Yes**.

■ To Set Up Text/E-mail Message Options

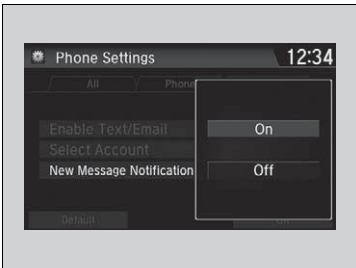
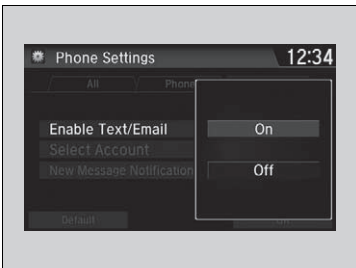

■ To turn on or off the text/e-mail message function

1. Go to the **Phone Settings** screen.
 - ▶ **Phone Settings screen** P. 338
2. Select the **Text/Email** tab, then **Enable Text/Email**.
 - ▶ A pop-up menu appears on the screen.
3. Select **On** or **Off**.

■ To turn on or off the text/e-mail message notice

1. Go to the **Phone Settings** screen.
 - ▶ **Phone Settings screen** P. 338
2. Select the **Text/Email** tab, then **New Message Notification**.
 - ▶ A pop-up menu appears on the screen.
3. Select **On** or **Off**.

▶▶ To Set Up Text/E-mail Message Options

To use the text/e-mail message function, it may be necessary to set up on your phone.

Some text/e-mail message features may not be available depending on a cellular phone.

▶▶ To turn on or off the text/e-mail message notice

On: A pop-up notification comes on every time you receive a new message.

Off: The message you receive is stored in the system without notification.

Ring Tone

You can change the ring tone setting.



1. Go to the **Phone Settings** screen.
 ▶ **Phone Settings screen** P. 338
2. Select **Ring Tone**.
3. Select **Fixed** or **Mobile Phone**.

Ring Tone

Fixed: The fixed ring tone sounds from the speakers.
Mobile Phone: For certain connected phones, the ring tone stored in the phone sounds from the speakers.

Continued

■ Automatic Import of Cellular Phonebook and Call History

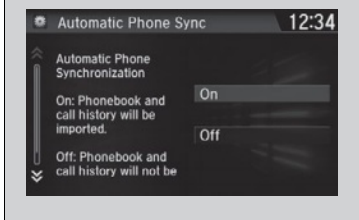
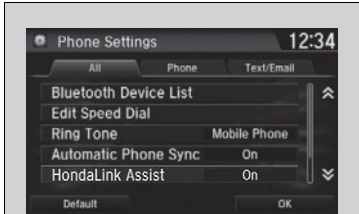
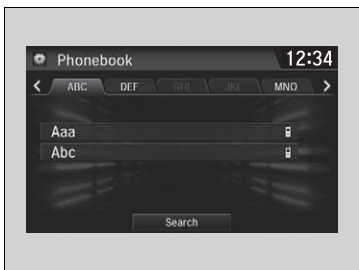

■ When Automatic Phone Sync is set to On:

When your phone is paired, the contents of its phonebook and call history are automatically imported to the system.

■ Changing the Automatic Phone Sync setting

1. Go to the **Phone Settings** screen.
 - ▶ **Phone Settings screen** P. 338
2. Select **Automatic Phone Sync**.
3. Select **On** or **Off**.

▶ Automatic Import of Cellular Phonebook and Call History

When you select a name from the list in the cellular phonebook, you can see up to three category icons. The icons indicate what types of numbers are stored for that name.

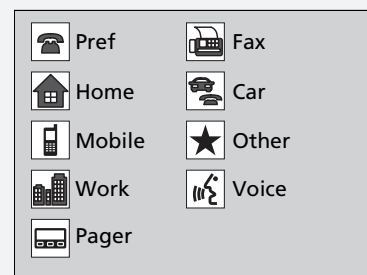

On some phones, it may not be possible to import the category icons to the system.

The phonebook is updated after every connection. Call history is updated after every connection or call.

Speed Dial

Up to 20 speed dial numbers can be stored per phone.



To store a speed dial number:

1. Go to the **Phone Menu** screen.

➤ **Phone Menu screen** P. 341

2. Select **Speed Dial**.

3. Select **New Entry**.

From **Import from Call History**:

▶ Select a number from the call history.

From **Manual Input**:

▶ Input the number manually.

From **Import from Phonebook**:

▶ Select a number from the connected cell phone's imported phonebook.

4. When the speed dial is successfully stored, you are asked to create a voice tag for the number. Select **Yes** or **No**.

5. Select **Record**, or use the [RECORD] button and follow the prompts to complete the voice tag.

Speed Dial

When a voice tag is stored, press the [RECORD] button to call the number using the voice tag. Say the voice tag name.

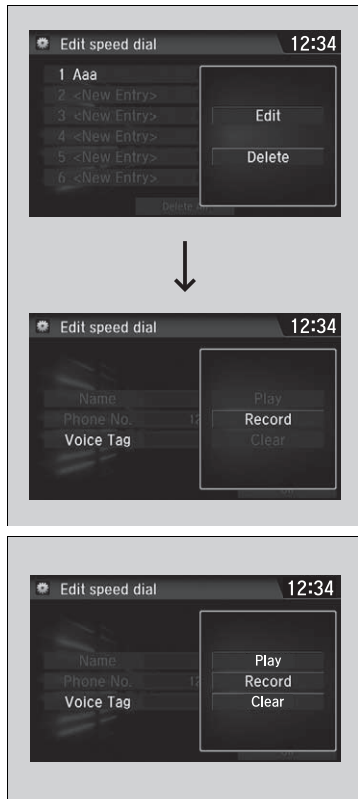

■ To add a voice tag to a stored speed dial number

1. Go to the **Phone Settings** screen.
 ▶ **Phone Settings screen** P. 338
2. Select **Edit Speed Dial**.
3. Select an existing speed dial entry.
 ▶ From the pop-up menu, select **Edit**.
4. Select **Voice Tag**.
 ▶ From the pop-up menu, select **Record**.
5. Select **Record**, or use the  button and follow the prompts to complete the voice tag.

■ To delete a voice tag

1. Go to the **Phone Settings** screen.
 ▶ **Phone Settings screen** P. 338
2. Select **Edit Speed Dial**.
3. Select an existing speed dial entry.
 ▶ From the pop-up menu, select **Edit**.
4. Select **Voice Tag**.
 ▶ From the pop-up menu, select **Clear**.
5. A confirmation message appears on the screen. Select **Yes**.

▶▶ Speed Dial

Avoid using duplicate voice tags.
 Avoid using "home" as a voice tag.
 It is easier for the system to recognize a longer name.
 For example, use "John Smith" instead of "John."

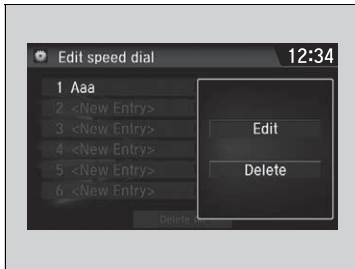

■ To edit a speed dial

1. Go to the **Phone Settings** screen.
 - ▶ **Phone Settings screen** P. 338
2. Select **Edit Speed Dial**.
3. Select an existing speed dial entry.
 - ▶ From the pop-up menu, select **Edit**.
4. Select a setting you want.

■ To delete a speed dial

1. Go to the **Phone Settings** screen.
 - ▶ **Phone Settings screen** P. 338
2. Select **Edit Speed Dial**.
3. Select an existing speed dial entry.
 - ▶ From the pop-up menu, select **Delete**.
4. A confirmation message appears on the screen. Select **Yes**.

■ Phonebook Phonetic Modification

Add phonetic modifications or a new voice tag to the phone's contact name so that it is easier for HFL to recognize voice commands.

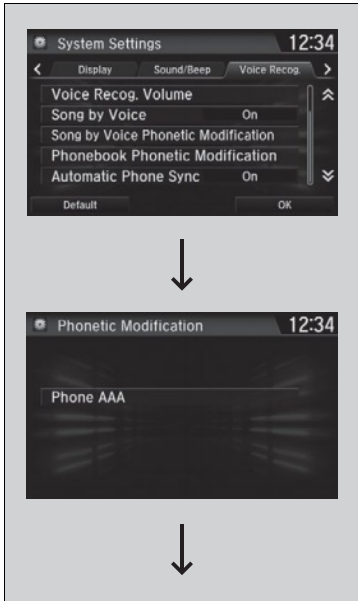

■ To add a new voice tag

1. Select .
2. Select **Settings**.
3. Select **System**.
4. Select the **Voice Recog.** tab.
5. Select **Phonebook Phonetic Modification**.
6. Select the phone you want to add phonetic modification to.

▶▶ Phonebook Phonetic Modification



You can store up to 20 phonetic modification items.



7. Select **New Voice Tag**.
8. Select a contact name you want to add to.
 - ▶ The pop-up menu appears on the screen.
9. Select **Modify**.
10. Using **Record** or the  button, follow the prompts to complete the voice tag.
11. You will receive a confirmation message on the screen, then select **OK**.



■ **To modify a voice tag**

1. Select .
2. Select **Settings**.
3. Select **System**.
4. Select the **Voice Recog.** tab.
5. Select **Phonebook Phonetic Modification**.
6. Select the phone you want to modify phonetic modification.
7. Select a contact name you want to modify.
 - ▶ The pop-up menu appears on the screen.
8. Select **Modify**.
9. Using **Record** or the  button, follow the prompts to complete the voice tag.
10. You will receive a confirmation message on the screen, then select **OK**.

▶▶ Phonebook Phonetic Modification

You can only modify or delete contact names for the currently connected phone.

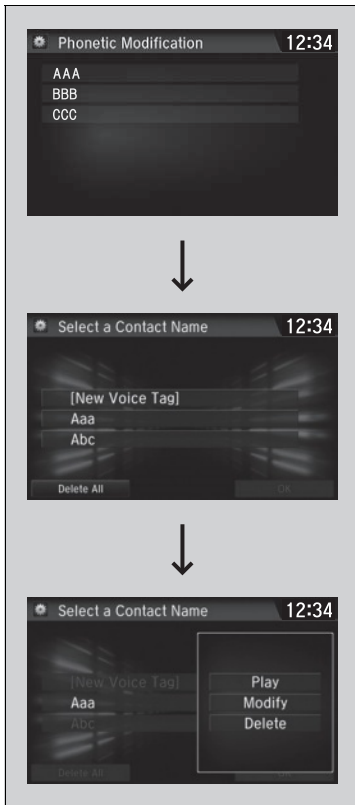

■ To delete a modified voice tag

1. Select .
2. Select **Settings**.
3. Select **System**.
4. Select the **Voice Recog.** tab.
5. Select **Phonebook Phonetic Modification**.
6. Select the phone you want to delete phonetic modification.
7. Select a contact name you want to delete.
 - ▶ The pop-up menu appears on the screen.
8. Select **Delete**.
 - ▶ The selected contact name has been selected.
9. Select **OK**.

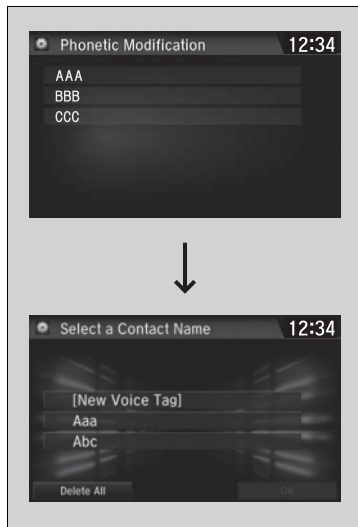

■ **To delete all modified voice tags**

1. Select .
2. Select **Settings**.
3. Select **System**.
4. Select the **Voice Recog.** tab.
5. Select **Phonebook Phonetic Modification**.
6. Select the phone you want to delete phonetic modification.
 - ▶ The contact name list appears.
7. Select **Delete All**.
8. You will receive a confirmation message on the screen, then select **Yes**.

■ **Making a Call**

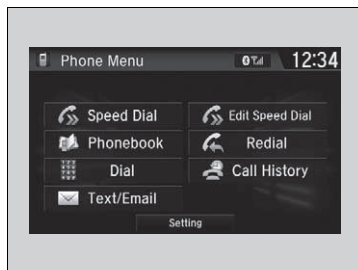

You can make calls by inputting any phone number, or by using the imported phonebook, call history, speed dial entries, or redial.

⌘ **Making a Call**

Any voice-tagged speed dial entry can be dialed by voice from most screens.

Press the  button and say the voice tag name.

Once a call is connected, you can hear the voice of the person you are calling through the audio speakers.

While there is an active connection with Apple CarPlay, phone calls cannot be made with HandsFreeLink® and are only made from Apple CarPlay.

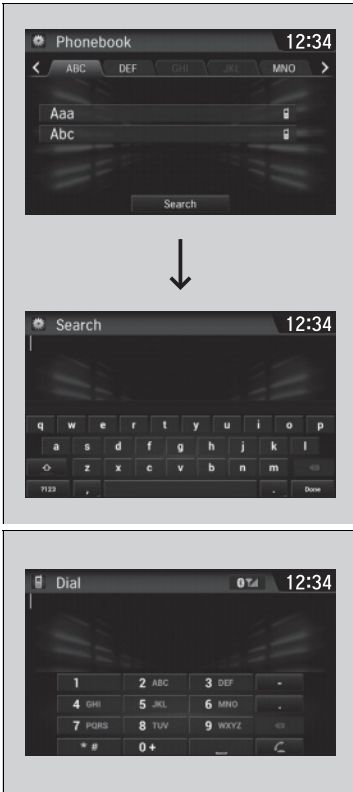

■ **To make a call using the imported phonebook**

1. Go to the **Phone Menu** screen.
 ▶ **Phone Menu screen** P. 341
2. Select **Phonebook**.
3. Select a name.
 ▶ You can also search by letter. Select **Search**.
 ▶ Use the keyboard on the touch screen for entering a name, if multiple numbers exist select a number.
4. Select a number.
 ▶ Dialing starts automatically.

■ **To make a call using a phone number**

1. Go to the **Phone Menu** screen.
 ▶ **Phone Menu screen** P. 341
2. Select **Dial**.
3. Select a number.
 ▶ Use the keyboard on the touch screen for entering numbers.
4. Select .
 ▶ Dialing starts automatically.

☒ **To make a call using the imported phonebook**

You can call a stored voice-tagged speed dial number using voice commands.
 ▶ **Speed Dial** P. 349

☒ **To make a call using a phone number**

You can call a stored voice-tagged speed dial number using voice commands.
 ▶ **Speed Dial** P. 349

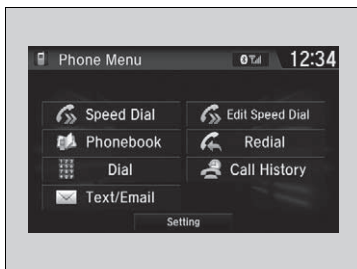

■ **To make a call using redial**

1. Go to the **Phone Menu** screen.
 - ▶ **Phone Menu screen** P. 341
2. Select **Redial**.
 - ▶ Dialing starts automatically.

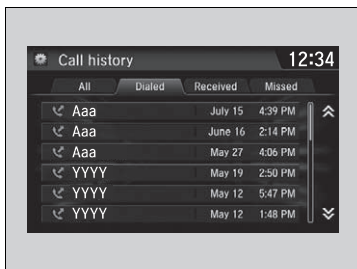

■ **To make a call using the Call History**

Call history is stored by **All**, **Dialed**, **Received**, and **Missed**.

1. Go to the **Phone Menu** screen.
 - ▶ **Phone Menu screen** P. 341
2. Select **Call History**.
3. Select **All**, **Dialed**, **Received**, or **Missed**.
4. Select a number.
 - ▶ Dialing starts automatically.



■ **To make a call using a Speed Dial entry**

1. Go to the **Phone Menu** screen.
 - ▶ **Phone Menu screen** P. 341
2. Select **Speed Dial**.
3. Select a number.
 - ▶ Dialing starts automatically.

☒ **To make a call using the Call History**

The call history displays the last 20 all, dialed, received, or missed calls. (Appears only when a phone is connected to the system.)

☒ **To make a call using a Speed Dial entry**

When a voice tag is stored, press the  button to call the number using the voice tag.

▶ **Speed Dial** P. 349



Any voice-tagged speed dial entry can be dialed by voice from any screen.

Press the  button and follow the prompts.

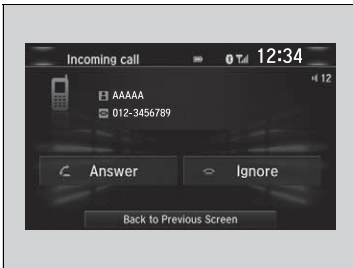
Receiving a Call



When there is an incoming call, an audible notification sounds (if activated) and the **Incoming call** screen appears.

Press the  button to answer the call.
Press the  button to decline or end the call.

Options During a Call

The following options are available during a call.

Mute: Mute your voice.

Transfer: Transfer a call from the system to your phone.

Touch Tones: Send numbers during a call. This is useful when you call a menu-driven phone system.

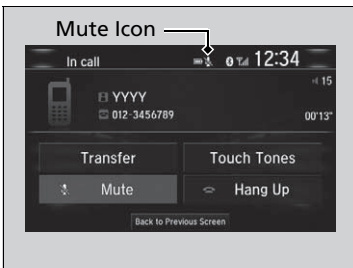

The available options are shown on the lower half of the screen.

Select the option.

- ▶ The mute icon appears when **Mute** is selected. Select **Mute** again to turn it off.

Receiving a Call



Call Waiting

Press the  button to put the current call on hold to answer the incoming call.

Press the  button again to return to the current call.

Select **Ignore** to ignore the incoming call if you do not want to answer it.

Press the  button if you want to hang up the current call.

You can select the icons on the audio/information screen instead of the  and  buttons.

Options During a Call

Touch Tones: Available on some phones.

You can select the icons on the audio/information screen.

■ Receiving a Text/E-mail Message

HFL can display newly received text or e-mail messages as well as 20 of the most recently received messages on a linked cell phone. Each received message can be read aloud and replied to using a fixed common phrase.



1. A pop-up appears and notifies you of a new text or e-mail message.
2. Select **Read** to listen to the message.
 - ▶ The text or e-mail message is displayed. The system automatically starts reading out the message.
3. To discontinue the message read-out, select **Stop**.

▣ Receiving a Text/E-mail Message

The system does not display any received messages while you are driving. You can only hear them read aloud.

The system can only receive messages that are sent as text (SMS) messages. Messages sent using data services will not be displayed in the list.

With some phones, you may be able to display up to 20 most recent text and e-mail messages.

State or local laws may limit your use of the HFL text/e-mail message feature. Only use the text/e-mail message feature when conditions allow you to do so safely.

When you receive a text or e-mail message for the first time since the phone is paired to HFL, you are asked to turn the **New Message Notification** setting to **On**.

▣ **To turn on or off the text/e-mail message notice** P. 346

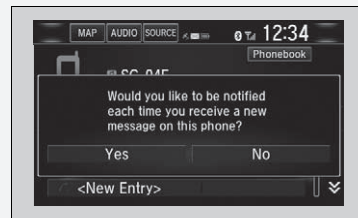

Selecting a Mail Account

If a paired phone has text message or mail accounts, you can select one of them to be active and receive notifications.

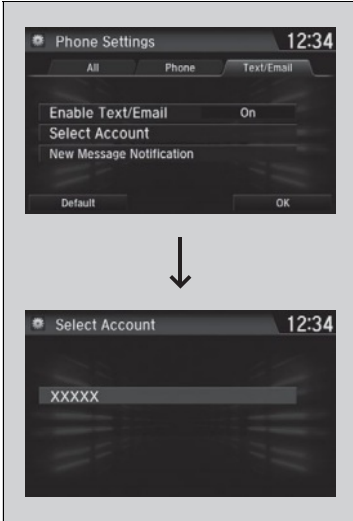

1. Go to the **Phone Settings** screen.
 ▶ **Phone Settings screen** P. 338
2. Select the **Text/Email** tab, then **Select Account**.
 ▶ A pop-up menu appears on the screen.
3. Select **Text Messages** or an e-mail message account you want.

Selecting a Mail Account

You can also select a mail account from the folder list screen or the message list screen.

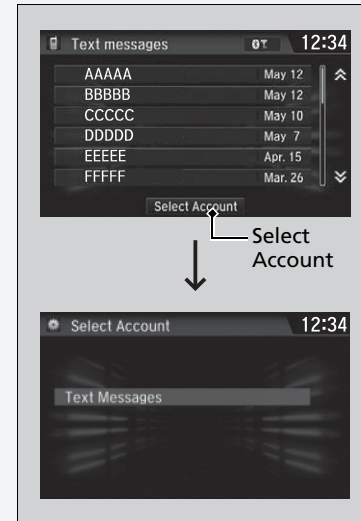

You can only receive notifications from one text message or mail account at a time.

■ Displaying Messages

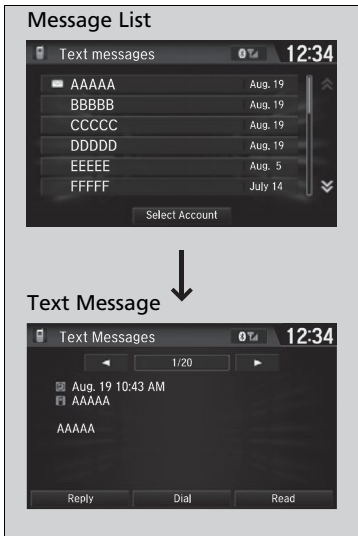



■ Displaying text messages

1. Go to the **Phone Menu** screen.
 - ▶ **Phone Menu screen** P. 341
2. Select **Text/Email**.
 - ▶ Select account if necessary.
3. Select a message.
 - ▶ The text message is displayed. The system automatically starts reading the message aloud.

» Displaying Messages

The  icon appears next to an unread message.

If you delete a message on the phone, the message is also deleted in the system. If you send a message from the system, the message goes to your phone's mailbox.

To see the previous or next message, select  (previous) or  (next) on the message screen.

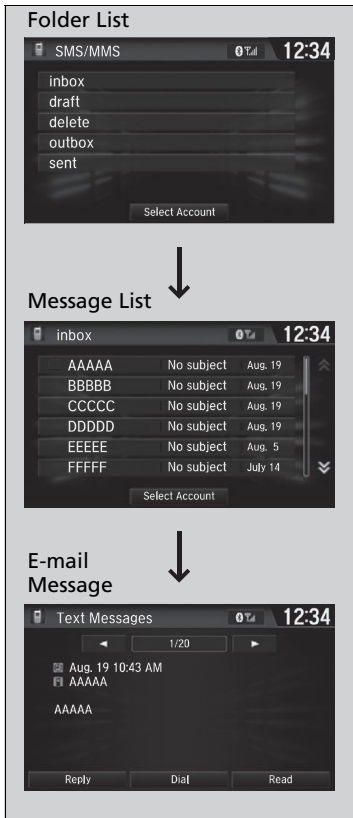

■ Displaying e-mail messages

1. Go to the **Phone Menu** screen.
 - ▶ **Phone Menu screen** P. 341
2. Select **Text/Email**.
 - ▶ Select **Select Account** if necessary.
3. Select a folder.
4. Select a message.
 - ▶ The e-mail message is displayed. The system automatically starts reading the message aloud.

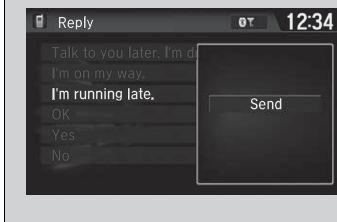
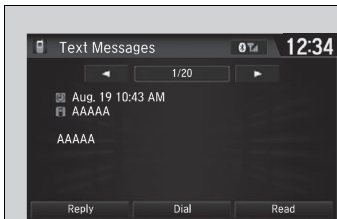
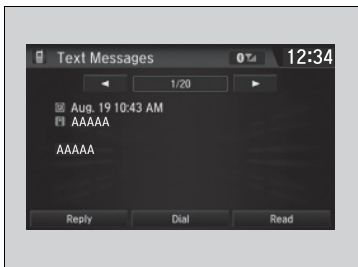

■ Read or Stop reading a message

1. Go to the text or e-mail message screen.
 - ▶ The system automatically starts reading the message aloud.
 - ☒ **Displaying Messages** P. 362
2. Select **Stop** to stop reading.
 - Select **Read** again to start reading the message from the beginning.

■ Reply to a message

1. Go to the text or e-mail message screen.
 - ▶ The system automatically starts reading the message aloud.
 - ☒ **Displaying Messages** P. 362
2. Select **Reply**.
3. Select the reply message.
 - ▶ The pop-up menu appears on the screen.
4. Select **Send** to send the message.
 - ▶ **Message sent** appears on the screen when the reply message was successfully sent.

☒ Reply to a message

The available fixed reply messages are as follows:

- **Talk to you later, I'm driving.**
- **I'm on my way.**
- **I'm running late.**
- **OK**
- **Yes**
- **No**

You cannot add, edit, or delete reply messages.

Only certain phones receive and send messages when paired and connected. For a list of compatible phones:

- U.S.: Visit automobiles.honda.com/handsfreelink/, or call 1-888-528-7876.
- Canada: For more information on smartphone compatibility, call 1-888-528-7876.

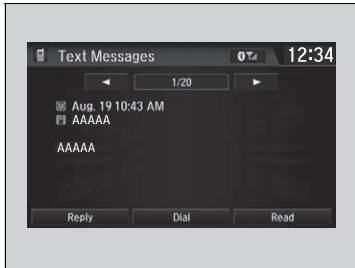

■ Making a call to a sender

1. Go to the text message screen.
2. Select **Dial**.

■ In Case of Emergency

■ Automatic collision notification

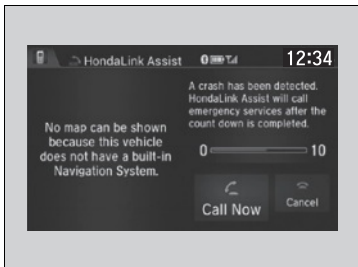

If your vehicle’s airbags deploy or if the unit detects that the vehicle is severely impacted, your vehicle automatically will attempt to connect to the HondaLink operator. If connected, information about your vehicle, its location, and its condition can be sent to the operator*1; you also can speak to the operator when connected.

IMPORTANT: For vehicles equipped with HondaLink Assist, owner activation constitutes authorization for Honda to collect information from your vehicle needed to provide the service, and agreement to the Terms of Use at www.hondalink.com/TermsAndConditions. In a crash, HondaLink Assist will attempt to notify emergency services but NEITHER Honda-PRO NOR ITS SERVICE PROVIDERS GUARANTEE THAT SUCH NOTIFICATION WILL OCCUR.

Honda reserves the right to terminate HondaLink Assist services at any time or for any reason, and in the future may not be able to provide services due to changes in, or obsolescence of, technology integral to the service or changes in governmental regulation.

*1: Depending on your phone and adequate cellular coverage, your vehicle’s location may not be sent to the operator.

☒ In Case of Emergency

Your vehicle may not be able to connect to the operator if the 12-volt battery level is low, the line is disconnected, or you do not have adequate cellular coverage.

You cannot use this emergency service when:

- You travel outside the HondaLink service coverage areas.
- There is a problem with the connecting devices, such as the microphones, speakers, or the unit itself.

You cannot operate other phone-related functions using the screen while talking to the operator. Select **Hang Up** to terminate the connection to your vehicle.

☒ Automatic collision notification

If the unit fails to connect to the operator, it repeatedly tries until it succeeds.

■ To enable notification

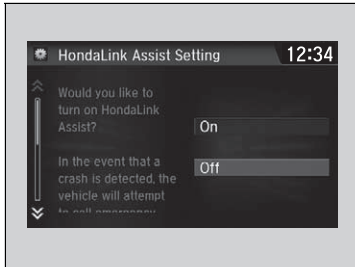

1. Go to the **Phone Settings** screen.
 - ▶ **Phone Settings screen** P. 338
2. Select the **Phone** tab, then **HondaLink Assist**.
 - ▶ A pop-up menu appears on the screen.
3. Select **On** or **Off**.

☒ To enable notification

Setting options:

- **On:** Notification is available.
- **Off:** Disable the feature.



Driving

This chapter discusses driving and refueling.

Before Driving	370
Towing a Trailer	375
When Driving	
Turning on the Power	376
Precautions While Driving.....	380
Transmission	381
Shifting	382
ECON Mode	388
SPORT Mode.....	389
Deceleration Paddle Selector	390
Acoustic Vehicle Alerting System.....	393
Front Sensor Camera	394
Road Departure Mitigation (RDM) System	396

Adaptive Cruise Control (ACC) with Low Speed Follow (LSF)	400
Lane Keeping Assist System (LKAS) ..	415
Vehicle Stability Assist (VSA®), aka Electronic Stability Control (ESC), System	422
Agile Handling Assist	424
Tire Pressure Monitoring System (TPMS) ..	425
Tire Pressure Monitoring System (TPMS) - Required Federal Explanation	427
LaneWatch™	429
Braking	431
Parking Your Vehicle	
When Stopped.....	447

Multi-View Rear Camera	449
Refueling	
Fuel Information	451
How to Refuel	452
Charging	
Before Charging	454
Charge the High Voltage battery using a Level 1 or 2 charger	455
Control Box	461
High Voltage Battery.....	466
Using a Timer	467
Fuel Economy and CO₂ Emissions	
Improving Fuel Economy and Reducing CO ₂ Emissions.....	469

Driving Preparation

Check the following items before you start driving.

Exterior Checks

- Make sure there are no obstructions on the windows, door mirrors, exterior lights, or other parts of the vehicle.
 - ▶ Remove any frost, snow, or ice.
 - ▶ Remove any snow on the roof, as this can slip down and obstruct your field of vision while driving. If frozen solid, remove ice once it has softened.
 - ▶ When removing ice from around the wheels, be sure not to damage the wheel or wheel components.
- Make sure the hood is securely closed.
 - ▶ If the hood opens while driving, your front view will be blocked.
- Make sure the tires are in good condition.
 - ▶ Check air pressures, and check for damage and excessive wear.
 - ✦ **Checking and Maintaining Tires** P. 499
- Make sure there are no people or objects behind or around the vehicle.
 - ▶ There are blind spots from the inside.
- Disconnect the charging cable.

Exterior Checks

NOTICE

When doors are frozen shut, use warm water around the door edges to melt any ice. Do not try to force them open, as this can damage the rubber trim around the doors. When done, wipe dry to avoid further freezing.

Do not pour warm water into the key cylinder. You will be unable to insert the key if the water freezes in the hole.

Heat from the engine and exhaust can ignite flammable materials left under the hood, causing a fire. If you've parked your vehicle for an extended period, inspect and remove any debris that may have collected, such as dried grass and leaves that have fallen or have been carried in for use as a nest by a small animal. Also check under the hood for leftover flammable materials after you or someone else has performed maintenance on your vehicle.

Interior Checks

- Store or secure all items on board properly.
 - ▶ Carrying too much cargo, or improperly storing it, can affect your vehicle's handling, stability, stopping distance, and tires, and make it unsafe.
 - 📖 **Maximum Load Limit** P. 373
- Do not pile items higher than the seat height.
 - ▶ They can block your view and may be thrown forward in the event of sudden braking.
- Do not place anything in the front seat footwells. Make sure to secure the floor mat.
 - ▶ An object or unsecured floor mat can interfere with your brake and accelerator pedal operation while driving.
- If you have any animals on board, do not let them move around in the vehicle.
 - ▶ They may interfere with driving and a crash could occur.
- Securely close and lock all doors and the trunk.
 - 📖 **Locking/Unlocking the Doors from the Inside** P. 146
- Adjust your seating position properly.
 - ▶ Adjust the head restraint, too.
 - 📖 **Adjusting the Seats** P. 175
 - 📖 **Adjusting the Front Head Restraints Positions** P. 178
- Adjust the mirrors and steering wheel properly for your driving.
 - ▶ Adjust them while sitting in the proper driving position.
 - 📖 **Adjusting the Mirrors** P. 173
 - 📖 **Adjusting the Steering Wheel** P. 172

Interior Checks

The headlight aim is set by the factory, and does not need to be adjusted. However, if you regularly carry heavy items in the trunk, have the aiming readjusted at an authorized Honda Clarity Plug-In Hybrid dealer or by a qualified technician.

- Be sure items placed on the floor behind the front seats cannot roll under the seats.
 - ▶ They can interfere with the driver's ability to operate the pedals, the operation of the seats, or the operation of the sensors under the seats.
- Everyone in the vehicle must fasten their seat belt.
 - 📄 **Fastening a Seat Belt** P. 50
- Make sure that the indicators in the instrument panel come on when you start the vehicle, and go off soon after.
 - ▶ Always have an authorized Honda Clarity Plug-In Hybrid dealer check the vehicle if a problem is indicated.
 - 📄 **Indicators** P. 86

Maximum Load Limit

The maximum load for your vehicle is 850 lbs (385 kg). See the Tire and Loading Information label attached to the driver's doorjamb.

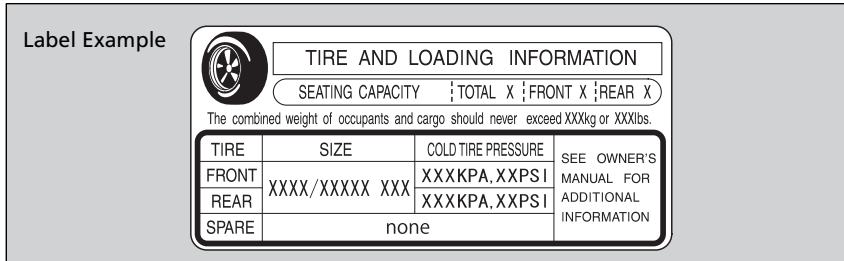

This figure includes the total weight of all occupants, cargo, and accessories, and the tongue load if you are towing a trailer.

Steps for Determining Correct Load Limit -

- (1)** Locate the statement "The combined weight of occupants and cargo should never exceed XXX kg or XXX lbs." on your vehicle's placard.
- (2)** Determine the combined weight of the driver and passengers that will be riding in your vehicle.
- (3)** Subtract the combined weight of the driver and passengers from XXX kg or XXX lbs.
- (4)** The resulting figure equals the available amount of cargo and luggage load capacity. For example, if the "XXX" amount equals 1,400 lbs. and there will be five 150 lb. passengers in your vehicle, the amount of available cargo and luggage load capacity is 650 lbs.
(1,400 - 750 (5 x 150) = 650 lbs.)

Continued

Maximum Load Limit

⚠ WARNING

Overloading or improper loading can affect handling and stability and cause a crash in which you can be hurt or killed.

Follow all load limits and other loading guidelines in this manual.

Gross Vehicle Weight Rating (GVWR):
The maximum allowable weight of the vehicle, all occupants, all accessories and all cargo.

➤ **Specifications** P. 566



Gross Axle Weight Rating (GAWR):
The maximum allowable weight of the vehicle axle.



➤ **Specifications** P. 566

- (5) Determine the combined weight of luggage and cargo being loaded on the vehicle. That weight may not safely exceed the available cargo and luggage load capacity calculated in step 4.
- (6) If your vehicle will be towing a trailer, load from your trailer will be transferred to your vehicle. Consult this manual to determine how this reduces the available cargo and luggage load capacity of your vehicle.

In addition, the total weight of the vehicle, all occupants, accessories, cargo, and trailer tongue load must not exceed the Gross Vehicle Weight Rating (GVWR) or the Gross Axle Weight Rating (GAWR). Both are on a label on the driver's doorjamb.

Load Limits Example

<p>Example 1</p>  <p>Max Load 850 lbs (385 kg)</p>	\geq		<p>+</p>	
		<p>Passenger Weight 150 lbs x 2 = 300 lbs (68 kg x 2 = 136 kg)</p>		<p>Cargo Weight 550 lbs (249 kg)</p>

<p>Example 2</p>  <p>Max Load 850 lbs (385 kg)</p>	\geq		<p>+</p>	
		<p>Passenger Weight 150 lbs x 5 = 750 lbs (68 kg x 5 = 340 kg)</p>		<p>Cargo Weight 100 lbs (45 kg)</p>

Your vehicle is not designed to tow a trailer. Attempting to do so can void your warranties.

Towing Your Vehicle

Your vehicle is not designed to be towed behind a motor home. If your vehicle needs to be towed in an emergency, refer to the emergency towing information.

📄 **Emergency Towing** P. 561

Turning on the Power



1. Make sure the parking brake is applied.

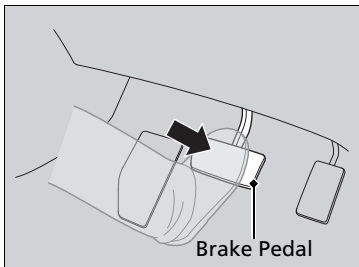

2. Depress the brake pedal.

When Driving

When you set the power mode to ON, you may feel as if the brake pedal is sinking down. This is normal.

Turning on the Power

Keep your foot firmly on the brake pedal when starting the power system.

The engine is harder to start in cold weather and in thinner air found at altitudes above 8,000 feet (2,400 meters).

When turning on the power system in cold weather, turn off all electrical accessories such as the lights, climate control system, and rear defogger in order to reduce 12-volt battery drain.

U.S. models

If the temperature of the High Voltage battery drops below approximately -22°F (-30°C), the power system will not start, the High Voltage battery will not operate and, as a result, the vehicle will not start. Store the vehicle in a garage or take another measure to insure that temperature of the High Voltage battery does not fall below this temperature. If necessary, consult an authorized Honda Clarity Plug-In Hybrid dealer.

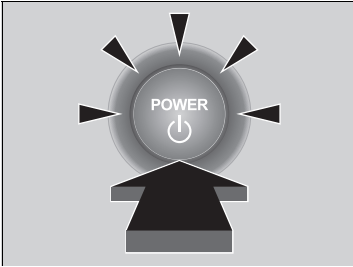

3. Press the **POWER** button without depressing the accelerator pedal.
 - ▶ The **Ready To Drive** message appears on the driver information interface.
 - ▶ When the ambient temperature is extremely low, the vehicle does not move until certain conditions are met. A warning message appears instead of **Ready To Drive**.
 - ▣ **Driver Information Interface Warning and Information Messages**
P. 103
 - ▶ If the High Voltage battery is fully charged, the gasoline engine may not start.
 - ▶ If the High Voltage battery charge level is low, the gasoline engine starts.

▶▶ Turning on the Power

Canadian models

If the temperature of the High Voltage battery drops to approximately -22°F (-30°C) or below, the power system will not start. Wait for the High Voltage battery to warm up or move the vehicle to a warmer location. Note plugging the vehicle in will not help in this case.

Store the vehicle in a garage or take another measure to insure that temperature of the High Voltage battery does not fall below this temperature. If necessary, consult an authorized Honda Clarity Plug-In Hybrid dealer.

If the exhaust system sounds abnormal or you can smell exhaust gas inside the vehicle, have your vehicle checked by an authorized Honda Clarity Plug-In Hybrid dealer. There may be a problem with the engine or exhaust system.

The immobilizer system protects your vehicle from theft.

If an improperly coded device is used, the power system does not activate.

▣ **Immobilizer System** P. 153

■ Stopping the Power System

You can turn the power system off when the vehicle is completely stopped.

1. Put the transmission into **P**.
2. Press the **POWER** button.

▶▶ Turning on the Power

Bring the smart entry remote close to the **POWER** button if the battery in the smart entry remote is weak.

▶ **If the Smart Entry Remote Battery is Weak**
P. 537

The power system may not activate if the smart entry remote is subjected to strong radio waves.

Do not hold the **POWER** button to start the power system.
If the power system does not start, wait at least 30 seconds before trying again.

Starting to Drive

1. Keeping your right foot on the brake pedal, press the **[D]** button. Select **[R]** when reversing.
2. With the parking brake applied, release the brake pedal and gently depress the accelerator pedal.
 - ▶ Make sure the parking brake and brake system indicator (red) goes off.
 - ▣ **Parking Brake** P. 431

Hill Start Assist System

Hill start assist keeps the brake engaged briefly to help prevent the vehicle from rolling on inclines as you move your foot from the brake pedal to the accelerator.

Change to **[D]** when facing uphill, or **[R]** when facing downhill, then release the brake pedal.

Starting to Drive

You can also release the parking brake by pressing the electric parking brake switch while depressing the brake pedal.

When facing downhill, you can start your vehicle more smoothly by manually releasing it with the electric parking brake switch than by releasing it with the accelerator pedal.

Hill Start Assist System

Hill start assist may not prevent the vehicle from rolling downhill on a very steep or slippery slope, and does not operate on small inclines.

Hill start assist is not a replacement for the parking brake.

Precautions While Driving

In Rain

Avoid driving in deep water and on flooded roads. This can damage the power system or driveline, or cause electrical component failure.

Precautions While Driving

NOTICE

Do not select a shift button while pressing the accelerator pedal. You could damage the transmission.

NOTICE

The following can damage the rear frames and rear suspensions. Be careful when driving.

- Backing up the vehicle into a space with a parking block or road shoulder
- Driving up or down to a different surface level (such as a road shoulder)
- Driving on a road with potholes

NOTICE

If you repeatedly turn the steering wheel at an extremely low speed, or hold the steering wheel in the full left or right position for a while, the electric power steering (EPS) system heats up. The system goes into a protective mode, and limits its performance. The steering wheel becomes harder and harder to operate. Once the system cools down, the EPS system is restored.

Repeated operation under these conditions can eventually damage the system.

If the power mode is set to ACCESSORY while driving, the power system will shut down and all steering and brake power assist functions will stop, making it difficult to control the vehicle.

■ Other Precautions

If there is a strong impact with something under the vehicle, stop in a safe location. Check the underside of the vehicle for damage or any fluid leaks, and contact an authorized Honda Clarity Plug-In Hybrid dealer.

Transmission

■ Creeping

As with a conventional gasoline-powered vehicle with an automatic transmission, this vehicle will creep. Keep the brake pedal firmly depressed when stopped.

■ Kickdown

Quickly depressing the accelerator pedal while driving uphill may cause the vehicle to react similar to an automatic transmission vehicle, unexpectedly increasing vehicle speed. Depress the accelerator pedal carefully, especially on slippery roads and curves.

⌘ Precautions While Driving

Do not press the **N** button, as you will lose regenerative braking (and acceleration) performance.

During the first 600 miles (1,000 km) of operation, avoid sudden acceleration or full throttle operation so as to not damage the engine or powertrain.

Avoid hard braking for the first 200 miles (300 km). You should also follow this when the brake pads are replaced.

Shifting

Change the gear position in accordance with your driving needs.

■ Shift button positions



P **Park**
Used when parking or before turning the power on or off

R **Reverse**
Used when reversing

N **Neutral**
Transmission is not locked

D **Drive**
Used for:
Normal driving

- The deceleration paddle selector can be used temporarily.
The deceleration paddle selector can be used when SPORT mode is on.

⌘ Shifting

⚠ WARNING

The vehicle can roll away if left unattended without confirming that Park is engaged.

A vehicle that rolls away could cause a crash resulting in serious injury or death.

Always keep your foot on the brake pedal until you have confirmed that **P** is shown on the gear position indicator.

To prevent malfunction and unintended engagement:

- Do not spill any liquids on or around shift buttons.
- Do not place or drop any objects on or around shift buttons.
- Do not let passengers or children operate the shift buttons.

You may occasionally find that it takes longer than usual for the vehicle to start moving when you select **R**, release the brake pedal, and/or depress the accelerator pedal. This may occur when the High Voltage battery level is extremely low, and does not indicate a vehicle malfunction.

■ P (parking) button

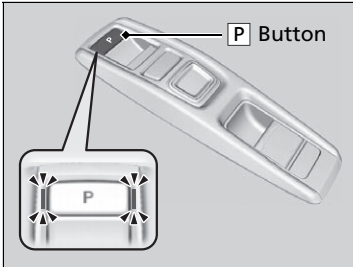

The gear position changes to **P** when you press the **P** button while the vehicle is parked with the power mode in ON. The indicators on the sides of the **P** button come on.

☞ Shifting

The beeper sounds and the message appears on the driver information interface when you depress the accelerator pedal with the gear position in **N**. Change the gear position to **D** or **R** with the brake pedal depressed.

Continued

■ Shift Operation

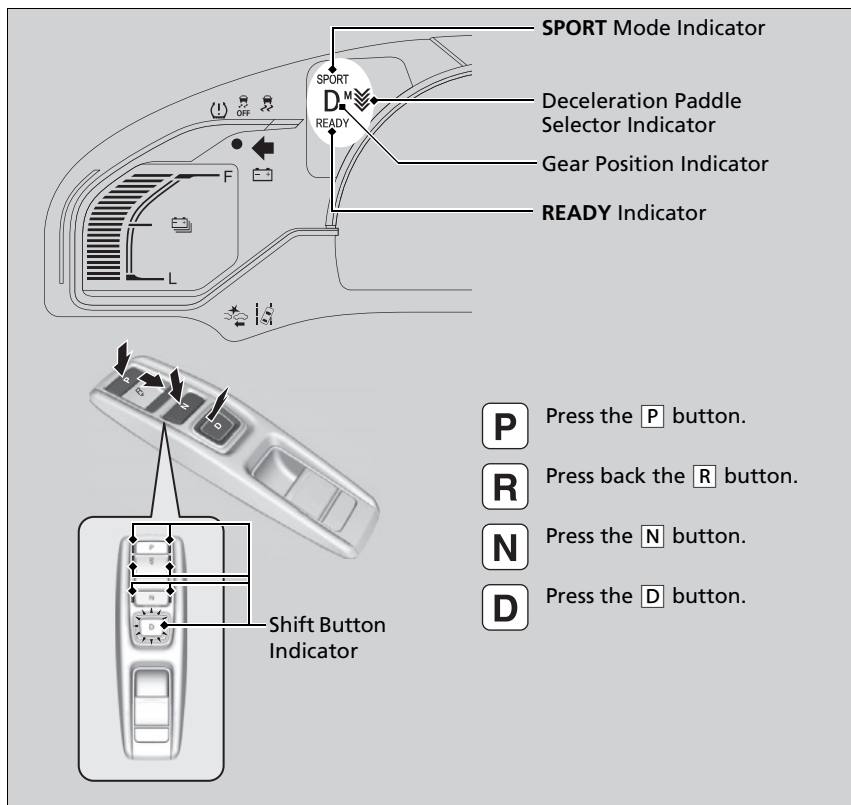

▶▶ Shift Operation

NOTICE

When you change **D** to **R** and vice versa, come to a complete stop and keep the brake pedal depressed. Operating the shift button before the vehicle has come to a complete standstill can damage the transmission.

Use the gear position indicator and the shift button indicator to check the gear position before and after selecting a shift button.

If the indicator of the currently selected gear position, or all the gear position indicators are blinking simultaneously, there is a problem with the transmission.

Avoid sudden acceleration and have the transmission checked by an authorized Honda Clarity Plug-In Hybrid dealer as soon as possible.

The beeper sounds once when you change to **R**.

■ When opening the driver's door

If you open the driver's door under the following conditions, the gear position automatically changes to **P**.

- The vehicle is in stationary with the power mode in ON, or moving at 1 mph (2 km/h) or slower.
- The transmission is in other than **P**.
- You have unfastened the driver side seat belt.
 - ▶ If you manually change the gear position from **P** with the brake pedal depressed, the gear position will automatically return to **P** once you release the brake pedal.

■ When turning off the power mode

If you turn the power system off while the vehicle is stationary, and the transmission is in other than **P**, the gear position automatically changes to **P**.

⌘ When opening the driver's door

While the system is designed to automatically change the gear position to **P** under the described conditions, in the interest of safety you should always select **P** before opening the driver's door. Make sure to park the vehicle in a safe place.

📌 When Stopped P. 447

If you want to drive the vehicle after the gear position has automatically changed to **P** under the described conditions, close the door, fasten the seat belt, depress the brake pedal, then change the gear position.

If you leave the vehicle, turn off the power system and lock the doors.

■ **If you want to keep the transmission in **N** position [car wash mode]**

With the power system on:

1. Depress the brake pedal.
2. Make sure the **READY** indicator is on.
3. Press **N**. Within six seconds press and hold **N** for two seconds.
 - ▶ This puts the vehicle in car wash mode which must be used when your vehicle is pulled through a conveyor type automatic car wash where you or an attendant do not remain in the vehicle.

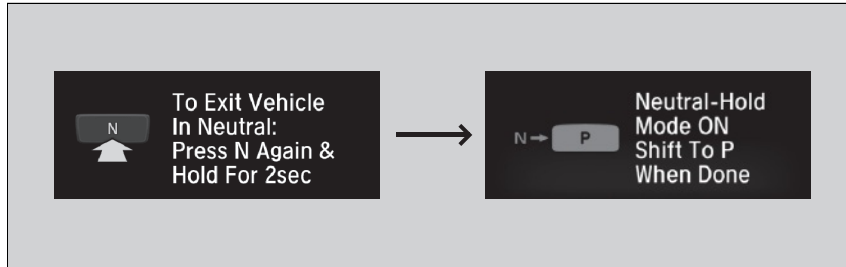

If you want to cancel car wash mode, select a position other than **N**.

■ **If you want to reduce energy consumption in car wash mode:**

Press the **POWER** button during car wash mode.

- ▶ Make sure the **READY** indicator is off.
- ▶ The gear position remains in **N** with the power mode in **ACCESSORY** for 15 minutes, then, it automatically changes to **P** and the power mode changes to **OFF**.

Manually changing to **P** cancels **ACCESSORY** mode. The **P** indicator comes on and the power mode changes to **OFF**. You must always shift to **P** when car wash mode is no longer needed.

⌘ If you want to keep the transmission in **N** position [car wash mode]

To keep the vehicle in **N** position, you can also follow this procedure:

While the power system is on, select **N**, and then within five seconds, press the **POWER** button.

Note that the transmission may not stay in **N** position while any of the following indicators is on:

- **POWER SYSTEM** indicator
- Transmission system indicator
- 12-volt battery charging system indicator

■ Restriction on selecting a gear position

You cannot select a gear position under certain circumstances that may lead to a crash.

When the transmission is in:	1. Under the circumstances of that:	2. You cannot select:	3. The gear position remains in/changes to:	How to change the gear position
P	The brake pedal is not depressed.	Other gear position	P	Release the accelerator pedal and depress the brake pedal.
	The accelerator pedal is depressed.			
N	The vehicle is moving at low speed without the brake pedal depressed.		N	
	The vehicle is moving at low speed with the accelerator pedal depressed.			
N or D	The vehicle is moving forward.		R	
R or N	The vehicle is moving backward.	D		
R , N , or D	The vehicle is moving.	P		
P or N	The READY indicator is not on.	A gear position other than P or N	P or N	Make sure that the READY indicator comes on.

ECON Mode

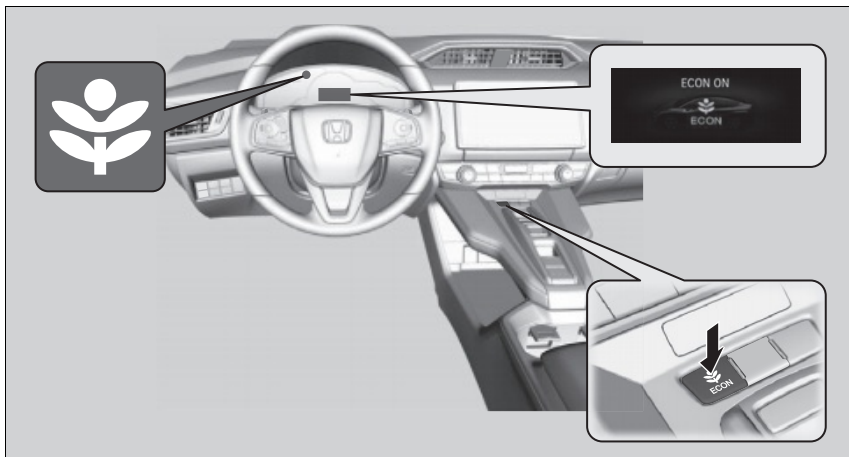

The **ECON** button turns the ECON mode on and off. The ECON mode helps you improve your energy economy by adjusting the performance of the climate control system and the accelerator pedal response.

▶▶ ECON Mode

While in the ECON mode, the climate control system has greater temperature fluctuations.

When the ECON mode is active, the driver's side seat heater functions according to the status of the climate control system. If you want to use only the climate control system, press the seat heater button to OFF.

If you select ECON mode, the threshold for the engine to provide additional power is higher than it is when the vehicle is in either of the other two drive modes. Note that if the accelerator pedal is depressed past the point at which you feel a click, the engine will start in the ECON mode.

SPORT Mode

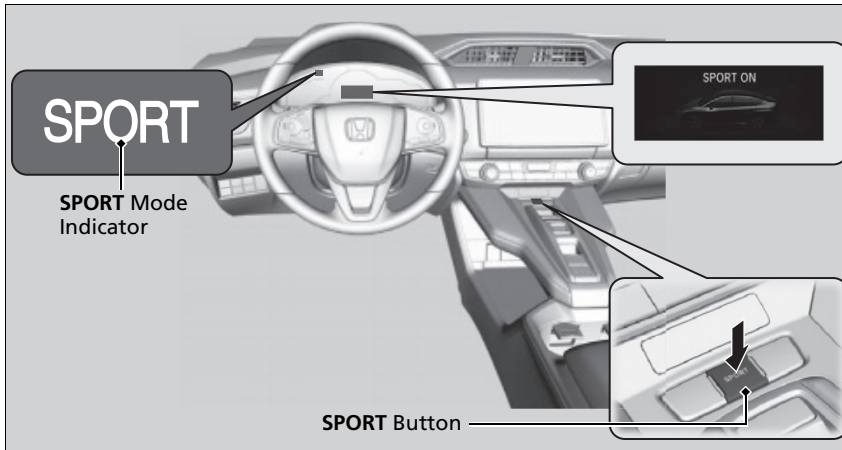

To turn the SPORT mode on and off, press the **SPORT** button.

The SPORT mode delivers crisp agility and responsiveness. This mode is suitable for driving on hills or through curves on mountain roads.

The SPORT mode is turned off every time you start the power system, even if you turned it on the last time you drove the vehicle.

SPORT Mode

Depending on the driving conditions, the engine may start if you depress the accelerator pedal past the point at which you feel a click. In SPORT mode, however, the engine will start before this point.

Deceleration Paddle Selector

When you release the accelerator pedal, you can control the rate of deceleration without releasing your hands from the steering wheel. Using the deceleration paddle selector situated on the steering wheel, you can sequentially shift through four stages of deceleration.

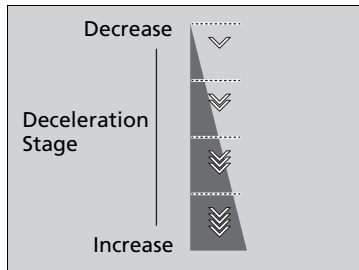

When descending a hill, you can use the deceleration paddle selector to help maintain the rate of deceleration, thereby allowing you to keep a safe distance between your vehicle and the vehicle ahead as well as utilize engine braking.



The default deceleration stage is . Each paddle selector operation makes a single stage deceleration change.

- ▶ The deceleration stage may not change if you pull the paddle selector continuously.

To select the different stages of deceleration:

- Pull back the  selector (right side) to decrease the deceleration stage.
- Pull back the  selector (left side) to increase the deceleration stage.

Pull the  selector for a few seconds when you want to cancel the deceleration paddle selector.

▶▶ Deceleration Paddle Selector

⚠ CAUTION

Rapidly increasing the deceleration rate by quickly shifting the deceleration paddle can cause the tires to skid, resulting in a crash that could injure or kill someone.

Always maintain a reasonable rate of deceleration.

If you are descending a hill when you select stage , the vehicle may enter stage .

If you pull back right and left paddle selector at the same time, the deceleration stage may not change.

When to use

Gear position is in **D**

When SPORT mode is OFF, the deceleration stage appears.

Deceleration Stage

When SPORT mode is ON, the deceleration stage and **M** appear.

Increase the deceleration stage when pulling the **-** paddle selector (left side)

Decrease the deceleration stage when pulling the **+** paddle selector (right side)

Paddle Selector

» Deceleration Paddle Selector

In the following situations, the stage may not change and the stage number will blink even if you pull back the selector. The deceleration stage may decrease or cancel automatically:

- The high voltage battery is fully charged or its temperature is too cold or too hot.
- The speed of the vehicle is beyond the deceleration range with SPORT mode off.
- Hybrid system protection is needed.
- The paddle selector is operated while your vehicle is stopped automatically by ACC with LSF.

If either paddle selector is operated, ACC with LSF will cancel automatically.

■ **When SPORT mode is OFF**

If you pull back the paddle selector, the rate of deceleration will change temporarily, and the stage will appear in the driver information interface.

When you want to cancel the deceleration paddle selector, pull the  selector (right side) for a few seconds.

The deceleration paddle selector will cancel automatically and deceleration stage in the driver information interface disappear when you drive with constant speed, situations of acceleration and decelerate just before stopping your vehicle.

■ **When SPORT mode is ON**

If you pull back the paddle selector, the rate of deceleration will change and the stage along with **M** will appear in the driver information interface. The deceleration stage is not cancel automatically while SPORT mode is ON.

When you want to cancel the deceleration paddle selector, turn the SPORT mode OFF, or pull the  selector (right side) for a few seconds. When canceled, deceleration stage in the driver information interface disappear.

Acoustic Vehicle Alerting System

Alerts pedestrians that a vehicle is approaching when the vehicle speed is around 12 mph (20 km/h) or less.

Canadian models

Acoustic Vehicle Alerting System Button

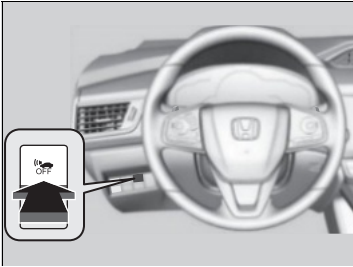

Press the button to turn the system on and off.

- ▶ The indicator in the button comes on when the system is off.

The system is turned on every time you turn the power system on, even if you turned it off the last time you drove the vehicle.

Front Sensor Camera

The camera, used in systems such as LKAS, RDM, ACC with LSF, and CMBS™, is designed to detect an object that triggers any of the systems to operate its functions.

■ Camera Location and Handling Tips

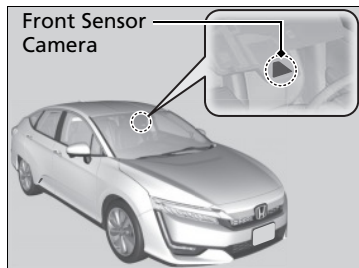

This camera is located behind the rearview mirror.

To help reduce the likelihood that high interior temperatures will cause the camera's sensing system to shut off, when parking, find a shady area or face the front of the vehicle away from the sun. If you use a reflective sun shade, do not allow it to cover the camera housing. Covering the camera can concentrate heat on it.

📷 Front Sensor Camera

Never apply a film or attach any objects to the windshield, hood, or front grill that could obstruct the camera's field of vision and cause the system to operate abnormally.

Scratches, nicks, and other damage to the windshield within the camera's field of vision can cause the system to operate abnormally. If this occurs, we recommend that you replace the windshield with a genuine Honda replacement windshield. Making even minor repairs within the camera's field of vision or installing an aftermarket replacement windshield may also cause the system to operate abnormally. After replacing the windshield, have an authorized Honda Clarity Plug-In Hybrid dealer recalibrate the camera. Proper calibration of the camera is necessary for the system to operate properly.

Do not place an object on the top of the instrument panel. It may reflect onto the windshield and prevent the system from detecting lane lines properly.

⌘ Front Sensor Camera

If the **Some Driver Assist Systems Cannot Operate: Camera Temperature Too High** message appears:

- Use the climate control system to cool down the interior and, if necessary, also use defroster mode with the airflow directed towards the camera.
- Start driving the vehicle to lower the windshield temperature, which cools down the area around the camera.

If the **Some Driver Assist Systems Cannot Operate: Clean Front Windshield** message appears:

- Park your vehicle in a safe place, and clean the windshield. If the message does not disappear after you have cleaned the windshield and driven for a while, have your vehicle checked by an authorized Honda Clarity Plug-In Hybrid dealer.

Road Departure Mitigation (RDM) System

Alerts and helps to assist you when the system detects a possibility of your vehicle unintentionally crossing over detected lane markings and/or leaving the roadway altogether.

How the System Works

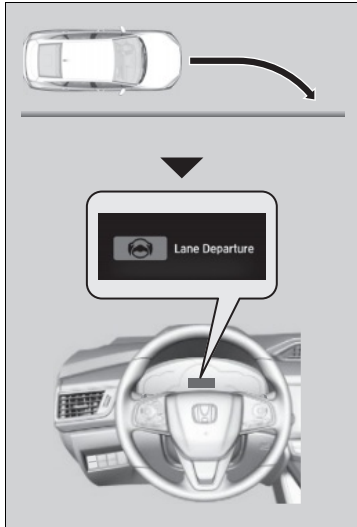

The front camera behind the rearview mirror monitors left and right lane markings (in white or yellow). If your vehicle is getting too close to detected lane markings without a turn signal activated, the system, in addition to a visual alert, applies steering torque and alerts you with rapid vibrations on the steering wheel, to help you remain within the detected lane.

▶ **Customized Features** P. 306

As a visual alert, the **Lane Departure** message appears on the driver information interface.

If the system determines that its steering input is insufficient to keep your vehicle on the roadway, it may apply braking.

▶ Braking is applied only when the lane markings are solid continuous lines.

The system cancels assisting operations when you turn the steering wheel to avoid crossing over detected lane markings.

If the system operates several times without detecting driver response, the system beeps to alert you.

⚠ Road Departure Mitigation (RDM) System

Important Safety Reminder

Like all assistance systems, the RDM system has limitations.

Over-reliance on the RDM system may result in a collision. It is always your responsibility to keep the vehicle within your driving lane.

The RDM system only alerts you when lane drift is detected without a turn signal in use. The RDM system may not detect all lane markings or lane or roadway departures; accuracy will vary based on weather, speed and lane marker condition. It is always your responsibility to safely operate the vehicle and avoid collisions.

You can read about handling information for the camera equipped with this system.

▶ **Front Sensor Camera** P. 394

The RDM system may not work properly or may work improperly under the certain conditions:

▶ **RDM Conditions and Limitations** P. 398

There are times when you may not notice RDM functions due to your operation of the vehicle, or road surface conditions.

How the System Activates

The system becomes ready to start searching for lane markings when all the following conditions are met:

- The vehicle is traveling between about 45 and 90 mph (72 and 145 km/h).
- The vehicle is on a straight or slightly curved road.
- The turn signals are off.
- The brake pedal is not depressed.
- The wipers are not in continuous operation.
- The vehicle is not accelerating or braking, and the steering wheel is not being turned.
- The system makes a determination that the driver is not actively accelerating, braking or steering.

How the System Activates

If LKAS is off and you have selected **Narrow** from the customized options using the driver information interface, the message below will appear in case the system determines a possibility of your vehicle crossing over detected lane markings.

➤ **Customized Features** P. 133

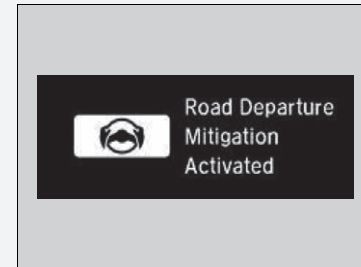

The RDM system may automatically shut off and the  indicator comes and stays on.

➤ **Indicators** P. 86

RDM system function can be impacted when the vehicle is:

- Not driven within a traffic lane.
- Driven on the inside edge of a curve, or outside of a lane.
- Driven in a narrow lane.

RDM On and Off

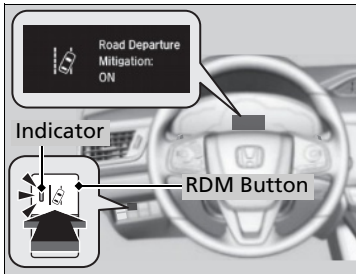

Press the RDM button to turn the system on and off.

- ▶ The indicator in the button comes on and the message appears on the driver information interface when the system is on.

RDM Conditions and Limitations

The system may not properly detect lane markings and the position of your vehicle under certain conditions. Some examples of these conditions are listed below.

Environmental conditions

- Driving in bad weather (rain, fog, snow, etc.).
- Sudden changes between light and dark, such as an entrance or exit of a tunnel.
- There is little contrast between lane lines and the roadway surface.
- Driving into low sunlight (e.g., at dawn or dusk).
- Strong light is reflected onto the roadway.
- Driving in the shadows of trees, buildings, etc.
- Shadows of adjacent objects are parallel to lane markings.
- Roadway objects or structures are misinterpreted as lane markers.
- Reflections on the interior of the windshield.

RDM On and Off

When you have selected **Warning Only** from the customized options using the audio/information screen, the system does not operate the steering wheel and braking.

■ Roadway conditions

- Driving on a snowy or wet roadway (obscured lane marking, vehicle tracks, reflected lights, road spray, high contrast).
- Driving on a road with temporary lane markings.
- Faint, multiple, or varied lane markings are visible on the roadway due to road repairs or old lane markings.
- The roadway has merging, split, or crossing lines (e.g., such as at an intersection or crosswalk).
- The lane markings are extremely narrow, wide, or changing.
- The vehicle in front of you is driving near the lane lines.
- The road is hilly or the vehicle is approaching the crest of a hill.
- Driving on rough or unpaved roads, or over bumpy surfaces.
- When objects on the road (curb, guard rail, pylons, etc.) are recognized as white lines (or yellow lines).
- Driving on roads with double lines.

■ Vehicle conditions

- Headlight lenses are dirty or the headlights are not properly adjusted.
- The outside of the windshield is streaked or blocked by dirt, mud, leaves, wet snow, etc.
- The inside of the windshield is fogged.
- The camera temperature gets too high.
- An abnormal tire or wheel condition (wrong sized, varied size or construction, improperly inflated tire, etc.).
- The vehicle is tilted due to a heavy load or suspension modifications.
- When tire chains are installed.

Adaptive Cruise Control (ACC) with Low Speed Follow (LSF)

Helps maintain a constant vehicle speed and a set following-interval behind a vehicle detected ahead of yours and, if the detected vehicle comes to a stop, can decelerate and stop your vehicle, without you having to keep your foot on the brake or the accelerator.

When ACC with LSF slows your vehicle by applying the brakes, your vehicle's brake lights will illuminate.

When to use

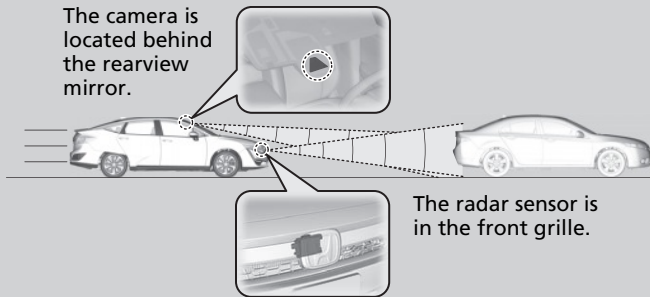

- Vehicle speed for ACC with LSF: A vehicle is detected ahead within ACC with LSF range – ACC with LSF operates at speeds up to 90 mph (145 km/h). No vehicle is detected within ACC with LSF range – ACC with LSF operates at the speed of 25 mph (40 km/h) or above.
- Gear position for ACC with LSF: In **D**.

▶ Adaptive Cruise Control (ACC) with Low Speed Follow (LSF)

⚠ WARNING

Improper use of ACC with LSF can lead to a crash.

Use ACC with LSF only when driving on expressways or freeways and in good weather conditions.

⚠ WARNING

ACC with LSF has limited braking capability and may not stop your vehicle in time to avoid a collision with a vehicle that quickly stops in front of you.

Always be prepared to apply the brake pedal if the conditions require.

Important Reminder

As with any system, there are limits to ACC with LSF. Use the brake pedal whenever necessary, and always keep a safe interval between your vehicle and other vehicles.

Be careful not to severely impact the radar sensor cover.

■ How to activate the system

How to use

- Press the **MAIN** button on the steering wheel.

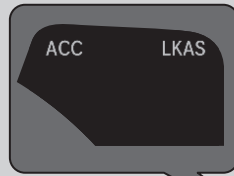

ACC (green) is on in the instrument panel. ACC with LSF is ready to use.



▣ Adaptive Cruise Control (ACC) with Low Speed Follow (LSF)

When the **MAIN** button is pressed, both ACC with LSF and the Lane Keeping Assist System (LKAS) are either turned on or off.

ACC with LSF may not work properly under certain conditions.

▣ ACC with LSF Conditions and Limitations P. 406

When not using ACC with LSF: Turn off adaptive cruise by pressing the **MAIN** button. This also will turn off the Lane Keeping Assist System (LKAS).

Do not use ACC with LSF under the following conditions:

- On roads with heavy traffic or while driving in continuous stop and go traffic.
- On roads with sharp turns.
- On roads with steep downhill sections, as the set vehicle speed can be exceeded by coasting. In such cases, ACC with LSF will not apply the brakes to maintain the set speed.
- On roads with toll collection facilities or other objects between lanes of traffic, or in parking areas, or facilities with drive through access.

■ To Set the Vehicle Speed

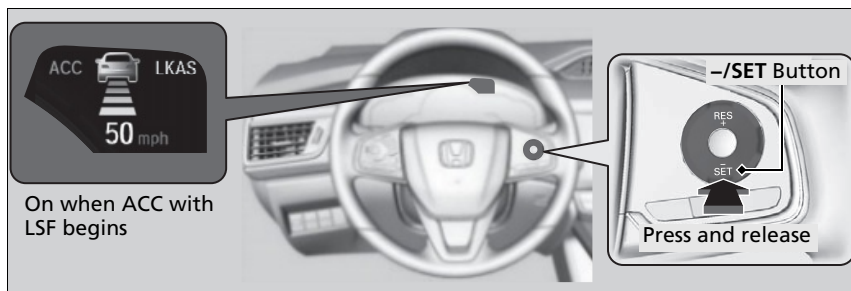

When driving at about 25 mph (40 km/h) or above: Take your foot off the pedal and press the **-/SET** button when you reach the desired speed. The moment you release the button, the set speed is fixed, and ACC with LSF begins.

When driving at slower than about 25 mph (40 km/h): If the vehicle is moving and the brake pedal is not depressed, pressing the button fixes the set speed to about 25 mph (40 km/h) regardless of current vehicle speed. If your vehicle is stationary, you can set the vehicle speed even with the brake pedal depressed.

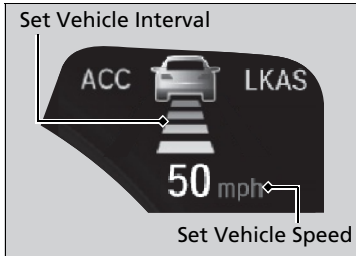

When ACC with LSF starts operating, the vehicle icon, interval bars and set speed appear on the driver information interface.

When you use ACC with LSF, Straight Driving Assist (a feature of the Electric Power Steering system) is activated.

By enabling the steering system to automatically compensate for natural steering pull, Straight Driving Assist makes it easier for you to keep your vehicle in a straight line.

■ When in Operation

■ There is a vehicle ahead

ACC with LSF monitors if a vehicle ahead of you enters the ACC with LSF range. If a vehicle is detected doing so, the ACC with LSF system maintains or decelerates your vehicle's set speed in order to keep the vehicle's set following-interval from the vehicle ahead.

➤ **To Set or Change Following-Interval** P. 409

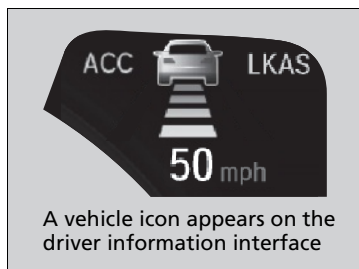
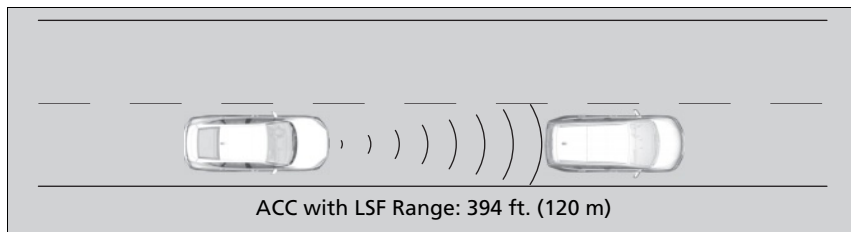

When a vehicle whose speed is slower than your set speed is detected in front of you, your vehicle starts to slow down.

⌘ When in Operation

If the vehicle ahead of you slows down abruptly, or if another vehicle is detected cutting in front of you, the beeper sounds, a message appears on the driver information interface.

Depress the brake pedal, and keep an appropriate interval from the vehicle ahead.

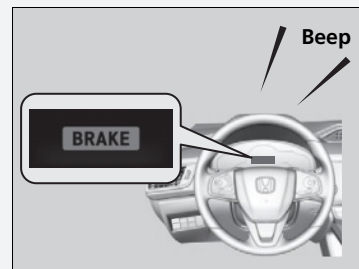

Even if the interval between your vehicle and the vehicle detected ahead is short, ACC with LSF may start accelerating your vehicle under the following circumstances:

- The vehicle ahead of you is going at almost the same speed as, or faster than, your vehicle.
- A vehicle that cuts in front of you is going faster than your vehicle, gradually increasing the interval between the vehicles.

You can also set the system to beep when a vehicle detected in front of you comes in and goes out of the ACC with LSF detecting range. Change the **ACC Forward Vehicle Detect Beep** setting.

➤ **Customized Features** P. 306

■ **There is no vehicle ahead**

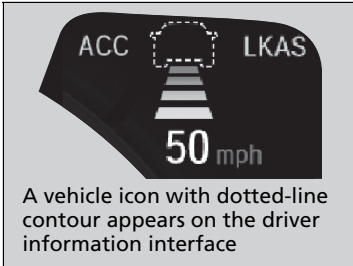

Your vehicle maintains the set speed without having to keep your foot on the brake or accelerator pedal. If there previously was a vehicle detected ahead that kept your vehicle from traveling at the set speed, ACC with LSF accelerates your vehicle to the set speed, and then maintains it.

■ **When you depress the accelerator pedal**

You can temporarily increase the vehicle speed. In this case, there is no audible or visual alert even if a vehicle is in the ACC with LSF range. ACC with LSF stays on unless you cancel it. Once you release the accelerator pedal, the system resumes an appropriate speed for keeping the following-interval while a vehicle ahead is within the ACC with LSF range.

■ **A vehicle detected ahead is within ACC with LSF range and slows to a stop**



Your vehicle also stops, automatically. The **Stopped** message appears on the driver information interface.

When the vehicle ahead of you starts again, the vehicle icon on the driver information interface blinks. If you press the **RES/+** or **-/SET** button, or depress the accelerator pedal, ACC with LSF operates again within the prior set speed.

▶▶When in Operation

⚠ WARNING

Exiting a vehicle that has been stopped while the ACC with LSF system is operating can result in the vehicle moving without operator control.

A vehicle that moves without operator control can cause a crash, resulting in serious injury or death.

Never exit a vehicle when the vehicle is stopped by ACC with LSF.

Limitations

You may need to use the brake to maintain a safe interval when using ACC with LSF. Additionally, ACC with LSF may not work properly under certain conditions.

▶▶ **ACC with LSF Conditions and Limitations**
P. 406

▶▶When you depress the accelerator pedal

While the accelerator pedal is depressed, the system does not apply the brakes to keep the following interval, as well as the **BRAKE** message on the driver information interface does not appear.

■ ACC with LSF Conditions and Limitations

The system may automatically shut off and the **ACC** indicator will come on under certain conditions. Some examples of these conditions are listed below. Other conditions may reduce some of the ACC functions.

➤ **Front Sensor Camera** P. 394

■ Environmental conditions

Driving in bad weather (rain, fog, snow, etc.).

■ Roadway conditions

Driving on a snowy or wet roadway (obscured lane marking, vehicle tracks, reflected lights, road spray, high contrast).

■ Vehicle conditions

- The outside of the windshield is blocked by dirt, mud, leaves, wet snow, etc.
- An abnormal tire or wheel condition (Wrong sized, varied size or construction, improperly inflated tire, etc.).
- The camera temperature gets too high.
- The parking brake is applied.
- When the front grille is dirty.
- The vehicle is tilted due to a heavy load or suspension modifications.
- When tire chains are installed.

➤ ACC with LSF Conditions and Limitations

The radar sensor for ACC with LSF is shared with the collision mitigation braking system™ (CMBS™).

➤ **Collision Mitigation Braking System™ (CMBS™)** P. 439

You can read about handling information for the camera equipped with this system.

➤ **Front Sensor Camera** P. 394

Always keep the radar sensor cover clean.

Never use chemical solvents or polishing powder for cleaning the sensor cover. Clean it with water or a mild detergent.

Do not put a sticker on the radar sensor cover or replace the radar sensor cover.

If you need the radar sensor to be repaired, or removed, or the radar sensor cover is strongly impacted, turn off the system by pressing the **MAIN** button and take your vehicle to an authorized Honda Clarity Plug-In Hybrid dealer.

Have your vehicle checked by an authorized Honda Clarity Plug-In Hybrid dealer if you find any unusual behavior of the system (e.g., the warning message appears too frequently).

■ Detection limitations

- A vehicle or pedestrian suddenly crosses in front of you.
- The interval between your vehicle and the vehicle or pedestrian ahead of you is too short.
- A vehicle cuts in front of you at a slow speed, and it brakes suddenly.
- When you accelerate rapidly and approach the vehicle or pedestrian ahead of you at high speed.
- The vehicle ahead of you is a motorcycle, bicycle, mobility scooter, or other small vehicle.
- When there are animals in front of your vehicle.
- When you drive on a curved or winding or undulating road that makes it difficult for the sensor to properly detect a vehicle or a pedestrian in front of you.
- The speed difference between your vehicle and a vehicle or pedestrian in front of you is significantly large.
- An oncoming vehicle suddenly comes in front of you.
- Your vehicle abruptly crosses over in front of an oncoming vehicle.
- When driving through a narrow iron bridge.
- When the vehicle ahead of you brakes suddenly.
- When the vehicle ahead of you has a unique shape.
- When your vehicle or the vehicle ahead of you is driving on one edge of the lane.

■ To Adjust the Vehicle Speed

Increase or decrease the vehicle speed using the **RES/+** or **-/SET** button on the steering wheel.

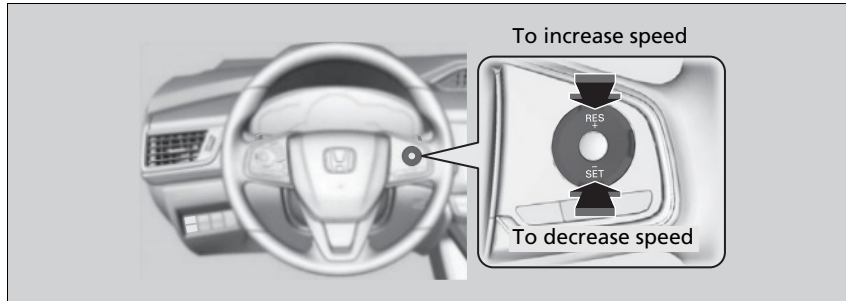

- Each time you press the **RES/+** or **-/SET** button, the vehicle speed is increased or decreased by about 1 mph or 1 km/h accordingly.
- If you press and hold the **RES/+** or **-/SET** button, the vehicle speed increases or decreases by about 5 mph or 5 km/h accordingly.

▶▶ To Adjust the Vehicle Speed

If a vehicle detected ahead is going at a speed slower than your increased set speed, ACC with LSF may not accelerate your vehicle. This is to maintain the set interval between your vehicle and the vehicle ahead.

You can switch the displayed set speed measurements on the driver information interface between mph and km/h.

▶ **Gauges** P. 121



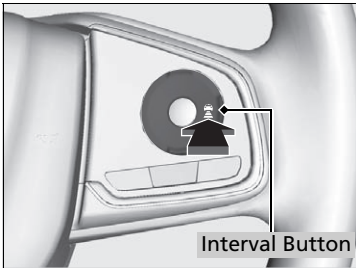

■ To Set or Change Following-Interval



Press the  (interval) button to change the ACC with LSF following-interval. Each time you press the button, the following-interval (the interval behind a vehicle detected ahead of you) setting cycles through extra long, long, middle, and short following-intervals.

Determine the most appropriate following-interval setting based on your specific driving conditions. Be sure to adhere to any following-interval requirements set by local regulation.

The higher your vehicle's following-speed is, the longer the short, middle, long or extra long following-interval becomes. See the following examples for your reference.

Following-interval		When the Set Speed is:	
		50 mph (80 km/h)	65 mph (104 km/h)
Short		83 feet 25 meters 1.1 sec	100 feet 31 meters 1.1 sec
Middle		110 feet 33 meters 1.5 sec	142 feet 43 meters 1.5 sec
Long		154 feet 47 meters 2.1 sec	200 feet 61 meters 2.1 sec
Extra Long		204 feet 62 meters 2.8 sec	265 feet 81 meters 2.8 sec

When your vehicle stops automatically because a vehicle detected ahead of you has stopped, the interval between the two vehicles will vary based on the ACC with LSF interval setting.

■ To Cancel

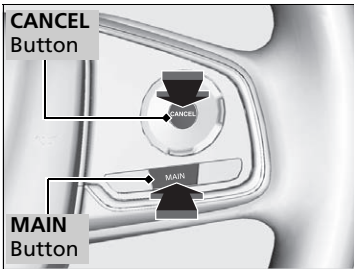

To cancel ACC with LSF, do any of the following:

- Press the **CANCEL** button.
- Press the **MAIN** button.
 - ▶ ACC with LSF indicator goes off.
- Depress the brake pedal.
 - ▶ When the LSF function has stopped the vehicle, you cannot cancel ACC with LSF by depressing the brake pedal.

☒ To Cancel

Resuming the prior set speed: After you have canceled ACC with LSF, you can resume the prior set speed while it is still displayed. Press the **RES/+** button.

The set speed cannot be set or resumed when ACC with LSF has been turned off using the **MAIN** button. Press the **MAIN** button to activate the system, then set the desired speed.

■ Automatic cancellation

The beeper sounds and a message appears on the driver information interface when ACC with LSF is automatically canceled. Any of these conditions may cause the ACC with LSF to automatically cancel:

- Bad weather (rain, fog, snow, etc.)
- When the radar sensor in the front grille gets dirty.
- An abnormal tire condition is detected, or the tires are skidding.
- Driving on a mountainous road, or driving off road for extended periods.
- Abrupt steering wheel movement.
- When the ABS, VSA® or CMBS™ is activated.
- When the ABS or VSA® system indicator comes on.
- When the vehicle is stopped on a very steep slope.
- When you manually apply the parking brake.
- When the detected vehicle within the ACC with LSF range is too close to your vehicle.
- The camera behind the rearview mirror, or the area around the camera, including the windshield, gets dirty.

The ACC with LSF automatic cancellation can be also triggered by the following causes. In these cases, the parking brake will be automatically applied.

- The driver's seat belt is unfastened when the vehicle is stationary.
- The vehicle stops for more than 10 minutes.
- The power system is turned off.

In the following cases, a buzzer sounds, ACC with LSF is deactivated, and the message **Cruise Cancelled: Slope Too Steep. Watch Downhill Speed** appears in the driver information interface.

- While descending a long slope and the vehicle has repeatedly applied the brakes to maintain the set speed.

▶▶ Automatic cancellation

Even though ACC with LSF has been automatically canceled, you can still resume the prior set speed. Wait until the condition that caused ACC with LSF to cancel improves, then press the **RES/+** button.

■ To Switch ACC with LSF to Cruise Control

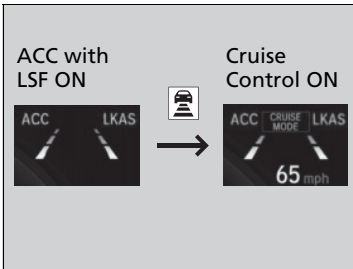

Press and hold the  (interval) button for one second. **Cruise Mode Selected** appears on the driver information interface for two seconds, and then the mode switches to Cruise.

To switch back to ACC with LSF, press and hold the  button again for one second. **ACC Mode Selected** appears on the driver information interface for two seconds.

■ When to use

Desired speed in a range above roughly 25 mph (40 km/h) ~.

■ To Set the Vehicle Speed

Take your foot off the pedal and press the **-/SET** button when you reach the desired speed.

The moment you release the **-/SET** button, the set speed is fixed, and cruise control begins. The **CRUISE CONTROL** indicator comes on.

■ To Adjust the Vehicle Speed

Each time you press the **RES/+** or **-/SET** button, the vehicle speed is increased or decreased by about 1 mph (1.6 km/h).

If you keep the **RES/+** or **-/SET** button pressed, the vehicle speed increases or decreases until you release it. This speed is then set.

☒ To Switch ACC with LSF to Cruise Control

Always be aware which mode you are in. When you are driving in Cruise mode, the system will not assist you to maintain a following-interval from a vehicle ahead of you.

You can switch the displayed set speed measurements on the driver information interface between mph and km/h.

➤ **Gauges** P. 121

■ To Cancel

To cancel cruise control, do any of the following:

- Press the **CANCEL** button.
- Press the **MAIN** button.
- Depress the brake pedal.

The **CRUISE CONTROL** indicator goes off.

☞ To Cancel

Resuming the prior set speed:

After cruise control has been canceled, you can still resume the prior set speed by pressing the **RES/+** button while driving at a speed of at least 25 mph (40 km/h) or more.

You cannot set or resume in the following situations:

- When vehicle speed is less than 25 mph (40 km/h).
- When the **MAIN** button is turned off.

At vehicle speeds of 22 mph (35 km/h) or less, cruise control canceled automatically.

Lane Keeping Assist System (LKAS)

Provides steering input to help keep the vehicle in the middle of a detected lane and provides tactile and visual alerts if the vehicle is detected drifting out of its lane.

■ Steering input assist
The system applies torque to the steering to keep the vehicle between the left and right lane lines. The applied torque becomes stronger as the vehicle gets closer to either of the lane lines.

■ Front Sensor Camera
Monitors the lane lines

■ Tactile and visual alerts
Rapid vibrations on the steering wheel and a warning display alert you that the vehicle is drifting out of a detected lane.

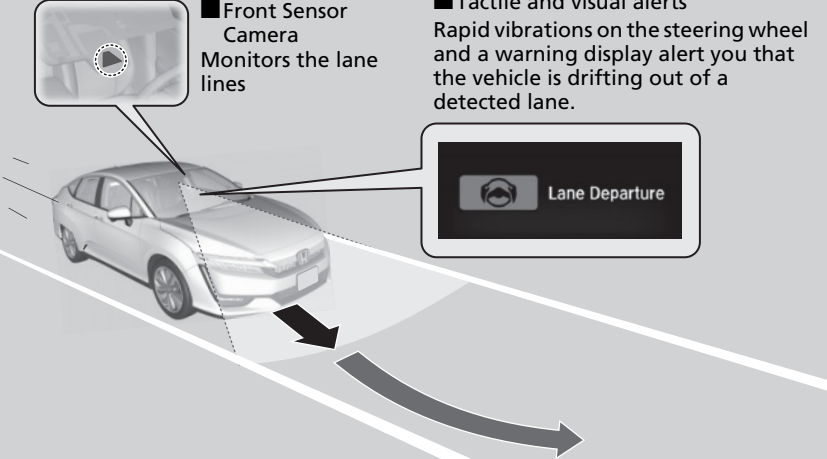

When you operate the turn signals to change lanes, the system is suspended, and resumes after the signals are off.

➡ If you make a lane change without operating the turn signals, the LKAS alerts activate, and torque is applied to the steering.

☒ Lane Keeping Assist System (LKAS)

Important Safety Reminders

The LKAS is for your convenience only. It is not a substitute for your vehicle control. The system does not work if you take your hands off the steering wheel or fail to steer the vehicle.

☒ Driver Information Interface Warning and Information Messages P. 119

Do not place objects on the instrument panel. Objects may reflect on the front windshield and prevent correct detection of the traffic lanes.

The LKAS only alerts you when lane drift is detected without a turn signal in use. The LKAS may not detect all lane markings or lane departures; accuracy will vary based on weather, speed, and lane marker condition. It is always your responsibility to safely operate the vehicle and avoid collisions.

The LKAS is convenient when it is used on freeways.

The LKAS may not work properly or may work improperly under the certain conditions:

☒ LKAS Conditions and Limitations P. 420

You can read about handling information for the camera equipped with this system.

☒ Front Sensor Camera P. 394

■ Lane Keep Support Function

Provides assistance to keep the vehicle in the center of the lane, when the vehicle nears a white or yellow line, steering force of the electric power steering will become stronger.

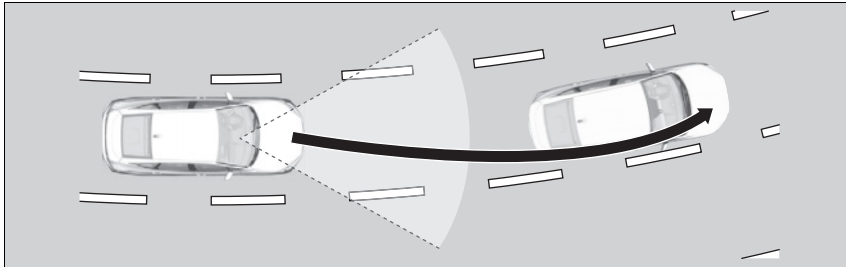

■ Lane Departure Warning Function

When the vehicle enters the warning area, the LKAS alerts you with slight steering wheel vibration as well as a warning display.

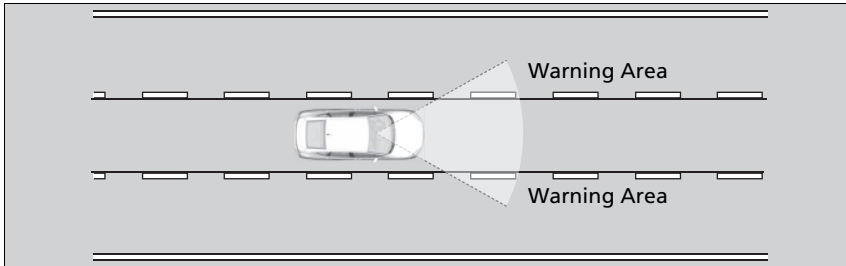

☒ Lane Keeping Assist System (LKAS)

The LKAS may not function as designed while driving in frequent stop and go traffic, or on roads with sharp curves.

When it fails to detect lanes, the system will temporarily be canceled. When lane is detected, system will recover automatically.

■ When the System can be Used

The system can be used when the following conditions are met.

- The lane in which you are driving has detectable lane markers on both sides, and your vehicle is in the center of the lane.
- The vehicle speed is between 45 and 90 mph (72 and 145 km/h).
- You are driving on a straight or slightly curved road.
- The turn signals are off.
- The brake pedal is not depressed.
- The wipers are not in continuous operation.

■ How to activate the system

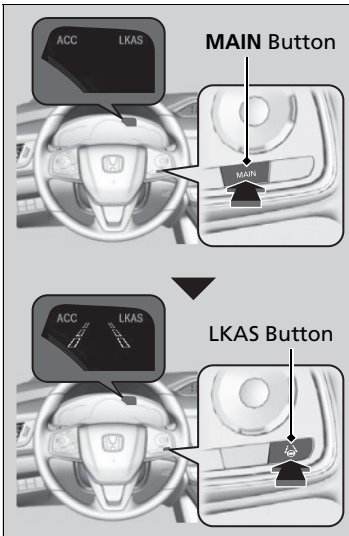

1. Press the **MAIN** button.
 - ▶ The LKAS (green) is on in the driver information interface.
The system is ready to use.
2. Press the LKAS button.
 - ▶ Lane outlines appear on the driver information interface.
The system is activated.

▶▶ When the System can be Used

If the vehicle drifts toward either left or right lane line due to the system applying torque, turn off the LKAS and have your vehicle checked by an authorized Honda Clarity Plug-In Hybrid dealer.

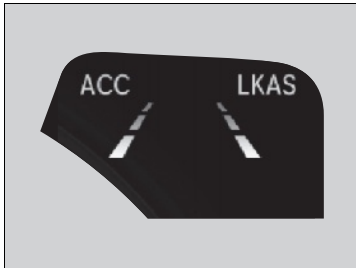

3. Keep your vehicle near the center of the lane while driving.
 - ▶ The dotted outer lines change to solid ones once the system starts operating after detecting the left and right lane markings.

■ To Cancel

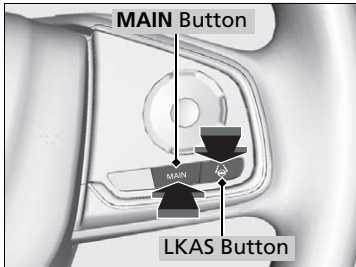

To cancel the LKAS:
Press the **MAIN** or LKAS button.

The LKAS is turned off every time you turn the power system off, even if you turned it on the last time you drove the vehicle.

☒ To Cancel

Pressing the **MAIN** button also turns ACC with LSF on and off.

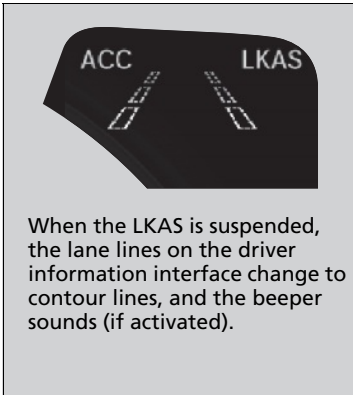

■ **The system operation is suspended if you:**

- Set the wipers to **HI**.
 - ▶ Set the wiper switch to other than **HI** resumes the LKAS.
- Decrease the vehicle speed to about 40 mph (64 km/h) or less.
 - ▶ Increasing the vehicle speed to about 45 mph (72 km/h) or more resumes the LKAS.
- Depress the brake pedal.
 - ▶ The LKAS resumes and starts detecting the lane lines again once you release the brake pedal.

■ **The LKAS may automatically be suspended when:**

- The system fails to detect lane lines.
- The steering wheel is quickly turned.
- You fail to steer the vehicle.
- Driving through a sharp curve.
- Driving at a speed in excess of approximately 90 mph (145 km/h).

Once these conditions no longer exist, the LKAS automatically resumes.

■ **The LKAS may automatically be canceled when:**

- The camera temperature gets extremely high or low.
- The camera behind the rearview mirror, or the area around the camera, including the windshield, gets dirty.
- The ABS or VSA® systems engage.

A beeper will sound if the LKAS is automatically canceled.

LKAS Conditions and Limitations

The system may not detect lane markings and therefore may not keep the vehicle in the middle of a lane under certain conditions, including the following:

■ **Environmental conditions**

- Driving in bad weather (rain, fog, snow, etc.).
- Sudden changes between light and dark, such as an entrance or exit of a tunnel.
- There is little contrast between lane lines and the roadway surface.
- Driving into low sunlight (e.g., at dawn or dusk).
- Strong light is reflected onto the roadway.
- Driving in the shadows of trees, buildings, etc.
- Shadows of adjacent objects are parallel to lane markings.
- Roadway objects or structures are misinterpreted as lane markers.
- Reflections on the interior of the windshield.

■ Roadway conditions

- Driving on a snowy or wet roadway (obscured lane marking, vehicle tracks, reflected lights, road spray, high contrast).
- Driving on a road with temporary lane markings.
- Faint, multiple, or varied lane markings are visible on the roadway due to road repairs or old lane markings.
- The roadway has merging, split, or crossing lines (e.g., such as at an intersection or crosswalk).
- The lane markings are extremely narrow, wide, or changing.
- The vehicle in front of you is driving near the lane lines.
- The road is hilly or the vehicle is approaching the crest of a hill.
- Driving on rough or unpaved roads, or over bumpy surfaces.
- When objects on the road (curb, guard rail, pylons, etc.) are recognized as white lines (or yellow lines).
- Driving on roads with double lines.

■ Vehicle conditions

- Headlight lenses are dirty or the headlights are not properly adjusted.
- The outside of the windshield is streaked or blocked by dirt, mud, leaves, wet snow, etc.
- The inside of the windshield is fogged.
- The camera temperature gets too high.
- An abnormal tire or wheel condition (wrong sized, varied size or construction, improperly inflated tire, etc.).
- The vehicle is tilted due to a heavy load or suspension modifications.

Vehicle Stability Assist (VSA®), aka Electronic Stability Control (ESC), System

VSA® helps to stabilize the vehicle during cornering if the vehicle turns more or less than what was intended. It also assists in maintaining traction on slippery surfaces. It does so by regulating engine and motor output and selectively applying the brakes.

■ VSA® Operation

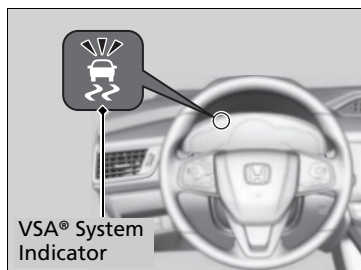

When VSA® activates, you may notice that the engine and motor do not respond to the accelerator. You may also notice some noise from the hydraulic system. You will also see the indicator blink.

▣ Vehicle Stability Assist (VSA®), aka Electronic Stability Control (ESC), System

The VSA® may not function properly if tire type and size are mixed. Make sure to use the same size and type of tire, and the air pressures as specified.

When the VSA® system indicator comes on and stays on while driving, there may be a problem with the system. While this may not interfere with normal driving, have your vehicle checked by an authorized Honda Clarity Plug-In Hybrid dealer immediately.

The indicators for the Vehicle Stability Assist (VSA®) System, Vehicle Stability Assist (VSA®) OFF, low tire Pressure/TPMS and Collision Mitigation Braking System™ (CMBS™) may come on along with a message in the driver information interface after reconnecting the 12-volt battery. Drive a short distance at more than 12 mph (20 km/h). The indicator should go off. If it does not, have your vehicle checked by an authorized Honda Clarity Plug-In Hybrid dealer.

VSA® cannot enhance stability in all driving situations and does not control the entire braking system. You still need to drive and corner at speeds appropriate for the conditions and always leave a sufficient margin of safety.

The main function of the VSA® system is generally known as Electronic Stability Control (ESC). The system also includes a traction control function.

VSA® On and Off

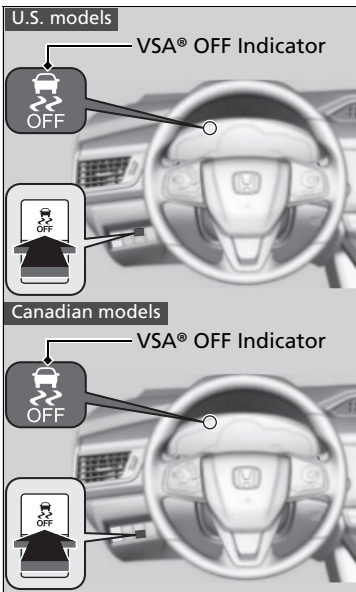

This button is on the driver side control panel. To partially disable VSA® functionality/features, press and hold it until you hear a beep.

Your vehicle will have normal braking and cornering ability, but traction control function will be less effective.

To restore VSA® functionality/features, press the  (VSA® OFF) button until you hear a beep.

VSA® is turned on every time you turn the power system on, even if you turned it off the last time you drove the vehicle.

Vehicle Stability Assist (VSA®), aka Electronic Stability Control (ESC), System

In certain unusual conditions when your vehicle gets stuck in shallow mud or fresh snow, it may be easier to free it with the VSA® temporarily switched off.

When the  button is pressed, the traction control function becomes less effective. This allows for the wheels to spin more freely at low speed. You should only attempt to free your vehicle with the VSA® off if you are not able to free it when the VSA® is on.

Immediately after freeing your vehicle, be sure to switch VSA® on again. We do not recommend driving your vehicle with the VSA® system switched off.

You may hear a motor sound coming from the engine compartment while system checks are being performed immediately after turning the power system on or while driving. This is normal.

Agile Handling Assist

Lightly brakes each of the front and rear wheels, as needed, when you turn the steering wheel, and helps support the vehicle's stability and performance during cornering.

Agile Handling Assist

The agile handling assist cannot enhance stability in all driving situations. You still need to drive and corner at speeds appropriate for the conditions and always leave a sufficient margin of safety.

When the VSA® system indicator comes on and stays on while driving, the agile handling assist does not activate.

You may hear a sound coming from the engine compartment while the agile handling assist is activated. This is normal.

Tire Pressure Monitoring System (TPMS)

Instead of directly measuring the pressure in each tire, the TPMS on this vehicle monitors and compares the rolling radius and rotational characteristics of each wheel and tire while you are driving to determine if one or more tires are significantly under-inflated. This will cause the low tire pressure/TPMS indicator to come on and a message to appear on the driver information interface.

TPMS Calibration

You must start TPMS calibration every time you:

- Adjust the pressure in one or more tires.
- Rotate the tires.
- Replace one or more tires.

Before calibrating the TPMS:

- Set the cold tire pressure in all four tires.
 - **Checking Tires** P. 499

Make sure:

- The vehicle is at a complete stop.
- The gear position is in **P**.
- The power mode is in ON.

⊗ Tire Pressure Monitoring System (TPMS)

The system does not monitor the tires when driving at low speed.

Conditions such as low ambient temperature and altitude change directly affect tire pressure and can trigger the low tire pressure/TPMS indicator to come on.

Tire pressure checked and inflated in:

- Warm weather can become under-inflated in colder weather.
- Cold weather can become over-inflated in warmer weather.

The low tire pressure/TPMS indicator will not come on as a result of over inflation.

The TPMS may not function properly if tire type and size are mixed. Make sure to use the same size and type of tire.

➤ **Checking and Maintaining Tires** P. 499

The low tire pressure/TPMS indicator may come on with a delay or may not come on at all when:

- You rapidly accelerate, decelerate, or turn the steering wheel.
- You drive on snowy or slippery roads.
- Snow chains are used.

The low tire pressure/TPMS indicator may come on under the following conditions:

- There is a heavier and uneven load on the tires, such as when towing a trailer, than the condition at calibration.
- Snow chains are used.

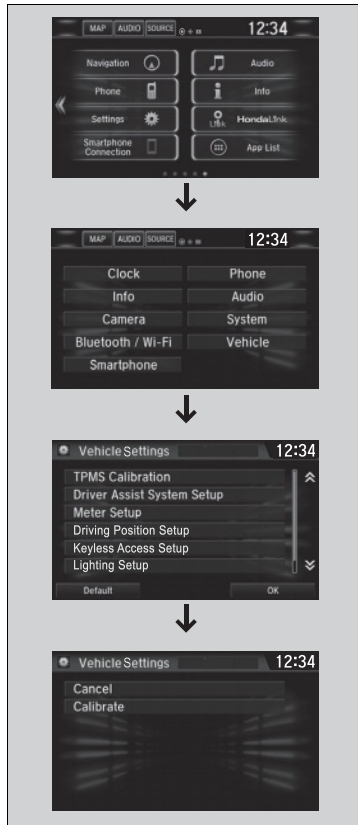

You can calibrate the system from the customized feature on the audio/information screen.

1. Set the power mode to ON.
2. Select .
3. Select **Settings**.
4. Select **Vehicle**.
5. Select **TPMS Calibration**.
6. Select **Cancel** or **Calibrate**.

▶ When the calibration is complete, the display returns to the customization menu screen.

- If the **Calibration Failed To Start** message appears, repeat steps 4-6.
- The calibration process finishes automatically.

▶▶ TPMS Calibration

- The calibration process requires approximately 30 minutes of cumulative driving at speeds between 30-65 mph (48-105 km/h).
- During this period, if the power system is turned on and the vehicle is not moved within 45 seconds, you may notice the low tire pressure/TPMS indicator comes on briefly. This is normal and indicates that the calibration process is not yet complete.

If snow chains are installed, remove them before calibrating the TPMS.

If the low tire pressure/TPMS indicator comes on even when the properly inflated specified regular tires are installed, have your vehicle checked by an authorized Honda Clarity Plug-In Hybrid dealer.

We recommend that the tires be replaced with the same brand, model, and size as the originals. Ask an authorized Honda Clarity Plug-In Hybrid dealer for details.

The indicators for the Vehicle Stability Assist (VSA®) System, Vehicle Stability Assist (VSA®) OFF, low tire Pressure/TPMS and Collision Mitigation Braking System™ (CMBS™) may come on along with a message in the driver information interface after reconnecting the 12-volt battery. Drive a short distance at more than 12 mph (20 km/h). The indicator should go off. If it does not, have your vehicle checked by an authorized Honda Clarity Plug-In Hybrid dealer.

Tire Pressure Monitoring System (TPMS) - Required Federal Explanation

Each tire, including the spare (if provided), should be checked monthly when cold and inflated to the inflation pressure recommended by the vehicle manufacturer on the vehicle placard or tire inflation pressure label.

(If your vehicle has tires of a different size than the size indicated on the vehicle placard or tire inflation pressure label, you should determine the proper tire inflation pressure for those tires.)

As an added safety feature, your vehicle has been equipped with a tire pressure monitoring system (TPMS) that illuminates a low tire pressure telltale



when one or more of your tires is significantly under-inflated.

Accordingly, when the low tire pressure telltale illuminates, you should stop and check your tires as soon as possible, and inflate them to the proper pressure.

Driving on a significantly under-inflated tire causes the tire to overheat and can lead to tire failure. Under-inflation also reduces fuel efficiency and tire tread life, and may affect the vehicle's handling and stopping ability.

Please note that the TPMS is not a substitute for proper tire maintenance, and it is the driver's responsibility to maintain correct tire pressure, even if under-inflation has not reached the level to trigger illumination of the TPMS low tire pressure telltale.

Your vehicle has also been equipped with a TPMS malfunction indicator to indicate when the system is not operating properly. The TPMS malfunction indicator is combined with the low tire pressure telltale. When the system detects a malfunction, the telltale will flash for approximately one minute and then remain continuously illuminated. This sequence will continue upon subsequent vehicle start-ups as long as the malfunction exists.

When the malfunction indicator is illuminated, the system may not be able to detect or signal low tire pressure as intended.

TPMS malfunctions may occur for a variety of reasons, including the installation of replacement or alternate tires or wheels on the vehicle that prevent the TPMS from functioning properly.

Always check the TPMS malfunction telltale after replacing one or more tires or wheels on your vehicle to ensure that the replacement or alternate tires and wheels allow the TPMS to continue to function properly.

LaneWatch™

LaneWatch is an assistance system that allows you to check the passenger side rear areas displayed on the audio/information screen when the turn signal is activated to the passenger's side. A camera in the passenger side door mirror monitors these areas and allows you to check for vehicles, in addition to your visual check and use of the passenger door mirror. You can also keep the system on for your convenience while driving.

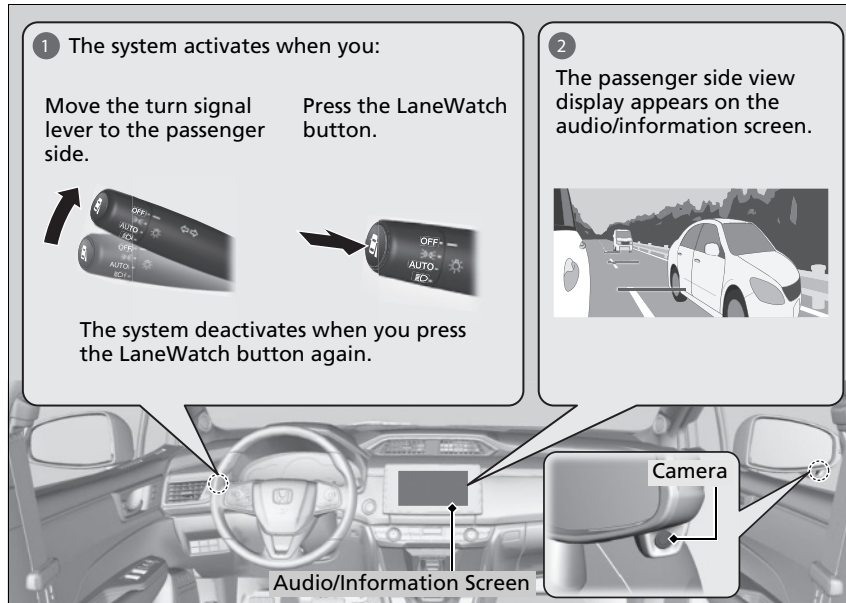

LaneWatch™

⚠ WARNING

Failure to visually confirm that it is safe to change lanes before doing so may result in a crash and serious injury or death.

Do not rely only on LaneWatch while driving.

Always look in your mirrors, to either side of your vehicle, and behind you for other vehicles before changing lanes.

Important Safety Reminder

Like all assistance systems, LaneWatch has limitations. Over reliance on LaneWatch may result in a collision.

The LaneWatch function can be affected by weather, lighting (including headlights and low sun angle), ambient darkness, camera condition, and loading.

The LaneWatch may not provide the intended display of traffic to the side and rear under the following conditions:

- Your vehicle's suspension has been altered, changing the height of the vehicle.
- Your tires are over or under inflated.
- Your tires or wheels are of varied size or construction.

Continued

■ Customizing the LaneWatch settings

You can customize the following items using the audio/information screen.

- **Show with Turn Signal:** Selects whether LaneWatch monitor comes on when you operate the turn signal light lever.
- **Display Time after Turn Signal Off:** Changes the length of time the LaneWatch display stays on after you pull the turn signal lever back.
- **Reference Line:** Selects whether the reference lines appear on the LaneWatch monitor.
- **Display:** Allows for display adjustments of items, such as brightness, contrast and black level. This setting is part of the **System** setup group.

📄 **Customized Features** P. 306

■ Reference Lines

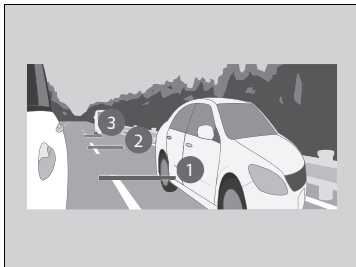

Three lines that appear on the screen can give an idea of how far the vehicles or objects on the screen are from your vehicle, respectively. If an object is near line 1 (in red), it indicates that it is close to your vehicle whereas an object near line 3 farther away.

📄 LaneWatch™

The LaneWatch camera view is restricted. Its unique lens makes objects on the screen slightly look different from what they are.

LaneWatch display does not come on when the gear position is in **R**.

For proper LaneWatch operation:

- The camera is located in the passenger side door mirror. Always keep this area clean. If the camera lens is covered with dirt or moisture, use a soft, moist cloth to keep the lens clean and free of debris.
- Do not cover the camera lens with labels or stickers of any kind.
- Do not touch the camera lens.

📄 Reference Lines

The area around the reference line 1 (red) is very close to your vehicle. As always, make sure to visually confirm the safety of a lane change before changing lanes.

The distance between your vehicle and lines 1, 2 and 3 on the screen vary depending on road conditions and vehicle loading. For example, the reference lines on the screen may seem to appear closer than the actual distances when the rear of your vehicle is more heavily loaded.

Consult an authorized Honda Clarity Plug-In Hybrid dealer if:

- The passenger side door mirror, or area around it is severely impacted, resulting in changing the camera angle.
- The LaneWatch display does not come on at all.

Brake System

■ Parking Brake

Use the parking brake to keep the vehicle stationary when parked. When the parking brake is applied, you can manually or automatically release it.



■ To apply

The electric parking brake can be applied any time the vehicle has battery, no matter which position the power mode is in.

Pull the electric parking brake switch up gently and securely.

- ▶ The parking brake and brake system indicator (red) comes on.

■ To release

The power mode must be in ON in order to release the electric parking brake.

1. Depress the brake pedal.
 2. Press the electric parking brake switch.
- ▶ The parking brake and brake system indicator (red) goes off.

Manually releasing the parking brake using the switch helps your vehicle start slowly and smoothly when facing down hill on steep hills.

⊗ Brake System

When you depress the brake pedal, you may hear a whirling sound from the engine compartment. This is because the brake system is in operation, and it is normal.

⊗ Parking Brake

You may hear the electric parking brake system motor operating from the rear wheel area when you apply or release the parking brake, or set the power mode to OFF. This is normal.

The brake pedal may slightly move due to the electric parking brake system operation when you apply or release the parking brake. This is normal.

You cannot apply or release the parking brake if the 12-volt battery goes dead.

➤ **Jump Starting** P. 539

If you pull up and hold the electric parking brake switch while driving, the brakes on all four wheels are applied by the electric servo brake system until the vehicle comes to a stop. The electric parking brake then applies, and the switch should be released.

■ To release automatically

Depressing the accelerator pedal releases the parking brake. Use the accelerator pedal to release the brake when you are starting the vehicle facing uphill, or in a traffic jam.

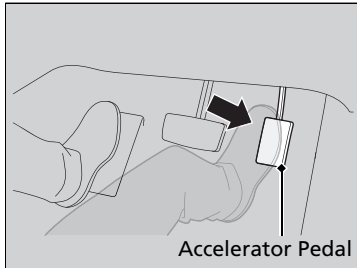

Gently depress the accelerator pedal. When on a hill, it may require more accelerator input to release.

- The parking brake and brake system indicator (red) goes off.

You can release the parking brake automatically when:

- You are wearing the driver's seat belt.
- The power system is on.
- The transmission is not in **P** or **N**.

▣ Parking Brake

In the following situations, the parking brake automatically operates.

- When the vehicle stops more than 10 minutes while ACC with LSF is activated.
- When the driver's seat belt is unfastened while your vehicle is stopped automatically by ACC with LSF.
- When the power system is turned off while ACC with LSF is activated.
- When the vehicle stops with the automatic brake hold system activated for more than 10 minutes.
- When the driver's seat belt is unfastened while your vehicle is stopped and brake hold is applied.
- When the power system is turned off while brake hold is applied.
- When there is a problem with the Brake Hold System.

If the parking brake cannot be released automatically, release it manually.

The parking brake may not be released automatically while the following indicators are on:

- **POWER SYSTEM** indicator
- Transmission system indicator
- Parking brake and brake system indicator (amber)
- VSA® system indicator
- **ABS** indicator
- Supplemental restraint system indicator

■ Foot Brake

Your vehicle is equipped with disc brakes at all four wheels. The brake assist system increases the stopping force when you depress the brake pedal hard in an emergency situation. The anti-lock brake system (ABS) helps you retain steering control when braking very hard.

➤ **Brake Assist System** P. 438

➤ **Anti-lock Brake System (ABS)** P. 437

☒ Foot Brake

Check the brakes after driving through deep water, or if there is a buildup of road surface water. If necessary, dry the brakes by lightly depressing the pedal several times.

If you hear a continuous metallic friction sound when applying the brakes, this is caused by the brake wear indicator rubbing on the brake rotor and indicates that the brake pads need to be replaced. Have the vehicle checked by an authorized Honda Clarity Plug-In Hybrid dealer. If you hear only an occasional squeak or squeal when you initially apply the brake pedal, this may be normal and caused by high frequency vibration of the brake pads against the rotating brake disc.

Foot Brake

Applying constant pressure to the brakes while going down a long hill can cause the brakes to heat up, resulting in a loss of stopping power. Therefore, when descending a long hill, release the accelerator pedal and allow regenerative braking to slow the vehicle down. To adjust the rate of deceleration, use the deceleration paddle selector.

When the high voltage battery is recharging, regenerative braking may not be possible.

► **POWER/CHARGE Gauge** P. 122



► **High Voltage Battery Charge Level Gauge**
P. 123

► **Deceleration Paddle Selector** P. 390

Do not rest your foot on the brake pedal while driving, as it will lightly apply the brakes and cause them to lose effectiveness over time and reduce pad life. It will also confuse drivers behind you.

Automatic Brake Hold

Keeps the brake applied after releasing the brake pedal until the accelerator pedal is pressed. You can use this system while the vehicle is temporarily stopped, like at traffic lights and in heavy traffic.

■ Turning on the system	■ Activating the system	■ Canceling the system
 <p>Automatic Brake Hold Button</p>	 <p>Brake Pedal</p>	 <p>Accelerator Pedal</p>
<p>Fasten your seat belt properly, then start the power system. Press the automatic brake hold button.</p> <ul style="list-style-type: none"> The automatic brake hold system indicator comes on. The system is turned on. 	<p>Depress the brake pedal to come to a complete stop. The transmission must be in D or N.</p> <ul style="list-style-type: none"> The automatic brake hold indicator comes on. Braking is kept for up to 10 minutes. Release the brake pedal after the automatic brake hold indicator comes on. 	<p>Depress the accelerator pedal while the transmission is in D. The system is canceled and the vehicle starts to move.</p> <ul style="list-style-type: none"> The automatic brake hold indicator goes off. The system continues to be on.

Automatic Brake Hold

⚠ WARNING

Activating the automatic brake hold system on steep hills or slippery roads may still allow the vehicle to move if you remove your foot from the brake pedal.

If a vehicle unexpectedly moves, it may cause a crash resulting in serious injury or death.

Never activate the automatic brake hold system or rely on it to keep a vehicle from moving when stopped on a steep hill or slippery roads.

⚠ WARNING

Using the automatic brake hold system to park the vehicle may result in the vehicle unexpectedly moving.

If a vehicle moves unexpectedly, it may cause a crash, resulting in serious injury or death.

Never leave the vehicle when braking is temporarily kept by automatic brake hold and always park the vehicle by putting the transmission in **P** and applying the parking brake.

■ **The system automatically cancels when:**

- You depress the brake pedal and change to **P** or **R**.
- You engage the parking brake.

■ **The system automatically cancels and the parking brake is applied when:**

- Braking is kept for more than 10 minutes.
- The driver's seat belt is unfastened.
- The power system is turned off.
- **Brake Hold System Problem** appears on the driver information interface.

■ **Turning off the automatic brake hold system**

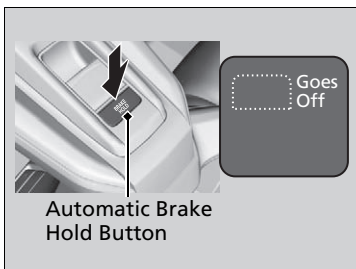

While the system is on, press the automatic brake hold button again.

- The automatic brake hold system indicator goes off.

If you want to turn off automatic brake hold while the system is in operation, press the automatic brake hold button with the brake pedal depressed.

⌘ Automatic Brake Hold

While the system is activated, you can turn off the power system or park the vehicle through the same procedure as you normally do.

⌘ **When Stopped** P. 447

Whether the system is on, or the system is activated, the automatic brake hold turns off once the power system is off.

⌘ Turning on the system

Make sure to turn off the automatic brake hold system before using an automated car wash.

You may hear an operating noise if the vehicle moves while the automatic brake hold system is in operation. The system generates sound while holding the vehicle and it moves.

Anti-lock Brake System (ABS)

■ ABS

Helps prevent the wheels from locking up, and helps you retain steering control by pumping the brakes rapidly, much faster than you.

The electronic brake distribution (EBD) system, which is part of the ABS, also balances the front-to-rear braking distribution according to vehicle loading.

You should never pump the brake pedal. Let the ABS work for you by always keeping firm, steady pressure on the brake pedal. This is sometimes referred to as “stomp and steer.”

■ ABS operation

You may hear an operating noise when the ABS is working. Keep holding the pedal firmly down. On dry pavement, you will need to press on the brake pedal very hard before the ABS activates. However, you may feel the ABS activate immediately if you are trying to stop on snow or ice.

ABS may activate when you depress the brake pedal when driving on:

- Wet or snow covered roads.
- Roads paved with stone.
- Roads with uneven surfaces, such as potholes, cracks, manholes, etc.

When the vehicle speed goes under 6 mph (10 km/h), the ABS stops.

▶▶ Anti-lock Brake System (ABS)

NOTICE

The ABS may not function correctly if you use a tire of the wrong size or type.

If the **ABS** indicator comes on while driving, there may be a problem with the system. While normal braking will not be affected, there is a possibility that the ABS will not operating. Have your vehicle checked by an authorized Honda Clarity Plug-In Hybrid dealer immediately.

The ABS is not designed for the purpose of reducing the time or distance it takes for a vehicle to stop: It is designed to limit brake lockup which can lead to skidding and loss of steering control.

In the following cases, your vehicle may need more distance to stop than a vehicle without the ABS:

- You are driving on rough or uneven road surfaces, such as gravel or snow.
- The tires are equipped with snow chains.

The following may be observed with the ABS system:

- Motor sounds coming from the engine compartment when the brakes are applied, or when system checks are being performed after the power system has been turned on and while vehicle is accelerates.
- Brake pedal and/or the vehicle body vibration when ABS activates.

These vibrations and sounds are normal to ABS systems and are no cause for concern.

Brake Assist System

■ Brake Assist System

Designed to assist the driver by generating greater braking force when you depress the brake pedal hard during emergency braking.

■ Brake assist system operation

Press the brake pedal firmly for more powerful braking.

Collision Mitigation Braking System™ (CMBS™)

Can assist you when there is a possibility of your vehicle colliding with a vehicle or a pedestrian detected in front of yours. The CMBS™ is designed to alert you when a potential collision is determined, as well as to reduce your vehicle speed to help minimize collision severity when a collision is deemed unavoidable.

■ How the system works

When to use

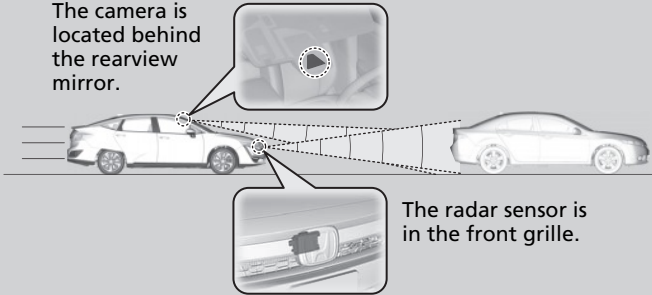

The camera is located behind the rearview mirror.

The radar sensor is in the front grille.

The system starts monitoring the roadway ahead when your vehicle speed is about 3 mph (5 km/h) and there is a vehicle in front of you.

The CMBS™ activates when:

- The speed difference between your vehicle and a vehicle or pedestrian detected in front of you becomes about 3 mph (5 km/h) and over with a chance of a collision.
- Your vehicle speed is about 62 mph (100 km/h) or less and there is a chance of a collision with an oncoming detected vehicle or a pedestrian in front of you.

Continued

▣ Collision Mitigation Braking System™ (CMBS™)

Important Safety Reminder

The CMBS™ is designed to reduce the severity of an unavoidable collision. It does not prevent a collision nor stop the vehicle automatically. It is still your responsibility to operate the brake pedal and steering wheel appropriately according to the driving conditions.

The CMBS™ may not activate or may not detect a vehicle in front of your vehicle under certain conditions:

▣ **CMBS™ Conditions and Limitations** P. 443

You can read about handling information for the camera equipped with this system.

▣ **Front Sensor Camera** P. 394

Be careful not to severely impact the radar sensor cover.

▣ How the system works

Rapid vibrations on the steering wheel alert you when the your vehicle speed is between 19 and 62 mph (30 and 100 km/h) with an oncoming vehicle detected in front of you.

When the CMBS™ activates, it may automatically apply the brake. It will be canceled when your vehicle stops or a potential collision is not determined.

■ When the system activates

The system provides visual, audible and tactile alerts of a possible collision, and stops if the collision is avoided.

- ▶ Take appropriate action to prevent a collision (apply the brakes, change lanes, etc.)

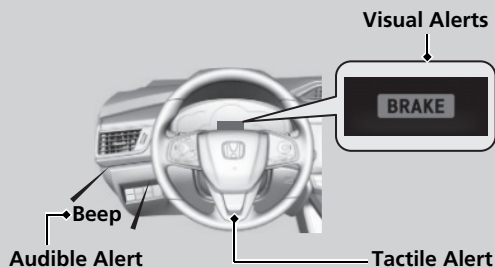

At system's earliest collision alert stage, you can change the distance (**Long/Normal/Short**) between vehicles at which alerts will come on through audio/information screen setting options.

- ▶ **Customized Features** P. 306

■ Vibration alert on the steering wheel

When a potential collision to an oncoming detected vehicle is determined, the system alerts you with rapid vibration on the steering wheel, in addition to visual and audible alerts.

- ▶ Take appropriate action to prevent a collision (apply the brakes, operate the steering wheel, etc.).

▶▶ When the system activates

The camera in the CMBS™ is also designed to detect pedestrians.

However, this pedestrian detection feature may not activate or may not detect a pedestrian in front of your vehicle under certain conditions.

Refer to the ones indicating the pedestrian detection limitations from the list.

- ▶ **CMBS™ Conditions and Limitations** P. 443



▶▶ Vibration alert on the steering wheel

Vibration alert function is disabled when the electric power steering (EPS) system indicator comes on.

- ▶ **Electric Power Steering (EPS) System Indicator** P. 94

■ Collision Alert Stages

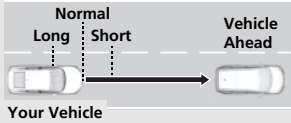
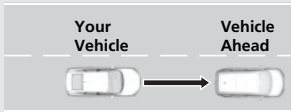
The system has three alert stages for a possible collision. However, depending on circumstances, the CMBS™ may not go through all of the stages before initiating the last stage.

Distance between vehicles		CMBS™			
		The sensor detects a vehicle	Audible & Visual WARNINGS	Steering Wheel	Braking
Stage one		There is a risk of a collision with the vehicle ahead of you.	When in Long , visual and audible alerts come on at a longer distance from a vehicle ahead than in Normal setting, and in Short , at a shorter distance than in Normal .	In case of an oncoming vehicle detected, rapid vibration is provided.	—
Stage two		The risk of a collision has increased, time to respond is reduced.	Visual and audible alerts.	—	Lightly applied
Stage three		The CMBS™ determines that a collision is unavoidable.			Forcefully applied

■ CMBS™ On and Off

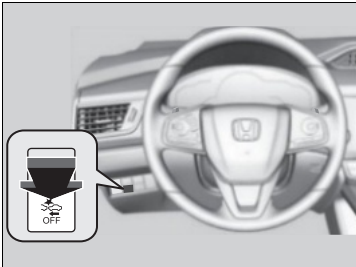

Press and hold the button until the beeper sounds to switch the system on or off.

When the CMBS™ is off:

- The CMBS™ indicator in the instrument panel comes on.
- A message on the driver information interface reminds you that the system is off.

The CMBS™ is turned on every time you start the power system, even if you turned it off the last time you drove the vehicle.

▣ Collision Mitigation Braking System™ (CMBS™)

The CMBS™ may automatically shut off, and the CMBS™ indicator will come and stay on under certain conditions:

▣ **CMBS™ Conditions and Limitations** P. 443

The indicators for the Vehicle Stability Assist (VSA®) System, Vehicle Stability Assist (VSA®) OFF, low tire Pressure/TPMS and Collision Mitigation Braking System™ (CMBS™) may come on along with a message in the driver information interface after reconnecting the 12-volt battery. Drive a short distance at more than 12 mph (20 km/h). The indicator should go off. If it does not, have your vehicle checked by an authorized Honda Clarity Plug-In Hybrid dealer.

■ CMBS™ Conditions and Limitations

The system may automatically shut off and the CMBS™ indicator will come on under certain conditions. Some examples of these conditions are listed below. Other conditions may reduce some of the CMBS™ functions.

📷 Front Sensor Camera P. 394

■ Environmental conditions

- Driving in bad weather (rain, fog, snow, etc.).
- Sudden changes between light and dark, such as an entrance or exit of a tunnel.
- There is little contrast between objects and the background.
- Driving into low sunlight (e.g., at dawn or dusk).
- Strong light is reflected onto the roadway.
- Driving in the shadows of trees, buildings, etc.
- Roadway objects or structures are misinterpreted as vehicles and pedestrians.
- Reflections on the interior of the windshield.
- Driving at night or in a dark condition such as a tunnel.

■ Roadway conditions

- Driving on a snowy or wet roadway (obscured lane marking, vehicle tracks, reflected lights, road spray, high contrast).
- Driving on curvy, winding, or undulating roads.
- The road is hilly or the vehicle is approaching the crest of a hill.

■ Vehicle conditions

- Headlight lenses are dirty or the headlights are not properly adjusted.
- The outside of the windshield is blocked by dirt, mud, leaves, wet snow, etc.
- The inside of the windshield is fogged.
- An abnormal tire or wheel condition (wrong sized, varied size or construction, improperly inflated tire, etc.).
- When tire chains are installed.
- The vehicle is tilted due to a heavy load or suspension modifications.
- The camera temperature gets too high.
- Driving with the parking brake applied.
- When the radar sensor in the front grille gets dirty.

■ Detection limitations

- A vehicle or pedestrian suddenly crosses in front of you.
- The distance between your vehicle and the vehicle or pedestrian ahead of you is too short.
- A vehicle cuts in front of you at a slow speed, and it brakes suddenly.
- When you accelerate rapidly and approach the vehicle or pedestrian ahead of you at high speed.
- The vehicle ahead of you is a motorcycle, bicycle, mobility scooter or other small vehicle.
- When there are animals in front of your vehicle.
- When you drive on a curved, winding or undulating road that makes it difficult for the sensor to properly detect a vehicle in front of you.
- The speed difference between your vehicle and a vehicle or pedestrian in front of you is significantly large.
- An oncoming vehicle suddenly comes in front of you.
- Another vehicle suddenly comes in front of you at an intersection, etc.
- Your vehicle abruptly crosses over in front of an oncoming vehicle.
- When driving through a narrow iron bridge.
- When the lead vehicle suddenly slows down.

Limitations applicable to pedestrian detection only

- When there is a group of people in front of your vehicle walking together side by side.
- Surrounding conditions or belongings of the pedestrian alter the pedestrian's shape, preventing the system from recognizing that the person is a pedestrian.
- When the pedestrian is shorter than about 3.3 feet (1 meter) or taller than about 6.6 feet (2 meters) in height.
- When a pedestrian blends in with the background.
- When a pedestrian is bent over or squatting, or when their hands are raised or they are running.
- When several pedestrians are walking ahead in a group.
- When the camera cannot correctly identify that a pedestrian is present due to an unusual shape (holding luggage, body position, size).

■ Automatic shutoff

The CMBS™ may automatically shut itself off and the CMBS™ indicator comes and stays on when:

- The temperature inside the system is high.
- You drive off-road or on a mountain road, or curved and winding road for an extended period.
- An abnormal tire condition is detected (wrong tire size, flat tire, etc.).
- The camera behind the rearview mirror, or the area around the camera, including the windshield, gets dirty.

Once the conditions that caused the CMBS™ to shut off improve or are addressed (e.g., cleaning), the system comes back on.

■ With Little Chance of a Collision

The CMBS™ may activate even when you are aware of a vehicle ahead of you, or when there is no vehicle ahead. Some examples of this are:

■ When Passing

Your vehicle approaches another vehicle ahead of you and you change lanes to pass.

■ At an intersection

Your vehicle approaches or passes another vehicle that is making a left or right turn.

■ On a curve

When driving through curves, your vehicle comes to a point where an oncoming vehicle is right in front of you.

■ Through a low bridge at high speed

You drive under a low or narrow bridge at high speed.

■ Speed bumps, road work sites, train tracks, roadside objects, etc.

You drive over speed bumps, steel road plates, etc., or your vehicle approaches train tracks or roadside objects [such as a traffic sign and guard rail] on a curve or, when parking, stationary vehicles and walls.

⚠ Collision Mitigation Braking System™ (CMBS™)

For the CMBS™ to work properly:

Always keep the radar sensor cover clean.

Never use chemical solvents or polishing powder for cleaning the sensor cover. Clean it with water or a mild detergent.

Do not apply any coverings or paint to the radar sensor area. Do not put a sticker on the emblem or replace the emblem. These can impact CMBS™ operation.

If you need the radar sensor to be repaired, or removed, or the radar sensor cover is strongly impacted, turn off the system by pressing the CMBS™ off button and take your vehicle to an authorized Honda Clarity Plug-In Hybrid dealer.

Have your vehicle checked by an authorized Honda Clarity Plug-In Hybrid dealer if you find any unusual behavior of the system (e.g., the warning message appears too frequently).

If the front of the vehicle is impacted in any of the following situations, the radar sensor may not work properly. Have your vehicle checked by an authorized Honda Clarity Plug-In Hybrid dealer:

- The vehicle mounted onto a bump, curb, chock, embankment, etc.
- You drive the vehicle where the water is deep.
- Your vehicle has a frontal collision.

When Stopped

1. Depress the brake pedal firmly.
2. With the brake pedal depressed, pull up the electric parking brake switch slowly, but fully.
3. Change the gear position to **P**.
4. Turn off the power system.
 - ▶ The parking brake and brake system indicator (red) goes off in about 15 seconds.

▣ Parking Your Vehicle

⚠ WARNING

The vehicle can roll away if left unattended without confirming that Park is engaged.

A vehicle that rolls away could cause a crash resulting in serious injury or death.

Always keep your foot on the brake pedal until you have confirmed that **P** is shown on the gear position indicator.

Do not park your vehicle near flammable objects, such as dry grass, oil, or timber. Heat from the exhaust can cause a fire.

▣ When Stopped

NOTICE

The following can damage the driveline:

- Depressing the accelerator and brake pedals simultaneously.
- Holding the vehicle in place when facing uphill by depressing the accelerator pedal.
- Changing into **P** before the vehicle stops completely.

Always confirm the electric parking brake is set, in particular if you are parked on an incline.

⚠ When Stopped

When facing uphill, do not hold the vehicle by depressing the accelerator pedal. Doing so may cause the power system to overheat and fail.

In extremely cold temperatures, the parking brake may freeze up if applied. If such temperatures are expected, do not apply the parking brake but, if parking on a slope, either turn the front wheels so they will contact the curb if the vehicle rolls down the slope or block the wheels to keep the vehicle from moving. If you do not take either precaution, the vehicle may roll unexpectedly, leading to a crash.

About Your Multi-View Rear Camera

The audio/information screen can display your vehicle's rear view. The display automatically changes to the rear view when the transmission is put into **R**.

Multi-View Rear Camera Display Area

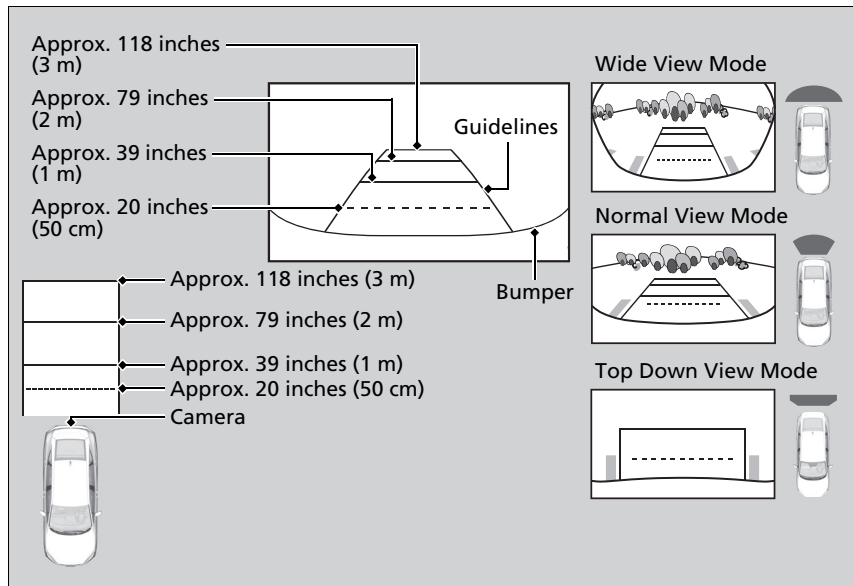

About Your Multi-View Rear Camera

The rear camera view is restricted. You cannot see the corner ends of the bumper or what is underneath the bumper. Its unique lens also makes objects appear closer or farther than they actually are.

Visually confirm that it is safe to drive before backing up. Certain conditions (such as weather, lighting, and high temperatures) may also restrict the rear view. Do not rely on the rearview display which does not give you all information about conditions at the back of your vehicle.

If the camera lens is covered with dirt or moisture, use a soft, moist cloth to keep the lens clean and free of debris.

You can change the **Fixed Guideline** and **Dynamic Guideline** settings.

➤ **Customized Features** P. 306

Fixed Guideline

On: Guidelines appear when you put the transmission into **R**.



Off: Guidelines do not appear.

Dynamic Guideline

On: Guidelines move according to the steering wheel direction.

Off: Guidelines do not move.

You can view three different camera modes on the rearview display. Touch the appropriate icon to switch the mode.

- : Wide view mode
- : Normal view mode
- : Top down view mode

- If the last used viewing mode was Wide or Normal view mode, the same mode is selected the next time you put the transmission into **R**.
- If Top down view mode was last used before you turned off the power system, Wide View mode is selected next time you turn the power on and put the transmission into **R**.
- If Top down view mode was last used more than 10 seconds after you change from **R**, Wide View mode is selected the next time you put the transmission into **R**.

Fuel Information

■ Fuel recommendation

Unleaded gasoline, pump octane number 87 or higher

Use of a lower octane gasoline can cause a persistent, heavy metallic knocking noise that can lead to engine damage.

■ Top tier detergent gasoline

Because the level of detergency and additives in gasoline vary in the market, Honda endorses the use of “TOP TIER Detergent Gasoline” where available to help maintain the performance and reliability of your vehicle. TOP TIER Detergent Gasoline meets a new gasoline standard jointly established by leading automotive manufacturers to meet the needs of today’s advanced engines.

Qualifying gasoline retailers will, in most cases, identify their gasoline as having met “TOP TIER Detergent Gasoline” standards at the retail location. This fuel is guaranteed to contain the proper level of detergent additives and be free of metallic additives. The proper level of detergent additives, and absence of harmful metallic additives in gasoline, help avoid build-up of deposits in your engine and emission control system.

For further important fuel-related information for your vehicle, or on information on gasoline that does not contain MMT, visit www.hondacars.com. In Canada, visit www.honda.ca for additional information on gasoline. For more information on top tier gasoline, visit www.toptiergas.com.

■ Fuel tank capacity: 7.0 US gal (26.5 liters)

⌘ Fuel Information

NOTICE

We recommend quality gasoline containing detergent additives that help prevent fuel system and engine deposits. In addition, in order to maintain good performance, fuel economy, and emissions control, we strongly recommend the use of gasoline that does NOT contain harmful manganese-based fuel additives such as MMT, if such gasoline is available.

Use of gasoline with these additives may adversely affect performance, and cause the malfunction indicator lamp on your instrument panel to come on. If this happens, contact an authorized Honda Clarity Plug-In Hybrid dealer for service.

Some gasoline today is blended with oxygenates such as ethanol. Your vehicle is designed to operate on oxygenated gasoline containing up to 15% ethanol by volume. Do not use gasoline containing methanol. If you notice any undesirable operating symptoms, try another service station or switch to another brand of gasoline.

How to Refuel

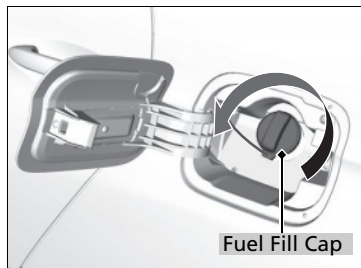
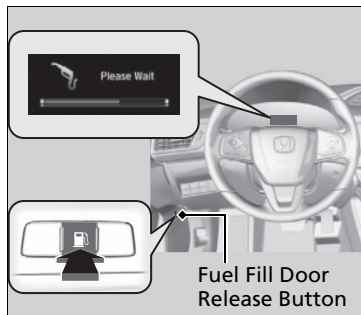

1. Stop your vehicle with the service station pump on the left side of the vehicle in the rear.
2. Put the transmission into **P**.
3. Turn the power system off.
4. Press the fuel fill door release button.
 - ▶ **Please Wait** appears for a few seconds on the driver information interface.
5. When the message changes to **Ready**, the fuel fill door automatically opens.
 - ▶ You can now unscrew the fuel cap and start refueling.
6. Remove the fuel fill cap slowly. If you hear a release of air, wait until this stops, then turn the knob slowly to open the fuel fill cap.

How to Refuel

⚠ WARNING

Gasoline is highly flammable and explosive. You can be burned or seriously injured when handling fuel.

- Stop the engine, and keep heat, sparks, and flame away.
- Handle fuel only outdoors.
- Wipe up spills immediately.

This vehicle has a pressurized fuel system. When the fuel vapor pressure inside the fuel tank is high, it takes about 10 seconds for the vehicle to vent the fuel tank. Once the pressure is vented, the driver information interface changes from **Please Wait** to **Ready**.

If the filler nozzle keeps turning off when the tank is not full, there may be a problem with the pump's fuel vapor recovery system. Try filling at another pump. If this does not fix the problem, consult an authorized Honda Clarity Plug-In Hybrid dealer.

Do not continue to add fuel after the filler nozzle has automatically stopped. Additional fuel can exceed the full tank capacity.

The filler nozzle automatically stops to leave space in the fuel tank so that fuel does not overflow as a result of changes in air temperature.

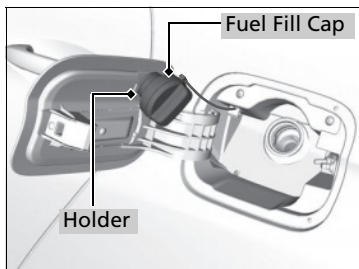

7. Place the fuel fill cap in the holder.
8. Insert the fuel filler nozzle fully.
 - ▶ When the tank is full, the filler nozzle will click off automatically. This leaves space in the fuel tank in case the fuel expands with a change in the temperature.
9. After filling, replace the fuel fill cap, tightening it until you hear it click at least once.
 - ▶ Shut the fuel fill door by hand.

▶▶ How to Refuel

If the fuel fill door does not open after you press the button, even after the display changes to **Ready**, you can manually open the door.

▶ **When You Cannot Unlock the Fuel Fill Door** P. 562

An internal valve automatically closes after 30 minutes from the moment you press the fuel fill door release button. When it does, do not continue to refuel as fuel may spill out.

When the fuel fill door automatically opens, a vent valve in the fuel system also opens to allow the air and the vapors being displaced by the fuel to escape. This valve automatically closes, however, if the refueling is not completed within 30 minutes. If this happens, reinstall the fuel cap, close the fuel fill door, and then follow these steps again to restart the system. If you decide to add fuel after the vent valve has automatically closed (i.e. after 30 minutes), do so very slowly. Trying to add fuel too rapidly after the vent valve has closed will cause fuel vapors to be pushed out the filler pipe and could cause a small amount of liquid fuel to be spilled onto the ground.

Before Charging

Check the following items before you start charging your vehicle.

Safety Checklist

- Make sure to use a dedicated and properly grounded circuit, that is rated for at least 15 amps.
 - ▶ Have an electrician inspect the outlet you are using to see if it meets these criteria.
- Make sure you plug the charging cable directly into the wall outlet dedicated to vehicle charging.
 - ▶ Do not use extension cords, adaptors, or multi-outlet plugs between the charging cable and the outlet.
- Make sure the charging cable is fully uncoiled before use.
- Make sure the control box, charging connector, and charging cable are free from any damage, including cracks or frays.
 - ▶ If you find any damage to the devices, contact an authorized Honda Clarity Plug-In Hybrid dealer.
- Make sure the charging connector and inlet are clean.
 - ▶ If you find any contamination or foreign object in the connector or inlet, contact an authorized Honda Clarity Plug-In Hybrid dealer.
- Make sure the charging cable is dry.
 - ▶ Check that there is no water in the immediate area, and that your hands are dry.

Note: Outlet needs to be in good shape. Worn or damaged outlet will not make good contact with the plug. Ensure that the plug is fully inserted and does not come out of the outlet after installation. A loose connection will cause excessive heat build up within the plug and damage it.

Charging

WARNING

Using a 120 volt wall outlet that is rated less than 15 amps or one that is powering other devices can cause a fire, seriously injuring you or others.

When using the 120 volt charger, use a dedicated and properly grounded circuit rated 15 amps or more. Consult an electrician if you are not sure.

Charge the High Voltage battery using a Level 1 or 2 charger

There are two ways to charge the High Voltage battery; by using the Level 1 120 volt (15 amp) charger supplied with the vehicle plugged into a standard three-prong wall outlet, or by using a professionally installed Level 2 240 volt (32 amp) charger.

Charging with	Suggested full charging time
AC 240 V (Level 2)	2.5 hours* ¹
AC 120 V (Level 1)	12 hours* ¹

* 1: Charging time varies depending on conditions, such as the remaining battery level and the ambient temperature.

The suggested full charging time in this table indicates the hours it may likely take for the High Voltage battery to be fully charged.

⚡ Charging

⚠ WARNING

Improper usage and handling of the 120 volt charger can cause a fire, seriously injuring you or others.

- Always insert the plug fully into a properly rated and grounded the wall outlet.
- Plug the charging cable directly to the wall outlet. Do not use extension cords or multi-plug adapters.
- Prevent the vehicle charging connector from becoming contaminated. Clean if necessary.

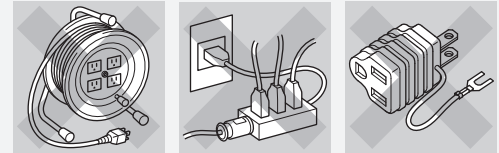

Canadian models

When the battery warming system is activated, the battery may take longer to charge.

When the 12-volt battery is disconnected, vehicle charging is not possible. After reconnecting the battery, turn the power system on, then turn it off. Confirm that charging is possible.

➤ **Turning on the Power** P. 376

Continued

■ How to Charge (Level 1)

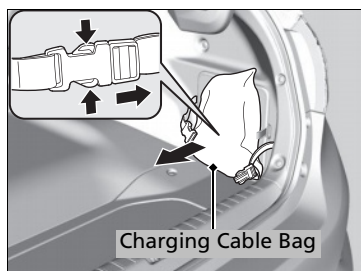
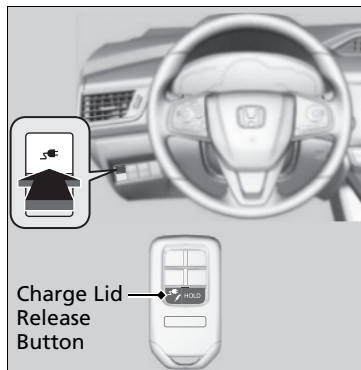

1. Put the transmission into **P** and set the power mode to OFF.
 - ▶ The lid opens.
 - ▶ The illumination lamp inside the charge lid comes on for a few minutes.
2. Press and hold the lid open button on the remote transmitter, or press and hold the charge lid release button on the dashboard.
3. Open the trunk, and remove the bag.
4. Open the bag, and take the charging cable out.
 - ▶ Do not tie or coil the cable when in use.

⚡ Charging

⚠ WARNING

Charging the High Voltage battery under the following conditions is a potential source of electric shock and fire, which can result in serious injury or death:

- Charging the battery during an electric storm.
- Using the charging cable near water or handling with wet hands.
- Using a charger, whose case is broken or cracked or whose cable is frayed or damaged.

Never charge the vehicle in any of the above situations.

⚠ WARNING

Using a charger that is damaged or modified can cause electrical shock and fire, which can result in serious injury or death.

Never disassemble or modify the charger. If the charger becomes damaged, stop using it and consult an authorized Honda Clarity Plug-In Hybrid dealer.

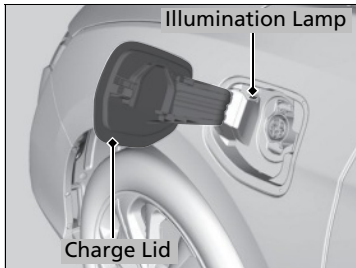

5. Open the vehicle's charge lid.

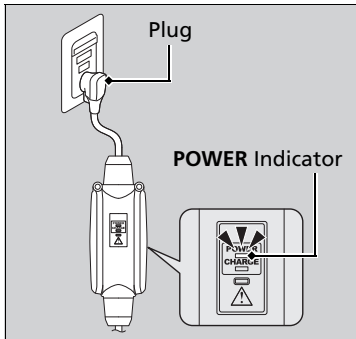

6. Insert the plug into a 120 volt wall outlet.
 ▶ Insert the plug completely until it stops.
7. Check that the **POWER** indicator on the control box comes on.

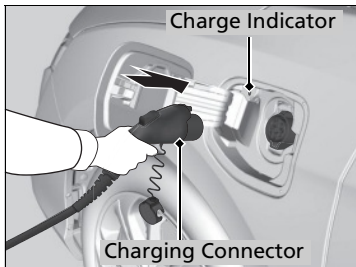

8. Remove the cover from the charging connector. Align and insert the charging connector into the vehicle's inlet until you hear a click.
 ▶ The charge indicator stops blinking, and stays on when charging starts.

⌘ Charging

NOTICE

Do not charge the vehicle with a vehicle cover on. It can cause a malfunction and damage the vehicle or charging components.

The 120 volt charger requires a properly grounded and dedicated 15 amp or greater circuit. For more information consult an authorized Honda Clarity Plug-In Hybrid dealer.

We recommend that a GFCI (ground-fault circuit interrupter) protected outlet be used to charge the vehicle. Follow the GFCI maker's installation instructions, or consult an electrician if you are not sure about installation requirements.

Inspect the charging cable plug and charging connector, as well as the vehicle's charge inlet, before use. If the plug or connector are dirty or otherwise contaminated, carefully clean them with a dry clean cloth before use. Do not wipe the metal part of the inlet and the charging connector. Also, if you are unable to clean the plug or connector, if the inlet is dirty, or if any are damaged or corroded, take the charging cable and vehicle to an authorized Honda Clarity Plug-In Hybrid dealer for inspection and possible repair.

Continued

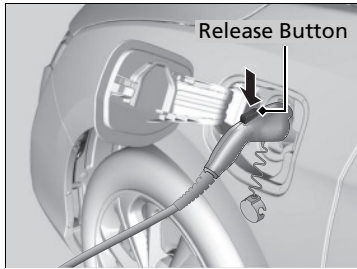

■ **When charging is completed**

Press the release button on the charging connector to disengage it from the inlet.

The charge indicator goes off once charging is completed.

⌘ **Charging**

Before using a vehicle charging cable, inspect the cable for damage such as scratches, cracks, or tears. If you find any damage, do not use the charging cable; instead, take it to an authorized Honda Clarity Plug-In Hybrid dealer for inspection.

If a blackout or other electrical interruption occurs during vehicle charging, the vehicle will automatically resume charging once power is restored.

If available, use a 240 V AC level 2 charger. Using a level 2 charger takes less time than using a level 1 120 V AC charger.

If the ambient air is cold enough to lower the High Voltage battery temperature below -22F° (-30°C), charging may not start.

How to Charge (Level 2)

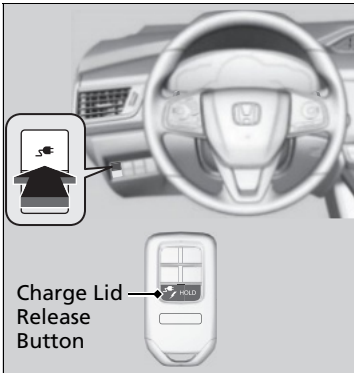

1. Stop your vehicle at a station specified for electric vehicles. Park with the charge lid closest to the charge plug, just in front of the driver's door.
 2. Put the transmission into **P**.
 3. Turn off the power system.
 4. Press and hold the charge lid release button.
 - ▶ The lid opens.
- The illumination lamp inside the charge lid comes on for a few minutes.

⊠ Charge the High Voltage battery using a Level 1 or 2 charger

The High Voltage battery may not be charged even if the charging connector is properly connected to the vehicle's inlet when the charging timer is set but the timer has not yet started.

To avoid damage to the charger, take these precautions:

- Do not hit the charging connector components with a hard object or drop them on the ground.
- Do not pull, twist, tangle, drag or step on the charging cable.
- Do not use or store near any sources of heat.
- Do not expose to liquids or use harsh chemicals to clean.

If you unplug the charging connector from the inlet, charging cancels automatically.

The charge speed slows down towards the completion of the battery charging. When the High Voltage battery temperature is low, the charge speed may slow or it may not be fully charged.

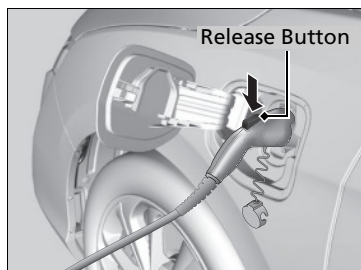
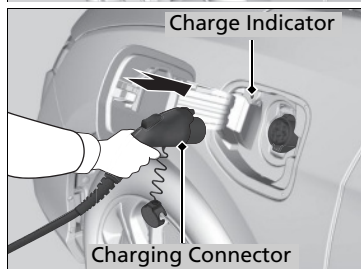
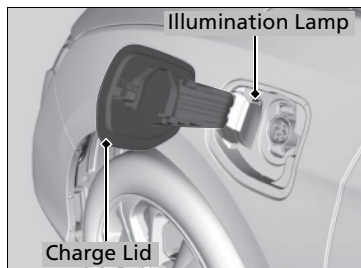

5. Open the vehicle's charge lid.

6. To connect the cable to the vehicle, push the cable's charging connector until it clicks to the charge lid.

- ▶ The charge indicator on the charge lid stays on.

■ **When charging is completed**

Press the release button on the charging connector to disengage it from the inlet.

The charge indicator goes off once charging is completed.

⌘ **How to Charge (Level 2)**

The charge lid can be opened by remote transmitter.

The High Voltage battery may not be charged even if the charge connector is properly connected to the vehicle's inlet when the charging timer is set but the timer has not yet started.

Be sure to follow the instructions and safety precautions provided with the Level 2 charging equipment.

Control Box

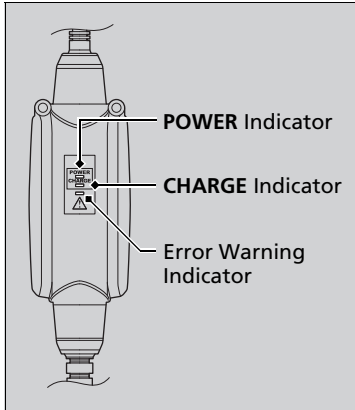

Vehicle Status	Control Box LED Status Indicator			Charge Indicator	Explanatory notes ● Goes off ○ Stays on ☉ Blinking
	POWER	CHARGE	⚠ (Error Warning)		
Initializing	○	●	●	●	Initial processing
Stand by	○	●	●	☉ Slowly	Ready and waiting for the timer
Charge	○	○	●	○	Comes on during charge.
Completion	○	●	●	●	Charge end

Vehicle Status	Control Box LED Status Indicator			Charge Indicator	Explanatory notes ● Goes off ○ Stays on ☼ Blinking
	POWER	CHARGE	⚠ (Error Warning)		
Plug temperature rise detected	☼	● or ☼	●	○	<p>A rise in plug temperature due to bad electrical contact between the outlet and the plug was detected. Check the connection between the outlet and the plug.</p> <ul style="list-style-type: none"> Charging is carried out with a limited charging current.
Fault	Except above lighting patterns			○ or ● or ☼	<p>There could be a problem with the electric supply or an internal failure. Contact an authorized Honda Clarity Plug-In Hybrid dealer. You don't have to charge before contacting the dealer.</p>

■ What to do when you cannot start charging

If charging does not start, even if the **POWER** indicator comes on, and the charging connector is plugged in, perform one of the following solutions.

Cause	Solution
<p>The timer has been set, but the start time is in the future.</p>	<p>Start charging using the smart entry remote. Press and hold the charge lid release button on the smart entry remote.</p> <ul style="list-style-type: none"> ▶ The charge indicator on the charge lid comes on when charging starts. <p>Change the customized setting of the charge timer to OFF using the driver information interface.</p> <ul style="list-style-type: none"> ▶ The timer setting will be canceled. ☒ Using a Timer P. 467
<p>The 12-volt battery is weak.</p>	<p>Check the 12-volt battery condition. If necessary, charge the battery.</p>
<p>The power mode is ON.</p>	<p>Set the power mode to ACCESSORY or VEHICLE OFF (LOCK).</p>
<p>The charging connector is not properly attached to the vehicle's inlet.</p>	<p>Disengage the connector from the inlet. Align and insert the connector into the inlet until you hear a click.</p>

Note: The charging equipment provided with this vehicle has been tested and found to comply with the limits for a Class B digital device, pursuant to part 15 of the FCC Rules.

These limits are designed to provide reasonable protection against harmful interference in a residential installation.

This equipment generates, uses and can radiate radio frequency energy and, if not installed and used in accordance with the instructions, may cause harmful interference to radio communications.

However, there is no guarantee that interference will not occur in a particular installation.

If this equipment does cause harmful interference to radio or television reception, which can be determined by turning the equipment off and on, the user is encouraged to try to correct the interference by one or more of the following measures:

- Reorient or relocate the receiving antenna.
- Increase the separation between the equipment and receiver.
- Connect the equipment into an outlet on a circuit different from that to which the receiver is connected.
- Consult the dealer or an experienced radio/TV technician for help.

■ Charge Indicator on the Vehicle Side

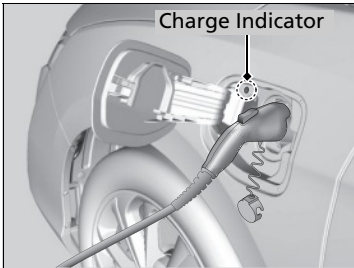

Shows the High Voltage battery charging status.

If it blinks for a while, then stays on after the charge connector is plugged in, it indicates that the battery is being charged.

Indicator status	Explanation
Blinks slowly	<ul style="list-style-type: none"> • The charger is ready to charge the battery. • Charging is programmed to start using the timer. <ul style="list-style-type: none"> ▶ The indicator goes off after about 15 seconds. • The power mode is set to ON while the battery is being charged.
Stays on	<ul style="list-style-type: none"> • The battery is being charged.
Goes off	<ul style="list-style-type: none"> • Charging is complete.
Canadian models Blinks once after staying on for a few seconds.	<ul style="list-style-type: none"> • The battery has been fully charged and the battery heating system has been activated.
Blinks rapidly	<ul style="list-style-type: none"> • When the 12-volt battery is disconnected. <ul style="list-style-type: none"> ▶ After reconnecting the battery, turn the power system on, then turn it off. The charging connector is replugged in. Confirm that charging is possible. • There is a problem with the charging system. <ul style="list-style-type: none"> ▶ The indicator goes off after 15 seconds. Charging does not start.

High Voltage Battery

The High Voltage battery gradually discharges even if the vehicle is not in use. As a result, if your vehicle is parked for an extended period of time, the battery level may get low. Keeping your vehicle's battery level low can shorten the battery life. To maintain the battery while the vehicle is not in use, recharge the battery at least once every three months.

The High Voltage battery life can also be affected by ambient temperature. In particular, when it is cold outside, the vehicle's driving range on electric power can be reduced, and a longer battery charging time is required. In addition, parking in extremely hot or cold environments can accelerate battery drain.

To help extend the lifespan of the battery, it is recommended that you fully charge the battery each time prior to driving.

U.S. models

Store the vehicle in a garage to insure that the temperature of the High Voltage battery does not drop too low.

Canadian models

■ Battery Warming System

Designed to prevent the temperature of the battery from dropping when outside temperatures drop, thereby maintaining starting and running efficiency.

If the vehicle is plugged in when outside temperatures are low, the battery warming system will use the power from the charging equipment to maintain the temperature of the battery until the next time the vehicle is driven.

⌘ High Voltage Battery

The High Voltage battery drains over time, and under some conditions, drains faster. When the battery life is shortened, this changes the vehicle's driving distance.

Be careful not to let the High Voltage battery drain too much. If the battery level becomes close to zero, it will make it impossible to start the engine.

⌘ Battery Warming System

If the vehicle is left unplugged in cold temperatures, the temperature of the battery will drop, possibly resulting in a loss of running efficiency. If left for an extended period of time in extremely cold temperatures, the vehicle may not start. We recommend that you plug in your vehicle when you are parking or storing your vehicle in cold temperatures.



Using a Timer

You can set the timer for the High Voltage battery charge using the driver information interface's customization feature.

The vehicle automatically begins charging at the scheduled time when the charging connector is connected to the vehicle.

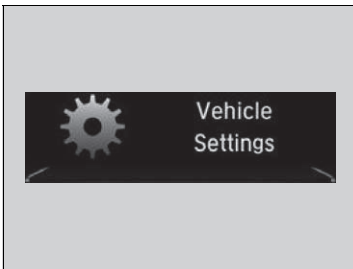
Driver Information Interface



1. Press the  (display/information) button and press  or  until **Vehicle Settings** appears on the display, then press the **ENTER** button.

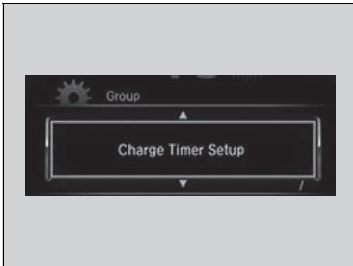

2. Select **Charge Timer Setup**, then press the **ENTER** button.

Using a Timer

Canadian models

When the battery warming system is activated, it may not sufficiently charge within the charging period that you have set.

Driver Information Interface

Timer: Select **ON** or **OFF**.

Mode: When **Timer** is **ON**, select the charging mode, **Full** or **Time**.

Full: Charging will continue until the battery is fully charged.

Time: The battery will be charged between the time you have designated to start and end.

Start: Set the time when to start the High Voltage battery charge.

End: Set the time when to end the High Voltage battery charging. You cannot set this when the **Full** mode is selected.

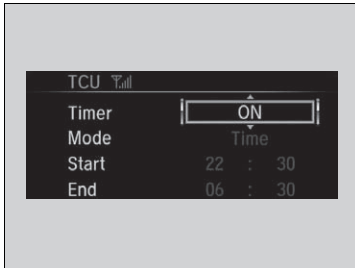

3. Press the **ENTER** button to select the item you want to set.
4. Press the / button to select when to start and end the charging, and the charging mode.
5. Press the **ENTER** button again.

Improving Fuel Economy and Reducing CO₂ Emissions

Achieving fuel economy and reducing CO₂ emissions is dependent on several factors, including driving conditions, load weight, idling time, driving habits, and vehicle condition. Depending on these and other factors, you may not achieve the rated fuel economy of this vehicle.

Maintenance and Fuel Economy

You can optimize your fuel economy with proper maintenance of your vehicle. Always maintain your vehicle in accordance with the messages displayed on the driver information interface.

- Use the recommended viscosity engine oil, displaying the API Certification Seal.
- Maintain the specified tire pressure.
- Do not load the vehicle with excess cargo.
- Keep your vehicle clean. A buildup of snow or mud on your vehicle's underside adds weight and increases wind resistance.

Improving Fuel Economy and Reducing CO₂ Emissions

Direct calculation is the recommended method to determine actual fuel consumed while driving.



In Canada, posted fuel economy numbers are established following a simulated test. For more information on how this test is performed, please visit <http://oee.nrcan.gc.ca/>

Maintenance

This chapter discusses basic maintenance.



Before Performing Maintenance

Inspection and Maintenance	472
Safety When Performing Maintenance...	473
Parts and Fluids Used in Maintenance	
Service	474

Maintenance Minder™

475

Maintenance Under the Hood

Maintenance Items Under the Hood..	480
Opening the Hood	481
Recommended Engine Oil	482
Oil Check	483
Adding Engine Oil	484
Changing the Engine Oil and Oil Filter...	485

Engine Coolant	488
Cooling System	490
Transmission Fluid	492
Brake Fluid	492
Refilling Window Washer Fluid	493
Replacing Light Bulbs	494

Checking and Maintaining Wiper

Blades	496
--------------	-----

Checking and Maintaining Tires

Checking Tires	499
Tire and Loading Information Label ..	500
Tire Labeling	500
DOT Tire Quality Grading (U.S. Vehicles)..	502

Wear Indicators	504
Tire Service Life	504
Tire and Wheel Replacement	505
Tire Rotation	506
Winter Tires	507
12-Volt Battery	508

Remote Transmitter Care

Replacing the Button Battery	510
------------------------------------	-----

Climate Control System Maintenance ..

511

Cleaning

Interior Care	513
Exterior Care	515

Accessories and Modifications

519

Inspection and Maintenance

For your safety, perform all listed inspections and maintenance to keep your vehicle in good condition. If you become aware of any abnormality (noise, smell, insufficient brake fluid, oil residue on the ground, etc.), have your vehicle inspected by an authorized Honda Clarity Plug-In Hybrid dealer. (Note, however, that service at an authorized Honda Clarity Plug-In Hybrid dealer is not mandatory to keep your warranties in effect.)

Types of Inspection and Maintenance

■ Daily inspections

Perform inspections before long distance trips, when washing the vehicle, or when refueling.

■ Periodic inspections

- Check the brake fluid level monthly.
 - **Brake Fluid** P. 492
- Check the tire pressure monthly. Examine the tread for wear and foreign objects.
 - **Checking and Maintaining Tires** P. 499
- Check the operation of the exterior lights monthly.
 - **Replacing Light Bulbs** P. 494
- Check the condition of the wiper blades at least every six months.
 - **Checking and Maintaining Wiper Blades** P. 496

Inspection and Maintenance

U.S. models

Maintenance, replacement, or repair of emissions control devices and systems may be done by any automotive repair establishment or individuals using parts that are “certified” to EPA standards.

According to state and federal regulations, failure to perform maintenance on the maintenance main items marked with # will not void your emissions warranties. However, all maintenance services should be performed in accordance with the intervals indicated by the driver information interface.

➤ **Maintenance Service Items** P. 477

If you want to perform complex maintenance tasks that require more skills and tools, you can purchase a subscription to the Service Express website at www.techinfo.honda.com.

➤ **Authorized Manuals** P. 576

If you want to perform maintenance yourself, make sure that you have the necessary tools and skills first. After performing maintenance, update the records in the separate maintenance booklet.

Safety When Performing Maintenance

Some of the most important safety precautions are given here. However, we cannot warn you of every conceivable hazard that can arise in performing maintenance. Only you can decide whether you should perform a given task.

Maintenance Safety

- To reduce the possibility of fire or explosion, keep cigarettes, sparks, and flames away from the 12-volt battery, all High Voltage system, and all fuel related parts.
- Never leave rags, towels, or other flammable objects under the hood.
 - ▶ Heat from the engine and exhaust can ignite them, causing a fire.
- To clean parts, use a commercially available degreaser or parts cleaner, not gasoline.
- Wear eye protection and protective clothing when working with the 12-volt battery or compressed air.
- Engine exhaust contains carbon monoxide, which is poisonous and can kill you.
 - ▶ Only operate the engine if there is sufficient ventilation.

ⓘ Safety When Performing Maintenance

WARNING

Improperly maintaining this vehicle or failing to correct a problem before driving can cause a crash in which you can be seriously hurt or killed.

Always follow the inspection and maintenance recommendations according to the schedules in this owner's manual.

WARNING

Failure to properly follow maintenance instructions and precautions can cause you to be seriously hurt or killed.

Always follow the procedures and precautions in this owner's manual.

Continued

■ Vehicle Safety

- The vehicle must be in a stationary condition.
 - ▶ Make sure your vehicle is parked on level ground, the parking brake is set, and the power system is turned off.
- Be aware that hot parts can burn you.
 - ▶ Make sure to let the power system including the engine and exhaust system cool thoroughly before touching vehicle parts.
- Be aware that moving parts can injure you.
 - ▶ Do not activate the power system unless instructed, and keep your hands and limbs away from moving parts. When the power mode is on, the engine can automatically start, or the radiator fan may start operating without the engine running.



Parts and Fluids Used in Maintenance Service

The use of Honda genuine parts and fluids is recommended when maintaining and servicing your vehicle. Honda genuine parts are manufactured according to the same high quality standards used in Honda vehicles.

If the vehicle has maintenance items due within 30 days, you will see the Maintenance Minder messages appear on the driver information interface every time you set the power mode to ON. The messages notify you when to bring your vehicle to an authorized Honda Clarity Plug-In Hybrid dealer for indicated maintenance services.

To Use Maintenance Minder™

■ Displaying the Maintenance Minder Information

1. Set the power mode to ON.
2. Press the  (display/ information) button.
3. Press the  button to select the , and press the **ENTER** button.

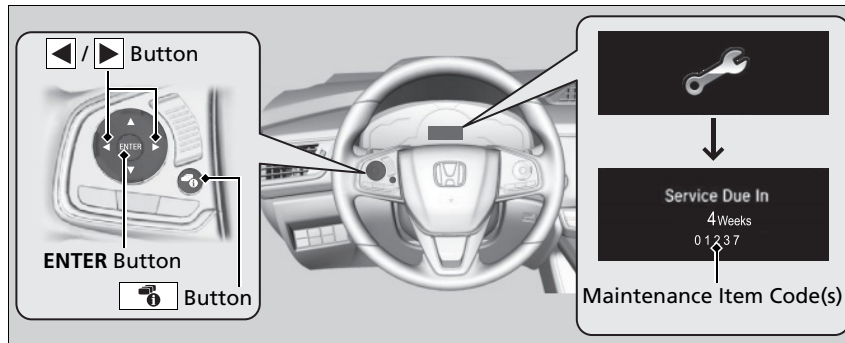







▣ Displaying the Maintenance Minder Information

Based on the engine operating conditions and engine oil conditions, the system calculates the remaining days before the next service is to be performed.

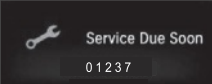
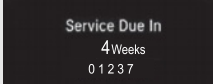
There is a list of maintenance main and sub items you can view on the driver information interface.

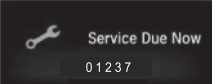
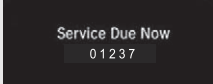
▣ **Maintenance Service Items** P. 477

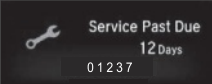
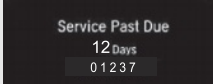
Warning Message and Maintenance Minder Information on the Driver Information Interface

Warning Message	Maintenance Minder Information	Explanation	Information
<p>Service Due Soon</p> 		<p>One or more of the service items are required in less than 30 days. Press the  button to switch to another display.</p>	<p>The remaining days will be counted down per day.</p>
<p>Service Due Now</p> 		<p>One or more of the service items are required in less than 10 days. Press the  button to switch to another display.</p>	<p>Have the indicated service performed as soon as possible.</p>
<p>Service Past Due</p> 		<p>The indicated maintenance service is still not done after the remaining time reaches 0. Press the  button to switch to another display.</p>	<p>Your vehicle has passed the service required point. Immediately have the service performed and make sure to reset the Maintenance Minder™.</p>

The system message indicator (i) comes on along with the Maintenance Minder message.

Maintenance Service Items

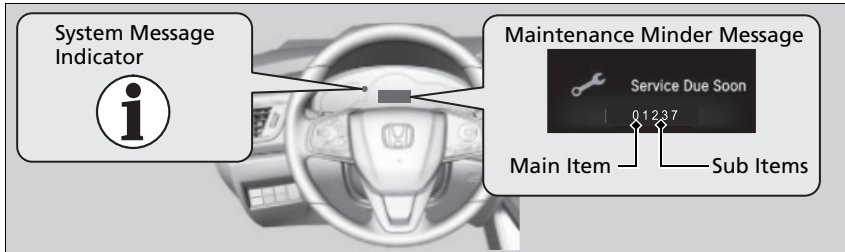

Maintenance Service Items

- Adjust the valves during services A, 0, 1, 2, or 3 if they are noisy.

U.S. models

CODE	Maintenance Main Items
A	<ul style="list-style-type: none"> • Replace engine oil*¹ and oil filter
0	<ul style="list-style-type: none"> • Inspect front and rear brakes • Check expiration date for Temporary Tire Repair Kit • Inspect these items: <ul style="list-style-type: none"> • Tie rod ends, steering gearbox, and boots • Suspension components • Driveshaft boots • Brake hoses and lines (including ABS/VSA) • All fluid levels and condition of fluids • Exhaust system[#] • Fuel lines and connections[#] • Stay RR, RR Subframe • Under body battery cover

*1: If a Maintenance Minder message does not appear more than 12 months after the display is reset, change the engine oil every year.

#: See information on maintenance and emissions warranty.

CODE	Maintenance Sub Items
1	<ul style="list-style-type: none"> • Rotate tires
2	<ul style="list-style-type: none"> • Replace dust and pollen filter*²
3	<ul style="list-style-type: none"> • Replace transmission fluid*³
4	<ul style="list-style-type: none"> • Replace spark plugs • Inspect valve clearance
5	<ul style="list-style-type: none"> • Replace engine coolant
7	<ul style="list-style-type: none"> • Replace brake fluid*⁴
8	<ul style="list-style-type: none"> • Replace air cleaner element*⁵

*2: If you drive primarily in urban areas that have high concentrations of soot in the air from industry and from diesel-powered vehicles, replace the dust and pollen filter every 15,000 miles (24,000 km).

*3: Driving in mountainous areas at very low vehicle speeds results in higher transmission temperatures. This requires transmission fluid changes more frequently than recommended by the Maintenance Minder. If you regularly drive your vehicle under these conditions, have the transmission fluid changed every 47,500 miles (75,000 km) or 3 years.

*4: If a Maintenance Minder message does not appear more than 36 months after the display for item 7 is reset, change the brake fluid every 3 years.

*5: If you drive in dusty conditions, replace the air cleaner element every 15,000 miles (24,000 km).

Continued

Canadian models

» Maintenance Service Items

- Adjust the valves during services A, 9, 1, 2, or 3 if they are noisy.

CODE	Maintenance Main Items
A	• Replace engine oil* ¹ and oil filter

- *1: If a Maintenance Minder message does not appear more than 12 months after the display is reset, change the engine oil every year.
- *2: If you drive primarily in urban areas that have high concentrations of soot in the air from industry and from diesel-powered vehicles, replace the dust and pollen filter every 24,000 km (15,000 miles).
- *3: Driving in mountainous areas at very low vehicle speeds results in higher transmission temperatures. This requires transmission fluid changes more frequently than recommended by the Maintenance Minder. If you regularly drive your vehicle under these conditions, have the transmission fluid changed every 75,000 km (47,500 miles) or 3 years.
- *4: If a Maintenance Minder message does not appear more than 36 months after the display for item 7 is reset, change the brake fluid every 3 years.
- *5: If you drive in dusty conditions, replace the air cleaner element every 24,000 km (15,000 miles).
- # : See information on maintenance and emissions warranty.

CODE	Maintenance Sub Items
1	• Rotate tires
2	• Replace dust and pollen filter* ²
3	• Replace transmission fluid* ³
4	• Replace spark plugs • Inspect valve clearance
5	• Replace engine coolant
7	• Replace brake fluid* ⁴
8	• Replace air cleaner element* ⁵
9	• Service front and rear brakes • Check expiration date for Temporary Tire Repair Kit • Inspect these items: <ul style="list-style-type: none"> • Tie rod ends, steering gearbox, and boots • Suspension components • Driveshaft boots • Brake hoses and lines (including ABS/VSA) • All fluid levels and condition of fluids • Exhaust system# • Fuel lines and connections# • Stay RR, RR Subframe • Under body battery cover

Resetting the Display

Reset the maintenance minder information display if you have performed the maintenance service.

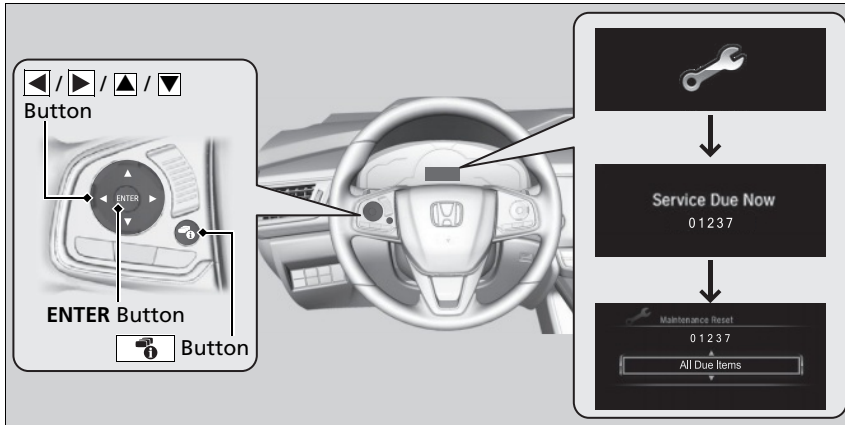

1. Set the power mode to ON.
2. Press the (display/information) button.
3. Press the button to select the icon, and press the **ENTER** button.
4. Press and hold the **ENTER** button for about 10 seconds to enter the reset mode.
5. Press to select a maintenance item to reset, or to select **All Due Items** (You can also select **Cancel** to end the process).
6. Press the **ENTER** button to reset the selected item.
7. Repeat from step 4 for other items you wish to reset.

Resetting the Display

NOTICE

Failure to reset the Maintenance Minder™ display after a maintenance service results in the system showing incorrect maintenance intervals, which can lead to serious mechanical problems.

The authorized Honda Clarity Plug-In Hybrid dealer will reset the Maintenance Minder™ display after completing the required maintenance service. If someone other than an authorized Honda Clarity Plug-In Hybrid dealer performs maintenance service, reset the Maintenance Minder™ display yourself.

You can reset the Maintenance Minder™ display using the audio/information screen.

▶ **Customized Features P. 306**

Maintenance Items Under the Hood

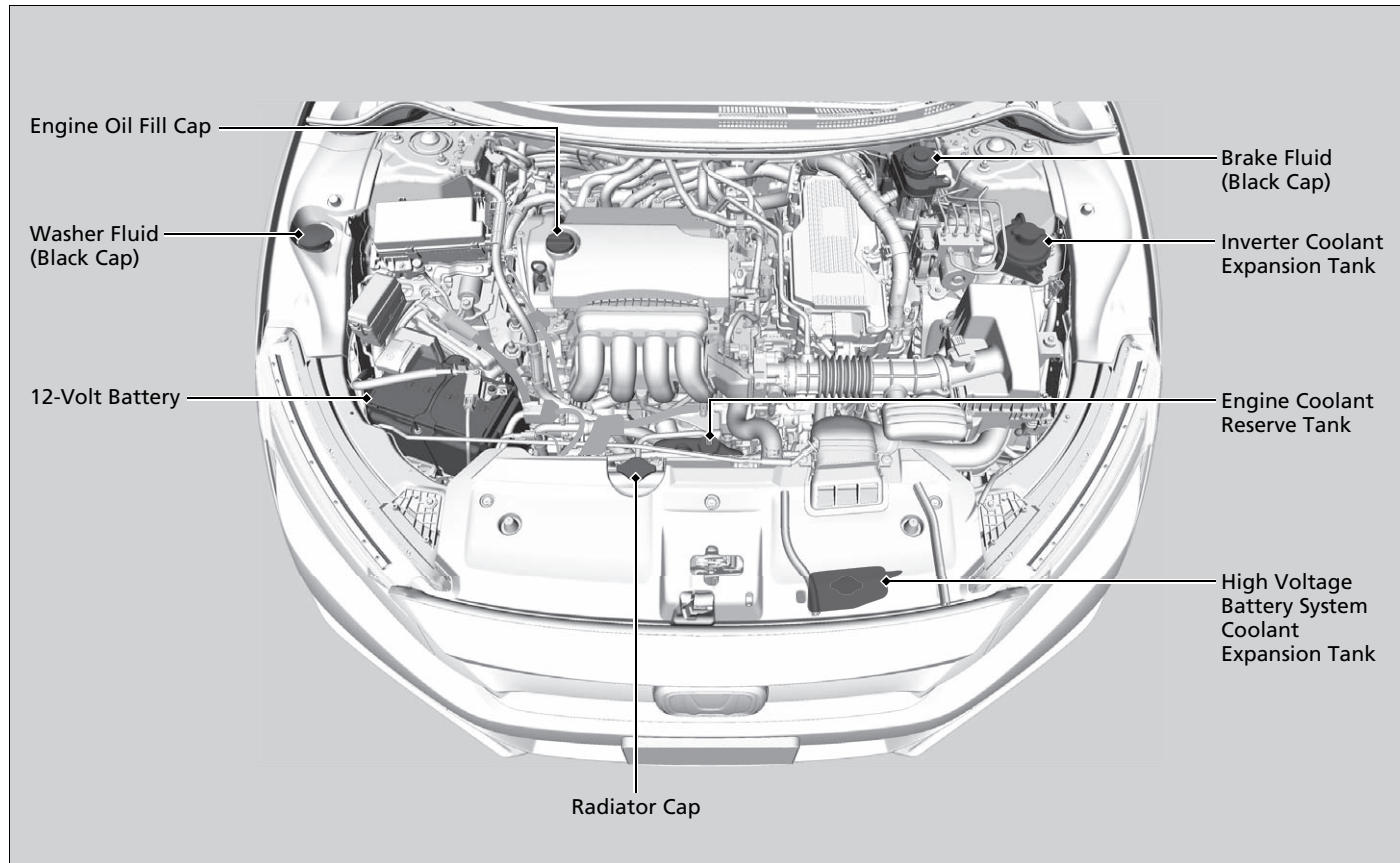

Opening the Hood

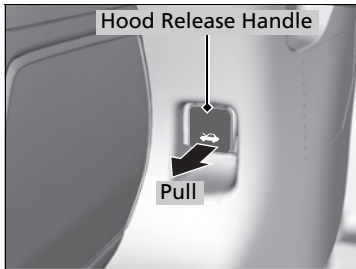

1. Park the vehicle on a level surface, and set the parking brake.
2. Pull the hood release handle under the driver's side lower corner of the dashboard.
 - The hood will pop up slightly.

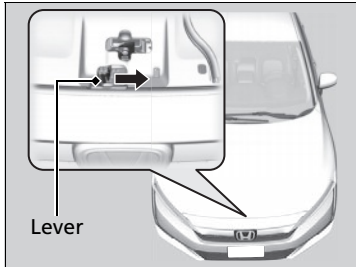

3. Push the hood latch lever (located under the front edge of the hood to the center) to the side and raise the hood. Once you have raised the hood slightly, you can release the lever.

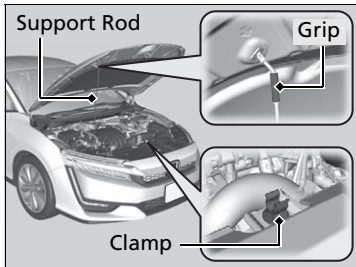

4. Remove the support rod from the clamp using the grip. Mount the support rod in the hood.

When closing, remove the support rod, and stow it in the clamp, then gently lower the hood. Remove your hand at a height of approximately 12 inches (30 cm) and let the hood close.

Opening the Hood

NOTICE

Do not open the hood when the wiper arms are raised: The hood will strike the wipers, resulting in possible damage to the hood and/or the wipers.

When closing the hood, check that the hood is securely latched.

If the hood latch lever moves stiffly, or if you can open the hood without lifting the lever, the latch mechanism should be cleaned and lubricated.

Recommended Engine Oil

- **Genuine Honda Motor Oil**
- **Premium-grade 0W-20 detergent oil with an API Certification Seal on the container.**



Oil is a major contributor to your engine's performance and longevity. If you drive the vehicle with insufficient or deteriorated oil, the engine may fail or be damaged.

This seal indicates the oil is energy conserving and that it meets the American Petroleum Institute's latest requirements.

Use a Genuine Honda Motor Oil or another commercial engine oil of suitable viscosity for the ambient temperature as shown.

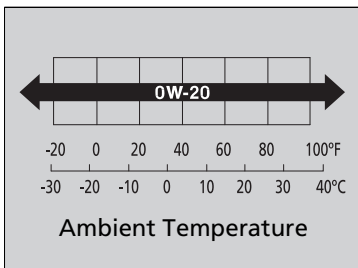

■ Synthetic oil

You may also use synthetic motor oil if it is labeled with the API Certification Seal and is the specified viscosity grade.

►► Recommended Engine Oil

Engine Oil Additives

Your vehicle does not require oil additives. In fact, they may adversely affect the engine performance and durability.

Oil Check

We recommend that you check the engine oil level every time you refuel or you charge the High Voltage battery.
Park the vehicle on level ground.

Turn off the power system. You can check the oil level without the engine having run beforehand. If the engine has been running, wait approximately three minutes before you check the oil.

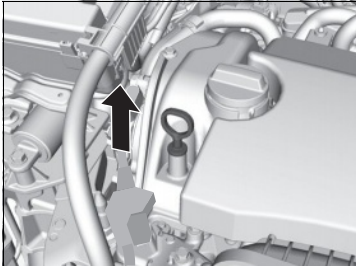

1. Remove the dipstick (orange).
2. Wipe the dipstick with a clean cloth or paper towel.
3. Insert the dipstick back all the way into its hole.
4. Remove the dipstick again, and check the level. It should be between the upper and lower marks. Add oil if necessary.

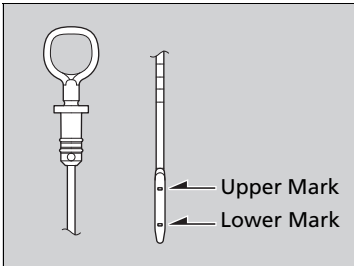

Oil Check

If the oil level is near or below the lower mark, slowly add oil, being careful not to overfill.

Adding Engine Oil

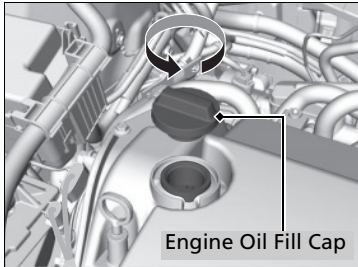

1. Unscrew and remove the engine oil fill cap.
2. Add oil slowly.
3. Reinstall the engine oil fill cap, and tighten it securely.
4. Wait for three minutes and recheck the engine oil dipstick.

► Adding Engine Oil

NOTICE

Do not fill the engine oil above the upper mark. Overfilling the engine oil can result in leaks and engine damage.

If any oil spills, wipe it away immediately. Spilled oil may damage the engine compartment components.

Changing the Engine Oil and Oil Filter

You must change the engine oil and oil filter regularly in order to maintain the engine's lubrication. The engine may be damaged if they are not changed regularly.

Turning the power system on automatically starts the engine if the High Voltage battery charge level gauge shows one segment or less.

➤ **High Voltage Battery Charge Level Gauge** P. 123

To start the engine, the vehicle needs to be in HV Charge.

➤ **HV Button** P. 16

Change the oil and filter in accordance with the maintenance message on the driver information interface.

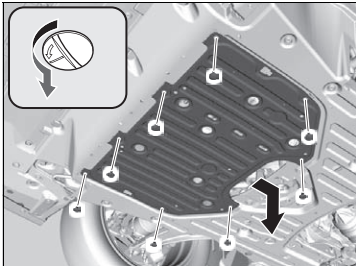

1. Run the engine until it reaches normal operating temperature, and then turn the engine off.
 - If necessary, drive the vehicle until the engine turns on.
2. Open the hood and remove the engine oil fill cap.
3. Remove the slotted head screws by turning 90° counterclockwise on the undercarriage and remove the under cover.

Changing the Engine Oil and Oil Filter

NOTICE

You may damage the environment if you do not dispose of the oil in a suitable way. If you are changing the oil by yourself, appropriately dispose of the used oil. Put the oil in a sealed container and take it to a recycling center. Do not throw the oil away into a garbage can or onto the ground.

Continued

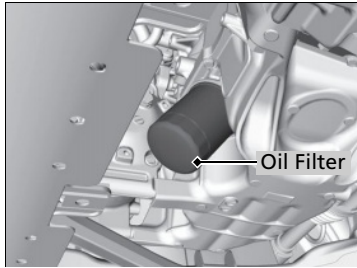
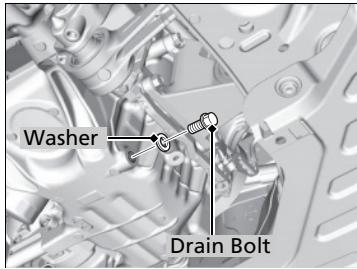

4. Remove the drain bolt and washer from the bottom of the engine, and drain the oil into a suitable container.

5. Remove the oil filter and dispose of the remaining oil.
6. Check that the filter gasket is not stuck to the engine contact surface.
 - If it is stuck, you must detach it.
7. Wipe away dirt and dust adhering to the contact surface of the engine block, and install a new oil filter.
 - Apply a light coat of new engine oil to the filter gasket.
8. Put a new washer on the drain bolt, then reinstall the drain bolt.
 - Tightening torque:
30 lbf-ft (40 N·m, 4.0 kgf·m)
9. Pour the recommended engine oil into the engine.
 - Engine oil change capacity (including filter):
3.5 US qt (3.3 L)

✎ Changing the Engine Oil and Oil Filter

You will need a special wrench to replace the oil filter. You can buy this wrench from an authorized Honda Clarity Plug-In Hybrid dealer.

When installing the new oil filter, follow the instructions supplied with the oil filter.

10. Reinstall the engine oil fill cap securely and start the engine.
11. Run the engine for a few minutes, and then check that there is no leak from the drain bolt or oil filter.
12. Stop the engine, wait for three minutes, and then check the oil level on the dipstick.
 - If necessary, add more engine oil.

✕ Changing the Engine Oil and Oil Filter

Reinstall the engine oil fill cap. Start the engine. The low oil pressure indicator should go off within five seconds. If it does not, turn off the engine, and check your work.

Engine Coolant

Specified coolant: Honda Long Life Antifreeze/Coolant Type 2

This coolant is premixed with 50% antifreeze and 50% water. Do not add any straight antifreeze or water.

We recommend you check the engine coolant level every time you refuel or you charge the High Voltage battery. Check the reserve tank first. If it is completely empty, also check the coolant level in the radiator. Add the engine coolant accordingly.

Reserve Tank

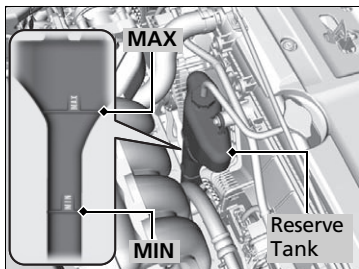

1. Make sure the engine and radiator are cool.

2. Check the amount of coolant in the reserve tank.

► If the coolant level is below the **MIN** mark, add the specified coolant until it reaches the **MAX** mark.

3. Inspect the cooling system for leaks.

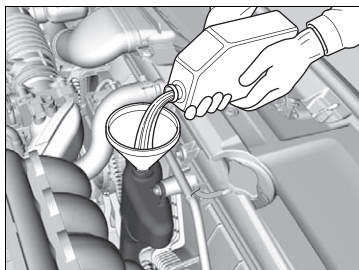

Engine Coolant

NOTICE

Genuine Honda engine coolant is a 50/50 mixture of antifreeze and water that can withstand freezing at temperatures as low as about -31°F (-35°C). If your vehicle is consistently subjected to temperatures below this, the concentration of antifreeze in the coolant should be increased. Consult an authorized Honda Clarity Plug-In Hybrid dealer for details.

If Honda antifreeze/coolant is not available, you may use another major brand of non-silicate coolant as a temporary replacement. Check that it is a high quality coolant recommended for aluminum engines. Continued use of any non-Honda coolant can result in corrosion, causing the cooling system to malfunction or fail. Have the cooling system flushed and refilled with Honda antifreeze/coolant as soon as possible.

Do not add rust inhibitors or other additives to your vehicle's cooling system. They may not be compatible with the coolant or with the engine components.

Radiator

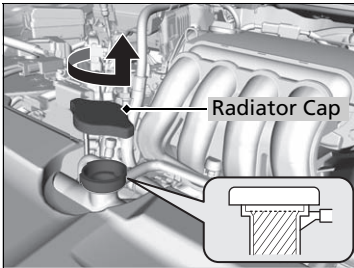

1. **Make sure the engine and radiator are cool.**
2. Turn the radiator cap 1/8 turn counter-clockwise and relieve any pressure in the cooling system.
3. Push down and turn the radiator cap counter-clockwise to remove it.
4. The coolant level should be up to the base of the filler neck. Add coolant if it is low.
5. Put the radiator cap back on, and tighten it fully.

Radiator

⚠ WARNING

Removing the radiator cap while the engine is hot can cause the coolant to spray out, seriously scalding you.

Always let the engine and radiator cool down before removing the radiator cap.

NOTICE

Pour the fluid slowly and carefully so you do not spill any. Clean up any spills immediately; they can damage components in the engine compartment.

Cooling System

Specified coolant: Honda Long Life Antifreeze/Coolant Type 2

Coolant is used to reduce the temperature of the high voltage battery and inverter coolant. When checking the coolant level, make sure to follow the procedures listed below. If the coolant level is below the **MIN** mark, have your vehicle inspected by an authorized Honda Clarity Plug-In Hybrid dealer.

Checking the Inverter Coolant Level

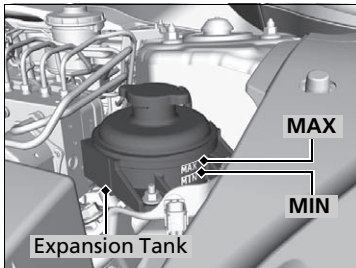

1. Check the fluid level in the tank.
2. If the coolant level has dropped below the **MIN** level, have your vehicle serviced at an authorized Honda Clarity Plug-In Hybrid dealer.
 - Only a properly trained technician can refill the coolant and check the system for leaks.

Cooling System

NOTICE

Genuine Honda engine coolant is a 50/50 mixture of antifreeze and water that can withstand freezing at temperatures as low as about -31°F (-35°C). If your vehicle is consistently subjected to temperatures below this, the concentration of antifreeze in the coolant should be increased. Consult an authorized Honda Clarity Plug-In Hybrid dealer for details.

Only use the genuine Honda coolant.

■ Checking the Coolant Level for the High Voltage Battery and Related Parts

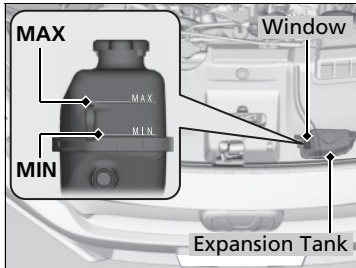

1. Check the fluid level in the tank from the window.
2. If the coolant level has dropped below the **MIN** level, have your vehicle serviced at an authorized Honda Clarity Plug-In Hybrid dealer.
 - ▶ Only a properly trained technician can refill the coolant and check the system for leaks.

Transmission Fluid

■ Transmission Fluid

Specified fluid: Honda ATF DW-1 (automatic transmission fluid)

Have an authorized Honda Clarity Plug-In Hybrid dealer check the fluid level and replace if necessary.

Do not attempt to check or change the transmission fluid yourself.

Brake Fluid

Specified fluid: Honda Heavy Duty Brake Fluid DOT 3

■ Checking the Brake Fluid

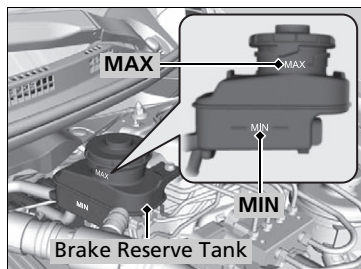

The fluid level should be between the **MIN** and **MAX** marks on the side of the reserve tank.

►► Transmission Fluid

NOTICE

Do not mix Honda ATF DW-1 with other transmission fluids.

Using a transmission fluid other than Honda ATF DW-1 may adversely affect the operation and durability of your vehicle's transmission, and damage the transmission.

Any damage caused by using a transmission fluid that is not equivalent to Honda ATF DW-1 is not covered by Honda's new vehicle limited warranty.

►► Brake Fluid

NOTICE

Brake fluid marked DOT 5 is not compatible with your vehicle's braking system and can cause extensive damage.

If the specified brake fluid is not available, you should use only DOT 3 or DOT 4 fluid from a sealed container as a temporary replacement.

Using any non-Honda brake fluid can cause corrosion and decrease the longevity of the system. Have the brake system flushed and refilled with Honda Heavy Duty Brake Fluid DOT 3 as soon as possible.

If the brake fluid level is at or below the **MIN** mark, have an authorized Honda Clarity Plug-In Hybrid dealer inspect the vehicle for leaks or worn brake pads as soon as possible.

Refilling Window Washer Fluid

Check the amount of window washer fluid using the washer fluid level gauge on the cap.

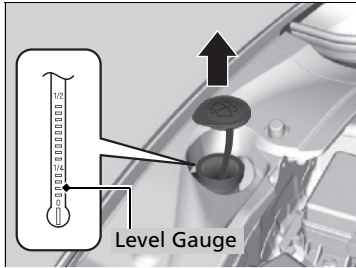

If the level is low, fill the washer reservoir.

Canadian models

If the washer fluid is low, the washer level indicator comes on.

Pour the washer fluid carefully. Do not overflow the reservoir.

Refilling Window Washer Fluid

NOTICE

Do not use engine antifreeze or a vinegar/water solution in the windshield washer reservoir. Antifreeze can damage your vehicle's paint. A vinegar/water solution can damage the windshield washer pump. Use only commercially available windshield washer fluid. Avoid prolonged use of hard water to prevent lime scale build up.

Headlights

Headlights are LED type. Have an authorized Honda Clarity Plug-In Hybrid dealer inspect and replace the light assembly.

Front Turn Signal and Front Side Marker Lights

Front turn signal and front side marker lights are LED type. Have an authorized Honda Clarity Plug-In Hybrid dealer inspect and replace the light assembly.

Parking/Daytime Running Lights

Parking/daytime running lights are LED type. Have an authorized Honda Clarity Plug-In Hybrid dealer inspect and replace the light assembly.

Headlights

The headlight aim is set by the factory, and does not need to be adjusted. However, if you regularly carry heavy items in the trunk, have the aiming readjusted at an authorized Honda Clarity Plug-In Hybrid dealer or by a qualified technician.

Taillights/Rear Side Marker, Brake and Rear Turn Signal Lights

Taillights/rear side marker, brake and rear turn signal lights are LED type. Have an authorized Honda Clarity Plug-In Hybrid dealer inspect and replace the light assembly.

Taillights and Back-Up Lights

Taillights and back-up lights are LED type. Have an authorized Honda Clarity Plug-In Hybrid dealer inspect and replace the light assembly.

Rear License Plate Light

Rear license plate light is LED type. Have an authorized Honda Clarity Plug-In Hybrid dealer inspect and replace the light assembly.

High-Mount Brake Light

High-mount brake light is LED type. Have an authorized Honda Clarity Plug-In Hybrid dealer inspect and replace the light assembly.

Checking Wiper Blades

If the wiper blade rubber has deteriorated, it will leave streaks and the hard surfaces of the blade may scratch the window glass.

Changing the Wiper Blade Rubber

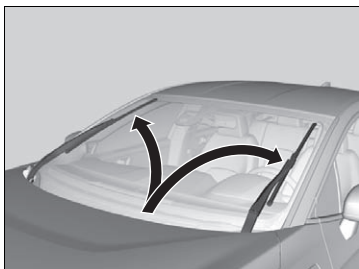

1. Set the power mode to VEHICLE OFF (LOCK).
2. While holding the wiper switch in the **MIST** position, set the power mode to ON, then to VEHICLE OFF (LOCK).
 - ▶ Both wiper arms are set to the maintenance position as shown in the image.

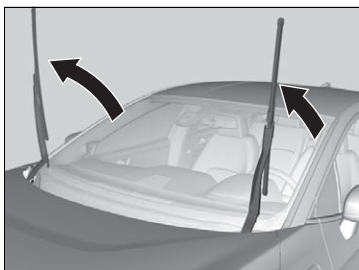

3. Lift both wiper arms.

Changing the Wiper Blade Rubber

NOTICE

Avoid dropping the wiper arm onto the windshield, it may damage the wiper arm and/or the windshield.

When you raise a wiper arm, you may inadvertently alter the position of the arm by applying undue force. If you notice that an arm is not in its proper return position, activate the wipers once and they will automatically reset.

➤ **Wipers and Washers** P. 166

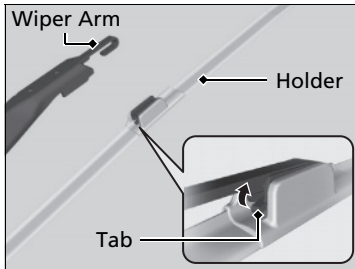

4. Press and hold the tab, then slide the holder off the wiper arm.

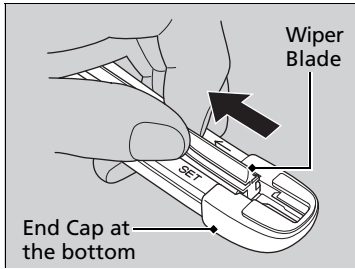

5. Pull the end of the wiper blade in the direction of the arrow in the image until it is out of the holder's end cap.

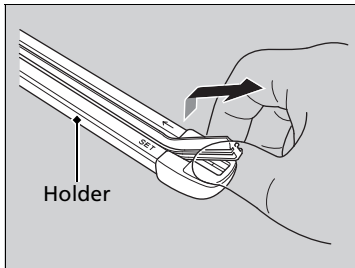

6. Pull the wiper blade in the opposite direction to slide it out of the holder.

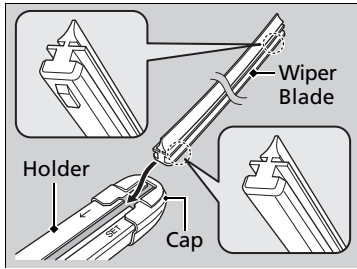

7. Insert the flat side of the new wiper blade onto the bottom part of the holder. Insert the blade all the way.
8. Install the end of the wiper blade into the cap.
9. Slide the holder onto the wiper arm until it locks.
10. Lower both wiper arms.
11. Set the power mode to ON and hold the wiper switch in the **MIST** position until both wiper arms return to the standard position.

Checking Tires

To safely operate your vehicle, your tires must be of the proper type and size, in good condition with adequate tread, and properly inflated.

■ Inflation guidelines

Properly inflated tires provide the best combination of handling, tread life, and comfort. Refer to the driver's doorjamb label or specifications page for the specified pressure.

Underinflated tires wear unevenly, adversely affect handling and fuel economy, and are more likely to fail from overheating.

Overinflated tires make your vehicle ride harshly, are more prone to road hazards, and wear unevenly.

Every day before you drive, look at each of the tires. If one looks lower than the others, check the pressure with a tire gauge.

At least once a month or before long trips, use a gauge to measure the pressure in all tires. Even tires in good condition can lose 1–2 psi (10–20 kPa, 0.1–0.2 kgf/cm²) per month.

■ Inspection guidelines

Every time you check inflation, also examine the tires and valve stems.

Look for:

- Bumps or bulges on the side or in the tread. Replace the tire if you find any cuts, splits, or cracks in the side of the tire. Replace it if you see fabric or cord.
- Remove any foreign objects and inspect for air leaks.
- Uneven tread wear. Have an authorized Honda Clarity Plug-In Hybrid dealer check the wheel alignment.
- Excessive tread wear.
 - **Wear Indicators** P. 504
- Cracks or other damage around valve stem.

☒ Checking Tires

⚠ WARNING

Using tires that are excessively worn or improperly inflated can cause a crash in which you can be seriously hurt or killed.

Follow all instructions in this owner's manual regarding tire inflation and maintenance.

Measure the air pressure when tires are cold. This means the vehicle has been parked for at least three hours, or driven less than 1 mile (1.6 km). If necessary, add or release air until the specified pressure is reached.

If checked when hot, tire pressure can be as much as 4–6 psi (30–40 kPa, 0.3–0.4 kgf/cm²) higher than if checked when cold.

Whenever tire pressure is adjusted, you must calibrate the TPMS.

➤ **TPMS Calibration** P. 425

Have an authorized Honda Clarity Plug-In Hybrid dealer check the tires if you feel a consistent vibration while driving. New tires and any that have been removed and reinstalled should be properly balanced.

Tire and Loading Information Label

The label attached to the driver's doorjamb provides necessary tire and loading information.

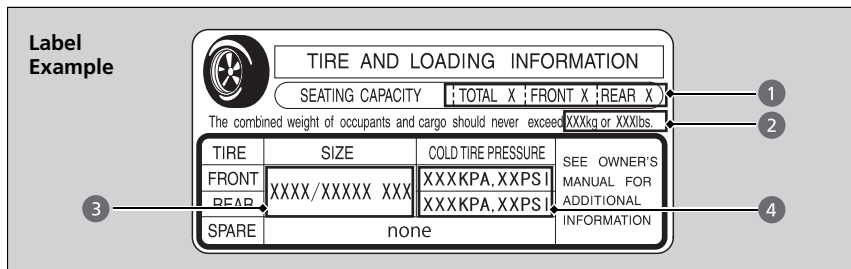

▶▶ Tire and Loading Information Label

The tire and loading information label attached to the driver's doorjamb contains:

- 1 The number of people your vehicle can carry.
- 2 The total weight your vehicle can carry. Do not exceed this weight.
- 3 The original tire sizes for front, rear, and spare, if equipped.
- 4 The proper cold tire pressure for front, rear, and spare, if equipped.

Tire Labeling

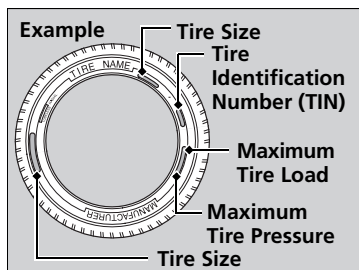

The tires that came on your vehicle have a number of markings. Those you should be aware of are described as shown.

▶▶ Tire Sizes

Following is an example of tire size with an explanation of what each component means.

235/45R18 94V

235: Tire width in millimeters.

45: Aspect ratio (the tire's section height as a percentage of its width).

R: Tire construction code (R indicates radial).

18: Rim diameter in inches.

94: Load index (a numerical code associated with the maximum load the tire can carry).

V: Speed symbol (an alphabetical code indicating the maximum speed rating).

Tire Sizes

Whenever tires are replaced, they should be replaced with tires of the same size.

■ Tire Identification Number (TIN)

The tire identification number (TIN) is a group of numbers and letters that look like the example in the side column. TIN is located on the sidewall of the tire.

■ Glossary of Tire Terminology

Cold Tire Pressure – The tire air pressure when the vehicle has been parked for at least three hours or driven less than 1 mile (1.6 km).

Load Rating – Means the maximum load that a tire is rated to carry for a given inflation pressure.

Maximum Inflation Pressure – The maximum tire air pressure that the tire can hold.

Maximum Load Rating – Means the load rating for a tire at the maximum permissible inflation pressure for that tire.

Recommended Inflation Pressure – The cold tire inflation pressure recommended by the manufacturer.

Treadwear Indicators (TWI) – Means the projections within the principal grooves designed to give a visual indication of the degrees of wear of the tread.

☒ Tire Identification Number (TIN)

DOT B97R FW6X 2209

DOT: This indicates that the tire meets all requirements of the U.S. Department of Transportation.

B97R: Manufacturer's identification mark.

FW6X: Tire type code.

22 09: Date of manufacture.

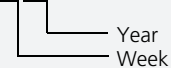

DOT Tire Quality Grading (U.S. Vehicles)

The tires on your vehicle meet all U.S. Federal Safety Requirements. All tires are also graded for treadwear, traction, and temperature performance according to Department of Transportation (DOT) standards. The following explains these gradings.

■ Uniform Tire Quality Grading

Quality grades can be found where applicable on the tire sidewall between tread shoulder and maximum section width.

■ Treadwear

The treadwear grade is a comparative rating based on the wear rate of the tire when tested under controlled conditions on a specified government test course. For example, a tire graded 150 would wear one and one-half (1 1/2) times as well on the government course as a tire graded 100. The relative performance of tires depends upon the actual conditions of their use, however, and may depart significantly from the norm due to variations in driving habits, service practices and differences in road characteristics and climate.

▣ Uniform Tire Quality Grading

For example:

Treadwear 200
Traction AA
Temperature A

All passenger car tires must conform to Federal Safety Requirements in addition to these grades.

■ Traction

The traction grades, from highest to lowest, are AA, A, B, and C. Those grades represent the tire's ability to stop on wet pavement as measured under controlled conditions on specified government test surfaces of asphalt and concrete. A tire marked C may have poor traction performance.

■ Temperature

The temperature grades are A (the highest), B, and C, representing the tire's resistance to the generation of heat and its ability to dissipate heat when tested under controlled conditions on a specified indoor laboratory test wheel. Sustained high temperature can cause the material of the tire to degenerate and reduce tire life, and excessive temperature can lead to sudden tire failure. The grade C corresponds to a level of performance which all passenger car tires must meet under the Federal Motor Vehicle Safety Standard No. 109. Grades B and A represent higher levels of performance on the laboratory test wheel than the minimum required by law.

⌘ Traction

Warning: The traction grade assigned to this tire is based on straight-ahead braking traction tests, and does not include acceleration, cornering, hydroplaning, or peak traction characteristics.

⌘ Temperature

Warning: The temperature grade for this tire is established for a tire that is properly inflated and not overloaded. Excessive speed, underinflation, or excessive loading, either separately or in combination, can cause heat buildup and possible tire failure.

Wear Indicators

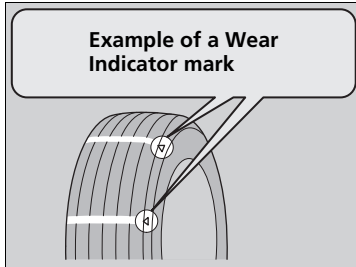

The groove where the wear indicator is located is 1/16 inch (1.6 mm) shallower than elsewhere on the tire. If the tread has worn so that the indicator is exposed, replace the tire.

Worn out tires have poor traction on wet roads.

Tire Service Life

The life of your tires is dependent on many factors, including driving habits, road conditions, vehicle loading, inflation pressure, maintenance history, speed, and environmental conditions (even when the tires are not in use).

In addition to regular inspections and inflation pressure maintenance, it is recommended that you have annual inspections performed once the tires reach five years old. All tires should be removed from service after 10 years from the date of manufacture, regardless of their condition or state of wear.

Tire and Wheel Replacement

Replace your tires with radials of the same size, load range, speed rating, and maximum cold tire pressure rating (as shown on the tire's sidewall). Using tires of a different size or construction can cause certain vehicle systems such as the ABS and Vehicle Stability Assist (VSA®) system to work incorrectly.

It is best to replace all four tires at the same time. If that isn't possible, replace the front or rear tires in pairs.

Make sure that the wheel's specifications match those of the original wheels.

⚠ Tire and Wheel Replacement

⚠ WARNING

Installing improper tires on your vehicle can affect handling and stability. This can cause a crash in which you can be seriously hurt or killed.

Always use the size and type of tires recommended in this owner's manual.

Tire Rotation

Rotating tires according to the maintenance messages on the driver information interface helps to distribute wear more evenly and increase tire life.

■ Tires without rotation marks

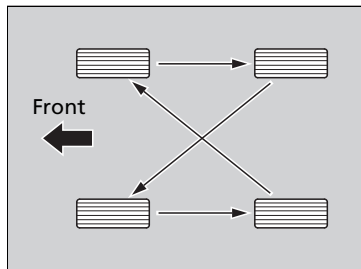

Rotate the tires as shown here.

■ Tires with rotation marks

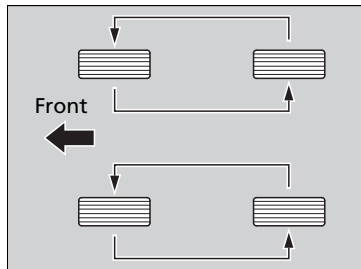

Rotate the tires as shown here.

▶▶ Tire Rotation

Tires with directional tread patterns should only be rotated front to back (not from one side to the other). Directional tires should be mounted with the rotation indication mark facing forward, as shown below.

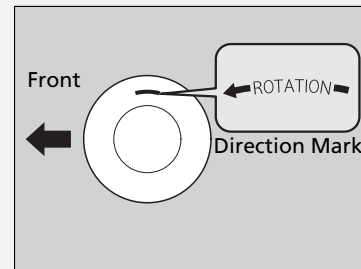

Whenever tires are rotated, you must calibrate the TPMS.

▶▶ **TPMS Calibration** P. 425

Winter Tires

If driving on snowy or frozen roads, mount all season marked **M+S** tires, snow tires, or tire chains; reduce speed; and maintain sufficient distance between vehicles when driving.

Be particularly careful when operating the steering wheel or brakes to prevent skidding.

Use tire chains, snow tires, or all season tires when necessary or according to the law.

When mounting, refer to the following points.

For winter tires:

- Select the size and load ranges that are the same as the original tires.
- Mount the tires to all four wheels.

For tire chains:

- Install them on the front tires only.
- Because your vehicle has limited tire clearance, we strongly recommend using the chains listed below:

Cable-type: SCC Radial Chain SC1040

- Follow the chain manufacturer's instruction when installing. Mount them as tightly as you can.
- Check that the chains do not touch the brake lines or suspension.
- Drive slowly.

❖ Winter Tires

⚠ WARNING

Using the wrong chains, or not properly installing chains, can damage the brake lines and cause a crash in which you can be seriously injured or killed.

Follow all instructions in this owner's manual regarding the selection and use of tire chains.

NOTICE

Traction devices that are the wrong size or improperly installed can damage your vehicle's brake lines, suspension, body, and wheels. Stop driving if they are hitting any part of the vehicle.

When tire chains are mounted, follow the chain manufacturer's instructions regarding vehicle operational limits.

If your vehicle is equipped with summer tires, be aware that these tires are not designed for winter driving conditions. For more information, contact an authorized Honda Clarity Plug-In Hybrid dealer.

Checking the 12-Volt Battery

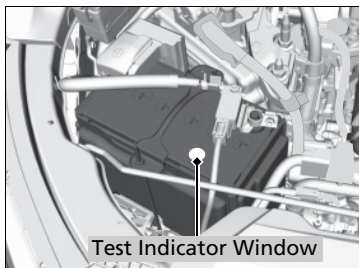

Check the battery condition monthly. Look at the test indicator window and check the terminals for corrosion.

The battery condition is monitored by the sensor on the negative terminal. If there is a problem with the sensor, the warning message on the driver information interface will let you know. Have your vehicle checked by an authorized Honda Clarity Plug-In Hybrid dealer.

If your vehicle's battery is disconnected or goes dead:

- The audio system is disabled.
 - **Reactivating the audio system** P. 206
- The clock resets.
 - **Clock** P. 136
- The vehicle cannot be charged. After reconnecting the battery, turn the power system on, then turn it off. Confirm that charging is possible.
 - **Turning on the Power** P. 376
 - **Charging** P. 454
- **Canadian models only**
 - The immobilizer system needs to be reset.
 - **Immobilizer System Indicator** P. 97

12-Volt Battery

⚠ WARNING

The battery gives off explosive hydrogen gas during normal operation.

A spark or flame can cause the battery to explode with enough force to kill or seriously hurt you.

When conducting any battery maintenance, wear protective clothing and a face shield, or have a skilled technician do it.

WARNING: Battery post, terminals, and related accessories contain lead and lead compounds.
Wash your hands after handling.

The test indicator's color information is on the battery.

When you find corrosion, clean the battery terminals by applying a baking powder and water solution. Clean the terminals with a damp towel. Cloth/towel dry the battery. Coat the terminals with grease to help prevent future corrosion.

Charging the 12-Volt Battery

Disconnect both battery cables to prevent damaging your vehicle's electrical system. Always disconnect the negative (-) cable first, and reconnect it last.

12-Volt Battery

When replacing the battery, the replacement must be of the same specifications. Consult an authorized Honda Clarity Plug-In Hybrid dealer for more information.

The indicators for the Vehicle Stability Assist (VSA®) system, VSA® OFF, Collision Mitigation Braking System™ (CMBS™), and low tire pressure/Tire Pressure Monitoring System (TPMS) may come on along with a message in the driver information interface when you turn the power system on after reconnecting the battery.

Drive a short distance at 12 mph (20 km/h). The indicator should go off. If it does not, have your vehicle checked by an authorized Honda Clarity Plug-In Hybrid dealer.

Replacing the Button Battery

If the indicator does not come on when the button is pressed, replace the battery.

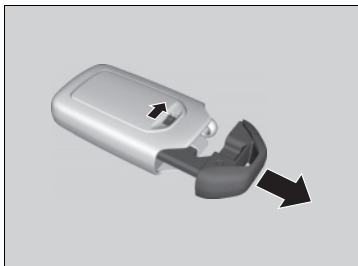

Battery type: CR2032

1. Remove the built-in key.
2. Remove the upper half of the cover by carefully prying on the edge with a coin.
 - ▶ Remove carefully to avoid losing the buttons.
 - ▶ Wrap a coin with a cloth to prevent scratching the smart entry remote.
3. Make sure to replace the battery with the correct polarity.

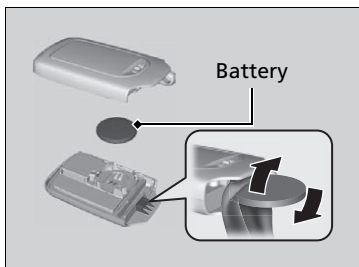

Replacing the Button Battery

WARNING

CHEMICAL BURN HAZARD

The battery that powers the remote transmitter can cause severe internal burns and can even lead to death if swallowed. Keep new and used batteries away from children.

If you suspect that a child has swallowed the battery, seek medical attention immediately.

NOTICE

An improperly disposed of battery can damage the environment. Always confirm local regulations for battery disposal.

Replacement batteries are commercially available or at an authorized Honda Clarity Plug-In Hybrid dealer.

Air Conditioning

To ensure proper and safe operation, the Society of Automotive Engineers (SAE J2845) recommends that the refrigerant system only be serviced by trained and certified technicians.

Never repair or replace the air conditioning evaporator (cooling coil) with one removed from a used or salvaged vehicle.

New replacement mobile air conditioning evaporators must be certified (and labeled) as meeting SAE Standard J2842.

Climate Control System Maintenance

NOTICE

Vented refrigerant is harmful to the environment. To avoid refrigerant from venting, never replace the evaporator with one removed from a used or salvaged vehicle.

Refrigerant in your vehicle's air conditioning system is flammable and can be ignited during servicing if proper procedures are not followed.

The air conditioner label is found under the hood:

➤ **Safety Labels** P. 83

➤ **Specifications** P. 566

Canadian models



-  : Caution
-  : Flammable Refrigerant
-  : Requires Registered Technician to Service
-  : Air Conditioning System

Dust and Pollen Filter

The climate control system is equipped with a dust and pollen filter that collects pollen, dust, and other debris in the air. The Maintenance Minder™ messages will let you know when to replace the filter.

We recommend that you replace the dust and pollen filter sooner when using your vehicle in areas with high concentrations of dust.

🔍 Dust and Pollen Filter

If the airflow from the climate control system deteriorates noticeably, and the windows fog up easily, the filter may need to be replaced. Please contact an authorized Honda Clarity Plug-In Hybrid dealer for replacement.

Interior Care

Use a damp cloth with a mixture of mild detergent and warm water to remove dirt. Use a clean cloth to remove detergent residue.

Cleaning Seat Belts

Use a soft brush with a mixture of mild soap and warm water to clean the seat belts. Let the belts air dry. Wipe the openings of the seat belt anchors using a clean cloth.

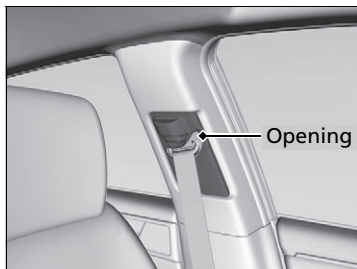

Interior Care

Do not spill liquids inside the vehicle. Electrical devices and systems may malfunction if liquids are splashed on them.

Do not use silicone based sprays on electrical devices such as audio devices and switches. Doing so may cause the items to malfunction or cause a fire inside the vehicle.

If a silicone based spray is inadvertently used on electrical devices, consult an authorized Honda Clarity Plug-In Hybrid dealer.

Depending on their composition, chemicals and liquid aromatics may cause discoloration, wrinkles, and cracking to resin-based parts and textiles. Do not use alkali solvents or organic solvents such as benzene or gasoline.

After using chemicals, make sure to gently wipe them away using a dry cloth.

Do not place used cloths on top of resin based parts or textiles for long periods of time without washing.

■ Cleaning the Window

Wipe using a glass cleaner.

⌘ Cleaning the Window

Wires are mounted to the inside of the rear window. Wipe along the same direction as the wires with a soft cloth so as not to damage them.

Be careful not to spill fluids, such as water or glass cleaner, on or around the cover of the front sensor camera.

➔ **Front Sensor Camera** P. 394

■ Floor Mats

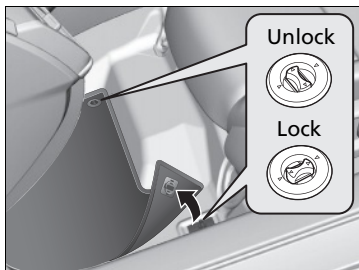

The front and rear floor mats hook over floor anchors, which keep them from sliding forward. To remove a mat for cleaning, turn the anchor knobs to the unlock position. When reinstalling the mat after cleaning, turn the knobs to the lock position.

Do not put additional floor mats on top of the anchored mats.

⌘ Floor Mats

If you use any floor mats that were not originally provided with your vehicle, make sure they are designed for your specific vehicle, fit correctly, and are securely anchored by the floor anchors. Position the rear seat floor mats properly. If they are not properly positioned, the floor mats can interfere with the front seat functions.

■ Maintaining Genuine Leather*

To properly clean leather:

1. Use a vacuum or soft dry cloth first to remove any dirt or dust.
2. Clean the leather with a soft cloth dampened with a solution comprised of 90% water and 10% neutral soap.
3. Wipe away any soap residue with a clean damp cloth.
4. Wipe away residual water and allow leather to air dry in the shade.

⌘ Maintaining Genuine Leather*

It is important to clean or wipe away dirt or dust as soon as possible. Spills can soak into leather resulting in stains. Dirt or dust can cause abrasions in the leather. In addition, please note that some dark colored clothing can rub onto the leather seats resulting in discoloration or stains.

Exterior Care

Dust off the vehicle body after you drive. Regularly inspect your vehicle for scratches on painted surfaces. A scratch on a painted surface can result in body rust. If you find a scratch, promptly repair it.

■ Washing the Vehicle

Wash the vehicle regularly. Wash more frequently when driving in the following conditions:

- If driving on roads with road salt.
- If driving in coastal areas.
- If tar, soot, bird droppings, insects, or tree sap are stuck to painted surfaces.

■ Using an Automated Car Wash

- Make sure to follow the instructions indicated on the automated car wash.
- Fold in the door mirrors.

▶▶ Washing the Vehicle

Do not spray water into the air intake vents. It can cause a malfunction.

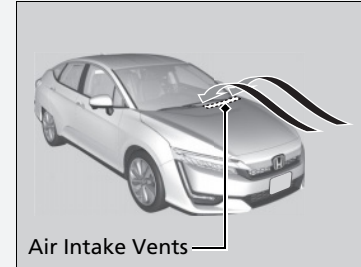

If you need to lift the wiper arms away from the windshield, first set the wiper arms to the maintenance position.

▶▶ **Changing the Wiper Blade Rubber** P. 496

▶▶ Using an Automated Car Wash

When using an automated car wash that pulls the vehicle through with a conveyor, make sure vehicle is in car wash mode.

▶▶ **If you want to keep the transmission in N position [car wash mode]** P. 386

Continued

■ Using High Pressure Cleaners

- Keep sufficient distance between the cleaning nozzle and the vehicle body.
- Take particular care around the windows. Standing too close may cause water to enter the vehicle interior.
- Do not spray water into the engine compartment.

■ Applying Wax

A good coat of automotive body wax helps protect your vehicle's paint from the elements. Wax will wear off over time and expose your vehicle's paint to the elements, so reapply as necessary.

■ Maintaining the Bumpers and Other Resin Coated Parts

If you get gasoline, oil, coolant, or battery fluid on resin coated parts, they may be stained or the coating may peel. Promptly wipe it away using a soft cloth and clean water.

■ Cleaning the Window

Wipe using a glass cleaner.

🔧 Applying Wax

NOTICE

Chemical solvents and strong cleaners can damage the paint, metal, and plastic on your vehicle. Wipe away spills immediately.

🔧 Maintaining the Bumpers and Other Resin Coated Parts

Ask an authorized Honda Clarity Plug-In Hybrid dealer about the correct coating material when you want to repair the painted surface of the parts made of resin.

🔧 Cleaning the Window

When you raise a wiper arm, you may inadvertently alter the position of the arm by applying undue force. If you notice that an arm is not in its proper return position, active the wipers once and they will automatically reset.

➡ **Wipers and Washers** P. 166

■ Maintaining Aluminum Wheels

Aluminum is susceptible to deterioration caused by salt and other road contaminants. When necessary, as early as possible use a sponge and mild detergent to wipe away these contaminants. Do not use a stiff brush or harsh chemicals (including some commercial wheel cleaners). These can damage the protective finish on aluminum alloy wheels, resulting in corrosion. Depending on the type of finish, the wheels also may lose their luster or appear burnished. To avoid water stains, wipe the wheels dry with a cloth while they are still wet.

■ Fogged Exterior Light Lenses

The inside lenses of exterior lights (headlights, brake lights, etc.) may fog temporarily if you have driven in the rain, or after the vehicle has been run through a car wash. Dew condensation also may build up inside the lenses when there is a significant enough difference between the ambient and inside lens temperatures (similar to vehicle windows fogging up in rainy conditions). These conditions are natural processes, not structural design problems in the exterior lights.

Lens design characteristics may result in moisture developing on the light lens frame surfaces. This also is not a malfunction.

However, if you see large amounts of water accumulation, or large water drops building up inside the lenses, have your vehicle inspected by an authorized Honda Clarity Plug-In Hybrid dealer.

■ Painting the Vehicle

Refer to the temperature notice label affixed to the driver's doorjamb before painting the vehicle.

▶▶ Painting the Vehicle

U.S. models

NOTICE

High temperature may damage the high-voltage battery used to power the electric motor. When drying paint in a heated paint booth, make sure the temperature does not exceed 150°F(65°C).



A0

Canadian models

NOTICE

High temperature may damage the high-voltage battery used to power the electric motor. When drying paint in a heated paint booth, make sure the temperature does not exceed 150°F(65°C).

AVIS

Des températures importantes pourraient endommager la batterie haute tension qui alimente le moteur électrique de la voiture.

Lors du séchage de la peinture, s'assurer que la température dans la cabine de peinture chauffante ne dépasse pas 150°F(65°C).



C0

Accessories

When installing accessories, check the following:

- Do not install accessories on the windshield. They can obstruct your view and delay your reaction to driving conditions.
- Do not install any accessories over areas marked SRS Airbag, on the sides or backs of the front seats, on front or side pillars, or near the side windows. Accessories installed in these areas may interfere with proper operation of the vehicle's airbags or may be propelled into you or another occupant if the airbags deploy.
- Be sure electronic accessories do not overload electrical circuits or interfere with proper operation of your vehicle.
 - **Fuses** P. 553
- Before installing any electronic accessory, have the installer contact an authorized Honda Clarity Plug-In Hybrid dealer for assistance. If possible, have an authorized Honda Clarity Plug-In Hybrid dealer inspect the final installation.

Accessories and Modifications

WARNING

Improper accessories or modifications can affect your vehicle's handling, stability, and performance, and cause a crash in which you can be seriously hurt or killed.

Follow all instructions in this owner's manual regarding accessories and modifications.

WARNING

Use of improperly designed, engineered or manufactured high-voltage battery assemblies could cause a fire in your vehicle.

A vehicle fire could result in a crash or injury.

Only use a genuine Honda high-voltage battery assembly, or its equivalent, in your vehicle.

Honda Genuine accessories are recommended to ensure proper operation on your vehicle.

Modifications

Do not modify your vehicle in a manner that may affect its handling, stability, or reliability, or install non-genuine Honda parts or accessories that may have a similar effect.

Even minor modifications to vehicle systems can affect overall vehicle performance. Always make sure all equipment is properly installed and maintained, and do not make any modification to your vehicle or its systems that might cause your vehicle to no longer meet federal, state, province, territory, and local regulations.

The on-board diagnostic port (OBD-II/SAE J1962 connector) installed on this vehicle is intended to be used with automobile system diagnostic devices or with other devices that Honda has approved. Use of any other type of device may adversely affect the vehicle's electronic systems or allow them to be compromised, possibly resulting in a system malfunction, drained battery, or other unexpected problems.

Do not modify or attempt to repair your vehicle's high-voltage hybrid power system or otherwise modify vehicle electrical systems. Disassembling or modifying electrical equipment can result in a crash or a fire.

If you ever need to replace your vehicle's high-voltage battery assembly outside of warranty coverage, we highly recommend that you only use a genuine Honda high-voltage battery assembly. Genuine Honda high-voltage battery assemblies are designed to work with your vehicle's hybrid power system and have been designed, engineered and manufactured to avoid overcharging situations. Non-genuine high-voltage battery assemblies may not have been similarly designed, engineered and manufactured, and installation of such assemblies could result in overcharging, fires, loss of power, or other conditions that may increase the likelihood of a crash or injury.

Handling the Unexpected

This chapter explains how to handle unexpected troubles.

If a Tire Goes Flat

Temporarily Repairing a Flat Tire..... 522

Handling of the Jack..... 534

Power System Won't Start

Checking the Procedure..... 535

If the Smart Entry Remote Battery is

Weak.....537

Emergency Power System Off..... 538

Jump Starting..... 539

Overheating

How to Handle Overheating..... 542

Indicator, Coming On/Blinking

If the Low Oil Pressure Warning Appears .. 545

If the 12-Volt Battery Charging System

Indicator Comes On 546

If the Malfunction Indicator Lamp Comes

On or Blinks..... 547

If the Brake System Indicator (Red) Comes

On or Blinks 548

If the Electric Power Steering (EPS) System

Indicator Comes On 549

If the Brake System Indicator (Red)

Comes On or Blinks at the Same Time

When the Brake System Indicator

(Amber) Comes On 550

If the Low Tire Pressure/TPMS Indicator

Comes On or Blinks 551

If the Transmission System Indicator Blinks

along with the Warning Message.... 552

Fuses

Fuse Locations 553

Inspecting and Changing Fuses..... 560

Emergency Towing..... 561

When You Cannot Unlock the Fuel Fill

Door..... 562

When You Cannot Open the Charge

Lid.....563

When You Cannot Open the Trunk.. 564

Temporarily Repairing a Flat Tire

If the tire has a large cut or is otherwise severely damaged, you will need to have the vehicle towed. If the tire only has a small puncture, from a nail for instance, you can use the temporary tire repair kit so that you can drive to the nearest service station for a more permanent repair.

If a tire goes flat while driving, grasp the steering wheel firmly, and brake gradually to reduce speed. Then stop in a safe place.

1. Park the vehicle on a firm, level, and non-slippery surface and apply the parking brake.
2. Change the gear position to **P**.
3. Turn on the hazard warning lights and set the power mode to VEHICLE OFF (LOCK).

Temporarily Repairing a Flat Tire

The kit should not be used in the following situations. Instead, contact an authorized Honda Clarity Plug-In Hybrid dealer or roadside assistance to have the vehicle towed.

- The tire sealant has expired.
- More than one tire is punctured.
- The puncture or cut is larger than 3/16 inch (4 mm).
- The tire side wall is damaged or the puncture is outside the contact area.



When the puncture is:	Kit Use
Smaller than 3/16 inch (4 mm)	Yes
Larger than 3/16 inch (4 mm)	No

- Damage has been caused by driving with the tire extremely under inflated.
- The tire bead is no longer seated.
- The rim is damaged.

Do not remove a nail or screw that punctured the tire. If you remove it from the tire, you may not be able to repair the puncture using the kit.

Getting Ready to Temporarily Repair the Flat Tire

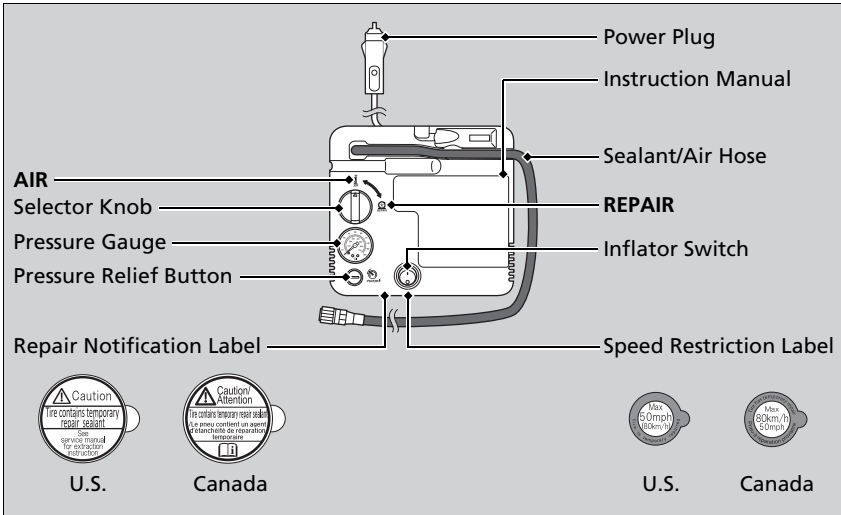

Getting Ready to Temporarily Repair the Flat Tire

Repair notification label and speed restriction label are applied to the side of temporary tire repair kit.

When making a temporary repair, carefully read the instruction manual provided with the kit.

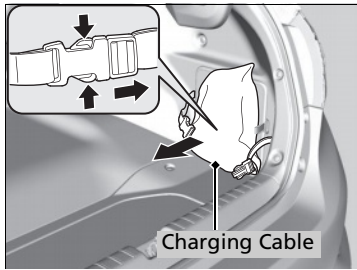

1. Remove the charging cable by releasing the belt.

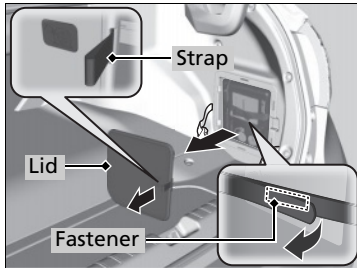

2. Pull the strap on the right side of the trunk and open the lid.
3. Open the fastener and take the kit out of the trunk.
4. Place the kit face up, on flat ground near the flat tire, and away from traffic. Do not place the kit on its side.

Injecting Sealant and Air

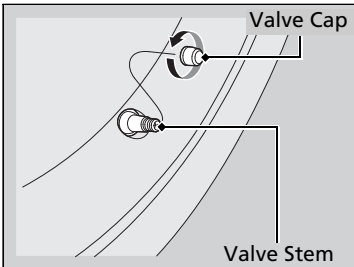

1. Remove the valve cap from the tire valve stem.

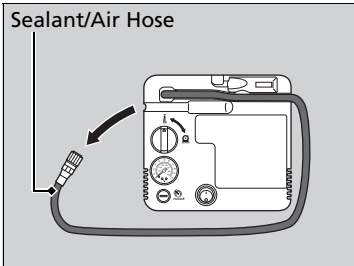

2. Remove the sealant/air hose from the packaging.

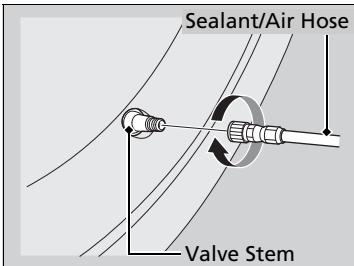

3. Attach the sealant/air hose onto the tire valve stem. Screw it until it is tight.

Injecting Sealant and Air

⚠ WARNING

Tire sealant contains substances that are harmful and can be fatal if swallowed.

If accidentally swallowed, do not induce vomiting. Drink plenty of water and get medical attention immediately.

For skin or eye contact, flush with cool water and get medical attention if necessary.

In cold temperatures, the sealant may not flow easily. In this situation, warm it up for five minutes before using.

The sealant can permanently stain clothing and other materials. Be careful during handling and wipe away any spills immediately.

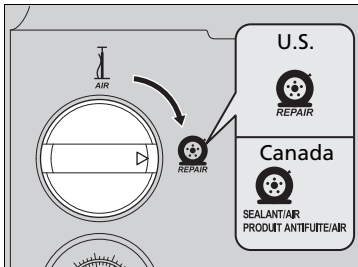
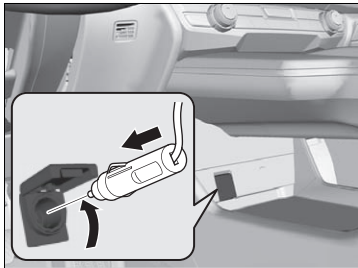

4. Plug in the compressor to the accessory power socket.
 - ▶ Be careful not to pinch the cord in a door or window.
 - ▶ Do not plug any other electronic devices into other accessory power sockets.
 - 🔧 **Accessory Power Sockets** P. 189
5. Turn the power system on.
 - ▶ Keep the power system on while injecting sealant and air.
6. Turn the selector knob to **REPAIR***1, **SEALANT/AIR***2, **PRODUIT ANTIFUITE/AIR***2.

🔧 Injecting Sealant and Air

⚠ WARNING

Running the engine with the vehicle in an enclosed or even partly enclosed area can cause a rapid build-up of toxic carbon monoxide.

Breathing this colorless, odorless gas can cause unconsciousness and even death. Only run the engine to power the air compressor with the vehicle outdoors.

NOTICE

Do not operate the temporary tire repair kit compressor for more than 15 minutes. The compressor can overheat and become permanently damaged.

There are two accessory power sockets:

- In the back of the console compartment
- In the console panel

🔧 **Accessory Power Sockets** P. 189

*1: U.S. models

*2: Canadian models

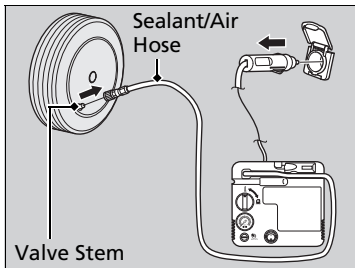
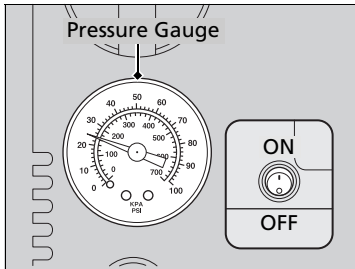

7. Press the inflator switch to turn on the compressor.
 - ▶ The compressor starts injecting sealant and air into the tire.
 - ▶ When the sealant injection is complete, continue to add air.
8. After the air pressure reaches 36 psi (250 kPa), turn off the kit.
 - ▶ To check the pressure, occasionally turn off the compressor, and read the gauge.
9. Unplug the power plug from the accessory power socket.
10. Unscrew the sealant/air hose from the tire valve stem. Reinstall the valve cap.
11. Press the pressure relief button until the gauge returns to 0 psi (0 kPa).

✘ Injecting Sealant and Air

Until the sealant injection is complete, the pressure shown on the pressure gauge will appear higher than actual. After the sealant injection is complete the pressure will drop and then begin to rise again as the tire is inflated with air. This is normal. To accurately measure the air pressure using the gauge, turn the air compressor off only after the sealant injection is complete.

If the required air pressure is not reached within 10 minutes, the tire may be too severely damaged for the kit to provide the necessary seal, and your vehicle will need to be towed.

See an authorized Honda Clarity Plug-In Hybrid dealer for a replacement sealant bottle and proper disposal of an empty bottle.

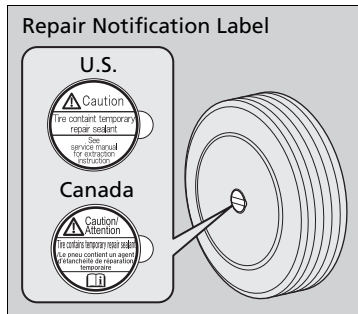

12. Apply the repair notification label to the flat surface of the wheel.
 - ▶ The wheel surface must be clean to ensure the label adheres properly.

■ Distributing the Sealant in the Tire

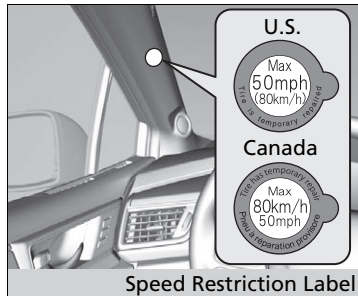

1. Apply the speed restriction label to the location as shown.
2. Drive the vehicle for about 10 minutes.
 - ▶ Do not exceed 50 mph (80 km/h).
3. Stop the vehicle in a safe place.

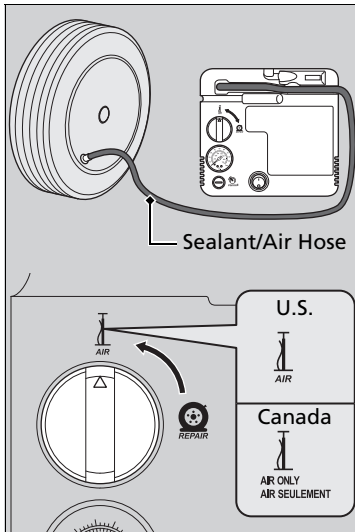

4. Recheck the air pressure using the sealant/air hose on the compressor.
5. Turn the selector knob to **AIR**^{*1}, **AIR ONLY**^{*2}, **AIR SEULEMENT**^{*2}.
 - ▶ Do not turn the air compressor on to check the pressure.
 - ▶ **Inflating an Under-inflated Tire** P. 531
6. If the air pressure is
 - Less than 25 psi (175 kPa):
Do not add air or continue driving. The leak is too severe. Call for help and have your vehicle towed.
 - ▶ **Emergency Towing** P. 561
 - 36 psi (250 kPa) or more:
Continue driving for another 10 minutes or until you reach the nearest service station, whichever is sooner. Do not exceed 50 mph (80 km/h). If you have not reached a service station after 10 minutes, stop in a safe place and check the tire pressure.
 - ▶ If the air pressure does not go down after the 10 minute driving, you do not need to check the pressure any more.

*1: U.S. models

*2: Canadian models

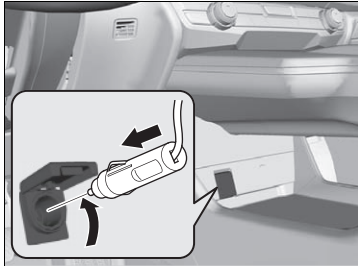

- Greater than 25 psi (175 kPa), but less than 36 psi (250 kPa):

Turn the air compressor on to inflate the tire until the tire pressure reaches 36 psi (250 kPa).

▶ **Inflating an Under-inflated Tire** P. 531

Then drive carefully for 10 more minutes or until you reach the nearest service station, whichever is sooner. Do not exceed 50 mph (80 km/h). If you have not reached a service station after 10 minutes, stop in a safe place and check the tire pressure.

- ▶ You should repeat this procedure as long as the air pressure is within this range.

7. Unplug the kit from the accessory power socket.
8. Unscrew the air only hose from the tire valve stem. Reinstall the valve cap.
9. Press the pressure relief button until the gauge returns to 0 psi (0 kPa).
10. Repackage and properly stow the kit.

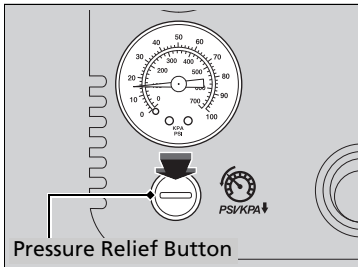

▶▶ Distributing the Sealant in the Tire

⚠ WARNING

Running the engine with the vehicle in an enclosed or even partly enclosed area can cause a rapid build-up of toxic carbon monoxide.

Breathing this colorless, odorless gas can cause unconsciousness and even death. Only run the engine to power the air compressor with the vehicle outdoors.

■ Inflating an Under-inflated Tire

You can use the kit to inflate a non-punctured under-inflated tire.

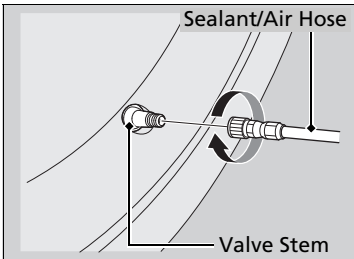
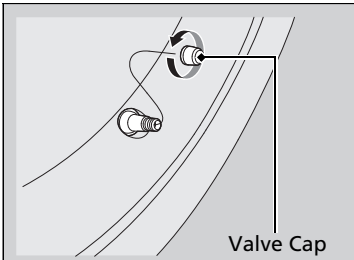
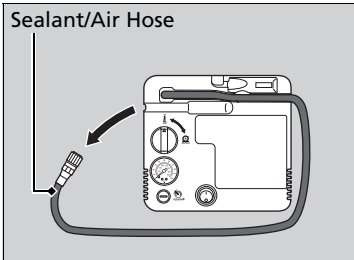

1. Open the trunk floor lid.
 - **Getting Ready to Temporarily Repair the Flat Tire** P. 523
2. Remove the kit from the case.
3. Place the kit, face up, on flat ground near the flat tire, away from traffic. Do not place the kit on its side.
4. Remove the air only hose from the kit.
5. Remove the valve cap.
6. Attach the sealant/air hose onto the tire valve stem. Screw it until it is tight.

▣ Inflating an Under-inflated Tire

NOTICE

Do not operate the temporary tire repair kit compressor for more than 15 minutes. The compressor can overheat and become permanently damaged.

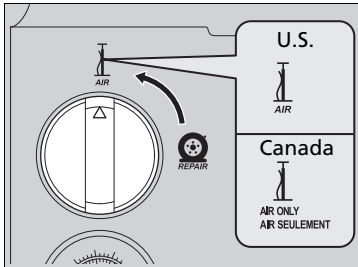
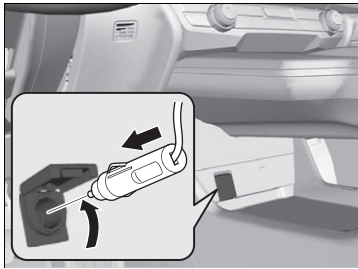

7. Plug in the kit to the accessory power socket.
 - ▶ Be careful not to pinch the cord in a door or window.
 - ▶ Do not plug any other electronic devices into other accessory power sockets.
 - ☒ **Accessory Power Sockets** P. 189
8. Turn the power system on.
 - ▶ Keep the power system on while injecting air.
9. Turn the selector knob to **AIR***¹, **AIR ONLY***², **AIR SEULEMENT***².
10. Press the inflator switch to turn on the kit.
 - ▶ The compressor starts to inject air into the tire.
11. Inflate the tire to the specified air pressure.

▶▶ Inflating an Under-inflated Tire

⚠ WARNING

Running the engine with the vehicle in an enclosed or even partly enclosed area can cause a rapid build-up of toxic carbon monoxide.

Breathing this colorless, odorless gas can cause unconsciousness and even death. Only run the engine to power the air compressor with the vehicle outdoors.

*1: U.S. models

*2: Canadian models

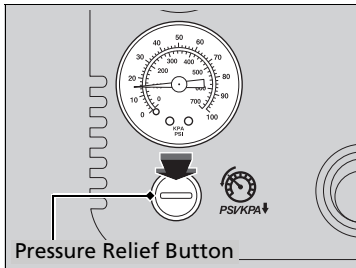

12. Turn off the kit.
 - Check the pressure gauge on the air compressor.
 - If overinflated, press the pressure relief button.
13. Unplug the kit from the accessory power socket.
14. Unscrew the sealant/air hose from the tire valve stem. Reinstall the valve cap.
15. Press the pressure relief button until the gauge returns to 0 psi (0 kPa).
16. Repackage and properly stow the kit.

Handling of the Jack

Your vehicle has jacking points as shown.

When replacing your tires, consult an authorized Honda Clarity Plug-In Hybrid dealer.

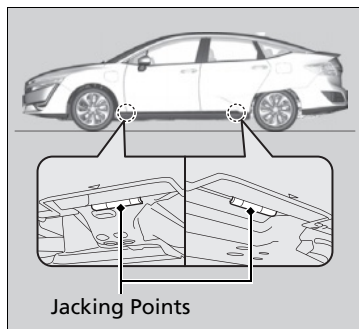

Checking the Procedure

When the **READY** indicator does not come on and the **Ready To Drive** message does not appear on the driver information interface, check the following items and take appropriate action.

☒ Checking the Procedure

If you must start the vehicle immediately, use an assisting vehicle or booster battery to jump start it.

☒ **Jump Starting** P. 539

Checklist	Condition	What to Do
Check if the related indicator or driver information interface messages come on.	The Remove Charger Connector message appears	Removing a charge connector. Set the power mode to ACCESSORY, then to ON.
	The Low Battery Charge. Power Reduced. message appears	Charge the High Voltage battery. ☒ Charging P. 454
	The Temperature Is Too Cold For Vehicle To Operate message appears.	☒ Driver Information Interface Warning and Information Messages P. 103
	The To Start, Hold Remote Near Start Button message appears. ▶ Make sure the smart entry remote is in its operating range. ☒ POWER Button Operating Range P. 158	☒ If the Smart Entry Remote Battery is Weak P. 537
	The POWER SYSTEM indicator comes on.	Have your vehicle checked by an authorized Honda Clarity Plug-In Hybrid dealer.
Check the brightness of the interior lights.	The transmission system indicator blinks and Transmission Problem Apply Parking Brake When Parked message appears.	The power system can be activated as a temporary measure. ☒ If the Transmission System Indicator Blinks along with the Warning Message P. 552
	The interior lights are dim or do not come on at all. The interior lights come on normally.	Have the 12-volt battery checked by an authorized Honda Clarity Plug-In Hybrid dealer. Check all fuses, or have your vehicle checked by an authorized Honda Clarity Plug-In Hybrid dealer. ☒ Inspecting and Changing Fuses P. 560

Checklist	Condition	What to Do
Check the Security System Alarm indicator.	When the Security System Alarm indicator is blinking, the power system cannot be turned on.	▶ Security System Alarm P. 153

If the Smart Entry Remote Battery is Weak

If the beeper sounds, the **To Start, Hold Remote Near Start Button** message appears on the driver information interface, and the **POWER** button flashes, the **READY** indicator does not come on.

Turn on the power system as follows:

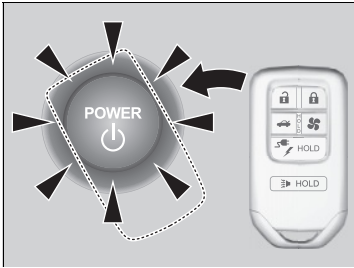

1. Touch the center of the **POWER** button with the **H** logo on the smart entry remote while the indicator on the **POWER** button is flashing. The buttons on the smart entry remote should be facing you.
 - ▶ The **POWER** button flashes for about 30 seconds.

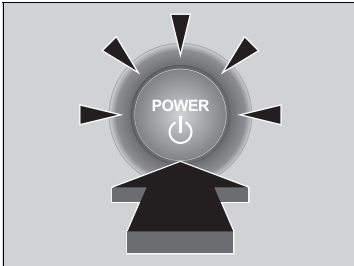

2. Depress the brake pedal and press the **POWER** button within 10 seconds after the beeper sounds and the **POWER** button changes from flashing to on.
 - ▶ If you do not depress the pedal, the mode will change to ACCESSORY.

Emergency Power System Off

The **POWER** button may be used to turn the power system off due to an emergency situation even while driving. If you must turn the power system off, do either of the following operations:

- Press and hold the **POWER** button for about two seconds.
- Firmly press the **POWER** button three times.

The steering wheel will not lock. However, because turning off the power system disables the power assist the power system provides to the steering and braking systems, it will require significantly more physical effort and time to steer and slow the vehicle. Use both feet on the brake pedal to slow down the vehicle and stop immediately in a safe place.

The gear position automatically changes to **P** after the vehicle comes to a complete stop. Then, the power mode changes to VEHICLE OFF.

Emergency Power System Off

Do not press the button while driving unless it is absolutely necessary for the power system to be turned off.

Jump Starting Procedure

Turn off the power to electric devices, such as the audio and lights. Turn off the power system, then open the hood.

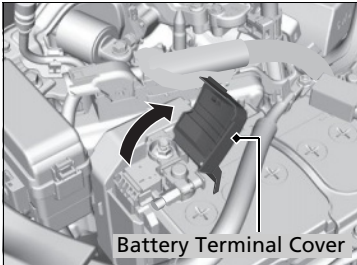

1. Open the battery terminal cover.

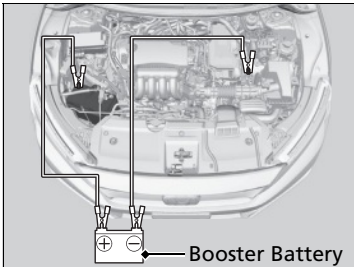

2. Connect the first jumper cable to your vehicle's 12-volt battery \oplus terminal.
3. Connect the other end of the first jumper cable to the booster battery \oplus terminal.
 - ▶ If you use a booster battery, only use a 12-volt booster battery.
 - ▶ When using an automotive battery charger, select a charging voltage lower than 15-volts. Check the charger manual for the proper setting.
4. Connect the second jumper cable to the booster battery \ominus terminal.

Jump Starting

⚠ WARNING

A 12-volt battery can explode if you do not follow the correct procedure, seriously injuring anyone nearby.

Keep all sparks, open flames, and smoking materials away from the 12-volt battery.

Securely attach the jumper cable clips so that they do not come off when the power system vibrates. Also be careful not to tangle the jumper cables or allow the cable ends to touch each other while attaching or detaching the jumper cables.

12-volt Battery performance degrades in cold conditions and may prevent the power system from starting.

Continued

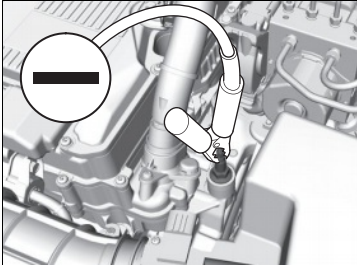

5. Connect the other end of the second jumper cable to the power system mounting bolt as shown. Do not connect this jumper cable to any other part of the vehicle.
6. If your vehicle is connected to another vehicle, start the assisting vehicle's engine, and increase its rpm slightly.
7. Attempt to start your vehicle's power system. If it does not turn on, check that the jumper cables have good metal-to-metal contact.

■ What to Do After the Power System Starts

Once your vehicle's power system has started, remove the jumper cables in the following order:

1. Disconnect the jumper cable from your vehicle's ground.
2. Disconnect the other end of the jumper cable from the booster battery ⊖ terminal.
3. Disconnect the jumper cable from your vehicle's 12-volt battery ⊕ terminal.
4. Disconnect the other end of the jumper cable from the booster battery ⊕ terminal.

Have your vehicle inspected by a nearby service station or an authorized Honda Clarity Plug-In Hybrid dealer.

▣ What to Do After the Power System Starts

The indicators for the Vehicle Stability Assist (VSA®) system, VSA® OFF, Collision Mitigation Braking System™ (CMBS™), and low tire pressure/Tire Pressure Monitoring System (TPMS) may come on along with a message in the driver information interface when you turn the power system on after reconnecting the battery.

Drive a short distance at 12 mph (20 km/h). The indicator should go off. If it does not, have your vehicle checked by an authorized Honda Clarity Plug-In Hybrid dealer.

How to Handle Overheating

Overheating symptoms are as follows:

- The **High Temperature. Power Reduced.** message appears on the multi-information display.
- The **Stop Driving When Safe. Engine Temperature Too Hot** message appears on the multi-information display.
- Steam or spray comes out of the engine compartment.

The High Temperature. Power Reduced. Message Appears on the Multi-Information Display

The **High Temperature. Power Reduced.** message appears on the multi-information display when the power system temperature is high.

➤ **Driver Information Interface Warning and Information Messages** P. 103

1. Immediately park the vehicle in a safe place.
 - ▶ Change the gear position to **P**, and set the parking brake. Turn off all accessories and turn on the hazard warning lights.
2. Keep the power mode in ON, and wait until the message disappears.
 - ▶ If the message does not disappear, have the vehicle inspected at an authorized Honda Clarity Plug-In Hybrid dealer.

■ The Stop Driving When Safe. Engine Temperature Too Hot Message Appears on the Multi-Information Display

■ First thing to do

1. Immediately park the vehicle in a safe place.
2. Turn off all accessories and turn on the hazard warning lights.
 - ▶ **No steam or spray present:** Keep the power system on and open the hood.
 - ▶ **Steam or spray is present:** Turn off the power system and wait until it subsides. Then open the hood.

☒ The Stop Driving When Safe. Engine Temperature Too Hot Message Appears on the Multi-Information Display

⚠ WARNING

Steam and spray from an overheated engine can seriously scald you.

Do not open the hood if steam is coming out.

NOTICE

Continuing to drive with the **Stop Driving When Safe. Engine Temperature Too Hot** message on the multi-information display may damage the engine.

Continued

■ Next thing to do

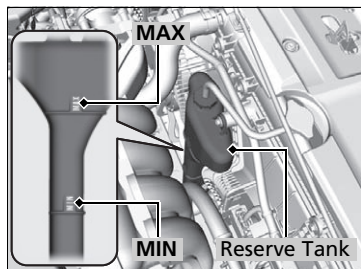

1. Check that the cooling fan is operating and turn the power system off once the **Stop Driving When Safe. Engine Temperature Too Hot** message disappears.

► If the cooling fan is not operating, immediately turn the power system off.

2. Once the engine has cooled down, inspect the coolant level and check the cooling system components for leaks.

► If the coolant level in the reserve tank is low, add coolant until it reaches the **MAX** mark.

► If there is no coolant in the reserve tank, check that the radiator is cool. Cover the radiator cap with a heavy cloth and open the cap. If necessary, add coolant up to the base of the filler neck, and put the cap back on.

■ Last thing to do

Once the engine has cooled sufficiently, turn the power system on.

If the **Stop Driving When Safe. Engine Temperature Too Hot** message does not appear, resume driving. If it appears again, contact an authorized Honda Clarity Plug-In Hybrid dealer for repairs.

► The Stop Driving When Safe. Engine Temperature Too Hot Message Appears on the Multi-Information Display

⚠ WARNING

Removing the radiator cap while the engine is hot can cause the coolant to spray out, seriously scalding you.

Always let the engine and radiator cool down before removing the radiator cap.

If the coolant is leaking, contact an authorized Honda Clarity Plug-In Hybrid dealer for repairs.

Use water as an emergency/temporary measure only. Have an authorized Honda Clarity Plug-In Hybrid dealer flush the system with proper antifreeze as soon as possible.

If the Low Oil Pressure Warning Appears

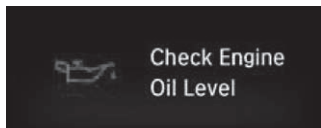

■ **Reasons for the Warning to appear**
Appears when the engine oil pressure is low.

■ **What to do as soon as the warning appears**

1. Immediately park the vehicle on level ground in a safe place.
2. If necessary, turn the hazard warning lights on.

■ **What to do after parking the vehicle**

1. Stop the engine and let it sit for approximately three minutes.
2. Open the hood and check the oil level.
 - **Oil Check** P. 483
3. Start the engine and check the low oil pressure warning.
 - ▶ The warning disappears: Start driving again.
 - ▶ The warning does not disappear within 10 seconds: Immediately stop the engine and contact an authorized Honda Clarity Plug-In Hybrid dealer for repairs.

☞ If the Low Oil Pressure Warning Appears

NOTICE

Running the engine with low oil pressure can cause serious mechanical damage almost immediately.

If the 12-Volt Battery Charging System Indicator Comes On



■ Reasons for the indicator to come on

Comes on when the 12-volt battery is not being charged.

■ What to do when the indicator comes on

Turn off the climate control system, rear defogger, and other electrical systems, and immediately contact an authorized Honda Clarity Plug-In Hybrid dealer for repairs.

⚠ If the 12-Volt Battery Charging System Indicator Comes On

If you need to stop temporarily, do not turn off the power system. Restarting the power system may rapidly discharge the battery.

If the Malfunction Indicator Lamp Comes On or Blinks



■ Reasons for indicator lamp to come on or blink

- Comes on when there is a problem with the engine emissions control system, or the fuel fill cap is missing, or loose.
- Blinks when engine misfiring is detected.

■ What to do when the indicator lamp comes on

Avoid high speeds and immediately get your vehicle inspected at an authorized Honda Clarity Plug-In Hybrid dealer.

■ What to do when the indicator lamp blinks

Park the vehicle in a safe place with no flammable items and wait at least 10 minutes or more with the power system stopped until it cools.

■ Tighten Fuel Cap Message

■ The message appears on when:

An evaporative system leak is detected. This may be caused by the fuel fill cap being loose or not being installed.

■ What to do when the message appears:

1. Stop the power system.
2. Check if the fuel fill cap is fully installed.
 - ▶ If not, loosen the cap, and then retighten it until it clicks at least once.
3. Drive for several days of normal driving.
 - ▶ The message should go off.

■ When the malfunction indicator lamp comes on

The malfunction indicator lamp comes on if the system continues to detect a leak of gasoline vapor. If this happens, follow the procedures described earlier to check the fuel fill cap.

▶▶ If the Malfunction Indicator Lamp Comes On or Blinks

NOTICE

If you drive with the malfunction indicator lamp on, the emissions control system and the engine could be damaged.

If the malfunction indicator lamp blinks again when restarting the engine, drive to the nearest authorized Honda Clarity Plug-In Hybrid dealer at 31 mph (50 km/h) or less. Have your vehicle inspected.

If the Brake System Indicator (Red) Comes On or Blinks

U.S.



Canada



■ Reasons for the indicator to come on

- The brake fluid is low.
- There is a malfunction in the brake system.

■ What to do when the indicator comes on while driving

Depress the brake pedal lightly to check pedal pressure.

- If normal, check the brake fluid level the next time you stop.
- If abnormal, take immediate action. If necessary, slow the vehicle using the deceleration paddle selector.

■ Reason for the indicator to blink

- There is a problem with the electric parking brake system.

■ What to do when the indicator blinks

Avoid using the parking brake and have your vehicle checked by an authorized Honda Clarity Plug-In Hybrid dealer immediately.

⚠ If the Brake System Indicator (Red) Comes On or Blinks

Have your vehicle repaired immediately. It is dangerous to drive with low brake fluid. If there is no resistance from the brake pedal, stop immediately in a safe place. If necessary, downshift the gears.

If the brake system indicator and **ABS** indicator come on simultaneously, the electronic brake distribution system is not working. This can result in vehicle instability under sudden braking. Have your vehicle inspected by an authorized Honda Clarity Plug-In Hybrid dealer immediately.

If the brake system indicator (red) blinks at the same time when the brake system indicator (amber) comes on, the parking brake may not work. Avoid using the parking brake and have your vehicle checked by an authorized Honda Clarity Plug-In Hybrid dealer immediately.

- ▶ **If the Brake System Indicator (Red) Comes On or Blinks at the Same Time When the Brake System Indicator (Amber) Comes On**
P. 550

If the Electric Power Steering (EPS) System Indicator Comes On



■ Reasons for the indicator to come on

- Comes on when there is a problem with the EPS system.
- If you depress the accelerator pedal repeatedly to increase the motor speed while the motor is idling, the indicator comes on, and sometimes the steering wheel becomes harder to operate.
- Comes on when the EPS steering angle center point memory is lost. This could be due to a number of problems including: battery disconnection, main fuse blow, low battery causing the reset of the EPS system, wire damage to EPS harness. Vehicle Stability Assist (VSA®), VSA® OFF, Collision Mitigation Braking System™ (CMBS™), and low tire pressure/TPMS indicators come on along with a message in the driver information interface.

■ What to do when the indicator comes on

- Stop the vehicle in a safe place, turn off the power system, and turn on the power system again.
If the indicator re-appears and stays on, immediately have your vehicle inspected by an authorized Honda Clarity Plug-In Hybrid dealer.
- If VSA® indicator, VSA® OFF indicator, CMBS™ indicator, and low tire pressure/TPMS indicator come on along with a message in the driver information interface, you need to calibrate the VSA and EPS systems. Drive a short distance at more than 12 mph (20 km/h) to calibrate the VSA and EPS systems.
If the indicators come on and stay on, park your vehicle in a safe place, turn off and turn on the power system, then repeat the above operation.
If the indicators still come on and stay on, immediately have your vehicle inspected by an authorized Honda Clarity Plug-In Hybrid dealer.

If the Brake System Indicator (Red) Comes On or Blinks at the Same Time When the Brake System Indicator (Amber) Comes On

U.S.



(Red)

Canada



(Red)

U.S.



(Amber)

Canada



(Amber)

■ **If the brake system indicator (red) comes on or blinks at the same time when the brake system indicator (amber) comes on, release the parking brake manually or automatically.**

▶ **Parking Brake** P. 431

- If the brake system indicator (red) continuously comes on or blinks at the same time the brake system indicator (amber) comes on, stop the vehicle in a safe place, and have it inspected by an authorized Honda Clarity Plug-In Hybrid dealer immediately.

▶ Prevents the vehicle from moving gear position to **P**.

- If only the Brake System Indicator (Red) is turned off, avoid using the parking brake, and have your vehicle checked by an authorized Honda Clarity Plug-In Hybrid dealer immediately.

▶▶ If the Brake System Indicator (Red) Comes On or Blinks at the Same Time When the Brake System Indicator (Amber) Comes On

If you apply the parking brake, you may not be able to release it.

If the brake system indicator (red) and the brake system indicator (amber) come on at the same time, the parking brake is working.

If the brake system indicator (red) blinks at the same time when the brake system indicator (amber) comes on, the parking brake may not work because it is checking the system.

If the Low Tire Pressure/TPMS Indicator Comes On or Blinks



■ Reasons for the indicator to come on or blink

A tire pressure is significantly low, or the TPMS has not been calibrated. If there is a problem with the TPMS, the indicator blinks for about one minute, and then stays on.

■ What to do when the indicator comes on

Drive carefully and avoid abrupt cornering and hard braking.

Stop your vehicle in a safe place. Check the tire pressure and adjust the pressure to the specified level. The specified tire pressure is on a label on the driver's side doorjamb.

▶ Calibrate the TPMS after the tire pressure is adjusted.

■ What to do when the indicator blinks, then remains on

Have the tire inspected by an authorized Honda Clarity Plug-In Hybrid dealer as soon as possible.

▶▶ If the Low Tire Pressure/TPMS Indicator Comes On or Blinks

NOTICE

Driving on an extremely underinflated tire can cause it to overheat. An overheated tire can fail. Always inflate your tires to the prescribed level.

If the Transmission System Indicator Blinks along with the Warning Message



Transmission
Problem Apply
Parking Brake
When Parked

■ Reasons for the indicator to blink

The transmission is malfunctioning.

■ What to do when the indicator blinks

- Immediately have your vehicle inspected by an authorized Honda Clarity Plug-In Hybrid dealer.
- Change the gear position to **N** when you turn the power system on.
 - ▶ Check if the **N** position in the instrument panel and the indicator on the **N** button light/blink.
 - ▶ The power system cannot be turned on unless the parking brake is set.
 - **Turning on the Power** P. 376

ⓘ If the Transmission System Indicator Blinks along with the Warning Message

You may not be able to turn on the power system.

Make sure to set the parking brake when parking your vehicle.

Call a professional towing service if you need to tow your vehicle.

➤ **Emergency Towing** P. 561

Fuse Locations

If any electrical devices are not working, set the power mode to VEHICLE OFF (LOCK), and check to see if any applicable fuse is blown.

Engine Compartment Fuse Box

There are three fuse boxes in the engine compartment. Fuse locations are shown on the fuse box cover. Locate the fuse in question by the fuse number and box cover number.

■ Fuse box A

Located near the windshield washer reservoir. Push the tabs to open the box.

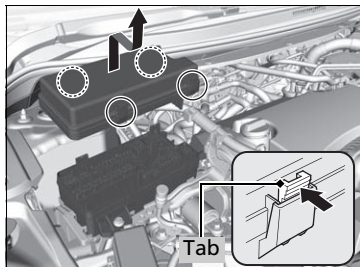

■ Circuit protected and fuse rating

	Circuit Protected	Amps
1	BATTERY	175 A
	EPS	70 A
	ESB	40 A
	IG MAIN (SMART)	30 A
2	ABS/SA MOTOR	40 A
	WIPER MOTOR 1	30 A
	ABS/SA FSR	40 A
	–	30 A
3	Engine EWP	30 A
	SUB FUSE BOX 2-1	30 A
	SUB FUSE BOX 3-2	30 A
	IG MAIN 2	30 A
4	IG COIL	15 A
5	H/L LO MAIN	15 A
6	EVTC	20 A
7	DTWP	10 A
8	DBW	15 A
9	VBU	10 A
10	STOP LIGHT	7.5 A
11	IGP	15 A

	Circuit Protected	Amps	
12	FUSE BOX MAIN 1	60 A	
	FUSE BOX MAIN 2	40 A	
	FUSE BOX MAIN 3	50 A	
	H/L HI MAIN	30 A	
	SMALL MAIN	20 A	
	SUB FUSE BOX 4	(30 A)	
	–	30 A	
	WIPER MOTOR 2	30 A	
	–	30 A	
	–	30 A	
	13	HEATER MOTOR	40 A
	14	REAR DEFROSTER	40 A
15	–	–	
16	BATT SNSR	7.5 A	
17	ES EWP	15 A	
18	A/C MAIN/DRL	10 A	
19	ES VLV	7.5 A	
20	HORN	10 A	
21	BACK UP	10 A	
22	AUDIO	15 A	
23	IGPS (LAF)	10 A	
24	R H/L LO	7.5 A	
25	L H/L LO	7.5 A	
26	IGPS	10 A	

■ Fuse box B

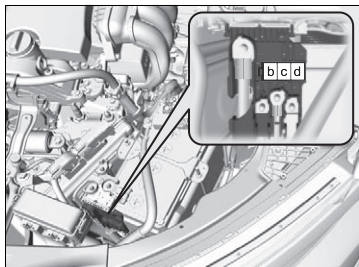
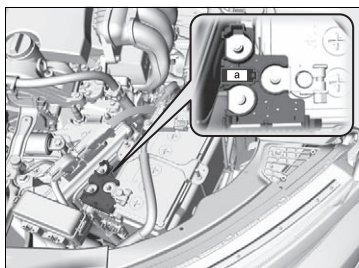
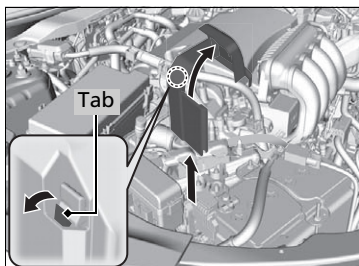

Pull up the cover on the ⊕ terminal, then remove it while pulling out the tab as shown.

Replacement of engine compartment fuses should be done by an authorized Honda Clarity Plug-In Hybrid dealer.

■ Circuit protected and fuse rating

	Circuit Protected	Amps
a	MAIN	200 A
b	RB MAIN 1	70 A
c	RB MAIN 2	80 A
d	GLOW	60 A

■ **Fuse Box C**

Located near the fuse box B.

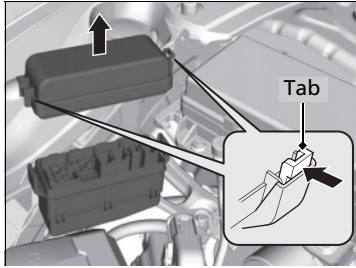

Fuse locations are shown on the fuse box cover. Locate the fuse in question by the fuse number and box cover number.

■ **Circuit protected and fuse rating**

	Circuit Protected	Amps
1	RFC1	30 A
2	RFC2	30 A
3	P-ACT	30 A
4	IGB RFC1	7.5 A
5	IGB RFC2	7.5 A

■ Driver's Side Interior Fuse Box

There are four fuse boxes on the driver's side.

■ Fuse Box A

Located under the dashboard.

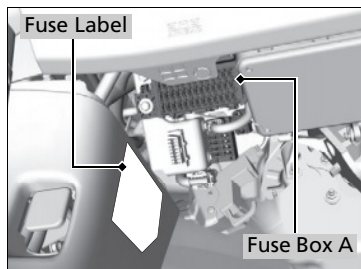

Fuse locations are shown on the label on the under panel.

Locate the fuse in question by the fuse number and label number.

■ Circuit protected and fuse rating

	Circuit Protected	Amps
1	ACC	7.5 A
2	–	–
3	VB SOL	10 A
4	SHIFTER	7.5 A
5	OPTION MAIN	15 A
6	SRS OPTION	7.5 A
7	METER	10 A
8	FUEL PUMP	15 A
9	OPTION	7.5 A
10	CTR ACC SOCKET	20 A
11	–	–
12	R SIDE DOOR LOCK	10 A
13	L SIDE DOOR UNLOCK	10 A
14	RR L P/W	20 A
15	AS P/W	20 A
16	DOOR LOCK	20 A
17	P-DRV	7.5 A
18	–	–
19	WASHER	15 A
20	–	–

	Circuit Protected	Amps
21	ACG	7.5 A
22	DRL	7.5 A
23	–	10 A
24	FR SENSOR CAMERA	5 A
25	DR DOOR LOCK	10 A
26	R SIDE DOOR UNLOCK	10 A
27	RR R P/W	20 A
28	DR P/W	20 A
29	FR ACC SOCKET	20 A
30	INTERIOR LIGHT	7.5 A
31	DR P/SEAT REC	20 A
32	FR SEAT HEATER	20 A
33	DR P/SEAT SLI	20 A
34	ABS/VSA	7.5 A
35	SRS	10 A
36	–	–
37	LID ACT	10 A
38	L SIDE DOOR LOCK	10 A
39	DR DOOR UNLOCK	10 A

■ Fuse Box B

Located under the fuse box A.

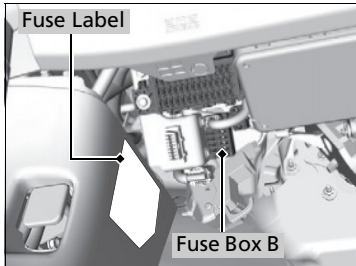

Fuse locations are shown on the label on the under panel.

Locate the fuse in question by the fuse number and label number.

■ Circuit protected and fuse rating

	Circuit Protected	Amps
c	QC CNT	(10 A)
d	R H/L HI	7.5 A
e	L H/L HI	7.5 A
f	IGC	10 A
g	HAZARD	10 A
h	IGB	15 A
i	SMART	10 A
j	IGA	10 A

■ **Fuse Box C**

Located on the right side of fuse box B.

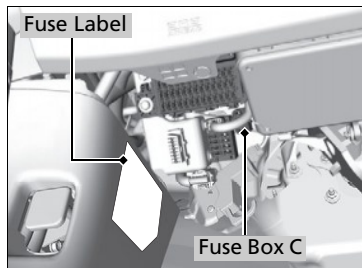

Fuse locations are shown on the label on the under panel.

Locate the fuse in question by the fuse number and label number.

■ **Circuit protected and fuse rating**

	Circuit Protected	Amps
k	AS P/SEAT REC	(20 A)
l	AS P/SEAT SLIDE	(20 A)
m	ILLUMI	7.5 A
n	SMALL	7.5 A

■ Fuse Box D

Located inside the driver's side outer panel.

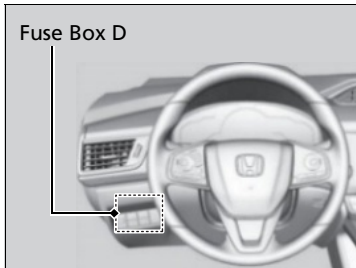

Replacement of fuses in the driver's side outer panel should be done by an authorized Honda Clarity Plug-In Hybrid dealer.

■ Circuit protected and fuse rating

	Circuit Protected	Amps
p	COMBO	(10 A)
q	IGMG	(7.5 A)
r	SHIFTER	7.5 A
s	P-ACT DRV	7.5 A
t	–	–
u	EPP	(7.5 A)
v	OPTION	7.5 A
w	ESB	7.5 A

Inspecting and Changing Fuses

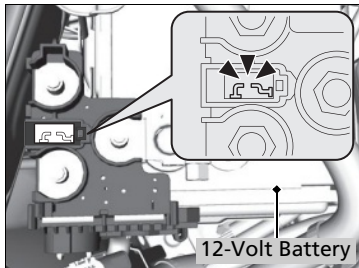

1. Set the power mode to VEHICLE OFF (LOCK). Turn headlights and all accessories off.
2. Check the fuses on the battery in the engine compartment.
 - ▶ If the fuse is blown, have it replaced by an authorized Honda Clarity Plug-In Hybrid dealer.
3. Remove the fuse box cover.
4. Check the large fuse in the engine compartment.
 - ▶ If the fuse is blown, use a Phillips-head screwdriver to remove the screw, and replace it with a new one.

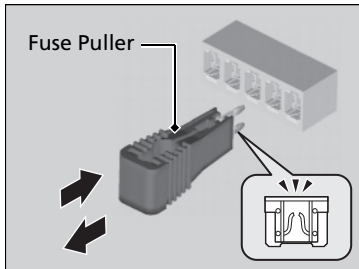
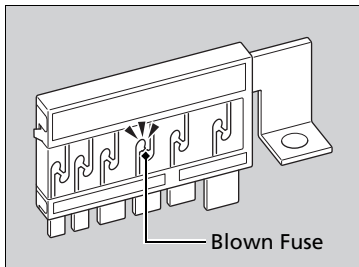

5. Inspect the small fuses in the engine compartment and the vehicle interior.
 - ▶ If there is a blown fuse, remove it with the fuse puller, and replace it with a new one.

Inspecting and Changing Fuses

NOTICE

Replacing a fuse with one that has a higher rating greatly increases the chances of damaging the electrical system.

Replace the fuse with a spare fuse of the same specified amperage. Confirm the specified amperage using the charts on P. 553 to 559.

There is a fuse puller on the back of the cover of the engine compartment fuse box A.

Emergency Towing

Call a professional towing service if you need to tow your vehicle.

■ Flat bed equipment

The operator loads your vehicle on the back of a flat bed truck.

This is the only way you can safely transport your vehicle.

Any other towing method will damage the vehicle's drive system.

Emergency Towing

NOTICE

Trying to lift or tow your vehicle by the bumpers will cause serious damage. The bumpers are not designed to support the vehicle's weight.

NOTICE

Improper towing, such as towing behind a motorhome or other motor vehicle can damage the transmission.

Never tow your vehicle with just a rope or chain. It is very dangerous since ropes or chains may shift from side to side or break.

Do not use the hook on the rear of your vehicle for the towing of other vehicles or emergency removal of your vehicle. The hook may break.

If your vehicle needs to be towed backward, contact an authorized Honda Clarity Plug-In Hybrid dealer or a professional towing service.

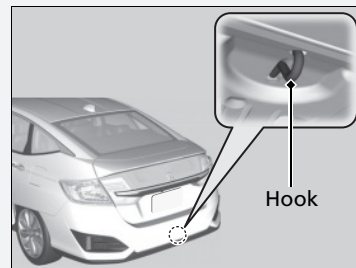

When You Cannot Unlock the Fuel Fill Door

■ What to Do When Unable to Unlock the Fuel Fill Door

If you cannot open the fuel fill door, use the following procedure.



1. Open the trunk and pull off the left inside cover.

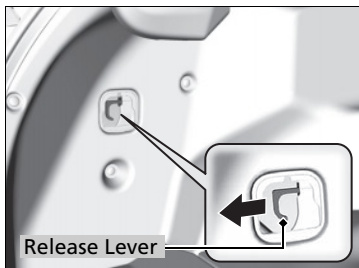

2. Pull the release lever towards you.
 - ▶ The release lever opens the fuel fill door when it is pulled.
3. Slowly remove the fuel fill cap by turning it to the left. If you hear a release of pressure, wait until it stops, then continue to slowly remove the fuel fill cap.

➤ **How to Refuel** P. 452

4. Add fuel very slowly.
 - ▶ The automatic fuel tank vent valve does not operate when the fuel fill door is opened manually. Trying to add fuel too rapidly when the vent valve is closed will cause fuel vapors to be pushed out the filler pipe and can cause a small amount of liquid fuel to be spilled onto the ground.

ⓘ When You Cannot Unlock the Fuel Fill Door

⚠ WARNING

Gasoline vapors in tank are under pressure.

- If using the manual fuel door release, open the cap slowly to gradually release pressure.
- Stop the engine, and keep all sparks, heat, and flame away.

The automatic fuel tank vent does not operate when using the manual fuel door release. Gradually release pressure by slowly turning the fuel fill cap to the left. If you hear a release of fuel vapors, wait until it stops, then continue to slowly remove the fuel fill cap.

The malfunction indicator lamp may come on when driving after you have refueled by manually opening the fuel fill door.

➤ **If the Malfunction Indicator Lamp Comes On or Blinks** P. 547

After taking these steps, contact an authorized Honda Clarity Plug-In Hybrid dealer to have the vehicle checked.

What to Do When Unable to Open the Charge Lid

If you cannot open the charge lid, use the following procedure:

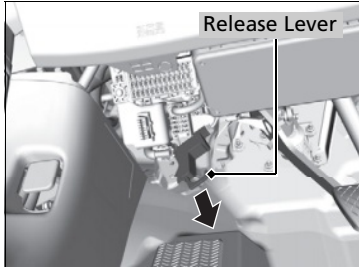

1. Pull the release lever under the lower left corner of the dashboard.
 - ▶ The lid will pop up slightly.

When You Cannot Open the Charge Lid

After taking this step, contact an authorized Honda Clarity Plug-In Hybrid dealer to have the vehicle checked.

■ What to Do When Unable to Open the Trunk

If you cannot open the trunk, use the following procedure:

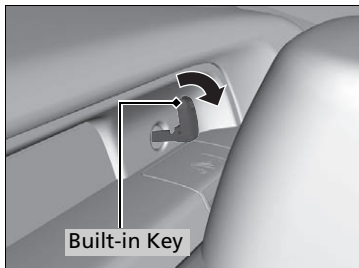

1. Insert the built-in key into the cylinder and turn the key clockwise (as shown).
 - ▶ The trunk unlocks and opens.

▣ When You Cannot Open the Trunk

Following up:

After taking these steps, contact an authorized Honda Clarity Plug-In Hybrid dealer to have your vehicle checked.

Information

This chapter includes your vehicle's specifications, locations of identification numbers, and other information required by regulation.

Specifications	566
Identification Numbers	
Vehicle Identification Number (VIN), Engine Number, Motor Number, and Transmission Number.....	568
Devices that Emit Radio Waves	569
Reporting Safety Defects	571
Emissions Testing	572
Testing of Readiness Codes.....	572
Warranty Coverages	573
Authorized Manuals	576
Customer Service Information	577

Specifications

■ Vehicle Specifications

Model	CLARITY PLUG-IN HYBRID	
No. of Passengers:		
Front	2	
Rear	3	
Total	5	
Weights:		
Gross Vehicle Weight	U.S.:	4,965 lbs (2,252 kg)
Rating	Canada:	2,252 kg
Gross Axle Weight	U.S.:	2,579 lbs (1,170 kg)
Rating (Front)	Canada:	1,170 kg
Gross Axle Weight	U.S.:	2,460 lbs (1,116 kg)
Rating (Rear)	Canada:	1,116 kg

■ Air Conditioning

Refrigerant Type	HFO-1234yf (R-1234yf)	
Charge Quantity	13.9 – 15.7 oz (395 – 445 g)	
Lubricant Type	SE-A2 (POE)	
Quantity	8.54 – 10.4 cu-in (140 – 170 cc)	

■ Engine Specifications

Displacement	91.4 cu-in (1,498 cm ³)	
Spark Plugs	NGK	DILZKAR7C11H

■ Fuel

Type	Unleaded gasoline, Pump octane number of 87 or higher
Fuel Tank Capacity	7.0 US gal (26.5 L)

■ Washer Fluid

Tank Capacity	1.43 US qt (1.35 L)
---------------	---------------------

■ Light Bulbs

Headlights (Low Beam)	LED
Headlights (High Beam)	LED
Front Turn Signal Lights	LED
Front Side Marker Lights	LED
Parking/Daytime Running Lights	LED
Taillights/Rear Side Marker Lights	LED
Brake Lights	LED
Taillights	LED
Back-Up Lights	LED
Rear Turn Signal Lights	LED
High-Mount Brake Light	LED
Rear License Plate Light	LED
Interior Lights	
Front and Rear Map Lights	LED
Front and Rear Ambient Lights	LED
Vanity Mirror Lights	1.4 W
Center Console Light	LED
Glove Box Light	LED
Front Foot Lights*	LED
Trunk Light	LED
Charge Indicator Light	LED

■ Brake Fluid

Specified	Honda Heavy Duty Brake Fluid DOT 3
-----------	------------------------------------

■ Transmission Fluid

Specified	Honda Automatic Transmission Fluid ATF DW-1	
Capacity	Change	2.23 US qt (2.11 L)

■ Engine Oil

Recommended	-Genuine Honda Motor Oil 0W-20 -API Premium-grade 0W-20 detergent oil	
	Change	3.3 US qt (3.1L)
Capacity	Change including filter 3.5 US qt (3.3L)	

■ Engine Coolant

Specified	Honda Long Life Antifreeze/Coolant Type2	
Ratio	50/50 with distilled water	
Capacity	1.31 US gal (4.97 L)	
	(change including the remaining 0.14 US gal (0.52 L) in the reserve tank)	

■ High Voltage Battery System Coolant

Specified	Honda Long Life Antifreeze/Coolant Type2
-----------	--

■ Inverter Coolant

Specified	Honda Long Life Antifreeze/Coolant Type2
-----------	--

■ Tire

Regular	Size	235/45R18 94V
	Pressure psi (kPa [kgf/cm ²])	36 (250 [2.5])
Wheel Size	Regular	18 x 8J

Vehicle Identification Number (VIN), Engine Number, Motor Number, and Transmission Number

Your vehicle has a 17-digit vehicle identification number (VIN) used to register your vehicle for warranty purposes, for licensing, and insuring your vehicle. The locations of your vehicle's VIN, engine number, motor number, and transmission number are shown as follows:

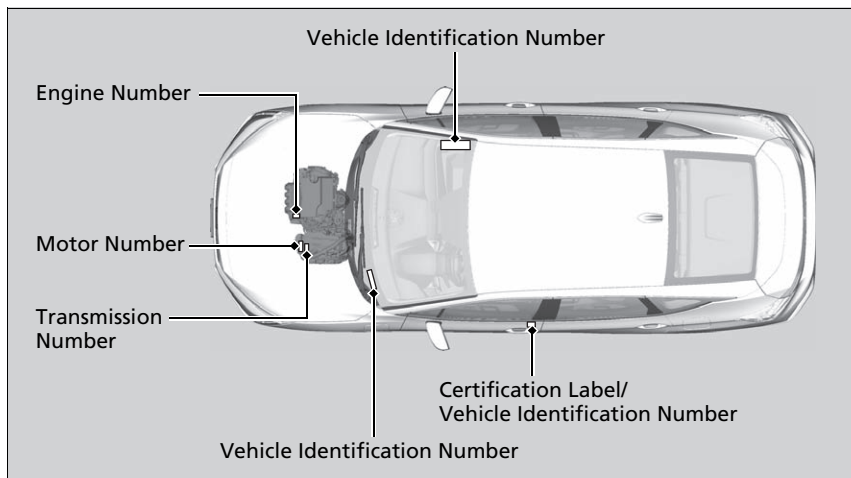

Vehicle Identification Number (VIN), Engine Number, Motor Number, and Transmission Number

The vehicle identification number (VIN) is located under the cover.

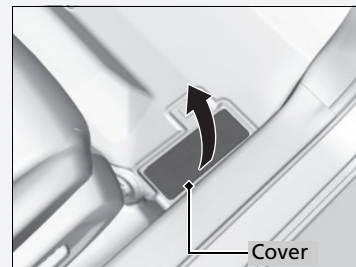

Devices that Emit Radio Waves

The following products and systems on your vehicle emit radio waves when in operation.

Adaptive Cruise Control (ACC) with Low Speed Follow (LSF)

Audio System

Bluetooth® Audio

Bluetooth® HandsFreeLink®

Charging Cable

Collision Mitigation Braking System™

HomeLink® Universal Transceiver*

Immobilizer System

Smart Entry System

Wi-Fi

Each of the above complies with the appropriate requirements or the required standards of FCC (Federal Communications Commission) and Industry Canada Standard, described below:

As required by the FCC:

This device complies with Part 15 of the FCC rules. Operation is subject to the following two conditions: (1) This device may not cause harmful interference, and (2) this device must accept any interference received, including interference that may cause undesired operation.

Changes or modifications not expressly approved by the party responsible for compliance could void the user's authority to operate the equipment.

* Not available on all models

This device complies with Industry Canada licence-exempt RSS standard(s).

Operation is subject to the following two conditions: (1) this device may not cause interference, and (2) this device must accept any interference, including interference that may cause undesired operation of the device.

In the U.S.

If you believe that your vehicle has a defect which could cause a crash or could cause injury or death, you should immediately inform the National Highway Traffic Safety Administration (NHTSA) in addition to notifying American Honda Motor Co., Inc.

If NHTSA receives similar complaints, it may open an investigation, and if it finds that a safety defect exists in a group of vehicles, it may order a recall and remedy campaign. However, NHTSA cannot become involved in individual problems between you, your dealer, or American Honda Motor Co., Inc.

To contact NHTSA, you may call the Vehicle Safety Hotline toll-free at 1-888-327-4236 (TTY: 1-800-424-9153); go to <http://www.safercar.gov>; or write to: Administrator, NHTSA, 1200 New Jersey Avenue, SE., Washington, DC 20590. You can also obtain other information about motor vehicle safety from <http://www.safercar.gov>.

In Canada

If you believe that your vehicle has a defect which could cause a crash or could cause injury or death, you should immediately inform Honda Canada Inc. and you may also inform Transport Canada.

If Transport Canada receives similar complaints, it may open an investigation, and if it finds that a safety defect exists in a group of vehicles, it may lead to a recall and remedy campaign. However, Transport Canada cannot become involved in individual problems between you, your dealer, or Honda Canada Inc.

To contact Transport Canada's Defect Investigations and Recalls Division, you may call 1-800-333-0510. For more information on reporting safety defects or about motor vehicle safety, go to <http://www.tc.gc.ca/roadsafety>.

Testing of Readiness Codes

Your vehicle has readiness codes as part of the onboard self diagnostic system. Some states use these codes for testing to verify whether your vehicle's emissions components are working properly. The codes may not be read properly if testing is performed just after the 12-volt battery has gone dead or been disconnected.

To check if they are set, set the power mode to ON, without turning the power system on. The malfunction indicator lamp will come on for several seconds. If it then goes off, the readiness codes are set. If it blinks five times, the readiness codes are not set.

If you are required to have your vehicle tested before the readiness codes are ready, prepare the vehicle for retesting by doing the following:

1. Fill the gas tank to approximately 3/4 full.
2. Park the vehicle and leave the power system off for 6 hours or more.
3. Make sure the ambient temperature is between 40°F and 95°F (4°C and 35°C).
4. Turn the power system on.
5. Use the **HV** button to select HV or HV Charge.
 - ❏ **HV Button** P. 16
6. Select a nearby, lightly traveled major highway where you can maintain a speed of 50 mph (80 km/h) over for at least 20 minutes. Drive on the highway in **[D]** with SPORT mode. Do not use cruise control.
7. Drive in city or suburban traffic for at least 10 minutes. When traffic conditions allow, let the vehicle coast for several seconds without using the accelerator pedal or the brake pedal.
8. Park the vehicle and leave the power system off for 40 minutes.

❏ Testing of Readiness Codes

The readiness codes are erased when the 12-volt battery is disconnected, and set again only after several days of driving under a variety of conditions.

If a testing facility determines that the readiness codes are not set, you may be requested to return at a later date to complete the test.

If the testing facility determines the readiness codes are still not set, see an authorized Honda Clarity Plug-In Hybrid dealer.

■ U.S. Owners

Your new vehicle is covered by these warranties:

New Vehicle Limited Warranty – covers your new vehicle, except for the emissions control systems and accessories, against defects in materials and workmanship.

Powertrain Limited Warranty – the powertrain in your new Honda is covered by a limited warranty. The duration of warranty coverage may vary. Please read your warranty booklet for details.

High Voltage Battery Capacity Warranty – gradual capacity loss of the high voltage battery is expected and not covered under warranty. Greater than normal degradation is covered and can be determined by an authorized Honda Clarity Plug-In Hybrid dealer. Please read your warranty booklet for details.

Emissions Control Systems Defects Warranty and Emissions Performance Warranty – these two warranties cover your vehicle's emissions control systems. Time, mileage, and coverage are conditional. Please read your warranty booklet for exact information.

Seat Belt Limited Warranty – a seat belt that fails to function properly is covered by a limited warranty. Please read your warranty booklet for details.

Rust Perforation Limited Warranty – all exterior body panels are covered against rusting from the inside out for the specified time period, regardless of mileage.

Accessory Limited Warranty – Honda accessories are covered under this warranty. Time and mileage limits depend on the type of accessory and other factors. Please read your warranty booklet for details.

Replacement Parts Limited Warranty – covers all Honda replacement parts against defects in materials and workmanship.

Replacement 12-Volt Battery Limited Warranty – provides prorated coverage for a replacement battery purchased from an authorized Honda Clarity Plug-In Hybrid dealer.

Replacement Muffler Lifetime Limited Warranty – provides coverage for as long as the purchaser of the muffler owns the vehicle.

Tire Warranty – the original tires are warranted by their manufacturer. Your Honda automobile dealer will be glad to assist you in contacting the tire's manufacturer, if needed. Please read your warranty booklet for details.

Restrictions and exclusions apply to all these warranties. Please read the Honda warranty information booklet that came with your vehicle for precise information on warranty coverages. Your vehicle's original tires are covered by their manufacturer. Tire warranty information is in a separate booklet.

■ **Canadian Owners**

Please refer to the warranty manual that came with your vehicle.

■ **EPA Contact Information**

An owner may obtain further information concerning emission warranties or report violations of the terms of the emission warranties by contacting:

U.S. Environmental Protection Agency
Office of Transportation and Air Quality
Compliance Division, Light-Duty Vehicle Group
Attn: Warranty Complaints
2000 Traverwood Drive
Ann Arbor, MI 48105
Email: complianceinfo@epa.gov

■ Service Express

For electronic copies of service publications, you can purchase a subscription to Service Express. Visit www.techinfo.honda.com for pricing and options.

■ For U.S. Owners

Manuals can be purchased from Helm Incorporated. You can order a manual by phone at 1 (800) 782-4356 (credit card orders only), or online at www.helminc.com.

■ For Canadian Owners

Please contact a dealer to order any manuals that you may require.

Honda dealership personnel are trained professionals who should be able to deal with any problems you may encounter with your vehicle. If, however, you are faced with a problem that they cannot resolve to your satisfaction, contact Honda Customer Services.

U.S. Owners

American Honda Motor Co., Inc.
Honda Automobile Customer Services
Mail Stop 100-5E-8A
1919 Torrance Blvd.
Torrance, CA 90501-2746
Tel: 1 (800) 999-1009

Canadian Owners

Honda Canada Inc.
Customer Relations 180 Honda Boulevard
Markham, ON
L6C 0H9
Tel: 1-888-9-HONDA-9
Fax: 1-877-939-0909
E-mail: Honda_cr@ch.honda.com

Customer Service Information

When you call or write, please give us the following information:

- Vehicle Identification Number
 - ▣ **Vehicle Identification Number (VIN), Engine Number, Motor Number, and Transmission Number** P. 568
- Date of purchase
- Odometer reading of your vehicle
- Your name, address, and telephone number
- A detailed description of the problem
- Name of the dealer who sold the vehicle to you

■ Disclaimer of Pandora®*

Requirements to access Pandora®

- Latest version of the Pandora app installed on your Android, Blackberry, or iPhone.
- Registered Pandora account (you can create a free account at www.pandora.com <<http://www.pandora.com/>> or on your smartphone)
- Connection to the internet via Wi-Fi or cellular data network.

Limitations

- Access to Pandora requires an active internet connection
- Ability to access Pandora through this system is subject to change without notice
- Certain functionality of Pandora service is not available when accessing the service through this system including, but not limited to, creating new stations, deleting stations, emailing current stations, buying tracks, viewing additional text information, logging in to Pandora, and adjusting Cell Network Audio Quality. Pandora internet radio is a music service not affiliated with HONDA. More information is available at <http://www.pandora.com> <<http://www.pandora.com/>>. Pandora, the Pandora logo, and the Pandora trade dress are trademarks or registered trademarks of Pandora Media, Inc., used with permission.
- Mobile access requires a smartphone with an active data plan. Standard data rates may apply.
- Pandora is only available in the United States.

Numbers

120V AC (AC Level 1)	456
12-Volt Battery Charging System	
Indicator	90
240V AC (AC Level 2)	459

A

ABS (Anti-lock Brake System)	437
Accessories and Modifications	519
Accessory Power Sockets	189
Acoustic Vehicle Alerting System	393
Adaptive Cruise Control (ACC) with Low	
Speed Follow (LSF)	400
Indicator	100
Additives	
Coolant	488
Engine Oil	482
Washer	493
Additives, Engine Oil	482
Adjusting	
Armrest	182
Front Seats	175
Head Restraints	178
Mirrors	173
Steering Wheel	172
Temperature	126
Agile Handling Assist	424
Air Conditioning System (Climate Control	
System)	193
Changing the Mode	195
Defrosting the Windshield and	
Windows	197
Dust and Pollen Filter	512
Sensors	201
Synchronized Mode	198
Using Automatic Climate Control	193
Air Pressure	500, 567
Airbags	54
Advanced Airbags	60
Airbag Care	68
Driver's Knee Airbag	61
Event Data Recorder	0
Front Airbags (SRS)	57
Indicator	66, 94
Passenger Front Airbag Off Indicator	67
Sensors	54
Side Airbags	63
Side Curtain Airbags	65
AM/FM Radio	243
Android Auto	280
Anti-lock Brake System (ABS)	437
Indicator	93
Apple CarPlay	277
Armrest	182
Audio Remote Controls	207
Audio System	204, 210
Adjusting the Sound	236
Audio/Information Screen	211
Changing the Home Screen Icon Layout ..	219
Changing the Screen Interface	233
Closing Apps	235
Customizing the Meter	219
Display Setup	237
Error Messages	284
General Information	288
Home Screen	225
Limitations for Manual Operation	238
Menu Customize	234
MP3/WMA/AAC	264
Reactivating	206
Recommended Devices	290
Remote Controls	207
Security Code	206
Selecting an Audio Source	238
Status Area	232
Theft Protection	206
USB Flash Drives	290
USB Port	205
Voice Control Operation	239
Wallpaper Setup	223
Audio/Information Screen	211
Authorized Manuals	576
Auto Door Locking/Unlocking	149
Automatic Brake Hold	435
Indicator	87, 435
Automatic Brake Hold System	
Indicator	87, 435
Automatic Lighting	163
Average Fuel Economy	126
Average Fuel Economy Records	129
Average Speed	127

- B**
- Battery** 466
 - 12-Volt 508
 - 12-Volt Battery Charging System
 - Indicator 90, 546
 - Charging (12-Volt Battery) 509
 - Charging (High Voltage Battery) 454
 - High Voltage 466
 - Jump Starting 539
 - Maintenance (Checking the 12-Volt Battery) 508
 - Maintenance (Replacing) 510
 - Belts (Seat)** 47
 - Beverage Holders** 187
 - Bluetooth® Audio** 267
 - Bluetooth® HandsFreeLink®** 335
 - Booster Seats (For Children)** 81
 - Brake System** 431
 - Anti-lock Brake System (ABS) 437
 - Automatic Brake Hold 435
 - Brake Assist System 438
 - Fluid 492
 - Foot Brake 433
 - Indicator (Red) 550
 - Parking Brake 431
 - Brake System (Amber)**
 - Indicator 88
 - Brake System (Red)**
 - Indicator 86, 87, 548
 - Bulb Replacement** 494
 - Front Turn Signal and Front Side Marker Lights 494
 - Headlights 494
 - High-Mount Brake Light 495
 - Parking/Daytime Running Lights 494
 - Rear License Plate Lights 495
 - Taillights and Back-Up Lights 495
 - Taillights/Rear Side Marker, Brake and Rear Turn Signal Lights 495
 - Bulb Specifications** 566
- C**
- Carbon Monoxide Gas** 82
 - Carrying Cargo** 371, 373
 - Certification Label** 568
 - Changing Bulbs** 494
 - Charge Connector** 457, 460
 - Charge Lid** 457, 460
 - Charge Lid Release Button** 456, 459
 - Charge Timer Setting** 467
 - Charging (High Voltage Battery)** 454
 - 120V AC (AC Level 1) 456
 - 240V AC (AC Level 2) 459
 - Cannot Start Charging 463
 - Charge Connector 457, 460
 - Charge Indicator (vehicle side) 465
 - Charge Lid 457, 460
 - Control Box 461
 - High Voltage Battery 466
 - Timer 467
 - Charging System Indicator** 546
 - Child Safety** 69
 - Childproof Door Locks 148
 - Child Seat** 69
 - Booster Seats 81
 - Child Seat for Infants 71
 - Child Seat for Small Children 72
 - Installing a Child Seat with a Lap/Shoulder Seat Belt 76
 - Larger Children 80
 - Rear-facing Child Seat 71
 - Selecting a Child Seat 73
 - Using a Tether 78
 - Childproof Door Locks** 148
 - Cleaning the Exterior** 515
 - Cleaning the Interior** 513
 - Climate Control System** 193
 - Changing the Mode 195
 - Defrosting the Windshield and Windows 197
 - Dust and Pollen Filter 512
 - Sensors 201
 - Using Automatic Climate Control 193
 - Clock** 136
 - CMBS™ (Collision Mitigation Braking System™)** 439
 - Coat Hook** 190
 - Collision Mitigation Braking System™ (CMBS™)** 439
 - Console Compartment** 186

Control Box	461
Controls	135
Coolant (Engine)	488
Adding to the Radiator	489
Adding to the Reserve Tank	488
Overheating	542
Creeping (Transmission)	381
Cup Holders	187
Customer Service Information	577
Customized Features	133, 306

D

Daytime Running Lights	165
Dead Battery (12-Volt)	539
Deceleration Paddle Selector	390
Deceleration Paddle Selector Indicator	91
Defrosting the Windshield and Windows	197
Devices that Emit Radio Waves	569
Dimming	
Headlights	162
Rearview Mirror	173
Dipstick (Engine Oil)	483
Directional Signals (Turn Signal)	161
Display Button	211
Door Mirrors	174
Doors	137
Auto Door Locking	149
Auto Door Unlocking	149
Door Open Message	46

Keys	137
Locking/Unlocking the Doors from the Inside	25, 146
Locking/Unlocking the Doors from the Outside	139
Lockout Prevention System	145
DOT Tire Quality Grading	502
Drive Cycle Score/Lifetime Points	131
Driver Information Interface	124
Driver's Knee Airbag	61
Driving	369
Braking	431
Shifting Gear	382
Transmission	381
Turning on the Power	376
Driving Position Memory System	170
Dust and Pollen Filter	512

E

Eco Assist® System	20
Eco Drive Display	130
ECON Mode	388
Elapsed Time	127
Electric Power Steering (EPS) System	
Indicator	94
Electronic Stability Control (ESC)	422
Emergency	561
Emissions Testing (Readiness Codes)	572
Energy Flow Screen	215

Engine

Coolant	488
Oil	482
Engine Coolant	488
Adding to the Radiator	489
Adding to the Reserve Tank	488
Overheating	542
Engine Oil	482
Adding	484
Checking	483
Recommended Engine Oil	482
EPS (Electric Power Steering) System	94
EV Indicator	89
Exhaust Gas Hazard (Carbon Monoxide) ..	82
Expanded View Driver's Mirror	174
Exterior Care (Cleaning)	515
Exterior Mirrors	174

F

Features	203
Filters	
Dust and Pollen	512
Oil	485
Flat Tire	522
Floor Mats	514
Fluids	
Brake	492
Engine Coolant	488
Transmission	492
Windshield Washer	493

FM/AM Radio	243
Foot Brake	433
Front Airbags (SRS)	57
Front Seat Heaters	191
Front Seats	175
Adjusting	175
Front Sensor Camera	394
Fuel	33, 451
Fuel Economy and CO ₂ Emissions	469
Gauge	121
Instant Fuel Economy	127
Range	121
Recommendation	451
Refueling	451
Requirement	566
Fuel Economy and CO ₂ Emissions	469
Fuel Fill Cap	33, 452
Fuel Fill Door	33, 452
Fuses	553
Inspecting and Changing	560
Locations	553, 556
G	
Gasoline (Fuel)	
Economy	469
Information	451
Refueling	451
Gauges	121
Gear Position Indicator	91, 384

Gear Shift Positions	
Transmission	382
Glass (care)	514, 516
Glove Box	185

H

Handling the Unexpected	521
HandsFreeLink® (HFL)	335
Automatic Import of Cellular Phonebook and Call History	348
Displaying Messages	362
HFL Buttons	335
HFL Menus	338
HFL Status Display	337
In Case of Emergency	366
Limitations for Manual Operation	337
Making a Call	356
Options During a Call	359
Phone Setup	343
Phonebook Phonetic Modification	352
Receiving a Call	359
Receiving a Text Message/E-mail	360
Ring Tone	347
Selecting a Mail Account	361
Speed Dial	349
To Set Up Text Message/E-mail Options	346
Hazard Warning Button	6
HD Radio™	243
Head Restraints	178

Headlights	162
Aiming	494
Automatic Operation	163
Dimming	162, 165
Operating	162
Heated Door Mirror Button	169
Heaters (Seat)	191
HFL (HandsFreeLink®)	335
High Beam Indicator	97
High Voltage Battery	466
Charging	454
High Voltage Battery Charge Level	
Gauge	123
Hill Start Assist System	379
Home Screen	225
HomeLink® Universal Transceiver	332
Honda App License Agreement	291
Honda Sensing™	34
HondaLink®	269
HV Button	16
HV Charge	17
HV Charge Indicator	89
HV Indicator	89

I

Identification Numbers	
Motor, and Transmission	568
Vehicle Identification	568
Immobilizer System	153
Indicator	97

Indicators	86	Seat Belt Reminder	49, 93	Types and Functions.....	137
12-Volt Battery Charging System	90, 546	Security System Alarm	98	Kickdown	381
Adaptive Cruise Control (ACC) with		SPORT Mode	98, 389		
Low Speed Follow (LSF).....	100, 400	Supplemental Restraint System	66, 94	L	
Anti-lock Brake System (ABS)	93	System Message	98	Lane Keeping Assist System (LKAS)	415
Automatic Brake Hold.....	87, 435	Transmission System.....	92	LaneWatch™	429
Automatic Brake Hold System	87, 435	Turn Signal and Hazard Warning	97	Language (HFL)	337
Collision Mitigation Braking System™		Vehicle Stability Assist (VSA®)		LATCH (Child Seats)	74
(CMBS™)	101, 102	System.....	95, 422	Lights	162, 494
Deceleration Paddle Selector	91	VSA® OFF	95, 423	Automatic.....	163
ECON Mode	98	Information	565	Bulb Replacement	494
Electric Power Steering (EPS) System	94	Instant Fuel Economy	127	Daytime Running Lights.....	165
EV.....	89	Instrument Panel	85	High Beam Indicator.....	97
Gear Position	91	Interior Lights	183	Interior	183
High Beam	97	Interior Rearview Mirror	173	Light Switches	162
HV	89	iPod	255	Lights On Indicator.....	97
HV Charge.....	89			Turn Signals	161
Immobilizer System	97	J		Load Limits	373
Lane Keeping Assist System		Jacking Points	534	Locking/Unlocking	137
(LKAS).....	101, 417	Jump Starting	539	Auto Door Locking/Unlocking.....	149
Lights On	97			Childproof Door Locks.....	148
Low Fuel	91	K		From Inside	146
Low Tire Pressure/TPMS	96, 425, 427	Key Number Tag	138	From Outside	139
Malfunction Indicator Lamp	90	Keyless Lockout Prevention	145	Keys.....	137
Parking Brake and Brake System		Keys	137	Using a Key	144
(Amber)	88, 550	Lockout Prevention.....	145	Lockout Prevention System	145
Parking Brake and Brake		Number Tag	138	Low Battery Charge (12-Volt)	546
System (Red).....	86, 87, 548, 550	Rear Door Won't Open	148	Low Fuel Indicator	91
POWER SYSTEM	88	Remote Transmitter	143	Low Smart Entry Remote Signal	
READY	90			Strength	138
Road Departure Mitigation (RDM)	99				

Lower Anchors.....	74
Luggage (Maximum Load Limit).....	373

M

Maintenance.....	471
12-Volt Battery.....	508
Brake Fluid.....	492
Cleaning.....	513
Climate Control System.....	511
Coolant.....	488
Maintenance Minder™.....	475
Oil.....	483
Precautions.....	472
Radiator.....	489
Remote Transmitter.....	510
Replacing Light Bulbs.....	494
Safety.....	473
Service Items.....	477
Tires.....	499
Transmission Fluid.....	492
Under the Hood.....	480
Malfunction Indicator Lamp.....	90
Map Lights.....	184
Maximum Load Limit.....	373
Meters, Gauges.....	121
Mirrors.....	173
Adjusting.....	173
Door.....	174
Exterior.....	174
Interior Rearview.....	173

Modifications (and Accessories).....	519
Motor.....	568
Jump Starting.....	539
MP3.....	264
Multi-View Rear Camera.....	449

N

Numbers (Identification).....	568
-------------------------------	-----

O

Odometer.....	126
Oil (Engine).....	482
Adding.....	484
Checking.....	483
Displaying Oil Life.....	475
Recommended Engine Oil.....	482
Viscosity.....	482
Warning.....	545
Open Source Licences.....	305
Opening.....	
Trunk.....	564
Opening/Closing.....	
Hood.....	481
Power Windows.....	156
Trunk.....	150
Operating the Switches Around the.....	
Steering Wheel.....	158
Outside Temperature Display.....	126
Overheating.....	542

P

Pandora®.....	262
Panic Mode.....	155
Parking.....	447
Parking Brake.....	431
Parking Brake and Brake System.....	
Indicator (Red).....	550
Passenger Front Airbag Off Indicator.....	67
Passing Indicators.....	162
Playing Bluetooth® Audio.....	267
POWER Button.....	158
Power Flow Monitor.....	132
Power System.....	
Turning on.....	376
POWER SYSTEM Indicator.....	88
Power Windows.....	156
POWER/CHARGE Gauge.....	122
Precautions While Driving.....	
Rain.....	380
Pregnant Women.....	52
Puncture (Tire).....	522

R

Radiator.....	489
Radio (FM/AM).....	243
Radio (SiriusXM®).....	247
Radio Data System (RDS).....	245
Range.....	121, 129
RDS (Radio Data System).....	245
Readiness Codes (Emissions Testing).....	572

READY Indicator	90
Rear Defogger Button	169
Rear Seats	181
Rearview Mirror	173
Refueling	451
Fuel	566
Fuel Gauge	121
Gasoline	451
Regulations	427, 464, 502, 569
Remote Transmitter	143
Replacement	
Battery	510
Bulbs	494
Fuses	553, 556
Tires	505
Wiper Blade Rubber	496
Reporting Safety Defects	571
Resetting a Trip Meter	126
Road Departure Mitigation (RDM)	396
On and Off	398
S	
Safe Driving	41
Safety Checklist	46
Safety Labels	83
Safety Message	4
Seat Belts	47
Adjusting the Shoulder Anchor	51
Automatic Seat Belt Tensioners	49
Checking	53

Fastening	50
Installing a Child Seat with a Lap/Shoulder Seat Belt	76
Pregnant Women	52
Reminder	49, 93
Warning Indicator	49, 93
Seat Heaters	191
Seats	175
Adjusting	175
Front Seats	175
Rear Seats	181
Seat Heaters	191
Security System	153
Immobilizer System Indicator	97
Security System Alarm Indicator	98
Selecting a Child Seat	73
Setting the Clock	136
Shift Button	31, 382
Operation	384
Shifting (Transmission)	31, 382
Shoulder Anchor	51
Side Airbags	63
Side Curtain Airbags	65
Siri Eyes Free	276
SiriusXM® Radio	247, 288
Smart Entry System	139
Snow Tires	507
Song By Voice™ (SBV)	258
Specifications	566
Specified Fuel	451, 566

SPORT HYBRID i-MMD Plug-in (Intelligent Multi-mode Drive Plug-in)	11
SPORT Mode	389
SPORT Mode Indicator	98, 389
SRS Airbags (Airbags)	57
Status Area	232
Steering Wheel	
Adjusting	172
Stopping	447
Summer Tires	507
Sunglasses Holder	192
Supplemental Restraint System (SRS)	57
Switches (Around the Steering Wheel)	6, 7, 158
Synchronization Mode	198
System Message Indicator	98

T

Telematics Control Unit	133
Temperature Sensor	201
Temporary Tire Repair Kit	523
Time (Setting)	136
Timer	467
Tire Pressure Monitoring System (TPMS)	425
Indicator	96, 551

- Tires 499
 Air Pressure 500, 567
 Chains 507
 Checking and Maintaining 499
 Flat Tire (Puncture) 522
 Inspection 499
 Labeling 500
 Regulations 502
 Rotation 506
 Summer 507
 Temporary Tire Repair Kit 523
 Wear Indicators 504
 Winter 507
- Towing a Trailer** 375
- Towing Your Vehicle** 375
 Emergency 561
- TPMS (Tire Pressure Monitoring System)** 425
- Transmission** 31, 381, 382
 Creeping 381
 Fluid 492
 Gear Position Indicator 91, 384
 Indicator 92
 Number 568
 Operating the Shift Button 31, 384
 Shifting 382
 Warning Message 552
- Trip Meter** 126
- Troubleshooting** 521
 Blown Fuse 553, 556
 Brake Pedal Vibrates 37
 Buzzer Sounds When Opening Door 37
 Cannot Start Charging 463
 Emergency Towing 561
 Flat Tire/Puncture 522
 Noise When Braking 39
 Overheating 542
 Power System Won't Start 535
 Rear Door Won't Open 37, 148
 Unable to Open the Charge Lid 563
 Unable to Unlock the Fuel Fill Door 562
 Warning Indicators 86
- Trunk** 150
 Lid 150
 Light Bulbs 566
 Unable to Open 564
- Turn Signals** 161
 Indicators (Instrument Panel) 97
- Turn-by-Turn Directions** 127
- Turning on the Power** 376
 Does Not Activate 535
 Jump Starting 539
- U**
- Under-Floor Storage Area** 190
- Unlocking the Doors** 139
- Unlocking the Front Doors from the Inside** 25, 146
- USB Flash Drives** 264, 290
- USB Ports** 205
- Using the Smart Entry with Push Button Start System** 139
- V**
- Vanity Mirrors** 9
- Vehicle Identification Number** 568
- Vehicle Monitoring System** 3
- Vehicle Stability Assist (VSA®)** 422
 Off Button 423
 Off Indicator 95, 423
 System Indicator 95, 422
- Viscosity (Oil)** 482
- Voice Control Operation** 239
 Audio Commands 241
 Climate Control Commands 242
 General Commands 242
 Music Search Commands 242
 On Screen Commands 242
 Phone Commands 241
 Useful Commands 241
 Voice Portal Screen 240
 Voice Recognition 239
- VSA® (Vehicle Stability Assist)** 422
- W**
- Wallpaper** 223
- Warning and Information Messages** 103
- Warning Indicator On/Blinking** 545
- Warning Labels** 83

Warranties (Warranty Manual provided separately)	573
Watts	566
Wear Indicators (Tire)	504
Wi-Fi Connection	274
Window Washers	166
Adding/Refilling Fluid	493
Switch	166
Windows (Opening and Closing)	156
Windshield	
Cleaning	514, 516
Defrosting/Defogging	197
Washer Fluid	493
Wiper Blades	496
Wipers and Washers	166
Winter Tires	
Snow Tires	507
Tire Chains	507
Wipers and Washers	166
Checking and Replacing Wiper Blades.....	496
WMA	264
Worn Tires	499



31TRW600
OM-06704
00X31-TRW-6000

owners.honda.com (U.S.)
myhonda.ca (Canada)

2018 Honda Clarity Plug-In Hybrid Owner's Manual
©2017 Honda Motor Co., Ltd. — All Rights Reserved

Printed in U.S.A.