

California Proposition 65 Warning

WARNING: This product contains or emits chemicals known to the state of California to cause cancer and birth defects or other reproductive harm.

Event Data Recorders

This vehicle is equipped with an event data recorder (EDR).

The main purpose of an EDR is to record, in certain crash or near crash-like situations, such as an air bag deployment or hitting a road obstacle, data that will assist in understanding how a vehicle's systems performed. **The EDR is designed to record data related to vehicle dynamics and safety systems for a short period of time, typically 30 seconds or less. The EDR in this vehicle is designed to record such data as:**

- **How various systems in your vehicle were operating;**
- **Whether or not the driver and passenger safety belts were buckled/fastened;**
- **How far (if at all) the driver was depressing the accelerator and/or brake pedal; and,**
- **How fast the vehicle was traveling.**

These data can help provide a better understanding of the circumstances in which crashes and injuries occur. NOTE: EDR data are recorded by your vehicle only if a non-trivial crash situation occurs; no data are recorded by the EDR under normal driving conditions and no personal data (e.g., name, gender, age, and crash location) are recorded. However, other parties, such as law enforcement, could combine the EDR data with the type of personally identifying data routinely acquired during a crash investigation.

To read data recorded by an EDR, special equipment is required, and access to the vehicle or the EDR is needed. In addition to the vehicle manufacturer, other parties, such as law enforcement, that have the special equipment, can read the information if they have access to the vehicle or the EDR.

The data belongs to the vehicle owner and may not be accessed by anyone else except as legally required or with the permission of the vehicle owner.

Service Diagnostic Recorders

This vehicle is equipped with service-related devices that record information about powertrain performance. The data can be used to verify emissions law requirements and/or help technicians diagnose and solve service problems. It may also be combined with data from other sources for research purposes, but it remains confidential.

California Perchlorate Contamination Prevention Act

The airbags, seat belt tensioners, and CR type batteries in this vehicle may contain perchlorate materials - special handling may apply. See www.dtsc.ca.gov/hazardouswaste/perchlorate/

As you read this manual, you will find information that is preceded by a **NOTICE** symbol. This information is intended to help you avoid damage to your vehicle, other property, or the environment.

A Few Words About Safety

Your safety, and the safety of others, is very important. And operating this vehicle safely is an important responsibility.

To help you make informed decisions about safety, we have provided operating procedures and other information on labels and in this manual. This information alerts you to potential hazards that could hurt you or others.

Of course, it is not practical or possible to warn you about all the hazards associated with operating or maintaining your vehicle. You must use your own good judgment.

You will find this important safety information in a variety of forms, including:

- **Safety Labels** - on the vehicle.
- **Safety Messages** - preceded by a safety alert symbol  and one of three signal words: **DANGER**, **WARNING**, or **CAUTION**. These signal words mean:

 **DANGER**

You WILL be KILLED or SERIOUSLY HURT if you don't follow instructions.

 **WARNING**

You CAN be KILLED or SERIOUSLY HURT if you don't follow instructions.

 **CAUTION**

You CAN be HURT if you don't follow instructions.

- **Safety Headings** - such as Important Safety Precautions.
- **Safety Section** - such as Safe Driving.
- **Instructions** - how to use this vehicle correctly and safely.

This entire book is filled with important safety information - please read it carefully.

This owner's manual should be considered a permanent part of the vehicle and should remain with the vehicle when it is sold.

This owner's manual covers all models of your vehicle. You may find descriptions of equipment and features that are not on your particular model.

Images throughout this owner's manual (including the front cover) represent features and equipment that are available on some, but not all, models. Your particular model may not have some of these features.

This owner's manual is for vehicles sold in the United States and Canada.

The information and specifications included in this publication were in effect at the time of approval for printing. Honda Motor Co., Ltd. reserves the right, however, to discontinue or change specifications or design at any time without notice and without incurring any obligation.

➤ Safe Driving P. 29

For Safe Driving P. 30 Seat Belts P. 35 Airbags P. 44

➤ Instrument Panel P. 71

Indicators P. 72 Gauges and Displays P. 88

➤ Controls P. 93

Clock P. 94 Locking and Unlocking the Doors P. 96
Opening and Closing the Windows P. 119
Operating the Switches Around the Steering Wheel P. 122
Interior Lights/Interior Convenience Items P. 150

➤ Features P. 175

Audio System P. 176 Audio System Basic Operation P. 182, 203
Customized Features P. 238 *Bluetooth*® HandsFreeLink® P. 260, 283

➤ Driving P. 313

Before Driving P. 314 Towing a Trailer P. 319
Parking Your Vehicle P. 371 Multi-View Rear Camera P. 372

➤ Maintenance P. 379

Before Performing Maintenance P. 380 Maintenance Minder™ P. 383
Checking and Maintaining Wiper Blades P. 407
Heating and Cooling System*/Climate Control System* Maintenance P. 424

➤ Handling the Unexpected P. 431

Tools P. 432 If a Tire Goes Flat P. 434
Overheating P. 449 Indicator, Coming On/Blinking P. 451 Fuses P. 456

➤ Information P. 465

Specifications P. 466 Identification Numbers P. 468
Emissions Testing P. 471 Warranty Coverages P. 473

Contents

Child Safety P. 57

Exhaust Gas Hazard P. 69

Safety Labels P. 70

Opening and Closing the Tailgate P. 113
Opening and Closing the Moonroof* P. 121
Adjusting the Mirrors P. 138
Heating and Cooling System* P. 161

Security System P. 116
Adjusting the Seats P. 140
Climate Control System* P. 165

Audio Error Messages P. 231

General Information on the Audio System P. 235

Off-Highway Driving Guidelines P. 323
Refueling P. 374

When Driving P. 325
Fuel Economy P. 376

Braking P. 363
Accessories and Modifications P. 377

Maintenance Under the Hood P. 387
Checking and Maintaining Tires P. 411
Cleaning P. 425

Replacing Light Bulbs P. 399
Battery P. 420

Remote Transmitter Care P. 422

Engine Does Not Start P. 443
Emergency Towing P. 461

Jump Starting P. 446
When You Cannot Open the Tailgate P. 462

Shift Lever Does Not Move P. 448

Devices that Emit Radio Waves P. 469
Authorized Manuals P. 475

Reporting Safety Defects P. 470
Customer Service Information P. 476

Quick Reference Guide P. 4

Safe Driving P. 29

Instrument Panel P. 71

Controls P. 93

Features P. 175

Driving P. 313

Maintenance P. 379

Handling the Unexpected P. 431

Information P. 465

Index P. 478

Visual Index

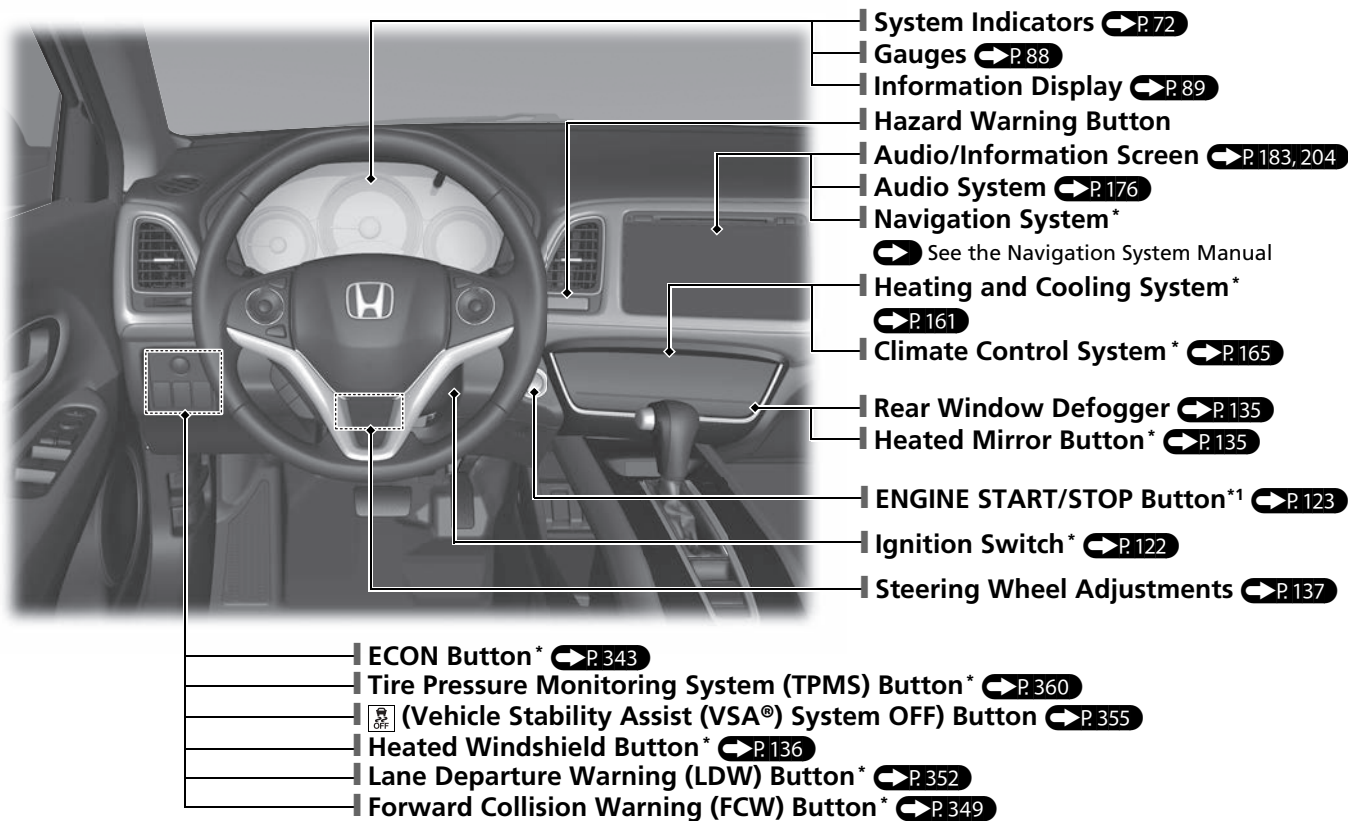

*1: Models with the smart entry system have an **ENGINE START/STOP** button instead of an ignition switch.

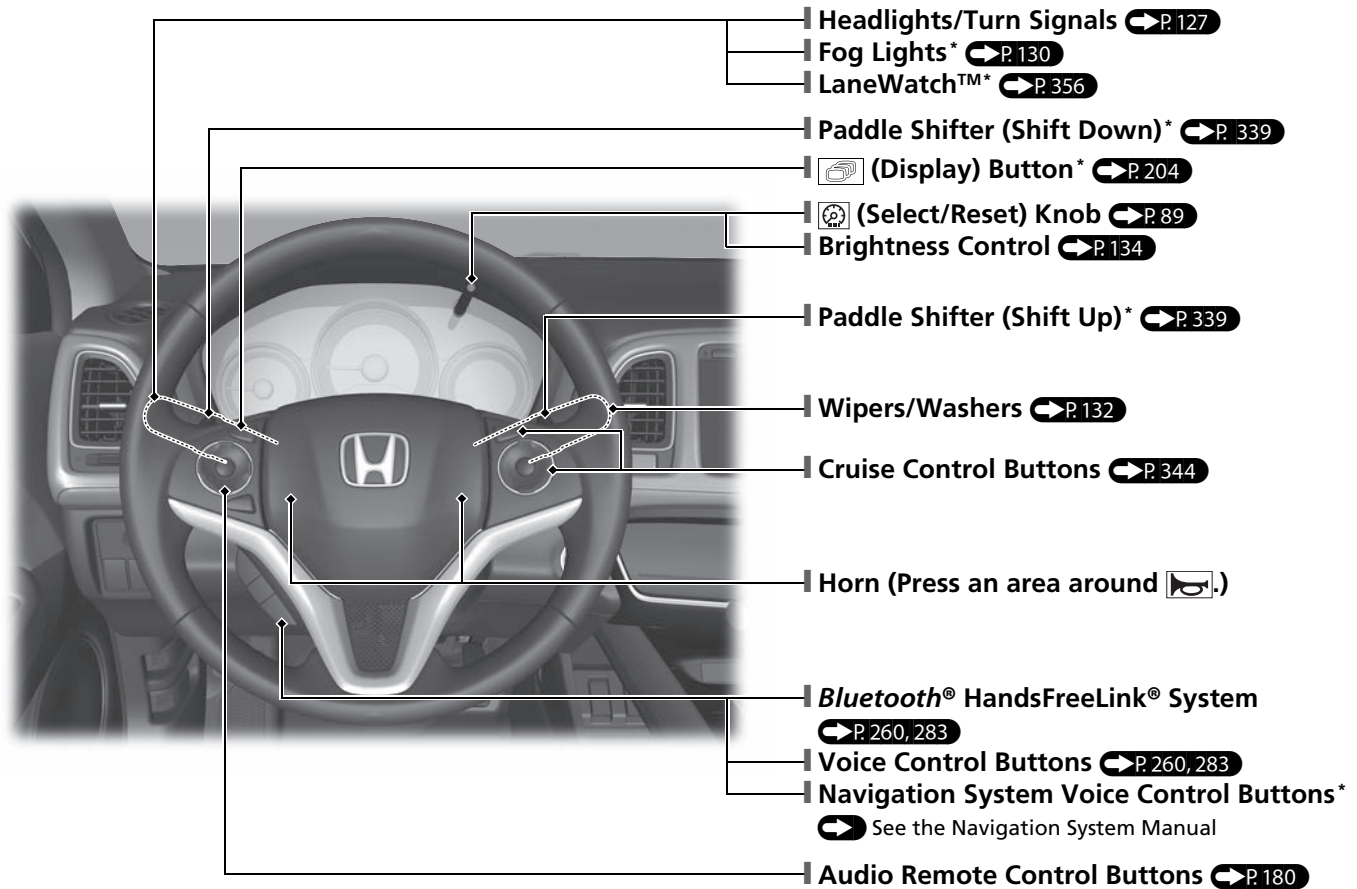

Visual Index

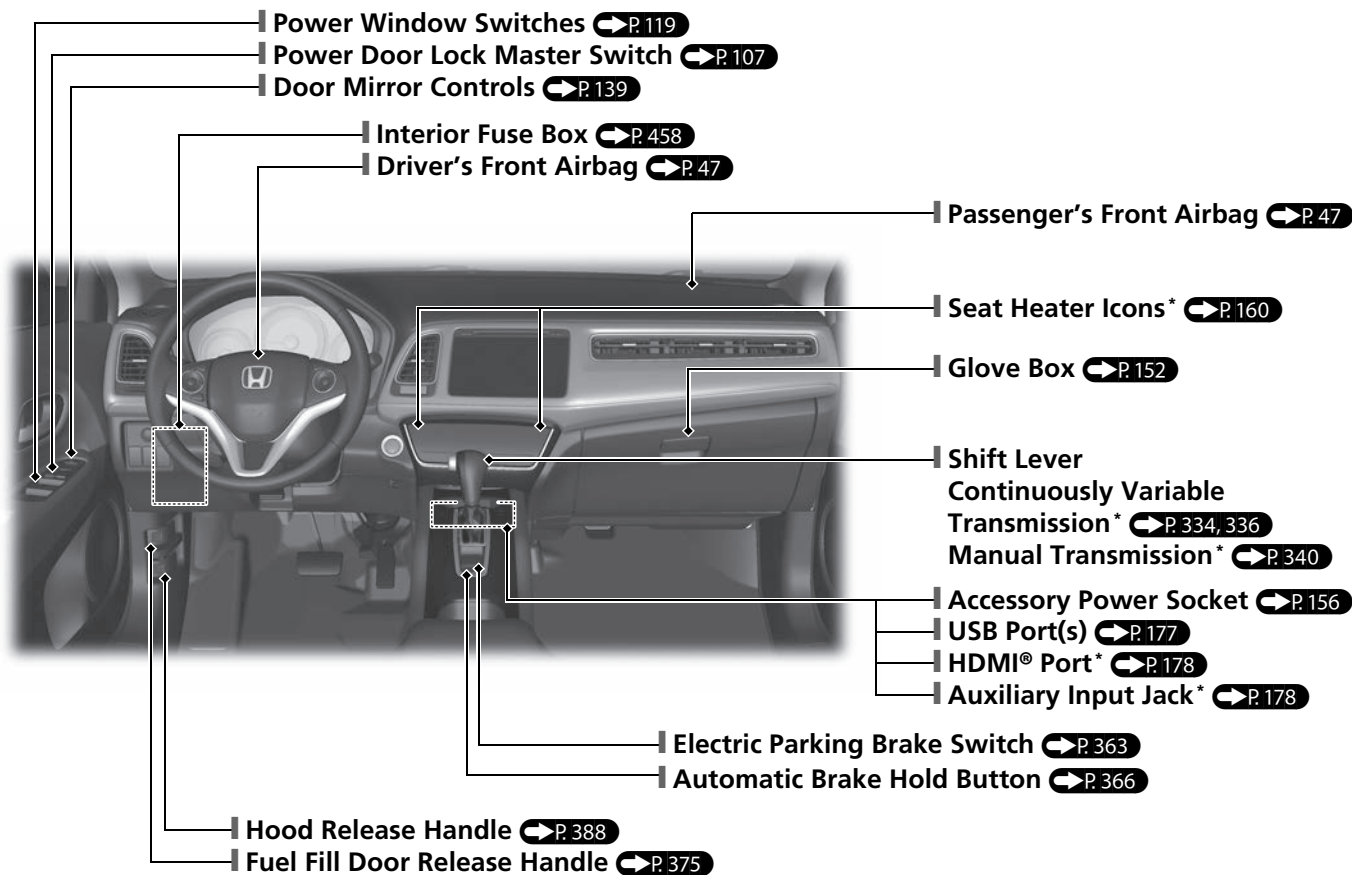

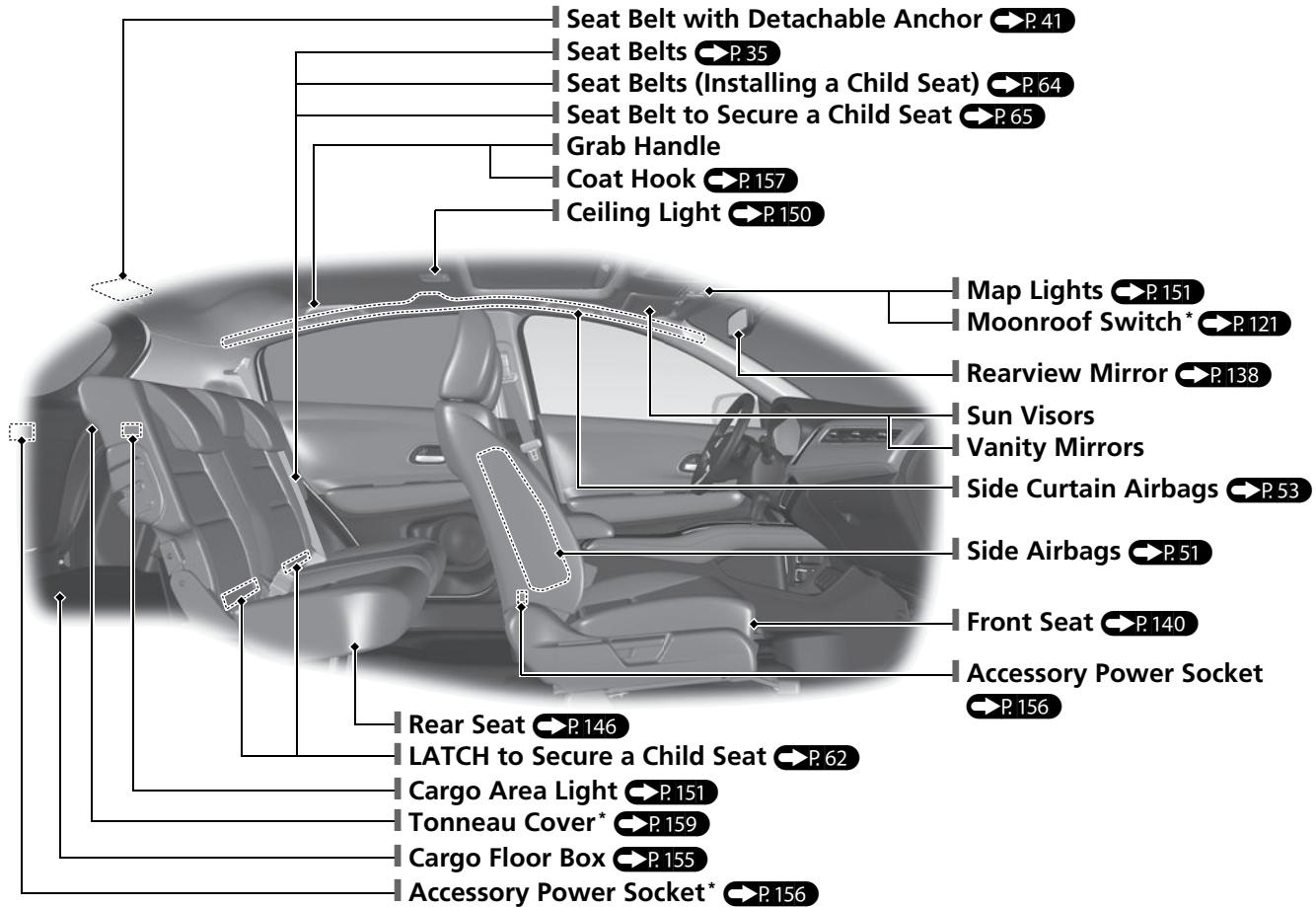

* Not available on all models

Visual Index

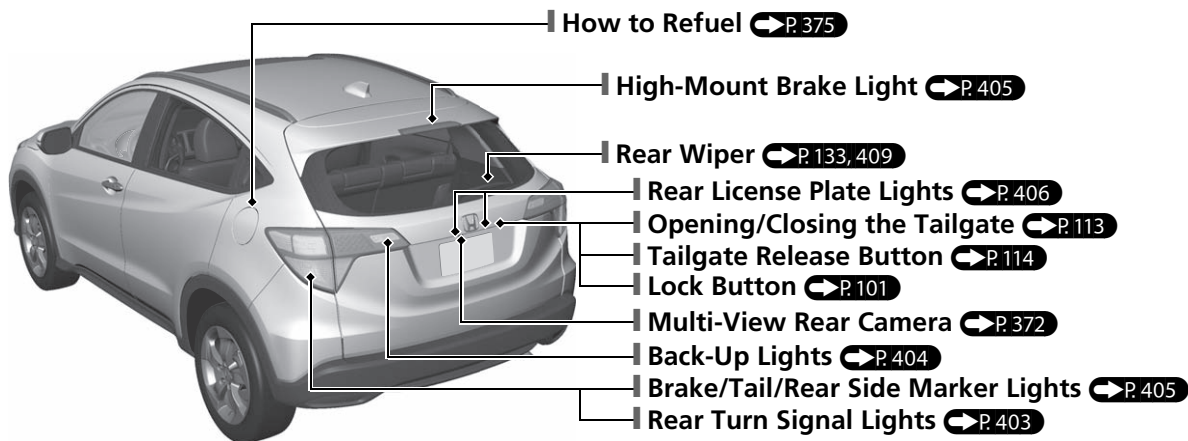
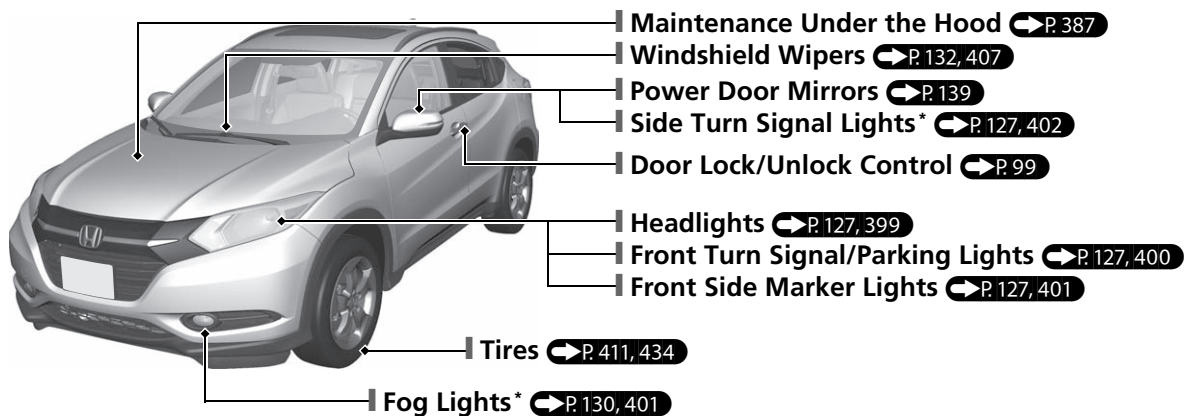

Eco Assist System

Ambient Meter

- Changes color to reflect your driving style.
 - Green:** Fuel efficient driving
 - Light green:** Moderate acceleration/deceleration
 - White:** Aggressive acceleration/deceleration
- The ambient meter color changes in accordance with your brake or accelerator pedal operation.
- You can change color while the vehicle is at a stop in ACCESSORY [1], LOCK [0] or VEHICLE OFF with the ambient meter on. Press the select/reset knob repeatedly; the color changes from white*1, blue, purple, pink, red, amber to yellow.

*1 : Default setting

➤ Changing Ring Color ➔ P.92

ECON Mode Indicator*

➔ P.81

Comes on when the ECON button is pressed.



ECON Button*

➔ P.343

Helps maximize your fuel economy.

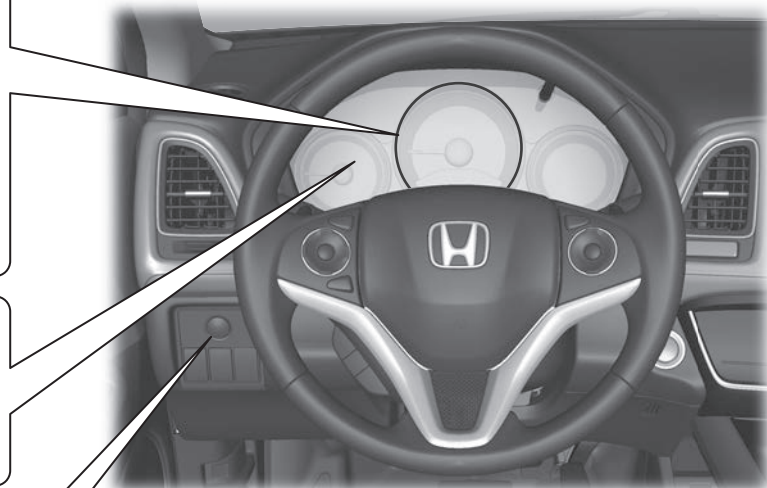

Safe Driving P. 29

Airbags P. 44

- Your vehicle is fitted with airbags to help protect you and your passengers during a moderate-to-severe collision.

Child Safety P. 57

- All children 12 and younger should be seated in the rear seat.
- Smaller children should be properly restrained in a forward-facing child seat.
- Infants must be properly restrained in a rear-facing child seat.

Exhaust Gas Hazard P. 69

- Your vehicle emits dangerous exhaust gases that contain carbon monoxide. Do not run the engine in confined spaces where carbon monoxide gas can accumulate.

Seat Belts P. 35

- Fasten your seat belt and sit upright well back in the seat.
- Check that your passengers are wearing their seat belts correctly.

Before Driving Checklist P. 314

- Before driving, check that the front seats, head restraints, steering wheel, and mirrors have been properly adjusted.

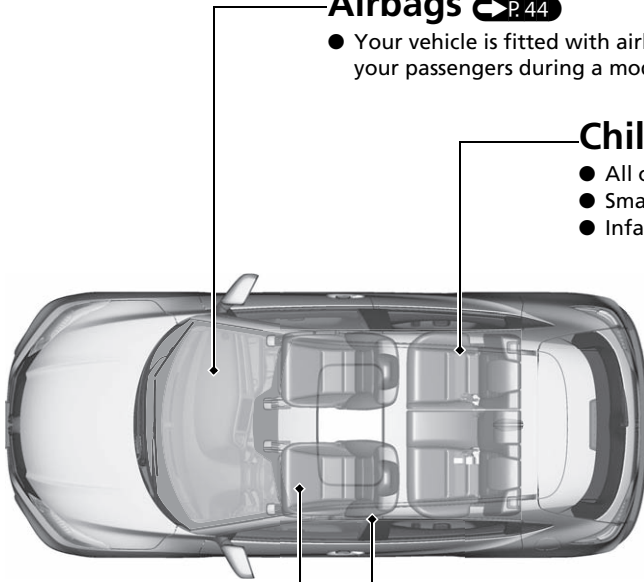



Fasten your lap belt as low as possible.













Instrument Panel P.71

Gauges P.88 / Information Display P.89 / System Indicators P.72

Lights Indicators



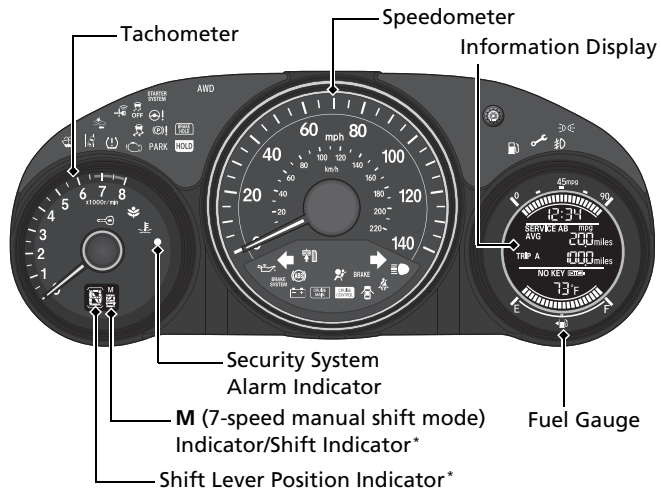

-  Fog Light Indicator*
-  High Beam Indicator
-  Lights On Indicator

System Indicators





-  Malfunction Indicator Lamp
-  Charging System Indicator
-  Low Oil Pressure Indicator
-  High Temperature Indicator (Red)
-  Low Temperature Indicator (Blue)
-  Vehicle Stability Assist (VSA®) System Indicator
-  VSA® OFF Indicator
-  Electric Power Steering (EPS) System Indicator
-  Automatic Brake Hold System Indicator
-  Automatic Brake Hold System Indicator
-  Automatic Brake Hold System Indicator
-  Electric Parking Brake System Indicator
-  Electric Parking Brake System Indicator















System Indicators

-  Maintenance Minder Indicator
-  Turn Signal and Hazard Warning Indicators
-  ECON Mode Indicator*
-  Forward Collision Warning (FCW) Indicator*
-  Lane Departure Warning (LDW) Indicator*

System Indicators

-  **CRUISE MAIN** Indicator
-  **CRUISE CONTROL** Indicator
-  **U.S. models only**
Low Tire Pressure/TPMS Indicator
-  **AWD** All-Wheel Drive (AWD) System Indicator*

System Indicators

-  Smart Entry System Indicator*
-  **STARTER SYSTEM** U.S. Starter System Indicator*
-  Supplemental Restraint System Indicator
-  Immobilizer System Indicator
-  Seat Belt Reminder Indicator
-  Door and Tailgate Open Indicator
-  Washer Level Indicator*
-  Anti-lock Brake System (ABS) Indicator
-  **BRAKE** U.S. Brake System Indicator (Red)
-  **BRAKE** U.S. Brake System Indicator (Amber)
-  Low Fuel Indicator
-  Continuously variable transmission models
Brake Depressing Indicator
-  Manual transmission models
Brake Depressing Indicator

* Not available on all models

Controls P.93

Clock P.94

Models with navigation system

The navigation system receives signals from GPS satellites, updating the clock automatically.

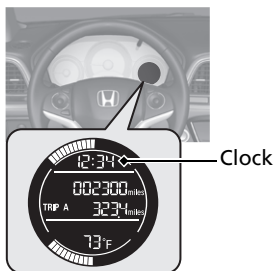

Models without navigation system



The clock in the information display is automatically updated along with the audio system's clock display.





Models with display audio system



- 1 Select the  (HOME) icon, then select **Settings**.
- 2 Select **System**, **Clock**, then **Clock Adjustment**.
- 3 Touch the  /  icon to adjust the numbers up or down.
- 4 Select **OK**.

Models with color audio system



- 1 Press and hold the **MENU/CLOCK** button.
- 2 Rotate  to change hour, then press .
- 3 Rotate  to change minute, then press .
- 4 Select **SET**, then press .

These indications are used to show how to operate the **LIST/SELECT** (List/Selector) knob.

- Rotate  to select.
- Press  to enter.

ENGINE START/STOP

Button* P.123

Press the button to change the vehicle's power mode.

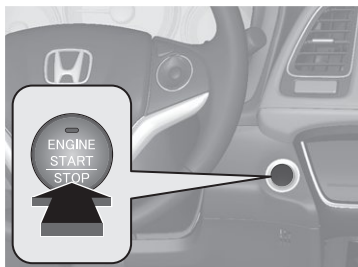

Turn Signals P.127

Turn Signal Control Lever

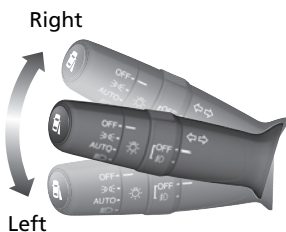

Lights P.127

Light Control Switches

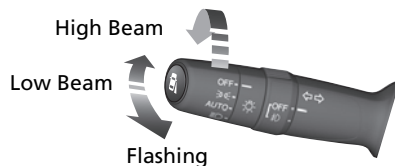

Wipers and Washers

P.132

Wiper/Washer Control Lever

Adjustment Ring*

- ↓: Lower speed, fewer sweeps
- ↑: Higher speed, more sweeps

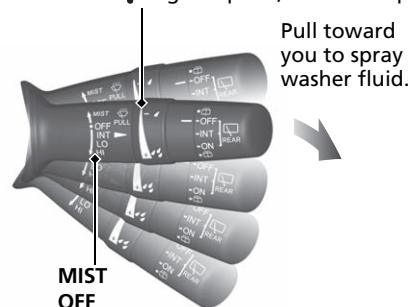

MIST
OFF

INT: Low speed with intermittent
LO: Low speed wipe
HI: High speed wipe

Steering Wheel P.137

- To adjust, pull the adjustment lever towards you, adjust to the desired position, then lock the lever back in place.

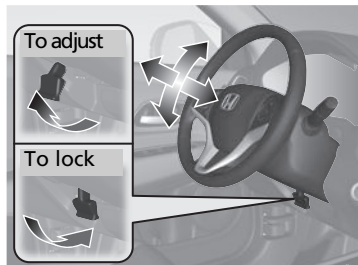

Unlocking the Front Doors from the Inside

 P.106

- Pull either front door inner handle to unlock and open it in one motion.

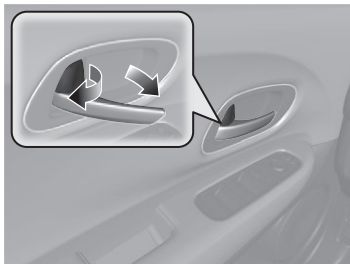

- Unlocking and opening the driver's door from the inner handle unlocks all the other doors.

Tailgate P.113

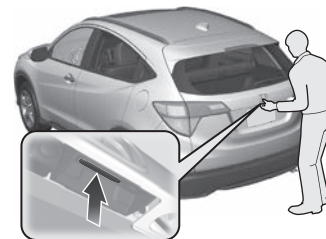

Models without smart entry system

- With all the doors unlocked, press the tailgate release button and lift open the tailgate.

Models with smart entry system

- Press the tailgate release button to unlock and open the tailgate when you carry the smart entry remote.

Power Door Mirrors

➔ P.139

- With the ignition switch in ON **II***1, move the selector switch to **L** or **R**.
- Push the appropriate edge of the adjustment switch to adjust the mirror.

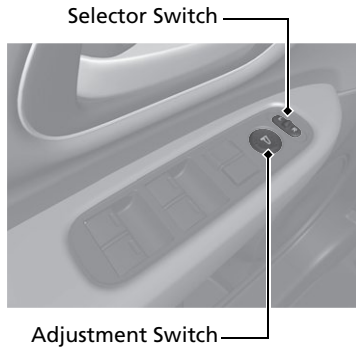





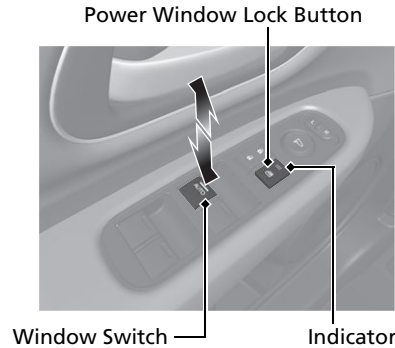

Power Windows ➔ P.119

- With the ignition switch in ON **II***1, open and close the power windows.
- If the power window lock button is in the off position, each passenger's window can be opened and closed with its own switch.
- If the power window lock button is in the on position (indicator on), each passenger's window switch is disabled.





*1: Models with the smart entry system have an **ENGINE START/STOP** button instead of an ignition switch.

Heating and Cooling System*

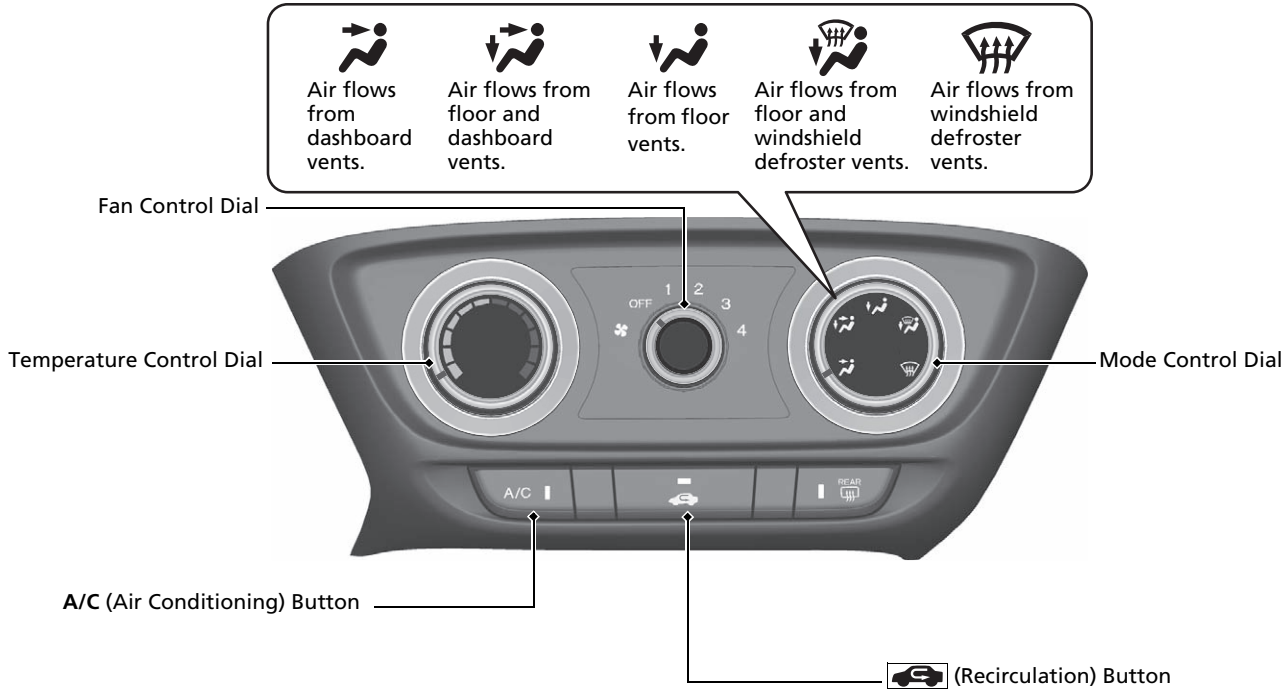
- Rotate the fan control dial to adjust the fan speed.
- Rotate the mode control dial ( /  /  /  / ) to select the vents air flows from.
- Rotate the temperature control dial to adjust the temperature.
- Rotate the fan control dial to **OFF** to turn the system off.
- Rotate the mode control dial to  to defrost the windshield.



Climate Control System*

- Select the **AUTO** icon to activate the climate control system.
 - Select the  icon to turn the system on or off.
 - Select the  icon to defrost the windshield.
 - The climate control system is voice operable.
-  See the Navigation System Manual for complete details.

Models without SYNC icon

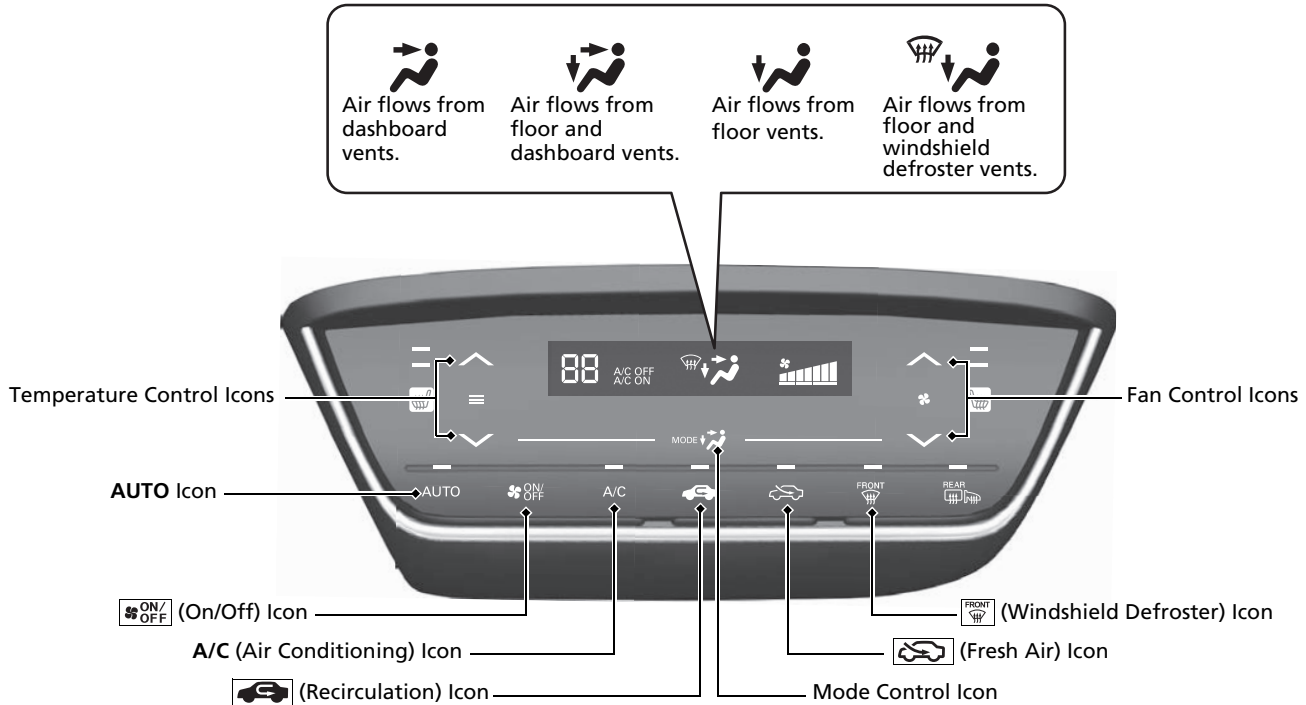

* Not available on all models

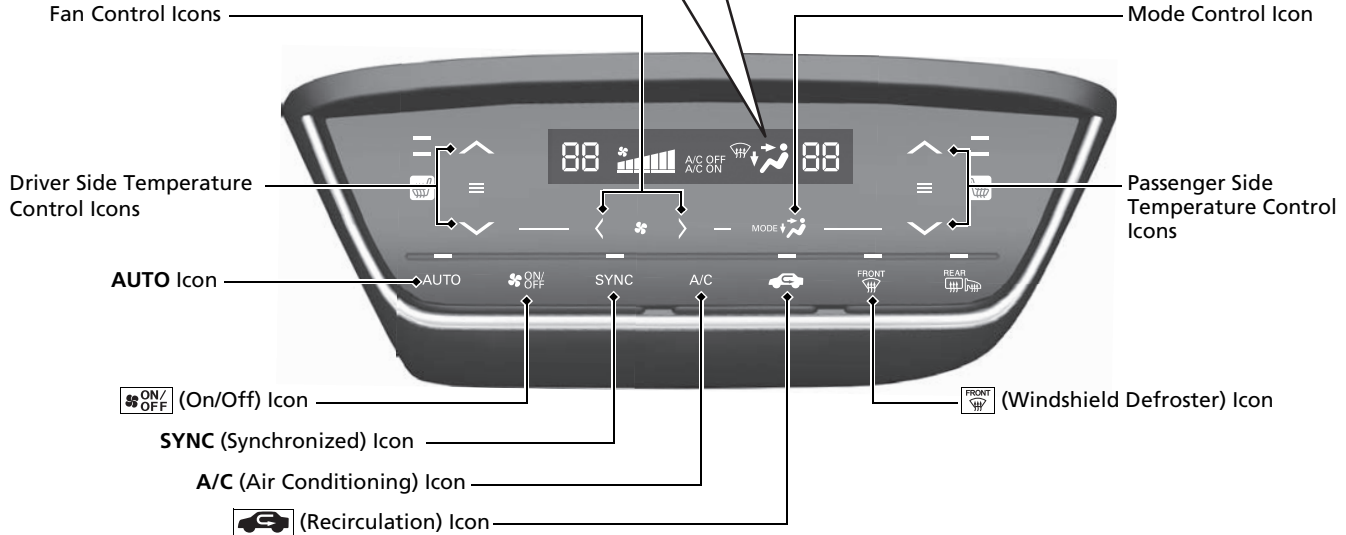
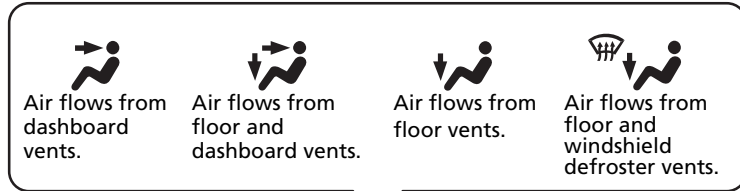

Features P.175



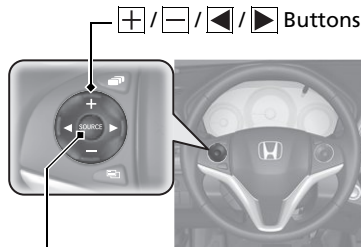

Models without navigation system

Audio Remote Controls

 P.180



SOURCE Button

-  /  **Button**
Press to adjust the volume up/down.
- **SOURCE Button**
Press to change the audio mode: FM/AM/CD/USB/iPod/Bluetooth/Pandora®/Aha™*/AUX.
-  /  **Button**
Radio: Press to change the preset station.
Press and hold to select the next or previous strong station.

CD/USB device:

Press to skip to the beginning of the next song or return to the beginning of the current song.
Press and hold to change a folder.

Audio System P.176

For navigation system operation  See the Navigation System Manual

Models with color audio system

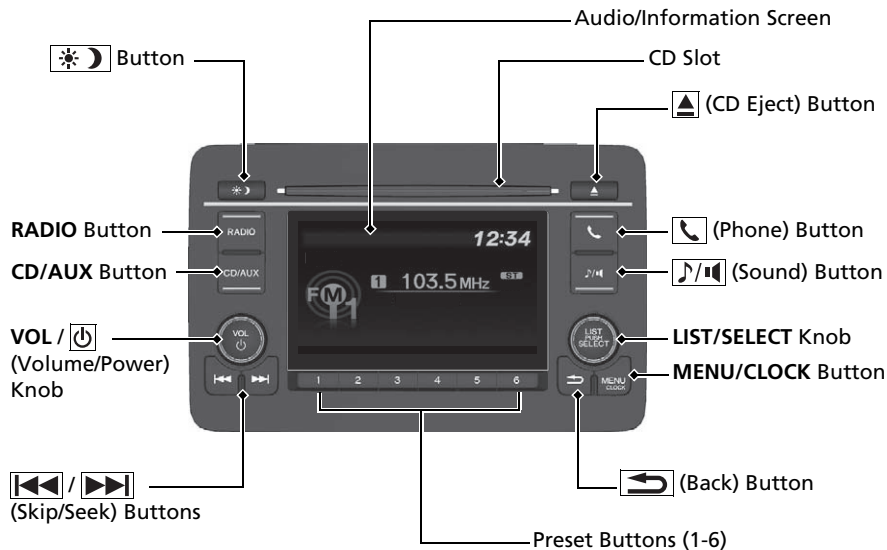

Models with display audio system

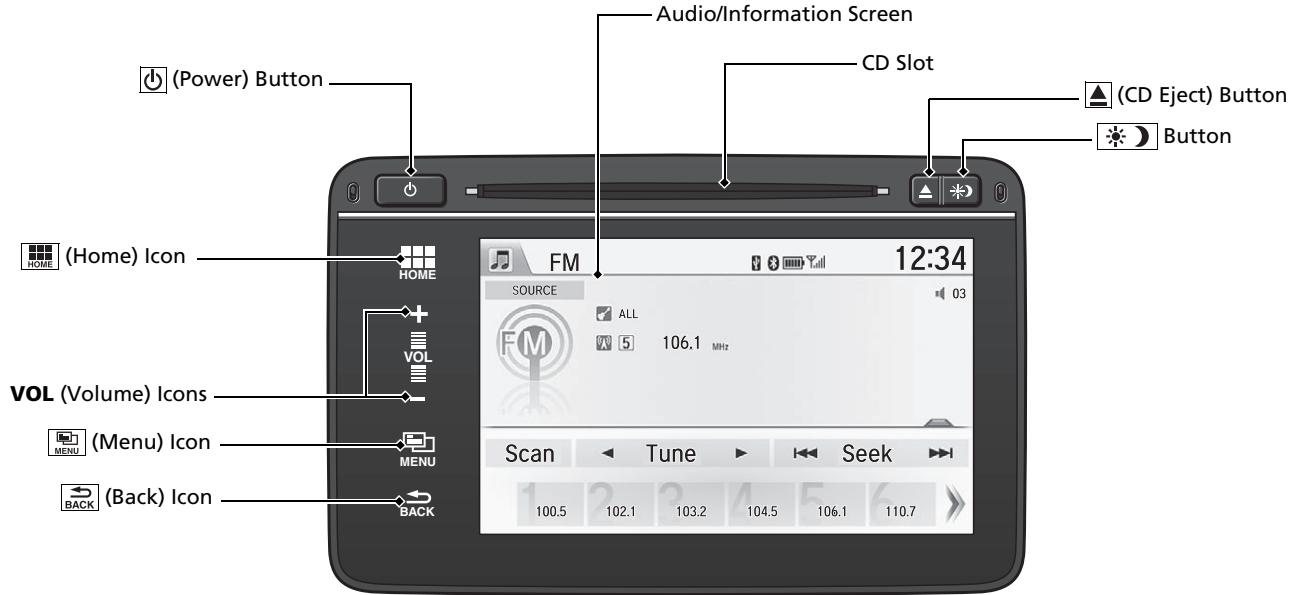

Driving ↔ P.313

Manual Transmission* ↔ P.340

Continuously Variable Transmission*

↔ P.334, 336

- Shift to **P** and depress the brake pedal when starting the engine.

Shifting

Models with
paddle shifters

Models without
paddle shifters

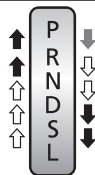

- ↓ Depress the brake pedal and press the release button to move out of **P**.
- ↕ Move the shift lever without pressing the release button.
- ↕ Press the release button to move the shift lever.

P **Park**
Turn off or start the engine.
Transmission is locked.

R **Reverse**
Used when reversing.

N **Neutral**
Transmission is not locked.

D **Drive**
Normal driving.
On models with paddle shifters, 7-speed mode can be used temporarily.

S **Models with paddle shifters**
Drive (S)
7-speed manual shift mode can be used.

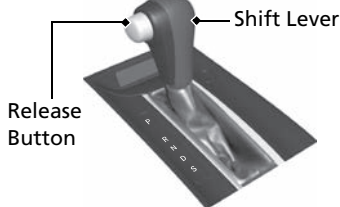

S **Models without paddle shifters**
Drive (S)

- Better acceleration
- Used to increase engine braking
- Used when going up or down hills

L **Models without paddle shifters**
Low

- Used to further increase engine braking
- Used when going up or down hills

7-Speed Manual Shift Mode* ↔ P.338

- Allows you to manually shift the transmission up or down without removing your hands from the steering wheel.

When the shift lever is in **S**

- Pulling a paddle shifter changes the mode from continuously variable transmission to 7-speed manual shift mode.
- The **M** indicator and the selected speed number are displayed in the shift indicator.

When the shift lever is in **D**

- Pulling a paddle shifter temporarily changes the mode from continuously variable transmission to 7-speed manual shift mode. The selected speed number is displayed in the shift indicator.

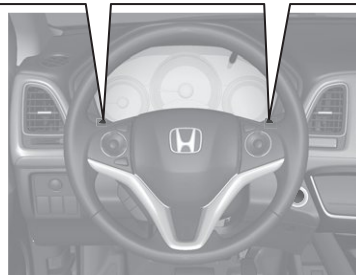
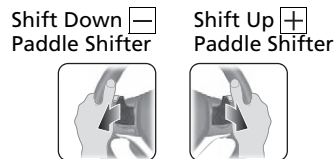
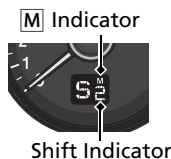

* Not available on all models

VSA® OFF Button P.355

- The vehicle stability assist (VSA®) system helps stabilize the vehicle during cornering, and helps maintain traction while accelerating on loose or slippery road surfaces.
- VSA® comes on automatically every time you start the engine.
- To turn VSA® on or off, press and hold the button until you hear a beep.

Cruise Control P.344

- Cruise control allows you to maintain a set speed without keeping your foot on the accelerator pedal.
- To use cruise control, press the **CRUISE** button, then press the **-/SET** button once you have achieved the desired speed (above 25 mph or 40 km/h).

Tire Pressure Monitoring System (TPMS) P.359

U.S. models only

- Detects a change in tire conditions and overall dimensions due to decrease in tire pressures.
- TPMS is turned on automatically every time you start the engine.
- A calibration procedure must be performed when certain conditions arise.

Refueling P.374

Fuel recommendation: Unleaded gasoline with a pump octane number 87 or higher required

Fuel tank capacity: 13.2 US gal (50 L)

- 1 Pull the fuel fill door release handle.

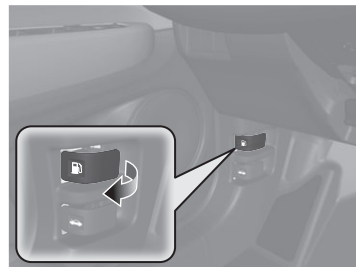

- 2 Turn the fuel fill cap slowly to remove the cap.



- 3 Place the cap in the holder on the fuel fill door.



- 4 After refueling, screw the cap back on until it clicks at least once.



Maintenance P. 379

Under the Hood P. 387

- Check engine oil, engine coolant, and window washer fluid. Add when necessary.
- Check brake fluid.
- Check the battery condition monthly.

- 1** Pull the hood release handle under the corner of the dashboard.

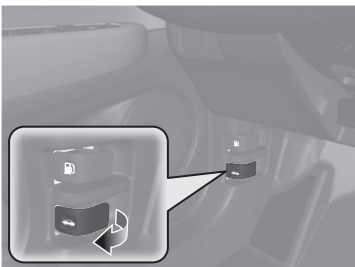

- 2** Locate the hood latch lever, push the lever, and lift up the hood.



- 3** When finished, close the hood and make sure it is firmly locked in place.

Wiper Blades P. 407

- Replace blades if they leave streaks across the windshield.



Tires P. 411

- Inspect tires and wheels regularly.
- Check tire pressures regularly.
- Install snow tires for winter driving.

Lights P. 399

- Inspect all lights regularly.

Handling the Unexpected P. 431

Flat Tire P. 434

- Park in a safe location and replace the flat tire with the compact spare tire in the cargo area.



Engine Won't Start P. 443

- If the battery is dead, jump start using a booster battery.

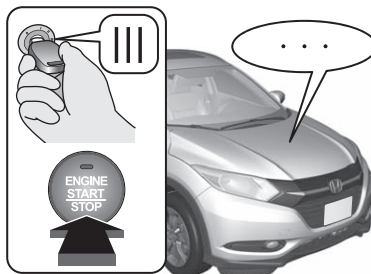

Overheating P. 449

- Park in a safe location. If you do not see steam under the hood, open the hood, and let the engine cool down.



Indicators Come On

 P. 451

- Identify the indicator and consult the owner's manual.

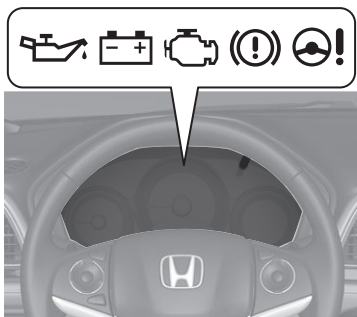

Blown Fuse P. 456

- Check for a blown fuse if an electrical device does not operate.

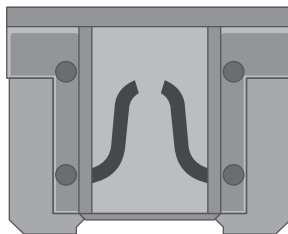

Emergency Towing P. 461

- Call a professional towing service if you need to tow your vehicle.



What to Do If

Q U.S. models with manual transmission
Canadian models
The ignition switch does not turn from **0** to **I***1.
Why?

A

- The steering wheel may be locked.

Models without smart entry system

- Try to turn the steering wheel left and right while turning the ignition key.

Models with smart entry system

- Move the steering wheel left and right while pressing the **ENGINE START/STOP** button at the same time.

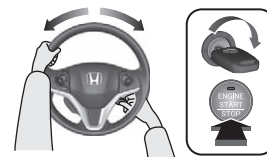

Q Models without smart entry system
The ignition switch does not turn from **I** to **0** and I cannot remove the key.
Why?

A The shift lever should be moved to **P**.



Models with smart entry system
The power mode does not change from ON to VEHICLE OFF (LOCK). Why?

Q Why does the brake pedal pulsate slightly when applying the brakes?

A This can occur when the ABS activates, and does not indicate a problem. Apply firm, steady pressure on the brake pedal. Never pump the brake pedal.

*1: Models with the smart entry system have an **ENGINE START/STOP** button instead of an ignition switch.

Q The rear door cannot be opened from inside the vehicle. Why?

A Check if the childproof lock is in the lock position. If so, open the rear door with the outside door handle. To cancel this function, push the lever to the unlock position.



Q Why do the doors lock after I unlocked the doors using a remote transmitter?

A If you do not open the doors within 30 seconds, the doors are relocked automatically for security.

Q Why does the beeper sound when I open the driver's door?

A The beeper sounds when:

- The exterior lights are left on.

Models without smart entry system

- The key is left in the ignition switch.

Models with smart entry system

- The power mode is in ACCESSORY.

Q Why does the beeper sound when I start driving?

A The beeper sounds when driver and/or front passenger are not wearing their seat belts.

Q Why do I hear a screeching sound when I apply the brake pedal?

A The brake pads may need to be replaced. Have your vehicle inspected by a dealer.



Pressing the electric parking brake switch does not release the parking brake. Why?



Press the electric parking brake switch with the brake pedal depressed.



Depressing the accelerator pedal does not release the parking brake automatically. Why?



- Fasten the driver's seat belt.
 - Check if the transmission is in **P** or **N**. If so, select any other position.
-

Safe Driving

You can find many safety recommendations throughout this chapter, and throughout this manual.

For Safe Driving

Important Safety Precautions	30
Important Handling Information.....	32
Your Vehicle's Safety Features.....	33

Seat Belts

About Your Seat Belts.....	35
Fastening a Seat Belt.....	38
Seat Belt Inspection.....	43

Airbags

Airbag System Components.....	44
Types of Airbags	47
Front Airbags (SRS)	47

Side Airbags	51
Side Curtain Airbags	53
Airbag System Indicators.....	54
Airbag Care	56

Child Safety

Protecting Child Passengers	57
Safety of Infants and Small Children	59
Safety of Larger Children	67

Exhaust Gas Hazard

Carbon Monoxide Gas.....	69
--------------------------	----

Safety Labels

Label Locations	70
-----------------------	----

The following pages explain your vehicle's safety features and how to use them properly. The safety precautions below are ones that we consider to be among the most important.

Important Safety Precautions

■ Always wear your seat belt

A seat belt is your best protection in all types of collisions. Airbags are designed to supplement seat belts, not replace them. So even though your vehicle is equipped with airbags, make sure you and your passengers always wear your seat belts, and wear them properly.

■ Restrain all children

Children ages 12 and under should ride properly restrained in a back seat, not the front seat. Infants and small children should be restrained in a child seat. Larger children should use a booster seat and a lap/shoulder seat belt until they can use the belt properly without a booster seat.

■ Be aware of airbag hazards

While airbags can save lives, they can cause serious or fatal injuries to occupants who sit too close to them, or are not properly restrained. Infants, young children, and short adults are at the greatest risk. Be sure to follow all instructions and warnings in this manual.

■ Don't drink and drive

Alcohol and driving don't mix. Even one drink can reduce your ability to respond to changing conditions, and your reaction time gets worse with every additional drink. So don't drink and drive, and don't let your friends drink and drive, either.

⌘ Important Safety Precautions

Some states, provinces and territories prohibit the use of cell phones other than hands-free devices by the driver while driving.

■ **Pay appropriate attention to the task of driving safely**

Engaging in cell phone conversation or other activities that keep you from paying close attention to the road, other vehicles, and pedestrians could lead to a crash. Remember, situations can change quickly, and only you can decide when it is safe to divert some attention away from driving.

■ **Control your speed**

Excessive speed is a major factor in crash injuries and deaths. Generally, the higher the speed, the greater the risk, but serious injuries can also occur at lower speeds. Never drive faster than is safe for current conditions, regardless of the maximum speed posted.

■ **Keep your vehicle in safe condition**

Having a tire blowout or a mechanical failure can be extremely hazardous. To reduce the possibility of such problems, check your tire pressures and condition frequently, and perform all regularly scheduled maintenance.

Important Handling Information

Your vehicle has higher ground clearance than a passenger vehicle designed for use only on pavement. Higher ground clearance has many advantages for off-highway driving. It allows you to travel over bumps, obstacles, and rough terrain. It also provides good visibility so you can anticipate problems earlier.

These advantages come at some cost. Because your vehicle is taller and rides higher off the ground, it has a higher center gravity making it more susceptible to tripping or roll over if you make abrupt turns. Utility vehicles have a significantly higher rollover rate than other types of vehicles. In a rollover crash, an unbelted person is significantly more likely to die than a person wearing a seat belt. As a reminder, make sure you and your passengers always wear seat belts.

Important Handling Information

For information on how to reduce the risk of rollover, read:

► **Driving Guidelines for Your Utility Vehicle**
P. 332

► **Off-Highway Driving Guidelines** P. 323

Failure to operate your vehicle correctly might result in a crash or a rollover.

Your Vehicle's Safety Features

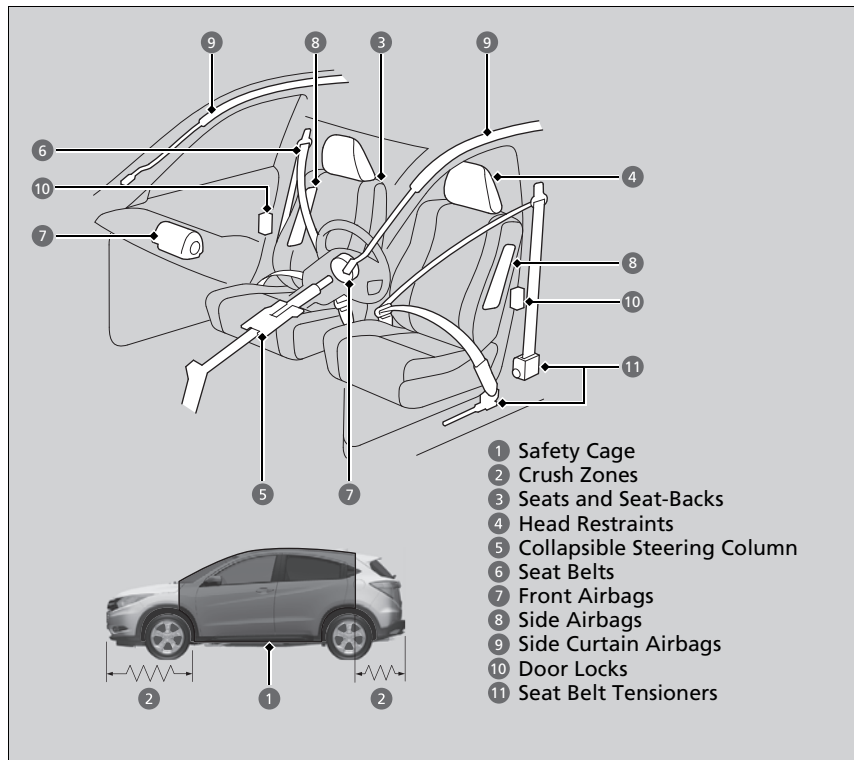

The following checklist will help you take an active role in protecting yourself and your passengers.

▣ Your Vehicle's Safety Features

Your vehicle is equipped with many features that work together to help protect you and your passengers during a crash.

Some features do not require any action on your part. These include a strong steel framework that forms a safety cage around the passenger compartment, front and rear crush zones, a collapsible steering column, and tensioners that tighten the front seat belts in a sufficient crash.

However, you and your passengers cannot take full advantage of these features unless you remain seated in the correct position and always wear your seat belts. In fact, some safety features can contribute to injuries if they are not used properly.

■ Safety Checklist

For the safety of you and your passengers, make a habit of checking these items each time before you drive.

- After everyone has entered the vehicle, be sure all doors and the tailgate are closed and locked. Locking the doors and the tailgate helps prevent an occupant from being ejected and an outsider from unexpectedly opening a door or the tailgate.
 - ❏ **Locking/Unlocking the Doors from the Inside** P. 105
- Adjust your seat to a position suitable for driving. Be sure the front seats are adjusted as far to the rear as possible while allowing the driver to control the vehicle. Sitting too close to a front airbag can result in serious or fatal injury in a crash.
 - ❏ **Adjusting the Seats** P. 140
- Adjust head restraints to the proper position. Head restraints are most effective when the center of the head restraint aligns with the center of your head. Taller persons should adjust their head restraint to the highest position.
 - ❏ **Adjusting the Head Restraints** P. 142
- Always wear your seat belt, and make sure you wear it properly. Confirm that any passengers are properly belted as well.
 - ❏ **Fastening a Seat Belt** P. 38
- Protect children by using seat belts or child seats according to a child's age, height and weight.
 - ❏ **Child Safety** P. 57

❏ Safety Checklist

If the door and tailgate open indicator is on, a door and/or the tailgate is not completely closed. Close all doors and the tailgate tightly until the indicator goes off.

❏ **Door and Tailgate Open Indicator** P. 78

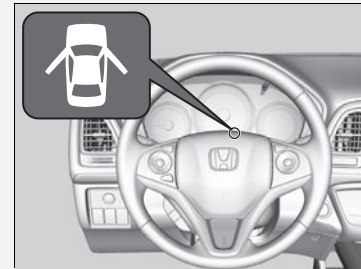

About Your Seat Belts

Seat belts are the single most effective safety device because they keep you connected to the vehicle so that you can take advantage of many built-in safety features. They also help keep you from being thrown against the inside of the vehicle, against other passengers, or out of the vehicle. When worn properly, seat belts also keep your body properly positioned in a crash so that you can take full advantage of the additional protection provided by the airbags.

In addition, seat belts help protect you in almost every type of crash, including:

- frontal impacts
- side impacts
- rear impacts
- rollovers

■ Lap/shoulder seat belts

All five seating positions are equipped with lap/shoulder seat belts with emergency locking retractors. In normal driving the retractor lets you move freely while keeping some tension on the belt. During a collision or sudden stop the retractor locks to restrain your body. The rear seat belts also have a lockable retractor for use with child seats.

➤ **Installing a Child Seat with a Lap/Shoulder Seat Belt** P. 64

ⓘ About Your Seat Belts

⚠ WARNING

Not wearing a seat belt properly increases the chance of serious injury or death in a crash, even though your vehicle has airbags.

Be sure you and your passengers always wear seat belts and wear them properly.

Seat belts cannot completely protect you in every crash. But in most cases, seat belts can reduce your risk of serious injury.

Most states and all Canadian provinces and territories require you to wear seat belts.

The emergency locking retractor may lock if you lean forward too quickly. Slower movements will allow the belt to extend fully without locking.

■ Proper use of seat belts

Follow these guidelines for proper use:

- All occupants should sit upright, well back in the seat, and remain in that position for the duration of the trip. Slouching and leaning reduce the effectiveness of the belt and can increase the chance of serious injury in a crash.
- Never place the shoulder part of a lap/shoulder seat belt under your arm or behind your back. This could cause very serious injuries in a crash.
- Two people should never use the same seat belt. If they do, they could be very seriously injured in a crash.
- Do not put any accessories on the seat belts. Devices intended to improve comfort or reposition the shoulder part of a seat belt can reduce the protective capability and increase the chance of serious injury in a crash.

■ Seat Belt Reminder



Your vehicle monitors front seat belt use. If the ignition switch is turned to ON **II***1 before the driver's seat belt is fastened, the beeper will sound and the indicator will blink. If the driver does not fasten the belt before the beeper stops, the indicator will remain on.

The beeper will also periodically sound and the indicator will blink while driving until the driver's and front passenger's seat belts are fastened.

*1: Models with the smart entry system have an **ENGINE START/STOP** button instead of an ignition switch.

▣ About Your Seat Belts

If a rear seat passenger moves around and extends the seat belt, the lockable retractor may activate. If this happens, release the retractor by unfastening the seat belt and allow the belt to retract completely. Then refasten the belt.

▣ Seat Belt Reminder

The indicator will also come on if a front passenger does not fasten their seat belt within six seconds after the ignition switch is turned to ON **II***1. When no one is sitting in the front passenger's seat, the indicator will not come on and the beeper will not sound. The indicator also may not come on and the beeper may not sound when the occupant is not heavy enough to trigger the weight sensor. Such occupants (e.g., infants and smaller children) should be moved to the rear seat as a deploying front airbag likely will injure or kill them.

▣ **Protecting Child Passengers** P. 57

Automatic Seat Belt Tensioners

The front seats are equipped with automatic seat belt tensioners to enhance safety.

The tensioners automatically tighten the front seat belts during a moderate-to-severe frontal collision, sometimes even if the collision is not severe enough to inflate the front airbags.

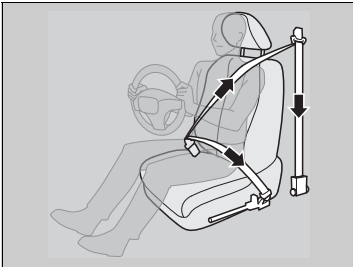

Automatic Seat Belt Tensioners

The seat belt tensioners can only operate once. If a tensioner is activated, the SRS indicator will come on. Have a dealer replace the tensioner and thoroughly inspect the seat belt system as it may not offer protection in a subsequent crash.

During a moderate-to-severe side impact, the tensioner on that side of the vehicle also activates.

Fastening a Seat Belt

After adjusting a front seat to the proper position, and while sitting upright and well back in the seat:

➤ **Adjusting the Seats** P. 140

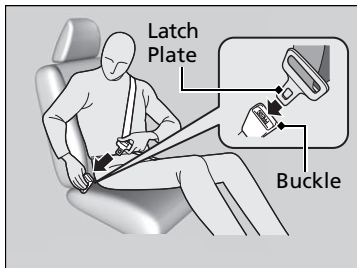
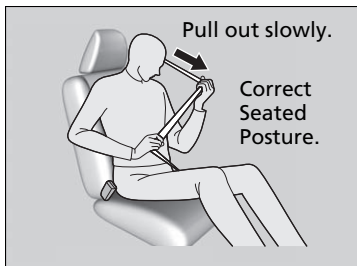

1. Pull the seat belt out slowly.

2. Insert the latch plate into the buckle, then tug on the belt to make sure the buckle is secure.

▶ Make sure that the belt is not twisted or caught on anything.

Fastening a Seat Belt

No one should sit in a seat with an inoperative seat belt or one that does not appear to be working correctly. Using a seat belt that is not working properly may not protect the occupant in a crash. Have a dealer check the belt as soon as possible.

Never insert any foreign objects into the buckle or retractor mechanism.



3. Position the lap part of the belt as low as possible across your hips, then pull up on the shoulder part of the belt so the lap part fits snugly. This lets your strong pelvic bones take the force of a crash and reduces the chance of internal injuries.
4. If necessary, pull up on the belt again to remove any slack, then check that the belt rests across the center of your chest and over your shoulder. This spreads the forces of a crash over the strongest bones in your upper body.

Fastening a Seat Belt

⚠ WARNING

Improperly positioning the seat belts can cause serious injury or death in a crash.

Make sure all seat belts are properly positioned before driving.

To release the belt, push the red **PRESS** button then guide the belt by hand until it has retracted completely.

When exiting the vehicle, be sure the belt is out of the way and will not get caught by closing the door.

■ Adjusting the Shoulder Anchor

The front seats have adjustable shoulder anchors to accommodate taller and shorter occupants.

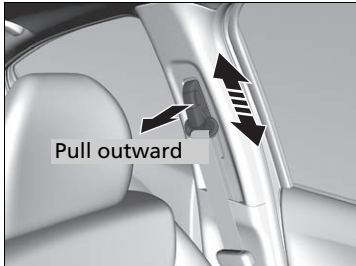

1. Move the anchor up and down while pulling the release outward.
2. Position the anchor so that the belt rests across the center of your chest and over your shoulder.

▣ Adjusting the Shoulder Anchor

The shoulder anchor height can be adjusted to four levels. If the belt contacts your neck, lower the height one level at a time.

After an adjustment, make sure that the shoulder anchor position is secure.

Seat Belt with Detachable Anchor

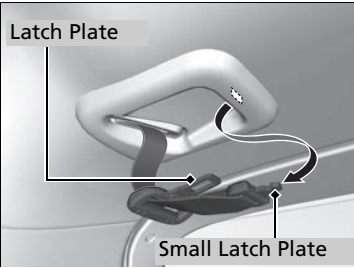

1. Pull out the seat belt's small latch plate and the latch plate from each holding slot in the ceiling.

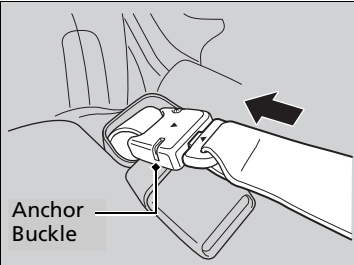

2. Line up the triangle marks on the small latch plate and anchor buckle. Make sure the seat belt is not twisted. Attach the belt to the anchor buckle.

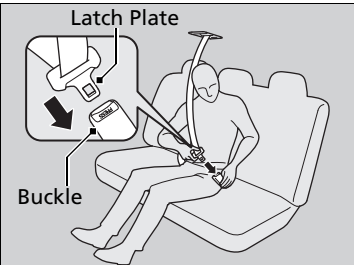

3. Insert the latch plate into the buckle. Properly fasten the seat belt the same way you fasten the lap/shoulder seat belt.

Seat Belt with Detachable Anchor

⚠ WARNING

Using the seat belt with the detachable anchor unlatched increases the chance of serious injury or death in a crash.

Before using the seat belt, make sure the detachable anchor is correctly latched.

To unlatch the detachable anchor, insert the latch plate into the slot on the side of the anchor buckle.

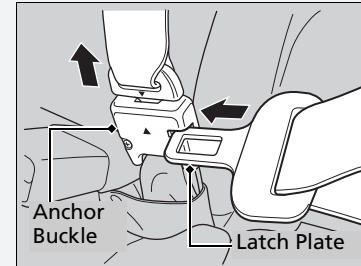

■ Advice for Pregnant Women

If you are pregnant, the best way to protect yourself and your unborn child when driving or riding in a vehicle is to always wear a seat belt and keep the lap part of the belt as low as possible across the hips.



▣ Advice for Pregnant Women

Each time you have a checkup, ask your doctor if it is okay for you to drive.

To reduce the risk of injuries to both you and your unborn child that can be caused by an inflating front airbag:

- When driving, sit upright and adjust the seat as far back as possible while allowing full control of the vehicle.
- When sitting in the front passenger's seat, adjust the seat as far back as possible.

Seat Belt Inspection

Regularly check the condition of your seat belts as follows:

- Pull each belt out fully, and look for frays, cuts, burns, and wear.
- Check that the latches work smoothly and the belts retract easily.
 - ▶ If a belt does not retract easily, cleaning the belt may correct the problem. Only use a mild soap and warm water. Do not use bleach or cleaning solvents. Make sure the belt is completely dry before allowing it to retract.

Any belt that is not in good condition or working properly will not provide proper protection and should be replaced as soon as possible.

A belt that has been worn during a crash may not provide the same level of protection in a subsequent crash. Have your seat belts inspected by a dealer after any collision.

Seat Belt Inspection

WARNING

Not checking or maintaining seat belts can result in serious injury or death if the seat belts do not work properly when needed.

Check your seat belts regularly and have any problem corrected as soon as possible.

Airbag System Components

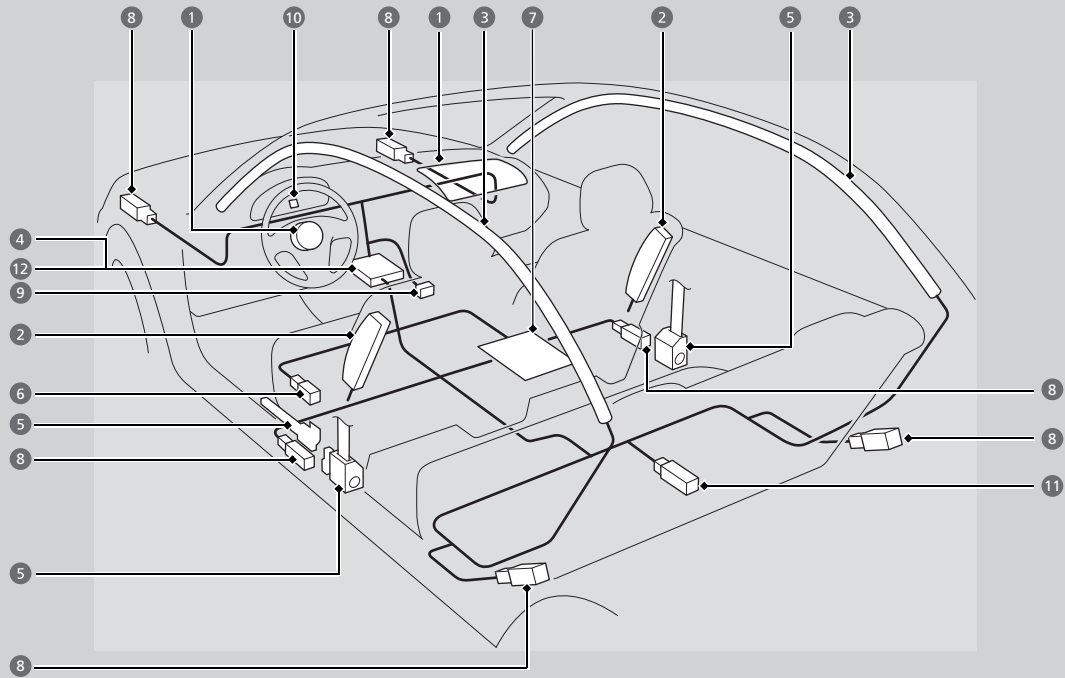

The front, front side, and side curtain airbags are deployed according to the direction and severity of impact. Both side curtain airbags are deployed in a rollover. The airbag system includes:

- 1 Two SRS (Supplemental Restraint System) front airbags. The driver's airbag is stored in the center of the steering wheel; the front passenger's airbag is stored in the dashboard. Both are marked **SRS AIRBAG**.
- 2 Two side airbags, one for the driver and one for a front passenger. The airbags are stored in the outer edges of the seat-backs. Both are marked **SIDE AIRBAG**.
- 3 Two side curtain airbags, one for each side of the vehicle. The airbags are stored in the ceiling, above the side windows. The front and rear pillars are marked **SIDE CURTAIN AIRBAG**.
- 4 An electronic control unit that continually monitors and can record information about the sensors, the airbag activators, the seat belt tensioners, and driver and front passenger seat belt use when the ignition switch is in ON *1.
- 5 Automatic front seat belt tensioners. The driver's and front passenger's seat belts incorporate sensors that detect whether or not they are fastened.
- 6 A driver's seat position sensor. If the seat is too far forward, the airbag will inflate with less force.
- 7 Weight sensors in the front passenger's seat. The front passenger's airbag will be turned off if the weight on the seat is 65 lbs (29 kg) or less (the weight of an infant or small child).
- 8 Impact sensors that can detect a moderate-to-severe front or side impact.
- 9 An indicator near the shift lever that alerts you that the front passenger's front airbag has been turned off.
- 10 An indicator on the instrument panel that alerts you to a possible problem with your airbag system or seat belt tensioners.
- 11 Safing Sensor
- 12 A rollover sensor that detects whether the vehicle is about to roll over.

*1: Models with the smart entry system have an **ENGINE START/STOP** button instead of an ignition switch.

■ Important Facts About Your Airbags

Airbags can pose serious hazards. To do their job, airbags must inflate with tremendous force. So, while airbags help save lives, they can cause burns, bruises, and other minor injuries, sometimes even fatal ones if occupants are not wearing their seat belts properly and sitting correctly.

What you should do: Always wear your seat belt properly, and sit upright and as far back from the steering wheel as possible while allowing full control of the vehicle. A front passenger should move their seat as far back from the dashboard as possible.

Remember, however, that no safety system can prevent all injuries or deaths that can occur in a severe crash, even when seat belts are properly worn and the airbags deploy.

Do not place hard or sharp objects between yourself and a front airbag.

Carrying hard or sharp objects on your lap, or driving with a pipe or other sharp object in your mouth, can result in injuries if your front airbag inflates.

Do not attach or place objects on the front airbag covers. Objects on the covers marked **SRS AIRBAG** could interfere with the proper operation of the airbags or be propelled inside the vehicle and hurt someone if the airbags inflate.

▣ Important Facts About Your Airbags

Do not attempt to deactivate your airbags. Together, airbags and seat belts provide the best protection.

When driving, keep hands and arms out of the deployment path of the front airbag by holding each side of the steering wheel. Do not cross an arm over the airbag cover.

Types of Airbags

Your vehicle is equipped with three types of airbags:

- **Front airbags:** Airbags in front of the driver's and front passenger's seats.
- **Side airbags:** Airbags in the driver's and front passenger's seat-backs.
- **Side curtain airbags:** Airbags above the side windows.

Each is discussed in the following pages.

Front Airbags (SRS)

The front SRS airbags inflate in a moderate-to-severe frontal collision to help protect the head and chest of the driver and/or front passenger.

SRS (Supplemental Restraint System) indicates that the airbags are designed to supplement seat belts, not replace them. Seat belts are the occupant's primary restraint system.

Housing Locations

The front airbags are housed in the center of the steering wheel for the driver, and in the dashboard for the front passenger. Both airbags are marked **SRS AIRBAG**.

*1: Models with the smart entry system have an **ENGINE START/STOP** button instead of an ignition switch.

Types of Airbags

The airbags can inflate whenever the ignition switch is in ON *1.

After an airbag inflates in a crash, you may see a small amount of smoke. This is from the combustion process of the inflator material and is not harmful. People with respiratory problems may experience some temporary discomfort. If this occurs, get out of the vehicle as soon as it is safe to do so.

Front Airbags (SRS)

Dual-Stage, Multiple-Threshold Front Airbags (SRS)

Your vehicle is equipped with dual-stage, multiple-threshold front airbags (SRS).

During a frontal crash severe enough to cause one or both front airbags to deploy, the airbags can inflate at different rates, depending on the severity of the crash, whether or not the seat belts are latched, and/or other factors. Frontal airbags are designed to supplement the seat belts to help reduce the likelihood of head and chest injuries in frontal crashes.

■ Operation

Front airbags are designed to inflate during moderate-to-severe frontal collisions. When the vehicle decelerates suddenly, the sensors send information to the control unit which signals one or both front airbags to inflate.

A frontal collision can be either head-on or angled between two vehicles, or when a vehicle crashes into a stationary object, such as a concrete wall.

■ How the Front Airbags Work

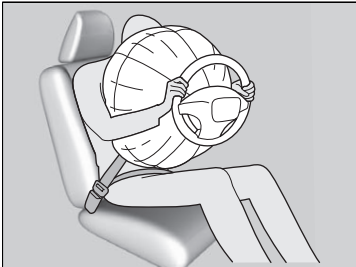

While your seat belt restrains your torso, the front airbag provides supplemental protection for your head and chest.

The front airbags deflate immediately so that they won't interfere with the driver's visibility or the ability to steer or operate other controls.

The total time for inflation and deflation is so fast that most occupants are not aware that the airbags deployed until they see them lying in front of them.

⌘ How the Front Airbags Work

Although the driver's and front passenger's airbags normally inflate within a split second of each other, it is possible for only one airbag to deploy. This can happen if the severity of a collision is at the margin, or threshold, that determines whether or not the airbags will deploy. In such cases, the seat belt will provide sufficient protection, and the supplemental protection offered by the airbag would be minimal.

■ When front airbags should not deploy

Minor frontal crashes: Front airbags were designed to supplement seat belts and help save lives, not to prevent minor scrapes, or even broken bones that might occur during a less than moderate-to-severe frontal crash.

Side impacts: Front airbags can provide protection when a sudden deceleration causes a driver or front passenger to move towards the front of the vehicle. Side airbags and side curtain airbags have been specifically designed to help reduce the severity of injuries that can occur during a moderate-to-severe side impact which can cause the driver or passenger to move towards the side of the vehicle.

Rear impacts: Head restraints and seat belts are your best protection during a rear impact. Front airbags cannot provide any significant protection and are not designed to deploy in such collisions.

Rollovers: Seat belts and, in vehicles equipped with a rollover sensor, side airbags and side curtain airbags offer the best protection in a rollover. Because front airbags could provide little if any protection, they are not designed to deploy during a rollover.

■ When front airbags deploy with little or no visible damage

Because the airbag system senses sudden deceleration, a strong impact to the vehicle framework or suspension might cause one or more of the airbags to deploy. Examples include running into a curb, the edge of a hole, or other low fixed object that causes a sudden deceleration in the vehicle chassis. Since the impact is underneath the vehicle, damage may not be readily apparent.

■ When front airbags may not deploy, even though exterior damage appears severe

Since crushable body parts absorb crash energy during an impact, the amount of visible damage does not always indicate proper airbag operation. In fact, some collisions can result in severe damage but no airbag deployment because the airbags would not have been needed or would not have provided protection even if they had deployed.

Advanced Airbags

Your front airbags have advanced features to help reduce the likelihood of airbag related injuries to smaller occupants.

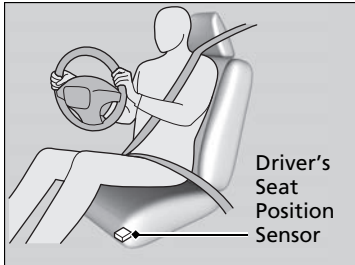

The driver's advanced front airbag system includes a seat position sensor.

If the seat is too far forward, the airbag inflates with less force, regardless of the severity of the impact.

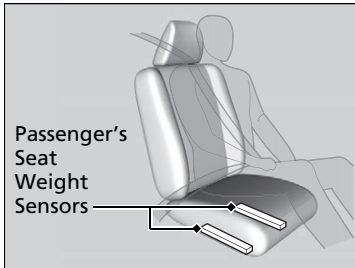

The passenger's advanced front airbag system has weight sensors.

Although we recommend against carrying an infant or small child in front, if the sensors detect the weight of a child (up to about 65 lbs or 29 kg), the system will automatically turn off the passenger's front airbag.

Advanced Airbags

If there is a problem with the driver's seat position sensor, the SRS indicator will come on and the airbag will inflate with full (normal) force, regardless of the driver's seating position.

For both advanced front airbags to work properly:

- Do not spill any liquid on or under the seats.
- Do not put any object under the passenger's seat.
- Make sure any objects are positioned properly on the floor. Improperly positioned objects can interfere with the advanced airbag sensors.
- All occupants should sit upright and wear their seat belts properly.
- Do not place any cover over the passenger side dashboard.

Side Airbags

The side airbags help protect the torso and pelvis of the driver or a front passenger during a moderate-to-severe side impact.

Housing Locations

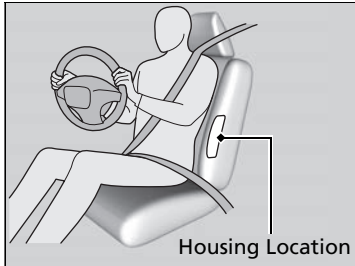

The side airbags are housed in the outside edge of the driver's and passenger's seat-backs.

Both are marked **SIDE AIRBAG**.

Operation

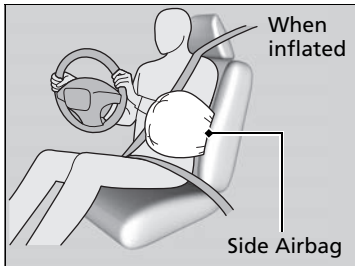

When the sensors detect a moderate-to-severe side impact, the control unit signals the side airbag on the impact side to immediately inflate.

Side Airbags

Make sure you and your front seat passenger always sit upright. Leaning into the path of a side airbag can prevent the airbag from deploying properly and increases your risk of serious injury.

Do not attach accessories on or near the side airbags. They can interfere with the proper operation of the airbags, or hurt someone if an airbag inflates.

If the impact is on the passenger side, the airbag deploys even if there is no passenger in the passenger seat.

Do not cover or replace the front seat-back covers without consulting a dealer.

Improperly replacing or covering front seat-back covers can prevent your side airbags from properly deploying during a side impact.

■ **When a side airbag deploys with little or no visible damage**

Because the airbag system senses sudden acceleration, a strong impact to the side of the vehicle's framework can cause a side airbag to deploy. In such cases, there may be little or no damage, but the side impact sensors detected a severe enough impact to deploy the airbag.

■ **When a side airbag may not deploy, even though visible damage appears severe**

It is possible for a side airbag to not deploy during an impact that results in apparently severe damage. This can occur when the point of impact was towards the far front or rear of the vehicle, or when the vehicle's crushable body parts absorbed most of the crash energy. In either case, the side airbag would not have been needed nor provided protection even if it had deployed.

Side Curtain Airbags

The side curtain airbags help protect the heads of the driver and passengers in outer seating positions during a moderate-to-severe side impact. The side curtain airbags equipped in this vehicle are also designed to help reduce the likelihood of partial and complete ejection of vehicle occupants through side windows in crashes, particularly rollover crashes.

Housing Locations

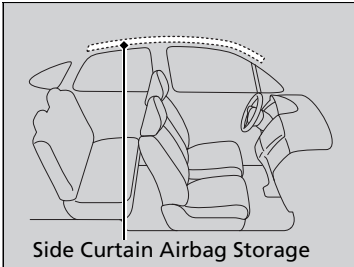

The side curtain airbags are located in the ceiling above the side windows on both sides of the vehicle.

Operation

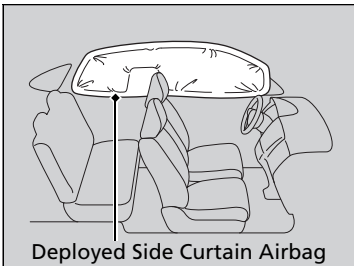

The side curtain airbag is designed to deploy in a rollover or a moderate-to-severe side impact.

Side Curtain Airbags

If the SRS control unit senses that your vehicle is about to rollover, it immediately deploys both side curtain airbags and activates both front seat belt tensioners.

If the impact is on the passenger's side, the passenger's side curtain airbag will inflate even if there are no occupants on that side of the vehicle.

To get the best protection from the side curtain airbags, occupants should wear their seat belts properly and sit upright and well back in their seats.

Do not attach any objects to the side windows or roof pillars as they can interfere with the proper operation of the side curtain airbags.

■ When side curtain airbags deploy in a frontal collision

One or both side curtain airbags may inflate in a moderate-to-severe angled frontal collision.

In this case, the side curtain airbags will deploy slightly after the front airbags.

Airbag System Indicators

If a problem occurs in the airbag system, the SRS indicator will come on.

■ Supplemental Restraint System (SRS) Indicator

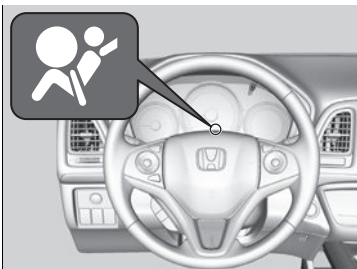

■ When the ignition switch is turned to ON *1

The indicator comes on for a few seconds, then goes off. This tells you the system is working properly.

If the indicator comes on at any other time, or does not come on at all, have the system checked by a dealer as soon as possible. If you don't, your airbags and seat belt tensioners may not work properly when they are needed.

*1: Models with the smart entry system have an **ENGINE START/STOP** button instead of an ignition switch.

ⓘ Supplemental Restraint System (SRS) Indicator

WARNING

Ignoring the SRS indicator can result in serious injury or death if the airbag systems or tensioners do not work properly.

Have your vehicle checked by a dealer as soon as possible if the SRS indicator alerts you to a possible problem.

Passenger Airbag Off Indicator

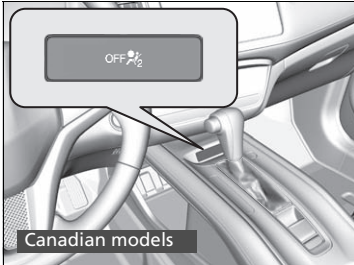
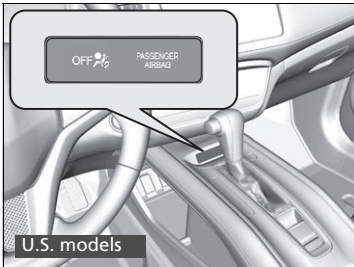

When the passenger airbag off indicator comes on

The indicator comes on to alert you that the passenger's front airbag has been turned off. This occurs when the front passenger's weight sensors detect 65 lbs (29 kg) or less, the weight of an infant or small child, on the seat.

Infants and small children should always ride properly restrained in a back seat.

➤ **Child Safety** P. 57

Objects placed on the seat can also cause the indicator to come on.

If the front passenger seat is empty, the passenger's front airbag will not deploy and the indicator will not come on.

Passenger Airbag Off Indicator

If the indicator comes on with no front passenger and no objects on the passenger's seat, or with an adult riding there, something may be interfering with the weight sensors, such as:

- An object hanging on the seat or in the seat-back pocket.
- A child seat or other object pressing against the rear of the seat-back.
- A rear passenger pushing or pulling on the back of the front passenger's seat.
- The front seat or seat-back is forced back against an object on the seat or floor behind it.
- An object placed under the front passenger's seat.

If none of these conditions exist, have your vehicle checked by a dealer as soon as possible.

The passenger airbag off indicator may come on and goes off repeatedly if the total weight on the seat is near the airbag cutoff threshold.

Airbag Care

You do not need to, and should not, perform any maintenance on or replace any airbag system components yourself. However, you should have your vehicle inspected by a dealer in the following situations:

■ When the airbags have deployed

If an airbag has inflated, the control unit and other related parts must be replaced. Similarly, once an automatic seat belt tensioner has been activated, it must be replaced.

■ When the vehicle has been in a moderate-to-severe collision

Even if the airbags did not inflate, have your dealer inspect the following: the driver's seat position sensor, weight sensors in the passenger's seat, front seat belt tensioners, and each seat belt that was worn during the crash.

■ Do not remove or modify a front seat without consulting a dealer

This would likely disable the driver's seat position sensor or the weight sensors in the passenger's seat. If it is necessary to remove or modify a front seat to accommodate a person with disabilities, contact a Honda dealer, or for U.S. vehicles, American Honda Automobile Customer Service at 800-999-1009 and for Canadian vehicles, Honda Canada Customer Relations at 888-9-HONDA-9.

✎ Airbag Care

We recommend against the use of salvaged airbag system components, including the airbag, tensioners, sensors, and control unit.

Protecting Child Passengers

Each year, many children are injured or killed in vehicle crashes because they are either unrestrained or not properly restrained. In fact, vehicle accidents are the number one cause of death of children ages 12 and under.

To reduce the number of child deaths and injuries, every state, Canadian province and territory requires that infants and children be properly restrained when they ride in a vehicle.

Children should sit properly restrained in a rear seat. This is because:

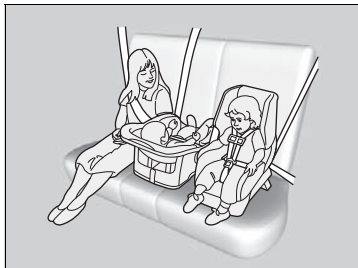

- An inflating front or side airbag can injure or kill a child sitting in the front seat.
- A child in the front seat is more likely to interfere with the driver's ability to safely control the vehicle.
- Statistics show that children of all sizes and ages are safer when they are properly restrained in a rear seat.

Protecting Child Passengers

⚠ WARNING

Children who are unrestrained or improperly restrained can be seriously injured or killed in a crash.

Any child too small for a seat belt should be properly restrained in a child seat. A larger child should be properly restrained with a seat belt, using a booster seat if necessary.

The National Highway Traffic Safety Administration and Transport Canada recommend that all children ages 12 and under be properly restrained in a rear seat. Some states or provinces/territories have laws restricting where children may ride.

- Any child who is too small to wear a seat belt correctly must be restrained in an approved child seat that is properly secured to the vehicle using either the lap belt portion of the lap/shoulder belt or the lower anchors of the LATCH system.
- Never hold a child on your lap because it is impossible to protect them in the event of a collision.
- Never put a seat belt over yourself and a child. During a crash, the belt would likely press deep into the child and cause serious or fatal injuries.
- Never let two children use the same seat belt. Both children could be very seriously injured in a crash.
- Do not allow children to operate the doors, windows or seat adjustments.
- Do not leave children in the vehicle unattended, especially in hot weather when the inside of the vehicle can get hot enough to kill them. They could also activate vehicle controls causing it to move unexpectedly.

► Protecting Child Passengers

⚠ WARNING

Allowing a child to play with a seat belt or wrap one around their neck can result in serious injury or death.

Instruct children not to play with any seat belt and make sure any unused seat belt a child can reach is buckled, fully retracted, and locked.

To deactivate a lockable retractor, release the buckle and allow the seat belt to wind up all the way.

To remind you of the passenger's front airbag hazards and child safety, your vehicle has warning labels on the dashboard (U.S. models) and on the front visors. Please read and follow the instructions on these labels.

► **Safety Labels** P. 70

Safety of Infants and Small Children

■ Protecting Infants

An infant must be properly restrained in a rear-facing, reclining child seat until the infant reaches the seat maker's weight or height limit for the seat, and the infant is at least one year old.

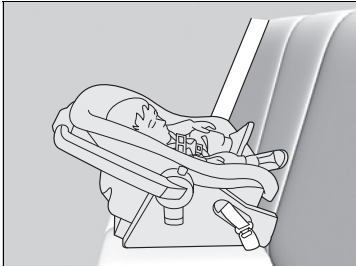

■ Positioning a rear-facing child seat

Child seats must be placed and secured in a rear seating position.

When properly installed, a rear-facing child seat may prevent the driver or a front passenger from moving their seat all the way back, or from locking their seat-back in the desired position.

It can also interfere with proper operation of the passenger's advanced front airbag system.

➤ **Airbags** P. 44

If this occurs, we recommend that you install the child seat directly behind the front passenger's seat, move the seat as far forward as needed, and leave it unoccupied. Or, you may wish to get a smaller rear-facing child seat.

☒ Protecting Infants

⚠ WARNING

Placing a rear-facing child seat in the front seat can result in serious injury or death during a crash.

Always place a rear-facing child seat in the rear seat, not the front.

Rear-facing child seats should never be installed in a forward facing position.

Always refer to the child seat manufacturer's instructions before installation.

■ Protecting Smaller Children

If a child is at least one year old and within the weight range indicated by the child seat manufacturer, the child should be properly restrained in a firmly secured forward-facing child seat.

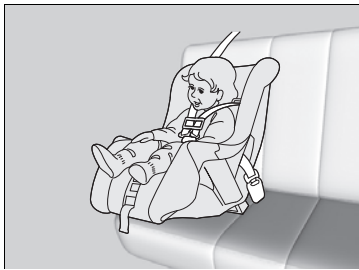

■ **Forward-facing child seat placement**
We strongly recommend placing a forward-facing child seat in a rear seating position.

Placing a forward-facing child seat in the front seat can be hazardous, even with advanced front airbags that automatically turn the passenger's front airbag off. A rear seat is the safest place for a child.

▶▶ Protecting Smaller Children

⚠ WARNING

Placing a forward-facing child seat in the front seat can result in serious injury or death if the front airbag inflates.

If you must place a forward-facing child seat in front, move the vehicle seat as far back as possible, and properly restrain the child.

Educate yourself about the laws and regulations regarding child seat use where you are driving, and follow the child seat manufacturer's instructions.

Many experts recommend use of a rear-facing seat for a child up to two years old if the child's height and weight are appropriate for a rear-facing seat.

■ Selecting a Child Seat

Most child seats are LATCH-compatible (Lower Anchors and Tethers for CHildren). Some have a rigid-type connector, while others have a flexible-type connector. Both are equally easy to use. Some existing and previously owned child seats can only be installed using the seat belt. Whichever type you choose, follow the child seat manufacturer's use and care instructions as well as the instructions in this manual. Proper installation is key to maximizing your child's safety.

In seating positions and vehicles not equipped with LATCH, a LATCH compatible child seat can be installed using the seat belt and a top tether for added security. This is because all child seats are required to be designed so that they can be secured with a lap belt or the lap part of a lap/shoulder belt. In addition, the child seat manufacturer may advise that a seat belt be used to attach a LATCH-compatible seat once a child reaches a specified weight. Please read the child seat owner's manual for proper installation instructions.

■ Important consideration when selecting a child seat

Make sure the child seat meets the following three requirements:

- The child seat is the correct type and size for the child.
- The child seat is the correct type for the seating position.
- The child seat is compliant with Federal Motor Vehicle Safety Standard 213 or Canadian Motor Vehicle Safety Standard 213.

▶▶ Selecting a Child Seat

Installation of a LATCH-compatible child seat is simple.

LATCH-compatible child seats have been developed to simplify the installation process and reduce the likelihood of injuries caused by incorrect installation.

■ Installing a LATCH-Compatible Child Seat

A LATCH-compatible child seat can be installed in either of the two outer rear seats. A child seat is attached to the lower anchors with either the rigid or flexible type of connectors.

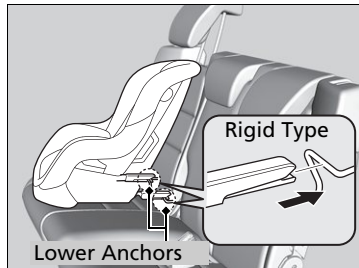
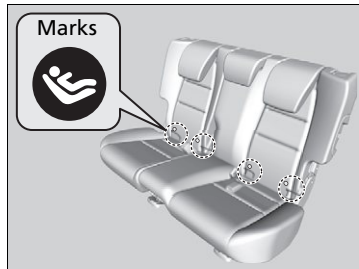

1. Locate the lower anchors under the marks.
2. Raise the head restraint to its highest position.
3. Place the child seat on the vehicle seat then attach the child seat to the lower anchors according to the instructions that came with the child seat.
 - When installing the child seat, make sure that the lower anchors are not obstructed by the seat belt or any other object.

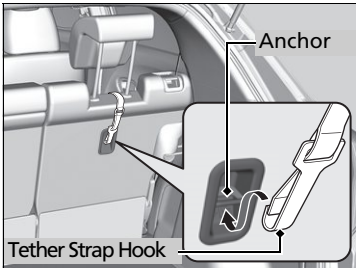
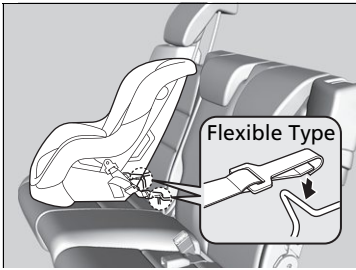

4. Remove the tonneau cover*.
 ▣ **Tonneau Cover*** P. 159
5. Route the tether strap between the head restraint legs, and secure the tether strap hook onto the anchor.
 Make sure the strap is not twisted.
6. Tighten the tether strap as instructed by the child seat manufacturer.
7. Make sure the child seat is firmly secured by rocking it forward and back and side to side; little movement should be felt.
8. Make sure any unused seat belt that a child can reach is buckled, the lockable retractor is activated, and the belt is fully retracted and locked.
9. Reinstall the tonneau cover*.

▣ Installing a LATCH-Compatible Child Seat

For your child's safety, when using a child seat installed using the LATCH system, make sure that the seat is properly secured to the vehicle. A child seat that is not properly secured will not adequately protect a child in a crash and may cause injury to the child or other vehicle occupants.

* Not available on all models

Continued

■ Installing a Child Seat with a Lap/Shoulder Seat Belt



1. Raise the head restraint to its highest position.
2. Place the child seat on the vehicle seat.
3. Route the seat belt through the child seat according to the seat maker's instructions, and insert the latch plate into the buckle.
 - Insert the latch plate fully until it clicks.
4. Slowly pull the shoulder part of the belt all the way out until it stops. This activates the lockable retractor.
5. Let the seat belt completely wind up into the retractor, then try to pull it out to make sure the retractor is locked.
 - If you are able to pull the shoulder belt out, the lockable retractor is not activated. Pull the seat belt all the way out, and repeat steps 4 – 5.
6. Grab the shoulder part of the seat belt near the buckle, and pull up to remove any slack from the lap part of the belt.
 - When doing this, place your weight on the child seat and push it into the vehicle seat.

▣ Installing a Child Seat with a Lap/Shoulder Seat Belt

A child seat that is not properly secured will not adequately protect a child in a crash and may cause injury to the child or other vehicle occupants.

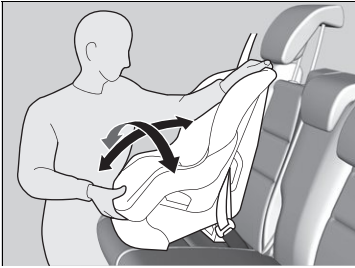

7. Make sure the child seat is firmly secured by rocking it forward and back and side to side; little movement should be felt.
8. Make sure any unused seat belt that a child can reach is buckled, the lockable retractor is activated, and the belt is fully retracted and locked.

■ Adding Security with a Tether

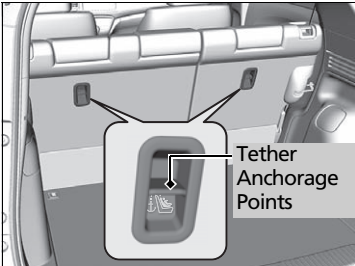

Two tether anchorage points are provided behind the rear outer seating positions and one in the ceiling for the rear center. A child seat that is installed with a seat belt and comes with a tether can use the tether for additional security.

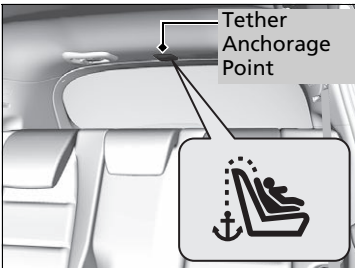

▣ Installing a Child Seat with a Lap/Shoulder Seat Belt

To deactivate a lockable retractor, release the buckle and allow the seat belt to wind up all the way.

▣ Adding Security with a Tether

Since a tether can provide additional security to the lap/shoulder seat belt installation, we recommend using a tether whenever one is available.

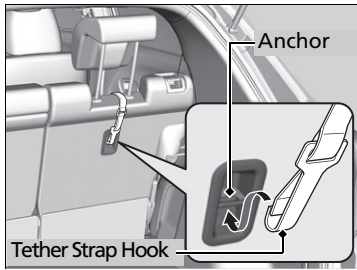

■ Using an outer anchor

1. Remove the tonneau cover*.
 ▣ Tonneau Cover* P. 159
2. Put the outer head restraint to its upper most position, then route the tether strap between the head restraint legs, and secure the tether strap hook onto the anchor. Make sure the strap is not twisted.
3. Tighten the tether strap as instructed by the child seat manufacturer.
4. Reinstall the tonneau cover*.

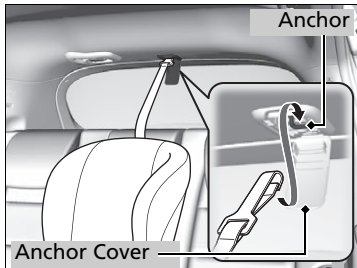

■ Using the center anchor

1. Lower the head restraint to its lowest position.
2. Open the anchor cover.
3. Route the tether strap over the head restraint. Make sure the strap is not twisted.
4. Secure the tether strap hook onto the anchor.
5. Tighten the tether strap as instructed by the child seat manufacturer.

Safety of Larger Children

■ Protecting Larger Children

The following pages give instructions on how to check proper seat belt fit, what kind of booster seat to use if one is needed, and important precautions for a child who must sit in front.

■ Checking Seat Belt Fit

When a child is too big for a child seat, secure the child in a rear seat using the lap/shoulder seat belt. Have the child sit upright and all the way back, then answer the following questions.



■ Checklist

- Do the child's knees bend comfortably over the edge of the seat?
- Does the shoulder belt cross between the child's neck and arm?
- Is the lap part of the seat belt as low as possible, touching the child's thighs?
- Will the child be able to stay seated like this for the whole trip?

If you answer yes to all these questions, the child is ready to wear the lap/shoulder seat belt correctly. If you answer no to any question, the child needs to ride on a booster seat until the seat belt fits properly without a booster seat.

▶▶ Safety of Larger Children

⚠ WARNING

Allowing a child age 12 or under to sit in front can result in injury or death if the passenger's front airbag inflates.

If a larger child must ride in front, move the vehicle seat as far to the rear as possible, have the child sit up properly and wear the seat belt properly, using a booster seat if needed.

Booster Seats



If a lap/shoulder seat belt cannot be used properly, position the child in a booster seat in a rear seating position. For the child's safety, check that the child meets the booster seat manufacturer's recommendations.

Protecting Larger Children-Final Checks

Your vehicle has a rear seat where children can be properly restrained. If you ever have to carry a group of children, and a child must ride in front:

- Make sure you read and fully understand the instructions and safety information in this manual.
- Move the front passenger seat as far back as possible.
- Have the child sit upright and well back in the seat.
- Check that the seat belt is properly positioned so that the child is secure in the seat.

Monitoring child passengers

We strongly recommend that you keep an eye on child passengers. Even older, more mature children sometimes need to be reminded to fasten their seat belts and sit up properly.

Booster Seats

When installing a booster seat, make sure to read the instructions that came with it, and install the seat accordingly.

There are high- and low-type booster seats. Choose a booster seat that allows the child to wear the seat belt correctly.

Some U.S. states and Canadian provinces and territories require children to use a booster seat until they reach a given age or weight (e.g. 6 years or 60 lbs). Be sure to check current laws in the state or province, or territory where you intend to drive.

Carbon Monoxide Gas

The engine exhaust from this vehicle contains carbon monoxide, a colorless, odorless, and highly toxic gas. As long as you properly maintain your vehicle, carbon monoxide gas will not get into the interior.

■ Have the exhaust system inspected for leaks whenever

- The exhaust system is making an unusual noise.
- The exhaust system may have been damaged.
- The vehicle is raised for an oil change.

When you operate a vehicle with the tailgate open, airflow can pull exhaust gas into the interior and create a hazardous condition. If you must drive with the tailgate open, open all the windows and set the heating and cooling system*/climate control system* as shown below.

1. Select the fresh air mode.
2. Select the  mode.
3. Set the fan speed to high.
4. Set the temperature control to a comfortable setting.

Adjust the heating and cooling system*/climate control system* in the same manner if you sit in your parked vehicle with the engine running.

Carbon Monoxide Gas

⚠ WARNING

Carbon monoxide gas is toxic. Breathing it can cause unconsciousness and even kill you.

Avoid any enclosed areas or activities that expose you to carbon monoxide.

An enclosed area such as a garage can quickly fill up with carbon monoxide gas. Do not run the engine with the garage door closed. Even when the garage door is open, drive out of the garage immediately after starting the engine.

* Not available on all models

Label Locations

These labels are in the locations shown. They warn you of potential hazards that can cause serious injury or death. Read these labels carefully.

If a label comes off or becomes hard to read (except for the U.S. dashboard label which may be removed by the owner), contact a dealer for a replacement.

Sun Visor

U.S. models

⚠ WARNING

EVEN WITH ADVANCED AIR BAGS

- Children can be killed or seriously injured by the air bag.
- The back seat is the safest place for children.
- Never put a rear-facing child seat in the front.
- Air bags can kill babies and child restraints.
- See owner's manual for more information about air bags.

CAUTION
TO AVOID SERIOUS INJURY:
• FOR MAXIMUM SAFETY PROTECTION IN ALL TYPES OF CRASHES YOU MUST ALWAYS WEAR YOUR SAFETY BELT.
• DO NOT INSTALL REARWARD-FACING CHILD SEATS IN ANY FRONT PASSENGER SEAT POSITION.
• DO NOT SIT OR LEAN UNNECESSARILY CLOSE TO THE AIR BAG.
• DO NOT PLACE ANY OBJECTS OVER THE AIR BAG OR BETWEEN THE AIR BAG AND YOURSELF.
• SEE THE OWNER'S MANUAL FOR FURTHER INFORMATION AND EXPLANATIONS.

PRECAUTIONS:
POUR EVITER DES BLESSURES GRAVES:

- POUR PROFITER D'UNE PROTECTION MAXIMALE LORS D'UNE COLLISION BOUCLEZ TOUJOURS VOTRE CEINTURE DE SECURITE.
- N'INSTALLEZ JAMAIS UN SIEGE POUR ENFANTS FAISANT FACE A L'ARRIERE SUR LE SIEGE DU PASSAGER AVANT.
- NE VOUS APPROVEZ PAS ET NE VOUS ASSOYEZ PAS PRES DU COUSSIN GONFLABLE.
- NE DEPOSEZ AUCUN OBJET SUR LE COUSSIN GONFLABLE OU ENTRE LE COUSSIN GONFLABLE ET VOUS.
- LISEZ LE GUIDE UTILISATEUR POUR DE PLUS AMPLES RENSEIGNEMENTS.

Sun Visor

U.S. models only

⚠ WARNING: HIGHER ROLLOVER RISK

- Avoid Abrupt Maneuvers and Excessive Speed. Always Buckle Up. See Owner's Manual For Further Information.

Doorjamb

U.S. models

SIDE AIRBAG

- This car is equipped with side airbags in the front seats and side curtain airbags.
- Do not lean against the door.
- See owner's manual for more information.

Doorjamb

Canadian models

SIDE AIRBAG

- This car is equipped with side airbags in the front seats and side curtain airbags.
- Do not lean against the door.
- See owner's manual for more information.

COUSSIN GONFLABLE LATERAL

- Cette automobile est équipée de coussins gonflables latéraux dans les sièges avant ainsi que de coussins gonflables latéraux de type rideau.
- Né vous appuyez pas sur la porte.
- Consultez le Manuel du propriétaire pour en savoir plus.

Dashboard

U.S. models only

This Vehicle is Equipped with Advanced Air Bags

Even with Advanced Air Bags, children can be killed or seriously injured by the air bag. The back seat is the safest place for children. Never put a rear-facing child seat in the front. Air bags can kill babies and child restraints. See owner's manual for more information about air bags.

Radiator Cap

⚠ DANGER
WARNING
危險
危險
危險

NEVER OPEN WHEN HOT. Hot coolant will scald you.
NEVER OPEN WHEN HOT. NE PAS OUVRIER QUAND CHAUD. Le liquide de refroidissement est très chaud. Ne jamais ouvrir quand chaud. 危險
危險
危險





1.1

Instrument Panel









This chapter describes the buttons, indicators, and gauges that are used while driving.











Indicators	72
Information Display Warning and Information Messages.....	85
Gauges and Displays	
Gauges.....	88
Information Display.....	89

Indicator	Name	On/Blinking	Explanation
<div style="display: flex; flex-direction: column; align-items: center;"> <div style="border: 1px solid black; padding: 2px; margin-bottom: 5px;">U.S.</div> <div style="font-weight: bold; font-size: 1.2em; margin-bottom: 5px;">BRAKE</div> <div style="border: 1px solid black; padding: 2px; margin-bottom: 5px;">Canada</div>  <div style="margin-top: 5px;">(Red)</div> </div>	Brake System Indicator (Red)	<ul style="list-style-type: none"> • Comes on for a few seconds when you turn the ignition switch to ON *1, then goes off. • Comes on when the brake fluid level is low. • Comes on if there is a problem with the brake system. 	<ul style="list-style-type: none"> • Comes on while driving - Check the brake fluid level. <ul style="list-style-type: none"> ➤ What to do when the indicator comes on while driving P. 453 • Comes on along with the ABS indicator - Have your vehicle checked by a dealer. <ul style="list-style-type: none"> ➤ If the Brake System Indicator (Red) Comes On P. 453
<div style="display: flex; flex-direction: column; align-items: center;"> <div style="border: 1px solid black; padding: 2px; margin-bottom: 5px;">U.S.</div> <div style="font-weight: bold; font-size: 1.2em; margin-bottom: 5px;">BRAKE SYSTEM</div> <div style="border: 1px solid black; padding: 2px; margin-bottom: 5px;">Canada</div>  <div style="margin-top: 5px;">(Amber)</div> </div>	Brake System Indicator (Amber)	<ul style="list-style-type: none"> • Comes on for a few seconds when you turn the ignition switch to ON *1, then goes off. • Comes on if there is a problem with an automatic brake hold system. 	<ul style="list-style-type: none"> • Stays on constantly - Have your vehicle checked by a dealer.





*1: Models with the smart entry system have an **ENGINE START/STOP** button instead of an ignition switch.

Indicator	Name	On/Blinking	Explanation
	Electric Parking Brake Indicator	<ul style="list-style-type: none"> • Comes on for a few seconds when you turn the ignition switch to ON ^{*1}, then goes off if the parking brake has been released. • Comes on when the parking brake is applied, and goes off when it is released. • Comes on for about 15 seconds when you pull the electric parking brake switch while the ignition switch is in LOCK ^{*1}. • Stays on for about 15 seconds when you turn the ignition switch to LOCK ^{*1} while the electric parking brake is set. 	<ul style="list-style-type: none"> • Blinks and the electric parking brake system indicator comes on at the same time - There is a problem with the electric parking brake system. The parking brake may not be set.
	Electric Parking Brake System Indicator	<ul style="list-style-type: none"> • Comes on for a few seconds when you turn the ignition switch to ON ^{*1}, then goes off. • Comes on if there is a problem with the electric parking brake system. 	<ul style="list-style-type: none"> • Comes on while driving - Avoid using the parking brake and have your vehicle checked by a dealer immediately. <ul style="list-style-type: none"> ➤ If the Electric Parking Brake System Indicator Comes On P. 454
	Automatic Brake Hold System Indicator	<ul style="list-style-type: none"> • Comes on for a few seconds when you turn the ignition switch to ON ^{*1}, then goes off. • Comes on when the automatic brake hold system is on. 	<ul style="list-style-type: none"> ➤ Automatic Brake Hold P. 366





*1: Models with the smart entry system have an **ENGINE START/STOP** button instead of an ignition switch.

Indicator	Name	On/Blinking	Explanation
	Automatic Brake Hold Indicator	<ul style="list-style-type: none"> • Comes on for a few seconds when you turn the ignition switch to ON *¹, then goes off. • Comes on when the automatic brake hold is activated. 	<p> Automatic Brake Hold P. 366</p>
<p>Continuously variable transmission models</p>  <p>Manual transmission models</p> 	Brake Depressing Indicator	<ul style="list-style-type: none"> • Comes on for a few seconds when you turn the ignition switch to ON *¹, then goes off. <p>Electric Parking Brake System</p> <ul style="list-style-type: none"> • Comes on when the electric parking brake switch is pressed without depressing the brake pedal while the electric parking brake is in operation. <p>Automatic Brake Hold System</p> <ul style="list-style-type: none"> • Comes on when the automatic brake hold button is pressed without depressing the brake pedal while the automatic brake hold is in operation. • Blinks if the automatic brake hold is automatically canceled while it is in operation. The beeper sounds. 	<ul style="list-style-type: none"> • Comes on while driving - Press the electric parking brake switch with the brake pedal depressed. <ul style="list-style-type: none">  Parking Brake P. 363 • Comes on while driving - Press the automatic brake hold button with the brake pedal depressed. <ul style="list-style-type: none">  Automatic Brake Hold P. 366 • Immediately depress the brake pedal.







*1: Models with the smart entry system have an **ENGINE START/STOP** button instead of an ignition switch.

Indicator	Name	On/Blinking	Explanation
	Low Oil Pressure Indicator	<ul style="list-style-type: none"> • Comes on when you turn the ignition switch to ON II*1, and goes off when the engine starts. • Comes on when the engine oil pressure is low. 	<ul style="list-style-type: none"> • Comes on while driving - Immediately stop in a safe place. <ul style="list-style-type: none"> ➤ If the Low Oil Pressure Indicator Comes On P. 451
	Malfunction Indicator Lamp	<ul style="list-style-type: none"> • Comes on when you turn the ignition switch to ON II*1, and goes off either when the engine starts or after several seconds if the engine did not start. If "readiness codes" have not been set, it blinks five times before it goes off. • Comes on if there is a problem with the emissions control system. • Blinks when a misfire in the engine's cylinders is detected. 	<ul style="list-style-type: none"> • Readiness codes are part of the on board diagnostics for the emissions control systems. <ul style="list-style-type: none"> ➤ Testing of Readiness Codes P. 471 • Comes on while driving - Have your vehicle checked by a dealer. • Blinks while driving - Stop in a safe place where there are no flammable objects. Stop the engine for 10 minutes or more, and wait for it to cool down. Then, take your vehicle to a dealer. <ul style="list-style-type: none"> ➤ If the Malfunction Indicator Lamp Comes On or Blinks P. 452
	Charging System Indicator	<ul style="list-style-type: none"> • Comes on when you turn the ignition switch to ON II*1, and goes off when the engine starts. • Comes on when the battery is not charging. 	<ul style="list-style-type: none"> • Comes on while driving - Turn off the heating and cooling system*/climate control system* and rear defogger in order to reduce electricity consumption. <ul style="list-style-type: none"> ➤ If the Charging System Indicator Comes On P. 451
	Shift Lever Position Indicator*	<ul style="list-style-type: none"> • Indicates the current shift lever position. 	<ul style="list-style-type: none"> ➤ Shifting P. 334, 336









*1: Models with the smart entry system have an **ENGINE START/STOP** button instead of an ignition switch.

Indicator	Name	On/Blinking	Explanation
	Transmission Indicator*	<ul style="list-style-type: none"> Blinks if the transmission system has a problem. 	<ul style="list-style-type: none"> Blinks while driving - Avoid sudden starts and acceleration and have your vehicle checked by a dealer immediately.
	M (7-speed manual shift mode) Indicator/Shift Indicator*	<ul style="list-style-type: none"> Comes on when 7-speed manual shift mode is applied. 	<p>► 7-Speed Manual Shift Mode P. 338</p>
	Seat Belt Reminder Indicator	<ul style="list-style-type: none"> Comes on and the beeper sounds if you are not wearing a seat belt when you turn the ignition switch to ON *1. If the front passenger is not wearing a seat belt, the indicator comes on a few seconds later. Blinks while driving if either you or the front passenger has not fastened a seat belt. The beeper sounds and the indicator blinks at regular intervals. 	<ul style="list-style-type: none"> The beeper stops and the indicator goes off when you and the front passenger fasten their seat belts. Stays on after you or the front passenger has fastened the seat belt - A detection error may have occurred in the sensor. Have your vehicle checked by a dealer. <ul style="list-style-type: none"> ► Seat Belt Reminder P. 36
	Low Fuel Indicator	<ul style="list-style-type: none"> Comes on when the fuel reserve is running low (approximately 1.98 U.S. gal./7.5 Liter left). Blinks if there is a problem with the fuel gauge. 	<ul style="list-style-type: none"> Comes on - Refuel your vehicle as soon as possible. Blinks - Have your vehicle checked by a dealer.





*1:Models with the smart entry system have an **ENGINE START/STOP** button instead of an ignition switch.

Indicator	Name	On/Blinking	Explanation
	Anti-lock Brake System (ABS) Indicator	<ul style="list-style-type: none"> • Comes on for a few seconds when you turn the ignition switch to ON *1, then goes off. • If it comes on at any other time, there is a problem with the ABS. 	<ul style="list-style-type: none"> • Stays on constantly - Have your vehicle checked by a dealer. With this indicator on, your vehicle still has normal braking ability but no anti-lock function. <ul style="list-style-type: none"> ➤ Anti-lock Brake System (ABS) P. 369
	Supplemental Restraint System Indicator	<ul style="list-style-type: none"> • Comes on for a few seconds when you turn the ignition switch to ON *1, then goes off. • Comes on if a problem with any of the following is detected: <ul style="list-style-type: none"> - Supplemental restraint system - Side airbag system - Side curtain airbag system - Seat belt tensioner 	<ul style="list-style-type: none"> • Stays on constantly or does not come on at all - Have your vehicle checked by a dealer.
	High Temperature Indicator (Red)	<ul style="list-style-type: none"> • Comes on for a few seconds when you turn the ignition switch to ON *1, then goes off. • Blinks when the engine coolant temperature goes up, and stays on if the temperature continues to rise. 	<ul style="list-style-type: none"> • Goes off, then comes on in blue when the engine coolant temperature is low. • Blinks while driving - Drive slowly to prevent overheating. • Stays on while driving - Immediately stop in a safe place and allow the engine to cool. <ul style="list-style-type: none"> ➤ Overheating P. 449
	Low Temperature Indicator (Blue)	<ul style="list-style-type: none"> • Comes on while the engine coolant temperature is low, then goes off once the engine reaches normal operating temperature. 	<ul style="list-style-type: none"> • If the indicator stays on after the engine has reached normal operating temperature, there may be a problem with the temperature sensors. Have your vehicle inspected by a dealer.





*1: Models with the smart entry system have an **ENGINE START/STOP** button instead of an ignition switch.







Indicator	Name	On/Blinking	Explanation
	Vehicle Stability Assist (VSA®) System Indicator	<ul style="list-style-type: none"> • Comes on for a few seconds when you turn the ignition switch to ON *1, then goes off. • Blinks when VSA® is active. • Comes on if there is a problem with the VSA® system or hill start assist system. 	<ul style="list-style-type: none"> • Stays on constantly - Have your vehicle checked by a dealer. <ul style="list-style-type: none"> ➤ Vehicle Stability Assist (VSA®), aka Electronic Stability Control (ESC), System P. 354
	Vehicle Stability Assist (VSA®) OFF Indicator	<ul style="list-style-type: none"> • Comes on for a few seconds when you turn the ignition switch to ON *1, then goes off. • Comes on when you deactivate VSA®. 	<ul style="list-style-type: none"> ➤ VSA® OFF Button P. 355
	Door and Tailgate Open Indicator	<ul style="list-style-type: none"> • Comes on for a few seconds if you turn the ignition switch to ON *1, then goes off. • Comes on if any door or the tailgate is not completely closed. • The beeper sounds and the indicator comes on if any door or the tailgate is opened while driving. 	<ul style="list-style-type: none"> • Goes off when all doors and the tailgate are closed.
	Electric Power Steering (EPS) System Indicator	<ul style="list-style-type: none"> • Comes on when you turn the ignition switch to ON *1, and goes off when the engine starts. • Comes on if there is a problem with the EPS system. 	<ul style="list-style-type: none"> • Stays on constantly or does not come on at all - Have your vehicle checked by a dealer. <ul style="list-style-type: none"> ➤ If the Electric Power Steering (EPS) System Indicator Comes On P. 453

*1:Models with the smart entry system have an **ENGINE START/STOP** button instead of an ignition switch.









Indicator	Name	On/Blinking	Explanation
 	Low Tire Pressure/TPMS Indicator	<ul style="list-style-type: none"> • Comes on for a few seconds when you turn the ignition switch to ON *1, then goes off. • May come on briefly if the ignition switch is turned to ON *1 and the vehicle is not moved within 45 seconds, to indicate the calibration process is not yet complete. • Comes on and stays on when: <ul style="list-style-type: none"> - One or more tires' pressures are determined to be significantly low. - The system has not been calibrated. • Blinks for about one minute, and then stays on if there is a problem with the TPMS, or when a compact spare tire is temporarily installed. 	<ul style="list-style-type: none"> • Comes on while driving - Stop in a safe place, check tire pressures, and inflate the tire(s) if necessary. • Stays on after the tires are inflated to the recommended pressures - The system needs to be calibrated. <ul style="list-style-type: none"> ▶ TPMS Calibration P. 359 • Blinks and remains on - Have your vehicle checked by a dealer. If the vehicle is fitted with a compact spare, get your regular tire repaired or replaced and put back on your vehicle as soon as you can.
	Smart Entry System Indicator*	<ul style="list-style-type: none"> • Comes on for a few seconds when you set the power mode to ON, then goes off. • Comes on as soon as a problem is detected in the smart entry system or push button starting system. 	<ul style="list-style-type: none"> • Stays on constantly or does not come on at all - Have your vehicle checked by a dealer.

*1: Models with the smart entry system have an **ENGINE START/STOP** button instead of an ignition switch.

Indicator	Name	On/Blinking	Explanation
	Starter System Indicator*	<ul style="list-style-type: none"> • Comes on for a few seconds when you set the power mode to ON, then goes off when the engine starts. • Comes on if the starter system has a problem. 	<ul style="list-style-type: none"> • As a temporary measure, press and hold the ENGINE START/STOP button for up to 15 seconds while pressing the brake pedal and clutch pedal (manual transmission only), and manually start the engine. Have your vehicle checked by a dealer.
	Turn Signal and Hazard Warning Indicators	<ul style="list-style-type: none"> • Blinks when you operate the turn signal lever. • Blink if you press the hazard warning button. 	<ul style="list-style-type: none"> • Does not blink or blinks rapidly - A turn signal light bulb has blown. Change the bulb immediately. <ul style="list-style-type: none"> ► Replacing Light Bulbs P. 400, 403
	High Beam Indicator	<ul style="list-style-type: none"> • Comes on when the high beam headlights are on. 	—
	Lights On Indicator	<ul style="list-style-type: none"> • Comes on whenever the light switch is on, or in AUTO* when the exterior lights are on. 	<ul style="list-style-type: none"> • If you remove the key from the ignition switch*, or set the power mode* to VEHICLE OFF (LOCK) while the exterior lights are on, a chime sounds when the driver's door is opened.
	Fog Light Indicator*	<ul style="list-style-type: none"> • Comes on when the fog lights are on. 	—







Indicator	Name	On/Blinking	Explanation
	Immobilizer System Indicator	<ul style="list-style-type: none"> • Comes on briefly when you turn the ignition switch to ON *¹, then goes off. • Comes on if the immobilizer system cannot recognize the key information. 	<ul style="list-style-type: none"> • Blinks - <ul style="list-style-type: none"> Models without smart entry system You cannot start the engine. Turn the ignition switch to LOCK , pull the key out, and then insert the key and turn it to ON  again. Models with smart entry system You cannot start the engine. Set the power mode to VEHICLE OFF (LOCK), then select the ON mode again. • Repeatedly blinks - The system may be malfunctioning. Have your vehicle checked by a dealer. • Do not attempt to alter this system or add other devices to it. Electrical problems can occur.
	ECON Mode Indicator*	<ul style="list-style-type: none"> • Comes on for a few seconds when you turn the ignition switch to ON *¹, then goes off. • Comes on when you press the ECON button. 	 ECON Button * P. 343

*1:Models with the smart entry system have an **ENGINE START/STOP** button instead of an ignition switch.







Indicator	Name	On/Blinking	Explanation
	Security System Alarm Indicator	<ul style="list-style-type: none"> Blinks when the security system alarm has been set. 	<ul style="list-style-type: none"> ➤ Security System Alarm P. 116
	CRUISE MAIN Indicator	<ul style="list-style-type: none"> Comes on when you press the CRUISE button. 	<ul style="list-style-type: none"> ➤ Cruise Control P. 344
	CRUISE CONTROL Indicator	<ul style="list-style-type: none"> Comes on if you have set a speed for cruise control. 	<ul style="list-style-type: none"> ➤ Cruise Control P. 344
	Washer Level Indicator*	<ul style="list-style-type: none"> Comes on when the washer fluid gets low. 	<ul style="list-style-type: none"> • Refill washer fluid. ➤ Refilling Window Washer Fluid P. 398
	Maintenance Minder Indicator	<ul style="list-style-type: none"> Comes on when the scheduled maintenance is due soon. 	<ul style="list-style-type: none"> ➤ Maintenance Minder™ P. 383
	All-Wheel Drive (AWD) System Indicator*	<ul style="list-style-type: none"> Comes on for a few seconds when you turn the ignition switch to ON *1, then goes off. Comes on if there is a problem with the AWD. Blinks when the AWD system is overheated. The system is inactive. 	<ul style="list-style-type: none"> • Stays on constantly - the engine drives only the front wheels in this state. Have your vehicle checked by a dealer. • Blinks while driving - the engine drives only the front wheels in this state. Stop in a safe place, shift to , and idle the engine until the indicator goes off. If the indicator does not stop blinking, take your vehicle to a dealer. ➤ Real Time AWD with Intelligent Control System™* P. 358

*1: Models with the smart entry system have an **ENGINE START/STOP** button instead of an ignition switch.

* Not available on all models

Indicator	Name	On/Blinking	Explanation	Message
	Forward Collision Warning (FCW) Indicator*	<ul style="list-style-type: none"> Comes on for a few seconds when you turn the ignition switch to ON *¹, then goes off. Comes on if there is a problem with the FCW system. Comes on when you have customized FCW to turn off. 	<ul style="list-style-type: none"> Stays on constantly without FCW off - Have your vehicle checked by a dealer. 	
		<ul style="list-style-type: none"> Blinks when the system detects a likely collision with a vehicle in front of you. The beeper sounds. 	<ul style="list-style-type: none"> Blinks while driving - Take appropriate action to prevent a collision (apply the brakes, change lanes, etc.). 	
		<ul style="list-style-type: none"> Comes on when the FCW system shuts itself off. 	<ul style="list-style-type: none"> Stays on - The temperature inside the FCW system is too high. The system activates when the temperature inside the system cools down. <ul style="list-style-type: none"> ➤ Automatic shutoff P. 349 	
		<ul style="list-style-type: none"> Comes on when the area around the camera is blocked by dirt, mud, etc. Stop your vehicle in a safe place, and wipe it off with a soft cloth. Have your vehicle checked by a dealer if the indicator and message come back on after you cleaned the area around the camera. <ul style="list-style-type: none"> ➤ Automatic shutoff P. 349 	<ul style="list-style-type: none"> Stays on - The area around the camera is blocked by dirt, mud, etc. Stop your vehicle in a safe place, and wipe it off with a soft cloth. Have your vehicle checked by a dealer if the indicator and message come back on after you cleaned the area around the camera. <ul style="list-style-type: none"> ➤ Automatic shutoff P. 349 	

*1: Models with the smart entry system have an **ENGINE START/STOP** button instead of an ignition switch.

Indicator	Name	On/Blinking	Explanation	Message
	Lane Departure Warning (LDW) Indicator*	<ul style="list-style-type: none"> Comes on for a few seconds when you turn the ignition switch to ON *1, then goes off. Comes on if there is a problem with the LDW system. 	<ul style="list-style-type: none"> Stays on constantly - Have your vehicle checked by a dealer. 	
		<ul style="list-style-type: none"> Blinks when your vehicle is too close to the lane lines. The beeper sounds. 	<ul style="list-style-type: none"> Blinks while driving - Take appropriate action to keep your vehicle within the lane lines. 	—
		<ul style="list-style-type: none"> Comes on when the LDW system shuts itself off. 	<ul style="list-style-type: none"> Stays on - The temperature inside the LDW camera is too high. The system activates when the temperature inside the camera cools down.  LDW Camera P. 352 Stays on - The area around the camera is blocked by dirt, mud, etc. Stop your vehicle in a safe place, and wipe it off with a soft cloth. Have your vehicle checked by a dealer if the indicator and message come back on after you cleaned the area around the camera.  LDW Camera P. 352 	 



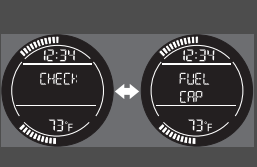
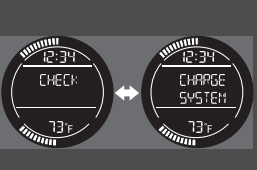

*1: Models with the smart entry system have an **ENGINE START/STOP** button instead of an ignition switch.

Information Display Warning and Information Messages

The following messages appear only on the information display.

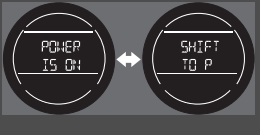
Message	Condition	Explanation
	<ul style="list-style-type: none"> • Appears when the fuel fill cap is loose or is not installed. 	<p>➔ Check Fuel Cap Message P. 452</p>
	<ul style="list-style-type: none"> • Appears when there is a problem with the sensor on the battery. 	<ul style="list-style-type: none"> • Stays on constantly - Have your vehicle checked by a dealer.

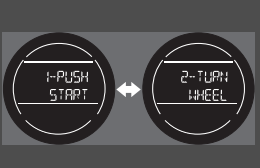
Models with smart entry system

Message	Condition	Explanation
	<ul style="list-style-type: none"> Appears if you push the ENGINE START/STOP button to turn the engine off without the shift lever in P. 	<p>Canadian models with continuously variable transmission</p> <ul style="list-style-type: none"> Push the ENGINE START/STOP button twice after moving the shift lever to P. <p>U.S. models with continuously variable transmission</p> <ul style="list-style-type: none"> Move the shift lever to P.
	<ul style="list-style-type: none"> Appears when the power mode is in ACCESSORY. 	—
	<p>U.S. models with manual transmission</p> <p>Canadian models</p> <ul style="list-style-type: none"> Appears when the steering wheel is locked. 	<ul style="list-style-type: none"> Move the steering wheel left and right while pressing the ENGINE START/STOP button at the same time.
<p>NO KEY</p>	<ul style="list-style-type: none"> Appears when you close the door with the power mode in ON without the smart entry remote inside the vehicle. 	<ul style="list-style-type: none"> Disappears when you bring the smart entry remote back inside the vehicle and close the door.
<p>KEY </p>	<ul style="list-style-type: none"> Appears when the smart entry remote's battery becomes weak. 	<ul style="list-style-type: none"> Replace the battery as soon as possible. <ul style="list-style-type: none"> ➤ Replacing the Button Battery P. 422

Models with FCW

Message	Condition	Explanation
 <p>The image shows three sequential instrument cluster displays. Each display is circular with a speedometer scale around the perimeter. The top display shows '12:34' at the top, 'FCW' in the middle, 'LONG' below it, and '73 F' at the bottom. The middle display shows '12:34' at the top, 'FCW' in the middle, 'NORMAL' below it, and '73 F' at the bottom. The bottom display shows '12:34' at the top, 'FCW' in the middle, 'SHORT' below it, and '73 F' at the bottom.</p>	<ul style="list-style-type: none"> • Appears when the warning distance setting has been changed. 	<p>➤ To change vehicle distance and to turn the system on and off P. 349</p>

Gauges

Gauges include the speedometer, tachometer and related indicators. They are displayed when the ignition switch is in ON *1.

■ Speedometer

Displays your driving speed in mph and km/h.

■ Tachometer

Shows the number of engine revolutions per minute.

*1: Models with the smart entry system have an **ENGINE START/STOP** button instead of an ignition switch.

Information Display

The information display shows the fuel gauge, odometer, trip meter, engine oil life and maintenance service item codes, and other gauges.

Switching the Display

Press the  (select/reset) knob to change the display.

Switching the Display

Models with display audio system

Some of the items on the information display also appear on the audio/information screen. They also change along with the information display changes while the fuel consumption is shown.

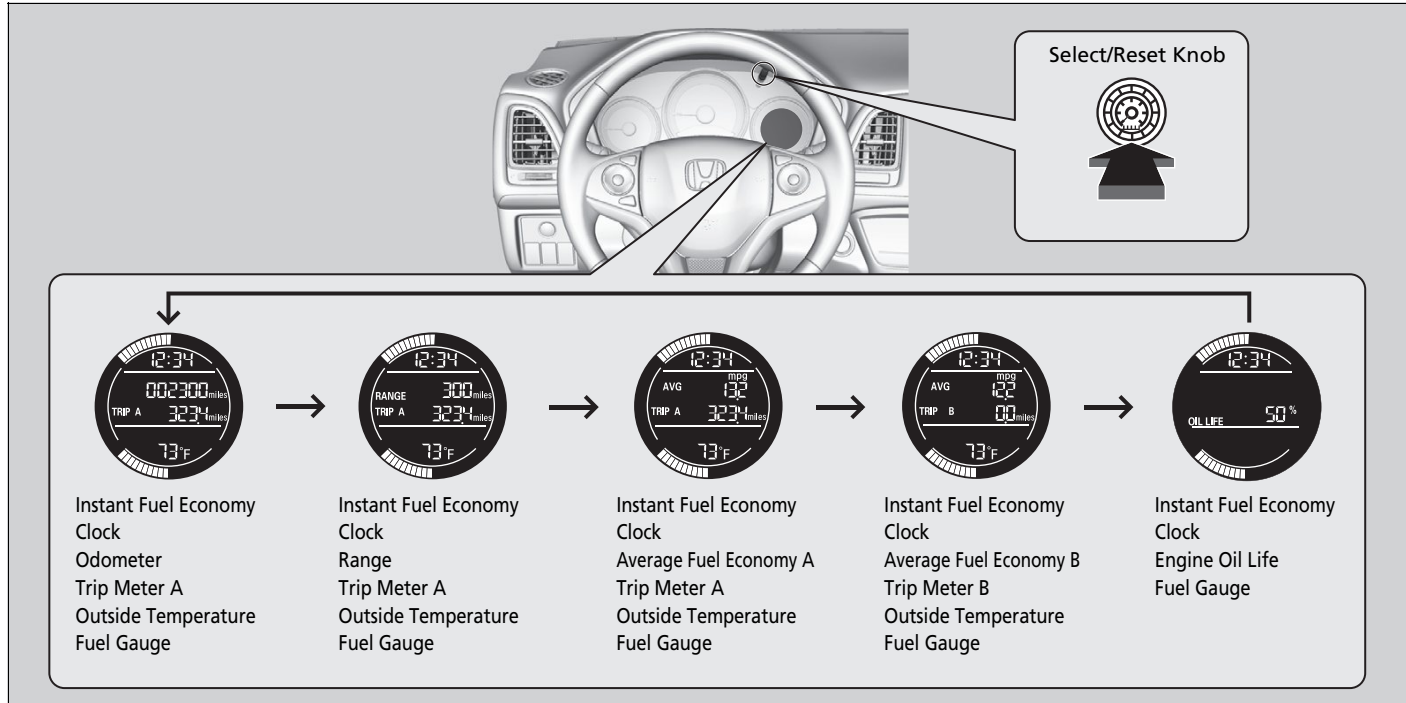

■ Instant Fuel Economy

Shows the instant fuel economy as a bar graph in mpg (U.S.) or l/100 km (Canada).

■ Odometer

Shows the total number of miles (U.S.) or kilometers (Canada) that your vehicle has accumulated.

■ Trip Meter

Shows the total number of miles (U.S.) or kilometers (Canada) driven since the last reset. TRIP A and B can be used to measure two separate trips.

■ Resetting a trip meter

To reset a trip meter, display it, then press and hold the  knob. The trip meter is reset to **0.0**.

■ Range

Shows the estimated distance you can travel on the remaining fuel. This distance is estimated from the fuel economy of your previous trips.

■ Average Fuel Economy

Shows the estimated average fuel economy of each trip meter in mpg (U.S.) or l/100 km (Canada). The display is updated at set intervals. When a trip meter is reset, the average fuel economy is also reset.

✕ Trip Meter



Switch between trip meter A and trip meter B by pressing the  knob.

■ Outside Temperature

Shows the outside temperature in Fahrenheit (U.S.) or Celsius (Canada).

■ Adjusting the outside temperature indicator

Adjust the temperature reading up to $\pm 5^{\circ}\text{F}$ or $\pm 3^{\circ}\text{C}$ if the temperature reading seems incorrect.

1. Turn the ignition switch to ON *1.
2. Press and hold the  (Select/Reset) knob for 10 seconds or more while the outside temperature is shown on the information display.
 - The information display goes into temperature adjustment mode. The display starts showing from -5°F to $+5^{\circ}\text{F}$ (U.S.) or -3°C to $+3^{\circ}\text{C}$ (Canada).
3. Release the  knob when the right adjustment amount is shown.
 - The adjustment is complete.

■ Engine Oil Life and Maintenance Items

Shows the remaining oil life and Maintenance Minder™.

 **Maintenance Minder™** P. 383

■ Fuel Gauge

Displays the amount of fuel left in the fuel tank.

*1: Models with the smart entry system have an **ENGINE START/STOP** button instead of an ignition switch.

⌘ Outside Temperature

The temperature sensor is in the front bumper. Road heat and exhaust from another vehicle can affect the temperature reading when your vehicle speed is less than 19 mph (30 km/h).

It may take several minutes for the display to be updated after the temperature reading has stabilized.

When the engine oil life is shown on the information display, you cannot adjust the outside temperature. Push the  knob to select the other display.

⌘ Fuel Gauge

NOTICE

You should refuel when the reading approaches . Running out of fuel can cause the engine to misfire, damaging the catalytic converter.

The actual amount of remaining fuel may differ from the fuel gauge reading.

■ Changing Ring Color

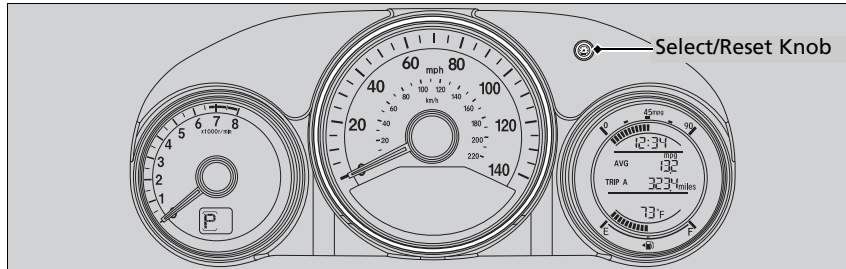

The center ring illumination can be changed to a color of your choice. With the ignition switch in the ACCESSORY **I** or LOCK **0***1 position and with the meter ring illuminated, press the select/reset knob. Each time the knob is pressed, the colors change in the following order:

White → Blue → Purple → Pink → Red → Amber → Yellow

*1: Models with the smart entry system have an **ENGINE START/STOP** button instead of an ignition switch.

Controls

This chapter explains how to operate the various controls necessary for driving.



Clock	94
Locking and Unlocking the Doors	
Key Types and Functions.....	96
Low Smart Entry Remote Signal Strength *.....	98
Locking/Unlocking the Doors from the Outside.....	99
Locking/Unlocking the Doors from the Inside.....	105
Childproof Door Locks.....	108
Auto Door Locking/Unlocking.....	109
Customizing the Auto Door Locking/Unlocking Setting.....	110
Opening and Closing the Tailgate	113
Using the Tailgate Release Button.....	114
Security System	116
Immobilizer System.....	116
Security System Alarm.....	116
Opening and Closing the Windows	119
Opening and Closing the Moonroof*	121

Operating the Switches Around the Steering Wheel

Models without smart entry system	
Ignition Switch.....	122
Models with smart entry system	
ENGINE START/STOP Button.....	123
Ignition Switch and Power Mode Comparison ...	126
Turn Signals.....	127
Light Switches.....	127
Fog Lights*.....	130
Daytime Running Lights.....	131
Wipers and Washers.....	132
Brightness Control.....	134
Defogger/Heated Door Mirror*/Heater Windshield*....	135
Adjusting the Steering Wheel.....	137

Adjusting the Mirrors

Interior Rearview Mirror.....	138
Power Door Mirrors.....	139

Adjusting the Seats

Adjusting the Seat Positions.....	140
Rear Seats.....	146
Armrest.....	149

Interior Lights/Interior Convenience Items

Interior Lights.....	150
Interior Convenience Items.....	152

Heating and Cooling System*

Using Vents, Heating and A/C.....	161
-----------------------------------	-----

Climate Control System*

Using Automatic Climate Control.....	165
Synchronized Mode*.....	172
Automatic Climate Control Sensors.....	173

* Not available on all models

Adjusting the Clock



Models without navigation system

You can adjust the time in the clock display with the ignition switch is in ON *1.

Adjusting the Time

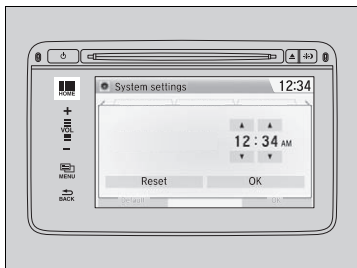
Display audio system*



1. Select the  (**HOME**) icon, then select **Settings**.
2. Select **System**, **Clock**, then **Clock Adjustment**.
3. Adjust the hours and minutes by selecting /.
4. Select **OK** to set the time.

Adjusting the Time

The clock in the information display is automatically adjusted along with the audio system's clock display.

Models with navigation system

The clock is automatically updated through the navigation system, so the time does not need to be adjusted.

Models without navigation system

You can customize the clock display to show the 12 hour clock or 24 hour clock.

 **Customized Features** P. 238

Display audio system*

You can turn the clock display on and off.







 **Customized Features** P. 238

*1: Models with the smart entry system have an **ENGINE START/STOP** button instead of an ignition switch.

* Not available on all models

■ Color audio system*



1. Press and hold the **MENU/CLOCK** button.
▶ **Adjust Clock** is selected.
2. Rotate  to change hour, then press .
3. Rotate  to change minute, then press .
4. To enter the selection, rotate  and select **Set**, then press .



☒ Color audio system*

These indications are used to show how to operate the **LIST/SELECT** (List/Selector) knob.

Rotate  to select.

Press  to enter.

You can also select **Adjust Clock** by pressing the **MENU/CLOCK** button.

Rotate  to select **Adjust Clock**, then press .

* Not available on all models

Key Types and Functions

This vehicle comes with the following keys:

Keys

Smart Entry Remote*



Ignition Key with Remote Transmitter*



Models with smart entry system

Use the smart entry remote to start and stop the engine, and to lock and unlock all the doors and tailgate. You can also use the smart entry system to lock and unlock the doors and tailgate.

Models without smart entry system

Use the key to start and stop the engine, and to lock and unlock all the doors and tailgate. You can also use the remote transmitter to lock and unlock the doors and tailgate.

Key Types and Functions

All the keys have an immobilizer system. The immobilizer system helps to protect against vehicle theft.

Immobilizer System P. 116

The keys contain precision electronics.

Adhere to the following advice to prevent damage to the electronics:

- Do not leave the keys in direct sunlight, or in locations with high temperature or high humidity.
- Do not drop the keys or set heavy objects on them.
- Keep the keys away from liquids.
- Do not take the keys apart except for replacing the battery.

If the circuits in the keys are damaged, the engine may not start, and the remote transmitter/smart entry system* may not work.

If the keys do not work properly, have them inspected by a dealer.

■ Smart entry remote*

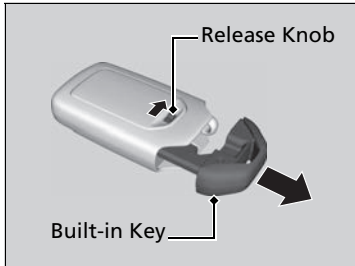

The built-in key can be used to lock/unlock the doors when the smart entry remote battery becomes weak and the power door lock/unlock operation is disabled.

To remove the built-in key, pull it out while sliding the release knob. To reinstall the built-in key, push the built-in key into the smart entry remote until it clicks.

■ Key Number Tag

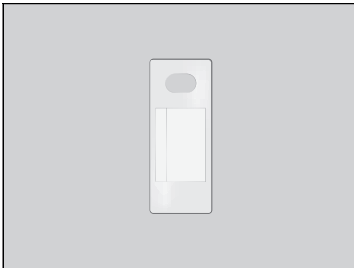

Contains a number that you will need if you purchase a replacement key.

⊠ Key Number Tag

Keep the key number tag separate from the key in a safe place outside of a vehicle.
If you wish to purchase an additional key, contact a dealer.

If you lose your key and you cannot start the engine, contact a dealer.

* Not available on all models

Low Smart Entry Remote Signal Strength *

The vehicle transmits radio waves to locate the smart entry remote when locking/unlocking the doors and tailgate, or to start the engine.

In the following cases, locking/unlocking the doors and tailgate, or starting the engine may be inhibited or operation may be unstable:

- Strong radio waves are being transmitted by nearby equipment.
- You are carrying the smart entry remote together with telecommunications equipment, laptop computers, cell phones, or wireless devices.
- A metallic object is touching or covering the smart entry remote.

Low Smart Entry Remote Signal Strength *

Communication between the smart entry remote and the vehicle consumes the smart entry remote's battery.

Battery life is about two years, but this varies depending on regularity of use.

The battery is consumed whenever the smart entry remote is receiving strong radio waves. Avoid placing it near electrical appliances such as televisions and personal computers.

Locking/Unlocking the Doors from the Outside

■ Using the Remote Transmitter

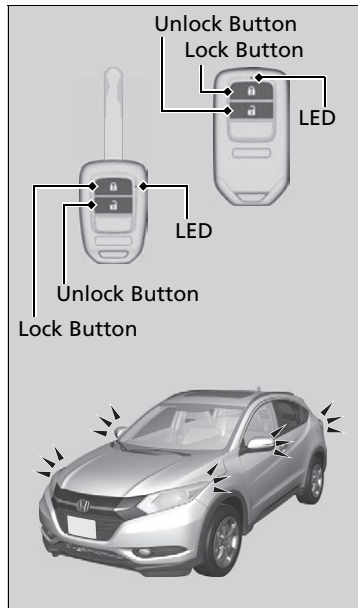

■ Locking the doors

Press the lock button.

Once:

- ▶ Some exterior lights flash, all the doors and tailgate lock, and the security system sets.

Twice (within five seconds after the first push):

- ▶ A beeper sounds and verifies the security system is set.

☒ Using the Remote Transmitter

If you do not open a door within 30 seconds of unlocking the vehicle with the remote transmitter, the doors will automatically relock.

If the interior light switch is in the door activated position, the interior lights come on when you press the unlock button.

No doors opened: The lights fade out after 30 seconds.

Doors relocked with the remote transmitter: The lights go off immediately.

The remote transmitter uses low-power signals, so the operating range may vary depending on the surroundings.

The remote transmitter will not lock the vehicle when a door is open.

Models without smart entry system

The remote transmitter will not work when the key is in the ignition switch.

Models with smart entry system

You can lock or unlock doors using the remote transmitter or smart entry system only when the power mode is in VEHICLE OFF.

■ Unlocking the doors

Press the unlock button.

Once:

- ▶ Some exterior lights flash twice, and the driver's door unlocks.

Twice:

- ▶ The remaining doors and the tailgate unlock.

☒ Using the Remote Transmitter

If the distance at which the remote transmitter works varies, the battery is probably low. Replace the button battery as soon as possible. If the LED does not come on when you press a button, the battery is dead.

☒ **Replacing the Button Battery** P. 422

■ Using the Smart Entry with Push Button Start System *

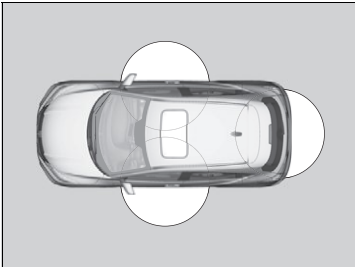

When you carry the smart entry remote, you can lock/unlock the doors and the tailgate. You can lock/unlock the doors and the tailgate within a radius of about 32 inches (80 cm) of the outside door handle. You can open the tailgate within about 32 inches (80 cm) radius from the tailgate release button.

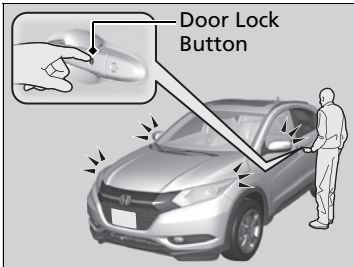

■ Locking the doors and tailgate

Press the door lock button on the front door or the tailgate.

- ▶ Some exterior lights flash; the beeper sounds; all the doors and tailgate lock; and the security system sets.

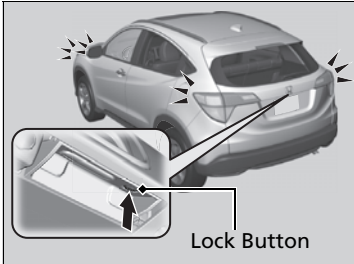

☒ Using the Smart Entry with Push Button Start System *

- Do not leave the smart entry remote in the vehicle when you get out. Carry it with you.
- Even if you are not carrying the smart entry remote, you can lock/unlock the doors and the tailgate while someone else with the remote is within range.
- The door may be unlocked if the door handle is covered with water in heavy rain or in a car wash if the smart entry remote is within range.
- If you grip a front door handle wearing gloves, the door sensor may be slow to respond or may not respond by unlocking the doors.
- You cannot unlock the door by gripping the handle after two seconds of locking it.
- The door might not open if you pull it immediately after gripping the door handle. Grip the handle again and confirm that the door is unlocked before pulling the handle.
- Even within the 32 inches (80 cm) radius, you may not be able to lock/unlock the doors and the tailgate with the smart entry remote if it is above or below the outside handle.
- The smart entry remote may not operate if it is too close to the door and door glass.

If the distance at which the remote transmitter works varies, the battery is probably low. Replace the button battery as soon as possible. If the LED does not come on when you press a button, the battery is dead.

☒ **Replacing the Button Battery** P. 422

* Not available on all models

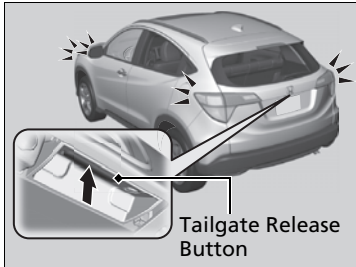
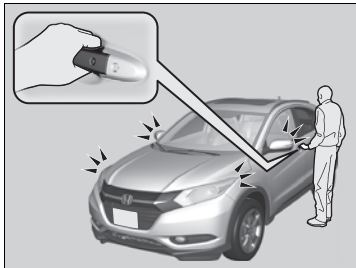

■ Unlocking the doors and tailgate

Grab the driver's door handle:

- ▶ The driver's door unlocks.
- ▶ Some exterior lights flash twice and the beeper sounds twice.

Grab the front passenger's door handle:

- ▶ All the doors and the tailgate unlock.
- ▶ Some exterior lights flash twice and the beeper sounds twice.

Press the tailgate release button:

- ▶ The tailgate unlocks.
- ▶ Some exterior lights flash twice and the beeper sounds twice.

▣ Using the Tailgate Release Button

P. 114

▣ Using the Smart Entry with Push Button Start System *

If you do not open a door or the tailgate within 30 seconds of unlocking the vehicle, the doors will automatically relock.

■ Locking/Unlocking the Doors Using a Key

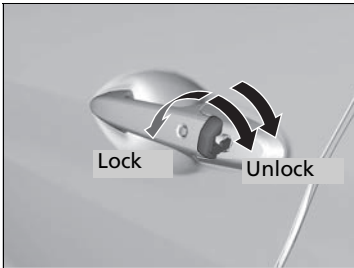

Fully insert the key and turn it.

When you lock the driver's door with a key, all the other doors and tailgate lock at the same time. When unlocking, the driver's door unlocks first. Turn the key a second time within a few seconds to unlock the remaining doors and the tailgate.

▣ Locking/Unlocking the Doors Using a Key

If you unlock the doors with the key, the alarm goes off when you open the hood or move the shift lever out of **P** (continuously variable transmission models).

Continued

■ Locking a Door Without Using a Key

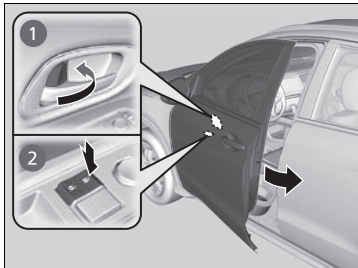

■ Locking the driver's door

Push the lock tab forward ❶ or push the master door lock switch in the lock direction ❷, and close the door.

■ Locking the passengers' doors

Push the lock tab forward and close the door.

■ Lockout prevention system

Models without smart entry system

The doors and the tailgate cannot be locked when the key is in the ignition switch.

Models with smart entry system

The doors and the tailgate cannot be locked when the smart entry remote is inside the vehicle.

▶▶ Locking a Door Without Using a Key

When you lock the driver's door, all the other doors and tailgate lock at the same time.

Make sure you have the key in your hand before locking the door to prevent it from being locked in the vehicle.

Locking/Unlocking the Doors from the Inside

■ Using the Lock Tab

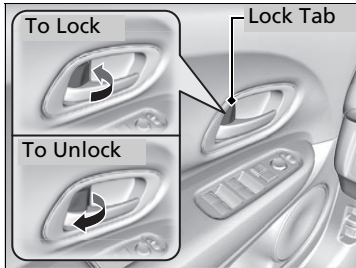

■ Locking a door

Push the lock tab forward.

■ Unlocking a door

Pull the lock tab rearward.

☒ Using the Lock Tab

When you lock the door using the lock tab on the driver's door, all the other doors and the tailgate lock at the same time.

When you unlock the door using the lock tab on the driver's door, only the driver's door will unlock.

Continued

■ Unlocking Using the Front Door Inner Handle

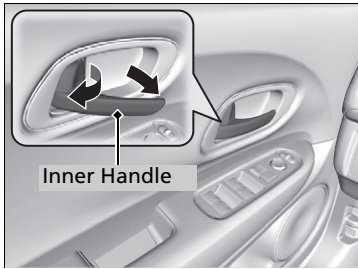

Pull the front door inner handle.

- ▶ The door unlocks and opens in one motion.

Unlocking and opening the driver's door from the inner handle unlocks all the other doors.

To prevent all the doors unlocking, use the lock tab on the driver's door to unlock, then lock again before opening the door.

- ▶ This setting works for one time only. If you do not want all the doors to unlock all the time, customize the Auto Door Unlock setting to Off using the master door lock switch.

🔧 **Auto Door Locking/Unlocking** P. 109

🔧 Unlocking Using the Front Door Inner Handle

The front door inner handles are designed to allow front seat occupants to open the door in one motion. However this feature requires that front seat occupants never pull a front door inner handle while the vehicle is in motion.

Children should always ride in a rear seat where childproof door locks are provided.

🔧 **Childproof Door Locks** P. 108

■ Using the Master Door Lock Switch

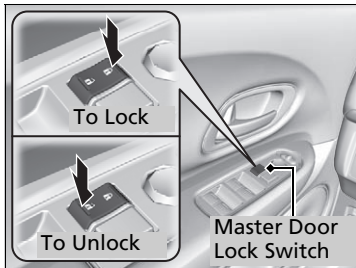

Press the master door lock switch in as shown to lock or unlock all doors and the tailgate.

☒ Using the Master Door Lock Switch

When you lock/unlock the driver's door using the master lock switch, all the other doors and the tailgate lock/unlock at the same time.

Childproof Door Locks

The childproof door locks prevent the rear doors from being opened from the inside regardless of the position of the lock tab.

■ Setting the Childproof Door Locks

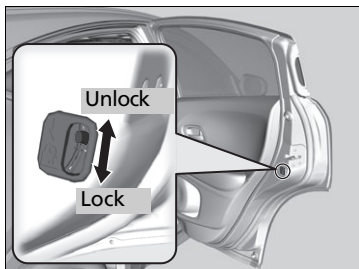

Slide the lever in the rear door to the lock position, and close the door.

■ When opening the door

Open the door using the outside door handle.

☒ Childproof Door Locks

To open the door from the inside when the childproof door lock is on, put the lock tab in the unlock position, lower the rear window, put your hand out of the window, and pull the outside door handle.

Auto Door Locking/Unlocking

Your vehicle locks and unlocks all doors automatically when a certain condition is met.

■ Auto Door Locking

■ Drive lock mode

All doors lock when the vehicle's speed reaches about 10 mph (15 km/h).

■ Auto Door Unlocking

■ Driver's door open mode

All doors unlock when the driver's door is opened.

☒ Auto Door Locking/Unlocking

You can turn off or change to another auto door locking/unlocking setting using the master door lock switch.

☒ Customizing the Auto Door Locking/Unlocking Setting P. 110

Customizing the Auto Door Locking/Unlocking Setting

You can customize the auto door locking/unlocking setting to your liking using the master door lock switch.

List of the Auto Door Locking/Unlocking Customizable Options

■ Auto door locking



Mode	Description
Drive Lock Mode^{*1}	All doors lock when the vehicle's speed reaches about 10 mph (15 km/h).
Off	The auto door locking is deactivated all the time.

■ Auto door unlocking

Mode	Description
Driver's Door Open Unlock Mode^{*1}	All doors unlock when the driver's door is opened.
Continuously variable transmission models Park Unlock Mode	All doors unlock when the shift lever is moved into P with the brake pedal depressed.
Off	The auto door unlocking is deactivated all the time.

*1: Default setting

■ Customizing Flow for Auto Door Locking Options

Steps	Drive Lock Mode*1	Off
1	Apply the parking brake.	
2	The driver's door must be closed at this stage.	Open the driver's door.
3	Turn the ignition switch to ON  *2. Push the ENGINE START/STOP button twice without depressing the brake pedal*3.	
4	Press and hold the front of the master door lock switch on the driver's door. You will hear a click more than five seconds elapsed. Release the switch.	
		
5	Turn the ignition switch to OFF  within 20 seconds*2. Push the ENGINE START/STOP button once without depressing the brake pedal*3. ▶ Customization is completed. ▶ All doors unlock and all turn signals blink three times.	

*1: Default setting

*2: Models without smart entry system

*3: Models with smart entry system

■ Customizing Flow for Auto Door Unlocking Options

Steps	Driver Door Open Unlock Mode*1	Continuously variable transmission models Park Unlock Mode	Off
1	Apply the parking brake. Continuously variable transmission models Move the shift lever out of P with the brake pedal depressed.	Apply the parking brake. Move the shift lever to P .	Apply the parking brake. Continuously variable transmission models Move the shift lever to P .
2	The driver's door must be closed at this stage.		Open the driver's door.
3	Turn the ignition switch to ON II *2. Push the ENGINE START/STOP button twice without depressing the brake pedal*3.		
4	Press and hold the rear of the master door lock switch on the driver's door. You will hear a click more than five seconds elapsed. Release the switch.		
			
5	Turn the ignition switch to OFF 0 within 20 seconds*2. Push the ENGINE START/STOP button once without depressing the brake pedal*3. <ul style="list-style-type: none"> ▶ Customization is completed. ▶ All doors lock and all turn signals blink three times. 		

*1: Default setting

*2: Models without smart entry system

*3: Models with smart entry system

Precautions for Opening/Closing the Tailgate

Always make sure individuals and objects are clear of the tailgate before opening or closing it.

■ Opening the tailgate

- Open the tailgate all the way.
 - ▶ If it is not fully opened, the tailgate may come down accidentally by its own weight.
- Be careful when it is windy. The wind may cause the tailgate to close.

■ Closing the tailgate

Keep the tailgate closed while driving to:

- ▶ Avoid possible damage.
- ▶ Prevent exhaust gas from leaking into the vehicle.
 - **Carbon Monoxide Gas** P. 69

⚠ Precautions for Opening/Closing the Tailgate

Be careful not to hit your head on the tailgate or to put your hands between the tailgate and the cargo area when closing the tailgate.

When you are storing or picking up luggage from the cargo area while the engine is idling, do not stand in front of the exhaust pipe. You may get burned.

Do not allow any passenger in the cargo space. They may get hurt during hard braking, a sudden acceleration, or a crash.

Using the Tailgate Release Button



When all the doors are unlocked or you press the tailgate unlock button on the remote transmitter, the tailgate is unlocked. Press the tailgate release button and lift open the tailgate.

Models with smart entry system

Even if the tailgate is locked, you can open the tailgate if you carry the smart entry remote.

To close the tailgate, grab the inner handle, pull the tailgate down, and push it closed from outside.

If you close the tailgate when all the doors are locked, the tailgate locks automatically.

- Some exterior lights flash.

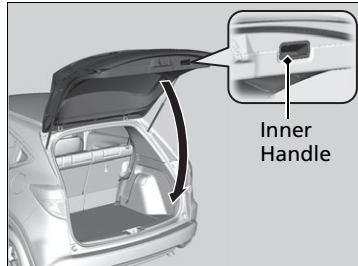

►► Using the Tailgate Release Button

Models with smart entry system

- Do not leave the smart entry remote in the vehicle when you get out. Carry it with you.
- Even if you are not carrying the smart entry remote, you can unlock the tailgate while someone else is with the remote is within range.

Remote Transmitter

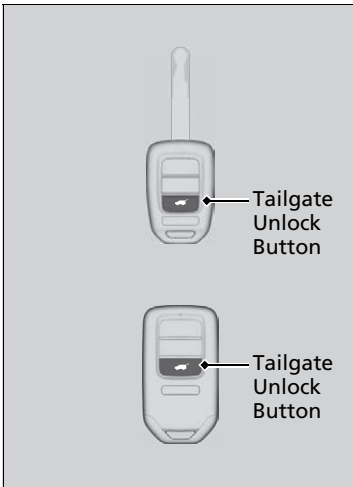

Press the tailgate unlock button to unlock the tailgate.

Remote Transmitter

If you have unlocked and opened the tailgate using the remote transmitter, or smart entry remote, when closing, the tailgate locks automatically.

Immobilizer System

The immobilizer system prevents a key that has not been pre-registered from starting the engine. Each key contains electronic transmitters that use electronic signals to verify the key.

Pay attention to the following when inserting the key into the ignition switch or pressing the **ENGINE START/STOP** button:

- Do not allow objects that emit strong radio waves near the ignition switch or the **ENGINE START/STOP** button.
- Make sure the key is not covered by or touching a metal object.
- Do not bring a key from another vehicle's immobilizer system near the ignition switch.

Security System Alarm

The security system alarm activates when the tailgate, hood or doors are forcibly opened. The alarm does not go off if the tailgate or doors are opened with the key, remote transmitter or smart entry system.

However, the alarm goes off when a door is opened with the key, then the shift lever is moved out of **P** (continuously variable transmission models) or the hood is opened before the ignition switch is turned to ON **II***1.

■ When the security system alarm activates

The horn sounds intermittently and all of the exterior lights flash.

*1: Models with the smart entry system have an **ENGINE START/STOP** button instead of an ignition switch.

Immobilizer System

NOTICE

Leaving the ignition key in the vehicle can result in theft or accidental movement of the vehicle. Always take the ignition key with you whenever you leave the vehicle unattended.

Do not alter the system or add other devices to it. Doing so may damage the system and make your vehicle inoperable.

Security System Alarm

The security alarm continues for a maximum of two minutes until the security system deactivates.

■ To deactivate the security system alarm

Unlock the vehicle using the remote transmitter or smart entry remote, or turn the ignition switch to ON **II***1. The system, along with the horn and flashing lights, is deactivated.

■ Setting the security system alarm

The security system alarm automatically sets when the following conditions have been met:

- The ignition switch is in LOCK **0***1, and the key has been removed from the ignition switch.
- The hood is closed.
- All doors and the tailgate are locked from outside with the key, remote transmitter, or smart entry system.

■ When the security system alarm sets

The security system alarm indicator in the instrument panel blinks. When the blinking interval changes after about 15 seconds, the security system alarm is set.

■ To cancel the security system alarm

The security system alarm is canceled when the vehicle is unlocked using the remote transmitter or smart entry system, or the ignition switch is turned to ON **II***1. The security system alarm indicator goes off at the same time.

*1: Models with the smart entry system have an **ENGINE START/STOP** button instead of an ignition switch.

☒ Security System Alarm

Do not set the security system alarm when someone is in the vehicle or a window is open. The system can accidentally activate when:

- Unlocking the door with the lock tab.
- Opening the hood with the hood release handle.

Continuously variable transmission models

- Moving the shift lever out of **P**.

If the battery goes dead after you have set the security system alarm, the security alarm may go off once the battery is recharged or replaced.

If this occurs, deactivate the security system alarm by unlocking a door using the key, remote transmitter, or smart entry system.

Do not attempt to alter this system or add another device to it.

■ Panic Mode

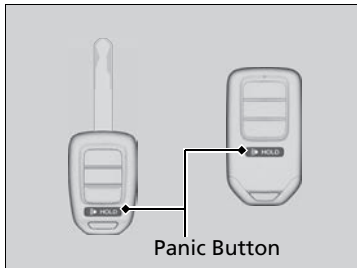

■ The panic button on the remote transmitter

If you press the panic button for approximately one second, the following will occur for about 30 seconds:

- The horn sounds.
- Some exterior lights flash.

■ Canceling panic mode

Press any button on the remote transmitter, or turn the ignition switch to ON *1.

*1: Models with the smart entry system have an **ENGINE START/STOP** button instead of an ignition switch.

Opening/Closing the Power Windows

The power windows can be opened and closed when the ignition switch is in ON **II***1, using the switches on the doors. The driver's side switches can be used to open and close all of the windows.

The power window lock button on the driver's side must be switched off (not pushed in, indicator off) to open and close the windows from anywhere other than the driver's seat.

When the power window lock button is pushed in, the indicator comes on and you can only operate the driver's window. Turn the power window lock button on when children are in the vehicle.

Opening/Closing Windows with Auto-Open/Close Function

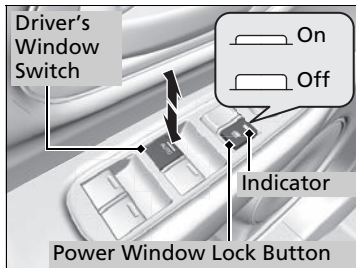

Automatic operation

To open: Push the switch down firmly.

To close: Pull the switch up firmly.

The window opens or closes completely. To stop the window at any time, push or pull the switch briefly.

Manual operation

To open: Push the switch down lightly, and hold it until the desired position is reached.

To close: Pull the switch up lightly, and hold it until the desired position is reached.

* 1: Models with the smart entry system have an **ENGINE START/STOP** button instead of an ignition switch.

Opening/Closing the Power Windows

WARNING

Closing a power window on someone's hands or fingers can cause serious injury.

Make sure your passengers are away from the windows before closing them.

The power windows can be operated for up to 10 minutes after you turn the ignition switch to LOCK **0***1. Opening either front door cancels this function.

Auto Reverse

If a power window senses resistance when closing automatically, it will stop closing and reverse direction.

The driver's window auto reverse function is disabled when you continuously pull up the switch.

The auto reverse function stops sensing when the window is almost closed to ensure that it fully closes.

■ Opening/Closing Windows without Auto-Open/Close Function

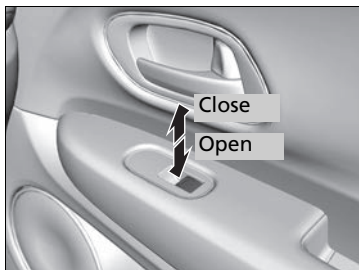

To open: Push the switch down lightly, and hold it until the desired position is reached.

To close: Pull the switch up lightly, and hold it until the desired position is reached.

Opening/Closing the Moonroof

You can only operate the moonroof when the ignition switch is in ON *1. Use the switch in the front of the ceiling to open and close the moonroof.

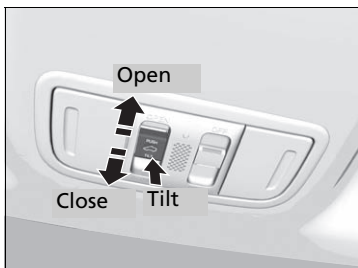

Automatic operation

To open: Pull the switch back firmly.

To close: Push the switch forward firmly.

The moonroof will automatically open or close all the way. To stop the moonroof midway, touch the switch briefly.

Manual operation

To open: Pull the switch back lightly, and hold it until the desired position is reached.

To close: Push the switch forward lightly, and hold it until the desired position is reached.

Tilting the moonroof up

To tilt: Push on the center of the moonroof switch.

To close: Push the switch forward firmly, then release.

Opening/Closing the Moonroof

⚠ WARNING

Opening or closing the moonroof on someone's hands or fingers can cause serious injury.

Make sure all hands and fingers are clear of the moonroof before opening or closing it.

NOTICE

Opening the moonroof in below freezing temperature or when it is covered with snow or ice can damage the moonroof panel or motor.

The power moonroof can be operated for up to 10 minutes after you turn the ignition switch to LOCK *1. Opening either front door cancels this function.

When resistance is detected, the auto reverse function causes the moonroof to change directions, then stop. Auto reverse stops sensing when the moonroof is almost closed to ensure that it fully closes.

*1: Models with the smart entry system have an **ENGINE START/STOP** button instead of an ignition switch.

* Not available on all models

Operating the Switches Around the Steering Wheel

Models without smart entry system

Ignition Switch

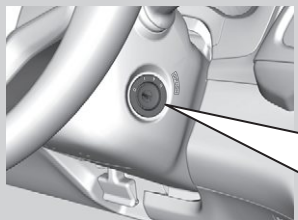

- 0** LOCK: Insert and remove the key in this position.
- I** ACCESSORY: Operate the audio system and other accessories in this position.
- II** ON: This is the position when driving.
- III** START: This position is for starting the engine. The switch returns to ON **II** when you let go of the key.

Ignition Switch

Manual transmission models

⚠ WARNING

Removing the key from the ignition switch while driving locks the steering. This can cause you to lose control of the vehicle.

Remove the key from the ignition switch only when parked.

Continuously variable transmission models

You cannot take the key out unless the shift lever is in **P**.

All models

If you open the driver's door when the key is in LOCK **0** or ACCESSORY **I**, a warning buzzer will sound to remind you to take the key out.

If the key won't turn from LOCK **0** to ACCESSORY **I**, turn the key while moving the steering wheel left and right. The steering wheel will unlock, allowing the key to turn.

Models with smart entry system

ENGINE START/STOP Button

Changing the Power Mode

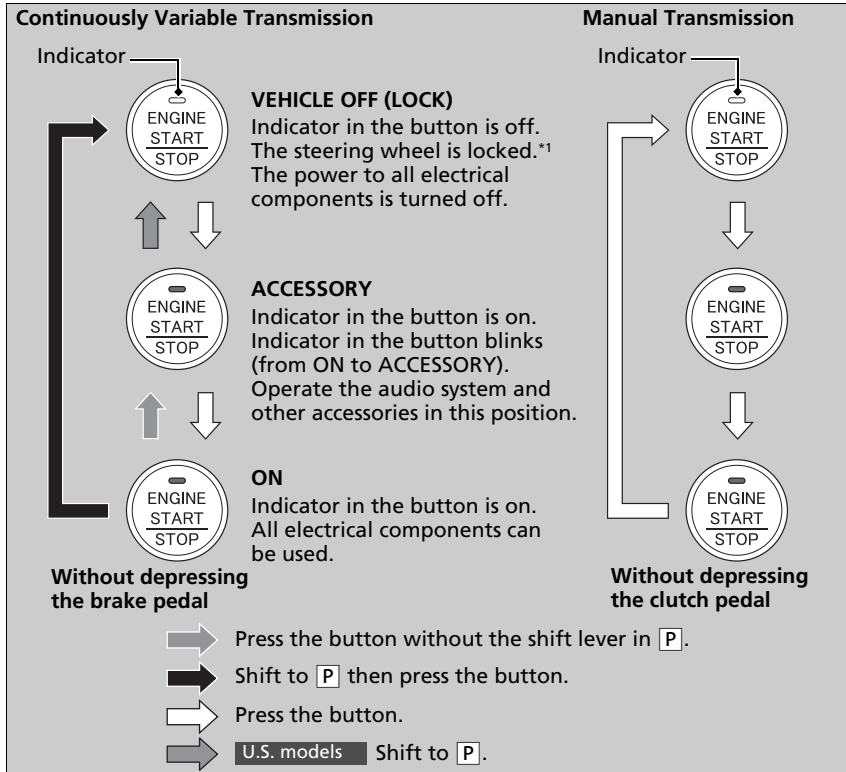

*1: Except U.S. models with continuously variable transmission

ENGINE START/STOP Button

ENGINE START/STOP Button Operating Range

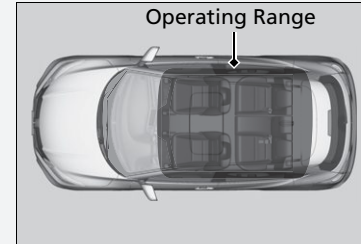

You can start the engine when the smart entry remote is inside the vehicle. The engine may also run if the smart entry remote is close to the door or window, even if it is outside the vehicle.

ON mode:
Indicator in the button is off, if the engine is running.

If the smart entry remote battery is weak, beeper sounds and the **KEY BATT** message appears in the information display.

➡ **If the Smart Entry Remote Battery is Weak**
P. 444

Do not leave the power mode in ACCESSORY or ON when you get out.

Except U.S. models with continuously variable transmission
If the power mode does not change from VEHICLE OFF to ACCESSORY, press the **ENGINE START/STOP** button while moving the steering wheel left and right. The steering wheel will unlock, allowing the mode to change.

■ Automatic Power Off

If you leave the vehicle for 30 to 60 minutes with the shift lever in **P***1 and the power mode in ACCESSORY, the vehicle automatically goes into the mode similar to VEHICLE OFF (LOCK) to avoid the battery drain.

Except U.S. models with continuously variable transmission

When in this mode:

The steering wheel does not lock.

You cannot lock or unlock doors with the remote transmitter or the smart entry system.

Press the **ENGINE START/STOP** button to switch the mode to VEHICLE OFF (LOCK).

*1: Continuously variable transmission models

■ Power Mode Reminder

If you open the driver's door when the power mode is set to ACCESSORY, a warning buzzer sounds.

■ Smart Entry Remote Reminder



Warning buzzers may sound from inside or/ and outside the vehicle to remind you that the smart entry remote is out of the vehicle. If the buzzer continues even after the remote is put back inside, place it to be within its operational range.

■ When the power mode is in ON

If the smart entry remote is taken out of the vehicle, and the driver's door is closed, warning buzzers sound from both inside and outside the vehicle. A warning message on the information display notifies the driver inside that the remote is out.

■ When the power mode is in ACCESSORY

If the smart entry remote is taken out of the vehicle, and all the doors are closed, a warning buzzer sounds from outside the vehicle.

☒ Smart Entry Remote Reminder









When the smart entry remote is within the system's operational range, and the driver's door is closed, the warning function cancels.

If the smart entry remote is taken out of the vehicle after the engine has been started, you can no longer change the **ENGINE START/STOP** button mode or restart the engine. Always make sure if the remote is in your vehicle when you operate the **ENGINE START/STOP** button.

Removing the smart entry remote from the vehicle through a window does not activate the warning buzzer.

Do not put the smart entry remote on the dashboard or in the glove box. It may cause the warning buzzer to go off. Under some other conditions that can prevent the vehicle from locating the remote, the warning buzzer may also go off even if the remote is within the system's operational range.

Ignition Switch and Power Mode Comparison

Ignition Switch Position	LOCK 0 (with/without the key) 	ACCESSORY I 	ON II 	START III 
Without Smart Entry System	<ul style="list-style-type: none"> • Engine is turned off and power is shut down. • The steering wheel is locked. • No electrical components can be used. 	<ul style="list-style-type: none"> • Engine is turned off. • Some electrical components such as the audio system and the accessory power socket can be operated. 	<ul style="list-style-type: none"> • Normal key position while driving. • All electrical components can be used. 	<ul style="list-style-type: none"> • Use this position to start the engine. • The ignition switch returns to ON II when you release the key.
Power Mode	VEHICLE OFF (LOCK) 	ACCESSORY 	ON   Indicator is: On Off	START 
With Smart Entry System and ENGINE START/STOP Button	Indicator-Off <ul style="list-style-type: none"> • Engine is turned off and power is shut down. • The steering wheel is locked.*1 • No electrical components can be used. 	Indicator-On or blinking <ul style="list-style-type: none"> • Engine is turned off. • Some electrical components such as the audio system and the accessory power socket can be operated. 	Indicator-On (engine is turned off) Off (engine is running) <ul style="list-style-type: none"> • All electrical components can be used. 	Indicator-Off <ul style="list-style-type: none"> • The mode automatically returns to ON after the engine starts.

*1: Except U.S. models with continuously variable transmission

Turn Signals

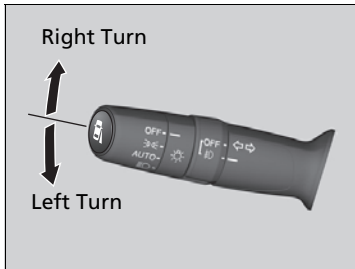

The turn signals can be used when the ignition switch is in ON *1.

■ One-touch turn signal

When you lightly push up or down and release the turn signal lever, the exterior turn signals and turn signal indicator blink three times.

This feature can be used when signaling for a lane change.

Light Switches

■ Manual Operation

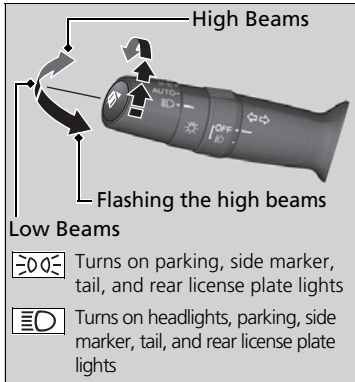

Rotating the light switch turns the lights on and off, regardless of the position of the ignition switch*1.

■ High beams

Push the lever forward until you hear a click.

■ Low beams

When in high beams, pull the lever back to return to low beams.

■ Flashing the high beams

Pull the lever back, and release it.

*1: Models with the smart entry system have an **ENGINE START/STOP** button instead of an ignition switch.

» Light Switches

Models without smart entry system

If you remove the key from the ignition switch while the lights are on, a chime sounds when the driver's door is opened.

Models with smart entry system

If you leave the power mode in VEHICLE OFF (LOCK) while the lights are on, a chime sounds when the driver's door is opened.

All models

Do not leave the lights on when the engine is off because it will cause the battery to discharge.

If you sense that the level of the headlights is abnormal, have your vehicle inspected by a dealer.

■ Automatic Lighting Control*

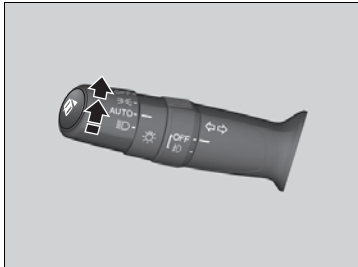

Automatic lighting control can be used when the ignition switch is in ON *1.

When you turn the light switch to **AUTO**, the headlights and other exterior lights will switch on and off automatically depending on the ambient brightness.

▶ Automatic Lighting Control*

We recommend that you turn on the lights manually when driving at night, in a dense fog, or in dark areas such as long tunnels or parking facilities.

The light sensor is in the location shown below. Do not cover this light sensor with anything; otherwise, the automatic lighting system may not work properly.

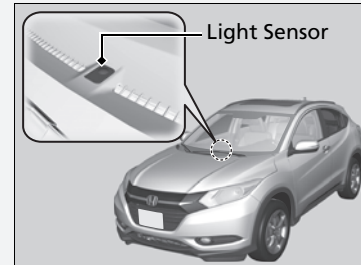

*1: Models with the smart entry system have an **ENGINE START/STOP** button instead of an ignition switch.

* Not available on all models

■ Headlight Integration with Wipers*

The headlights automatically come on when the wipers are used several times within a certain intervals with the headlight switch in **AUTO**.

The headlights automatically go off a few minutes later if the wipers are stopped.

■ Automatic Lighting Off Feature

The headlights, all other exterior lights, and the instrument panel lights turn off 15 seconds after you remove the key or set the power mode to VEHICLE OFF (LOCK), take the remote with you, and close the driver's door.

If you turn the ignition switch to LOCK *1 with the headlight switch on, but do not open the door, the lights turn off after 10 minutes (3 minutes, if the switch is in the **AUTO** position).

The lights turn on again when you unlock or open the driver's door. If you unlock the door, but do not open it within 15 seconds, the lights go off. If you open the driver's door, you will hear a lights on reminder chime.

*1: Models with the smart entry system have an **ENGINE START/STOP** button instead of an ignition switch.

* Not available on all models

▣ Headlight Integration with Wipers*

This feature activates while the headlights are off in **AUTO**.

The instrument panel brightness does not change when the headlights come on.

When the ambient light is at dark, the automatic lighting control feature overrides, and the headlights come on with or without the wipers sweeping more than several times.

Fog Lights*

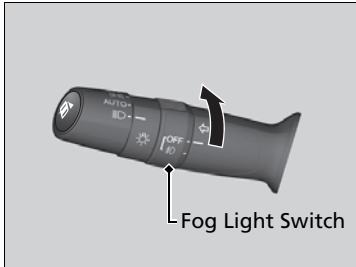

When the low beam headlights are on, turn the fog light switch on to use the fog lights.

☒ Fog Lights*



When the fog lights are on, the indicator in the instrument panel will be on.

☒ **Fog Light Indicator*** P. 80

The fog lights go off when the headlights turn off, or when the daytime running lights are on.

Daytime Running Lights

The headlights come on slightly dimmer than normal when the following conditions have been met:

- The ignition switch is in ON *1.
- The headlight switch is off, or in .
- The parking brake is released.

The lights remain on even if you set the parking brake. Turning off the ignition switch or setting the power mode to VEHICLE OFF will turn off the daytime running lights.

The headlights return to the original brightness once the headlight switch is turned on.

*1: Models with the smart entry system have an **ENGINE START/STOP** button instead of an ignition switch.

Wipers and Washers

■ Front Wiper/Washer

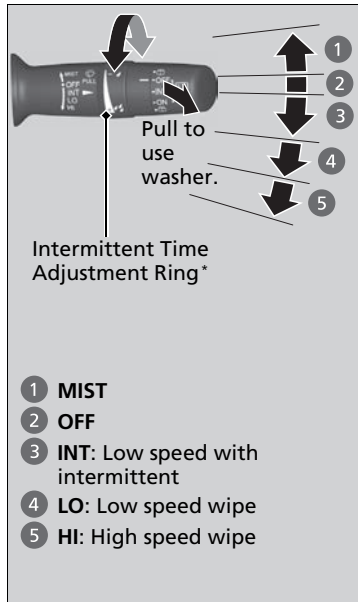

The windshield wipers and washers can be used when the ignition switch is in ON *1.

■ MIST

The wipers run at high speed until you release the lever.

■ Wiper switch (OFF, INT, LO, HI)

Change the wiper switch setting according to the amount of rain.

■ Adjusting wiper operation*

Turn the adjustment ring to adjust the wiper operation.

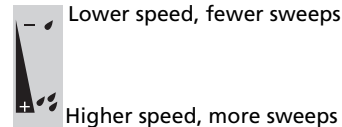

■ Washer

Sprays while you pull the lever toward you. When you release the lever, the wipers make two or three more sweeps before stopping.

*1: Models with the smart entry system have an **ENGINE START/STOP** button instead of an ignition switch.

* Not available on all models

▶▶ Wipers and Washers

NOTICE

Do not use the wipers when the windshield is dry. The windshield will get scratched, or the rubber blades will get damaged.

NOTICE

In cold weather, the blades may freeze to the windshield, becoming stuck. Operating the wipers in this condition may damage the wipers. Use the defroster to warm the windshield, then turn the wipers on.

Models with adjustment ring

If the vehicle speeds up while the wipers are operating intermittently, the length of the wipe interval shortens. When the vehicle starts moving, the wipers make a single sweep. When the vehicle speeds up, the wiper operation's shortest delay and the **LO** setting become the same.

All models

Turn the washers off if no washer fluid comes out. The pump may get damaged.

■ Rear Wiper/Washer

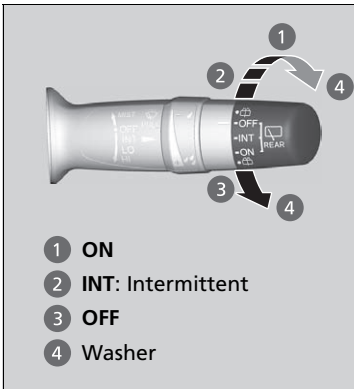

The rear wiper and washer can be used when the ignition switch is in ON *1.

■ Wiper switch (OFF, INT, ON)

Change the wiper switch setting according to the amount of rain.

■ Washer ()

Sprays while you rotate the switch to this position.

Hold it to activate the wiper and to spray the washer. Once released, it stops operating after a few more sweeps.

■ Operating in reverse

When you shift the transmission to R with the front wiper activated, the rear wiper operates automatically as follows even if its switch is off.

Front Wiper Position	Rear Wiper Operation
INT (Intermittent)	Intermittent
LO (Low speed wipe) HI (High speed wipe)	Continuous

*1: Models with the smart entry system have an **ENGINE START/STOP** button instead of an ignition switch.

⌘ Wipers and Washers



If the wiper stops operating due to any obstacle such as the build-up of snow, park the vehicle in a safe place.

Rotate the wiper switch to **OFF**, and turn the ignition switch to ACCESSORY 1 or LOCK 0*1, then remove the obstacle.

The wiper motor is equipped with a breaker that may stop motor operation temporarily to prevent an overload. Wiper operation will return to normal within a few minutes, once the circuit has returned to normal.

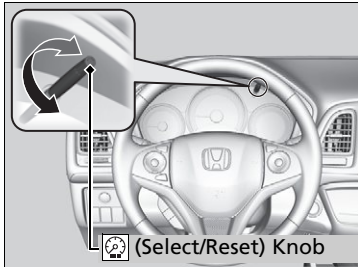
Brightness Control



When the ignition switch is in ON *1, you can use the  (select/reset) knob to adjust instrument panel brightness.

Brighten: Turn the knob to the right.

Dim: Turn the knob to the left.

You will hear a beep when the brightness reaches minimum or maximum. The information display will return to its original state several seconds after you adjust the brightness.

■ Brightness level indicator

The brightness level is shown on the information display while you are adjusting it.

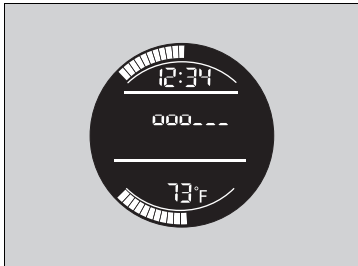

▶▶ Brightness Control

Instrument panel brightness varies, depending on whether the exterior lights are on or off. The instrument panel dims to reduce glare when they are on.

Pressing the  knob switches the display between the brightness level and other available information.

If you turn the knob to the right until the brightness display is up to max, the beeper sounds. This cancels the reduced instrument panel brightness when the parking lights are on.

The brightness can be set differently for when the exterior lights are on, and when they are off.

*1: Models with the smart entry system have an **ENGINE START/STOP** button instead of an ignition switch.

Defogger/Heated Door Mirror*/Heater Windshield*

Rear Defogger/Heated Door Mirror* Button



Press the rear defogger button or touch the icon to defog the rear window and mirrors when the ignition switch is in ON *1.

Models with climate control system

The rear defogger and heated door mirrors automatically switch off after 10-30 minutes depending on the outside temperature. However, if the outside temperature is 32°F (0°C) or below, they do not automatically switch off.

⌘ Rear Defogger/Heated Door Mirror* Button

NOTICE

When cleaning the inside of the rear window, be careful not to damage the heating wires. It is critical to wipe the window from side to side along the defogger heating wires.

This system consumes a lot of power, so turn it off when the window has been defogged. Also, do not use the system for a long period when the engine is idling. This may weaken the battery, making it difficult to start the engine.

*1: Models with the smart entry system have an **ENGINE START/STOP** button instead of an ignition switch.

* Not available on all models

Continued

Canadian models

Heated Windshield Button

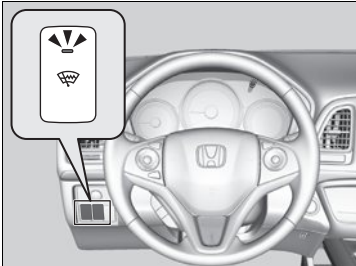

Press the heated windshield button to deice the windshield when the ignition switch is turned to ON *1.

The heated windshield automatically switch off after 15 minutes.

Heated Windshield Button

This system consumes a lot of power, so turn it off when the window has been defogged or deiced.

*1: Models with the smart entry system have an **ENGINE START/STOP** button instead of an ignition switch.

Adjusting the Steering Wheel

The steering wheel height and distance from your body can be adjusted so that you can comfortably grip the steering wheel in an appropriate driving posture.

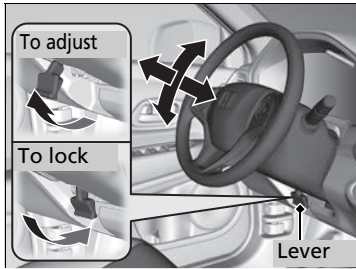

1. Pull the steering wheel adjustment lever up.
 - ▶ The steering wheel adjustment lever is under the steering column.
2. Move the steering wheel up or down, and in or out.
 - ▶ Make sure you can see the instrument panel gauges and indicators.
3. Push the steering wheel adjustment lever down to lock the steering wheel in position.
 - ▶ After adjusting the position, make sure you have securely locked the steering wheel in place by trying to move it up, down, in, and out.

Adjusting the Steering Wheel

⚠ WARNING

Adjusting the steering wheel position while driving may cause you to lose control of the vehicle and be seriously injured in a crash.

Adjust the steering wheel only when the vehicle is stopped.

Make any steering wheel adjustments before you start driving.

Interior Rearview Mirror

Adjust the angle of the rearview mirror when you are sitting in the correct driving position.

Rearview Mirror with Day and Night Positions*

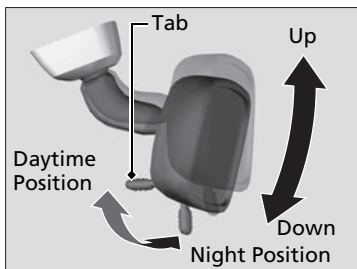

Flip the tab to switch the position. The night position will help to reduce the glare from headlights behind you when driving after dark.

Automatic Dimming Rearview Mirror*

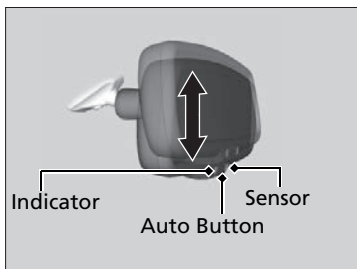

When driving after dark, the automatic dimming rearview mirror reduces the glare from headlights behind you. Press the auto button to turn this function on and off. When activated, the auto indicator comes on.

Adjusting the Mirrors

Keep the inside and outside mirrors clean and adjusted for best visibility.

Adjust the mirrors before you start driving.

➤ **Adjusting the Seat Positions** P. 140

Automatic Dimming Rearview Mirror*

The auto dimming function cancels when the shift lever is in **R**.

Power Door Mirrors

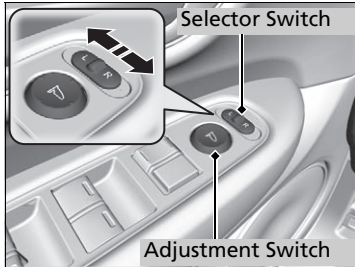

You can adjust the door mirrors when the ignition switch is in ON *1.

■ Mirror position adjustment

L/R selector switch: Select the left or right mirror. After adjusting the mirror, return the switch to the center position.

Mirror position adjustment switch: Press the switch left, right, up, or down to move the mirror.

■ Expanded View Driver's Mirror

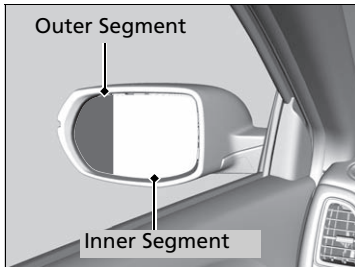

The driver side door mirror has outer and inner segments.

The outer segment is slightly curved to provide a wider angle view than a standard flat mirror. This wider view may help you check areas that are not visible using a standard door mirror.

⌘ Expanded View Driver's Mirror

Objects visible in the outer segment of the driver side door mirror appear smaller than objects in the rest of the mirror. But in fact, they are closer than they appear.

Do not rely on your mirrors. Always look to the side and behind your vehicle before changing lanes.

*1: Models with the smart entry system have an **ENGINE START/STOP** button instead of an ignition switch.

Adjusting the Seat Positions

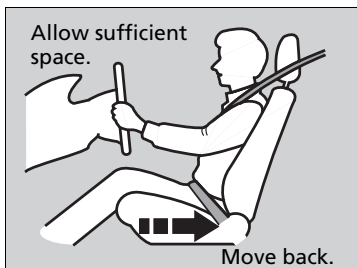

Adjust the driver's seat as far back as possible while allowing you to maintain full control of the vehicle. You should be able to sit upright, well back in the seat and be able to adequately press the pedals without leaning forward, and grip the steering wheel comfortably. The passenger's seat should be adjusted in a similar manner, so that it is as far back from the front airbag in the dashboard as possible.

■ Adjusting the front seat

Height Adjustment

(Driver side only)

Pull up or push down the lever to raise or lower the seat.



Horizontal Position Adjustment

Pull up on the bar to move the seat, then release the bar.

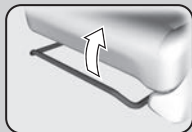

Seat-back Angle Adjustment

Pull up the lever to change the angle.



Driver's seat is shown.

Adjusting the Seats

⚠ WARNING

Sitting too close to a front airbag can result in serious injury or death if the front airbags inflate.

Always sit as far back from the front airbags as possible while maintaining control of the vehicle.

The National Highway Traffic Safety Administration and Transport Canada recommend that drivers allow at least 10 inches (25 cm) between the center of the steering wheel and the chest.

Always make seat adjustments before driving.

Adjusting the front seat

Once a seat is adjusted correctly, rock it back and forth to make sure it is locked in position.

■ Adjusting the Seat-Backs

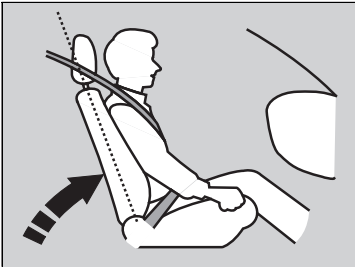

Adjust the driver's seat-back to a comfortable, upright position, leaving ample space between your chest and the airbag cover in the center of the steering wheel.

The front seat passenger should also adjust their seat-back to a comfortable, upright position.

Reclining a seat-back so that the shoulder part of the belt no longer rests against the occupant's chest reduces the protective capability of the belt. It also increases the chance of sliding under the belt in a crash and being seriously injured. The farther a seat-back is reclined, the greater the risk of injury.

▣ Adjusting the Seat-Backs

⚠ WARNING

Reclining the seat-back too far can result in serious injury or death in a crash.

Adjust the seat-back to an upright position, and sit well back in the seat.

Do not put a cushion, or other object, between the seat-back and your back.

Doing so may interfere with proper seat belt or airbag operation.

If you cannot get far enough away from the steering wheel and still reach the controls, we recommend that you investigate whether some type of adaptive equipment may help.

■ Adjusting the Head Restraints

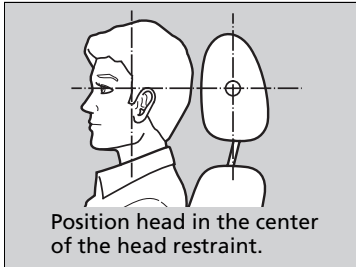

Your vehicle is equipped with head restraints in all seating positions.

Head restraints are most effective for protection against whiplash and other rear-impact crash injuries when the center of the back of the occupant's head rests against the center of the restraint. The tops of the occupant's ears should be level with the center height of the restraint.

■ Adjusting the front head restraint positions

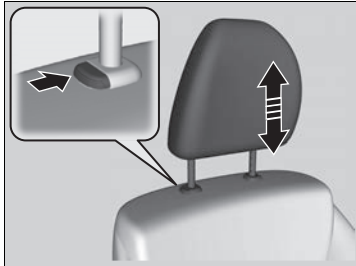

To raise the head restraint:

Pull it upward.

To lower the head restraint:

Push it down while pressing the release button.

►► Adjusting the Head Restraints

⚠ WARNING

Improperly positioning head restraints reduces their effectiveness and increases the likelihood of serious injury in a crash.

Make sure head restraints are in place and positioned properly before driving.

In order for the head restraint system to work properly:

- Do not hang any items on the head restraints, or from the restraint legs.
- Do not place any objects between an occupant and the seat-back.
- Install each restraint in its proper location.

■ Changing the Rear Seat Head Restraint Positions

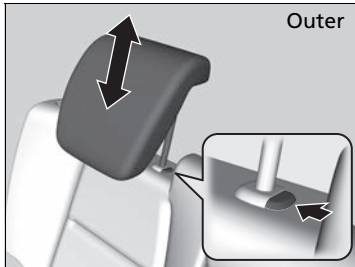

A passenger sitting in a back seating position should adjust the height of their head restraint to an appropriate position before the vehicle begins moving.

To raise the head restraint:

Pull it upward.

To lower the head restraint:

Push it down while pressing the release button.

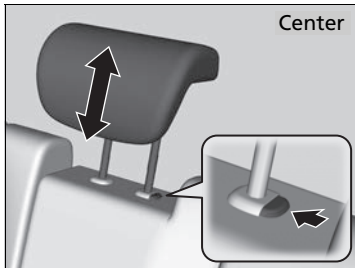

■ Removing and Reinstalling the Head Restraints

Head restraints can be removed for cleaning or repair.

To remove a head restraint:

Pull the restraint up as far as it will go. Then push the release button, and pull the restraint up and out.

To reinstall a head restraint:

Insert the legs back in place, then adjust the head restraint to an appropriate height while pressing the release button. Pull up on the restraint to make sure it is locked in position.

⌘ Removing and Reinstalling the Head Restraints

WARNING

Failure to reinstall, or correctly reinstall, the head restraints can result in severe injury during a crash.

Always replace the head restraints before driving.

To remove and install the rear outer head restraint, recline the seat-back slightly forward as the space between the ceiling and the seat-back is limited.

■ Maintain a Proper Sitting Position

After all occupants have adjusted their seats and head restraints, and put on their seat belts, it is very important that they continue to sit upright, well back in their seats, with their feet on the floor, until the vehicle is safely parked and the engine is off.

Sitting improperly can increase the chance of injury during a crash. For example, if an occupant slouches, lies down, turns sideways, sits forward, leans forward or sideways, or puts one or both feet up, the chance of injury during a crash is greatly increased.

In addition, an occupant who is out of position in the front seat can be seriously or fatally injured in a crash by striking interior parts of the vehicle or being struck by an inflating front airbag.

ⓘ Maintain a Proper Sitting Position

WARNING

Sitting improperly or out of position can result in serious injury or death in a crash.

Always sit upright, well back in the seat, with your feet on the floor.

Rear Seats

■ Adjusting the Rear Seat-Backs

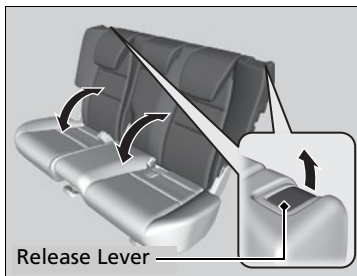

Pull the lever on the right to change the angle of the right half of the seat-back, and left for the left half.

Folding Down the Rear Seats

The rear seats can be folded down separately to allow for additional storage space.

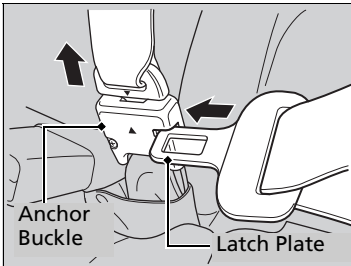

To fold down the seat

1. Store the center seat belt first. Insert the latch plate into the slot on the side of the anchor buckle.
2. Retract the seat belt into the holder on the ceiling.
 - ▣ **Seat Belt with Detachable Anchor** P. 41
3. Lower the head restraint to its lowest position.
4. Pull the release lever and fold down the seat-back.

To return the seat to the original position, pull up the seat-back in the upright position.

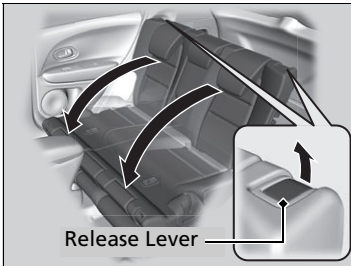

Folding Down the Rear Seats

Make sure all items in the cargo area or items extending to the rear seats are properly secured. Loose items can fly forward if you have to brake hard.

Remove any items from the rear seat cushion and floor before you fold down the rear seat.

To lock the seat-back upright, push it backwards until it locks.

Make sure the seat-back, head restraints and seat cushion are securely latched back into place before driving. Also, make sure all rear shoulder belts are positioned in front of the seat-back, and the center shoulder belt is re-positioned in the holding slot.

Make sure that the folded seat-back does not press against the front passenger seat, as this can cause the weight sensors in the front passenger seat to work improperly.

▣ **Passenger Airbag Off Indicator** P. 55

■ Folding the Rear Seat Up

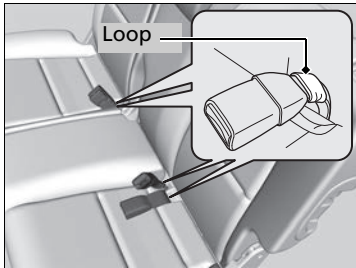

Separately lift up the left and right halves of the rear seat cushions to make room for cargo area.

■ Lifting up the seat cushion

1. Make sure the seat belt buckles are in their loops on the seat.
2. Pull up the rear seat cushion.
3. Fold the seat leg down while pushing the seat cushion firmly against the seat-back to lock it.

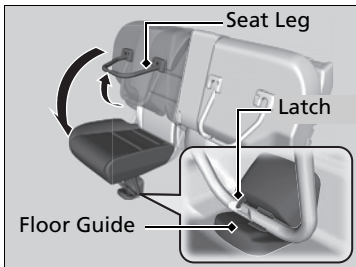
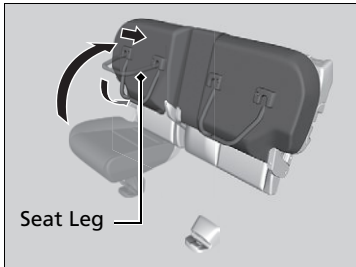

■ Putting the seat in the original position

1. Hold the seat cushion in the upright position, and pull up the seat leg fully.
 - ▶ The seat cushion can abruptly fall down once you pull up the seat leg.
2. Slowly put down the seat cushion and set the seat leg in the floor guide.
 - ▶ A latch comes out when the leg is set properly.

▶▶ Folding the Rear Seat Up

After you fold the seat up, or put it back in the original position, make sure the seat is firmly secured by rocking it forward and back.

Check if there are any items on the seat before you pull the seat cushion up. Check if there are any obstacles around the floor guide before you put the seat back in the original position.

Armrest

■ Using the Front Seat Armrest

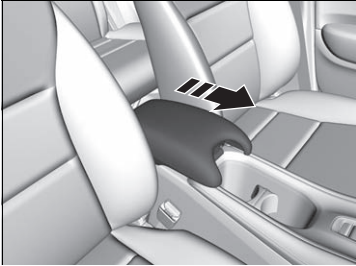

The console lid can be used as an armrest.

To adjust:

Slide the armrest to the desired position.

■ Using the Rear Seat Armrest*



Pull down the armrest in the center seat-back.

* Not available on all models

Interior Lights

Interior Light Switches

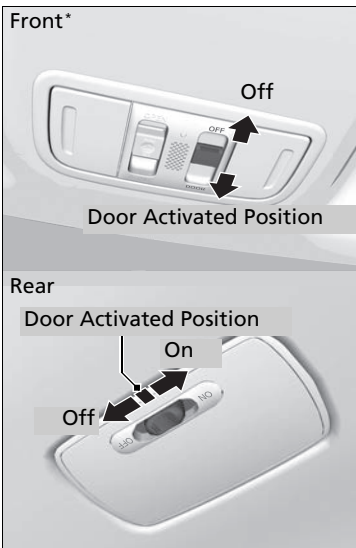

■ ON

The interior lights come on regardless of whether the doors are open or closed.

■ Door activated

The interior lights come on in the following situations:

- When any of the doors are opened.
- You unlock the driver's door.

Models without smart entry system

- You remove the key from the ignition switch.

Models with smart entry system

- When the power mode is set to VEHICLE OFF (LOCK).

■ OFF

The interior lights remain off regardless of whether the doors are open or closed.

Interior Light Switches

In the door activated position, the interior lights fade out and go off about 30 seconds after the doors are closed.

The lights go off after 30 seconds in the following situations:

- When you unlock the driver's door but do not open it.

Models without smart entry system

- When you remove the key from the ignition switch but do not open a door.

Models with smart entry system

- When you set the power mode to VEHICLE OFF (LOCK) but do not open a door.

The interior lights go off immediately in the following situations:

- When you lock the driver's door.
- When you turn the ignition switch to ON *1.

Models without smart entry system

- When you close the driver's door with the key in the ignition switch.

Models with smart entry system

- When you close the driver's door in ACCESSORY mode.

If you leave any of the doors open in VEHICLE OFF (LOCK) mode, or without the key in the ignition switch, the interior lights go off after about 15 minutes.

*1: Models with the smart entry system have an **ENGINE START/STOP** button instead of an ignition switch.

Map Lights

Models with moonroof



Models without moonroof



The map lights can be turned on and off by pressing the lenses.

Map Lights

Models with moonroof

When the interior light switch is in the door activated position and any door is open, the map light will not go off when you press the lens.

Cargo Area Light

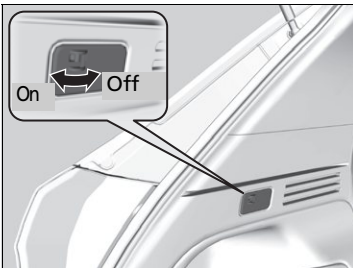

ON

The light comes on when you open the tailgate, and goes off when closed.

OFF

The light stays off with or without opening the tailgate.

Interior Convenience Items

■ Glove Box

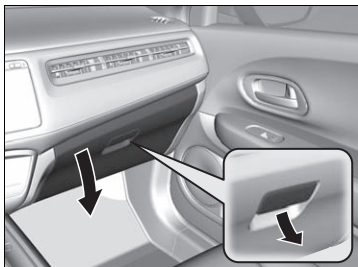

Pull the handle to open the glove box.

» Glove Box

⚠ WARNING

An open glove box can cause serious injury to your passenger in a crash, even if the passenger is wearing the seat belt.

Always keep the glove box closed while driving.

■ Console Compartment

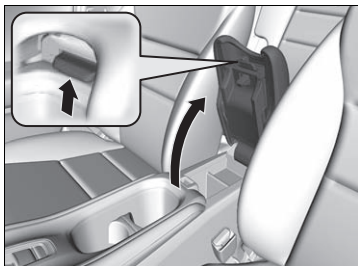

Pull the handle to open the console compartment.

■ Beverage Holders



■ Front seat beverage holders

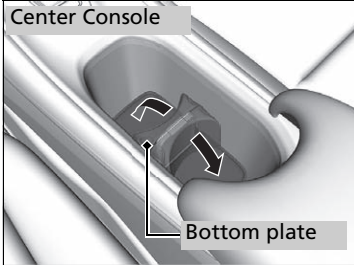

■ Center console beverage holders

To put a short-size beverage: Push down the bottom plate.

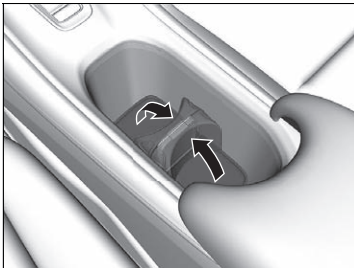

To put a tall-size beverage: Pull up the bottom plate.

» Beverage Holders

NOTICE

Spilled liquids can damage the upholstery, carpeting, and electrical components in the interior.

Be careful when you are using the beverage holders. Hot liquid can scald you.

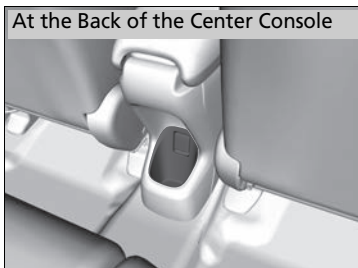

■ Rear seat beverage holders

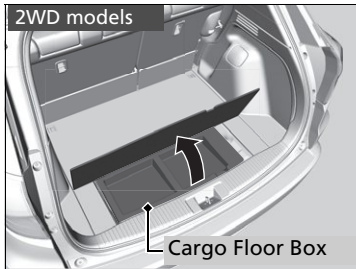

■ Cargo Floor Box

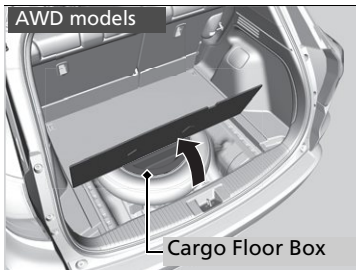

Pull up the cargo area floor lid.



■ Accessory Power Sockets

The accessory power socket can be used when the ignition switch is in ACCESSORY  or ON *1.

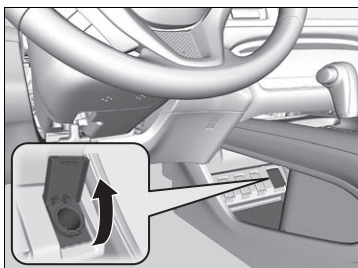

■ Accessory power socket (console panel)

Open the cover to use it.

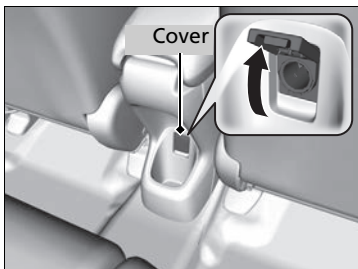

■ Accessory power socket (rearward of center console)

Open the cover to use it.

▶▶ Accessory Power Sockets

NOTICE

Do not insert an automotive type cigarette lighter element.

This can overheat the power socket.

Each accessory power socket is designed to supply power for 12 volt DC accessories that are rated 180 watts (15 amps) or less.

To prevent battery drain, only use the power socket with the engine running.

When both sockets are being used, the combined power rating of the accessories should not exceed 180 watts (15 amps).

*1: Models with the smart entry system have an **ENGINE START/STOP** button instead of an ignition switch.

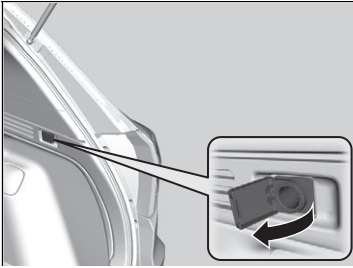

■ **Accessory power socket (cargo area)***

Open the cover to use it.

■ **Coat Hook**

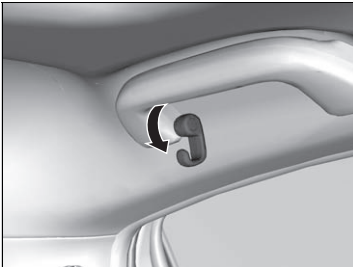

There is a coat hook on the rear left grab handle. Pull it down to use it.

▣ **Coat Hook**

The coat hook is not designed for large or heavy items.

* Not available on all models

Continued

■ Tie-down Anchors

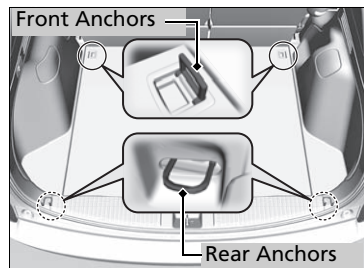

The tie-down anchors on the cargo area floor can be used to install a net for securing items.

■ Tonneau Cover*

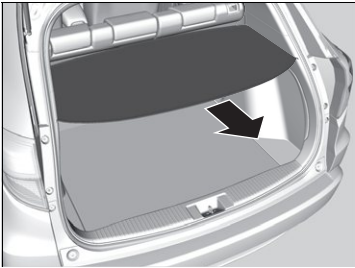

The tonneau cover can be used to conceal your items and protect them from direct sunlight.

■ To remove:

Pull out the tonneau cover rearwards and remove it.

■ To fold:

The tonneau cover is collapsible.

1. Take the opposite sides, fold the cover halfway, then twist into opposite ways.
2. Curl to narrow the cover as shown.

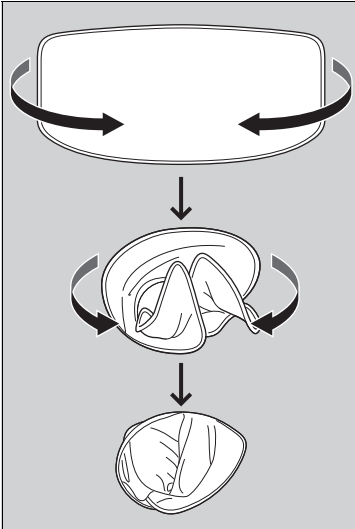

* Not available on all models

▣ Tonneau Cover*

Do not let anyone access items in the cargo area while driving. Loose items can cause injury if you have to brake hard.

Do not stack objects higher than the top of the seat in the cargo area. They could block your view and be thrown about the vehicle during a sudden stop.

To prevent tonneau cover damage, do not:

- Place items on the tonneau cover.
- Put weight on the tonneau cover.

When reinstalling the tonneau cover, put the tagged side first.

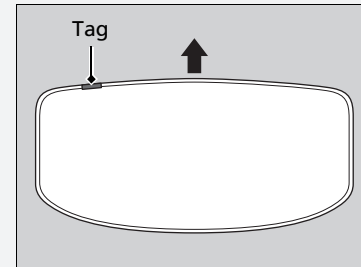

Continued

■ Seat Heaters*



The ignition switch must be in ON **II***1 to use the seat heaters. The HI setting heats the seats faster than the LO setting.

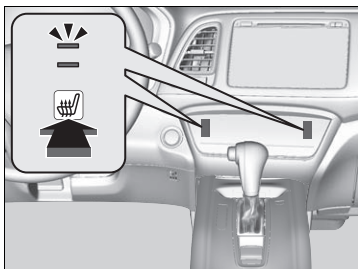

Touch the seat heater icon.

Once - The HI setting (two indicators on)

Twice - The LO setting

Three times - The OFF setting (no indicator on)

When a comfortable temperature is reached while using the seat heater in HI, select LO to keep the seat warm.

⌘ Seat Heaters*

⚠ WARNING

Heat induced burns are possible when using seat heaters.

Persons with a diminished ability to sense temperature (e.g., persons with diabetes, lower-limb nerve damage, or paralysis) or with sensitive skin should not use seat heaters.

Do not use the seat heaters even in LO when the engine is off. Under such conditions, the battery may be weakened, making the engine difficult to start.

In the LO setting, the heater runs continuously and does not automatically turn off.

*1: Models with the smart entry system have an **ENGINE START/STOP** button instead of an ignition switch.

* Not available on all models

Using Vents, Heating and A/C

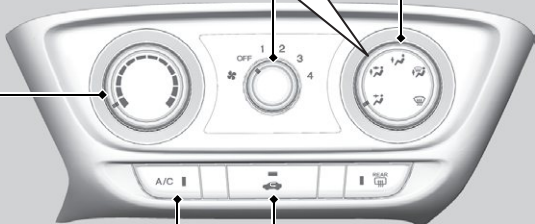

The diagram shows a car's climate control panel with several controls. A callout box at the top contains five icons representing different airflow modes: Dashboard vents, Dashboard and floor vents, Floor vents, Floor and defroster vents, and Defroster vents. Lines connect these icons to the Mode Control Dial on the panel. Other callouts point to the Fan Control Dial, Temperature Control Dial, A/C Button, and (Recirculation) Button.

Fan Control Dial
Adjusts the fan speed. Rotate the dial all the way to **OFF** to turn everything off.

Temperature Control Dial
Adjusts the interior temperature.

A/C Button
Press to cool the interior or dehumidify while heating.

(Recirculation) Button
Press the  button and switch the mode depending on environmental conditions.

Recirculation mode (indicator on):
Recirculates air from the vehicle's interior through the system.

Fresh air mode (indicator off):
Maintains outside ventilation. Keep the system in fresh air mode in normal situations.

Mode Control Dial
Changes airflow.

Dashboard vents
Dashboard and floor vents
Floor vents
Floor and defroster vents
Defroster vents

* Not available on all models

■ Passenger Side Vents

Three separate front passenger side air vents allow for different air flow rates through the vehicle. Passengers can separately:

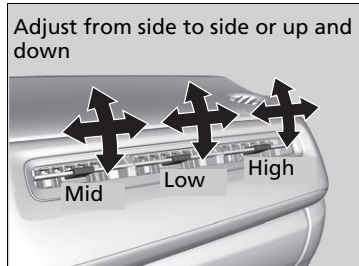

- Adjust each vent to optimize airflow throughout the vehicle.

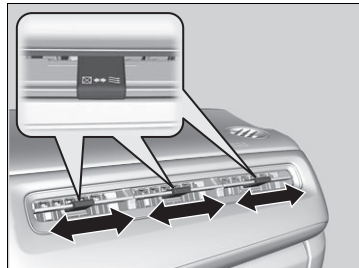

- Close individual vents to adjust passenger comfort levels.

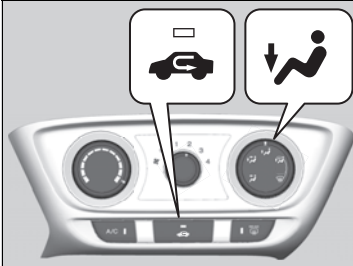

■ Heating



The heater uses heat from the engine coolant to warm the air.

1. Adjust the fan speed using the fan control dial.
2. Select .
3. Adjust the temperature using the temperature control dial.

■ To rapidly warm up the interior

1. Set the fan to the maximum speed.
2. Select .
3. Set the temperature to maximum warm.
4. Press the  button (the indicator on).

■ To dehumidify the interior

When used in combination with the heater, the air conditioning system makes the interior warm and dry and can prevent the windows from fogging up.

1. Turn the fan on.
2. Press the **A/C** button to turn on the air conditioning.

⌘ Heating

When you select , the mode automatically switches to fresh air.

⌘ To rapidly warm up the interior

Change to fresh air mode as soon as the interior gets warm enough. The windows may fog up if kept in recirculation mode.

■ Cooling

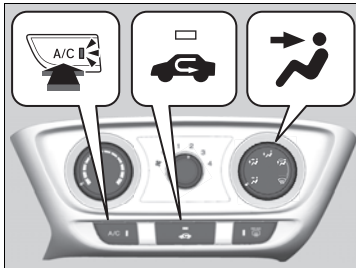



1. Adjust the fan speed using the fan control dial.
2. Select .
3. Adjust the temperature using the temperature control dial.
4. Press the **A/C** button (indicator on).

■ To rapidly cool down the interior

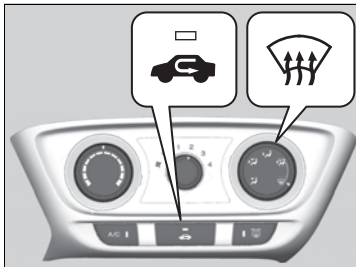

1. Set the fan to the maximum speed.
2. Set the temperature to maximum cool.
3. Press the  button (the indicator on).

■ Defrosting the Windshield and Windows



Selecting  turns the air conditioning system on and automatically switches the system to fresh air mode.

■ To rapidly defrost the windows

1. Set the fan to the maximum speed.
2. Select .
3. Press the  button.
4. Set the temperature to maximum warm.

▶▶ To rapidly cool down the interior

If the interior is very warm, you can cool it down more rapidly by partially opening the windows.

Models with ECON button

While in ECON mode, the system has greater temperature fluctuations.

▶▶ Defrosting the Windshield and Windows

For your safety, make sure you have a clear view through all the windows before driving.

Do not set the temperature near the upper or lower limit.

When cold air hits the windshield, the outside of the windshield may fog up.

If the side windows fog up, adjust the vents so that the air hits the side windows.

▶▶ To rapidly defrost the windows

After defrosting the windows, switch over to fresh air mode.

If you keep the system in recirculation mode, the windows may fog up from humidity. This impedes visibility.

Using Automatic Climate Control

The automatic climate control system maintains the interior temperature you select. The system also selects the proper mix of heated or cooled air that raises or lowers the interior temperature to your preference as quickly as possible.

Models without SYNC icon

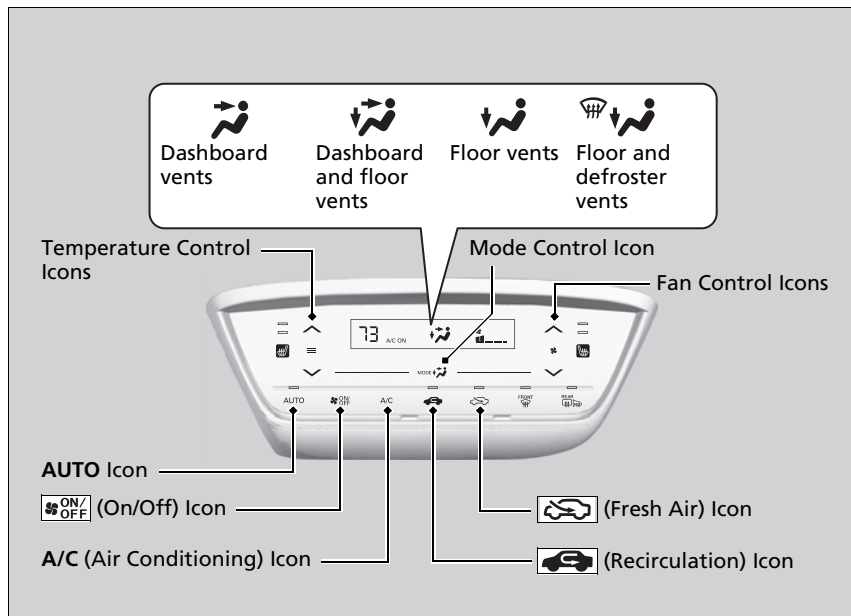

Use the system when the engine is running.

1. Select the **AUTO** icon.
2. Adjust the interior temperature using the temperature control icons.
3. Select the  icon to cancel.

* Not available on all models

Using Automatic Climate Control

If any icons are selected while using the climate control system in auto, the function of the icon that was selected will take priority.

The **AUTO** indicator will go off, but functions unrelated to the icon that was selected will be controlled automatically.

To prevent cold air from blowing in from outside, the fan may not start immediately when the **AUTO** icon is selected.

If the interior is very warm, you can cool it down more rapidly by partially opening the windows, turning the system on auto, and setting the temperature to low. Change the fresh air mode to recirculation mode until the temperature cools down.

When you set the temperature to the lower or upper limit, **Lo** or **Hi** is displayed.

You can raise or lower the temperature or fan speed setting flicking either control icon.

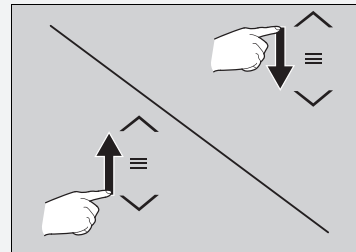

Continued

Models with SYNC icon

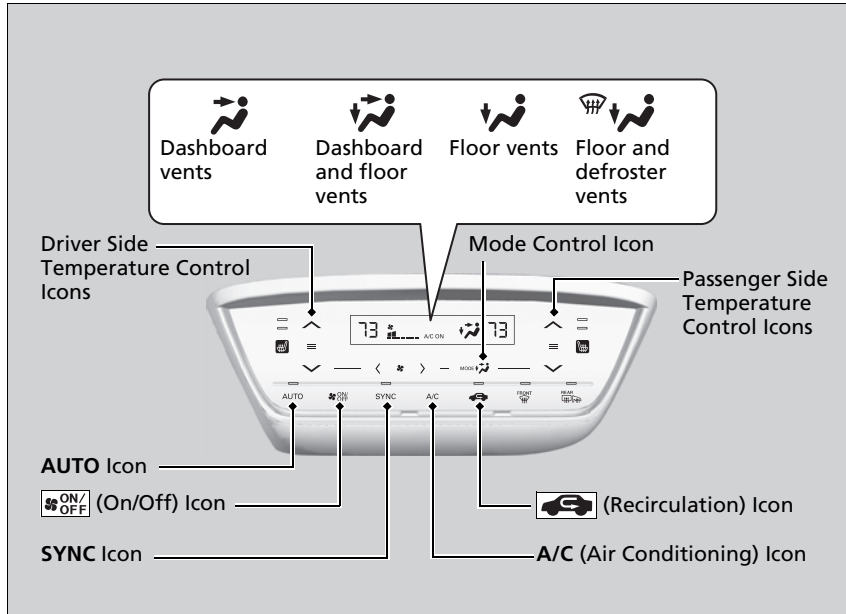

Use the system when the engine is running.

1. Select the **AUTO** icon.
2. Adjust the interior temperature using the driver side temperature control icons.
3. Select the  icon to cancel.

►► Using Automatic Climate Control

Selecting the  icon switches the climate control system between on and off. When turned on, the system returns to your last selection.

The climate control system is voice operable. See the navigation system manual.

Models with ECON button

While in ECON mode, the system has greater temperature fluctuations.

■ Switching between the recirculation and fresh air modes

Models without SYNC icon

Select the  (recirculation) or  (fresh air) icon to switch the mode depending on environmental conditions.

 Recirculation mode (indicator on): Recirculates air from the vehicle's interior through the system.

 Fresh air mode (indicator on): Maintains outside ventilation. Keep the system in fresh air mode in normal situations.

Models with SYNC icon

Select the  (recirculation) icon to switch the mode depending on environmental conditions.

Recirculation mode (indicator on): Recirculates air from the vehicle's interior through the system.

Fresh air mode (indicator off): Maintains outside ventilation. Keep the system in fresh air mode in normal situations.

Defrosting the Windshield and Windows

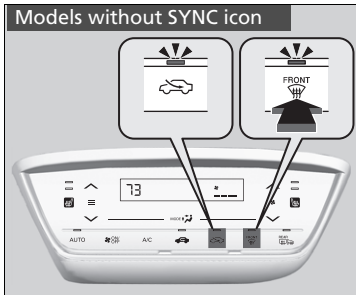

Select the  icon to turn the air conditioning system on and automatically switch the system to fresh air mode.

Select the  icon again to turn off, the system returns to the previous settings.

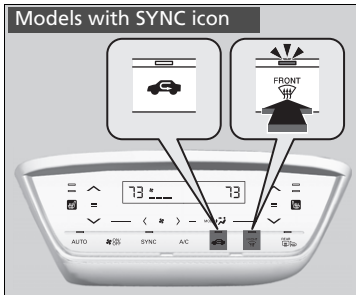

Defrosting the Windshield and Windows

For your safety, make sure you have a clear view through all the windows before driving.

Do not set the temperature near the upper or lower limit.

When cold air hits the windshield, the outside of the windshield may fog up.

If the side windows fog up, adjust the vents so that the air hits the side windows.

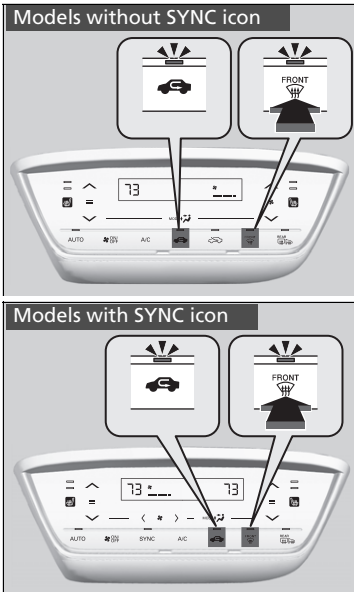

■ To rapidly defrost the windows

1. Select the  icon.
2. Select the  icon.

☒ To rapidly defrost the windows



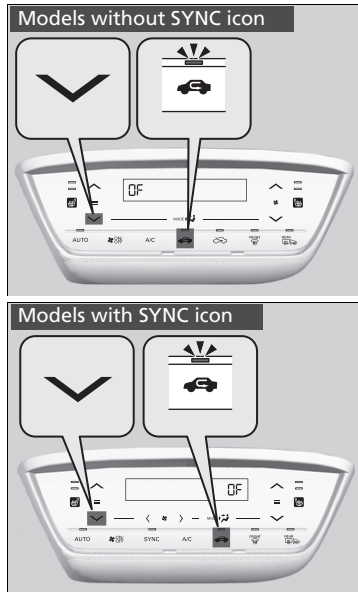

After defrosting the windows, switch over to fresh air mode. If you keep the system in recirculation mode, the windows may fog up from humidity. This impedes visibility.

■ Turning On and Off the Touch Screen Beep

You hear the beep when operating the climate control system on the touch screen. This can be turned on and off.



To turn off the beep:

1. Turn the ignition switch to ON *1.
2. Touch the  of the temperature control icon five times while pressing and holding the .
3. Release the , after -- blinks five times and **OF** is displayed.



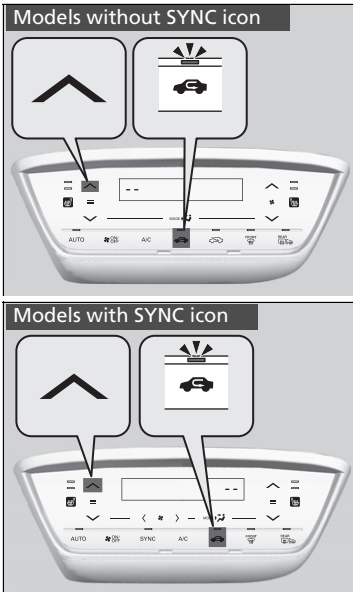

▶▶ Turning On and Off the Touch Screen Beep

If you touch any other icons during this procedure, the setting may fail. In this case, once you turn the ignition switch to OFF *1, then follow this procedure again.

*1: Models with the smart entry system have an **ENGINE START/STOP** button instead of an ignition switch.



To turn on the beep:

1. Turn the ignition switch to ON *1.
2. Touch the  of the temperature control icon five times while pressing and holding the .
3. Release the , after **OF** blinks five times and -- is displayed.

*1: Models with the smart entry system have an **ENGINE START/STOP** button instead of an ignition switch.

Synchronized Mode*

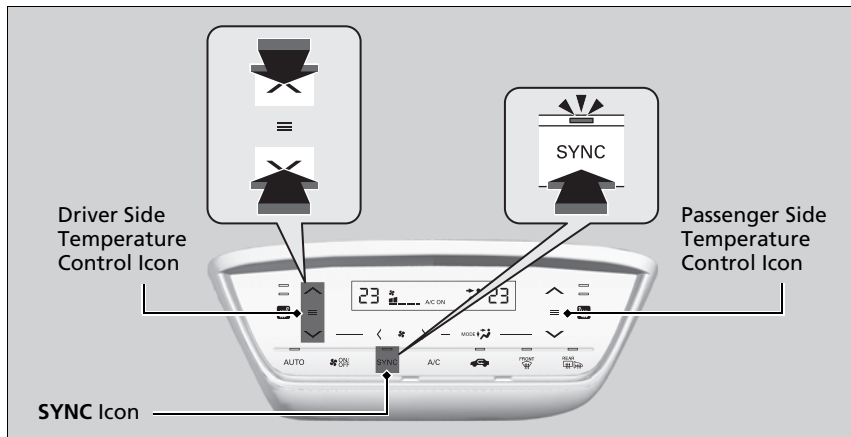

☒ Synchronized Mode*

When the system is in dual mode, the driver side temperature and the passenger side temperature can be set separately.

You can set the temperature synchronously for the driver side and the passenger side in synchronized mode.

1. Select the **SYNC** icon.
 - The system switches to synchronized mode.
2. Adjust the temperature using the driver's side temperature control icon.

Select the **SYNC** icon to return to dual mode.

Automatic Climate Control Sensors

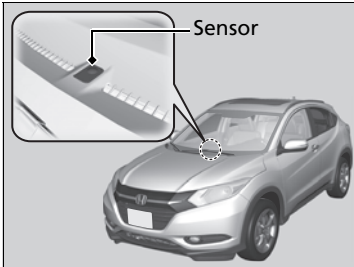

The automatic climate control system is equipped with sensors. Do not cover or spill any liquid on them.

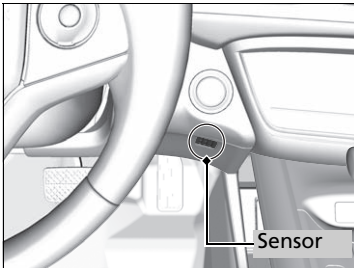

Features

This chapter describes how to operate technology features.

Audio System				
About Your Audio System	176			
USB Port(s)	177			
HDMI® Port*	178			
Auxiliary Input Jack*	178			
Audio System Theft Protection	179			
Audio Remote Controls	180			
Models with color audio system				
Audio System Basic Operation	182			
Audio/Information Screen	183			
Adjusting the Sound	187			
Display Setup	188			
Playing the AM/FM Radio	189			
Playing a CD	191			
Playing an iPod	194			
		Playing a USB Flash Drive	197	
		Playing <i>Bluetooth</i> ® Audio	200	
		Models with display audio system		
		Audio System Basic Operation	203	
		Audio/Information Screen	204	
		Adjusting the Sound	209	
		Display Setup	210	
		Playing the AM/FM Radio	211	
		Playing a CD	214	
		Playing an iPod	217	
		Playing Internet Radio	220	
		Playing a USB Flash Drive	222	
		Playing <i>Bluetooth</i> ® Audio	225	
		Playing a Video Using the HDMI®	227	
		Smartphone Apps	229	
			Siri Eyes Free	230
		Audio Error Messages	231	
		General Information on the Audio System	235	
		Customized Features	238	
		Models with color audio system		
		<i>Bluetooth</i>® HandsFreeLink®	260	
		Models with display audio system		
		<i>Bluetooth</i>® HandsFreeLink®	283	

* Not available on all models

About Your Audio System

Models with navigation system

See the navigation system manual for operation of the audio system.

Models without navigation system

The audio system features AM/FM radio. It can also play audio CDs, WMA/MP3/AAC files, USB flash drives, and iPod, iPhone and *Bluetooth*® devices.

You can operate the audio system from the buttons and switches on the panel, the remote controls on the steering wheel, or the icons on the touchscreen interface*.

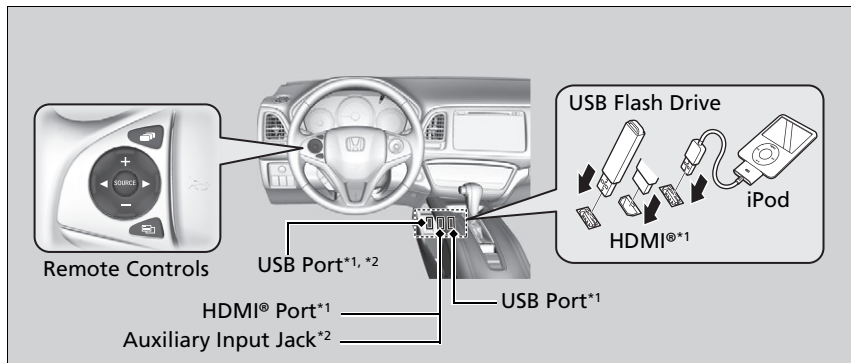

*1: Models with display audio system

*2: Models with color audio system

About Your Audio System

Video CDs, DVDs, and 3-inch (8-cm) mini CDs are not supported.

iPod, iPhone and iTunes are trademarks of Apple Inc.

State or local laws may prohibit the operation of handheld electronic devices while operating a vehicle.

USB Port(s)

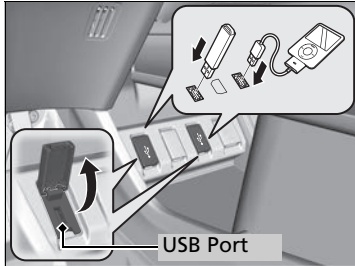

1. Open the cover.
2. Install the iPod dock connector or the USB flash drive to the USB port.

USB Port(s)

- Do not leave the iPod or USB flash drive in the vehicle. Direct sunlight and high temperatures may damage it.
- Do not connect the iPod or USB flash drive using a hub.
- Do not use a device such as a card reader or hard disk drive, as the device or your files may be damaged.
- We recommend your data backed up before using the device in your vehicle.
- Displayed messages may vary depending on the device model and software version.

If the audio system does not recognize the iPod, try reconnecting it a few times or reboot the device. To reboot, follow the manufacturer's instructions provided with the iPod or visit www.apple.com/ipod.

HDMI® Port*

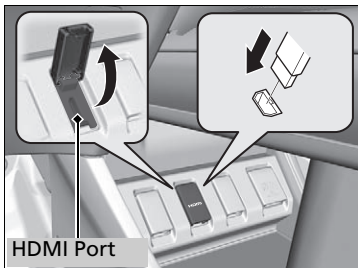

1. Open the cover.
2. Install the HDMI® cable to the HDMI® port.

⊗ HDMI® Port*

- Do not leave the HDMI® connected device in the vehicle. Direct sunlight and high temperatures may damage it.
- We recommend your data backed up before using the device in your vehicle.
- Displayed messages may vary depending on the device model and software version.

The terms HDMI and HDMI High-Definition Multimedia Interface, and the HDMI Logo are trademarks or registered trademarks of HDMI Licensing LLC in the United States and other countries.

⊗ Auxiliary Input Jack*

To switch mode, press any of the audio mode buttons. You can return to AUX mode by pressing the **CD/AUX** button.

Auxiliary Input Jack*

Use the jack to connect standard audio devices.

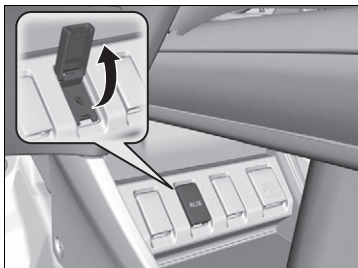

1. Open the **AUX** cover.
2. Connect a standard audio device to the input jack using a 1/8 inch (3.5 mm) stereo miniplug.
 - ▶ The audio system automatically switches to the AUX mode.

Audio System Theft Protection

The audio system is disabled when it is disconnected from the power source, such as when the battery is disconnected or goes dead. In certain conditions, the system may display **ENTER CODE**^{*2}/**Enter code**^{*3}. If this occurs, reactivate the audio system.

■ Reactivating the audio system

1. Turn the ignition switch to ON ^{*1}.
2. Turn on the audio system.
3. Press and hold the audio system power button for more than two seconds.
 - ▶ The audio system is reactivated when the audio control unit establishes a connection with the vehicle control unit. If the control unit fails to recognize the audio unit, you must go to a dealer and have the audio unit checked.

*1: Models with the smart entry system have an **ENGINE START/STOP** button instead of an ignition switch.

*2: Models with color audio system.

*3: Models with display audio system.

Audio Remote Controls

Allow you to operate the audio system while driving.

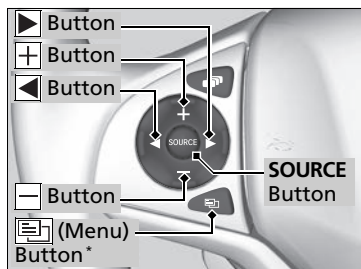

SOURCE Button

Cycles through the audio modes as follows:
 FM → AM → CD → USB → iPod → *Bluetooth*®
 Audio → Pandora®* → Aha™* → Apps* *1 →
 AUX*/AUX HDMI®*

(Volume) Buttons

Press : To increase the volume.

Press : To decrease the volume.

◀▶ Button

- When listening to the radio
 - Press** : To select the next preset radio station.
 - Press** : To select the previous preset radio station.
 - Press and hold** : To select the next strong radio station.
 - Press and hold** : To select the previous strong radio station.
- When listening to a CD, iPod, USB flash drive, or *Bluetooth*® Audio
 - Press** : To skip to the next song.
 - Press** : To go back to the beginning of the current or previous song.
- When listening to a CD or USB flash drive
 - Press and hold** : To skip to the next folder.
 - Press and hold** : To go back to the previous folder.
- When listening to Internet radio*
 - Press** : To skip to the next song.
 - Press and hold** : To select the next station.
 - Press and hold** : To select the previous station.

*1: Appears only when connected to HondaLink™.





* Not available on all models

▶▶ Audio Remote Controls

Some mode appear only when an appropriate device or medium is used.

Models with display audio system

Steering Wheel  (Menu) Button

- When listening to the radio
Press : To display the menu items. You can select **Scan**, **Save Preset**, or **Seek**.
- When listening to a CD or USB flash drive
Press : To display the menu items. You can select **Scan**, **Repeat**, or **Random**.
- When listening to an iPod
Press : To display the menu items. You can select **Repeat** or **Shuffle**.
- When listening to a *Bluetooth*® Audio
Press : To display the menu items. You can select **Pause** or **Play**.
- When listening to a Pandora®*
Press : To display the menu items. You can select **Bookmark**, or **Play/Pause**.

* Not available on all models

▶▶ Audio Remote Controls

The  button is available only when the audio mode is FM, AM, CD, USB, iPod, Pandora®*, Aha™*, or *Bluetooth*® Audio.

Models with color audio system

To use the audio system, the ignition switch must be in ACCESSORY  or ON .

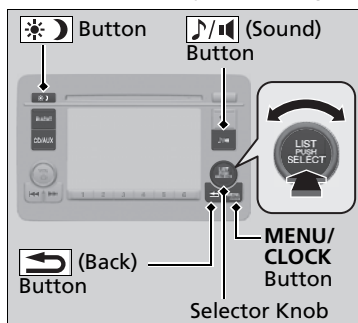

Use the selector knob or **MENU/CLOCK** button to access some audio functions.

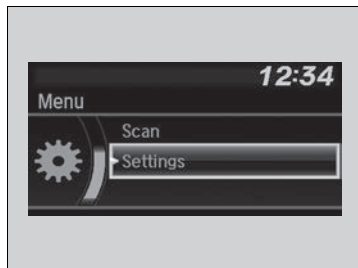

Press  to switch between the normal and extended display for some functions.



 **(Back) button**: Press to go back to the previous display.

 **button**: Press to select the sound setting mode.

 **button**: Press to change the audio/information screen brightness.

Press , then adjust the brightness using .

- ▶ Each time you press , the mode switches between the daytime mode, nighttime mode and **OFF** mode.

Audio System Basic Operation





These indications are used to show how to operate the selector knob.

Rotate  to select.

Press  to enter.

Menu Items

- ▶ **Adjust Clock** P. 95
- ▶ **Wallpaper Setup** P. 185
- ▶ **Display Setup** P. 188
- ▶ **Scan** P. 190, 193, 199
- ▶ **Play Mode** P. 193, 196, 199
- ▶ **RDS Settings** P. 190
- ▶ **Bluetooth** P. 242, 266

Press the **SOURCE**, , ,  or  button on the steering wheel to change any audio setting.

- ▶ **Audio Remote Controls** P. 180

One of the operating system used in this unit is eCos. For software license terms and conditions, visit their website (eCos license URL: <http://ecos.sourceforge.org/license-overview.html>) For source code disclosure and other details regarding eCos, visit: <http://www.hondaopensource2.com>

Audio/Information Screen

Displays the audio status and wallpaper. From this screen, you can go to various setup options.

Switching the Display

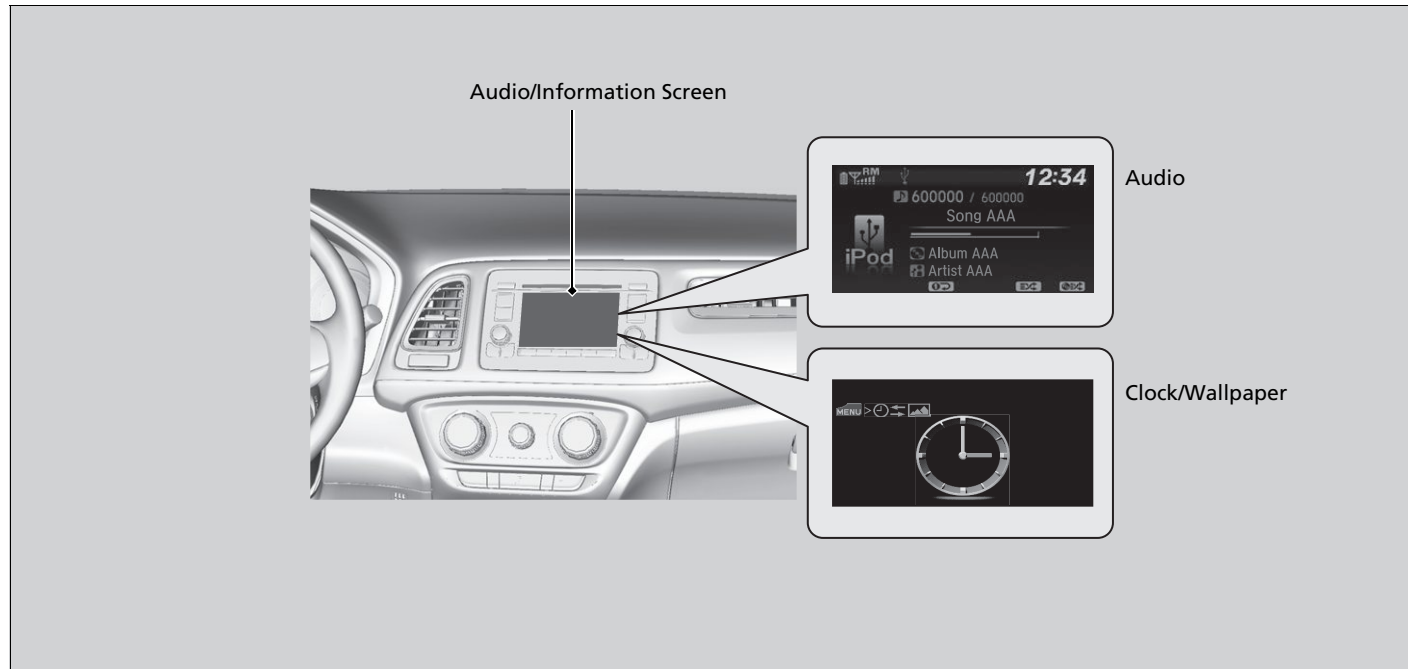







■ Audio

Shows the current audio information.

■ Clock/Wallpaper

Shows a clock screen or an image you import.

■ Change display

1. Press the **MENU/CLOCK** button.
2. Rotate  to select **Settings**, then press .
3. Rotate  to select **Display Change**, then press .
4. Rotate  to select **Wallpaper**, then press .
 - ▶ If you want to return to the audio display, select **Audio**.

Wallpaper Setup

You can change, store, and delete the wallpaper on the audio/information screen.

Import wallpaper

You can import up to three images, one at a time, for wallpaper from a USB flash drive.

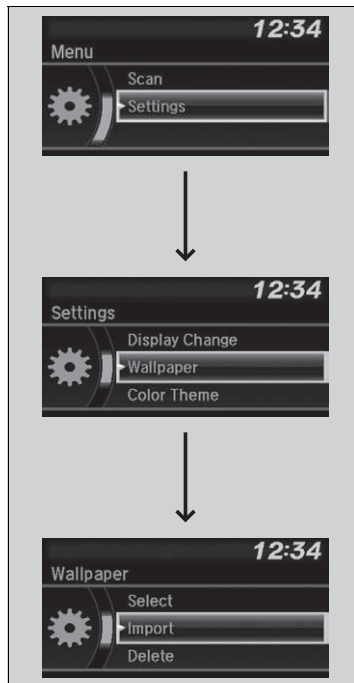









1. Connect the USB flash drive to the USB port.
▶ **USB Port(s)** P. 177
2. Press the **MENU/CLOCK** button.
3. Rotate to select **Settings**, then press .
4. Rotate to select **Wallpaper**, then press .
5. Rotate to select **Import**, then press .
▶ The picture name is displayed on the list.
6. Rotate to select a desired picture, then press .
▶ The selected picture is displayed.
7. Press to save the picture.
8. Press to select **OK**.
9. Rotate to select a location to save the picture, then press .
▶ The display will return to the wallpaper setting screen.

Wallpaper Setup





- When importing wallpaper files, the image must be in the USB flash drive's root directory. Images in a folder cannot be imported.
- The file name must be fewer than 64 characters.
- The file format of the image that can be imported is BMP (bmp) or JPEG (jpg).
- The individual file size limit is 2 MB.
- The maximum image size is 1,920 x 936 pixels. If the image size is less than 480 x 234 pixels, the image is displayed in the middle of the screen with the extra area appearing in black.
- Up to 255 files can be selected.
- If the USB flash drive does not have any pictures, the **No files detected** message appears.

Continued

■ Select wallpaper

1. Press the **MENU/CLOCK** button.
2. Rotate  to select **Settings**, then press .
3. Rotate  to select **Wallpaper**, then press .
4. Rotate  to select **Select**, then press 
 - ▶ The screen changes to the wallpaper list.
5. Rotate  to select a desired wallpaper, then press .

■ Delete wallpaper

1. Press the **MENU/CLOCK** button.
2. Rotate  to select **Settings**, then press .
3. Rotate  to select **Wallpaper**, then press .
4. Rotate  to select **Delete**, then press 
 - ▶ The screen changes to the wallpaper list.
5. Rotate  to select a wallpaper that you want to delete, then press .
6. Rotate  to select **Yes**, then press 
 - ▶ The display will return to the wallpaper setting screen.

▶▶ Wallpaper Setup

To go back to the previous screen, press the  (Back) button.

When the file size is large, it takes a while to be previewed.

Adjusting the Sound

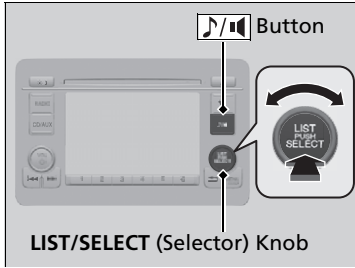

Press the (sound) button, and rotate to scroll through the following choices:

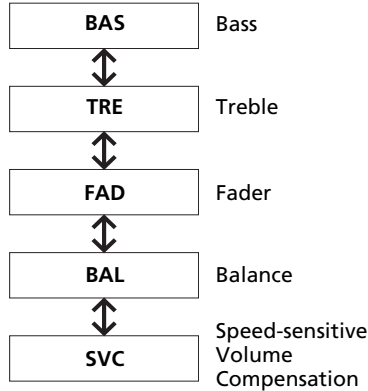
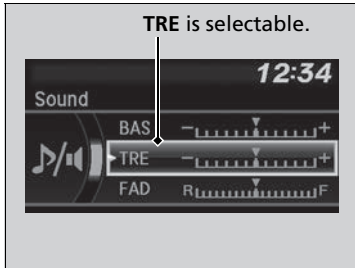

Rotate to adjust the sound setting, then press .

Adjusting the Sound







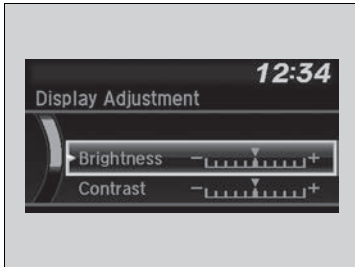

The SVC has four modes: **Off**, **Low**, **Mid**, and **High**. SVC adjusts the volume level based on the vehicle speed. As you go faster, audio volume increases. As you slow down, audio volume decreases.

Display Setup

You can change the brightness or color theme of the audio/information screen.







■ Changing the Screen Brightness

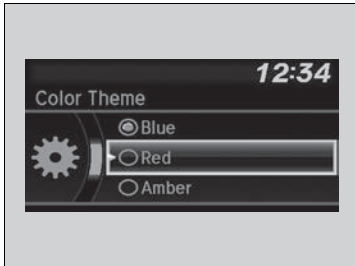

1. Press the **MENU/CLOCK** button.
2. Rotate  to select **Settings**, then press .
3. Rotate  to select **Display Adjustment**, then press .
4. Rotate  to select **Brightness**, then press .
5. Rotate  to adjust the setting, then press .

■ Changing the Screen's Color Theme



1. Press the **MENU/CLOCK** button.
2. Rotate  to select **Settings**, then press .
3. Rotate  to select **Color Theme**, then press .
4. Rotate  to select the setting you want, then press .

▣ Changing the Screen Brightness

You can change the **Contrast** and **Black level** settings in the same manner.

Playing the AM/FM Radio

RADIO Button
Press to select a band.

Audio/Information Screen

VOL/⏻ (Power/volume) Knob
Press to turn the audio system on and off.
Turn to adjust the volume.

⏮ / ⏭ (Seek/Skip) Buttons
Press **⏮** or **⏭** to search up and down the selected band for a station with a strong signal.

Preset Buttons (1-6)
To store a station:
1. Tune to the selected station.
2. Pick a preset button and hold it until you hear a beep.
To listen to a stored station, select a band, then press the preset button.

Selector Knob
Turn to tune the radio frequency.
Press and turn to select an item, then press to set your selection.



MENU/CLOCK Button
Press to display the menu items.

⏪ (Back) Button
Press to go back to the previous display or cancel a setting.

Radio Data System (RDS)

Provides text data information related to your selected RDS capable FM station.

■ To find an RDS station from Station List

1. Press  while listening to an FM station.
2. Rotate  to select the station, then press .



■ Update List

Updates your available station list at any time.

1. Press  while listening to an FM station.
2. Rotate  to select **Update List**, then press .

■ Radio text

Displays the radio text information of the selected RDS station.

1. Press the **MENU/CLOCK** button.
2. Rotate  to select **Settings**, then press .
3. Rotate  to select **RDS Settings**, then press .
4. Rotate  to select **Radio Text**, then press .

■ Scan

Samples each of the strongest stations on the selected band for 10 seconds.

1. Press the **MENU/CLOCK** button.
2. Rotate  to select **Scan**, then press .

To turn off scan, press .

▶▶ Playing the AM/FM Radio

The **ST** indicator appears on the display indicating stereo FM broadcasts.

Stereo reproduction in AM is not available.

You can store 6 AM stations and 12 FM stations into the preset memory.

Switching the Audio Mode

Press the **SOURCE** button on the steering wheel.

 **Audio Remote Controls** P. 180

▶▶ Radio Data System (RDS)

When you select an RDS-capable FM station, the RDS automatically turns on, and the frequency display changes to the station name. However, when the signals of that station become weak, the display changes from the station name to the frequency.

Playing a CD

Your audio system supports audio CDs, CD-Rs, and CD-RWs in either MP3 or WMA, or AAC*1 format. With the CD loaded, press the **CD/AUX** button.

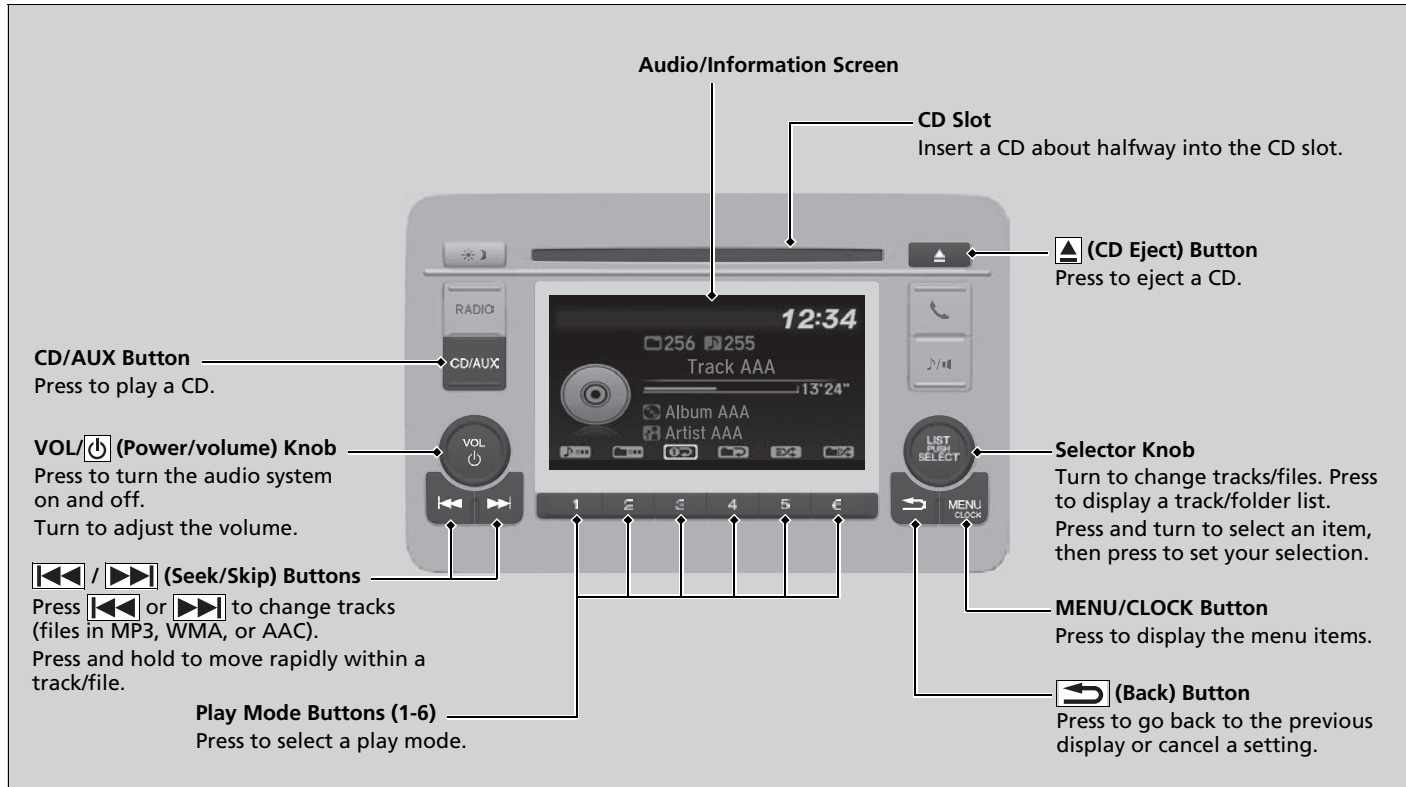

*1: Only AAC format files recorded with iTunes are playable on this unit.

How to Select a File from a Folder with the Selector Knob (MP3/WMA/AAC)

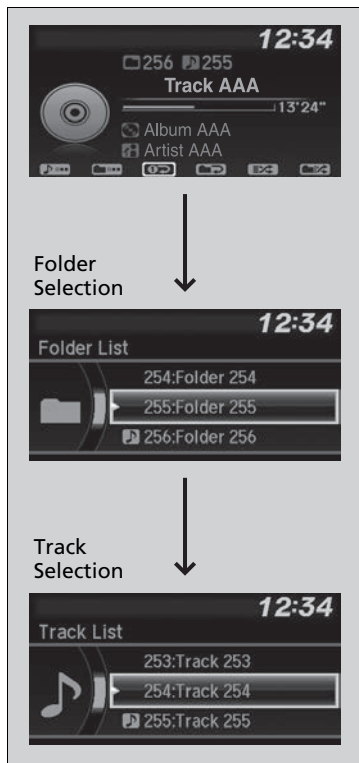

1. Press to switch the display to a folder list.

2. Rotate to select a folder.

3. Press to display a list of tracks in that folder.

4. Rotate to select a track, then press .

▶▶ Playing a CD

NOTICE

Do not use CDs with adhesive labels. The label can cause the CD to jam in the unit.

WMA files protected by digital rights management (DRM) cannot be played.

The audio system displays **UNPLAYABLE FILE**, then skips to the next file.

Text data appears on the display under the following circumstances:

- When you select a new folder, file, or track.
- When you change the audio mode to CD.
- When you insert a CD.

If you eject the CD but do not remove it from the slot, the system reloads the CD automatically after several seconds.

How to Select a Play Mode

You can select repeat, random, and scan modes when playing a track or file.



Available mode icons appear above the play mode buttons.

Press the button corresponding to the mode you want to select.

To turn off a play mode

Press the selected button.

How to Select a Play Mode

Play Mode Menu Items

Repeat

 **Repeat One Folder (MP3/WMA/AAC):** Repeats all files in the current folder.

 **Repeat One Track:** Repeats the current track/file.

Random

 **Random in Folder (MP3/WMA/AAC):** Plays all files in the current folder in random order.

 **Random All:** Plays all tracks/files in random order.



Scan



 **Scan Folders (MP3/WMA/AAC):** Provides 10-second sampling of the first file in each of the main folders.

 **Scan Tracks:** Provides 10-second sampling of all tracks on the CD (all files in the current folder in MP3, WMA, or AAC).

You can also select a play mode by pressing the **MENU/CLOCK** button.

Rotate  to select **Play Mode**, then press .

Rotate  to select a mode, then press .

To turn it off, rotate  to select **Normal Play**, then press .

Playing an iPod

Connect the iPod using your dock connector to the USB port, then press the **CD/AUX** button.

➤ **USB Port(s)** P. 177

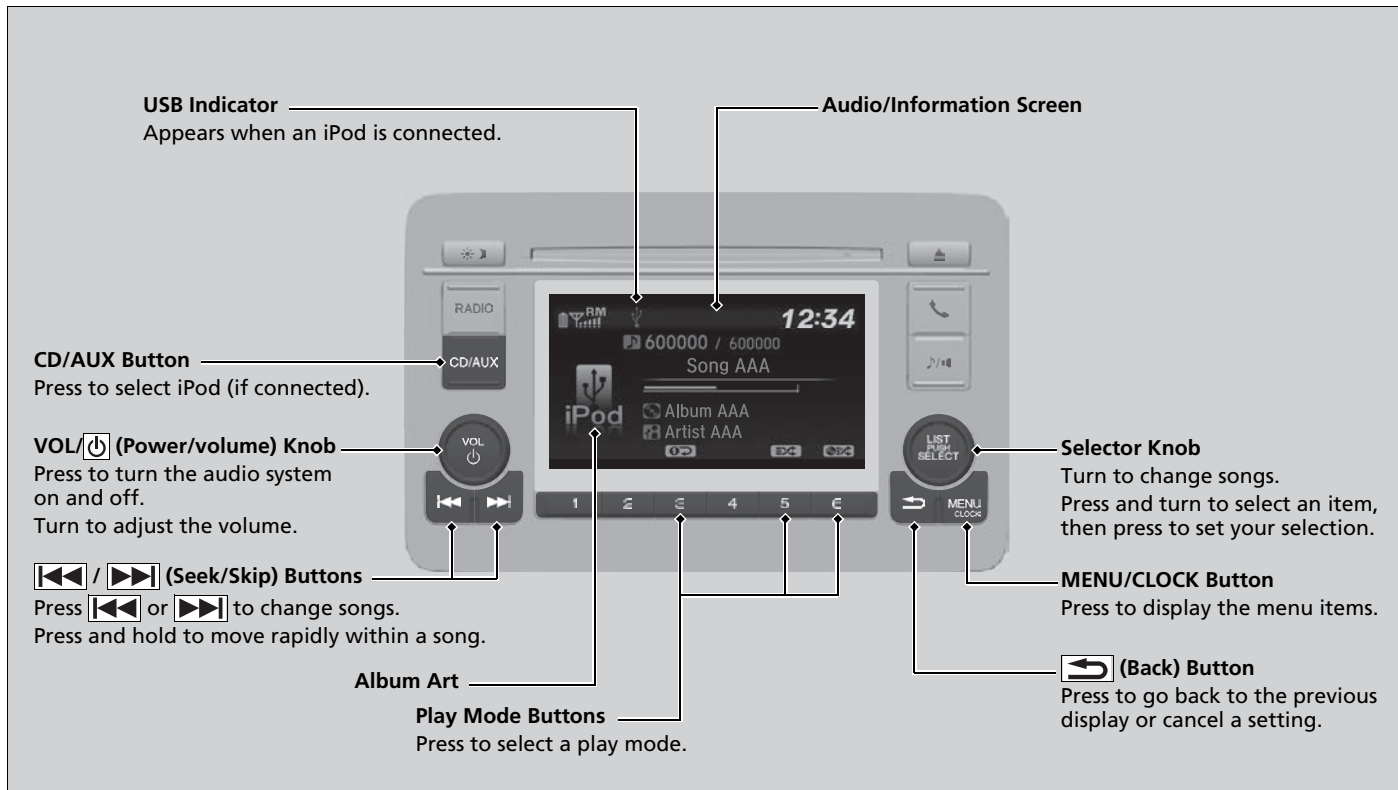

How to Select a Song from the iPod Music List with the Selector Knob



1. Press to display the iPod music list.

2. Rotate to select a category.

3. Press to display a list of items in the category.

4. Rotate to select an item, then press .

- ▶ Press and rotate repeatedly until a desired item you want to listen is displayed.

▶▶ Playing an iPod

Available operating functions vary on models or versions. Some functions may not be available on the vehicle's audio system.

If there is a problem, you may see an error message on the audio display.

iPod/USB Flash Drive P. 232

Continued

■ How to Select a Play Mode

You can select repeat and shuffle modes when playing a song.

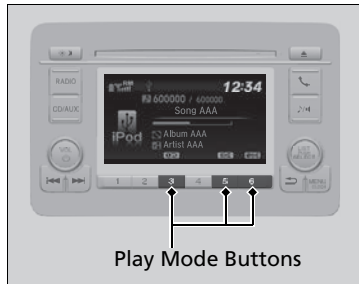

Available mode icons appear above the play mode buttons.

Press the button corresponding to the mode you want to select.

■ To turn off a play mode

Press the selected button.

▶▶ How to Select a Play Mode

Play Mode Menu Items



 **Shuffle Album:** Plays all available albums in a selected category (playlists, artists, albums, songs, genres, or composers) in random order.



 **Shuffle All:** Plays all available songs in a selected category (playlists, artists, albums, songs, genres, or composers) in random order.

 **Repeat One Track:** Repeats the current song.

You can also select a play mode by pressing the **MENU/CLOCK** button.

Rotate  to select **Play Mode**, then press .

Rotate  to select a mode, then press .

To turn it off, rotate  to select **Normal Play**, then press .

Playing a USB Flash Drive

Your audio system reads and plays sound files on a USB flash drive in either MP3, WMA or AAC*1 format.

Connect your USB flash drive to the USB port, then press the **CD/AUX** button.

📌 **USB Port(s)** P. 177

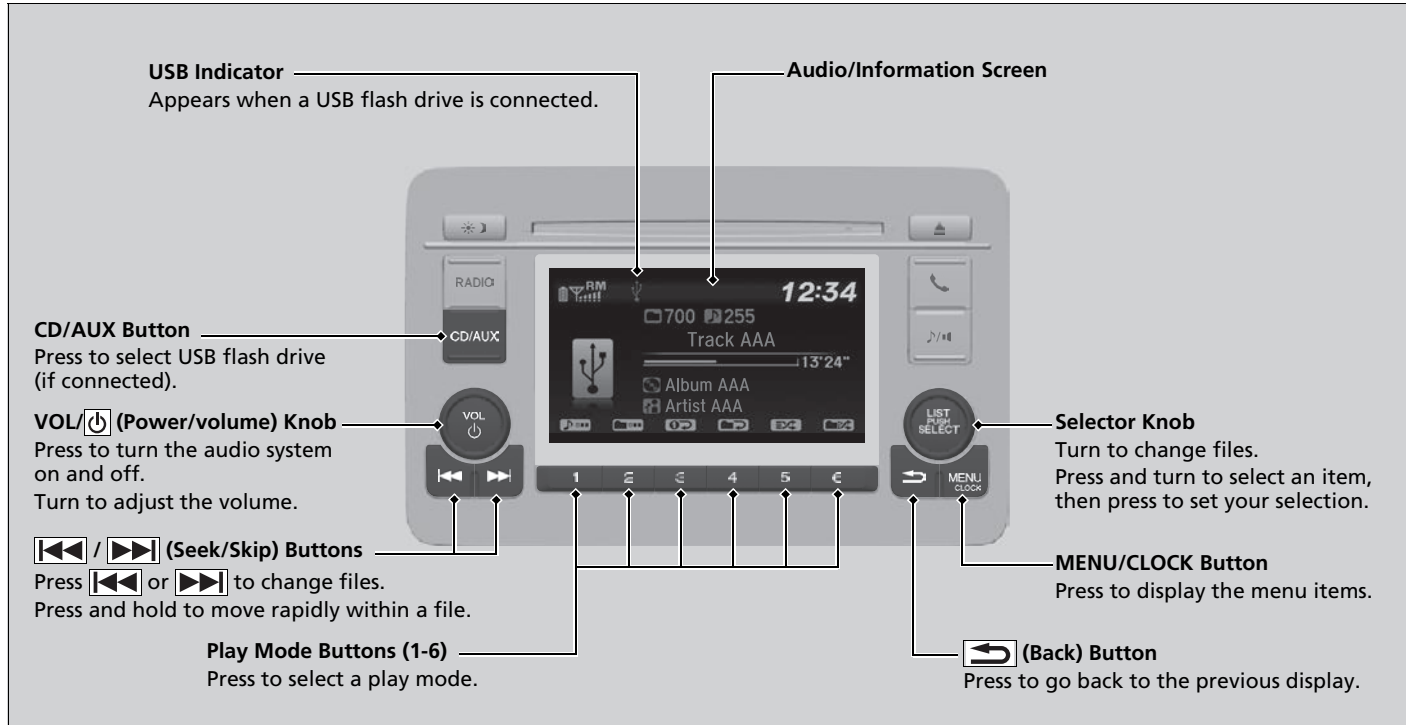

*1: Only AAC format files recorded with iTunes are playable on this unit.

How to Select a File from a Folder with the Selector Knob

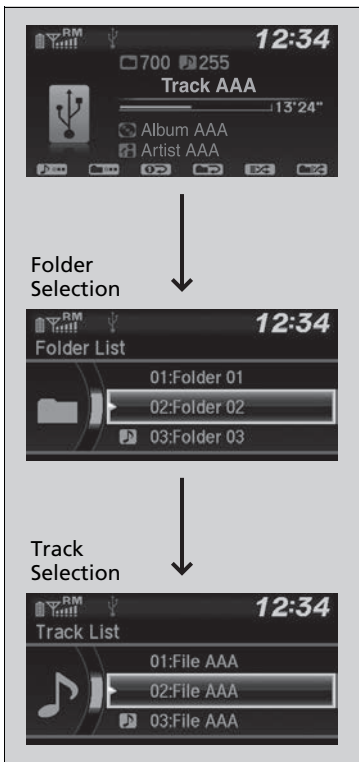

1. Press to display a folder list.
2. Rotate to select a folder.
3. Press to display a list of files in that folder.
4. Rotate to select a file, then press .

▶▶ Playing a USB Flash Drive

Use the recommended USB flash drives.
▶ **General Information on the Audio System**
P. 235

Files in WMA format protected by digital rights management (DRM) cannot be played. The audio system displays **UNPLAYABLE FILE**, and then skips to the next file.

If there is a problem, you may see an error message on the audio/information screen.
▶ **iPod/USB Flash Drive** P. 232

How to Select a Play Mode

You can select repeat, random, and scan modes when playing a file.



Available mode icons appear above the play mode buttons.

Press the button corresponding to the mode you want to select.

To turn off a play mode

Press the selected button.

How to Select a Play Mode

Play Mode Menu Items

Repeat

 **Repeat One Folder:** Repeats all files in the current folder.

 **Repeat One Track:** Repeats the current file.

Random

 **Random in Folder:** Plays all files in the current folder in random order.

 **Random All:** Plays all files in random order.



Scan



 **Scan Folders:** Provides 10-second sampling of the first file in each of the main folders.

 **Scan Tracks:** Provides 10-second sampling of all files in the current folder.

You can also select a play mode by pressing the **MENU/CLOCK** button.

Rotate  to select **Play Mode**, then press .

Rotate  to select a mode, then press .

To turn it off, rotate  to select **Normal Play**, then press .

Playing *Bluetooth*® Audio

Your audio system allows you to listen to music from your *Bluetooth*-compatible phone.

This function is available when the phone is paired and connected to the vehicle's *Bluetooth*® HandsFreeLink® (HFL) system.

☒ **Phone Setup** P. 266

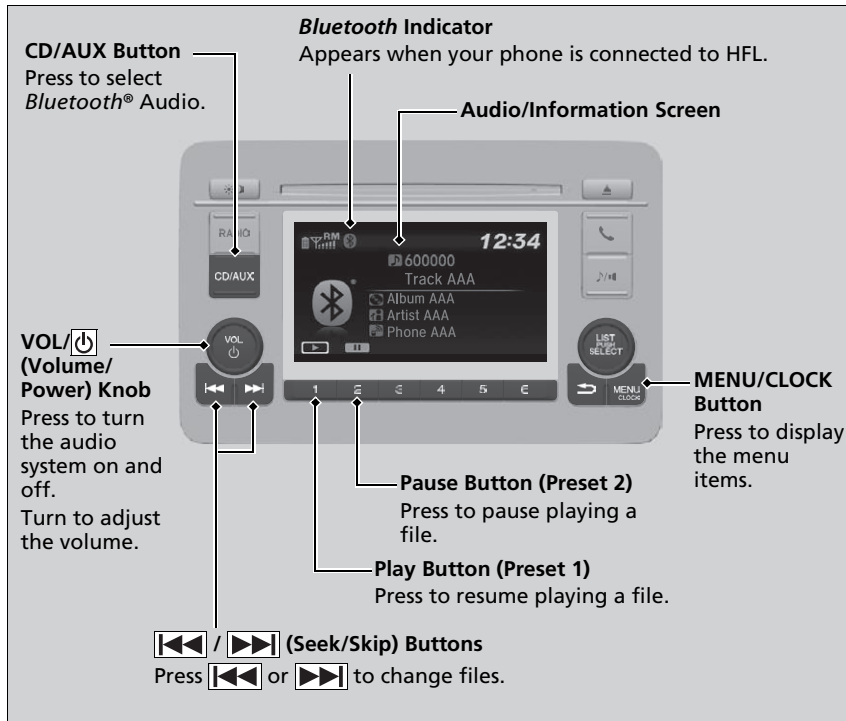

▶▶ Playing *Bluetooth*® Audio

Not all *Bluetooth*-enabled phones with streaming audio capabilities are compatible with the system.

For a list of compatible phones:

- U.S.: Visit www.handsfreelink.honda.com, or call 1-888-528-7876.
- Canada: Visit www.handsfreelink.ca, or call 1-888-528-7876.

In some states, it may be illegal to perform some data device functions while driving.

Only one phone can be used with HFL at a time. When there are more than two paired phones in the vehicle, the first paired phone the system finds is automatically connected.

If more than one phone is paired to the HFL system, there will be a delay before the system begins to play.

In some cases, the name of the artist, album, or track may not appear correctly.

Some functions may not be available on some devices.

■ To Play *Bluetooth*® Audio Files

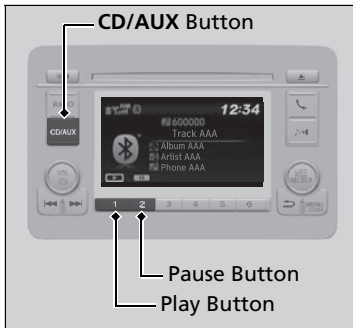

1. Make sure that your phone is paired and connected to HFL.
2. Press the **CD/AUX** button until the *Bluetooth* Audio Source is selected.

If the phone is not recognized, another HFL-compatible phone, which is not compatible for *Bluetooth*® Audio, may already be connected.

■ To pause or resume a file

Press a **Play** or **Pause** button to select a mode.

▶▶ To Play *Bluetooth*® Audio Files

To play the audio files, you may need to operate your phone. If so, follow the phone maker's operating instructions.

The pause function may not be available on some phones.

If any audio device is connected to the auxiliary input jack or USB port, you may need to press the **CD/AUX** button repeatedly to select the *Bluetooth*® Audio system.

Switching to another mode pauses the music playing from your phone.

How to Select a Song from the Music Search List with the Selector Knob

▶▶ How to Select a Song from the Music Search List with the Selector Knob



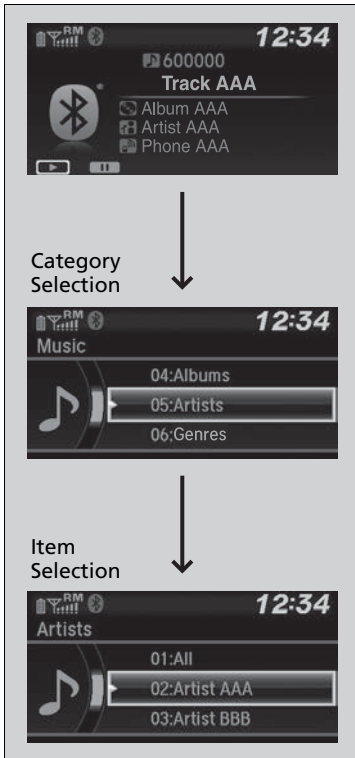

Depending on the *Bluetooth*® device you connect, some or all of the categories may not be displayed.



1. Press  to display the music search list.



2. Rotate  to select a category.

3. Press  to display a list of items in the category.

4. Rotate  to select an item, then press .
▶ Press  and rotate  repeatedly until a desired item you want to listen is displayed.

Audio System Basic Operation

Models with display audio system

To use the audio system function, the ignition switch must be in ACCESSORY  or ON *1.

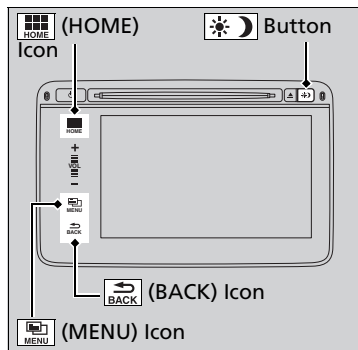



: Select to go to the **HOME** screen.



 **Switching the Display** P. 204

: Touch to select any mode.

The available mode includes **Change Source**, **Station List**, **Save Preset**, **Radio Text**, **Music Search**, and play modes. Play modes can be also selected from **Scan**, **Random/Repeat**, and so on.

: Select to go back to the previous display when it is displayed.

 **button**: Press to change the audio/information screen brightness.

Press  once and select  or  to make an adjustment.

▶ Each time you press , the mode switches between the daytime mode, nighttime mode and **OFF** mode.

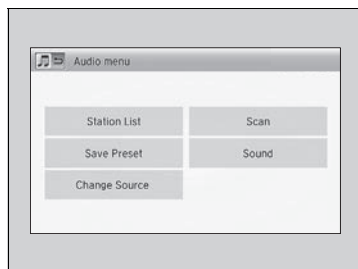

*1: Models with the smart entry system have an **ENGINE START/STOP** button instead of an ignition switch.

Audio System Basic Operation

Audio Menu Items

▶ **Station List** P. 212

▶ **Music Search** P. 215, 218, 223

▶ **Random/Repeat** P. 216, 224

▶ **Scan** P. 213, 216, 224

Audio/Information Screen

Displays the audio status and wallpaper. From this screen, you can go to various setup options.

Switching the Display

Using the  button

Press the  (display) button on the steering wheel to change the display.

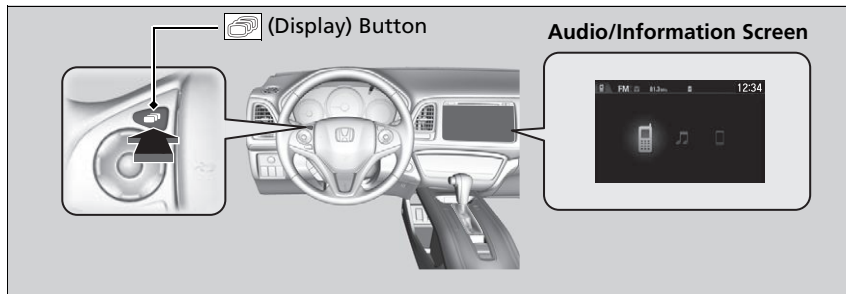

Audio/Information Screen

- Use simple gestures — including touching, swiping, and scrolling — to operate certain audio functions.
- Wearing gloves may limit or prevent touchscreen response.
- You can use the microfiber soft cleaning cloth to remove dust or fingerprints from the touchscreen.

Using the HOME screen

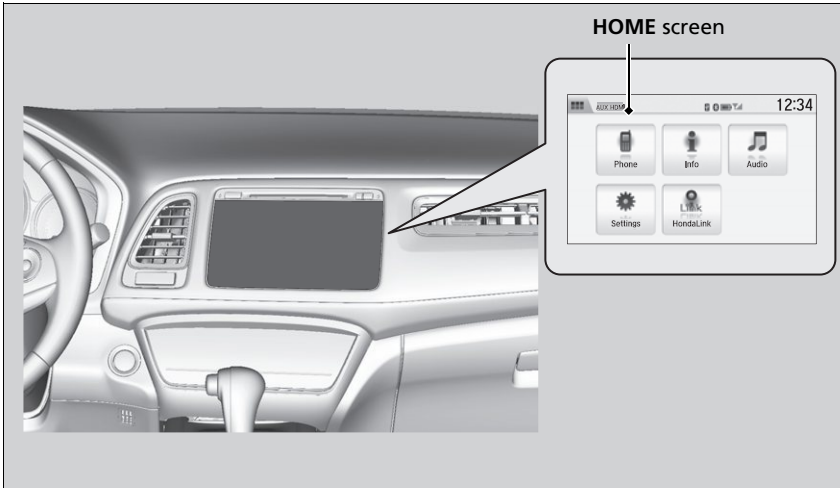

Select **HOME** to go to the **HOME** screen.
 Select **Phone**, **Info**, **Audio**, **Settings**, or **HondaLink**.

■ Phone

Shows the HFL information.

➤ **Bluetooth® HandsFreeLink®** P. 283

■ Info

Shows the **Trip Computer**, **Clock/Wallpaper**, **Voice Info**, or **System/Device Information**.

■ Audio

Shows the current audio information.

■ Settings

Enters the customizing menu screen.

➤ **Customized Features** P. 238

■ HondaLink Apps

Connects with your smartphone*1 to play personalized music, information, and social media streams.

➤ **Smartphone Apps** P. 229

*1: Available on specific phones only. Check handsfreelink.honda.com for compatible phones and hondalink.com for feature details.

Wallpaper Setup

You can change, store, and delete the wallpaper on the audio/information screen.

Import wallpaper

You can import up to five images, one at a time, for wallpaper from a USB flash drive.

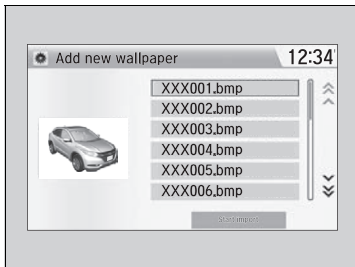
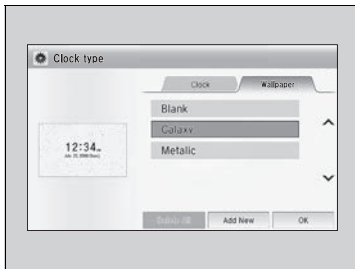

1. Connect the USB flash drive to the USB port.
 ▶ **USB Port(s)** P. 177
2. Select **Settings** to go to the **Settings** screen.
3. Select **Info**.
4. Select **Clock/Wallpaper Type**, then the **Wallpaper** tab.
5. Select **Add New**.
 ▶ The picture name is displayed on the list.
6. Select a desired picture.
 ▶ The preview is displayed on the left side on the screen.
7. Select **Start Import** to save the data.
 ▶ Then the display will return to the wallpaper list.

Wallpaper Setup

- When importing wallpaper files, the image must be in the USB flash drive's root directory. Images in a folder cannot be imported.
- The file name must be fewer than 256 characters.
- The file format of the image that can be imported is BMP (bmp) or JPEG (jpg).
- The individual file size limit is 5 MB.
- The maximum image size is 4,096 x 4,096 pixels. If the image size is less than 800 x 480 pixels, the image is displayed in the middle of the screen with the extra area appearing in black.
- Up to 5 files can be selected.
- If the USB flash drive does not have any pictures, the **No files detected** message appears.

Continued

■ Select wallpaper

1. Select **Settings** to go to the **Settings** screen.
2. Select **Info**.
3. Select **Clock/Wallpaper Type**, then the **Wallpaper** tab.
 - ▶ The screen changes to the wallpaper list.
4. Select a desired wallpaper.
 - ▶ The preview is displayed on the left side on the screen.
 - ▶ The pop-up menu appears on the screen.
5. Select **Set**.
 - ▶ The display will return to the wallpaper list.

■ Delete wallpaper

1. Select **Settings** to go to the **Settings** screen.
2. Select **Info**.
3. Select **Clock/Wallpaper Type**, then the **Wallpaper** tab.
 - ▶ The screen changes to the wallpaper list.
4. Select a wallpaper that you want to delete.
 - ▶ The preview is displayed on the left side on the screen.
 - ▶ The pop-up menu appears on the screen.
5. Select **Delete**.
 - ▶ The confirmation message will appear.
6. Select **Yes** to delete completely.
 - ▶ The display will return to the wallpaper list.

▶▶ Wallpaper Setup

From the pop-up menu, select **Preview** to see a preview at full-size screen.

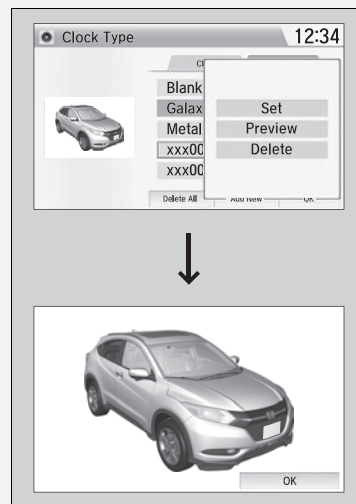

To go back to the previous screen, select **OK**, or **BACK**.

When the file size is large, it takes a while to be previewed.

To delete all wallpapers you add, select **Delete All**, then **Yes**.

Adjusting the Sound

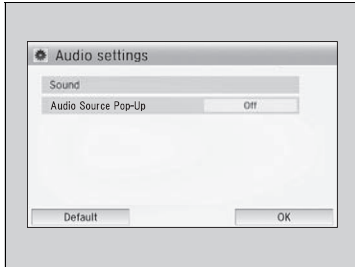

1. Select **HOME**.
2. Select **Settings**.
3. Select **Audio**.
4. Select **Sound**.

Select the tabs to adjust the following choices:
BASS, TREBLE, FADER, BALANCE, SVC
 (Speed-sensitive Volume Compensation)

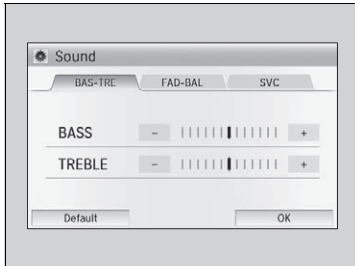

Adjusting the Sound

The SVC has four modes: **Off, Low, Mid, and High**. SVC adjusts the volume level based on the vehicle speed. As you go faster, audio volume increases. As you slow down, audio volume decreases.

Display Setup

You can change the brightness or color theme of the audio/information screen.

■ Changing the Screen Brightness

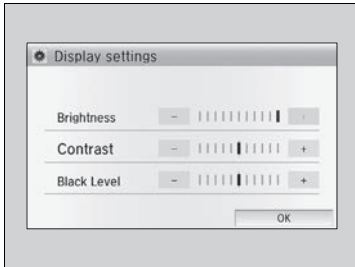

1. Select **HOME**.
2. Select **Settings** to go to the **Settings** screen.
3. Select **System**.
4. Select the **Display** tab.
5. Select **Display Settings**.
6. Select the setting you want.
7. Select **OK**.

■ Changing the Screen's Color Theme

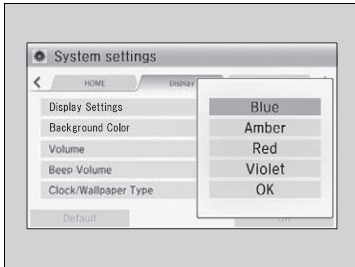

1. Select **HOME**.
2. Select **Settings** to go to the **Settings** screen.
3. Select **System**.
4. Select the **Display** tab.
5. Select **Background Color**.
6. Select the setting you want.
7. Select **OK**.

☒ Changing the Screen Brightness

You can change the **Contrast** and **Black Level** settings in the same manner.

Playing the AM/FM Radio

(Power) Button
Press to turn the audio system on and off.

VOL (Volume) Icons
Select to adjust the volume.

(MENU) Icon
Select to display the menu items.

(BACK) Icon
Select to go back to the previous display.

Scan
Select to scan each station with a strong signal.

Tune Icons
Select ◀ or ▶ to tune the radio frequency.

Seek Icons
Select ◀◀ or ▶▶ to search up and down the selected band for a station with a strong signal.

Preset Icons
Turn the radio frequency for preset memory. Select and hold the preset icon to store that station. Select >> to display preset 7 onwards.

Open/Close Icon^{*1}
Displays/hides the detailed information.

Audio/Information Screen

The diagram shows a car's infotainment screen displaying the FM radio interface. The screen shows 'FM' at the top, 'SOURCE' with 'ALL' and '5' icons, and the frequency '106.1 MHz'. Below this are 'Scan', 'Tune', and 'Seek' buttons. A frequency list at the bottom shows '100.5', '102.1', '103.2', '104.5', '106.1', and '110.7'. On the left side of the screen, there are 'HOME', 'VOL' (with +, -, and list icons), 'MENU', and 'BACK' buttons. The top of the screen has a power button, a volume knob, and a mute icon. The time '12:34' is displayed in the top right corner.

*1: Some or all of the lists may not be displayed.

■ Preset Memory

To store a station:

1. Tune to the selected station.
2. Select **MENU**.
3. Select **Save Preset**.
4. Select the preset number you want to store that station.

■ Radio Data System (RDS)

Provides text data information related to your selected RDS-capable FM station.

■ To find an RDS station from Station List

1. Select **MENU** while listening to an FM station.
2. Select **Station List**.
3. Select the station.

■ Manual update

Updates your available station list at any time.

1. Select **MENU** while listening to an FM station.
2. Select **Station List**.
3. Select **Refresh**.

▶▶ Playing the AM/FM Radio

The **ST** indicator appears on the display indicating stereo FM broadcasts. Stereo reproduction in AM is not available.

Switching the Audio Mode

Press the **SOURCE** button on the steering wheel or select **SOURCE** on the list.

▶▶ **Audio Remote Controls** P. 180

You can also switch the mode by selecting **Change Source** on the **MENU** screen.

You can store 6 AM stations and 12 FM stations into the preset memory.

▶▶ Radio Data System (RDS)

When you select an RDS-capable FM station, the RDS automatically turns on, and the frequency display changes to the station name. However, when the signals of that station become weak, the display changes from the station name to the frequency.

■ Radio text

Displays the radio text information of the selected RDS station.

1. Select **MENU**.
2. Select **View Radio Text**.

■ Scan

Samples each of the strongest stations on the selected band for 10 seconds.

1. Select **MENU**.
2. Select **Scan**.

To turn off scan, select **Cancel**.

Playing a CD

Your audio system supports audio CDs, CD-Rs, and CD-RWs in either MP3 or WMA, or AAC*1 format. With the CD loaded, select the CD mode.

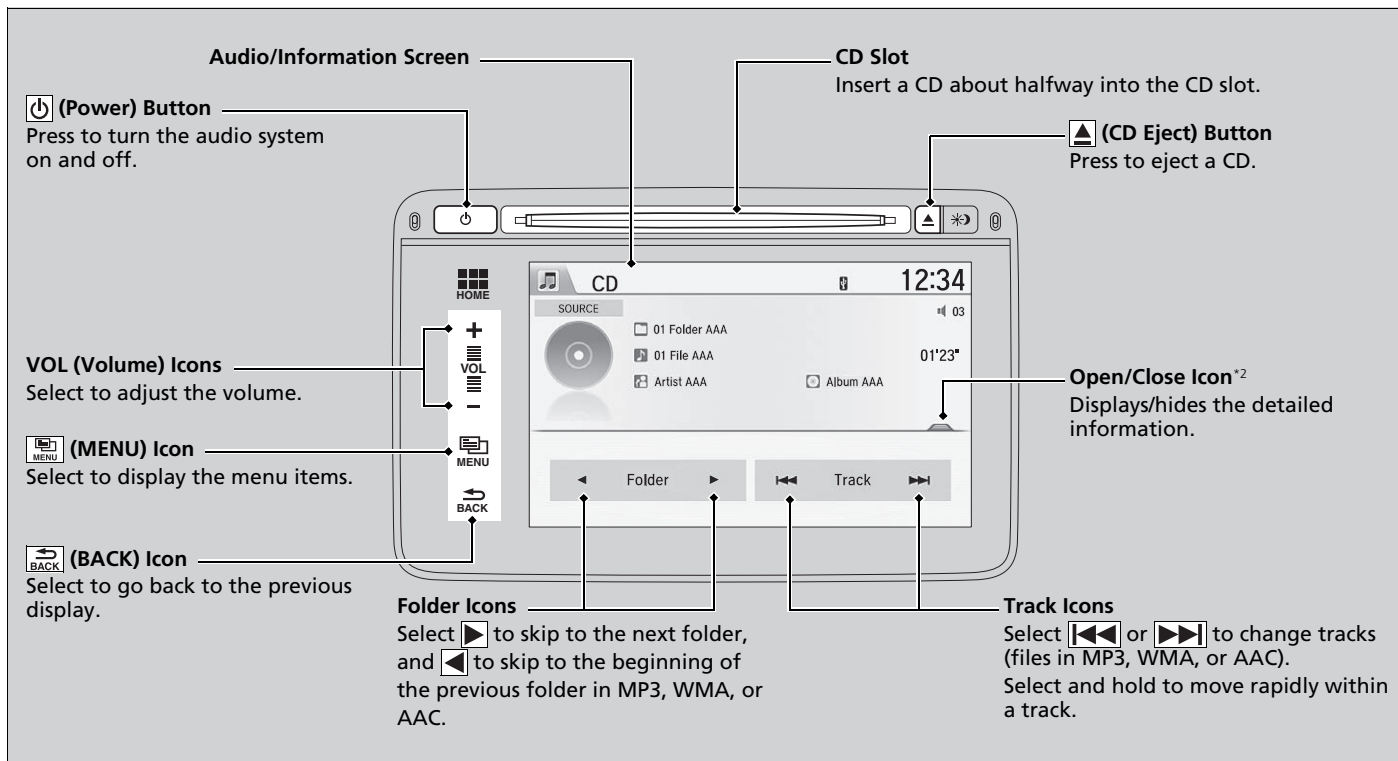

*1: Only AAC format files recorded with iTunes are playable on this unit.

*2: Some or all of the lists may not be displayed.

How to Select a File from the Music Search List (MP3/WMA/AAC)

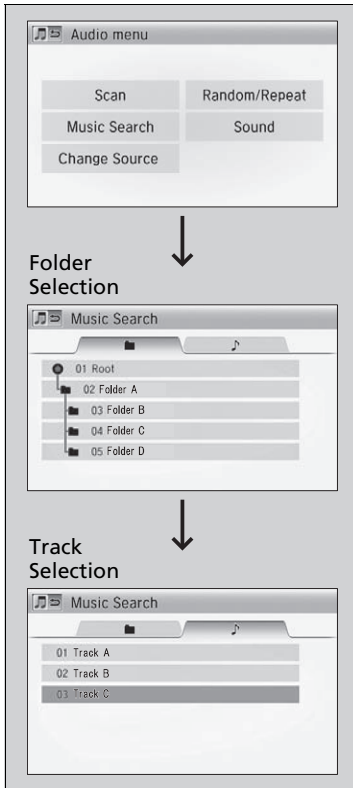

1. Select **MENU** and select **Music Search**.

2. Select a folder.

3. Select a track.

▶▶ Playing a CD

NOTICE

Do not use CDs with adhesive labels. The label can cause the CD to jam in the unit.

WMA files protected by digital rights management (DRM) cannot be played.

The audio system displays **Unplayable File**, then skips to the next file.

Text data appears on the display under the following circumstances:

- When you select a new folder, file, or track.
- When you change the audio mode to CD.
- When you insert a CD.

If you eject the CD but do not remove it from the slot, the system reloads the CD automatically after several seconds.

Continued

■ How to Select a Play Mode

You can select scan, repeat, and random modes when playing a track or file.



1. Select **MENU**.
2. Select **Scan** or **Random/Repeat**.
3. Select a mode.

■ To turn off a play mode

1. Select **MENU**.
2. Select the mode you want to turn off.

▶▶ How to Select a Play Mode

Play Mode Menu Items

Scan

Scan Folders (MP3/WMA/AAC): Provides 10-second sampling of the first file in each of the main folders.

Scan Tracks: Provides 10-second sampling of all tracks on the CD (all files in the current folder in MP3, WMA, or AAC).

Random/Repeat

Repeat Folder (MP3/WMA/AAC): Repeats all files in the current folder.

Repeat Track: Repeats the current track/file.

Random in Folder (MP3/WMA/AAC): Plays all files in the current folder in random order.

Random All Tracks: Plays all tracks/files in random order.

Playing an iPod

Connect the iPod using your dock connector to the USB port, then select the iPod mode.

 **USB Port(s)** P. 177

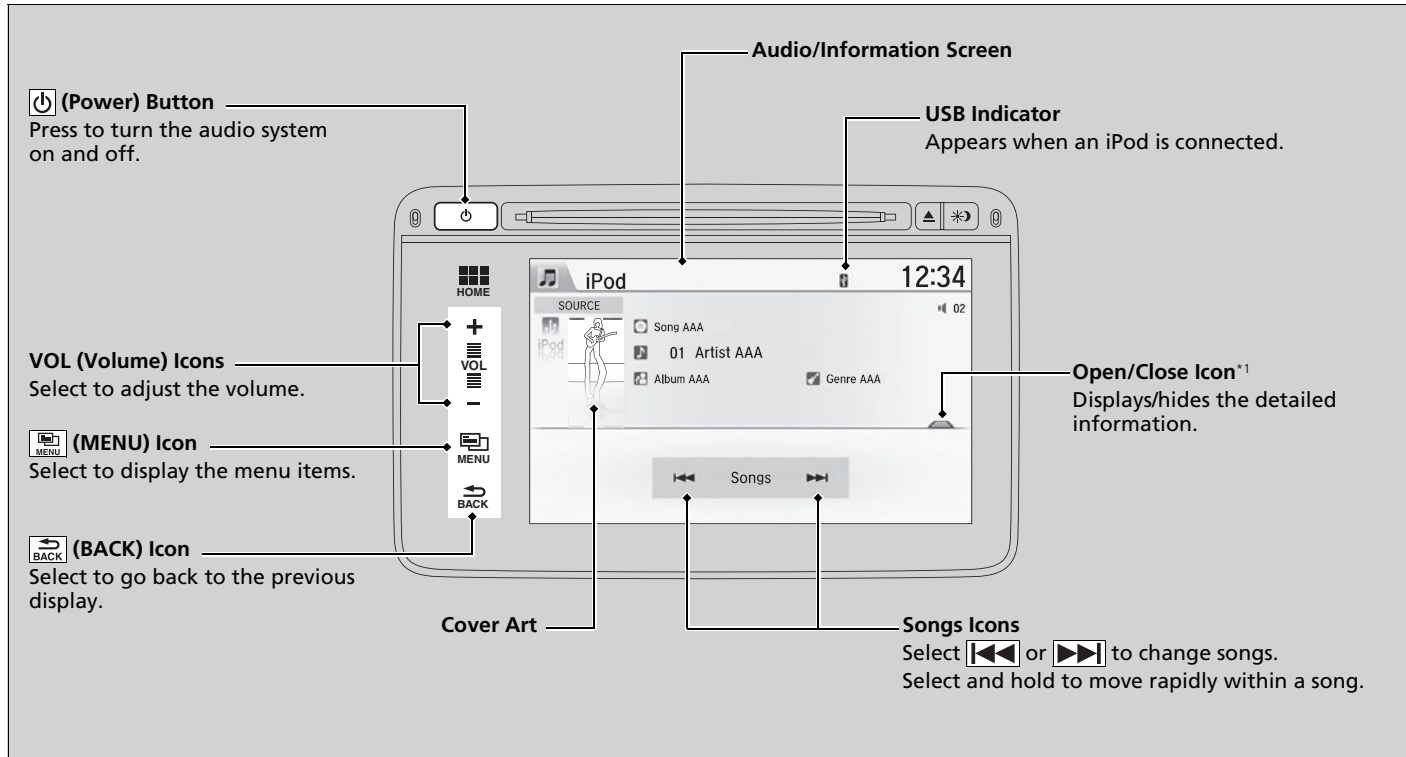

*1: Some or all of the lists may not be displayed.

■ How to Select a Song from the Music Search List

1. Select **MENU** and select **Music Search**.
2. Select the items on that menu.

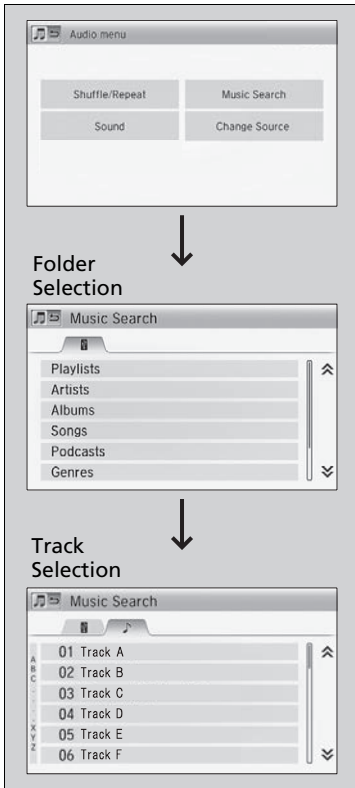

▶▶ How to Select a Song from the Music Search List

Available operating functions vary on models or versions. Some functions may not be available on the vehicle's audio system.

If there is a problem, you may see an error message on the audio/information screen.

▶▶ **iPod/USB Flash Drive** P. 232

If you operate the music app on your iPhone/iPod while the phone is connected to the display audio system, you may no longer be able to operate the same app on the display audio. Reconnect the device if necessary.

How to Select a Play Mode

You can select repeat and shuffle modes when playing a file.



1. Select **MENU**.
2. Select **Shuffle/Repeat**.
3. Select a mode.

To turn off a play mode

1. Select **MENU**.
2. Select the mode you want to turn off.

How to Select a Play Mode

Play Mode Menu Items

Repeat Song: Repeats the current file.

Shuffle Albums: Plays all available albums in a selected list (playlists, artists, albums, songs, genres, or composers) in random order.

Shuffle All Songs: Plays all available files in a selected list (playlists, artists, albums, songs, genres, or composers) in random order.

U.S. models

Compatible phones only

Playing Internet Radio

Connect a compatible phone through *Bluetooth*®.

➔ **Phone Setup** P. 291

iPhone only

You can also connect the phone using your dock connector to the USB port. Select **Source** to select Pandora mode.

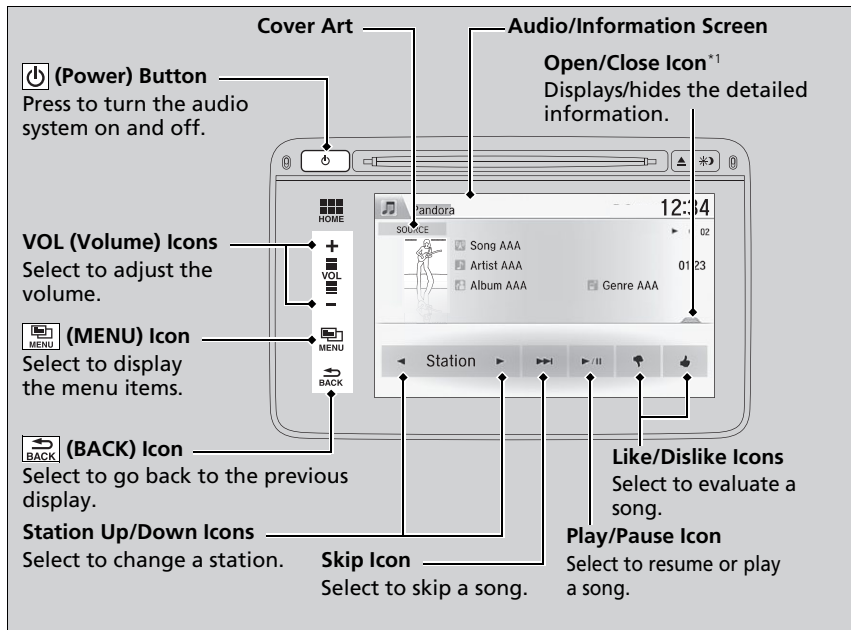

*1:Some or all of the lists may not be displayed.

▶▶ Playing Internet Radio

Pandora®, the Pandora logo, and the Pandora trade dress are trademarks or registered trademarks of Pandora Media, Inc., used with permission. Pandora is currently available exclusively in the United States.

To find out if your phone is compatible with this feature, visit www.handsfreelink.honda.com, or call 1-888-528-7876

To use this service in your vehicle, the Pandora® app must first be installed on your phone. Visit www.pandora.com. for more information.

■ Pandora® Menu

You can operate some of the Pandora® menu items from your vehicle's audio system. The available items are:

- **Bookmark**
- **Station List**
- **New Station**
- **Change Source**
- **Sound**

■ Operating a menu item

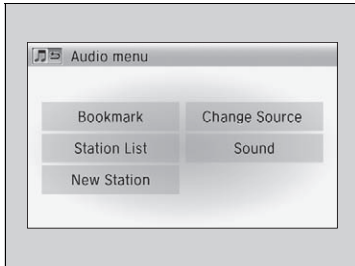

1. Select **MENU**.
2. Select an item.

▶▶ Playing Internet Radio

Pandora® is free, personalized radio that plays music and comedy you'll love. Just start with the name of one of your favorite artists, songs, comedians or composers and Pandora® will create a custom station that plays similar tracks. Pandora® also features hundreds of genre stations ranging from Dubstep to Smooth Jazz to Power Workout.

If you cannot operate Pandora® through the audio system, it may be streaming through *Bluetooth®* Audio. Make sure Pandora® mode on your audio system is selected.

▶▶ Changing Stations

To change stations, activate the Pandora® menu, select **Station List**, and then select a new station.

▶▶ Pandora® Menu

Available operating functions vary on software versions. Some functions may not be available on the vehicle's audio system.

If there is a problem, you may see an error message on the audio/information screen.

▶▶ **Pandora®** P. 233

Pandora® may limit the total number of skips allowed on the service. If you dislike a track after the skip limit has been reached, your feedback will be saved but the current track will continue to play.

Playing a USB Flash Drive

Your audio system reads and plays sound files on a USB flash drive in either MP3, WMA or AAC*1 format.

Connect your USB flash drive to the USB port, then select the USB mode.

➤ **USB Port(s)** P. 177

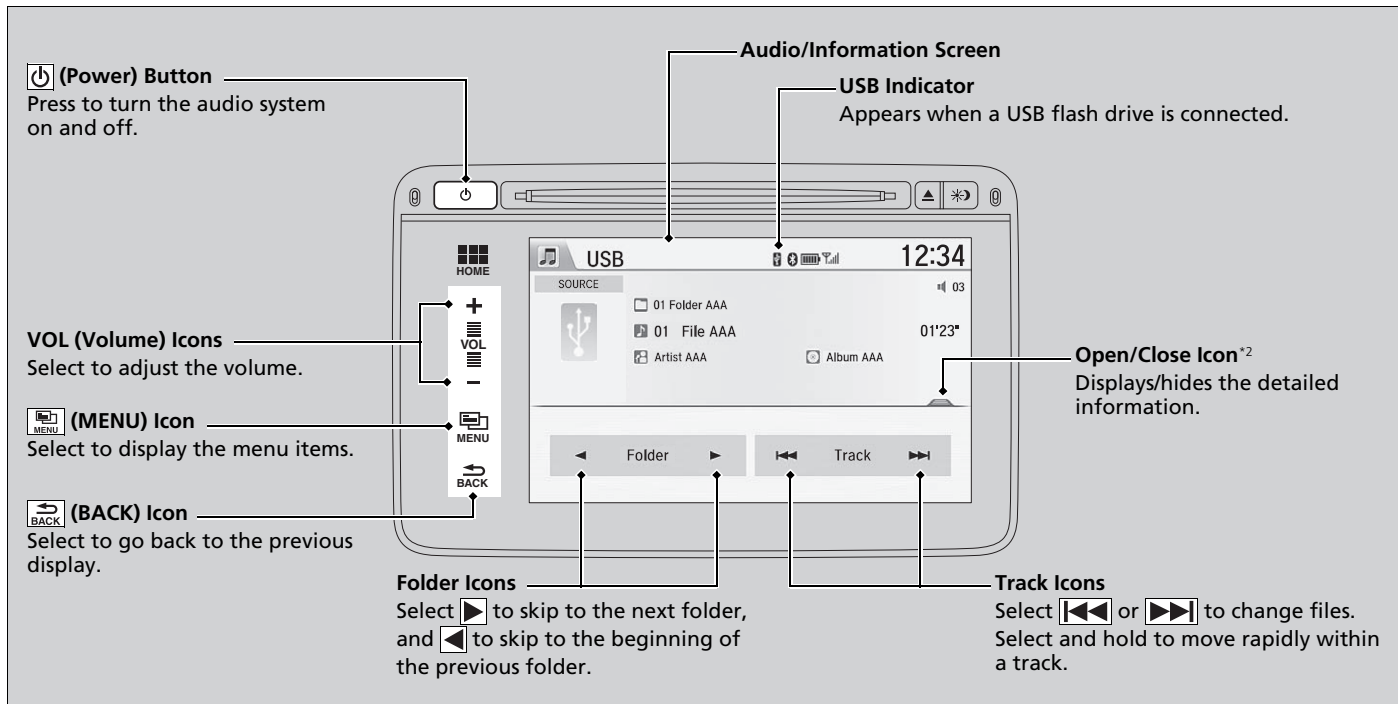

*1: Only AAC format files recorded with iTunes are playable on this unit.

*2: Some or all of the lists may not be displayed.

How to Select a File from the Music Research List

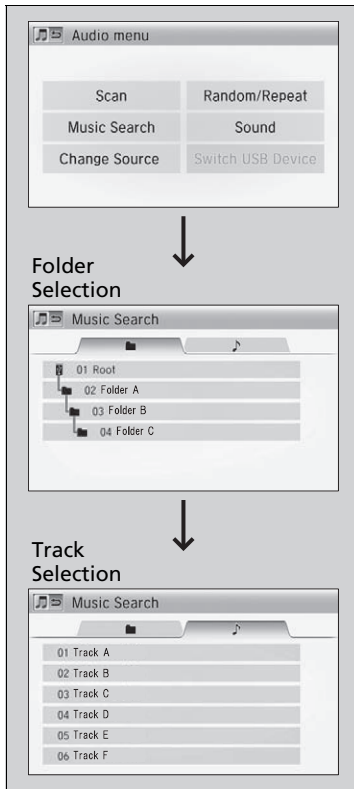

1. Select **MENU** and select **Music Search**.

2. Select a folder.

3. Select a track.

▶▶ Playing a USB Flash Drive

Use the recommended USB flash drives.

▶ **General Information on the Audio System**
P. 235

Files in WMA format protected by digital rights management (DRM) cannot be played.

The audio system displays **Unplayable File**, and then skips to the next file.

If there is a problem, you may see an error message on the audio/information screen.

▶ **iPod/USB Flash Drive** P. 232

■ How to Select a Play Mode

You can select scan, repeat, and random modes when playing a file.



1. Select **MENU**.
2. Select **Scan** or **Random/Repeat**.
3. Select a mode.

■ To turn off a play mode

1. Select **MENU**.
2. Select the mode you want to turn off.

▶▶ How to Select a Play Mode

Play Mode Menu Items

Scan

Scan Folders: Provides 10-second sampling of the first file in each of the main folders.

Scan Tracks: Provides 10-second sampling of all files in the current folder.

Random/Repeat

Repeat Folder: Repeats all files in the current folder.

Repeat Track: Repeats the current file.

Random in Folder: Plays all files in the current folder in random order.

Random All Tracks: Plays all files in random order.

Playing *Bluetooth*® Audio

Your audio system allows you to listen to music from your *Bluetooth*-compatible phone.

This function is available when the phone is paired and connected to the vehicle's *Bluetooth*® HandsFreeLink® (HFL) system.

📌 **Phone Setup** P. 291

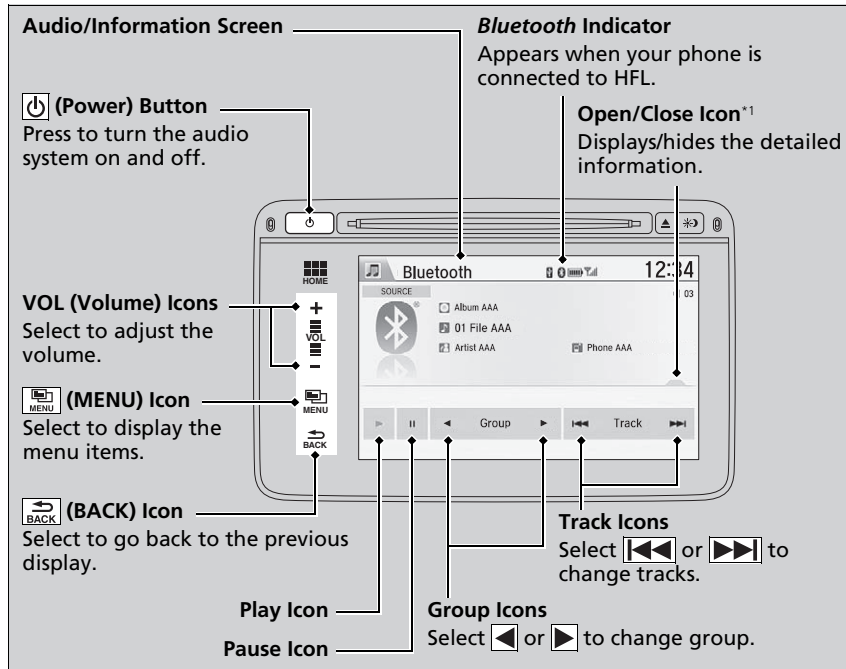

*1: Depending on the *Bluetooth* device you connect, some or all of the lists may not be displayed.

▶▶ Playing *Bluetooth*® Audio

Not all *Bluetooth*-enabled phones with streaming audio capabilities are compatible with the system.

For a list of compatible phones:

- U.S.: Visit www.handsfreelink.honda.com, or call 1-888-528-7876.
- Canada: Visit www.handsfreelink.ca, or call 1-888-528-7876.

In some states, it may be illegal to perform some data device functions while driving.

Only one phone can be used with HFL at a time. When there are more than two paired phones in the vehicle, the first paired phone the system finds is automatically linked.

If more than one phone is paired to the HFL system, there may be a delay before the system begins to play.

In some cases, the name of the artist, album, or track may not appear correctly.

A **No Device Connected** message may be displayed if:

- The phone is not linked to HFL.
- The phone is not turned on.
- The phone is not in the vehicle.
- An incompatible phone is connected.

The following functions may not be available on some devices:

- Pause function
- Group selection

■ To Play *Bluetooth*® Audio Files

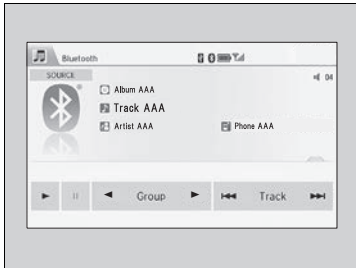

1. Make sure that your phone is paired and connected to HFL.
2. Press the *Bluetooth*® Audio mode.

If the phone is not recognized, another HFL-compatible phone, which is not compatible for *Bluetooth*® Audio, may already be connected.

■ To pause or resume a file

Select the play icon or pause icon.

■ Searching for Music

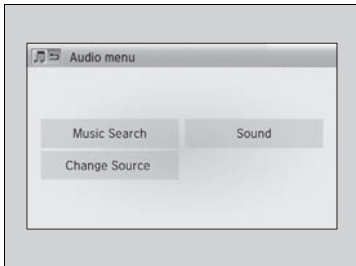

1. Select **MENU**.
2. Select **Music Search**.
3. Select a search category (e.g., Albums).
4. Select an item.
 - ▶ The selection begins playing.

▶▶ To Play *Bluetooth*® Audio Files

To play the audio files, you may need to operate your phone. If so, follow the phone maker's operating instructions.

Switching to another mode pauses the music playing from your phone.

▶▶ Searching for Music

Depending on the *Bluetooth* device you connect, some or all of the lists may not be displayed.

Playing a Video Using the HDMI®

Your audio system allows you to play videos from an HDMI®-compatible device when parked.

Connect the device, using an HDMI® cable, then select the HDMI® mode.

📖 **HDMI® Port*** P. 178

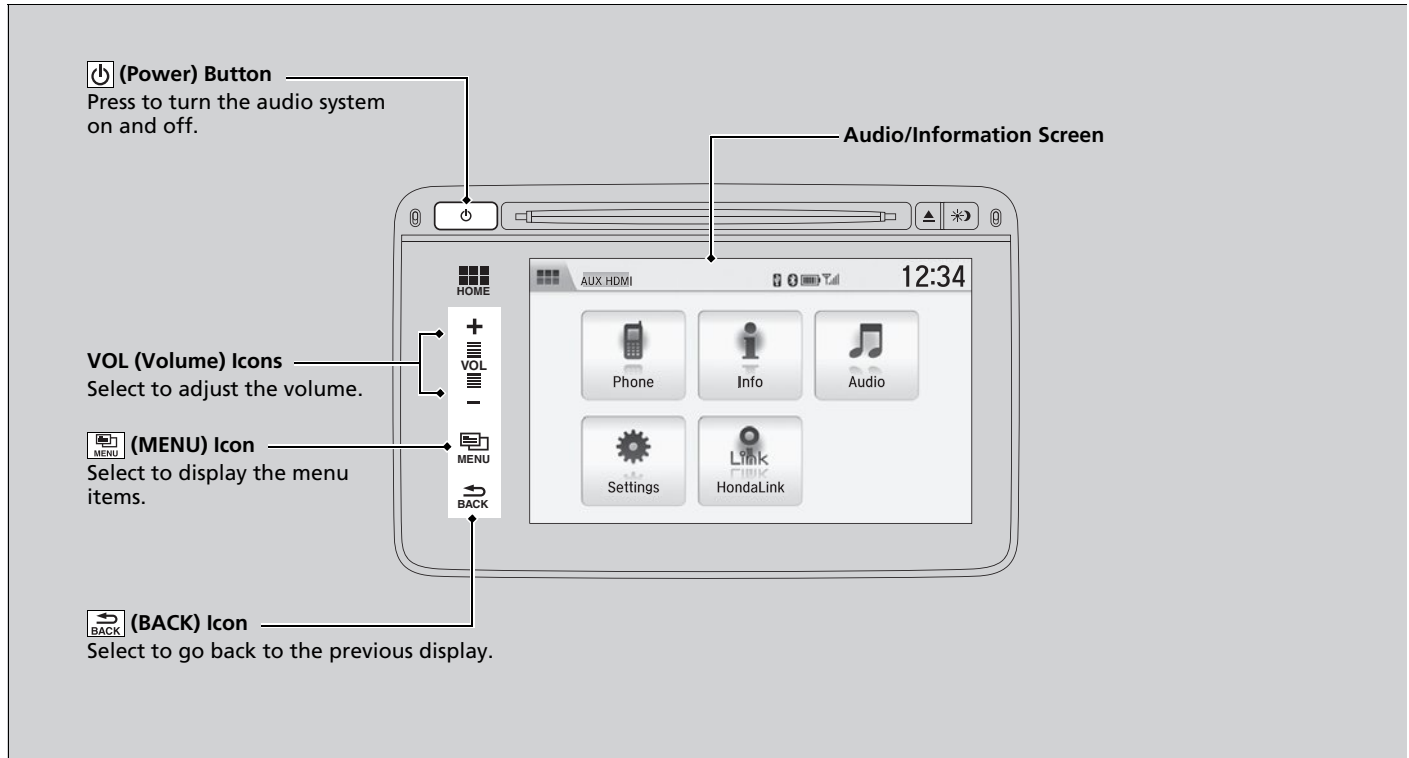

* Not available on all models

■ Changing the Screen Aspect

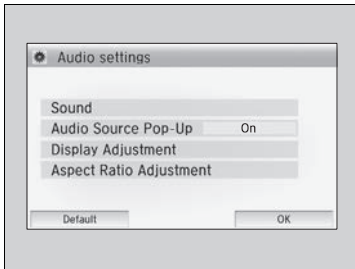

1. Select **HOME**.
2. Select **Settings** to go to the **Settings** screen.
3. Select **Audio**.
4. Select **Aspect Ratio Adjustment**.
5. Select the setting you want.
6. Select **OK**.

▶▶ Playing a Video Using the HDMI®

This feature is limited while driving. To play videos, stop your vehicle and apply the parking brake.

Smartphone Apps

You can connect a compatible smartphone to the system to enable integration between the smartphone's approved apps and the vehicle. This allows you to control the phone through the vehicle display. To check smart phone compatibility, download the HondaLink app, and view connection instructions, visit handsfreelink.honda.com. For the latest apps and feature details, check hondalink.com.

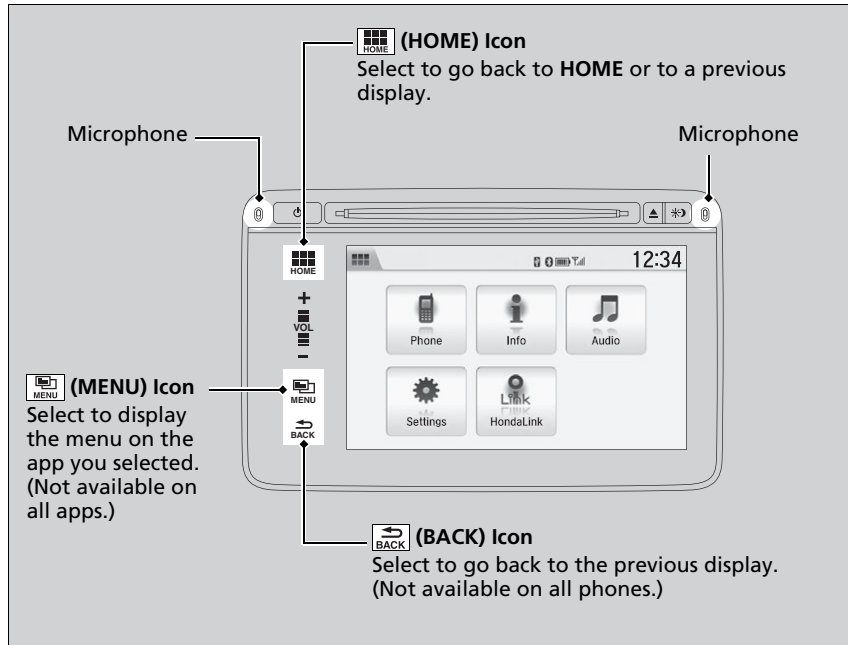

Smartphone Apps

Park in a safe place before connecting your phone and while operating the displayed apps.

Not all phones and apps are compatible with the system. The system does not display all the available apps on smartphone, and some apps need to be preinstalled. Ask a dealer for details.

You need to switch the *Bluetooth* connection to your smartphone if another electronic device is connected.

Changing the currently paired phone P. 292

The following may vary by phone type:

- How to connect a smartphone to the system.
- Apps that can be operated on the screen.
- Display response time/update time.

We do not support every app operation on the display audio.

Ask the app provider for any questions on the app's features.

Siri Eyes Free

You can talk to Siri using the Talk button on the steering wheel when your iPhone is paired to *Bluetooth*® HandsFreeLink®.

➔ **Phone Setup** P. 291

❏ Siri Eyes Free

Siri is a trademark of Apple Inc.

Check Apple Inc. website for features available for Siri.

When operating the vehicle, only use Siri through the Talk button.

❏ Using Eyes Free

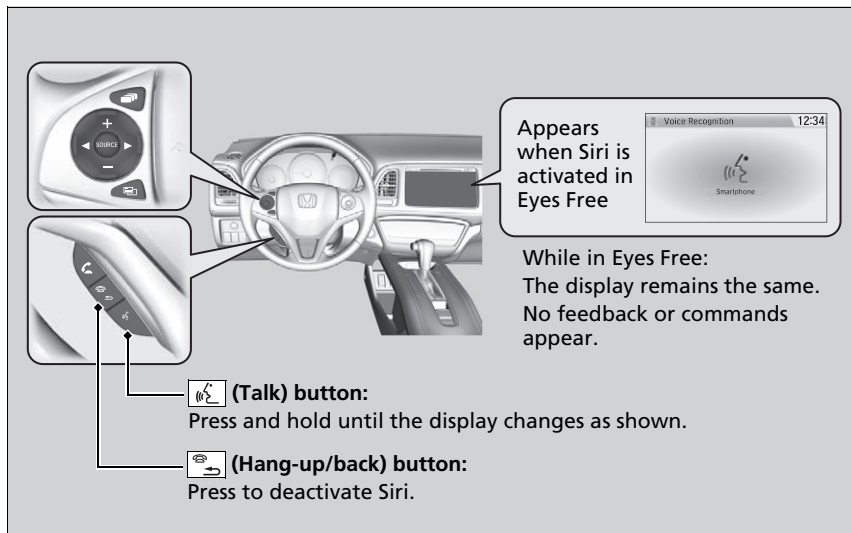

Some commands work only on specific phone features or apps.

■ Using Eyes Free



CD Player

If a disc error occurs, you may see the following error messages.

Error Message	Cause	Solution
Unplayable File	Track/file format not supported	<ul style="list-style-type: none"> • Current track/file will be skipped. The next supported track/file plays automatically.
Bad Disc Please check Owner's Manual Please push eject button*1 Bad Disc Please Check Owners Manual Push Eject*2	Mechanical error	<ul style="list-style-type: none"> • Press the  (eject) button and remove the disc, and check that the error message is cleared. • Check that the disc is not damaged or deformed, and insert the disc again. <ul style="list-style-type: none"> ➤ Protecting CDs P. 236 • If the error message reappears, press the  button, and pull out the disc. • Insert a different disc. <p>If the new disc plays, there is a problem with the first disc.</p> <ul style="list-style-type: none"> • If the error message repeats, or the disc cannot be removed, contact a dealer. <p>Do not try to force the disc out of the player.</p>
Mecha Error		
Bad Disc Please Check Owner's Manual*1 Bad Disc Please Check Owners Manual*2	Servo error	<ul style="list-style-type: none"> • If the error message repeats, or the disc cannot be removed, contact a dealer. <p>Do not try to force the disc out of the player.</p>
Check Disc	Disc error	<ul style="list-style-type: none"> • Check that the disc is not damaged or deformed. <ul style="list-style-type: none"> ➤ Protecting CDs P. 236
Heat Error	High temperature	<ul style="list-style-type: none"> • Turn the audio system off and allow the player to cool down until the error message is cleared.

*1: Display audio system

*2: Color audio system

iPod/USB Flash Drive

If an error occurs while playing an iPod or USB flash drive, you may see the following error messages. If you cannot clear the error message, contact a dealer.

Error Message	Solution
USB Error	Appears when there is a problem with the USB adapter unit. Check if the device is compatible with the USB adapter unit.
The connected USB device has a problem. See Owner's Manual*¹ Bad USB Device*²	Appears when an incompatible device is connected. Disconnect the device. Then turn the audio system off, and turn it on again. Do not reconnect the device that caused the error.
Unsupported Version*¹ Unsupported Ver*²	Appears when an unsupported iPod is connected. If it appears when a supported iPod is connected, update the iPod software to the newer version.
Connect Retry*¹ Retry Connection*²	Appears when the system does not acknowledge the iPod. Reconnect the iPod.
Unplayable File	Appears when the files in the USB flash drive are DRM or an unsupported format. This error message appears for about 3 seconds, then plays the next song.
No Data*¹, *² USB No Song*² iPod No Song*²	iPod Appears when the iPod is empty.
	USB flash drive Appears when the USB flash drive is empty or there are no MP3, WMA, or AAC files in the USB flash drive.
	iPod and USB flash drive Check that compatible files are stored on the device.
Unsupported	Appears when an unsupported device is connected. If it appears when a supported device is connected, reconnect the device.

*1 : Display audio system

*2 : Color audio system

Models with display audio system

Pandora®

If an error occurs while playing Pandora®, you may see the following error messages.

If you cannot clear the error message, contact a dealer.

Error Message	Solution
The maximum number of stations has been created. To create more, please delete one or more previously created stations.	<ul style="list-style-type: none"> • Appears when the number of stations that can be created is exceeded. Follow the message.
Unable to create new station. Please try again.	
Unable to play Pandora. Please try again later.	<ul style="list-style-type: none"> • Appears when the commanded operation is failed. Try again later.
Unable to save bookmark.	
This Pandora station is currently not available. Please select another station.	<ul style="list-style-type: none"> • Appears when the station you selected is not available. Change a station, or try again later.
Unable to play Pandora. When stopped, log-in to Pandora.	<ul style="list-style-type: none"> • Appears when you have not logged into Pandora®. Follow the message.
Unable to connect to Pandora. When stopped, check your mobile phone.	
Unable to play Pandora. Please try again later.	<ul style="list-style-type: none"> • Appears when failed to connect. Check your device and try again.
Connect Retry	

Error Message	Solution
Unsupported	<ul style="list-style-type: none"> • Appears when the device is not supported. Use another device.
Unsupported Version	
Pandora App version is not supported	<ul style="list-style-type: none"> • Appears when Pandora® version is not supported. Update Pandora® to the latest version.
Unable to connect to the phone. Please make sure the phone's Bluetooth setting is ON and try again.	<ul style="list-style-type: none"> • Appears when Pandora® is unable to play music. Check the Bluetooth status on your device.
No Data	<ul style="list-style-type: none"> • Appears when no data is available with Pandora® activated. Reboot the app and reconnect the device.
The connected USB device has a problem. See Owner's Manual	<ul style="list-style-type: none"> • Appears when an incompatible device is connected. Disconnect the device. Then turn the audio system off, and turn it again. Do not reconnect the device that caused the error.
No stations found. Please create a station.	<ul style="list-style-type: none"> • Appears when there is no station list on the device. Create one on your device.
The maximum number of tracks that can be skipped per hour has been reached.	<ul style="list-style-type: none"> • Appears when you try to skip a song or select dislike over the predetermined number of times in an hour.

Recommended CDs

- Use only high-quality CD-R or CD-RW discs labeled for audio use.
- Use only CD-R or CD-RW discs on which the recordings are closed.
- Play only standard round-shaped CDs.

The CD packages or jackets should have one of these marks.



CDs with MP3, WMA, or AAC files

- Some software files may not allow for audio play or text data display.
- Some versions of MP3, WMA, or AAC formats may be unsupported.

Recommended CDs

A Dual-disc cannot play on this audio unit. If recorded under certain conditions, a CD-R or CD-RW may not play either.

■ Protecting CDs

Follow these precautions when handling or storing CDs:

- Store a CD in its case when it is not being played.
- When wiping a CD, use a soft clean cloth from the center to the outside edge.
- Handle a CD by its edge. Never touch either surface.
- Never insert foreign objects into the CD player.
- Keep CDs out of direct sunlight and extreme heat.
- Do not place stabilizer rings or labels on the CD.
- Avoid fingerprints, liquids, and felt-tip pens on the CD.

▶▶ Protecting CDs

NOTICE

Do not insert a damaged CD. It may be stuck inside and damage the audio unit.

Examples:

- Bubbled, wrinkled, labeled, and excessively thick CDs



Bubbled/
Wrinkled



With Label/
Sticker



Using
Printer Label
Kit



Sealed



With Plastic Ring

- Damaged CDs



Chipped/
Cracked



Warped



Burrs

- Poor quality CDs

- Small CDs



3-inch (8-cm)
CD

Compatible iPod, iPhone, and USB Flash Drives

■ iPod and iPhone Model Compatibility

Model
iPod (5th generation)
iPod classic 80GB/160GB (launch in 2007)
iPod classic 120GB (launch in 2008)
iPod classic 160GB (launch in 2009)
iPod nano
iPod touch
iPhone 3G/iPhone 3GS/iPhone 4/iPhone 4S/iPhone 5

■ USB Flash Drives

- Use a recommended USB flash drive of 256 MB or higher.
- Some digital audio players may not be compatible.
- Some USB flash drives (e.g., a device with security lockout) may not work.
- Some software files may not allow for audio play or text data display.
- Some versions of MP3, WMA, or AAC formats may be unsupported.

⌘ iPod and iPhone Model Compatibility

This system may not work with all software versions of these devices.

⌘ USB Flash Drives

Files on the USB flash drive are played in their stored order. This order may be different from the order displayed on your PC or device.

Customized Features

Use the audio/information screen to customize certain features.

Models with navigation system

See the navigation system manual for information of the customized features.

Models with color audio system

■ How to customize

While the vehicle is at a complete stop with the ignition switch in ON (II), press the **MENU/CLOCK** button, then select **Settings**. To customize the phone settings, press the  button, then select **Phone Setup**.

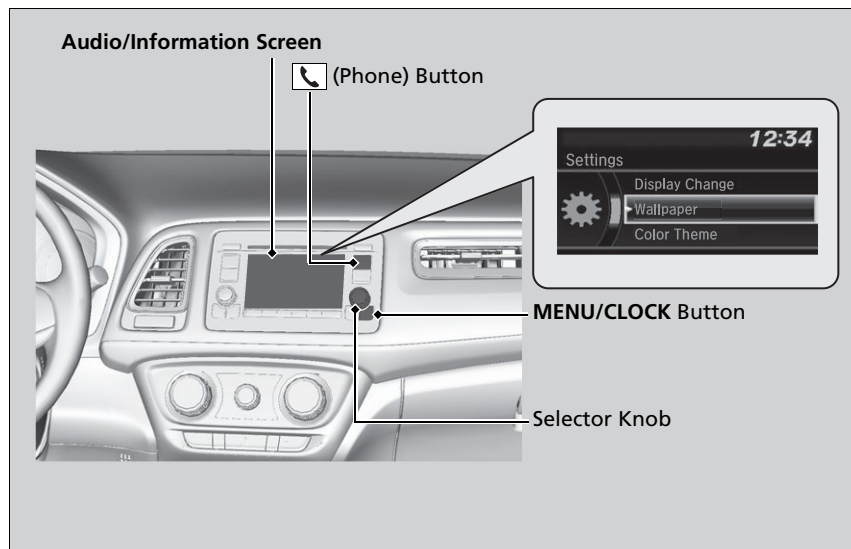

» Customized Features

When you customize settings:

- Make sure that the vehicle is at a complete stop.

Continuously variable transmission models

- Shift to **P**.

Manual transmission models



- Set the parking brake.

» How to customize

These indications are used to show how to operate the selector knob.

Rotate  to select.

Press  to enter.

To customize other features, select **Settings**, rotate , then press .

➔ **List of customizable options** P. 242

Models with color audio system

■ Customization Flow

Press the MENU/CLOCK button.

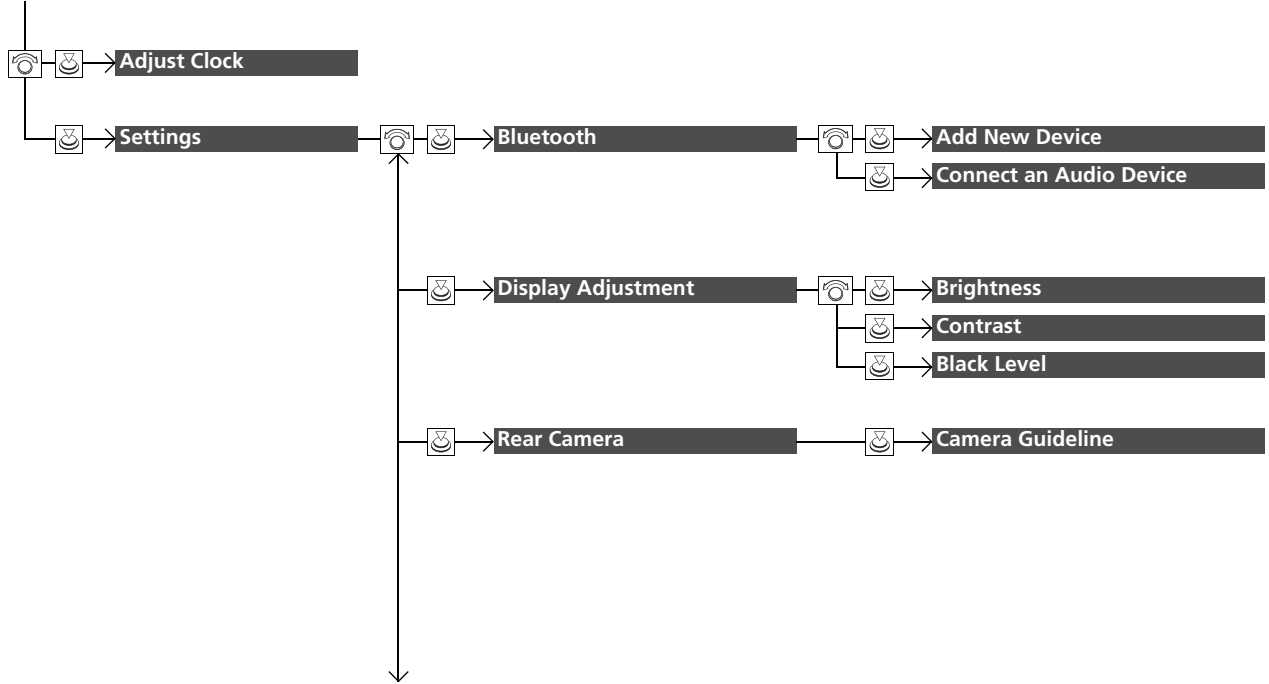

Features

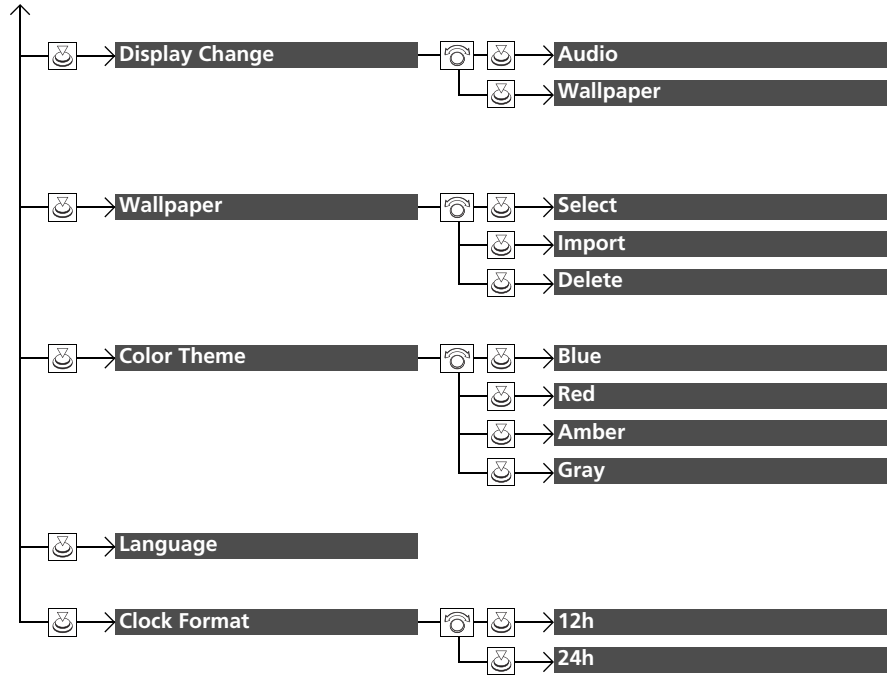

Press the  button and rotate  to select **Phone Setup**, then press .

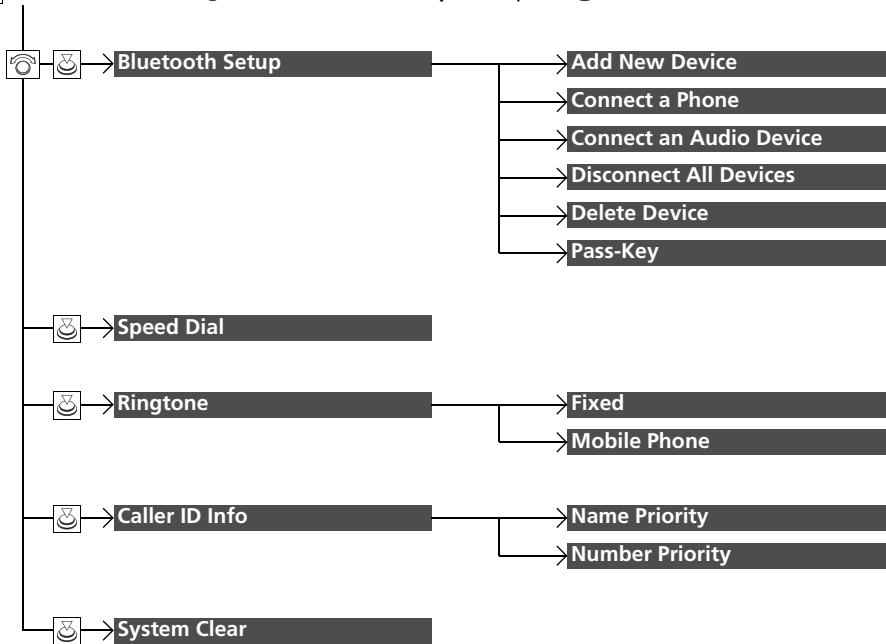

Models with color audio system

■ List of customizable options

Setup Group	Customizable Features	Description	Selectable Settings	
Settings	Adjust Clock	Adjusts the clock. ☒ Clock P. 94	—	
	Bluetooth	Add New Device	Pairs a new phone to HFL, edits and deletes a paired phone, and create a code for a paired phone. ☒ Phone Setup P. 266	—
		Connect an Audio Device	Connects, disconnects or pairs a <i>Bluetooth</i> ® Audio device to HFL.	—
	Display Adjustment	Brightness	Changes the brightness of the audio/information screen.	—
		Contrast	Changes the contrast of the audio/information screen.	—
		Black Level	Changes the black level of the audio/information screen.	—
	Rear Camera	Camera Guideline	Selects whether the guidelines come on the audio/information screen.	On *1/ Off

*1:Default Setting

Setup Group	Customizable Features	Description	Selectable Settings
Settings	Display Change	Changes the display type.	Audio^{*1}/Wallpaper
	Wallpaper		
	Select	Changes the wallpaper type.	Clock^{*1}/Image1/Image2/ Image3
	Import	Imports an image file for a new wallpaper.  Wallpaper Setup P. 185	—
	Delete	Deletes an image file for a wallpaper.	Image1^{*1}/Image2/Image3
	Color Theme	Changes the background color of the audio/ information screen.	Blue^{*1}/Red/Amber/Gray
	Language	Changes the display language.	English^{*1}/French/Spanish
	Clock Format	Selects the digital clock display from 12H to 24H.	12h^{*1}/24h

*1:Default Setting

Setup Group	Customizable Features	Description	Selectable Settings
Phone Setup	Add New Device	Pairs a new phone to HFL. ➤ Phone Setup P. 266	—
	Connect a Phone	Pairs a new phone or connects a paired phone to HFL. ➤ Phone Setup P. 266	—
	Bluetooth Setup		
	Connect an Audio Device	Connects a <i>Bluetooth</i> ® Audio device to HFL.	—
	Disconnect All Devices	Disconnects a paired phone from HFL.	—
	Delete Device	Deletes a paired phone.	—
	Pass-Key	Inputs and changes a code for a paired phone.	—
	Speed Dial	Edits, adds or deletes a speed dial entry. ➤ Speed Dial P. 273	—
	Ringtone	Selects the ring tone.	Fixed * ¹ / Mobile Phone
	Caller ID Info	Prioritizes the caller's name or phone number as the caller ID.	Name Priority * ¹ / Number Priority
System Clear	Cancels/Resets all customized items in the Phone Setup group as default.	—	

*1:Default Setting

Models with display audio system

■ How to customize

While the vehicle is at a complete stop with the ignition switch in ON *1, select **Settings**, then select a setting item.

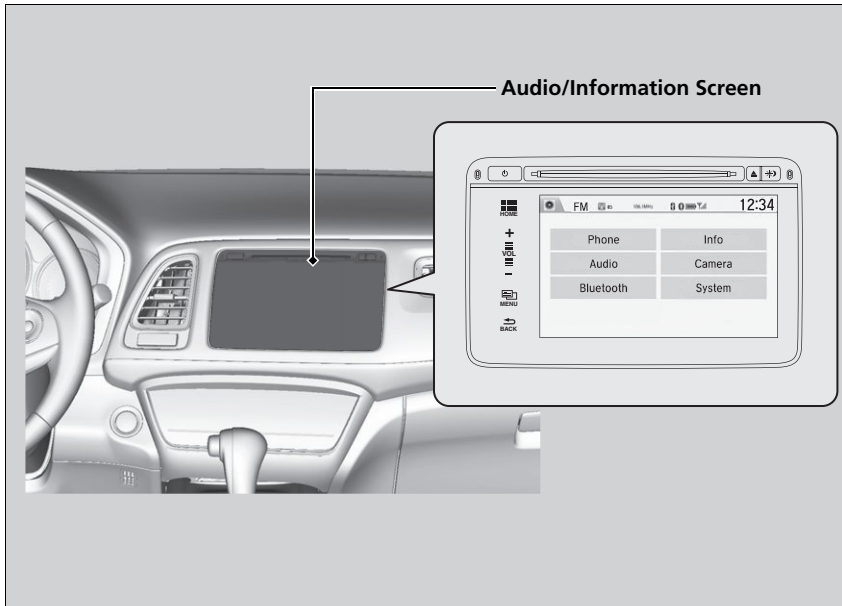

*1: Models with the smart entry system have an **ENGINE START/STOP** button instead of an ignition switch.

▶ Customized Features

When you customize settings:

- Make sure that the vehicle is at a complete stop.
- **Continuously variable transmission models**
Shift to **P**.
- **Manual transmission models**
Set the parking brake.

▶ How to customize

To customize other features, select **Settings**.

▶ **List of customizable options** P. 251

Models with display audio system

■ Customization Flow

Select HOME.

Select Settings.

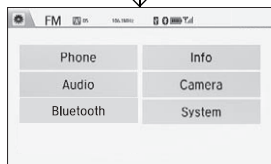

Features

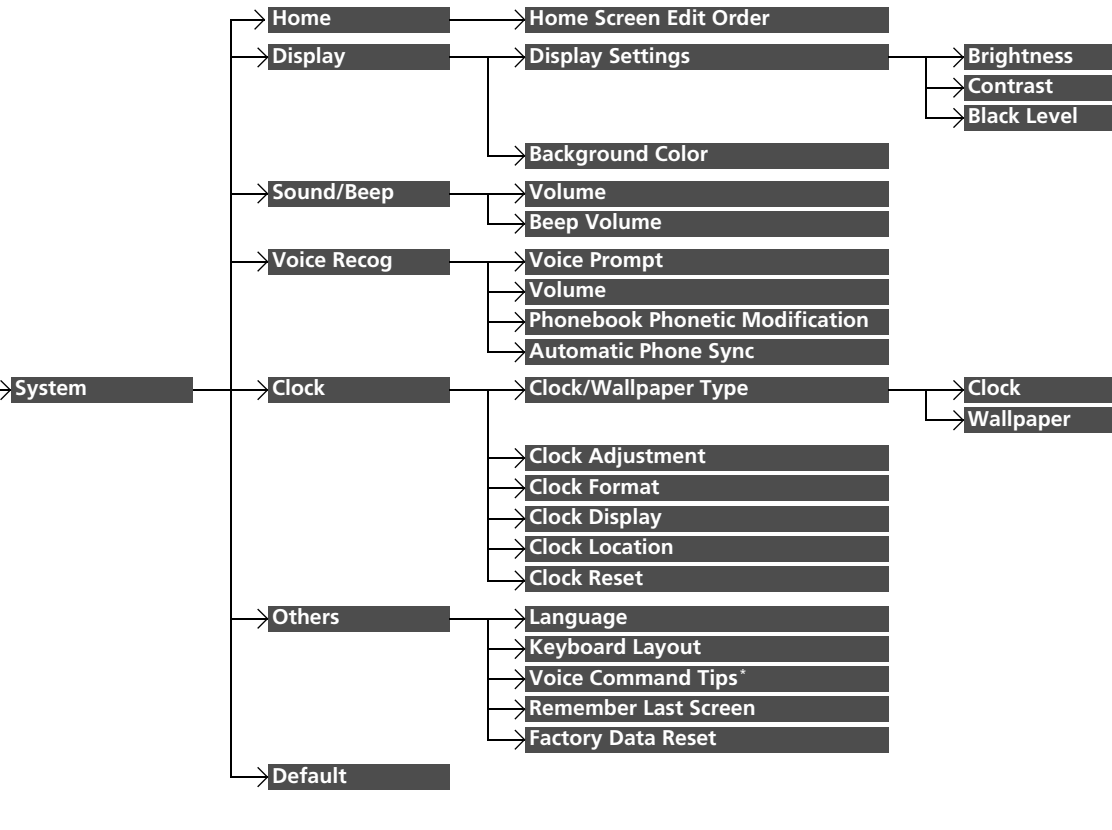

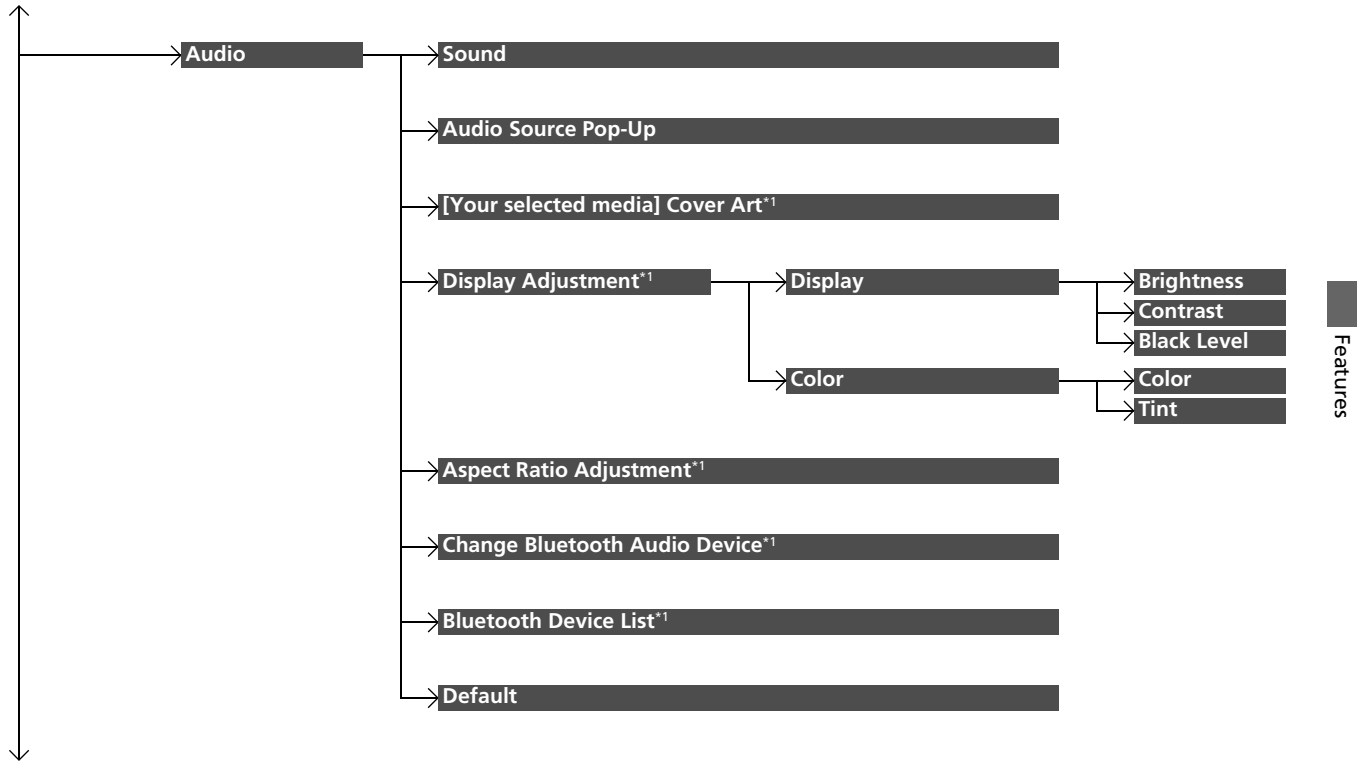

*1: May change depending on your currently selected source.

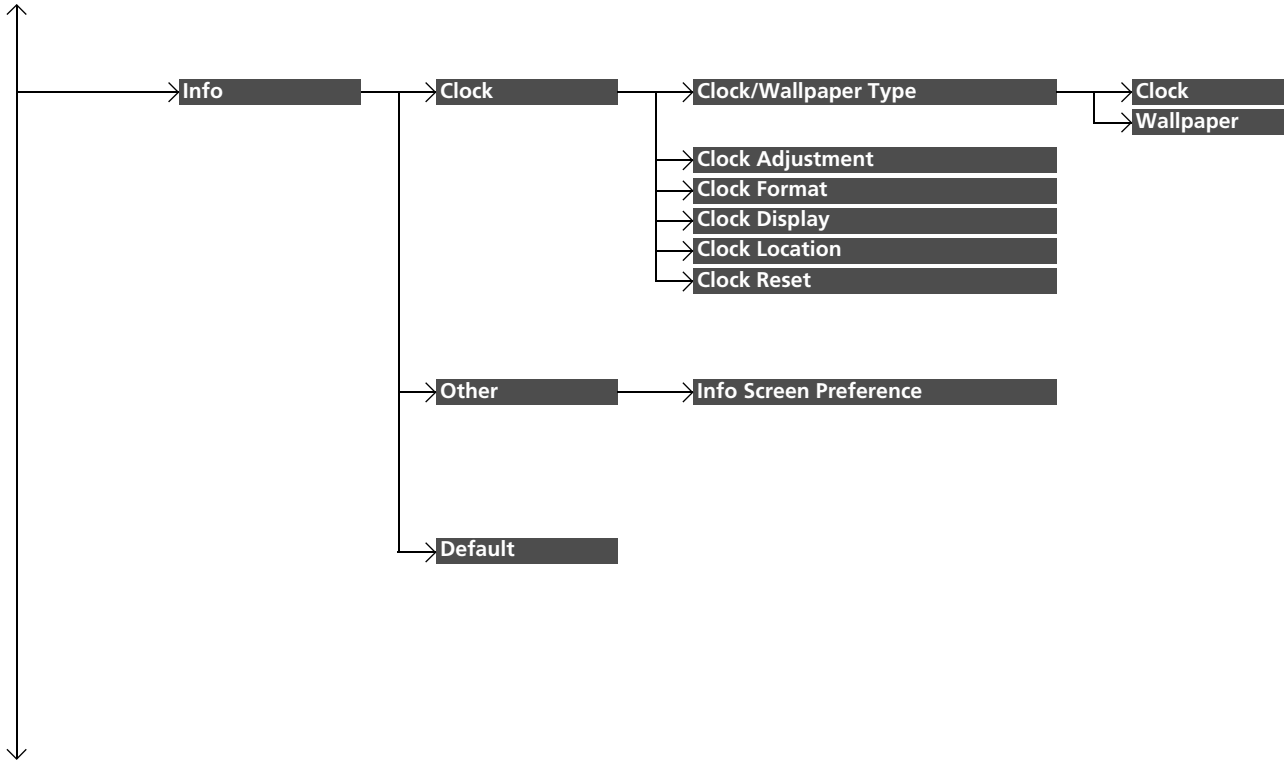

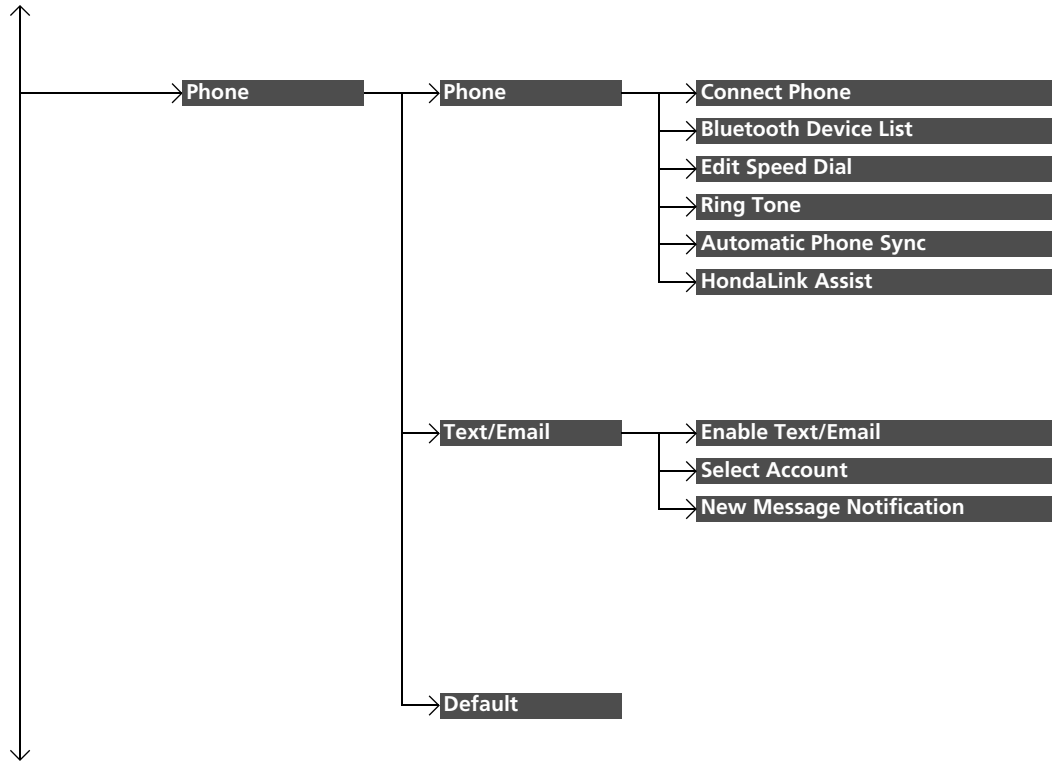

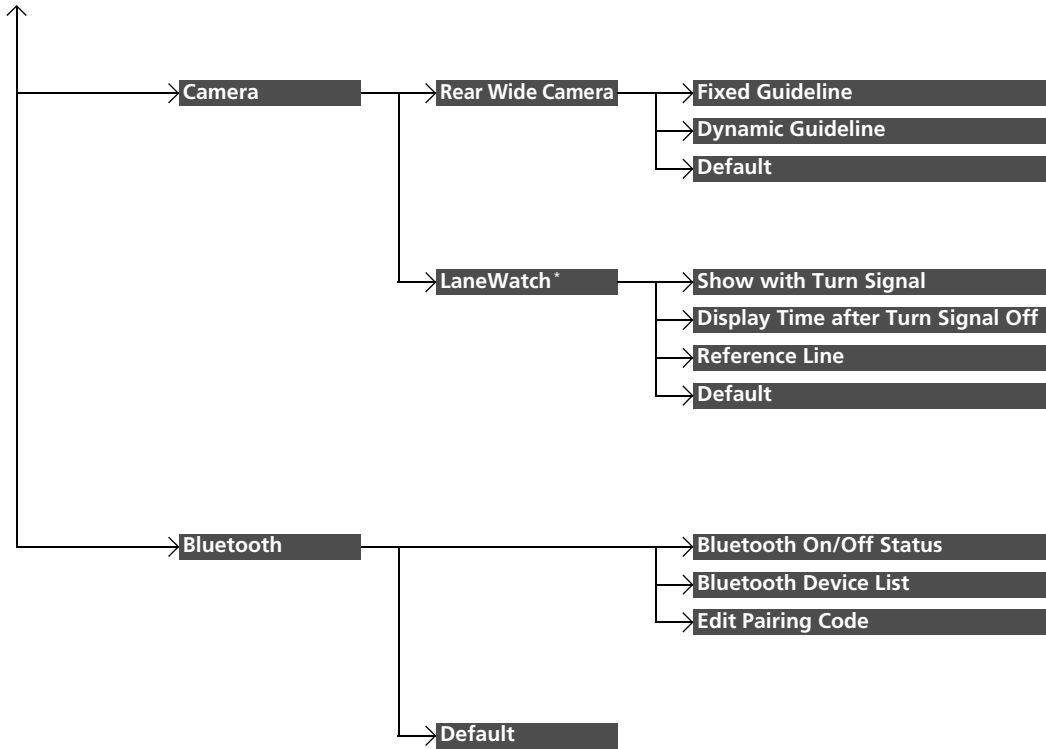



Models with display audio system



■ List of customizable options

Setup Group	Customizable Features		Description	Selectable Settings
System	Home	Home Screen Edit Order	Changes the HOME screen icon layout.	—
	Display	Brightness	Changes the brightness of the audio/information screen.	—
		Contrast	Changes the contrast of the audio/information screen.	—
		Black Level	Changes the black level of the audio/information screen.	—
		Background Color	Changes the background color of the audio/information screen.	Blue^{*1}/Amber/Red/Violet
	Sound/Beep	Volume	Changes the sound volume.	0-6^{*1}-11
		Beep Volume	Changes the beep volume.	Off/1/2^{*1}/3

*1:Default Setting

Setup Group	Customizable Features		Description	Selectable Settings	
System	Voice Recog	Voice Prompt	Turns the voice prompt on and off.	On^{*1}/Off	
		Volume	Changes the volume of the voice prompt.	0-6^{*1}-11	
		Phonebook Phonetic Modification	Modifies a voice command for the phonebook.	—	
		Automatic Phone Sync	Sets a phonebook data to be automatically imported when a phone is paired to HFL.	On/Off	
	Clock	Clock/Wallpaper Type	Clock	Changes the clock display type.	Analog/Digital^{*1}/Small Digital/Off
			Wallpaper	<ul style="list-style-type: none"> Changes the wallpaper type. Imports an image file for a new wallpaper. Deletes an image file for a wallpaper.  Wallpaper Setup P. 207	Blank/Galaxy^{*1}/Metallic
			Clock Adjustment	Adjusts the clock.  Clock P. 94	—
			Clock Format	Selects the digital clock display from 12H to 24H.	12H^{*1}/24H
			Clock Display	Selects whether the clock display comes on.	On^{*1}/Off
			Clock Location	Changes the clock display layout.	Upper Right^{*1}/Upper Left/Lower Right/Lower Left/Off
			Clock Reset	Cancels/Resets all customized items for clock display as default.	Yes/No

*1:Default Setting

Setup Group	Customizable Features	Description	Selectable Settings	
System	Language	Changes the display language.	English^{*1}/French/Spanish	
	Keyboard Layout	Selects the on-screen keyboard type.	Alphabet/QWERTY^{*1}	
	Others	Voice Command Tips[*]	Alerts you when manual control of the system is disabled to prevent distraction while driving. Only voice commands are available.	On^{*1}/Off
		Remember Last Screen	Selects whether the device remembers the last screen.	On/Off^{*1}
	Factory Data Reset	Resets all the settings to their factory default.  Defaulting All the Settings P. 259	Yes/No	
Default	Cancels/Resets all customized items in the System group as default.	Yes/No		
Audio	Sound	Adjusts the settings of the audio speaker's sound  Adjusting the Sound P. 209	-6 ~ 0^{*1} ~ +6 (BASS and TREBLE), RR9~0^{*1}~FR9 (FADER), L9~0^{*1}~R9 (BALANCE), Off/Low/Mid^{*1}/High (SVC)	
	Audio Source Pop-Up	Selects whether the list of selectable audio sources comes on when Audio is selected on the HOME screen.	On/Off^{*1}	



*1:Default Setting

Setup Group	Customizable Features	Description	Selectable Settings	
Audio	iPod or USB mode [Your selected media] Cover Art	Turns on and off the cover art display.	On*¹/Off	
	Display	Brightness	☑ System P. 251	—
		Contrast		
		Black Level		
	Display Adjustment	Color	Color	—
			Tint	—
			Changes the aspect ratio and zoom settings of the audio/information screen.	
	HDMI® mode Aspect Ratio Adjustment	Changes the aspect ratio and zoom settings of the audio/information screen.		
	Change Bluetooth Audio Device	Connects, disconnects or pairs a <i>Bluetooth</i> ® Audio device to HFL.	—	
	Bluetooth Device List	Pairs a new phone to HFL, edits or deletes a paired phone. ☑ Phone Setup P. 291	—	
Default	Cancels/Resets all customized items in the Audio group as default.	Yes/No		

*1:Default Setting

Setup Group	Customizable Features	Description	Selectable Settings												
Info	<table border="1"> <tr> <td>Clock/ Wallpaper type</td> <td>Clock Wallpaper</td> </tr> <tr> <td>Clock Adjustment</td> <td></td> </tr> <tr> <td>Clock Format</td> <td></td> </tr> <tr> <td>Clock Display</td> <td></td> </tr> <tr> <td>Clock Location</td> <td></td> </tr> <tr> <td>Clock Reset</td> <td></td> </tr> </table>	Clock/ Wallpaper type	Clock Wallpaper	Clock Adjustment		Clock Format		Clock Display		Clock Location		Clock Reset		 System P. 251	
	Clock/ Wallpaper type	Clock Wallpaper													
	Clock Adjustment														
Clock Format															
Clock Display															
Clock Location															
Clock Reset															
Other	Info Screen Preference	Changes the Info Screen type.	Info Top/Info Menu/Off^{*1}												
Default		Cancels/Resets all customized items in the Info group as default.	Yes/No												

*1:Default Setting

Setup Group	Customizable Features	Description	Selectable Settings	
Phone	Connect Phone	Pairs a new phone to HFL, connects or disconnects a paired phone.  Phone Setup P. 291	—	
	Bluetooth Device List	Pairs a new phone to HFL, edits or deletes a paired phone.  Phone Setup P. 291	—	
	Edit Speed Dial	Edits, adds or deletes a speed dial entry.  Speed Dial P. 298	—	
	Ring Tone	Selects the ring tone.	Fixed/Mobile Phone ^{*1}	
	Automatic Phone Sync	Sets a phonebook data to be automatically imported when a phone is paired to HFL.	On/Off	
	HondaLink Assist	Turns HondaLink Assist on and off.	On/Off ^{*1}	
	Text/Email	Enable Text/Email	Turns the text/e-mail message function on and off.	On ^{*1} / Off
		Select Account	Selects a mail or text message account.	—
		New Message Notification	Selects whether a pop-up alert comes on the screen when HFL receives a new text/e-mail message.	On/Off ^{*1}
	Default	Cancels/Resets all customized items in the Phone and Text/Email group as default.	Yes/No	

*1:Default Setting

Setup Group	Customizable Features	Description	Selectable Settings	
Camera	Rear Wide Camera	Fixed Guideline	Selects whether the fixed guidelines come on on the rear camera monitor.	On ^{*1} /Off
		Dynamic Guideline	Selects whether the dynamic guidelines come on on the rear camera monitor.	On ^{*1} /Off
		Default	Cancels/Resets all customized items in the Rear Wide Camera group as default.	Yes/No
	LaneWatch [*]	Show with Turn Signal	Selects whether the LaneWatch display comes on when you move the turn signal lever to the passenger side.	On ^{*1} /Off
		Display Time after Turn Signal Off	Changes the length of time the LaneWatch display stays on after you pull the turn signal lever back.	0 second ^{*1} /2 seconds
		Reference Line	Selects whether the reference lines come on the LaneWatch monitor.	On ^{*1} /Off
		Default	Cancels/Resets all customized items in the LaneWatch group as default.	Yes/No

*1:Default Setting

Setup Group	Customizable Features	Description	Selectable Settings
Bluetooth	Bluetooth On/Off Status	Changes the <i>Bluetooth</i> ® status.	On*¹/Off
	Bluetooth Device List	Pairs a new phone to HFL, edits or deletes a paired phone, or creates a security PIN. ➤ Phone Setup P. 291	—
	Edit Pairing Code	Edits Pairing Code . ➤ To change the pairing code setting P. 292	Random/Fixed*¹
	Default	Cancels/Resets all customized items in the Bluetooth group as default.	Yes/No

*1: Default Setting

Defaulting All the Settings

Models with display audio system

Reset all the menu and customized settings as the factory defaults.

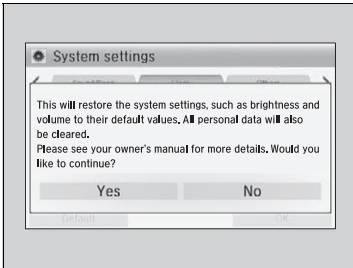

1. Select **HOME**.
2. Select **Settings**.
3. Select **System**.
 - Repeat the procedure to select the **Others** tab, then **Factory Data Reset**.
 - The confirmation message will appear.
4. Select **Yes** to reset the settings.
5. Select **Yes** again to reset the settings.
 - The confirmation message will appear. Select **OK**.

Defaulting All the Settings

When you transfer the vehicle to a third party, reset all settings to default and delete all personal data.

The following settings will be reset:

- Audio preset settings
- Phonebook entries
- Other display and personal settings.

Models with navigation system

See the navigation system manual for how to operate the *Bluetooth*® HandsFreeLink®.

Models without navigation system

Bluetooth® HandsFreeLink® (HFL) allows you to place and receive phone calls using your vehicle's audio system, without handling your cell phone.

Models with color audio system

Using HFL

HFL Buttons

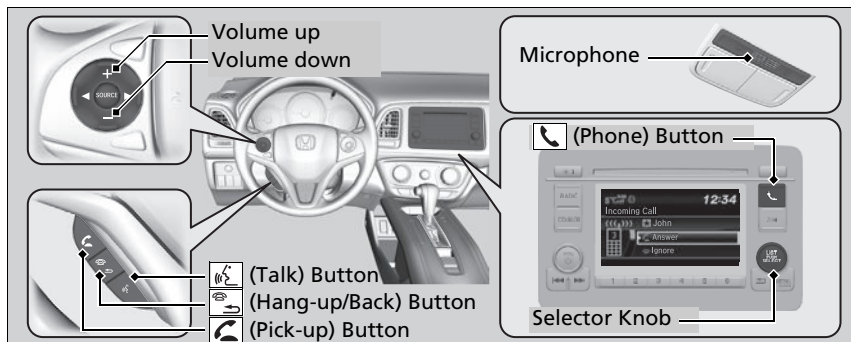

(Pick-up) button: Press to go directly to the **Phone** screen or to answer an incoming call.

(Hang-up/Back) button: Press to end a call or to cancel a command.

(Talk) button: Press to call a number with a stored voice tag.

(Phone) button: Press to go directly to the **Phone** screen.

Selector knob: Rotate to select an item on the screen, then press .

* Not available on all models

Bluetooth® HandsFreeLink®

To use HFL, you need a *Bluetooth*-compatible cell phone. For a list of compatible phones, pairing procedures, and special feature capabilities:

- U.S.: Visit www.handsfreelink.honda.com, or call 1-888-528-7876.
- Canada: Visit www.handsfreelink.ca, or call 1-888-528-7876.

Voice control tips

- Aim the vents away from the ceiling and close the windows, as noise coming from them may interfere with the microphone.
- Press and release the button when you want to call a number using a stored voice tag. Speak clearly and naturally after a beep.
- If the microphone picks up voices other than yours, the command may be misinterpreted.
- To change the volume level, use the audio system's volume knob or the remote audio controls* on the steering wheel.

State or local laws may prohibit the operation of handheld electronic devices while operating a vehicle.

If you receive a call while using the audio system, the system resumes its operation after ending the call.

Up to 20 speed dial entries can be stored. If there is no entry in the system, Speed Dial is disabled.

Speed Dial P. 273

Up to 20 call histories can be stored. If there is no call history, Call History is disabled.

HFL Status Display

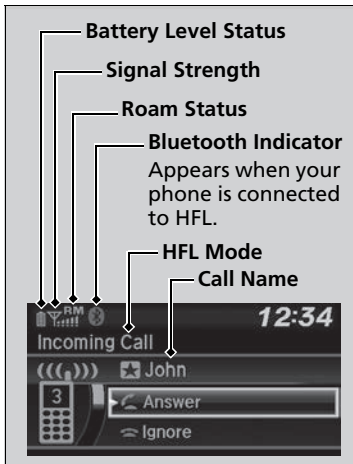

The audio/information screen notifies you when there is an incoming call.

Limitations for Manual Operation

Certain manual functions are disabled or inoperable while the vehicle is in motion. You cannot select a grayed-out option until the vehicle is stopped.

Only previously stored speed dial entries can be called using voice commands while the vehicle is in motion.

▶ **Speed Dial** P. 273

Bluetooth® HandsFreeLink®

Bluetooth® Wireless Technology

The *Bluetooth*® word mark and logos are registered trademarks owned by *Bluetooth* SIG, Inc., and any use of such marks by Honda Motor Co., Ltd., is under license. Other trademarks and trade names are those of their respective owners.

HFL Limitations

An incoming call on HFL will interrupt the audio system when it is playing. It will resume when the call is ended.

HFL Status Display

The information that appears on the audio/information screen varies between phone models.

You can change the system language to English, French, or Spanish.

▶ **Customized Features** P. 238

HFL Menu

The ignition switch must be in ACCESSORY **I** or ON **II** to use HFL.

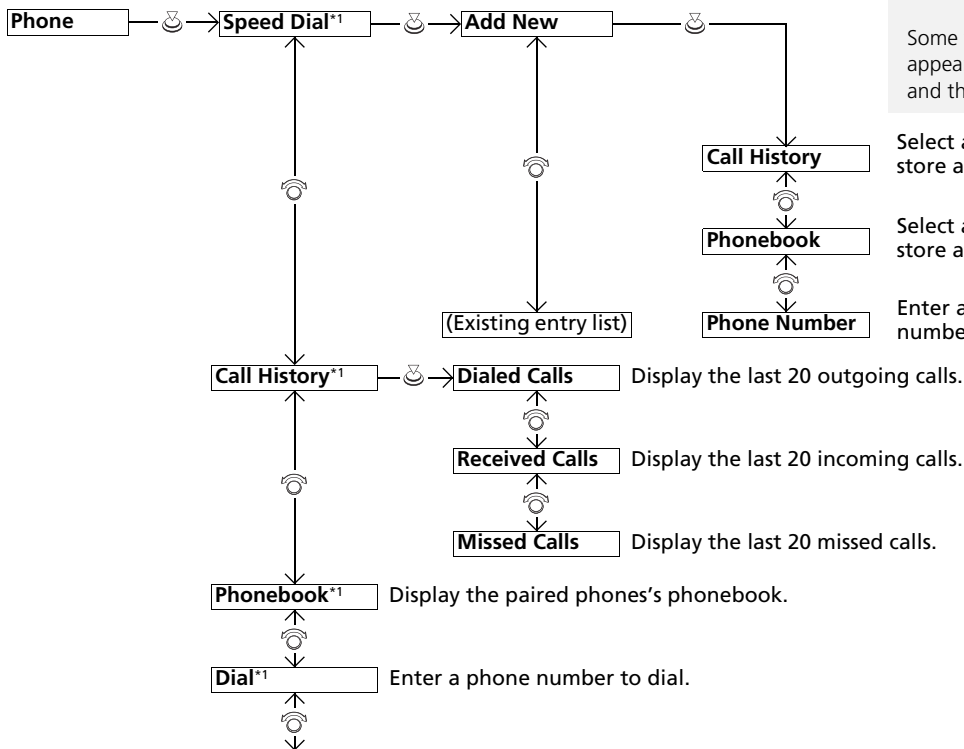
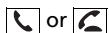

HFL Menu

To use HFL, you must first pair your Bluetooth-compatible cell phone to the system while the vehicle is parked.

Some functions are limited while driving. A message appears on the screen when the vehicle is moving and the operation is canceled.

- Select a phone number from the call history to store as a speed dial number.
- Select a phone number from the phonebook to store as a speed dial number.
- Enter a phone number to store as a speed dial number.

Dialed Calls Display the last 20 outgoing calls.

Received Calls Display the last 20 incoming calls.

Missed Calls Display the last 20 missed calls.

Phonebook*1 Display the paired phones's phonebook.

Dial*1 Enter a phone number to dial.

*1: Appears only when a phone is connected to HFL.

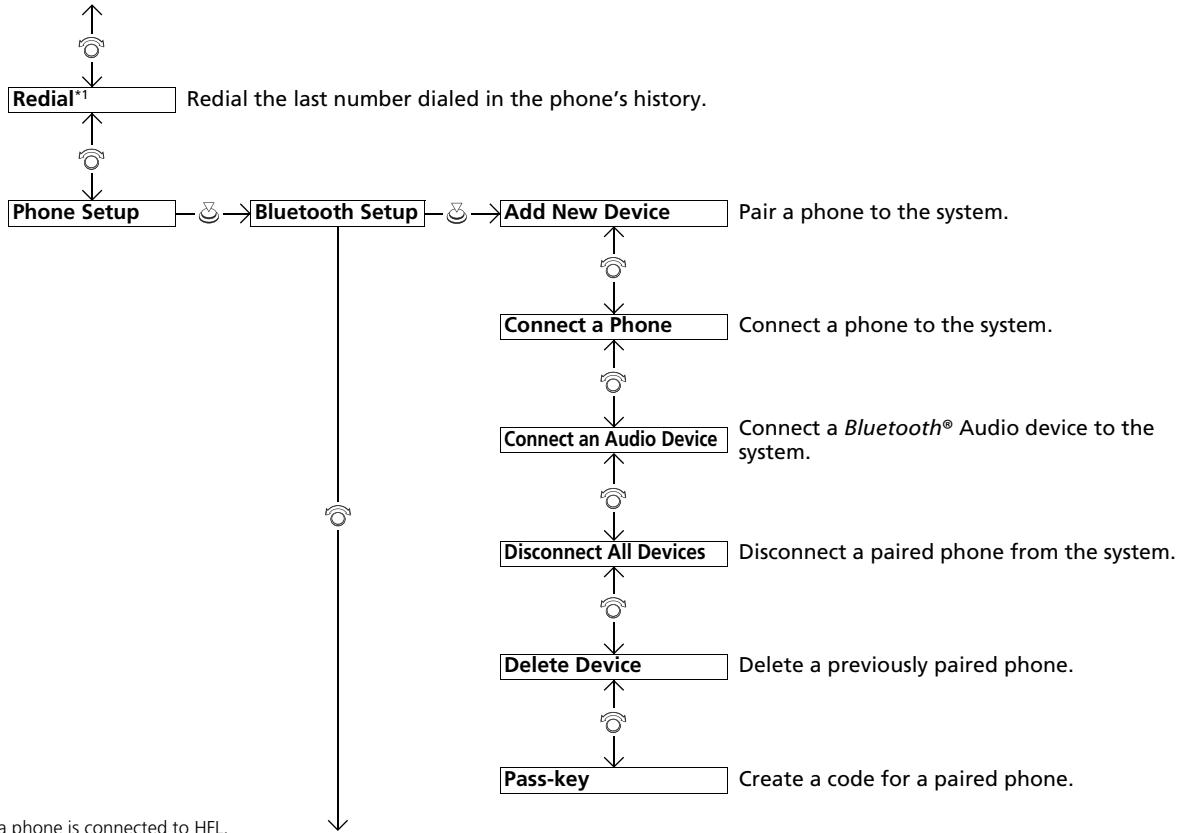

*1: Appears only when a phone is connected to HFL.

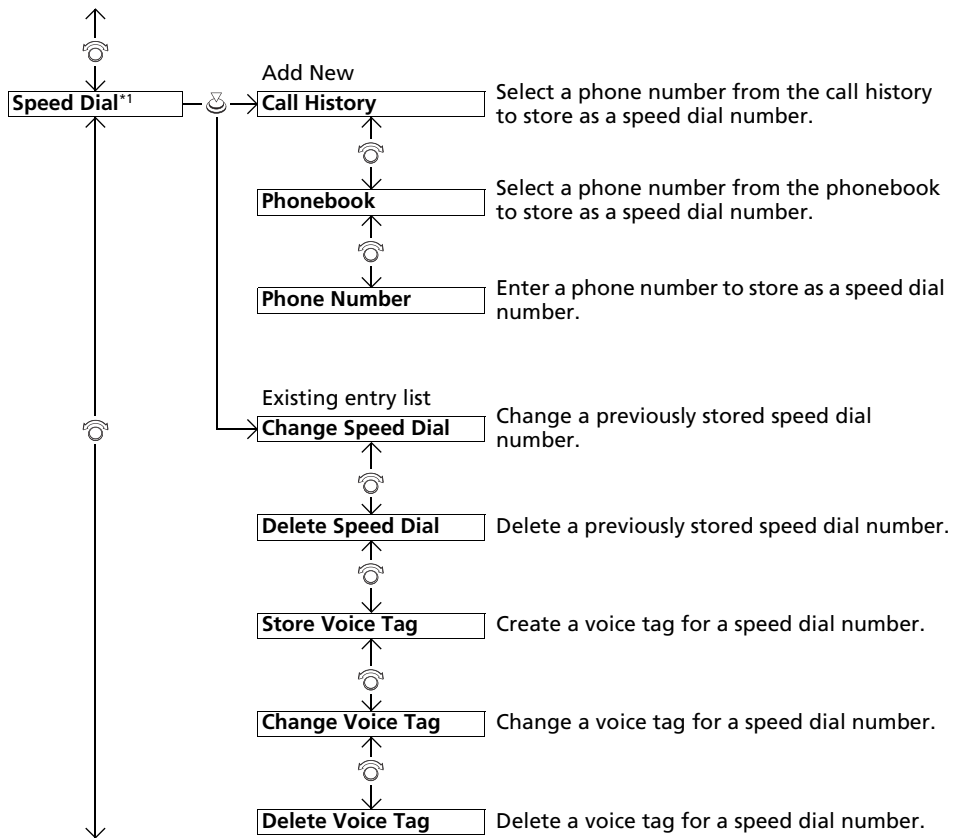

*1: Appears only when a phone is connected to HFL.

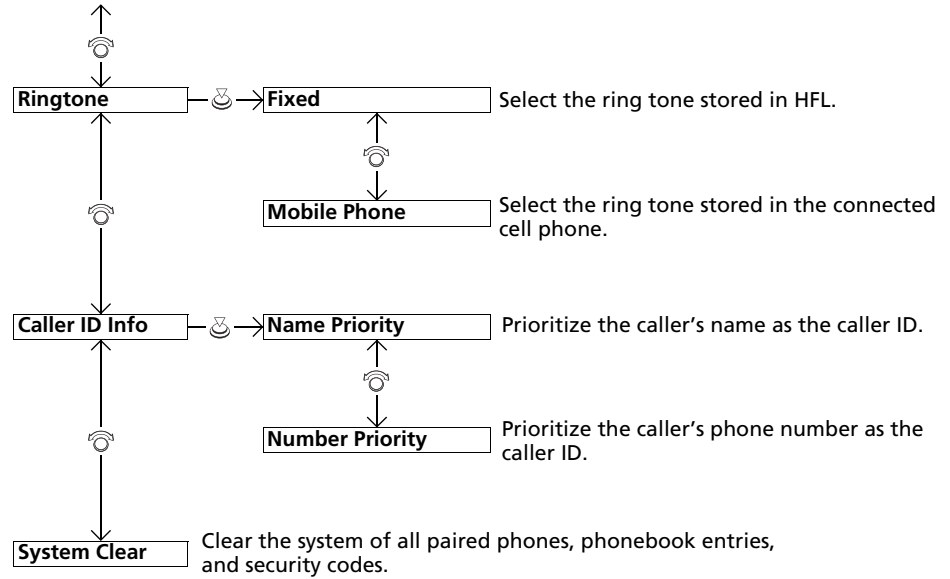

Phone Setup

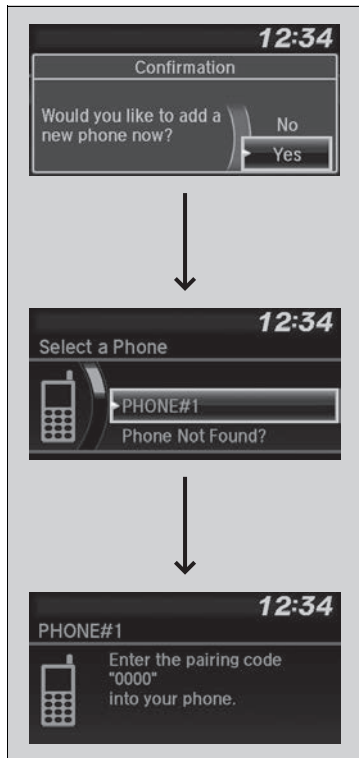

■ To pair a cell phone (No phone has been paired to the system)

1. Press the button or the button.
2. Rotate to select **Yes**, then press .
3. Make sure your phone is in search or discoverable mode, then press .
 - ▶ HFL automatically searches for a *Bluetooth*® device.
4. When your phone appears on the list, select it by pressing .
 - ▶ If your phone doesn't appear, select **Phone Not Found?** and search for *Bluetooth*® devices using your phone. From your phone, select **HandsFreeLink**.
5. The system gives you a pairing code on the audio/information screen.
 - ▶ Confirm if the pairing code on the screen and your phone match. This may vary by phone.
6. A notification appears on the screen if pairing is successful.

☞ Phone Setup

Your *Bluetooth*-compatible phone must be paired to HFL before you can make and receive hands-free calls.

Phone Pairing Tips:

- You cannot pair your phone while the vehicle is moving.
- Up to six phones can be paired.
- Your phone's battery may drain faster when it is connected to HFL.
- If your phone is not ready for pairing or not found by the system within three minutes, the system will time out and returns to idle.

Once you have paired a phone, you can see it displayed on the screen with one or two icons on the right side.

These icons indicate the following:

- : The phone can be used with HFL.
- : The phone is compatible with *Bluetooth*® Audio.

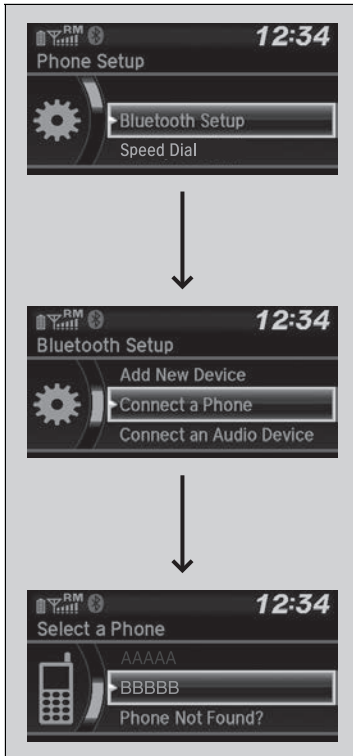

■ **To Change the currently paired phone**

1. Press the button or the button.
2. Rotate to select **Phone Setup**, then press .
3. Rotate to select **Bluetooth Setup**, then press .
4. Rotate to select **Connect a Phone**, then press .
 - ▶ The screen changes to a device list.
5. Rotate to select a desired device name, then press .
 - ▶ HFL disconnects the connected phone and starts searching for another paired phone.

☒ Phone Setup

You can pair a phone in the following steps.

Phone Setup → **Bluetooth Setup** → **Add New Device** → confirmation message → **Yes** → confirmation message → **OK** → **Select a Phone** → **Pairing code**.

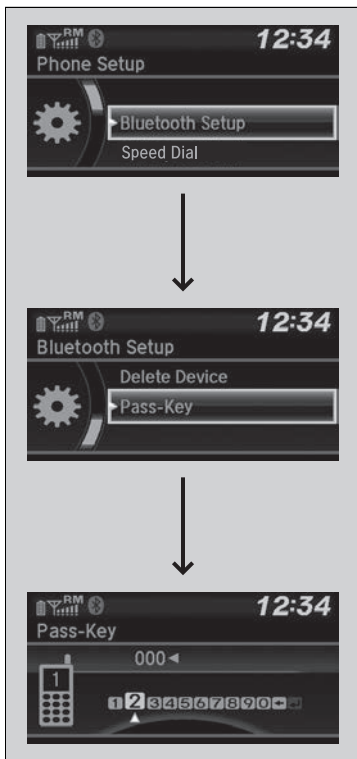

■ **To change the pairing code setting**

1. Press the button or the button.
2. Rotate to select **Phone Setup**, then press .
3. Rotate to select **Bluetooth Setup**, then press .
4. Rotate to select **Pass-Key**, then press .
5. Input a new pairing code, then press .

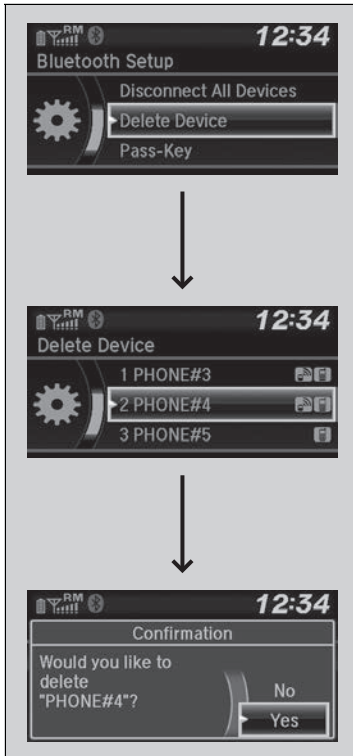

■ **To delete a paired phone**

1. Press the button or the button.
2. Rotate to select **Phone Setup**, then press .
3. Rotate to select **Bluetooth Setup**, then press .
4. Rotate to select **Delete Device**, then press .
 - ▶ The screen changes to a device list.
5. Rotate to select a phone you want to delete, then press .
6. A confirmation message appears on the screen. Rotate to select **Yes**, then press .

■ Ring Tone

You can change the ring tone setting.



1. Press the button or the button.
2. Rotate to select **Phone Setup**, then press .
3. Rotate to select **Ringtone**, then press .
4. Rotate to select **Fixed** or **Mobile Phone**, then press .

■ Caller's ID Information

You can select a caller's information to be displayed when you have an incoming call.

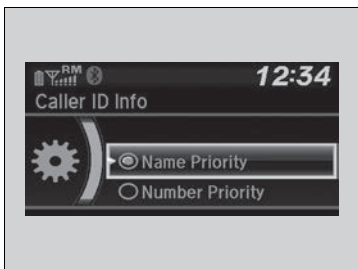

1. Press the button or the button.
2. Rotate to select **Phone Setup**, then press .
3. Rotate to select **Caller ID Info**, then press .
4. Rotate to select a mode you want, then press .

▶▶ Ring Tone

Fixed: The fixed ring tone sounds from the speakers.

Mobile Phone: The ring tone stored in the connected cell phone sounds from the speakers.

▶▶ Caller's ID Information

Name Priority: A caller's name is displayed if it is stored in the phonebook.

Number Priority: A caller's phone number is displayed.

To Clear the System

Pairing codes, paired phones, all stored voice tags, all speed dial entries, all call history data, and all imported phonebook data are erased.

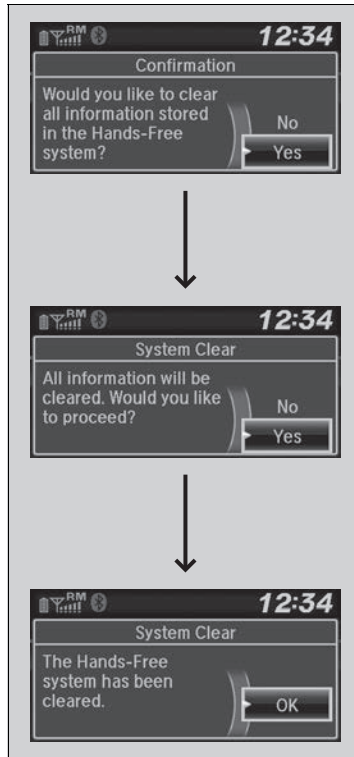

1. Press the button or the button.
2. Rotate to select **Phone Setup**, then press .
3. Rotate to select **System Clear**, then press .
4. Rotate to select **Yes**, then press .
5. A confirmation message appears on the screen. Rotate to select **Yes**, then press .
6. A notification appears on the screen. Press .

Continued

■ Automatic Import of Cellular Phonebook and Call History

When your phone is paired, the contents of its phonebook and call history are automatically imported to HFL.



Features

▶ Automatic Import of Cellular Phonebook and Call History

When you select a person from the list in the cellular phonebook, you can see up to three category icons. The icons indicate what types of numbers are stored for that name.

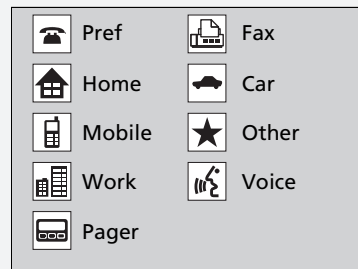

If a name has four or more numbers, ... appears instead of category icons.

On some phones, it may not be possible to import the category icons to HFL.

The phonebook is updated after every connection. Call history is updated after every connection or call.

Speed Dial

Up to 20 speed dial numbers can be stored per phone.



To store a speed dial number:

1. Press the button or the button.
2. Rotate to select **Speed Dial**, then press .
3. Rotate to select **Add New**, then press .
4. Rotate to select a place to choose a number from, then press .
 - From **Call History**:
 - ▶ Select a number from the call history.
 - From **Phonebook**:
 - ▶ Select a number from the connected cell phone's imported phonebook.
 - From **Phone Number**:
 - ▶ Input the number manually.
5. When the speed dial is successfully stored, you are asked to create a voice tag for the number. Rotate to select **Yes** or **No**, then press .
6. Using the button, follow the prompts to say the name for the speed dial entry.

Speed Dial

You can use the audio preset buttons during a call to store a speed dial number:







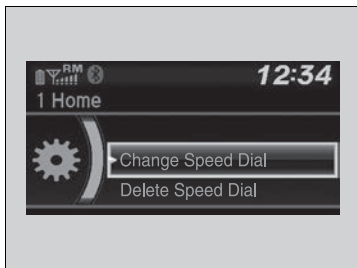

1. Press and hold the desired audio preset button during a call.
2. The contact information for the active call will be stored for the corresponding speed dial.

When a voice tag is stored, you can press the button and call the number using voice commands.

Continued



■ To edit a speed dial

1. Press the  button or the  button.
2. Rotate  to select **Phone Setup**, then press .
3. Rotate  to select **Speed Dial**, then press .
4. Select an existing speed dial entry.
5. Rotate  to select **Change Speed Dial**, then press .
6. Select a new speed dial number, then press .

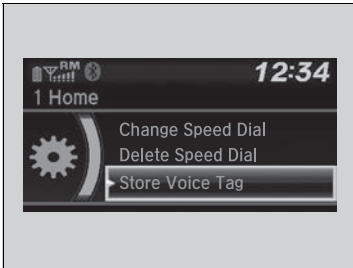

■ **To add a voice tag to a stored speed dial number**

1. Press the button or the button.
2. Rotate to select **Phone Setup**, then press .
3. Rotate to select **Speed Dial**, then press .
4. Select an existing speed dial entry.
5. Rotate to select **Store Voice Tag**, then press .
6. Using the button, follow the prompts to complete the voice tag.

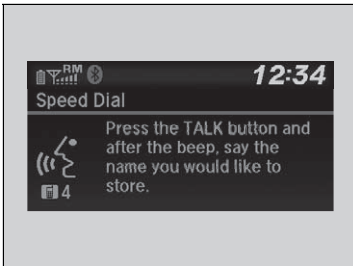

■ **To change a voice tag**

1. Press the button or the button.
2. Rotate to select **Phone Setup**, then press .
3. Rotate to select **Speed Dial**, then press .
4. Select an existing speed dial entry.
5. Rotate to select **Change Voice Tag**, then press .
6. Using the button, follow the prompts to complete the voice tag.

Speed Dial

Avoid using duplicate voice tags.
 Avoid using "home" as a voice tag.
 It is easier for HFL to recognize a longer name. For example, use "John Smith" instead of "John."

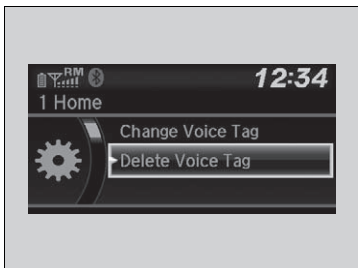

■ **To delete a voice tag**

1. Press the button or the button.
2. Rotate to select **Phone Setup**, then press .
3. Rotate to select **Speed Dial**, then press .
4. Select an existing speed dial entry.
5. Rotate to select **Delete Voice Tag**, then press .
 - ▶ A confirmation message appears on the screen. Rotate to select **Yes**, then press .

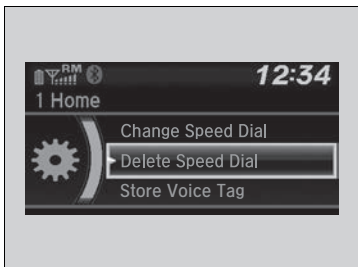

■ **To delete a speed dial number**

1. Press the button or the button.
2. Rotate to select **Phone Setup**, then press .
3. Rotate to select **Speed Dial**, then press .
4. Select an existing speed dial entry.
5. Rotate to select **Delete Speed Dial**, then press .
 - ▶ A confirmation message appears on the screen. Rotate to select **Yes**, then press .

Making a Call

You can make calls by inputting any phone number, or by using the imported phonebook, call history, speed dial entries, or redial.

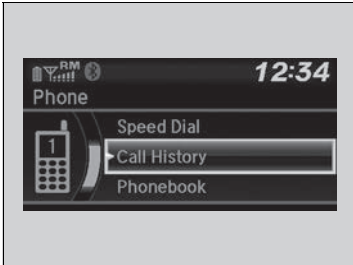

▶▶ Making a Call

Any voice-tagged speed dial entry can be dialed by voice from any screen. Press the  button and follow the prompts.

The maximum range between your phone and vehicles is 30 feet (10 meters).

Once a call is connected, you can hear the voice of the person you are calling through the audio speakers.

Continued

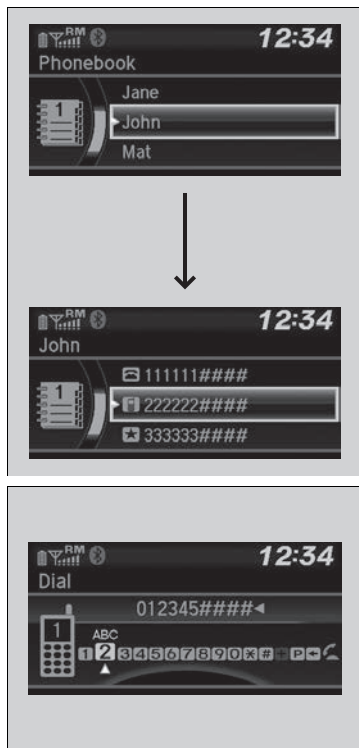

■ To make a call using the imported phonebook

When your phone is paired, the contents of its phonebook are automatically imported to HFL.

1. Press the button or the button.
 2. Rotate to select **Phonebook**, then press .
 3. The phonebook is stored alphabetically. Rotate to select the initial, then press .
 4. Rotate to select a name, then press .
 5. Rotate to select a number, then press .
- ▶ Dialing starts automatically.

■ To make a call using a phone number

1. Press the button or the button.
 2. Rotate to select **Dial**, then press .
 3. Rotate to select a number, then press .
 4. Rotate to select , then press .
- ▶ Dialing starts automatically.

▶▶ To make a call using the imported phonebook

This function is disabled while the vehicle is moving. However, you can call a stored voice-tagged speed dial number using voice commands.

- ▶ **Limitations for Manual Operation** P. 261
- ▶ **Speed Dial** P. 273

▶▶ To make a call using a phone number

This function is disabled while the vehicle is moving. However, you can call a stored voice-tagged speed dial number using voice commands.

- ▶ **Limitations for Manual Operation** P. 261
- ▶ **Speed Dial** P. 273



■ **To make a call using redial**

1. Press the button or the button.
 2. Rotate to select **Redial**, then press .
- ▶ Dialing starts automatically.

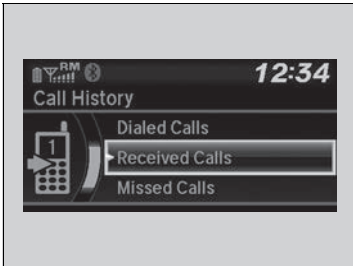

■ **To make a call using the call history**

Call history is stored by **Dialed Calls**, **Received Calls**, and **Missed Calls**.

1. Press the button or the button.
 2. Rotate to select **Call History**, then press .
 3. Rotate to select **Dialed Calls**, **Received Calls**, or **Missed Calls**, then press .
 4. Rotate to select a number, then press .
- ▶ Dialing starts automatically.

☒ To make a call using redial

Press and hold the button to redial the last number dialed in your phone's call history.

☒ To make a call using the call history

The call history appears only when a phone is connected to HFL, and displays the last 20 dialed, received, or missed calls.

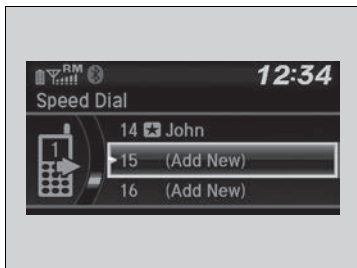

■ **To make a call using a speed dial entry**

1. Press the button or the button.
 2. Rotate to select **Speed Dial**, then press .
 3. Rotate to select a number, then press .
- ▶ Dialing starts automatically.

▶▶ To make a call using a speed dial entry

On the **Phone** screen, the first six speed dials on the list can be directly selected by pressing the corresponding audio preset buttons (1-6).

Select **Others** to view another paired phone's speed dial list.

When a voice tag is stored, press the button and call the number using voice commands.

▶ **Speed Dial** P. 273

Any voice-tagged speed dial entry can be dialed by voice from any screen. Press the button and follow the prompts.

Receiving a Call

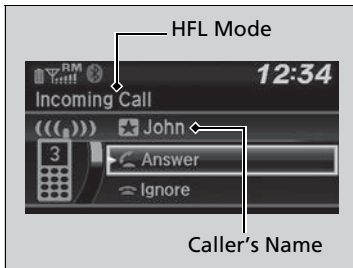

When there is an incoming call, an audible notification sounds and the **Incoming Call** screen appears.

Press the  button to answer the call.

Press the  button to decline or end the call.

Receiving a Call





Call Waiting

Press the  button to put the current call on hold to answer the incoming call.

Press the  button again to return to the current call.

Select **Ignore** to ignore the incoming call if you do not want to answer it.

Press the  button if you want to hang up the current call.

You can select the icons on the audio/information screen instead of the  and  buttons. Rotate  to select the icon, then press .

■ Options During a Call

The following options are available during a call.



Swap Call: Put the current call on hold to answer the incoming call.

Mute: Mute your voice.

Transfer Call: Transfer a call from HFL to your phone.

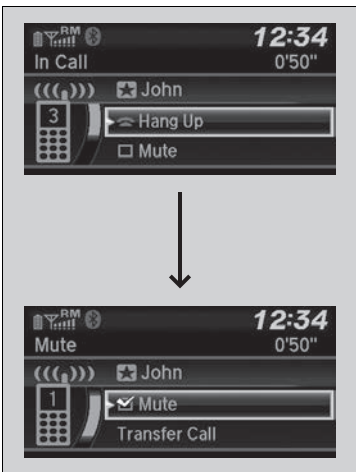
Dial Tones: Send numbers during a call. This is useful when you call a menu-driven phone system.



1. To view the available options, press the  button.
2. Rotate  to select the option, then press .
 - ▶ The check box is checked when **Mute** is selected. Select **Mute** again to turn it off.

▶▶ Options During a Call

Dial Tones: Available on some phones.

Models with navigation system

See the navigation system manual for how to operate the *Bluetooth®* HandsFreeLink®.

Models without navigation system

Bluetooth® HandsFreeLink® (HFL) allows you to place and receive phone calls using your vehicle's audio system, without handling your cell phone.

Models with display audio system

Using HFL

HFL Buttons

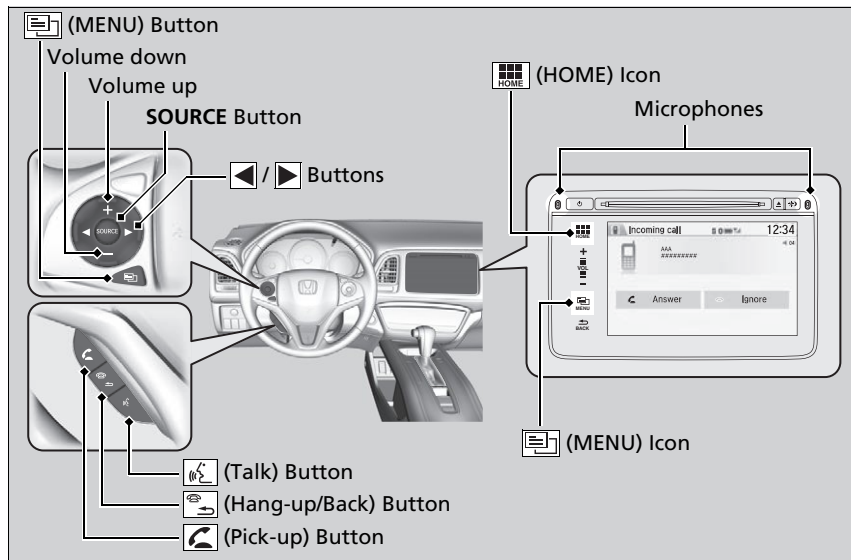

Bluetooth® HandsFreeLink®

To use HFL, you need a *Bluetooth*-compatible cell phone. For a list of compatible phones, pairing procedures, and special feature capabilities:

- U.S.: Visit www.handsfreelink.honda.com, or call 1-888-528-7876.
- Canada: Visit www.handsfreelink.ca, or call 1-888-528-7876.

To use HFL, the **Bluetooth On/Off Status** setting must be **On**.

➤ **Customized Features** P. 238

Voice control tips

- Press and release the  button when you want to call a number using a stored voice tag, a phonebook, name or a number. Speak clearly and naturally after a beep.
- If the microphone picks up voices other than yours, the command may be misinterpreted.
- To change the volume level, use the audio system's **VOL** (Volume) or use the remote audio controls on the steering wheel.

State or local laws may prohibit the operation of handheld electronic devices while operating a vehicle.

Continued

 **(Pick-up) button:** Press to go directly to the **Phone** screen, or to answer an incoming call.

 **(Hang-up/Back) button:** Press to end a call, go back to the previous command, or to cancel a command.

 **(Talk) button:** Press to call a number with a stored voice tag, a phonebook, name, or a number.

 **button:** Press to display **Speed Dial**, **Call History**, or **Redial** on the **Phone** screen.

 **button:** Press to select an item displayed on the **Phone** screen.

SOURCE button: Press to call a number listed in the selected item on the **Phone** screen.

To go to the **Phone menu** screen:

1. Select **HOME**.
2. Select **Phone** to switch the display to the **Phone** screen.
3. Select **MENU**.

Bluetooth® HandsFreeLink®

Up to six speed dial entries can be displayed among a total of 20 that can be entered. If there is no entries in the system, Speed Dial is disabled.

 **Speed Dial** P. 273

Bluetooth® Wireless Technology

The *Bluetooth®* word mark and logos are registered trademarks owned by Bluetooth SIG, Inc., and any use of such marks by Honda Motor Co., Ltd., is under license. Other trademarks and trade names are those of their respective owners.

HFL Limitations

An incoming call on HFL will interrupt the audio system when it is playing. It will resume when the call is ended.

■ HFL Status Display

The audio/information screen notifies you when there is an incoming call.

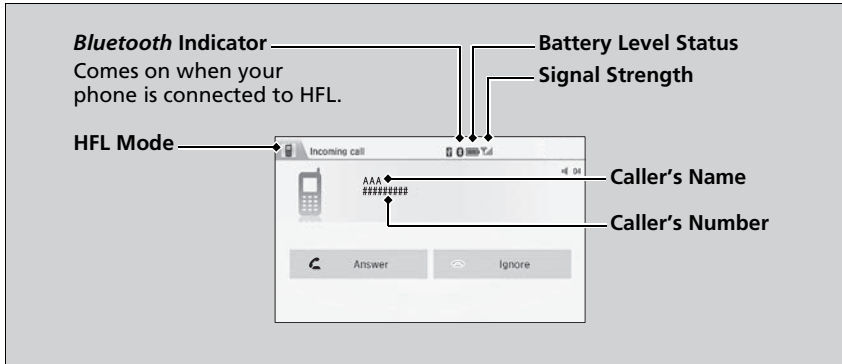

■ Limitations for Manual Operation

Certain manual functions are disabled or inoperable while the vehicle is in motion. You cannot select a grayed-out option until the vehicle is stopped.

Only previously stored speed dial entries with voice tags, phone book names, or numbers can be called using voice commands while the vehicle is in motion.

▶ **Speed Dial** P. 298

▶▶ HFL Status Display

The information that appears on the audio/information screen varies between phone models.

You can change the system language to English, French, or Spanish.

▶ **Customized Features** P. 238

HFL Menus

The ignition switch must be in ACCESSORY  or ON *1 to use HFL.

■ Phone settings screen

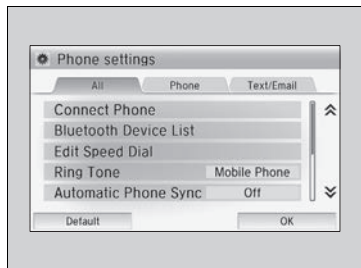

1. Select **HOME**.
2. Select **Settings**.
3. Select **Phone Settings**.

 **HFL Menu**

To use HFL, you must first pair your *Bluetooth*-compatible mobile phone to the system while the vehicle is parked.

Some functions are limited while driving. A message appears on the screen when the vehicle is moving and the operation is canceled.

Features

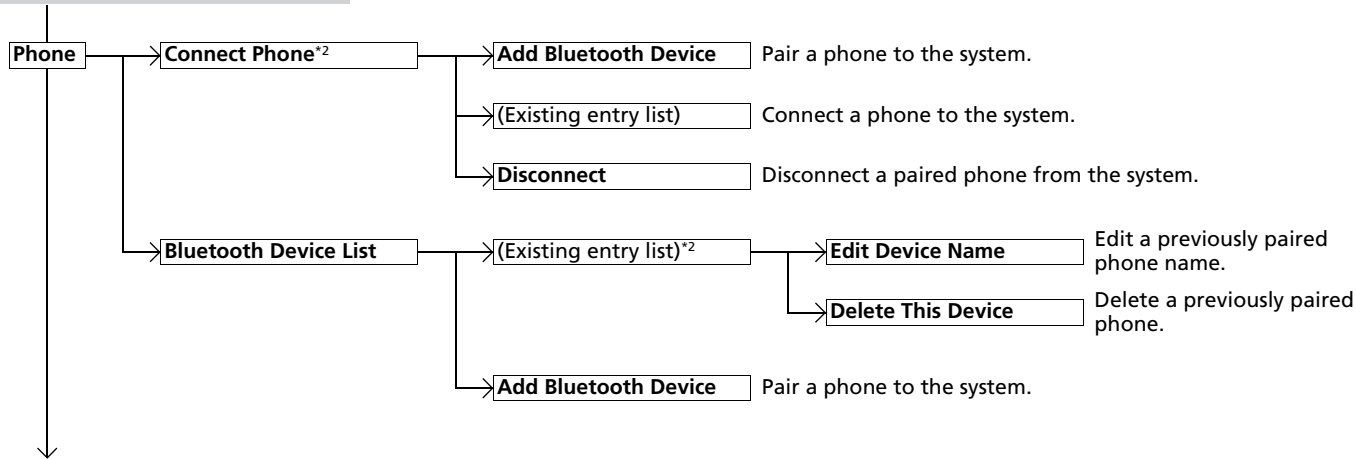

*1: Models with the smart entry system have an **ENGINE START/STOP** button instead of an ignition switch.

*2: Appears only when a phone is connected to HFL.

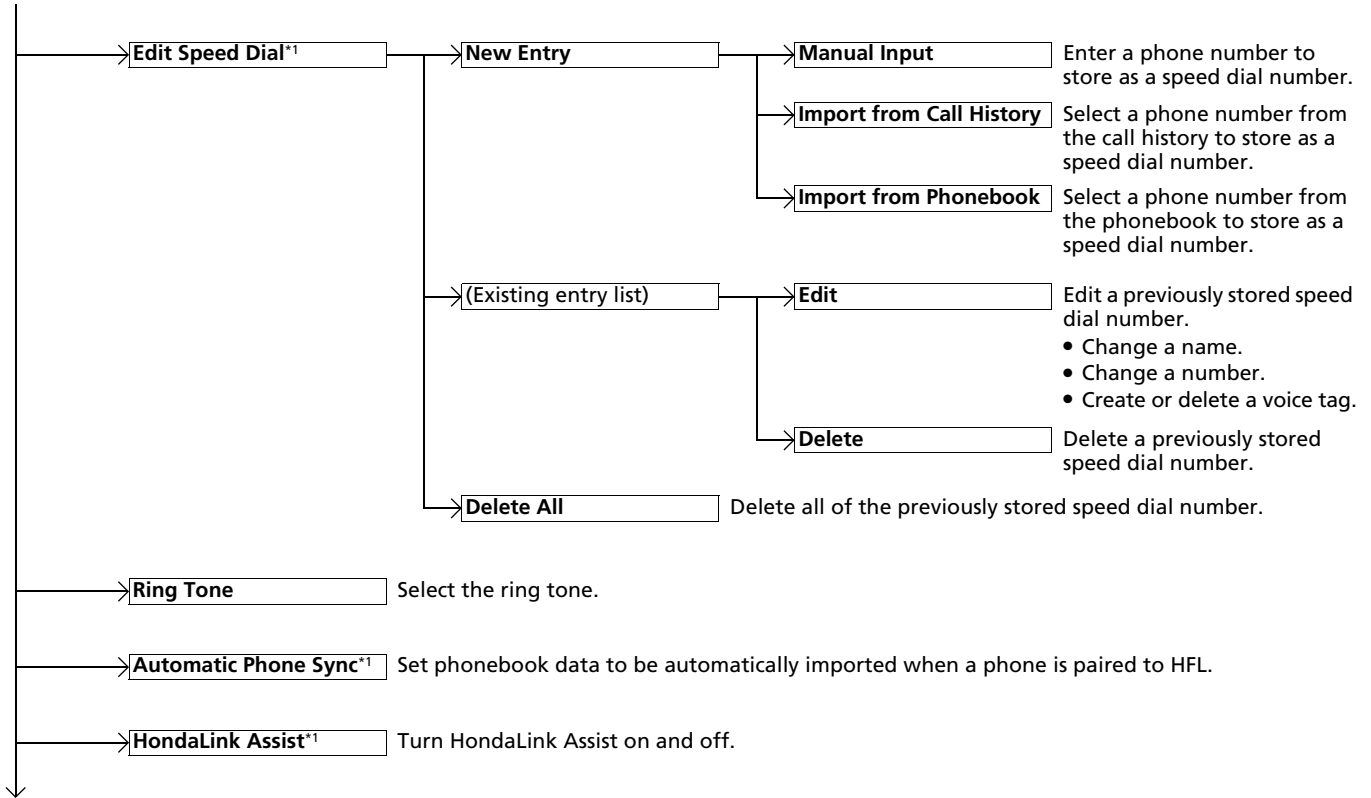

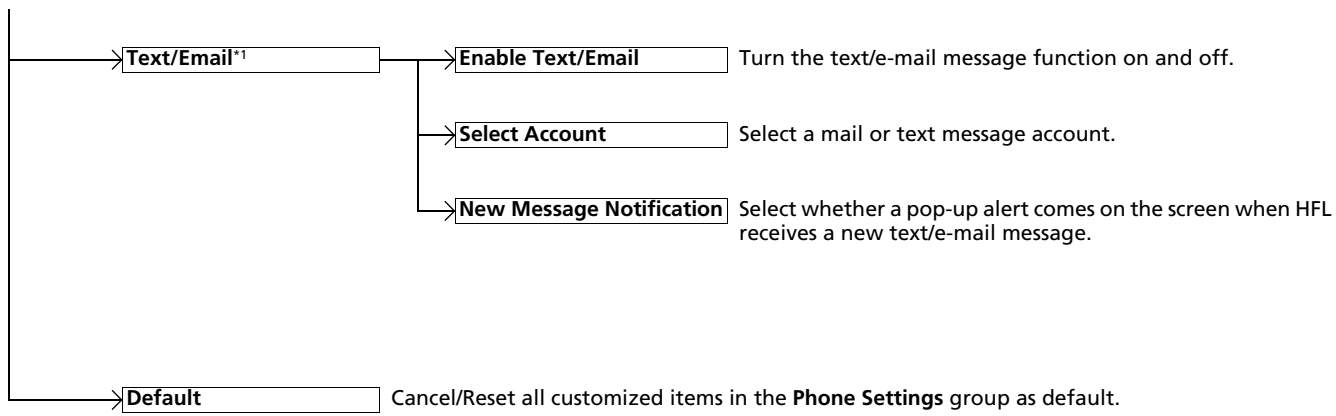

*1: Appears only when a phone is connected to HFL.

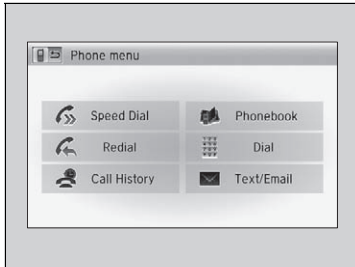

*1: Appears only when a phone is connected to HFL.

■ Phone menu screen



1. Press , or select **HOME**, then select **Phone**.
2. Press  (MENU) on the steering wheel, or select **MENU**.

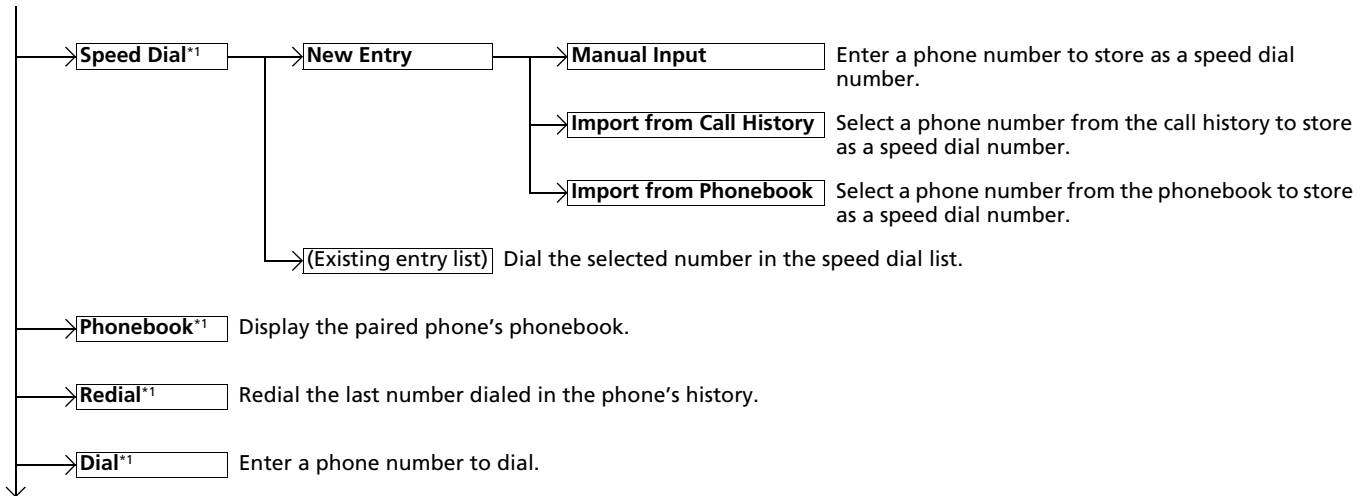

*1: Appears only when a phone is connected to HFL.

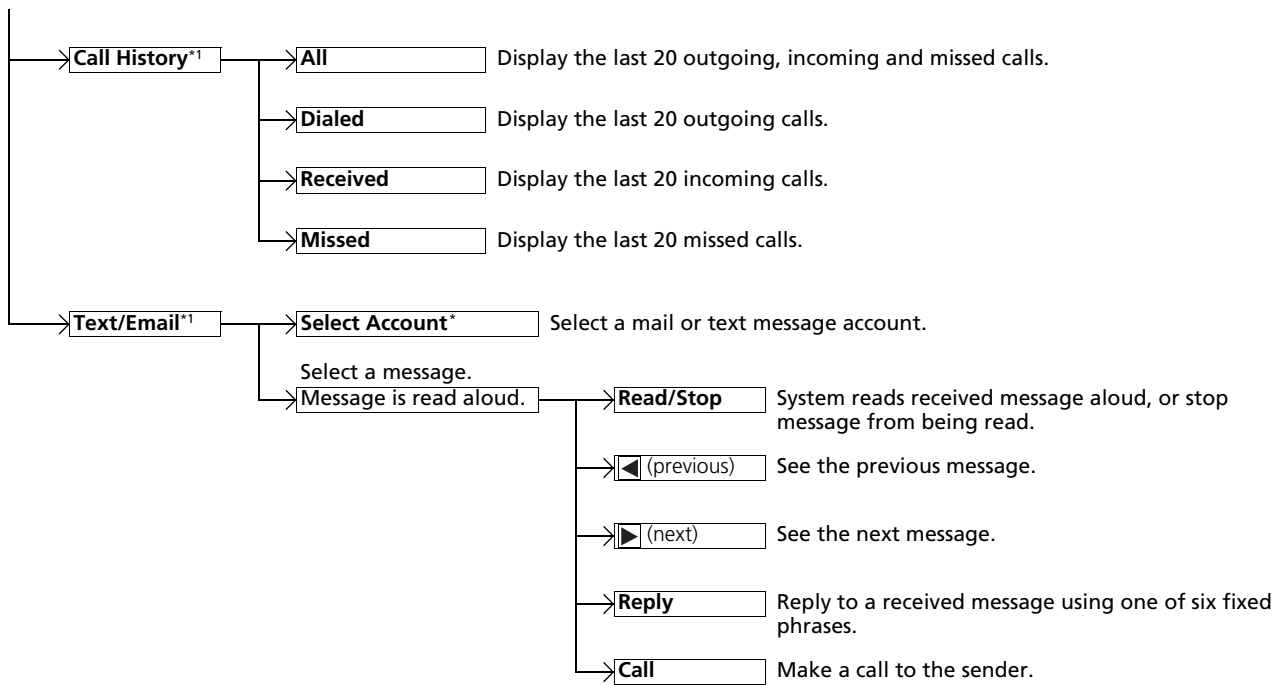

*1: Appears only when a phone is connected to HFL.

Phone Setup



■ To pair a mobile phone (when there is no phone paired to the system)

1. Select **Phone**.
2. Select **Yes**.
3. Make sure your phone is in search or discoverable mode, then select **OK**.
 - ▶ HFL automatically searches for a *Bluetooth* device.
4. Select your phone when it appears on the list.
 - ▶ If your phone does not appear, you can select **Refresh** to search again.
 - ▶ If your phone still does not appear, select **Phone not found** and search for *Bluetooth* devices using your phone. From your phone, select **HandsFreeLink**.
5. The system gives you a pairing code on the audio/information screen.
 - ▶ Confirm if the pairing code on the screen and your phone match. This may vary by phone.
6. A notification appears on the screen if pairing is successful.

☒ Phone Setup

Your *Bluetooth*-compatible phone must be paired to HFL before you can make and receive hands-free calls.

Phone Pairing Tips:

- You cannot pair your phone while the vehicle is moving.
- Up to six phones can be paired.
- Your phone's battery may drain faster when it is paired to HFL.
- If your phone is not ready for pairing or not found by the system, the system will return to the previous screen.

Continued

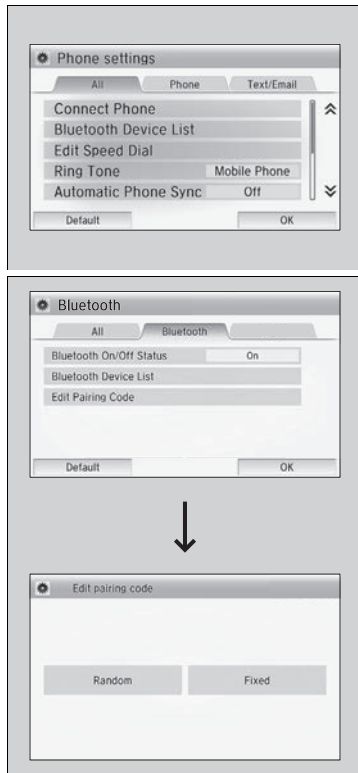

■ Changing the currently paired phone

1. Go to the **Phone settings** screen.
 - ▶ **Phone settings screen** P. 286
2. Select **Connect Phone**.
3. Select a phone to connect.
 - ▶ HFL disconnects the current phone and starts searching for another paired phone.

■ To change the pairing code setting

1. Select **HOME**.
2. Select **Settings**.
3. Select **Bluetooth**.
4. Select the **Bluetooth** tab.
5. Select **Edit Pairing Code**.
6. Select **Fixed** or **Random**.

☞ Changing the currently paired phone

If no other phones are found or paired when trying to switch to another phone, HFL will inform you that the original phone is connected again.

☞ To change the pairing code setting

The default pairing code is **0000** until you change the setting.

To create your own, select **Fixed**, and delete the current code, then enter a new one.

For a randomly generated pairing code each time you pair a phone, select **Random**.

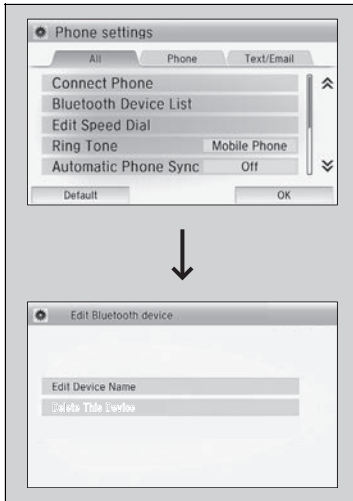

■ To edit an already-paired phone name

1. Go to the **Phone settings** screen.
 - ▶ **Phone settings screen** P. 286
2. Select the **Phone** tab.
3. Select **Bluetooth Device List**.
4. Select a paired phone you want to edit.
5. Select **Edit Device Name**.
6. Edit the name and select **OK**.
7. A notification appears if the change is successful.

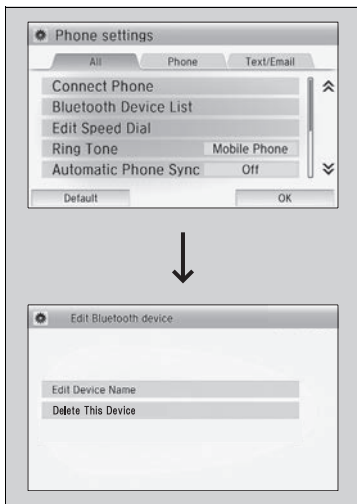

■ To delete a paired phone

1. Go to the **Phone settings** screen.
 - **Phone settings screen** P. 286
2. Select the **Phone** tab.
3. Select **Bluetooth Device List**.
4. Select a phone you want to delete.
5. Select **Delete This Device**.
6. You will receive a confirmation message on the screen. Select **Yes**.
7. A notification appears if the deletion is successful.

■ To Set Up a Text/E-mail Message Options

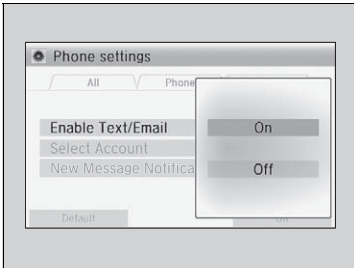

■ To turn on or off the text/e-mail function

1. Go to the **Phone settings** screen.
 - ▶ **Phone settings screen** P. 286
2. Select the **Text/Email** tab, then **Enable Text/Email**.
 - ▶ A pop-up menu appears on the screen.
3. Select **On** or **Off**.

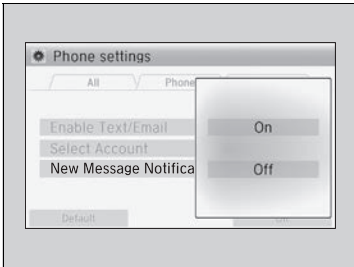

■ To turn on or off the text/e-mail notice

1. Go to the **Phone settings** screen.
 - ▶ **Phone settings screen** P. 286
2. Select the **Text/Email** tab, then **New Message Notification**.
 - ▶ A pop-up menu appears on the screen.
3. Select **On** or **Off**.

☒ To turn on or off the text/e-mail notice

- On:** A pop-up notification comes on every time you receive a new message.
- Off:** The message you receive is stored in the system without notification.

■ Ring Tone

You can change the ring tone setting.



1. Go to the **Phone settings** screen.
 - ▶ **Phone settings screen** P. 286
2. Select the **Phone** tab, then **Ring Tone**.
3. Select **Fixed** or **Mobile Phone**.

☒ Ring Tone

Fixed: The fixed ring tone sounds from the speaker.

Mobile Phone: The ring tone stored in the connected cell phone is heard through the vehicle speakers.

Automatic Import of Cellular Phonebook and Call History



■ When Automatic Phone Sync is set to On:

When your phone is paired, the contents of its phonebook and call history are automatically imported to the system.

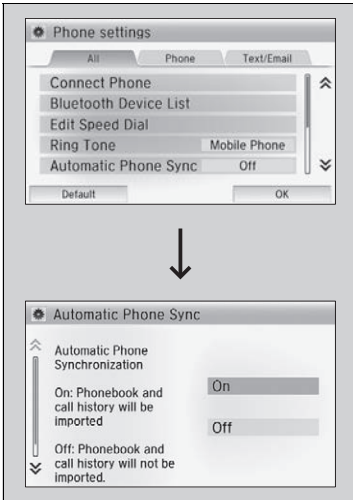

■ Changing the Automatic Phone Sync setting

1. Go to the **Phone settings** screen.
 ▶ **Phone settings screen** P. 286
2. Select the **Phone** tab, then **Automatic Phone Sync**.
3. Select **On** or **Off**.

⌘ Automatic Import of Cellular Phonebook and Call History

When you select a person from the list in the cellular phonebook, you can see up to three category icons. The icons indicate what types of numbers are stored for that name.

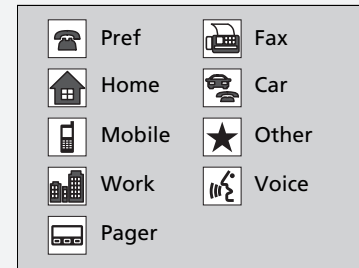

On some phones, it may not be possible to import the category icons to the system.

The phonebook is updated after every connection. Call history is updated after every connection or call.

■ Speed Dial

Up to 20 speed dial numbers can be stored per phone.

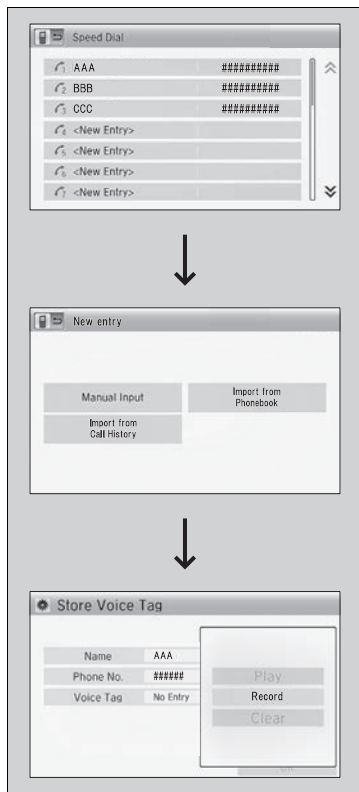

To store a speed dial number:

1. Go to the **Phone menu** screen.
 - ▶ **Phone menu screen** P. 289
2. Select **Speed Dial**.
 - ▶ Repeat the procedure to select **New Entry**.
3. Select a place to choose a number.
 - From **Import from Call History**:
 - ▶ Select a number from the call history.
 - From **Manual Input**:
 - ▶ Input the number manually.
 - From **Import from Phonebook**:
 - ▶ Select a number from the linked cell phone's imported phonebook.
4. When the speed dial is successfully stored from **Import from Call History** or **Import from Phonebook**, you are asked to create a voice tag for the number. Select **Yes** or **No**.
5. Select **Record** to store a voice tag for the speed dial entry.
 - ▶ Using the  button, follow the prompts to store a voice tag for the speed dial entry.

▶▶ Speed Dial

When a voice tag is stored, press the  button to call the number using the voice tag. Say "Call" and the voice tag name.

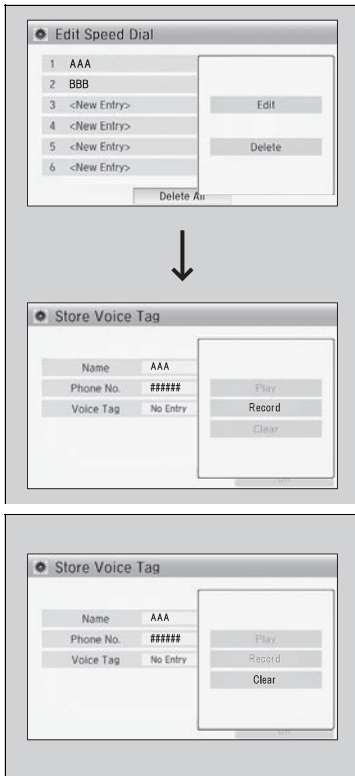

■ **To add a voice tag to a stored speed dial number**

1. Go to the **Phone settings** screen.
 - ▶ **Phone settings screen** P. 286
2. Select **Phone** tab, then **Edit Speed Dial**.
3. Select an existing speed dial entry.
 - ▶ From the pop-up menu, select **Edit**.
4. Select **Voice Tag**.
 - ▶ From the pop-up menu, select **Record**.
5. Select **Record** to store the voice tag.
6. Using the  button, follow the prompts to complete the voice tag.

■ **To delete a voice tag**

1. Go to the **Phone settings** screen.
 - ▶ **Phone settings screen** P. 286
2. Select **Phone** tab, then **Edit Speed Dial**.
3. Select an existing speed dial entry.
 - ▶ From the pop-up menu, select **Edit**.
4. Select **Voice Tag**.
 - ▶ From the pop-up menu, select **Clear**.
5. A confirmation message appears on the screen. Select **Yes**.

☒ Speed Dial

Avoid using duplicate voice tags.
 Avoid using "home" as a voice tag.
 It is easier for the system to recognize a longer name.
 For example, use "John Smith" instead of "John."

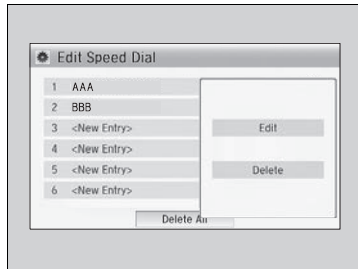

■ **To delete a speed dial**

1. Go to the **Phone settings** screen.
 ▶ **Phone settings screen** P. 286
2. Select **Phone** tab, then **Edit Speed Dial**.
3. Select an existing speed dial entry.
 ▶ From the pop-up menu, select **Delete**.
4. A confirmation message appears on the screen. Select **Yes**.

■ **Making a Call**

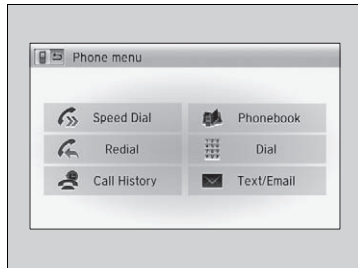

You can make calls by inputting any phone number, or by using the imported phonebook, call history, speed dial entries, or redial.

☒ **Making a Call**

Any voice-tagged speed dial entry, phonebook name, or number can be dialed by voice from most screens. Press the  button and say "Call" and the stored voice tag name.

The maximum range between your phone and vehicles is 30 feet (10 meters).

Once a call is connected, you can hear the voice of the person you are calling through the audio speakers.



■ **To make a call using the imported phonebook**

1. Go to the **Phone menu** screen.
 ▶ **Phone menu screen** P. 289
2. Select **Phonebook**.
3. Select a name.
 ▶ You can also search by letter. Select **Search**.
 ▶ Use the keyboard on the touch screen for entering letters.
4. Select a number.
 ▶ Dialing starts automatically.

■ **To make a call using a phone number**

1. Go to the **Phone menu** screen.
 ▶ **Phone menu screen** P. 289
2. Select **Dial**.
3. Select a number.
 ▶ Use the keyboard on the touch screen for entering numbers.
4. Select 
 ▶ Dialing starts automatically.

☒ **To make a call using the imported phonebook**

This function is disabled while the vehicle is moving. However, you can call a stored voice-tagged speed dial number using voice commands.

- ▶ **Limitations for Manual Operation** P. 285
- ▶ **Speed Dial** P. 298

☒ **To make a call using a phone number**

This function is disabled while the vehicle is moving. However, you can call a stored voice-tagged speed dial number using voice commands.

- ▶ **Limitations for Manual Operation** P. 285
- ▶ **Speed Dial** P. 298

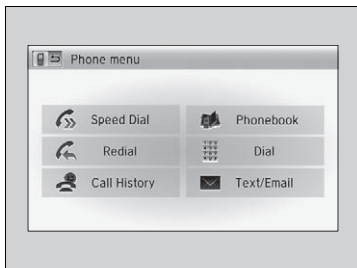

■ **To make a call using redial**

1. Go to the **Phone menu** screen.
 - ▶ **Phone menu screen** P. 289
2. Select **Redial**.
 - ▶ Dialing starts automatically.

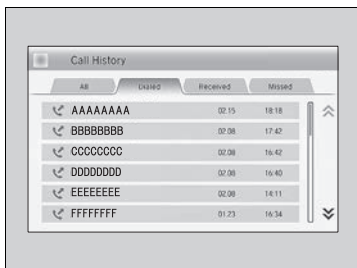

■ **To make a call using the call history**
Call history is stored by **All, Dialed, Received, and Missed.**

1. Go to the **Phone menu** screen.
 - ▶ **Phone menu screen** P. 289
2. Select **Call History**.
3. Select **All, Dialed, Received, or Missed.**
4. Select a number.
 - ▶ Dialing starts automatically.

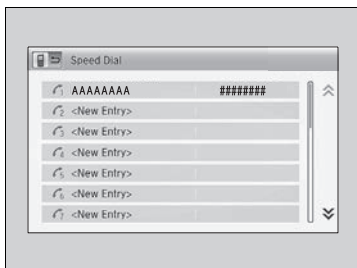

■ **To make a call using a speed dial entry**

1. Go to the **Phone menu** screen.
 - ▶ **Phone menu screen** P. 289
2. Select **Speed Dial**.
3. Select a number.
 - ▶ Dialing starts automatically.

☒ **To make a call using redial**

Press and hold the button to redial the last number dialed in your phone's history.

☒ **To make a call using the call history**

The call history displays the last 20 dialed, received, or missed calls.
(Appears only when a phone is connected to the system.)

☒ **To make a call using a speed dial entry**

When a voice tag is stored, press the button to call the number using the voice tag.

▶ **Speed Dial** P. 298



Any voice-tagged speed dial entry can be dialed by voice from any screen.

Press the button and follow the prompts.

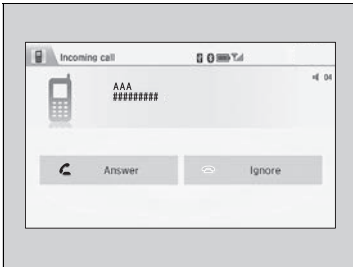
Receiving a Call



When there is an incoming call, an audible notification sounds and the **Incoming call** screen appears.

Press the  button to answer the call.
Press the  button to decline or end the call.

Options During a Call

The available options appear on the screen during a call.

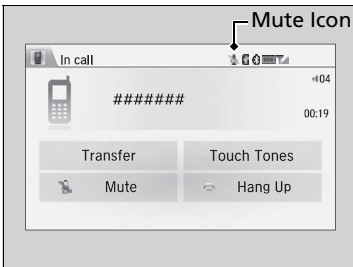

Mute: Mute your voice.

▶ The mute icon appears when **Mute** is selected. Select **Mute** again to turn it off.

Transfer: Transfer a call from the system to your phone.

Touch Tones: Send numbers during a call. This is useful when you call a menu-driven phone system.

Receiving a Call



Call Waiting

Press the  button to put the current call on hold to answer the incoming call.

Press the  button again to return to the current call.

Select **Ignore** to ignore the incoming call if you do not want to answer it.

Press the  button if you want to hang up the current call.

You can select the icons on the touch screen instead of the  and  buttons.

Options During a Call

Touch Tones: Available on some phones.

You can select the icons on the touch screen.

■ Receiving a Text/E-mail Message

HFL can display newly received text or e-mail messages as well as 20 of the most recently received messages on a linked cell phone. Each received message can be read aloud and replied to using a fixed common phrase.

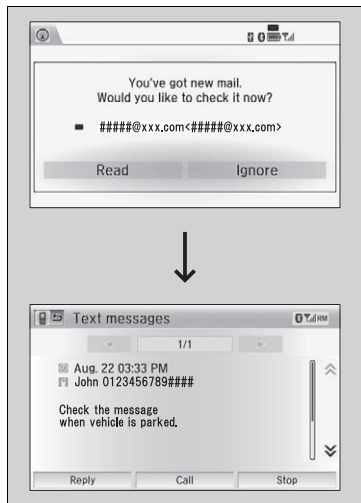

1. A pop-up appears and notifies you of a new text or e-mail message.
2. Select **Read** to listen to the message.
 - ▶ The text or e-mail message is displayed. The system automatically starts reading out the message.
3. To discontinue the message read-out, select **Stop**.

▣ Receiving a Text/E-mail Message

The system does not display any received messages while you are driving. You can only hear them read aloud.

With some phones, you may be able to display up to 20 most recent text and e-mail messages.

State or local laws may limit your use of the HFL text/e-mail message feature. Only use the text/e-mail message feature when conditions allow you to do so safely.

When you receive a text or e-mail message for the first time since the phone is paired to HFL, you are asked to turn the **New Message Notification** setting to **On**.

▶ **To turn on or off the text/e-mail notice**
P. 295

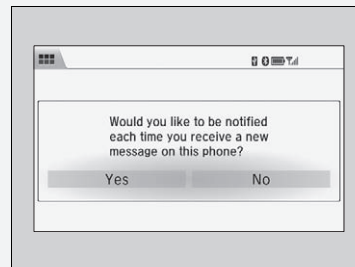

Selecting a Mail Account

If a paired phone has text or mail message accounts, you can select one of them to be active and receive notifications.

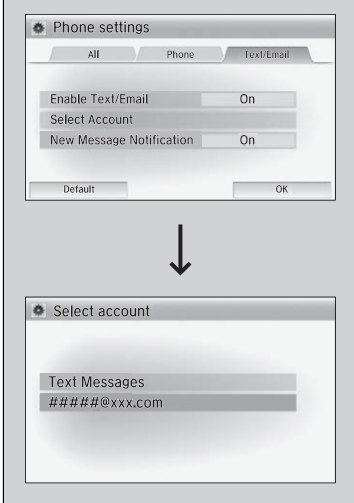

1. Go to the **Phone settings** screen.
 ▶ **Phone settings screen** P. 286
2. Select **Text/Email** tab, then **Select Account**.
 ▶ A pop-up menu appears on the screen.
3. Select **Text Messages** or an e-mail account you want.

Selecting a Mail Account

You can also select a mail account from the folder list screen or the message list screen.

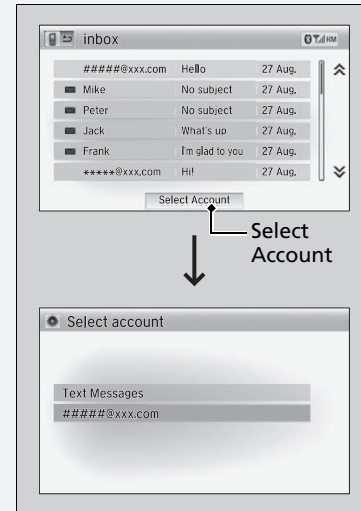

You can only receive notifications from one text message or mail account at a time.

■ Displaying Messages

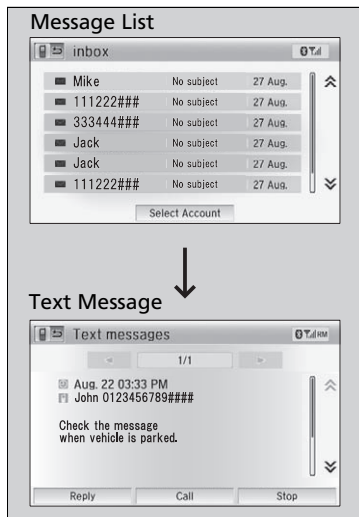



■ Displaying text messages

1. Go to the **Phone menu** screen.
 - ▶ **Phone menu screen** P. 289
2. Select **Text/Email**.
 - ▶ Select account if necessary.
3. Select a message.
 - ▶ The text message is displayed. The system automatically starts reading the message aloud.

▶▶ Displaying Messages

The  icon appears next to an unread message.

If you delete a message on the phone, the message is also deleted in the system. If you send a message from the system, the message goes to your phone's mailbox.

To see the previous or next message, select  (previous) or  (next) on the message screen.

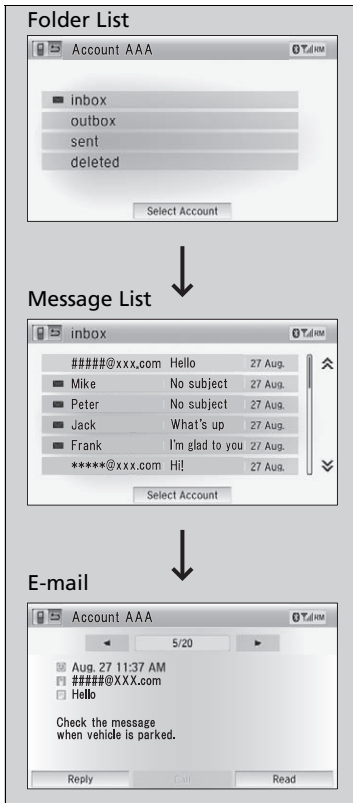

■ Displaying e-mails

1. Go to the **Phone menu** screen.
 - ▶ **Phone menu screen** P. 289
2. Select **Text/Email**.
 - ▶ Select **Select Account** if necessary.
3. Select a folder.
 - ▶ The e-mail is displayed. The system automatically starts reading the message aloud.
4. Select a message.
 - ▶ The e-mail is displayed. The system automatically starts reading the message aloud.

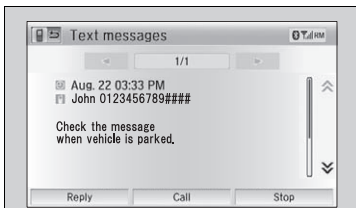
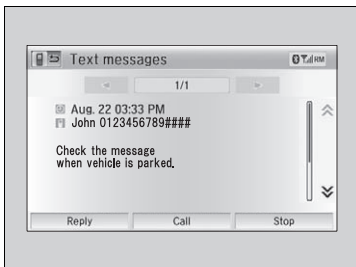

■ **Read or Stop reading a message**

1. Go to the text or e-mail message screen.
 - ▶ The system automatically starts reading the message aloud.
 - ☑ **Displaying Messages** P. 306
2. Select **Stop** to stop reading.
 - Select **Read** again to start reading the message from the beginning.

■ **Reply to a message**

1. Go to the text or e-mail message screen.
 - ▶ The system automatically starts reading the message aloud.
 - ☑ **Displaying Messages** P. 306
2. Select **Reply**.
3. Select the reply message.
 - ▶ The pop-up menu appears on the screen.
4. Select **Send** to send the message.
 - ▶ **Complete** appears on the screen when the reply message was successfully sent.

☒ Reply to a message

The available fixed reply messages are as follows:

- **Talk to you later, I'm driving.**
- **I'm on my way.**
- **I'm running late.**
- **OK**
- **Yes**
- **No**

You cannot add, edit, or delete reply messages.

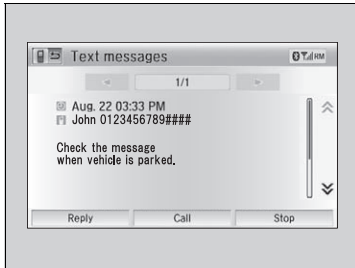

■ Making a call to a sender

1. Go to the text message screen.
2. Select **Call**.

■ In Case of Emergency

■ Automatic collision notification

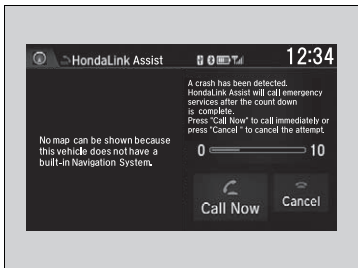

If your vehicle's airbags deploy or if the unit detects that the vehicle is severely impacted, your vehicle automatically will attempt to connect to the HondaLink operator. If connected, information about your vehicle, its location, and its condition will be sent to the operator; you also can speak to the operator when connected.

IMPORTANT: For vehicles equipped with HondaLink Assist, owner activation constitutes authorization for Honda to collect information from your vehicle needed to provide the service, and agreement to the Terms of Use at www.hondalink.com/TermsAndConditions. In a crash, HondaLink Assist will attempt to notify emergency services but NEITHER HONDA NOR ITS SERVICE PROVIDERS GUARANTEE THAT SUCH NOTIFICATION WILL OCCUR.

Honda reserves the right to terminate HondaLink Assist services at any time or for any reason, and in the future may not be able to provide services due to changes in, or obsolescence of, technology integral to the service or changes in governmental regulation.

▶▶ In Case of Emergency

Your vehicle may not be able to connect to the operator if the battery level is low, the line is disconnected, or you do not have adequate cellular coverage.

You cannot use this emergency services when:

- You travel outside the HondaLink service coverage areas.
- There is a problem with the connecting devices, such as the microphones, speakers, or the unit itself.

You cannot operate other phone-related functions using the screen while talking to the operator. Select **Hang Up** to terminate the connection to your vehicle.

▶▶ Automatic collision notification

If the unit fails to connect to the operator, it repeatedly tries until it succeeds.

■ To enable notification

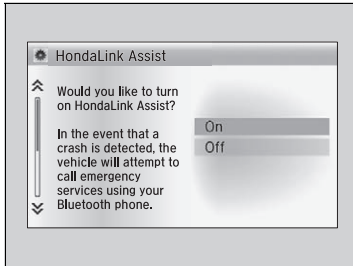

1. Go to the **Phone settings** screen.
 - ▶ **Phone settings screen** P. 286
2. Select **Phone** tab, then **HondaLink Assist**.
 - ▶ A pop-up menu appears on the screen.
3. Select **On** or **Off**.

☒ To enable notification

Setting options:

- **On:** Notification is available.
- **Off:** Disable the feature.

Driving



This chapter discusses driving, refueling, and information on items such as accessories.

Before Driving

Driving Preparation	314
Maximum Load Limit	317

Towing a Trailer

Towing Your Vehicle	320
---------------------------	-----

Off-Highway Driving Guidelines..... 323

When Driving

Models without smart entry system

Starting the Engine	325
---------------------------	-----

Models with smart entry system

Starting the Engine	328
Precautions While Driving	332
Continuously Variable Transmission *	333

Continuously variable transmission models without paddle shifters

Shifting	334
----------------	-----

Continuously variable transmission models with paddle shifters

Shifting	336
----------------	-----

Manual transmission models

Shifting	340
ECON Button*	343
Cruise Control	344
Forward Collision Warning (FCW)*	347
Lane Departure Warning (LDW)*	351
Vehicle Stability Assist (VSA®), aka Electronic Stability Control (ESC), System	354
LaneWatch™*	356
Real Time AWD with Intelligent Control System™*	358
Tire Pressure Monitoring System (TPMS)	359
Tire Pressure Monitoring System (TPMS) - Required Federal Explanation	361

Braking

Brake System	363
Anti-lock Brake System (ABS)	369
Brake Assist System	370

Parking Your Vehicle

When Stopped	371
--------------------	-----

Multi-View Rear Camera..... 372

Refueling

Fuel Information	374
How to Refuel	375

Fuel Economy

Improving Fuel Economy	376
------------------------------	-----

Accessories and Modifications

Accessories	377
Modifications	377

* Not available on all models

Driving Preparation

Check the following items before you start driving.

Exterior Checks

- Make sure there are no obstructions on the windows, door mirrors, exterior lights, or other parts of the vehicle.
 - ▶ Remove any frost, snow, or ice.
 - ▶ Remove any snow on the roof, as this can slip down and obstruct your field of vision while driving. If frozen solid, remove ice once it has softened.
 - ▶ When removing ice from around the wheels, be sure not to damage the wheel or wheel components.
- Make sure the hood is securely closed.
 - ▶ If the hood opens while driving, your front view will be blocked.
- Make sure the tires are in good condition.
 - ▶ Check air pressure, check for damage and excessive wear.
 - ✦ **Checking and Maintaining Tires** P. 411
- Make sure there are no people or objects behind or around the vehicle.
 - ▶ There are blind spots from the inside.

Exterior Checks

NOTICE

When doors are frozen shut, use warm water around the door edges to melt any ice. Do not try to force them open, as this can damage the rubber trim around the doors. When done, wipe dry to avoid further freezing.

Do not pour warm water into the key cylinder. You will be unable to insert the key if the water freezes in the hole.

Heat from the engine and exhaust can ignite flammable materials left under the hood, causing a fire. If you've parked your vehicle for an extended period, inspect and remove any debris that may have collected, such as dried grass and leaves that have fallen or have been carried in for use as a nest by a small animal. Also check under the hood for leftover flammable materials after you or someone else has performed maintenance on your vehicle.

Interior Checks

- Store or secure all items on board properly.
 - ▶ Carrying too much cargo, or improperly storing it, can affect your vehicle's handling, stability, stopping distance, and tires, and make it unsafe.
 - ✦ **Maximum Load Limit** P. 317
- Do not pile items higher than the seat height.
 - ▶ They can block your view and may be thrown forward in the event of sudden braking.
- Do not place anything in the front seat footwells. Make sure to secure the floor mat.
 - ▶ An object or unsecured floor mat can interfere with your brake and accelerator pedal operation while driving.
- If you have any animals on board, do not let them move around in the vehicle.
 - ▶ They may interfere with driving and a crash could occur.
- Securely close and lock all doors and the tailgate.
 - ✦ **Locking/Unlocking the Doors from the Inside** P. 105
- Adjust your seating position properly.
 - ▶ Adjust the head restraint, too.
 - ✦ **Adjusting the Seats** P. 140
 - ✦ **Adjusting the Head Restraints** P. 142
- Adjust the mirrors and steering wheel properly for your driving.
 - ▶ Adjust them while sitting in the proper driving position.
 - ✦ **Adjusting the Mirrors** P. 138
 - ✦ **Adjusting the Steering Wheel** P. 137

Interior Checks

The headlight aim is set by the factory, and does not need to be adjusted. However, if you regularly carry heavy items in the cargo area, have the aiming readjusted at a dealer or by a qualified technician.

- Be sure items placed on the floor behind the front seats cannot roll under the seats.
 - ▶ They can interfere with the driver's ability to operate the pedals, the operation of the seats, or the operation of the sensors under the seats.
- Everyone in the vehicle must fasten their seat belt.
 - 📄 **Fastening a Seat Belt** P. 38
- Make sure that the indicators in the instrument panel come on when you start the vehicle, and go off soon after.
 - ▶ Always have a dealer check the vehicle if a problem is indicated.
 - 📄 **Indicators** P. 72

Maximum Load Limit

The maximum load for your vehicle is 850 lbs (385 kg). See Tire and Loading Information label attached to the driver's doorjamb.

Label Example

TIRE	SIZE	COLD TIRE PRESSURE	SEE OWNER'S MANUAL FOR ADDITIONAL INFORMATION
FRONT	XXXX/XXXXX XXX	XXXKPA, XXPSI	
REAR	XXXX/XXXXX XXX	XXXKPA, XXPSI	
SPARE	XXXX/XXXXX XXX	XXXKPA, XXPSI	

This figure includes the total weight of all occupants, cargo, and accessories, and the tongue load if you are towing a trailer. Steps for Determining Correct Load Limit -

- (1)** Locate the statement "The combined weight of occupants and cargo should never exceed XXX kg or XXX lbs." on your vehicle's placard.
- (2)** Determine the combined weight of the driver and passengers that will be riding in your vehicle.
- (3)** Subtract the combined weight of the driver and passengers from XXX kg or XXX lbs.
- (4)** The resulting figure equals the available amount of cargo and luggage load capacity. For example, if the "XXX" amount equals 1,400 lbs. and there will be five 150 lb. passengers in your vehicle, the amount of available cargo and luggage load capacity is 650 lbs.
(1,400 - 750 (5 x 150) = 650 lbs.)

Continued

Maximum Load Limit

⚠ WARNING

Overloading or improper loading can affect handling and stability and cause a crash in which you can be hurt or killed.

Follow all load limits and other loading guidelines in this manual.

Gross Vehicle Weight Rating (GVWR):
The maximum allowable weight of the vehicle, all occupants, all accessories, all cargo, and the tongue load.

➤ Specifications P. 466

Gross Axle Weight Rating (GAWR):
The maximum allowable weight of the vehicle axle.



➤ Specifications P. 466

- (5) Determine the combined weight of luggage and cargo being loaded on the vehicle. That weight may not safely exceed the available cargo and luggage load capacity calculated in step 4.
- (6) If your vehicle will be towing a trailer, load from your trailer will be transferred to your vehicle. Consult this manual to determine how this reduces the available cargo and luggage load capacity of your vehicle.



In addition, the total weight of the vehicle, all occupants, accessories, cargo, and trailer tongue load must not exceed the Gross Vehicle Weight Rating (GVWR) or the Gross Axle Weight Rating (GAWR). Both are on a label on the driver's doorjamb.

Load Limits Example

Example1

	\geq		+	
Max Load 850 lbs (385 kg)		Passenger Weight 150 lbs x 2 = 300 lbs (68 kg x 2 = 136 kg)		Cargo Weight 550 lbs (249 kg)

Example2

	\geq		+	
Max Load 850 lbs (385 kg)		Passenger Weight 150 lbs x 5 = 750 lbs (68 kg x 5 = 340 kg)		Cargo Weight 100 lbs (45 kg)

Towing a Trailer

Your vehicle is not designed to tow a trailer. Attempting to do so can void your warranties.

Towing Your Vehicle

Continuously variable transmission models

Your vehicle is not designed to be towed behind a motorhome. If your vehicle needs to be towed in an emergency, refer to the emergency towing information.

➔ **Emergency Towing** P. 461

Manual transmission models

Your vehicle can be towed behind a motorhome.

Manual transmission models

■ When Your Vehicle is Towed Behind a Motorhome

Perform the following procedure before towing your vehicle.

1. Shift to **N**.
2. Release the parking brake.
3. Turn the ignition switch to **ACCESSORY I***1.
 - ▶ Make sure the steering wheel does not lock.
4. Turn off all the electric devices. Do not use any accessory power sockets.
 - ▶ This can prevent the battery from running down.

*1: Models with the smart entry system have an **ENGINE START/STOP** button instead of an ignition switch.

» Towing Your Vehicle

Manual transmission models

Do not exceed 65 mph (100 km/h).

Consult your towing parts sales or rental agency if any other items are recommended or required for your towing situation.

■ Extended towing

If you tow more than eight hours in one day, you should repeat the “before towing your vehicle procedure” at least every eight hours.

You also need to perform the following procedure to prevent the battery from running down.

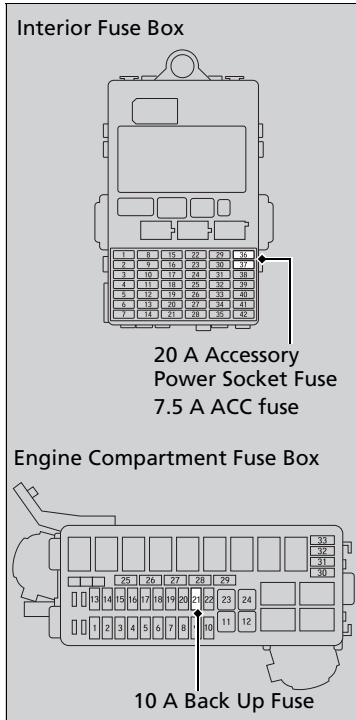

Models without smart entry system

1. Remove the 20 A accessory power socket and 7.5 A ACC fuses. These fuses are located in the interior fuse box.
 - Interior Fuse Boxes P. 458
2. Remove the 10 A Back up fuse. This fuse is located in the engine compartment fuse box.
 - Engine Compartment Fuse Box P. 456
3. Store the fuses in a safe place so you do not lose them.
 - ▶ Make sure to reinstall the fuses before you start driving your vehicle.
4. Shift to **N**.
5. Turn the ignition switch to ACCESSORY **I**.
 - ▶ Make sure the steering wheel does not lock.

▶▶ Towing Your Vehicle

Make sure to reinstall the fuses before you start driving your vehicle.

Continued

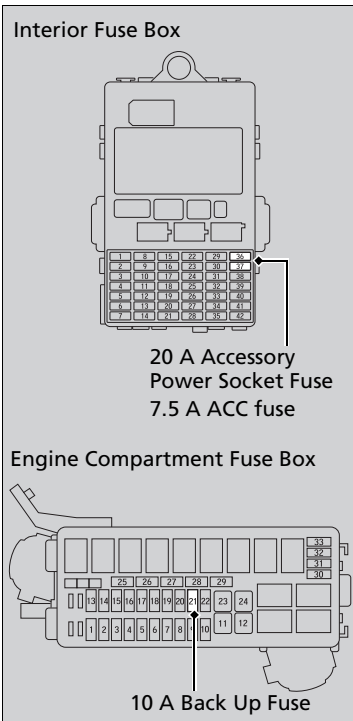

Models with smart entry system

1. Remove the 20 A accessory power socket and 7.5 A ACC fuses. These fuses are located in the interior fuse box.
 - **Interior Fuse Boxes** P. 458
2. Remove the 10 A Back up fuse. This fuse is located in the engine compartment fuse box.
 - **Engine Compartment Fuse Box** P. 456
3. Store the fuses in a safe place so you do not lose them.
 - Make sure to reinstall the fuses before you start driving your vehicle.
4. Push the **ENGINE START/STOP** button without depressing the clutch pedal.
 - The indicator on the **ENGINE START/STOP** button blinks.
5. Touch the center of the **ENGINE START/STOP** button with the **H** logo on the smart entry remote while the indicator is blinking.
 - The indicator stop blinking, then stays on.
6. Shift to **N**.
7. Push the **ENGINE START/STOP** button once without depressing the clutch pedal.
 - Make sure the steering wheel does not lock.

General Information

Your vehicle has been designed primarily for use on pavement, however, its higher ground clearance allows you to occasionally travel on unpaved roads. It is not designed for trail-blazing, or other challenging off-road activities.

If you decide to drive on unpaved roads, you will find that it requires somewhat different driving skills and that your vehicle will handle somewhat differently than it does on pavement. Pay attention to the precautions and tips in this section, and get acquainted with your vehicle before leaving the pavement.

Important Safety Precautions

To avoid loss of control or rollover, be sure to follow all precautions and recommendations:

- Be sure to store cargo properly and do not exceed your cargo load limits.
 - **Maximum Load Limit** P. 317
- Whenever you drive, make sure you and your passengers always wear seat belts.
- Keep your speed low, and never go faster than the conditions allow.
- It's up to you to continually assess the situation and drive within the limits.

Off-Highway Driving Guidelines

WARNING

Improperly operating this vehicle on or off pavement can cause a crash or rollover in which you and your passengers can be seriously injured or killed.

- Follow all instructions and guidelines in this owner's manual.
- Keep your speed low, and don't drive faster than conditions permit.

Failure to operate your vehicle correctly might result in a crash or a rollover.

- **Important Handling Information** P. 32
- **Precautions While Driving** P. 332

Avoiding Trouble

- **Check Out Your Vehicle** before you leave the pavement and make sure that all scheduled maintenance has been completed. Pay special attention to the condition of the tires, and check the tire pressures.
- **Remember** the route you choose presents limits (too steep or bumpy), you have limits (driving skill and comfort), and your vehicle has limits (traction, stability, and power). Failing to recognize these limits will likely put you and your passengers in a hazardous situation.
- **Accelerating and Braking** should be done slowly and gradually. Trying to start or stop too fast can cause a loss of traction and you could lose control.
- **Avoiding Obstacles and Debris** in the road reduces the likelihood of a rollover or damage to your suspension or other components.
- **Driving on Slopes** increases your risk of a rollover, particularly if you attempt to drive across a slope that is too steep. Going straight up or down a slope is usually the safest. If you can't clearly see all conditions or obstacles on a slope, walk it before you drive it. If there is any doubt whether you can safely pass, don't try it. Find another route. If you get stuck when climbing, do not try to turn around. Back down slowly following the same route you took up the hill.
- **Crossing a Stream** - Avoid driving through deep water. If you encounter water in your route (a small stream or large puddle, for example), evaluate it carefully before going ahead. Make sure it is shallow, flowing slowly, and has firm ground underneath. If you are not sure of the depth or the ground, turn around and find another route. Driving through deep water can also damage your vehicle. The water can get into the transmission and differential, diluting the lubricant and causing an eventual failure. It can also wash the grease out of the wheel bearings.
- **If You Get Stuck**, carefully go in the direction that you think will get you unstuck. Do not spin the tires as this will only make things worse and could damage the transmission. If you are unable to free yourself, your vehicle will need to be towed. Front and rear tow hooks are provided for this purpose.

Models without smart entry system

Starting the Engine

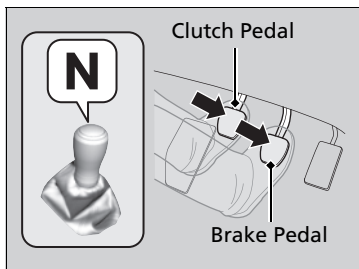
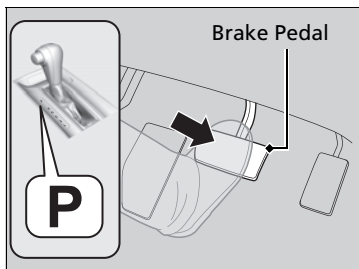

1. Make sure the parking brake is applied.
 - ▶ The electric parking brake indicator comes on for 15 seconds when you pull up to electric parking brake switch.

Continuously variable transmission models

2. Check that the shift lever is in **P**, then depress the brake pedal.
 - ▶ Although it is possible to start the vehicle in **N**, it is safer to start it in **P**.

Manual transmission models

2. Check that the shift lever is in **N**. Then depress the brake pedal with your right foot, and the clutch pedal with your left foot.
 - ▶ The clutch pedal must be fully depressed to start the engine.

Starting the Engine

Keep your foot firmly on the brake pedal when starting the engine.

The engine is harder to start in cold weather and in thinner air found at altitudes above 8,000 feet (2,400 meters).

When starting the engine in cold weather, turn off all electrical accessories such as the lights, heating and cooling system 'climate control system', and rear defogger in order to reduce battery drain.

If you live in a region where winter is extremely cold, an engine block heater will improve starting and warming of the engine. If temperatures consistently below -22°F (-30°C) are expected, the coolant mixture should be changed to a higher concentration to prevent freezing. Consult a dealer for details.

If the exhaust system sounds abnormal or you can smell exhaust gas inside the vehicle, have your vehicle checked by a dealer. There may be a problem with the engine or exhaust system.

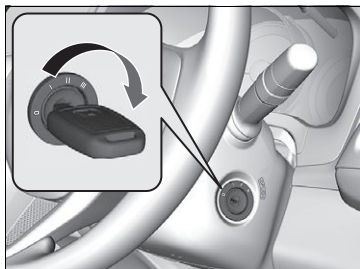

3. Turn the ignition switch to START **[III]** without depressing the accelerator pedal.

▶▶ Starting the Engine

Do not hold the key in START **[III]** for more than 15 seconds.

- If the engine does not start right away, wait for at least 10 seconds before trying again.
- If the engine starts, but then immediately stops, wait at least 10 seconds before repeating step 3 while gently depressing the accelerator pedal. Release the accelerator pedal once the engine starts.

The immobilizer system protects your vehicle from theft. If an improperly coded device is used, the engine's fuel system is disabled.

▶ **Immobilizer System** P. 116

▶▶ Starting to Drive

You can also release the parking brake by pressing the electric parking brake switch while depressing the brake pedal.

When facing downhill, you can start your vehicle more smoothly by manually releasing it with the electric parking brake switch than by releasing it with the accelerator pedal.

Starting to Drive

Continuously variable transmission models

1. Keeping your right foot on the brake pedal, put the shift lever in **[D]**. Select **[R]** when reversing.
2. With the parking brake applied, release the brake pedal and gently depress the accelerator pedal.
 - ▶ Make sure the electric parking brake indicator goes off.
 - ▶ **Parking Brake** P. 363

■ Hill start assist system

Hill start assist keeps the brake engaged briefly to help prevent the vehicle from rolling on inclines as you move your foot from the brake pedal to the accelerator.

Manual transmission models

Depress the clutch pedal, and shift to one of the forward gears when facing uphill, or **R** when facing downhill, then release the brake pedal.

Continuously variable transmission models

Move the shift lever to **D**, **S**, or **L** when facing uphill, or **R** when facing downhill, then release the brake pedal.

⌘ Hill start assist system

Hill start assist may not prevent the vehicle from rolling downhill on a very steep or slippery slope, and does not operate on small inclines.

Hill start assist is not a replacement for the parking brake.

Models with smart entry system

Starting the Engine

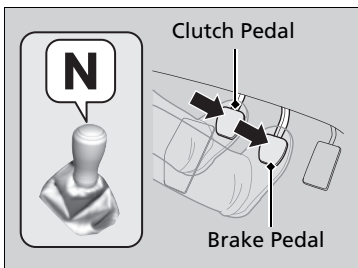
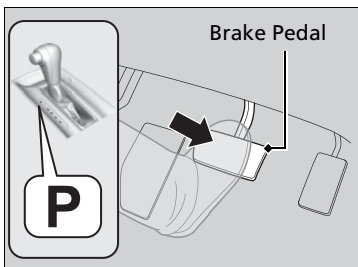

1. Make sure the parking brake is applied.
 - ▶ The electric parking brake indicator comes on for 15 seconds when you pull up to electric parking brake switch.

Continuously variable transmission models

2. Check that the shift lever is in **P**, then depress the brake pedal.
 - ▶ Although it is possible to start the vehicle in **N**, it is safer to start it in **P**.

Manual transmission models

2. Check that the shift lever is in **N**. Then depress the brake pedal with your right foot, and the clutch pedal with your left foot.
 - ▶ The clutch pedal must be fully depressed to start the engine.

Starting the Engine

Keep your foot firmly on the brake pedal when starting the engine.

The engine is harder to start in cold weather and in thinner air found at altitudes above 8,000 feet (2,400 meters).

When starting the engine in cold weather, turn off all electrical accessories such as the lights, climate control system, and rear defogger in order to reduce battery drain.

If you live in a region where winter is extremely cold, an engine block heater will improve starting and warming of the engine. If temperatures consistently below -22°F (-30°C) are expected, the coolant mixture should be changed to a higher concentration to prevent freezing. Consult a dealer for details.

If the exhaust system sounds abnormal or you can smell exhaust gas inside the vehicle, have your vehicle checked by a dealer. There may be a problem with the engine or exhaust system.

The immobilizer system protects your vehicle from theft. If an improperly coded device is used, the engine's fuel system is disabled.

▶ **Immobilizer System** P. 116

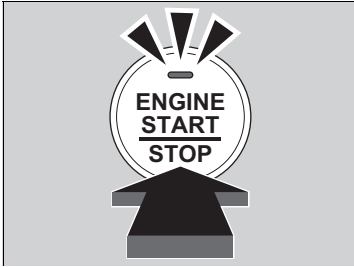

3. Press the **ENGINE START/STOP** button without depressing the accelerator pedal.

▶▶ Starting the Engine

Bring the smart entry remote close to the **ENGINE START/STOP** button if the battery in the smart entry remote is weak.

- ▶ **If the Smart Entry Remote Battery is Weak**
P. 444

The engine may not start if the smart entry remote is subjected to strong radio waves.

Do not hold the **ENGINE START/STOP** button to start the engine.
If the engine does not start, wait at least 10 seconds before trying again.

■ Stopping the Engine

You can turn the engine off when the vehicle is completely stopped.

Continuously variable transmission models

1. Shift to **P**.
2. Press the **ENGINE START/STOP** button.

Manual transmission models

- If the shift lever is in **N**, press the **ENGINE START/STOP** button.
- If the shift lever is in any gear other than **N**, depress the clutch pedal, then press the **ENGINE START/STOP** button.

■ Starting to Drive

Continuously variable transmission models

1. Keeping your right foot on the brake pedal, put the shift lever in **D**. Select **R** when reversing.
2. With the parking brake applied, release the brake pedal and gently depress the accelerator pedal.
 - ▶ Make sure the electric parking brake indicator goes off.
 - 🔲 **Parking Brake** P. 363

▶▶ Starting to Drive

You can also release the parking brake by pressing the electric parking brake switch while depressing the brake pedal.

When facing downhill, you can start your vehicle more smoothly by manually releasing it with the electric parking brake switch than by releasing it with the accelerator pedal.

■ Hill start assist system

Hill start assist keeps the brake engaged briefly to help prevent the vehicle from rolling on inclines as you move your foot from the brake pedal to the accelerator.

Manual transmission models

Depress the clutch pedal, and shift to one of the forward gears when facing uphill, or **R** when facing downhill, then release the brake pedal.

Continuously variable transmission models

Move the shift lever to **D** or **S** when facing uphill, or **R** when facing downhill, then release the brake pedal.

⌘ Hill start assist system

Hill start assist may not prevent the vehicle from rolling downhill on a very steep or slippery slope, and does not operate on small inclines.

Hill start assist is not a replacement for the parking brake.

Precautions While Driving

■ Driving Guidelines for Your Utility Vehicle

Utility vehicles have a significantly higher rollover rate than other types of vehicles. To prevent rollovers or loss of control:

- Take corners at slower speeds than you would with a passenger vehicle.
- Avoid sharp turns and abrupt maneuvers whenever possible.
- Do not modify your vehicle in any way that you would raise the center of gravity.
- Never carry more than 165 lbs (75 kg) of cargo on the roof rack (Honda accessory).

■ In Rain

Avoid driving in deep water and on flooded roads. This can damage the engine or driveline, or cause electrical component failure.

⌘ Precautions While Driving

NOTICE

Do not operate the shift lever while pressing the accelerator pedal. You could damage the transmission.

NOTICE

If you repeatedly turn the steering wheel at an extremely low speed, or hold the steering wheel on the full left or right position for a while, the electric power steering (EPS) system heats up. The system goes into a protective mode, and limits its performance. The steering wheel becomes harder and harder to operate. Once the system cools down, the EPS system is restored. Repeated operation under these conditions can eventually damage the system.

If the ignition switch is turned to ACCESSORY **I** or LOCK **0***1 while driving, the engine will shut down and all steering and brake power assist functions will stop, making it difficult to control the vehicle.

Do not put the shift lever in **N**, as you will lose engine braking (and acceleration) performance.

During the first 600 miles (1,000 km) of operation, avoid sudden acceleration or full throttle operation so as to not damage the engine or powertrain.

Avoid hard braking for the first 200 miles (300 km). You should also follow this when the brake pads are replaced.

*1: Models with the smart entry system have an **ENGINE START/STOP** button instead of an ignition switch.

■ Other Precautions

If there is a strong impact with something under the vehicle, stop in a safe location. Check the underside of the vehicle for damage or any fluid leaks.

Continuously Variable Transmission *

■ Creeping

The engine runs at a higher idle speed and creeping increases. Keep the brake pedal firmly depressed when stopped.

■ Kickdown

Quickly depressing the accelerator pedal while driving uphill may cause the transmission to drop to a lower gear, unexpectedly increasing vehicle speed. Depress the accelerator pedal carefully, especially on slippery roads and curves.

⌘ Driving Guidelines for Your Utility Vehicle

Failure to operate your vehicle correctly might result in a crash or a rollover.

➤ **Important Handling Information** P. 32

➤ **Precautions While Driving** P. 332

* Not available on all models

Continuously variable transmission models without paddle shifters

Shifting

Change the shift position in accordance with your driving needs.

■ Shift lever positions



Release Button

P	Park Used when parking or starting the engine
R	Reverse Used when reversing
N	Neutral Used when idling
D	Drive Used for normal driving
S	Drive (S) Used: <ul style="list-style-type: none">• For better acceleration• To increase engine braking• When going up or down hills
L	Low <ul style="list-style-type: none">• Used to further increase engine braking• Used when going up or down hills

▶▶ Shifting

You cannot turn the ignition switch to LOCK [0] and remove the key unless the shift lever is in [P].

The vehicle may move forward very slightly even in [N] while the engine is cold. Depress the brake pedal firmly and, when necessary, apply the parking brake.

When shifting positions in extremely low temperatures (-22°F/-30°C), there may be a short delay before the shift position is displayed. Always confirm you are in the correct shift position before driving.

Shift Lever Operation

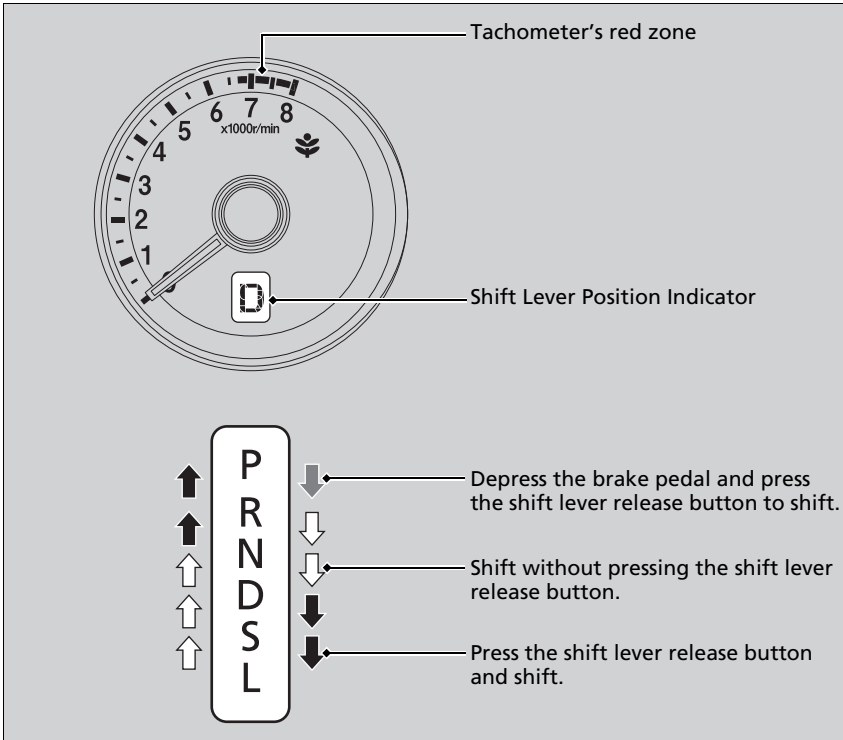

Shift Lever Operation

NOTICE

When you change the shift lever from **[D]** to **[R]** and vice versa, come to a complete stop and keep the brake pedal depressed. Operating the shift lever before the vehicle has come to a complete standstill can damage the transmission.

Use the shift lever position indicator to check the lever position before pulling away.

If the transmission indicator blinks when driving, in any shift position, there is a problem with the transmission. Avoid sudden acceleration and have the transmission checked by a dealer as soon as possible.

The fuel supply may be cut off if you drive at engine speeds in or over the tachometer red zone (engine speed limit). If this happens, you may experience a slight jolt.

It may not be possible to operate the shift lever if the brake pedal is applied while the shift lever release button is held down. Depress the brake pedal first.

Continuously variable transmission models with paddle shifters

Shifting

Change the shift position in accordance with your driving needs.

■ Shift lever positions



P **Park**
Used when parking or starting the engine

R **Reverse**
Used when reversing

N **Neutral**
Used when idling

D **Drive**
Used:
• For normal driving
• When temporarily driving in the 7-speed manual shift mode

S **Drive (S)**
Used for:
• For better acceleration
• To increase engine braking
• When going up or down hills
• When driving in the 7-speed manual shift mode

Release Button

▶▶ Shifting

You cannot change the power mode from ON to VEHICLE OFF (LOCK) unless the shift lever is in **P**.

The vehicle may move forward very slightly even in **N** while the engine is cold.

Depress the brake pedal firmly and, when necessary, apply the parking brake.

When shifting positions in extremely low temperatures (-22°F/-30°C), there may be a short delay before the shift position is displayed. Always confirm you are in the correct shift position before driving.

Shift Lever Operation

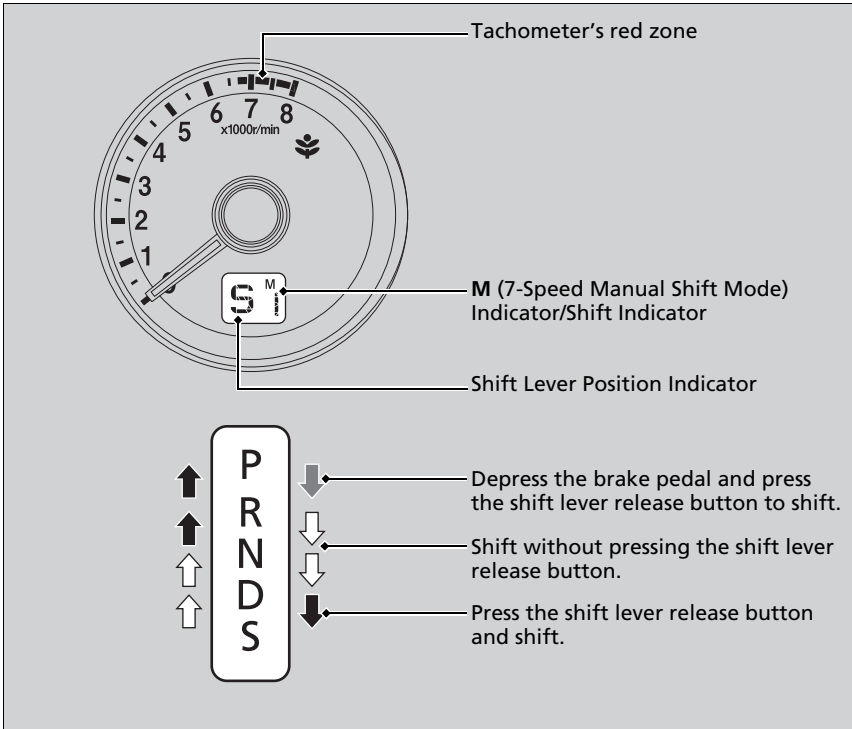

Shift Lever Operation

NOTICE

When you change the shift lever from **[D]** to **[R]** and vice versa, come to a complete stop and keep the brake pedal depressed. Operating the shift lever before the vehicle has come to a complete standstill can damage the transmission.

Use the shift lever position indicator to check the lever position before pulling away.

If the transmission indicator blinks when driving, in any shift position, there is a problem with the transmission. Avoid sudden acceleration and have the transmission checked by a dealer as soon as possible.

The fuel supply may be cut off if you drive at engine speeds in or over the tachometer red zone (engine speed limit). If this happens, you may experience a slight jolt.

It may not be possible to operate the shift lever if the brake pedal is applied while the shift lever release button is held down. Depress the brake pedal first.

■ 7-Speed Manual Shift Mode

Use the paddle shifters to change between 1st and 7th speeds without removing your hands from the steering wheel. The transmission switches to the 7-speed manual shift mode when you pull a paddle shifter while driving. This mode is useful when engine braking is needed.

■ When the shift lever is in **D**:

The shift mode goes into the 7-speed manual shift mode temporarily, and the number is displayed in the shift indicator.

The 7-speed manual shift mode is canceled automatically if you drive at constant speed or accelerate, and the number in the shift indicator goes off.

You can cancel this mode by pulling the **+** paddle shifter for a few seconds.

The 7-speed manual shift mode is especially useful when reducing the vehicle speed temporarily before making a turn.

■ When the shift lever is in **S**:

The shift mode goes into the 7-speed manual shift mode. The **M** indicator and the speed number are displayed in the shift indicator. As the vehicle speed slows down, the transmission automatically shifts down accordingly. When the vehicle comes to a stop, it automatically shifts down into 1st.

If the vehicle speed increases and the engine speed reaches near the tachometer's red zone, the transmission automatically shifts up.

You can only pull away in 1st speed.

When canceling the 7-speed manual shift mode, move the shift lever from **S** to **D**. When the 7-speed manual shift mode is canceled, the **M** indicator and shift indicator go off.

⌘ 7-Speed Manual Shift Mode

To improve fuel economy, the transmission may shift up to a higher speed than the seventh under certain circumstances. In this case, the number in the shift indicator remains as **7**.

In the 7-speed manual shift mode, the transmission shifts up or down by operating either paddle shifter under the following conditions:

Shift Up: The engine speed reaches the lowest threshold of the higher speed position.

Shift Down: The engine speed reaches the highest threshold of the lower speed position.

When the engine speed reaches near the tachometer's red zone, the transmission shifts up automatically.

When the engine speed reaches the lowest threshold of the selected speed position, the transmission shifts down automatically.

Operating the paddle shifters on slippery surfaces may cause the tires to lock up. In this case, the 7-speed manual shift mode is canceled and goes back to the normal D driving mode.

7-Speed Manual Shift Mode Operation

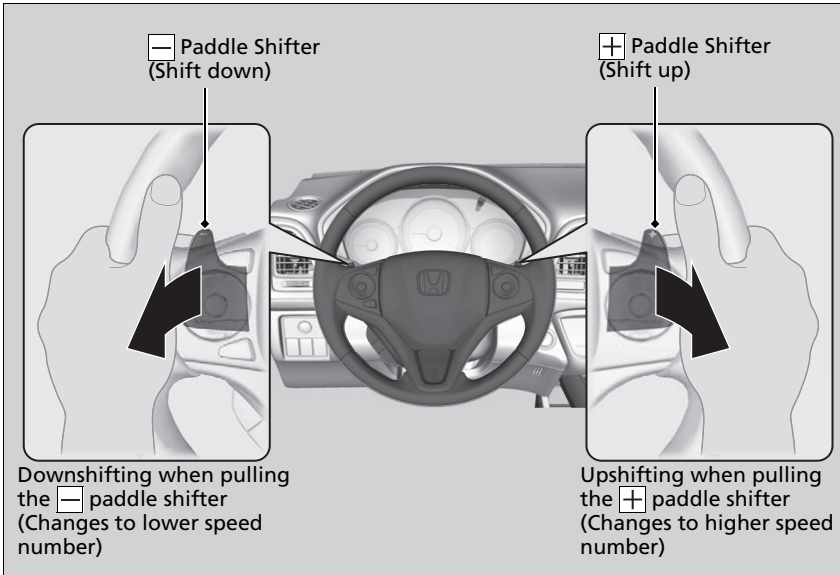

7-Speed Manual Shift Mode Operation

Each paddle shift operation makes a single speed change. To change continuously, release the paddle shifter before pulling it again for the next speed.

Recommended Shift Points

Use this table as a guideline for efficient fuel economy and effective emission control.

Shift Up	Normal Acceleration
1 to 2	15 mph (24 km/h)
2 to 3	25 mph (40 km/h)
3 to 4	40 mph (64 km/h)
4 to 5	47 mph (76 km/h)
5 to 6	52 mph (84 km/h)
6 to 7	57 mph (92 km/h)

The shift indicator blinks when you cannot shift up or down. It indicates that your vehicle speed is not in its allowable shifting range.

Slightly accelerate to shift up and decelerate to shift down while the indicator is blinking.

The shift indicator may also blink when you cannot shift down while driving in low speed. This prevents the transmission from being damaged.

Manual transmission models

Shifting

Shift Lever Operation

Fully depress the clutch pedal to operate the shift lever and change gears, then slowly release the pedal.

Depress the clutch pedal, and pause for a few seconds before shifting into **[R]**, or shift into one of the forward gears for a moment. This stops the gears so they do not “grind.”

Shifting

NOTICE

Do not shift to **[R]** before the vehicle comes to a complete stop. Shifting to **[R]** before stopping can damage the transmission.

NOTICE

Before downshifting, make sure the engine will not go into the tachometer’s red zone. Should this occur, it can severely damage your engine.

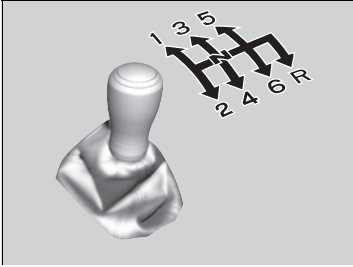

When you are not shifting, do not rest your foot on the clutch pedal. This can cause your clutch to wear out faster.

Shifting

Recommended Shift Points

Driving in the highest gear that allows the engine to run and accelerate smoothly helps to optimize fuel economy and effective emissions control. The following shift points are recommended:

Shift Up	Normal Acceleration
1st to 2nd	16 mph (25 km/h)
2nd to 3rd	26 mph (42 km/h)
3rd to 4th	35 mph (56 km/h)
4th to 5th	41 mph (66 km/h)
5th to 6th	43 mph (69 km/h)

If you exceed the maximum speed for the gear you are in, the engine speed will enter into the tachometer's red zone. When this happens, you may experience a slight jolt.

Reverse Lockout

The manual transmission has a lockout mechanism that stops you from accidentally shifting into **R** from a forward gear while the vehicle is moving above a certain speed.

If you cannot shift to **R** when the vehicle is stopped, do the following:

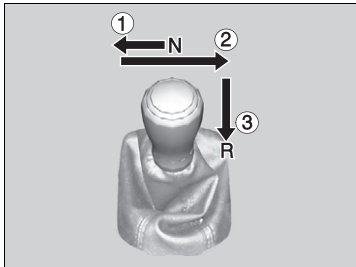

1. Depress the clutch pedal, move the shift lever all the way to the left, and shift to **R**.
2. If you still cannot shift into **R**, apply the parking brake, and turn the ignition switch to ACCESSORY **I** or LOCK **O***1.
3. Depress the clutch pedal and shift into **R**.
4. Keep depressing the clutch pedal and start the engine.

Have your vehicle checked by a dealer if you have to go through this procedure repeatedly.

*1: Models with the smart entry system have an **ENGINE START/STOP** button instead of an ignition switch.

ECON Button*



The **ECON** button turns the ECON mode on and off. The ECON mode helps you improve your fuel economy by adjusting the performance of the engine, transmission, heating and cooling system*/climate control system*, and cruise control.

▶▶ ECON Button*

Models with climate control system

While in ECON mode, the climate control system has greater temperature fluctuations.

* Not available on all models

Cruise Control

Maintains a constant vehicle speed without having to keep your foot on the accelerator. Use cruise control on freeways or open roads where you can travel at a constant speed with little acceleration or deceleration.

When to use

- Vehicle speed for cruise control: Desired speed in a range above roughly 25 mph (40 km/h) ~

Continuously variable transmission models

- Shift positions for cruise control: In **D** or **S**

Always keep sufficient distance between you and the vehicle in front of you.

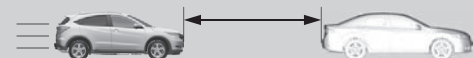

How to use

- Press the **CRUISE** button on the steering wheel.



CRUISE MAIN

CRUISE MAIN is on in the instrument panel. Cruise control is ready to use.



⚠ Cruise Control

⚠ WARNING

Improper use of the cruise control can lead to a crash.

Use the cruise control only when traveling on open highways in good weather.

It may not be possible to maintain a constant speed when driving uphill or downhill.

When not using cruise control: Turn off cruise control by pressing the **CRUISE** button.

Models with ECON button

While in ECON mode, it may take relatively more time to accelerate to maintain the set speed.

Manual transmission models

When the engine speed slows down, try to downshift.

You can maintain the set speed if you change gear within five seconds.

■ To Set the Vehicle Speed

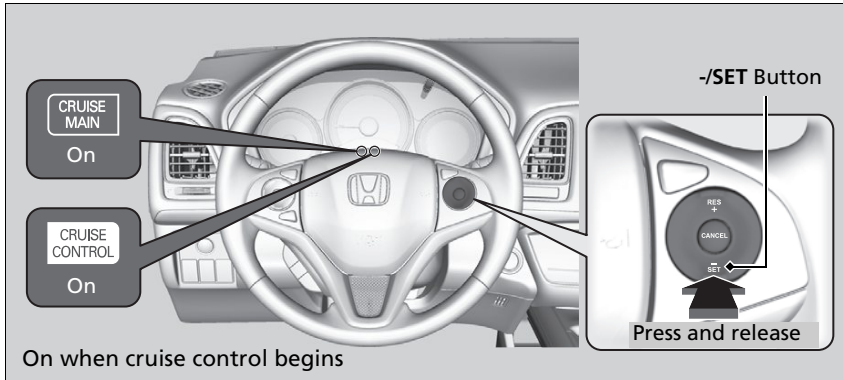

Take your foot off the pedal and press the **-/SET** button when you reach the desired speed.

The moment you release the **-/SET** button, the set speed is fixed, and cruise control begins. The **CRUISE CONTROL** indicator comes on.

■ To Adjust the Vehicle Speed

Increase or decrease the vehicle speed using the **RES/+** or **-/SET** buttons on the steering wheel.

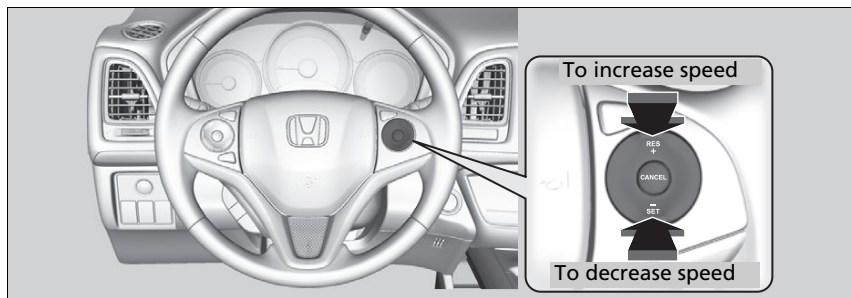

- Each time you press the button, the vehicle speed is increased or decreased by about 1 mph (1.6 km/h).
- If you keep the button pressed, the vehicle speed increases or decreases until you release it. This speed is then set.

■ To Cancel

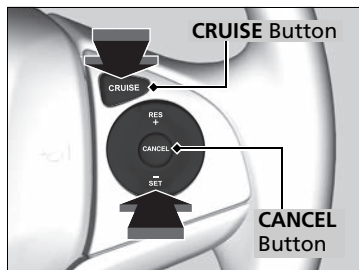

To cancel cruise control, do any of the following:

- Press the **CANCEL** button.
- Press the **CRUISE** button.
- Depress the brake pedal.

Manual transmission models

- Depress the clutch pedal for five seconds or more.

The **CRUISE CONTROL** indicator goes off.

▶▶ To Adjust the Vehicle Speed

You can set the vehicle speed using the **-/SET** button on the steering wheel when adjusting the speed with the accelerator and brake pedals.

▶▶ To Cancel

Resuming the prior set speed:
After cruise control has been canceled, you can still resume the prior set speed by pressing the **RES/+** button while driving at a speed of at least 25 mph (40 km/h) or more.

You cannot set or resume in the following situations:

- When vehicle speed is less than 25 mph (40 km/h)
- When the **CRUISE** button is turned off

At vehicle speeds of 22 mph (35 km/h) or less, cruise control is canceled automatically.

Canadian models

Forward Collision Warning (FCW)*

Alerts you when it determines there is a possibility of your vehicle colliding with the vehicle detected in front of yours.

If the system determines a collision is possible, it gives both visual and audible alerts.

- ▶ Take appropriate action to prevent a collision (apply the brakes, change lanes, etc.).

■ How the system works

The system may give warnings of potential collisions when your vehicle speed is above 10 mph (15 km/h).

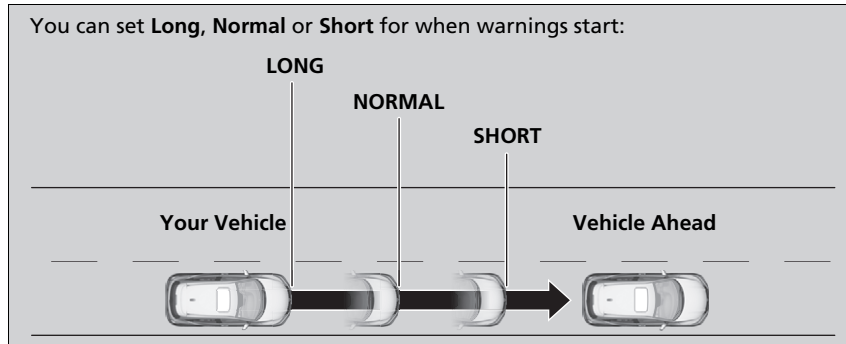

* Not available on all models

Continued

⊞ Forward Collision Warning (FCW)*

Important Safety Reminder

FCW cannot detect all objects ahead and may not detect a given object; accuracy of the system will vary based on weather, speed and other factors. FCW does not include a braking function. It is always your responsibility to safely operate the vehicle and avoid collisions.

You can change the Forward Collision Warning Distance setting or turn the system on and off.

- ⊞ **To change vehicle distance and to turn the system on and off** P. 349

The camera is shared with Lane Departure Warning (LDW).

- ⊞ **LDW Camera** P. 352

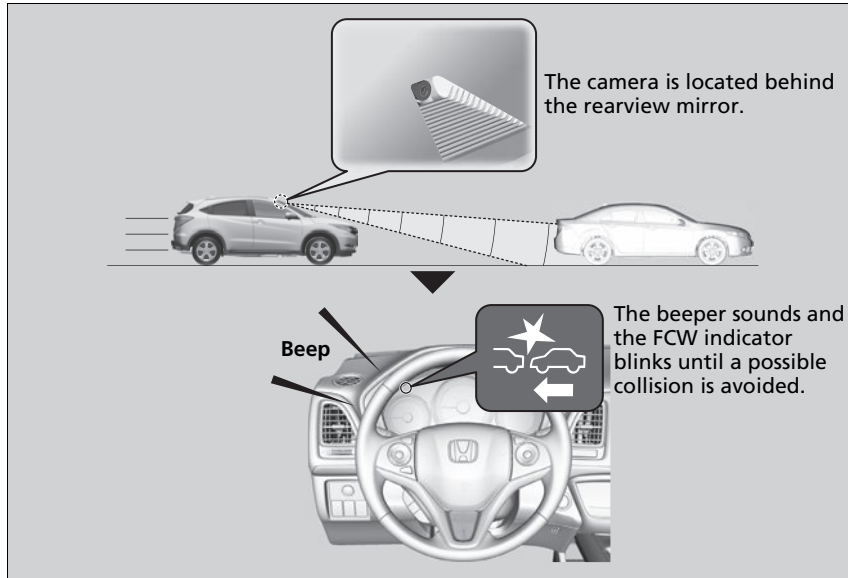

⊠ Forward Collision Warning (FCW)*

Never apply a film or attach any objects to the windshield that could obstruct the FCW camera's field of vision. Scratches, nicks, and other damage to the windshield within the FCW camera's field of vision can cause the system to operate abnormally. If this occurs, we recommend that you replace the windshield with a genuine Honda replacement windshield. Making even minor repairs within the camera's field of vision or installing an aftermarket replacement windshield may also cause the system to operate abnormally. After replacing the windshield, have a dealer recalibrate the camera. Proper calibration of the FCW camera is necessary for the system to operate properly.

■ To change vehicle distance and to turn the system on and off

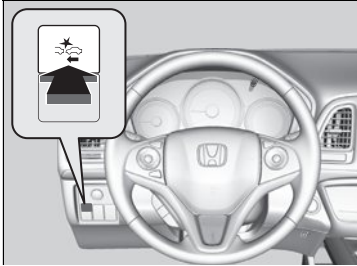

Press the  (FCW) button to change FCW range.

Each time you press the button, the warning distance (the distance behind a vehicle detected ahead of you) setting cycles through **FCW LONG**, **FCW NORMAL**, and **FCW SHORT** warning distance.

➤ **Information Display Warning and Information Messages** P. 85

To turn the system on and off, press and hold the button until you hear a beep.

■ Automatic shutoff

FCW may automatically shut itself off and the FCW indicator comes and stays on when:

- The temperature inside the system is high.
- The windshield is blocked by dirt, mud, leaves, wet snow, etc.

Once the conditions that caused FCW to shut off improve or are addressed (e.g., cleaning), the system comes back on.

⊗ Automatic shutoff

To help reduce the likelihood that high interior temperatures will cause the camera system to shut off, when parking, find a shady area or face the front of the vehicle away from the sun. If you use a reflective sun shade, do not allow it to cover the camera housing. Covering the camera can concentrate heat on the camera.

If the **CAMERA HOT** message appears:

- Use the climate control system to cool down the interior and, if necessary, the defroster mode when windows are fogged.
- Start driving the vehicle to lower the windshield temperature, which cools down the area around the FCW system.

FCW Limitations

FCW may not activate or may not detect a vehicle in front of your vehicle, and may activate even when you are aware of a vehicle ahead of you, or when there is no vehicle ahead under the following conditions.

Condition

- The distance between your vehicle and the vehicle ahead of you is too short.
- A vehicle cuts in front of you at a slow speed, and it brakes suddenly.
- A vehicle suddenly crosses in front of you.
- When either your vehicle or the vehicle ahead of you accelerates rapidly.
- The vehicle ahead of you is a motorcycle, a small vehicle, or a unique vehicle such as a tractor.
- When you drive off-road or on a mountain road, or curved and winding road for an extended period that makes it difficult for the camera to properly detect a vehicle in front of you.
- When there are pedestrians or animals in front of your vehicle.
- When you drive in bad weather (rain, fog, etc.).
- A heavy load in the rear or modifications to the suspension tilts your vehicle.
- An abnormal tire condition is detected (wrong tire size, flat tire, etc.).
- When the windshield is blocked by dirt, mud, leaves, wet snow, etc.
- When the temperature inside the system is high.
- A sudden change between light and dark such as an entrance or exit of a tunnel.
- You drive into the sunlight (e.g. at dawn or dusk).
- When the windshield is dirty or cloudy.
- When streetlights are perceived as the taillight of a vehicle in front of yours.
- When driving at night, the vehicle ahead of you is running with either taillight bulb burned out.
- When you drive in the shadows of trees, buildings, etc.

Lane Departure Warning (LDW)*

Alerts you when the system determines it is possible of your vehicle unintentionally crossing over detected left or right side lane markings.

How the System Works

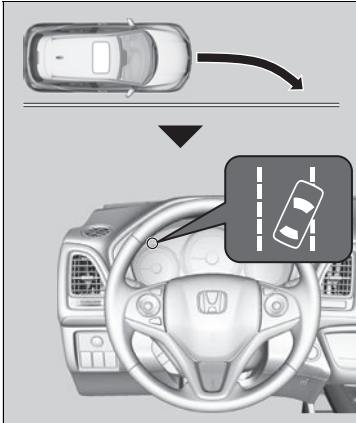

If your vehicle is getting too close to detected left or right side lane markings without a turn signal activated, LDW will give audible and visual alerts.

The beeper sounds and the LDW indicator blinks, letting you know that you need to take appropriate action.

⚠ Lane Departure Warning (LDW)*

Important Safety Reminder

Like all assistance systems, LDW has limitations. Over-reliance on LDW may result in a collision. It is always your responsibility to keep the vehicle within your driving lane.

LDW only alerts you when lane drift is detected without a turn signal in use. LDW may not detect all lane markings or lane departures; accuracy will vary based on weather, speed and lane marker condition. It is always your responsibility to safely operate the vehicle and avoid collisions.

* Not available on all models

Continued

■ How the System Activates

The system begins to search for lane markings when all the following conditions are met:

- The vehicle is traveling between at 45-90 mph (72-145 km/h).
- The vehicle is on a straight or slightly curved road.
- The turn signals are off.
- The brake pedal is not pressed.

■ LDW Camera

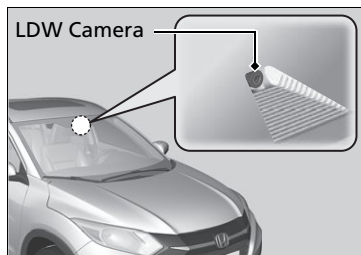

The camera is located behind the rearview mirror.

■ LDW On and Off

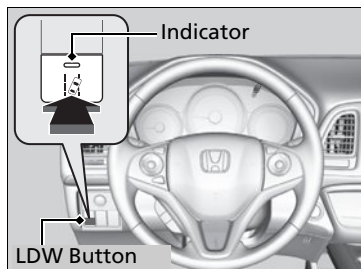

Press the LDW button to turn the system on and off.

- ▶ The indicator in the button comes on when the system is on.

▶ How the System Activates

LDW may automatically shut off and the LDW indicator comes and stays on.

▶ Indicators P. 84

▶ LDW Camera

Never apply a film or attach any objects to the windshield that could obstruct the LDW camera's field of vision.

Scratches, nicks, and other damage to the windshield within the LDW camera's field of vision can cause the system to operate abnormally. If this occurs, we recommend that you replace the windshield with a genuine Honda replacement windshield. Making even minor repairs within the camera's field of vision or installing an aftermarket replacement windshield may also cause the system to operate abnormally. After replacing the windshield, have a dealer recalibrate the camera. Proper calibration of the LDW camera is necessary for the system to operate properly.

To help reduce the likelihood that high interior temperatures will cause the camera system to shut off, when parking, find a shady area or face the front of the vehicle away from the sun. Also, do not use a reflective sunshade that can concentrate heat on the camera.

If the **CAMERA HOT** message appears:

- Use the climate control system to cool down the interior and, if necessary, the defroster mode when windows are fogged.
- Start driving the vehicle to lower the windshield temperature, which cools down the area around the LDW system.

LDW Limitations

LDW may not activate or may not recognize lanes, and may activate even when keeping in the middle of a lane under the following conditions.

Condition

- When you drive in bad weather (rain, fog, etc.).
- A heavy load in the rear or modifications to the suspension tilts your vehicle.
- An abnormal tire condition is detected (wrong tire size, flat tire, etc.).
- When the windshield is blocked by dirt, mud, leaves, wet snow, etc.
- When the temperature inside the system is high.
- A sudden change between light and dark such as an entrance or exit of a tunnel.
- You drive into the sunlight (e.g. at dawn or dusk).
- When the windshield is dirty or cloudy.
- When you drive in the shadows of trees, buildings, etc.
- When you drive on a wet road surface following another vehicle.
 - ▶ The camera may perceive the tire tracks in the water as lane lines.
- When there is snow or wheel tracks on the side of the road.
- When the road has many repaired areas or an erased lane line.
- When the vehicle is running over painted signs or crosswalk markings.
- When you drive in a lane with worn-out lane markups.

Vehicle Stability Assist (VSA®), aka Electronic Stability Control (ESC), System

Helps to stabilize the vehicle during cornering if the vehicle turns more or less than what was intended. It also assists in maintaining traction on slippery surfaces. It does so by regulating engine output and selectively applying the brakes.

■ VSA® Operation

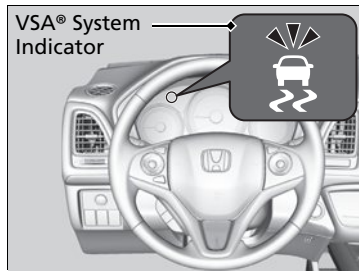

When VSA® activates, you may notice that the engine does not respond to the accelerator. You may also notice some noise from the hydraulic system. You will also see the indicator blink.

▣ Vehicle Stability Assist (VSA®), aka Electronic Stability Control (ESC), System

VSA® may not function properly if tire type and size are mixed. Make sure to use the same size and type of tire, and the air pressures as specified.

When the VSA® indicator comes on and stays on while driving, there may be a problem with the system. While this may not interfere with normal driving, have your vehicle checked by a dealer immediately.

VSA® cannot enhance stability in all driving situations and does not control the entire braking system. You still need to drive and corner at speeds appropriate for the conditions and always leave a sufficient margin of safety.

The main function of the VSA® system is generally known as Electronic Stability Control (ESC). The system also includes a traction control function.

VSA® OFF Button

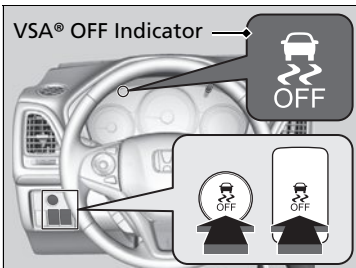

This button is on the driver side control panel. To partially turn the VSA features on and off, press and hold it until you hear a beep.

The traction control stops fully functioning, allows the wheels to spin more freely at low speed. The VSA® OFF indicator will also come on.

To turn it on again, press the  (VSA® **OFF**) button until you hear a beep.

VSA® is turned on every time you start the engine, even if you turned it off the last time you drove the vehicle.

Vehicle Stability Assist (VSA®), aka Electronic Stability Control (ESC), System

With the  button pressed, your vehicle will have normal braking and cornering ability, but VSA® traction and stability enhancement becomes less effective.

In certain unusual conditions when your vehicle gets stuck in shallow mud or fresh snow, it may be easier to free it with the VSA® temporarily switched off.

When the  button is pressed, the traction control function becomes less effective. This allows for the wheels to spin more freely at low speed. You should only attempt to free your vehicle with the VSA® off if you are not able to free it when the VSA® is on.

Immediately after freeing your vehicle, be sure to switch VSA® on again. We do not recommend driving your vehicle with the VSA® system switched off.

You may hear a motor sound coming from the engine compartment while system checks are being performed immediately after starting the engine or while driving. This is normal.

LaneWatch™*

Is an assistance system that allows you to check the passenger side rear areas displayed on the audio/information screen when the turn signal is activated to the passenger's side. A camera in the passenger side door mirror monitors these areas and allows you to check for vehicles, in addition to your visual check and use of the passenger door mirror. You can also keep the system on for your convenience while driving.

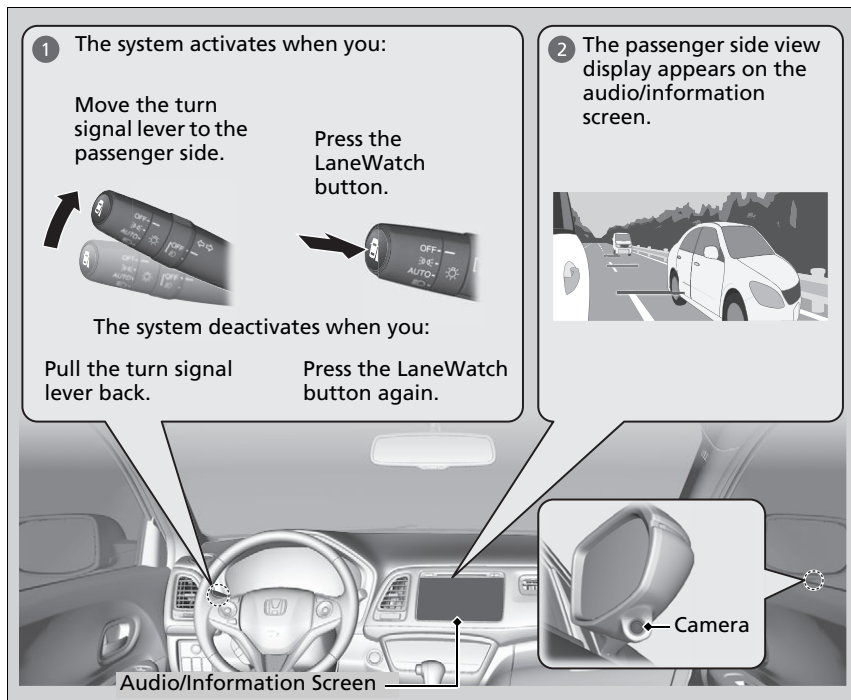

▶ LaneWatch™*

⚠ WARNING

Failure to visually confirm that it is safe to change lanes before doing so may result in a crash and serious injury or death.

Do not rely only on LaneWatch while driving.

Always look in your mirrors, to either side of your vehicle, and behind you for other vehicles before changing lanes.

Important Safety Reminder

Like all assistance systems, LaneWatch has limitations. Over reliance on LaneWatch may result in a collision.

The LaneWatch function can be affected by weather, lighting (including headlights and low sun angle), ambient darkness, camera condition, and loading.

The LaneWatch may not provide the intended display of traffic to the side and rear under the following conditions:

- Your vehicle's suspension has been altered, changing the height of the vehicle.
- Your tires are over or under inflated.
- Your tires or wheels are of varied size or construction.

■ Customizing the LaneWatch settings

You can customize the following items using the audio/information screen.

- **Show with Turn Signal:** Selects whether LaneWatch monitor comes on when you operate the turn signal light lever.
- **Display Time after Turn Signal Off:** Changes the length of time the LaneWatch display stays on after you pull the turn signal lever back.
- **Reference Line:** Selects whether the reference lines appear on the LaneWatch monitor.
- **Next Maneuver Pop up*:** Selects whether a turn direction screen of the navigation system interrupts the LaneWatch display.
- **Display:** Adjusts display settings.
 - **Customized Features** P. 238

■ Reference Lines

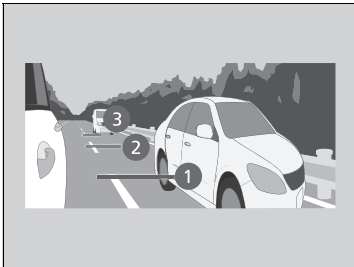

Three lines that appear on the screen can give an idea of how far the vehicles or objects on the screen are from your vehicle, respectively. If an object is near line 1 (in red), it indicates that it is close to your vehicle whereas an object near line 3 farther away.

☒ LaneWatch™*

The LaneWatch camera view is restricted. Its unique lens makes objects on the screen look slightly different from what they are.

LaneWatch display does not come on when the shift lever is in **[R]**.

For proper LaneWatch operation:

- The camera is located in the passenger side door mirror. Always keep this area clean. If the camera lens is covered with dirt or moisture, use a soft, moist cloth to keep the lens clean and free of debris.
- Do not cover the camera lens with labels or stickers of any kind.
- Do not touch the camera lens.

☒ Reference Lines

The area around the reference line 1 (red) is very close to your vehicle. As always, make sure to visually confirm the safety of a lane change before changing lanes.

The distance between your vehicle and lines 1, 2 and 3 on the screen vary depending on road conditions and vehicle loading. For example, the reference lines on the screen may seem to appear closer than the actual distances when the rear of your vehicle is more heavily loaded.

Consult a dealer if:

- The passenger side door mirror, or area around it is severely impacted, resulting in changing the camera angle.
- The LaneWatch display does not come on at all.

* Not available on all models

Real Time AWD with Intelligent Control System™*

Your vehicle is equipped with the AWD system. When the system senses a loss of front wheel traction, it automatically transfers some power to the rear wheels. This allows you to utilize all available traction and may increase mobility.

You still need to exercise the same care when accelerating, steering, and braking that you would in a two wheel drive vehicle.

If you excessively spin all four wheels and overheat the AWD system, only the front wheels receive power. Stop until the system cools down.

⌘ Real Time AWD with Intelligent Control System™*

NOTICE

Do not continuously spin the front tires of your vehicle. Continuously spinning the front tires can cause transmission or rear differential damage.

The AWD system may not function properly if tire type and size are mixed. Make sure to use the same size and type of tire, and the air pressures as specified.

➤ **Tire and Wheel Replacement** P. 417

U.S. models only

Tire Pressure Monitoring System (TPMS)

Instead of directly measuring the pressure in each tire, the TPMS on this vehicle monitors and compares the rolling radius and rotational characteristics of each wheel and tire while you are driving to determine if one or more tires are significantly under-inflated. This will cause the low tire pressure/TPMS indicator to come on.

TPMS Calibration

You must start TPMS calibration every time you:

- Adjust the pressure in one or more tires.
- Rotate the tires.
- Replace one or more tires.

Before calibrating the TPMS:

- Set the cold tire pressure in all four tires.

➤ **Checking Tires** P. 411

Make sure:

- The vehicle is at a complete stop.

- **Manual transmission models**

The shift lever is in **N**.

- **Continuously variable transmission models**

The shift lever is in **P**.

- **All models**

The ignition switch is in ON **II***1.

*1: Models with the smart entry system have an **ENGINE START/STOP** button instead of an ignition switch.

⊗ Tire Pressure Monitoring System (TPMS)

The system does not monitor the tires when driving at low speed.

Conditions such as low ambient temperature and altitude change directly affect tire pressure and can trigger the low tire pressure/TPMS indicator to come on.

Tire pressure checked and inflated in:

- Warm weather can become under-inflated in colder weather.
- Cold weather can become over-inflated in warmer weather.

The low tire pressure/TPMS indicator will not come on as a result of over inflation.

The TPMS may not function properly if tire type and size are mixed. Make sure to use the same size and type of tire.

➤ **Checking and Maintaining Tires** P. 411

The low tire pressure/TPMS indicator may come on with a delay or may not come on at all when:

- You rapidly accelerate, decelerate, or turn the steering wheel.
- You drive on snowy or slippery roads.
- Snow chains are used.

The low tire pressure/TPMS indicator may come on under the following conditions:

- A compact spare tire is used.
- There is a heavier and uneven load on the tires than the condition at calibration.
- Snow chains are used.

Continued

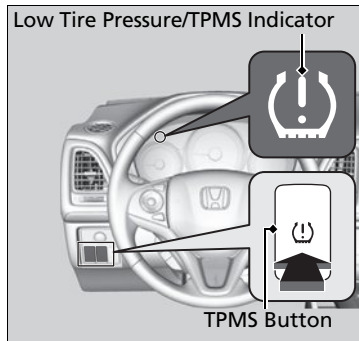

Press and hold the TPMS button until the low tire pressure/TPMS indicator blinks twice, indicating the calibration process has begun.

- If the low tire pressure/TPMS indicator does not blink, confirm the above conditions then press and hold the TPMS button again.
- The calibration process finishes automatically.

▶▶ TPMS Calibration

- TPMS cannot be calibrated if a compact spare tire is installed.
- The calibration process requires approximately 30 minutes of cumulative driving at speeds between 30-60 mph (48-97 km/h).
- During this period, if the ignition is turned on*1 and the vehicle is not moved within 45 seconds, you may notice the low tire pressure/TPMS indicator comes on briefly. This is normal and indicates that the calibration process is not yet complete.

If the snow chains are installed, remove them before calibrating the TPMS.

If the low tire pressure/TPMS indicator comes on even when the properly inflated specified regular tires are installed, have your vehicle checked by a dealer.

We recommend that the tires be replaced with the same brand, model, and size as the originals. Ask a dealer for details.

*1: Models with the smart entry system have an **ENGINE START/STOP** button instead of an ignition switch.

U.S. models

Tire Pressure Monitoring System (TPMS) - Required Federal Explanation

Each tire, including the spare (if provided), should be checked monthly when cold and inflated to the inflation pressure recommended by the vehicle manufacturer on the vehicle placard or tire inflation pressure label.

(If your vehicle has tires of a different size than the size indicated on the vehicle placard or tire inflation pressure label, you should determine the proper tire inflation pressure for those tires.)

As an added safety feature, your vehicle has been equipped with a tire pressure monitoring system (TPMS) that illuminates a low tire pressure telltale



when one or more of your tires is significantly under-inflated.

Accordingly, when the low tire pressure telltale illuminates, you should stop and check your tires as soon as possible, and inflate them to the proper pressure.

Driving on a significantly under-inflated tire causes the tire to overheat and can lead to tire failure. Under-inflation also reduces fuel efficiency and tire tread life, and may affect the vehicle's handling and stopping ability.

Please note that the TPMS is not a substitute for proper tire maintenance, and it is the driver's responsibility to maintain correct tire pressure, even if under-inflation has not reached the level to trigger illumination of the TPMS low tire pressure telltale.

Your vehicle has also been equipped with a TPMS malfunction indicator to indicate when the system is not operating properly. The TPMS malfunction indicator is combined with the low tire pressure telltale. When the system detects a malfunction, the telltale will flash for approximately one minute and then remain continuously illuminated. This sequence will continue upon subsequent vehicle start-ups as long as the malfunction exists.

When the malfunction indicator is illuminated, the system may not be able to detect or signal low tire pressure as intended.

TPMS malfunctions may occur for a variety of reasons, including the installation of replacement or alternate tires or wheels on the vehicle that prevent the TPMS from functioning properly.

Always check the TPMS malfunction telltale after replacing one or more tires or wheels on your vehicle to ensure that the replacement or alternate tires and wheels allow the TPMS to continue to function properly.

Brake System

■ Parking Brake

Use the parking brake to keep the vehicle stationary when parked. You can manually apply and release, or automatically release it.

■ Manual operations

Use the electric parking brake switch to apply or release the brake. Manually releasing the parking brake using the switch helps your vehicle start slowly and smoothly when facing down hill on steep hills.



■ To apply manually

Pull the electric parking brake switch up gently and securely.

- ▶ The electric parking brake indicator comes on.

■ To release manually

1. Depress the brake pedal.
2. Press the electric parking brake switch.

- ▶ The electric parking brake indicator goes off.

*1: Models with the smart entry system have an **ENGINE START/STOP** button instead of an ignition switch.

⊗ Parking Brake

You may hear the electric parking brake system operating from the rear wheel area when you apply or release the parking brake, or turn the ignition switch to LOCK [0]*1. This is normal.

The brake pedal may slightly move due to the electric parking brake system operation when you apply or release the parking brake. This is normal.

You cannot apply or release the parking brake if the battery goes dead.

⊗ Jump Starting P. 446

If you pull up the electric parking brake switch while driving, the parking brake is applied.

In the following situations, the parking brake automatically operates.

- When the vehicle stops with the automatic brake hold system activated for more than 10 minutes.

■ To release automatically

Use the accelerator pedal to release the brake when you are starting the vehicle facing uphill, or in a traffic jam.

Continuously variable transmission models

Depressing the accelerator pedal releases the parking brake.

Manual transmission models

Depressing the accelerator pedal while releasing the clutch pedal releases the parking brake.

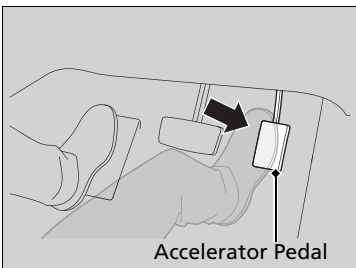

Continuously variable transmission models

Gently depress the accelerator pedal.

- The electric parking brake indicator goes off.

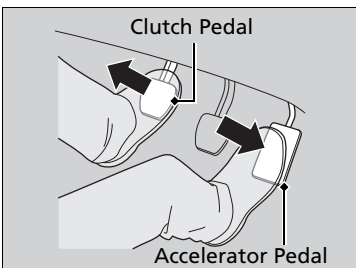

Manual transmission models

Gently depress the accelerator pedal and release the clutch pedal.

- The electric parking brake indicator goes off.

▣ Parking Brake

If the parking brake cannot be released automatically, release it manually.

The parking brake cannot be released automatically while the following indicators are on:

- Malfunction indicator lamp
- Transmission indicator

The parking brake may not be released automatically while the following indicators are on:

- Electric parking brake system indicator
- VSA® system indicator
- **ABS** indicator
- Supplemental restraint system indicator

Manual transmission models

The clutch pedal is fully depressed before gently depress the accelerator pedal and release the clutch pedal.

You can release the parking brake automatically when:

- You are wearing the driver's seat belt.
- The engine is running.

Continuously variable transmission models

- The transmission is not in **P** or **N**.

Manual transmission models

- The transmission is not in **N**.

Foot Brake

Your vehicle is equipped with disc brakes at all four wheels. A vacuum power assist helps to reduce the effort needed on the brake pedal. The brake assist system increases the stopping force when you depress the brake pedal hard in an emergency situation. The anti-lock brake system (ABS) helps you retain steering control when braking very hard.

➤ **Brake Assist System** P. 370

➤ **Anti-lock Brake System (ABS)** P. 369

Foot Brake

Check the brakes after driving through deep water, or if there is a buildup of road surface water. If necessary, dry the brakes by lightly depressing the pedal several times.

If you hear a continuous metallic friction sound when applying the brakes, the brake pads need to be replaced. Have your vehicle checked by a dealer.



Constantly using the brake pedal while going down a long hill builds up heat, which reduces the brake effectiveness. Apply engine braking by taking your foot off the accelerator pedal and downshifting to a lower gear/speed position. With manual transmission use a lower gear for greater engine braking.

Do not rest your foot on the brake pedal while driving, as it will lightly apply the brakes and cause them to lose effectiveness over time and reduce pad life. It will also confuse drivers behind you.

Automatic Brake Hold

Continuously variable transmission models

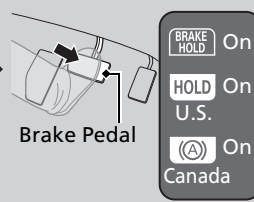
Keeps the brake applied after releasing the brake pedal until the accelerator pedal is pressed. You can use this system while the vehicle is temporarily stopped, such as when you stop at a traffic light.

■ Turning on the system	■ Activating the system	■ Canceling the system
 <p>Automatic Brake Hold Button</p>	 <p>Brake Pedal</p>	 <p>Accelerator Pedal</p>
<p>Fasten your seat belt properly, then start the engine. Press the automatic brake hold button.</p> <ul style="list-style-type: none"> • The automatic brake hold system indicator comes on. The system is turned on. 	<p>Depress the brake pedal to come to a complete stop. The shift lever must be in other than P or R.</p> <ul style="list-style-type: none"> • The automatic brake hold indicator comes on. Braking is kept for up to 10 minutes. • Release the brake pedal after the automatic brake hold indicator comes on. 	<p>Depress the accelerator pedal while the shift lever is in other than P or N. The system is canceled and the vehicle starts to move.</p> <ul style="list-style-type: none"> • The automatic brake hold indicator goes off. The system releases the brake automatically.

Automatic Brake Hold

⚠ WARNING

Activating the automatic brake hold system on steep hills or slippery roads may still allow the vehicle to move if you remove your foot from the brake pedal.

If a vehicle unexpectedly moves, it may cause a crash resulting in serious injury or death.

Never activate the automatic brake hold system or rely on it to keep a vehicle from moving when stopped on a steep hill or slippery roads.

⚠ WARNING

Using the automatic brake hold system to park the vehicle may result in the vehicle unexpectedly moving.

If a vehicle moves unexpectedly, it may cause a crash, resulting in serious injury or death.

Never leave the vehicle when braking is temporarily kept by automatic brake hold and always park the vehicle by putting the transmission in **P** and applying the parking brake.

Manual transmission models

Keeps the brake applied after releasing the brake pedal until you change a gear to a position other than **N** and:

- Release the clutch pedal on a level road or when facing downhill.
- Release the clutch pedal and depress the accelerator pedal when facing uphill.

You can use this system while the vehicle is temporarily stopped, such as when you stop at a traffic light.

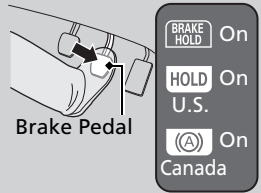
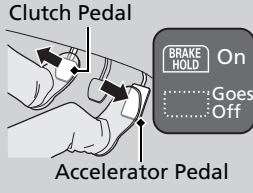
■ Turning on the system	■ Activating the system	■ Canceling the system
 <p>Automatic Brake Hold Button</p>	 <p>Brake Pedal</p>	 <p>Clutch Pedal Accelerator Pedal</p>
<p>Fasten your seat belt properly, then start the engine. Press the automatic brake hold button.</p> <ul style="list-style-type: none"> • The automatic brake hold system indicator comes on. The system is turned on. 	<p>Depress the brake pedal to come to a complete stop.</p> <ul style="list-style-type: none"> • The automatic brake hold indicator comes on. Braking is kept for up to 10 minutes. • Release the brake pedal after the automatic brake hold indicator comes on. 	<p>Shift into one of the gears other than N and:</p> <ul style="list-style-type: none"> • Release the clutch pedal on a level road or when facing downhill. • Release the clutch pedal and depress the accelerator pedal when facing uphill. <p>The system is canceled and the vehicle starts to move.</p> <ul style="list-style-type: none"> • The automatic brake hold indicator goes off. The system releases the brake automatically.

Continued

■ **The system automatically cancels when:**

- You engage the parking brake.

Continuously variable transmission models

- You depress the brake pedal and move the shift lever to **P** or **R**.

Under the following conditions, the system automatically cancels, and the parking brake is applied:

- Braking is kept for more than 10 minutes.
- The driver's seat belt is unfastened.
- The engine is turned off.
- There is a problem with automatic brake hold system.

Manual transmission models

- The engine stalls.

■ **Turning off the automatic brake hold system**

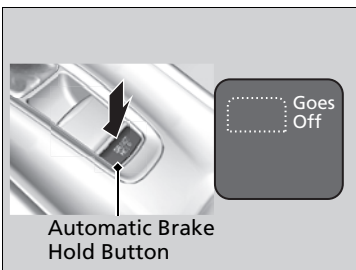

While the system is on, press the automatic brake hold button again.

- The automatic brake hold system indicator goes off.

If you want to turn off automatic brake hold while the system is in operation, press the automatic brake hold button with the brake pedal depressed.

►► Automatic Brake Hold

While the system is activated, you can turn off the engine or park the vehicle through the same procedure as you normally do.

► **When Stopped** P. 371

Whether the system is on, or the system is activated, the automatic brake hold turns off once the engine is off.

Manual transmission models

The system turns off if the engine stalls while automatic brake hold is active or the system is on.

►► Turning on the system

Make sure to turn off the automatic brake hold system before using an automated car wash.

You may hear an operating noise if the vehicle moves while the automatic brake hold system is in operation. The system generates sound while holding the vehicle and it moves.

Anti-lock Brake System (ABS)

■ ABS

Helps prevent the wheels from locking up, and helps you retain steering control by pumping the brakes rapidly, much faster than you.

The electronic brake distribution (EBD) system, which is part of the ABS, also balances the front-to-rear braking distribution according to vehicle loading.

You should never pump the brake pedal. Let the ABS work for you by always keeping firm, steady pressure on the brake pedal. This is sometimes referred to as “stomp and steer.”

■ ABS operation

The brake pedal may pulsate slightly when the ABS is working. Keep holding the pedal firmly down. On dry pavement, you will need to press on the brake pedal very hard before the ABS activates. However, you may feel the ABS activate immediately if you are trying to stop on snow or ice.

When the vehicle speed goes under 6 mph (10 km/h), the ABS stops.

▶▶ Anti-lock Brake System (ABS)

NOTICE

The ABS may not function correctly if you use an incorrect tire type and size.

When the **ABS** indicator comes on while driving, there may be a problem with the system. While normal braking is not affected, there is a possibility of the ABS not operating. Have your vehicle checked by a dealer immediately.

The ABS does not reduce the time or distance it takes to stop the vehicle. It only helps with steering control during hard braking.

In the following cases, your vehicle may need more stopping distance than a vehicle without the ABS:

- When driving on rough road surfaces, including when driving on uneven surfaces, such as gravel or snow.
- When tire chains are installed.

You may hear a motor sound coming from the engine compartment while system checks are being performed immediately after starting the engine or while driving. This is normal.

Brake Assist System

■ Brake Assist System

Designed to assist the driver by generating greater braking force when you depress the brake pedal hard during emergency braking.

■ Brake assist system operation

Press the brake pedal firmly for more powerful braking.

When brake assist operates, the pedal may wiggle slightly and an operating noise may be heard. This is normal. Keep holding the brake pedal firmly down.

When Stopped

1. Depress the brake pedal firmly.
2. With the brake pedal depressed, pull up the electric parking brake switch slowly, but fully.

Continuously variable transmission models

3. Move the shift lever from **D** to **P**.

Manual transmission models

3. Move the shift lever to **R**.
4. Turn off the engine.
 - ▶ The electric parking brake indicator goes off in about 15 seconds.

Always confirm the electric parking brake is set, in particular if you are parked on an incline.

▣ Parking Your Vehicle

Do not park your vehicle near flammable objects, such as dry grass, oil, or timber. Heat from the exhaust can cause a fire.

▣ When Stopped

NOTICE

Continuously variable transmission models

The following can damage the transmission:

- Depressing the accelerator and brake pedals simultaneously.
- Holding the vehicle in place when facing uphill by depressing the accelerator pedal.
- Moving the shift lever into **P** before the vehicle stops completely.

Raise the wiper arms when snow is expected.

Multi-View Rear Camera

Models with navigation system

See the Navigation System Manual.

Models without navigation system

About Your Multi-View Rear Camera

The audio/information screen can display your vehicle's rear view.

The display automatically changes to a rear view when the shift lever is moved to **R**.

Multi-View Rear Camera Display Area

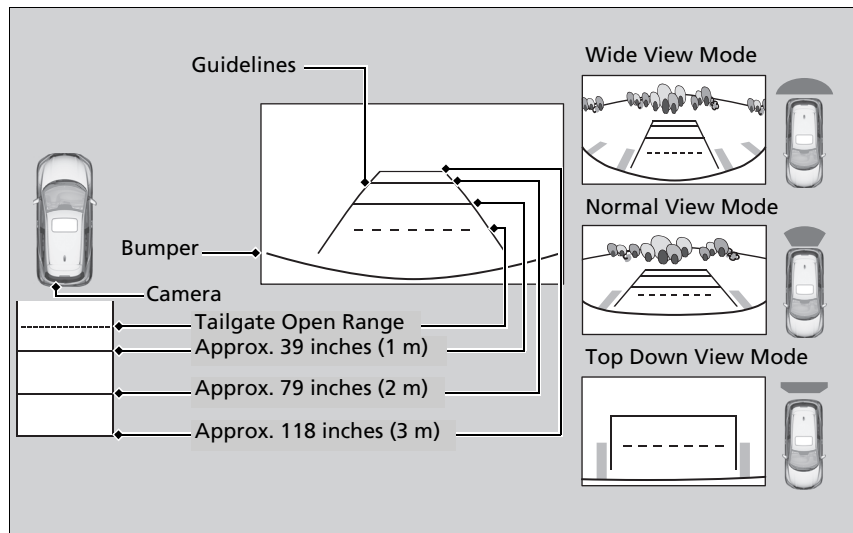

About Your Multi-View Rear Camera

The rear camera view is restricted. You cannot see the corner ends of the bumper or what is underneath the bumper. Its unique lens also makes objects appear closer or farther than they actually are.

Visually confirm that it is safe to drive before backing up. Certain conditions (such as weather, lighting, and high temperatures) may also restrict the rear view. Do not rely on the rearview display which does not give you all information about conditions at the back of your vehicle.

If the camera lens is covered with dirt or moisture, use a soft, moist cloth to keep the lens clean and free of debris.

Models with display audio system

You can change the **Fixed Guideline** and **Dynamic Guideline** settings.

➤ **Customized Features** P. 245

Fixed Guideline

On: Guidelines appear when you shift into **R**.

Off: Guidelines do not appear.

Dynamic Guidelines

On: Guidelines move according to the steering wheel direction.

Off: Guidelines do not move.

You can view three different camera angles on the rearview display.

Models with color audio system

Press the **LIST/SELECT** (selector) knob to switch the angle.

Models with display audio system

Touch the appropriate icon to switch the angle.

 : Wide view

 : Normal view

 : Top down view

All models

If the last used viewing mode is Wide or Normal, the same mode is selected the next time you shift into **R**. If Top View is last used before you turned off the engine, Wide mode is selected next time you turn the ignition switch to ON **II**^{*1} and shift to **R**.

*1: Models with the smart entry system have an **ENGINE START/STOP** button instead of an ignition switch.

Fuel Information

■ Fuel recommendation

Unleaded gasoline, pump octane number 87 or higher

Use of lower octane gasoline can cause a persistent, heavy metallic knocking noise that can lead to engine damage.

■ Top tier detergent gasoline

Because the level of detergency and additives in gasoline vary in the market, Honda endorses the use of "TOP TIER Detergent Gasoline" where available to help maintain the performance and reliability of your vehicle. TOP TIER Detergent Gasoline meets a new gasoline standard jointly established by leading automotive manufacturers to meet the needs of today's advanced engines.

Qualifying gasoline retailers will, in most cases, identify their gasoline as having met "TOP TIER Detergent Gasoline" standards at the retail location. This fuel is guaranteed to contain the proper level of detergent additives and be free of metallic additives. The proper level of detergent additives, and absence of harmful metallic additives in gasoline, help avoid build-up of deposits in your engine and emission control system.

For further important fuel-related information for your vehicle, or on information on gasoline that does not contain MMT, visit www.hondacars.com. In Canada, visit www.honda.ca for additional information on gasoline. For more information on top tier gasoline, visit www.toptiergas.com.

■ **Fuel tank capacity: 13.2 US gal (50 liters)**

» Fuel Information

NOTICE

We recommend quality gasoline containing detergent additives that help prevent fuel system and engine deposits. In addition, in order to maintain good performance, fuel economy, and emissions control, we strongly recommend the use of gasoline that does NOT contain harmful manganese-based fuel additives such as MMT, if such gasoline is available.

Use of gasoline with these additives may adversely affect performance, and cause the malfunction indicator lamp on your instrument panel to come on. If this happens, contact a dealer for service.

Some gasoline today is blended with oxygenates such as ethanol. Your vehicle is designed to operate on oxygenated gasoline containing up to 15% ethanol by volume. Do not use gasoline containing methanol. If you notice any undesirable operating symptoms, try another service station or switch to another brand of gasoline.

How to Refuel

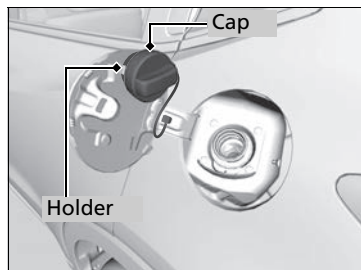
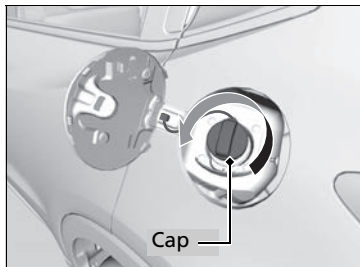
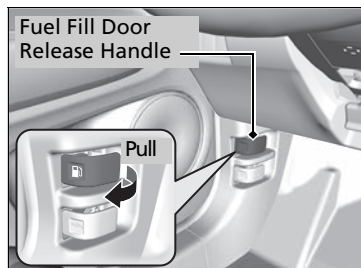

1. Stop your vehicle with the service station pump on the left side of the vehicle in the rear.
2. Turn off the engine.
3. Pull on the fuel fill door release handle under the lower left corner of the dashboard.
 - ▶ The fuel fill door opens.
4. Remove the fuel fill cap slowly. If you hear a release of air, wait until this stops, then turn the knob slowly to open the fuel fill cap.
5. Place the fuel fill cap in the holder.
6. Insert the filler nozzle fully.
 - ▶ When the tank is full, the fuel nozzle will click off automatically. This leaves space in the fuel tank in case the fuel expands with a change in the temperature.
7. After filling, replace the fuel fill cap, tightening it until you hear it click at least once.
 - ▶ Shut the fuel fill door by hand.

How to Refuel

⚠ WARNING

Gasoline is highly flammable and explosive. You can be burned or seriously injured when handling fuel.

- Stop the engine, and keep heat, sparks, and flame away.
- Handle fuel only outdoors.
- Wipe up spills immediately.

The filler nozzle automatically stops to leave space in the fuel tank so that fuel does not overflow as a result of changes in air temperature.

If the filler nozzle keeps turning off when the tank is not full, there may be a problem with the pump's fuel vapor recovery system. Try filling at another pump. If this does not fix the problem, consult a dealer.

Do not continue to add fuel after the nozzle has automatically stopped. Additional fuel can exceed the full tank capacity.

Improving Fuel Economy

Fuel economy depends on several conditions, including driving conditions, your driving habits, the condition of your vehicle, and loading. Depending on these and other conditions, you may or may not achieve the rated fuel economy of this vehicle.

Maintenance and Fuel Economy

You can optimize your fuel economy with proper maintenance of your vehicle. Always maintain your vehicle in accordance with the messages displayed on the information display.

- Use the recommended viscosity engine oil, displaying the API Certification Seal.
- Maintain the specified tire pressure.
- Do not load the vehicle with excess cargo.
- Keep your vehicle clean. A buildup of snow or mud on your vehicle's underside adds weight and increases wind resistance.

Improving Fuel Economy

Direct calculation is the recommended method to determine actual fuel consumed while driving.

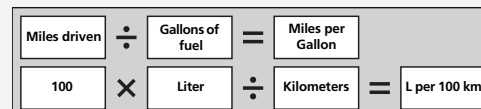

In Canada, posted fuel economy numbers are established following a simulated test. For more information on how this test is performed, please visit <http://oee.nrcan.gc.ca/>

Accessories

When installing accessories, check the following:

- Do not install accessories on the windshield. They can obstruct your view and delay your reaction to driving conditions.
- Do not install accessories over areas marked **SRS AIRBAG**, on the sides or backs of the front seats, on front or side pillars, or near the side windows. Accessories installed in these areas may interfere with proper operation of the vehicle's airbags or may be propelled into you or another occupant if the airbags deploy.
- Be sure electronic accessories do not overload electrical circuits or interfere with proper operation of your vehicle.
 - **Fuses** P. 456
- Before installing any electronic accessory, have the installer contact a dealer for assistance. If possible, have a dealer inspect the final installation.

Modifications

Do not modify your vehicle or use non-Honda components that can affect its handling, stability, and reliability.

Overall vehicle performance can be affected. Always make sure all equipment is properly installed and maintained, and that it meets federal, state, province, territory, and local regulations.

Accessories and Modifications

WARNING

Improper accessories or modifications can affect your vehicle's handling, stability, and performance, and cause a crash in which you can be seriously hurt or killed.

Follow all instructions in this owner's manual regarding accessories and modifications.

Honda Genuine accessories are recommended to ensure proper operation on your vehicle.

Maintenance

This chapter discusses basic maintenance.



Before Performing Maintenance

Inspection and Maintenance	380
Safety When Performing Maintenance	381
Parts and Fluids Used in Maintenance	
Service	382

Maintenance Minder™

Maintenance Items Under the Hood.....	387
Opening the Hood	388
Recommended Engine Oil	389
Oil Check	390
Adding Engine Oil	391
Changing the Engine Oil and Oil Filter.....	392

Engine Coolant	394
Transmission Fluid	396
Brake Fluid	397
Refilling Window Washer Fluid.....	398
Replacing Light Bulbs	399
Checking and Maintaining Wiper	
Blades	407
Checking and Maintaining Tires	
Checking Tires	411
Tire and Loading Information Label..	412
Tire Labeling	412
DOT Tire Quality Grading (U.S. Vehicles).....	414
Wear Indicators.....	416

Tire Service Life	416
Tire and Wheel Replacement	417
Tire Rotation	418
Winter Tires	419
Battery	420
Remote Transmitter Care	
Replacing the Button Battery	422
Heating and Cooling System*/Climate	
Control System* Maintenance	424
Cleaning	
Interior Care	425
Exterior Care.....	427

* Not available on all models

Inspection and Maintenance

For your safety, perform all listed inspections and maintenance to keep your vehicle in good condition. If you become aware of any abnormality (noise, smell, insufficient brake fluid, oil residue on the ground, etc.), have your vehicle inspected by a dealer. (Note, however, that service at a dealer is not mandatory to keep your warranties in effect.) Refer to the separate maintenance booklet for detailed maintenance and inspection information.

Types of Inspection and Maintenance

■ Daily inspections

Perform inspections before long distance trips, when washing the vehicle, or when refueling.

■ Periodic inspections

- Check the brake fluid level monthly.
 - **Brake Fluid** P. 397
- Check the tire pressure monthly. Examine the tread for wear and foreign objects.
 - **Checking and Maintaining Tires** P. 411
- Check the operation of the exterior lights monthly.
 - **Replacing Light Bulbs** P. 399
- Check the condition of the wiper blades at least every six months.
 - **Checking and Maintaining Wiper Blades** P. 407

Inspection and Maintenance

U.S. models

Maintenance, replacement, or repair of emissions control devices and systems may be done by any automotive repair establishment or individuals using parts that are "certified" to EPA standards.

According to state and federal regulations, failure to perform maintenance on the maintenance main items marked with # will not void your emissions warranties. However, all maintenance services should be performed in accordance with the intervals indicated by the information display.

➤ **Maintenance Service Items** P. 385

If you want to perform complex maintenance tasks that require more skills and tools, you can purchase a subscription to the Service Express website at www.techinfo.honda.com.

➤ **Authorized Manuals** P. 475

If you want to perform maintenance yourself, make sure that you have the necessary tools and skills first. After performing maintenance, update the records in the separate maintenance booklet.

Safety When Performing Maintenance

Some of the most important safety precautions are given here. However, we cannot warn you of every conceivable hazard that can arise in performing maintenance. Only you can decide whether or not you should perform a given task.

Maintenance Safety

- To reduce the possibility of fire or explosion, keep cigarettes, sparks, and flames away from the battery and all fuel related parts.
- Never leave rags, towels, or other flammable objects under the hood.
 - ▶ Heat from the engine and exhaust can ignite them causing a fire.
- To clean parts, use a commercially available degreaser or parts cleaner, not gasoline.
- Wear eye protection and protective clothing when working with the battery or compressed air.
- Engine exhaust contains carbon monoxide, which is poisonous and can kill you.
 - ▶ Only operate the engine if there is sufficient ventilation.

Vehicle Safety

- The vehicle must be in a stationary condition.
 - ▶ Make sure your vehicle is parked on level ground, the parking brake is set, and the engine is off.
- Be aware that hot parts can burn you.
 - ▶ Make sure to let the engine and exhaust system cool thoroughly before touching vehicle parts.
- Be aware that moving parts can injure you.
 - ▶ Do not start the engine unless instructed, and keep your hands and limbs away from moving parts.

⚠ Safety When Performing Maintenance

⚠ WARNING

Improperly maintaining this vehicle or failing to correct a problem before driving can cause a crash in which you can be seriously hurt or killed.

Always follow the inspection and maintenance recommendations according to the schedules in this owner's manual.

⚠ WARNING

Failure to properly follow maintenance instructions and precautions can cause you to be seriously hurt or killed.

Always follow the procedures and precautions in this owner's manual.

Parts and Fluids Used in Maintenance Service



The use of Honda genuine parts and fluids is recommended when maintaining and servicing your vehicle. Honda genuine parts are manufactured according to the same high quality standards used in Honda vehicles.

If the engine oil life is less than 15%, you will see the Maintenance Minder messages appear on the information display every time you turn the ignition switch to ON *1. The messages notify you when to change the engine oil, or when to bring your vehicle to a dealer for indicated maintenance services.

To Use Maintenance Minder™

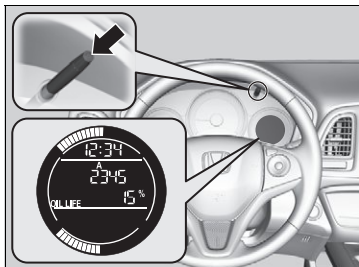
■ Displaying the Engine Oil Life



1. Turn the ignition switch to ON *1.
2. Press the  (select/reset) knob repeatedly until the engine oil life appears on the information display.

The Maintenance Minder indicator () stays on in the instrument panel after the engine oil life becomes **0%**. Have the indicated maintenance done by a dealer immediately.

▣ Displaying the Engine Oil Life





Based on the engine operating conditions, the remaining engine oil life is calculated and displayed as a percentage.

Displayed Engine Oil Life (%)	Calculated Engine Oil Life (%)
100	100 to 91
90	90 to 81
80	80 to 71
70	70 to 61
60	60 to 51
50	50 to 41
40	40 to 31
30	30 to 21
20	20 to 16
15	15 to 11
10	10 to 6
5	5 to 1
0	0

*1: Models with the smart entry system have an **ENGINE START/STOP** button instead of an ignition switch.

■ Maintenance Minder Messages on the Information Display

To switch the display, press the  (select/reset) knob.

Oil Life Display	Explanation	Information	Maintenance Minder Indicator
	<p>The engine oil life indicator starts to appear along with other due soon maintenance item codes when the remaining oil life becomes 15 percent.</p>	<p>The engine oil is approaching the end of its service life.</p>	 <p>Starts to come on when the remaining engine oil life becomes 15 percent. It goes off when the display is switched.</p>
	<p>The SERVICE message also starts to appear along with the engine oil life indicator and the maintenance item codes.</p>	<p>The engine oil has almost reached the end of its service life, and the maintenance items should be inspected and serviced as soon as possible.</p>	
	<p>The remaining engine oil life has passed its service life, and a negative distance appears after driving over 10 miles (U.S. models) or 10 km (Canadian models). The negative distance on the display blinks.</p>	<p>The engine oil life has passed. The maintenance items must be inspected and serviced immediately.</p>	 <p>Stays on as a reminder even when the display is switched.</p>

Maintenance Service Items

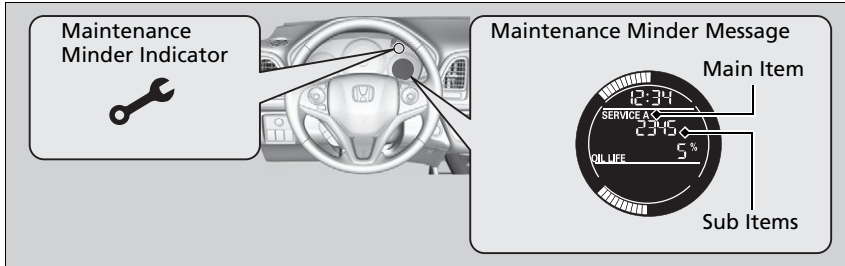

Maintenance Service Items

- Independent of the Maintenance Minder information, replace the brake fluid every 3 years.
- Inspect idle speed every 160,000 miles (256,000 km).
- Adjust the valves during services A, B, 1, 2, or 3 if they are noisy.

CODE	Maintenance Main Items
A	<ul style="list-style-type: none"> • Replace engine oil*1
B	<ul style="list-style-type: none"> • Replace engine oil*1 and oil filter • Inspect front and rear brakes • Inspect tie rod ends, steering gearbox, and boots • Inspect suspension components • Inspect driveshaft boots • Inspect brake hoses and lines (Including ABS/VSA) • Inspect all fluid levels and condition of fluids • Inspect exhaust system# • Inspect fuel lines and connections#

CODE	Maintenance Sub Items
1	<ul style="list-style-type: none"> • Rotate tires
2	<ul style="list-style-type: none"> • Replace air cleaner element*2 • Replace dust and pollen filter*3 • Inspect drive belt
3	<ul style="list-style-type: none"> • Replace transmission fluid*4
4	<ul style="list-style-type: none"> • Replace spark plugs • Inspect valve clearance
5	<ul style="list-style-type: none"> • Replace engine coolant
6	<ul style="list-style-type: none"> • Replace rear differential fluid*

*1: If a message **SERVICE** does not appear more than 12 months after the display is reset, change the engine oil every year.

: See information on maintenance and emissions warranty.

*2: If you drive in dusty conditions, replace the air cleaner element every 15,000 miles (24,000 km).

*3: If you drive primarily in urban areas that have high concentrations of soot in the air from industry and from diesel-powered vehicles, replace the dust and pollen filter every 15,000 miles (24,000 km).

Continuously variable transmission models only

*4: Driving in mountainous areas at very low vehicle speeds results in higher transmission temperatures. This requires transmission fluid changes more frequently than recommended by the Maintenance Minder. If you regularly drive your vehicle under these conditions, have the transmission fluid changed every 25,000 miles (40,000 km).

* Not available on all models

Continued

■ Resetting the Display

Reset the engine oil life display if you have performed the maintenance service.

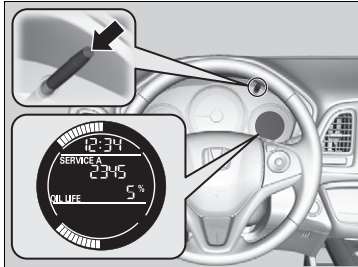

1. Turn the ignition switch to ON *1.
2. Display the engine oil life by repeatedly pressing the (select/reset) knob.
3. Press and hold the knob for ten seconds or more.
 - The engine oil life indicator and the maintenance item codes blink.
4. Press the knob for five seconds or more.
 - The displayed maintenance items disappear, and the engine oil life display returns to **100%**.

► Resetting the Display

NOTICE

Failure to reset the engine oil life after a maintenance service results in the system showing incorrect maintenance intervals, which can lead to serious mechanical problems.

The dealer will reset the engine oil life display after completing the required maintenance service. If someone other than a dealer performs maintenance service, reset the engine oil life display yourself.

*1: Models with the smart entry system have an **ENGINE START/STOP** button instead of an ignition switch.

Maintenance Items Under the Hood

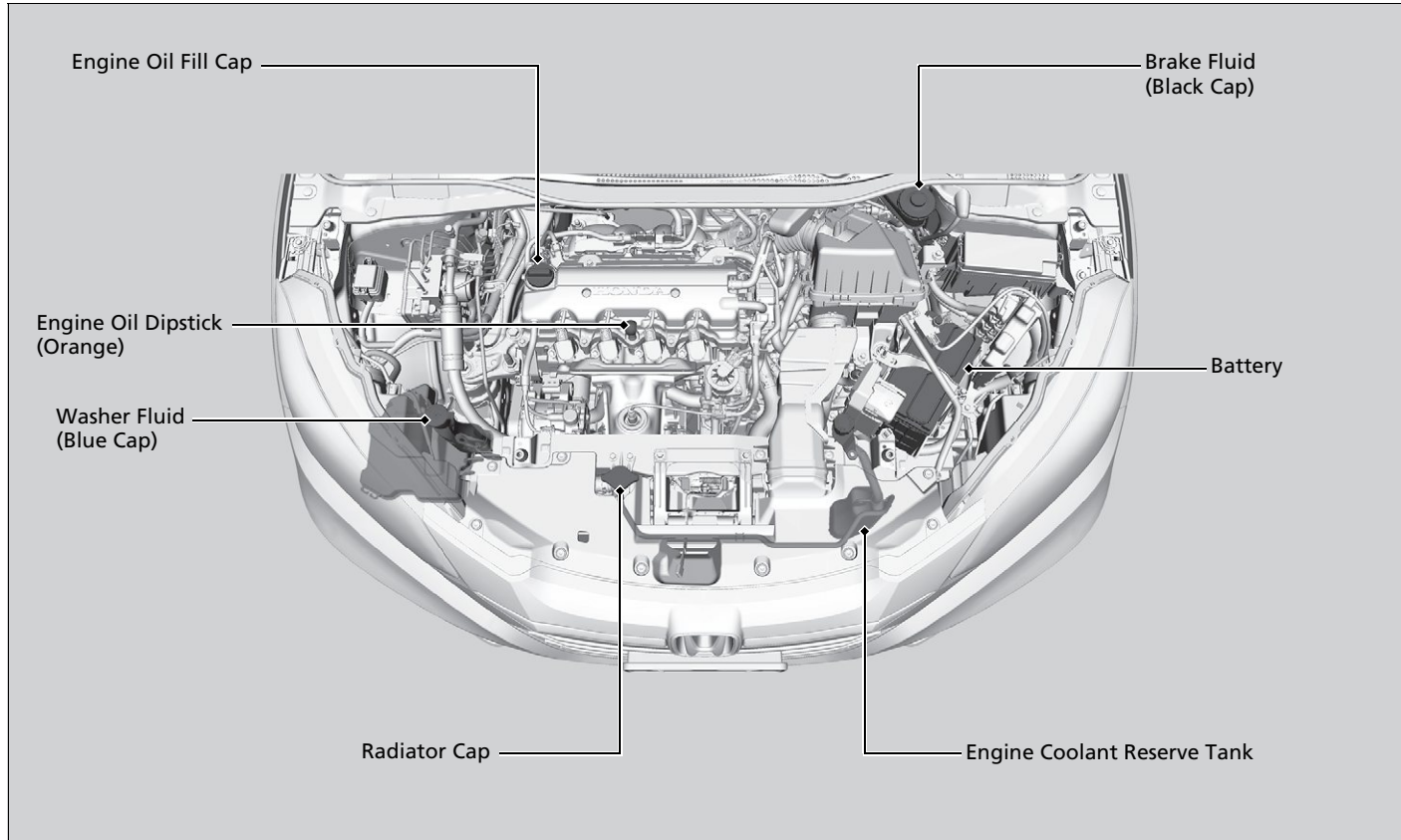

Opening the Hood

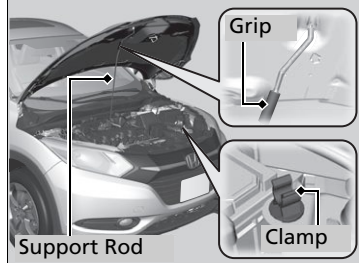
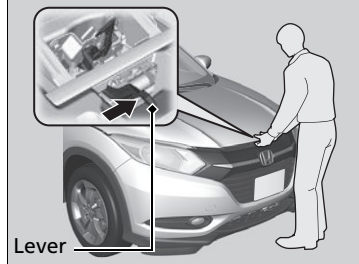
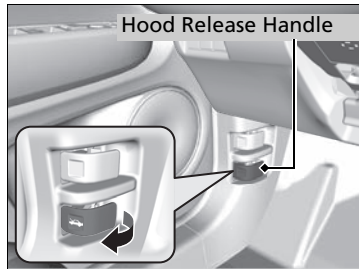

1. Park the vehicle on a level surface, and set the parking brake.
2. Pull the hood release handle under the lower left corner of the dashboard.
 - The hood will pop up slightly.
3. Pull up the hood latch lever in the center of the hood to release the lock mechanism, and open the hood.

4. Remove the support rod from the clamp using the grip. Mount the support rod in the hood.

When closing, remove the support rod, and stow it in the clamp, then gently lower the hood. Remove your hand at a height of approximately 12 inches (30 cm) and let the hood close.

►► Opening the Hood

NOTICE

Do not open the hood when the wiper arms are raised. The hood will strike the wipers, and may damage either the hood or the wipers.

When closing the hood, check that the hood is securely latched.

If the hood latch lever moves stiffly, or if you can open the hood without lifting the lever, the latch mechanism should be cleaned and lubricated.

Recommended Engine Oil

- **Genuine Honda Motor Oil**
- **Premium-grade 0W-20 detergent oil with an API Certification Seal on the container.**



Oil is a major contributor to your engine's performance and longevity. If you drive the vehicle with insufficient or deteriorated oil, the engine may fail or be damaged.

This seal indicates the oil is energy conserving and that it meets the American Petroleum Institute's latest requirements.

Use a Genuine Honda Motor Oil or another commercial engine oil of suitable viscosity for the ambient temperature as shown.

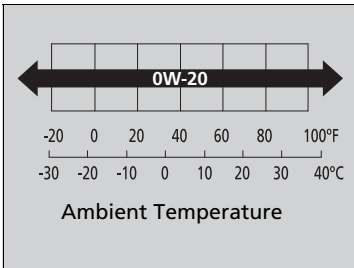

■ Synthetic oil

You may also use synthetic motor oil if it is labeled with the API Certification Seal and is the specified viscosity grade.

☒ Recommended Engine Oil

Engine Oil Additives

Your vehicle does not require oil additives. In fact, they may adversely affect the engine performance and durability.

Oil Check

We recommend that you check the engine oil level every time you refuel.

Park the vehicle on level ground.

Wait approximately three minutes after turning the engine off before you check the oil.

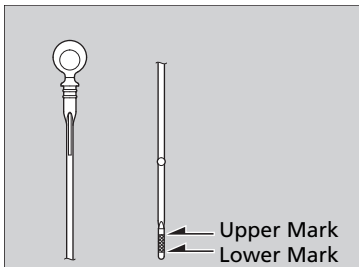
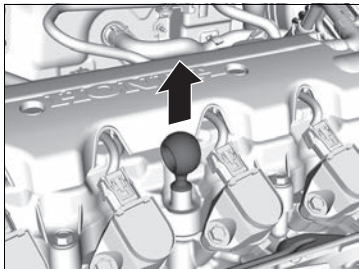

1. Remove the dipstick (orange).
2. Wipe the dipstick with a clean cloth or paper towel.
3. Insert the dipstick back all the way into its hole.
4. Remove the dipstick again, and check the level. It should be between the upper and lower marks. Add oil if necessary.

Oil Check

If the oil level is near or below the lower mark, slowly add oil being careful not to overfill.

Adding Engine Oil

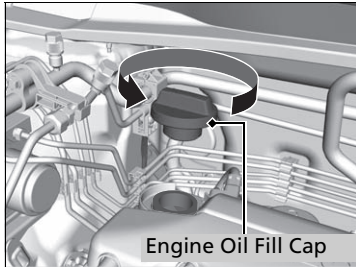

1. Unscrew and remove the engine oil fill cap.
2. Add oil slowly.
3. Reinstall the engine oil fill cap, and tighten it securely.
4. Wait for three minutes and recheck the engine oil dipstick.

✘ Adding Engine Oil

If any oil spills, wipe it away immediately. Spilled oil may damage the engine compartment components.

NOTICE

Do not fill the engine oil above the upper mark. Overfilling the engine oil can result in leaks and engine damage.

Changing the Engine Oil and Oil Filter

You must change the engine oil and oil filter regularly in order to maintain the engine's lubrication. The engine may be damaged if they are not changed regularly.

Change the oil and filter in accordance with the Maintenance Minder message on the information display.

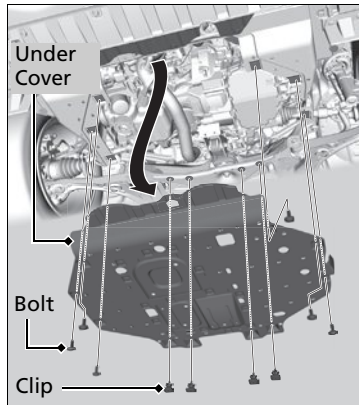

1. Run the engine until it reaches normal operating temperature, and then turn the engine off.
2. Open the hood and remove the engine oil fill cap.

2WD models

3. Remove the bolts and clips on the undercarriage and remove the under cover.

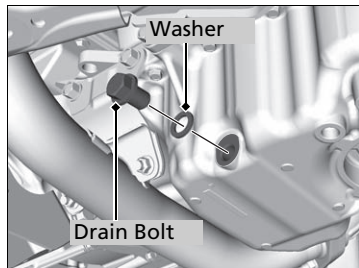

All models

4. Remove the drain bolt and washer from the bottom of the engine, and drain the oil into a suitable container.

Changing the Engine Oil and Oil Filter

NOTICE

You may damage the environment if you do not dispose of the oil in a suitable way. If you are changing the oil by yourself, appropriately dispose of the used oil. Put the oil in a sealed container and take it to a recycling center. Do not throw the oil away into a garbage can or onto the ground.

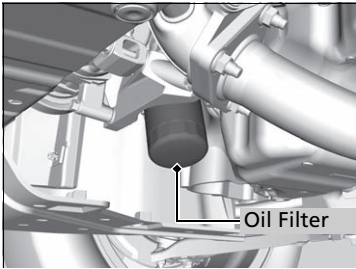

5. Remove the oil filter and dispose of the remaining oil.
6. Check that the filter gasket is not stuck to the engine contact surface.
 - If it is stuck, you must detach it.
7. Wipe away dirt and dust adhering to the contact surface of the engine block, and install a new oil filter.
 - Apply a light coat of new engine oil to the oil filter gasket.
8. Put a new washer on the drain bolt, then reinstall the drain bolt.
 - Tightening torque:
30 lbf·ft (40 N·m, 4.0 kgf·m)
9. Pour the recommended engine oil into the engine.
 - Engine oil change capacity (including filter):
3.9 US qt (3.7 L)
10. Reinstall the engine oil fill cap securely and start the engine.
11. Run the engine for a few minutes, and then check that there is no leak from the drain bolt or oil filter.
12. Stop the engine, wait for three minutes, and then check the oil level on the dipstick.
 - If necessary, add more engine oil.

✕ Changing the Engine Oil and Oil Filter

You will need a special wrench to replace the oil filter. You can buy this wrench from a dealer.

When installing the new oil filter, follow the instructions supplied with the oil filter.

Reinstall the engine oil fill cap. Start the engine. The low oil pressure indicator should go off within five seconds. If it does not, turn off the engine, and check your work.

Engine Coolant

Specified coolant: Honda Long Life Antifreeze/Coolant Type 2

This coolant is premixed with 50% antifreeze and 50% water. Do not add any straight antifreeze or water.

We recommend you check the engine coolant level every time you refuel. Check the reserve tank first. If it is completely empty, also check the coolant level in the radiator. Add the engine coolant accordingly.

Reserve Tank

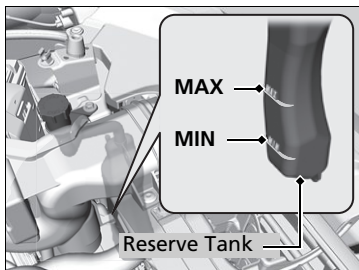

1. Check the amount of coolant in the reserve tank.

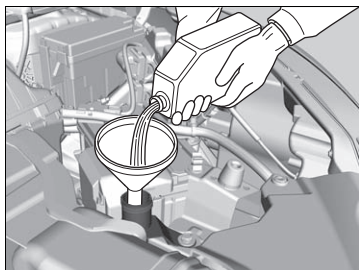

2. If the coolant level is below the **MIN** mark, add the specified coolant until it reaches the **MAX** mark.
3. Inspect the cooling system for leaks.

Engine Coolant

NOTICE

If Honda antifreeze/coolant is not available, you may use another major brand non-silicate coolant as a temporary replacement. Check that it is a high quality coolant recommended for aluminum engines. Continued use of any non-Honda coolant can result in corrosion, causing the cooling system to malfunction or fail. Have the cooling system flushed and refilled with Honda antifreeze/coolant as soon as possible.

Do not add rust inhibitors or other additives to your vehicle's coolant system. They may not be compatible with the coolant or with the engine components.

If temperatures consistently below -22°F (-30°C) are expected, the coolant mixture should be changed to a higher concentration. Consult a dealer for more information.

Radiator

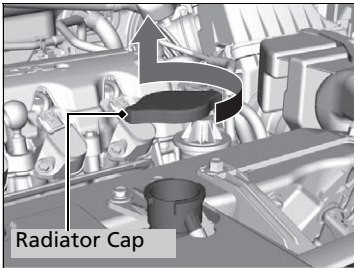

1. **Make sure the engine and radiator are cool.**
2. Turn the radiator cap counterclockwise and relieve any pressure in the cooling system. Do not push the cap down when turning.
3. Push down and turn the radiator cap counterclockwise to remove it.
4. The coolant level should be up to the base of the filler neck. Add coolant if it is low.
5. Put the radiator cap back on, and tighten it fully.
6. Pour coolant into the reserve tank until it reaches the **MAX** mark. Put the cap back on the reserve tank.

ⓘ Radiator

⚠ WARNING

Removing the radiator cap while the engine is hot can cause the coolant to spray out, seriously scalding you.

Always let the engine and radiator cool down before removing the radiator cap.

NOTICE

Pour the fluid slowly and carefully so you do not spill any. Clean up any spills immediately; they can damage components in the engine compartment.

Transmission Fluid

Continuously variable transmission models

Continuously Variable Transmission Fluid

Specified fluid: Honda HCF-2 Transmission Fluid

Have a dealer check the fluid level and replace if necessary.

Manual transmission models

Manual Transmission Fluid

Specified fluid: Honda Manual Transmission Fluid (MTF)

Have a dealer check the fluid level and replace if necessary.

Continuously Variable Transmission Fluid

NOTICE

Do not mix HCF-2 with other transmission fluids

Using a transmission fluid other than HCF-2 may adversely affect the operation and durability of your vehicle's transmission, and damage the transmission. Any damage caused by using a transmission fluid that is not equivalent to HCF-2 is not covered by Honda's new vehicle warranty.

Manual Transmission Fluid

If Honda MTF is not available, you may use the API certificated SAE 0W-20 or 5W-20 viscosity motor oil as a temporary measure. Replace with MTF as soon as possible. Motor oil does not contain the proper additives for the transmission and continued use can cause decreased shifting performance and lead to transmission damage.

Brake Fluid

Specified fluid: Honda Heavy Duty Brake Fluid DOT 3

Checking the Brake Fluid

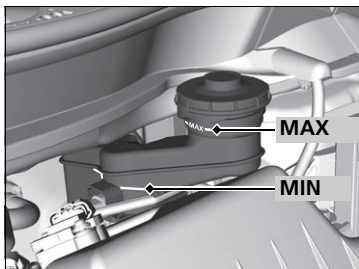

The fluid level should be between the **MIN** and **MAX** marks on the side of the reservoir.

Manual transmission models

The brake fluid reservoir is also used for your vehicle's clutch fluid. As long as you keep the brake fluid level as instructed above, there is no need for checking the clutch fluid level.

Brake Fluid

NOTICE

Brake fluid marked DOT 5 is not compatible with your vehicle's braking system and can cause extensive damage.

If the specified brake fluid is not available, you should use only DOT 3 or DOT 4 fluid from a sealed container as a temporary replacement.

Using any non-Honda brake fluid can cause corrosion and decrease the longevity of the system. Have the brake system flushed and refilled with Honda Heavy Duty Brake Fluid DOT 3 as soon as possible.

If the brake fluid level is at or below the **MIN** mark, have a dealer inspect for leaks or worn brake pads as soon as possible.

Refilling Window Washer Fluid

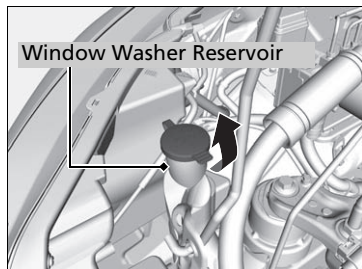

Models without washer level sensor

Check the amount of window washer fluid by looking at the reservoir.
If the level is low, fill the washer reservoir.

Canadian models

If the washer fluid is low, the washer level indicator comes on.

Pour the washer fluid carefully. Do not overflow the reservoir.

» Refilling Window Washer Fluid

NOTICE

Do not use engine antifreeze or a vinegar/water solution in the window washer reservoir. Antifreeze can damage your vehicle's paint. A vinegar/water solution can damage the window washer pump.

Headlight Bulbs

When replacing, use the following bulbs.

High/Low beam headlight: 60/55 W (HB2 for halogen bulb type)

High/Low Beam Headlight

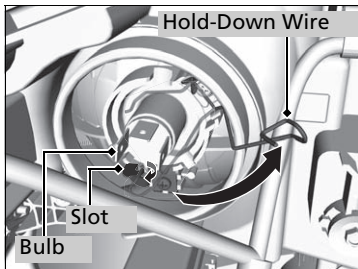
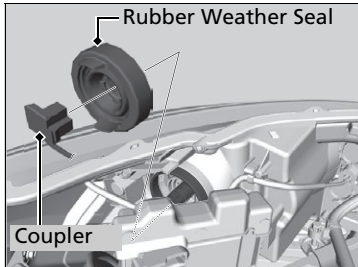

1. Remove the coupler.
2. Remove the rubber weather seal.
3. Remove the hold-down wire, then remove the bulb.
4. Insert a new bulb.
5. Reinstall the hold-down wire. Hook the end of the wire on the knob in the slot.
6. Reinstall the rubber weather seal.
7. Insert the coupler into the connector of the bulb.

Headlight Bulbs

NOTICE

Halogen bulbs get very hot when lit.

Oil, perspiration, or a scratch on the glass can cause the bulb to overheat and shatter.

The headlight aim is set by the factory, and does not need to be adjusted. However, if you regularly carry heavy items in the cargo area, have the aiming readjusted at a dealer or by a qualified technician.

When replacing a halogen bulb, handle it by its base, and protect the glass from contact with your skin or hard objects. If you touch the glass, clean it with denatured alcohol and a clean cloth.

Front Turn Signal/Parking Light Bulbs

When replacing, use the following bulbs.

Front Turn Signal/Parking Light: 28/8 W (Amber)

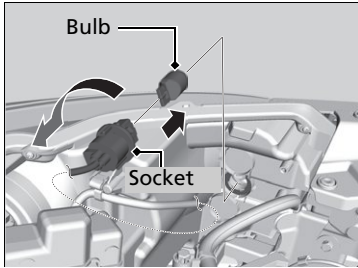

1. Turn the socket to the left and remove it.
2. Remove the old bulb and insert a new bulb.

Front Side Marker Light Bulbs

When replacing, use the following bulbs.

Front Side Marker Light: 5 W

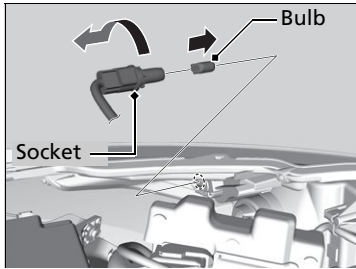

1. Turn the socket to the left and remove it.
2. Remove the old bulb and insert a new bulb.

Fog Light Bulbs *

When replacing, use the following bulbs.

Fog Light: 35 W (H8 for halogen bulb type)

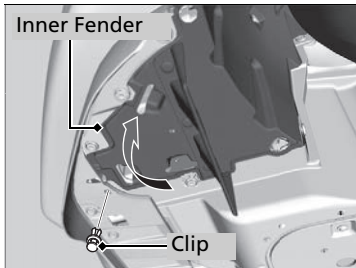

1. Remove the clip using a flat-tip screwdriver, and push up the inner fender.

⌘ Fog Light Bulbs *

NOTICE

Halogen bulbs get very hot when lit. Oil, perspiration, or a scratch on the glass can cause the bulb to overheat and shatter.

When replacing a halogen bulb, handle it by its plastic case, and protect the glass from contact with your skin or hard objects. If you touch the glass, clean it with denatured alcohol and a clean cloth.

* Not available on all models

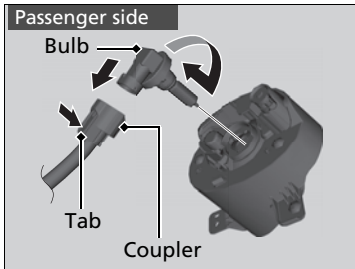
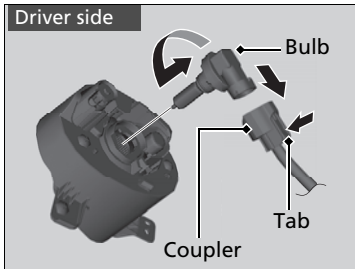

2. Push the tab to remove the coupler.
3. Rotate the old bulb to the left on driver side and to the right on passenger side to remove.
4. Insert a new bulb into the fog light assembly and turn it to the right on driver side and to the left on passenger side.
5. Insert the coupler into the connector of the bulb.

Side Turn Signal/Emergency Indicator Light Bulbs*

Door mirrors have the side turn lights. Have an authorized Honda dealer inspect and replace the light assembly.

⌘ Fog Light Bulbs*

Insert a flat-tip screwdriver, lift and remove the center pin to remove the clip.

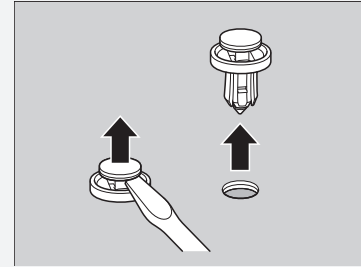

Insert the clip with the center pin raised, and push until it is flat.

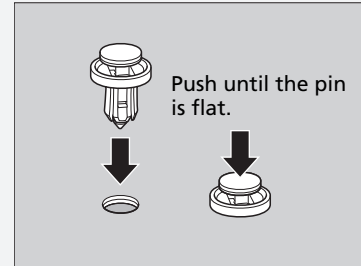

Rear Turn Signal Light Bulbs

When replacing, use the following bulbs.

Rear Turn Signal Light: 21 W (Amber)

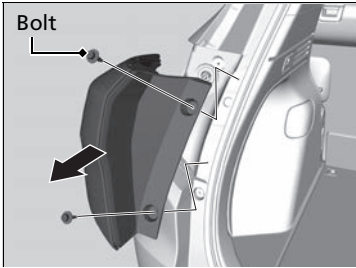

1. Use a Phillips-head screwdriver to remove the bolts.
2. Pull the light assembly out of the rear pillar.

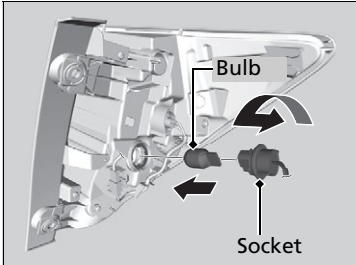

3. Turn the socket to the left and remove it.
4. Remove the old bulb.
5. Insert a new bulb.
6. Slide the light assembly onto the guide on the body.

Back-Up Light Bulbs

When replacing, use the following bulbs.

Back-Up Light: 16 W

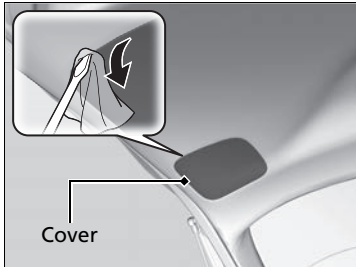

1. Remove the cover by prying on the edge using a flat-tip screwdriver.
 - Wrap the flat-tip screwdriver with a cloth to prevent scratches.

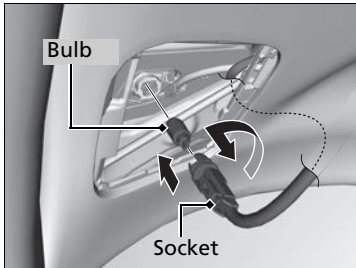

2. Turn the socket to the left and remove it.
3. Remove the old bulb.
4. Insert a new bulb.

Brake/Tail/Rear Side Marker Light Bulbs

Brake/tail/rear side marker light bulbs are the LED type. Have an authorized Honda dealer inspect and replace the light assembly.

High-Mount Brake Light Bulb

High-mount brake light bulb is a LED type. Have an authorized Honda dealer inspect and replace the light assembly.

Rear License Plate Light Bulbs

When replacing, use the following bulbs.

Rear License Plate Light: 5 W

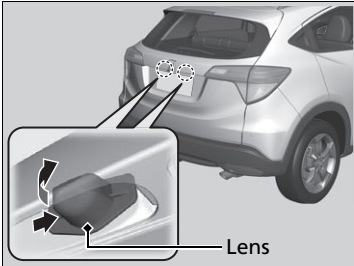

1. Push the lens on the left and pull out the lens and the socket attached to it.

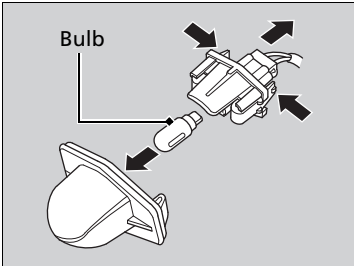

2. Remove the license plate light assembly by squeezing the tabs on both sides of the socket.
3. Remove the old bulb and insert a new bulb.

Checking Wiper Blades

If the wiper blade rubber has deteriorated, it will leave streaks and the hard surfaces of the blade may scratch the window glass.

Changing the Front Wiper Blade Rubber

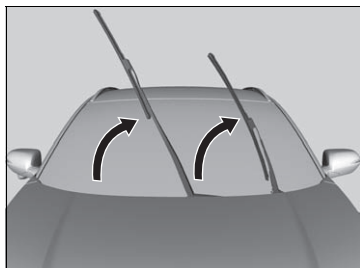

1. Lift the driver side wiper arm first, then the passenger side.

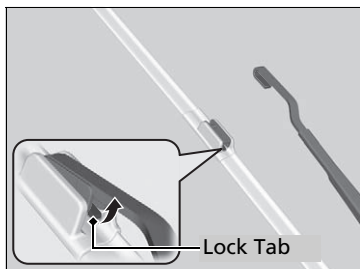

2. Press and hold the tab, then slide the blade from the wiper arm.

Changing the Front Wiper Blade Rubber

NOTICE

Avoid dropping the wiper arm; it may damage the windshield.

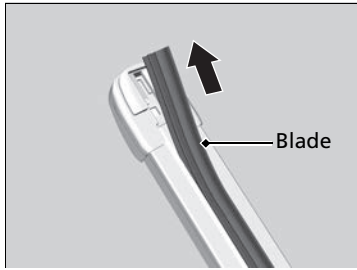

3. Slide the wiper blade out from its holder by pulling the tabbed end out.

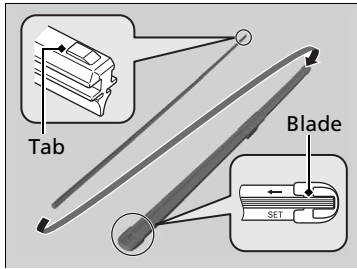

4. Slide the new wiper blade onto the holder from the bottom end.

▶ The tab on the blade should fit in the indent of the top of the wiper holder.

5. Slide the wiper blade onto the wiper arm securely.

6. Lower the passenger side wiper arm first, then the driver side.

Changing the Rear Wiper Blade Rubber

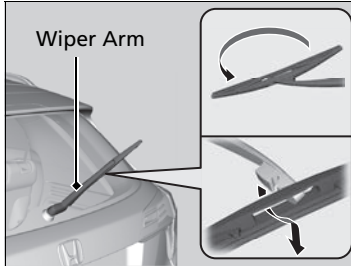

1. Raise the wiper arm off.
2. Pivot up the bottom end of the wiper blade until it comes off from the wiper arm.

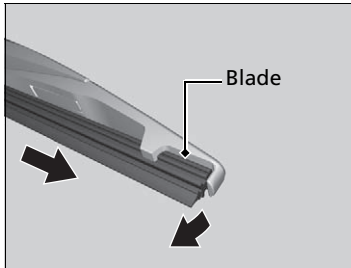

3. Slide the wiper blade out from the end with the indent.

Changing the Rear Wiper Blade Rubber

NOTICE

Avoid dropping the wiper arm; it may damage the rear window.

Continued

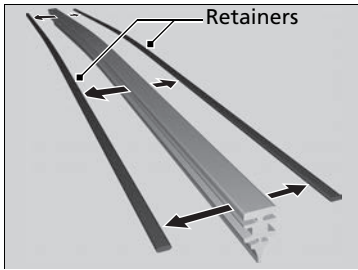

4. Remove the retainers from the rubber blade that has been removed, and mount to a new rubber blade.

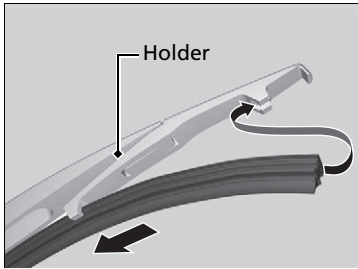

5. Slide the wiper blade onto the holder.
 - ▶ Make sure it is engaged correctly, then install the wiper blade assembly onto the wiper arm.

Checking Tires

To safely operate your vehicle, your tires must be of the proper type and size, in good condition with adequate tread, and properly inflated.

■ Inflation guidelines

Properly inflated tires provide the best combination of handling, tread life, and comfort. Refer to the driver's doorjamb label or specification's page for the specified pressure.

Underinflated tires wear unevenly, adversely affect handling and fuel economy, and are more likely to fail from overheating.

Overinflated tires make your vehicle ride harshly, are more prone to road hazards, and wear unevenly.

Every day before you drive, look at each of the tires. If one looks lower than the others, check the pressure with a tire gauge.

At least once a month or before long trips, use a gauge to measure the pressure in all tires, including the spare. Even tires in good condition can lose 1 to 2 psi (10 to 20 kPa, 0.1 to 0.2 kgf/cm²) per month.

■ Inspection guidelines

Every time you check inflation, also examine the tires and valve stems. Look for:

- Bumps or bulges on the side or in the tread. Replace the tire if you find any cuts, splits, or cracks in the side of the tire. Replace it if you see fabric or cord.
- Remove any foreign objects and inspect for air leaks.
- Uneven tread wear. Have a dealer check the wheel alignment.
- Excessive tread wear.

➤ **Wear Indicators** P. 416

- Cracks or other damage around valve stem.

☒ Checking Tires

⚠ WARNING

Using tires that are excessively worn or improperly inflated can cause a crash in which you can be seriously hurt or killed.

Follow all instructions in this owner's manual regarding tire inflation and maintenance.

Measure the air pressure when tires are cold. This means the vehicle has been parked for at least three hours, or driven less than 1 mile (1.6 km). If necessary, add or release air until the specified pressure is reached.

If checked when hot, tire pressure can be as much as 4–6 psi (30–40 kPa, 0.3–0.4 kgf/cm²) higher than if checked when cold.

Have a dealer check the tires if you feel a consistent vibration while driving. New tires and any that have been removed and reinstalled should be properly balanced.

U.S. models

Whenever tire pressure is adjusted, you must calibrate the TPMS.

➤ **TPMS Calibration** P. 359

Tire and Loading Information Label

The label attached to the driver's doorjamb provides necessary tire and loading information.

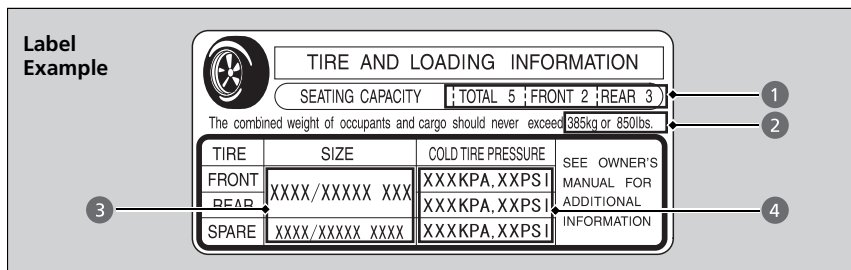

▶▶ Tire and Loading Information Label

The tire and loading information label attached to the driver's doorjamb contains:

- 1 The number of people your vehicle can carry.
- 2 The total weight your vehicle can carry. Do not exceed this weight.
- 3 The original tire sizes for front, rear, and spare.
- 4 The proper cold tire pressure for front, rear, and spare.

Tire Labeling

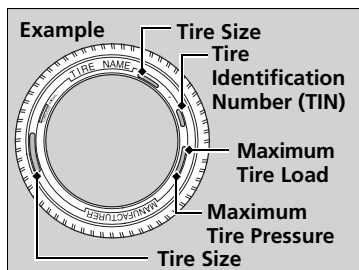

The tires that came on your vehicle have a number of markings. Those you should be aware of are described below.

▶▶ Tire Sizes

Following is an example of tire size with an explanation of what each component means.

215/55R17 94V

215: Tire width in millimeters.

55: Aspect ratio (the tire's section height as a percentage of its width).

R: Tire construction code (R indicates radial).

17: Rim diameter in inches.

94: Load index (a numerical code associated with the maximum load the tire can carry).

V: Speed symbol (an alphabetical code indicating the maximum speed rating).

Tire Sizes

Whenever tires are replaced, they should be replaced with tires of the same size.

■ Tire Identification Number (TIN)

The tire identification number (TIN) is a group of numbers and letters that look like the example in the side column. TIN is located on the sidewall of the tire.

■ Glossary of Tire Terminology

Cold Tire Pressure – The tire air pressure when the vehicle has been parked for at least three hours or driven less than 1 mile (1.6 km).

Load Rating – Means the maximum load that a tire is rated to carry for a given inflation pressure.

Maximum Inflation Pressure – The maximum tire air pressure that the tire can hold.

Maximum Load Rating – Means the load rating for a tire at the maximum permissible inflation pressure for that tire.

Recommended Inflation Pressure – The cold tire inflation pressure recommended by the manufacturer.

Treadwear Indicators (TWI) – Means the projections within the principal grooves designed to give a visual indication of the degrees of wear of the tread.

☒ Tire Identification Number (TIN)

DOT B97R FW6X 2209

DOT: This indicates that the tire meets all requirements of the U.S. Department of Transportation.

B97R: Manufacturer's identification mark.

FW6X: Tire type code.

22 09: Date of manufacture.

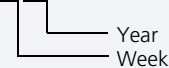

DOT Tire Quality Grading (U.S. Vehicles)

The tires on your vehicle meet all U.S. Federal Safety Requirements. All tires are also graded for treadwear, traction, and temperature performance according to Department of Transportation (DOT) standards. The following explains these gradings.

■ Uniform Tire Quality Grading

Quality grades can be found where applicable on the tire sidewall between tread shoulder and maximum section width.

■ Treadwear

The treadwear grade is a comparative rating based on the wear rate of the tire when tested under controlled conditions on a specified government test course. For example, a tire graded 150 would wear one and one-half (1 1/2) times as well on the government course as a tire graded 100. The relative performance of tires depends upon the actual conditions of their use, however, and may depart significantly from the norm due to variations in driving habits, service practices and differences in road characteristics and climate.

▣ Uniform Tire Quality Grading

For example:

Treadwear 200
Traction AA
Temperature A

All passenger car tires must conform to Federal Safety Requirements in addition to these grades.

■ Traction

The traction grades, from highest to lowest, are AA, A, B, and C. Those grades represent the tire's ability to stop on wet pavement as measured under controlled conditions on specified government test surfaces of asphalt and concrete. A tire marked C may have poor traction performance.

■ Temperature

The temperature grades are A (the highest), B, and C, representing the tire's resistance to the generation of heat and its ability to dissipate heat when tested under controlled conditions on a specified indoor laboratory test wheel. Sustained high temperature can cause the material of the tire to degenerate and reduce tire life, and excessive temperature can lead to sudden tire failure. The grade C corresponds to a level of performance which all passenger car tires must meet under the Federal Motor Vehicle Safety Standard No. 109. Grades B and A represent higher levels of performance on the laboratory test wheel than the minimum required by law.

⌘ Traction

Warning: The traction grade assigned to this tire is based on straight-ahead braking traction tests, and does not include acceleration, cornering, hydroplaning, or peak traction characteristics.

⌘ Temperature

Warning: The temperature grade for this tire is established for a tire that is properly inflated and not overloaded. Excessive speed, underinflation, or excessive loading, either separately or in combination, can cause heat buildup and possible tire failure.

Wear Indicators

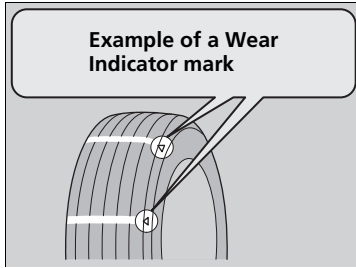

The groove where the wear indicator is located is 1/16 inch (1.6 mm) shallower than elsewhere on the tire. If the tread has worn so that the indicator is exposed, replace the tire.

Worn out tires have poor traction on wet roads.

Tire Service Life

The life of your tires is dependent on many factors, including driving habits, road conditions, vehicle loading, inflation pressure, maintenance history, speed, and environmental conditions (even when the tires are not in use).

In addition to regular inspections and inflation pressure maintenance, it is recommended that you have annual inspections performed once the tires reach five years old. All tires, including the spare, should be removed from service after 10 years from the date of manufacture, regardless of their condition or state of wear.

Tire and Wheel Replacement

Replace your tires with radials of the same size, load range, speed rating, and maximum cold tire pressure rating (as shown on the tire's sidewall). Using tires of a different size or construction can cause the ABS, vehicle stability assist (VSA®) system, hill start assist, and the AWD* system to work incorrectly.

It is best to replace all four tires at the same time. If that isn't possible, replace the front or rear tires in pairs.

Make sure that the wheel's specifications match those of the original wheels.

⚠ Tire and Wheel Replacement

⚠ WARNING

Installing improper tires on your vehicle can affect handling and stability. This can cause a crash in which you can be seriously hurt or killed.

Always use the size and type of tires recommended in this owner's manual.

* Not available on all models

Tire Rotation

Rotating tires according to the Maintenance Minder message on the information display helps to distribute wear more evenly and increase tire life.

■ Tires without rotation marks

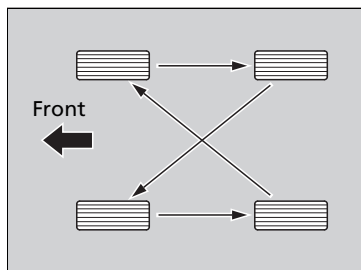

Rotate the tires as shown here.

■ Tires with rotation marks

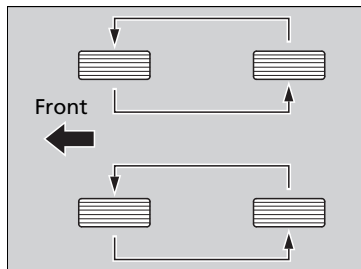

Rotate the tires as shown here.

▶▶ Tire Rotation

Tires with directional tread patterns should only be rotated front to back (not from one side to the other). Directional tires should be mounted with the rotation indication mark facing forward, as shown below.

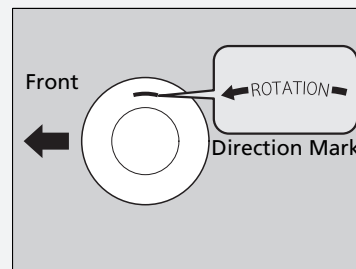

U.S. models

Whenever tires are rotated, you must calibrate the TPMS.

▶▶ **TPMS Calibration** P. 359

Winter Tires

If driving on snowy or frozen roads, mount all season marked **M+S** tires, snow tires, or tire chains; reduce speed; and maintain sufficient distance between vehicles when driving.

Be particularly careful when operating the steering wheel or brakes to prevent skidding.

Use tire chains, snow tires, or all season tires when necessary or according to the law.

When mounting, refer to the following points.

For winter tires:

- Select the size and load ranges that are the same as the original tires.
- Mount the tires to all four wheels.

For tire chains:

- Install them on the front tires only.
- Because your vehicle has limited tire clearance, we strongly recommend using the chains listed below:

Cable-type: SCC Radial Chain SC1034

- Follow the chain manufacturer's instruction when installing. Mount them as tightly as you can.
- Check that the chains do not touch the brake lines or suspension.
- Drive slowly.

ⓘ Winter Tires

⚠ WARNING

Using the wrong chains, or not properly installing chains, can damage the brake lines and cause a crash in which you can be seriously injured or killed.

Follow all instructions in this owner's manual regarding the selection and use of tire chains.

NOTICE

Traction devices that are the wrong size or improperly installed can damage your vehicle's brake lines, suspension, body, and wheels. Stop driving if they are hitting any part of the vehicle.

When tire chains are mounted, follow the chain manufacturer's instructions regarding vehicle operational limits.

If your vehicle is equipped with summer tires, be aware that these tires are not designed for winter driving conditions. For more information, contact a dealer.

Checking the Battery

The battery condition is being monitored by the sensor on the negative terminal. If there is a problem with the sensor, the warning message on the information display will let you know. Have your vehicle checked by a dealer.

Check the battery terminals for corrosion monthly.

If your vehicle's battery is disconnected or goes dead:

- The audio system is disabled.
 - **Audio System Theft Protection** P. 179
- The clock resets.
 - **Clock** P. 94
- The navigation system* is disabled.
 - **Refer to the navigation system manual**

ⓘ Battery

WARNING

The battery gives off explosive hydrogen gas during normal operation.

A spark or flame can cause the battery to explode with enough force to kill or seriously hurt you.

When conducting any battery maintenance, wear protective clothing and a face shield, or have a skilled technician do it.

WARNING: Battery post, terminals, and related accessories contain lead and lead compounds.

Wash your hands after handling.

When replacing the battery, the replacement must be of the same specifications.
Consult a dealer for more information.

Charging the Battery

Disconnect both battery cables to prevent damaging your vehicle's electrical system. Always disconnect the negative (-) cable first, and reconnect it last.

⌘ Battery

When you find corrosion, clean the battery terminals by applying a baking powder and water solution. Clean the terminals with a damp towel. Cloth/towel dry the battery. Coat the terminals with grease to help prevent future corrosion.

Replacing the Button Battery

If the indicator does not come on when the button is pressed, replace the battery.

■ Keys with Remote Transmitter*

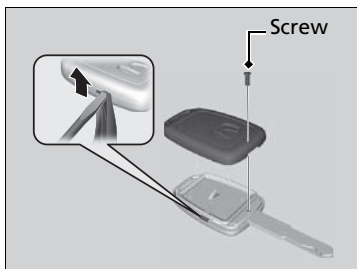

Battery type: CR1620

1. Unscrew the cover with a small Phillips-head screwdriver.
2. Open the remote transmitter.
 - ▶ Wrap the small flat-tip screwdriver with a cloth to prevent scratching the transmitter.
3. Remove the button battery with the small flat-tip screwdriver.
4. Make sure to replace the battery with the correct polarity.

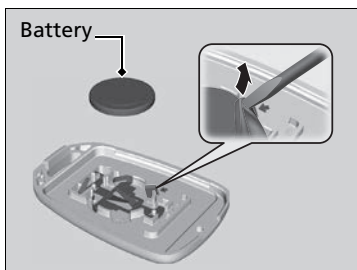

▣ Replacing the Button Battery

NOTICE

An improperly disposed of battery can damage the environment. Always confirm local regulations for battery disposal.

Replacement batteries are commercially available or at a dealer.

Smart Entry Remote*

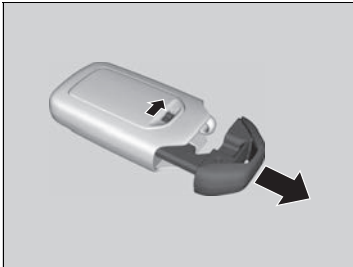

Battery type: CR2032

1. Remove the built-in key.

2. Remove the upper half of the cover by carefully prying on the edge with a coin.
 - ▶ Remove carefully to avoid losing the buttons.
 - ▶ Wrap a coin with a cloth to prevent scratching the smart entry remote.
3. Make sure to replace the battery with the correct polarity.

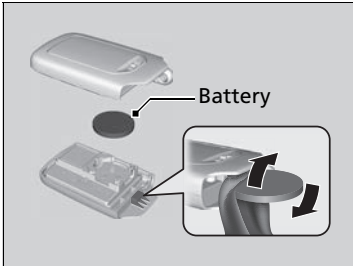

* Not available on all models

Dust and Pollen Filter

The heating and cooling system*/climate control system* is equipped with a dust and pollen filter that collects pollen, dust, and other debris in the air. The Maintenance Minder™ messages will let you know when to replace the filter.

We recommend that you replace the dust and pollen filter sooner when using your vehicle in areas with high concentrations of dust.

» Dust and Pollen Filter

If the airflow from the heating and cooling system*/climate control system* deteriorates noticeably, and the windows fog up easily, the filter may need to be replaced. Please contact a dealer for replacement.

Interior Care

Use a damp cloth with a mixture of mild detergent and warm water to remove dirt.
Use a clean cloth to remove detergent residue.

Cleaning Seat Belts

Use a soft brush with a mixture of mild soap and warm water to clean the seat belts.
Let the belts air dry. Wipe the loop of the seat belt anchors using a clean cloth.

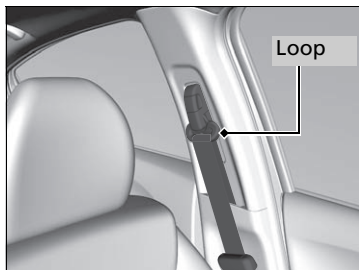

Cleaning the Window

Wipe using a glass cleaner.

Interior Care

Do not spill liquids inside the vehicle.
Electrical devices and systems may malfunction if liquids are splashed on them.

Do not use silicone based sprays on electrical devices such as audio devices and switches.
Doing so may cause the items to malfunction or a fire inside the vehicle.
If a silicone based spray is inadvertently used on electrical devices, consult a dealer.

Depending on their composition, chemicals and liquid aromatics may cause discoloration, wrinkles, and cracking to resin-based parts and textiles.
Do not use alkali solvents or organic solvents such as benzene or gasoline.

After using chemicals, make sure to gently wipe them off using a dry cloth.
Do not place used cloths on top of resin based parts or textiles for long periods of time without washing.

Cleaning the Window

Wires are mounted to the inside of the rear window.
Wipe along the same direction as the wires with a soft cloth so as not to damage them.

■ Floor Mats

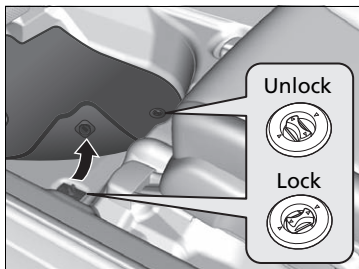

The driver's floor mat hooks over the floor anchors, which keep the mat from sliding forward. To remove a mat for cleaning, turn the anchor knobs to the unlock position. When reinstalling the mat after cleaning, turn the knobs to the lock position.

Do not put additional floor mats on top of the anchored mat.

■ Maintaining Genuine Leather*

Vacuum dirt and dust from the leather frequently. Pay close attention to the pleats and seams. Clean the leather with a soft cloth dampened with a 90% water and 10% neutral soap solution. Then buff it with a clean, dry cloth. Remove any dust or dirt on leather surfaces immediately.

▣ Floor Mats

If you use any floor mats that were not originally provided with your vehicle, make sure they are designed for your specific vehicle, fit correctly, and are securely anchored by the floor anchors. Position the rear seat floor mats properly. If they are not properly positioned, the floor mats can interfere with the front seat functions.

Exterior Care

Dust off the vehicle body after you drive.

Regularly inspect your vehicle for scratches on painted surfaces. A scratch on a painted surface can result in body rust. If you find a scratch, promptly repair it.

■ Washing the Vehicle

Wash the vehicle regularly. Wash more frequently when driving in the following conditions:

- If driving on roads with road salt.
- If driving in coastal areas.
- If tar, soot, bird droppings, insects, or tree sap are stuck to painted surfaces.

■ Using an Automated Car Wash

Fold in the door mirrors.

Make sure to follow the instructions indicated on the automated car wash.

■ Using High Pressure Cleaners

- Keep sufficient distance between the cleaning nozzle and the vehicle body.
- Take particular care around the windows. Standing too close may cause water to enter the vehicle interior.
- Do not spray high pressure water directly into the engine compartment. Instead, use low pressure water and a mild detergent.

▣ Washing the Vehicle

Do not spray water into the air intake vents. It can cause a malfunction.



■ Applying Wax

A good coat of automotive body wax helps protect your vehicle's paint from the elements. Wax will wear off over time and expose your vehicle's paint to the elements, so reapply as necessary.

■ Maintaining the Bumpers and Other Resin Coated Parts

If you get gasoline, oil, engine coolant, or battery fluid on resin coated parts, they may be stained or the coating may peel. Promptly wipe it away using a soft cloth and clean water.

■ Cleaning the Window

Wipe using a glass cleaner.

■ Maintaining Aluminum Wheels

Aluminum is susceptible to deterioration caused by salt and other road contaminants. Use a sponge and mild detergent to wipe away promptly. Be careful not to use harsh chemicals (including some commercial wheel cleaners) or a stiff brush. They can damage the clear coat of the aluminum alloy wheels that helps keep the aluminum from corroding and tarnishing.

►► Applying Wax

NOTICE

Chemical solvents and strong cleaners can damage the paint, metal, and plastic on your vehicle. Wipe up spills immediately.

►► Maintaining the Bumpers and Other Resin Coated Parts

Ask a dealer about the correct coating material when you want to repair the painted surface of the parts made of resin.

■ Fogged Exterior Light Lenses

The inside lenses of exterior lights (headlights, brake lights etc.) may fog temporarily if you have driven in the rain, or after the vehicle has been run through a car wash. Dew condensation also may build up inside the lenses when there is a significant enough difference between the ambient and inside lens temperatures (similar to vehicle windows fogging up in rainy conditions). These conditions are natural processes, not structural design problems in the exterior lights.

Lens design characteristics may result in moisture developing on the light lens frame surfaces. This also is not a malfunction.

However, if you see large amounts water accumulation, or large water drops building up inside the lenses, have your vehicle inspected by a dealer.

Handling the Unexpected

This chapter explains how to handle unexpected troubles.

Tools

Types of Tools..... 432

If a Tire Goes Flat

Changing a Flat Tire..... 434

Engine Does Not Start

Checking the Engine..... 443

If the Smart Entry Remote Battery is Weak.....444

Emergency Engine Stop 445

Jump Starting..... 446

Shift Lever Does Not Move..... 448

Overheating

How to Handle Overheating..... 449

Indicator, Coming On/Blinking

If the Low Oil Pressure Indicator Comes On.....451

If the Charging System Indicator Comes On 451

If the Malfunction Indicator Lamp Comes On or Blinks 452

If the Brake System Indicator (Red) Comes On.....453

If the Electric Power Steering (EPS) System Indicator Comes On 453

If the Electric Parking Brake System

Indicator Comes On 454

If the Low Tire Pressure/TPMS Indicator

Comes On or Blinks 455

Fuses

Fuse Locations 456

Inspecting and Changing Fuses..... 460

Emergency Towing..... 461

When You Cannot Open the Tailgate..... 462

Types of Tools

2WD models

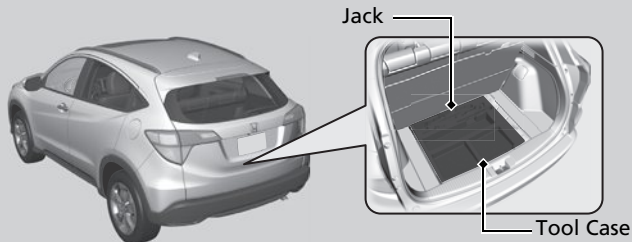

Jack



Wheel Nut Wrench/
Jack Handle



Detachable Towing Hook

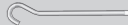

Jack Handle Bar

Types of Tools

The tools are stored in the cargo area.

AWD models

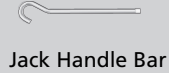
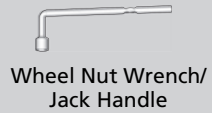
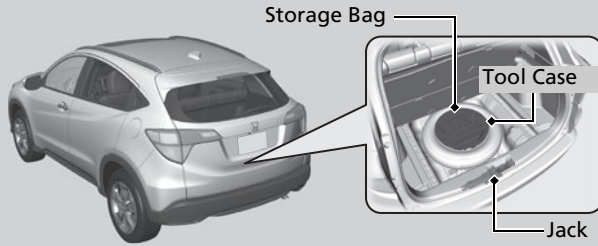

Changing a Flat Tire

If a tire goes flat while driving, grasp the steering wheel firmly, and brake gradually to reduce speed. Then, stop in a safe place. Replace the flat tire with a compact spare tire. Go to a dealer as soon as possible to have the full-size tire repaired or replaced.

1. Park the vehicle on firm, level, and non-slippery surface and apply the parking brake.

Continuously variable transmission models

2. Move the shift lever to **P**.

Manual transmission models

2. Move the shift lever to **R**.

All models

3. Turn on the hazard warning lights and turn the ignition switch to LOCK **0***1.

*1: Models with the smart entry system have an **ENGINE START/STOP** button instead of an ignition switch.

Changing a Flat Tire

Periodically check the tire pressure of the compact spare. It should be set to the specified pressure. Specified Pressure: 60 psi (420 kPa, 4.2 kgf/cm²)

When driving with the compact spare tire, keep the vehicle speed under 50 mph (80 km/h). Replace with a full-size tire as soon as possible.

The compact spare tire and wheel in your vehicle are specifically for this model. Do not use them with another vehicle. Do not use another type of compact spare tire or wheel with your vehicle.

Do not mount tire chains on a compact spare tire. If a chain-mounted front tire goes flat, remove one of the full-size rear tires and replace it with the compact spare tire. Remove the flat front tire and replace it with the full-size tire that was removed from the rear. Mount the tire chains on the front tire.

Getting Ready to Replace the Flat Tire

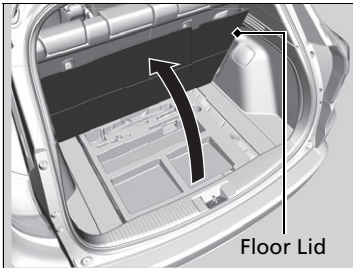

1. Open the cargo area floor lid.

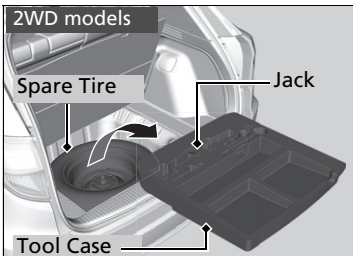

2. Take the tool case out of the cargo area.

2WD models

Take the wheel nut wrench, jack handle bar and jack out of the tool case.

AWD models

Take the wheel nut wrench and jack handle bar out of the tool case.

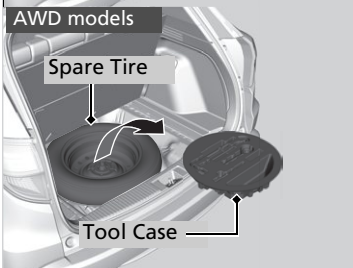

All models

3. Unscrew the wing bolt, and remove the spacer cone. Then, remove the spare tire.

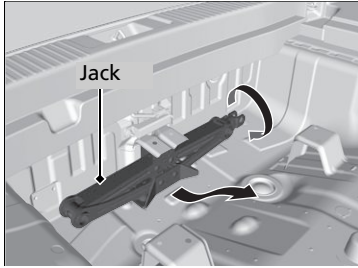

AWD models

4. Turn the jack's end bracket anti-clockwise to loosen it, then remove the jack.

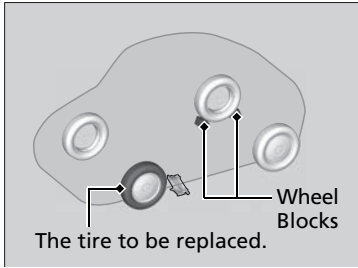

All models

5. Place a wheel block or rock in front and rear of the wheel diagonal to the flat tire.



6. Place the compact spare tire (wheel side up) under the vehicle body, near the tire that needs to be replaced.



7. Loosen each wheel nut about one turn using the wheel nut wrench.

How to Set Up the Jack

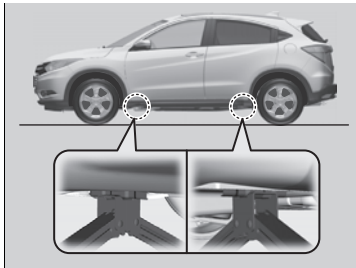

1. Place the jack under the jacking point closest to the tire to be changed.

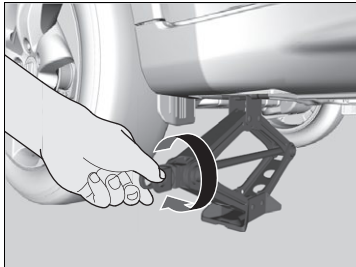

2. Turn the end bracket as shown in the image until the top of the jack contacts the jacking point.
 - ▶ Make sure that the jacking point tab is resting in the jack notch.

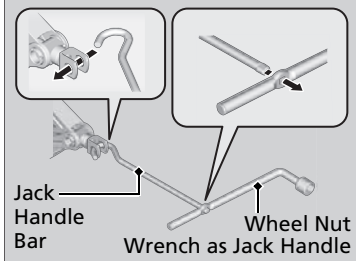

3. Raise the vehicle, using the jack handle bar and the jack handle, until the tire is off the ground.

How to Set Up the Jack

WARNING

The vehicle can easily roll off the jack, seriously injuring anyone underneath.

Follow the directions for changing a tire exactly, and never get under the vehicle when it is supported only by the jack.

Do not use the jack with people or luggage in the vehicle.

Use the jack provided in your vehicle. Other jacks may not support the weight ("load") or may not fit the jacking point.

The following instructions must be followed to use the jack safely:

- Do not use while the engine is running.
- Use only where the ground is firm and level.
- Use only at the jacking points.
- Do not get in the vehicle while using the jack.
- Do not put anything on top of or underneath the jack.

Replacing the Flat Tire

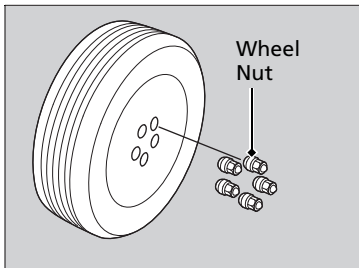

1. Remove the wheel nuts and flat tire.

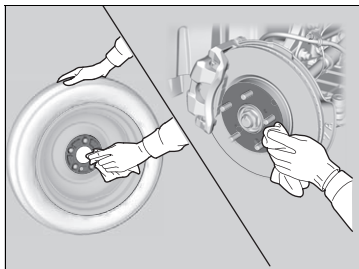

2. Wipe the mounting surfaces of the wheel with a clean cloth.

3. Mount the compact spare tire.

4. Screw the wheel nuts until they touch the lips around the mounting holes, then stop rotating.

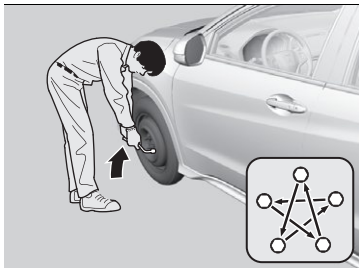

5. Lower the vehicle and remove the jack. Tighten the wheel nuts in the order indicated in the image. Go around, tightening the nuts, two to three times in this order.

Wheel nut torque:

80 lbf-ft (108 N·m, 11 kgf·m)

Replacing the Flat Tire

Do not over tighten the wheel nuts by applying extra torque using your foot or a pipe.

2WD models

Storing the Flat Tire

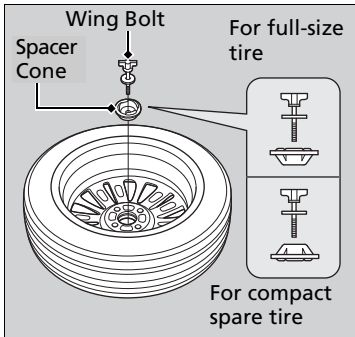

1. Remove the center cap.
2. Place the flat tire face down in the spare tire well.
3. Remove the spacer cone from the wing bolt, flip it over, and insert it back on the bolt. Secure the flat tire with the wing bolt.
4. Securely store the wheel nut wrench, jack handle bar and jack back in the tool case. Store the case in the cargo area under the cargo floor lid.

Storing the Flat Tire

⚠ WARNING

Loose items can fly around the interior in a crash and can seriously injure the occupants.

Store the wheel, jack, and tools securely before driving.

AWD models

Storing the Flat Tire

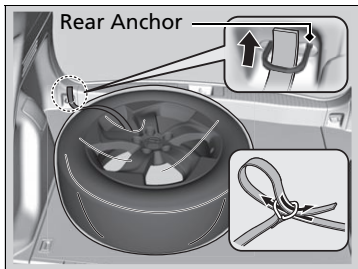
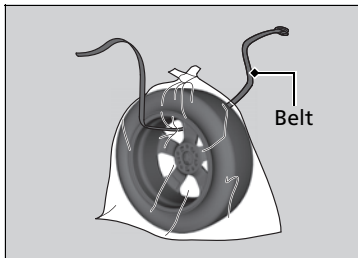
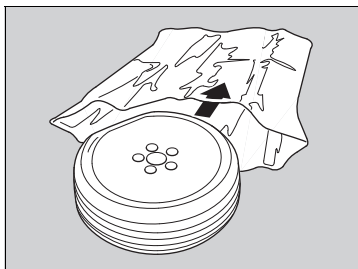

1. Put the flat tire in the storage bag provided with your vehicle.
 - ▶ The storage bag is in the tool case.
2. Knot the top of the storage bag.
3. Store the jack in its holder. Turn the jack's end bracket to lock it in place.
4. Securely put the wheel nut wrench and jack handle bar back in the tool case.
5. Bore through the bag, and pass the holding belt through the hole of the bag and the wheel of the flat tire as shown.
6. Place the flat tire in the cargo area, and thread the belt through the rear anchor as shown.
7. Pass the belt through the ring, and tighten the belt to secure the flat tire in place.

Storing the Flat Tire

⚠ WARNING

Loose items can fly around the interior in a crash and can seriously injure the occupants.

Store the wheel, jack, and tools securely before driving.

Continued

U.S. models

■ TPMS and the Spare Tire

If you replace a flat tire with the spare tire, the low tire pressure/TPMS indicator comes on while you are driving. After driving for a few miles (kilometers), the indicator will start blinking for a short time and then stay on, but this is normal.

Calibrate the TPMS when you replace the tire with a specified regular tire.

➤ **TPMS Calibration** P. 359

Checking the Engine

If the engine does not start, check the starter.

☞ Checking the Engine

If you must start the vehicle immediately, use an assisting vehicle to jump start it.

☞ **Jump Starting** P. 446

Starter condition	Checklist
Starter doesn't turn or turns over slowly. The battery may be dead. Check each of the items on the right and respond accordingly.	Check the brightness of the interior lights. Turn on the interior lights and check the brightness. <ul style="list-style-type: none">• If the interior lights are dim or do not come on at all ☞ Battery P. 420• If the interior lights come on normally ☞ Fuses P. 456
The starter turns over normally but the engine doesn't start. There may be a problem with the fuse. Check each of the items on the right and respond accordingly.	Review the engine start procedure. Follow its instructions, and try to start the engine again. ☞ Starting the Engine P. 325, P. 328
	Check the immobilizer system indicator. When the immobilizer system indicator is blinking, the engine cannot be started. ☞ Immobilizer System P. 116
	Check the fuel level. There should be enough fuel in the tank. ☞ Fuel Gauge P. 91
	Check the fuse. Check all fuses, or have your vehicle checked by a dealer. ☞ Inspecting and Changing Fuses P. 460
	If the problem continues: ☞ Emergency Towing P. 461

Models with smart entry system

If the Smart Entry Remote Battery is Weak

If the beeper sounds, the indicator on the **ENGINE START/STOP** button flashes, and the engine won't start.

Start the engine as follows.

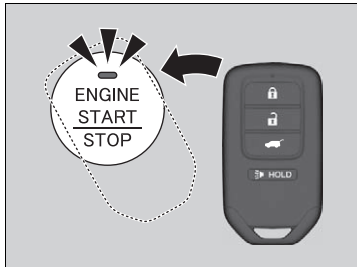

1. Touch the center of the **ENGINE START/STOP** button with the **H** logo on the smart entry remote while the indicator on the **ENGINE START/STOP** button is flashing. The buttons on the smart entry remote should be facing you.

▶ The indicator flashes for about 30 seconds.

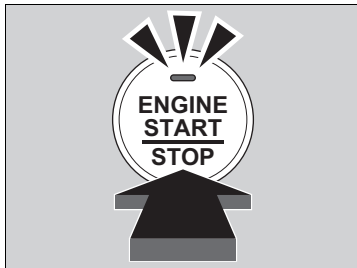

2. Depress the brake pedal (continuously variable transmission) or clutch pedal (manual transmission) and press the **ENGINE START/STOP** button within 10 seconds after the beeper sounds and the indicator stays on.

▶ If you don't depress the pedal, the mode will change to **ACCESSORY**.

Models with smart entry system

Emergency Engine Stop

The **ENGINE START/STOP** button may be used to stop the engine due to an emergency situation even while driving. If you must stop the engine, do either of the following operations:

- Press and hold the **ENGINE START/STOP** button for about two seconds.
- Firmly press the **ENGINE START/STOP** button twice.

The steering wheel will not lock. However, because turning off the engine disables the power assist the engine provides to the steering and braking systems, it will require significantly more physical effort and time to steer and slow the vehicle. Use both feet on the brake pedal to slow down the vehicle and stop immediately in a safe place. With manual transmission models you can also downshift the transmission to utilize engine braking.

Continuously variable transmission models

The power mode is in ACCESSORY when the engine is stopped. To change the mode to VEHICLE OFF, move the shift lever to **P** after the vehicle comes to a complete stop.

Canadian continuously variable transmission models

Then press the **ENGINE START/STOP** button twice without depressing the brake pedal.

Manual transmission models

The power mode changes to VEHICLE OFF.

Emergency Engine Stop

Do not press the button while driving unless it is absolutely necessary for the engine to be switched off.

Jump Starting Procedure

Turn off the power to electric devices, such as audio and lights. Turn off the engine, then open the hood.

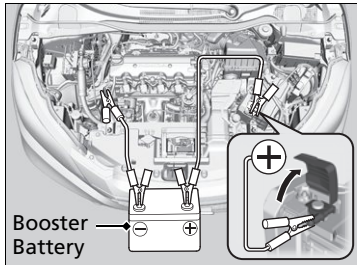

1. Connect the first jumper cable to your vehicle's battery \oplus terminal.
 - ▶ Remove the cover from the under-hood fuse box.
 - ▶ **Engine Compartment Fuse Box** P. 456
2. Connect the other end of the first jumper cable to the booster battery \oplus terminal.
 - ▶ Use a 12-volt booster battery only.
 - ▶ Connect when using the automotive battery charger to boost your 12-volt battery, select a lower charging voltage than 15-volt. Check the charger manual for the proper setting.
3. Connect the second jumper cable to the booster battery \ominus terminal.
4. Connect the other end of the second jumper cable to the stud bolt as shown. Do not connect this jumper cable to any other part.
5. If your vehicle is connected to another vehicle, start the assisting vehicle's engine and increase its rpm slightly.
6. Attempt to start your vehicle's engine. If it turns over slowly, check that the jumper cables have good metal-to-metal contact.

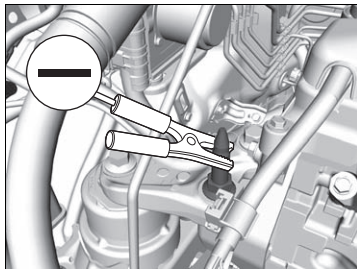

Jump Starting

WARNING

A battery can explode if you do not follow the correct procedure, seriously injuring anyone nearby.

Keep all sparks, open flames, and smoking materials away from the battery.

Securely attach the jumper cables clips so that they do not come off when the engine vibrates. Also be careful not to tangle the jumper cables or allow the cable ends to touch each other while attaching or detaching the jumper cables.

Battery performance degrades in cold conditions and may prevent the engine from starting.

■ What to Do After the Engine Starts

Once your vehicle's engine has started, remove the jumper cables in the following order.

1. Disconnect the jumper cable from your vehicle's stud bolt.
2. Disconnect the other end of the jumper cable from the booster battery \ominus terminal.
3. Disconnect the jumper cable from your vehicle's battery \oplus terminal.
4. Disconnect the other end of the jumper cable from the booster battery \oplus terminal.

Have your vehicle inspected by a nearby service station or a dealer.

Shift Lever Does Not Move

Continuously variable transmission models

Follow the procedure below if you cannot move the shift lever out of the **P** position.

Releasing the Lock

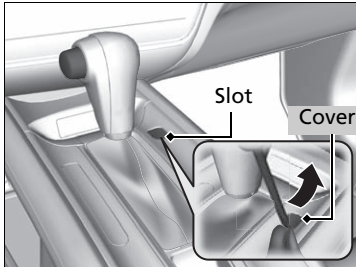

1. Set the parking brake.

Models without smart entry system

2. Remove the key from the ignition switch.

Models with smart entry system

2. Remove the built-in key from the smart entry remote.

All models

3. Wrap a cloth around the tip of a small flat-tip screwdriver. Put it into the shift lock release slot as shown in the image, and remove the cover.
4. Insert the key into the shift lock release slot.
5. While pushing the key down, press the shift lever release button and place the shift lever into **N**.
 - ▶ The lock is now released. Have the shift lever checked by a dealer as soon as possible.

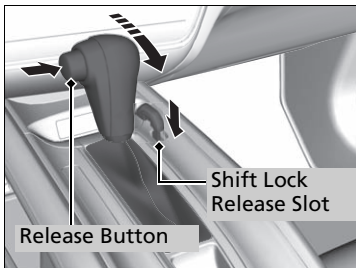

How to Handle Overheating

Overheating symptoms are as follows:

- The high temperature indicator (red) comes on or the engine suddenly loses power.
- Steam or spray comes out of the engine compartment.

■ First thing to do

1. Immediately park the vehicle in a safe place.
2. Turn off all accessories and turn on the hazard warning lights.
 - ▶ **No steam or spray present:** Keep the engine running and open the hood.
 - ▶ **Steam or spray is present:** Turn off the engine and wait until it subsides. Then open the hood.

☒ How to Handle Overheating

WARNING

Steam and spray from an overheated engine can seriously scald you.

Do not open the hood if steam is coming out.

NOTICE

Continuing to drive with the high temperature indicator on may damage the engine.

■ Next thing to do

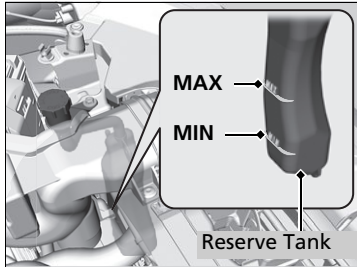

1. Check that the cooling fan is operating and stop the engine once the high temperature indicator goes off.
 - If the cooling fan is not operating, immediately stop the engine.
2. Once the engine has cooled down, inspect the coolant level and check the cooling system components for leaks.
 - If the coolant level in the reserve tank is low, add coolant until it reaches the **MAX** mark.
 - If there is no coolant in the reserve tank, check that the radiator is cool. Cover the radiator cap with a heavy cloth and open the cap. If necessary, add coolant up to the base of the filler neck, and put the cap back on.

■ Last thing to do

Once the engine has cooled sufficiently, restart it and check the high temperature indicator.

If the high temperature indicator is off, resume driving. If it stays on, contact a dealer for repairs.

► How to Handle Overheating

⚠ WARNING

Removing the radiator cap while the engine is hot can cause the coolant to spray out, seriously scalding you.

Always let the engine and radiator cool down before removing the radiator cap.

If the coolant is leaking, contact a dealer for repairs.

Use water as an emergency/temporary measure only. Have a dealer flush the system with proper antifreeze as soon as possible.

If the Low Oil Pressure Indicator Comes On



■ Reasons for the indicator to come on

Comes on when the engine oil pressure is low.

■ What to do as soon as the indicator comes on

1. Immediately park the vehicle on level ground in a safe place.
2. If necessary, turn the hazard warning lights on.

■ What to do after parking the vehicle

1. Stop the engine and let it sit for about three minutes.
2. Open the hood and check the oil level.
 - ▶ Add oil as necessary.
 - ▶ **Oil Check** P. 390
3. Start the engine and check the low oil pressure indicator.
 - ▶ The indicator goes off: Start driving again.
 - ▶ The indicator does not go off within 10 seconds: Stop the engine and contact a dealer for repairs immediately.

If the Charging System Indicator Comes On



■ Reasons for the indicator to come on

Comes on when the battery is not being charged.

■ What to do when the indicator comes on

Turn off the heating and cooling system*/climate control system*, rear defogger, and other electrical systems, and immediately contact a dealer for repairs.

☒ If the Low Oil Pressure Indicator Comes On

NOTICE

Running the engine with low oil pressure can cause serious mechanical damage almost immediately.

☒ If the Charging System Indicator Comes On

If you need to stop temporarily, do not turn off the engine. Restarting the engine may rapidly discharge the battery.

* Not available on all models

If the Malfunction Indicator Lamp Comes On or Blinks



■ Reasons for the indicator lamp to come on or blink

- Comes on when there is a problem with the engine emissions control system, or the fuel fill cap is missing, or loose.
- Blinks when engine misfiring is detected.

■ What to do when the indicator lamp comes on

Avoid high speeds and immediately get your vehicle inspected at a dealer.

■ What to do when the indicator lamp blinks

Park the vehicle in a safe place with no flammable items and wait at least ten minutes or more with the engine stopped until it cools.

■ Check Fuel Cap Message

■ The message appears on when:

An evaporative system leak is detected. This may be caused by the fuel fill cap being loose or not being installed.

■ What to do when the message appears:

1. Stop the engine.
2. Check if the fuel fill cap is fully installed.
 - ▶ If not, loosen the cap, and then retighten it until it clicks at least once.
3. Drive for several days of normal driving.
 - ▶ The message should go off.

■ When the malfunction indicator lamp comes on

The malfunction indicator lamp comes on if the system continues to detect a leak of gasoline vapor. If this happens, follow the procedures described earlier to check the fuel fill cap.

▶▶ If the Malfunction Indicator Lamp Comes On or Blinks

NOTICE

If you drive with the malfunction indicator lamp on, the emissions control system and the engine could be damaged.

If the malfunction indicator lamp blinks again when restarting the engine, drive to the nearest dealer at 31 mph (50 km/h) or less. Have your vehicle inspected.

If the Brake System Indicator (Red) Comes On



■ Reasons for the indicator to come on

- The brake fluid is low.
- There is a malfunction in the brake system.

■ What to do when the indicator comes on while driving

Press the brake pedal lightly to check pedal pressure.

- If normal, check the brake fluid level the next time you stop.
- If abnormal, take immediate action. If necessary, downshift the transmission to slow the vehicle using engine braking.

If the Electric Power Steering (EPS) System Indicator Comes On



■ Reasons for the indicator to come on

- Comes on when there is a problem with the EPS system.
- If you depress the accelerator pedal repeatedly to increase the engine speed while the engine is idling, the indicator comes on, and sometimes the steering wheel becomes harder to operate.

■ What to do when the indicator comes on

Stop the vehicle in a safe place and restart the engine.

If the indicator comes on and stays on, immediately have your vehicle inspected by a dealer.

ⓘ If the Brake System Indicator (Red) Comes On

Have your vehicle repaired immediately. It is dangerous to drive with low brake fluid. If there is no resistance from the brake pedal, stop immediately in a safe place. If necessary downshift the gears.

If the brake system indicator and **ABS** indicator come on simultaneously, the electronic brake distribution system is not working. This can result in vehicle instability under sudden braking. Have your vehicle inspected by a dealer immediately.

If the Electric Parking Brake System Indicator Comes On



■ Reasons for the indicator to come on

Comes on when there is a problem with the electric parking brake system.

■ What to do when the indicator comes on

Avoid using the parking brake and immediately get your vehicle inspected at a dealer.

■ What to do when the electric parking brake indicator comes on or blinks at the same time.

- Release the parking brake. If you cannot release it, immediately stop the vehicle in a safe place and call a dealer.
- If only the electric parking brake indicator goes off, immediately get your vehicle inspected at a dealer.
- If the electric parking brake indicator remains on or blinks even after releasing the parking brake, immediately stop the vehicle in a safe place and call a dealer.

U.S. models

If the Low Tire Pressure/TPMS Indicator Comes On or Blinks



■ Reasons for the indicator to come on or blink

A tire pressure is significantly low, or the TPMS has not been calibrated. If there is a problem with the TPMS or the compact spare tire is installed, the indicator blinks for about one minute, and then stays on.

■ What to do when the indicator comes on

Drive carefully and avoid abrupt cornering and hard braking.

Stop your vehicle in a safe place. Check the tire pressure and adjust the pressure to the specified level. The specified tire pressure is on a label on the driver side doorjamb.

▶ Calibrate the TPMS after the tire pressure is adjusted.

■ What to do when the indicator blinks, then remains on

Have the tire inspected by a dealer as soon as possible. If the compact spare tire causes the indicator to blink, change the tire to a full-size tire. The indicator goes off after driving for a few miles (kilometers).

▶ Calibrate the TPMS after a full-size tire is reinstalled.

▶▶ If the Low Tire Pressure/TPMS Indicator Comes On or Blinks

NOTICE

Driving on an extremely underinflated tire can cause it to overheat. An overheated tire can fail. Always inflate your tires to the prescribed level.

Fuse Locations

If any electrical devices are not working, turn the ignition switch to LOCK [0]^{*1} and check to see if any applicable fuse is blown.

Engine Compartment Fuse Box

■ Fuse box A

Located near the brake fluid reservoir. Push the tabs to open the box.

Fuse locations are shown on the fuse box cover. Locate the fuse in question by the fuse number and box cover number.

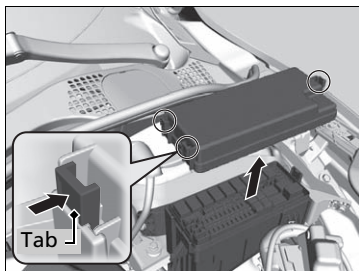

■ Circuit protected and fuse rating

	Circuit Protected	Amps
1	Headlight Low Beam Main	20 A
2	CDC *	(30 A)
3	Hazard	10 A
4	DBW	15 A
5	Wiper*	(30 A)
6	Stop	10 A
7	IGP	15 A
8	IG Coil	15 A
9	EOP*	(10 A)
10	INJ*	(20 A)
11	VST2*	(30 A)
12	Main Fan	30 A
13	Starter SW*	(30 A)
14	MG Clutch	7.5 A
15	Battery Sensor	(7.5 A)
16	Small Light	10 A
17	AFP Main *	(10 A)
18	Horn	10 A
19	Fog Light*	(10 A)
20	SBW*	(10 A)

	Circuit Protected	Amps
21	Back Up Main	10 A
22	Audio	(10 A)
23	Sub Fan	(30 A)
24	VST1*	(30 A)
25	STRLD*	(7.5 A)
26	IGP CAM*	(7.5 A)
27	–	–
28	–	–
29	Back Up*	(30 A)
30	IGP LAF	(7.5 A)
31	IGPS	(7.5 A)
32	Right Headlight Low Beam	10 A
33	Left Headlight Low Beam	10 A

*1: Models with the smart entry system have an **ENGINE START/STOP** button instead of an ignition switch.

■ Fuse box B

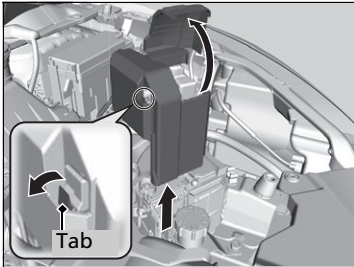

Pull up the cover on the ⊕ terminal, then remove it while pulling out the tab as shown.
Replacement of engine compartment fuses should be done by a dealer.

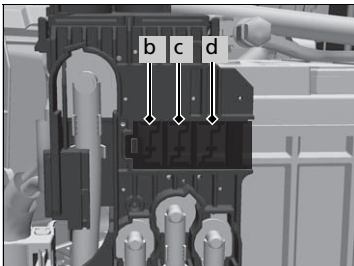
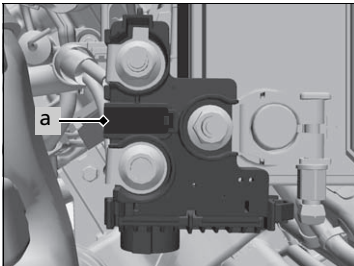

■ Circuit protected and fuse rating

	Circuit Protected	Amps
a	Battery Main	100 A
b	RB Main 1	70 A
c	RB Main 2	80 A
d	CAP Main	70 A

Interior Fuse Boxes

Fuse box A

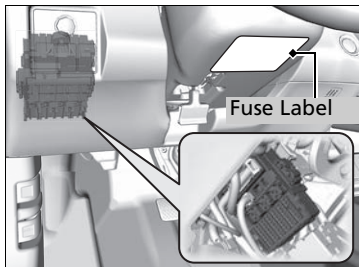

Located behind the instrument panel. Fuse locations are shown on the label under the steering column. Locate the fuse in question by the fuse number and label number.

Circuit protected and fuse rating

	Circuit Protected	Amps
1	Door Lock	20 A
2	–	–
3	Smart*	(10 A)
4	Driver Side Door Unlock	10 A
5	Passenger Side Door Unlock	10 A
6	Driver Door Unlock	10 A
7	Driver Door Lock	10 A
8	Driver's Power Window	20 A
9	Passenger's Power Window	20 A
10	Rear Left Power Window	20 A
11	Rear Right Power Window	20 A
12	Driver Side Door Lock	10 A
13	Passenger Side Door Lock	10 A
14	–	–
15	Right Headlight High Beam	10 A
16	STS*	(7.5 A)
17	Sunshade*	(20 A)
18	Moonroof*	(20 A)
19	Front Seat Heater*	(20 A)
20	–	–

	Circuit Protected	Amps
21	MP Camera*	(10 A)
22	Washer	15 A
23	Rear Wiper*	(10 A)
24	A/C	7.5 A
25	Daytime Running Lights	7.5 A
26	Starter Cut*	(7.5 A)
27	ABS/SA	7.5 A
28	SRS	10 A
29	Left Headlight High Beam	10 A
30	ACG	10 A
31	IG Relay	10 A
32	Fuel Pump	15 A
33	SRS	(7.5 A)
34	Meter	7.5 A
35	Mission SOL	7.5 A
36	Front ACC Socket	20 A
37	ACC	(7.5 A)
38	ACC*	(7.5 A)
39	Option	10 A
40	Rear Wiper	10 A
41	–	–
42	–	–

■ Fuse box B

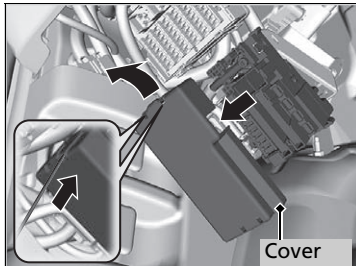
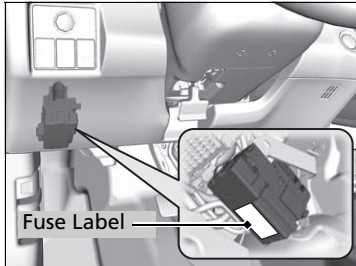

Remove the cover by putting the flat-tip screwdriver into the side slot as shown.

■ Circuit protected and fuse rating

	Circuit Protected	Amps
1	EPS	70 A
	IG Main	30 A ^{*1}
		50 A ^{*2}
	Fuse Box Main 2	50 A
	ABS/VSA Motor	40 A
	Fuse Box Main 1	30 A
	Fuse Box Main 3	40 A
	Rear Defogger	30 A
2	EPB L	30 A
	IG Main ^{*1}	30 A
	- ^{*2}	30 A
	HTR	40 A
	EPB R	30 A
	E-DPS	30 A

	Circuit Protected	Amps
3	–	–
4	–	–
5	ABS/VSA FSR	30 A
6	Deicer*	(10 A)
7	RR ACC SOCKET*	(20 A)
8	–	–
9	Interior Light	7.5 A
10	ACC Socket (Console)	(20 A)
11	–	–
12 ^{*1}	–	–
12 ^{*2}	ACC Key Lock	(7.5 A)
13	Heated Door Mirror*	(10 A)
14	A/C Blower SW*	(7.5 A)
15 ^{*1}	–	–
15 ^{*2}	Wiper	30 A

*1: Models with smart entry system

*2: Models without smart entry system

* Not available on all models

Inspecting and Changing Fuses

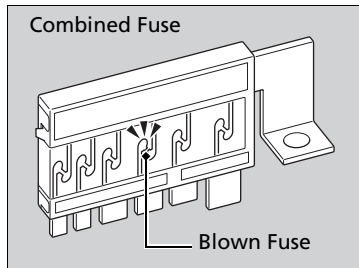
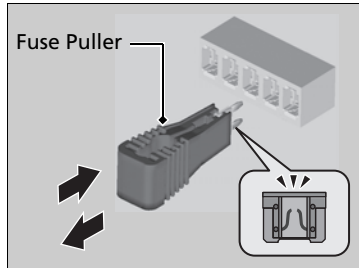
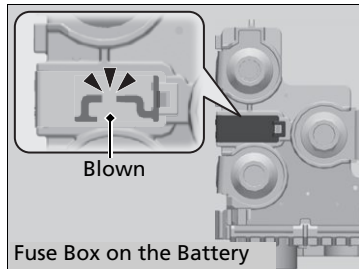

1. Turn the ignition switch to LOCK **0***1. Turn headlights and all accessories off.
2. Check the fuses on the battery in the engine compartment.
 - If the fuse is blown, have it replaced by a dealer.
3. Remove the fuse box cover.
4. Inspect the small fuses in the engine compartment and the vehicle interior.
 - If there is a burned out fuse, remove it with the fuse puller and replace it with a new one.
5. Check the large fuse in the vehicle interior.
 - If the fuse is blown, use a Phillips-head screwdriver to remove the screw and replace it with a new one.

Inspecting and Changing Fuses

NOTICE

Replacing a fuse with one that has a higher rating greatly increases the chances of damaging the electrical system.

Replace fuse with a new one of the same specified amperage. Confirm the specified amperage using the charts on **Fuse Locations**.

There is a fuse puller on the back of the engine compartment fuse box cover.

*1: Models with the smart entry system have an **ENGINE START/STOP** button instead of an ignition switch.

Emergency Towing

Call a professional towing service if you need to tow your vehicle.

All models

■ Flat bed equipment

The operator loads your vehicle on the back of a truck.

This is the best way to transport your vehicle.

2WD models

■ Wheel lift equipment

The tow truck uses two pivoting arms that go under the front tires and lift them off the ground. The rear tires remain on the ground. **This is an acceptable way to tow your vehicle.**

» Emergency Towing

NOTICE

Trying to lift or tow your vehicle by the bumpers will cause serious damage. The bumpers are not designed to support the vehicle's weight.

NOTICE

Improper towing such as towing behind a motorhome or other motor vehicle can damage the transmission.

Never tow your vehicle with just a rope or chain. It is very dangerous since ropes or chains may shift from side to side or break.

2WD models

Make sure the parking brake is released. If you cannot release the parking brake, your vehicle must be transported by the flat bed equipment.

➔ **Parking Brake** P. 363

What to Do When Unable to Open the Tailgate

If you cannot open the tailgate, use the following procedure.



1. Wrap a cloth around the flat-tip screwdriver. Put it into the cover as shown in the image, and open it.

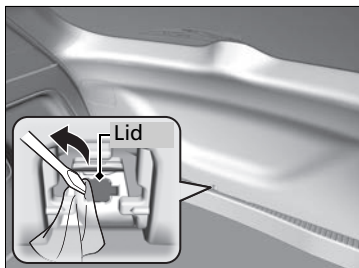

2. Wrap a cloth around the flat-tip screwdriver. Put it into the lid as shown in the image, and open the lid.

When You Cannot Open the Tailgate

After taking these steps, contact a dealer to have your vehicle checked.

When you open the tailgate from inside, make sure there is enough space around the tailgate, and it does not hit anyone or any object.

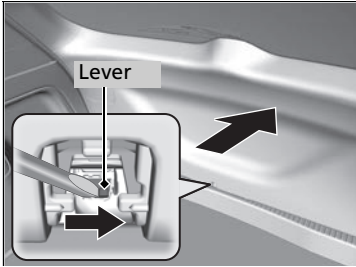

3. To open the tailgate, push the tailgate while sliding the lever to the right.

Information

This chapter includes your vehicle's specifications, locations of identification numbers, and other information required by regulation.

Specifications	466
Identification Numbers	
Vehicle Identification Number (VIN), Engine Number and Transmission Number	468
Devices that Emit Radio Waves	469
Reporting Safety Defects	470
Emissions Testing	
Testing of Readiness Codes	471
Warranty Coverages	473
Authorized Manuals	475
Customer Service Information	476

■ Vehicle Specifications

Model	HR-V
No. of Passengers:	
Front	2
Rear	3
Total	5
Weights:	
Gross Vehicle	4,001 lbs (1,815 kg)* ¹
Weight Rating	4,166 lbs (1,890 kg)* ²
Gross Axle Weight	2,127 lbs (965 kg)* ¹
Rating (Front)	2,178 lbs (988 kg)* ²
Gross Axle Weight	1,873 lbs (850 kg)* ¹
Rating (Rear)	1,988 lbs (902 kg)* ²
Air Conditioning:	
Refrigerant Type	HFC-134a (R-134a)
Charge Quantity	14.3 - 16.0 oz (405 - 455 g)
Lubricant Type	ND-OIL8

*1: 2WD

*2: AWD

■ Engine Specifications

Displacement	109.8 cu-in (1,799 cm ³)	
Spark Plugs	NGK	DILZKR7B11GS
	DENSO	DXU22HCR-D11S

■ Fuel

Fuel:	Unleaded gasoline, Pump octane number of 87 or higher
Type	
Fuel Tank Capacity	13.2 US gal (50 ℓ)

■ Washer Fluid

Tank Capacity	U.S.: 2.6 US qt (2.5 ℓ)
	Canada: 4.8 US qt (4.5 ℓ)

■ Light Bulbs

Headlights (High/Low Beam)	60/55W (HB2)
Fog Lights*	35W (H8)
Side Marker Lights	5W
Front Turn Signal/Parking Lights	28/8W (Amber)
Brake/Tail/Side Marker Lights	LED
Back-Up Lights	16W
Rear Turn Signal Lights	21W (Amber)
High-Mount Brake Light	LED
Side Turn Signal Lights*	LED
Rear License Plate Lights	5W
Interior Lights	
Vanity Mirror Light*	1.8W
Map Lights	8W
Ceiling Light	8W
Cargo Area Light	5W

■ Brake Fluid

Specified	Honda Heavy Duty Brake Fluid DOT 3	
-----------	------------------------------------	--

■ Continuously Variable Transmission Fluid*

Specified	Honda HCF-2 Transmission Fluid	
-----------	--------------------------------	--

Capacity	Change	3.7 US qt (3.5 ℓ) ^{*1}
		4.2 US qt (4.0 ℓ) ^{*2}

*1: 2WD

*2: AWD

■ Manual Transmission Fluid*

Specified	Honda Manual Transmission Fluid	
-----------	---------------------------------	--

Capacity	Change	2.0 US qt (1.9 ℓ)
----------	--------	-------------------

■ Rear Differential Fluid*

Specified	Honda Dual Pump Fluid II	
-----------	--------------------------	--

Capacity	Change	1.318 US qt (1.247 ℓ)
----------	--------	-----------------------

■ Engine Oil

Recommended	-Genuine Honda Motor Oil 0W-20	
	-API Premium-grade 0W-20 detergent oil	

Change	3.7 US qt (3.5 ℓ)	
--------	-------------------	--

Capacity	Change	3.9 US qt (3.7 ℓ)
	including filter	

■ Engine Coolant

Specified	Honda Long-Life Antifreeze/Coolant Type2	
-----------	--	--

Ratio	50/50 with distilled water	
-------	----------------------------	--

Capacity	1.39 US gal (5.25 ℓ) ^{*1}	
	(change including the remaining 0.13 US gal (0.5 ℓ) in the reserve tank)	
	1.38 US gal (5.24 ℓ) ^{*2}	

Capacity	(change including the remaining 0.13 US gal (0.5 ℓ) in the reserve tank)	
	0.13 US gal (0.5 ℓ) in the reserve tank	

*1: Continuously variable transmission models

*2: Manual transmission models

■ Tire

Regular	Size	215/55R17 94V	
	Pressure psi (kPa[kgf/cm ²])	Front	32 (220 [2.2])

		Rear	30 (210 [2.1])
--	--	------	----------------

Compact Spare	Size	T135/90D16 102M	
	Pressure psi (kPa[kgf/cm ²])	60 (420 [4.2])	

Wheel Size	Regular	17 x 7 1/2J	
	Compact Spare	16 x 4T	

* Not available on all models

Vehicle Identification Number (VIN), Engine Number and Transmission Number

Your vehicle has a 17-digit vehicle identification number (VIN) used to register your vehicle for warranty purposes, and for licensing and insuring your vehicle. The locations of your vehicle's VIN, engine number and transmission number are shown as follows.

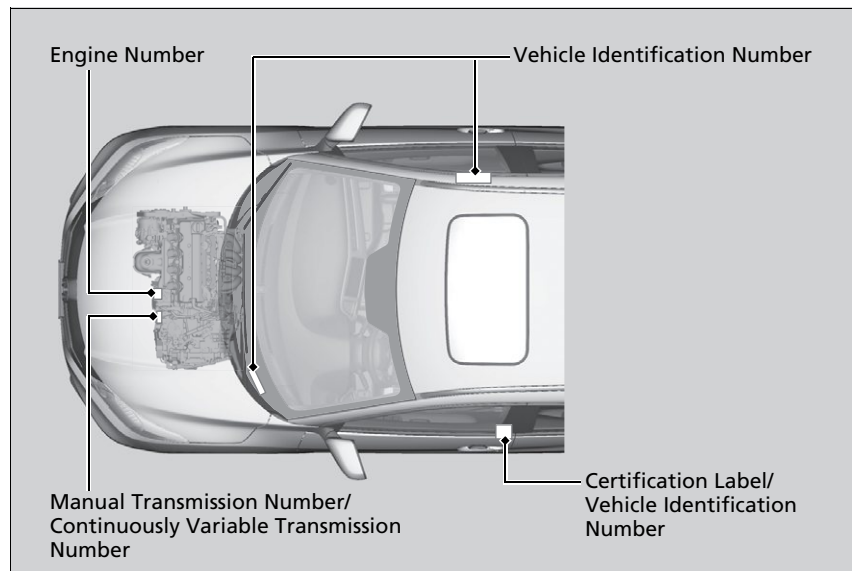

Vehicle Identification Number (VIN), Engine Number and Transmission Number

The interior vehicle identification number (VIN) is located under the cover.

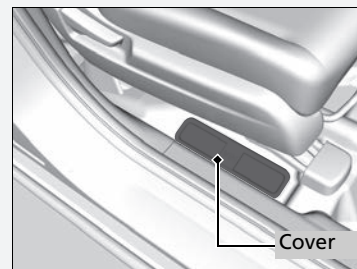

Devices that Emit Radio Waves

The following products and systems on your vehicle emit radio waves when in operation.

Audio System

Bluetooth® Audio

Bluetooth® HandsFreeLink®

Immobilizer System

Smart Entry System

Remote Transmitter

Each of the above complies with the appropriate requirements or the required standards of FCC (Federal Communications Commission) and Industry Canada Standard, described below:

As required by the FCC:

This device complies with Part 15 of the FCC rules. Operation is subject to the following two conditions: (1) This device may not cause harmful interference, and (2) this device must accept any interference received, including interference that may cause undesired operation.

Changes or modifications not expressly approved by the party responsible for compliance could void the user's authority to operate the equipment.

This device complies with Industry Canada Standard RSS-Gen/210/310.

Operation is subject to the following two conditions: (1) this device may not cause interference, and (2) this device must accept any interference, including interference that may cause undesired operation of the device.

In the U.S.

If you believe that your vehicle has a defect which could cause a crash or could cause injury or death, you should immediately inform the National Highway Traffic Safety Administration (NHTSA) in addition to notifying American Honda Motor Co., Inc.

If NHTSA receives similar complaints, it may open an investigation, and if it finds that a safety defect exists in a group of vehicles, it may order a recall and remedy campaign. However, NHTSA cannot become involved in individual problems between you, your dealer, or American Honda Motor Co., Inc.

To contact NHTSA, you may call the Vehicle Safety Hotline toll-free at 1-888-327-4236 (TTY: 1-800-424-9153); go to <http://www.safercar.gov>; or write to: Administrator, NHTSA, 1200 New Jersey Avenue, SE., Washington, DC 20590. You can also obtain other information about motor vehicle safety from <http://www.safercar.gov>.

In Canada

If you believe that your vehicle has a defect which could cause a crash or could cause injury or death, you should immediately inform Honda Canada Inc. and you may also inform Transport Canada.

If Transport Canada receives similar complaints, it may open an investigation, and if it finds that a safety defect exists in a group of vehicles, it may lead to a recall and remedy campaign. However, Transport Canada cannot become involved in individual problems between you, your dealer, or Honda Canada Inc.

To contact Transport Canada's Defect Investigations and Recalls Division, you may call 1-800-333-0510. For more information on reporting safety defects or about motor vehicle safety, go to <http://www.tc.gc.ca/roadsafety>.

Testing of Readiness Codes

Your vehicle has “Readiness Codes,” as part of the onboard self diagnostic system. Some states use these codes as a test to see if your vehicle’s emissions components are working properly. The codes may not be read properly if testing is performed just after the battery has gone dead or been disconnected.

To check if they are set, turn the ignition switch to ON **[II]***1, without starting the engine. The malfunction indicator lamp will come on for several seconds. If it then goes off, the readiness codes are set. If it blinks five times, the readiness codes are not set.

If you are required to have your vehicle tested before the readiness codes are ready, prepare the vehicle for retesting by doing the following:

1. Fill the gas tank to approximately 3/4 full.
2. Park the vehicle and leave the engine off for 6 hours or more.
3. Make sure the ambient temperature is between 40°F and 95°F (4°C and 35°C).
4. Start the engine without touching the accelerator pedal, and let it idle for 20 seconds.
5. Keep the vehicle in **[P]** (continuously variable transmission) or **[N]** (manual transmission). Increase the engine speed to 2,000 rpm, and hold it there for about three minutes.
6. Let the engine idle with your foot off the accelerator for 20 seconds.

*1: Models with the smart entry system have an **ENGINE START/STOP** button instead of an ignition switch.

Testing of Readiness Codes

The readiness codes are erased when the battery is disconnected, and set again only after several days of driving under a variety of conditions.

If a testing facility determines that the readiness codes are not set, you may be requested to return at a later date to complete the test.

If the testing facility determines the readiness codes are still not set, see a dealer.

7. Select a nearby, lightly traveled major highway where you can maintain a speed of 50 to 60 mph (80 to 97 km/h) for at least 20 minutes. Drive on the highway in **D** (continuously variable) or 5th (manual). Do not use cruise control. When traffic allows, drive for 90 seconds without moving the accelerator pedal. (Vehicle speed may vary slightly; this is okay.) If you cannot do this for a continuous 90 seconds because of traffic conditions, drive for at least 30 seconds, then repeat it two more times (for a total of 90 seconds).
8. Drive in city/suburban traffic for at least 10 minutes. When traffic conditions allow, let the vehicle coast for several seconds without using the accelerator pedal or the brake pedal.
9. Park the vehicle and leave the engine off for 30 minutes.

■ U.S. Owners

Your new vehicle is covered by these warranties:

New Vehicle Limited Warranty – covers your new vehicle, except for the emissions control systems and accessories, against defects in materials and workmanship.

Emissions Control Systems Defects Warranty and Emissions Performance Warranty – these two warranties cover your vehicle's emissions control systems. Time, mileage, and coverage are conditional. Please read your warranty booklet for exact information.

Seat Belt Limited Warranty – a seat belt that fails to function properly is covered by a limited warranty. Please read your warranty booklet for details.

Rust Perforation Limited Warranty – all exterior body panels are covered for rust-through from the inside for the specified time period with no mileage limit.

Accessory Limited Warranty – Honda accessories are covered under this warranty. Time and mileage limits depend on the type of accessory and other factors. Please read your warranty booklet for details.

Replacement Parts Limited Warranty – covers all Honda replacement parts against defects in materials and workmanship.

Replacement Battery Limited Warranty – provides prorated coverage for a replacement battery purchased from a dealer.

Replacement Muffler Lifetime Limited Warranty – provides coverage for as long as the purchaser of the muffler owns the vehicle.

Restrictions and exclusions apply to all these warranties. Please read the Honda warranty information booklet that came with your vehicle for precise information on warranty coverages. Your vehicle's original tires are covered by their manufacturer. Tire warranty information is in a separate booklet.

■ **Canadian Owners**

Please refer to the warranty manual that came with your vehicle.

■ Service Express

For electronic copies of service publications, you can purchase a subscription to Service Express. Visit www.techinfo.honda.com for pricing and options.

■ For U.S. Owners:

Manuals be purchased from Helm Incorporated. You can order a manual by phone at (800) 782-4356 (credit card orders only), or online at www.helminc.com.

■ For Canadian Owners:

Please contact a dealer to order any manuals that you may require.

Honda dealership personnel are trained professionals.

They should be able to answer all your questions. If you encounter a problem that your dealership does not solve to your satisfaction, please discuss it with the dealership's service manager or general manager. If you are dissatisfied with the decision made by the dealership's management, contact Honda Customer Services.

U.S. Owners:

American Honda Motor Co., Inc.
Honda Automobile Customer Services
Mail Stop 500-2N-7A
1919 Torrance Blvd.
Torrance, CA 90501-2746
Tel: (800) 999-1009

Canadian Owners:

Honda Canada Inc.
Customer Relations
180 Honda Boulevard
Markham, ON
L6C 0H9
Tel: 1-888-9-HONDA-9
Fax: 1-877-939-0909
E-mail: Honda_cr@ch.honda.com

In Puerto Rico and the U.S. Virgin Islands:

Bella International
P.O. Box 190816
San Juan, PR 00919-0816
Tel: (787) 620-7546

Customer Service Information

When you call or write, please give us the following information:

- Vehicle Identification Number
 - ▣ **Vehicle Identification Number (VIN), Engine Number and Transmission Number** P. 468
- Date of purchase
- Odometer reading of your vehicle
- Your name, address, and telephone number
- A detailed description of the problem
- Name of the dealer who sold the vehicle to you

Disclaimer of Pandora®*

Requirements to access Pandora®

- Latest version of the Pandora application installed on your mobile device. (Visit the Apple iTunes store or Google Play Marketplace to download the latest version.)
- Registered Pandora account (you can create a free account at www.pandora.com <<http://www.pandora.com>> or on your smartphone)
- Connection to the internet via WiFi or cellular data network.
- Android devices must be connected to the vehicle via *Bluetooth*, iPhone devices may be connected via *Bluetooth* or USB.

Limitations

- Access to Pandora requires an active internet connection
- Ability to access Pandora through this system is subject to change without notice
- Certain functionality of Pandora service is not available when accessing the service through this system including, but not limited to, creating new stations, deleting stations, emailing current stations, buying songs, viewing additional text information, logging in to Pandora, and adjusting Cell Network Audio Quality. Pandora internet radio is a music service not affiliated with HONDA. More information is available at <http://www.pandora.com> <<http://www.pandora.com>>. Pandora, the Pandora logo, and the Pandora trade dress are trademarks or registered trademarks of Pandora Media, Inc., used with permission.
- Mobile access requires a smartphone with an active data plan. Standard data rates may apply.
- Pandora is only available in the United States.

* Not available on all models

Numbers

7-Speed Manual Shift Mode 338

A

ABS (Anti-lock Brake System)..... 369

Accessories and Modifications..... 377

Accessory Power Sockets..... 156

Additives

Coolant..... 394

Engine Oil..... 389

Washer..... 398

Additives, Engine Oil..... 389

Adjusting

Armrest..... 149

Front Seats..... 140

Head Restraints..... 142

Headlights..... 399

Mirrors..... 138

Rear Seats..... 146

Steering Wheel..... 137

Adjusting the Sound..... 187, 209

Air Conditioning System

Climate Control System..... 165

Defrosting the Windshield and

Windows..... 164, 168

Dust and Pollen Filter..... 424

Heating and Cooling System..... 161

Air Conditioning System (Climate Control System)

Synchronized Mode..... 172

Air Conditioning System (Heating and Cooling System)

Cooling..... 164

Heating..... 163

Air Pressure..... 412, 467

Airbags

Advanced Airbags..... 50

Airbag Care..... 56

Event Data Recorder..... 0

Front Airbags (SRS)..... 47

Indicator..... 54, 77

Passenger Airbag Off Indicator..... 55

Sensors..... 44

Side Airbags..... 51

Side Curtain Airbags..... 53

All-Wheel Drive (AWD)..... 358

Anti-lock Brake System (ABS)..... 369

Indicator..... 77

Armrest..... 149

Audio Remote Controls..... 180

Audio System..... 176

Adjusting the Sound..... 187, 209

Auxiliary Input Jack..... 178

Error Messages..... 231

General Information..... 235

HDMI® Port..... 178

iPod..... 194, 217

MP3/WMA/AAC..... 197, 222

Recommended CDs..... 235

Recommended Devices..... 237

Remote Controls..... 5, 180

Security Code..... 179

Theft Protection..... 179

USB Flash Drives..... 237

USB Port(s)..... 177

Audio/Information Screen..... 183, 204

Authorized Manuals..... 475

Auto Door Locking/Unlocking..... 109

Customize..... 110

Automatic Brake Hold..... 366

Indicator..... 74, 366

Automatic Brake Hold System

Indicator..... 73, 366

Automatic Climate Control Sensors..... 173

Auxiliary Input Jack..... 178

Average Fuel Economy..... 90

B

Battery..... 420

Charging System Indicator..... 75, 451

Jump Starting..... 446

Maintenance (Checking the Battery)..... 420

Maintenance (Replacing)..... 422

Belts (Seat)..... 35

Beverage Holders..... 153

Bluetooth® HandsFreeLink®..... 260, 283

Booster Seats (For Children)..... 68

Brake System..... 363

Anti-lock Brake System (ABS)..... 369

Automatic Brake Hold..... 366

Brake Assist System..... 370

Fluid	397	Child Safety	57	High Temperature Indicator.....	77
Foot Brake	365	Childproof Door Locks.....	108	Low Temperature Indicator.....	77
Indicator (Amber).....	72	Child Seat	57	Overheating	449
Indicator (Red)	72, 453	Booster Seats.....	68	Creeping (Continuously Variable	
Parking Brake.....	363	Child Seat for Infants.....	59	Transmission).....	333
Brake System Indicator (Amber)	72	Child Seat for Small Children	60	Cruise Control	344
Brake System Indicator (Red)	72	Installing a Child Seat with a Lap/Shoulder Seat		Indicator.....	82
Brightness Control (Instrument Panel) ...	134	Belt.....	64	Cup Holders	153
Bulb Replacement	399	Larger Children.....	67	Customer Service Information	476
Back-Up Light	404	Rear-facing Child Seat	59		
Brake/Tail/Rear Side Marker Lights.....	405	Selecting a Child Seat	61	D	
Fog Lights.....	401	Childproof Door Locks	108	Daytime Running Lights	131
Front Side Marker Lights	401	Cleaning the Exterior	427	Dead Battery	446
Front Turn Signal/Parking Lights	400	Cleaning the Interior	425	Defrosting the Windshield and	
Headlights	399	Climate Control System	165	Windows	164, 168
High-Mount Brake Light.....	405	Synchronized Mode.....	172	Devices that Emit Radio Waves	469
Rear License Plate Lights	406	Clock	94	Dimming	
Rear Turn Signal Lights.....	403	Coat Hook	157	Headlights.....	127
Side Turn Signal, Emergency Indicator		Compact Spare Tire	434, 467	Rearview Mirror.....	138
Lights.....	402	Continuously Variable Transmission	333	Dipstick (Engine Oil)	390
Bulb Specifications	466	7-Speed Manual Shift Mode	338	Directional Signals (Turn Signal)	127
		Creeping	333	Display Setup	188, 210
		Fluid	396	Door Mirrors	139
		Kickdown	333	Doors	96
		Operating the Shift Lever.....	21, 335, 337	Auto Door Locking.....	109
		Shift Lever Does Not Move	448	Auto Door Unlocking	109
		Shifting	334, 336	Door and Tailgate Open Indicator.....	34, 78
		Controls	93	Keys.....	96
		Coolant (Engine)	394	Locking/Unlocking the Doors from	
		Adding to the Radiator	395	the Inside	105
		Adding to the Reserve Tank.....	394		

C

Carbon Monoxide Gas	69
Cargo Floor Box	155
Carrying Cargo	315, 317
CD Player	191, 214
Certification Label	468
Changing Bulbs.....	399
Charging System Indicator	75, 451

Locking/Unlocking the Doors from the Outside.....	99
Lockout Prevention System	104
DOT Tire Quality Grading	414
Driving	313
Braking.....	363
Continuously Variable Transmission	333
Cruise Control	344
Shifting Gear	334, 336, 340
Starting the Engine.....	325, 328
Dust and Pollen Filter	424

E

ECO Assist System	9
ECON Button	343
ECON Mode Indicator	81
Electric Parking Brake	
Indicator.....	73
Electric Parking Brake System	
Indicator.....	73, 454
Electric Power Steering (EPS) System	
Indicator.....	78, 453
Electronic Stability Control (ESC)	354
Emergency	461
Emissions Testing (Readiness Codes)	471
Engine	
Coolant.....	394
Jump Starting	446
Number.....	468
Oil	389

Starting	325, 328
Switch Buzzer.....	122
Engine Coolant	394
Adding to the Radiator.....	395
Adding to the Reserve Tank.....	394
High Temperature Indicator.....	77
Low Temperature Indicator.....	77
Overheating	449
Engine Oil	389
Adding.....	391
Checking.....	390
Displaying Oil Life.....	383
Low Oil Pressure Indicator	75, 451
Recommended Engine Oil	389

Exhaust Gas Hazard (Carbon

Monoxide)	69
Exterior Care (Cleaning)	427
Exterior Mirrors	139

F

Features	175
Filters	
Dust and Pollen	424
Oil.....	392
Flat Tire	434
Floor Mats	426
Fluids	
Brake	397
Continuously Variable Transmission.....	396
Engine Coolant	394

Manual Transmission	396
Windshield Washer	398
FM/AM Radio	189, 211
Fog Light Indicator	80
Folding Down the Rear Seats	147
Folding the Rear Seat Up	148
Foot Brake	365
Forward Collision Warning (FCW)	347
Indicator	83
Front Airbags (SRS)	47
Front Seats	140
Adjusting	140
Fuel	22, 374
Economy.....	376
Gauge	91
Low Fuel Indicator.....	76
Recommendation.....	374
Refueling	22, 374
Fuel Economy	376
Fuel Fill Cap	22, 375
Message	452
Fuel Fill Door	22, 375
Fuses	456
Inspecting and Changing	460
Locations	456

G

Gasoline (Fuel)

Economy.....	376
Gauge	91

Information.....	374
Low Fuel Indicator.....	76
Refueling.....	374
Gauges	88
Gear Shift Lever Positions	
Continuously Variable	
Transmission.....	334, 336
Manual Transmission.....	341
Glass (care)	425, 428
Glove Box	152

H

Halogen Bulbs	399, 401
Handling the Unexpected	431
HandsFreeLink® (HFL)	260, 283
Menus.....	262, 286
Phone Setup.....	266, 291
Hazard Warning Button	4
Head Restraints	142
Headlights	127
Aiming.....	399
Dimming.....	127, 131
Operating.....	127
Heated Door Mirrors	135
Heated Windshield	136
Heating and Cooling System	161
Cooling.....	164
Defrosting the Windshield and	
Windows.....	164
Dust and Pollen Filter.....	424

Heating.....	163
HFL (HandsFreeLink®)	260, 283
High Beam Indicator	80
Hill Start Assist System	327, 331

I

Identification Numbers	468
Engine and Transmission.....	468
Vehicle Identification.....	468
Ignition Switch	122
Illumination Control	134
Knob.....	134
Immobilizer System	116
Indicator.....	81
Important Handling Information	32
Indicators	72
All-Wheel Drive (AWD).....	82
Anti-lock Brake System (ABS).....	77
Automatic Brake Hold.....	74, 366
Automatic Brake Hold System.....	73, 366
Brake Depressing.....	74
Brake System (Amber).....	72
Brake System (Red).....	72, 453
Charging System.....	75, 451
CRUISE CONTROL.....	82, 345
CRUISE MAIN.....	82, 344
Door and Tailgate Open.....	34, 78
ECON Mode.....	81
Electric Parking Brake.....	73
Electric Parking Brake System.....	73, 454

Electric Power Steering (EPS)	
System.....	78, 453
Fog Light.....	80
Forward Collision Warning (FCW).....	83
High Beam.....	80
High Temperature.....	77
Immobilizer System.....	81
Lane Departure Warning (LDW).....	84
Lights On.....	80
Low Fuel.....	76
Low Oil Pressure.....	75, 451
Low Temperature.....	77
Low Tire Pressure.....	79, 359
Maintenance Minder™.....	82, 383
Malfunction Indicator Lamp.....	75, 452
Seat Belt Reminder.....	36, 76
Security System Alarm.....	82
Shift Lever Position.....	75
Smart Entry System.....	79
Starter System.....	80
Supplemental Restraint System.....	54, 77
TPMS.....	79
Transmission.....	76
Turn Signal.....	80
Vehicle Stability Assist (VSA®)	
System.....	78, 354
VSA® OFF.....	78, 355
Washer Level.....	82
Information	465
Information Display	89

Instrument Panel	71
Brightness Control	134
Interior Lights	150
Interior Rearview Mirror	138
Internet Radio	220, 221

J

Jack (Wheel Nut Wrench)	432, 438
Jump Starting	446

K

Keyless Lockout Prevention	104
Keys	96
Lockout Prevention	104
Number Tag	97
Rear Door Won't Open	108
Remote Transmitter	99
Types and Functions	96
Won't Turn	25
Kickdown (Continuously Variable Transmission)	333

L

Lane Departure Warning (LDW)	351
Indicator	84
LaneWatch™	356
LATCH (Child Seats)	62

Lights	127, 399
Bulb Replacement	399
Daytime Running Lights	131
Fog Lights	130
High Beam Indicator	80
Interior	150
Light Switches	127
Lights On Indicator	80
Turn Signals	127
Load Limits	317
Locking/Unlocking	96
Auto Door Locking/Unlocking	109
Childproof Door Locks	108
From Inside	105
From Outside	99
Keys	96
Lockout Prevention System	104
Using a Key	103
Lockout Prevention System	104
Low Battery Charge	451
Low Fuel Indicator	76
Low Oil Pressure Indicator	75, 451
Lower Anchors	62
Lubricant Specifications Chart	467
Luggage (Maximum Load Limit)	317

M

Maintenance	379
Battery	420
Brake Fluid	397

Cleaning	425
Coolant	394
Heating and Cooling System/Climate Control System	424
Maintenance Minder™	383
Oil	390
Precautions	381
Radiator	395
Remote Transmitter	422
Replacing Light Bulbs	399
Safety	381
Service Items	385
Tires	411
Transmission Fluid	396
Under the Hood	387
Malfunction Indicator Lamp	75, 452
Manual Transmission	340
Reverse Lockout	342
Map Lights	151
Maximum Load Limit	317
Meters, Gauges	88
Mirrors	138
Adjusting	138
Door	139
Exterior	139
Interior Rearview	138
Modifications (and Accessories)	377
Moonroof	121
MP3	191, 197, 214, 222
Multi-View Rear Camera	372

N

Numbers (Identification) 468

O

Odometer 90

Off-Highway Driving Guidelines 323

Oil (Engine) 389

Adding 391

Checking 390

Displaying Oil Life 383

Low Oil Pressure Indicator 75, 451

Recommended Engine Oil 389

Viscosity 389

Opening and Closing the Moonroof 121

Opening/Closing

Hood 388

Moonroof 121

Power Windows 119

Tailgate 113

Overheating 449

P

Paddle Shifters (7-Speed Manual Shift Mode) 21, 338, 339

Pandora® 221

Panic Mode 118

Parking 371

Parking Brake 363

Passenger Airbag Off Indicator 55

Passing Indicators 127

Playing *Bluetooth*® Audio 200, 225

Power Windows 119

Precautions While Driving 332

Driving Guidelines for Your Utility

Vehicle 332

Rain 332

Pregnant Women 42

Puncture (Tire) 434

R

Radiator 395

Radio (FM/AM) 189, 211

Radio Data System (RDS) 190, 212

RDS (Radio Data System) 190, 212

Readiness Codes (Emissions Testing) 471

Real Time AWD with Intelligent Control System™ 358

Rear Defogger/Heated Door Mirror

Button 135

Rear Seats (Folding Down) 147

Rearview Mirror 138

Refueling 374

Fuel Gauge 91

Gasoline 374, 466

Low Fuel Indicator 76

Regulations 361, 414, 469

Remote Transmitter 99

Replacement

Battery 422

Bulbs 399

Fuses 456, 458

Tires 417

Wiper Blade Rubber 407, 409

Reporting Safety Defects 470

Resetting a Trip Meter 90

S

Safe Driving 29

Safety Check 34

Safety Labels 70

Safety Message 1

Seat Belts 35

Adjusting the Shoulder Anchor 40

Automatic Seat Belt Tensioners 37

Checking 43

Detachable Anchor 41

Fastening 38

Installing a Child Seat with a Lap/Shoulder Seat

Belt 64

Pregnant Women 42

Reminder 36

Warning Indicator 36, 76

Seat Heaters 160

Seats 140

Adjusting 140

Front Seats 140

Rear Seats 146

Security System	116	Steering Wheel	137	Tire Chains	419
Immobilizer System Indicator	81	Adjusting	137	Wear Indicators	416
Security System Alarm Indicator	82	Stopping	371	Winter	419
Select Lever	21, 334, 340	Summer Tires	419	Tonneau Cover	159
Operation	21, 335, 336, 337	Supplemental Restraint System (SRS)	47	Tools	432
Releasing	448	Switches (Around the Steering		Towing a Trailer	319
Won't Move	448	Wheel)	4, 5, 122	Towing Your Vehicle	320
Select/Reset Knob	89			Emergency	461
Selecting a Child Seat	61	T		TPMS (Tire Pressure Monitoring	
Selector Knob (Audio)	182	Tachometer	88	System)	359
Setting the Clock	94	Tailgate	113	Indicator	79
Shift Lever	21, 334, 336, 340	Unable to Open	462	Transmission	334, 336, 340
Shift Lever Position Indicator	75, 335, 337	Temperature		7-Speed Manual Shift Mode	338
Shifting (Transmission)	334, 336, 340	High Temperature Indicator	77	Continuously Variable	333
Shoulder Anchor	40	Low Temperature Indicator	77	Fluid	396
Side Airbags	51	Tie-down Hooks	158	Manual	340
Side Curtain Airbags	53	Time (Setting)	94	Number	468
Siri Eyes Free	230	Tire Pressure Monitoring System		Shift Lever Position Indicator	75, 335, 337
Snow Tires	419	(TPMS)	359	Trip Meter	90
Spare Tire	434, 467	Indicator	79	Troubleshooting	431
Spark Plugs	466	Tires	411	Blown Fuse	456, 458
Specifications	466	Air Pressure	412, 467	Brake Pedal Vibrates	25
Specified Fuel	374, 466	Checking and Maintaining	411	Buzzer Sounds When Opening Door	26
Speedometer	88	Inspection	411	Emergency Towing	461
SRS Airbags (Airbags)	47	Labeling	412	Engine Won't Start	443
Starter System Indicator	80	Puncture (Flat Tire)	434	Noise When Braking	26
Starting the Engine	325, 328	Regulations	414	Overheating	449
Does Not Start	443	Rotation	418	Puncture/Flat Tire	434
Engine Switch Buzzer	122	Spare Tire	434, 467	Rear Door Won't Open	26, 108
Jump Starting	446	Summer	419	Shift Lever Won't Move	448
				Warning Indicators	72

Turn Signals	127
Indicators (Instrument Panel)	80

U

Unlocking the Doors	99, 105
USB Flash Drives	237
USB Port(s)	177

V

Vanity Mirrors	7
Vehicle Identification Number (VIN)	468
Vehicle Stability Assist (VSA®)	354
Off Button	355
Off Indicator	78
System Indicator	78
Viscosity (Oil)	389, 467
VSA® (Vehicle Stability Assist)	354

W

Wallpaper	185, 207
Warning Indicator On/Blinking	451
Warning Labels	70
Warranties (Warranty Manual provided separately)	473
Watts	466
Wear Indicators (Tire)	416
Wheel Nut Wrench (Jack Handle) ...	432, 438

Window Washers	132
Adding/Refilling Fluid	398
Switch	132
Windshield	132
Cleaning	425, 428
Defrosting/Defogging	136, 164, 168
Washer Fluid	398
Wiper Blades	407
Wipers and Washers	132
Winter Tires	419
Snow Tires	419
Tire Chains	419
Wipers and Washers	132
Checking and Replacing Wiper Blades	407, 409
WMA	191, 197, 214, 222
Worn Tires	411, 416

